

TV SERVICING VIA TEST POINTS

RADIO & TELEVISION NEWS

**FEBRUARY
1955**

35 CENTS
In U. S. and Canada

World's Leading Electronics Magazine

IN THIS ISSUE

**A 60-WATT
"ULTRA-LINEAR" AMPLIFIER**

PRESELECTOR FOR THE SWL

**THE MOTOROLA 19"
COLOR TV RECEIVER**

**CARRIER-CONTROLLED
SWITCHING**

**LOW-DISTORTION
LIMITING AMPLIFIER**

A "UNIVERSAL" COUNTER

SERVICING COLOR TV

"MOBILE METER"

**INTERMODULATION
DISTORTION TESTER**

**FLEXIBLE
TV PROGRAM CENTER** ▶
(See Page 78)



RAYTHEON



Makes Long Lasting
Aluminized Picture Tubes

With **RAYTHEON LUMILAC**

Exclusive Aluminizing Lacquer

Now you can get all the benefits of aluminized picture tubes — sharper picture, superior contrast, high light output — and *excellent picture tube life!*

Raytheon aluminized picture tubes are processed with the purest aluminum *plus* LUMILAC — a lacquer especially blended and used exclusively by Raytheon.

This lacquer produces an extra smooth unbroken surface for the aluminized coating, yet leaves no gas-

producing residues which could impair cathode emission and hence shorten tube life.

Next time you replace a picture tube try a Raytheon LUMILAC Aluminized Picture Tube. You'll be delighted with its performance in any set — amazed at how it will improve the picture of a low cost, low voltage range TV receiver. And so will your customer. Ask your Raytheon Tube Distributor for Raytheon Aluminized Picture Tubes with LUMILAC. Like all Raytheon Picture Tubes they are Right for Sight, Right for You and Always New.



RAYTHEON MANUFACTURING COMPANY

Receiving and Cathode Ray Tube Operations
Newton, Mass. Chicago, Ill., Atlanta, Ga., Los Angeles, Calif.

Excellence in Electronics

RAYTHEON MAKES ALL THESE:

RECEIVING AND PICTURE TUBES • RELIABLE SUBMINIATURE AND MINIATURE TUBES • SEMICONDUCTOR DIODES AND TRANSISTORS • NUCLEONIC TUBES • MICROWAVE TUBES

Why Guess? There's a Quick, Sure Way to Find TV Set Troubles

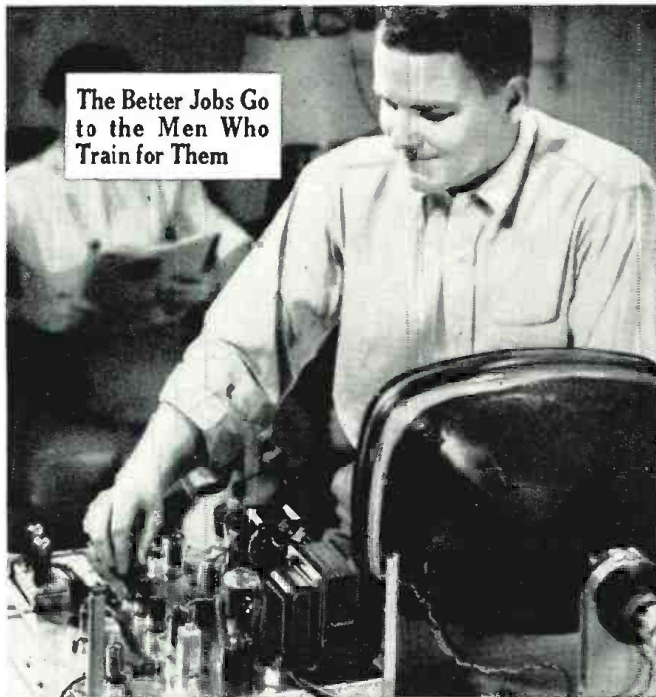

The Better Jobs Go to the Men Who Train for Them

NEW ALL-PRACTICE COURSE Shows How top TV servicemen fix ANY MAKE or model

Home Training includes 17" Picture Tube, components for a TV Receiver, Scope, Signal Generator, HF Probe, all for introductory price under \$200 on easy terms.

PUT YOURSELF IN THIS PICTURE, experimenting at home with equipment we furnish, getting set to go places in TV servicing. Speed in servicing TV sets means stepped up earnings, greater security for you.

ACQUIRE SUPERIOR SKILLS AT HOME IN SPARE TIME

TV Servicing . . . real, professional TV Servicing, pays good money to men with specialized knowledge and training. The exciting, expanding TV industry offers more than just good jobs. It offers success, a career to men qualified to render an essential community service.

Be one of these experienced TV Servicemen. NRI's new course is 100% learn-by-doing, practical training. We supply all the equipment plus comprehensive manuals covering a thoroughly planned program of practice. You learn how experts diagnose TV receiver defects quickly. You learn the causes of defects . . . audio and video . . . accurately, easily. And you learn how to fix them.

ALL LEARN BY DOING

You do more than just build circuits. You get experience aligning TV receivers, isolating complaints from scope patterns, eliminating interference, use germanium crystals to rectify the TV picture signal, adjust the ion trap and dozens of other professional TV Servicing techniques.

Many fellows "go around in circles" trying to isolate TV receiver defects. Don't guess! Learn professional techniques. Take this training now. If you want to go places in TV servicing you will act quickly to find

out what you get, what you practice and how you can advance with better practical knowledge through NRI's new course in Professional Television Servicing. Accept this personal invitation to get a free copy of our booklet which describes this training in detail. Mail the coupon now. Remember, with this course you keep right on working, keep right on earning at your job while you learn through actual practice at home in your spare time.

UHF AND COLOR CREATE GROWING OPPORTUNITIES

To cash in on the present UHF and the coming Color TV boom you'll need the kind of knowledge and experience this Professional Television Servicing

Course gives you. There is no other training like this. Here, condensed into a few months of training at home, is everything that TV servicemen learn in months, even years of bench work. You get practice installing front-end channel selector strips in modern UHF-VHF receivers. You learn UHF servicing problems and their solution. Mail the coupon below. Discover how this new course meets the needs of the man who wants to get ahead in TV Servicing.

NOT FOR BEGINNERS

NRI's Professional All-Practice Television Servicing Course is for men with some knowledge of Radio and TV fundamentals but who need intensive, practical training and actual experience with TV circuits and professional servicing techniques to be self-reliant, confident, expert TV servicemen. Get this book FREE and judge for yourself how NRI's course will further your ambition to reach the top in TV Servicing. Mail the coupon . . . there is no obligation . . . and it can open the door to a better career for you.

MAIL THIS NOW



NATIONAL RADIO INSTITUTE, Dept. 5BET
16th and U Sts., N. W., Washington 9, D. C.

Please send my FREE copy of "How to Reach the Top in TV Servicing." I understand no salesman will call.

Name.....Age.....

Address.....

City.....Zone.....State.....

RADIO & TELEVISION NEWS is published monthly by Ziff-Davis Publishing Company, William B. Ziff, Chairman of the Board (1948-1953), at 64 E. Lake St., Chicago 1, Ill. Entered as second-class matter July 21, 1948, at the Post Office, Chicago, Ill., under the act of March 3, 1879. Authorized by Post Office Department, Ottawa, Canada, as second-class matter. SUBSCRIPTION RATES: Radio & Television News—one year U. S. and Possessions, and Canada \$4.00; Pan-American Union countries \$4.50; all other foreign countries \$5.00. Radio-Electronic Engineering Edition—One year U. S. and Possessions, and Canada \$6.00; Pan-American Union countries \$6.50; all other foreign countries \$7.00. Postmaster—Please return undelivered copies under form 3589 to 64 E. Lake St., Chicago 1, Ill.

Editor and Asst. Publisher
OLIVER READ, D.Sc., W1ETI

Managing Editor
WM. A. STOCKLIN, B. S.

Technical Editor
H. S. RENNE, M. S.

Service Editor
CHARLES TEPPER

Assistant Editors
P. B. HOEFER
J. JUSTER

Television Consultant
WALTER H. BUCHSBAUM

Short-Wave Editor
KENNETH R. BOORD

Art Editor
FRANK SAYLES

Draftsmen
A. A. GANS, W2T5F
J. A. GOLANEK

Advertising Director
L. L. OSTEN

Advertising Manager
MURRAY GOLDMAN

Midwest Adv. Manager
JOHN A. RONAN, JR.

Western Adv. Manager
JOHN E. PAYNE

*First in radio-
television-audio-electronics*
Average Net Paid Circulation 246,119



Radio News Trademark Reg. U. S. Pat. Office • Television News Trademark Reg. U. S. Pat. Office.

CONTENTS

FEBRUARY, 1955

TV Servicing via Test Points.....	Walter H. Buchsbaum	37
A Preselector for the SWL.....	R. W. Myerholtz	40
"Mobile Meter" of Many Uses.....	Ralph Hasslinger, W2CVF	42
Troubleshooting Radio Intermittents.....	James A. McRoberts	44
A 60-Watt "Ultra-Linear" Amplifier.....	David Hafler	45
Certified Record Revue.....	Bert Whyte	48
Servicing Color TV (Part 2).....	Milton S. Kiver	49
Radio Licensing and the FCC.....	Jay Robin Gnessin	52
One More Band with Your Present Antenna.....	William J. Vette, W4SWI	53
A "Universal" Counter.....	Louis E. Garner, Jr.	54
Power Supply Regulation.....	Gerard J. Wendelken	56
TV Signal Tracer.....	Harry E. Newton	58
An Effective, Low-Distortion Limiting Amplifier.....	W. Herbert Hartman, W6UAF	60
Intermodulation Distortion Tester.....	Joseph Chernof	65
Carrier-Controlled Switching.....	Warner Clements	68
Improving Audio Quality in A.C.-D.C. Receivers.....	John P. Billon	70
Oscilloscope Photography.....	E. G. Louis	71
The Motorola 19" Color TV Receiver (Part 2).....	M. S. Kay	72
Mac's Radio Service Shop.....	John T. Frye	76
Flexible TV Program Center.....		78
"Satellite" TV Transmission System.....		112
A Single-Stage Tape Recorder Monitor.....	Harold Reed	136
Time Signals Available from Canadian Sources.....		154
New TV Grants Since Freeze Lift.....		156
New TV Stations on the Air.....		156
Radio-TV Service Industry News.....		168



COVER PHOTO: "Television City," CBS's fantastic new programming center in Hollywood, offers every facility for televising both black-and-white and color programs. A special crane permits interesting TV effects. (Ektachrome by Peter J. Samerjan)

ZIFF-DAVIS PUBLISHING COMPANY

President
B. G. DAVIS

Vice-Presidents
H. J. MORGANROTH
M. H. FROELICH

Secretary-Treasurer
G. E. CARNEY

Circulation Manager
M. MICHAELSON

BRANCH OFFICES

CHICAGO (11)
64 E. Lake St., AN 3-5200

LOS ANGELES (14)

Stalter Center, 900 Wilshire Blvd., Mich. 9836

DEPARTMENTS

For the Record.....	The Editor	8	Technical Books	84
Spot Radio News.....		16	Manufacturers' Literature	122
Within the Industry.....		26	What's New in Radio.....	132
Short-Wave.....	K. R. Boord	64	New Audio Equipment.....	158



COPYRIGHT 1955
(All Rights Reserved)
ZIFF-DAVIS PUBLISHING COMPANY
WILLIAM B. ZIFF (1898-1953) FOUNDER
Editorial and Executive Offices
366 Madison Ave., New York 17, N. Y.
VOLUME 53 • NUMBER 2



Member
Audit Bureau of
Circulations

SUBSCRIPTION SERVICE: All communications concerning subscriptions should be addressed to Circulation Dept., 64 E. Lake St., Chicago 1, Ill. Subscribers should allow at least four weeks for change of address.

CONTRIBUTIONS: Contributors are advised to retain a copy of their manuscripts and illustrations. Contributions should be mailed to the New York Editorial Office and must be accompanied by return postage. Contributions will be handled with reasonable care, but this magazine assumes no responsibility for their safety. Any copy accepted is subject to whatever adaptations and revisions are necessary to meet the requirements of this publication. Payment covers all author's, contributor's, and contestant's rights, title, and interest in and to the material accepted and will be made at our current rates upon acceptance. All photos and drawings will be considered as part of the material purchased.

RADIO & TELEVISION NEWS

*Here, I am confident,
is the finest Home
training of its kind
in Television, Radio,
and Electronics.
W. C. DeVry*



You get laboratory type **PRACTICAL EXPERIENCE** from your own **HOME LABORATORY**. Work over **300 projects**.

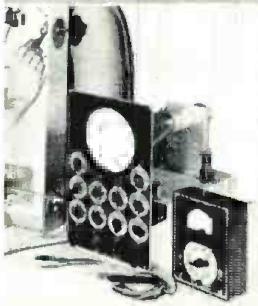

You build and keep a **5-INCH OSCILLOSCOPE** and jewel bearing **MULTI-METER**. Helps you **EARN** while learning.



Wonderfully effective, exclusive **HOME MOVIES** help you grasp important points faster, easier, better.

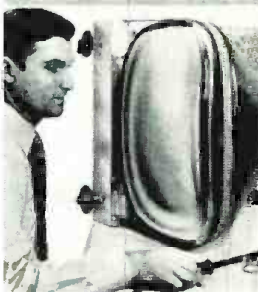

You may also build and keep a **21 INCH TV SET**. D.T.I. offers another home training without the TV set.



"One of America's Foremost Television Training Centers"

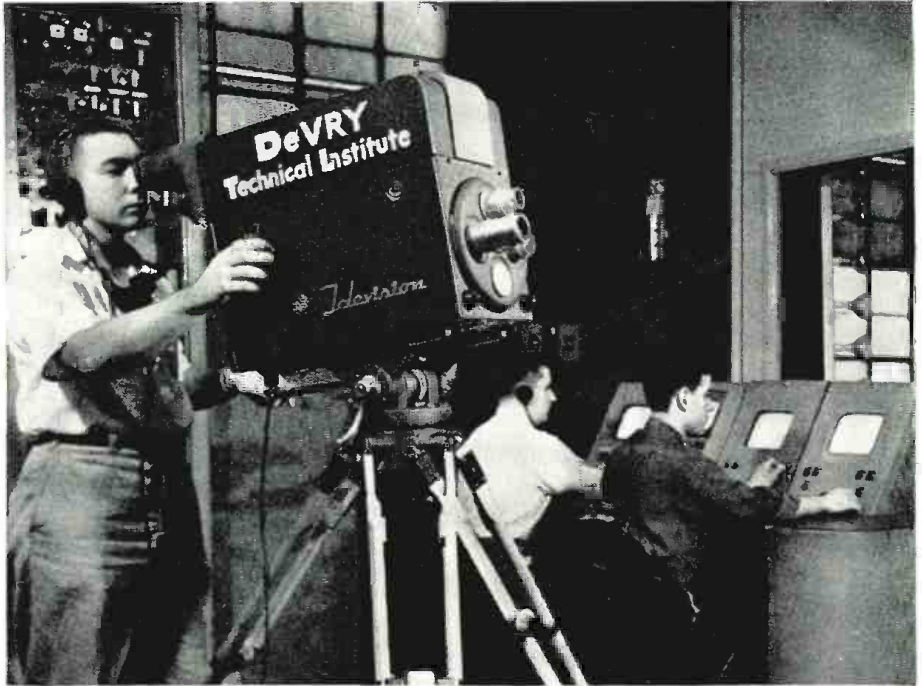

Here is one of the most effective ways to OPEN THE DOOR to opportunity in TELEVISION - ELECTRONICS

Your future is the *most important thing in your life!* Give it every advantage you can. Find out about the wonderfully promising years facing YOU in America's great, billion dollar field of Television-Electronics . . . once you are properly trained.

And you can now get the very training industry wants, either by attending D.T.I.'s wonderfully equipped Chicago laboratories—one of the nation's finest—or by getting laboratory type training in your spare time at home.

Remember—you receive more than just home training from D.T.I. You get training that has profited from the knowledge and experience gained in preparing thousands of men in D.T.I.'s Chicago laboratories.

You get training that includes all of the wonderful features shown to the left. You learn-by-reading from lessons . . . you learn-by-seeing from D.T.I.'s exclusive, remarkably effective visual training MOVIES . . . you learn-by-doing from many shipments of electronic parts.

EMPLOYMENT SERVICE

And upon completing either the Home Program or Chicago Laboratory Training, you get the **SAME EFFECTIVE EMPLOYMENT SERVICE** that has already helped thousands of men to a real job or their own profitable business in Television-Radio-Electronics.

Little wonder so many men express amazement at the results secured through D.T.I. There's **NOTHING ELSE** like it! See for yourself. Mail coupon today for the fascinating story about D.T.I. There's no obligation. The time to act about your future is . . . NOW!

The **DeVRY Technical Institute**



4141 Belmont Avenue Chicago 41 Illinois

Affiliated with DeForest's Training, Inc.



Here, and above, are typical views in D.T.I.'s great Chicago training center—attended by many students from the United States, Canada and the Hawaiian Islands. These men come here to benefit from one of the finest, practical laboratory trainings, of its kind—not only in Television and Radio—but also in Industrial Electronics, Nuclear Instrumentation, and other highly promising branches of today's great, billion dollar Electronics field.



DeVRY TECHNICAL INSTITUTE
4141 Belmont Ave., Chicago 41, Ill., Dept. RN-2-L

I would like late facts about the many opportunities in Television-Radio-Electronics, and how D.T.I. can prepare me for my start in this billion dollar field.

Name _____ Age _____
Street _____ Apt. _____
City _____ Zone _____ State _____

DTI's training is available in Canada

PICKERING models **220** / cartridges
240

*The Most Nearly
Perfect Phono Pickups
Ever Produced . . .*

they are sold separately for all standard arms or mounted back-to-back to make up the famous
PICKERING 260 TURNOVER PICKUP.

MODEL 220—for 78 rpm records
diamond or sapphire stylus



MODEL 240—for 33 1/3
and 45 rpm records
diamond stylus only

MODEL 260—turnover
cartridge for 78 or 33 1/3
and 45 rpm records
(the 220 and 240
back-to-back)



The 220 and 240 are engineered to maximize performance. By comparison they are without equal . . .

The **220** and **240** are

Lighter—5 1/2 grams

Smaller—5/8 by 3/4 by 3/8 inches

The **220** and **240** have

Highest Output—30 millivolts/10cm/sec.

More Compliance with Less Tracking Force

Lower Overall Distortion

Less Moving Mass

Wider Frequency Response

Mu-Metal Shielding for Less Hum

These characteristics have real meaning to those who understand that maximum performance depends upon components which meet professional standards. If you want the best that high fidelity can offer, ask your dealer to demonstrate the 220, 240 and 260 Pickering cartridges . . .

The Most Nearly Perfect Phono Pickups Ever Produced

PICKERING and company incorporated • **Oceanside, L.I., New York**



PICKERING COMPONENTS ARE PROFESSIONAL QUALITY

“For those who can hear the difference”

. . . Demonstrated and sold by Leading Radio Parts Distributors everywhere. For the one nearest you and for detailed literature; write Dept. C-7

RADIO & TELEVISION NEWS

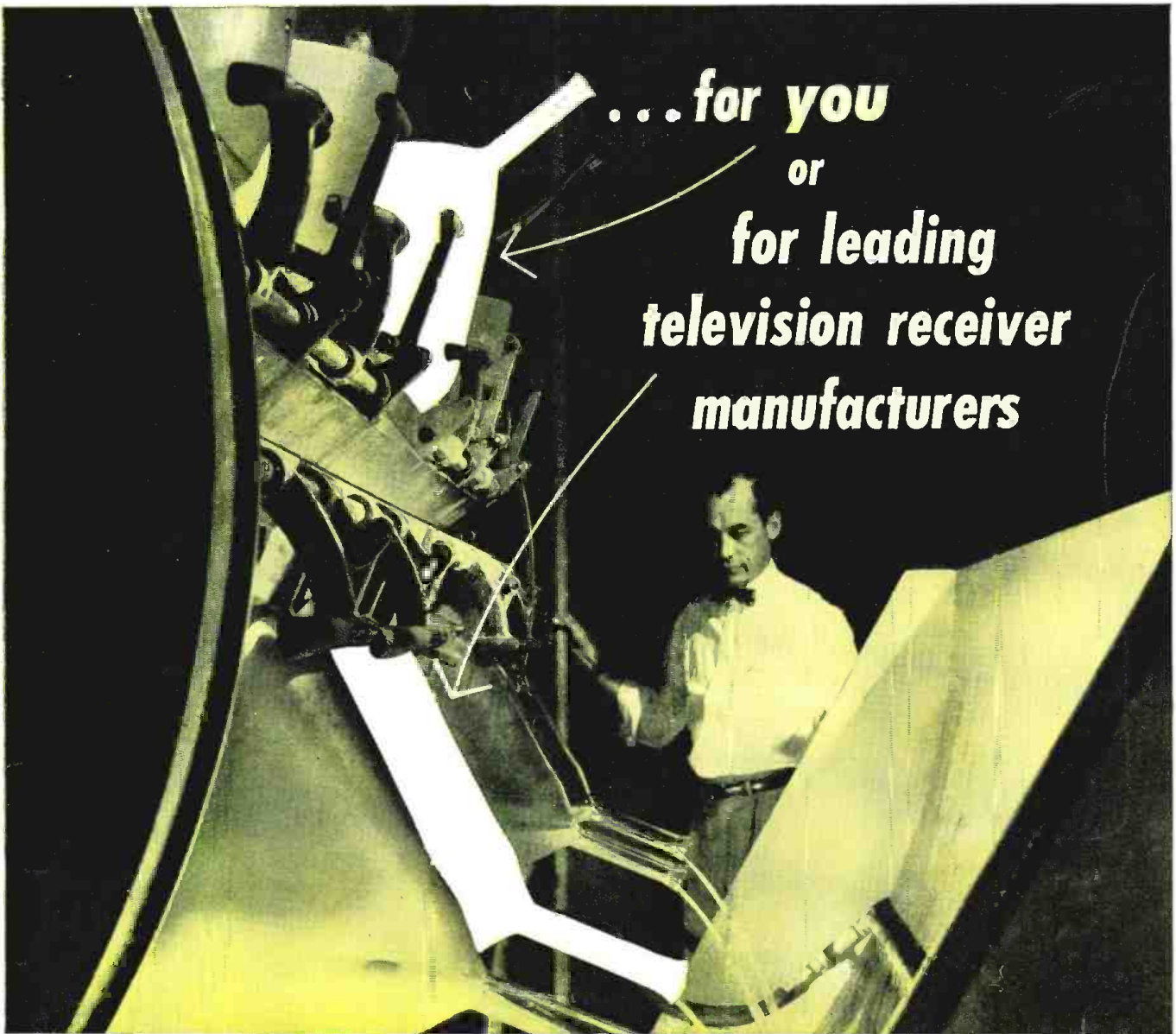

...for you
or
for leading
television receiver
manufacturers

At Du Mont there is only one

Standard of Quality...



All Du Mont picture tubes are built to the highest standards of quality – whether for leading TV receiver manufacturers as initial equipment, or for the individual serviceman. The same careful assembly, processing and inspection is done on *every* picture tube bearing the Du Mont name.

Do as leading TV receiver manufacturers do – choose Du Mont initial quality picture tubes for new set performance.

CATHODE-RAY TUBE DIVISION
ALLEN B. DU MONT LABORATORIES, INC.
CLIFTON, N. J.

*Trade Mark
February, 1955

for the Finest in
HIGH FIDELITY—

Electro-Voice®

**ENCLOSURES
and
SPEAKER SYSTEMS**



Pioneer
in Hi-Fi



the Aristocrat

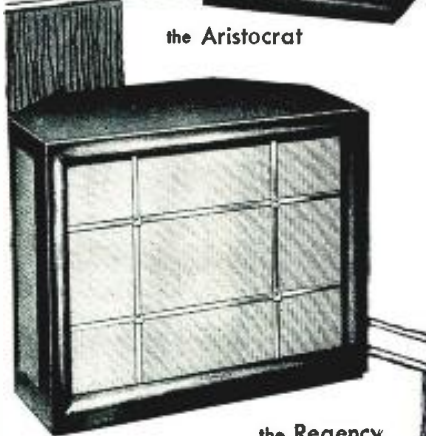

the Regency

The Speaker System and Enclosure are the cornerstone of every high fidelity system
From the complete E-V line, you can easily choose the exact reproducer to meet your musical taste and budget. The Aristocrat and Regency shown here are but two of the 2, 3 and 4-way speaker systems and enclosures designed by E-V to provide the full range of properly balanced music for most enjoyable high fidelity reproduction.

Aristocrat—from \$66.00 Audiophile Net and up
Regency—from \$120.00 Audiophile Net and up
Others from \$39.00 to \$727.50

See your E-V Authorized Distributor

Write for Condensed
Catalog No. 119

Electro-Voice, INC.
BUCHANAN, MICHIGAN

For the **RECORD.**

BY THE EDITOR

TAPE REMEMBERS ALMOST EVERYTHING

MMAGNETIC tape is generally associated with record players as a medium for the recording and reproduction of sound. The ever-increasing popularity of recorded tapes for hi-fi results from its ability to accurately store information (wide-range music) so that such information may be played back and enjoyed through conventional hi-fi audio channels.

Not nearly as well known are the many applications and techniques for magnetic tape in the fields of instrumentation, control, medicine, and in military applications. Because tape can "remember" sounds better than other media, it provides a positive method of recording any phenomenon which may be "played back" as an electrical signal.

Magnetic tape can record temperatures, vibrations, forces, pressures, motions, numbers and video signals in almost any relation or in combination. And multiple phenomena taking place at the same time can be permanently recorded for future study or application. Information is recorded on a tape as a pattern of fluctuating magnetic current. The electrical characteristics comprising amplitude, frequency, phase, duration, wave shape, and relative timing are all "remembered" by the tape. And tape can speak a universal language by conveying its information of voltage patterns for recording, control, and instrumentation.

One of the most informative analysis of magnetic tape (*Ampex* bulletin D2-1) refers to tape patterns as the best "common denominator" in the fields of recording, instrumentation, and control. Mechanical vibrations, for example, can become voltage oscillations. Rises in temperature or changes in pressure can be translated to a scale of voltage amplitudes.

Information recorded on tape can be fed to any machine or instrument that can react to electrical signals. This may be done any number of times, at any place, and in any number of ways. Taped information may be fed to instruments that scan (the oscilloscope), to instruments that write (oscillographs and pen recorders), to machines that analyze (computers and data reducers), to machines that translate (card punch machines), and to machines that act (process controls and machine tools).

Applications for magnetic tape that are unfamiliar to the average technician include "flight testing" of both piloted aircraft and missiles, either in the air or on the ground. Tape is used

in "telemetering" the data being transmitted from an airplane to a receiver-tape recorder on the ground. The data is thus "remembered" irrespective of the outcome of the flight.

Tape overcomes some of the problems of handling and analyzing the enormous quantities of data accumulated on test grounds. Tape is relatively compact and unlike film it requires no processing. Because data is in electrical form, it lends itself to rapid electronic scanning methods that locate maximum and minimum values, inflection points, and frequency components. Its electrical nature also for the first time makes possible automatic data reduction methods and high speed feed to electronic computers.

Recording shock and vibration aboard moving vehicles is done on specially designed recorders like one produced by *Ampex* for this special application. And tape is ideally suited to the control of machines. Relative movements of cutting tools and work can be controlled with precision by electrical signals from magnetic tape. Servo controls translate the signals to movements that can be repeated with accuracy, again and again.

Tape is now widely used in geophysical exploration. Review of key geophysical data may be done after crews return from the field. The FM carrier-type magnetic recording used in this work has less phase shift and distortion, wider frequency response, and greater signal-to-noise ratio than older oscillograph methods.

Electronic brains (computing devices) are using tape containing numbers, equations, and programming information. Because taped magnetic signals are largely free from inertia, they overcome the speed limitations of other media.

Magnetic tapes are also useful as internal elements to provide high capacity memory for any time duration from milliseconds on up.

Magnetic tape has been a most valuable tool in medical teaching and research. Heart disorders, for example, are studied by listening to recorded heart sounds. And basic studies of nerve and brain functions are made from taped information providing voltage change occurring with each nerve impulse. A large class of student doctors may, from a single tape, hear and observe the sounds of many individual patients.

These are only a few of many applications for magnetic tape, and its future possibilities are almost unlimited. O.R.

FREE

1955 ALLIED 308-PAGE CATALOG

the only COMPLETE catalog
for everything in TV, Radio
and Industrial Electronics

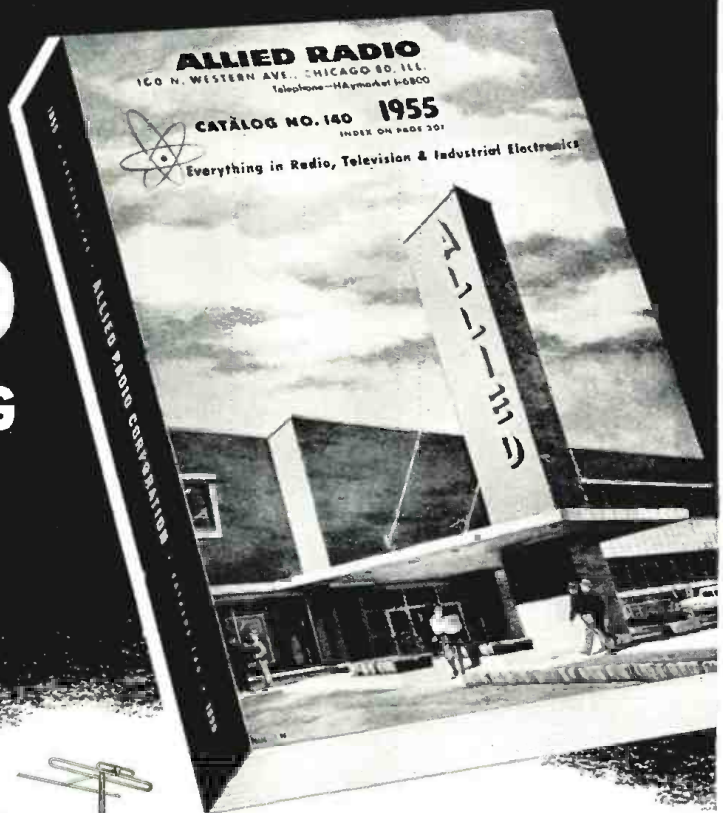

World's largest Stocks

- All TV and Radio Parts
- All Electron Tube Types
- Test and Lab Instruments
- High Fidelity Equipment
- Custom TV Chassis
- AM, FM Receiving Equipment
- Recorders and Supplies
- P.A. Systems, Accessories
- Amateur Station Gear
- Builders' Kits, Supplies
- Equipment for Industry



ultra-modern facilities for the
FASTEST SERVICE IN ELECTRONIC SUPPLY

SEND FOR IT TODAY!

Get ALLIED's 1955 Catalog—308 pages packed with the world's largest selection of quality electronic equipment at lowest, money-saving prices. Select from the latest in High Fidelity systems and components; custom TV chassis, TV antennas and accessories; AM and FM receiving equipment; P. A. systems and accessories; recorders and supplies; Amateur receivers, transmitters and station gear; specialized industrial electronic equipment; test instruments; builders' kits; huge listings of parts, tubes, tools, books—the world's *most complete* stocks of quality equipment. ALLIED gives you *every* buying advantage: fastest shipment, expert personal help, lowest prices, assured satisfaction. Get the big 1955 ALLIED Catalog. Keep it handy. Send for your FREE copy today.

IT'S VALUE PACKED... SAVE ON EVERYTHING IN ELECTRONICS

**SEND FOR THE LEADING
ELECTRONIC SUPPLY GUIDE**

FREE



ALLIED RADIO
world's largest Electronic Supply House

EASY-PAY TERMS

Use ALLIED'S liberal Easy Payment Plan—only 10% down, 12 months to pay—no carrying charges if you pay in 60 days. Available on Hi-Fi and P.A. units, recorders, TV chassis, test instruments, Amateur gear, etc.

HI-FI SPECIALISTS

To keep up with the latest and best in High Fidelity, look to ALLIED. Count on us for all the latest releases and largest stocks of Hi-Fi equipment. We specialize, too, in TV supply, and are foremost in the field of Builders' Kits.

ALLIED RADIO CORP., Dept. 1-B-5
100 N. Western Ave., Chicago 80, Illinois

Send FREE 308-Page 1955 ALLIED Catalog.

Name _____

Address _____

City _____ Zone _____ State _____

One modern picture tube overshadows all others!

THE SYLVANIA

"Silver Screen 85"

Acclaimed by service industry—Dealers and servicemen everywhere acclaim the "Silver-Screen 85." Sylvania's revolutionary "Silver-Screen 85" is the *one* modern picture tube that overshadows all others.

Super-performance plus—Only Sylvania's "Silver-Screen 85" combines these three outstanding design advances: (1) Silver-activated screen (2) Super-aluminized reflector, and (3) Precision-focus electron gun. Together, they achieve a picture, so clear, so sharp, that only professional motion pictures can duplicate it.

Overwhelming consumer reaction—Already, TV set owners across the nation are asking for the Sylvania "Silver-Screen 85" by name. And the demand is pyramiding.



The "Silver-Screen 85" story is reaching millions of TV homes each week through Sylvania's top-rated TV show, "Beat the Clock."

Silent salesmen work for TV service—Thousands of the "Silver-Screen 85" consumer booklets are being read by TV set owners who have written to request them. An even greater number are requesting them

from progressive dealers and servicemen who display the Sylvania service sign. This is Sylvania's way of including you in its national advertising program. Leave a copy of the booklet on each new service call and experience the magic of national advertising right in your own business!



Good way to build "good will"—You can build customer confidence and repeat business by stocking and selling Sylvania's great "Silver-Screen 85" picture tube. You're assured of customer satisfaction because your customers are pre-sold on the "Silver-Screen 85." And Sylvania puts the name on the face for your double protection. "Silver-Screen 85" customers stay happy too, because they get better-than-ever performance from their old TV sets.

A built-in profit bonus—Every "Silver-Screen 85" you install means extra profit because you offer the finest performance money can buy. And there's a full line of "Silver-Screen 85" types in the most popular sizes. Start cashing in on America's demand for television's most modern picture tube. You just can't miss!

SYLVANIA ELECTRIC PRODUCTS INC.
1740 Broadway, New York 19, N. Y.

In Canada: Sylvania Electric (Canada) Ltd.
University Tower Bldg., St. Catherine Street
Montreal, P. Q.

LIGHTING • RADIO • ELECTRONICS
TELEVISION • ATOMIC ENERGY

A complete package of promotion aids for your use, including window display and streamers, postal cards, bill inserts, radio spot announcements, and TV films.





SYLVANIA
SILVER SCREEN 85

"The name's on
the face for
your protection"

**3 great engineering advances
achieve new heights in
picture-tube design—**



**Silver activated
screen**

—light-giving atoms of silver are added to Sylvania's special screen phosphors to produce a new level of picture contrast.



**The super-aluminized
reflector**

—a microscopic film of aluminum behind the silver activated screen captures the extra brightness and makes it useful. Greater depth and contrast result.

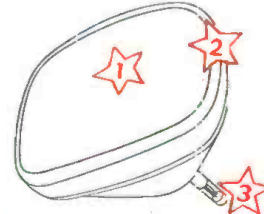

**Precision-focus
electron gun**

—the powerful electron beam in the "Silver-Screen 85" energizes the entire screen in pin-point detail to produce a new degree of all-over sharpness and clearness.

Keep your eye on

SYLVANIA 

...fastest growing name in sight

The
Most
Complete
Line

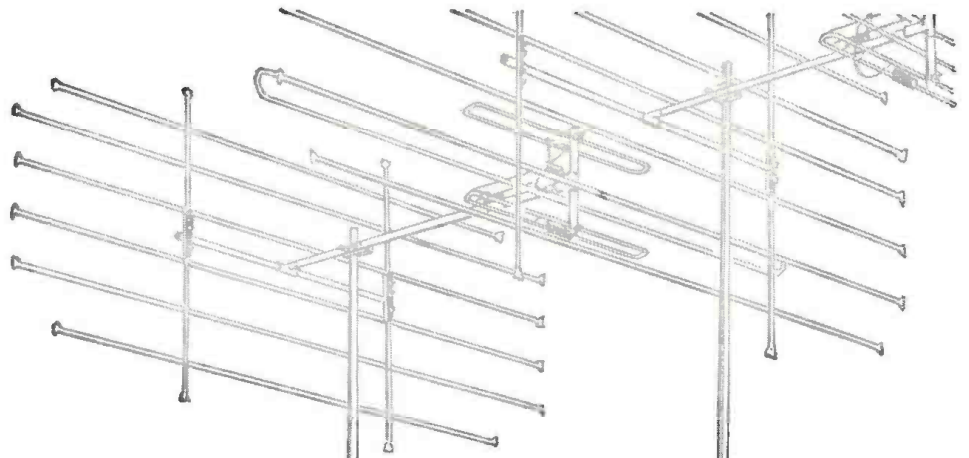

C·D·R ROTORS are BEST

Most Powerful—Most Dependable—Sharpest Tuning

BEST...
*from the bottom up...
inside out...
because*

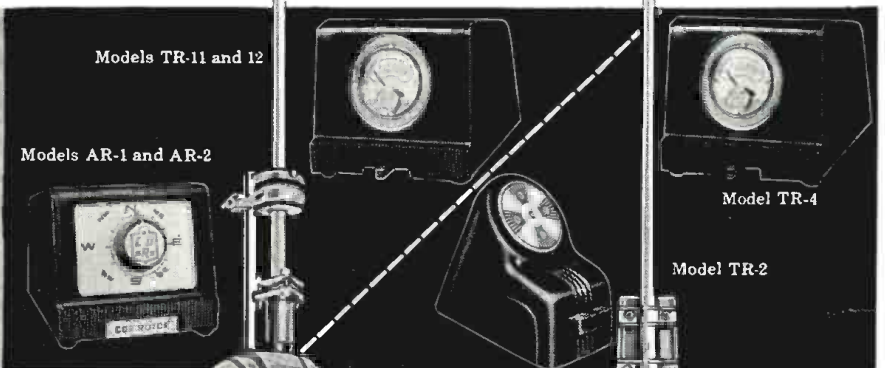

C·D·R ROTORS
have
AXS 679*

* The highest grade premium die cast aluminum... so rugged and durable that it is used for aircraft landing gear.

PRE-SOLD to MILLIONS
through spot announcements on television.

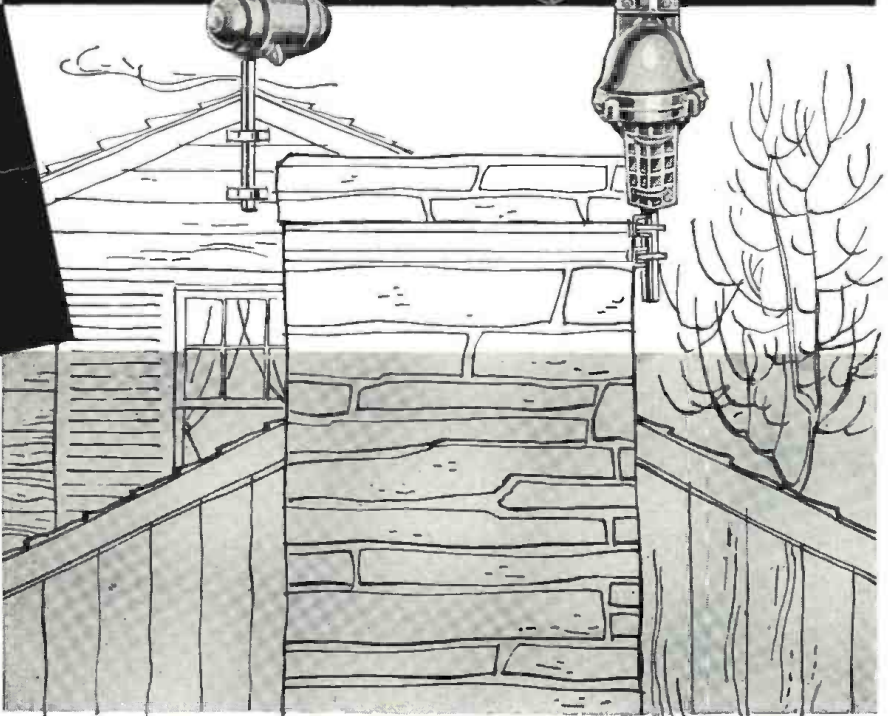

CORNELL-DUBILIER
SOUTH PLAINFIELD, N. J.



THE RADIART CORP.
CLEVELAND 13, OHIO

RADIO & TELEVISION NEWS

Millions of TV Owners
 Who Read **LIFE** will read about you . . .
 Their Television Serviceman . . . on March 7th

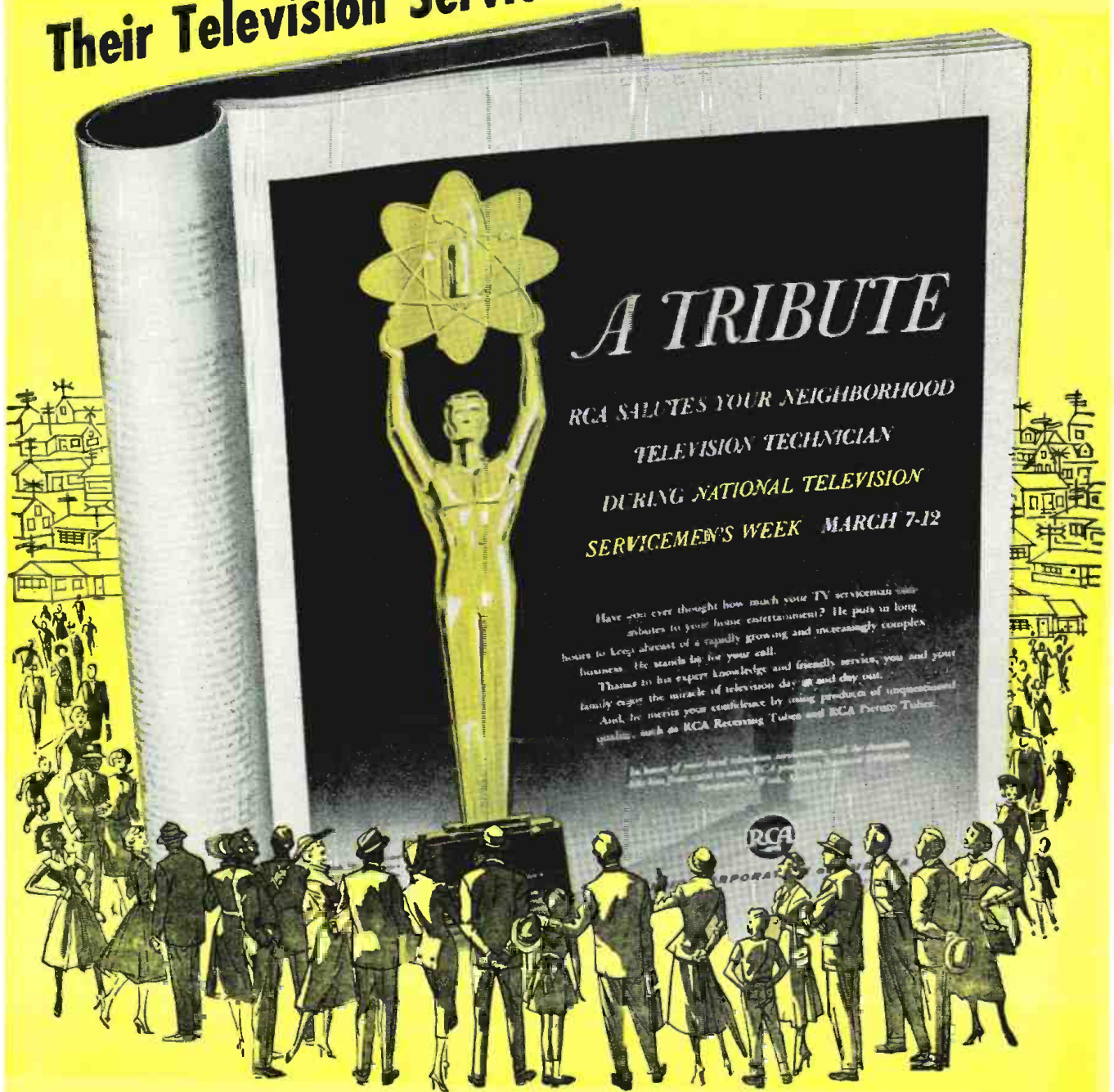

In the March 7th issue of LIFE magazine, readers all over America will see a special advertisement, sponsored by the RCA Tube Division, paying tribute to local television servicemen and dealers everywhere. This will mark the opening of the consumer phase of National Television Servicemen's Week—a perfect opportunity for you to tell your story to your community.

SEE your RCA Tube Distributor NOW

. . . for details about NATIONAL TELEVISION SERVICEMEN'S WEEK (March 7-12). Be ready to take full advantage of this big event planned by RCA—exclusively for YOU!



**RADIO CORPORATION
 of AMERICA**

ELECTRON TUBES HARRISON, N.J.

FOR THREE-WAY PERFORMANCE

3 TRIAXIALS

BY

University

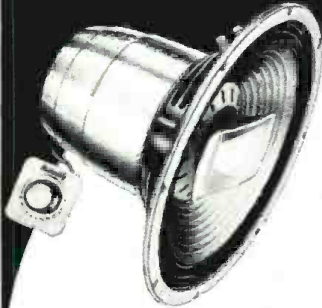

IT'S **2**ND TO NONE—
THE MODEL 312 TRIAXIAL

BY **University**

A new advance by University in the 12" field. Full range response from 40 cycles to inaudibility. Employs the "Diffusicone" principle for full-bodied mid-range and the HF-206 Super Tweeter for clean, brilliant highs. Built-in L/C network and "balance" control permit you to adjust tonal quality to your own listening tastes. All-Alnico-5 exclusive University "W" magnet and duraluminum voice coil suspension in woofer section results in deep and highly efficient bass response. 8 ohms impedance, 25 watts power capacity.

Custom Design For **University** Speaker Systems

Fine Speaker Enclosures Engineered To Acoustically Enhance The Performance Of University Speakers... Tastefully Styled To Complement The Decor Of Your Home Rather Than Dominate It

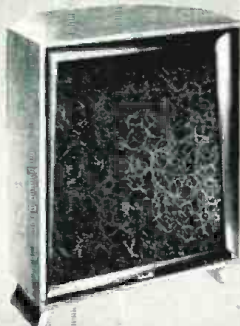

EN-15

The best features of rear horn loading, phase inversion, and direct radiation are integrated to result in a highly efficient, extended range enclosure capable of unusual power handling capacity and excellent transient response. Ideally suited for the Model 312 or Model 315 Triaxial speakers, or any of the other fine 12" or 15" University speakers. Available in cherry or blond mahogany at no extra cost, or unfinished.

The EN-15 comes equipped with adapter boards for mounting 2 or 3-way combinations of University woofers and tweeters.

EN-8

Utilizes a combination of rear horn loading for unexcelled power handling and distortion control, and tuned horn mouth for phase inverter action for increased bass efficiency. The perfect enclosure for the Model 308 Triaxial speaker or Diffusicone-8. Available in cherry or blond mahogany at no extra cost, or in unfinished mahogany.

The EN-8 has cut-out for University tweeters for use with 8" woofer or other cones.



THE **1** AND ONLY
8" TRIAXIAL SPEAKER—
MODEL 308

BY **University**

No other speaker like it! An 8" 3-way speaker—ideal for hi-fi installations where space is at a premium and quality is not to be compromised. Response down to better than 50 cycles, provided by voice coil and diaphragm operated with the exclusive University Alnico-5 "W" magnet. Rich, full-bodied mid-range is achieved through the use of the patented "Diffusicone" section of the unit, crossing over at 1,000 cycles. The high frequency reproducer, a compression driver unit wide angle tweeter which extends to 15,000 cycles, crosses over electrically at 5,000 cycles. Impedance 8 ohms, power capacity 25 watts.



IT'S A
3-WAY WONDER—
MODEL 315 TRIAXIAL

BY **University**

Reproduces the entire range, from 30 cycles to inaudibility with such amazing clarity and presence that the superiority of this unit is readily obvious. Built around the sensational C15W woofer assembly, mid-range is provided by the patented "Diffusicone" device, while the clean and brilliant highs are reproduced by a compression driver unit with wide angle horn through an L/C electrical network crossing over at 5,000 cycles. Impedance 8 ohms, power capacity 50 watts.



University Engineering Superiority

Proven by Years of Acceptance



Model 6200 Extended Range Speaker

Full bodied response to beyond 10,000 cycles makes it ideal for radio, TV and phono applications. Excellent basic unit. Eight ohms impedance, 25 watts power capacity.



Diffusicone—8" and 12" Coaxial Speakers

Exclusive patented "Diffusicone" design with 1000-cycle mechanical crossover results in full fidelity anywhere in the room... full undistorted response without loss of highs at listening points progressively off speaker axis. Eight ohms impedance, 25 watts power capacity.

Model 6201 Dual Range System

Acknowledged as the industry's finest value in a high quality 12" loudspeaker. Complete with coaxial tweeter driver and wide angle horn, it is one of the few true dual range systems in its price class. Built-in L/C network and balance control. Eight ohms impedance, 25 watts power capacity.



For complete information on the entire University high fidelity line, write Desk 55

University Loudspeakers

INC.

80 SOUTH KENSICO AVENUE,

WHITE PLAINS, NEW YORK

RADIO & TELEVISION NEWS



NEW PATENTED RADAR ANTENNA

OPENS NEW HORIZONS TO TV VIEWERS

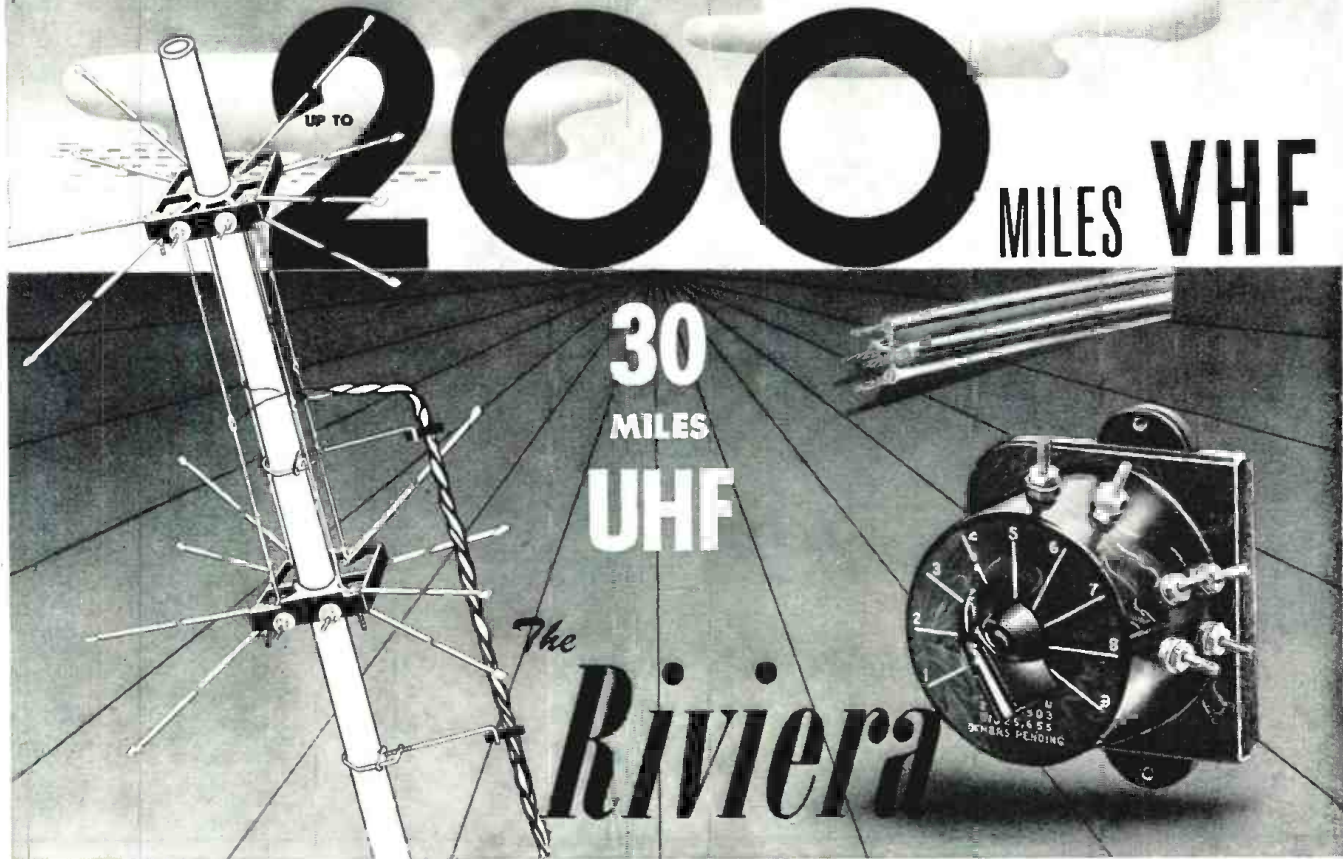

ALL DIRECTIONS • ALL CHANNELS • 2-83
COLOR AND BLACK-WHITE without ANY ROTORMOTOR

These are the reasons why the "Riviera" is by far the most powerful VHF antenna on the market today!

1. Utilizes 16 elements 60" long, 1/2" diameter.
2. Utilizes a specially designed, extra low loss four conductor air-dielectric POLYMICALENE transmission line which has up to 50% less loss when wet than the finest conventional transmission lines.
3. The "Riviera" encompasses an electro-magnetic capture volume of well over 650 cubic feet, many times more than conventional antennas.
4. The antenna works on the revolutionary principle that the approaching wave front is elliptically rather than horizontally polarized.
5. The new specially designed 9 position electronic orientation switch, aside from changing directivity, maintains a consistently better impedance match over the entire UHF-VHF spectrum.
6. The above features combine to give the "Riviera" antenna greater usable gain at the TV set antenna terminals than the best of any competitive antennas using rotor motors.

This new wonder antenna, called the "Riviera", is already making history. Beyond any question of a doubt, and on an unconditional money back guarantee, it will positively outperform in the field under actual installation conditions, any and all competitive antennas on the VHF channels, with or without rotor motors.

POLAR PATTERNS

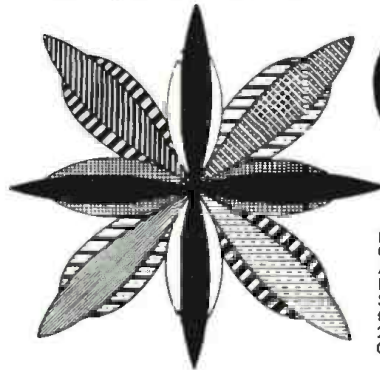

only
\$49⁵⁰
 LIST PRICE

Price includes:
 Complete Stacked
 Array • Stacking
 Bars • 9 Position
 Switch • Switch-
 to-set Coupler •
 2 Stand-offs, 7 1/2" •
 Complete instructions

The polar directivity response patterns show the major lobes of the "Riviera" antenna on VHF. It shows the fullness of coverage in all directions of this remarkable, patented antenna as it is turned through each of the nine switch positions. Each degree of shading constitutes a different switch position. This excellent directivity response, which can be switched at will, plus the extremely high gains, clearly indicate why the Riviera is such a superior performer.

ALL CHANNEL ANTENNA CORP.
 47-39 49th STREET, WOODSIDE 77, N. Y. EXETER 2-1336

IN UHF-VHF DISTRICTS . . . USE
The **NEW Super 60**
 100 MILES VHF • 60 MILES UHF

10 (Yes, all TEN!) LONG PLAYING, 33 1/3 R. P. M., HIGH-FIDELITY MASTERPIECES



complete to the last note
\$100

Not \$1 each but \$1 for ALL 10

MOZART

Symphony No. 26 in E Flat, K. 184

BETHOVEN

Piano Sonata No. 24 in F Sharp, Opus 78

BRAHMS

The Academic Festival

BERLIOZ

The Roman Carnival

VIVALDI

Concerto in C for Two Trumpets and Orchestra

WAGNER

Die Meistersinger, Prelude, Act I

BACH

Tocatta and Fugue in D Minor

DUKAS

Sorcerer's Apprentice

MOUSSORGSKY

Night on Bald Mountain

CHOPIN

Fantaisie-Impromptu, Op. 66

NOW you can get a real start on a complete record collection. Yes, you get ALL TEN of these great masterpieces—complete to the last note—for only \$1.00!

Why We Make this Amazing Offer

We were FORCED to make this "give-away" offer — for only by putting our records in your hands can we demonstrate their wonderful quality and extreme value. Performed by internationally renowned orchestras and artists. Custom-pressed on purest vinyl plastic. Reproduced with a tone fidelity encompassing the entire range of human hearing . . . 50 to 15,000 cycles!

Mail Coupon Now

As a Trial Member of the Musical Masterpiece Society, you are not obligated to ever buy another record from us. You do have the right to try — free of charge — any of the Society's monthly selections you wish. You receive prior notice of these and pay nothing in advance. Those you want are sent to you for FREE trial. After 5 days, the records you decide to keep are billed you at the low Membership Price of only \$1.50 per disc (average playing time 40 minutes). You save 2/3 the usual retail price! And, on this sensational demonstration offer, you start your collection with these TEN masterpieces for only \$1. But production capacity limits our membership rolls; when they are filled this offer must be withdrawn. Avoid disappointment. Rush coupon with a dollar today!

The Musical Masterpiece Society, Inc., Dept. 472
43 West 61st Street, New York 23, N. Y.

Enclosed is \$1 in full payment for recordings of the 10 masterpieces listed. Enroll me as a trial member. Privileges: No purchase obligation ever! Monthly advance notice of releases. 5 day free trial on any discs. I may reject records before or after receipt; may cancel membership at any time. For future l.p. discs I decide to keep, I'll pay only \$1.50 each.

Name.....

Address.....

City.....State.....

In Can., address: 686 Bathurst St., Toronto 4, Ont.

Spot Radio News

* Presenting latest information on the Radio Industry.

By RADIO & TELEVISION NEWS'
WASHINGTON EDITOR

A HISTORIC CEREMONY marked the dedication of the western labs of the Bureau of Standards several months ago. Out in Boulder, Colorado, the new striking, extensive facilities of the Central Radio Propagation Laboratories received the full champagne treatment (electronically) from none other than the President.

Before a distinguished audience of scientists, educators, Congressmen, and Senators, President Eisenhower depressed a button which activated a tube-controlled relay chain, that released a veil over the building's cornerstone. Basing his dedicatory comments on a tour of the huge labs, the President said that it seemed to him that we now have a new type of frontier where the labs have been built.

"This spot," he declared, "only a few short decades ago was inhabited by Indians, and by buffalo, and, later, by trappers and miners. It became the center of a great mining and agricultural region, which has meant so much to the United States in the past, and indeed does now.

"But the frontier days when we could go out and discover new land, new wonders of geography and of nature have seemed largely in the past," the President added. "Here today," he said, "inside this building, we have a frontier of possibly even greater romantic value, as well as greater material value to us, than were some of the discoveries of those days."

Pointing out that we are all laboratories, the President reminded his listeners that it is up to each of us to . . . "discover what we can contribute toward the growth of that kind of spirit among men that will make all of the discoveries of . . . dedicated scientists become assets to us, as we try to develop for ourselves and our children a better life, a richer life, one that gives us more opportunity to grow intellectually and spiritually.

"It is then, in those terms," the President stressed, "that we should look on the growth of science, as we think of the men laboring in this building, of the scientists in our universities, in the National Bureau of Standards in Washington, and in the great laboratories and factories of our nation.

"And I think," he emphasized, "that if each one of us does his part, then we will steadily go down the ages as a people more prosperous, more happy,

more secure, and more confident in peace."

A NUMBER OF SPECIAL features have been included in the new radio lab building, a reinforced concrete, wing-type structure featuring a four-story central spine, with one-story wings extending on either side at the second and third-floor levels.

Rooms in the labs have exact temperature and humidity controls to permit precision experiments. There are also radio-shielded rooms to minimize electrical interference, stable platforms for mounting delicate instruments, an open-roof laboratory for unconfined radio experiments, and access doors for bringing mobile radio test vehicles directly into the building for adjustment and control.

Actually, there are four scientific divisions at the Boulder Labs. The propagation lab, which previously had been a single division in Washington, now consists of three divisions, each representing a different phase of research; radio propagation physics, radio propagation engineering, and radio standards. In addition, there is a Cryogenic Engineering Lab, established in cooperation with the Atomic Energy Commission. This lab provides facilities for the development and evaluation of engineering materials and equipment for use at very low temperatures, temperatures which may be as low as -450° F, or several hundred degrees below the coldest ever observed in the most severe climates. Such temperatures, which are attained with liquefied gases (oxygen, hydrogen, nitrogen, and helium) are being used more and more in national defense and industry, and for laboratory research.

A TINY TRANSISTORIZED TRANSMITTER, known as the 20-mm "spin sonde," designed by the Naval Ordnance Laboratory for the study of projectiles using fins as a means of providing rotation, or spin, in flight, has gone to work for the Ballistics Ranges. The sender is so small it can fit into the nose of a 20-millimeter projectile and it's so rugged, that it will withstand acceleration shocks of over 30,000 g's.

According to the Navy, the new device will assist in the problem of determining the spin rate, as it changes during the flight of these projectiles

RADIO & TELEVISION NEWS

PRODUCTION RATE

TV PICTURE TUBES

AS OF DEC. 1st = PLACES

CBS-HYTRON IN "BIG THREE"



*Another demonstration
of confidence
in CBS-Hytron
advanced-engineering*



CBS-HYTRON Main Office: Danvers, Massachusetts
A Division of Columbia Broadcasting System, Inc.

H. H. Scott

AWARD WINNING AUDIO COMPONENTS

310 FM BROADCAST MONITOR TUNER — Most important new development in tuner design — 2-megacycle wide-band circuitry for outstanding reception quality even on weak signals. Convenient single-sweep tuning. DYNAURAL interstation noise suppressor. Automatic gain control. Tuning and signal-strength meter. Three IF's, three limiters. Sensitivity: 2 microvolts with 20 db quieting. Capture ratio better than 2.5 db. \$149.50* net

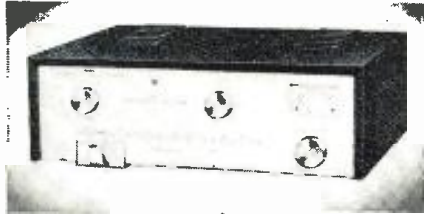

710A STROBOSCOPIC TURNTABLE — Radically new torsional and dual-stage mechanical filtering reduces rumble by more than 60 db, "wow" to less than 0.1%. Built-in optical stroboscope visible with record in place. Push-button selection of 33 $\frac{1}{3}$, 45, and 78 rpm speeds. Each speed vernier adjustable $\pm 5\%$ for pitch control. Acoustic feedback eliminated by a basic new pickup-arm mounting. \$102.00* net, Optional base \$14.95* net.

121-A DYNAURAL Equalizer-Preamplifier — The most versatile control and compensation unit ever offered, the 121 affords the music connoisseur adjustment for any recording curve and record quality. Patented DYNAURAL noise suppressor and record-distortion filter. Rolloff equalization, turn-over frequency, and maximum "boost" continuously variable. The 121 incorporates all refinements known at this stage of the art. \$162.75* net



265-A 70-watt LABORATORY POWER AMPLIFIER — A distinguished amplifier for the perfectionist. Exclusive adjustable "Dynamic Power Monitor" control allows full output on music, with maximum speaker protection. Damping factor continuously adjustable from 30/1 to 0.5/1. Class A circuitry throughout. Frequency response flat from 12 cps to 80,000 cps. Intermodulation distortion less than 0.1%, harmonic distortion less than 0.5% at full output. \$200.00* net.

210-C 23-watt COMPLETE AMPLIFIER — Incorporating the best features developed by H. H. Scott, the 210-C offers an outstanding combination of styling, performance and price. Patented DYNAURAL noise suppressor, 8-position equalizer, three-channel tone controls, Loudness control, and provision for convenient tape recording. Flat from 19 to 35,000 cps. Intermodulation distortion less than 0.1% at full output. \$172.50* net.



*Prices slightly higher west of Rockies. Prices and specifications subject to change without notices.

Professional recognition includes:

- "Electrical Manufacturing" Award for outstanding laboratory instrument design
- The Audio Engineering Society's award of the John H. Potts memorial medal to H. H. Scott for outstanding contributions to audio science
- H. H. Scott amplifiers were rated "first choice" in the "Saturday Review Home Book of Recorded Music and Sound Reproduction."

Engineering Leadership
for Superior Performance

H. H. SCOTT inc.
385 PUTNAM AVENUE
CAMBRIDGE, MASSACHUSETTS

Write for
FREE BOOKLET R255

from zero to a maximum. Such information, it was said, is essential to round out the data needed for calculating the aeroballistic constants of Navy weapons under development. Used with information on flight behavior, the constants serve as a guide to changes in design that may be required for improved flight performance.

Use of telemetering devices, such as the new transmitter, previously has been limited to projectiles larger than 20 millimeters. The new version actually fits inside a tapered plastic nose approximately one inch long. A tiny mercury battery, even smaller than a cuff link, is used for power; it has been tested for 200 hours of use.

In operation, the "spin sonde" transmits signals of uniform amplitude. However, the amplitude appears to vary because of changes in the orientation of a transmitter coil in relation to the antenna. The transmitter coil spins with the projectile. A receiving antenna, installed along the path of the projectile, picks up the signals and feeds them into an oscilloscope. The scope's traces are photographed at stations along the range.

SINCE THE EARLY '30's a number of systems for the activation of airport lights from aircraft have been devised and evaluated. Two general types were found to be most popular: one involving audio and the other radio. In the former, a microphone served to pick up sound of the aircraft engine and propeller. The microphone was connected to a suitable amplifier which actuated a relay for controlling the lights. The radio system featured transmissions (usually on 3105 kilocycles) picked up on a receiver on the ground. The output of the receiver operated a relay which, in turn, controlled airport lights, either directly or through additional relays.

In general, the records reveal, these systems functioned satisfactorily under favorable operating conditions, but under adverse conditions, they had some serious limitations. In the audio setup, sensitivity had to be set low enough to prevent triggering of the system by ground noises and by large aircraft passing over at en-route altitudes. This problem was found to make it necessary for small aircraft to pass directly over the microphone at low altitude with full power to activate the system. And even with this reduced sensitivity, the sound of thunder and of rain falling on or near the microphone had been found to actuate the audio chain and turn on the lights.

In the radio systems, the propagation characteristics of the frequency employed were found to be so variable that inadvertent operation of lights by aircraft hundreds of miles away occurred. In addition, the level of the noise created by abnormal atmospheric conditions was found, at times, sufficiently high to cause continuous operation of the lights.

Recently, a system activated by sig-
(Continued on page 155)

I Will Train You at Home

For Good Pay Jobs, Success in

RADIO-TELEVISION

J. E. SMITH
President
National Radio
Institute
Washington, D. C.
40 years of success
training men at
home in spare time.



Practice Broadcasting with Equipment I Send

As part of my Communications Course I send you kits of parts to build the low-power Broadcasting Transmitter shown at the left. You use it to get practical experience putting a station "on the air," performing procedures demanded of Broadcasting Station Operators. An FCC Commercial Operator's License can be your ticket to a better job and a bright future; my Communications Course gives you the training you need to get your license. Mail card below and see in my book other valuable equipment you build.



Practice Servicing with Equipment I Send

Nothing takes the place of PRACTICAL EXPERIENCE. That's why NRI training is based on LEARNING BY DOING. You use parts I furnish to build many circuits common to Radio and Television. With my Servicing Course you build a modern Radio (shown at right). You build a Multimeter which you use to help fix sets while training. Many students make \$10, \$15 a week extra fixing sets in spare time starting a few months after enrolling. All equipment is yours to keep. Card below will bring book showing other equipment you build.

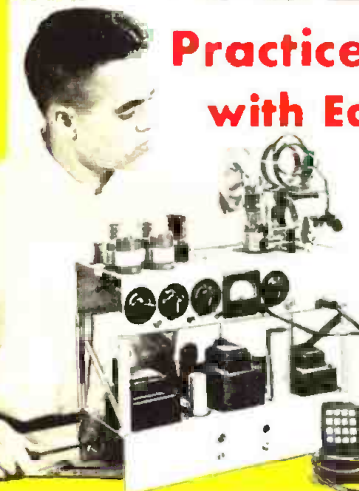

Television is Growing Fast Making New Jobs, Prosperity

More than 25 million homes now have Television sets and thousands more are being sold every week. Well trained men are needed to make, install, service TV sets. About 200 television stations on the air with hundreds more being built. Think of the good job opportunities here for qualified technicians, operators, etc. If you're looking for opportunity get started now learning Radio-Television at home in spare time. Cut out and mail postage free card. J. E. Smith, President, National Radio Institute, Washington, D. C. OUR 40TH YEAR.

AVAILABLE TO
VETERANS
UNDER G.I. BILL

Good Jobs, Good Pay, Success
in Radio-TV! SEE OTHER SIDE

CUT OUT AND MAIL THIS CARD NOW

Sample Lesson & 64-Page Book Both FREE

This card entitles you to Actual Lesson on Servicing, shows how you learn Radio-Television at home. You'll also receive my 64-Page Book, "How to Be a Success in Radio-Television." Mail card now!

NO STAMP NEEDED! WE PAY POSTAGE

Mr. J. E. SMITH, President,
National Radio Institute, Washington 9, D. C.

Mail me Lesson and Book, "How to Be a Success in Radio-Television." (No Salesman will call. Please write plainly.)

NAME.....AGE.....

ADDRESS.....

CITY.....ZONE.....STATE.....

VETS write in date of discharge.....

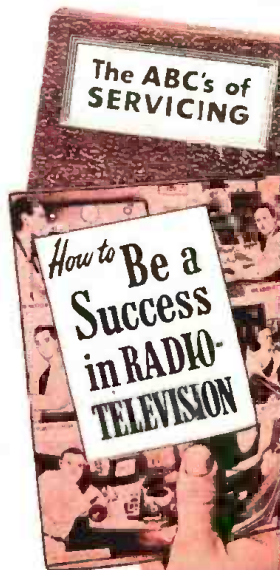

Train at Home to Jump Your Pay as a RADIO-TV Technician

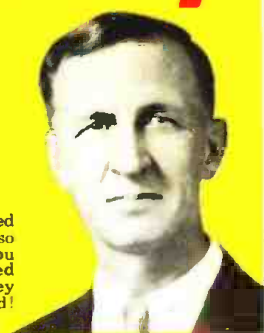

J. E. Smith, President
National Radio Institute

The men whose messages are published below were not born successful. Not so long ago they were doing exactly as you are now... reading my ad! They decided they should KNOW MORE... so they could EARN MORE... so they acted! Mail card below now.

Get a Better Job—Be Ready for a Brighter Future in America's Fast Growing Industry

Training PLUS opportunity is the PERFECT COMBINATION for job security, good pay, advancement. When times are good, the trained man makes the BETTER PAY. GETS PROMOTED. When jobs are scarce, the trained man enjoys GREATER SECURITY. NRI training can help assure you and your family more of the better things of life.

Radio-Television is today's opportunity field. Even without Television, Radio is bigger than ever before. Over 3,000 Radio Broadcasting Stations on the air; more than 115 million home and Automobile Radios are in use. Then add Television. Television Broadcast Stations extend from coast to coast now with over 25 million Television sets already in use. There are channels for 1,800 more Television Stations. Use of

Aviation and Police Radio, Micro-Wave Relay, Two-way Radio communication for buses, taxis, trucks, etc. is expanding. New uses for Radio-Television principles coming in Industry, Government, Communications and Homes.

My Training is Up-to-Date You Learn by Practicing

Get the benefit of my 40 years experience training men. My well-illustrated lessons give you the basic principles you must have to assure continued success. Skillfully developed kits of parts I furnish "bring to life" the principles you learn from my lessons. Read more about equipment you get on other side of this page.

Naturally, my training includes Television. I have, over the years, added more and more Television information to my courses. The equipment I furnish students gives experience on circuits common to BOTH Radio and Television.

Find Out About the Tested Way to Better Pay

Read at the right how just a few of my students made out who acted to get the better things of life. Read how NRI students earn \$10, \$15 a week extra fixing Radios in spare time starting soon after enrolling. Read how my graduates start their own businesses. Then take the next step—mail card below.

You take absolutely no risk. I even pay postage. I want to put an Actual Lesson in your hands to prove NRI home training is practical, thorough. I want you to see my 64-page book, "How to Be a Success in Radio-Television" because it tells you about my 40 years of training men and important facts about present and future Radio-Television job opportunities. You can take NRI training for as little as \$5 a month. Many graduates make more than the total cost of my training in two weeks. Mailing postage free card can be an important step in making your future successful. J. E. Smith, President, National Radio Institute, Washington 9, D. C. OUR 40TH YEAR.

I TRAINED THESE MEN

 Consultant on Antenna Systems "I resigned as Chief Engineer. Now I am on my own as consultant on private and commercial antenna systems." R. J. Bailey, Weston, W. Va.	<p>\$10 a Week In Spare Time</p> "Before finishing, I earned as much as \$10 a week in Radio servicing. In my spare time I recommend NRI." S. J. Petruff, Miami, Fla.
 Control Operator, Station WEAN "I received my license and worked on ships. Now with WEAN as control operator, NRI course is complete." R. Arnold, Humford, R. I.	<p>Has Own Radio-Television Shop</p> "Doing Radio and Television servicing full time. Have my own shop. I owe my success to NRI." Curtis Stath, Fort Madison, Iowa.
 Radio-Television Service Chief "Am chief Radio and Television serviceman for large repair shop. Pay very good; working conditions pleasant." P. G. Brogan, Louisville, Ky.	<p>Got First Job Thru NRI</p> "My first job was with KDLR, Now Chief Engr. of Radio Equipment for Police and Fire Dept." T. Norton, Hamilton, Ohio.

Start Soon to Make \$10 to \$15 a Week Extra Fixing Sets



Keep your job while training. Many NRI students make \$10, \$15 and more a week extra fixing neighbors' Radios in spare time, starting a few months after enrolling. I start sending you special booklets that show you how to fix sets, the day you enroll. The multitester you build with parts I furnish helps discover and correct troubles.

SEE OTHER SIDE

My Training Leads to Jobs Like These

- | | | |
|-------------------------------|---|------------------------------------|
| BROADCASTING | Service Manager | AVIATION RADIO |
| Chief Technician | Tester | Plane Radio Operator |
| Chief Operator | Serviceman | Transmitter Technician |
| Power Monitor | Research Assistant | Receiver Technician |
| Recording Operator | | Airport Transmitter Operator |
| Remote Control Operator | | |
| | SHIP AND HARBOR RADIO | TELEVISION |
| SERVICING | Chief Operator | Pick-Up Operator |
| Home and Auto Radios | Assistant Operator | Voice Transmitter Operator |
| P.A. Systems | Radiotelephone Operator | Television Technician |
| Television Receivers | | Remote Control Operator |
| Electronic Controls | GOVERNMENT RADIO | Service and Maintenance Technician |
| FM Radios | Operator in Army, Navy, Marine Corps, Coast Guard | |
| | Forestry Service | POLICE RADIO |
| IN RADIO PLANTS | Dispatcher | Transmitter Operator |
| Design Assistant | Airways Radio Operator | Receiver Serviceman |
| Transmitter Design Technician | | |

FIRST CLASS
Permit No. 20-R
(Sec. 34.9, P.L. & R.)
Washington, D.C.

BUSINESS REPLY CARD
No Postage Stamp Necessary If Mailed In The United States

POSTAGE WILL BE PAID BY
NATIONAL RADIO INSTITUTE
16th and U Sts., N.W.
Washington 9, D. C.



CUT OUT-MAIL Postage Free CARD



SAMPLE LESSON and 64-PAGE BOOK Both FREE

Have Your Own Business

Many NRI trained men start their own successful Radio-Television sales and service business with capital earned in spare time. Joe Travers, a graduate of mine, in Asbury Park, N. J., writes: "I've come a long way in Radio and Television since graduating. Have my own business on Main Street."



Jerrold TV Multi-Outlet SYSTEM



DISTRIBUTION AMPLIFIER

Type ABD-1—Amplifies antenna signal 25db, channels 2-13. Sensitive 5-tube cascade circuit. Exceptionally low noise—only 6db (approaching theoretical minimum). Mounts indoors. 115 volt operated. 72 or 300 ohm antenna input. 72 ohm output to "Splitter." Flat response for color.

...for fast, low-cost installation
in motels, apartments, clubs

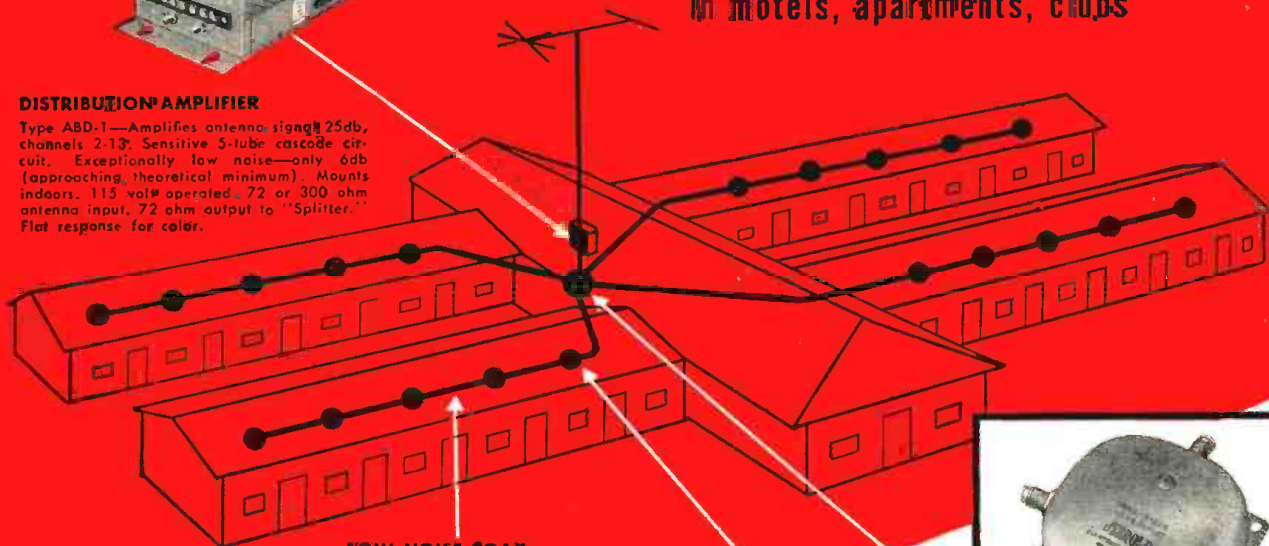

LOW-NOISE COAX

Use any length to interconnect receivers. Amplifier and Line Tap compensate for line losses.

Here's a TV *Multi-Outlet* distribution system that gives clean, snow-free reception to every receiver . . . with an increase in signal strength and with signal-to-noise ratio maintained in the bargain. A single *Multi-Outlet* Jerrold System can feed 20 receivers, and Jerrold Distribution Amplifiers can be grouped for larger installations. Reception at each receiver, on all channels, will be the best the antenna can provide in the area.

The complete Jerrold Distribution System designed for 24 hour operation is built to the same standards as larger Jerrold Community TV systems which serve as many as 5000 sets from a single antenna. Yet a Jerrold *Multi-Outlet* System costs less than half the price of ordinary installations using unsightly separate antennas for each receiver.

Investigate this profitable field now! Send for free catalog sheets describing all components.



LINE SPLITTER (if needed)

Type T1604—Equally divides amplifier output up to 4 ways. No tubes. Cannot overload.

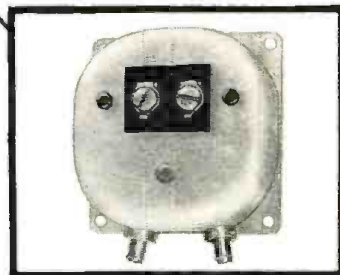

LINE TAP IMPEDANCE MATCHER

One for each receiver. Compensates for line response tilt. Completely isolates receivers from each other. Matches 72 ohm feed line to 300 ohm set. No tubes.

INSTALLATION MADE EASY

Profusely-illustrated booklet tells all about distribution systems—theory, cost estimates, installation, etc. Free with each ABD-1 Amplifier. 25c separately. Write for your copy today.

JERROLD

JERROLD ELECTRONICS CORPORATION
26TH & DICKINSON STS.
PHILADELPHIA 46, PA.

the fabulous VHF-UHF antenna that actually
sells itself with performance!



RAINBOW*

What do America's servicemen think of Channel Master's RAINBOW antenna? Here are their very words†:

"The RAINBOW brings metropolitan reception to isolated areas."

"Gets more stations in this fringe area than any other antenna made."

"Just what our customers have been waiting for -- a powerful, sturdy, economical antenna."

†Just a few of the many letters of praise we receive daily.

LOOK at the RAINBOW'S unique design, so deceptively simple, yet so unbelievably efficient. **LOOK** at its advanced features: New Spacing Formula, new Triple-Section High Band elements, new full-efficiency Intermix Design, and the brilliant triple-power TRI-POLE! **LOOK** at its remarkable Yagi performance on every channel, its sharp single lobe. **LOOK** at its rugged, durable 100% aluminum construction, reinforced at all stress points. **LOOK** at its trigger-fast "Snap-Lock" Action, Channel Master's fabulous preassembly that snaps open, locks open, without hardware or tightening.

With every installation, Channel Master's RAINBOW again proves itself the most powerful TV antenna yet developed by modern science. Buy for buy, it out-performs every all-channel antenna on the market today!

Get In On This High-Powered Advertising Deal

Your Channel Master distributor offers you a hard-hitting promotion program which includes TV spot films, newspaper mat ads, radio ads, full-color display material, and consumer literature. Advertise and install America's best known, most wanted antenna.

Here's how the RAINBOW out-performs the famous Champion:

		CHANNEL	2	3	4	5	6	7	8	9	10	11	12	13
Gain Over 1-Bay Champion	1-Bay RAINBOW	0	0	0	+1	+2	+3	+2.5	+1	+5	+5	+1.5	+2.5	
	1-Bay SUPER RAINBOW	+1	+1	+1.5	+2.5	+3.5	+3.5	+3	+2	+1.5	+2	+3.5	+4.5	
		CHANNEL	4	5	6	7	8	9	10	11	12	13		
Gain Over Stacked Champion	Stacked RAINBOW	+1.5	+2	+1.5	+1.5	+2	+5	+5	+0	+0	+0	+1	+1.5	
	Stacked SUPER RAINBOW	+2	+2.5	+3	+3	+4	+5	+1	+1	+2	+2	+2.5	+3.5	

There's a RAINBOW model for every area . . .
 for every purse!

For fringe and super-fringe areas:

Super RAINBOW model no. 331, \$37⁵⁰ list

stacked Super RAINBOW model no. 331-2, \$75⁷⁰ list

For suburban and near-fringe areas:

Champion RAINBOW model no. 330, \$23⁶⁰ list

stacked Champion RAINBOW model no. 330-2, \$48⁶⁰ list

For economy installations:

(featuring butted tubing)

Challenger RAINBOW model no. 332, \$18⁰⁶ list

stacked Challenger RAINBOW model no. 332-2, \$37⁵⁰ list

don't
 kid me!

NOTHING
 outperforms

CHANNEL
 MASTER

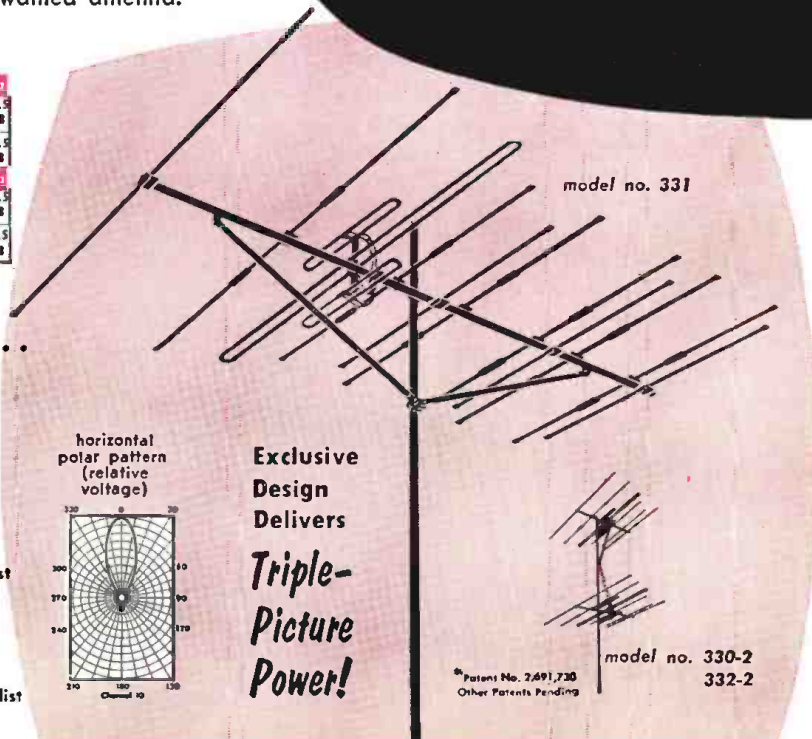

a major step forward
in installation procedures —

CHANNEL MASTER'S SELECTENNA coupling system

the great Channel Master development
that permits *unlimited antenna combinations*
with only *one* transmission line to the set!

the **NEW WAY**, the **BEST WAY**,
the only **AUTOMATIC WAY** to get
all-channel, all-direction reception . . .

● **Without rotators!**

SelecTenna means: no extra control unit on the set; no moving parts to get out of order; antennas are always in perfect orientation.

● **Without switches!**

SelecTenna means: no manual switches to bother with; better performance because couplers have less insertion loss than switches.

● **Without multiple lead-in wires!**

SelecTenna means: neater, more professional installations, because no complicated wiring enters the home. Only one lead connects to the set.

This modern way to obtain multi-directional reception — with its individual band-pass filter networks — offers the consumer great convenience advantages possible in no other system. There's never been anything like it! The SelecTenna System is rapidly replacing all older methods. Use it on your next "multi-direction" installation!

**FREE TECHNICAL
ADVISORY SERVICE**

Our engineers will tell you the correct hook-up for your area. Merely list the channels you expect to receive, as well as the different antennas you would like to hook up. No charge or obligation.

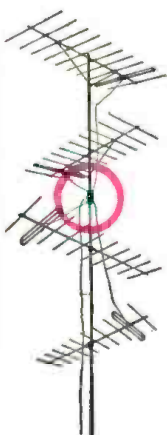

Simple as:

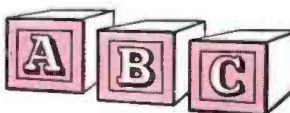

Simply select your
channel on the set---
the right signal is
always there!

list price:
\$542
each

including mounting
hardware and
connecting wire.

Couplers snap together. This particular interlocked stack consists of four Antenna Couplers and one Hi-Lo Coupler, for joining two High Band and two Low Band antennas.

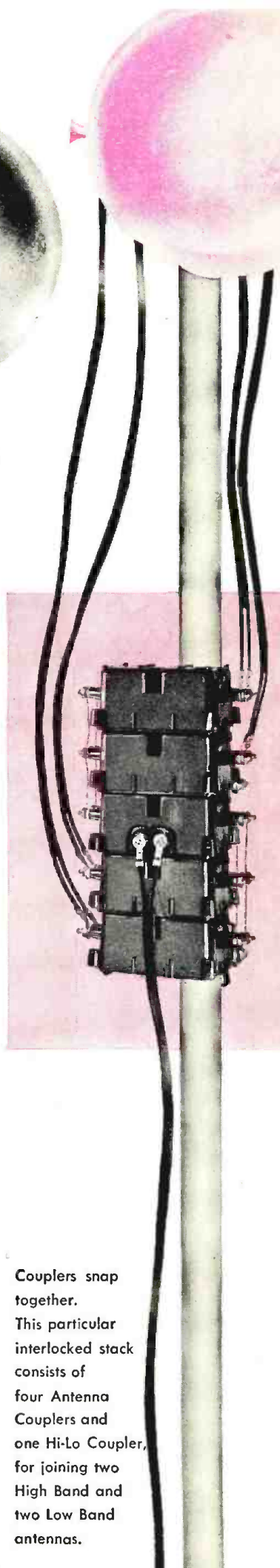

CHANNEL MASTER CORP. ELLENVILLE, N. Y.
The World's Largest Manufacturer of Television Antennas and Accessories.

Copyright 1954, Channel Master Corp.



Better for you

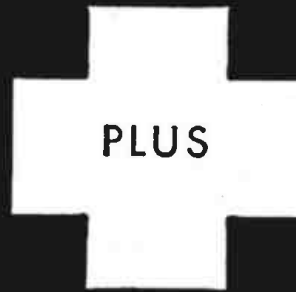

*Pyramid will now
be listed in
Photofact folders.*

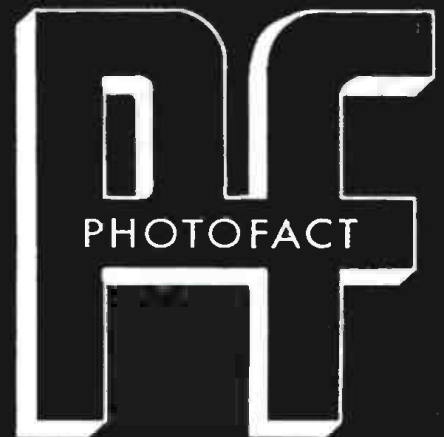

Pyramid has joined the select group of manufacturers who participate in this most valuable of all service aids to make available to you an immediate cross reference between the set manufacturer's part and the part number of the exact Pyramid equivalent.

You will find Pyramid capacitors as original components in sets bearing such famous brand names as

RCA • GE • CBS • Arvin • DuMont • Zenith • Raytheon • Emerson
Motorola • Sylvania • Packard-Bell • Hallicrafters • Westinghouse • Hoffman
and at leading parts distributors everywhere.

 **PYRAMID ELECTRIC CO.**, 1445 Hudson Boulevard, North Bergen, N. J.

LOOKING FOR JOB SECURITY AND SUCCESS? LET MY STUDENTS AND GRADUATES TELL YOU —



L. C. Lane, B.S., M.A.
President, Radio-Television Training Association. Executive Director, Pierce School of Radio & Television.

ABOUT MY TRAINING —

\$60 A WEEK IN SPARE TIME



I have the skill and know-how to do the work I love best and to enjoy better things in life, thanks to RTTA. I am working on TV servicing and making \$60 a week sparetime.

Harold Gimlen, Flint, Mich.

HAS OWN BUSINESS



I have a shop at home and have been working on radio and TV after working hours of my regular job. I average \$50 a week for this part time work. RTTA training helped me in making extra money and giving me experience in the electronic field.

Richard Hennis, Little Rock, Ark.

AIRCRAFT INSPECTOR



With RTTA training and through repairing radios and televisions for the right people at the right price, I was able to make the right contacts. I am now an Inspector for Douglas Aircraft at about \$125 a week.

Hugh Maddox, Los Angeles, Calif.

SERVICE MANAGER



I manage two radio and television shops, one here and one in Pompano Beach. RTTA training increased my knowledge of TV circuits and showed me new, quicker methods of repairing. Lessons as presented are very concise and clear.

William Phillips, Fort Lauderdale, Fla.

ELECTRICAL TESTER



RTTA training has helped me understand TV and many variations of simple circuits. The course covers all subjects very clearly. I am now an Electrical Tester for Western Electric Co. at \$83.42 a week.

Raymond Lapan, Burlington, N. C.

REPAIRED EVERY SET



RTTA training helped me to understand TV more thoroughly. I have repaired every set that I was called on to repair.

Andrew Busi, Jr., Iselin, Pa.

— ABOUT MY EQUIPMENT

YOU GET ALL THIS EQUIPMENT AND MORE

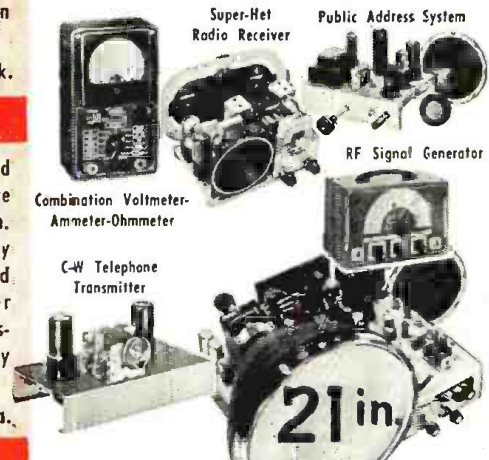

"... a money making little gem."

I have completed kit #6 and was amazed at how it works. I showed it to a friend of mine and he asked me to set it up for one of the picnics his social club was having. That sure is a money making little gem.

John Fernandez, Fresno, Calif.

"We get excellent pictures..."

I would like to compliment you on an excellent and complete course. We get excellent pictures on my TV set from WSYR (Syracuse, N.Y.), approximately 110 air miles away. The set is working good and I have had to replace only three tubes since I assembled it two years ago.

Larry H. Stafford, Kingston, Ont., Canada

"... very good reception..."

I have really enjoyed the course and have come a long way in TV servicing. I am getting very good reception on my TV station considering that the nearest VHF station is 120 miles.

J. W. Hanlon, Jr., Henderson, Texas

YOU, TOO, CAN GET A BETTER-PAYING JOB IN THE EVER-EXPANDING RADIO-TELEVISION-ELECTRONICS FIELD

Why limit yourself and your earnings because of your lack of training. Learn AT HOME in your SPARE TIME to be an electronic technician, television repairman, or studio technician. You don't need any experience whatsoever. Many students earn up to \$25 weekly in spare time while learning.

After you finish my Radio-FM Television Course or FM-Television Course you can have, if you want it, two weeks of laboratory training at my associate resident school in New York City—AT NO EXTRA COST.

If you have had previous radio and television experience you can take my practical TV Cameraman and Studio Technician Course to qualify for a good-paying job in a TV studio.

Write to me today and let me show you how you can begin now to put yourself on the road to a better future.

VETERANS!

My school fully approved to train veterans under new Korean G.I. Bill. Write discharge date on coupon.

Radio Television Training Association

52 EAST 19th STREET • NEW YORK 3, N. Y.

Licensed by the State of New York • Approved for Veteran Training

YOU GET ALL FOUR FREE



MAIL THIS COUPON TODAY! NO SALESMAN WILL CALL

Mr. Leonard C. Lane, President
RADIO-TELEVISION TRAINING ASSOCIATION Dept. T-2
52 East 19th Street, New York 3, N. Y.

Dear Mr. Lane: Mail me your NEW FREE BOOK, FREE SAMPLE LESSON, and FREE aids that will show me how I can make BIG MONEY IN TELEVISION. I understand I am under no obligation and no salesman will call.

(PLEASE PRINT PLAINLY)

Name _____ Age _____

Address _____

City _____ Zone _____ State _____

I AM INTERESTED IN:

- Radio-FM-TV Technician Course
- FM-TV Technician Course
- TV Cameraman & Studio Technician Course

VETERANS!
Write discharge date

**COMPLETELY
SERVICE...
COLOR TV
with only two
NEW instruments!**

\$4995
NET



RAINBOW GENERATOR
Model 150
Patent Pending

NEW CIRCUITS incorporated in this instrument greatly simplify the TEST and ALIGNMENT of color TV circuits. NEW LINEAR PHASE SWEEP produces the COMPLETE PHASE RESPONSE CURVE, assuring greater accuracy with faster alignment and elimination of color bar drift problems.

APPLICATIONS

- MASTER PHASE CONTROL test and alignment
- CHROMA DEMODULATOR test and alignment (either I/Q or R-Y/B-Y)
- QUADRATURE TRANSFORMER test and alignment
- MATRIX CIRCUIT test and alignment
- BURST AMPLIFIER test and alignment
- PHASE DETECTOR CIRCUIT alignment for reference oscillator
- REACTANCE CONTROL and REFERENCE OSCILLATOR adjustment
- 3.58 MC TRAP alignment
- TROUBLESHOOTING and PHASE ALIGNMENT in the home by picture patterns.



\$7995
NET

WHITE DOT GENERATOR
Model 160

THE WHITE DOT GENERATOR ENABLES COMPLETE ALIGNMENT OF ALL COLOR CONVERGENCE CIRCUITS PLUS SWEEP CIRCUIT LINEARITY AND SIZE, AS WELL AS GENERAL TROUBLESHOOTING BY SIGNAL TRACING.

APPLICATIONS

- DYNAMIC CONVERGENCE—vertical and horizontal test and adjustment
- DC CONVERGENCE—test and adjustment
- DEFLECTION COIL—positioning for best convergence
- BEAM MAGNETS—alignment for best convergence
- DYNAMIC PHASE ADJUSTMENT—vertical and horizontal
- FOCUS—test and adjustment of DC and dynamic focus
- TROUBLESHOOTING of all circuits affecting convergence
- LINEARITY—test and adjustment of horizontal and vertical sweep linearity.

FREE LITERATURE ON REQUEST

WIN-TRONIX

WINSTON ELECTRONICS, INC.

Dept. 101, 4312 Main Street
Philadelphia 27, Pa.

Within the
INDUSTRY

HOWARD E. RIORDON has been appointed general manager of the Radio and Television Division of *Sylvania Electric Products Inc.* He has held executive posts with this firm and its subsidiary and predecessor companies for the past 23 years. He succeeds John K. McDonough, who recently resigned from the company.



Mr. Riordon joined the *Colonial Radio Corporation* of Buffalo in 1931 as assistant treasurer and in 1936 became secretary and controller. *Sylvania* purchased *Colonial* in 1944 and in that year Mr. Riordon was made vice-president of the subsidiary.

His most recent post was as president of *Sylvania Electric of Puerto Rico, Inc.*

ROBINS INDUSTRIES CORP. is the new name of **YALE INDUSTRIES CORP.**, manufacturers of the "Gibson Girl" tape splicers. The firm will continue business at 82-09 251st St., Bellerose 26, N. Y. . . . **THE FLEETWOOD CORPORATION** has been formed at 1037 Custer Drive, Toledo, Ohio to manufacture and supply television equipment for studio, remote, and closed-circuit use. The firm is headed by John W. McGee, former general manager of the Electronics Division of **WILLYS MOTORS, INC.**, Toledo . . . A new service for architects, engineers, and contractors has been established by **AUDIO EQUIPMENT COMPANY**, 15749 Wyoming Avenue, Detroit 38, Michigan . . . **HETHERINGTON, INC.** of Sharon Hill, Pa. has announced the establishment of a coil division which is prepared to handle the production of coils, solenoids, transformers, small motors, ignition coils for photoflash equipment, or gasoline engines . . . **TAPE RECORDERS INCORPORATED** has been established at 1501 W. Congress St., Chicago 7, to manufacture three new magnetic tape recorders which will be marketed as the "Tri Fy" line . . . **PRECISION TRANSFORMER CORPORATION**, 660 W. Grand Ave., Chicago 10, has set up a special department to produce transformers to custom specifications and assist manufacturers in the design of equipment requiring non-standard transformers.

COLONEL W. MACK THAMES has been appointed chief of the Signal Plans and Operations Division of the Office of the Chief Signal Officer, U. S. Army, succeeding **BRIG. GEN. REGINALD P. LYMAN**, who has retired . . . **DONALD W. JACKSON** has been appointed national merchandising manager for the *Dage*

Television Division . . . The Tube Division of *Radio Corporation of America* has named **LEE F. HOLLERAN**, a 20-year veteran of *RCA* sales and product activities, to the post of general marketing manager . . . **LOUIS SILVER**, vice-president of *Wilcox-Gay Corporation*, has resigned that post to set up a manufacturer's sales representative office in New York City . . . **JACK WHITESIDE** has been appointed general manager of *Simpson Electric Co.* succeeding the late **H. A. BERNREUTER** . . . *Radio Receptor Company, Inc.* has named **J. J. CLARK**, retired admiral, USN, to the post of vice-president . . . **PATRICK E. LANNAN** has been promoted to the post of vice-president and project manager of electrical and electronic development at *Designers for Industry, Inc.*, Cleveland research and development firm . . . **ARNOLD DEUTSCHMANN** has been elected to the newly-created post of executive vice-president and **MORRIS M. NEWMAN** vice-president of *Radio Shack Corp.* of Boston . . . **MAJOR GEN. WILLIAM L. RICHARDSON**, U.S. Air Force (Ret.), has been named to the newly-created post of manager, Defense Projects Coordination for the Engineering Products Division of *Radio Corporation of America* . . . **ALEXANDER KIDD**, formerly vice-president of *The M. W. Kellogg Company*, was elected vice-president of *Stewart-Warner Corporation* of Chicago . . . **E. GORDON BURLINGHAM** has been named to the new post of sales service manager of *CBS-Hytron* with headquarters at the company's Danvers plant.

HORACE L. WHITE, veteran of 26 years of service with *Jensen Manufacturing Co.*, has been appointed industrial sales manager of the firm.

He will be in charge of the industrial activities of sales representatives and all sales liaison with industrial accounts, except where government contracts are involved.

For the past two and a half years, he has been in the industrial sales division and prior to that time he was traffic manager.

THE HIGH FIDELITY INSTITUTE, INC., a non-profit association dedicated to the promotion of high-fidelity products to the American public, is going ahead with plans for an educational program aimed at telling the "hi-fi story" to millions of music lovers and audio enthusiasts.

Jerome J. Kahn, commissioner of the Institute, revealed that some of



Home Study Courses in TELEVISION SERVICING offered by RCA INSTITUTES



Study Television Servicing—from the very source of the latest, up-to-the-minute TV and Color TV developments. Train under the direction of men who are experts in this field. Take advantage of this opportunity to place yourself on the road to success in television. RCA Institutes, Inc. (A Service of Radio Corporation of America), thoroughly trains you in the "why" as well as the "how" of servicing television receivers.

FIRST HOME STUDY COURSE IN COLOR TV SERVICING

Now you can train yourself to take advantage of the big future in Color TV. RCA Institutes Home Study Course covers all phases of Color TV Servicing. It is a practical down-to-earth course in basic color theory as well as how-to-do-it servicing techniques.

This color television course was planned and developed through the combined efforts of instructors of RCA Institutes, engineers of RCA Laboratories, and training specialists of RCA Service Company. You get the benefit of years of RCA research and development in color television.

Because of its highly specialized nature, this course is offered only to those already experienced in radio-television servicing. Color TV Servicing will open the door to the big opportunity you've always hoped for. Find out how easy it is to cash in on color TV. *Mail coupon today.*

SEND FOR FREE BOOKLET

Mail coupon in envelope or paste on postal card. Check course you are interested in. We will send you a booklet that gives you complete information. No salesman will call.



RCA INSTITUTES, INC.
A SERVICE OF RADIO CORPORATION OF AMERICA
350 WEST FOURTH STREET, NEW YORK 14, N. Y.

HOME STUDY COURSE IN BLACK-AND-WHITE TV SERVICING

Thousands of men in the radio-electronics industry have successfully trained themselves as qualified specialists for a good job or a business of their own—servicing television receivers. You can do this too.

This RCA Institutes TV Servicing course gives you up-to-the-minute training and information on the very latest developments in black-and-white television.

As you study at home, in your spare time, you progress rapidly. Hundreds of pictures and diagrams, easy-to-understand lessons help you to quickly become a qualified TV serviceman.

There are ample opportunities in TV, for radio servicemen who have expert training. Mail coupon today. Start on the road to success in TV Servicing.



MAIL COUPON NOW

RCA INSTITUTES, INC.
Home Study Dept. RN 255
350 West Fourth Street, New York 14, N. Y.
Without obligation on my part, please send me copy of booklet on:

- Home Study Course in TELEVISION SERVICING.
 Home Study Course in COLOR TV SERVICING.

Name _____
(please print)

Address _____

City _____ Zone _____ State _____

DEPENDABLE PERFORMANCE

with



TWIN-LEAD

Twin-leads can look alike to the casual glance. It is difficult to distinguish between materials and impossible to evaluate electrical characteristics without conducting extensive laboratory tests under simulated weathering conditions.

If you do not have the facilities required to conduct such tests the only way to protect your business and to provide dependable twin-lead installations for your customers is to use twin-leads manufactured by reputable manufacturers.

Using AMPHENOL Twin-Lead gives you this protection — for AMPHENOL guarantees every foot of Twin-Lead sold to be free from defects and maintains the strict quality controls necessary to insure this guarantee!

the industry's leading promotional, sales, and advertising authorities have been consulted with the result that the framework for an all-industry public educational program is being set up.

The Institute's Board of Governors include: Leonard Carduner, *British Industries Corp.*; Robert Newcomb, *Newcomb Audio Products*; Walter O. Stanton, *Pickering & Co.*; Sam Poncher, *Newark Electric Co.*; E. Berlant, *Berlant Associates*; and Theodore Rossman, *Pentron Corp.*

* * *

RICHARDS W. COTTON has been named assistant to the president of *National Company, Inc.*, Malden, Mass., engineers and manufacturers of communications receivers and audio equipment.



Mr. Cotton comes to the firm from *Philco Corporation* where he served in the same capacity. In his new post, he will assist the president in the executive administration of the company's program of development and expansion in the field of electronics.

Since 1953, he has also served as a consultant to the Secretary of Defense, the Office of Defense Mobilization, and the Electronics Division of the Department of Commerce.

He represented the U. S. at the NATO conference and was sent to Japan on a special government assignment last year.

* * *

SYLVANIA ELECTRIC PRODUCTS INC. has recently completed a new 51,000 square-foot building in Fullerton, California in order to meet the requirements of West Coast distributors and dealers for television picture tubes . . .

FEDERAL PACIFIC ELECTRIC COMPANY of Newark, New Jersey has opened a new plant in Scranton, Pa. and completed construction of a new and modern warehouse at its Newark plant . . .

Elaborate dedication ceremonies marked the opening of **HELIPOT CORPORATION'S** new Canadian plant at No. 3 Six Points Road, Toronto, Ontario . . .

PHILCO CORPORATION'S Government and Industrial Division has moved to new and larger quarters at 10589 Santa Monica Boulevard in Los Angeles . . .

KEPCO LABORATORIES has moved into the new addition to its Flushing, N. Y. plant at 131-38 Sanford Ave. The new addition triples the company's production area . . .

A new research and product development center has been opened in Denver, Colorado by **MICRO SWITCH**, a division of **MINNEAPOLIS-HONEYWELL REGULATOR COMPANY**. The new center is located at 387 Corona Street . . .

SPRAGUE ELECTRIC COMPANY has started construction of a 13,000 square foot, one-story building in the Venice section of Los Angeles to house all of its Southern California operations. Completion is expected in late Spring . . .

IMPERIAL RADAR AND WIRE CORPORATION has
(Continued on page 176)

RADIO & TELEVISION NEWS

14-056 Standard Flat Twin-Lead

14-271 AIR-CORE Tubular Twin-Lead*

14-100 New CENTURY Twin-Lead

14-185 New HEAVY DUTY Twin-Lead

14-076 Deluxe AIR-CORE Tubular Twin-Lead*

14-298 Four Conductor Rotator Cable

*U.S. Pat. 2,543,696



Send for your copy



Vest Pocket Guide to Transmitting and Receiving Twin-Leads

AMERICAN PHENOLIC CORPORATION
1830 S. 54th Ave., Chicago 50, Ill.

In Canada: AMPHENOL CANADA LIMITED Toronto

CREI prepares you quickly for success in

The future is in your hands!

The signs are plain as to the future of the trained men in the electronics industry. It is a tremendous industry, and—at the *present time* there are more jobs than there are trained men to fill them. But—when there's a choice between a trained and untrained applicant, the trained man will get the job. Your biggest problem is to decide on—and begin the best possible training program.

CREI Home Study . . . The Quick Way to Get There.



Since 1927, CREI has given thousands of ambitious young men the technical knowledge that leads to more money and security. The time-tested CREI procedure can help *you*, too—if you really want to be helped. CREI lessons are prepared by experts in easy-to-understand form. There is a course of instruction geared to the field in which you want to specialize. You study at *your* convenience, at *your* rate of speed. Your CREI instructors guide you carefully through the material, and grade your written work personally (not by machine).

Industry Recognizes CREI Training.

CREI courses are prepared, and taught with an eye to the needs and demands of industry, so your CREI diploma can open many doors for you. Countless CREI graduates now enjoy important,

good-paying positions with America's most important companies. Many famous organizations have arranged CREI group training for their radio-electronics-television personnel. To name a few: All America Cables and Radio, Inc.; Canadian Aviation Electronics, Ltd.; Canadian Broadcasting Corporation; Columbia Broadcasting System; Canadian Marconi Company; Hoffman Radio Corporation; Machlett Laboratories; Glenn L. Martin Company; Magnavox Company; Pan American Airways, Atlantic Division; Radio Corporation of America, RCA Victor Division; Technical Appliance Corporation; Trans-Canada Air Lines; United Air Lines. Their choice for training of their own personnel is a good cue for *your* choice of a school.

Benefits Felt Right Away.



Almost immediately, you feel the benefits of CREI training. Your employer, when informed of your step toward advancement (only at your request), is certain to take new interest in you and in your future. What you learn in CREI Home Study can start helping you do a better job immediately.

- BROADCASTING
- TELEVISION
- MANUFACTURING
- COMMUNICATIONS
- SERVICING
- AERONAUTICAL ELECTRONICS



CREI also offers Resident Instruction

at the same high technical level—day or night, in Washington, D. C. New classes start once a month. If this instruction meets your requirements, check the coupon for Residence School catalog.

INFORMATION FOR VETERANS

If you were discharged after June 27, 1950—let the new G. I. Bill of Rights help you obtain resident instruction. Check the coupon for full information.

Get this fact-packed booklet today. It's free.

Called "Your Future in the New World of Electronics," this free illustrated booklet gives you the latest picture of the growth and future of the gigantic electronics world. It includes a complete outline of the courses CREI offers (except Television and FM Servicing) together with all the facts you need to judge and compare. Take 2 minutes to send for this booklet right now. We'll promptly send you your copy. The rest—your future—is up to you.



CAPITOL RADIO ENGINEERING INSTITUTE

Accredited Technical Institute Curricula • Founded in 1927

3224 16th Street, N. W.
Washington 10, D.C.

MAIL COUPON TODAY

Capitol Radio Engineering Institute

Dept. 112-B, 3224 16th St., N. W., Washington 10, D. C.

Send booklet "Your Future in the New World of Electronics" and course outline.

CHECK FIELD OF GREATEST INTEREST Practical Television Engineering Broadcast Radio Engineering (AM, FM, TV) Practical Radio Engineering TV, FM & Advanced AM Servicing Aeronautical Radio Engineering

Name.....

Street.....

City..... Zone..... State.....

Check— Residence School Veteran

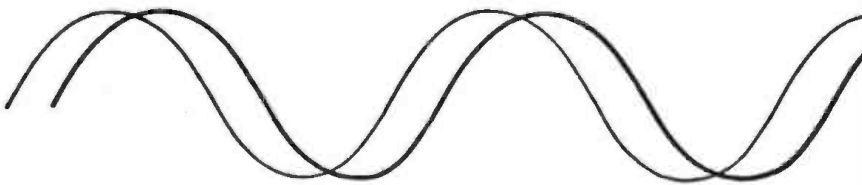
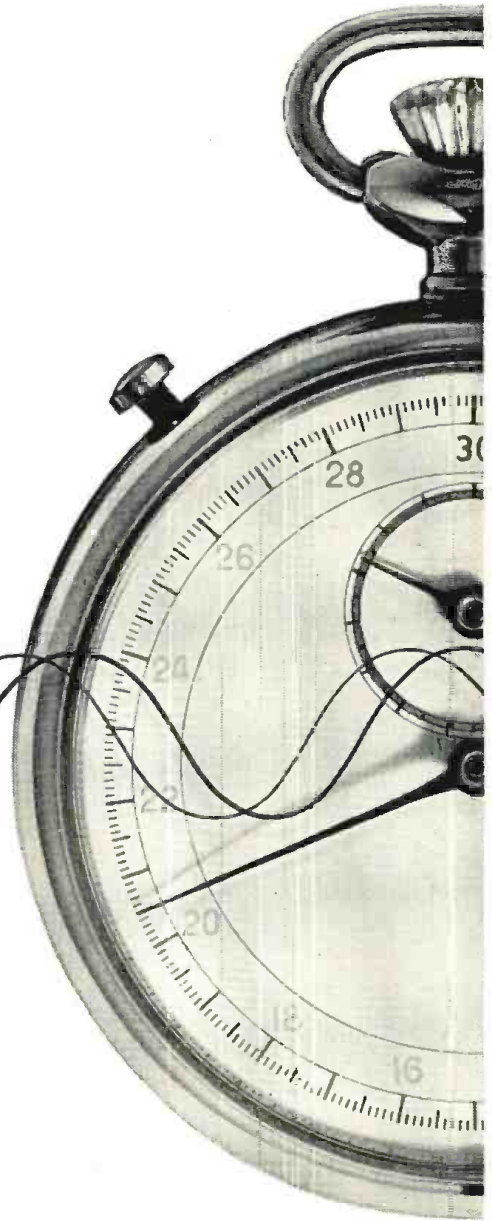

WHAT TIME IS GREEN?

In color television, the colors on the screen are determined in a special way. A reference signal is sent and then the color signals are matched against it. For example, when the second signal is out of step by 50-billionths of a second, the color is green; 130-billionths means blue.

For colors to be true, the timing must be exact. An error of unbelievably small size can throw the entire picture off color. A delay of only a few billionths of a second can make a yellow dress appear green or a pale complexion look red.

To ready the Bell System's television network for color transmission, scientists at Bell Telephone Laboratories developed equipment which measures wave delay to one-billionth of a second. If the waves are off, as they wing their way across the country, they are corrected by equalizers placed at key points on the circuit.

This important contribution to color television is another example of the pioneer work done by Bell Telephone Laboratories to give America the finest communications in the world.

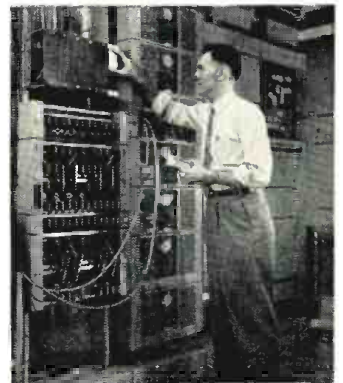

To keep colors true in television, signals must be kept on one of the world's strictest timetables. Equalizers that correct off-schedule waves are put into place at main repeater stations of the transcontinental radio-relay system.

BELL TELEPHONE LABORATORIES

IMPROVING TELEPHONE SERVICE FOR AMERICA PROVIDES CAREERS FOR
CREATIVE MEN IN SCIENTIFIC AND TECHNICAL FIELDS.



**It's New! 3 Years in Development
-NOW READY FOR YOU!**

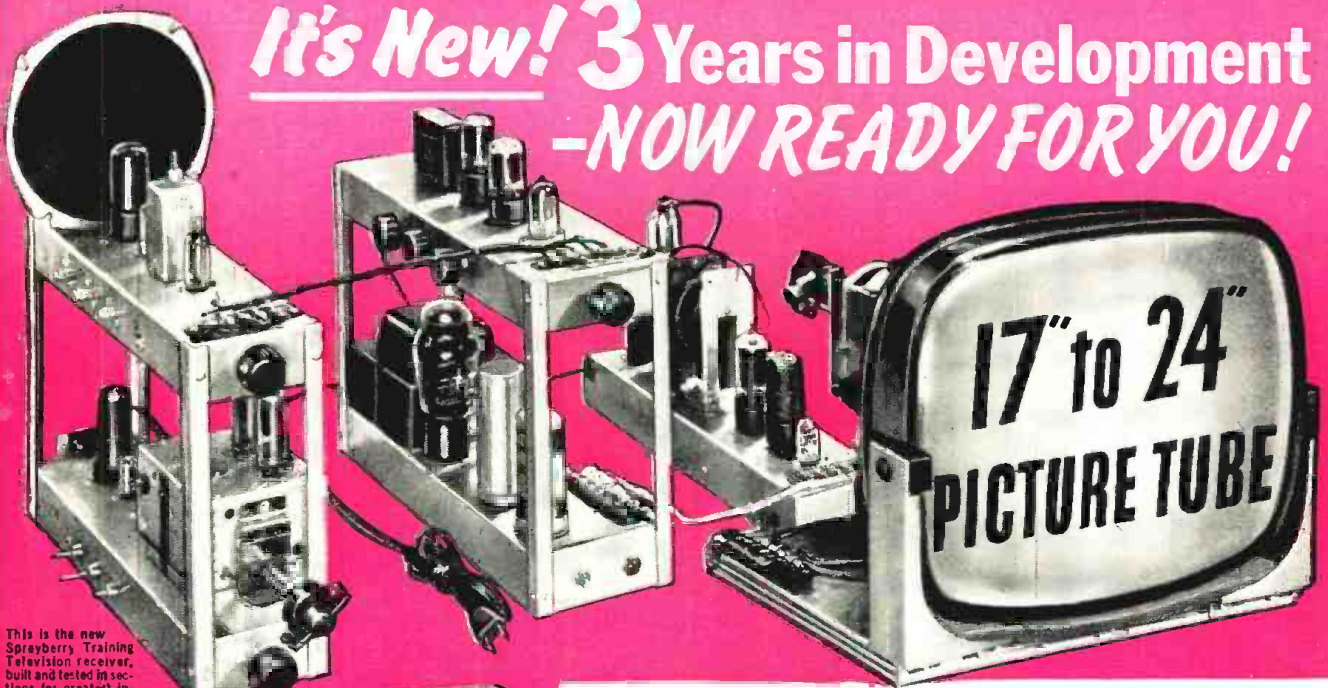

This is the new Sprayberry Training Television receiver, built and tested in sections for greatest instruction value.

**17" to 24"
PICTURE TUBE**

**New Equipment! New Lessons! Enlarged Course!
SPRAYBERRY PRACTICAL TRAINING IN**

RADIO-TELEVISION

3 NO OBLIGATION TRAINING PLANS

**You have NO MONTHLY PAYMENT CONTRACT to sign
... pay for this outstanding training as you learn!**



Frank L. Sprayberry
President, Sprayberry
Academy of Radio

The complete facts are so big and so important to any man seeking training in Radio-Television that I urge you to mail the coupon below at once for my big all-new 56 page FREE CATALOG and FREE Sample Lesson. Get the full story of this remarkable new and up-to-the-second Training Plan. You'll read about my 3 NO OBLIGATION PLANS or "packaged unit" instruction for both beginners and the experienced man. You'll learn how I can now prepare you in as little as 10 MONTHS to take your place in this fast moving big money industry as a Trained Radio-Television Technician. You'll see that you take no risk in enrolling for my Training because you DO NOT SIGN A BINDING TIME PAYMENT CONTRACT. I have been training successful Radio-TV technicians for 22 years . . . I can prepare you too, to get into your own profitable Service Shop or a good paying job, even if you have no knowledge of Radio-Television. Mail the coupon . . . I rush full information FREE and without obligation. (No salesman will call.)

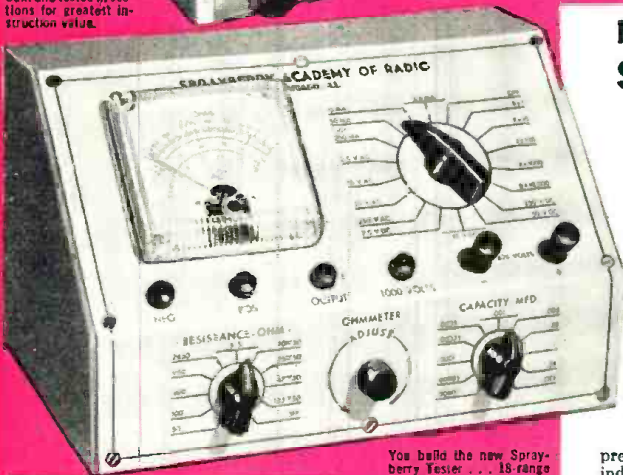

These photos show only a small part of the training equipment I send my students.

You build the new Sprayberry Tester . . . 18 range Vo I-Ohm-Milliammeter readings plus output meter and condenser and resistor substitution selector.

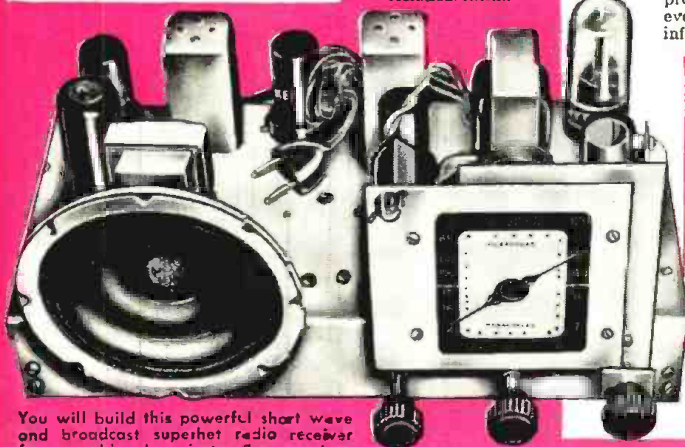

You will build this powerful short wave and broadcast superhet radio receiver for valuable shop instruction practice.

NEWEST DEVELOPMENTS

Your training covers U H F, Color Television, F.M., Oscilloscope Servicing, High Fidelity Sound and Transistors.

PRACTICE AND TRAIN AT HOME WITH 25 NEW KITS OF EQUIPMENT

You get valuable practical experience in construction, testing and shop practice. You build a powerful 2 band superhet radio, the all-new 18 range Sprayberry multimeter, the new Sprayberry Training Television receiver, signal generator, signal tracer and many other projects. All equipment is yours to use and keep . . . and you have practically everything needed to set up a Radio-Television Service Shop.

All your training is IN YOUR HOME in spare hours. Keep on with your present job and income while learning. I help you earn extra spare time money while you learn. If you expect to be in the armed forces later, there is no better preparation than practical Sprayberry Radio-Television training. Rush coupon below for all the facts—FREE!

SPRAYBERRY ACADEMY OF RADIO
111 NORTH CANAL STREET, DEPT. 25-U, CHICAGO 6, ILLINOIS

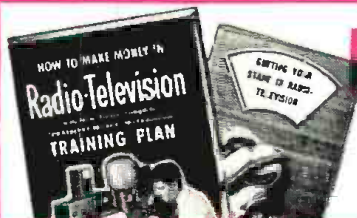

FREE CATALOG AND SAMPLE LESSON

Rush coupon for my catalog "How to Make Money in Radio-Television". PLUS an actual sample Sprayberry Lesson without obligation—ALL FREE. Mail coupon NOW!

SPRAYBERRY ACADEMY OF RADIO MAIL THIS COUPON FOR FREE
Dept. 25-U, 111 N. Canal St., Chicago 6, Ill. **FACTS AND SAMPLE LESSON**

Please rush all information on your ALL-NEW Radio-Television Training Plan. I understand this does not obligate me and that no salesman will call upon me. Include New Catalog and Sample Lesson FREE.

Name _____ Age _____

Address _____

City _____ Zone _____ State _____

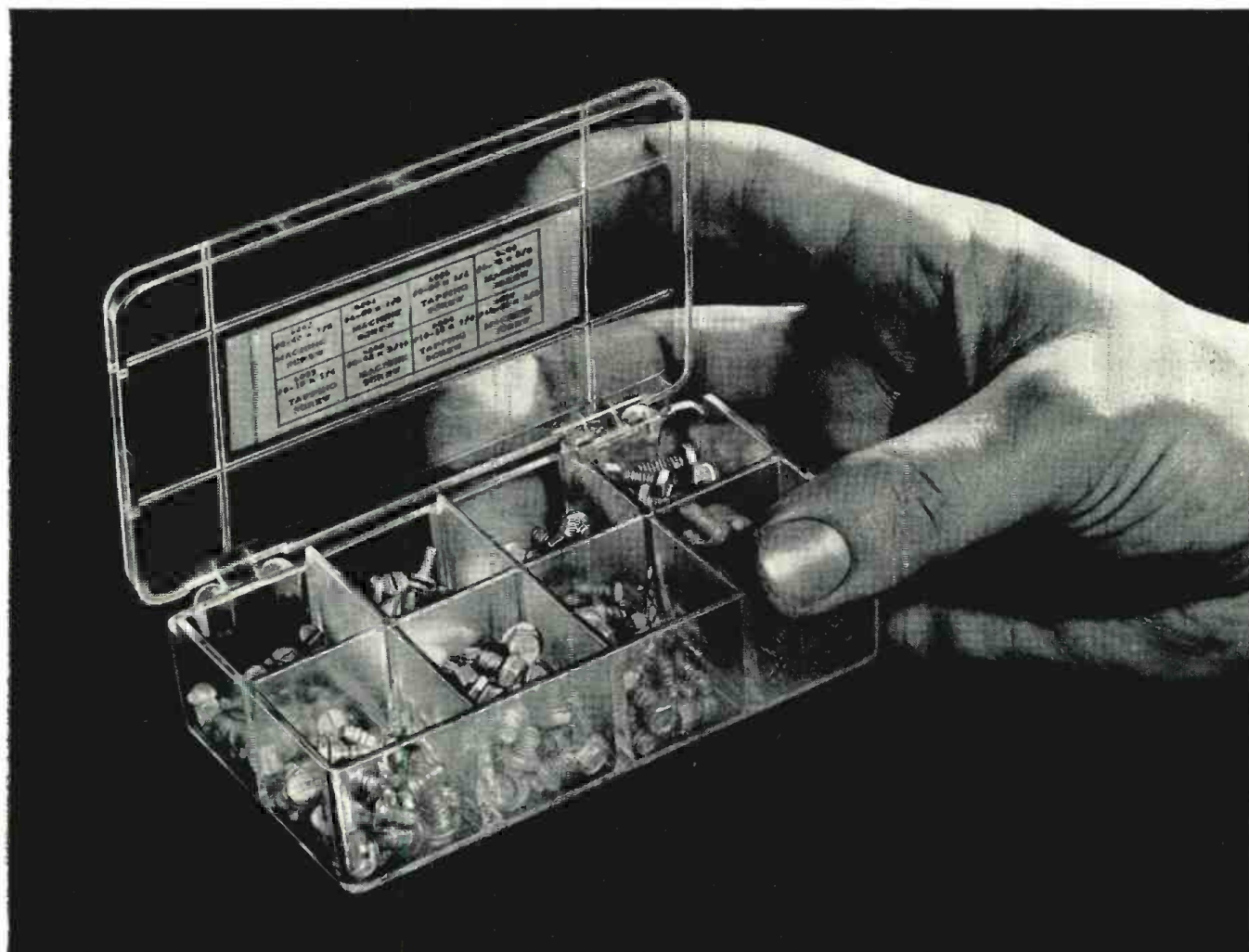

Now...Delco offers **POCKET-SIZE** kits that keep replacement hardware at your fingertips

**A GREAT NEW
CONVENIENCE
FOR AUTO RADIO
TECHNICIANS!**

For quicker, easier servicing of Delco auto radios, a large assortment of replacement hardware—from tuner bearings to case screws—is now available in *four* clear polystyrene kits.

There's no more fumbling in a dark drawer when you need a hardware replacement part. You can see it immediately in these transparent kits. And each part fits your repair need exactly.

A handy chart attached to the inside cover of the box shows the contents of each of the eight compartments—a convenience when ordering re-fills for the compartments in plastic bags.

You can obtain these convenient pocket-size kits through your UMS Delco Electronics Parts Distributor today.

A GENERAL MOTORS PRODUCT  A UNITED MOTORS LINE

DISTRIBUTED BY ELECTRONICS DISTRIBUTORS EVERYWHERE



DELCO RADIO

DIVISION OF GENERAL MOTORS, KOKOMO, INDIANA

Depend on the COMPLETE line of ROHN

"SUPERIOR DESIGN" towers and accessories

for **LARGER PROFITS** **MORE SATISFACTION** **GREATER EASE IN HANDLING**

3 added towers to solve ALL your needs

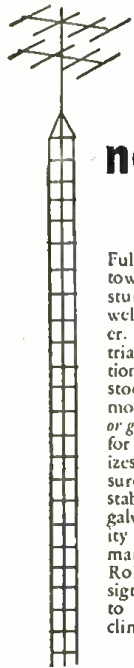

no. 6 tower

"All-Purpose" tower.

Fulfills 75% of your general tower needs—is structurally as sturdy—yet costs less than the well-known Rohn No. 10 Tower. Ideal for home and industrial installations, communication requirements... eliminates stocking many different tower models. Self-supporting to 50 ft. or guyed to 120 ft.! Easy to climb for fast, efficient servicing. Utilizes "Magic Triangle" which insures far greater strength and stability. Permanent hot-dipped galvanized coating. Dependability — a feature customers demand — is assured with the Rohn No. 6 Tower... designed to "stand up" for years to the rigors of weather and climatic conditions.



Package Tower

"Space Saver"—cuts storage space 300% or more!

Popular PT-48 has almost 50' of sturdy tower within a compact 8' x 20" package! "Magic Triangle" design is adapted to a pyramid shape using a wide 19" base with progressively decreasing size upward. Decreases your overhead... easy to transport and assemble—cuts shipping costs. Galvanized throughout. Available in heights of 24, 32, 40, 48, 50 and 64 feet!



no. 30 tower

Heights up to 200' or more when guyed
Self-supporting up to 60'

Sturdy communication or TV tower that "stands up" to all the stresses of weather and climatic conditions... will withstand heavy wind and ice loading. Heavy gauge tubular steel, electrically welded throughout. Weather resistant, non-corrosive double coating provides durable finish. All sections in 10' lengths. Only 2-4 manhours required for installing 50' tower!

also



ROHN Fold-over tower

For experimenters, TV service departments and retailers. Use this kit with regular Rohn tower sections. Simple and easy to use.

ROHN Telescoping Masts

Heavy-duty hot-dipped galvanized steel tubing and rigid joints give extraordinary strength. Quick installation... mast attached to base—antenna fixed, then mast hoisted quickly to desired height. Utilizes special clamp and guy ring arrangement. Flanged interior section; crimped exterior section gives mast stability that can't be beat. Complete with guy rings and necessary erection parts. In 20, 30, 40 and 50 ft. sizes. Bases and ground mounts available.



Both Towers Feature

THE ROHN MAGIC TRIANGLE

For structural superiority, famed wrap-around "magic triangle" design is featured in these all-steel towers. Towers have full 2 1/2" wide corrugated cross-bracing welded to tubular steel legs. The exclusive design assures dependable strength and permanence.

and a complete line of ROHN accessories—all galvanized

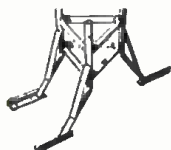

PEAK ROOF MOUNT

Heavy duty for quick, secure mounting of tower to top of peak roof. Flanges hinged, fastened to roof with 2 lag screws in each flange.

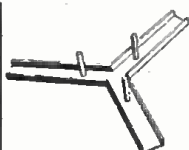

FLAT ROOF MOUNT

For all types flat surfaces. 3-1" solid steel projections permit first section of tower to be mounted directly on roof mount by inserting usual 3/8" bolts.

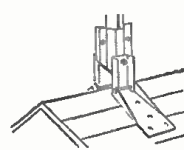

MAST BASES

Complete line of telescoping mast bases for every requirement, accommodating masts from 1"-2 1/4" diameter. Also available—drive-in mast bases.



MAST 'N' TV TUBING

Heavy-duty, hot-dipped galvanized steel tubing. Machined to perfection. Extra sturdy joints slotted for full, perfect coupling.

ALSO AVAILABLE

Rotator posts for mounting rotator to tower; House Brackets; Guying Brackets; UHF Side Arm Mounts; Mounts for Additional Antennae on a Tower; Erection Fixtures; Guy Rings; Installation Accessories; and dozens of other items!



PEAK and WALL MOUNTS

For mounting of mast or pole to roof or wall. Heavy-duty steel. Variable sizes. Models for most every need.



DRIVE-IN BASE

Set on top of ground... 3-4' drive rods driven through base into ground. First tower section secured to rods with single bolt in each leg. Instant erection.



SERVICE TABLE

Perfect answer for television servicing, display and storage. Truly one of the finest of its kind in economy price range.

For complete catalog and prices, see your authorized Rohn Representative or Distributor; or write or wire direct.

Designed and Manufactured Exclusively by **ROHN Manufacturing Company**

116 Limestone, Bellevue Peoria, Illinois

OPPORTUNITY AT RCA FOR BROADCAST FIELD ENGINEERS

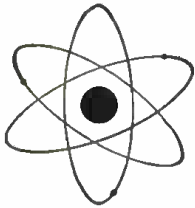

RCA needs trained broadcast engineers who can direct and participate in the installation and service of television broadcast equipment. Here's an *excellent* opportunity for training and experience with color TV transmitters.

CAN YOU QUALIFY ?

You need: 2-3 years' experience in broadcast equipment, including work on TV transmitter installation. You should have: EE degree or good technical schooling, 1st Class Radio-Telephone License.

Enjoy RCA advantages:

*Top Salaries
Many Liberal Company-Paid Benefits
Relocation Assistance*

For personal interview, please send a complete resume of your education and experience to:

**Mr. John R. Weld, Employment Manager
Dept. Y-2B, Radio Corporation of America
Camden 2, N. J.**



RCA SERVICE COMPANY, INC.
A Radio Corporation of America Subsidiary

Six months from today

Which Will You Hold?

this-

or this

REGRET TO ADVISE
YOU FAILED YOUR
FCC EXAMINATIONS -

1st CLASS
RADIO TELEPHONE-
OPERATOR'S LICENSE

Add Technical Training
To Your Practical Experience -
**GET YOUR FCC LICENSE
IN A HURRY!**

Then use our Amazingly Effective
JOB-FINDING SERVICE

Money-Making
FCC
Commercial
Radio Operator
LICENSE
Information

Get This
Valuable Booklet

TV ENGINEERING
INCLUDED IN OUR
TRAINING & COACHING

FREE!

● TELLS HOW -

Here Is Your
GUARANTEE

If you fail to pass your Commercial License exam after completing our course, we guarantee to continue your training without additional cost of any kind until you successfully obtain your Commercial license, provided you first sit for this examination within 90 days after completing your course.

WE GUARANTEE
TO TRAIN AND COACH YOU
AT HOME IN
SPARE TIME UNTIL YOU GET
YOUR FCC LICENSE

If you have had any practical experience—
Amateur, Army, Navy, radio repair, or
experimenting.

● TELLS HOW -

Employers make **JOB OFFERS** Like These
to Our Graduates Every Month

Letter from nationally-known Airlines: "Radio Operators and Radio Mechanics are needed for our company. Periodic wage increase with opportunity for advancement. Both positions include many company benefits such as paid vacations, free flight mileage allowance and group insurance."

Letter from nationally-known manufacturer: "We have a very great need at the present time for radio-electronics technicians and would appreciate any helpful suggestions that you may be able to offer."

These are just a few samples of the job offers that come to our office periodically. Some licensed radioman filled each of these jobs . . . it might have been you!

**HERE'S PROOF FCC LICENSES ARE OFTEN
SECURED IN A FEW HOURS OF STUDY WITH
OUR Coaching AT HOME in Spare Time.**

Name and Address	License	Time
Harry G. Frame, Box 429, Charlestown, W. Va.	2nd Class	13 Weeks
Charles Ellis, Box 449, Charles City, Iowa	1st Class	28 Weeks
Omar Bibbs, 1320 E. 27th St., Kansas City, Mo.	1st Class	34 Weeks
Kenneth Rue, Dresser, Wisconsin	2nd Class	20 Weeks
B. L. Jordan, Seattle, Washington	1st Class	20 Weeks

Carl E. Smith, E.E., Consulting Engineer, President
CLEVELAND INSTITUTE OF RADIO ELECTRONICS
DESK RN-73, 4900 Euclid Bldg., Cleveland 3, Ohio

An Approved
Member



● TELLS HOW -

Our Amazingly Effective
JOB-FINDING SERVICE
Helps **CIRE** Students Get Better Jobs

Here are a few recent examples of Job-Finding results:

GETS CIVIL SERVICE JOB

"Thanks to your course I obtained my 2nd phone license, and am now employed by Civil Service at Great Lakes Naval Training Station as an Engineering Specialist."
Kenneth R. Leiser, Fair Oaks, Md. Del., Meltenry, Ill.

GETS STATE POLICE JOB

"I have obtained my 1st class ticket (thanks to your school) and since receiving same I have held good jobs at all times. I am now Chief Radio Operator with the Kentucky State Police."
Edwin P. Healy, 264 E. 3rd St., London, Ky.

GETS BROADCAST JOB

"I wish to thank your Job-Finding Service for the help in securing for me the position of transmitter operator here at WCAE, in Pittsburgh."
Walter Kosechik, 1442 Bidge Ave., N. Braddock, Pa.

GETS AIRLINES JOB

"Due to your Job-Finding Service, I have been getting many offers from all over the country, and I have taken a job with Capital Airlines in Chicago, as a Radio Mechanic."
Harry Clare, 4537 S. Drexel Blvd., Chicago, Ill.

Your FCC Ticket is recognized by most employers in the
electronic field as proof of your technical ability

OURS IS THE ONLY
HOME STUDY
COURSE WHICH
SUPPLIES FCC-
TYPE EXAMINA-
TIONS WITH ALL
LESSONS AND
FINAL TESTS.



Get All 3 FREE

MAIL COUPON NOW

CLEVELAND INSTITUTE OF RADIO ELECTRONICS
Desk RN-73—4900 Euclid Bldg., Cleveland 3, Ohio
(Address to Desk No. to avoid delay)

I want to know how I can get my FCC ticket in a minimum of time. Send me your FREE booklet, "How to Pass FCC License Examinations" (does not cover exams for Amateur License), as well as a sample FCC-type exam and the valuable booklet, "Money-Making FCC License Information." Be sure to tell me about your Television Engineering Course. Please print clearly.

B

NAME
ADDRESS
CITY ZONE STATE

For prompt results, send airmail.
Special tuition rates to members of the U. S. Armed Forces.

**FREE 1955
EICO CATALOG!**
Tells you how to SAVE 50% on
your test equipment costs!

EICO
THE LARGEST MANUFACTURER OF ITS KIND IN THE WORLD

**KITS
INSTRUMENTS**

THE INDUSTRY'S MOST COMPLETE LINE OF KITS & INSTRUMENTS
1/3 MILLION EICO INSTRUMENTS IN USE THE WORLD OVER —
SAVE 50% — BUILD 'EM IN ONE EVENING... THEY LAST A LIFETIME

The Exclusive **EICO** Make-Good
GUARANTEE

Each EICO Kit and Instrument is neatly guaranteed by EICO and your
jobber in certain only selected quartz components. EICO guarantees to
repair any component which might become defective in normal use if
returned to the factory within 90 days of purchase.
EICO guarantees all kits, also actual according to EICO's included
instructions will operate as specified therein.
EICO guarantees service and calibration of every EICO Kit and Instru-
ment at the nominal charge specified in the instructions.

ELECTRONIC INSTRUMENT CO., INC.
Test Equipment Manufacturers
84 WITHERS STREET, BROOKLYN 11, N. Y.



NEW! #232 PEAK-TO-PEAK
VTVM with DUAL-PURPOSE
AC/DC UNI-PROBE (pat. pend.)
KIT \$29.95 WIRED \$49.95

NEW! #249 DELUXE
PEAK-TO-PEAK VTVM with 7 1/2"
METER & UNI-PROBE (pat. pend.)
KIT \$39.95 WIRED \$59.95



VACUUM TUBE VOLTMETER #221
KIT \$25.95 WIRED \$39.95
DELUXE VTVM (with 7 1/2" METER) #214
KIT \$34.95 WIRED \$54.95



R-C BRIDGE & R-C-L
COMPARATOR #950B
KIT \$19.95 WIRED \$29.95



MULTI-SIGNAL
TRACER #145
KIT \$19.95 WIRED \$28.95



DELUXE RF SIGNAL
GENERATOR #315
KIT \$39.95 WIRED \$59.95

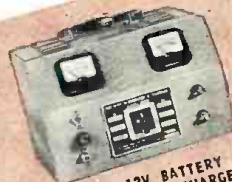

6V & 12V BATTERY
ELIMINATOR & CHARGER
#1050
KIT \$29.95 WIRED \$38.95



NEW! #944 FLYBACK
TRANSFORMER & YOKE
TESTER
KIT \$23.95 WIRED \$34.95



RF SIGNAL GENERATOR #320
KIT \$19.95 WIRED \$29.95



TV/FM SWEEP GENERATOR #360
KIT \$34.95 WIRED \$49.95

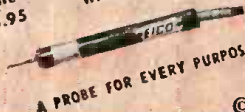

A PROBE FOR EVERY PURPOSE

© 54

EICO

See the famous EICO line at your jobber today
SEND FOR FREE CATALOG R-2
ELECTRONIC INSTRUMENT CO., Inc.
84 Withers Street • Brooklyn 11, N. Y.
Prices 5% higher on West Coast



5" PUSH-PULL OSCILLOSCOPE #425
KIT \$44.95 WIRED \$79.95
NEW! #470 7" PUSH-PULL OSCILLOSCOPE
KIT \$79.95 WIRED \$129.50

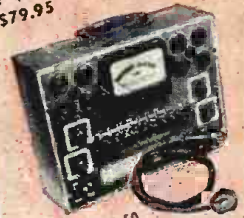

CRA #450 \$4.50
TUBE TESTER #625
KIT \$34.95 WIRED \$49.95



20,000 Ohms/Volt
MULTIMETER #565
KIT \$24.95 WIRED \$29.95



1,000 Ohms/Volt
MULTIMETER #536
KIT \$12.90 WIRED \$14.90

TV SERVICING

VIA

TEST POINTS

By **WALTER H. BUCHSBAUM**

Television Consultant
RADIO & TELEVISION NEWS

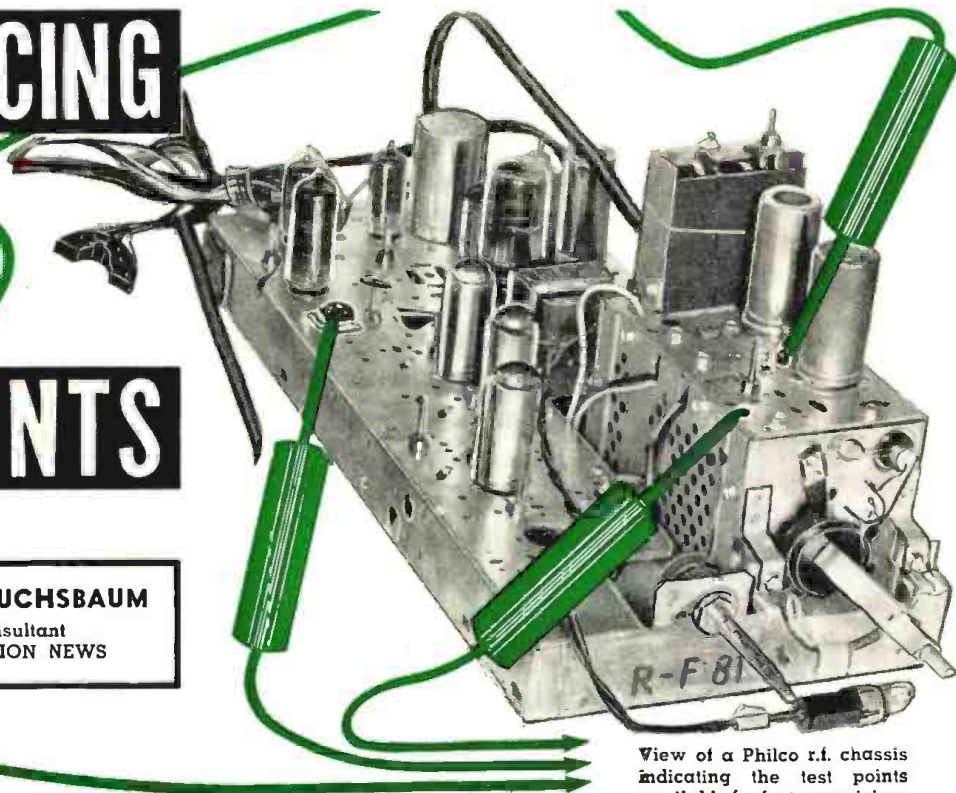

View of a Philco r.f. chassis indicating the test points available for faster servicing.

For faster TV servicing in the home and the shop, and for more accurate estimates, use chassis test points.

THE TV technician has, when checking a defective set, certain check points available which give him an indication of at least the section of the receiver where the defect lies and some idea as to the complexity of the job.

In older TV receivers, few "hot" points were accessible at the top of the chassis or could be reached without removing the chassis from the cabinet. The latest model TV receivers, however, have either a chassis design which makes much of the circuitry accessible from the back of the cabinet or else they use certain test points brought out to sockets, plug-in adapters, etc. The vertically-mounted chassis is a "natural" for allowing simple tests to be made with the set in the cabinet. Another type of receiver suitable for such testing is one which uses printed wiring.

Where none of these features is found, it is possible to perform many checks with the chassis in the cabinet by using tube socket adapters, such as the series currently made by *CBS-Hytron*. These adapters are plugged into the tube socket and then the tube is plugged into the adapter. Each tube pin connects to a little terminal on the periphery of the adapter making the various tube-pin voltages and signals available for test purposes while the set is operating with all of its tubes.

As every technician knows, it is most efficient, both for the customer and the service technician, to perform a repair right in the home, if it is at all pos-

sible. Certainly it is important to be able to tell the set owner directly and positively if it is necessary to pull the set out and take it to the shop and also to give him an estimate on the spot as to the repair cost. Troubleshooting a TV set in the home by the use of test points determines quickly where the defect can be.

Most of the test instruments used for such servicing already are part of the standard equipment carried by most TV service technicians on house calls. The first item which is absolutely necessary is a good vacuum-tube voltmeter. This meter should have voltage ranges from 0 to 5 volts up to about 1000 volts. In addition, several ohmmeter ranges should also be available and a bleeder type high-voltage probe should be taken along for high-voltage tests.

TV technicians don't usually pay much attention to the type of test prods they use. Frequently, the meter leads end in alligator or crocodile clips or else in broken off test prods which have been resoldered, etc., until their test points are not very reliable. For efficient troubleshooting in the home, a choice of test prods, preferably of the type that can be plugged into each other, is recommended. One particularly useful type of test prod which allows both clipping on to a wire and plugging into a socket hole is sold under the tradename "*Klipzon*."

Although an oscilloscope is not generally carried on outside calls, for efficient troubleshooting by the method

outlined here a small scope would come in very handy. With both scope and v.t.v.m. several special probes should be carried. A probe using a 1-megohm series resistor is essential for measuring voltages and observing signals without loading down the circuit. Another useful probe is a crystal detector and filter for measuring r.f. An adjustable-type voltage regulator will also come in handy in low line-voltage cases.

The last group of items needed, other than usual hand tools, is the tube socket adapters mentioned before. It is usually sufficient to carry one adapter each for 7-pin, 9-pin, octal, and loctal tube sockets. The economy-minded service technician can make his own adapters by connecting a male and female tube socket together with bus bar and providing little solder lugs for each pin at the female end of the adapter.

Isolating the Section

For operational and troubleshooting purposes, any TV receiver is usually divided into certain sections as shown in Fig. 1. Trouble in a particular section can be isolated and then the guilty component in that section located. Before each section is examined in detail, however, certain symptoms give a definite clue as to the trouble area. For example, if the picture is good, but no sound is heard, the defect obviously will not be due to some component in the deflection circuit. We would look first in the sound section. Similarly, if there is no raster but good sound, there would be little point to troubleshooting the sound section.

ratio detector circuit are available at the test socket.

3. Measure d.c. voltage at the detector output. As the station is switched, the voltage should drop. Adjusting the fine tuning control should also have some effect on the d.c. output of the FM detector. If no detector output is observed, the defect probably lies in the i.f. or limiter stage. Replacement of these tubes may clear up the trouble. If not, the set has to be taken to the shop for detailed troubleshooting.

Locating Complex Troubles

Up to now we have only considered the use of test points for locating troubles of a very basic nature. Although the test-point method is not always as decisive and rapid in more complex cases, it will often give a very good indication of the trouble area and, frequently, may even allow a quick repair on the spot.

Many intermittent defects are found to be due to line voltage variations, made worse by low "B+" or weak tubes in some sections. Whenever such a possibility is indicated, connect the receiver to a line-voltage regulating transformer and measure the "B+" at the test point or through an adapter at the "B+" rectifier. Where selenium rectifiers are used, the "B+" voltage is not accessible from the top of the chassis in some instances and then it is possible to get at this voltage at the screen of the audio output tube or some similar point.

Another access point for "B+" voltage is shown in Fig. 5, the power supply connections for the RCA model 21S519N chassis. Here the octal plug connecting the deflection yoke to the main chassis also acts as "B+" interlock and by inserting an adapter at this point, the "B+" as well as the rectifier voltage can be readily measured.

For locating intermittent defects due to voltage variations, adjust the line voltage regulator to 117 volts and check the "B+" voltage. Next, reduce the line voltage to 95 volts and again measure the "B+". This corresponds to about a 20 per-cent reduction in voltage and should be accompanied by a 20 per-cent reduction in "B+". In other words, a 250 volt "B+" supply at 117 volts a.c. line voltage should give about 200 volts for 95 volts a.c. When the "B+" drops much lower than that, say to 160 volts, the rectifier tubes are probably weak and should be replaced.

Unstable horizontal or vertical sync is not always due to bad tubes in the sync separator or the sweep section, but can be caused by a defect in the video or i.f. section. To determine this quickly without removing the chassis, just measure or better still observe, the video signals at the detector test point.

In addition to the voltage measurements, many defects can be located by ohmmeter measurements directly at the accessible test points. One good

example is the tracing of a "B+" short. Measuring between the "B+" test point and ground with an ohmmeter will show a momentary short and then an increase in resistance until at least 5000 ohms are measured. If the final resistance is measured at once without this charging up, the electrolytic capacitors are open or disconnected. If a short or a very low resistance is measured, one of the capacitors is shorted. Referring back to Fig. 5, we can determine which of the two capacitors is shorted by measuring first at pin 7 and then at pin 1. If we read zero resistance at pin 7 and 60 to 100 ohms at pin 1 then the filter input capacitor, 80 μ fd., is shorted. If the readings are the opposite, chances are that the output capacitor, 100 μ fd., is shorted, although the short could be in some other part of the "B+" bus.

Finding Test Points

The method of quickly locating troubles in the home by using test points above the chassis can be extended by the ability of the individual service technician. A great deal depends on the availability of such test points at the TV set, and many manufacturers have come to recognize the need for these points on their latest model receivers. Of course, many manufacturers have made provisions for test points for quite a while.

In color TV the design slate is still fresh and a good start has been made by the major manufacturers to include accessible test points. The *Motorola* 19-inch color receiver uses a 5-prong test receptacle which makes the video detector signal, a.g.c. bias, heater, and two "B+" voltages available to the service technician. Similarly, the *CBS-Columbia* 19-inch color set also has a test socket mounted on the back of the chassis featuring the same voltages as their monochrome receiver test point of Fig. 4.

The best known test point probably is the one found on most v.h.f. TV tuners and which is used for alignment of the r.f. stage. Similar points are also used on u.h.f. tuners.

In the *Emerson* model 760 three important test points are located on the top of the chassis. These are shown in Fig. 6. The two points brought out for the horizontal oscillator coil serve to short circuit this coil during adjustment of the horizontal balance control. During that process the grid of the preceding control triode is grounded. Another test point brought out in the *Emerson* models is the video detector output.

In the 1954 and 1955 *General Electric* TV receivers using printed circuits, a total of 10 test points has been designated, all accessible from the back. These allow very extensive troubleshooting without having to remove the chassis. These points are listed below and are all part of the printed wiring:

1, Converter grid (tuner); 2, 1st i.f. grid; 3, sync amplifier grid; 4, video-detector output; 5, kinescope grid; 6,



Fig. 3. Waveform at the grid of the horizontal output amplifier tube of a TV set; its amplitude is 40 to 60 volts.

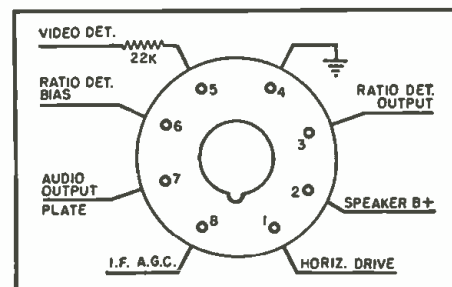

Fig. 4. Detailed drawing of the test socket shown on the chassis in Fig. 2.

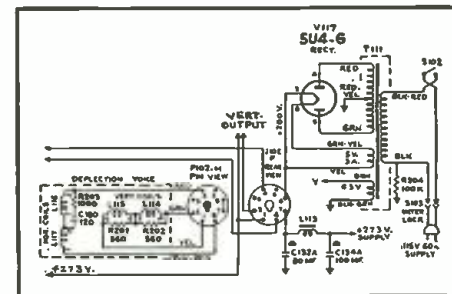
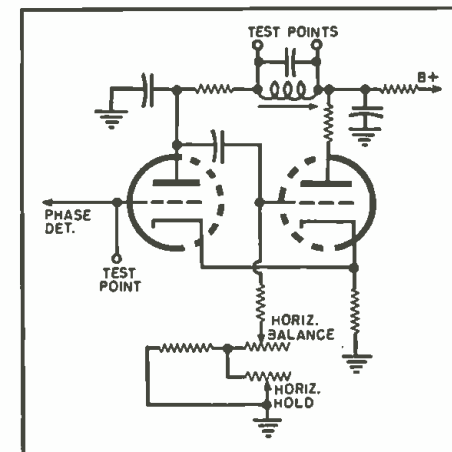

Fig. 5. Typical low-voltage power supply circuit of a television receiver.

limiter grid; 7, ratio-detector output; 8, a.g.c. to i.f. section; 9, sync amplifier plate; and 10, a.g.c. to tuner.

A note of caution should be included here as concerns working with printed wiring. Do not use any sharp test prods, and avoid scratching or forcing
(Continued on page 86)

Fig. 6. The circuit location of three important test points for the horizontal oscillator circuit of Emerson sets.





Over-all view of SWL preselector.

A PRESELECTOR FOR THE SWL

By
R. W. MYERHOLTZ

A single 6AK5 tube is used in a tuned grid amplifier circuit. It covers 5.5 to 21 mc.

THE SWL using one of the less expensive receivers which does not have an r.f. amplifier stage misses a lot of interesting "contacts" simply because his receiver lacks sufficient sensitivity to "pull in" the many weak signals he encounters. A preselector used ahead of the receiver, however, will boost many of those barely readable signals to the "loud and clear" classification.

The preselector described herein consists of a single tuned stage of r.f. amplification which amplifies the signal from the antenna before it is presented to the mixer tube of the receiver. The frequency range of 5.5 to 21 mc. covers the wavelengths used by the principal short-wave stations of the world as well as the 40, 20, and 15 meter amateur bands.

Circuit Description

A single 6AK5 is used in a straightforward tuned grid amplifier circuit. A tuned grid—tuned plate circuit would undoubtedly have greater selectivity, but the need for ganged tuning capacitors and an additional set of coils would increase the cost, necessitate a larger cabinet, and introduce a tracking problem.

Instead of using choke-capacitor coupling to the receiver, it is possible to connect the primary of the receiver antenna coil directly into the plate circuit of the 6AK5. The choke-capacitor coupling, however, has the advantage that it may be employed with receivers not designed for use with doublet antennas without digging into the receiver to unsolder the grounded end of the primary winding. Furthermore, one will not be breaking the 6AK5 plate circuit each time the re-

ceiver bandswitch is turned, an act which might eventually lead to fouling of the bandswitch contacts.

A self-contained power supply was used to make the unit completely independent of the receiver with which it is employed. Transformer operation was chosen in order to permit operation with a.c.-d.c. receivers without the problem of wondering which way to insert the line plug and the coincident danger of a "hot" chassis. Since the current drain of the 6AK5 heater is considerably less than the rated value of the transformer filament winding, the filament voltage was a little too high. To reduce it to a more suitable value, a 3.3-ohm resistor was inserted in one lead.

A 10,000-ohm wirewound potentiometer in the cathode circuit provides a means for reducing the gain to prevent cross modulation effects when strong signals are encountered. The 10-ohm resistor, R_1 , was found to be necessary to prevent oscillation under certain tuning conditions when the gain was run "wide open."

A three-lug terminal strip permits the use of a doublet or single wire antenna. In the latter case it is only necessary to connect a jumper between two of the lugs as shown by the dotted line in the schematic diagram. One position of the selector switch is used for "straight-through" operation with single wire antennas, permitting the unit to be bypassed when it is desired to tune the receiver to frequencies not covered by the preselector. Two other positions are used for bandswitching, while the two remaining positions are unused.

With the coils wound according to the data given in the parts list, the

first band should cover about 5.5 to 11 mc. and the second, 10 to 21 mc. Slight differences in distributed capacitances arising from arrangement of leads and parts different from those used by the author may alter the coverage somewhat. If it is desired to raise the upper frequency limit, simply remove one-half to one turn from the grid winding. To lower the frequency limit, the reverse applies.

Since the tuning action of the preselector is somewhat broad, the vernier action of the MCN dial permits sufficiently precise adjustment of the tuned circuit at the lower frequencies. At the upper end of the frequency range, however, stations will be crowded closer together on the dial and the bandspread action of C_2 permits more critical peaking of the signal being received.

Construction

A 6" x 6" x 6" aluminum utility cabinet houses all of the components without undue crowding. A sheet aluminum "deck" mounted 2 $\frac{1}{2}$ inches from the bottom edge of the cabinet serves as a chassis and provides good shielding between components mounted above and below it. The paint on the inside of the cabinet should be scraped away to permit good electrical bonding between the chassis and cabinet.

Before fashioning the deck, the inside dimensions of the cabinet should be carefully measured in order to assure a snug fit. It will be necessary to file a shallow notch in two corners of the deck in order to clear overlapped portions of the cabinet sides. Since the dial mechanism extends behind the panel, C_1 was mounted on an "L" bracket attached to the deck. C_2 ,

however, was mounted directly on the panel.

Incidentally, for those who find sheet aluminum for construction purposes difficult to obtain, the author suggests the use of aluminum cookie sheets available in most department stores.

The Mallory 177C ceramic selector switch is modified by placing a shield between the two gangs to prevent coupling between the input and output circuits. The procedure is quite simple. First remove the nuts and lock washers holding the last gang in place. By removing the cotter pin at the shaft, this gang may now be slipped off. Discard the two spacers found on the screws. In their place thread two 6-32 nuts onto each screw. A piece of sheet aluminum drilled to clear the two screws and the shaft is then slipped on, followed by two more nuts to act as spacers. The last gang is then replaced. A small shield should also be fashioned to straddle the tube socket in order to isolate the input and output circuits of the tube.

The coils are wound on Millen $\frac{3}{4}$ inch forms and mounted with 6-32 screws. It is important that the grid and antenna windings be wound in the same direction. The primary windings should be spaced $\frac{1}{8}$ inch from the secondary in both coils. After the coils are wound, they should be coated with coil dope to keep the turns rigidly in place. Lacking coil dope, clear fingernail polish will make a good substitute.

The coils may be wound more neatly if one end of the necessary length of wire is first clamped in a vise and the wire is then stretched about $\frac{1}{4}$ inch with a pair of pliers. This will serve both to remove kinks and to stiffen the wire for easier winding.

Below chassis view of preselector. Note particularly the metal shields across the tube socket and between switch sections.

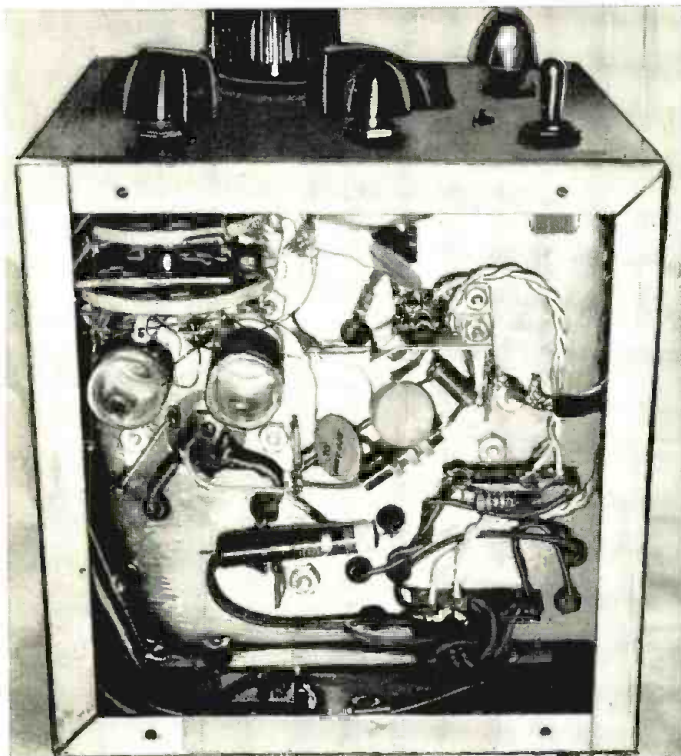

February, 1955

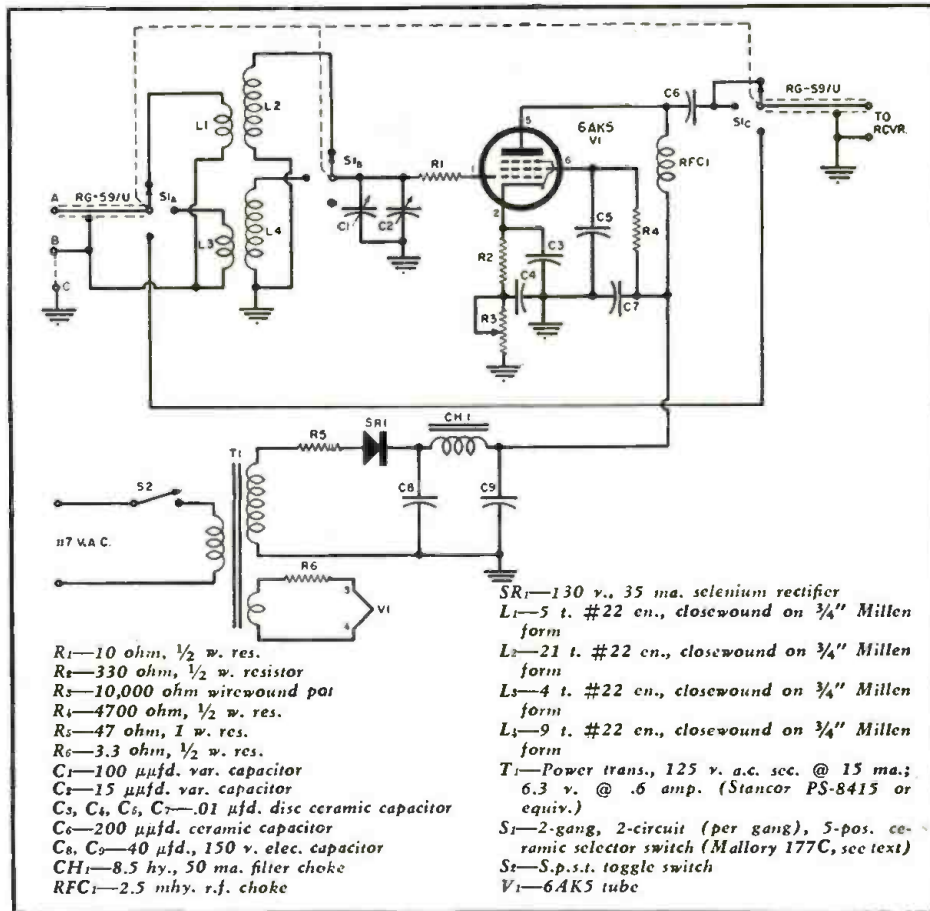

As shown in diagram, ϕ 6AK5 is the only tube required in assembling this unit.

In wiring the unit one should follow the usual practice of keeping all leads as short as possible and taking care to keep grid and plate leads well separated. Be sure to twist together the filament leads from the transformer to pins 3 and 4 of the 6AK5, as well

as the leads to the "on-off" switch. This will prevent the pickup of a.c. hum by other nearby wiring.

All grounded leads in the r.f. portion of the circuit should be grounded at a common point to prevent ground (Continued on page 106)

Top view of the preselector showing general layout of major components. The actual assembly is simple and straightforward.

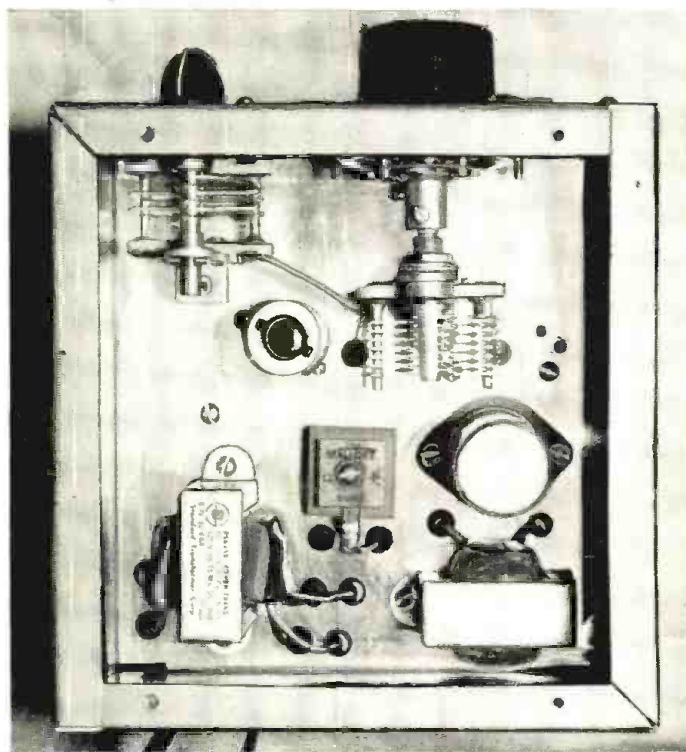

"MOBILE METER" OF MANY USES

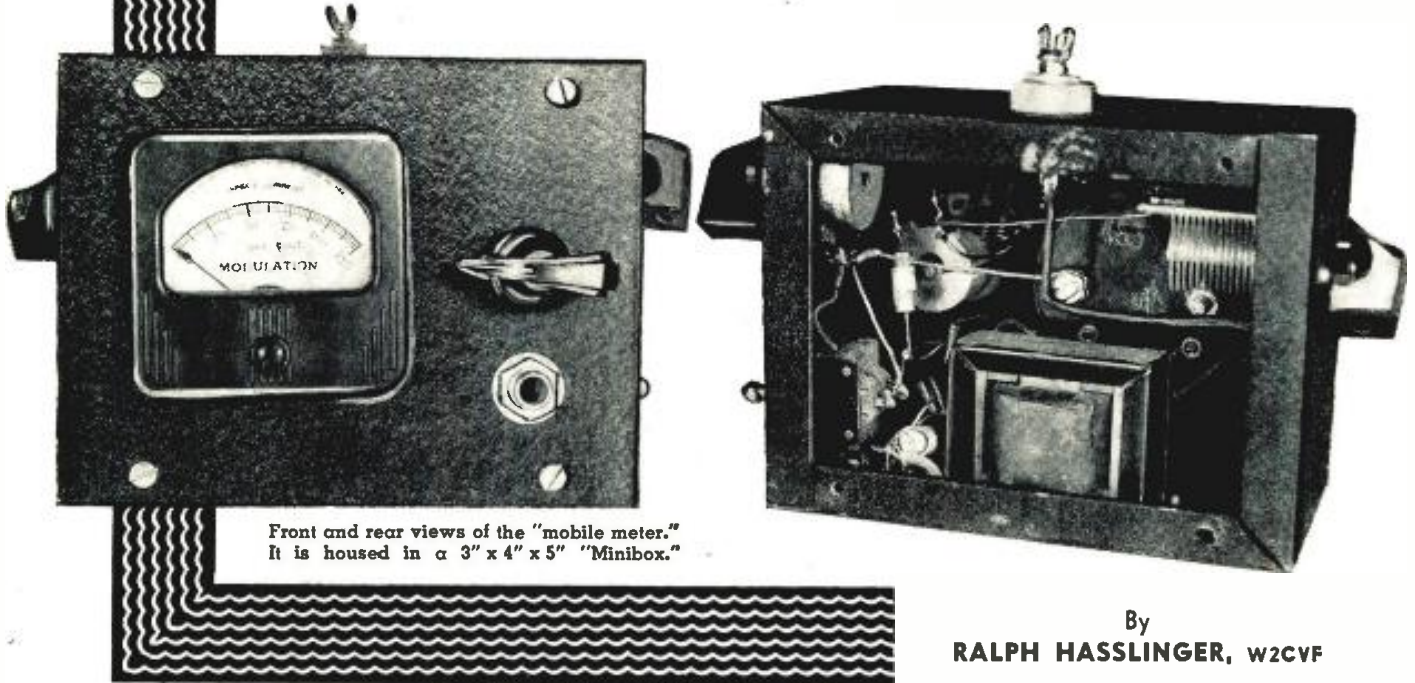

Front and rear views of the "mobile meter."
It is housed in a 3" x 4" x 5" "Minibox."

By
RALPH HASSLINGER, W2CVF

ONE of the major problems in mobile operation, where the transmitter is located in the trunk, is the question of knowing up front, just what is going on in the transmitter behind.

The dash-mounted meter to be described was constructed to solve this problem and has done an excellent job for mobile W2CVF. It indicates r.f. (field strength), reads modulation directly in per-cent, monitors the transmitted voice with headphones, and can even be used as an "S" meter—no more reporting—"if I had an 'S' meter in the car you'd be S9."

The main feature is its ability to read modulation directly in per-cent. Mobile operation, with its high noise level from both ignition and mechanical sources, makes high level modulation mandatory. The writer attributes his success in working 10-meter mobiles all over the New York metropolitan area, up into Connecticut and out on Long Island, from the home station in West Englewood, mainly to the high level of modulation maintained. Although the power is only 75 watts and the location is average, the modulation is kept at a high level with the aid of a large 5" modulation meter directly in front of the operating position. It is regrettable that the outputs of crystal mikes change under humid conditions and carbon granules tend to pack.

The intelligence in voice transmission is in the modulation, not the carrier. A 10-watt carrier, 100% modulated will get through better than 100 watts, 50% modulated. With the transmitter located out of sight, modulation percentage becomes mere guesswork unless some type of indicator is used.

The circuitry of the instrument to be

Details on a useful instrument which reads modulation directly in per-cent, acts as an audio monitor using headphones, as a field strength meter, a carrier shift indicator, a calibrated receiving "S" meter, as well as a 0-12½ or 0-1250 volt direct-current voltmeter.

described is ordinary, being that of the usual field strength meter, which all of us have constructed at one time or other, with an added audio rectifier circuit for the modulation metering.

The audio transformer enables the audio portion to function with less r.f. energy input. The particular nondescript transformer used came out of the junk box, but any interstage audio transformer can be used. It should be noted that the primary and secondary windings are reversed in the circuit.

One of the first requirements of a dash mount instrument is that it be as small as reasonably possible. A 3"x4"x5" standard black box was selected to house the 2-inch 1 ma. meter which we happened to have on hand. The meter, M_1 , frequency tuning capacitor C_2 , and monitoring jack J_1 are mounted on the 4"x5" cover. Before mounting the meter, the meter case should be removed and 25, 50, 75, 100, and 125 marked over the .2, .4, .6, .8, and 1, which appear on the scale. A neater and more commercial looking job can be done by cutting these numbers out of the text of any handbook and pasting them in place with rubber cement.

The tuning coil is mounted directly on the capacitor terminals. These components are wired before placing the cover on the box. Two 5" pieces of

wire should be soldered to the ungrounded terminals of the jack to be connected in the circuit when the cover and box is finally assembled.

The "S" meter and voltmeter feature, involving components J_2 , J_3 , J_4 , J_5 , P_1 , S_2 , and R_2 were not incorporated in the unit pictured. If desired, these can be added and parts can be mounted on the side panel.

L_1 - C_2 should be capable of tuning to the transmitted frequency. Coil details on L_1 are given only for the ten meter band. If the transmitter is to be operated on other bands it will be necessary to make L_1 a plug-in coil, or coil switching may be used for multi-band operation.

To calibrate the modulation meter it will be necessary to use a scope or a transmitter with a meter that has already been calibrated.

Place the meter near the transmitter. Attach a short piece of wire (about 3 or 4 feet) to the pickup terminal on the meter. S_1 should be set for r.f. reading. R_1 should be adjusted to have about 30,000 ohms in the circuit. C_1 and C_2 should be set at minimum capacity.

Turn on the transmitter and tune C_2 for resonance as indicated by maximum meter reading. Increase C_1 capacity and retune C_2 and keep repeat-

ing until the meter reads 100 at resonance. Throw S_1 to audio position and modulate transmitter to 100% as shown on the scope, or previously calibrated meter.

If the meter being calibrated reads low, the resistance at R_1 is too low and should be increased. If the meter reads too high, resistance R_1 is too high and should be decreased. Each time R_1 is changed S_1 should be changed back to the r.f. position and r.f. coupling tuning procedure should be repeated to obtain a 100% reading with C_2 tuned to resonance.

When R_1 has finally been set it should never be changed. If no accurate means of calibration is available, the meter may still be used as an arbitrary modulation indicator.

If the meter is also to be used as an "S" meter R_1 should be replaced with a fixed carbon $\frac{1}{2}$ watt resistor of the same resistance obtaining in the calibrated circuit. The mounting hole for R_1 may now be used to mount R_2 .

"S" Meter

The a.v.c. action of the car broadcast receiver furnishes the basis for using this instrument as a direct reading "S" meter. The a.v.c. negative i.f. grid voltage is developed in proportion to the strength of the signal received. As the bias increases, the i.f. plate current decreases.

It will be necessary to open the cathode circuit of the car radio i.f. tube. A jack mounted on the car b.c. receiver and connected as shown in the diagram will not inactivate the car receiver when the "S" meter is not plugged in.

The meter should be calibrated as follows: Cut out a strip of blank index card to fit the glass contour of the meter above the needle point, and paste to outside face of glass. Set S_1 at "S" position. Set R_2 at dead short. Plug the meter into the car's broadcast receiver. Remove antenna from converter to obtain a no-signal, no-noise condition. Back off on R_2 until meter reads full scale. This will be "S" zero.

If converter does not have an r.f. gain control it will be necessary to temporarily insert some means of controlling the amount of signal at the converter antenna terminal. This can be accomplished by an input circuit pot.

Tune in a friend's signal—one who can vary his transmitter on a 1 to 4 power ratio. The amount of power is immaterial, it can be $\frac{1}{4}$ watt to 1 watt, or 250 watts to 1000 watts. However, the lower the power the closer one will have to be to the transmitter.

For explanatory purposes we will assume that the transmitter power will be 25 and 100 watts. Proceed as follows:

1. Transmitter at 25 watts. Adjust converter input gain control so that meter shows a slight deflection from "S" zero. Mark S_1 on the scale at this point.

2. Transmitter power increased by

four times to 100 watts. Needle will move up. Mark S_2 at this needle position.

3. Transmitter power 25 watts. Needle will return to S_1 . Increase r.f. gain control on converter so that the needle will rest where you have marked S_2 .

4. Transmitter power 100 watts. Needle will again move up. This should be marked S_3 .

5. Transmitter power 25 watts. Increase converter r.f. gain control so needle points to S_3 .

6. Transmitter power 100 watts. Needle will move up again. This will be S_4 .

Continue this procedure until entire scale is calibrated. When completed the meter will be a really accurate one, with each S unit equaling 6 db or four times power—the generally accepted standard. Also it will be accurate, 6 db to the S unit, regardless of frequency or band being tuned by converter!

Any signal generator or oscillator that can be varied on a 1 to 4 power ratio may also be used with the aforementioned instructions still obtaining.

The r.f. or antenna input control may now be removed from the converter if it was a temporary addition. In my own installation I would not be without the r.f. gain control. It enables working mobiles or fixed stations in close proximity without having the front end of the converter blocked.

Most commercial receiver "S" meters indicate nothing more than arbitrary readings. If you have no means of calibrating in this manner arbitrary "S" markings maybe employed, but when the other chap increases power it's nice to be able to tell approximately how much before he tells you. Also if he makes a change of antennas, or what have you, it is invaluable to know just how much change in

power it would take to make an equal change in signal strength. This cannot be done unless the meter is accurately calibrated.

Mounting in Car

The meter should be mounted, and case grounded, on the dash as nearly in front of the driver as possible in order to avoid the necessity of taking eyes off the road. A source of r.f. pick-up will be necessary of course. In most cases this may be left to experimentation, however a surefire method is to run a small wire in close proximity to the base of the whip. A slight amount of coupling only, will be necessary.

After you have used this instrument in your car a short time you will wonder how you ever operated without it.

While this instrument was designed primarily for mobile service it also makes an excellent fixed station or portable meter.

For those who desire a final touch, positive or negative peaks may be read by the addition of another d.p.d.t. switch inserted to reverse the audio transformer connections of either the primary or secondary.

A pin jack and 1.25 megohm resistor may be connected in series with the positive terminal of the milliammeter to read the percentage scale as d.c. volts X 10. To operate as a d.c. voltmeter, however, S_2 must have a neutral position and be so set or damage to the instrument will result.

If battery negative is grounded, a 12,500 ohm resistor may also be used to obtain a $12\frac{1}{2}$ v. full-scale reading.

With the voltmeter feature, generator input and output voltages may be checked, as well as general receiver and transmitter voltages.

Many other uses for this multipurpose instrument will undoubtedly come to mind.

Schematic diagram covering the "mobile meter." If the meter is to be used as a voltmeter, S_2 must have an "open center" position. Low voltage reading cannot be used if the car's battery positive terminal is grounded. See discussion in text.

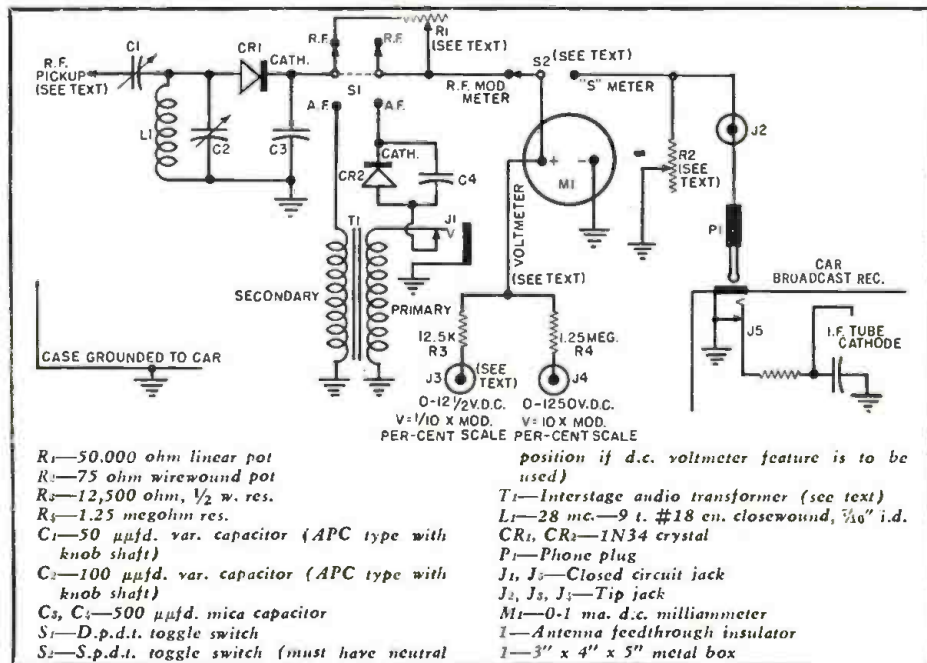

A 60-WATT "ULTRA-LINEAR" AMPLIFIER

By
DAVID HAFLER
Acro Products Company

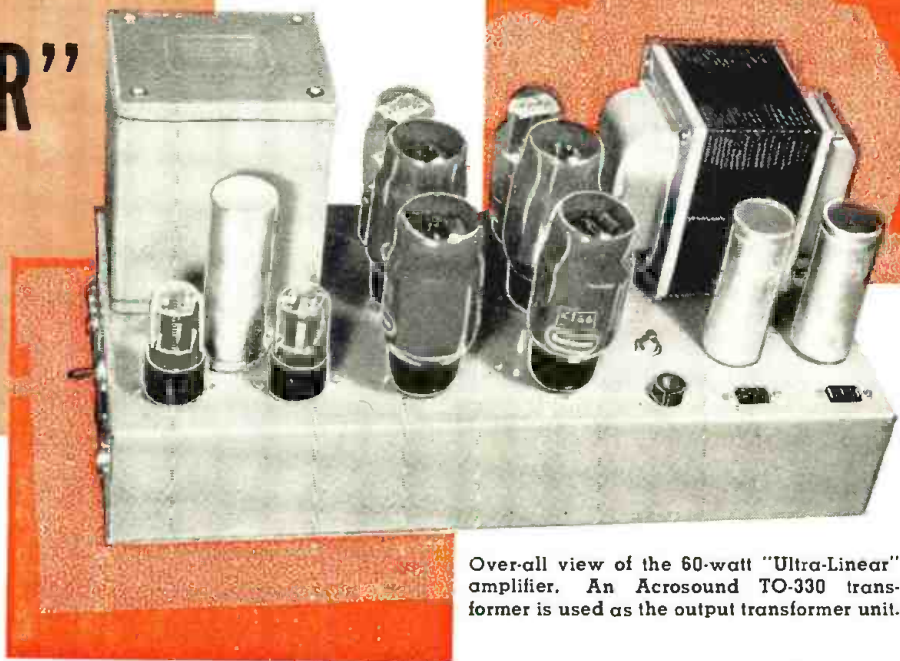

Over-all view of the 60-watt "Ultra-Linear" amplifier. An Acrosound TO-330 transformer is used as the output transformer unit.

MANY high fidelity amplifier circuits have been made available in the low and medium power brackets. However, there has been very little activity in development and public dissemination of high powered amplifier circuits in the power range over 50 watts.

There are many applications in which high powered, high fidelity amplifier capabilities are desirable or even mandatory. In addition to non-sound reproducing functions in laboratory and industrial applications, high powered audio units find application in recording work, in auditorium and amphitheater work, and in systems where power is divided over many different speakers in different rooms or areas. There is also a school of thought which believes that high power is required in home high fidelity installations for the ultimate in realistic reproduction.

The necessity for high power in home use has been doubted by some authorities, but its proponents have several valid arguments which must be given some weight. They claim that high power is required for proper reproduction of musical transients since transient waveforms require more power than the sine waves which are used as the basis for conventional amplifier ratings. For example, reproduction of a square wave of given amplitude requires *twice* the power of a sine wave of the same amplitude.

Another cogent argument for high power is that amplifiers have to work into loudspeaker loads of widely varying impedance. At the bass resonant frequency a loudspeaker might show an impedance of many times the nominal value. No amplifier can deliver its rated undistorted power into a load which represents such a severe mismatch. A wide reserve of power capability is thus required to maintain high fidelity operation under normal listening conditions. The argument, which always is used as a "clincher" for high power, claims that like a high powered car, a high powered amplifier is smoother at all levels because

Construction details on a commercially-designed, high-power amplifier for the serious audiophile. It uses four KT66's.

it operates at only a fraction of its potentialities and is rarely pushed to the limit.

On the other hand, many experiments have been made to demonstrate that only a few watts are needed in home installations. This is generally done by measuring the *average* power used in a specific installation and allowing for an estimated ratio of peak to average power. This type of test indicates the *customary* listening level at a specific audio installation. It does not actually indicate how much power would be required to simulate the *realistic* auditory loudness of live music. Few people are interested in reproducing the full acoustic power of an orchestra in their living rooms. However, many want to have the same sound pressure at their ears that they would get in the concert hall. Anybody who has listened to a full scale symphonic orchestra, or even a large dance band, is immediately aware that it takes tremendous power to duplicate the same sound intensity even in a smaller room where power requirements are far below those of the concert hall.

If the goal of high fidelity is "concert hall realism in the home" as many people agree, then a lot of power is required. Estimates of requirements run extremely high. One published figure¹ calls for 100 watts of clean power. In contrast, estimates based on average usage generally run about 10 watts. Superficially, this divergence of opinion looks extreme. However, the range of 10 to 100 watts is only 10 decibels wide

—approximately 10 audible steps of difference. The extremes are not as far apart as it appears on the surface, and it is probable that an intermediate rating will serve the needs of the most critical home installations. However, it is difficult to achieve intermediate power levels of 50 watts or more using conventional parts and conventional circuitry.

Approaches to High Power

There are many designs available for powers up to about 25 watts. When this point is passed, ordinary operating conditions and circuits are not directly applicable. When it is desired to exceed 50 watts of clean power and still preserve high quality, the problems of design are rather acute. There are several possible approaches which warrant consideration:

1. *Class B* (overbiased operation) provides high efficiency and delivers high power at low operating cost. However, overbiased operation causes excessive distortion at lower levels even though high level distortion can be made relatively low. A Class B amplifier with 1 per-cent distortion at 50 watts may have ½ per-cent at 1 watt—an excessive amount for high fidelity standards. Class B amplifiers also have inherently poor regulation, and careful attention must be paid to the design of power and bias voltage supplies or peaks of operation will shift voltages and operating conditions causing transient distortion.

2. *Class AB₂* operation provides high power by driving the output stage into

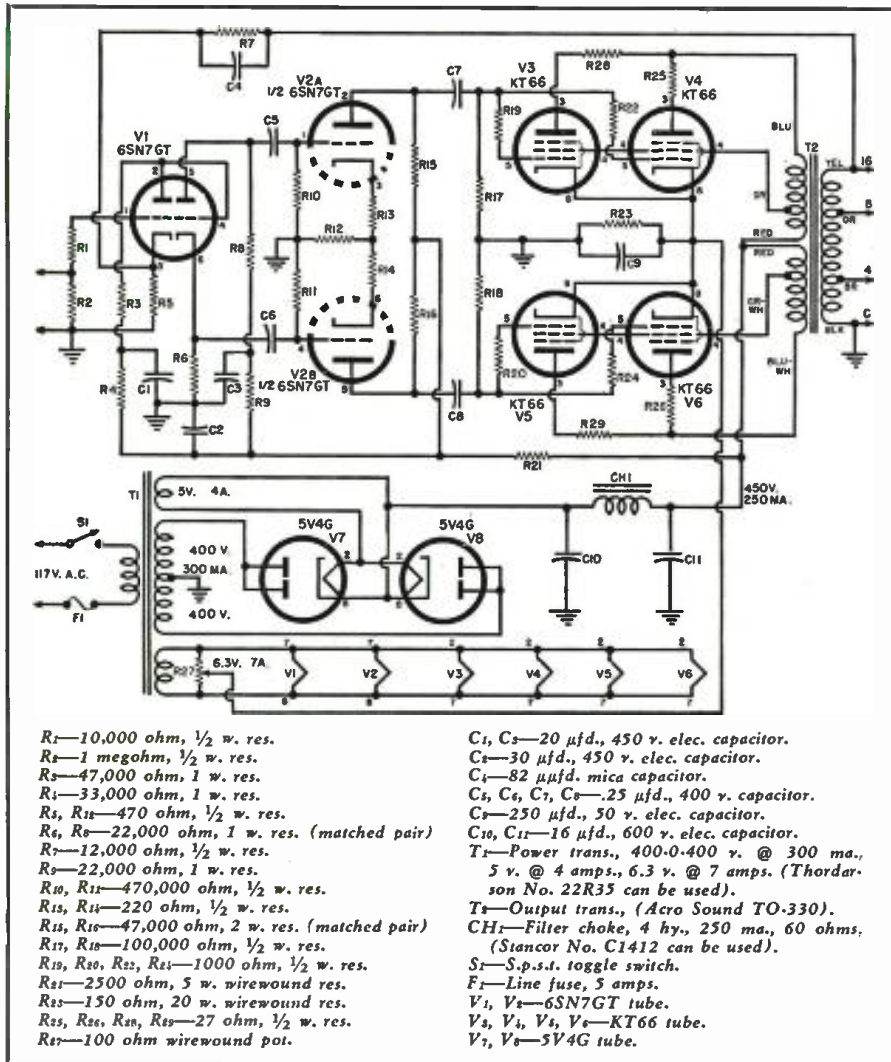

Complete schematic diagram of the Acro-designed 60-watt "Ultra-Linear" amplifier.

the grid current region. The driving stage must be able to deliver power at low distortion into the output grids. These grids present a low impedance when they are driven positive, and distortion is created in the driving stage unless transformer coupling or other involved and expensive circuitry is utilized. This mode of operation also has poor inherent regulation as the Class B stage with consequent problems of power supply design. Lastly, it utilizes a lowered plate to plate impedance to get higher output, and this creates high distortion at low levels similar to what happens with a Class B stage.

3. *High voltage transmitting tubes* can be used for high power output. However, the associated voltages are in the lethal range of 1000 volts or over, which is definitely undesirable. In addition, the tubes and necessary power supply make the amplifier quite costly.

4. *There are "hot" tubes* on the market such as the RCA 6146 (and the Tung-Sol 6550 which will be available shortly) which can provide high power at reasonable supply voltages. Experiments with these tubes for high fidelity circuits are being carried out, and results will be made available

eventually. Present efforts have not surmounted all the problems of using these tubes in reasonably-priced, efficient circuitry.

5. *Parallel operation* of tubes is relatively inefficient and requires careful design to avoid parasitic oscillations. However, there can hardly be a better way of getting high power than by taking a stage of desirable characteristics and paralleling it with another stage. Williamson mentions using sufficient pairs of output tubes in his famous circuit to achieve 70 watts of output. The inefficiency of this arrangement renders it rather impractical; but if the basic stage is efficient and can do better than 25 watts, parallel operation with two pairs of tubes will produce the desired output power and will still be practical.

Circuit Considerations

Consideration of the various alternatives for getting high power and high fidelity simultaneously points to the paralleled stage as being the simplest and most foolproof and bug free. It is not efficient, but this means merely that a slightly higher drain is put on the electric meter than would exist with Class B or Class AB₂ operation.

Efficiency is of minor importance unless portable operation is required where power is costly.

The choice of type of output stage to parallel is restricted. There are no triode stages with conventional receiving tubes which provide sufficient output. Tetrode stages have excessive low level distortion, are very sensitive to impedance mismatch and, therefore, are subject to nonlinearity using speaker loads since these have a reactive component and an impedance which varies with frequency. The choices left are the Ultra-Linear stage or the tetrode with local feedback such as is achieved with a cathode winding on the output transformer. This latter circuit has had a recent revival of popularity after favorable comment by Williamson.

Obviously, the use of local feedback will improve the characteristics of the output stage and seems to be an attractive arrangement. However, there is a penalty attached to the use of feedback. Sensitivity is reduced in proportion to the amount of feedback. This puts a severe limitation on the use of feedback over an output stage alone. In the circuitry under consideration, the driver stage must supply about 30 volts r.m.s. to each output grid. If 6 db of local feedback is used on the output stage, the driving requirement is 60 volts r.m.s., or about 88 volts peak, for each grid. This brings the driver stage to the point where its distortion becomes significant.

Good design calls for integrated performance of an amplifier, and the driver and output stage must be considered as a unit. On this basis, a conventional type of RC coupled driver combined with an Ultra-Linear output stage will give less distortion than the same driver and a tetrode stage with cathode feedback. Therefore, Ultra-Linear operation has been selected for the paralleled output stage. The justification of this choice is shown by the extremely low distortion characteristics of the push-pull parallel amplifier.

Experience with paralleled output tubes has indicated that some parasitic oscillation is probable unless "stoppers" are used for partial isolation of paralleled elements. The present design, therefore, uses grid stoppers of 1000 ohms each and plate stoppers of 27 ohms each. These eliminate the usual difficulties encountered when tubes are paralleled.

The four tube output stage requires the same signal drive at the grids as is needed in a two tube circuit. Therefore, a push-pull driver stage similar to that of the Williamson circuit will handle the drive requirements adequately and with low distortion. This, in turn, can be preceded by any high quality phase inverter. Again the Williamson arrangement of voltage amplifier directly coupled to the cathodyne inverter is satisfactory.

The basic tube alignment described must be powered by a fairly heavy

power supply. The use of four output tubes doubles the normal current consumption of the Ultra-Linear output stage, and the B+ requirement is about 250 ma. To exceed 50 watts of clean output, the B+ voltage should be in excess of 425 volts. A 300 ma. transformer of 400 volt rating, along with two 5V4G's paralleled, and capacitor input can supply the amplifier with the desired requirements. There is no need for choke input or other means of improving power supply regulation because the amplifier has good inherent regulation with practically no change in current drain as the output level is varied. This good regulation is a very desirable characteristic of the amplifier as it obviates the possibility of transient distortion caused by momentary changes in tube operating conditions. It makes the use of cathode bias practical, just as with Class A triode stages, since the constancy of cathode current in the output tubes maintains a corresponding constancy of bias, with a fixed drop across the cathode resistor.

The final element in the design of the amplifier, and a very important element, is the feedback circuit. In a circuit of the quality sought, it is desirable to utilize about 20 db of negative feedback in order to provide the well known advantages of lowered distortion, reduced hum and noise, and improved damping of the loudspeaker. However, feedback must be integrated into the design and cannot be added haphazardly or indiscriminately with the expectation of experiencing no difficulty. It is probable that the uninformed use of feedback will result in the degraded performance of most circuits since the feedback may not be stable, and *regeneration* rather than *degeneration* will be experienced. This can cause increased distortion, hangover, boom, and screechy effects caused by high frequency ringing. Even if the amplifier is stable under quiescent conditions, it is possible for instability to occur momentarily under some operating conditions. This transient instability is one of the factors which makes for discrepancy between the measured performance of an amplifier and its listening characteristics. They can measure well and not sound well.

Considerations of Feedback Stability

In any feedback amplifier, regeneration will occur if the phase shift reaches 180 degrees before the amplifier gain has dropped by an amount equal to the amount of feedback. For example, if it is desired to use 20 db of feedback, the 180 degree phase shift points at high and low frequencies should not be reached until the gain of the amplifier without feedback has decreased by at least 20 db. In other words, phase shift must be kept down until the normal roll-off of the stages has taken effect.

A quick appreciation of the design problems involved can be had by observing the problems of feedback de-

AMPLIFIER SPECIFICATIONS

POWER RATING	60 watts at not over 1 per-cent IM distortion
SENSITIVITY	1.3 volts r.m.s. for 60 watts output
FREQUENCY RESPONSE	@ 1 watt plus or minus 1 db; 2 cps to 200 kc. @ 20 watts plus or minus 1 db; 10 cps to 100 kc. @ 60 watts plus or minus 1 db; 20 cps to 20 kc.
DAMPING FACTOR	16

sign at low frequencies. If there are two RC stages and the output transformer included in the feedback loop (as is true in the Williamson type of circuit), there are three sources of low frequency phase shift. If each of these has the same time constant, the 180 degree point is reached when each of these three sources contributes 60 degrees of phase shift. In this hypothetical case, the gain has decreased 18 db at the critical phase shift point, since 60 degrees of phase shift corresponds to 6 db of gain reduction in a single stage, and there are three such stages involved. Thus 18 db is the limit to the permissible feedback if instability is to be avoided.

How can 20 db of feedback be run if the amplifier goes unstable with 18 db? The answer is that the phase shift must be reduced. This can be accomplished by introducing *phase shifting networks* or by *staggering* the time constants of the various stages so that a given gain reduction is accompanied by less phase shift.

The low frequency stability of the original Williamson circuit was dependent on two RC networks with equal time constants and the output transformer time constant. When the inductance of the transformer made its time constant equal to that of the interstage networks, 20 db of feedback could not be accomplished with the desired degree of stability. Since the transformer's time constant is variable depending on the d.c. balance of the output tubes, a.c. excitation level of the output stage, variability in core material, production quality control, etc., there was always the possibility of running into instability either continuously or during some intervals of

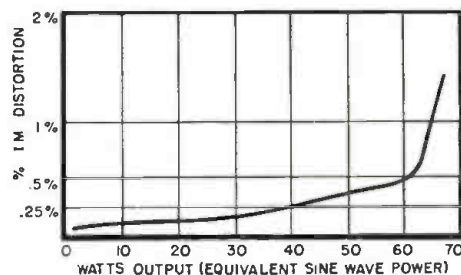

Intermodulation distortion vs power output (40 and 60 cps mixed at ratio 4:1)

use. This is certainly an undesirable condition which caused many Williamson amplifiers to have low frequency instability.

When the Ultra-Linear version of the Williamson type circuit was designed, this problem of low frequency stability was investigated, and steps were taken to extend the margin of stability. This was done by *staggering* the interstage RC networks by lengthening one of them. The same expedient has proven beneficial in the push-pull parallel version of this circuit and has, therefore, been included in the design.

The high frequency stability problem is not as simple to analyze because of the fact that the performance of the output transformer at high frequencies is more complex than that of a simple RC network. As a general rule, the amount of feedback obtainable at high frequencies for a given circuit is directly dependent on the quality of the output transformer which must have both low and smooth phase characteristics over a very wide bandpass. Many criticisms leveled at feedback circuits made condemnations

(Continued on page 100)

Underchassis view of the 60-watt amplifier. Parts layout eliminates hum problems.

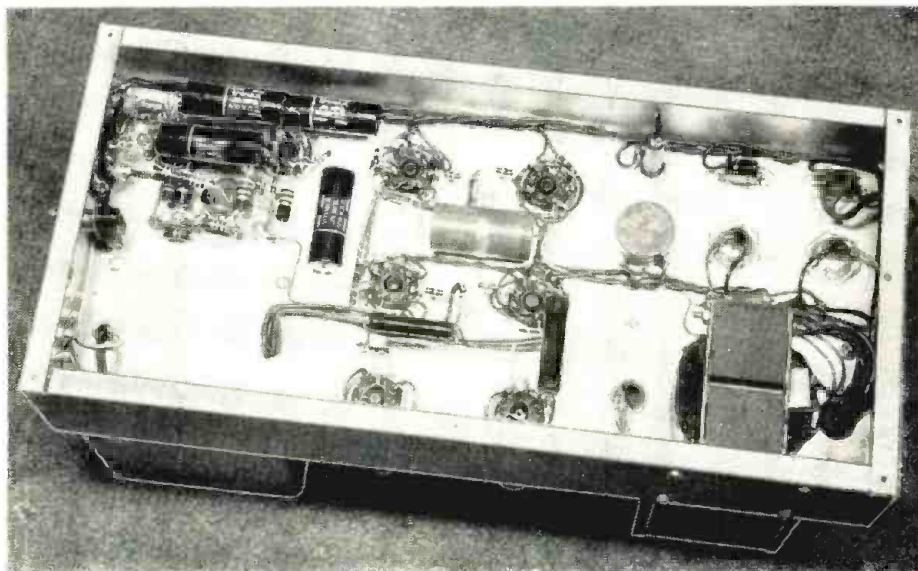

By BERT WHYTE

THE New Year is the traditional time to make resolutions, and I have a whole passel of them. One of the most important concerns you, dear reader! You see, a great many of you nice people have been writing me letters about records, equipment, etc., and I have been most remiss in my answering. Nothing deliberate, you understand. Your letters are always sincerely appreciated, but it has been difficult to find the time to take care of much of the correspondence. Not having a secretary makes it doubly tough to get my mail out as fast as I would like. However, I hereby resolve that in this year of 1955, your letters will receive prompt attention and I hope no one will have to wait for an answer more than two weeks.

A recent article in a contemporary publication, dealing with the foibles and failings of record critics, makes necessary a re-statement of one of the basic policies of this review column. In the magazine world, space is all important. A given number of editorial pages must be supported by a certain minimum of advertising pages. Any expansion in an article or of a department, invariably calls for increased advertising revenues. In short . . . space is very, very precious. It therefore behooves one to use the available space with discretion . . . to achieve maximum utility. I have said it before, and although I may be wrong . . . I'll say it again; what is the use of filling up this precious space with reviews of *poor recordings*, when there are so many *good recordings* to bring to your attention? Naturally, there is flexibility in this operation. An outstanding work of music, like a Beethoven "9th," or a Brahms "Requiem," coming from a major company, with an important conductor and orchestra . . . *must be reviewed* whether the recording is good, bad, or indifferent. But this is the exception that proves the rule. By and large, I try to confine the contents of this column to those recordings which seem to be musically and technically acceptable to my ear, and which I think will be of interest to you. Once again let me state that I do not imply that a recording which doesn't appear in this column, is categorically, "no good." It is obvious that the LP output is so great, no critic can cope with all the releases, and some good recordings are bound to get overlooked. So that's it, friends. As long as the record companies keep on turning out enough *good recordings* each month, this is the kind that will be reviewed in these pages.

Equipment used this month: *Weathers* arm, oscillator and cartridge; two *McIntosh* M30 amplifiers; *McIntosh* C8P audio compensator; *Componentis* Corporation turntable; *Jim Lansing* D34001 horn speaker; *Electro-Voice* "Georgian" speaker; tape equipment: *Ampe*x 600.

The opinions expressed in this column are those of the reviewer and do not necessarily reflect the views or opinions of the editors or the publisher of this magazine.

BERLIOZ
SYMPHONIE FANTASTIQUE
Minneapolis Symphony Orchestra conducted by Antal Dorati. Mercury MG50034, RIAA curve. Price \$5.95.

In a year of notable recordings of Berlioz works, this is easily one of the most outstanding. Dorati brings to this symphony a new approach which is quite a refreshing change. He treats the work in a more integrated fashion than other conductors who seem in a hurry to get through with the early movements, so they can land with both feet on the "March to the Gallows" and the "Witches Sabbath." Dorati's handling of these last two movements is hair-raising, for the passionate intensity and propulsive energy with which he imbues them. Yet, the earlier movements are not glossed over, nor made subsidiary to the ensuing "fire-breathers." Dorati's tempi are generally straight-forward, perhaps a mite slower than some recent performances I have heard, notably Charles Munch's. While Mr. Dorati hews to the broad line throughout the work, he has not neglected to use his extraordinary talents for dynamic expression. This is certainly the most colorful version of this score on records, and in the matter of sound, it wins hands down. Strings are silky smooth, brass is ultra-bright, with the brass choirs in superb balance, and the woodwinds have a remarkable "liveness" and purity of tone. The tremendous impact of bass drum and tympani in the last two movements, has to be heard to be believed. Couple all this wide range, distortion-free sound with an incredible range of dynamics and the "just right" acoustic perspective, and you have an absolutely stunning recording. The surfaces in my copy were quiet and the RIAA curve was improved by a little bass boost.

HANDEL
THE WATER MUSIC
The Hewitt Orchestra conducted by Maurice Hewitt. Haydn Society HSL-107, NARTB curve. Price \$5.95.

This is the third recording of the complete "Water Music," and by far the best. The earlier efforts by Bales on the *WCFM* label and by Lehmann on the *Decca* label were fair representations of the work, but the sound is now somewhat dated. I must admit that while I have heard of the Hewitt Orchestra, I know very little about its background or accomplishment. From what I have heard on this disc, it seems a better than average orchestra of the type usually employed in European recording. If the ensemble work is a little sloppy at times, they make up for it in the spritely performance. Hewitt is quite apparently an old hand with this score and his reading is to be preferred over the earlier recordings. Soundwise, this has no competition from either the *WCFM* or the *Decca* versions. String tone is generally good, and the all important horns are splendidly repro-

duced. If you want the best available of one of the most interesting and enjoyable of Handel's scores, this is the recording of choice. The disc conformed to the NARTB curve.

FRANCK
SYMPHONIC VARIATIONS
D'INDY
SYMPHONY ON A MOUNTAIN AIR
Aldo Ciccolini, pianist, Orchestre de la Societe des Concerts du Conservatoire conducted by Andre Cluytens. Angcl 35104. RIAA curve. Price \$5.95.

These works should be better known than they are. The average audiophile will give you a blank stare if you mention D'Indy's name, yet his "Symphony on a Mountain Air" is certainly the colorful type of thing that they like. Perhaps it is because there have been few recordings of the work and up to this present version, none that was really "hi-fi" in sound. At any rate, the D'Indy and the Franck works are here afforded the proper recording. The piano is beautifully reproduced, a very liquid type of sound; the strings are quite clean and the woodwinds, so important in the D'Indy, are of exceptional clarity. It is unfortunate that there are a few faults which may negate the value of the recording to some. One thing is the "dead" acoustics, which are most annoying in the 2nd movement of the D'Indy. The other is the somewhat lackluster performance of Ciccolini. His tempi are quite slow and the music has none of the zip and sparkle of the old Casadesus-Munch recording. No adjustment of the RIAA curve was necessary and surfaces were exceptionally quiet.

SHOWPIECES FOR ORCHESTRA
RIAS Symphony Orchestra, Berlin, and the Berlin Philharmonic Orchestra conducted by Ferenc Fricsay. Decca DL-9738, NARTB curve. Price \$5.95.

Ferenc Fricsay is one of the most acclaimed of post-war European conductors. Here, in this potpourri of standard works, he gives considerable evidence to support this reputation. His readings are well balanced, nicely paced, and his dynamic shadings are quite impressive. I find the work of the RIAS Symphony a notch or two higher than the Berlin Philharmonic, possibly due to the closer association of conductor and orchestra. The "1812 Overture" of Tchaikovsky is heard on this disc in the seldom-performed choral arrangement, an interesting novelty which collectors will want. The sound on this disc is quite variable. In the "1812 Overture" and "Bohemia's Woods and Fields," the sound is fairly wide range, clean but not outstanding. In the preludes to Acts 1 and 3 of "La Traviata," there is some magnificent string work of beautiful quality. And in Johann Strauss, Sr.'s "Radetzky March" some really rip-snortin' brass and a big bass drum sound of noble proportions. If you own a king-size speaker system, this March is worth the price.

MASSENET
SCENES PITTORESQUES
SCENES ALSACIENNES
Orchestra de Concerts Lamoureux conducted by Jean Fournet. Epic LC3053, NARTB curve. Price \$5.95.

These colorful and charming orchestral suites have long been relegated to the "pop concert" repertoire, but not without a struggle. They are still occasionally programmed in symphony concerts (mostly in Europe) and fare very well. While this present recording has a few faults, it is far beyond the old Mitropoulos-Columbia, especially in the sound department. Fournet gives the works a spirited and ingratiating reading and gets some fine playing from his orchestra. Sound is moderately wide-range, with naught but infre-

(Continued on page 114)

SERVICING

COLOR TV

By MILTON S. KIVER *



Removing a Westinghouse color TV receiver chassis from its cabinet. Not all color TV sets consist of a single chassis as this one does for easy removal.

LAST month we considered two major aspects of color TV servicing: checking the raster and viewing the black-and-white picture to see whether any extraneous color appears. These two checks would always be made in the sequence given, in order to isolate a disturbance to a specific section of the receiver. We have reference here to defects whose origins are not immediately recognizable from an initial inspection of the screen. However, if no picture at all can be obtained on the screen, then obviously raster inspection would hardly be necessary. In this instance, the best approach would be to trace the signal with an oscilloscope, starting perhaps at the video second detector. On the other hand, if we do obtain a picture on the screen and it is distorted, either in shape or in color, then the testing procedure outlined in Part 1 would be entirely in order.

We come now to those color troubles which have their origins in the color sections of the receiver. Analysis reveals that these color defects will generally fall into one of three categories.

1. No color at all, when we know that there should be color
2. Incorrect color rendition
3. Color instability

Once a specific trouble is categorized, the technician is then able to proceed in a logical manner to narrow down further the location of the defect. The rewards of a systematic procedure include not only shorter servicing time and the assurance of doing the job correctly the first time,

but also the self satisfaction and pride that every successful technician feels from the knowledge of a job well done.

Complete Lack of Color

There are a number of reasons why a color set will not develop a color picture when it is definitely known that a color signal is being received.

One possibility which immediately suggests itself is misadjustment of the fine-tuning control. To appreciate the reason for this, let us consider the action of this control in its relation to the manner in which the set treats the signal.

In the incoming signal the picture carrier is always below the sound carrier. On channel 3 (60-66 mc.), for example, the picture r.f. carrier is positioned at 61.25 mc. and the sound r.f. carrier is at 65.75 mc. These signals mix with the output of an r.f. oscillator to produce the desired i.f. frequencies. In almost all designs the oscillator frequency is above any of the frequencies of the incoming signal. For the example chosen, channel

3, the r.f. oscillator frequency would be 107 mc.

The result of mixing the oscillator and r.f. carriers, is to produce a video i.f. carrier signal at 45.75 mc. (107-61.25 mc.) and a sound i.f. carrier at 41.25 mc. (107-65.75 mc.). On the response curve of the video i.f. system, these carriers would appear in the positions shown in Fig. 1.

The color subcarrier of the signal is positioned 3.58 mc. above the picture r.f. frequency. Its i.f., then, would be 42.17 mc. and it would occupy the position shown in Fig. 1. The left-hand edge of the response curve should extend to at least 41.65 mc., this being the end frequency of the video signal with its color sideband components. (41.65 mc. is 4.1 mc. from the video i.f. carrier of 45.75 mc.)

All of the foregoing signals will fall at the points designated in Fig. 1 if (and here is the crux of this discussion) the oscillator frequency is set at exactly 107 mc. This, in turn, depends upon the setting of the fine-tuning control.

Now let us see what happens if the control is rotated too far to one side or the other of this correct position. The viewer who thinks he is tuning his set for best picture by striving for high contrast, is in error because he will adjust the fine tuning control until the video carrier is on the flat portion of the response curve and not at the 50 per-cent point. With this situation, the high end of the signal spectrum, where the color information exists, will be pushed down the oppo-

Fig. 1. Over-all i.f. response curve of a color TV receiver indicating the need for a really broadband response.

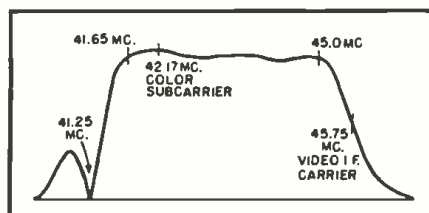

* Author of "Television Simplified," "Television and FM Receiver Servicing," and other books.

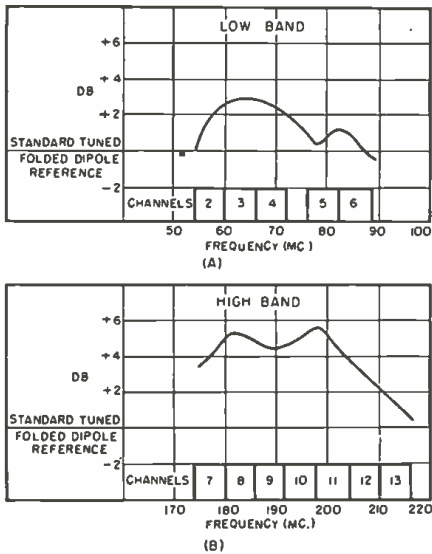

Fig. 2. Gain curves for a popular TV antenna. (A) is the low band; (B) is the high band. The flatter these curves are the better for color reception.

site side of the response curve. This will usually attenuate the color burst to such an extent that not enough will get through to activate the various color circuits. The result is that there is no color on the screen.

Rotation of the fine-tuning control in the opposite direction will lead to the loss (or attenuation) of the video carrier and its companion low video frequencies and will produce either a negative picture (as in black-and-white sets) or no picture at all. Present, too, will be sound bars because of the increased amplification accorded the sound signal.

Thus, adjustment of the fine-tuning control in present color television receivers is a more critical operation

than in monochrome receivers and this fact must be carefully impressed upon the viewer. An excellent adjustment sequence for obtaining a good color picture is as follows:

1. Adjust the receiver in the usual manner for a black-and-white picture.
2. Advance the color control approximately two-thirds from its maximum counterclockwise position.
3. Carefully advance the fine tuning control clockwise until the picture just begins to disappear, then turn counterclockwise slowly to the position where the sound bars just disappear and color is in the picture.
4. Adjust the color control for the desired saturation or strength of color.
5. Adjust the hue control to achieve the most pleasing flesh tones or color of some familiar object.

Another method of adjusting correctly the fine-tuning control which the service technician can use is to rotate this control to the point where the visible 920 kc. beat pattern (between the 4.5 mc. sound carrier and the 3.58 mc. color subcarrier) on the CRT screen is minimized. This is a more precise method, particularly when the low end of the i.f. response curve has a steep roll-off.

The importance of having the color end of the video signal receive sufficient amplification—as indicated by the foregoing discussion—will also point out to the service technician other causes for poor or no color rendition in the picture. For example, a video i.f. response curve which falls off too rapidly at its low end, or an r.f. bandpass which is too narrow will produce the same results as misadjustment of the fine-tuning control.

In black-and-white receivers, the extent of the circuit's bandpass, while

important, is nowhere near as critical as it is in a color receiver. In a monochrome set we might possibly lose some detail, a fact which very few observers could detect. In a color set, the picture will still be seen, but all semblance of color would be absent.

The critical dependence of color on bandwidth can conceivably force circuit realignment of the r.f. and video i.f. systems every time a tube is changed. Different interelectrode capacitances in tubes, even of the same type, will have marked effects on the bandpass of the fairly high frequency circuits now common in r.f. and i.f. systems. It may be that methods will be found to overcome this very evident weak point, but until that happens there is likely to be some difficulty even if it is encountered only part of the time.

In this same vein, it has been found that poor color in a picture or no color at all may also stem from inadequate bandwidth of the antenna system. This would encompass the antenna and any r.f. boosters and/or distribution amplifiers that may be employed. Particularly important is the response to those frequencies clustered around the color subcarrier. Ideally, gain or loss should not vary more than 1 db from 1.5 mc. below to .6 mc. above the color subcarrier. Now let us apply these suggested limits to a popular antenna operating over the 12 v.h.f. channels. The gain curves are shown in Fig. 2. Over the low band, the response falls within the limits specified. On channel 2, the gain variation from the low to the high end is greater than 2 db. However, in its favor is the fact that the high end receives more gain than the low end, thereby tending to accentuate the color signals. Furthermore, the gain variation around the color subcarrier frequency (near the upper end of the channel) is less than 1 db.

On the high band, the response is excellent for channels 7, 8, 9, and 10. On channel 11, gain variation near the upper end is quite marked and could lead to trouble. This is particularly true since the gain is decreasing here. Channels 12 and 13 are subject to an even greater drop-off in gain and the performance of a color receiver on these channels could be expected to be poorer.

High gain, narrow-band antennas such as the multi-element yagi may be especially troublesome in this respect.

Another item that is frequently found in the antenna system is an r.f. booster. If this is of the untuned wide-band variety, then it probably would not attenuate the color subcarrier any more than it might affect the video carrier. However, in an adjustable booster, where each channel is tuned in separately, narrow bandwidth is a distinct possibility. Also, it is well to remember that while one item, by itself, may not cause too much damage, the combined attenuation of several components can prove decisive.

What has been said with regard to

Fig. 3. Schematic diagram of the color sync section of an RCA CT-100 color receiver. Here, the 3.58 mc. oscillator is always in operation, even without color.

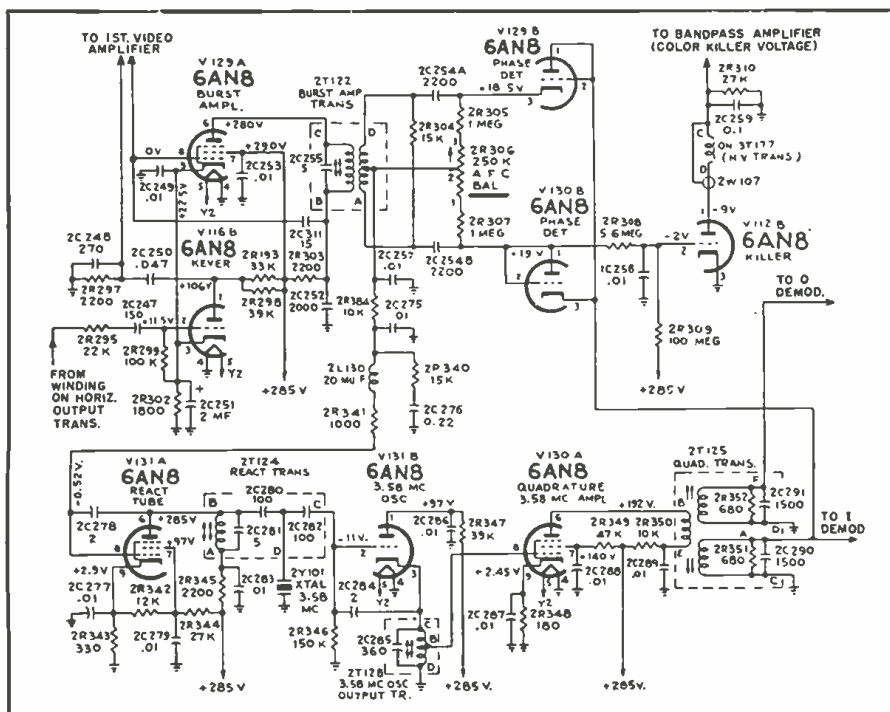

boosters applies with equal force to antenna distribution systems where the incoming signal is first amplified before it is dispatched to the various sets.

The necessity for knowing whether each component of an installation is doing its full share will be more pressing than ever and undoubtedly require additional testing equipment for the service technician. The technician will require more comprehensive methods for checking receivers in the home. If a set does not produce suitable color pictures, is the receiver at fault or does it stem from an inadequately applied signal? Some instrument, such as a color bar generator, which will definitely establish the condition of the receiver will almost be a necessity. The only other alternative would be to take the set back to the shop, a time consuming and certainly uneconomical procedure. The reliance of the service technician on accurate and reliable test equipment will be greater than ever.

There are, of course, additional reasons why a color television receiver is unable to produce color pictures. Consider, for example, the color subcarrier oscillator in the color sync section. The color signals which the *I* and *Q* (or *R-Y*, *B-Y*) demodulators receive from the bandpass amplifier are amplitude and phase modulated. To re-obtain the original information imparted to this signal, we need the presence of the missing subcarrier. This is supplied, with the proper phase, by the color sync section. Now, the heart of this section is the 3.58-mc. subcarrier oscillator and should something prevent this oscillator from generating the necessary voltage, no color demodulation will occur and with this, no color signals.

In the absence of color, then, a good place to check is at the 3.58-mc. oscillator. The tube might be tested first. If this is found to be good, an oscilloscope might be employed to check for the presence of a 3.58-mc. signal in the oscillator circuit. Measuring the control grid voltage of the oscillator is another good way to determine whether or not this stage is operating.

There are two methods in use for generating 3.58-mc. oscillations and a different service approach is required in each instance. For example, in the color sync system shown in Fig. 3, the 3.58-mc. oscillator is always in operation, color signal or no color signal. This means that if a color signal is reaching the color demodulators, the 3.58-mc. oscillator voltage should likewise be present unless the oscillator itself is inoperative. It makes little difference here whether the color burst reaches the color sync section or not. The oscillator, whether it is on frequency or not, will be developing a 3.58-mc. signal and some color should appear on the screen, even if this color has the wrong hue or is unstable.

On the other hand, consider the situation in a ringing-type color sync system, Fig. 4. Here, the 3.58-mc. gen-

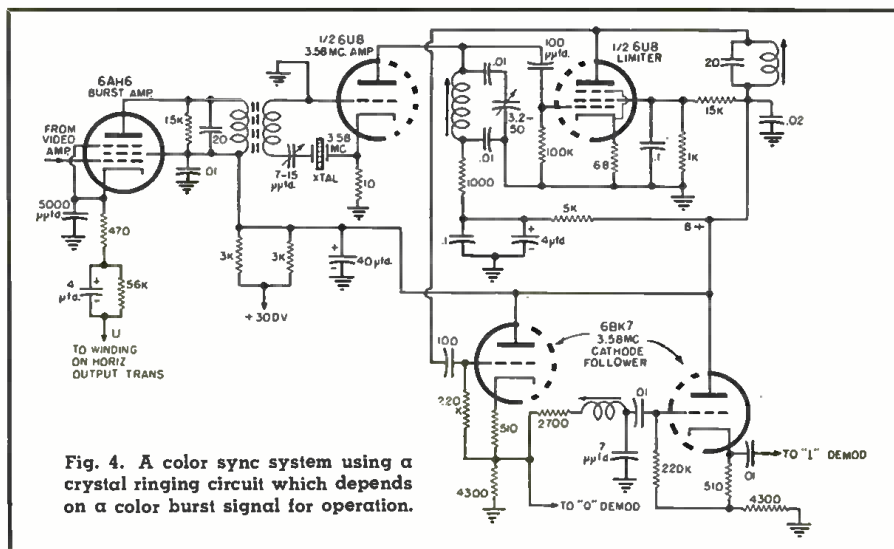

Fig. 4. A color sync system using a crystal ringing circuit which depends on a color burst signal for operation.

erator is not in operation unless it is being pulsed by the incoming color bursts. Failure of the bursts to reach the ringing oscillator, perhaps because of a defective color burst amplifier, would result in a colorless picture. Hence, the logical place to check in this system is the color burst amplifier to see if the tube is good and if so, the rest of the color burst stage, including the voltages.

Note that in the color sync system of Fig. 3, trouble in the color burst stage, in the reactance tube, or in the phase detector would not keep the 3.58-mc. oscillator from operating. Color would appear on the screen even though, in all probability, the shading of the various objects would be wrong.

In the ringing system, for the generated 3.58-mc. voltage to reach the color demodulators, it is necessary that the stages between the oscillator and the demodulator be operating normally. This includes an amplifier, a limiter, and perhaps a cathode follower. See Fig. 4. Tests should be

made, with an oscilloscope, at each of these points.

Another item which may be responsible for the absence of color is a defective bandpass amplifier. This stage stands at the head of the entire chrominance section of the receiver and any break in the signal path here would prevent the color sidebands from reaching the color demodulators.

Whether a defective bandpass amplifier will cause the complete absence of color on a screen, or simply lead to a condition where we have a black-and-white picture with a mottled (confetti-like) background depends upon the particular circuit in question. In the partial circuit of Fig. 5, the burst gate amplifier receives its pulses from the plate circuit of the bandpass (here called chroma) amplifier. Failure in the bandpass stage will not only prevent any of the color sidebands from reaching the color demodulators, but would likewise shut off the flow of color burst signals to the burst gate stage and the ringing oscillator that

(Continued on page 172)

Fig. 5. A defect in the chroma amplifier would completely inactivate the entire color section of the receiver using the chrominance circuits diagrammed here.

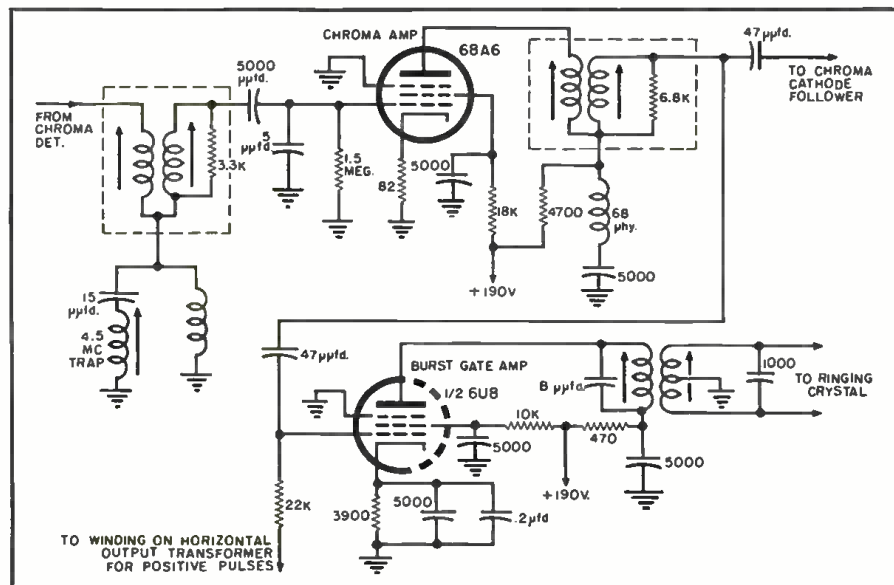

RADIO LICENSING AND THE FCC

By JAY ROBIN GNESSIN

A handy précis of current FCC rules and regulations for radio licenses, with hints on preparing for your exams.

THERE is no charge for any of the fifteen kinds of radio operator licenses issued by the Federal Communications Commission. It is not difficult to obtain a license. The certificate makes a handsome addition to your trophy collection, boosts your ego by proving you have passed the test, and counts heavily on any employment application form.

Are you far away from a metropolitan center so that you are unable to take an FCC exam in person? No matter! The "conditional class" amateur license exam will be given by mail if the applicant is more than 75 miles from the nearest examination point, yet it provides all regular amateur privileges. The same rule holds if the applicant is physically disabled or in the Armed Forces.

The "novice and "technician" class examinations are given by mail only. These provide for operation of your

own amateur radio station with certain limitations. Each requires the applicant to pass a 5 wpm code test as certified by a volunteer examiner in your own neighborhood. Any ham will be glad to give you the code test. The written test you get by mail covers basic radio law or theory, depending upon the class.

What used to be the "Amateur Class C" is now covered by these new classes. The old "Class B" is now the "general class." This is relatively unchanged. It requires the applicant to present himself in person to an FCC Field Office at the designated time to take a 13 wpm code test with a written exam on basic amateur practice and general amateur regulations.

The old "Class A" was replaced for a while with "advanced class." This will continue to be renewed as long as the license holder continues to meet current requirements. No new exami-

nation for this class will be offered.

The "extra class" is the cream of the amateur licenses, the acme of advancement in these ranks. It is the highest grade of amateur license. It's reserved for old-timers. Licensed hams should write to the FCC if interested in this particular license.

When you apply for an amateur operator license you generally also apply for an *amateur station* license. In that case the application for station license must be notarized. It's worth it, though, since in that case you get a combination (really *two* licenses) deal. The operator's license permits you to operate any amateur radio station. The station license assigns you a set of call letters and you are authorized to operate a station of your very own.

There is some talk that a fee may be charged eventually for the station license only. At this writing the amateur station license is free for the application.

Citizens Radio Service

This is a new form of radio service for private or personal use for short distance radio communication, signaling and radio control of objects and devices such as model airplanes, garage doors, etc. Only citizens 18 years or older may obtain a station license in this service. It must not duplicate like facilities in any other radio service. Therefore it is not just another *amateur* radio service.

Where manually-operated telegraphy is used, or where adjustments during installation, testing, or servicing may cause the transmitter to change frequency or any other technical characteristic, an applicable operator's license is required. Where FCC-approved commercial Citizens Band transmitters are utilized without adjustments or telegraphy only a station license is required when purchasing the equipment. The store selling the transmitters generally keeps the required forms. In this case no operator's license is needed. The station licensee is responsible for the proper operation of his station at all times.

If simple antennas not exceeding 20 feet above terrain or structure are used no additional license is required in this service. For more elaborate structures, exceeding this minimum,

(Continued on page 149)

FCC Field Offices where radio licensing examinations are given regularly.

Alabama, Mobile 10 419 U.S. Courthouse and Customhouse	Massachusetts, Boston 9 1600 Customhouse
Alaska, Anchorage P.O. Box 544 Room 53, U.S. Post Office and Courthouse Building	Michigan, Detroit 26 1029 New Federal Building
Alaska, Juneau P.O. Box 1421 Room 7-8, Shattuck Building	Minnesota, St. Paul 2 208 Uptown Post Office and Federal Courts Building
California, Los Angeles 12 539 U.S. Post Office and Courthouse Temple and Spring Streets	Missouri, Kansas City 6E 3200 Federal Office Building
California, San Diego 1 15-C, U.S. Customhouse	New York, Buffalo 3 328 Post Office Building
California, San Francisco 26 323-A, Customhouse	Ellicott and Swan Streets
Colorado, Denver 2 521 New Customhouse	New York, New York 14 954 Federal Building
19th between California and Stout St.	641 Washington Street
District of Columbia, Washington 25 Briggs Building	Oregon, Portland 5 307 Fitzpatrick Building
415 22nd St., N.W.	917 S.W. Oak Street
Florida, Miami 1 P.O. Box 150 312 Federal Building	Pennsylvania, Philadelphia 6 1005 New U.S. Customhouse
Florida, Tampa 2 409-410 Post Office Building	Puerto Rico, San Juan 13 P.O. Box 2987
Georgia, Atlanta 3 411 Federal Annex	322-323 Federal Building
Georgia, Savannah P.O. Box 77 214 Post Office Building	Texas, Beaumont P.O. Box 1527 329 Post Office Building
Hawaii, Honolulu 1, Oahu P.O. Box 1142 Lanikai	300 Willow Street
Illinois, Chicago 4 826 U.S. Courthouse	Texas, Dallas 22 P.O. Box 5238 500 U.S. Terminal Annex Bldg.
219 South Clark Street	Houston and Jackson Streets
Louisiana, New Orleans 16 400 Audubon Building	Texas, Houston 11 324 U.S. Appraisers Bldg.
Maryland, Baltimore 2 508 Old Town Bank Building	7300 Wingate Street
Gay Street and Fallsway	Virginia, Norfolk 10 402 Federal Building
	Washington, Seattle 4 802 Federal Office Building

Address: Engineer in Charge, Federal Communications Commission

ONE MORE BAND WITH YOUR PRESENT ANTENNA

The 20 meter coil assembled with 75 m. coil and lower antenna section (left). (Center) the 20 meter coil for mounting below low-frequency antenna loading coil. (Right) author's mobile antenna with 75 meter coil shorted out for 20 meter operation.

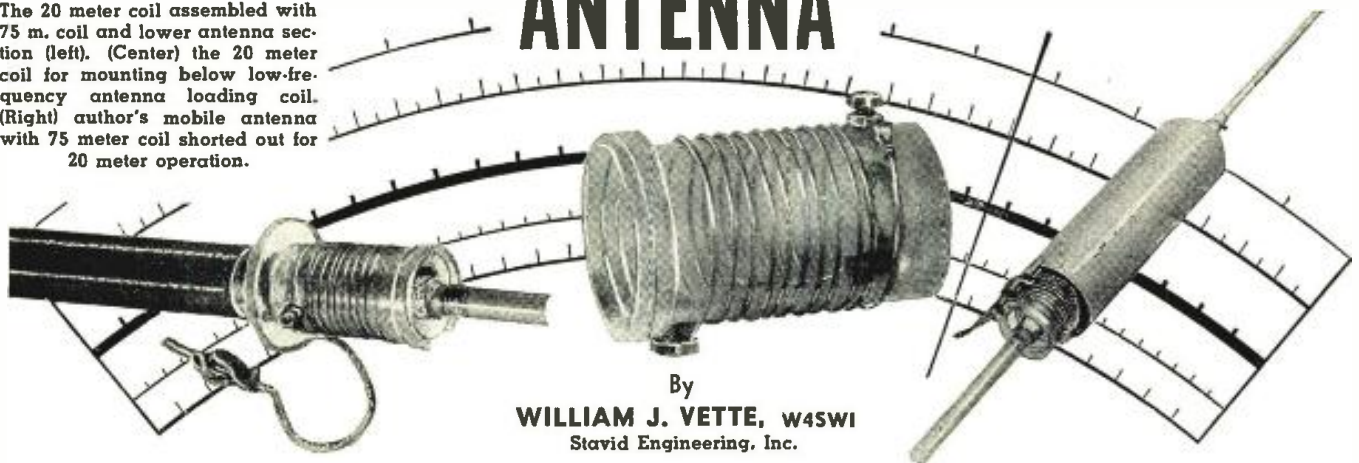

By
WILLIAM J. VETTE, W4SWI
Stavid Engineering, Inc.

Increase the usefulness of your mobile antenna by adding this simple and easy-to-build accessory to your set-up.

FOR the amateur mobile operator who wants to operate on two or three favorite bands, but doesn't want to fool around with high-priced, low-efficiency, all-band loading coils, or who doesn't have the luggage space to carry a whole set of separate coils for each band, here is a low-cost scheme for getting the high efficiency of individual loading coils in no more space than his present low-frequency loading coil.

Basically, the idea is to add a coil for a higher frequency band, either 15, 20, or 40 meters, below and in series with the present low-frequency coil for 75 or 40. Arranged to allow the bottom section of the antenna to go through the new coil, the length of the coil is not added to the antenna, nor is the new coil form called upon to take the strain of the top section of the antenna or the upper loading coil. As originally done by the writer, a 20-meter coil was added below a 75-meter *Master-Mobile* coil, but the actual combination of bands is up to the individual constructor. In any case, 10-meter operation is had by shorting across the whole coil assembly with a heavy piece of copper braid or a heavy wire.

The coil is quite easy to make and adjust, and the coil form (which is usually the stopper when trying to home-brew antenna loading coils) is probably already lying around the shack, if not, it can be readily procured from any parts supply house.

The coil form is a standard 1 1/4" diameter form, 2 1/2" long, with the prongs removed. As shown in the photo, the coil was wound on a polystyrene form, such as the *Amphenol* 24-4P, and the use of such a form is recommended. The prongs can be easily removed if they are carefully heated with a soldering iron just enough to soften the base slightly.

After removing the prongs, drill three holes in the form: one, 7/16" in diameter, in the exact center of the bottom, and two 1/8" in diameter on

either side of the form, as shown in Fig. 1. In each of these holes, insert a 6-32 screw, 3/8" long, from the inside, with a solder lug under the one at the open end of the form, and a similar lug on the outside of the form on the screw at the closed end of the form. When putting nuts on these screws, tighten very carefully, for the poly is easy to crack if put under much of a strain. Two nuts should be put on each screw.

A large solder lug with a 7/16" hole is placed inside the form, at the bottom, and should be connected to the solder lug at the opposite end of the form with short piece of stiff wire. If a lug of proper dimensions is not at hand, a brass washer might be used, soldering the connecting wire to it before inserting it into the form.

Connect one end of the wire you are using for the coil to the lug you placed on the outside of the form. The heat of soldering will soften the form slightly, and you should carefully re-tighten the nut as the connection cools to take up the slack caused by the screw sinking into the form. Do this carefully, or you will pull the screw right through the form wall. In winding the coil, add about 20% more turns than the table calls for, to allow for pruning the coil to frequency after installation. The number of turns as

given in the table is correct for the writer's installation, but the correct number will vary, depending on the location and height of the antenna in any other installation.

To prepare the low frequency coil, it is necessary to insure that the bottom end of the coil is no longer connected to the metal insert into which the lower section of the antenna screws. In the case of the older *Master-Mobile* type coils, this is accomplished by removing the screw under which the bottom end of the coil fastens, replacing it with another screw which is not long enough to make contact with the metal insert—a 6-32 screw about 1/8" long does the job nicely. Also, the polystyrene disc which mounts below the low-frequency coil must have a 3/32" hole drilled through it, 1/4" from the outer edge, to pass the wire connecting the two coils together.

Assemble the two coils atop the lower section of the antenna, with the polystyrene disc between them, and with the bottom screw of the low-frequency coil lined up with the top screw of the new high-frequency coil. Connect these two screws together, using a short piece of No. 16 wire passed through the hole in the plastic disc. (Continued on page 128)

Fig. 1. Cut-away view of coil form showing placement and dimensions of holes, coil table, and details on base extender to be used to raise h.f. coil on base-loaded whips.

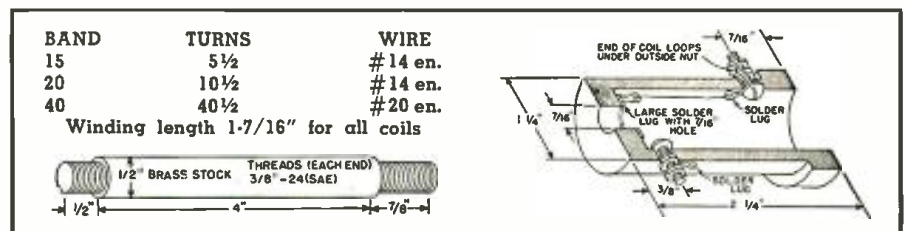



Fig. 1. Over-all view of the home-built counter with its associated accessories (from left to right): selenium photocell, mercury switch, the "Microswitch", and push-button switch.

A "UNIVERSAL" COUNTER

By
LOUIS E. GARNER, JR.

HERE is probably not an industry or business in the nation that has not, at one time or another, been confronted with a "counting" problem of some sort. Manufacturing firms may wish to count the items passing a given point in a production line, department stores may wish to count the number of customers entering a certain door, a real estate firm may wish to count the persons visiting a model home, and almost every merchant has a good-sized counting job at inventory time.

Although there are numerous commercial counters on the market, most units are designed to perform limited types of counting operations. In some instances, these limitations so restrict the applications of particular units that it is very often necessary to rely

Details on a versatile unit of many applications which features a compact, battery-powered transistor amplifier

on "custom-built" counting devices.

However, the counter and accessories shown in Fig. 1 combine to provide so many different types of counting operations as to be considered an almost "universal" counter. Not only will the instrument handle routine counting operations, where the closure of a simple switch is involved, but it will also "count" where the actuating signal is a small current, as might be obtained from a photocell or thermopile.

This extreme versatility has been made possible by combining the characteristics of a direct-coupled transi-

tor amplifier, a sensitive relay, and an electromagnetic counter in one compact assembly.

The basic design is straightforward and fairly simple, so the average technician should have little or no difficulty in assembling a similar unit in less than a day's time. Once assembled, the technician may keep the counter for his own use, or sell or rent it to firms requiring such an instrument.

Circuit Description

Reference to the schematic diagram given in Fig. 3 will show that the counter consists of three related but independent sections: a sensitive "electronic" relay featuring a transistor amplifier, a low voltage a.c. supply (T_1), and an electromagnetic counter. The connections from each section are brought out to separate terminals on screw-type terminal strips, permitting maximum flexibility in choosing a particular combination.

Let us discuss each section separately:

The "electronic" relay consists of a type CK722 *p-n-p* junction transistor connected as a direct-coupled grounded-emitter amplifier. A sensitive relay, RL_1 , serves as the collector "load." Power is supplied by a 6 volt battery, B_1 , controlled by power switch S_1 .

Two modes of operation are possible, depending on whether the control signal is furnished through the closed circuit jack J_1 or "control line" terminals "A." Closed circuit jack J_1 is used where the control signal consists of a small current (from 150 to several hundred microamperes), such as might

Fig. 2. Rear view of the counter with the terminals and controls labeled.

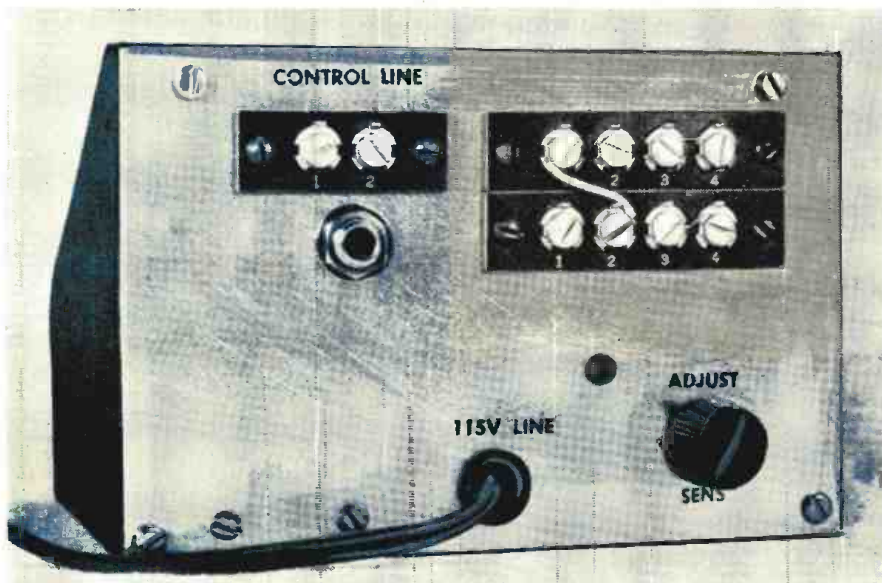

be obtained from a photocell. The "A" terminals are used where the actuating signal is the simple closing (or opening) of a circuit.

Let us first consider the operation of the circuit where the "A" terminals are used, and where a simple push-button switch is used to close the circuit.

With power switch S_1 closed, a voltage is applied between the collector and emitter of the transistor. However, there is little or no current flow in this circuit since the base-emitter circuit is open (at the "A" terminals) and base current flow cannot take place. Thus, relay RL_1 remains open.

When the external push-button is depressed, shorting the "A" terminals together, base current can flow over the path consisting of the negative terminal of the battery, switch S_1 , R_2 , through the shorted "A" terminals, R_1 , through jack J_1 (now closed), the base-emitter of the transistor, and back to the positive terminal of the battery. This base current flow permits a corresponding collector current flow, though of much greater amplitude due to the current amplification of the transistor stage. Relay RL_1 is thus closed and held in until the push-button is released, stopping base and collector current flow.

Resistor R_1 is used to limit the maximum base current flow, while R_2 is used to set the current flow to a fixed value within this maximum limit.

If the external switch is normally closed ("A" terminals shorted together), the action is just the reverse. Relay RL_1 is normally held closed, and "drops out" when the external circuit is opened.

Let us now consider the action of the circuit when a current generating device is plugged into the "control line" jack J_1 . Since this is a closed-circuit jack, inserting a phone plug immediately disconnects R_1 , "A" terminals, and the R_2 circuit.

Two conditions may exist. The external current generating device can supply a current only when the "counting" operation is to take place, or it can supply a current at all times, with the current dropping sharply or ceasing to flow when "counting" occurs.

In the first case, the relay will normally remain open, closing only when current is supplied to the base-emitter circuit of the transistor through J_1 . In the second case, the relay will close and "hold in" until the current supplied through J_1 drops appreciably.

Since the base-emitter current of the transistor is supplied solely by the external circuit, this source should be capable of supplying at least 150 microamperes, and should not supply more than 5 ma. If there is a possibility of the current supplied by the external source exceeding 5 ma., an external current limiting resistor should be provided.

A typical "current generating device" that might be plugged into J_1 is an ordinary self-generating (barrier

type) selenium photocell. Another such device could be a heat-operated thermopile (a series-parallel connection of several thermocouples to obtain greater current).

In any case, the connections of the external device to the phone plug should be such as to apply the negative terminal to the base of the transistor. See Fig. 5.

The low voltage a.c. supply is the next section of the "universal" counter to consider. This consists simply of a 6.3 volt transformer (T_1), a line cord, a power switch (part of S_1), and a pilot light.

The electromagnetic counter is a commercial unit having "reset" provision and operating on 6 volts a.c.

An a.c.-operated supply was not provided for the transistor amplifier circuit for several reasons. First, there is no real need for such a supply since, with normal use, battery life is quite long (due to the small power requirements of the transistor). Secondly, a battery supply permits completely independent operation of the transistor amplifier and relay circuit. This allows the circuit to be used alone for control purposes without requiring line connections. Finally, providing an a.c. supply would needlessly overcrowd an already well-filled cabinet.

Construction Hints

The general layout used in the author's model is clear from the exterior, back, and interior views of the instrument, given in Figs. 1, 2, and 4, respectively. The entire counter circuit has been assembled within a standard *Bud* sloping panel utility box. The electromagnetic counter, the 6.3 volt transformer (T_1), the power switch (S_1) and the pilot lamp socket and jewel are all mounted in the "cabinet." All other parts, including the relay, transistor, phone jack (J_1) and battery are mounted on the back panel. The *Mallory* battery is held in place by a large cable clamp.

Layout and wiring are not critical, however, and another builder may easily vary the layout to suit his own requirements.

Fig. 4. Interior view of the instrument showing components mounted on panel.

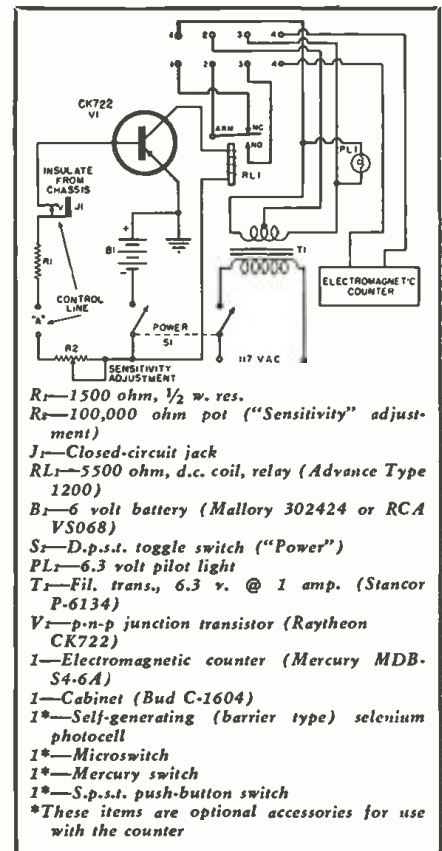
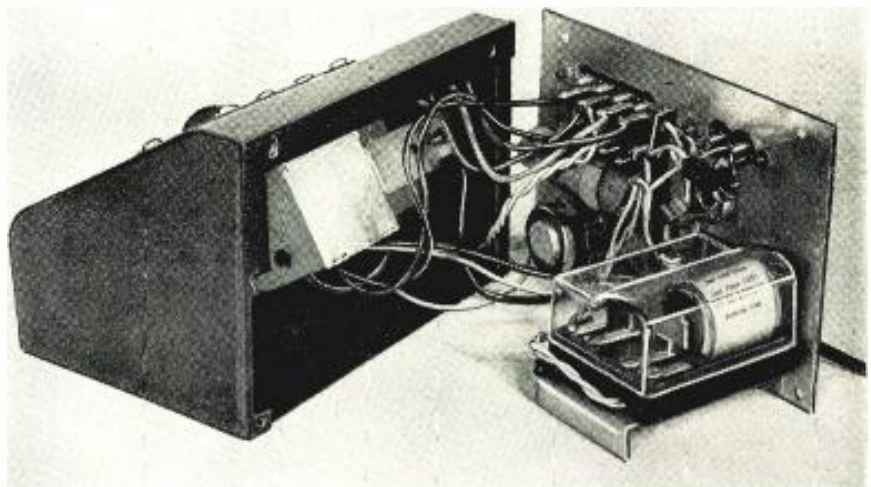

Fig. 3. Complete schematic diagram of the counter. It uses a Raytheon transistor.

Commercially available "decals" were used for labeling both the front panel (white decals) and the back (black decals). After application, the decals were protected with several coats of clear plastic, applied from a "spray can."

Two methods may be followed when installing the transistor. A socket may be provided or the transistor may be permanently wired into the circuit.

If the builder prefers to use a socket, a standard 5-pin subminiature tube socket is satisfactory. Only three of the pins are used.

On the other hand, if the builder

(Continued on page 173)

POWER SUPPLY REGULATION

By GERARD J. WENDELKEN

Color TV as well as many other electronic devices use the circuits described and explained in this article.

SINCE the introduction of color television, the service technician has heard more and more about power supply regulation. As a matter of fact, electronic devices of all types use more regulating circuits than ever before. This article will review some of the more important aspects of regulated power supplies.

In large cities, line voltage variations of ten per-cent are not uncommon; in rural areas, the voltage available may vary as much as twenty per-cent. Consider the result of such a change on the output of a typical power transformer with a voltage ratio of 1 to 2.56, primary to secondary. A twenty per-cent change in line voltage would mean that the primary voltage would vary between 105.3 and 128.7 volts (assuming that 117 volts were normal). The secondary output under such conditions would change from 270 to 330 volts, a total variation of 60 volts.

The power transformer itself is another important factor in a well regulated supply. If the transformer does not contain a sufficient amount of core material and wire of adequate size, the secondary voltages will change with even small variations in the load current drawn. When an adequately rated transformer is used, the secondary voltages will remain relatively stable regardless of the changes in load current. Similarly, the rectifier tube used in the supply circuit must also be adequately rated if voltage changes are to be minimized.

Another significant item which affects the supply regulation is the filter network used. This is illustrated in Fig. 1 which shows some of the operational characteristics of a 5V4G rectifier when used with various filter arrangements. Notice that when a 4 μ fd. capacitor is used in a capacitor input filter the output voltage variation is approximately 395 minus 330 or 65 volts for a load current change of between 25 and 100 milliamperes. If an 8 μ fd. capacitor is substituted, the output variation is approximately 395 minus 345 or only a 50 volt drop for the same load current change. When even smaller variations in output voltage are desired a choke input filter is generally used. Referring again to Fig. 1, note that for the same change in load current the output voltage variation is 260 minus 250 or only 10 volts.

The value of the choke in this instance is at least 4 henrys.

Bleeder or load resistors when used also affect the degree of regulation achieved in a well designed power supply. They provide a fixed minimum d.c. load into which the supply operates, and thus tend to minimize changes in supply voltage. This is illustrated in Fig. 2. Note that the circuit load in Fig. 2A varies from 2000 to 4000 ohms, or a maximum change of 2000 ohms. Assuming that a 4000 ohm bleeder resistor were inserted at the supply output as in Fig. 2B, note that the load variation would now be as follows: At minimum circuit load the power supply would be operating into 4000 ohms in parallel with 4000 ohms or 2000 ohms. At maximum circuit load the supply would operate into 2000 ohms in parallel with 4000 ohms or 1333 ohms. The maximum variation would then be 2000—1333 or 667 ohms, only one third of the original load variation. With a more stable load, the supply output voltage would then be more stable.

Another method of obtaining better regulation is through the use of a ballast tube. This tube contains a special wire element enclosed in a gas filled envelope. Variations in current passing through the element cause its resistance to change. When the current increases the element resistance increases. When the current decreases the resistance of the element becomes

less. The tube thus tends to minimize changes in current. In many circuits it is used for that very purpose. In other circuits it is inserted to compensate for variations in the voltage applied to the circuit. This type of regulator is very frequently found in series with a tube heater string. It must be remembered that this type of regulator is used to compensate for changes in input voltage and not variations in circuit load. Actually, if the load varied in a circuit using this tube the voltage change would be even greater than without the ballast. This can be visualized by assuming that the load on the power source increased. This would cause more current to flow through the ballast. The element resistance would increase causing an even greater voltage drop across it. For the above reason it is generally found only in circuits where the load is relatively constant.

While the preceding methods of improving regulation are important, they are usually considered passive methods. Although they are not often recognized as contributing to good regulation they are utilized in one form or another in almost every well designed power supply. There are, however, other voltage stabilizing means which are not often found in ordinary electronic equipment. These other stabilizing means are generally used when the regulation requirements are more critical, as in color TV receivers.

The VR or voltage regulator tube is one such device to limit variations in supply voltages. This tube contains a certain amount of argon or neon gas. Within the normal operating voltage range of the tube the gas ionizes with a visible glow, and because of this, it is often referred to as a glow tube regulator. VR tubes maintain a constant voltage drop across their output despite large variations in current. This is due to the fact that the degree of ionization of the gas within the tube changes depending upon the voltage across it. When the ionization is high, the internal resistance of the tube is low and the current through it is large. Conversely, when the tube's internal impedance is high the current is

Fig. 1. The effect of different filters on the output voltage of a rectifier tube.

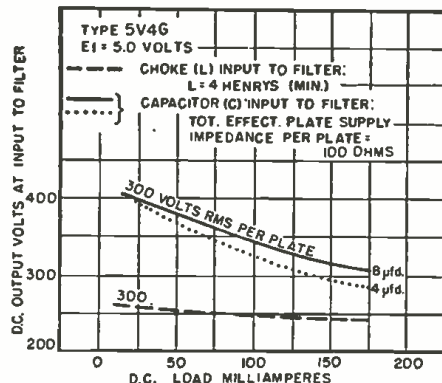

low. The IR drop across the tube tends to stay constant, and thus, the voltage across the tube remains constant. When properly utilized in conjunction with a suitable series resistor, these tubes will maintain relatively stable voltages despite considerable changes in circuit loads.

Two typical circuits using VR tubes are illustrated in Fig. 3. The basic function of the series resistor is to limit the current through the regulator tube to within its proper operating range. To illustrate clearly how the circuit of Fig. 3A operates, assume that the power supply voltage drops. The voltage across the VR tube is thus lowered, partially de-ionizing the gas and increasing the tube's internal resistance. Due to this, the current through the tube and series resistor decreases, and the IR drop across the resistor also decreases, keeping the output voltage stable.

In order to ionize the gas in a VR tube it is necessary for the supply voltage to be 20 to 30 per-cent greater than the normal operating voltage of the tube. Once the gas ionizes, the applied voltage drops to the normal rated value of the tube. Care must also be taken to insure that the circuit load variations do not exceed the normal rating of the tube. VR tubes can be connected in series as in Fig. 3B if higher voltages are involved. When they are connected in series, taps may be made in between the tubes to provide additional regulated voltages.

In some circuits vacuum tubes are used to maintain the proper degree of regulation. A simple circuit utilizing a vacuum tube is illustrated in Fig. 4. The amplifying properties of the tube give a more sensitive response to small variations in voltage. The tube is generally a triode with a low internal impedance, and in this application is used as a variable resistor and called a "pass tube." In the circuit of Fig. 4 it functions as the upper leg of a voltage divider, the bottom part of which is the load.

The internal resistance of the tube is determined by the bias applied to it by the circuit. With the grid connected to the VR tube, as shown, the output voltage will remain relatively constant. To illustrate the operation of the circuit, visualize that the voltage across the load has decreased. The cathode of the triode, which is positive with respect to the grid, would now be at a lower voltage. The voltage on the grid of the tube, however, has remained constant due to the action of the VR tube. As a result, the bias on the pass tube is less, and its internal resistance is lower. This causes a reduction in the voltage drop across the pass tube sufficient to correct for the original change in voltage. Where the rating of a single tube is not sufficient to compensate for large current variations, pass tubes are paralleled.

More sensitive regulation is possible by utilizing a vacuum tube amplifier to control the variable resistance or pass tube. A voltage regulator of this

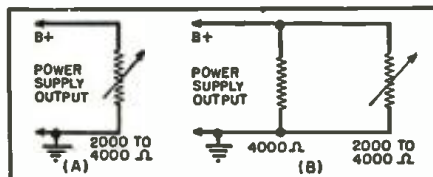

Fig. 2. Bleeder resistors across the output from a power supply are effective as regulators. The bleeder resistor shown in (B) increases the regulation of (A).

type is shown in Fig. 5. The amplifier tube used is usually a pentode because of the great amount of amplification possible. In the circuit of Fig. 5 the cathode of the amplifier is held at a constant voltage level by the VR tube. The grid voltage for the amplifier is obtained from the voltage divider network connected across the output of the supply. Plate and screen voltages for the tube are taken from the unregulated "B+" voltage. The screen resistor is actually part of the series resistance necessary for the proper operation of the VR tube.

The action of the regulator circuit is as follows: When the output voltage of the supply changes, the grid voltage on the amplifier tube changes. Since the cathode of the tube is held at a constant voltage, the effective bias on the amplifier tube changes, increasing or decreasing the tube current. This change in current causes a variation in the voltage drop across the amplifier tube plate load resistor. As connected, this tube is used to provide bias voltage for the pass tube. Thus, the change in voltage on the plate of the amplifier causes a change in bias on the pass tube, and as previously discussed varies its internal resistance and the voltage drop across it. This change in the voltage drop across the pass tube compensates for the original variation in the output of the supply.

The methods used to regulate high voltage power supplies are not very different from those used to regulate low voltage supplies. Special high voltage regulator tubes are available and function in the same manner as the VR tubes shown in Fig. 3. Another type of tube used for this purpose is a special high voltage, low current triode. This tube is usually connected as in Fig. 6. To understand how it functions, visualize that the load current has increased with a resultant drop in high voltage output. The cathode is maintained at a relatively constant voltage by the low voltage power supply. The grid voltage however, which is obtained from a tap on the high voltage bleeder network is now lower causing an increase in the negative bias on the regulator tube. This change in bias increases the internal resistance of the tube and reduces the regulator tube current by an amount roughly equal to the increase in current drawn by the load. The total current drawn thus stays constant.

Another means of regulating high voltage is to vary the screen voltage on the oscillator or output tube

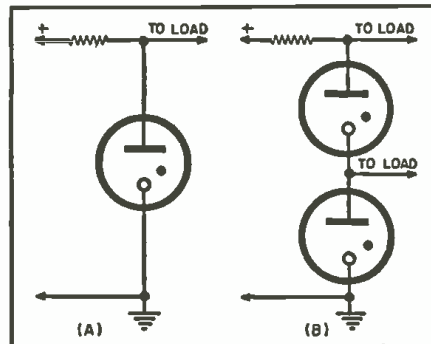

Fig. 3. The use of voltage regulator tubes (A) for a single output voltage, and (B) for two different output voltages.

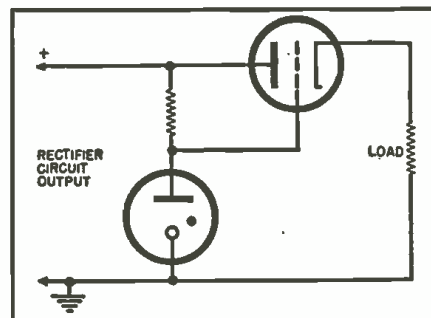

Fig. 4. The use of a triode vacuum tube for more sensitive voltage regulation.

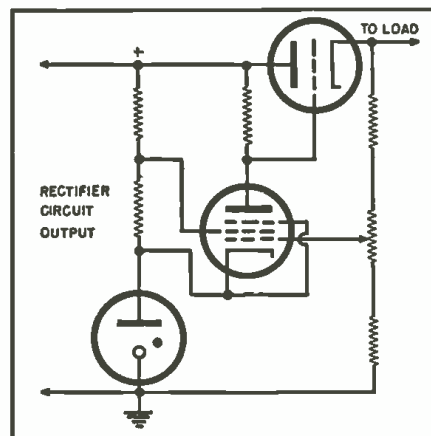
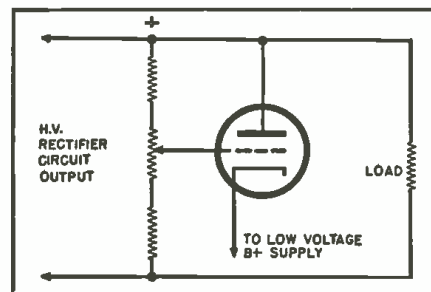

Fig. 5. Shown here is the use of a pentode amplifier tube to amplify small variations in output voltage for regulation.

driving the high voltage transformer. This is done in such a manner as to compensate for changes in the output voltage. The methods used to control the screen voltage are similar to those used in the low voltage supplies previously discussed.

Fig. 6. One type of power supply regulation circuit for TV high voltage.



TV SIGNAL TRACER

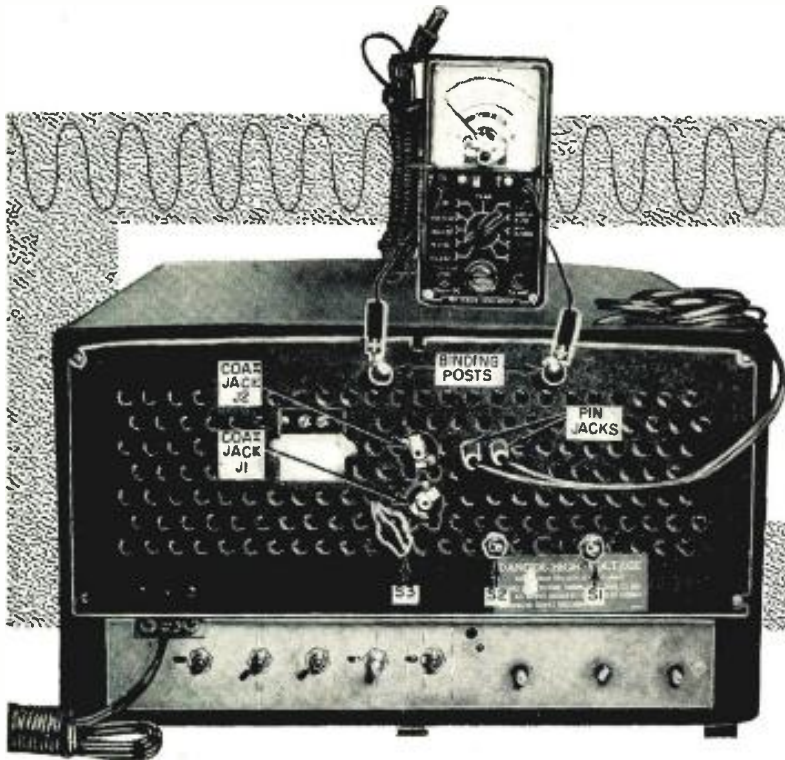

Fig. 1. Rear view of an old Admiral 19A1 TV receiver converted to a TV multi-tester as explained in the text.

By HARRY E. NEWTON

Convert a traded-in or unused small screen TV set into an oscilloscope or signal tracer for servicing.

DUE to the relatively high cost of 7-inch electrostatic deflection picture tubes as well as the demand for larger screens, many set owners traded in their small sets or put them aside when the picture tube became weak. Such sets can now be bought at relatively low cost and easily converted into one of the most versatile test instruments around the shop or home laboratory.

The addition of two jacks to the set converts it to a signal tracer as well as a source of signal for injection purposes. A pair of binding posts which can be used to facilitate antenna alignment and for making signal strength measurements on all channels. And lastly, by connecting the set to a suitable push-pull video amplifier, it becomes a 7-inch oscilloscope.

With all of these changes, the set remains a TV receiver both internally as well as externally. Other than wiring in the jacks and switches, no

changes are made in the circuit of the set. The amplifier used for the oscilloscope can be built on a separate chassis and mounted on the test bench if desired.

A good picture tube is desirable but a weak tube will function satisfactorily as an oscilloscope if the picture is bright enough to be observed indoors. A shield for the tube face will improve visibility out of doors.

Fig. 2 shows where the two jacks are added to the circuit. Jack 1 is connected to the 1st video i.f. grid and jack 2 is connected to the 3rd video i.f. output by link coupling to the i.f. transformer. These two jacks may be seen in Fig. 1 mounted one above the other on the back cover. If desired, they may be mounted on the chassis; it is much simpler to use the

back cover. Shielded leads should be used.

Connection of jack 2 to the 3rd i.f. is made by wrapping about 4 turns of insulated wire around the 3rd i.f. transformer. One end of the wire is grounded and the other terminates in jack 2.

The next step consists of extending the output of the video amplifier to a pair of binding posts in the rear of the set as shown in Fig. 1. The signal is taken from the video loading coil and used for antenna orientation and signal strength measurements. Since the plate load on the video amplifier is only on the order of 10,000 ohms or so, an ordinary 1000 ohms-per-volt meter may be used rather than a v.t.v.m. Sufficient voltage is obtained to permit the deflection to be seen from quite a distance, an important feature when moving an antenna about a roof.

The oscilloscope function of the tester takes advantage of the fact that most of the wave shapes to be observed in TV work require either a 60 cycle or a 15,750 cycle sweep and these sweeps are already built into the set being converted. All that is necessary is a push-pull video amplifier which is flat up to about 300 kilocycles and which can deliver about 250 volts of signal to the deflection plates. Provision is made for switching the amplifier signal from the vertical to the horizontal plates and at the same time making the unused sweep inoperative. This is done by the use of two double-pole, double-throw switches and one single-pole,

Fig. 2. Schematic diagram showing how the coaxial jacks are connected to the video i.f. section of the converted TV receiver. These jacks are shown in Fig. 1.

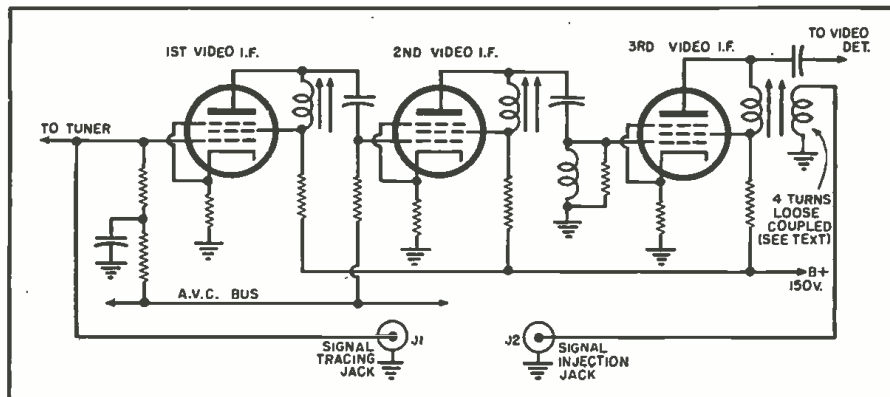

single-throw switch. The single-pole, single-throw switch grounds the grid of the vertical output tube when the signal is applied to the vertical plates.

Fig. 5 is a simplified schematic of the switch connections using one pair of pin jacks, three switches, and two binding posts. The scope amplifier is connected to the same binding post that brings out the video from the video amplifier for signal strength readings on a meter.

Using the Instrument

For signal tracing, plug a signal tracing probe into coaxial jack 1. Connect an antenna to the set under observation and turn on the set and the tester. Switch the tester to an unused channel and allow both sets to warm up. Bring the probe into the vicinity of a tube carrying i.f. or r.f., and the picture and sound will be seen and heard in the tester. As the probe is moved from the tuner of the set under observation toward its video amplifier, the picture and sound will become progressively clearer in the tester.

It is not necessary to remove the set being tested from the cabinet since these tests may be made on the top side of the chassis, with a resulting big saving in time for the technician. In checking tubes which are shielded, the probe should be touched to the shield which should be lifted, so that it does not make contact with the chassis.

To inject a signal into the set under test, connect an antenna to the tester and tune the tester to a channel in use. Connect a probe to jack 2 and, starting at the video detector tube in the set being worked on, move the probe from tube to tube toward the front end. As before, the set can be tested in the cabinet.

To make signal strength tests, the tester may be taken either to the roof or left below where a second technician telephones information on signal strength and ghosts to the man on the roof. The installation can be made by observing the meter readings and the actual picture.

The tester is turned on and tuned to the station which is expected to give the poorest reception in the locality where the installation is being made. The switches are set for normal TV reception (switches S_2 and S_3 open, S_1 down, see Fig. 5), and a v.o.m. is connected to the video output binding posts. Connect the antenna to the tester through twinlead of approximately the length of the downlead to be used in the installation and orient the antenna for a maximum reading on the v.o.m.

When the location of the antenna has been decided upon and the proper orientation found, it is a good idea to check the actual picture and sound before tying the antenna down. The reason for this is that a maximum reading may be obtained from ghosts and a compromise orientation must be

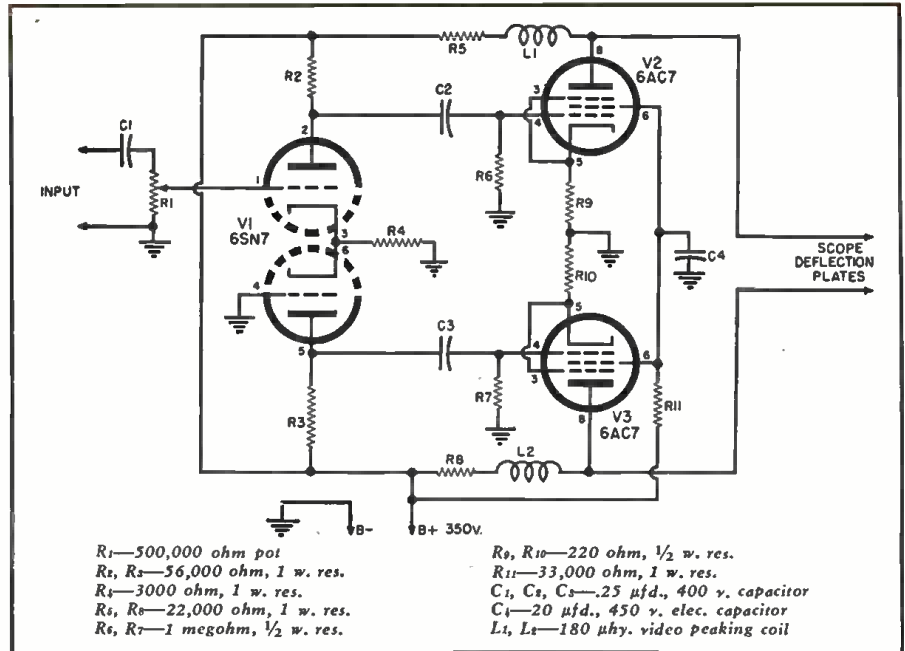

Fig. 3. Circuit diagram and parts list for a wide-band amplifier to be used with the converted TV set when it is used as an oscilloscope in servicing.

found in some locations. Bear in mind that the coiled up twinlead which connects the tester to the antenna is far more subject to extraneous noise and interference than it will be when run down the side of the building on stand-offs and twisted properly. Pull the twinlead out as straight as possible doubling it back upon itself and conditions will very nearly approximate the final installation.

The performance of the tester as an oscilloscope is limited by several factors. In the first place, it has, as presented here, only two sweep frequencies which may be varied a few cycles from their normal 60 or 15,750 cycles per second. However these two frequencies represent about 90 percent of the time-base frequencies required for TV service work. Secondly, the frequency response of the scope will be limited by the amplifier bandwidth and the fact that there will be high frequency losses in the cabling between the amplifier and the tester. By keeping these leads as short as possible these losses become negligible because the highest frequency to be passed is only 300 kc. The amplifier required is one that is relatively flat from 20 to 300,000 cps. It should be able to deliver about 250 volts of sig-

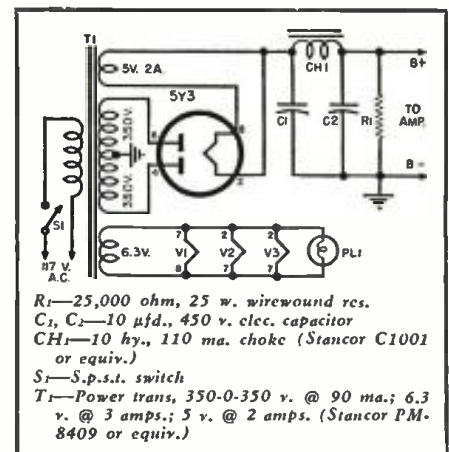
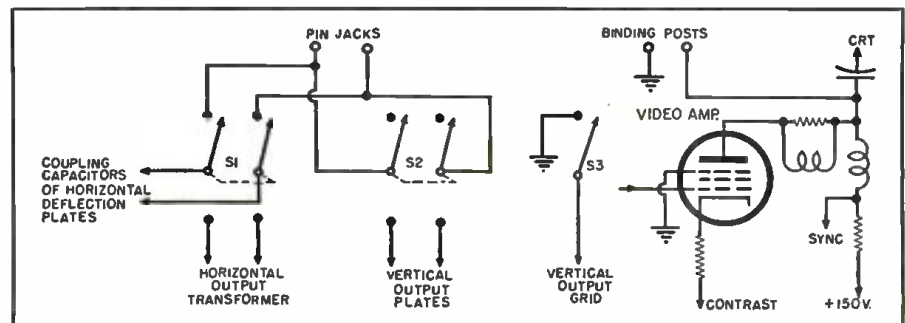

Fig. 4. Schematic diagram of a suitable power supply for the amplifier in Fig. 3. The tube numbers in the heater circuit of T_1 refer to the tubes in the amplifier.

nal to the deflection plates. Fig. 3 is a schematic for an easily constructed amplifier which meets these requirements. Fig. 4 is a diagram of a power supply that will furnish the necessary power for the amplifier.

To observe video and blanking pulses, connect a probe to the amplifier (Continued on page 153)

Fig. 5. Switch and binding post arrangement for the converted TV receiver.



AN EFFECTIVE, LOW-DISTORTION

LIMITING

AMPLIFIER

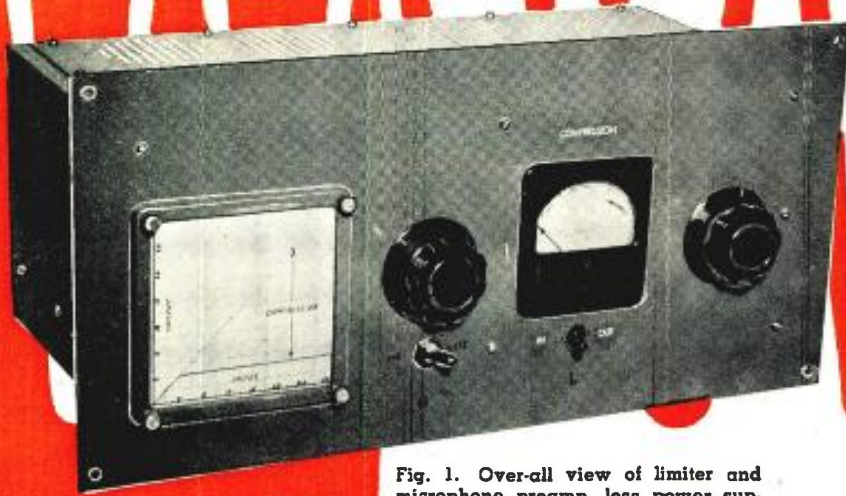

Fig. 1. Over-all view of limiter and microphone preamp, less power supply. Knob on left is interstage gain control in the preamp which adjusts the amount of limiting. The switches are to cut in high- or low-frequency compensation to emphasize speech frequencies, if desired. The chart is used to record the optimum settings.

By

W. HERBERT HARTMAN W6UAF

IT IS well recognized that an effective phone signal is one that is maintained at a high degree of modulation at all times. A completely modulated 250-watt signal is approximately as effective as a kilowatt signal that is only 50% modulated, and considering that a.v.c. action of the receiver adjusts the receiver volume in proportion to received carrier, the 250-watt signal would actually put out more volume from the speaker than would the kilowatt station.

It is the desire of every station operator to find an effective means of keeping the modulation level as high as possible, but at the same time preventing it from exceeding the legal maximum. Many schemes have been advanced, such as clipping-filtering combinations and various types of limiting or compression amplifiers.

It is the intent of this article to describe one such device that has proven to be very effective, yet includes few of the usual disadvantages. The limiter to be described is the outcome of several years' experimentation and closely parallels several of the commercially built units designed for broadcast work.

It might be well to begin by reviewing the requirements to be met by the limiting amplifier. (1) The amplifier must be capable of large amounts of compression with negligible distortion in the important speech frequency ranges. (2) It must have a high degree of control leverage, i.e., above the threshold point, the gain should virtually cease to increase for any further increase of input signal. The ideal curve of input plotted against output

Construction details on a unit which offers negligible distortion and has a high degree of control leverage.

would be one that suddenly flattened out to a perfectly straight line having no slope. See Fig. 2. (3) The limiter must have a fast attack time. Irrespective of amplitude, the limiter must catch the first impulse and prevent it from exceeding the pre-determined maximum. (4) It should also have a reasonable recovery time; fast enough to allow the gain to rise between syllables to keep every word at maximum modulation, yet slow enough so that clipping of individual cycles does not take place in the important speech range of frequencies. (5) There must be no type of instability nor should any control surges get through to cause popping or thumping in the output of the device. The unit to be described qualifies on all these points and its effectiveness is acknowledged by those who have heard it operate.

It may be of interest to the reader to know why the author felt that clipping-filtering does not meet the re-

quirements. A detailed discussion about transient response of filters, networks, and waveform distortion would be necessary to explain the deficiencies of the system. In a nutshell, the author believes it is much better to use a system that does not severely distort the waveform. Even after filtering, the clipper type of system exhibits an amazing amount of intermodulation products that cannot be eliminated, all of which seem to mask the intelligence of the signal and otherwise offset much of the increase in loudness. Also, due to the overshoot of a sharp cut-off type of filter when subjected to a square-wave type of impulse, an average loss of approximately 30% of possible modulation level must be maintained to prevent overmodulation. These factors made it desirable, in this instance, to concentrate on a compression type of circuit.

A compression, or limiting amplifier does not change the character of the waveform, unlike a clipper, but merely reduces the total size of the waveform to conform with certain pre-determined peak amplitudes. It does this instantaneously without detracting from the intelligence or articulation of the speech being transmitted. The manner in which this is accomplished can be seen from Fig. 3. If curve A of Fig. 3A is designated as the characteristic plate curve of tube V_1 (or V_2), Fig. 4, with no reduction in gain, an input volt-

Fig. 2. Ideal curve of input versus output.

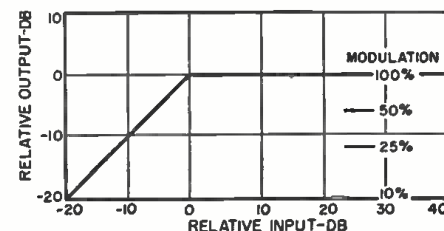

age E impressed on the tube will result in a given output voltage E' . If a control circuit is arranged to change the gain of V_1 by shifting the operating characteristics and hence the slope of the plate curve in such a way that when the impressed input voltage is raised, the slope will change in the same proportion, then the output waveform will remain substantially the same size, irrespective of the amount of input voltage, as in Figs. 3B or 3C. In other words, it is the slope of the curve that is changed, and not the shape of the waveform, which remains a perfect replica of the input waveform, except for size. The dynamic curve of the gain reduction amplifier stage is essentially a straight line under all degrees of compression. This, then, is the key to the operation of the limiter. It is a dynamic device that provides a set of operating conditions suited to each part of the signal it encounters in order to maintain a certain maximum peak level at all times.

The complete diagram of the W6UAF limiter is shown in Fig. 4. To make the device most effective for amateur work, several measures have been incorporated that would not prove desirable in broadcast work. A

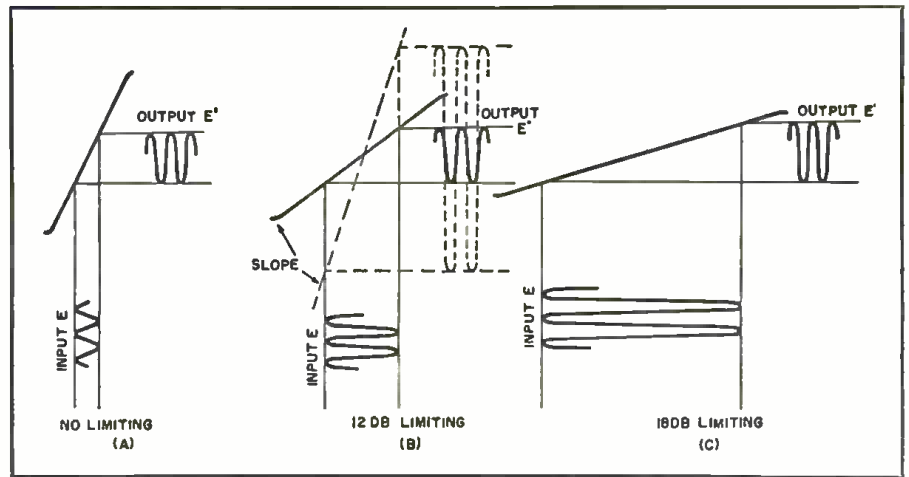
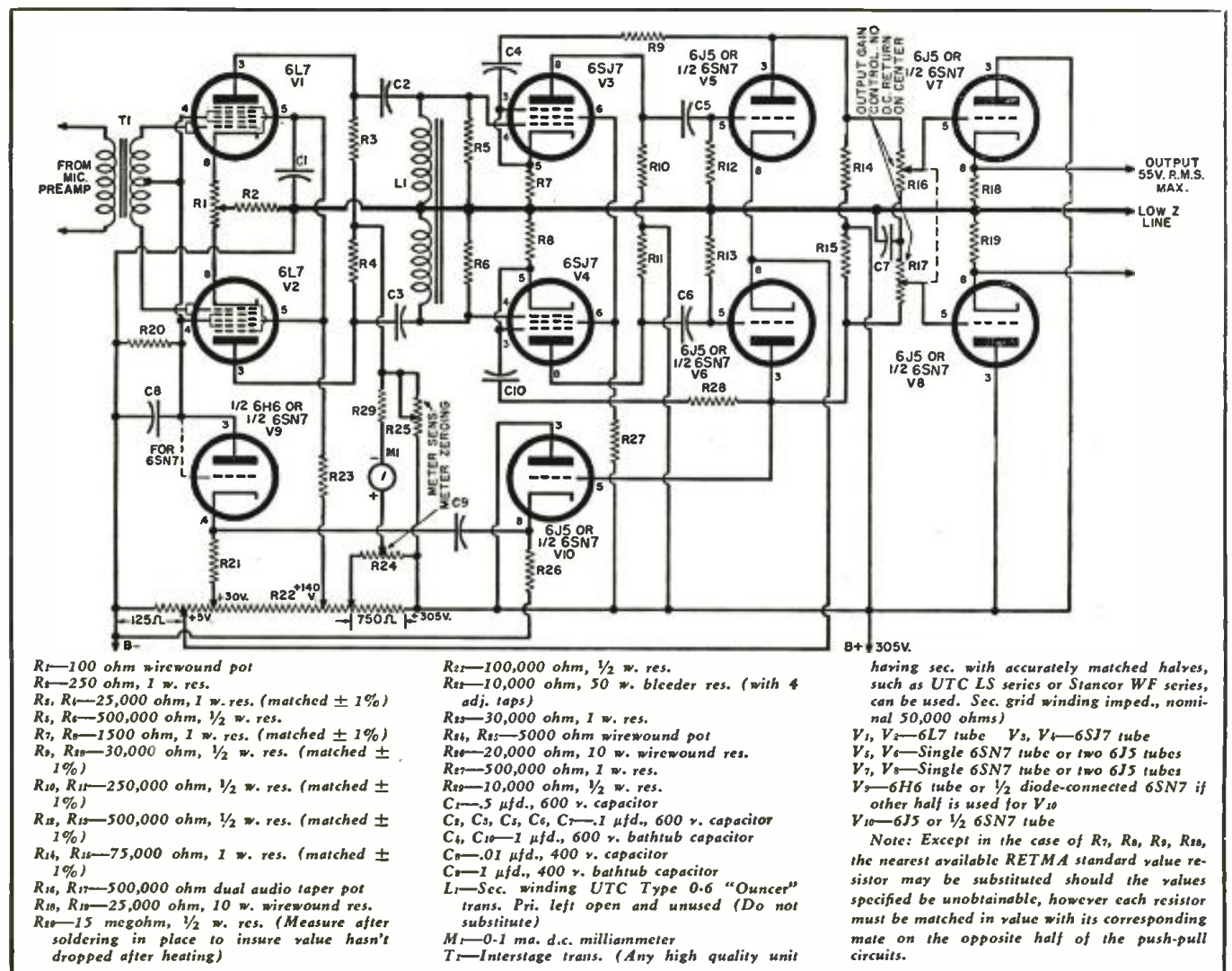

Fig. 3. Idealized characteristic curves of V_1 and V_2 . Fig. 4. See text.

higher degree of control ratio has been achieved, at the expense of distortion at extremely low frequencies. We are not concerned with small amounts of distortion at frequencies below 100 cycles, whereas such a compromise cannot be made in broadcast work. The recovery time of the control circuit has been made very short so it will effect its recovery be-

tween syllables instead of after several words have been spoken. This keeps the modulation high for each word or syllable, even when speaking at a rapid rate. This has also been done at the expense of low frequency distortion. Extremely fast attack time has been achieved through the use of a low impedance cathode follower circuit that will charge the time

Fig. 4. Complete schematic diagram of limiting amplifier. For an auxiliary power supply to be used with this unit, see Fig. 6.



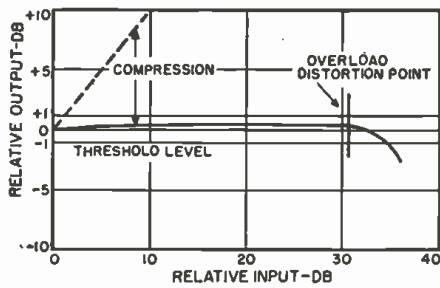

Fig. 5. Compression characteristics. Single tone distortion less than 2% up to 30 db compression for any frequency above 100 cps and less than 5% down to 50 cps (a steady-state tone). See discussion in text.

constant capacitor at a very rapid rate. Push-pull circuits are used throughout to prevent undesirable thumps, and other phenomena attributable to control circuit surges, from appearing in the output of the speech system.

Upon examination of Fig. 4, it will be noticed that the control voltage is sampled off only one side of the waveform in a half-wave rectifier circuit. In broadcast work this would be undesirable since it would allow certain voices to sound much louder than other voices or music depending upon the polarity of the speech waveforms. This is no problem to the amateur, whose object is to sound as loud as possible from only one sound source, so the point can be taken to advantage. This is discussed later on in this article.

The circuit consists of three principal parts: the gain reduction stage, the stabilized amplifier, and the control circuit. Also included as a somewhat optional feature is the output coupling stage.

The variable gain stage consists of a pair of 6L7 tubes operated in push-pull, with the signal applied to one set of control grids and the control voltage to both sets of control grids. This gives the control voltage additional amplification or leverage over that of the signal voltage alone. The

6L7 tube is admirably suited to this purpose since it has a variable mu characteristic coupled with very low distortion over the entire operating range until the input signal is increased sufficiently to cause the signal grids to draw grid current. This latter factor becomes evident at input levels in excess of approximately 31 db of compression at which point the output level drops abruptly. It is interesting that once the limiter becomes overloaded, the output drops instead of continuing to increase so that even under these circumstances overmodulation of the transmitter will not occur.

The gain reduction stage is followed by a two stage amplifier having certain critical requirements. The gain-frequency characteristics have been carefully selected to make the amplifier stable under all conditions of compression. Stability has been made high by means of inverse feedback and other features make it relatively insensitive to control thumps. The design of this portion of the limiter is extremely important, since it is essentially a part of a very high gain feedback loop. The mechanical analogy is the governor-controlled engine. Any mechanical instability causing erratic or sluggish operation of the governor will result in "hunting," which is a form of oscillation.

Any type of feedback path formed by a control circuit that samples the output of the device being controlled is capable of oscillation unless the frequency response of the loop is carefully controlled over many octaves, especially when the control leverage is very high (large feedback factor). The low frequency design is of great importance because perhaps it is the most difficult to control. It is in order to meet this design requirement that the inductance, L_n , is used between the gain reduction stage and the remainder of the amplifier. Because of its effect on the control circuit loop,

the requirements for the secondary ratings of the interstage transformer from the preceding microphone stages are quite critical. This transformer must have a well balanced secondary winding with low residual parameters.

Another similar oscillation is possible in the limiting amplifier if any control surge gets through the signal portion, becomes amplified, and is again sampled by the control rectifier. The frequency of oscillation is determined by the discharge time of the time constant circuit, C_s and R_{20} , the circuit that normally determines the recovery rate of gain limiting. This oscillation is not likely to take place with matched tubes and components in a push-pull type of circuit. Means for balancing the circuit for dynamic operating conditions are provided by adjustment of R_n .

The high frequency response of the control loop determines the behavior to impulses or transients. This defines how quickly gain stability is obtained after a sudden increase in gain has taken place. Poor high frequency response of the loop will cause the control to overshoot. The output will then decrease below that desired, then above, etc., in a damped type of oscillation before equilibrium is established for the new steady-state value of input signal. Careful design of the response and amount of damping insure that overshoot will be negligible.

The control rectifier is biased so that limiting action is delayed until the output signal voltage exceeds the bias voltage. With the bias voltage set at 30 volts, the output signal on the side of the circuit that is sampled by the control circuit cathode follower cannot greatly exceed 30 volts since the amount beyond which it actually exceeds 30 volts is impressed directly as a negative bias on the grids of the 6L7 tubes. There is no such limitation to the level encountered on the opposite side of the push-pull amplifier. This means that if the side of the signal appearing in the controlled side of the amplifier is chosen to modulate in the downward direction, the absolute limit of modulation will be the desired amount on negative peaks, but any unsymmetrical speech wave having high peaks in the upward direction is not limited, except in its normal proportion to the height of the negative peak. Thus if the transmitter is capable of a very high degree of modulation in the positive direction, compared to the negative direction (as most transmitters are that are not skippy on design) advantage can be made of it. This will amount to some 6 db or better. There will be no difference in the height of the positive and negative peaks on sine-wave tone. Unfortunately speech does not consist of pure sine-wave tone and the energy content is much lower for the same peak amplitude, however the most can be made of the normal asymmetry existing in male speech by allowing the highest peaks to go only in the direction that can most easily be accom-

Fig. 6. Schematic diagram of a regulated power supply for limiter amplifier.

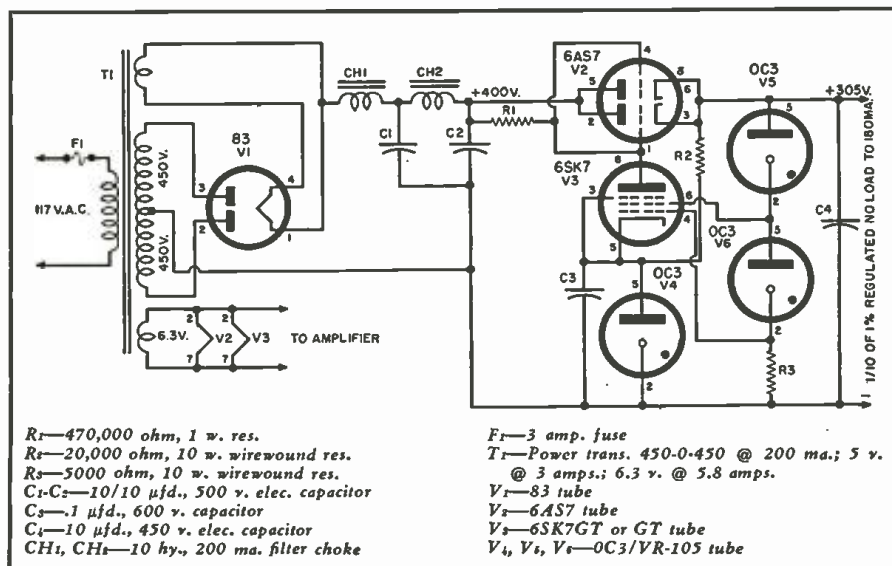

modated without distortion. Failure to regard the importance of this factor will result in seemingly weak modulation should the wrong speech wave polarity be observed, even though the scope shows consistent 100% modulation is being achieved on negative peaks.

The particular values chosen for the recovery-time-constant circuit were selected to allow the fastest possible attack time. The recovery rate is determined by the speed with which C_s discharges through R_{20} , according to the formula $T = CR$. T is the time measured in seconds, C is in microfarads and R is in megohms. This formula gives the time required for the voltage to decay to 63% of its steady-state value after the applied control voltage has been removed. The value of 15 megohms and 0.01 μ fd. gives a recovery rate of .15 second. The actual value is probably closer to .2 second if the stray capacity of the transformer winding of T_1 is included as part of C_s .

The attack time is determined by the series impedance of the source used to charge C_s . The resistance of the diode is probably in the vicinity of 300 ohms and the source impedance of the cathode follower is approximately $1/G_m$. Using published values of operating characteristics that most nearly match the actual operating conditions of the cathode follower, we obtain a source impedance of 385 ohms. This, added in series with the 300 ohm diode resistance gives a total charging resistance of 685 ohms. The charging time would be (neglecting the 15 megohms across the capacitor) $.01 \times .000685$ second. If we round off the .000685 to .0007 and assume some stray capacity in the transformer, we arrive at a time of approximately 7 microseconds. This is fast enough so that for all practical purposes the attack time can be assumed to be infinite for any impulse we propose to transmit having a frequency limitation of from 3000 to perhaps 10,000 cycles. It can be shown that if any appreciable overshoot does exist on the modulated carrier, it is probably due to poor transient response of the modulator rather than actual overshoot of the compression amplifier.

Thus, in order to utilize the full effectiveness of the limiter, the audio stages following the unit should be very carefully designed for minimum phase shift and flat response. A poor response curve following the stages of compression will result in persistent overmodulation at certain frequencies, or if this is corrected by lowering the gain, will necessitate the reduction of the average level of modulation. Restricted frequency range of the modulator will result in poor transient response and will cause hangover on steep wavefronts and result in shot type overmodulation. Phase shift of the relative frequency components will cause severe shifting of energy content-*vs*-peak power of the wave after the initial complex wave has already been limited by compression. This will cause wide variation in gain after it has supposedly been set to a definite maximum in the compressor. This would limit the effectiveness of the gain limiter as a device to prevent overmodulation.

Design the remainder of the modulator for the best frequency response possible even if the desired range is only that of the speech frequencies. Any frequency shaping or limitation *must* take place somewhere in the microphone preamplifier stages *preceding* the limiter.

The output circuit consists of a direct coupled, cathode follower circuit. This is an optional feature that performs the impedance transformation without the use of a costly transformer and allows the use of a simple dual volume control for the output gain control of the amplifier. It is to be noticed that d.c. appears on these leads and should be isolated with capacitors at the far end of the output leads before entering the input of a modulator, or if fed into a line-to-grid transformer means must be taken to keep the primary winding at d.c. potential above ground and to provide a large (25 μ fd.) capacitor from the center of the winding to ground as a bypass.

There is a certain maximum output voltage which can be obtained directly from the limiter. This limit is approximately 55 volts r.m.s. which allows considerable margin for speech waves having low energy content. The limitation is caused by certain requirements of the feedback loop in the two stage amplifier. This feedback is always

(Continued on page 129)

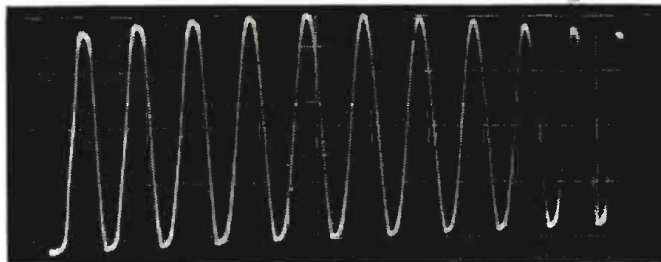

Fig. 7. Actual photo of output waveform when a 1000 cycle note is keyed. Triggered scope sweep started just as signal was keyed on. The oscillogram shows the first ten cycles after a signal was applied. This, and the other scope patterns, were taken with a Speed Graphic from the face of a Tektronix Model 514-D scope. The control rectifier sampled the side of the waveform that appears on the bottom of the pattern shown.

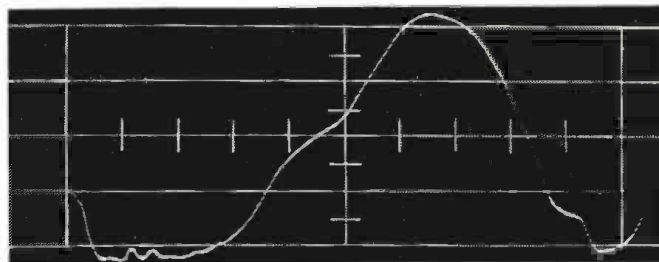

Fig. 8. Photo of first cycle undergoing compression in a wavetrain at 1000 cycles as in Fig. 7. Note the control circuit acts to make the first wave square-topped since the control cannot act until the actual signal exceeds the control bias voltage. The slight irregularities are due to the constants of the various feedback loops, as discussed in text. Circuit components were chosen to minimize these irregularities. Note that size of wave would be ten times as large had compression not taken place, barring overload of tube characteristics.

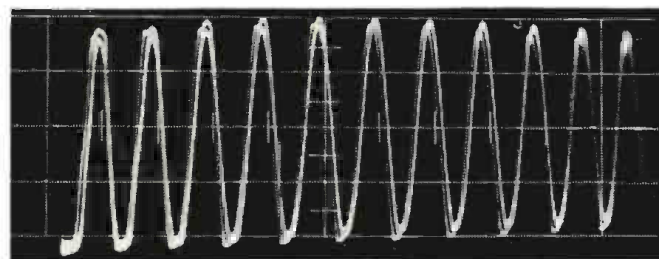

Fig. 9. Camera left open to record three separate, successive keyed 1000 cycle wavetrains at 20 db of compression. They do not precisely overlap because triggered sweep is more accurately activated with a pulse-type waveform than with sine wave.

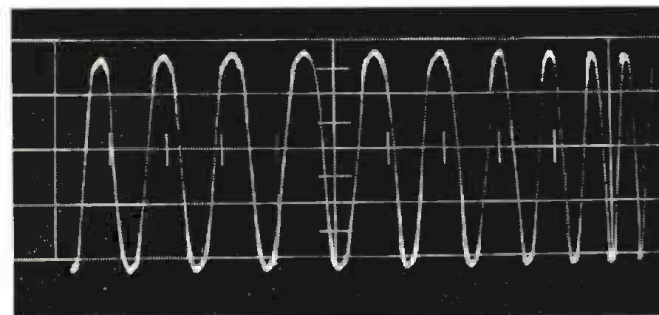
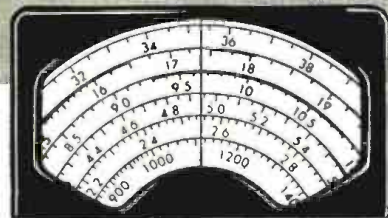

Fig. 10. Photo of first ten cycles of keyed 20 kc. note. This high frequency was immediately arrested on the first cycle, showing the effectiveness of the fast attack time. Waveform clipping exhibited in this and in all the preceding waveforms is more severe than would normally be encountered in speech material because the unit was keyed into very deep compression from a "no-limiting" condition. Unlike the keyed signal, the human voice usually requires several cycles to build up to maximum value, and the limiter has an opportunity to operate on a number of cycles of the wavetrain before the highest maximum occurs. The keyed tone is an especially severe test. Very little waveform clipping, except on the first cycle, will occur on normal speech wave under standard operating practice.



International SHORT-WAVE

Compiled by **KENNETH R. BOORD**



WE HAVE a fairly good "bag" of choice contacts to report this month as details pour in from all parts of the globe.

Around the World

Alaska—KLE, 3.35A, noted 0112 with test for tuning and circuit adjustment purposes. (Chamberlayne, Va.)

Albania—ZAA, 7.848 (measured), Tirana, noted 1530-1600 with *English* now. (Ferguson, N. C.; Cox, Dela.)

Andorra—Radio Andorra, 5.972AV, is scheduled now 0700-1900. (URDXC)

Angola—CR6RC, 11.862, Luanda, is again audible some days with interval signal of steady native drum beats, clock striking sequence, and "A Portuguesa," preceding actual sign-on 1330. (Niblack, Ind.) CR6RA, 4.870A, Luanda, noted 1505 with piano music, man announcer in Portuguese. (Cox, Dela.) Heard over 9.030 in Sweden 1650-1730 sign-off. (Nattugglan) Radio Diamang, Dundo, CR6RG, is heard in Sweden from 9.240 from 1410 to closedown 1430. (Etersvep)

Argentina—Radio del Estado, 9.690, Buenos Aires, noted at excellent level 1912-2000 with symphonic music. (Kippel, Colo.) LRY, 9.760, Buenos Aires,

is good level from around 1800 to 2258 closedown when has powerful signal. (Adam, B. C.)

Australia—When this was compiled, Radio Australia was testing VLB9 on 9.540 as a possible replacement for 9.615 in the 0700-0845 daily beam to Eastern North America. And VLA11, 11.810, had replaced VLA15, 15.200, to Western North America 2155-2315. VLA15, 15.200, noted by Woods, Utah, 0030-0100 with request musical program. Parsons, Pa., reports the 11.900 channel closing 1230 in the Asiatic beam.

VLI6, 6.090, Sydney, N.S.W., is good strength in Colo. 0500. (Kippel) VLX9, 9.610, Perth, noted 0300-0415, excellent level in B. C. (Adam)

Austria—Osterreichische Rundfunk, Innsbruck, is now back on 6.000, heard in Sweden around 1300. (Radio Sweden) Radio Osterreich, 7.245, Vienna,

(Note: Unless otherwise indicated, all time is expressed in American EST: add 5 hours for GCT. "News" refers to newscasts in the English language. In order to avoid confusion, the 24 hour clock has been used in designating the times of broadcasts. The hours from midnight until noon are shown as 0000 to 1300 while from 1 p.m. to midnight are shown as 1300 to 2400.) The symbol "V" following a listed frequency indicates "varying." The station may operate either above or below the frequency given. "A" means frequency is approximate.

This is the transmitter hall of the Belgian National Broadcasting Service, located at Wavre-Overijse, near Brussels, Belgium. In the foreground are the three short-wave transmitters and in the background are the two medium-wave transmitters (used for the Home Service). Currently, ORU has English for North America daily 2000-2200 EST over 6.085, relayed by OTC, 9.655, in Leopoldville, Belgian Congo. Look for it.

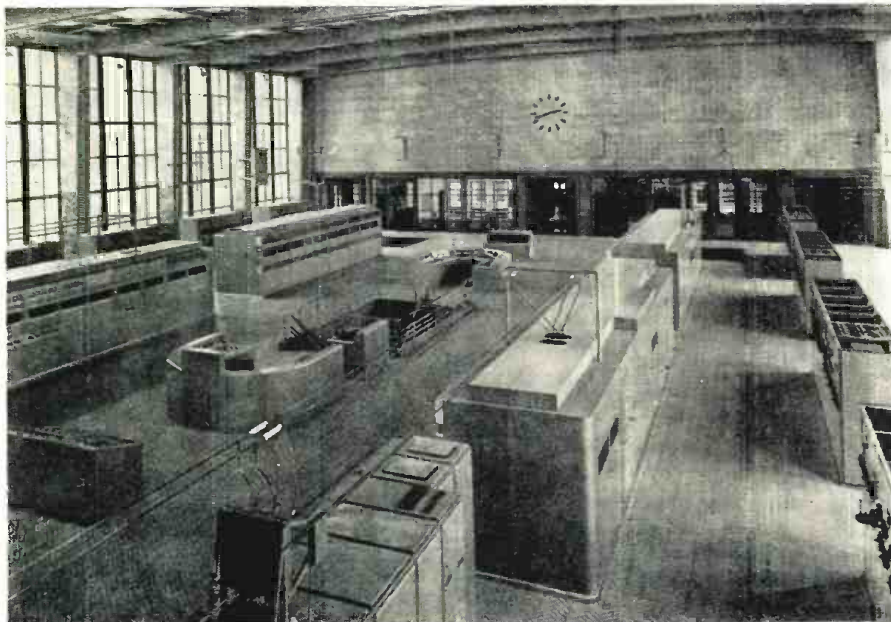

noted with call 0200, then news in German. (Pearce, England)

Belgian Congo—Radio Congo Belge, 9.380, Leopoldville, noted at good level 0000-0130 with music, news in French, Flemish 0100; now re-opens 1030 instead of 1130. (Morgan, Calif.)

Belgium—ORU4 noted on 6.085, poor to fair, 2000-2200 in *English* to North America. (Stanley, Conn., others) Heard opening in *English* 0500 over 17.860, good level in N. Z. (Hardwick)

Bolivia—CP38, measured 9.436, noted 1930 with news in Spanish followed by musical program; built up to good signal by 2000. (Ferguson, N. C.) CP5, Radio Illimani, 5.970, La Paz, heard in Sweden 2100-2200. (Nattugglan)

Brazil—ZYK3, 11.825, Recife, noted around 1900. (Anderson, Texas) ZYK3, 9.565, good level in *English* 2005-2025A, with "Brazil Calling" session. (Stanley, Conn.) PRL, 9.720, Rio de Janeiro, has news in Portuguese 2300, moderately strong level with some CWQRM from TGZ, Guatemala. (Kippel, Colo.) A Brazilian on 11.965A, giving location as Sao Paulo, observed closing 2300 on a *Sun*. (Niblack, Ind.) Radio Record, 9.505, Sao Paulo, noted at good level 1930-2000 with Portuguese music. (Mathieu, Mass.) PRL5, 11.950, heard 1825 with sports commentary in Portuguese; identifying on 9.770 at 1900 closedown (NNRC)

British Honduras—Radio Belize, 3.300A, noted 2040-2132. (Bannon, Fla., others)

British New Guinea—VLT6, 6.130, Port Moresby, heard with children's program on *Sat*. 0300. (Mike Christie, Calif.)

British Somaliland—VQ6MI, 7.125, Hargeisa, noted at poor level 0830, fair to good 0915-0930 closedown. (Morgan, Calif.)

Bulgaria—Radio Sofia, 6.070, noted with news to North America 1930. (Lipinski, Mich., others) Schedule for *English* to North America now is 1930-2030, 2300-2330. (Ferguson, N. C., others)

Burma—Sutton, Ohio, reports Radio Rangoon, 6.034, heard in *English* 0115-0145, news 0130, announcing "The Voice of Burma."

Canada—CHNX, 6.130, Halifax, N. S., is good level daily around 0600-0700 and later. (Snyder, Mass.) CFRX, 6.070, Toronto, Ont., good level 1330. (McGerald, Conn.) VE9AI, 9.540, Edmonton, Alta., strong with QRM in
(Continued on page 141)

INTERMODULATION DISTORTION TESTER



By JOSEPH CHERNOF

Over-all view of the author's intermodulation distortion tester setup. Shown are scope, tester, amplifier under test, and the v.t. voltmeter.

Details on an inexpensive unit for the audiophile which can be used with a standard oscilloscope or vacuum-tube voltmeter.

AN INSTRUMENT which measures audio frequency intermodulation distortion can be an extremely useful addition to the test equipment shelf. Of all the distortion tests available for evaluation of audio amplifier performance, none seems to agree so completely with listener judgment as the measurement of intermodulation distortion. While harmonic distortion should definitely be minimized in amplifier design, its presence in moderation merely adds some color, in the form of harmonics, to the reproduced sound which was not present in the original. This does not constitute faithful reproduction and is therefore to be avoided; however, the over-all effect is generally not displeasing to the human ear. In contrast, intermodulation distortion produces combination tones which usually bear no harmonic relationship to the original. The result is harsh, unpleasant, and, if present in any appreciable amount, conducive to listener fatigue.

An instrument for the detection and measurement of intermodulation distortion consists, basically, of a tone generator producing two separate output frequencies which are linearly combined and supplied to the amplifier under test. The output of this amplifier is then analyzed and the intermodulation distortion products present measured on a vacuum-tube voltmeter which is an integral part of the analyzer. This makes for a rather com-

plicated and expensive piece of equipment which may explain why few audio experimenters are able to make these measurements on home equipment.

The writer has attempted to work out the design of an inexpensive intermodulation distortion tester which would perform the same functions as its more expensive commercial counterpart. This has been done, in part, by avoiding the use of special or costly components and partly by eliminating the built-in vacuum-tube voltmeter which is a part of commercial circuits. This was done in the belief that practically every experimenter has access to either a v.t.v.m. or an oscilloscope so that there would be little purpose in duplicating the function of these

instruments in the design of an intermodulation distortion tester.

Fig. 1 shows a block diagram of a typical tester. The outputs of two audio oscillators, one a low and the other a relatively high frequency, are combined in a linear mixer circuit and the combination tone supplied to the input of the amplifier under test. This amplifier is then terminated in its rated load impedance and the output fed to the input of the analyzer circuitry. Here the combination tone is observed to determine the amount that the high-frequency tone has its amplitude modulated by the low-frequency tone. The low-frequency component is removed by means of a bandpass filter which accepts only the high-frequency component. The high-frequency tone accompanied by its associated modulation products is then detected and the carrier frequency filtered out. The low-frequency modulation products remaining are then measured and compared to the amplitude of the high-frequency carrier to determine the percentage of intermodulation distortion present.

At any given power output level, most amplifiers show indications of intermodulation distortion first at the lower audio frequencies. For this reason, an amplitude ratio of 4:1 between the low modulation frequency and the high modulation frequency is generally supplied to the amplifier under test so that low frequency distortion will be more apparent. If it is suspected that the amplifier under test has more distortion at the higher audio frequencies, an amplitude ratio of 1:1 will indicate a greater intermodulation distortion than the 4:1 ratio.

Fig. 1. Block diagram of the test setup.

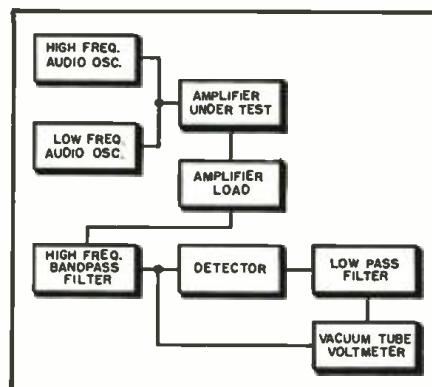

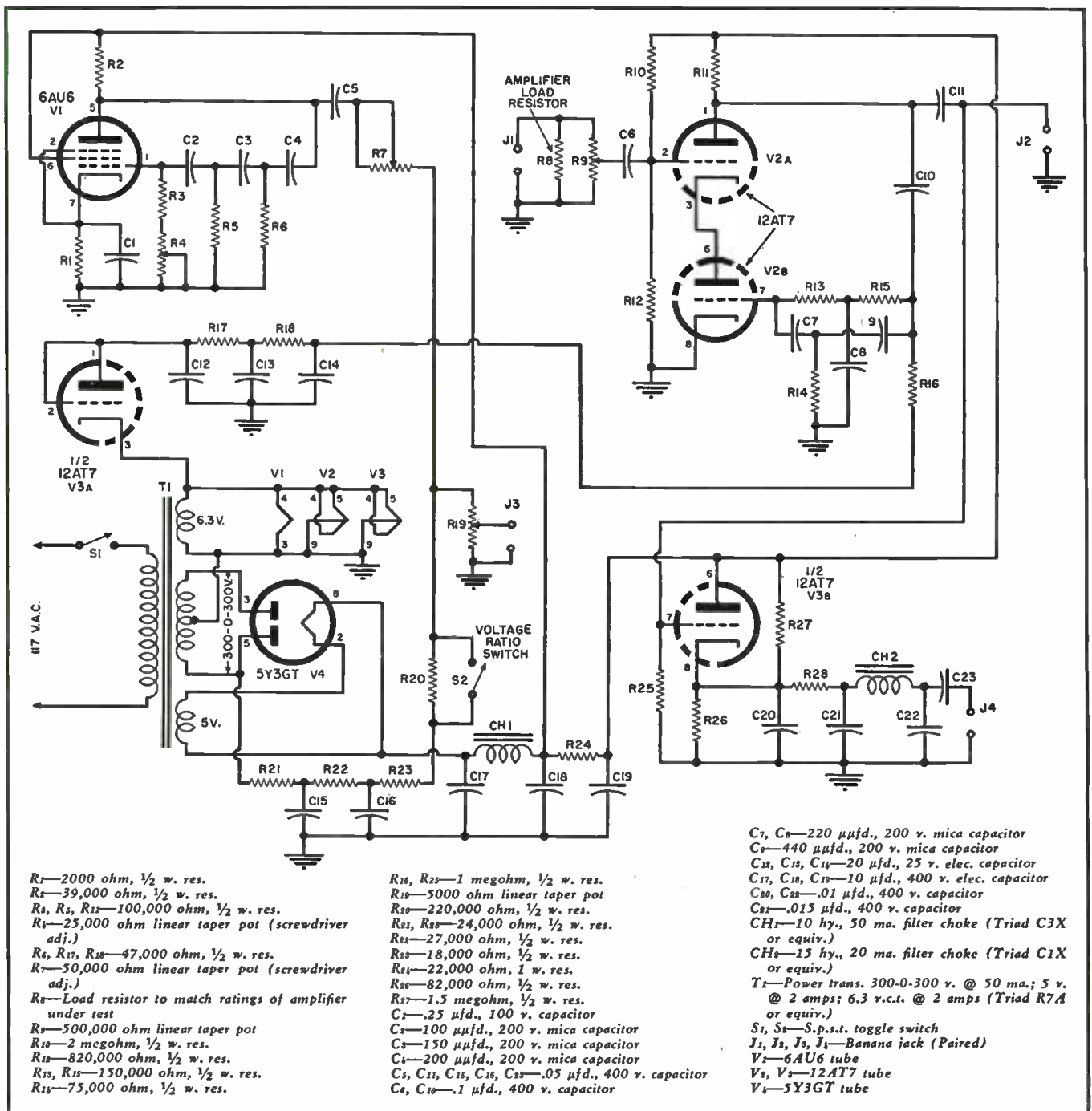

Fig. 2. Complete schematic diagram of the IM distortion analyzer. Quality parts should be used for best performance.

The schematic diagram of the complete intermodulation distortion tester is shown in Fig. 2. The high audio test frequency is generated by a phase-shift RC oscillator using a 6AU6 tube, V_1 . The output frequency is determined by the values chosen for $C_2, C_3, C_4, R_3, R_4, R_5$, and R_6 . This circuit has less distortion than the conventional phase-shift oscillator where all the "R's" and "C's" are made equal. A frequency of approximately 5000 cycles is produced by this oscillator. R_4 allows adjustment of the oscillator frequency over a small range. R_7 sets the output voltage of the high-frequency oscillator.

The low frequency audio signal is very simply obtained. 60-cycle voltage

is picked off from one side of the power transformer high-voltage winding and passed through an RC filter to remove higher harmonics and reduce the amplitude of the 60-cycle test signal to approximately 5 volts r.m.s. through the voltage dividing network consisting of $R_{16}, R_{20}, R_{21}, R_{22}$, and R_{23} , with the voltage ratio switch, S_2 , in the 1:1 position. With S_2 in the 4:1 position, R_{20} is shorted out to give the higher test voltage. The 60-cycle low-frequency test signal and the 5000-cycle high-frequency test signal are combined across audio output level control R_{10} . The variable output level is fed to output jack J_3 on the front panel where it is available for connection to the amplifier under test.

The output attenuator is used to set the power level at which an amplifier is to be tested.

The amplifier under test is terminated in its rated load impedance by a resistor capable of dissipating the full power output capabilities of the amplifier. This is shown as R_9 in the schematic diagram although it is not physically located in the tester chassis. The actual amplifier power output may be established by measuring the output voltage across this load resistor. Since a complex waveform is involved, a correction factor must be applied to the voltage measurement before the equivalent power output can be calculated. The correction factor for the 4:1 test voltage ratio is

approximately 1.3 and that for the 1:1 ratio is approximately 1.6. The output voltage is multiplied by this form factor to obtain the equivalent a.c. voltage corresponding to the voltage peaks of the complex output waveform.

The test amplifier output voltage is supplied from front panel jack J_1 to the analyzer section of the intermodulation distortion tester, attenuated in analyzer input level control R_6 , and then applied to the bandpass filter circuit consisting of both sections of V_2 , a 12AT7 twin-triode, connected in cascade with a twin-T RC feedback network. This network has a null frequency of approximately 5000 cycles and provides negative feedback at all frequencies but its null frequency to produce the bandpass filter effect at the null frequency. The 60-cycle low-frequency component is effectively removed by this filter leaving the 5000-cycle high-frequency component plus the sidebands which were generated by the interaction and distortion of the two test frequencies in the amplifier under test. The filter output is connected to the front panel jack J_2 so that the high-frequency carrier amplitude may be measured externally.

The 5000-cycle carrier is then demodulated by half a 12AT7, V_{3B} , in an infinite impedance detector circuit which builds up a voltage across its load resistor, R_{20} , practically equal to the envelope amplitude. A small positive bias is supplied to the cathode of V_{3B} to allow it to operate close to cut-off with no input signal. The demodulated output is applied to a low-pass filter consisting of R_{20} , CH_2 , C_{20} , C_{21} , and C_{22} and the carrier frequency is effectively removed. The low-frequency modulation products which now remain are a direct measure of the intermodulation distortion in the amplifier under test; these are connected to front panel jack J_1 . The exact percentage of distortion is determined as follows. The 5000 cycle carrier-frequency amplitude is measured by connecting an oscilloscope or v.t.v.m. to J_2 . This level is noted and

then the measuring instrument is connected to J_1 , and the amplitude of the modulation products is noted. The ratio of these two voltages is the percentage of intermodulation distortion.

A conventional power supply is employed using a 5Y3GT rectifier. The other power supply components are not critical and any comparable values that the experimenter may have in his parts box would be acceptable. The 6.3-volt a.c. filament voltage is rectified by bias rectifier V_{3A} , the remaining half of the 12AT7 connected as a diode, to provide the class A operating bias for the bandpass filter tube. Normal wiring procedures should suffice except that some care should be taken to isolate the 5000-cycle oscillator from the bandpass filter circuitry. Since 60 cycles is used as one of the test frequencies, every attempt should be made to eliminate stray 60-cycle fields during layout and wiring.

Initial set-up of the instrument is short and sweet. R_{20} , R_{21} , R_{22} , and R_{23} have been chosen to work with a power transformer with a high-voltage winding supplying 300 volts a.c. each side of the center tap. For any other voltage rating, it will be necessary to change the values of R_{20} and R_{23} , keeping in mind that 5 volts r.m.s. of 60-cycle signal is to be developed across output level control R_{10} with S_2 in the 1:1 position. Likewise, the high frequency oscillator output attenuator, R_7 , is adjusted until 5 volts of 5000-cycle signal is developed across R_{10} . This can be checked with a voltmeter or oscilloscope at J_3 . The high-frequency oscillator is adjusted to the center frequency of the analyzer bandpass filter by jumping J_3 to J_1 and observing the bandpass filter output at J_2 with an oscilloscope or v.t.v.m. The oscillator frequency is adjusted by means of R_1 for maximum output from the bandpass filter circuit. Analyzer input level attenuator R_6 is set just high enough to give sufficient output voltage at both J_2 and J_4 to be conveniently observed and measured. If R_6 is set too high, V_2 will be overdriven

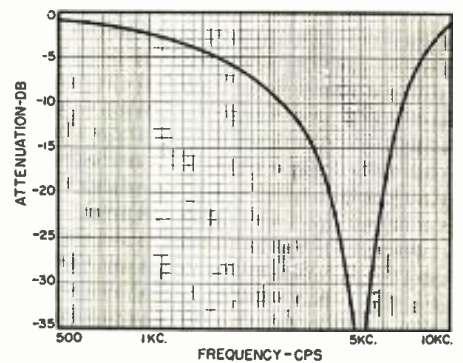

Fig. 3. Transfer characteristics of the twin-T feedback network as used in the IM distortion analyzer's bandpass filter circuit.

and the resulting distortion will cause erroneous results.

It is difficult to quote a figure for maximum allowable intermodulation distortion for a given amplifier, though it is generally accepted that a really top-notch amplifier should not exceed a figure of about 6% over its entire usable frequency range. Common causes of high amounts of distortion are operating circuit components such as tubes and output transformers beyond their normal ratings into regions of nonlinearity. Particularly in the case of output transformers, the highest quality components should be used whenever possible. When, in the interests of economy, compromises must be made, it is often possible to make up for component deficiencies by means of negative feedback loops around one or more amplifier stages.

Should the builder already have an audio oscillator in his possession, the construction of the IM distortion analyzer could be simplified. High-frequency test oscillator, V_1 , and its associated circuitry would then be deleted. The external audio oscillator voltage would be inserted into the circuit at the top of R_{10} . This could best be done, physically, by the addition of another pair of banana jacks on the front panel of the unit.

-30-

Side view of the analyzer showing location of tubes and chokes.

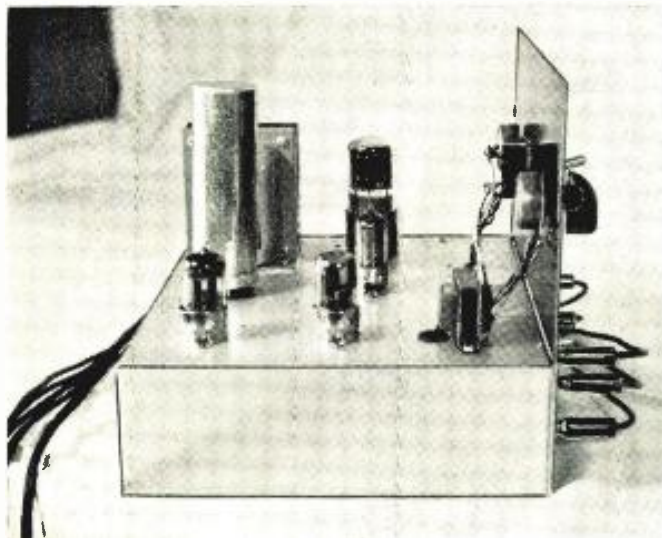

View from other side of chassis showing the power transformer.

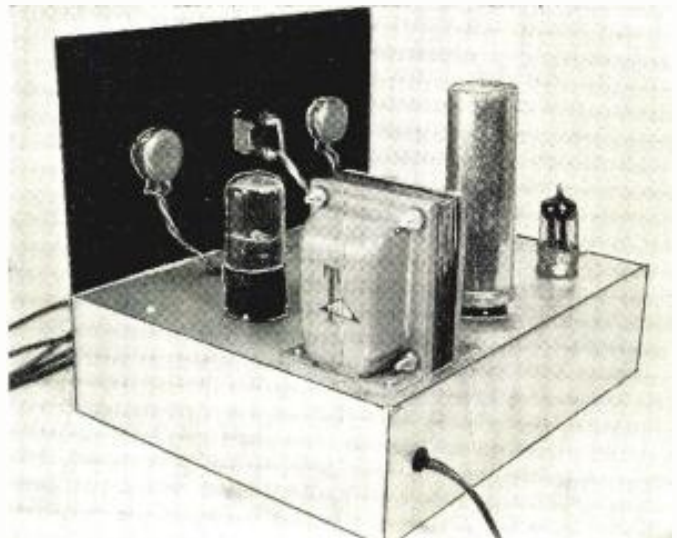

CARRIER-CONTROLLED SWITCHING



By
WARNER CLEMENTS

Transmitter units housed in home-built cabinets. Commercial housings are now available.

Construction details on a simple transmitter-receiver to operate remote equipment via the household power lines.

THE time to install wiring in a home, store, or office is when the building is under construction. If you have to do it at any other time it can be either very messy or very expensive.

Now suppose that you need new wiring for the purpose of turning some electrical device on and off from a distance, and that it looks like a formidable task to conceal the wiring you are going to have to run. Why not make use of the already-existing a.c. power wiring? You can send radio-frequency signals over the power lines to control a relay which does the required switching at the remote location. You

can, that is, if you can build equipment for the purpose that is simple and economical enough to be worth the trouble.

The simplest remote-unit (receiver) circuit for the purpose is that of Fig. 1. No detection is needed; the r.f. currents fire the cold-cathode gas discharge tube directly. This identical circuit (except that C_1 and R_3 have been added here) has been appearing in tube manuals for sixteen years. During that time it has probably broken the hearts of more people who tried to put it to work than any other circuit that would appeal to experimenters.

It's easy to make it work *after a fashion*, but hard to make it work reliably and consistently. I say "hard"; of course it will work reliably under any circumstances if you use a powerful enough transmitter. But it gets a little ridiculous to use, say, 100 watts input on the transmitter for the humble purpose of controlling a 60 watt light bulb in the garage.

A number of factors tend to bring about poor results with this circuit. These involve the control unit (transmitter) as well. One factor has to do with the unavailability of suitable high "Q" inductors. The sensitivity of the receiver is almost directly proportional to the "Q" of its tuned circuit; the transmitter needs a high "Q" tank for the sake of efficiency. While any good radioman can wind a coil suitable for

Fig. 1. Photograph and schematic diagram of remote receiver unit. Many such units can be built and operated from the transmitter.

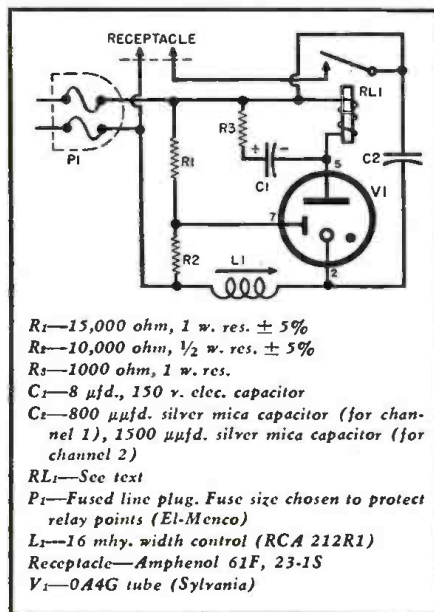
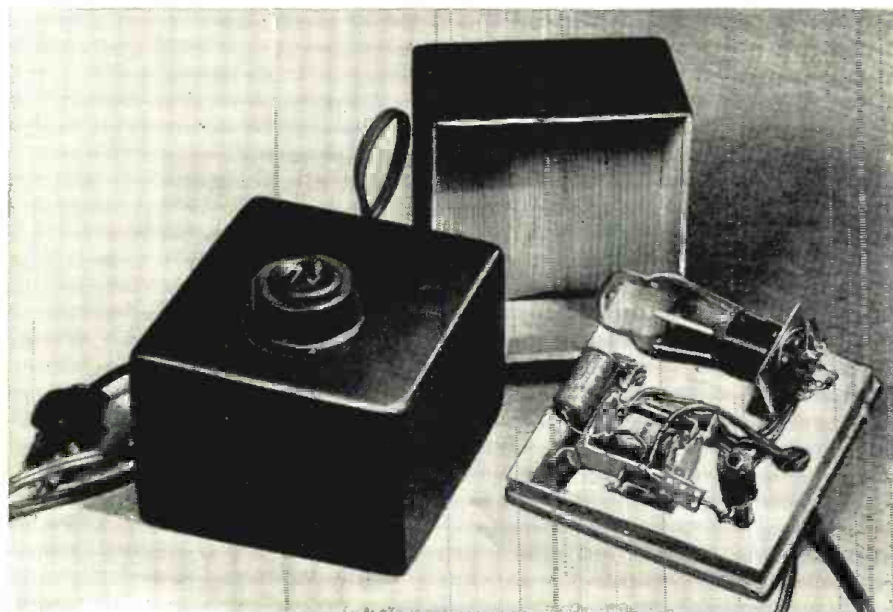

use at high frequencies, it's not so simple at the low frequencies necessary for so-called "carrier" transmission. In the latter case a coil-winding machine is a "must." It has been recommended elsewhere that 175 kc. i.f. transformers be used for this application. These just simply won't do the job. For one thing, 175 kc. is too high a frequency. Dozens of devices in modern homes have line filters built in; oil burners, vacuum cleaners, food mixers, electric razors, radios, etc. These all add up to pretty heavy and variable capacitive loading at 175 kc. You want a switching system that will work all of the time and not quit on you when a neighbor turns on his television set.

And if you work i.f. coils at lower frequencies than they were designed for, they cease, in effect, to be high-"Q." Another drawback to i.f. transformers is that any but a microbe-powered transmitter will burn them up, nor will iron-cored inductors designed for filter applications fill the bill. The latter will tolerate little or no d.c. current and anyway they cost too much.

The whole problem has been solved in the equipment described here through the use of inexpensive television components; namely width-linearity controls. The adjustable cores on these controls provide a convenient means of tuning.

The next problem is a little different. It concerns the coupling of the transmitter tank to the line. The impedance of the line is pretty low; seldom over a few ohms and as low as a fraction of an ohm. So why not use a transformer output to roughly match impedances? Well, there are two reasons why not. One is that the secondary of a transformer would short the power line without the use of a blocking capacitor. But the capacitance of that blocking capacitor would ideally be high enough so that it would also carry a very heavy 60-cycle current. The other objection to transformer coupling, as well as to any other form of coupling that would provide a good match over a broad band, is that you might want to use more than one channel. Then every time you turned on another transmitter (in the extreme theoretical case) you would cut the line impedance in half. Each transmitter would load down the others.

What is called for is a resonant impedance match and that is just what is provided in the transmitter circuit of Fig. 2. Here C_2 and C_1 are actually the tank capacitors. You can see that the power line is simply included in series with the respective tank circuits of the two oscillators. The high resonant currents flow through the line, while the tube still "sees" a shunt resonant circuit. There is a theoretical L/C ratio that will give the optimum match between any two impedances in this arrangement. The inductance selected for L_1 and for L_2 is somewhat higher than the optimum, for the sake of stronger oscillation. Anyway, some mismatch is desirable.

Speaking of line loading; as you can

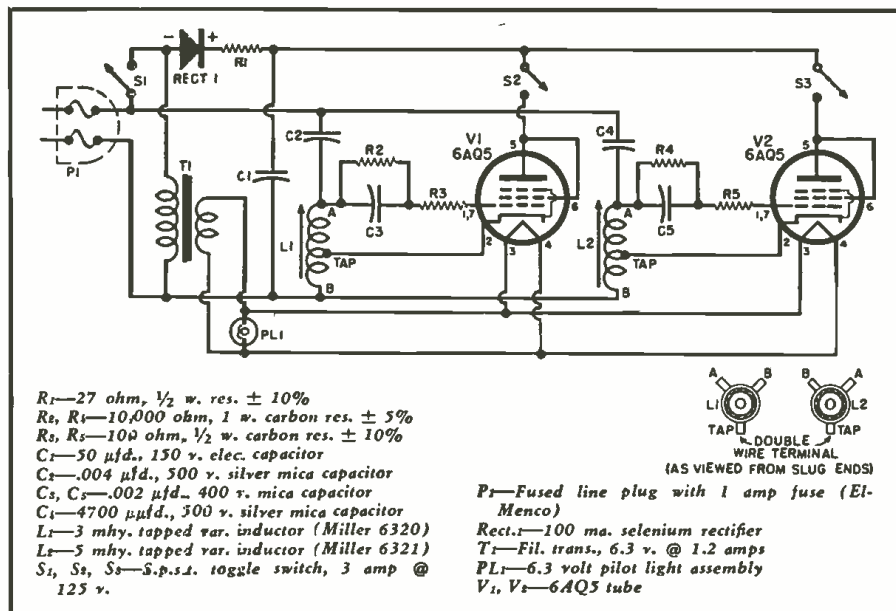

Fig. 2. Schematic diagram and parts list covering the control unit transmitter.

well imagine, every time somebody in the neighborhood turns anything off or on it detunes the transmitter to some extent (provided the latter is in operation). Many radiomen will be horrified at the idea of taking the r.f. power output directly from the oscillator. But before you start building an oscillator-buffer setup, you might consider what happens at the same time to receiver tuning. The receiver, too, has the line as part of its tuned circuit. The beauty of the transmitter coupling method described here is that in combination with line and receiver it adds up to a perfectly symmetrical arrangement, as shown in the equivalent circuit of Fig. 3. You might say that a given change in line loading detunes both transmitter and receiver in the same direction. (Not by the same amount in the present case, as L/C ratios are not the same.)

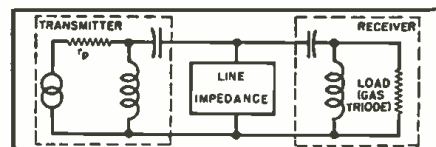
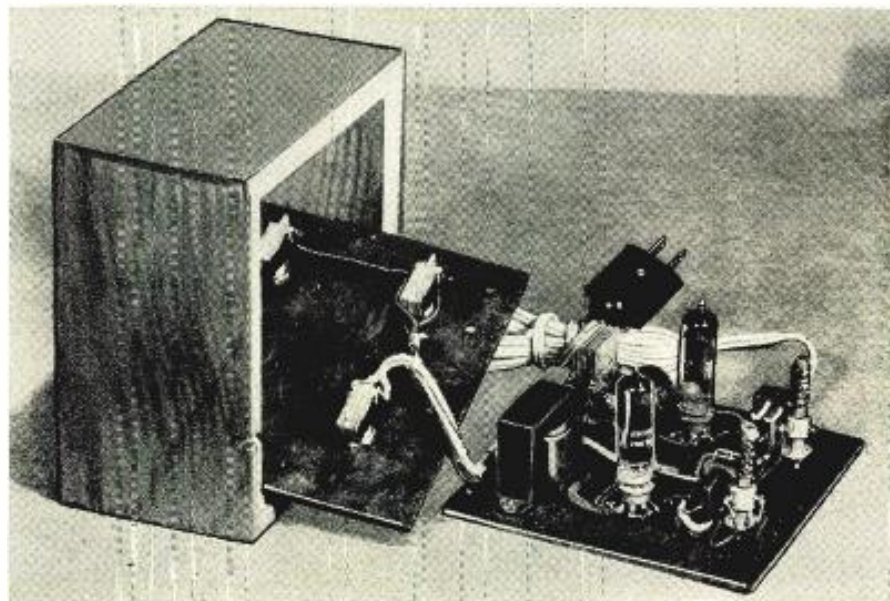

Fig. 3. Simplified equivalent circuit for r.f. portion of carrier switching system. Line constants are assumed to be lumped.

Anyway, the thing works up into an extremely simple and compact setup. You will note that the transmitter circuit requires neither chokes nor coupling capacitor. The well-built little Miller coils specified withstand high r.f. voltages and run for hours on end just warm to the touch. While a two-channel outfit is shown in the diagram and illustrations, there is nothing to prevent one from adding channels. The component values given here have

(Continued on page 147)

Fig. 4. Dual-channel control unit with cabinet disassembled. Note the roomy construction and the provision for ventilation via the perforated hardboard cover.



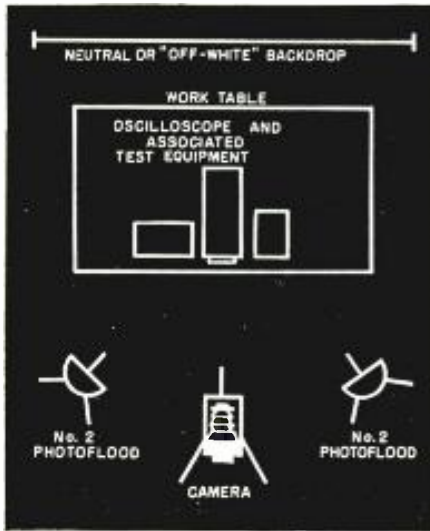

Fig. 1. The author's set-up for making oscilloscope waveform photographs. No special equipment is required with this method.

TECHNICIANS and engineers who are investigating new circuits frequently find it desirable to record oscilloscope waveform patterns. In many cases, the recording may consist of a simple sketch or tracing. Where extreme accuracy is required, however, a photographic record of the scope pattern will be made.

Oscilloscope pattern photography is not especially difficult in itself. Larger laboratories needing a good many waveform records employ specially-designed commercial *oscilloscope cameras*. These cameras are generally built to mount directly on the oscilloscope. They are available in a wide variety of designs to meet almost every laboratory requirement.

Smaller laboratories and individuals, on the other hand, usually rely on a standard camera. In some cases, the camera may be equipped with a reasonably light-tight cone shaped hood.

Although simple waveform photographs will satisfy the average laboratory demand, the need frequently arises for photographs in which not only the waveform pattern, but the settings of the oscilloscope controls and possibly a complete test equipment set-up are shown. A typical example, in which both oscilloscope con-

OSCILLOSCOPE PHOTOGRAPHY

By E. G. LOUIS

Details on a simple technique for recording waveforms using standard cameras, photofloods, and simple "props."

control settings and the pattern obtained are shown, is given in Fig. 2 (right).

In some cases, it may even be desirable to show human hands adjusting the test equipment controls. Photographs of this type are useful for illustrating technical reports, instruction books, and professional papers.

Under ideal conditions, it is sometimes possible to make such photographs by using average room lighting. The "Intensity" control of the scope is turned considerably past its normal setting, and a fairly long time exposure is made, using a relatively fast lens setting. Unfortunately, even when these precautions are taken, if a good "equipment" photo is obtained, the waveform pattern may lack contrast and may not be suitable for reproduction. Or, if a good waveform picture is obtained, portions of the test equipment may be fuzzy and out of focus due to a shallow depth of focus.

In any case, it is virtually impossible to stop down the lens opening to obtain good depth of focus, and to use floodlights and short exposure intervals without "washing out" the scope image.

The author, requiring a number of illustrations showing both oscilloscope waveform patterns and the equipment

control settings, worked out a special technique for making such photographs. The photo shown in Fig. 2 (right) was obtained using this method.

Equipment Required: The only "special" equipment used to obtain such photos is a dull black circular mask cut to fit over the cathode-ray tube screen. Such a mask may be obtained by cementing black "construction paper" to card stock. If construction paper is not available, the black inner envelope supplied with photographic enlarging paper may be used.

Of course, a camera, tripod, and a pair of standard floodlights (with stands) are needed. A neutral color or "off-white" backdrop is useful, but not essential. A satisfactory equipment arrangement is shown in Fig. 1.

Basic Technique: With the test equipment connected and adjusted to give the oscilloscope pattern desired, the camera is sharply focused on the cathode-ray tube screen. The lens opening is then stopped down until all the electronic test equipment is in sharp focus. The black mask previously prepared is placed on the face of the scope. If a human model is to be used, he is placed in position.

(Continued on page 94)



Fig. 2. (Left) Initial step in photographing waveform. Tube face is masked out as described in text. (Center) Second step in which pattern is photographed on film. (Right) The composite photograph obtained.

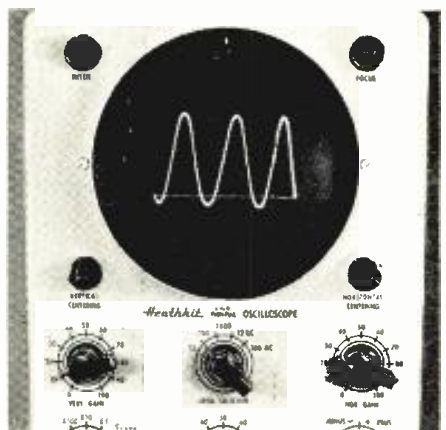
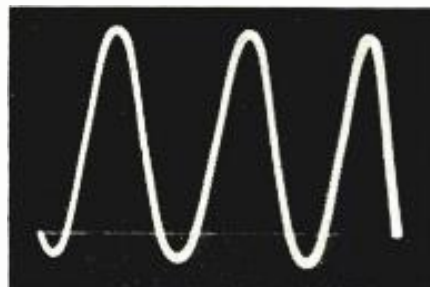

THE MOTOROLA

19" COLOR TV RECEIVER

By
M. S. KAY

Part 2. Sweep and convergence circuits of this first commercial large screen color TV set; also CRT circuits.

IN LAST MONTH'S article we covered the signal circuits of the *Motorola* color television receiver, from the antenna to the cathode and three control grids of the picture tube. In this article we will concentrate principally on the deflection and convergence circuits and on the color picture tube itself.

Deflection Systems

The deflection systems of a tri-gun color television receiver possess a marked similarity to the deflection systems of monochrome receivers. The same type of deflection waveforms are required at the deflection yoke and these are produced in more or less the same manner. Circuit variations that do exist stem primarily from the altered requirements of the high-voltage supply or because of the added precautions needed to maintain the three beams in close convergence over the entire area of the screen. Just what these differences are will become evident as we analyze, step-by-step, the deflection system of the *Motorola* color television receiver.

In the vertical section there is an integrating network, a blocking oscillator, and an output amplifier. The incoming sync pulses, both horizontal

and vertical, are applied to the integrator network but, because of the time constant involved, only the vertical sync pulses develop a sizable voltage at the grid of the blocking oscillator. The latter, in turn, uses these periodic pulses to synchronize its frequency to that of the received broadcast. A vertical hold control helps bring the oscillator frequency to a point where effective lock-in can be achieved.

The amplitude of the deflection wave developed by the oscillator is governed by the vertical size (i.e., height) control. The saw-tooth shape of this wave is established by a time-constant network in the output circuit of the vertical oscillator. This signal is then applied to the grid of the vertical output amplifier and, beyond this, to the vertical deflection coils of the yoke.

The only significant departure from monochrome practice is the fact that the bottom end of the vertical output transformer connects to a vertical convergence circuit. More on this presently.

In the horizontal sweep system there is an a.f.c. network, a stabilized horizontal multivibrator, and a power output amplifier. These are then followed by the horizontal output transformer,

the high-voltage system, and the boost "B+" circuit, wherein additional "B+" voltage is developed by utilizing the excess deflection energy. (The latter portion of the circuit is shown in Fig. 1.)

The final stage in the horizontal deflection system is a 6CD6 power output amplifier. The power requirements of the final stage in a color receiver are greater than for a comparable monochrome receiver because, first, three beams must be deflected instead of one and, second, a 25 kv. accelerating voltage is required by the tri-gun picture tube.

The horizontal output transformer contains two principal windings and a number of auxiliary windings. The two principal windings provide connections for the plate of the 6CD6, the high-voltage rectifiers, the deflection yoke, and the 6AU4 damper tube. The auxiliary windings provide positive and negative triggering pulses for the various a.g.c. and chrominance circuits, and filament power for the high-voltage rectifiers. In the circuit of Fig. 1, three high-voltage rectifiers are employed to develop the 25 kv. accelerating potential required by the tri-gun picture tube.

The accelerating potential required by the focus electrode is much less than the 25,000 volts of the *Aquadag* coating. Hence, it is possible to obtain the focus voltage from a prior point in the high-voltage rectifier system. A variable resistor is inserted between the first 3A2 and the diode coupler that follows it, and from this resistor the needed focus voltage is obtained.

Within the same high-voltage supply is a special gaseous regulator. The unit, labeled CR6, is a long, narrow cylinder which is filled with hydrogen gas. The purpose of this device is to maintain a constant load on the high voltage power supply so that changes in picture contrast will not cause the high voltage to change, with corresponding variations in brightness, focus, and deflection (i.e., picture size). What the regulator tube does, in essence, is vary its internal resistance in a manner opposite to the current drawn by the picture tube. For exam-

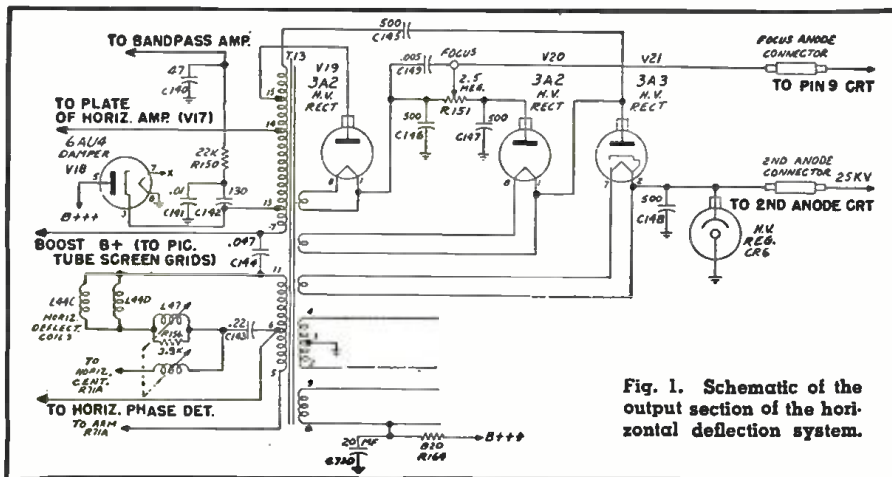

Fig. 1. Schematic of the output section of the horizontal deflection system.

capacitor and the horizontal dynamic phase coil. The circuit is tuned to 15,750 cycles per second and the strong circulating currents develop fairly large sine-wave voltages across each of the resonant components. See Fig 3D. This voltage, in turn, is forwarded to the dynamic convergence coils on the picture tube neck and through the resulting magnetic field, influences the electron beams which the guns develop. So far as the 15,750 cps voltages are concerned, the .05 μ fd. capacitor, the 70 μ fd. capacitor, and the 100 μ fd. capacitor all present low impedances between the horizontal phase coil and the convergence coil.

The horizontal dynamic amplitude control determines how much voltage reaches the convergence coil and, in consequence, how powerful a magnetic field is developed. The phase of the 15,750 cps sine wave depends upon the adjustment of the phase coil. Changing the frequency of the circuit by adjusting the phase coil slug will vary the phase of the voltage applied to the convergence coil. This, in turn, will change the deflection angle of the electron beam and thereby alter its point of convergence with the other two beams as they move from left to right across the screen. Thus, it is possible to change the beam convergence at the sides of the screen permitting us to counteract the normal misconvergence of the beams. Each beam has a similar convergence circuit and responds in a similar way.

One further point concerning this circuit. The series resonant network develops a sine wave instead of a parabolic wave. However, only the bottom

portion of the wave is used in the converging action and this is close enough to a parabola in shape to do an effective job.

Let us consider now the vertical portion of the dynamic convergence network. Referring back to Fig. 3A, we note that the bottom end of the vertical output transformer reaches "B+" through the vertical tilt potentiometer (100 ohms), a 2 henry choke (with a parallel 70 μ fd. capacitor), and finally a 1500 ohm resistor. The flow of plate current (from the vertical amplifier) develops a voltage across the 2 henry choke and the subsequent flow of current between the choke and its parallel capacitor produces a parabolic voltage across the combination. What happens here is that the saw-tooth plate current is converted *via* the capacitor (principally) into a parabolic wave and this voltage is applied across the convergence coil. The path from the choke and the 70 μ fd. capacitor to the convergence coil consists of a 100 μ fd. capacitor, the horizontal dynamic phase coil, and the parallel combination of a .05 μ fd. capacitor and a 2500-ohm potentiometer. At the vertical sweep frequency of 60 cycles, the horizontal dynamic phase coil and the 100 μ fd. capacitor offer negligible opposition. The vertical current, however, finds that the opposition of the .05 μ fd. capacitor is high and, so, the current is driven through the 2500-ohm potentiometer. The latter, then, rightfully becomes the vertical dynamic amplitude control.

Still required is some method of varying the phase of the vertical dynamic convergence voltage and this is

achieved through the presence of another winding on each convergence coil. This is the so-called tilt coil, the word tilt referring to the effect which its voltage has on the vertical parabolic wave.

The method of developing the required tilt (or phase) voltage is quite simple. The saw-tooth plate current of the vertical output amplifier flows through a 100-ohm potentiometer. The control contains a center tap and the movable arm may be moved above or below this tap. When the arm position is above the tap, the saw-tooth voltage fed to the tilt coil possesses one polarity; when the arm is below the tap, the polarity is reversed. Finally, no saw-tooth voltage is fed to the tilt coil when the arm and center tap coincide. In other words, a saw-tooth of variable amplitude and with positive or negative polarity may be added to the electron beam. The net effect of this is to add the saw-tooth to the vertical dynamic parabola voltages to shape them as required for best convergence in the vertical plane.

External Picture Tube Components

We come now to the components which are mounted on the neck of the 19-inch tri-color picture tube. See Fig. 4. The first item that we recognize is the deflection yoke. This is, to a considerable extent, similar to the deflection yokes used with black-and-white tubes. However, its design is more complex because three beams must be deflected instead of one and it is of the utmost importance that a symmetrical and uniform magnetic field be maintained throughout the deflection area. Also, the deflection power required is about twice that of present black-and-white TV sets (for the same size screen) and special insulation must be employed in the yoke structure to prevent arcing.

A second component found on the neck of the color picture tube is the purity coil or magnet. This device adjusts the axis of each electron beam so that it approaches each hole in the shadow mask at the right angle to strike the appropriate color phosphor dot. In other words, the purity magnet provides for the proper alignment of the three beams with respect to the phosphor-dot plate and the shadow mask. When this component is properly set, a uniform color field will be obtained for each gun. For example, with only the red gun in operation a uniform red raster should be observed. Any departure from pure red at any point on the screen indicates that the beam is striking phosphor dots other than red. Similarly, when only the green gun is in operation, a uniform green raster should be obtained, and when only the blue gun is active, a blue field should be visible.

The color tubes with which we are most concerned utilize magnetic convergence and toward that end employ three sets of convergence coils, each positioned directly over the pole pieces

Fig. 4. Three-gun color TV picture tube with the various external components.

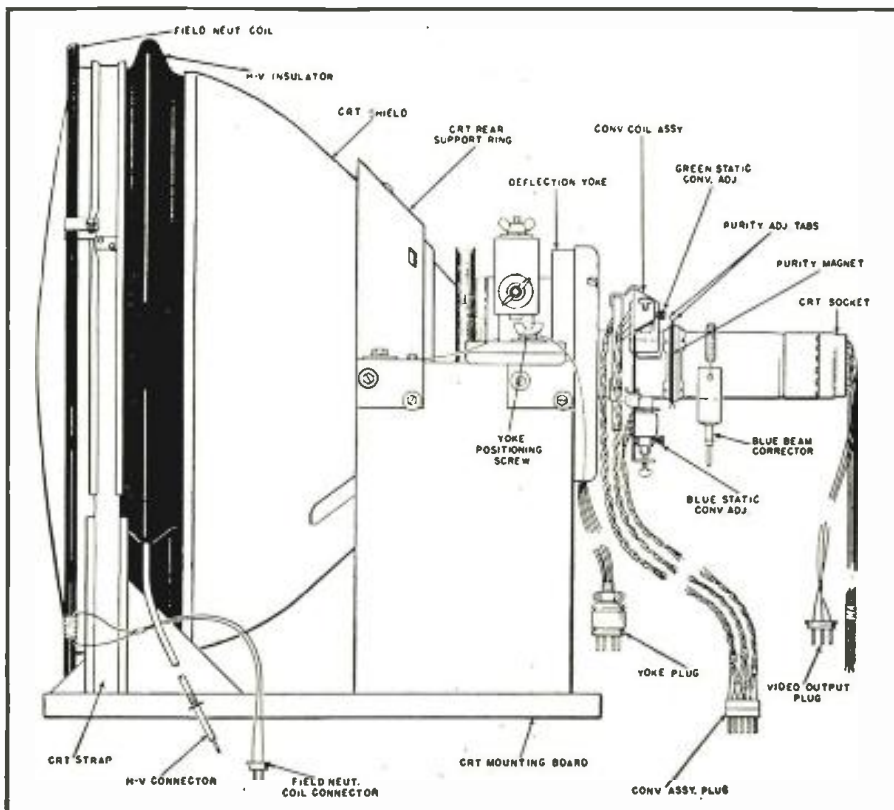

(Continued on page 91)



National Schools brings you a new dimension in training for TELEVISION-RADIO-ELECTRONICS

YOU CAN LEARN BY HOME STUDY, IF—

- you are ambitious to increase your earning power.
- you want to broaden your knowledge and skill.
- you choose the school with the most complete training and service.

50 Years of Successful Training

National Schools has been training men for success since 1905. Our graduates are located around the globe, in good-paying jobs in servicing, installation and manufacturing... in public and private industry, or in their own businesses. All this experience and background are your assurance of success.

What This New Dimension in Home Study Means to You

As a National Schools student, with Shop Method Home Training, you master *all phases* of the industry—TV, Radio, Electronics—theory and practice. You learn *HOW* and *WHY*, in one complete course at one low tuition.

Because National Schools' world headquarters are in Los Angeles—"capital city" of TV-Radio-Electronics—our staff is in close touch with industry. Our lessons and manuals are constantly revised to keep you up-to-the-minute on latest developments. We show you how to make spare time earnings as you learn, and we give you free placement assistance upon graduation. National Schools is approved for G. I. Training. Both Resident and Home Study courses are offered. If you are of draft age, our training helps you achieve specialized ratings and higher pay grades.

This *new dimension* enables us to train you as you should be trained at home, regardless of your age or previous education.

Your Course Includes Valuable Units

We send you important equipment, including a commercial, pro-

fessional Multitester... plus parts to build Receivers, Oscillators, Signal Generator, Continuity Checker, other units, and Short Wave and Standard Broadcast Superhet Receiver.

Mail Coupon for Complete Information

Get these two free books about this new dimension in Home Training. A comprehensive, illustrated fact-book and a sample National Schools lesson. No obligation, so mail coupon today.

NATIONAL SCHOOLS
TECHNICAL TRADE TRAINING SINCE 1905
Los Angeles 37, Calif. • Chicago: 323 W. Polk St.
In Canada: 811 W. Hastings St., Vancouver, B.C.



MAIL NOW TO OFFICE NEAREST YOU!

(mail in envelope or paste on postal card)

NATIONAL SCHOOLS, Dept. RG-25

4000 S. FIGUEROA STREET OR 323 W. POLK STREET
LOS ANGELES 37, CALIF., OR CHICAGO 7, ILL.

Rush FREE BOOK, "Your Future in Radio-TV-Electronics," and FREE LESSON. No obligation, no salesman will call.

NAME _____ BIRTHDAY _____ 19__

ADDRESS _____

CITY _____ ZONE _____ STATE _____

Check if interested ONLY in Resident Training at Los Angeles.

VETERANS: Give date of discharge _____

MAC'S RADIO SERVICE SHOP

By JOHN T. FRYE



BARNEY TAKES ON COLOR

HHEY! What gives?" Barney asked as he stopped short in the doorway of the service department that Monday morning.

"You mean you notice something different?" Mac, his boss, blandly inquired.

"I hope to kiss a pig I do," Barney retorted. "When did you do all this—and why?"

"The wife went to visit her sister over the weekend," Mac explained, "and whenever she is gone that darned house of ours seems as empty as a high vacuum rectifier. To get away from it, I came down here to sort of look around when there were no distractions—especially of the chattering, red-headed, Irish variety," he added with a teasing grin.

"I'm overlooking that crack—for the time being," Barney retorted.

"It's kind of funny how a familiar place seen under different circumstances spotlights things not normally noticed. I immediately saw several changes that cried out to be made; so I spent the whole of Sunday making them.

"First, I put up that little shelf right at the end of the service bench. This will now hold the few publications and sheets to which we refer constantly in our work. I call it the 'First Aid Shelf' because the articles on it are calculated to be the ones we shall normally consult before we turn to our service library. For example, there are the four dial-stringing manuals. Nine times out of ten these tell us all we need to know to replace a dial cord, and we do not have to go into our service data files at all. Also there is an up-to-date tube manual giving complete operating potentials,

characteristic curves, and base diagrams of all tubes. You know how often we reach for that. Naturally, the latest index to our service information on radios, TV sets, tape recorders, and record changers is here. A glance at this tells us at once if we have information on a particular piece of equipment and exactly where to find it, together with any factory-suggested changes to be made in that particular model.

"Our record changer manuals will go here, too. As you know, many manufacturers are pretty careless about listing the make and model number of a changer used in their combination sets—especially when they do not make the changer themselves. In such a case you can often spot a given changer quicker by leafing through the record changer manuals and looking at the pictures than you can by trying to work through service data cross-listings. Since about every changer that comes in can stand a minor adjustment of the needle set-down points, the tripping mechanism, etc., I think having the manuals right at hand will speed up this work. In addition, there is a sheet showing interchangeable portable batteries of different makes and another giving interchangeable phono cartridges. These allow us to carry a single line of each of these items and still be able to service most record players and portable receivers that come into the shop—and to do it quickly and accurately.

"Finally, there is a good wholesale radio and TV parts catalogue. The illustrations and descriptions contained in this can be a great help to a technician in selecting a needed repair part or tool, even though he does not order

from the firm putting out the catalogue. He can see side by side the offerings of competitive manufacturers with concise and accurate descriptions of each product. What's more, the catalogue gives him a good idea of what a fair price for the item should be. An intimate acquaintance with a good wholesale catalogue permits a technician to buy much more intelligently than is possible otherwise."

"As I get it," Barney said, "this 'First Aid Shelf' is to contain only the articles we use a lot. It is to be a sort of *Reader's Digest* of our service library."

"That's it exactly," Mac applauded; "and now let's turn our attention to this adjustable lamp clamped to the edge of the bench exactly between our two working positions."

"Is that what that is!" Barney marvelled. "I thought it was an overgrown modernistic sculpture of a praying mantis."

"There is a resemblance," Mac grinned as he looked at the folded, spring-loaded arms holding the deep shade of the lamp. "I firmly believe a service technician can never have too much light—either intellectual or actual—while doing his work. I'm doubly sure of this whenever I cut loose a wrong lead because I can't see clearly. Our overhead bench lights give all the light we need when the chassis is turned upside down, and of course we have various flashlights for looking into dark corners; but most TV chassis must be worked on while they are lying on their sides, and record changer action frequently must be watched while the changer is right side up. This new lamp gives a flood of light exactly where we need it and leaves both hands free at all times.

"Just look how it can reach out to any part of the bench and throw the light in any desired direction. That's because those folding arms extend out to forty-five inches and the lamp itself is mounted on a swivel. Notice, too, that while the lamp can be moved into any position with a touch of the finger, it stays exactly where you put it. When you want to watch a record changer going through its cycle, the lamp will get right down on its knees and peer up into the mechanism with you. If you drop something, the lamp will bend over so the bulb is nearly touching the floor to help you look for the dropped object. When you are taking a set out of a cabinet, the lamp will reach away out from the bench and throw a strong light over your shoulder or up into the speaker compartment to aid you in locating screw slots, and so on."

"Man, that thing has got more movements than a can-can dancer," was Barney's man-of-the-world comment.

Mac passed over this and went on to point out little plastic dishes mounted along the back of the service bench beneath various instruments.

"You know what a fan I am for all sorts of special probes to use with our instruments. I think we've got about

(Continued on page 80)

PRICES Slashed

SAVE UP TO
50%
during
GIGANTIC CLEARANCE SALE of
USED TEST and COMMUNICATION EQUIPMENT

Our entire stock of reconditioned, "good-as-new" equipment must go at a record-breaking sacrifice. Each and every instrument guaranteed to meet manufacturer's original tolerance when shipped to you. All bands and functions on receivers and all ranges on test equipment have been carefully checked. While this is only a partial list of our huge inventory (available at the time this publication goes to press) bargains like these simply can't last! So act now and avoid disappointment. Wire, write, phone or use the handy coupon today! When ordering indicate first and second choice. All merchandise subject to prior sale.

COMMUNICATIONS EQUIPMENT

Collins 32V1 Transmitter. \$375.00	Heath AT1 Transmitter— Wired.....	24.50
Collins 32V2 Transmitter. 419.50	Heath AR2 Receiver— Wired.....	24.95
Collins 32V3 Transmitter. 649.50	Johnson Viking I Trans.— Wired.....	179.50
Collins 75A3 Recvr. with spkr.....	Johnson Viking II Trans.— Wired.....	249.50
Collins 310B1 Exciter.... 190.00	Johnson Viking VFO— Wired.....	34.50
Eldico TR75TV Wired but AS IS.....	Johnson Viking Mobile Transmitter.....	79.50
Elmac PMR6A Mobile Receiver.....	Johnson Mobile VFO.... 21.50	
Elmac A54H Mobile Transmitter.....	Johnson Viking Ranger— Wired.....	219.50
Gon-Set Super 6 Converter.....	Jones MM1 Micromatch.. 9.95	
Gon-Set Super Ceiver.... 84.50	Lettime 240 Transmitter... 52.50	
Hallcrafters 5R10A Recvr. 39.50	Lysco 600 Transmitter.... 79.50	
Hallcrafters HT6 Trans... 57.50	Lysco 600S Transmitter... 109.50	
Hallcrafters 8R40 Recvr. 69.50	Lysco 650 Novice Trans... 59.50	
Hallcrafters HT9 Trans... 99.50	McMurdo Silver 908 Micromatch.....	12.50
Hallcrafters HT18 VFO... 42.50	Meck T60 Transmitter.... 49.50	
Hallcrafters SX32 Recvr.. 134.50	Meissner EX Signal Shifter.....	39.50
Hallcrafters S38C Recvr.. 27.50	Meissner FMX.....	5.00
Hallcrafters S40 Recvr... 59.50	Millen 90881 Final..... 59.50	
Hallcrafters S40A Recvr.. 69.50	Millen 92101 R9'er with 1 coil.....	12.50
Hallcrafters S40B Recvr.. 79.50	National NC33 Recvr.... 32.50	
Hallcrafters 5X42 Recvr.. 149.50	National SW54 Recvr.... 27.50	
Hallcrafters SP44 Panadaptor.....	National NC57 Recvr.... 59.50	
Hallcrafters S53A Recvr.. 52.50	National HRO60 Recvr. with speaker.....	409.50
Hallcrafters SX62 Recvr.. 179.50	National NC125 Recvr. with speaker.....	129.50
Hallcrafters SX71 Recvr.. 139.50	National NC173 Recvr. with speaker.....	129.50
Hallcrafters SR75 Transceiver.....	National NC183D Recvr. with speaker.....	309.50
Hallcrafters S76 Recvr... 119.50	RME VHF2-11 Receiver... 69.50	
Hallcrafters R46 Speaker. 15.00	RME HF10-20 Converter... 39.50	
Harvey Wells TBS50D Transmitter.....	RME DB22A Preselector... 37.50	
Hammarlund HQ129X with speaker.....		
Hammarlund HQ140X with speaker.....		
Hammarlund SP400X with speaker.....		

RME DB 23 Preselector... 39.50	Eico 322—Wired.....	19.95
RME45A Recvr. with speaker.....	Eico 360—Wired.....	22.50
RME VHF152A Converter. 39.50	Heath G1—Wired.....	17.50
Simpson 380 Wavemeter. 14.50	Heath G5—Wired.....	19.50
Sonar MR3 Mobile Recvr.. 32.50	Heath TS2—Wired.....	27.50
Sonar XE10 FM Exciter... 9.95	Hickok 191X.....	49.50
Surplus BC221 less P.S... 39.50	Hickok 288X.....	89.50
110V P.S.....	Hickok 610.....	99.50
49.50	Hickok 610A.....	119.50
Surplus LM Freq. Mtr. less P.S.....	Jackson 640.....	22.50
39.50	Precision E200.....	37.50
Sylvania X7018 Modulation Meter.... 12.50	Precision E200C.....	47.50
Masco WF1 Wirelesphone Per Pair.....	Precision E400.....	95.00
32.50	Simpson 479.....	159.50
Meissner 9-1091 AM-FM Tuner.....	Supreme 571.....	19.50
49.50		

TEST EQUIPMENT

TUBE TESTERS		
Superior 450.....	17.50	
FIELD STRENGTH METERS		
Approved Electronics A460.....	32.50	
Radion FSM5000— Batt. Operated.....	49.50	
Simpson 488.....	49.50	
Transvision FSM.....	32.50	
CROSS HATCH GENERATORS		
Hickok 620.....	69.50	
Simpson 488.....	59.50	
Superior Cross Bar.....	22.50	
SIGNAL GENERATORS		
Approved Electronics A200.....	17.50	
Eico 315—Wired.....	27.50	
Eico 320—Wired.....	17.50	

HUNDREDS OF ADDITIONAL GOOD BUYS IN USED COMMUNICATION AND TEST EQUIPMENT. SEND FOR COMPLETE LIST.

Walter Ashe Radio Co. RN-55-2
1125 Pine St., St. Louis 1, Mo.
Rush my order for used equipment as follows:
(1st Choice) _____
(2nd Choice) _____
Remittance for \$ _____ is enclosed.
 Send free list of additional used equipment bargains.
Name _____
Address _____
City _____ Zone _____ State _____

All prices
f. o. b.
St. Louis
•
Phone
Chestnut
1-1125

Walter Ashe
RADIO CO.
1125 PINE ST. • ST. LOUIS 1, MO.

Immortalizing the instrument...



For the "Instrument of the Immortals"... and all great instruments and voices, there are now magnetic recording tapes of matching quality. They are Soundcraft Tapes, created by leading recording engineers. Soundcraft Tapes alone combine:

- Constant depth oxide for uniform middle- and low-frequency response
- Micro-Polished[®] coating, a patented Soundcraft process that eliminates unnecessary head wear and gives uniform high-frequency response right from the start
- Pre-coated adhesive applied directly to base firmly anchors oxide. No flaking, no cracking.
- Surface-lubrication on both sides! No friction, no chatter, no squeal
- Chemical balance throughout to prevent cupping, curling, peeling, chipping
- Uniform output of $\pm 1/4$ db. within a reel $\pm 1/2$ db. reel-to-reel

THE WORLD'S FINEST TAPES... YET THEY COST NO MORE

SOUNDCRAFT TAPES FOR EVERY PURPOSE

Soundcraft Red Diamond Tape for high-fidelity.

Soundcraft Professional Tape for radio, TV and recording studios. Splice-free up to 2400 feet. Standard or professional hubs.

Soundcraft LIFETIME[®] Tape for priceless recordings. For rigorous use. For perfect program timing. A third as strong as steel. Store it anywhere. Guaranteed for a lifetime.

Get the Soundcraft Recording Tape you need today. Your dealer has it.

REEVES

SOUNDCRAFT

CORP. Dept. U2,

10 E. 52nd St., N. Y. 22, N. Y.

FOR EVERY SOUND REASON



LEONARD Radio says ...



Make every P.A. Job a Hi-Fi System with the

NEW UNIVERSITY BLC Weatherproof full range co-axial speaker

Better Lows: Balanced compression type folded horn.

Better Highs: Driver unit tweeter.

More Efficient: Dual range theatre type system.

Less Distortion: Separate low and high frequency driver systems.

More Compact: Exclusive weatherproof dual range co-axial design.

More Dependable: Experienced mechanical engineering and careful electrical design.

Specifications: Response: 70-15,000 cps. Power: 25 watts. Impedance: 8 ohms. Dispersion: 120 degrees. Mounting: 180° adjustable "U" bracket. Size: 22 1/2" x 9" deep.

NET: \$44.10

New! "Audio Reference Guide" 160 page book all about HI-FI and P.A. Write for your free copy today.

Mail and phone orders filled, 24 hr. service ... 25% deposit balance C.O.D.

LEONARD RADIO, INC.
AUDIO MART 69 Cortland St., New York 7, N.Y. Cortland 7-0315

QUARTZ CRYSTALS

FT-243-.093" PIN DIA.—.486" PIN SPC

FOR HAM AND GENERAL USE • GUARANTEED

4035 5700 5950 6675 7475 7700 7940	1015 6473 7100 8075 8525
4080 5706 5973 6700 7500 7706 7950	3735 6475 7125 8100 8550
4165 5725 6240 6706 7506 7725 7973	3940 6500 7150 8125 8575
4190 5740 6250 6725 7525 7740 7975	3990 6506 7175 8150 8600
4280 5750 6273 6750 7540 7750 8225	6000 6550 7250 8173 8625
4337 5773 6275 6775 7550 7773 8250	6025 6573 7300 8175 8650
4490 5806 6300 6800 7573 7775 8273	6050 6575 7306 8200 8700
4495 5840 6325 6825 7575 7800 8275	6075 6600 7325 8340 8733
4930 5850 6340 6850 7600 7825 8300	6100 6606 7340 8350
5030 5852 6350 6875 7606 7840 8325	6125 6625 7350 8375
5205 5873 6373 6900 7625 7850 8630	6140 6640 7375 8380
5300 5875 6375 6925 7640 7873	6150 6650 7400 8400
5385 5880 6400 6950 7641 7875	6175 7000 7425 8425
5485 5906 6406 6975 7650 7900	6200 7025 7440 8450
5500 5925 6425 7450 7673 7906	6440 7050 8025 8475
5675 5940 6673 7473 7675 7925	6450 7075 8050 8500

49c each - 10 for \$4.00

99c ea. 10 for \$8.00

Low Frequency—FT-241A for SSB, Lattice Filter etc., .093" Pin, .486" SPC., marked in Channel Nos. 0 to 79, 54th Harmonic and 270 to 389, 72nd Harmonic. Listed below by Fundamental Frequencies, fractions omitted.

370 393 414 438 502 523 400 462 5910	2125 2300 2532 3510
372 394 415 481 503 525 440 463 6370	2145 2305 2545 3520
374 395 416 483 504 526 441 464 6450	2155 2320 2557 3550
375 396 418 484 505 527 442 465 6470	
376 397 419 485 506 529 444 466 6497	
377 398 420 486 507 530 445 468 6522	
379 401 422 487 508 531 446 469 6547	
380 402 423 488 509 533 447 470 6610	
381 403 424 490 511 534 450 473 7350	
383 404 425 491 512 536 451 473 7380	
384 405 426 492 513 537 452 474 7390	
385 406 427 493 514 538 453 475 7480	
386 407 429 494 515 454 476 7580	
387 408 431 495 516 455 477 7810	
388 409 433 496 518 457 479 7930	
390 411 435 497 519 458 480	
391 412 436 498 520 459	
392 413 437 501 522 461	

49c each—10 for \$4.00

99c ea. 10 for \$8

FT171B BC-610

2 Banana Plugs

3/4" SPC

CR IA.

SCR 2030 2220 2360 3202 2945

522 2245 2258 2390 3215 3955

1/2" P 2065 2250 2415 3237 3995

2082 2282 2435 3250

2105 2290 2442 3322

99c each—10 for \$8.00

TG 34A

Code Keyer

Automatic Code Practice

Sending and Keying Oscillator,

115 or 230 V @

50-80 cycles. Portable, Built-in speaker and amplifier.

Variable speed from 5 to 25 w.p.m.

Uses inked tapes. Brand New \$19.95

Set of 3 different tapes \$3.75

Spec.—200KC or 500 KC in FT241A Holder, \$1.79 ea.

• Add 20c postage for every 10 crystals or less.

• Indicate second choice; subst. may be necessary.

swin

PARTS DISTRIBUTORS, LTD.

520 TENTH ST. N. W. — WASH. D. C., DEPT. N

FLEXIBLE TV PROGRAM CENTER

CBS' Hollywood facility is a fantastic "electronics lab."

COLUMBIA'S "Television City" in Hollywood is a self-contained television center which has been designed expressly for the efficient production of TV programs.

This mammoth plant consists of four fully-equipped theaters of operation under one roof, with an extensive decentralization of the video facilities in keeping with well-established audio practice.

The audio and video installations in all existing "Television City" studios are essentially identical, except for an added control booth in Studio 43 and technical facilities utilizing four complete color camera chains for color programs.

Equipment and techniques used in the production of programs are a combination of those developed especially for television plus those borrowed and adapted from the motion picture industry. Most productions utilize a four-camera setup for maximum coverage and selection of scene and to minimize stage floor traffic. Two microphone booms, normally used, are supplemented by strategically placed hidden microphones, depending on the production.

A standby in movie production and now converted, with refinements, for television use is the *Houston-Fearless* camera crane. Operated by a three-man crew, the crane is d.c. power driven and represents a miracle of teamwork to present wide latitude of camera shots, ranging from a simulated balcony-type high, wide-angle shot to a ground-level closeup. One operator steers the crane in its movement on the studio floor and ramp; the "arm man" directs the vertical movement of the crane arm in positioning the camera; and the cameraman governs lens selection, focus, and the panoramic movement of the camera proper. All three members are on an interphone system with each other and with the control room, and the camera monitor informs them of the scene covered by the crane camera. The crane, as used by CBS, is readily adaptable for the tri-tube color camera.

In addition to such modern studio facilities, "Television City" boasts unique patching bays, electronic lighting control boards, and sound studios for piping the musical backgrounds from remote areas to eliminate any possibility of cast mike pickups.

These are but a few of the modern electronic miracles that make CBS' "Television City" one of the most advanced "programming plants" in existence today.

—30—

NEW 1955

Heathkit

Engineering Features

New PRINTED CIRCUITS

One of the many tremendous improvements in the new 1955 Heathkits is the use of an etched metal process printed circuit board. Printed circuits will be used in Heathkits whenever they will affect construction simplification, performance stabilization, and lend themselves to instrument design. Now for the first time a kit instrument company offers the advantages of modern printed circuit instrument construction technique. For the first time consideration has been given toward reducing kit assembly time. Also this is the first time that printed circuit boards have been hand soldered on a volume basis. Offered only by Heathkit, the pioneer and leader in kit instrument design.

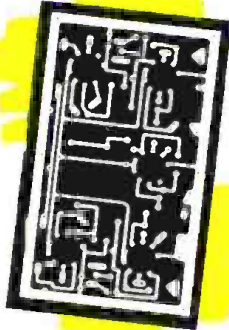

New PEAK-TO-PEAK VTVM CIRCUIT

New 6AL5 full wave rectifier in AC input circuit permits full scale peak-to-peak measurements. Several ranges — upper limits 4000 volts peak-to-peak. Just the thing you TV servicemen have needed in making TV circuit voltage checks. Precision resistor voltage divider limits AC RMS level to 150 volts. Prevents overloading the rectifier—extends upper limit AC RMS ranges to 1500 volts—further protects meter and circuitry against AC flash-over or arcing. Another definite example of continuing Heathkit design leadership in the kit instrument field.

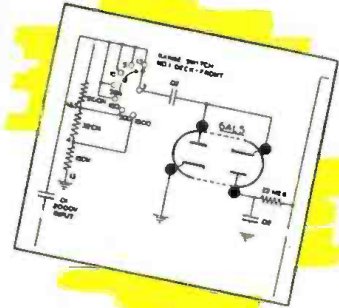

New HIGH READABILITY PANELS

New 1955 Heathkits feature complete panel redesign. Sharp white lettering applied to the beautiful charcoal gray panels, provide a new high in readability. Lettering is easy-to-read open style and panel calibrations are vividly clear against the pleasing soft gray background. New knobs of exclusive Heathkit design.



New 3" UTILITY SCOPE

The new 3" Scope is a "natural" for the well rounded line of Heathkit instruments. Small in size, 1 3/4" deep, 6 1/2" wide, 9 1/2" high, yet big in performance. Just think of the value, an Oscilloscope for \$29.50. Brilliant intensity, sharp focusing, wide positioning range. An ideal portable Scope for the TV serviceman—a second shop scope—modulation monitor for you fans (deflection plate terminals in rear of cabinet). Performance to spare for all general scope applications. See specifications on following page.



New STYLING New COLOR

New styling and coloring is responsible for tremendous improvement in Heathkit appearance. The new instrument panel color combination is high definition white lettering in a soft charcoal gray panel. Cabinet color is a light or leather gray. The satin gold baked enamel cabinet for the WA-12 Pre-amplifier is first or indicative of the modern pacemaking trend in Heathkit styling.



New SCOPE SWEEP CIRCUIT 10 CYCLES — 500 KC

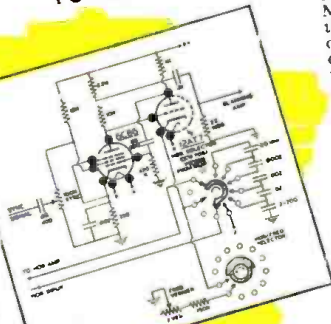

New 1955 Heathkit Model 0-10 Scope features a new wide frequency range sweep generator covering 10 cycles to 500,000 cycles. This coverage is available in five virtually decade sweep ranges and is five times greater than the sweep frequency range usually available. Excellent retrace time characteristics, actually less than 20% at 500 KC. Use of the free running Heath circuit provides a larger margin of stability and a new high in Heathkit Scope performance.

Continuing PROGRESS FUTURE LINE EXPANSION



The outstanding improvements featured in the 1955 Heathkit line are representative of the progress characteristic of the Heath Company operation. Long range planning will provide a continuing succession of new kit releases to further expand the Heathkit line which already represents the world's greatest selection of electronic kits. The innovations in the 1955 line, are representative of additional new models scheduled for release for the coming years.

SEE THE INSTRUMENTS ON THE FOLLOWING PAGES

HEATH COMPANY • Benton Harbor 15, Mich.

Heathkit ELECTRONIC SWITCH KIT

The basic function of the Heathkit Electronic Switch Kit is to permit simultaneous oscilloscope observation of two separate traces which can be either separated or superimposed for individual study. This is accomplished through the use of two individually controlled inputs working through amplifier, multi-vibrator, and blocking stages. The output of the Electronic Switch is connected directly to the vertical input of the Oscilloscope. A typical example of usefulness would be simultaneous observation of a signal or waveform as it appears at both the input and output stages of an amplifier.

APPLICATIONS

An Electronic Switch has many applications to increase the over-all operating versatility of your oscilloscope. It can be used to check amplifier distortion—audio crossover networks—phase inverter circuits—to measure phase shift—special waveform study, etc. The instrument can also be conveniently used as a square wave generator over the range of switching frequencies, often providing the necessary wave form response information without incurring the expense of an additional instrument. Ownership of this instrument will reveal many entirely new fields of oscilloscope application and will quickly justify the modest cost of the Electronic Switch Kit.

Tube complement:
2—6X7, 2—6S, 1—6X5.

Continuously variable switching rates in three ranges from less than 10 CPS to over 2000 CPS.



Individual input gain controls, position control, coarse frequency control, and fine frequency control.

Transformer operated for safety when used in conjunction with other equipment.

MODEL S-2

\$23⁵⁰

Shpg. Wt.
8 lbs.

Heathkit VOLTAGE CALIBRATOR KIT

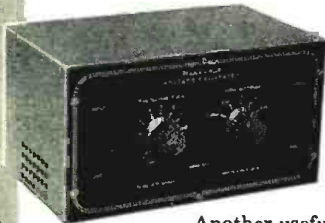

MODEL VC-2

\$11⁵⁰

Shpg. Wt. 4 lbs.

Another useful oscilloscope accessory particularly in circuit development work and in TV and radio service work. The Voltage Calibrator provides a convenient method for making peak-to-peak voltage measurements with an oscilloscope, by establishing a relationship on a comparison basis between the amplitude of an unknown wave shape and a known output of the voltage calibrator. Peak-to-peak voltage values are read directly from a calibrated panel scale without recourse to involved calculations.

FEATURES:

To off-set line voltage supply irregularities, the instrument features a voltage regulator tube. A convenient "signal" position on the panel switch by-passes the calibrator completely and the signal is applied through the oscilloscope vertical input, thereby eliminating the necessity for constantly transferring test leads.

RANGES:

With the Heathkit Voltage Calibrator it is possible to measure all types of complex waveforms within a voltage range of .01 to 100 volts peak-to-peak. Build this instrument in a few hours and enjoy the added benefits offered only through combination use of test equipment.

Heathkit LOW CAPACITY PROBE KIT



No. 342

\$3⁵⁰

Shpg. Wt. 1 lb.

An oscilloscope accessory, the 342 Low Capacity Probe permits observation of complex TV waveforms without distortion. An adjustable trimmer provides proper matching to any conventional scope input circuit. Excellent for high frequency, high impedance, or broad bandwidth circuits. The attenuation ratio can be varied to meet individual requirements.

Heathkit SCOPE DEMODULATOR PROBE KIT



No. 337-C

\$3⁵⁰

Shpg. Wt. 1 lb.

Extend the usefulness of your oscilloscope by observing modulation envelopes of RF or IF carriers found in TV and radio receivers. The Heathkit Demodulator Probe will be helpful in alignment work, as a gain analyzer and a signal tracer. Easy construction with the new modern printed circuit board. Voltage limits are 30 volts RMS and 500 volts D.C.

HEATH company

BENTON HARBOR 15,
MICHIGAN

Mac's Radio Service Shop (Continued from page 76)

every kind of probe you can mention, but we've not had a handy way of storing them. They've all been kept in a drawer where they have a nasty way of getting their leads tangled up. In fact, there have been times when you were trying to sort out a probe from this mess where I couldn't be sure if you were doing service work or trying to weave a fishnet. What's more, it was not always easy to remember which probe was designed for use with what instrument.

"That's a thing of the past now. Beneath each instrument you see a deep little plastic dish I bought at the dime store. Probes for each instrument are stored in its individual dish. For example, below the vacuum tube voltmeters we have a crystal probe for reading r.f. voltages, a high voltage probe for going up to 30,000 volts, and a peak-to-peak probe. The new v.t.v.m. reads peak-to-peak voltages directly, but this probe lets the older meter do the same thing. Under the signal tracer we have the r.f. crystal probe and the straight-through audio probe. Beneath the scope we have the demodulator or signal tracer probe, the 100/1 voltage divider probe, and the low-capacity probe, together with the single shielded lead that fits all three probe heads. The dish under the sweep generator doesn't hold probes but in it are stored the various special leads that go with this instrument. It is my fond hope that having these probes ready to hand will encourage you-know-who to use them more often. What's more, I want you-know-who to fold the probe leads up neatly and snap rubber bands around them to keep them in place when he is through using them."

"Roger from you-know-who. Wilco. Over and out," Barney chanted.

There was a brief silence finally broken by Barney:

"Say, Mac, I'm having a rough time trying to bone up on color TV. I've been reading everything I can get my hands on, but I just can't seem to nail it down the way I'd like. There seems to be so much repetition, conflicting analogies, etc., in the articles I've been reading that I'm downright confused. It's not that I'm not trying, either. I think about color TV so much that when I go to bed I even dream in technicolor."

Mac chuckled at this as he went over to a cabinet and took out a large bulging manila envelope. "I've been waiting impatiently for you to display interest in color television," he remarked, "but I didn't want you to feel I was pushing you into it. In this envelope is a complete nine-lesson home study course just for you!"

"When I finish the course, I'll know all I need to know about color TV, huh?"

"Not by a long shot. I intend for
RADIO & TELEVISION NEWS

NEW *Heathkit* 5" PUSH-PULL OSCILLOSCOPE KIT FOR COLOR TV

BRAND NEW DESIGN: The new Heathkit Model O-10 Oscilloscope would be something special at any price, but is almost unbelievable at \$69.50. Completely re-designed scope has broadband amplifiers for color TV work and offers brilliant overall performance. Vertical frequency response within 5 db from 5 cps to 5 mc. Even more astounding, the response is down less than 1½ db at 3.58 mc. the color TV sync burst frequency. It is essential that scopes for color work have these broadband characteristics.

PRINTED CIRCUITS: Two printed circuit boards used in this fine instrument to insure stable, consistent performance. Problems solved by pre-engineering of boards, and their use guarantees completed unit that will have same characteristics as lab development model. Printed circuits simplify construction and save labor.

NEW SWEEP CIRCUIT: Sweep circuit operates with exceptionally good linearity from 20 cps to over 500,000 cps. 5 times the usual range for scopes in this price range. An entirely new circuit introduced for the first time in any Heathkit.

FEATURES: Other outstanding characteristics of this professional oscilloscope are: Built-in 1V peak-to-peak reference for calibration of plastic CRT face-plate; 5" 5UP1 CRT; push-pull hor. and vert. deflection amplifiers; hor. trace width expandable to 3 times diameter of CR tube to allow inspection of any small portion of the signal; deflection sensitivity, .025 volts per inch; wiring harness pre-formed and cabled to save construction time and insure professional appearance and operation. Incorporates efficient retrace blanking. Frequency compensated step attenuator at the vertical input. Entire tube face useable. No foldover on vertical over-load. Performance obtainable only in much more expensive laboratory models.

Uses 5UP1, 6AB4, 6BO7, 12BH7, 6CB6, 12AT7, 2-12AU7, 6X4, 1V2, and 6C4. Quality components used throughout so that outstanding performance characteristics may be maintained for years to come. Plastic molded condensers are used in all coupling and by-pass applications. The "new-look" in Heathkit styling produces professional appearance in keeping with the professional performance of this instrument.

First color television service Oscilloscope with necessary high sensitivity and full 5 megacycle bandwidth.

New printed circuit construction, all components mounted on high insulation surface resulting in uniformly low circuit capacitance.

New type wide frequency range Heath sweep generator, 10 cycles to 500,000



New 5UP1 CR tube

New cabinet styling and color harmony—charcoal gray panel with high readability white lettering.

MODEL O-10

\$69⁵⁰

Shpg. Wt. 27 lbs.

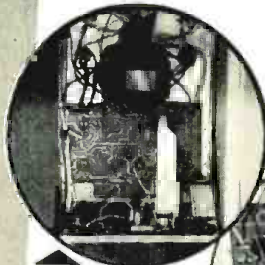

Clean open, under chassis construction and wiring. Possible only through use of pre-cabled wiring harness, and simplified printed circuit boards.

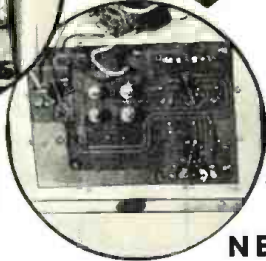

Simplified, standardized construction technique of vertical and horizontal amplifier construction made possible through the use of a single printed circuit board.

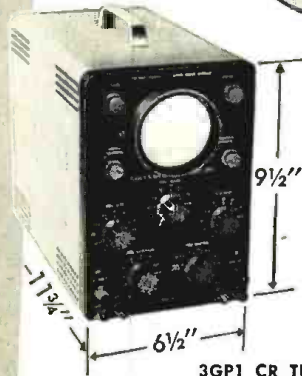

3GP1 CR TUBE

New compact utility Scope—light-weight—portable for service work.

Deflection plate terminals—ideal for ham transmitter modulation monitoring.

EXCEPTIONAL VALUE: The brand new Model OL-1 Utility Oscilloscope is designed especially for portable applications so that outside servicemen or persons performing field tests can have the advantages of a scope available. Then too, it is ideal for home workshop, the ham-shack, or as an "extra" scope for the service shop. It is compact, light in weight, and surprisingly versatile in operation. An outstanding instrument for the price.

Front panel controls are "bench-tested" for ease of operation and convenience. Printed circuit board used for constant circuit performance. Assembly time cut in half!

SPECIFICATIONS: Vertical amplifiers feature frequency response within 1 db from 10 cps to 100 ke, and within 5 db from 5 cps to 500 ke. Vertical sensitivity .2 volts per inch at 1 ke, with input impedance of 12 mmfd shunting 10 megohms.

Horizontal response within 1 db from 10 cps to 200 ke, and within 5 db from 5 cps to 500 ke. Hor. sensitivity .25 volts per inch at 1 ke, input impedance of 15 mmfd shunting 10 megohms. Sweep generator covers 10 cps to 100,000 cps with stable positive lock-in circuit. Cathode follower input in both vert. and hor. amplifiers; push-pull vertical and horizontal deflection amplifiers; 3" CRT; electronic positioning controls for wide range of vertical and horizontal spot deflection; provision for internal and external sync; 60 cycle line sweep. New modern color styling and unusual performance make this instrument an outstanding value.

NEW *Heathkit* 3" PRINTED CIRCUIT OSCILLOSCOPE KIT

MODEL OL-1

\$29⁵⁰ Shpg. Wt. 15 lbs.

New easy-to-build printed circuit board with high insulation factor.

New Heathkit Instrument styling—charcoal gray panel with high readability white lettering.

New Heath twin triode sweep generator 15-100,000 cycle sweep.

NEW *Heathkit* 5" PRINTED CIRCUIT OSCILLOSCOPE KIT

MODEL OM-1

\$39⁵⁰ Shpg. Wt. 24 lbs.

5BP1 CR TUBE



VERSATILE INSTRUMENT: The new Model OM-1 general purpose Oscilloscope represents an outstanding dollar value in reliable test equipment. Full 5 inch CRT. Printed circuit boards for ease of assembly, constant circuit characteristics, and rugged component mounting. Includes all the design features necessary for servicemen, students, experimenters, radio amateurs, etc. Frequency response of amplifiers flat within 1 db from 10 cps to 100 ke, and down only 7 db from 10 cps to 500 ke. Sweep generator range from 20 cps to 100,000 cps. Also features new Heathkit color styling with charcoal gray panel and high definition white lettering for readability even under subdued lighting conditions.

DESIGN FEATURES: A full-size, versatile oscilloscope at a price you can afford. Other features are: adjustable spot shape control; RF connections to deflection plates; direct coupled centering controls; external and internal sweep and sync; 60 cycle line sync; built in 1 volt peak-to-peak panel terminal reference voltage; professional appearance of cabinet, panel, and knob styling.

HEATH company
BENTON HARBOR 15,
MICHIGAN

Heathkit MULTIMETER KIT

The new Heathkit Multimeter is a "must" to complete the instrument lineup of any well equipped service shop. Here is an instrument packed with every desirable service feature, many of which are not found in other Multimeters. All of the measurement ranges you need or want. High sensitivity 20,000 ohms per volt DC; 5,000 ohms per volt AC.

★ ADVANTAGES

Complete portability through freedom from AC line power operation—provides service ranges of direct current measurements from 150 microamps up to 15 amperes—can be safely operated in RF fields without impairing accuracy of measurement.

★ RANGES

Full scale AC and DC voltage ranges are 0-1.5, 5, 50, 150, 500, 1500 and 5,000 volts. Direct current ranges are 150 microamps, 15, 150 and 500 milliamperes and 15 amperes. Resistances are measured from .2 ohms to 20 megohms in 3 ranges and db range from -10 to +65 db.

★ CONSTRUCTION

The Heathkit MM-1 features a unique resistor ring switch mounting assembly procedure. With this method of assembly the precision resistors are wired to the rings and range switch before actual mounting of the switch to the instrument panel. This procedure affords the advantage of simpler construction yet complete accessibility of precision resistors in event replacement is ever required. Ohmmeter batteries were selected for convenience of replacement and only standard commercially available types are used. Batteries consist of 1 type C flashlight cell and 4 Penlite cells. All batteries and necessary test leads are furnished with the kit.

20,000 ohms per volt sensitivity DC; 5,000 ohms per volt AC.

Polarity reversal switch eliminates transferring of test leads.

All 1% precision multiplier resistors—sensitive 50 Simpson meter.

Total of 35 meter ranges on two color scale.

New modern cabinet styling—attractive appearance.



MODEL MM-1

\$26⁵⁰

Shpg. Wt. 6 lbs.

Heathkit HANDITESTER KIT



MODEL M-1

\$14⁵⁰

Shpg. Wt. 3 lbs.

The Heathkit Model M-1 Handitester readily fulfills major requirements for a compact, portable volt-ohm milliammeter. The small size of the smooth gleaming molded bakelite case permits the instrument to be tucked into your coat pocket, toolbox or glove compartment of your car. Always the "Handitester" for those simple repair jobs.

RANGES:

Despite its compact size, the Handitester is packed with every desirable feature required in an instrument of this type. AC or DC voltage ranges, full scale, 10, 30, 300, 1,000 and 5,000 volts. 2 convenient ohmmeter ranges 0-3,000 ohms and 0-300,000 ohms. 2 DC milliammeter ranges 0-10 milliamperes and 0-100 milliamperes.

CONSTRUCTION

The instrument uses a 400 microampere meter movement which is shunted with resistors to provide a uniform 1 milliamper load in both AC and DC ranges. This design allows the use of but 1 set of 1% precision divider resistors on both AC and DC and provides a simplicity of switching. A small hearing aid type ohms adjust control provides the necessary zero adjust function on the ohmmeter range. The AC rectifier circuit uses a high quality Bradley rectifier and a dual half wave hookup. Necessary test leads and battery are included in the price of this popular kit.

Heathkit RESISTANCE SUBSTITUTION BOX KIT

MODEL RS-1

\$5⁵⁰



Shpg. Wt. 2 lbs.

36 standard RTMA 1 watt resistor values between 15 ohms and 10 megohms with an accuracy of 10% are at your fingertips in the Model RS-1 Resistance Substitution Box kit. This sturdy and attractive accessory will easily prove its worth many times over as a time saving device. Order several today.

Heathkit CONDENSER SUBSTITUTION BOX KIT

MODEL CS-1



\$5⁵⁰

Shpg. Wt. 2 lbs.

18 standard RTMA values are available from .0001 mfd to .22 mfd. An 18 position switch set in the panel of an attractive bakelite case allows quick changes without touching the test leads. Invest a few minutes of your time now and save hours of work later on.

HEATH company

BENTON HARBOR 15,
MICHIGAN

you to use this course as a kind of basic framework on which you will hang all the other things you will be continually learning about this fast-moving, far-from-simple subject. I know it will help you to approach color television in the carefully-planned, step-by-step procedure presented by this course; but there are bound to be many points that will not be crystal clear even after the course is finished. That's where your supplemental reading of magazine articles should help. Each writer sees things a little differently and writes about them from a different point of view. By reading what two or three of them have to say on the same subject, you often see quite clearly something that was a big mystery the first time you read about it.

"Speaking of magazine articles, I don't think you will find any much more helpful than those written by Milton Kiver in RADIO & TELEVISION NEWS, starting with the March, 1954, issue. I think he calls the series 'Fundamentals of Color TV.' One thing I like about the articles is that Kiver takes time at the end of several of them to prove mathematically puzzling general statements made in the body of the articles. I think you'll be surprised at how much more useful and informative a series of articles like this seems when you have several of them on hand and can refer back and forth through them and through your course, instead of just reading them one at a time, with a whole month elapsing between readings."

"You would help a guy out with his homework if he got stuck, wouldn't you?" Barney suggested slyly.

"Yes, if I could. But you've got to remember that when it comes to color TV I'm just a student same as you are; but we'll sure do our darndest to puzzle it out together." —30—

2 SETS OFF ONE ANTENNA

By ELMER C. FISCHER

HERE'S a little antenna tip that has proved quite successful.

Since the local TV stations have upped their power, the problem has become one of preventing overload and avoiding transmission-line pickup. This can be solved by inserting a 10 db pad at the receiver and running coax instead of twin-lead.

This excess signal can be put to better use by using it to drive two sets from one antenna. The author's installation consists of a "Q-Tec" antenna and two 75-ohm transmission lines from antenna to living room and basement sets. Each feed line connects from one antenna terminal to a common ground on the mast. Apparently, little transformer action takes place in the antenna since, with a 21-inch TV set monitoring one feed line, 200 feet of coax connected to the other was opened, shorted, and terminated with no noticeable effect on the picture.

With receivers using a center-tapped input coil, a good match can be obtained at the set by using only one-half the coil. —30—

NEW *Heathkit* VACUUM TUBE VOLTMETER KIT

PRINTED CIRCUIT DESIGN

New charcoal gray baked enamel panel with high readability, white lettering, soft leather gray cabinet, subdued pilot light indicator.

New printed circuit board for faster, easier construction—exact duplication of Lab development model.

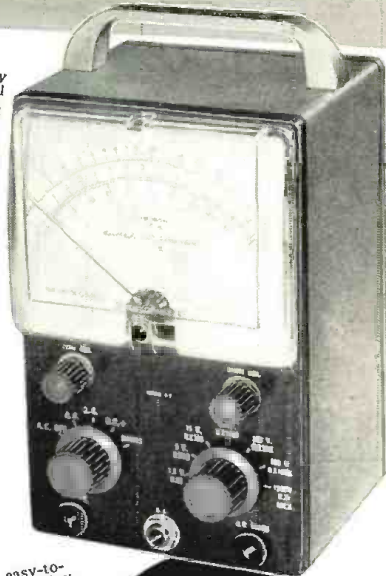

Another outstanding example of continuing Heath Company pioneering and leadership in the kit instrument field. A new **printed circuit** VTVM. New peak-to-peak circuit—new styling and new panel design. A prewired, prefabricated printed circuit board eliminates chassis wiring, cuts assembly time in half, assures duplication of Engineering pilot model specifications, and virtually eliminates possibility of construction error.

CIRCUIT:

A 6AL5 tube operated as a full wave AC input rectifier permits seven peak-to-peak voltage ranges with upper limits of 4000 volts P-P. Just the ticket for you TV servicemen. Voltage divider in the 6AL5 input circuit limits applied AC input to a safe level. This circuitry and the isolation of the meter in the cathode of the 12AU7 bridge circuit affords a high degree of protection to the sensitive 200 microampere meter.

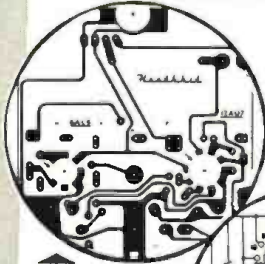

Full wave rectifier in AC input circuit. Read peak-to-peak and RMS volts with upper limit of 4000 P-P and 1500 volts RMS. Voltage divider input circuit.

RANGES:

Seven voltage ranges. 1.5, 5, 15, 50, 150, 500 and 1,500 volts DC and AC RMS. Peak-to-peak ranges 4, 14, 40, 140, 400, 1400, 4000. Ohmmeter ranges X1, X10, X100, X1000, X10K, X100K, X1 meg. Additional features are a db scale, a center scale zero position, and a polarity reversal switch.

IMPORTANT FEATURES:

High impedance 11 megohm input—transformer operated—1% precision resistors, 6AL5 and 12AU7 tube—selenium power rectifier—individual AC and DC calibrations—smoother improved zero adjust control action—new panel styling and color—new placement of pilot light—new positive contact battery mounting—new knobs—test leads included.

The new V-7 also sets the pace as a kit instrument style leader. Smart, good-looking charcoal gray panel and soft leather gray cabinet. High readability panel with sharply contrasting white calibrations. The pleasing, eye catching, modern styling is in harmonious balance with the outstanding circuit design improvements. Easily the best buy in kit instruments.

New easy-to-read open panel layout. Off-on switch now incorporated in the selector switch.

MODEL V-7

\$24.50

Shpg. Wt. 7 lbs.

New peak-to-peak meter scale—new color harmony—new knobs.

The first kit instrument to offer a labor-saving, error-free printed circuit board. Your instrument an exact wiring replica of Engineering development model.

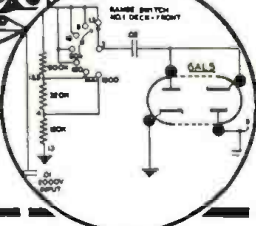

Heathkit AC VACUUM TUBE

VOLTMETER KIT

MODEL AV-2

\$29.50

Shpg. Wt. 5 lbs.

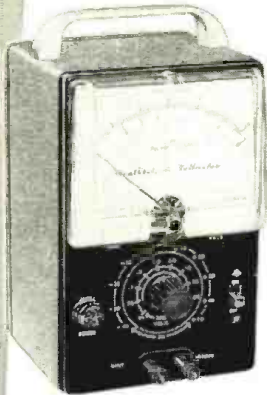

Extreme sensitivity has been emphasized in the design of the Heathkit AC VTVM. Ten full scale RMS ranges are .01, .03, .1, .3, 1, 3, 10, 30, 100, and 300 volts. Frequency response is substantially flat from 10 cycles per second to 50 KC with input impedance of 1 megohm at 1 KC. Will accurately measure as low as 1 millivolt at high impedance. Total db range is -52 db to +52 db. An excellent kit for measuring

the output of phono cartridges and the gain of amplifier stages. Use it also to check power supply ripple, as a sensitive null detector, and for compiling frequency response data. Features one knob operation, 200 microampere Simpson meter and precision resistors.

Heathkit 30,000 VOLTS DC

PROBE KIT

Measure up to 30,000 volts DC with the Heathkit VTVM and the 336 high voltage Probe. Precision resistor provides multiplication factor of 100. Can be used with any 11 megohm input VTVM. Housed in a Polystyrene two color sleek plastic probe body for safety of operation.

No. 336

\$4.50

Shpg. Wt. 1 lb.



Heathkit PEAK-TO-PEAK

PROBE KIT



No. 338-C

\$5.50

Shpg. Wt. 2 lbs.

Peak-to-peak values not exceeding 80 volts at a DC level of not more than 600 volts, can now be read directly by using 338-C Probe with previous model Heathkit VTVM's or any VTVM with 11 megohm input resistance. Probe construction features a modern printed circuit board for easy assembly. Frequency range 5 KC to 5 MC.

Heathkit RF PROBE KIT

The Heathkit RF Probe will permit the measurement of RF voltages up to 250 MC with an accuracy of $\pm 10\%$. The limits are 30 volts AC and a DC level of 500 volts. Designed for any 11 megohm input VTVM. Modern styling, Polystyrene aluminum housing, Polystyrene insulation, and printed circuit board for easy assembly.



No. 309-C

\$3.50

Shpg. Wt. 1 lb.

Heathkit

AUDIO WATTMETER KIT

Read audio power output directly without using external load resistors with the new Heathkit Audio Wattmeter. Built-in non-inductive load resistors provide impedances of 4, 8, 16, and 600 ohms. Flat response from 10 CPS to 250 KC. Full scale power ranges are 0-5 MW, 0-50 MW, 0-500 MW, 0-5 W and 0-50 W. Model AW-1 will operate continuously at 25 watts and has a duty cycle of 3 minutes at 50 watts. Total db range in five positions is -50 db to +48 db, using the standard 1 milliwatt 600 ohms.

MODEL AW-1

\$29.50

Shpg. Wt. 6 lbs.



HEATH company

BENTON HARBOR 15,
MICHIGAN

Heathkit 6-12 VOLT BATTERY ELIMINATOR KIT

Here is the new 12 volt Heathkit Battery Eliminator so necessary for modern up-to-date operation of your Service Shop. Furnishes either 6 or 12 volt output which can be selected at the flick of a panel switch. Use the BE-4 to service all of the new 12 volt car radios in addition to the conventional 6 volt models.

RANGES:

This new Battery Eliminator provides two continuously variable output voltage ranges. 0-6 volts D.C. at 10 amperes continuously or 15 amperes maximum intermittent and 0-12 volts D.C. at 5 amperes continuously or 7.5 amperes maximum intermittent. The output voltage is clean and well filtered, as the circuit uses two 10,000 mfd condensers.

The continuously variable voltage output feature is of definite aid in determining the starting point of vibrators, the voltage operating range of oscillator circuits, etc.

OTHER USES:

The controllable low voltage DC supply has many other applications besides primary use in car radio service work. Can be nicely used as a battery charger, or low voltage DC supply for electric trains. Has applications in high gain audio work requiring clean DC filament supply. Can be used for low power electro-plating or as a power supply for battery powered intercommunication systems.

Automatic overload relay—self resetting—fuse protected.

New 18 plate split-type heavy duty rectifier unit.



Continuously variable output voltage, either 6 or 12 volt operation.

Constant ammeter and voltmeter monitoring.

MODEL BE-4

\$31.50

Shpg. Wt. 17 lbs.

Heathkit VIBRATOR TESTER KIT



MODEL VT-1

\$14.50

Shpg. Wt. 6 lbs.

This time-saving device will quickly pay for itself in your auto radio service shop. 6 volt vibrators can be checked instantly on the Good-Bad type meter scale. Operation requires only a variable DC voltage from 4 to 6 volts at 4 amperes. Model BE-4 Battery Eliminator is recommended for this application.

Five test sockets provide for the testing of hundreds of interrupter and self-rectifier types. Proper starting voltage is determined easily and accurately. Over-all quality is then unmistakably indicated on the panel mounted meter.

Heathkit IMPEDANCE BRIDGE KIT

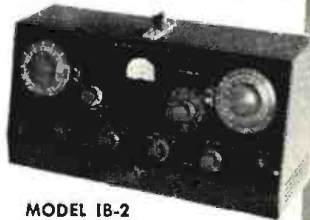

MODEL IB-2

\$59.50

Shpg. Wt. 12 lbs.

The new Heathkit Impedance Bridge features built-in adjustable phase shift oscillator and amplifier. This instrument actually represents four instruments in one compact unit. The Wheatstone bridge for resistance measurements, the Capacity Comparison bridge for capacity measurements, Maxwell bridge for low Q, and Hay bridge for high Q measurements.

DESIGN:

Panel provisions for external generator use. A new two section CRL dial, provides ten separate "units." Ten separate units switch settings and fractions of units are read on a continuously variable calibrated control. A special minimum capacity shielded and balanced impedance matching transformer between the generator and bridge circuit is automatically switched to provide correct load operation of the generator circuit. The instrument uses 1/4% precision resistors and condensers in all measurements circuits.

Heathkit VARIABLE VOLTAGE ISOLATION TRANSFORMER KIT

Variable output voltage between 90 and 130 volts AC. Rated at 100 volt—amperes continuously and 200 volt—amperes intermittently. The principle function of the Heathkit Isolation Transformer is to isolate the circuit being tested from line interference being caused by motors, appliances, etc. It works backward too by isolating such devices from the line.

Many other uses, especially with AC-DC type circuits. Do not confuse the Heathkit Isolation Transformer with the hazardous auto transformer type line voltage boosters.



MODEL IT-1

\$16.50

Shpg. Wt. 10 lbs.

HEATH company

BENTON HARBOR 15,
MICHIGAN

Technical BOOKS

"AUDIO AMPLIFIERS AND ASSOCIATED EQUIPMENT" by Sams Staff. Published by *Howard W. Sams & Co., Inc.*, Indianapolis. \$3.95. Paper bound. Vol. 5 (AA-5).

This newest volume in the *Sams' "Amplifier" series* covers 1953 and 1954 model audio amplifiers, preamps, and AM-FM custom tuners.

Each unit is pictured, controls are identified, tubes are listed and the power supply and rating given in tabular form. Under chassis and top chassis views are also provided along with complete parts lists and circuit diagrams.

Where pickup arms are part of the unit, complete details on the correct cartridges and needles to be used are also given.

This volume also contains a cumulative index covering all of the volumes in the series thus far for the speedy location of the desired schematic and service data. This listing is divided into amplifiers and tuners for further ease in spotting the correct diagram.

* * *

"MOST-OFTEN-NEEDED 1955 TELEVISION SERVICING INFORMATION" compiled by M. N. Beitman. Published by *Supreme Publications*, Chicago. 192 pages. Price \$3.00. Paper bound. Vol. TV-9.

This is the newest volume in the popular *Supreme series* of TV servicing data and covers practically all of the early 1955 video sets produced by some 26 manufacturers.

As with the earlier volumes, each receiver model is given a careful survey as to service faults and potential trouble spots, alignment procedures are outlined, waveform data is given, and the complete schematic of the set is provided.

Service technicians who rely on these compact manuals to speed their troubleshooting and repair work will welcome the appearance of this up-to-date volume. Those not yet acquainted with these books can get a good introduction with this most recent work.

* * *

"SINGLE SIDEBAND TECHNIQUES" by Jack N. Brown, W3SHY. Published by *Cowan Publishing Corp.*, New York. 112 pages. Price \$1.50. Paper bound.

This is a specialized text written by an enthusiastic champion of SSB operation and he is a persuasive advocate. The author has managed to transmit some of his enthusiasm to the reader both by hard hitting technical reasons for adopting the technique and by the infectious quality of his advocacy.

The text is divided into ten chapters covering a discussion of SSB, the filter method, phasing method, linear amplification theory, high-power linear final, balanced modulators, phase-shift networks, construction details on a 35-watt

RADIO & TELEVISION NEWS

NEW Heathkit TV ALIGNMENT GENERATOR KIT

Here is the most radically improved Sweep Generator in the history of the TV service industry. The basic design follows latest high frequency techniques which result in a combination of performance features not found in any other sweep generator.

SWEEP:

Sweep action is obtained electronically through the use of a newly developed controllable inductor, thereby eliminating all moving parts with their resultant hum, vibration, fatigue, etc. Frequency coverage entirely on fundamentals, is continuous from 4 MC to 220 MC at an output level well over a measurable .1 volt.

Triple marker system, 4.5 MC crystal controlled marker—continuously variable marker—provisions for external marker.

MARKER:

The same instrument incorporates a triple marker system with a crystal controlled reference. A variable marker provides accurate coverage from 19 to 60 MC on fundamentals, and 57 to 180 MC on calibrated harmonics. A separate fixed crystal controlled 4.5 MC marker can be used for checking IF, band-pass, calibration, reference, etc. Provisions are also made for external marker use. A 4.5 MC crystal is supplied with the kit.

POWER SUPPLY:

The transformer operated Power Supply features voltage regulation for stable oscillator operation. Three sets of shielded cables are furnished with the kit. Sweep range is completely and smoothly controllable from zero up to a maximum of 50 MC, depending upon base frequency.

Here is a TV Sweep Generator that truly no serviceman can afford to be without for rapid, accurate, TV alignment work.

Controllable inductor sweep oscillator with output entirely on fundamentals.

Triple marker system 4.5 MC crystal controlled—3 sets of cables included.

Electronically operated, smoothly continuous variable sweep circuit. No vibration, hum or noise.

Frequency coverage 4 MC—220 MC continuous including FM spectrum. RF output well over .1 volt.

MODEL TS-3

\$44.50

Shpg. Wt. 18 lbs.

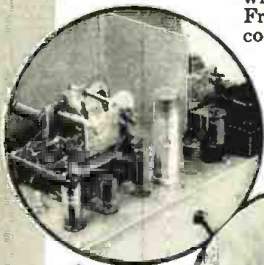

Automatic amplitude control circuit—constant output voltage regulated power supply.

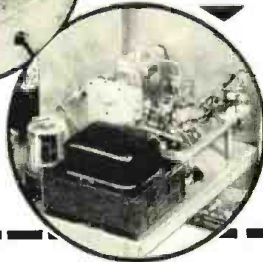

NEW Heathkit SIGNAL GENERATOR KIT

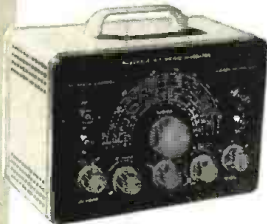

MODEL SG-8

\$19.50 Shpg. Wt. 8 lbs.

The new Heathkit service type Signal Generator, Model SG-8 incorporates many design features not usually found in this instrument price range. Frequency coverage

is from 160 KC to 110 MC in five ranges, all on fundamentals, with useful calibrated harmonics up to 220 MC. The RF output level is well in excess of 100,000 microvolts throughout the frequency range. The oscillator circuit consists of a twin triode tube, one-half used as a Colpitts oscillator, and the other half as a cathode follower output which acts as a buffer between the oscillator and external load, thereby eliminating oscillator frequency shift usually caused by external loading.

All coils are factory wound and adjusted, thereby completely eliminating the need for individual calibration and the use of additional calibrating equipment. The stable, low impedance output, features step and variable attenuation for complete control of RF level. A separate 6C4 triode acts as a 400 cycle sine wave oscillator, and a panel mounted switching system permits choice of either external or internal modulation.

Heathkit LABORATORY GENERATOR KIT



MODEL LG-1

\$39.50

Shpg. Wt. 16 lbs.

The new Heathkit Laboratory type Signal Generator definitely establishes a new performance standard for a kit instrument. An outstanding feature involves the use of a panel mounted 200 microampere meter calibrated both in microvolts and percent modulation, thereby providing a definite reference level for using the Signal Generator in design work, gain measurements, selectivity, frequency response checks.

DESIGN:

Additional design features are copper plated shield enclosure for oscillator and buffer stages resulting in effective double shielding. Fibre panel control shaft extensions in RF carrying circuits, thorough AC line filtering, careful shielding of the attenuator network, voltage regulated B plus supply, selenium rectifier, etc.

RANGES:

Frequency coverage from 150 KC to 30 MC all on fundamentals in five separate ranges. Output voltage .1 volt with provisions for metered external or internal modulation. Output impedance termination 50 ohms. Transformer operated power supply.

Investigate the many dollar stretching features offered by the LG-1 before investing in any generator for Laboratory or Service work.

NEW Heathkit BAR GENERATOR KIT



MODEL
BG-1

\$14.50 Shpg. Wt. 4 lbs.

The Heathkit BG-1 produces a series of horizontal or vertical bars on a TV screen. Since these bars are equally spaced, they will quickly indicate picture linearity of the receiver under test without waiting for transmitted test patterns. Panel switch provides "standby—horizontal and vertical position." The oscillator unit uses a 12AT7 twin triode for the RF oscillator and video carrier frequencies. A neon relaxation oscillator provides low frequency for vertical linearity tests. The instrument will also provide an indication of horizontal and vertical sync circuit stability as well as overall picture size. Operation is simple and merely requires connection to the TV receiver antenna terminal. Transformer operated for safety.

HEATH company
BENTON HARBOR 15,
MICHIGAN

Heathkit VISUAL-AURAL SIGNAL-TRACER KIT

The new Heathkit Visual-Aural Signal Tracer features a special high gain RF input channel used in conjunction with a newly designed wide frequency range demodulator probe. High RF sensitivity permits signal tracing from the receiver antenna input. Separate low gain channel and probe available for audio circuit exploration. Both input channels are constantly monitored by an electron ray beam indicator so that visual as well as aural indications may be obtained.

NOISE LOCATOR:

A decidedly unusual feature is a noise locator circuit used in conjunction with the audio probe. With this system, a DC potential is applied to a suspected circuit component and the action of the voltage in the component can be seen as well as heard. Invaluable for ferreting out noisy or intermittent condensers, noisy resistors, controls, IF and power transformers, etc.

WATTMETER:

Built-in calibrated wattmeter circuit will prove useful for quick preliminary check of total wattage consumption of equipment under test. Separate panel terminals provide external use of the speaker or output transformer for substitution purposes. Saves valuable service time by eliminating the necessity for speaker removal on every service job. The same panel terminals also provide easy access to a well filtered B plus supply for external use. Don't overlook the many interesting service possibilities provided through the use of this instrument, and let the Signal Tracer work for you by saving time and money.

Substitution test speaker—utility amplifier.

Noise locator circuit—calibrated wattmeter.

RF and audio probes supplied along with necessary test leads.

Visual and aural signal tracing.



MODEL T-3

\$23⁵⁰

Shpg. Wt. 9 lbs.

Heathkit CONDENSER CHECKER KIT



MODEL C-3

\$19⁵⁰ Shpg. Wt. 7 lbs.

Here is a handy test instrument for any Service Shop. Unknown values of capacity and resistance are quickly determined on the direct reading condenser checker dial. Capacity is measured in four ranges from .001 mfd to 1000 mfd. Resistance in the range from 100 ohms to 5 megohms.

DC polarizing voltages of 25, 150, 250, 350, and 450 volts are available for leakage tests on all types of condensers. For electrolytics, a power factor control is provided to balance out inherent leakage and to indicate directly the power factor of a condenser under test. Proper balancing of the AC bridge is reflected in the degree of closure of an electron beam indicator tube.

Model C-3 uses a transformer operated power supply, spring return leakage test switch, and a convenient combination of panel scales for all readings. Test leads are furnished in addition to precision components for calibrating purposes. Quick and easy to operate, the Heathkit Condenser Checker will save valuable time and increase your Shop efficiency.

Heathkit "Q" METER KIT



MODEL QM-1

\$44⁵⁰

Shpg. Wt. 14 lbs.

The Heathkit QM-1 represents the first practical popular priced Q meter available within the price range of schools, laboratories, TV service men, and experimenters. This instrument will enable the operator to simulate conditions encountered in practical circuits and to measure the performance of coils or condensers at the operating frequencies actually encountered. All indications of value are read directly on the $4\frac{1}{2}$ " 50 microampere Simpson calibrated meter scale. Measures Q of condensers, RF resistance, and the distributed capacity of coils. Oscillator section supplies RF frequencies 150 KC to 18 MC in four ranges. Calibrate capacity with range of 40 MMF to 450 MMF with vernier of ± 3 MMF. Investigate the many services this instrument can perform for you.

Heathkit AUDIO OSCILLATOR KIT

MODEL AO-1

\$24⁵⁰

Shpg. Wt. 10 lbs.



The Heathkit Audio Oscillator will produce both sine and square waves within the frequency range from 20 CPS to 20 KC in three ranges. Thermistor controlled linearity results in a variation of no more than ± 1 db in a 10 volt (no load) variable output level. There will be less than .6% distortion from 100 CPS throughout the audible range. Low impedance 600 ohm output. Precision 1% resistors, used in the range multiplier circuits to provide accurate calibration.

HEATH company

BENTON HARBOR 15,
MICHIGAN

SSB transmitter, high-level heterodyne unit, and filters and filter alignment. Two sections cover hints on better SSB operation. An index and bibliography complete this work.

The text material is lavishly illustrated and amplified by means of circuit diagrams, photographs, and oscillograms. Radio amateurs should find this book an especially valuable addition to their shack libraries as the circuitry and suggestions advanced by the author are worthwhile.

* * *

"VALVES FOR A.F. AMPLIFIERS" by E. Rodenhuis. Published by *Philips Technical Library*, Eindhoven. Available in the U.S. from *Elsevier Press Inc.*, 155 E. 82nd St., New York 28, N.Y. Price \$2.25.

This is a practical, non-theoretical handbook for the audiophile, engineer, and experimenter who likes to "roll-his-own" amplifier, incorporating selected features from various commercial circuit designs.

The avowed purpose of this book is to enlarge the reader's knowledge of amplifiers in general and to stimulate his interest to the point where he will experiment with amplifier circuits on his own. Toward this end, the text material contains general hints on amplifier design, the application of tube data, the functions of the different stages of the amplifier, and concludes with detailed descriptions of eight amplifier designs.

Although all of the tubes discussed and specified in the circuits are made by *Philips*, American-made equivalents could be used or the circuit features adapted to standard U.S.-type components.

-30-

Using Test Points

(Continued from page 39)

any component on the printed wiring board.

Additional test points are available by connecting to the exposed dip-soldered points around the tube sockets on the printed wiring boards.

In their 1955 TV receivers, many additional manufacturers have gone to the use of test sockets, primarily because of the simplifications it permits in their own production testing. The service technician who knows how to use these test points can save a great deal of time and often service a receiver quickly at the customer's home instead of having to lug it back and forth from the shop. The resulting reduction in servicing cost will be a credit to the service technician, a boon to the customer, and will increase the reputation of the manufacturer.

For color TV sets, the inclusion of test sockets above the chassis is still more important since the complexity of a color receiver is so much greater than the black-and-white set and service costs are correspondingly higher.

-30-

Heathkit TUBE CHECKER KIT

The Heathkit TC-2 Tube Checker was primarily designed for the convenience of radio and TV servicemen and will check the operating quality of tubes commonly encountered in this type of work. Test set-up procedure is simplified, rapid, and flexible. Panel sockets accommodate 4, 5, 6, and 7 pin tubes, octal and loctal, 7 and 9 pin miniatures, 5 pin Hytron, and a blank socket for new tubes. Built-in neon short indicator, individual 3-position lever switch for each tube element, spring return test switch, 14 filament voltage ranges, and line-set control to compensate for supply voltage variations, all represent features of the TC-2.

Illuminated for easy reading and quick identification of chart reference.

Improved smooth running roll chart mechanical action.

Simplified construction—new harness type wiring—closer tolerance resistors.

Smart, professional appearance—available in counter or portable models.

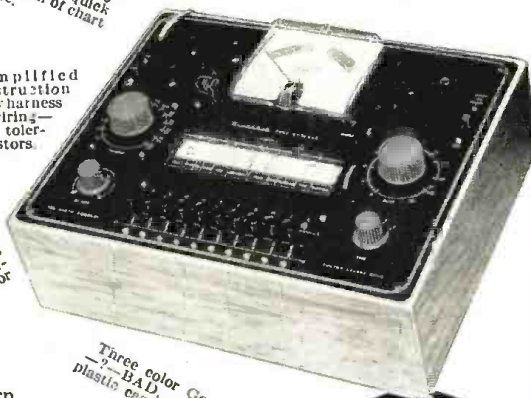

Three color Good —BAD— plastic cased meter.

MODEL TC-2

\$29.50

Shpg. Wt. 12 lbs.

Results of tube tests are read directly from the large 4 1/2" Simpson 3-color meter. Checks emission, shorted elements, open elements, and continuity. Wiring procedure has been simplified through the use of multi-wired color coded cable providing a harness type installation between tube sockets and lever switches. This procedure insures standard assembly and imparts a "factory built" appearance to the instrument. New Construction Manual furnishes detailed information regarding tube set-up procedure for testing of new or unlisted tube types. No delay necessary for release of factory data.

Heathkit PORTABLE TUBE CHECKER KIT

The portable model is supplied with a strikingly attractive two-tone cabinet finished in rich maroon proxylin impregnated fabric covering with a contrasting gray on the inside of the detachable cover.

MODEL TC-2P

\$34.50

Shpg. Wt. 15 lbs.



Heathkit REGULATED POWER SUPPLY KIT

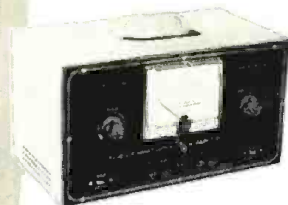

MODEL PS-2

\$33.50

Shpg. Wt. 15 lbs.

Here is a source of regulated D.C. voltage for circuit development work. Power supply voltage and current drain to the circuit under test are constantly monitored by the 4 1/2" panel mounted meter. Separate 6.3 volt at 4 ampere A.C. filament source available. The regulated and variable output voltage will be constant over wide load variations, and hum ripple will not exceed .012% at 250 volts under a 50 MA load. Completely isolated circuit, standby switch, and other desirable features, make the Model PS-2 extremely useful in a wide variety of applications.

Heathkit TV PICTURE TUBE TEST ADAPTER

The Heathkit TV Picture Tube Test Adapter used with the Heathkit Tube Checker Kit, will quickly check picture tubes for emission, shorts, etc. and determine tube quality. Consists of standard 12-pin TV tube socket, four feet of cable, octal socket connector, and data sheet.



No. 355

\$4.50 Shpg. Wt. 1 lb.

Heathkit DECADE RESISTANCE KIT



MODEL DR-1

\$19.50

Shpg. Wt. 4 lbs.

Twenty 1% resistors are decade in 1 ohm steps to provide any value between 1 ohm and 99,999 ohms. Sturdy ceramic switches with silver plated contacts insure reliable service. Use the Decade Resistance in bridge circuits, meter multipliers, calibrations, or any application requiring a wide range of precision resistance values.

Heathkit AUDIO GENERATOR KIT

Here is an Audio Generator with features generally found only in the most expensive instruments. Sine wave coverage from 20 cycles to 1 Megacycle—response flat ± 1 db from 20 cycles to 400 Kc—continuously variable and step attenuated output. Because the output voltage is relatively constant over wide frequency ranges, the AG-8 is ideal for running frequency response curves in audio circuits. Once set by means of the attenuator, this voltage may be relied upon for accuracy within ± 1 db. Instrument features low impedance 600 ohm output circuit and distortion less than .4 of 1% from 100 CPS through audible range.



MODEL AG-8

\$29.50

Shpg. Wt. 11 lbs.

Heathkit DECADE CONDENSER KIT

The Heathkit Decade Condenser provides a ready source of capacity values from 100 mmf to .111 mfd inclusive in capacity steps of 100 mmf. Silver plated contacts on husky ceramic switches, assure positive contact for each switch position. Precision silver mica condensers $\pm 1\%$ accuracy for close tolerance accurate work.

MODEL DC-1

\$16.50

Shpg. Wt. 3 lbs.



HEATH company

BENTON HARBOR 15,
MICHIGAN

NEW *Heathkit* HIGH FIDELITY PREAMPLIFIER KIT

Here is the exciting new Heathkit Preamplifier with all of the features you Audiophiles have asked for and at a down-to-earth price level. Beautiful satin gold baked enamel finish, striking control knobs and arrangement, attractive custom appearance and entirely functional design.

DESIGN:

Uses three twin triode tubes in a shock mounted chassis, 2-12AX7 and 1-12AU7. Features tube shielding, plastic sealed color coded capacitors, smooth acting controls, good filtering, excellent decoupling, low hum and noise level, and all aluminum cabinet. Special balancing control for absolute minimum hum level. Cathode follower, low impedance output circuit for complete installation flexibility.

SPECIFICATIONS:

Provides five switch selected inputs, 3 high level, and two low level, each with individual level controls—4 position LP, RIAA, AES, and early 78 equalization switch—4 position roll-off switch, 8, 12, 16 with one flat position. Separate tone controls, bass 18 db boost and 12 db cut at 50 CPS, treble 15 db boost, and 20 db cut at 15,000 CPS. Power re-

Equalization for LP, RIAA, AES, and early 78.

Separate bass and treble tone controls—special hum control.



Cathode follower low impedance output circuit.

Beautiful, modern appearance, blends with any interior or color scheme.

Five switch selected inputs with individual level controls.

quirements from Heathkit Williamson Type Amplifier power supply 6.3 volts AC at 1 ampere, and 300 volts DC at 10 MA. Over-all dimensions 12 $\frac{3}{8}$ " wide x 5 $\frac{1}{8}$ " deep x 3 $\frac{3}{8}$ " high.

APPLICATION:

The new Heathkit WA-P2 Preamplifier has been designed to operate with any of the Heathkit Williamson Type Amplifiers and is directly interchangeable with the previous Model WA-P1 Preamplifier unit. Order your kit today and enjoy completely smooth control over the operation of your Hi-Fi system. Obtain the exact tonal balance of bass and treble with the precise degree of equalization you want. Note that the design of the WA-P2 accommodates the newly established RIAA curve.

MODEL WA-P2

\$19.75

Shpg. Wt. 7 lbs.

HAM EQUIPMENT

Single knob band switching—prewound coils.



Crystal or VFO excitation—metered operation. 52 Ohm coaxial output—built-in power supply.

MODEL AT-1

\$29.50

Shpg. Wt. 16 lbs.

filter, good shielding and a 52 ohm coaxial output. The 425 volt, 100 milliamper power supply and 5U4 rectifier are more than adequate for the 6AG7 oscillator multiplier and 6L6 amplifier doubler.

Heathkit
AMATEUR

TRANSMITTER KIT

The Heathkit AT-1 Transmitter has established a high reputation and has been enthusiastically accepted by hundreds of experienced operators as well as beginners. Power input up to 35 watts for the novice and suitable as a standby exciter for your higher powered rig later on.

Model AT-1 can be crystal or VFO excited and operates on 80, 40, 20, 15, 11 and 10 meters. The prewound coils with the oscillator and amplifier are switched simultaneously

by the rugged band switch. Meter switch allows a reading of the final grid and plate current on the panel mounted meter. Modulator input and VFO power sockets are provided as well as a key jack for CW operation. Other features include a crystal socket, standby switch, key click filter, AC line

Brand
NEW

HEATHKIT VFO KIT

The new Heathkit VFO is the perfect companion to the Heathkit Model AT-1 Transmitter and it has sufficient output to drive any multi-stage transmitter of modern design. Good mechanical and electrical design insures operating stability. Coils are wound on stable, heavy duty, ceramic forms using Litz or double cellulose wire coated with Polystyrene cement and baked for humidity protection. Variable capacitor of differential type construction, especially designed for maximum bandsread. Kit is furnished with a carefully precalibrated scale which provides well over two feet of scale length. Smooth acting vernier reduction drive and illuminated dial provides easy tuning and zero beating.

Power requirements 6.3 volts AC at .45 amperes, and 250 volts DC at 15 mils. Just plug it into the power receptacle provided on the rear of the AT-1 Transmitter. Seven band coverage 160 through 10 meters with 10 volt average RF output. Uses 6AU6 electron coupled Clapp oscillator and OA2 voltage regulator.



Copper plated chassis—aluminum cabinet—easy to build.

Smooth acting illuminated and precalibrated dial.

Seven band coverage 160 through 10 meters at 10 volt RF output.

6AU6 electron coupled Clapp oscillator and OA2 voltage regulator.

MODEL VF-1

\$19.50

Shpg. Wt. 7 lbs.

Heathkit

GRID DIP METER KIT

The invaluable instrument for Hams, servicemen and experimenters. Useful in TV service work, for alignment of traps, filters, IF stages, peaking compensation networks, etc. Locates spurious oscillation, provides a relative indication of power in transmitter stages. Use it for neutralization, locating parasites, correcting TVI, measuring CI and Q of components, and determining RF circuit resonant frequencies. The variable meter sensitivity control, headphone jack, 500 microampere Simpson meter, continuous frequency coverage from 2 MC to 250 MC. Prewound coil kit and rack included.

LOW FREQUENCY COILS:

Low frequency range extended to 355 KC by the use of two additional coils. Complete with dial correlation curves. Set 341-A for GD-1B and set 341 for GD-1A. Shpg. wt. 1 lb. Price \$3.00



MODEL GD-1B

\$19.50

Shpg. Wt. 4 lbs.

Heathkit ANTENNA

IMPEDANCE METER KIT

MODEL AM-1

\$14.50

Shpg. Wt. 2 lbs.

Determine antenna resonance and resistance, transmission line surge impedance, and receiver input impedance. Works with one-half and one-quarter wave lines, half wave and folded dipoles, harmonic mobile and beam antennas. Resistance type SWR bridge—100 microampere meter—frequency range 0-150 MC—impedance range 0-600 ohms.



MODEL AC-1

\$14.50

Shpg. Wt. 4 lbs.

Heathkit

ANTENNA COUPLER KIT

For the Heathkit AT-1 Transmitter or any comparable Amateur Transmitter. Will handle power up to 75 watts at its 52 ohm coaxial input. Matches a wide range of antenna impedances with its L type tuning network and neon indicator. A tapped inductance provides coarse adjustment and a transmitting type variable condenser sets it "right on the nose." Will operate on the 10 through 80 meter bands.

HEATH company
BENTON HARBOR 15,
MICHIGAN

New LOW PRICED HEATHKIT SINGLE UNIT Williamson Type High Fidelity AMPLIFIER KIT

Here is the newest Heathkit Hi-Fi Amplifier at the lowest price ever quoted for a complete Williamson Type Amplifier circuit. The W-4 Model has been designed for single chassis construction, and only for the new Chicago Transformer Company Model BO-13 "super range" high fidelity output transformer. This transformer, a new development in the Hi-Fi field, is being offered at substantial saving over transformers of comparable quality. It is outstanding in performance and on the basis of our tests, we find it equal in every respect to transformers used in the W-2 and W-3 Heathkit series.

LOW PRICES:

Through utilization of a single chassis with resultant economy obtained through elimination of duplicate sheet metal fabrication, connecting cables, plugs, sockets, and a new Chicago "super range" output transformer, a 20% price reduction has been made possible without sacrificing kit quality.

COMPONENTS:

The new Heathkit W-4 uses the same heavy duty power transformer and choke. It has all of the features of previous models including individual jacks and a wire wound control to balance the output tubes—plastic high quality capacitors and the exact circuitry previously utilized in Williamson Type Amplifiers. Intermodulation distortion and harmonic distortion are both at the same low level as in the W-2 and W-3 models.

CONSTRUCTION:

Here is the opportunity for even the economy minded Hi-Fi enthusiast to enjoy all of the advantages offered through Hi-Fi reproduction of fine recorded music. Simplified step-by-step Construction Manual completely eliminates necessity of electronic knowledge or special equipment. Assemble this Amplifier in a few pleasant hours.

Rugged, heavy duty,
single chassis
construction.

Output impedances
4, 8, and 16 ohms.

Standard
brand
components used,
no sacrifice of
quality.

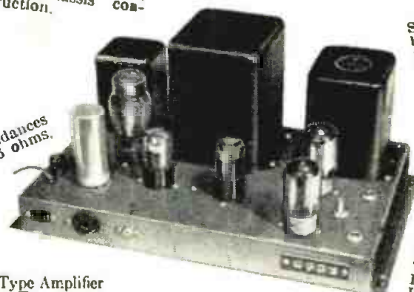

Lowest price high quality
Williamson Type Amplifier
ever offered.

Send for
free booklet
"High
Fidelity
Especially
For You."

COMBINATIONS AVAILABLE

W-4M with Chicago "super-range" transformer only. Single chassis main amplifier and power supply. Shipping weight 28 lbs. Express only **\$39.75**

COMBINATION W-4 with Chicago "super-range" transformer only includes single chassis main amplifier and power supply with WA-P2 preamplifier kit. Shpg. wt. 35 lbs. Express only **\$59.50**

NEW Heathkit 20 WATT High Fidelity AMPLIFIER KIT

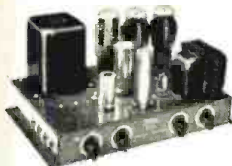

MODEL A-9B

\$35⁵⁰

Shpg. Wt. 24 lbs.

In keeping with the progressive policy of the Heath Company, further improvement has been made in the already famous Heathkit High Fidelity 20 Watt Amplifier. Additional reserve power has been obtained by using a heavier power transformer. A new output transformer designed and manufactured especially for the Heath Company, now provides output impedances of 4, 8, 16 and 500 ohms. The harmonic distortion level will not exceed 1% at the rated output.

FEATURES:

Outstanding features of the Heathkit 20 watt Amplifier include frequency response of ± 1 db from 20 CPS to 20 KC. Separate (boost and cut) bass and treble tone controls. Four switch selected input jacks and a special hum balancing control. Flexibility is emphasized in the in-

put circuits and proper equalization for all input devices is incorporated.

TUBE LINEUP:

12AX7 magnetic preamplifier and first audio amplifier. 12AU7 two stage amplifier with tone controls. 12AU7 voltage amplifier and phase splitter. Two 6L6 push-pull beam power output and 5U4G rectifier.

The Heathkit Model A-9B is excellent for custom installation and is designed for outstanding service at a very reasonable cost.

Heathkit SIX WATT AMPLIFIER KIT



MODEL A-7B

\$15⁵⁰

Shpg. Wt. 10 lbs.

An outstanding value, this economically priced 5 watt Amplifier is capable of performance expected only in much more expensive units. Only 2 or 3 watts output will ever be used in normal home applications and Model A-7B will be more than adequate for this purpose.

SPECIFICATIONS:

Two switch selected inputs are available for crystal and ceramic phono pickups, tuner, TV audio, tape recorder, and carbon type microphone. Model A-7B features separate bass and treble tone controls, push-pull balanced output stages, output impedances of 4, 8, and 15 ohms, and extremely wide frequency range $\pm 1\frac{1}{2}$ db from 20 CPS to 20 KC. Not just a souped up AC-DC job. Full wave rectification, transformer operated power supply and good filtering, result in exceptionally low hum level.

MODEL A-7C

Provides a preamplifier stage and proper compensation for the variable reluctance cartridge and low level microphone. **\$17.50**

Heathkit WILLIAMSON TYPE AMPLIFIER KIT

Here is the famous kit form Williamson Type high fidelity Amplifier that has deservedly earned highest praise from every strata of Hi-Fi music lovers. Virtually distortionless, clean musical reproduction, full range frequency response, and more than adequate power reserve.

OUTPUT TRANSFORMERS:

This outstanding Williamson Type Hi-Fidelity Amplifier is supplied with the famous Aerosound TO-300 output transformer. This quality transformer features the popular "ultra-linear" output circuit for clean maximum power level. Separate chassis for amplifier and power supply.

SPECIFICATIONS:

Frequency response within 1 db from 10 cycles to 100,000 cycles. Harmonic distortion at 5 watt output less than .5% between 20 cycles and 20,000 cycles. 1M distortion at 5 watts equivalent output .5% using 60 and 3,000 cycles. Output impedances of 4, 8, or 16 ohms. Overall dimensions for each unit 7" high x 5 $\frac{1}{2}$ " wide x 11 $\frac{1}{2}$ " long.

CONSTRUCTION MANUAL:

This fine kit is supplied with a completely detailed step-by-step Construction Manual and the only effort required is the assembly and wiring of the pre-engineered kit. Even the complete novice can successfully construct this Amplifier and have fun building it.

COMBINATIONS AVAILABLE:

W-3 Amplifier Kit (Includes Main Amplifier with Aerosound Output Transformer, Power Supply and WA-P2 Preamplifier.) Shipping weight 37 lbs. Shipped express only **\$69.50**

W-3M Amplifier Kit (Includes Main Amplifier with Aerosound Output Transformer and Power Supply.) Shipping weight 29 lbs. Express only **\$49.75**



HEATH company
BENTON HARBOR 15,
MICHIGAN

Motorola Color Receiver (Continued from page 74)

which are internally associated with each grid No. 4. The magnetic fields set up by the coils are coupled through the glass neck of the tube to the internal pole pieces which serve to shape and confine the fields so as to affect only the particular electron beams to which the individual pole pieces correspond. For example, the change in convergence angle of the red beam is a function only of the current through the external coil which couples to the internal set of pole pieces adjacent to the red beams. Likewise, the currents through the green and blue external magnets affect respectively only the green and blue beams.

Each external coil possesses two separate windings to provide for horizontal and vertical dynamic convergence correction. For the static convergence ad-

Fig. 5. (A) External and internal convergence components of the CRT. (B) Detailed drawing of the convergence coil and magnet assembly. (C) Effect of the three fixed magnets and the blue positioning magnet on the three CRT beams.

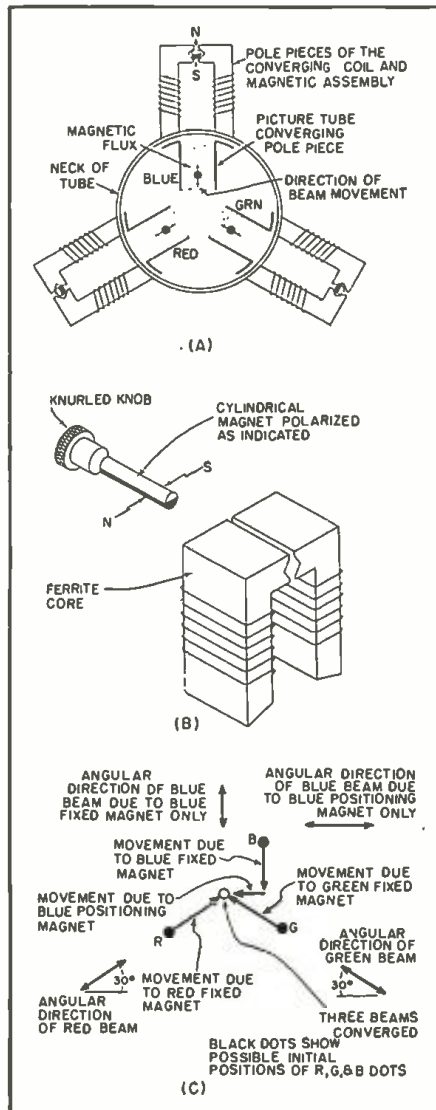

MAKE MORE MONEY ON SERVICE!

TELEVISION • RADIO • ELECTRONIC



Learn to handle ANY job easier, better and lots FASTER this modern professional way!

ONLY \$12 FOR THE COMPLETE TRAINING You Save \$125

THESE two big, fact-packed Ghirardi training books make it easy for you to become expert on all types of home radio and television receiver service—at absolute minimum cost!

Ask the men who already have good pay jobs! They'll tell you that Ghirardi training is the finest—AT ANY PRICE—because it is so outstandingly complete, and because it makes even the

toughest subjects so easy to understand.

Each of these two books is entirely new, completely modern in every respect—NOT a re-hash of old, outmoded material. Together, they form a complete service library written so you can easily understand every word—and designed to serve either as a complete training course or as a handy reference for experienced servicemen who want to look up puzzling jobs or develop new and faster methods.

Learn all about Circuits . . . AND WATCH SERVICE "HEADACHES" DISAPPEAR

Years of experience plus hundreds of talks with service technicians proved to Mr. Ghirardi the need for a book that got right down to earth in explaining the basic circuits and operation of modern radio and television receivers. Radio & Television Receiver Circuitry and Operation is the result. Backed by what you can learn from it, you'll find that 9 out of 10 service jobs are tremendously simplified. You'll work faster with less testing—and make more money in the bargain! Guesswork is eliminated.

Starting with AM and FM processes and characteristics, the book

progresses to a complete understanding of basic circuits, how they operate, how to recognize them quickly and what is likely to go wrong with them. By making it easy for you to understand each circuit and its relation to other circuits, the book helps you go right to the seat of trouble in far less time. You'll know what different trouble symptoms mean—and you'll know how to repair troubles lots faster and more efficiently.

Sold separately for \$6.50. Try it for 10 days on our FREE examination offer.

Complete Training in MODERN, PROFESSIONAL SERVICE METHODS

This big book makes the tough service jobs easy, makes the easy ones a cinch!

Actually, Radio & Television Receiver TROUBLESHOOTING AND REPAIR is a complete guide to modern professional service methods.

First you get a full analysis of components, their functions, their troubles and their remedies. Next you learn modern troubleshooting methods—from "static" tests to dynamic signal tracing and injection techniques. You learn basic procedures and how to interpret performance data. Four big chapters show how to maintain Television, FM and AM receivers in less time. You'll learn how a glance at a TV set may quickly tell you what is wrong. Special hard-to-fix service problems are explained. Puzzling "intermittent" troubles and their remedies are clearly outlined. Step-by-step service procedure charts demonstrate many operations almost at

a glance. In short, from the simplest troubles to the most difficult ones, nothing has been omitted—nothing has been condensed. Everything is carefully explained—and the entire book is fully indexed so you can find exactly what you want in a jiffy.

Read it 10 days FREE! See for yourself how this great book can pave your way for higher pay. Sold separately for \$6.75. Save money by ordering special combination offer.

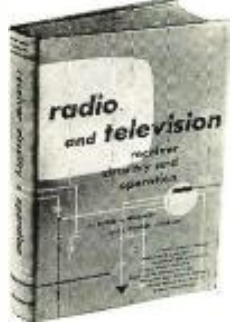

Radio and Television Receiver **CIRCUITRY AND OPERATION**
By Ghirardi and Johnson
669 pages, 417 helpful illustrations

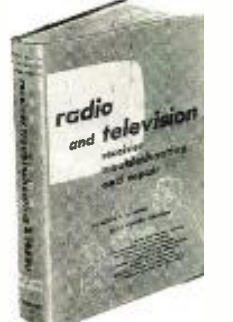

Radio and Television Receiver **TROUBLESHOOTING AND REPAIR**
By Ghirardi and Johnson
822 pages, 417 clear illustrations

SPECIAL money-saving OFFER!

Save \$1.25 by ordering both of the above big books. Make your service library complete!

Dept. RN-25, RINEHART & COMPANY, Inc.
232 Madison Ave., New York 16, N. Y.

Send books below for 10-day FREE EXAMINATION. In 10 days, I will either remit price as indicated (plus a few cents postage) or return books postpaid and owe you nothing.

Check here to order books singly:

Radio & TV Receiver **CIRCUITRY & OPERATION**
(Price \$6.50 separately)

Radio & TV Receiver **TROUBLESHOOTING & REPAIR**
(Price \$6.75 separately)

Check here for MONEY SAVING COMBINATION
Save \$1.25!

Both of the above big books at the special price of only \$12.00 for the two. (Regular price \$13.25—you save \$1.25.) Payable at the rate of \$3 after 10 days if you decide to keep books and \$3 a month thereafter until the total of \$12 has been paid.

Name
Address
City, Zone, State
OUTSIDE U. S. A.—\$7.25 for TROUBLESHOOTING & REPAIR book; \$7.00 for CIRCUITRY & OPERATION; \$13.00 for both books. Cash with order only. Money refunded if you return books in 10 days.

GREATEST TUBE BUY

EVERY TUBE GUARANTEED A FULL YEAR

Branded—Bulk Packed in Original Mfr's, Nested Cartons or Individually Boxed
JOBBER! DISTRIBUTOR! We have a Wonderful Deal For You. Write—Wire—Phone!

0A2	5.87	1U4	.46	6AT6	.36	6N7	.95	7E7	.64	12SF5	.48	35Z3	.40
0A3/VR75	.97	1U5	.40	6AU6	.40	6Q7	.49	7F8	.49	12SF7GT	.68	35Z5GT	.59
0A4G	.60	1X2	.55	6AV5GT	.79	6R7	.49	7G7	.80	12SQ7	.70	36	.35
0B2	.74	2A3	.90	6AV6	.36	6S4	.39	7K7	.80	12SH7	.70	37	.35
0B3/VR90	.69	2A3	.49	6AX4GT	.57	6S7G	.55	7L7	.77	12SL7	.58	39-44	.35
0C3/VR105-95	.95	2A6	.49	6B7	.93	6SA7	.40	7N7	.57	12SK7GT	.49	42	.40
0D3/VR150-85	.85	2A7	.60	6BB6	.29	6SC7	.75	7Q7	.57	12SL7GT	.49	43	.53
0Z4	.86	3B5	.62	6BA6	.38	6SD7GT	.38	7R7	.59	12SN7GT	.50	48-23	.40
1A4P	.35	2X2	.39	6BA7	.55	6SF5GT	.45	7S7	.83	12SQ7GT	.53	48	.45
1A5GT	.40	2X2A	1.14	6BC5	.49	6SF7	.58	7V7	.57	12SR7	.49	47	.85
1A7GT	.40	2A5	.44	6BE6	.37	6SQ7	.40	7W7	.85	12Z3	.39	49	.38
1AB5	.38	3A5	.90	6BF5	.69	6SH7	.60	7X6	.57	14A4	.65	50L6GT	.61
1B3GT	.67	3ABGT	.59	6BG6G	1.15	6SN7GT	.50	7Y4	.40	14A5	.57	50X6	.62
1C5GT	.40	3A5	.44	6BE6	.37	6SJ7	.54	7Z4	.65	14A7	.53	50Y6GT	.57
1C7G	.37	3D6	.38	6BH6	.45	6SK7	.49	12A6	.49	14F7	.59	56	.67
1D7GT	.75	3L4	.71	6BK7	.81	6SL7GT	.49	12A7	.98	14B8	.45	57	.53
1E7GT	.35	3Q4	.48	6BL7GT	.65	6SN7GT	.48	12A7GT	.85	14B8	.63	58	.56
1F4	.40	3Q5GT	.48	6BN6	.89	6SQ7	.40	12A7	.85	14C5	.80	70L7GT	1.00
1FSQ	.44	3S4	.46	6BQ6GT	.75	6SR7	.45	12A7B	.35	14C7	.65	71A	.52
1H4G	.40	3V4	.50	6BQ7	.88	6ST7	.48	12A7T	.62	14E6	.65	76	.42
1H5GT	.38	5T4	1.25	6C4	.35	6TB	.48	12A7V	.64	14F7	.59	77	.53
1L6G	.59	5U4G	.49	6C5	.39	6U7G	.45	12A7V	.59	14F7	.65	78	.43
1L4	.45	5V4G	.76	6C6	.54	6U8	.59	12A7V	.44	14FH	.90	81	1.10
1L6	.59	5Y2G	1.25	6C7	.35	6V6	.48	12A7V	.64	14H7	.59	83	.77
1L44	.59	5Z3	.33	6C8G	.42	6W4GT	.41	12AX4GT	.55	14N7	.67	83	.77
1L6A	.75	6A6	.45	6CD6G	1.05	6W6GT	.41	12AX7	.55	14Y4	.67	84	.52
1L64	.77	6A7	.80	6D6	.67	6X4	.45	12AX7	.72	15	.45	85	.57
1L5	.59	6A8	.65	6D8G	.95	6S5	.30	12B6	.47	13B6G	1.15	89Y	.59
1L6C	.75	6A8A	.42	6E5	.76	6X8	.70	12B7	.59	19T8	.75	117L7GT	1.17
1L5D5	.49	6AB7GT	.71	6F7	.45	7A4	.45	12B6G	.46	22	.40	117Z3	.38
1L8	.75	6AC5GT	.75	6F8	.90	7A5	.55	12B6G	.45	25AV5GT	.80	117Z4GT	.73
1L6H	.75	6AC7	.68	6F8G	.69	7A6	.65	12B7	.65	25B6GT	.75	117Z6GT	.70
1LH4	.75	6AF4	.89	6GGG	.63	7A7	.65	12C8	.34	25L6GT	.40	2051	.93
1LNS	.55	6AF6G	.75	6H6	.49	7AD7	.40	12C8GT	.64	25W4GT	.45	202	2.85
1NSGT	.61	6AG5	.47	6J5	.38	7AG7	.55	12N6	.45	25Z5	.60	807	1.45
1PSGT	.56	6AG7	.90	6J6	.50	7AH7	.55	12J5GT	.39	25Z6GT	.45	814	3.50
1Q5GT	.56	6AH6	.98	6K6	.49	7B4	.44	12J7GT	.57	26	.42	82A	5.95
1R4	.81	6AK5	.59	6J8G	.90	7B5	.55	12K7	.35	27	.37	866A	1.45
1R5	.47	6AL5	.35	6K6GT	.39	7B6	.55	12K8	.55	32L7GT	.95		
1S4	.55	6AQ5	.39	6K7G	.38	7C4	.55	12Q7G	.57	35C5	.37		
1S5	.40	6AQ6	.36	6K8G	.64	7C7	.65	12SQ7	.60	35L6GT	.45		
1SA6	.48	6AQ7GT	.68	6L6G	.98	7E5	.59	12SA7GT	.62	35W4	.53		
1T4	.46	6A55	.62	6L6GA	.99	7E6	.40	12SC7	.68	35Y4	.44		

Our Tubes are of Excellent Quality Because—

1. We've specialized in selling vacuum tubes exclusively for many years.
 2. All tubes offered herein are obtained from Receiver Manufacturers' surplus, various gov't agencies and other surplus sources. Most of these tubes are brand new and the balance is removed from gov't and other equipment. **WE UNCONDITIONALLY GUARANTEE EVERY TUBE YOU BUY.**
 3. Our modern, completely equipped laboratories check every tube received. You are invited to see this special equipment in operation.
- Even though our inventories include almost every tube type made over the past 20 years—in quantities of more than a million assorted types—it is impossible to list every type. You are, therefore, urged to include any additional types required in your order.
- Minimum Order: \$10.00. Terms: 25% with order, balance C.O.D. Please include postage. All prices subject to change without notice.

TRANSAMERICA ELECTRONICS CORP.

115A LIBERTY ST., NEW YORK 6, NEW YORK



Need a Tube Tester?
FOLLOW THE LEADER...

Buy **EICO**

TUBE TESTER #625
 KIT \$34.95 Wired \$49.95



More Servicemen buy EICO TUBE TESTERS—in KIT and wired form—than any others sold through distributors. Why? Because EICO gives you the MOST value at LOWEST cost.

- Test all conventional & TV tubes and pilot lights.
- 10 individual lever-type element switches.
- Illuminated anti-backlash rollchart kept up-to-date by EICO's Engineering Dept.
- 4 1/2" meter, 3-color "Good-Bad" scale.
- Line-adjust control. Blank socket for new tubes. Protective overload bulb.

In stock at your local jobber. Write for free Catalog RT 2. Prices 5% higher on West Coast.

ELECTRONIC INSTRUMENT CO., INC.
 84 Withers Street • Brooklyn 11, N. Y.

STAY ON THE AIR WHEN POWER FAILS...with an ONAN Electric Plant



AUTOMATIC START & STOP

Model 10HQ, 10KW A.C.

When storms, floods, or fires interrupt electricity and force you off the air, you lose listeners and income. Guard against loss, assure vital public service during emergencies by installing an Onan Electric Plant. Onan Standby Electric plants serve many network and private stations. Gasoline driven automatic models to 75,000 watts.



PORTABLE ELECTRIC PLANTS FOR MOBILE RADIO USES
 Supply A.C. power for broadcasting at scene of events. Light in weight. Can be carried by hand or in trunk of car. A.C. models: 400 to 3,500 watts.

Write for **FREE Folder**

D. W. ONAN & SONS INC.
 3381 University Avenue
 Minneapolis 14, Minnesota

justment, each coil has associated with it a small permanent magnet whose position can be varied.

A diagram of the individual static convergence magnets is shown in Fig. 5A. The heavy dots represent the individual electron beams as they pass through the gun on their way to the screen. The arrows at these beams indicate their direction of movement. Note that the red and green beams are confined to paths which make an angle of 60 degrees on either side of a vertical axis. The blue beam, on the other hand, can only move vertically, up or down.

Now it could readily happen that while the color dots of the green and red beams fall within the same trio, that of the blue beam does not. This means that while we can always cause the red and green beams (or color dots) to converge, it may not be possible to have the blue beam meet the other two. Still required is another adjustment, that of being able to move the blue beam from side to side (or laterally). To effect this, a special blue beam positioning magnet is also found on the neck of the tube. See Fig. 4. Now perfect convergence of the three beams at the center of the screen is always possible.

Note that no ion traps are used in this tube, principally because the color screen is aluminized. The layer of aluminum presents a barrier to any oncoming ions and prevents them from reaching and damaging the screen. Electrons, having only 1/1800th of the mass of an ion, encounter little difficulty in passing through this aluminum layer.

We would like to thank the *Motorola* Service Department for its cooperation in the preparation of this series. Particular thanks are due Mr. T. M. Alexander and Mr. Frank Uhrus.

-30-

PROBE SHIELDING

By HYMAN HERMAN

MOST shielded probes for oscilloscopes or v.t.v.m.'s do not provide shielding to cover the probe itself, usually of Bakelite or plastic. Hand capacity around such probes may cause changes in the readings.

The accompanying diagram shows how such shielding may be provided. The rubber insulation of the probe cable is removed for about one inch below the probe and a piece of copper braid, equal in length to the probe plus one inch, is slipped over the probe and the exposed braid of its cable. Now cover the braid completely with friction tape. Be careful that you do not allow the copper braid to touch the pin of the probe.

-30-

Copper braid, slipped over an ordinary probe, as shown, will shield the probe.

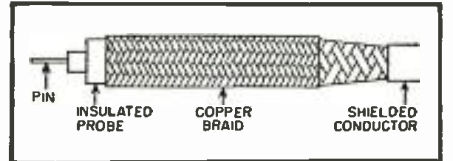

The Complete Line



Aptitude-Tested
ELECTRONIC
WIRES
and
CABLES

Belden makes a complete line of Aptitude-Tested electronic wires and cables. You can select the right wire for every application, because all performance values are shown. See your Belden Catalog.

Belden Manufacturing Company
Chicago, Illinois

Belden

**WIREMAKER
FOR INDUSTRY**

BIGGER AND BETTER THAN EVER!

B-A's NEW 1955

FREE CATALOG

**164
BIG PAGES**

LOADED WITH
SAVINGS AND
NEW ITEMS
IN RADIO,
TV AND
ELECTRONICS!

INCLUDES
23 PAGES OF
AMAZING
BARGAINS,
NOT FOUND
IN ANY OTHER
CATALOG

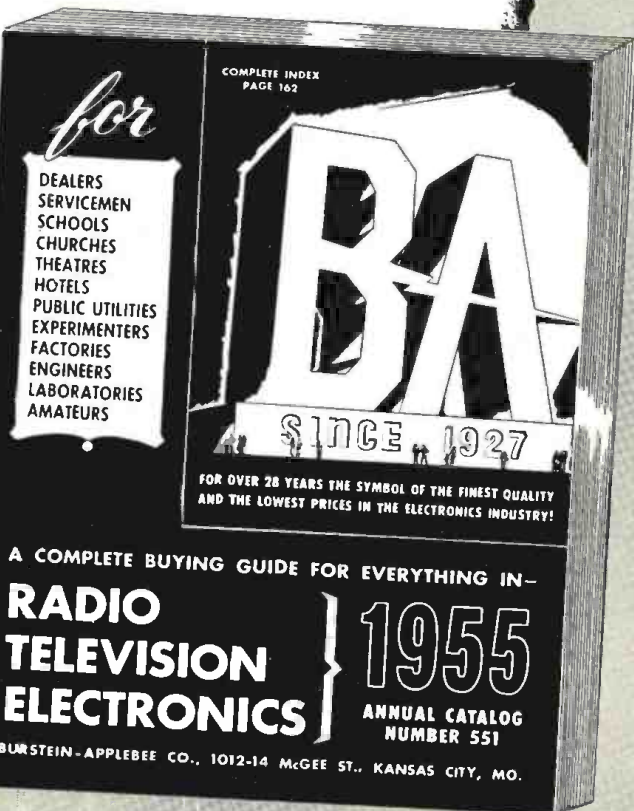

BURSTEIN-APPLEBEE CO. Dept. M,
1012-14 McGee St., Kansas City 6, Mo.

Send Free B-A Catalog No. 551.

NAME _____

ADDRESS _____

CITY _____

STATE _____

FREE
1955 CATALOG
SEND COUPON
FOR IT TODAY!

THE NEW PROBE-SCOPE



The smallest Oscilloscope on the market with a Cathode Ray Tube incorporated into a probe.

for quick trouble-shooting and wave-form analysis

Model
PO-1

\$77.95

F.O.B. N. Y. C.
Write for new
catalog.

PROBESCOPE CO.

44-05 30th Ave., Long Island City 3, N. Y.

Oscilloscope Photography

(Continued from page 71)

Next, the floodlights are turned on, and a normal exposure is made.

The type of photo that would be obtained, at this point, is shown in Fig. 2 (left). Note that the screen of the oscilloscope shows black rather than the usual white.

However, a second exposure is then made without changing the film in the camera. The room is darkened by turning "off" both the floodlights and normal room lights. The scope mask is removed so that the pattern is visible, and the second exposure is made with the camera iris opened fully to use maximum lens speed. Special care must be taken not to move the position of the camera relative to the test equipment set-up when making the second exposure.

The second exposure, alone, would be a simple waveform photograph, as shown in Fig. 2 (center). However, since a double exposure has been made, the sharp waveform pattern is superimposed on the darkened scope screen, and the final negative contains both a clear equipment photo and a sharp, contrasty waveform pattern.

If desired, special masks may be used when making the first exposure. For example, a small tab may be included to identify the waveform pattern and the date on which the photograph was taken. A typical example of this technique is given in Fig. 3.

Other masks may be made up to give calibration information or similar data. A polar coordinate or rectangular grid pattern may be superimposed on the oscilloscope waveform by drawing the desired pattern on the black mask. Opaque white drawing ink is used. Using the same technique, arrows may be included to indicate the direction of pattern movement.

The photograph given in Fig. 4 is an additional example of the results that may be obtained using this technique. Here, a single photo is used to show, simultaneously, the waveform pattern

Fig. 3. Details on the operating conditions and date of film are recorded on small tab.

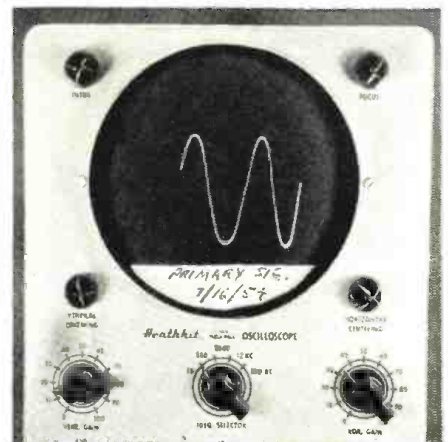

PRICES SLASHED ON BEST ELECTRONICS SURPLUS

SENSATIONAL VALUE!! 45 W. RADIOTELEPHONE FOR BOAT OR FIXED STATION

THE BIGGEST BARGAIN IN PLEASURE OR FISHING BOAT RADIOTELEPHONES! These units are moving fast, but luckily we obtained a good quantity of them, and can repeat our ad-offer in the Nov., '54, Radio Television News. This Radiotelephone Transmitter-Receiver (BC-669, part of SCR-543) is beautifully and ruggedly built. Designed for rough military service and engineered for maximum efficiency, it will provide trouble-free long-range communications from boat, vehicle, portable or fixed station installations. Both Transmitter and Receiver operate in the frequency range of 1680 to 4450 KC, and both are crystal-controlled on all six channels in this range. Manual tuning of the receiver is also provided. Power Output (Phone) is rated nominally at 45 watts.

Transmitter operation is performed with a minimum of controls, after installation adjustments have been made, consisting of: ON-OFF Power Switch, CHANNEL SELECTOR Switch to proper position, and ANTENNA TUNING Control, rotated for maximum indication in RF Meter. This latter control may be eliminated (knob removed) without detriment by following simple instructions furnished. Also furnished are instructions and drawing for circuit modification in anticipation of new KC regulations concerning harmonic suppression of transmitters operating in the 2 and 3 MC marine band. Operation of the 45-Watt Radiotelephone may be from 110 V. AC, 110 V. DC, 32 V. DC, 24 V. DC, or 12 V. DC. Complete constructional data and diagrams are furnished for building any of the above power supplies at minimum cost. For those who prefer to purchase ready manufactured power supplies, Telemarine will be glad to furnish quotes

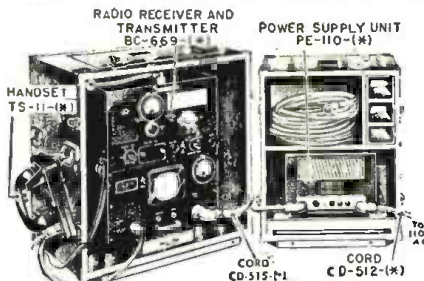

tions for any of the above voltage inputs. Each set is supplied with 12 crystals (6 for X-mit, 6 for receive) for operating on 1746, 2082, 2280, 2340, 3422.5 and 4255 KC. Receiving crystals differ by 385 KC (1F frequency). Most of these crystals can be reground to marine band frequencies. Receiver uses high-efficiency 10 Tube Superhet circuit with RF Stage for maximum selectivity, built-in loudspeaker. Static Filter (Noise Eliminator) Circuit with Switch, and RF Gain Control. Transmitter uses 8 Tubes (2-807's in Final) with 100% Plate Modulation, and Metering Switch with multi-range milliammeter for instant checking of any part of transmitting circuit.

LOOK AT THESE FEATURES!

- COMPLETE COVERAGE 2-3 MC MARINE BAND
- 6 CRYSTAL CHANNELS, X'MIT & R'CVR
- OPTIONAL MANUAL TUNING OF RECEIVER
- FULL 10-TUBE SUPERHET R'CVR WITH RF STAGE
- 8 TUBE X'MTTR, 100% PLATE MODULATION
- BUILT-IN SPEAKER, WITH ON-OFF SWITCH
- STATIC FILTER CIRCUIT & SWITCH CONTROL
- METER & METER SWITCH FOR CHECKING & ADJUSTING ALL TRANSMITTING CIRCUITS
- RUGGED DESIGN & CONSTRUCTION

LOOK AT THESE LOW PRICES!

45-WATT RADIOTELEPHONE (BC-669A, B, or C Models), complete with tubes, crystals (as specified), schematic diagram, Connecting Cord \$15.13 (to Power Supply), Modification and Power Supply Constructional Data. USED, GOOD CONDITION. Shpg. wt. 185 lbs. **\$69.50**
EACH
 Same as above, but LIKE-NEW CONDITION, w/Instruction Book. **\$89.50**
SAME AS ABOVE, NEW UNUSED CONDITION
 Export Packed. Shpg. Wt. 400 lbs. **\$139.50**
MODELS BC-669 D or E, Same as Above, but provides also CW (teletography) transmission and reception (incorp. BFO). NEW, EACH **\$169.50**
TS-11 HANDSET, with appropriate plug connector. EACH **\$14.50**
110 V. 60 C., AC POWER SUPPLY. EACH **\$89.50**

CONDENSER MICROPHONE With 2-Stage Pre-Amp.



Real, Precision quality construction, double Helmholtz Resonator type, with combination microphone and amplifier built-in cylindrical brass case 16 x 6 ins. Uses types 30 and 32 tubes in amplifier. Employs acoustical low-pass filter plugs (removable) for 5-25 cycle response; removing plugs (threaded) and venting cylinder case will result in high-quality, wide-range studio-type microphone. As is, excellent for vibration testing, percussion noises, shock sounds, oil exploration work. Original use—Sound (Artillery) Ranging Eqp't. Model T-21/6R-3-C. NEW UNITS. Shpg. wt. 25 lbs.

SLASHED TO **\$11.95 EACH**

50-60 W. SPEAKER UNIT

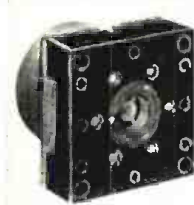

Western Electric Speaker units, for horn or baffleboard mtg. Shock and blast proof diaphragm, will handle up to 60 watts. Response to 7,000 cps, favoring high freq. Impedance 13 ohms. Dim.: 6" x 6" x 4 1/2" deep. Throat opening—1 3/4" dia. Alnico 5 slug wt. 6 lbs.

Shpg. wt. 20 lbs. SLASHED TO **\$11.95 EACH**

32 VDC-110V AC CONVERTER

Mfd. by Kato Engineering, for marine or farm installation. Rotary type, compact and ruggedly built for continuous duty. Rubber shock mounting on filter case, with complete input and output filtering. Output 110 volts, 60 cycles AC. 225 KVA, but will operate efficiently on loads up to 300 watts. New units. Shpg. wt. 60 lbs. **\$39.95**
PRICE, EACH

INFRA-RED IMAGE "SNOOPSCOPE" TUBE EXTRA-SPECIAL!!

We've sold thousands of them to labs, experimenters, industrial studios, etc. By using infra-red rays, this tube enables you to see in the dark. No scanning, no amplifiers, just a high-voltage power supply is all you need with this tube. Shows image in greenish-white on 1 1/2" screen. For night photography, stenciling, snapper or super scopes, underwater detectors, etc. British mfg. SOLD IN LOTS OF 6 ONLY. Literature and diagrams furnished with each sale. Shpg. wt. 2 lbs.

Slashed to 6 for **\$15.00**
FRONT-END LENS, for Infra-Red Tube. Ea. **\$10.00**
Plain, Mounted Type. Ea. **7.00**

EXPORTERS, GOVERNMENT AGENCIES, INDUSTRIALS!

We have a large stock of Transmitters, Receivers, Walkie-Talkies, VHF Equipment, Ship & Shore Communications, FM Broadcast Stations, Radar, Accessories, etc. Write and tell us of your requirements. Descriptive literature and prices available upon request.

SELECTIVE RINGER for MOBILE or SHIP-TO-SHORE RADIOTELEPHONES

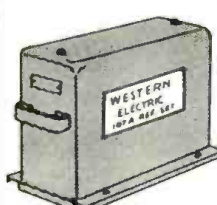

Permits Phone Operator to call your Radiotelephone exclusively, when operator has a call for you, by ringing a bell or lighting a light. Designed & Mfd. by Western Electric, MODEL 107A, modern, compact and efficient. Can be attached to any receiver, complete Instruction Book supplied. Dim.: 15 7/8" long, 3 1/2" high, 5 1/2" wide. Shpg. Wt. 25 lbs. NEW UNITS. Reg. value \$245.00 each.

OUR LOW PRICE— **\$85.00**
EACH

SUPER-SONIC SIGNAL RECEIVER AND DIRECTION-FINDER FOR MARINE OR AIRCRAFT

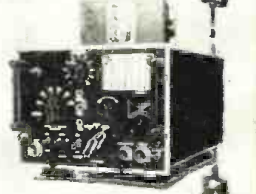

This is an outstanding Direction-Finder Receiver for boat or aircraft owners, at an unusually low price for such high-quality equipment. VERY POPULAR AS A SUPERSONIC RECEIVER. Tunes from 15 to 70 KC, and 100 KC to 1750 KC, all in 6 bands, covering maritime radio direction-finding, aeronautical navigation and full broadcast band frequencies. You can fix position on any station operating in those frequencies, as well as on broadcast stations, and use it for broadcast band reception. 8 tube superheterodyne, receives CW and tone signals. Loop supplied with either 34" or 55" extension shaft (specify), 24 v. DC Dynamotor w/filter, instruction manual (less cables) etc., Mfd. by RCA. All NEW eqpt. Shpg. wt. 225 lbs. **\$59.50**
SLASHED TO

SPECIAL BARGAIN! MODULATION PLATE & INPUT TRANSFORMERS, for 50-75 W. Ham Rig, designed for 2-tube in Push-Pull (AB1) to modulate single 814. Plate transf. Pri. Imped. 3,500 ohms. Sec. imped. 8,000 ohms. Input Transf. Pri. 3,500 ohms etc., Sec. #1—to grids of 616's, Sec. #2 used for side-tone pickup. Fully Shielded, **\$7.85**
 Compact. Shpg. wt. 8 lbs. **PAIR**

All Above Material Subject to Prior Sale. 25% Minimum Deposit with All C.O.D.'s. Min. Order —\$5.00. All Prices F.O.B. Our Address.

— **TELEMARINE** —
COMMUNICATIONS CO.
 3030 W. 21st Street, Brooklyn 24, N. Y.
 Cable Address: Telemarine N. Y.
 Phone: ES 2-4300

600 W. A.F. POWER AMPLIFIER

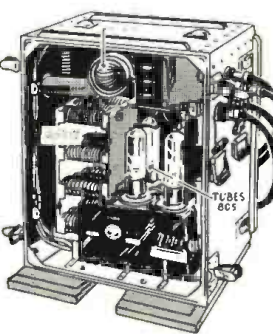

Designed by Bell Telephone Laboratories, ruggedly constructed 600 Watt Audio Power Amplifier. Ideal for use in airports, shipyards, or wherever rich intensity sound may be required. Excellent for conversion to Modulator Unit for modulating 1 KW transmitters. Comprises push-pull audio power stage utilizing 4 2-805 power triodes in push-pull parallel, with built-in motor blower for cooling. High voltage power supply uses selenium rectifiers, no tubes. Requires 40-60 watt pre-amplifier to drive to full capacity. Input impedance 250/500 ohms, output impedance 13/0.5 ohms (to speakers). Operates from 115 or 230 Volts, 3 phase 50/60 cycles AC. Dimensions of wooden chest 24 1/2" x 28 7/8" x 21 1/2". Supplied with tubes, connecting cables, schematic diagram, etc. Shipping weight 290 lbs. **\$169.50**
PRICE EACH, SLASHED TO

250 WATT BEACHMASTER AUDIO AMPLIFIER
 Pre-Amplifier for above, 60 W. Dim. 24 1/2" x 22 1/2" x 18 1/2". Shipping weight, complete with tubes 190 lbs. **\$119.50**
PRICE, EACH

250 WATT BEACHMASTER AUDIO AMPLIFIER

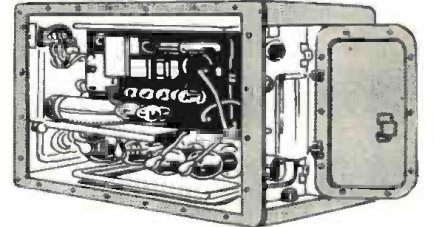

SUPER-POWER complete amplifier. Designed by Bell Tel. Labs. All self-contained in waterproof metal case, with blower system for ventilation, weatherproof receptacles, etc. Ideal for large auditoriums, airports, baseball parks, etc., or easy to convert to modulator for 500 Watt Transmitter. Operates from 110 V. 50/60 cycles AC. Uses total of 14 tubes, including 2-805 triodes in push-pull power stage and 1-6L5 maxie-eye tube to indicate gain. Like-new condition equipment. Dim. 26 1/2" x 16 1/4" x 19". Shipping weight, complete with tubes, 190 lbs. Supplied with connecting cables and schematic diagram. **\$169.50**
PRICE EACH, SLASHED TO

LOUDSPEAKER for above, consisting of 9 horns with masts mounted on metal square frame, with tripod for support. Dim: 23" x 22 1/4" x 11". Shipping weight 235 lbs. **\$180.00**
PRICE

DYNAMOTOR SPECIALS

DM-35, 12 v. DC input, 625V. at 225 ma., int. duty. Exc. cond. **EACH \$17.50**
 DY-10, 12.5/25 V. DC input, output 360 V. at 355 ma., int. duty, Exc. Cond. **EACH \$19.50**
 DM-28, for BC-318 Receivers. 28 V. DC in, 224 V. at 70 ma. out. Exc. Cond. **EACH \$9.95**
 DM-32/DY-2A, for ARR-2 Receivers. 28V. DC in, 250V. at 60 ma. out. Exc. Cond. **EACH \$4.95**

**BUY DIRECT...
SAVE MONEY!**

**Hi-Fi and
Binaural units...
wired or kits!**

New Imperial V-12-tube AM-FM Tuner Kit

- Band width — 200 kc • Tuned RF stage • Tuning Range 88-108 mc • Sensitivity 5-10 u/v, 20-30 db
- Iron core tuned I.F. disc. trans. • 6CB6 RF amplifier • 6AB4 mixer • 6AB4 oscillator • 6AU6 1st I.F. amplifier • 6AU6 2nd I.F. amplifier • 6AU6 1st limiter • 6AU6 2nd limiter • 6AL5 detector • 6C4 cathode follower output • AM tuning range 530-1650 kc • 6BA6 RF amplifier • 6BE6 converter • 6BA6 1st I.F. amplifier • 1N34 or 1N60 crystal diode detector • Tuned RF stage • Chassis dimensions: 9 3/4" long, 5" high, 8" W.

Complete kit of parts including tubes, pictorial and schematic diagrams. **\$37.50**

Frequency Response (FM) 20 — 20,000 CPS ± .5 DB

Frequency Response (AM) 20 — 7,500 CPS ± 3 DB

New V-9 FM Receiver Kit

- Self-contained AC Power Supply
- 3 section variable condenser • Tuning range 88-108 mc • Band width 200 kc • Sensitivity 10 microvolts 20 db • Tuned RF stage • Iron core tuned I.F.—disc. trans. • 6CB6 R.F. amplifier • 6AB4 mixer • 6AB4 oscillator (temp. compensated) • 6AU6 1st I.F. amplifier • 6AU6 2nd I.F. amplifier • 6AU6 1st limiter • 6AU6 2nd limiter • 6AL5 detector • 6C4 cathode follower output • #65 selenium rectifier • Dimensions 9 3/4" x 5" x 5 3/8"

Complete kit of parts including AC power supply, tubes, pictorial and schematic diagrams **\$29.50**

Frequency response 20-20,000 CPS ± .5 DB

Wired & Tested extra **\$5.00**

New V-5 AM Receiver Kit

- Self-contained AC power supply
- Tuning range 530-1650 kc • 6BA6 RF Amplifier • 6BE6 converter • 6BA6 1st I.F. amplifier • 6AL5 detector • 6C4 cathode follower output • #65 selenium rectifier • 3 section variable cond. • Tuned RF stage • Sensitivity 5 microvolts • Iron core tuned coils throughout • Dimensions 9 3/4" x 5" x 5 3/8"

Complete kit of parts, including AC power supply, tubes, pictorial and schematic diagrams **\$24.50**

Frequency Response 20-7,500 CPS ± 3 db

Wired & Tested extra **\$4.25**

FREE CATALOG OFFER!

Write today for free complete Approved catalog!
Dept. 4

ORDER DIRECT FROM

APPROVED
ELECTRONIC INSTRUMENT CORP.

928 BROADWAY NEW YORK 10, N. Y.

obtained, all test equipment used in the experimental set-up, actual lead connections, and all equipment control settings.

Camera Settings: Actual exposure time will vary with the film, lens, and f/stop employed. The photos of Figs. 2, 3, and 4 were made with a 2 1/4 x 3 3/4 Speed Graphic, using "Super XX" cut film. Two No. 2 photoflood bulbs in satin finished reflectors were placed about 4 feet to either side of the test equipment, approximately as shown in Fig. 1.

The first exposure, with floodlights on was 1/10 sec. at f/32. The second exposure, recording the waveform pattern, was 1/10 sec. at f/5.6.

Other Applications: Although developed primarily for obtaining oscilloscope pattern plus equipment photographs, the "double exposure" technique described may be used in other applications. It may be used, for example, to obtain "families" of characteristic curves without the need for step function generators, electronic switches, or any other similar specialized equipment.

The basic technique may be applied equally well to the photography of other cathode-ray tube displays, i.e., radar scopes, television screens, etc.



Fig. 4. Example of technique which provides complete details on equipment and pattern.

It should prove especially valuable in the preparation of instruction manuals on the use of any device employing a cathode-ray tube.

POTENTIOMETER SUBSTITUTION BOX

By RUFUS P. TURNER, K6AI

MOUNTED potentiometers are handy accessories. They can be used in circuit development in the laboratory, and as substitutions for volume controls, tone controls, rheostats, etc., in the service shop. The smooth, continuous variation of resistance provided by a potentiometer is preferred in some applications to the more accurate step variations of the decade box.

Many a technician has resolved to make up a set of mounted potentiometers, but failed to follow through. Too, single mounted units, unless they are expensive *Helipots*, are apt to find their way into permanent equipment.

A satisfactory solution is to mount a number of standard-range potentiometers on a single chassis with a selector switch, as shown in Fig. 1. The unit shown uses 11 potentiometers selected for their often-needed resistance values. The reader may make any other desired selection of resistance values and tapers. A 2-pole, 11-position, non-shorting rotary switch (S₁-S₂) connects the two outside binding posts successively to the resistance windings. All sliders are wired together and connected to the center binding post. Thus, either rheostat or potentiometer type of connections are available for each unit.

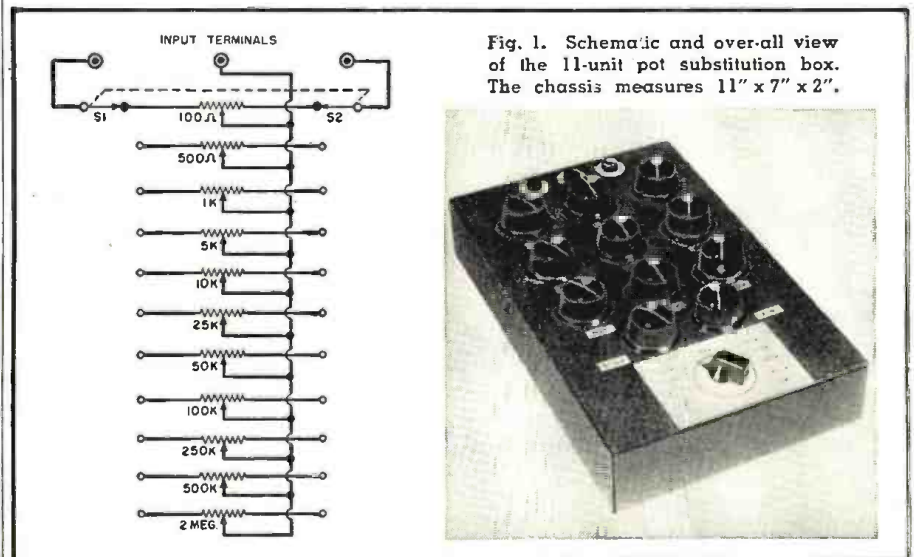
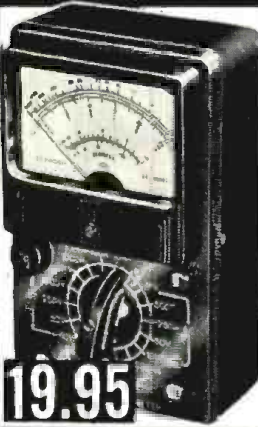

Fig. 1. Schematic and over-all view of the 11-unit pot substitution box. The chassis measures 11" x 7" x 2".

LAFAYETTE'S SPECTACULAR MULTITESTER VALUES



HIGH SENSITIVITY AC-DC MULTITESTER 20,000 ohms per Volt

The new Lafayette High Sensitivity Multitester is a complete instrument (not a kit). Here is an instrument packed with every desirable feature found only in instruments costing twice as much. One of the most sensitive multitesters ever offered. 20,000 ohms per volt DC; 8,000 ohms AC, having a high sensitivity 45 microamps meter. Full scale AC-DC voltage ranges are 1-10V, 0-30V, 0-250V, 0-500V, 0-100V; DC current ranges 50 microamps, 2.5 ma, 25 ma, 250 ma. Resistance: 0-5K ohms, 0-50K ohms, 0-500K, and 0-5 megohms. Decibel range: -20 +5 db; +5 +22 db (0 db -0.775V -600 ohms). Extreme versatility and accuracy. 1% precision resistors; 3" meter; beautiful plastic front, with metal bottom for ruggedness. Size: 3 3/4" x 5 3/4" x 2 5/8". Complete with batteries and leads. Shpg. Wt. 4 lbs.

19.95

MODEL RW-30G NET 19.95
In lots of 3 19.25

NEW POCKET AC-DC VOM MULTITESTER 1,000 ohms per Volt

This instrument is one of the best buys that Lafayette has ever offered in a Wide Range AC-DC MULTITESTER. An ideal portable unit that meets the need for a compact, yet rugged test instrument. Has ease of operation usually found ONLY IN MORE EXPENSIVE INSTRUMENTS. Has 1000 ohms/volt sensitivity on both AC or DC. Uses full 3" rectangular meter with large easy to read scale. Uses 1% precision resistors, jeweled D'Arsonval microamp meter movement. Ranges: AC-DC and output volts 0-5, 0-25, 0-250, 0-1000V; DC current 0-1, 0-10, 0-100 MA; Resistance 0-10K and 0-100K ohms. In handsome sturdy bakelite case. Size: 4 3/4" x 3 3/4" x 1 3/8". Supplied Complete with test leads and batteries. A Must for every serviceman, shop, Laboratory or experimenter—and at Lafayette's Price you can afford to own one. Shpg. Wt. 2 1/2 lbs.



9.95

MODEL RW-27C-Complete In Lots of 3 9.45
Single, ea. 9.95

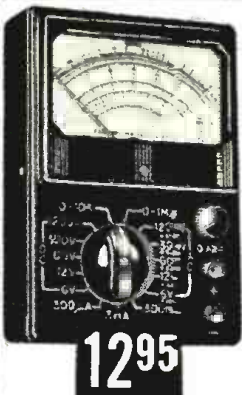

SENSITIVE AND ACCURATE AC-DC MULTITESTER 2000 OHMS PER VOLT ON BOTH DC AND AC

An unusual buy in a very accurate and sensitive VOM. Features single selector switch for all ranges. Has 3", sensitive 140 microamp meter, 2000 ohms per volt on both AC and DC, 21 full scale ranges, consisting of AC-DC Voltage Ranges: 0-6; 0-12; 0-60; 0-300; 0-1200 Volts; DC Current Ranges: 0-300 ua; 0-3 MA; 0-300 MA; Resistance Ranges: 0-2K ohms; 0-2 Megohms; Decibels: 0 db +6 db; +20 db; +34 db; +46 db (0 db -0.774V);

12.95

Extreme versatility and accuracy. 1% precision resistors; beautiful plastic front with metal bottom for ruggedness and shielding. Size 3 3/4" x 5 3/4" x 1 1/2". Shpg. Wt. 3 lbs.

MODEL RW-350 Complete
In lots of 3 12.45
Singly, ea. 12.95

NEW! SLOPING PANEL MULTITESTER

2,000 Ohm per Volt Sensitivity on both DC and AC

- High Sensitivity 3 1/4" 160 Microamp Meter Insures Accuracy
- 25 Full Scale Ranges
- Sloping Panel for Easy Reading
- 4 Resistance Ranges on Two Separate Scales
- 5 Output Ranges to Measure AC with DC present
- Convenient Pocket SIZE 3 3/4" x 5 3/4" x 2-2/8"

This unusual Multitester is a complete instrument (not a kit) with high quality and sensitive 160 microamp meter. Features extreme versatility, accuracy and ruggedness. In an attractive bakelite front panel, with metal bottom for ruggedness and shielding. Single switch selects all ranges; 1% precision resistors used throughout. An outstanding instrument, for the professional, serviceman or Laboratory. FULL SCALE RANGES: DC Volts: 0-10; 0-50; 0-250; 0-500; 0-1000 AC Volts: 0-10; 0-30; 0-250; 0-500; 0-1000 Output Volts: 0-1; 0-10; 0-250; 0-500; 0-1000 DC Current: 0-500 microamps; 0-2.5 MA; 0-25 MA; 0-250 MA; Resistance: 0-1K; 0-10K; 0-100K; 0-1 Meg; Decibels: +22 and +50 db (0 db -0.755V -600 ohm). COMPLETE with test leads and BATTERIES shpg. wt. 4 lbs.

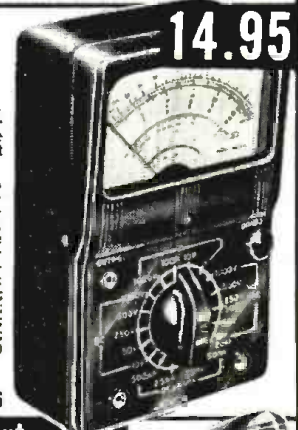

14.95

MODEL RW-29Y NET 14.95 In lots of 3, ea. 14.25

Collaro

THE WORLD'S FINEST 3 SPEED AUTOMATIC RECORD CHANGER

SPECIAL 29.50 LIST PRICE 54.50

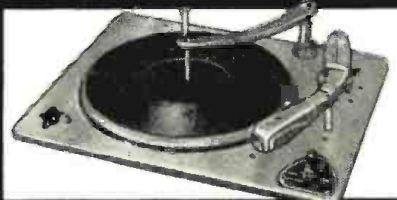

Lafayette scores again with an almost unbelievable price on the Collaro 3-speed Automatic record changer. We made a spectacular buy and we are passing the savings on to you. Here's the finest changer made. Manufactured in England—with a world-wide reputation. It plays all sizes and all speeds automatically. It's packed with quality features that the Hi-Fidelity enthusiast will appreciate: Jam-proof ball bearing mounted tone arm; automatic shut-off after last record; powerful fan cooled hum-shielded 1-pole motor with self-aligning oilite bearings; automatic muting switch; weighted ball-bearing mounted constant speed turntable; rubber drive couplings—and more! Base size 14 1/4" x 12 1/4". Depth below base 2 1/4". Shpg. Wt. 19 lbs. Available either less cartridge with plug-in shell or with famous turnover Ceramic or G.E. Triple-Play cartridge.

COLLARO Model 3/531 changer Net 29.50
COLLARO Model 3/531 with Turnover Ceramic cartridge Net 33.50
COLLARO Model 3/531 with G.E. Triple Play RPX-050 cartridge installed Net 34.50

45 RPM SPINDLE
Slips on in place of regular spindle, eliminating use of center inserts on 45 RPM records.
GSA Spindle Net 3.23

High Output Dynamic Microphone Worth Many Times Its Price

At Last! A Hi-Fi Dynamic Mike for tape recorders, etc.—at a price you'd expect to pay for a good crystal mike! Lafayette went abroad to obtain a high quality Dynamic MICROPHONE at a price that is 70% less than any comparable dynamic microphone on the market today. Exceptionally fine for public address, recording and other general purpose use. Substantially flat response, 60-10,000 cps, assures faithful reproduction of speech and music. Impedance 40,000 ohms ±15% at 1000 cps. Output Level -55 db. Die cast metal case finished in light gray and fine chromium. Compact and light weight. Net Wt. 1 lb. Head at fixed tilt of 15°, equipped with 6 ft. well shielded low-loss special vinyl-jacketed cord. Standard 3/8" x 27 thread. Dimensions 1-23/32" high, 2 1/2" wide, 3 3/8" deep. Shpg. Wt. 3 lbs.



14.95

PA-19...Singly, ea. 14.95...In lots of 3, 14.45

RCA 807 TUBES

QUANTITY LIMITED BRAND NEW JAN. SPECS. STOCK NO. SP-70 1.29



CROSLY UHF FRONT END

• Mallory 3 Gang Inductor
• 6AF4 — 6BZ7 and 1N72
• Parts Alone Worth Twice the Price

UHF front end covers all channels 14 through 82, using the famous Mallory continuous tuning inductor. Original replacement for Crosley part 154698-1-1 used in Crosley series EU chassis 393 and 394. Ideal for building UHF converters, etc. Output feeds into channel 5 I.F. Concentric shaft includes fine tuning. Built-in antenna switch operates off tuning shaft. Comes complete with 1N72 diode, 6BZ7 and shock mounted 6AF4 tubes. Size: 8 x 5 x 3 1/2". Shpg. Wt. 5 lbs. Quantity limited. TL-25 Lots of 3, ea. 4.45
Singly, ea. 4.95



CARDWELL UHF CONVERTER SALE!

List 42.50
Net 13.95 ea. Lots of 3
Singly 14.45 ea.



Outstanding Value! The Cardwell ES-1 UHF converter covers the entire UHF spectrum—channels 14-83. Has 6AF4 oscillator, 6CB6 IF amplifier and 1N72 crystal diode. Features printed circuit oscillator, high overall gain (3 to 4 times), high sensitivity, constant L/C ratio tuner, 25-1 gear drive Has AC cord and plug. 3-pos. switch for UHF, VHF and OFF. Handsome wood cabinet 8 1/2 x 8 1/2 x 3 1/2" with easy reading dial. Shpg. Wt. 4 1/2 lbs. Lots of 3 each 13.95
CARDWELL ES-1 Converter—Singly each 14.45

RADIART TV BOOSTER QUANTITY LIMITED

List 29.95
6.45 ea. in lots of 3
Singly, ea. 6.95

A special purchase enables Lafayette to offer Radiart Model TVB-1 at a fraction of their original cost. High signal-to-noise ratio greatly minimizes ghosts, snow and interference. Wide Band Amplification insures sharp pictures, free from smear. Attractive styled polished Mahogany cabinet. For 110 Volts, 60 cycles. Shpg. Wt. 4 lbs.



BINOCULARS. NEVER BEFORE AT THIS PRICE

IMPORTED DIRECT
Prism-Coated Lenses
• All-Metal Construction
• Individual Focus
• Leather Case & Straps

F-105, 8 x 30 with case NET 19.95
F-15, 7 x 35 with case NET 22.50
F-103, 7 x 50 with case NET 24.95
F-104, 12 x 50 with case NET 32.50

with order, Add 10% Fed. Tax



TIMER-SWITCH SALE
Automatically turns on radios, television sets, toasters, coffee makers, etc.—at any pre-set time within 12 hours period; also tells time. Built-in single-pole switch handles up to 15 amps, 115 volt. Requires 3/4" diameter round hole. Depth behind dial face 2 1/4". Shpg. Wt. 1 1/2 lbs. MS-62, for 110V/60 Cy AC 3.95

Lafayette Radio
DEPT. RB
NEW YORK, N.Y. 100 Sixth Ave.
BRONX, N.Y. 542 E. Fordham Rd.
NEWARK, N.J. 24 Central Ave.
PLAINFIELD, N.J. 139 West 2nd St.
BOSTON, MASS. 110 Federal St.
Include postage with order.
Write for FREE Bargain Packed Catalog!

McGEE OFFERS \$100,000 STOCK OF CUSTOM RADIO CHASSIS

NEVER BEFORE AT SUCH LOW PRICES! EVEN SAVE ON COAXIAL SPEAKERS AND RECORD CHANGERS

9-TUBE HI-FIDELITY

12 Watts Audio **\$39.95**
Dual Tone Controls LESS SPEAKER

RECEIVES BROADCAST 550 TO 1650 K.G.

Jackson Model AM9A, 12 watt high fidelity audio amplifier and broadcast tuner combined, at less than you would normally pay for the amplifier alone. Push-pull 6V6 output. Frequency response from 30 to 15,000 cps. Inputs for crystal or G.E. variable reluctance pickup and crystal or dynamic microphone. Separate bass boost and treble tone controls. Radio-phonograph switch on front of chassis. Shielded output 9 1/2" illuminated slide rule dial with etched glass scale. 3 gang condenser with tuned R.F. stage and loop antenna. Receives broadcast 550 to 1650 kc. Size 13" long, 6" high and 9 1/2" deep. Complete with tubes: 2-6BA6, 6AU6, 6BE6, 6SN7, 6AT6, 2-6V6 and 5Y3. Knobs, escutcheon, diagram and instructions included. Model AM9A, Hi-Fi amplifier and tuner. Ship. wt. 9 lbs. Sale price, \$39.95. Model AM9A with our CU-14Y 12" coaxial PM speaker, both for \$49.95. Model AM9A with our P15-CR 15" coaxial PM speaker, both for \$59.95.

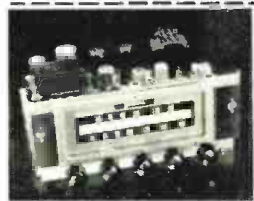

JACKSON AM9A

transformer matches 3.2 or 8 ohm speaker. Heavy duty 150 mil power transformer. 9 1/2" illuminated slide rule dial with etched glass scale. 3 gang condenser with tuned R.F. stage and loop antenna. Receives broadcast 550 to 1650 kc. Size 13" long, 6" high and 9 1/2" deep. Complete with tubes: 2-6BA6, 6AU6, 6BE6, 6SN7, 6AT6, 2-6V6 and 5Y3. Knobs, escutcheon, diagram and instructions included. Model AM9A, Hi-Fi amplifier and tuner. Ship. wt. 9 lbs. Sale price, \$39.95. Model AM9A with our CU-14Y 12" coaxial PM speaker, both for \$49.95. Model AM9A with our P15-CR 15" coaxial PM speaker, both for \$59.95.

11-TUBE FM-AM HALLICRAFTERS

Regular \$89.50
McGEE'S SALE PRICE **\$69.95**
★ HIGH FIDELITY LESS SPEAKER
★ AUTOMATIC FREQUENCY CONTROL

Hallcrafters Model 5-78A, 11 tube FM-AM superhet custom chassis. Size 7 3/8" x 12 1/2" x 11" deep. Complete with tubes, knobs, escutcheon, diagram and instructions. Receives broadcast 540 to 1700 kc, plus FM 88 to 108 mc. AFC holds FM stations in perfect tune. Output transformer matches 3.2 ohm or 500 ohmular, hi fidelity speaker. 50 to 14,000 cps. Bass boost tone control. A full 11 tube transformer powered chassis. Has input for crystal phono pickup. Self-powered preamplifier necessary for G.E. variable reluctance cartridge, \$3.95 extra.

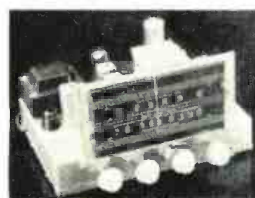

HALLICRAFTERS 5-78A

with push-pull 6K6 audio. This chassis found in S400 to S600 radio combinations. Has input for crystal phono pickup. Self-powered preamplifier necessary for G.E. variable reluctance cartridge, \$3.95 extra. 5-78A Hallcrafters 11 tube FM-AM chassis. Ship. wt. 22 lbs. Sale price, \$69.95. 5-78A Hallcrafters with our CU-14Y 12" coaxial PM speaker, both for \$79.95. 5-78A Hallcrafters with our P15-CR 15" coaxial PM speaker, both for \$89.95.

GARRARD-COLLARO-WEBCOR

3-SPEED RECORD CHANGERS
\$65.00 LIST COLLARO 3/532 \$38.95

Here are top values in modern up-to-date 3 speed automatic record changers. New Webcor model 114-43, 3 speed automatic changer with RPX-050 G.E. cartridge. Size, 13 1/2" x 12". Ship. wt. 12 lbs. Sale price only \$29.95.

Regular \$65.00 list Collaro model 3/532, 3 speed automatic record changer made in England. Intermixes 10 and 12" records of same speed. Constant speed 4 pole motor and weighted turntable with molded rubber pulley. Compensating spring to shift weight of tone arm for LP and std. records. Plug-in head will hold any popular cartridge. 14 3/4" long, 12 3/4" wide and 4 3/4" above motor board, 2 7/8" below. Available in green, grey, cream and gold hamptone. Ship. wt. 20 lbs. Regular net, \$48.75. Special sale price, \$38.95 less cartridge. Large 45 RPM spindle, \$2.50 extra. 3/532 Collaro changer with G.E. Golden Treasure RPX-052 cartridge, \$58.95. RC-80 Garrard-Collaro, 3 speed automatic changer, 13 1/2" wide, 15 1/2" deep and 8" high, 2 1/2" below motor board. Net price, less cartridge, \$48.51. 45 RPM spindle \$3.43 extra. RC-80 with G.E. RPX-052 Golden Treasure cartridge, Net \$68.51. RC-80 with crystal flip-over cartridge, only \$52.46. RC-90 Garrard-Collaro, 3 speed automatic changer, 13 1/2" x 15 1/2" x 5 3/4" above motor board and 3 7/8" below. Net price, less cartridge, \$68.11. With crystal flip-over cartridge, \$72.06. With G.E. RPX052 Golden Treasure, \$88.11. 45 RPM spindle, \$3.43 extra.

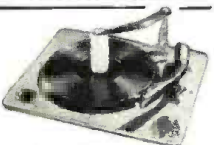

24" - 21"

Mahogany
TV Cabinet

SALE PRICE
\$39.95

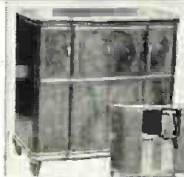

WALNUT
RADIO
PHONO
CABINET

SALE PRICE
\$59.95

Large mahogany open face cabinet for 27" or 24" television chassis. 44" high, 30 3/4" wide and 24 1/2" deep. Will hold a TV chassis 29" high, 29" wide and 23 1/2" deep. Offered at a fraction of the manufacturer's cost. Limited quantity available. Has room for 8" or 10" speaker. This cabinet and other TV cabinets listed might also be converted to a high fidelity speaker baffle. Stock No. KL-27X. Ship. wt. 90 lbs. Sale price \$39.95. Blank front panel available at \$5.00 extra.

WALNUT RADIO-PHONO-CABINET. Made for \$800.00 **\$59.95**

Class Capehart. Cost Over \$200.00 to Build. No. K-275 (right illustration). Walnut radio-phon cabinet 42" h, 42" w, 22" deep. Made for Capehart selling for \$800. Radio chassis area 14" h, 11 1/2" w. Changer compartment 14" x 26" w, 12" baffle completely enclosed. Cabinet weighs approx. 175 lbs. Ship. wt. 275 lbs. Sale price \$59.95.

21" Mahogany Television-Phono Cabinet



RT-21MA \$49.95

RT-21MA. Mahogany Television-Phono combination cabinet with half doors, for 20" and 21" TV chassis and record changer. Beautiful full door style with matching front panels and piano finish. 37" high, 40 1/2" wide and 22 3/4" deep. Baffle cut for 12" speaker. TV compartment 21 1/2" high, 21 1/4" wide and 19" deep will hold most 20" and 21" chassis. Changer shelf 15" x 16" with 9" height clearance. Ship. wt. 75 lbs. Sale price, only \$49.95. 21" gold trim plastic safety shield and mask to fit cabinet, \$6.95 extra. No. A13-9, ball bearing changer drawer slides, \$1.39 pr., extra.

DRT-21M \$59.95

DRT-21M. Deluxe fine grain mahogany Television-Phono combination cabinet for 20" and 21" TV chassis and record changer. Beautiful full door style with matching front panels and piano finish. 37" high, 40 1/2" wide and 22 3/4" deep. Baffle cut for 12" speaker. TV compartment 21 1/2" high, 23 1/2" wide and 19" deep. Will hold most 20" and 21" TV chassis. Changer shelf 15" x 17" with 9" height clearance. Ship. wt. 10 lbs. Stock No. DRT-21M, full door style with matching front panels and piano finish, available at \$6.95 extra. (Requires fitting to cabinet) No. A13-9, ball bearing changer drawer slides, \$1.39 pr.

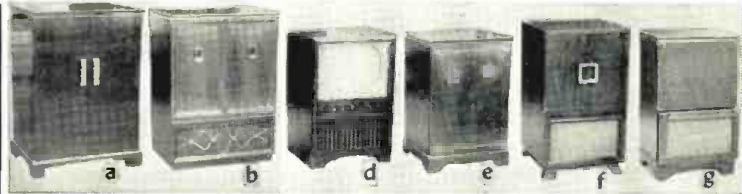

TELEVISION CONSOLE CABINETS AT LESS THAN FACTORY COST!

- FOR YOUR TV CHASSIS—MODELS FOR 27 INCH TO 16 INCH CHASSIS
- 27" Mahogany Full Door Cab. . . \$59.95
(a) No. 27-MA. Mahogany with full doors for 21", 24" and 27" TV sets. 43" h, 30 3/4" w, 22 3/4" deep. Chassis area 27 3/4" x 18 1/2" deep. Baffle for 10" speaker. A beautiful cabinet that cost the factory over \$100. Made for a \$600 TV set. Ship. wt. 90 lbs. Sale price \$59.95. Blank panel \$5.00 extra.
 - 27" 3/4 Door Mahogany Cab. . . \$59.95
(b) No. 27-3/4MA. Mahogany with 3/4 doors for 21", 24" and 27" sets. 43" h, 31 1/4" w, 22 3/4" deep. Chassis area 27 3/4" x 18 1/2" deep. Baffle cut for 2 10" speakers. Made for one of America's largest TV builders. Cost over \$100. Ship. wt. 90 lbs. Sale price \$59.95. Blank panel \$5.00 extra.
 - 21" Mahogany Cab. . . \$24.95
(d) No. 21-OFM, 21" Mahogany Open front. (e) No. 21-OFM, 21" Mahogany Open front. (f) No. 21-OFM, 21" Mahogany Open front. (g) No. 21-OFM, 21" Mahogany Open front. 24" w, 21 1/2" h, 18 3/4" deep. Baffle for 10" speaker. Small overall, but plenty big enough for 21" set. Made for a \$295 TV set. Ship. wt. 65 lbs. Sale Price \$24.95.
 - 17" Mahogany Full Door Cab. . . \$29.95
(e) No. AH-430. Mahogany with full doors. 36" h, 24" w, 21 3/4" deep. Chassis area 22" w, 17 1/2" h, 18 3/4" deep. Blank panel. Holds 17" TV easily. Baffle for 10" speaker. Ship. wt. 80 lbs. On sale at less than it cost a famous TV factory. Sale price \$29.95.
 - 17" Walnut 1/2 Door Cabinet. . . \$24.95
(f) No. AH-85A. Walnut with half doors. 36" h, 20 3/4" w, 21 1/4" deep. Chassis area 19" w, 18 3/4" h, 18 3/4" deep. Blank panel. Will hold most 17" sets. Baffle cut for 10" speaker. Ship. wt. 65 lbs. An attractive well proportioned cabinet on sale at only \$24.95.
 - 17" TV Cab. with Phono Drawer. . . \$19.95
(g) No. SE-21. TV-Phono comb. 40" h, 24" w, 18 1/2" deep. Blank panel. TV chassis area 19" h, 20 3/4" w. Changer drawer 19 1/2" x 13" deep. Baffle for 10" speaker. Mahogany finish. Ship. wt. 75 lbs. Sale price \$19.95.

McGEE RADIO COMPANY

OUR NEW ADDRESS IS
F.O.B. KANSAS CITY
SEND 25% OR FULL
REMITTANCE WITH ORDER.
BAL. SENT C.O.D.
1901 McGEE St., KANSAS CITY, MISSOURI

McGEE'S OUTSTANDING VALUES FOR FEBRUARY

MINIATURE BROADCASTING STATION FOR THE HOME

NEW 1955 MODEL WITH CRYSTAL MIKE \$9.95

Sensational new model MCL-E3 miniature broadcasting station for microphone and phonograph. Can be received on any broadcast radio in the home. No wires to connect, tunes in just like a radio station. Has input jacks for crystal mike or record player. Complete with 12K8 and 70L7 tubes and instructions. Operates on 110 volts AC. Simple to operate; one control fades from microphone to record. Frequency can be adjusted so as not to interfere with local radio stations. Miniature broadcasting station, complete with crystal hand mike and instructions. Ship. wt. 4 lbs. Net price \$9.95.

6" SESSIONS CLOCK-TIMER

With Plastic Cabinet \$3.95

6" Sessions Clock-Timer in plastic case 7" x 9 5/8" tall, 3" deep. Was intended for a kitchen clock radio. Lower portion of case was used for a small radio chassis. Lower portion has a usable space of 6 3/4" x 4" high and 2 3/8" deep with 3" diameter hole in front. Many ways this attractive clock and cabinet could be used, such as mounting on wall, on table, or on a kitchen counter. Clock has sweep second hand and 15 amp. 125 volt switch to turn on appliances at any pre-set time. Case available in Ivory, Green or Yellow. Stock No. MCT-63, Sessions Clock-Timer with case of your color choice. Sale price only \$3.95.

RC-600 REGENCY UHF CONVERTER \$16.95

UHF converter SCOPPI! Brand new RC-600, Regency UHF converters. Special sale price only \$16.95. Regular dealers net was \$37.46. All channel UHF, 14 thru 83. Only 100 to sell. Model RC-600. Ship. wt. 6 lbs. Special sale price only \$16.95.

50-WATT BOOSTER AMPLIFIER

50-WATT BOOSTER AMP. \$39.95

2-Mike Pre-Amp \$12.95 Extra. Not a Kit, but a Manufactured Amp. A sensational value. A 50 watt booster amplifier with push-pull, parallel 6L6 output tubes. Connect to your present amplifier as a booster or use with the PR-2X pre-amplifier to allow the use of 2 microphones and one low level input. The amplifier has one input jack with 1 volt input giving 50 watts of audio. Amplifier has a 6 lb. peaked case high fidelity output transformer with taps at 4-8-16-60 and 250 ohms. 225 mil power transformer and 5U4G rectifier. Includes tubes: 4-6L6, 7N7 and 5U4G. Two variable tone controls for master volume and bass boost control. Chassis size, 8" x 6 3/4" x 1 1/2". Model No. PA-55N. Ship. wt. 26 lbs. Sales price, \$39.95. PR-2X, 2 mike input pre-amplifier plugs is directly to the PA55N 50 watt booster amplifier. Allows use of 2 microphones, either crystal or dynamic and one low level input. Furnished with 4 ft. connecting cable and plug for remote control of the 50 watt booster. Chassis size, 5 3/4" x 3 1/2" x 2 1/2". Model PR-2X. Sale price, \$12.95.

FAMOUS STANDARD COIL CASCODE TUNERS

TV-2000 series Standard Coil cascode tuners complete with 6J6 and 6BK7 or 6BQ7 tubes. Thousands of TV sets use this famous type. Tunes 12 channels (2 thru 13). For 21 mc I.F. circuit. This tuner will give 2 to 1 better reception than the old pentode type. Many servicemen replace all older tuners with this cascode model. Available with either 2 7/8" or 4 1/2" shaft length. A tremendous purchase makes our low \$12.95 price possible. Specify shaft length desired. Stock No. TV-2000-3. Sale price \$12.95 each, 2 for \$25.00. No. 3103-5, 41 mc Standard Coil cascode 12 channel tuner with 41 mc I.F. for intercarrier sound circuits. With 6BK7 and 6J6 tubes. \$12.95 ea., 2 for \$25.00. No. TV-4001-7, 41 mc Standard Coil cascode 12 channel tuner with 13th position for use with separate UHF tuner. 6 3/4" shaft. With tubes 6BQ7 and 6J6. Used in Sentinel, MW, Arvin, etc. Sale price, \$12.95.

STANDARD COIL PENTODE TV TUNERS \$9.95

SC-947 Standard Coil Pentode 12 channel tuner, as used by Emerson 650D, 655, etc. Fine tuning shaft insulated from ground. Filaments shunted with resistor for .6 amp drain. 2 1/2" shaft. With tubes 6BC5 and 6J6. Sale price, \$9.95. SC-948 Standard Coil Pentode 12 channel tuner with 6BC5 or 6AG5 and 6J6 tubes. Millions of TV sets now in use have this tuner, 1 3/4", 2 7/8", 3", 4" or 5" shaft lengths. You can replace that old tuner cheaper than it can be repaired. Sale price, \$9.95. Matching knobs for Standard Coil tuners. Set No. SCR-2 for fine tuning and channel selector. Set VCK-2, matching volume and contrast knobs. Either set only \$9c a pair.

TWO-TUBE SARKES-TARZIAN TV TUNER \$8.95

New 2 tube Sarkes-Tarzan No. TT-3A, 12 channel TV tuner. 21-25 mc. Popular in many makes. Also ideal for general replacement use. Has 6J6 and 6BC5 tubes. Used in CBS, Arvin, Crosley F17TOLBU, TOLH, TOLU, F21CDLBM, etc. Also, ideal for general replacement use. A good replacement for one tube tuners. 3 3/8" shaft. No. TT-3A, Sale price, \$8.95. Takes SCK-2 knob set described above.

3 TUBE SARKES-TARZIAN, RCA, GEN'L. INST.

TV-53735, 3 tube Sarkes-Tarzan, 12 channel tuner, with 2-6AG5 and 6C4 tubes. 3" shaft. Used in the King 700 series. Sale price, \$7.95. Type 3, 3 tube Sarkes-Tarzan 12 channel tuner with 6C4, 6BH6 and 6AG5 tubes. Use with separate sound or intercarrier. Has converter coil, 2 7/8" shaft. Sale price, \$7.95. Famous RCA 201E1, 13 channel tuner with 3-6J6 tubes. Brand new as used in RCA 630 chassis. Stock No. RCA-13P. Sale price, \$7.95. RCA 4P-12, 12 channel printed circuit tuner used in Hallicrafters. With 6J6 and 6CB6 tubes. 5 1/2" shaft. Sale price, \$9.95. G1-44 General Inst. 12 channel tuner with 6BC5, 6AG5 and 6J6 tubes. 5" shaft. 21 mc I.F. Sale price only \$4.95.

TUNERS FOR EXPERIMENTERS, BUILDERS \$2.95

Bargain priced tuners, less tubes for the builders and experimenters. Ideal for building a field strength meter, etc. Type 4 Sarkes-Tarzan, has screw driver slot fine tuning instead of concentric shaft, \$2.95 less tubes. RCA-13X, 3 tubes RCA 201E1, has been removed from sets and may require some repair. \$2.95 less tubes. G1-13X, 3 tube Gen'l. Inst. 12 channel tuner. Removed from sets, will need repair. \$2.95 less tubes.

10" PM SPEAKER AND LEATHERETTE BAFFLE

Now, buy a full 10" PM speaker with Alnico V magnet with our top quality 10" leatherette wall baffle, both for only \$5.49. Baffle is finest lock joint construction with rounded corners, quality covering and plastic grill cloth. Stock No. 10RN, 10" speaker and baffle, \$5.49 each, 2 for \$10.00. 12" PM speaker with same quality 12" wall baffle, only \$7.49 each, 2 for \$15.00.

78 RPM-AMPLIFIED RECORD PLAYER \$8.95

78 RPM amplified player kit. Leatherette cabinet, 6 x 9" speaker. Buy this kit for less than the parts cost. This is a 78 RPM record player. Completely wired 3 tube amplifier with 12BF6, 35W4 covered cabinet 9 1/2" x 12" x 18 1/2" high. Made to sit on the floor. Has heavy 6 x 9" speaker, crystal pickup, phono motor, and amplifier. All you do is fasten the speaker, motor and amplifier in the cabinet. Cabinet, no hole to drill, only a few minutes required to assemble. Complete with simple instructions. Stock No. CPR-78K, ship. wt. 15 lb. Sale price \$8.95. Shipped via express only.

25 WATT HI-FI SPEAKER SYSTEM \$24.95 AND MAHOGANY SPEAKER CABINET \$79.95

2-12" Woofers
2-5" Tweeters
Power Supply and L-G Cross-over Network
ALL FOR \$24.95 WITH CAB.

25 WATT HI-FI SPEAKER SYSTEM \$24.95

25 watt, High-Fidelity Dynamic Speaker System, complete with 2000 cycle genuine inductance-capacitance cross-over network, two 12" woofer speakers, two 5" high frequency tweeter speakers and separate 110 volt AC power supply, less 18 inch baffle for only \$24.95. Frequency response 20 to 18,000 cps. Both the woofers and the tweeters are fine quality dynamic speakers with fields excited to saturation by the power supply. Tweeters are specially made with cones designed to respond only to the high frequencies of the audio spectrum. The 2000 cycle cross-over network is of the high quality inductance-capacitance type which prevents frequencies below 2000 cps from entering the tweeters and eliminates frequencies above 2000 cps from the woofer circuit. The cross-over network system is simple to connect to any 4 or 8 ohm output of your high fidelity audio amplifier or radio. No. SP-12125CR, High Fidelity Dynamic Speaker System, Ship. wt. 15 lbs., Sale price, \$24.95. No. SP-5-12125, High Fidelity Dynamic Speaker System, as described above, but less the 2000 cycle cross-over network and with a separate attenuator control. Sale price, \$14.95.

SPEAKER SYSTEM INSTALLED IN CABINET \$79.95

High Fidelity Speaker system installed in mahogany console speaker cabinet. A complete high fidelity speaker system contained in a beautiful hand rubbed mahogany console speaker cabinet. This 3/4 door style speaker cabinet is 43" high, 31" wide and 23" deep. This cabinet was intended for a 24" TV set and cost over \$100 to build. We have added a heavy laminated baffle, cut for the 4 speaker system and matching mahogany color plastic grill cloth that is acoustically correct for this speaker system. The baffle portion of this cabinet contains 9 cu. ft. of space. It could easily be made into a top quality bass reflex baffle with the addition of a back and the proper acoustical lining. Full shelf below speakers is 27" wide and has panel 4 1/2" high ideal for installation of a high fidelity amplifier or pre-amplifier. Bottom section of the cabinet is cut for two 10" speakers which were used with the TV set. This space could easily be converted for a number of uses. Speaker system described above is shipped installed in cabinet. Only two wires to connect to the output of your radio or amplifier. Model CSP-1212CR, High Fidelity Speaker System installed in mahogany console cabinet. Shipping wt. 105 lbs., Sale price, \$79.95. Model CSP-5-1212M, High Fidelity speaker system; less cross-over network, installed in mahogany console cabinet. Sale price, \$69.95.

3-STATION INTERCOM MASTER \$16.95

SUB-STATIONS \$3.95 EACH
Powerful 3 station intercom master housed in a chrome plated metal cabinet 7 1/2" x 6" x 5". Full 3 tube amplifier for AC-DC operation. Press-to-talk switch is on top of cabinet. Volume control, on/off switch and station selector are located on either side. May be used with one to three sub-stations. Master is quiet except when talk-listen switch is pressed or when call-back switch is pressed at the sub. Ship. wt. 10 lbs. Model MPM-A3, 3 station master, \$16.95. Matching sub-station, Model PMH-A5, complete with 5" speaker and call-back switch and call-back switch, \$3.95 each or 3 for \$10.00. Requires 3 wire intercom cable, \$1.95 per 100 ft., 500 ft. for \$8.95.

10 WATT PORTABLE P.A. SYSTEM \$34.95

PA-12, 5 tube 10 watt portable P.A. system. Push-pull 7C5's. U.S. approved amplifier with good frequency response. Inputs for crystal microphone and phono. Separate volume controls and variable tone control. Heavy 10" Alnico V PM speaker. Amplifier fits in bottom of case. Case size, 21" x 16" x 13". Snap-on removable back. Complete with tubes, crystal mike on non-removable desk stand and connecting cables. Stock No. PA-12. Ship. wt. 40 lbs. Sale price only \$34.95.

6-TUBE 2 BAND RADIO KIT \$14.95

6 tube, 2 band AC-DC radio kit, complete with speaker and cabinet. Popular for training in radio. Receives broadcast and shortwave. Full 2 gang superhet with 5" speaker and slide rule dial. A complete kit with tubes; 12K8, 2-12SK7, 12SQ7, 50L6 and 35Z5, diagram and instructions. Cabinet 13" x 6 3/4" x 6 1/4". Ship. wt. 12 lbs. Model MEG-2. Net \$14.95.

22 WATT HI-FIDELITY AMPLIFIER KIT \$29.95

COMPLETE WITH TUBES
8 Tubes—Push-Pull Output
As Featured in Esquire Article
22 watt, 8 tube High Fidelity amplifier kit with push-pull output tubes. Complete kit of parts to build this fine quality amplifier. Includes 3-7E5, 2-12AT7, and 2 Western Electric VT-52 (6A3) output tubes. All triode circuit minimizes harmonic distortion. Has inputs for Radio tube, crystal or variable reluctance phono pickup and crystal or dynamic microphone. Output transformer matches 8 ohm voice coil. Will match any of the high fidelity speakers shown on this page. Twin electronic bass and treble tone controls, with range selector switch for either juke box quality with heavy bass response or brilliant symphonic range. Response 20 to 18,000 cps. This is the very best quality amplifier kit we make. 22 watt, 8 tube all triode amplifier kit, complete with all parts, tubes, diagram and instructions. Model 7X5, Ship. wt. 25 lbs., Net price, \$29.95.

21" BLOND TV-RADIO-PHONO CABINET—SALE PRICE \$49.95

Blond mahogany combination TV-Radio-Phono cabinet. Has full door with panel cut for 26" or 21" TV chassis. Has space for radio chassis, record changer and record storage. Beautiful blonde finish with matching grill cloth and gold color hardware. TV compartment is 20 1/2" high, 24 3/4" wide and 21 1/4" deep. Chassis was intended to mount on side. Radio changer space will hold changer 13 3/4" x 14" and radio chassis 8" high and 13" wide. Baffle cut for 12" speaker. Overall cabinet size, 38" high, 42 1/2" wide and 24 1/4" deep. Ship. wt., 85 lbs. Stock No. DJB-21R, Sale price \$49.95.

78 RPM-AMPLIFIED RECORD PLAYER \$8.95

78 RPM amplified player kit. Leatherette cabinet, 6 x 9" speaker. Buy this kit for less than the parts cost. This is a 78 RPM record player. Completely wired 3 tube amplifier with 12BF6, 35W4 covered cabinet 9 1/2" x 12" x 18 1/2" high. Made to sit on the floor. Has heavy 6 x 9" speaker, crystal pickup, phono motor, and amplifier. All you do is fasten the speaker, motor and amplifier in the cabinet. Cabinet, no hole to drill, only a few minutes required to assemble. Complete with simple instructions. Stock No. CPR-78K, ship. wt. 15 lb. Sale price \$8.95. Shipped via express only.

Order From This 2-Page Ad. DEALERS-SERVICEMEN WRITE US—For Our Big Catalog and Bargain Flyers!

McGEE RADIO COMPANY

PRICES F.O.B. KANSAS CITY
SEND 25% OR FULL REMITTANCE WITH ORDER.
BAL. SENT C.O.D.

OUR NEW ADDRESS IS
1901 MCGEE ST., KANSAS CITY, MISSOURI

NEW! SUPER POWERFUL All Channel VHF-UHF TV RECEPTION IN ALL DIRECTIONS **Our Greatest BARGAIN**

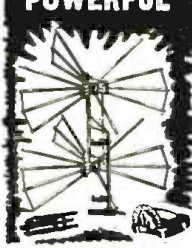

Model AX-524
ROCKET DIRECTRONIC MOTORLESS TV ANTENNA
 360° ELECTRONICALLY SWITCHED BEAM

In the fringe or ultra fringe, the NEW 1955 Motorless Directronic will out-perform any ordinary antenna. The sensational new 360° UHF-VHF TV Antenna offers "around the compass" reception WITH OUR Rotors. Provides superb ghost-free picture clarity. Model AX-524 "Serviceman's Array" contains Hi-Pac Molded Insulator of Extreme tensile strength, 24 hi-tensile aluminum elements, including 6 Multi-purpose Reflector-directors, 1 set matched tie rods, Universal Mast Clamps, 6-position Beam Selector Switch, 75' Low-loss UHF-VHF Tubular TRF-X Cable.

Only **\$23.50**

Super UHF RECEPTION HI-GAIN YAGI



Provides guaranteed sensational UHF fringe reception. Amazing sensitivity provides up to 30 db gain, using 2, 4, or 6 bay stacked arrays. Ghosts, interference minimized or eliminated. Each serviceman's array provides 4 directors, 2 folded dipoles, 2 reflectors. And our low price insures a low cost installation. Select the model required in your area.

\$195 Ea.

Model	Covering
F-7A	Channels 14-48
F-7B	Channels 27-62
F-7C	Channels 47-83
Matched stacking bars \$0.30 pr.	

UHF CORNER REFLECTOR ONLY 2.99 EACH IN LOTS OF 6

SINGLE LOTS \$3.50 EACH

This hi-gain UHF Corner Reflector can only be offered you at this low price for a short time, 8 to 11 db gain across UHF band. Order Model F-6.

ALL PRICES F.O.B. CLEVELAND, OHIO
 Do not remit more than complete purchase price. Pay shipping charges on receipt of goods. 25% deposit on all C.O.D. orders, please. Money-back guarantee. Prices Subject to Change Without Notice.

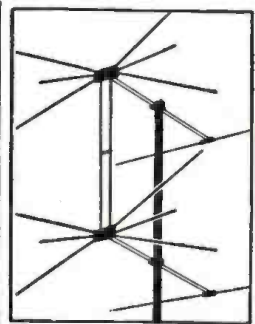

2-BAY 16-ELEMENT CONICAL ARRAY With Hi-Band Adapters
 Sturdy 3/8" Elements

\$4.99 EACH IN LOTS OF THREE
 SINGLE LOTS \$5.30

Never before has National Electronics had a BARGAIN like this. We made a special purchase in order to get these sensational prices. And this array has everything. This conical 2-bay 16-element array provides ultra-fine fringe reception. Includes sixteen 3/8 inch airplane type aluminum elements, including hi-band adapters for greater gain on the high channels and is complete with one pair of stacking bars to each array. These are packed in cartons of three 16-element arrays per carton, with tie rods, at \$14.95 per carton. When purchased in single 16-element arrays, separately boxed—your cost is... \$5.30 each
 3 Two-Bay Arrays per carton without Tie Rods... \$13.50 carton
 4 Bay Ultra-Fringe Stacking Assembly for Above—Model 48... \$1.95 set

FAMOUS ROCKET ZOOM-UP TOWERS

Sturdy • Reliable • Easiest Installation
 Economize with Rocket Zoom-up Towers. Offers quickest, easiest way to make an installation up to 50'. Each section telescopes inside the other—to erect, simply slide out each section in its turn—insert bolt thru section below—tighten to keep mast from turning. Each tower complete with guy runs, bolts, and mounting base suitable for peak or flat roof. Handsome and sturdy. Rocket Zoom-ups offer you economy and long life. Order by size.

20'	\$ 9.95	30'	\$15.95
40'	19.95	50'	29.95

(Deduct 10% discount in lots of 3)

National Electronics OF CLEVELAND
THE HOUSE OF TV VALUES
 6608 Euclid Ave., Dept. N-2, Cleveland 3, O.

"Ultra-Linear" Amplifier
 (Continued from page 47)

which are not the inherent faults of the circuits, but are due to the fact that the optimum transformer was not used.

In this push-pull parallel design, circuit considerations and transformer design have been integrated to provide a circuit of excellent stability—a circuit in which the feedback could be increased by 6 db without encountering instability either on resistive or speaker load.

However, some combinations of loading can lead to ringing or other transient disturbances under conditions of high level operation. This can be prevented completely by the addition of a 250 µfd. capacitor across one-half of the output transformer primary (from blue-white lead to red lead). The need for this expedient is the exception rather than the rule.

Special circuit considerations such as staggering at the low end and the introduction of local current feedback by splitting the driver stage cathodes in order to increase stability at high frequencies have been incorporated in this design. In addition, the output transformer was designed to have a bandpass flat plus or minus 1 db from 10 cps to 100 kc. with a smooth phase characteristic tailored to the phase characteristic of the amplifier. The transformer, the Acrosound TO-330, also was designed to provide high power at low distortion over a very wide band. The transformer combinations of bandwidth, preservation of operating characteristics at all power levels, and maintenance of push-pull balance over a very wide band all combine with the basic circuit configuration to give good stability and unusually outstanding performance characteristics.

The push-pull parallel circuit provides better results than would be anticipated on the basis of doubling the output stage capabilities. Since the TO-330 transformer is more efficient than the lower powered unit designed for a single pair of output tubes, more than twice as much power is available from the push-pull parallel circuit than from the regular push-pull amplifier using the same design criteria. Thus, it is practical to reach levels in excess of 60 watts before the intermodulation distortion reaches 1 percent—if four normal quality KT66 tubes are used. With selected tubes, the IM can be kept below .5 percent at 60 watts. Conventional commercial advertising of the power capability of the amplifier would classify it as a 65 or 70 watt amplifier with a specification of "peak power in excess of 100 watts."

As with all amplifiers, a mismatch of output impedance such as putting a 64 ohm load on the 16 ohm tap to simulate speaker behavior at the bass resonant frequency results in a decrease of power capability. However, this also results in a decrease in distortion. For

DON'T THROW OLD RADIOS AWAY!

Here's the data you need to fix them FAST and r-i-g-h-t!

There's a "secret" to repairing old radios fast and profitably... and this big RADIO TROUBLESHOOTER'S HANDBOOK is it!

Just look up the old make and model you want to fix. This manual-size, 3 1/2 pound, 744-page Ghirardi handbook tells what the trouble is likely to be... and shows you exactly how to fix it. No useless testing! No wasted time! Even beginners can handle jobs "slick as a whistle."

THE ONLY GUIDE OF ITS KIND!
 Cuts service time in half!

Included are common trouble symptoms and their remedies for over 4,800 models of home and auto radios and record changers. Actual case histories cover practically every model made by 202 manufacturers between 1925 and 1942—Airline, Apex, Arvin, Atwater Kent, Belmont, Bosch, Brunswick, Clarion, Crosley, Emerson, Fada, G.E., Kolster, Majestic, Motorola, Philco, Pilot, RCA, Silvertone, Sparton, Stromberg and dozens more. Gives how-to-do-it data on SPECIFIC jobs—NOT general theory. Includes hundreds of pages of invaluable tube and component data, service short cuts, etc.

.....TRY IT 10 DAYS... at our risk!.....

Dept. RN-25. RINEHART & Co., Inc.
 232 Madison Ave., New York 16, N. Y.

Send Ghirardi's RADIO TROUBLESHOOTER'S HANDBOOK for 10-day free examination. If I decide to keep book, I will then remit the full price of only \$8.50 plus a few cents postage. Otherwise, I will return book postpaid and owe you nothing.

NAME.....
 ADDRESS.....
 CITY, ZONE, STATE.....

ELECTRONIC WAR TERMINATION INVENTORY
 BIG SAVINGS... UP TO 85%

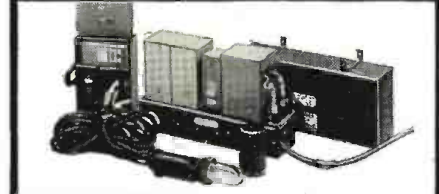

STROBOSCOPIC LIGHT (100 W. Sec.)
 For Lab, Testing and Photo Flash

A terrific piece of equipment, excellent for lab work, industrial testing and use in outdoor and studio flash applications. Operates on auto battery or any 6/12 or 12/24 VDC source. Comes complete with ignition coil, trigger housing and strobe light hand ass'y. Includes 20 ft. of cord. Uses Syvl. A-1073 200 WS bulb (similar to Syvl 4330, but has Pyrex shield). Price includes spare parts kit with extra A-1073, spare tubes, fuses and vibrator. BRAND NEW, ready to operate, instruction manual provided. Shipping weight approx. 50 lbs.

SPECIAL CLEARANCE PRICE \$25.00

RADAR SCOPE INDICATOR
 Type 1D-11/APS-4

Complete scope indicator unit. Contains 3FP7 tube, and two 6J6 tubes. Equipment totally enclosed by tube shield mounted on chassis. Includes capacitors, scope regulator and 3 ft. Amphenol lead connector.

TERMINATION PRICE... \$3.95

ENCLOSE CHECK WITH ORDER
 PRICES F. O. B. BURBANK, CALIF.

cal-tech SALES COMPANY
 449 S. San Fernando Road • Burbank, Calif.



Prepare now
**IN SPARE TIME
 AT HOME**
 for great opportunity
 field of...

TELEVISION

RADIO-ELECTRONICS

The future is YOURS in TV-RADIO!

A fabulous field—good pay—fascinating work—a prosperous future! Good jobs or independence in your own business!

Modern Training by Coyne RIGHT IN YOUR OWN HOME

Coyne brings you the first truly lower cost, MODERN—QUALITY Television Home Training; training designed to meet Coyne standards. Not an old Radio Course with Television "tacked on." Here is MODERN TELEVISION TRAINING including working knowledge of Radio. Includes UHF and COLOR TV. No Radio background or previous experience needed. Personal guidance by Coyne Staff.

The Institution Behind this Training

Famous for over 55 years, COYNE ELECTRICAL SCHOOL occupies this entire 6-story building. Coyne's modern resident training of men for Television, Radio, Electronics and Electricity has produced thousands of successful graduates.



D. W. COOKE, President

FOUNDED 1899

COYNE
ELECTRICAL SCHOOL
 A TECHNICAL TRADE INSTITUTE OPERATED
 NOT FOR PROFIT
 500 S. Paulina Street, Chicago 12, Dept. 25-TR5
MAIL COUPON NOW FOR DETAILS FREE

LEARN TO

EARN IN SPARE TIME AT HOME

COYNE offers a most practical, Home Television Training. Simple, easy to follow step-by-step instructions, fully illustrated. **Practical Job Guides** to show you how to do actual servicing jobs—**make money early in course.** Keep your present job while training.

Low Cost—Easy Terms

We save you money because we don't send you—AND CHARGE FOR—a long list of parts or "put together kits," which you may not want or do not need. With Coyne Television Home Training you pay only for your training, **no costly extras.**

Let us show you that this is not only the newest, most up-to-the-minute Training in Television-Radio-Electronics—but also it **costs you much less than other leading home training courses.** Send coupon today for details including Easy Payment Plan.

SEND COUPON FOR FREE BOOK

and full details, including Easy Payment Plan. **No obligation, no salesman will call.**



COYNE ELECTRICAL SCHOOL

Television Home Training Div.
 500 S. Paulina St., Chicago 12, Ill.
 Dept. 25-TR5

Send Free Book and details on Television Home Training. This does not obligate me and no salesman will call.

Name _____

Address _____

City _____ State _____

Check if interested in Resident School Training in Chicago.

THE NEW WRENCH WITH THE "INNER GRIP"

WALDEN

in-a-grip

TRADE MARK

WRENCHES PATENTS PENDING

... GRIP and DRIVE ALL HEX HOLLOW-HEAD SET SCREWS AND CAP SCREWS!

NO FUMBLING
NO DROPPING



OVER 200 TYPES AND SIZES IN STOCK

WRITE FOR CATALOGUE

MANUFACTURED EXCLUSIVELY BY

MAKERS OF SPINTITES, GRIP SPINTITES, — FORCE-FORMED SOCKET WRENCHES — AND ALL TYPES OF MECHANICS' HAND TOOLS

FOR OVER 50 YEARS

STEVENS WALDEN Inc.

450 SHREWSBURY STREET
WORCESTER, MASSACHUSETTS

RADIO ENGINEERING DEGREE IN 27 MONTHS

Radio engineering is a big field. There's room for you in it—if you're good. Get first-class training at Indiana Tech. Intensive, specialized course, including strong basis in mathematics and electrical engineering, advanced radio theory and design, television, electronics, Modern laboratories. Low rate. Also B.S. DEGREE IN 27 MONTHS in Aeronautical, Chemical, Civil, Electrical and Mechanical Engineering. G.I. Government approved. Enter June, September, December, March. You can earn part of your expenses right here in Fort Wayne while you are studying.

INDIANA TECHNICAL COLLEGE

925 E. Washington Blvd., Fort Wayne 2, Indiana
Please send me free information on B.S. Engineering Degree in 27 months as checked.

- Radio-Television Aeronautical
 Civil Mechanical Electrical

Name
Address

SELECT SURPLUS

Amateur and Industrial Components and Equipment

- RCA MODULATION TRANSFORMER—XT-2974—G16 to B07, HV Insul. B. New.....\$ 2.95
- THORNDARSON PUV Choke—10 Henry—450 MA—10,000 volt Insul. B. New..... 9.95
- THERMADOR or SOLA—modulation Xformer—1 kilowatt (Sik. Corps #229634.29) for 3047H, 3047L, etc. B. New crated—express or frt. 29.95
- T-23—100-150 MC—arc-5 Xmitter with tubes, xtal. fine condition—while they last..... 19.95
- BC-467—4.5-TMC—New—w/tubes 6.95
- BC-458—5.3-TMC—New—w/tubes 6.95
- BC-459—7.9-TMC—New—w/tubes 14.95
- PACKAGE DEAL FOR THE MAN WHO HAS EVERYTHING . . . 1 each: T-23, BC457, BC458, BC459..... 42.50
- KENYON PLATE XFORMER T-664—740-0-740—150 MILS.—fraction of original cost—B. New 4.95
- KENYON PLATE & FILA. XFORMER—400-0-400—325MA—5V-6A, 0.3V-6A \$40.00 list—B. New 6.95
- TUBE TYPE 3AS—11F1 twin triode—B. New RCA orig. box. . . 3 for \$1.00; 4 for IN80—gen'l purp. diode—Sylvania—clipped leads—guaranteed 4 for 1.00
- IN22—zoni'l purp. diode—W. E. 4 for 1.00
- IN22—zoni'l purp. diode—W. E. 4 for 1.00

REX RADIO SUPPLY

a good place to buy
88 Cortlandt St., New York 7, N. Y.

HIGHER POWER—HIGHER FIDELITY



\$169.50 net

Full descriptive data available on request

Sonex, Inc.

245 Sansom St., Upper Darby, Pa.

Sonex 60 WATT ULTRA-LINEAR AMPLIFIER

- 60 watts at less than 1% IM
- 10 watts at less than .1% IM
- Response \pm 1 db 2 cps to 200 kc
- Damping factor 16
- Acrosound TO-330 transformer

A combination integrated for the finest possible sound

Ultra-Linear Pre-amplifier

- Less than .05% IM distortion
- Response \pm 1 db 10 cps to 100 kc
- All feedback design with step controls
- Engineered for maximum flexibility

\$99.50

example, under matched impedance conditions, the IM distortion of one of these amplifiers at 24 watts is .14 per cent (based on a 40 cps and 7 kc. signal mixed 4:1). With the mismatched condition, the total power output is reduced to less than 40 watts, but the IM at 24 watts is .07 per cent—a reduction to one-half. Such low values of distortion exceed the capabilities of most measuring equipment.

The amplifier passes more than 50 watts of power without visible distortion on the scope at any frequency from 20 cps to 30 kc. Frequency response, of course, is far greater than this power curve indicates; and because normal frequency response is plus or minus 1 db from 2 cps to 200 kc., the square wave transmission at any frequency from 20 cps to 20 kc. is excellent.

The amplifier requires only 1.3 volts to drive to full output. This makes it practical for use with any preamplifier, as any commercial unit can supply the necessary signal voltage.

The combination of attributes available in this push-pull parallel design is unique. It offers more power, at lower distortion, over a wider bandpass than can be obtained by any conventional circuits.

It is realized that measured performance does not make an amplifier sound good. Of course, poor measurements generally indicate poor listening quality; but the converse is not true. Therefore, since measurements correlate imperfectly with listening qualities, it is necessary to make the listening test the final and most important test of merit. The performance of the push-pull parallel circuit remains superior on listening also.

Heavy bass passages have better definition and sound better damped on the push-pull parallel amplifier than on others. This is due apparently to more than the additional power capability alone. It seems to be also due to the high damping factor of 16, the fact that varying speaker impedances do not pull the power capability down to below a satisfactory level, and to the fact that distortion is at as low values as have ever been achieved outside the laboratory.

In the middle and upper frequency regions, the absence of intermodulation effects and the undistorted reproduction of transient signals make for a smoothness and clarity which is apparent in less listener fatigue. After continued exposure to the quality of the push-pull parallel circuit, it is difficult to listen to other circuits without becoming aware of their previously unnoticed shortcomings.

BIBLIOGRAPHY

1. Sarser and Sprinkle, "The Maestro—A Power Amplifier," *Audio Engineering*, November 1952.
2. Williamson, D. T. N., "A High Quality Amplifier Design," *Wireless World*, September 1947.
3. Williamson, D. T. N., "Amplifiers and Superlatives," *Wireless World*, September 1952.
4. Hafer, David, "Improving the Williamson Amplifier," *RADIO & TELEVISION NEWS*, February 1953.

OLSON'S PENNY PROFIT POLICY MEANS GREATER BARGAINS

ARVIN MAHOAGY TV BASE

with 4 E-Z Swivel Casters

BARGAIN OF A LIFETIME

STOCK NO. **\$3.95**
K-69 EACH

SPECIAL, 3 FOR.....\$10.95

A Real \$21.95 Retail Value

Just place a Table Model TV set on this base and it looks like a console. Fully finished and polished mahogany sides and front. Brass ornaments set off front panels. Equipped with four E-Z roll casters. Entire base made by cabinet craftsmen. Size 22" wide x 21" deep x 17" high. Brand new in factory-sealed air cushion carters. Shpg. wt. 15 lbs. Must be shipped by Express because of size.



GIANT TV ANTENNA KIT

Stock No. AU-24

REG. \$31.95 **\$12.99**

Complete kit—nothing more to buy. For best reception on all VHF channels. Rust-proof Aircraft Aluminum. Contains: 2 six-element conical bays, 1 pair Q bars, 2 5/8 ft. 1 1/4" mast sections, 60 ft. 300 ohm lead-in, 3 standoff insulators, 2 screw-eye standoffs, 1 mounting base, 1 guy ring, 1 clamp ass'y., 1 pipe strap, 4 lug bolts and full instructions. Save—order 12 sets—only \$219.50. Shpg. wt. each 13 lbs. Express only.

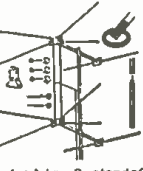

Electron-O-Jr. Sound System Kit



Stock No. **\$6.95** Reg. \$19.95
CAN BE ASSEMBLED IN TWO HOURS

Now build and operate a complete 1-tube plus rectifier-amplifier P.A. Sound System and easily learn principles of electronics. Includes 5" PM Selenium Dual Electrolytic Condenser, 75 ma Selenium Rectifier, 3 Resistors, 2 Switches, Volume control and knob, Input and Output Transformers, Carbon Granule Microphone, 12-24 Tube, 50 ft. 2-conductor Cable, Hook-up wire, Solder and all necessary clips, sockets, hardware, and punched forms to make amplifier cabinet and speaker baffle. Simple instruction book included. Operates on 115 Volts AC or DC. Comes in 4-color gift carton. Shpg. wt. 10 lbs.

Espey HI-FI AM-FM RADIO CHASSIS

Complete with 10 STOCK NO. RA-166
Matched Tubes, Knobs, Escutcheon, Antennas and Hardware, Only **\$49.95**

Espey Chassis with 12" Magnavox Speaker—STOCK NO. AS-117—ONLY... \$52.50

Olson scoops the nation with this tremendous HI-FI Buy. Regularly sells for \$147.50, but Olson put cash on the line so you could save money on the one chassis designed for Quality Installations. Every chassis packed in original factory-sealed carton. 100% Double-Guaranteed by Olson and the Manufacturer. Five of the ten matched tubes are dual-purpose—giving you the equivalent of 15 tube performance. This brilliant AM-FM radio is equipped with the built-in pre-amplifier for GE or any low variable reluctance or any standard crystal phone pickups. Features special amplifier, universal phono input, 3-position equalizer for flat record playback, beam power amplifiers for powerful audio and RCA-Hazeltine licensed circuits. Chassis finished in high-luxure and measures 13 1/2" wide, 7 1/2" high and 10" deep. Front panel neutral grey to match any decor. Dual edge lit slide-rule dial, 115 V. AC 60 cy. Full instructions and mounting diagrams included. Shpg. wt. without speaker 25 lbs., with speaker 32 lbs.



First Quality Plastic Base Recording Tape

1200 Ft. Tape on 7" Dia. Reel



STOCK NO. **\$1.59**
X-249. Lots of 6, Each...\$1.79
Lots of 12... EA. Single Each...\$2.19

Famous Brand—Reg. \$5.50—Now at 7 1/2% discount. Freq. response 50-15,000 cps—1/4" wide—fits all recorders. Shpg. wt. (one dozen) 10 lbs.

Olson Special 232 Resistors Bargin Kit



STOCK NO. **\$3.95**
AS-84.

Value packed with 200 1/2-watt, 20-1 and 2 watt; and 12 -5 to 25 watt wire-wound resistors worth over \$24.50, 5-10-20% tolerances. Includes IEC, Chromalox, Cermet, etc. 100% Olson Guaranteed. Shpg. wt. 2 lbs.

"Powerfone" Gradie-Phone



STOCK NO. X-448 **\$5.95** SET

Works up to one mile. Durable, dependable. Lifetime electro-magnetic earphone. Gold-plated diaphragm carbon mike. Connects in 2 seconds—place on table or mount on wall. Complete—you get 2 telephones with built-in buzzers 2 cradles, 2 batteries, 50 ft. double cable, handsome Gift Carton. Money-back Guarantee if not twice as Good as you Expected! Shpg. wt. 4 lbs.

Nationally Advertised Tester—SUPER METER

Combination Volt-Ohm-Milliammeter PLUS capacity, Resistance, Inductance and Decibels. Complete with instructions and Test Leads. Measures capacity

STOCK NO. **\$16.95** and leakage of capacitors. Look at all these Ranges—DC VOLTS: 0 to 7.5/75/150/750/1500; AC VOLTS: 0 to 15/150/300/1500; D.C. CURRENT: 0 to 7.5/75 MA 0-7.5 AMPS. RESISTANCE: 0 to 10,000/100,000 ohms 0 to 10 megs. CAPACITY: 0.01 to 2 MF; 1 to 20 MFD. REACTANCE: 150 to 25,000 ohms 15,000 ohms to 2.5 megs. INDUCTANCE: 35 to 70 Henries 55 to 7000 Henries. ELECTRICAL LEAKAGE: 0-100,000 ohms 100,000 to 10 megs. DECBELS: -10 to +18 db. +10 to +28 db. 4-50 to +28 db. Round engraved molded case measures 3 x 6 x 2 1/4". Operates on 115 Volts AC. Shpg. wt. 4 lbs.

Giant 0-1 MA Meter

STOCK NO. **\$4.99**
X-419. EA.

We guarantee these meters to be the best value in precision instruments we have ever offered. Every one 100% guaranteed. Size 4 1/2" x 3 1/2" Mounted on steel face panel. No big holes to drill. Equipped with zero adjustment on front glass. Genuine Perspex movement. Plastic case beautiful mottled brown.

TV IF Transformer Kit

Contains 10 Popular Width Transformers. Sound IF Transformers. Video IF Transformers. Some are dual. Equipped with iron laminating slugs. Genuine RCA and Dumont. Brand New. Value \$8.50. Shpg. wt. 2 lbs.

Hermetically Sealed Vibrators

STOCK NO. **\$1.99**
V8-52. A 6 volt, synchronous, single-speed vibrator—draws only 6 mmps. 1 1/2" dia. x 3/8" long. Octal Base. Shpg. wt. 1/2 lb. ea.

CATHODE RAY 'SCOPE TUBE

3CP1/1808P1 BRAND NEW RCA-REG. **\$14.50** STOCK NO. Z-230

A 3" Scope at our low price is unheard of. A great value for experimenter, lab. engineer, news, hams, students, industry, etc. In addition to the usual two pairs of electrostatic deflecting electrodes, this tube has a radial-deflecting electrode, which may be used if desired. This arrangement provides for observation and photography of recurrent and transient phenomena in polar coordinates. Medium persistence. Green fluorescence. Shpg. wt. 3 lbs. Full operating instructions and base layout included.

SALE! ONLY 200 AMPLIFIERS

A fine amplifier and we figured your cost down to the last penny. We have only 200. Give full ear tones. Look at these features which are found on much more expensive instruments. Inputs for BOTH reluctance cartridge or crystal cartridge. Also handles a radio tuner and a crystal microphone. Has built-in pre-amplifier. Equipped with output transformer. Excellent volume control, tone control and switch. Has power outlet for record player motor which shuts motor off automatically when amplifier is turned off. Operates 5 watts continuous. Completely assembled with matched parts and wired. Ready for use. Tubes included: 6X4 (Dual Tube), 6X4 (6X4) Chassis. Beautifully finished. Size 0 x 5 x 3". Shpg. wt. 12 lbs. EXTRA: Included is a transparent plastic engraved and drilled front panel which can be mounted on any cabinet.

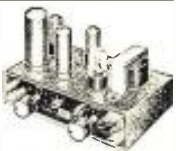

8-WATT PEAK OUTPUT Stock No. AMP-21

\$18.07

"Golden Classic" TRI-FI REPRODUCER

LEATHERETTE COVERED Stock No. **\$29.95**
S-186



Blonde—Stock No. S-187—\$33.95
Mahogany—Stock No. S-188—\$33.95

20 WATTS—20 TO 14,000 CYCLES
A new conception in High-Fidelity Reproduction. Outperforms any speaker arrangement costing 3 times the price. Contains 3 speakers with a crossover network that separates the function of each speaker. Speaker number one reproduces the extremely low notes. Speaker number two delivers the entire middle register with utmost clarity while speaker number three, a special tweeter reproduces the high frequencies only. The "Golden Classic" will recreate a tone balance which is unbelievable. Delivers full 20 watts with complete frequency range of 20 to 14,000 cycles. Reproducer is completely enclosed and each internal chamber is insulated with proper sound absorption material. Terminals on back of cabinet. Size 11" x 24" x 10". Shpg. wt. 20 lbs.

SPEAKER & Baffle COMBINATION

Perfect for Extension Speaker Use

May Be Purchased Separately

5" PM Speaker, STK. NO. S-5.....\$1.79
Baffle Box, Leatherette Covered, STK. NO. K-70.....1.11
Grille Cloth, STK. NO. X-481......20

If purchased separately, this outfit would cost \$3.10. However, Olson has a special deal on the kit—you get a beautiful brown leatherette covered wood case with proper mounting for a 5" speaker, an Alnico 5-5" PM Speaker and grille cloth—all for only \$2.66. Shpg. wt. 4 lbs.



STOCK NO. AS-141. COMPLETE KIT, SPEAKER, Baffle & GRILLE CLOTH, ONLY **\$2.66**

1/4" ELECTRIC DRILL

Limited Quantity—Reg. \$19.95
Made by Famous Manufacturer

Brand New—Factory Sealed Cartons

Never before could Olson make an offer like this. A precision Electric Drill with cast handle and gear box and a spun steel housing. Has a capacity of 1/4" in steel and 1/2" in hardest wood. The no-load speed is 1600 RPM and full load speed is 1000 RPM. Armature is dynamically and statically balanced for vibrationless operation. Armature is wound with triple formex wire. Gears are hobbed steel. Perfectly balanced pistol grip handle. Trigger switch can be locked down. These are brand new drills and worth much more. Every one is packed in a factory sealed carton with the manufacturer's guarantee. Equipped with 1/4" heavy duty Boldcord and rubber plug. Equipped with precision built three-jaw hand type chuck. Shpg. wt. 0 lbs.



STOCK NO. **\$9.96**
TL-41
With Hand-type Chuck Drill With Jacobs Chuck. List. \$24.95
Similar to above drill except with a coil rear type chuck and drill is satin finished.

STOCK NO. **\$13.22**
TL-42

HOW TO ORDER

MAIL ORDERS TO OLSON RADIO WAREHOUSE
275-F East Market St., Akron 8, Ohio

Send remittance with order (Add for postage 5c for each dollar's worth orders—10c for each dollar's worth if you are more than 1000 miles away. OLSON REFUNDS EVERY CENT NOT USED. Or send no money—we'll ship C.O.D.) and you pay mail or expressman for merchandise and postage. ALL MERCHANDISE 100% GUARANTEED. PLEASE—MINIMUM ORDER \$3.00.

OLSON BARGAIN STORES TO SERVE YOU IN:
Pittsburgh, Pa. ★ Chicago, Ill. ★ Cleveland, O.
5918 Penn Ave. ★ 623 W. Randolph ★ 2020 Euclid Ave.

Visit the Store nearest you.
Send to address below for Free Bargain Catalog.

MINIATURE ELECTRIC MOTORS



STOCK NO. X-403 **\$1.19**
3 FOR \$2.95, SINGLE... EA.

Ideal for running model cars, boats, remote control devices, etc. Operates on 3 to 6 Volts DC. 3 pole armature, bronze bearings and Alnico 6 Magnet. Shaft dia. 3/32". Size 1 1/2 x 3/4 x 3/4". Shpg. wt. 1 lb.

DELUXE SEALED UNIT MOTOR



Single **\$1.99**
EA.

3 for \$5.00 Stock No. X-407

Same fine features as Motor described above and in addition the entire motor is enclosed in a TRANSPARENT polystyrene case with dual shaft, phosphor bronze terminals. 1 1/2" high x 1" wide x 1 1/4" deep. The ideal motor with hundreds of uses.

Type 39/44 R.F. Amplifier Pentode Tubes

Brand new original factory packing. 1 tube to a carton, 30 to a case. Stock up on this regular \$2.80 list tube for less than a dime a piece. Manufactured by Tung-Sol, RCA and General Electric. 1 1/2" V-3A. Shpg. wt. 16-2 lbs.

STOCK NO. Z-228 **6 FOR 67c**
ONLY \$4.77

NEW WEBSTER-CHICAGO (Webcor) All-Speed Automatic Diskchangers



With Crystal Turn-over Cartridge and 2 Precious Tip Needles. STOCK NO. RA-157..... **\$28.95**
With GE V.R. Turn-about Cartridge and 2 Precious Tip Needles. STOCK NO. RA-158..... **\$32.95**

Now you can save \$20.00 on the latest model Webcor r. card changers. Your choice of either model. Ideal for use with Espey Chassis or any radio, amplifier or TV set installation.
Plays a 1" stack of 7, 10" or 12" records at 33 1/2, 45 or 78 RPM. Features include automatic adjustment for any dia. record stack, improved spindle and automatic shut-off after last record. For 115 V. AC eqy. Base size 13 3/4" x 12" x 8 1/4". Shpg. wt. 13 lbs. Webcor Mounting Base—STOCK NO. X-363, each \$4.95. Shpg. wt. 3 lbs.

OLSON RADIO WAREHOUSE 275-F EAST MARKET ST., AKRON 8, OHIO

The Model
TV-50

GENOMETER

A versatile all-inclusive GENERATOR which provides ALL the outputs for servicing:

A. M. Radio F. M. Radio Amplifiers Black and White TV Color TV

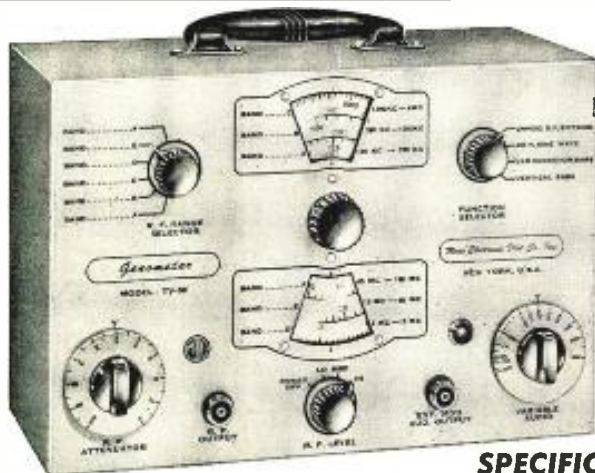

SPECIFICATIONS:

R. F. SIGNAL GENERATOR:

The Model TV-50 Genometer provides complete coverage for A.M. and F.M. alignment. Generates Radio Frequencies from 100 Kilocycles to 60 Megacycles on fundamentals and from 60 Megacycles to 180 Megacycles on powerful harmonics. Accuracy and stability are assured by use of permeability trimmed Hi-Q coils. R.F. is available separately, modulated by the fixed 400 cycle sine-wave audio or modulated by the variable 300 cycle to 20,000 cycle variable audio. Provision has also been made for injection of any external modulating source.

VARIABLE AUDIO FREQUENCY GENERATOR:

In addition to a fixed 400 cycle sine-wave audio, the Model TV-50 Genometer provides a variable 300 cycle to 20,000 cycle peaked wave audio signal. This service is used for checking distortion in amplifiers, measuring amplifier gain, trouble shooting hearing aids, etc.

BAR GENERATOR:

This feature of the Model TV-50 Genometer will permit you to throw an actual Bar Pattern on any TV Receiver Screen. Pattern will consist of 4 to 16 horizontal bars or 7 to 20 vertical bars. A Bar Generator is acknowledged to provide the quickest and most efficient way of adjusting TV linearity controls. The Model TV-50 employs a recently improved Bar Generator circuit which assures stable never-shifting vertical and horizontal bars.

CROSS HATCH GENERATOR:

The Model TV-50 Genometer will project a cross-hatch pattern on any TV picture tube. The pattern will consist of non-shifting, horizontal and vertical lines interlaced to provide a stable cross-hatch effect. This service is used primarily for correct ion trap positioning and for adjustment of linearity.

7 Signal Generators in One!

- ✓ R. F. Signal Generator for A.M.
- ✓ R. F. Signal Generator for F.M.
- ✓ Audio Frequency Generator
- ✓ Bar Generator
- ✓ Cross Hatch Generator
- ✓ Color Dot Pattern Generator
- ✓ Marker Generator

DOT PATTERN GENERATOR (For Color TV)

Although you will be able to use most of your regular standard equipment for servicing Color TV, the one addition which is a "must" is a Dot Pattern Generator. The Dot Pattern projected on any color TV Receiver tube by the Model TV-50 will enable you to adjust for proper color convergence. When all controls and circuits are in proper alignment, the resulting pattern will consist of a sharp white dot pattern on a black background. One or more circuit or control deviations will result in a dot pattern out of convergence, with the blue, red and green dots in overlapping dot patterns.

MARKER GENERATOR:

The Model TV-50 includes all the most frequently needed marker points. Because of the ever-changing and ever-increasing number of such points required, we decided against using crystal holders. We instead adjust each marker point against precise laboratory standards. The following markers are provided: 189 Kc., 262.5 Kc., 456 Kc., 600 Kc., 1000 Kc., 1400 Kc., 1600 Kc., 2000 Kc., 2500 Kc., 3579 Kc., 4.5 Mc., 5 Mc., 10.7 Mc. (3579 Kc. is the color burst frequency.)

The Model TV-50 comes absolutely complete with shielded leads and operating instructions. Only _____

\$ 47⁵⁰
NET

SHIPPED ON APPROVAL
NO MONEY WITH ORDER — NO C. O. D.

Try it for 10 days before you buy. If completely satisfied then send \$11.50 and pay balance at rate of \$6.00 per month for 6 months. **No Interest or Finance Charges Added!** If not completely satisfied return unit to us, no explanation necessary.

MOSS ELECTRONIC DISTRIBUTING CO., INC.
Dept. D-96, 3849 Tenth Ave., New York 34, N.Y.
Please rush one Model TV-50. I agree to pay \$11.50 within 10 days and to pay \$6.00 per month thereafter. It is understood there will be no finance, interest or any other charges, provided I send my monthly payments when due. It is further understood that should I fail to make payment when due, the full unpaid balance shall become immediately due and payable.

Name.....
Address.....
City.....Zone....State.....



Superior's new
Model 670-A

SUPER METER

A COMBINATION VOLT-OHM MILLIAMMETER PLUS
CAPACITY REACTANCE INDUCTANCE AND DECIBEL MEASUREMENTS

SPECIFICATIONS:

D.C. VOLTS: 0 to 7.5/15/75/150/750/1,500/7,500 Volts
A.C. VOLTS: 0 to 15/30/150/300/1,500/3,000 Volts
OUTPUT VOLTS: 0 to 15/30/150/300/1,500/3,000 Volts
D.C. CURRENT: 0 to 1.5/15/150 Ma. 0 to 1.5/15 Amperes
RESISTANCE: 0 to 1,000/100,000 Ohms 0 to 10 Megohms
CAPACITY: .001 to 1 Mfd. 1 to 50 Mfd. (Good-Bad scale for checking quality of electrolytic condensers)
REACTANCE: 50 to 2,500 Ohms, 2,500 Ohms to 2.5 Megohms
INDUCTANCE: .15 to 7 Henries 7 to 7,000 Henries
DECIBELS: -6 to +18 +14 to +38 +34 to +58

ADDED FEATURE:

Built-in ISOLATION TRANSFORMER reduces possibility of burning out meter through misuse.

The Model 670-A comes housed in a rugged, crackle-finished steel cabinet complete with test leads and operating instructions.

\$28⁴⁰
NET



Superior's new
Model TV-11

TUBE TESTER

SPECIFICATIONS:

- ★ Tests all tubes including 4, 5, 6, 7, Octal, Lock-in, Peanut, Bantam, Hearing Aid, Thyatron, Miniatures, Sub-Miniatures, Novals, Sub-minars, Proximity fuse types, etc.
- ★ Uses the new self-cleaning Lever Action Switches for individual element testing. Because all elements are numbered according to pin-number in the RMA base numbering system, the user can instantly identify which element is under test. Tubes having tapped filaments and tubes with filaments terminating in more than one pin are truly tested with the Model TV-11 as any of the pins may be placed in the neutral position when necessary.
- ★ The Model TV-11 does not use any combination type sockets. Instead individual sockets are used for each type of tube. Thus it is impossible

to damage a tube by inserting it in the wrong socket.

- ★ Free-moving built-in roll chart provides complete data for all tubes.
- ★ Newly designed Line Voltage Control compensates for variation of any Line Voltage between 105 Volts and 130 Volts.
- ★ NOISE TEST: Phono-jack on front panel for plugging in either phones or external amplifier will detect microphonic tubes or noise due to faulty elements and loose internal connections.

The model TV-11 operates on 105-130 Volt 60 Cycles A.C. Comes housed in a beautiful hand-rubbed oak cabinet complete with portable cover.

\$47⁵⁰
NET

EXTRA SERVICE—The Model TV-11 may be used as an extremely sensitive Condenser Leakage Checker. A relaxation type oscil-

lator incorporated in this model will detect leakages even when the frequency is one per minute.

SUPERIOR'S NEW MODEL TV-40



C.R.T. TUBE TESTER

★ A complete picture tube tester for little more than the price of a "make-shift" adapter!!

The Model TV-40 is absolutely complete! Self-contained, including built-in power supply, it tests picture tubes in the only practical way to efficiently test such tubes: that is by the use of a separate instrument which is designed exclusively to test the ever increasing number of picture tubes!

EASY TO USE:

Simply insert line cord into any 110 volt A.C. outlet, then attach tester socket to tube base (ion trap need not be on tube). Throw switch up for quality test . . . read direct on Good-Bad scale. Throw switch down for all leakage tests.

★ Tests all magnetically deflected tubes . . . in the set . . . out of the set . . . in the carton!!

SPECIFICATIONS:

- Tests all magnetically deflected picture tubes from 7 inch to 30 inch types.
- Tests for quality by the well established emission method. All readings on "Good-Bad" scale.
- Tests for inter-element shorts and leakages up to 5 megohms.
- Tests for open elements.

Model TV-40 C.R.T. Tube Tester comes absolutely complete—nothing else to buy. Housed in round cornered, molded bakelite case. Only

\$15⁸⁵
NET

**SHIPPED ON APPROVAL
NO MONEY WITH ORDER — NO C.O.D.**

Try any of the above instruments for 10 days before you buy. If completely satisfied then send down payment and pay balance as indicated on coupon. No Interest or Finance Charges Added! If not completely satisfied return unit to us, no explanation necessary.

MOSS ELECTRONIC DISTRIBUTING CO., INC.
Dept. D-96 3849 Tenth Ave., New York 34, N. Y.

Please send me the units checked. I agree to pay down payment within 10 days and to pay the monthly balance as shown. It is understood there will be no finance, interest or any other charges, provided I send my monthly payments when due. It is further understood that should I fail to make payment when due, the full unpaid balance shall become immediately due and payable.

Name.....
Address.....
City..... Zone..... State.....

Model 670-A..... Total Price \$28.40
\$7.40 within 10 days. Balance \$3.50
monthly for 6 months.

Model TV-11..... Total Price \$47.50
\$11.50 within 10 days. Balance \$6.00
monthly for 6 months.

Model TV-40..... Total Price \$15.85
\$3.85 within 10 days. Balance \$4.00
monthly for 3 months.

don't be vague...

insist on
SPRAGUE

Twist-Lok[®]
'lytics



*Trademark

SPRAGUE

NORTH ADAMS, MASS.

don't be vague...

insist
on
SPRAGUE

ATOMS[®]



SPRAGUE

NORTH ADAMS, MASS.

SWL Preselector (Continued from page 41)

loops. The author used two lugs under the mounting screws for C₁ as a tie-point for all such leads.

A short length of RG-59/U run from the output post of the selector switch through a grommet in the rear of the cabinet serves to connect the unit to the receiver antenna terminals. Small cable clamps will be useful in keeping the coax against the sides of the cabinet.

Since the layout of the components necessitated running the output coupling capacitor back past the tube socket to reach the selector switch, C₂ was run from pin 5 of the tube socket to a nearby terminal strip and a piece of RG-59/U was used to complete the connection to the switch.

It will be noted from the photographs that a capacitor of rather large physical dimensions was used for C₂. This was simply because it happened to be handy in the "junk box" and one of the midget types would be just as satisfactory. Although one of the new ferrite-core r.f. chokes was used in the plate circuit, one of the more common types should work just as well.

Operation

To place the unit in operation, first connect the output lead to the receiver—the inner conductor being attached to the antenna terminal and the braid to the receiver chassis. If the receiver has provisions for both single wire and doublet antennas, the output lead should be connected to the terminal designated for a single wire antenna.

Assuming the antenna being used is the single wire type, connect it to "A" on the preselector terminal strip and connect a jumper between "B" and "C". With the selector switch in the "straight-through" position, tune the receiver to a weak station in the range covered by the preselector. Then turn on the preselector power switch, advance the gain control to the "maximum" position, and set the selector switch to the proper coil. Now slowly rotate C₁.

As the unit is tuned closer to the frequency of the station being received, an increase in volume will be noted and will reach a maximum when the preselector is tuned to the same frequency as the receiver. Since the tuning characteristics are rather broad, it will be possible to tune the receiver to several stations in the same band without having to readjust the preselector.

The unit will seem to function better on weak signals than on strong ones. Actually, this is due to the tendency of the receiver's a.v.c. circuit to level off strong signals and is no reflection on the ability of the preselector to handle its job efficiently and according to specifications.

The builder may wish to calibrate

don't
be
vague...

insist on
SPRAGUE
BLACK
BEAUTY[®]

TELECAP[®]
tubulars



SPRAGUE

NORTH ADAMS, MASS.

don't

be

vague...

insist

on

SPRAGUE

NORTH ADAMS, MASS.

RADIO & TELEVISION NEWS

the dial so as to speed the process of tuning to a station of known frequency. In the simplest form this would merely consist of noting the dial settings for six or seven stations of known frequency in each of the two bands.

If a more thorough job is desired and an r.f. signal generator is available, it may be connected to the antenna terminals of the preselector and used to provide calibration points every 500 kc.

To do this, adjust the generator for a modulated signal of the desired frequency (say, 6.0 mc.) and with the selector switch at "straight-through", tune the receiver for maximum output, keeping the volume control set as low as possible. Then turn the selector switch to the proper coil, tune the preselector for maximum receiver output, and make a mark at this point on the dial. Repeat this procedure at 6.5 mc., 7.0 mc., and so on.

An a.c. voltmeter connected across the speaker voice coil terminals will give a more reliable indication of output than trying to judge by ear. If a readable voltage cannot be obtained without advancing the volume control considerably, connect the voltmeter between the plate of the receiver output tube and ground, with a 0.1 μ fd., 600 volt capacitor in the plate lead to block the d.c. component.

While the performance of the unit may not be in the same class as the more expensive commercial models using several tubes, the author has found it greatly increases the ability of his receiver to "reach out and pull them in." Signals which are completely unintelligible become strong and clear when this SWL preselector is switched on.

GERMANIUM DIODE LEADS

By ARTHUR TRAUFFER

WHEN experimenting with germanium diodes, the continual connection and disconnection of leads messes them up and eventually breaks them off short. Then, when soldered connections are made to the short leads there is danger of damaging the diode.

As shown in the photo, the author saves his leads by connecting the diodes to a two-terminal Cinch-Jones barrier type terminal strip. Thus, quick connections can be made to the diodes without any soldering, and the strips can be screwed onto a breadboard or bolted to a chassis.

How the leads on a germanium diode can be conserved and constant soldering avoided.

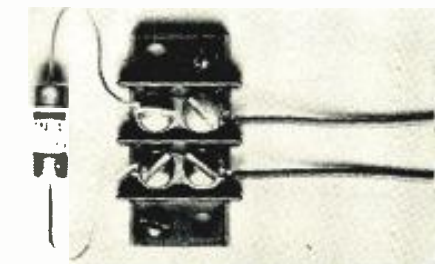

SAVE!... BARGAINS GALORE!... SAVE!

Build Your Own Scope!
U. S. Gov't. Scope Indicator BC-929
Complete with Tubes & 3BP1
Cathode Ray Tube

A Real Bargain!! Designed originally as a radar scope indicator, the BC 929A is easily converted to first class lab instrument at a minimum conversion cost. Has extremely high vertical and horizontal sensitivity as well as the extra-wide bandwidth required by microwave radar and television use. Controls include Vert. Centering, Horiz. Centering, Intensity, Focus, Horizontal and vertical amplitude and Sweep duration. Unit originally operated on 400 cycles 110 volt. Tube line-up includes: 2-6HG's, 2-6SN7's, 1-6G6G, 1-6X5GT and 1-2X2. Unit comes complete with tubes and 3BP1 cathode ray tube. **\$14.95**
Brand New! In Orig. Box.



SAVE! CLOSEOUT SAVE!
COMMAND SETS
NEVER BEFORE!... NEVER AGAIN!
"Q" 5's ¹⁹⁰⁻⁵⁵⁰ KC **\$10.95**
LIKE NEW! XLNT COND.

**274N and ARC 5
EQUIPMENT**

Type
BC-455 Revr. 6-9 Mc. Used, with tubes — Like **\$4.95**
New



BC-454 Revr. 3-6MC. Used **\$7.95**
with tubes. Like New.
Dynamotor for above Revr. \$1.00 ex. with each Revr.

BC-456 Modulator. Used with tubes. \$3.95
Sold as is. Less tubes. 2.95
BC-496 Xmt. As is. Less tubes. 9.95
BC-457 Xmt. 4-5.3 Mc. Used, with tubes. 6.95
Sold as is. Less tubes. 3.95
BC-458 Xmt. 5.3-7 Mc. Used, with tubes. 6.95
Sold as is. Less tubes. 3.95
BC-459 Xmt. 7-9.1 Mc. Used, with tubes. 9.95
Sold as is. Less tubes. 5.95
BC-450 3 Revr. Control Box. Used. 1.49
BC-451 Xmt. Control Box. Used. 1.49
3 Receiver Rack. Used. 1.49
2 Xmt. Rack. Used. 1.49
12 & 24 Volt Fil. XFMR for above equip. New. 2.49

METERS—WESTON • SANGAMO

All New. All D.C. 2" Square.
0-2 Ma **\$3.29 each**
0-5 Ma
0-15 Ma
0-50 Ma
0-100 Ma
0-200 Ma
0-300 Ma
0-500 Ma
OR
3 for \$9.00



DC VOLT METERS—2" SQ.
0-20 V. DC **\$3.29 each**
0-40 V. DC
0-300 V. DC **3 for \$9.00**

BC-375 Mod. XFMR. Matches pair of 6140's. **\$2.95**
New

OIL CONDENSERS

2 MFD—GE, 7500 V. New. \$14.95
2 MFD—300VDC G. 6.95
3 MFD—Sprague, 4000 V. New. 5.95
2 MFD—GE, 4000 V. New. 3.95
2 MFD—Aerovox, 2500 V. New. 2.49
10 MFD—Fast, 600 V. New. 1.49
2 MFD—Aerovox or Solar, 600 V. New.97
4 MFD—GE, 600 V. New.59



Brand New!

RADIO COMPASS INDICATOR
1-82A—Part of ARN/ARN-7
Selsyn Controlled

Ideal for use as originally intended, or as a remote indicator for a beam antenna. Unit contains Bendix remote selsyn. Dial scale 0 to 360 degrees with manual compensation adjustment. Numerals and pointer are white on a black background for maximum readability. When used in conjunction with another selsyn mounted on the antenna, Indicator 1-82-A will accurately show direction of beam. Units are brand new. Face is 5" in diameter. Over all depth 3 1/4". Shpg. wt. 2 lbs. **\$6.95**



T9-APQ/2 200-450 MC TRANSMITTER

10 Watts output—uses 2-388 type tubes as push-pull tunable oscillators. Pair of 807's as modulators. With Tubes ... **\$12.95**
Like New



Cash with order. Include 4% Sales Tax with California orders—All orders F.O.B. Los Angeles. When in Los Angeles visit our showroom and ask for Paul—W6QDK, Mgr.

SAM'S SURPLUS • 1306 BOND ST. • LOS ANGELES 15, CALIF.

PLATE TRANSFORMER

American Trans. Co. Input: 115 Vac 60 Cycle 525 KVA. PRI.—22/40/1120 V. Sec.
500 MA. New. **\$14.95**
Shipping Wt. 55 lbs.



**BC-357
Radio Beacon Receiver**
UHF Aircraft Receiver with frequency range from 62 to 80 mc for receiving 75 mc marker beacon signals. Power requirements are 24 volts DC at .158 amps and 220 volts at 4.5 milliamps. New **\$4.95**

TRANSMITTERS GP-7 TRANSMITTER

100-watt master oscill. type. Can be used on any frequency from 350 to 9050 KC by using the proper plug-in tuning unit. Type 803 P and built-in 400 cycle power supply using a pair of 1616 rectifiers. Three 2-inch panel meters: 0-300 MA DC, 0-0 RF Amps, 0-15 AC Volts. A "hot mine" of excellent usable components for building and servicing any high wattage rig. Comes complete with one tuning unit and tubes. Excellent condition. **\$13.95**

MOBILE GENERATOR NOISE FILTERS—55 amps. Gov't. Pr. Approx. \$15.00
With Any Order. 1.00
W/O Order. 1.49

TUNING UNITS FOR BC 375 OR 191 TRANS.

TU-7 4500-6200 kc New \$2.29
TU-8 6200-7700 kc 2.29
TU-9 7700-10000 kc 2.29
TU-10 10000-12500 kc 2.29
TU-26 200-300 kc 2.29

AM-14/APT

100 MC-100 MC—100 W. Power Amplifier for that 2 meter rig. Pair of 4E27 in final. Complete with 110 V. 400 Cy. power supply. Less tubes XLNT. cond. each **\$9.95**

Broadcast Band and Aero MN-26C Installation

A 12 tube remote control manual direction finder desirable for emergency type navigation on boats and planes. Has a frequency range of 150 kc to 1500 kc in 3 bands. This frequency covers the beacon and standard broadcast bands. Operates on 28 V. DC input. Complete installation consists of:
MN-26C Receiver Brand New **\$14.95**
MN-20E Rotatable Loop. New **4.95**
MN-52 Azimuth Control Box New **2.95**



ARC4—VHF TRANSCEIVER

Ideal substitute for SCT-522, freq. range 140-144 mc. crystal controlled, 10 watts. The receiver section has two individual RF sections, feeding a common 3 stage 10mc IF amplifier. Both RF sections may be operated simultaneously or either one in frequency range of the receiver unit has 13 tubes. The transmitter is of straight forward design. Transmitter unit has 7 tubes, one = 832 as final modulated by a pair of 6L6 and push-pull. Complete with tubes. Like New. **\$19.95**
ARC-4 Dynamotor 12 & 24 Volts. 9.95

SPECIAL! 2 MFD-5000 V.

5000 Working Volts. GE PYRANOL Complete with Mounting Brackets **\$5.95**
Brand New

PHONE-CW FILTER

MODEL FL-8
Completely eliminate 1020 cycle CW signals when used on Phone bands—or flip a switch and only 1020 cycle CW Signals **\$1.89**
come thru! New. ea.



DYNAMOTORS PE-101C DYNAMOTOR

6 or 12 Volt
(Reprints of original CQ conversion articles—Oct. and Dec., 1952 issue, furnished.)
• This is the Dynamotor the Hams have been talking about! Easily adapted to supply 625 V. @ 150 MA. and 325 V. 125 MA. at 12 Volts—or 300 V. 90 MA. and 160 V. 110 MA. at 6 Volts. (Illustration shows modified.) NEW. **\$5.95**
Floor Dynamotor—11.6 V. input—425 V.—Output at 375 MA—NEW **\$10.95**
PE-130 With Pack—6, 12 or 24 V. DC input. **\$14.95**
BRAND NEW **\$19.95**
BD-77 Dynamotors—12" input 1000 V. @ 330 MA. NEW **\$14.95**
PE-73 Dynamotors—28" V.—1000 V. @—350 MA. NEW **\$8.95**
PE-103—New, Orig. Crate—Dynamotor. **\$34.95**
Brand New Dynamotor—18 V input @ 450 input at 60 MA—can be operated on 6 or 12 V.—Orig. cost \$29.50. Now—NEW **\$4.95**
PE-126—Dynamotors—14 V. input—Output 350 V. @ 380 MA.—USED **\$6.95**
Wheeler Dynamotor—12 V. input—Output 450 V. @ 200 MA. Made for TCS Equip. NEW. **\$14.95**



CRYSTALS

Guaranteed to oscillate!
Your choice of frequencies!
Largest selection in the world!

NUMBERS LISTED ARE FUNDAMENTAL
 FREQUENCIES IN KILOCYCLES



FT-243 Lots of 10 or more. Ea. **69c**
 Lots of 5 or more. Ea. 79c
 Individually. Ea. 99c

1011	2490	2855	3150	4395	5820	6473.3	7350	7625	7860	8083.3	8310	8550
1105	2495	2860	3155	4445	5825	6475	7358.3	7630	7866.7	8090	8316.7	8558.3
1129	2505	2865	3160	4450	5850	6500	7366.7	7633.3	7870	8091.7	8320	8560
1150	2510	2870	3165	4455	5860	6506.6	7373.3	7640	7873.3	8100	8325	8566.7
1195	2515	2875	3170	4535	5892.5	6525	7375	7641.7	7875	8106.6	8330	8570
1525	2520	2880	3175	4540	5900	6540	7383.3	7650	7880	8108.3	8333.3	8573.3
1500	2525	2885	3200	4580	5907.5	6550	7391.7	7658.3	7883.3	8110	8340	8575
1915	2530	2890	3202	4610	5925	6573.3	7400	7660	7890	8116.7	8341.7	8580
1930	2535	2895	3205	4620	5955	6575	7406	7666.7	7891.7	8120	8350	8583.3
1940	2545	2900	3210	4635	5975	6600	7406.6	7670	7900	8125	8358.3	8590
1950	2550	2905	3220	4680	5995	6606.6	7408.3	7673.3	7906.6	8130	8360	8591.7
1965	2557	2910	3225	4695	6025	6625	7416.7	7675	7908.3	8133.3	8366.7	8600
2015	2560	2915	3230	4710	6006.6	6640	7425	7680	7910	8140	8370	8606.6
2017	2565	2920	3235	4735	6025	6650	7433.3	7683.3	7916.7	8141.7	8375	8608.3
2020	2570	2925	3240	4780	6040	6740	7440	7690	7920	8150	8380	8610
2025	2575	2930	3290	4785	6042	6773.3	7441.7	7691.7	7925	8158.3	8383.3	8616.7
2035	2580	2935	3300	4815	6050	6815	7450	7700	7930	8160	8390	8620
2040	2585	2940	3310	4820	6055	6825	7458.3	7706.6	7933.3	8163.3	8391.7	8625
2055	2590	2945	3320	4840	6075	6873.3	7466.7	7708.3	7940	8166.7	8400	8630
2060	2595	2950	3340	4845	6100	6906.6	7473.3	7710	7941.7	8170	8406.6	8633.3
2065	2600	2955	3410	4852.5	6106.6	6940	7475	7716.7	7950	8173.3	8408.3	8640
2090	2655	2960	3420	4880	6125	6973.3	7483.3	7720	7958.3	8175	8410	8641.7
2105	2660	2965	3455	4900	6140	7000	7491.7	7725	7960	8180	8416.7	8650
2125	2665	2970	3465	4930	6165	7240	7500	7730	7966.7	8183.3	8420	8658.3
2130	2670	2975	3500	4950	6150	7025	7506.6	7733.3	7970	8190	8425	8660
2135	2675	2980	3510	4995	6170	7205	7508.3	7740	7973.3	8191.7	8430	8666.7
2140	2680	2985	3525	5035	6175	7050	7510	7741.7	7975	8200	8433.3	8670
2195	2685	2990	3640	5090	6185	7073.3	7516.7	7750	7980	8206.6	8440	8673.3
2300	2690	2995	3655	5127.5	6200	7075	7520	7758.3	7983.3	8208.3	8441.7	8675
2305	2695	3005	3685	5165	6206.6	67100	7525	7760	7990	8210	8450	8680
2320	2705	3010	3700	5180	6225	7106.6	7530	7766.7	7991.7	8216.7	8458.3	8683.3
2350	2710	3015	3760	5235	6235	7125	7533.3	7770	8000	8220	8460	8690
2355	2715	3020	3800	5245	6240	7140	7540	7773.3	8006	8225	8466.7	8691.7
2360	2720	3025	3885	5285	6250	7150	7541.7	7775	8006.6	8230	8470	8700
2365	2750	3030	3940	5295	6273.3	7160	7550	7780	8008.3	8233.3	8473.3	8706.6
2370	2755	3035	3955	5305	6275	7173.3	7558.3	7783.3	8010	8240	8475	8708.3
2375	2760	3040	3980	5327.5	6300	7175	7560	7790	8016.7	8241.7	8480	8710
2390	2765	3045	3990	5335	6306.6	7200	7560	7791.7	8020	8250	8483.3	8716.7
2415	2770	3050	3995	5385	6315	7206.6	7570	7800	8025	8258.3	8490	8720
2430	2775	3055	4045	5397.5	6325	7225	7573.3	7806.6	8030	8260	8491.7	8725
2435	2780	3060	4095	5435	6335	7240	7575	7808.3	8033.3	8266.7	8500	8730
2440	2785	3065	4110	5545	6340	7273.3	7580	7810	8040	8270	8506.6	8733.3
2442	2790	3070	4135	5582.5	6350	7275	7583.3	7816.7	8041.7	8273.3	8508.3	8740
2450	2795	3075	4175	5587.5	6362	7300	7590	7820	8050	8275	8510	8741.7
2455	2815	3095	4215	5645	6373.3	7306.6	7591.7	7825	8058.3	8280	8516.7	8750
2460	2825	3100	4220	5687.5	6375	7308.3	7600	7830	8060	8283.3	8520	
2465	2830	3110	4295	5730	6405	7316.7	7606.6	7833.3	8066.7	8290	8525	
2470	2835	3130	4295	5760	6406.6	7325	7608.3	7840	8070	8291.7	8530	
2475	2840	3135	4300	5775	6425	7333.3	7610	7841.7	8073.3	8300	8533.3	
2480	2845	3140	4330	5827.5	6440	7340	7616.7	7850	8075	8306.6	8540	
2485	2850	3145	4340	5800	6450	7341.7	7620	7858.3	8080	8308.3	8541.7	

FT-243 Lots of 10 or more. Ea. **34c**
 Lots of 5 or more. Ea. 49c
 Individually. Ea. 99c

4035	4980	5660	5773.3	5880	6273.5	6400	6725	6875	7475	7673.3	7825
4080	5030	5675	5780	5906.7	6275	6406.6	6750	6900	7506.6	7675	7873.3
4155	5205	5700	5805.7	5940	6300	6425	6775	6925	7525	7706.6	7875
4190	5300	5706.7	5840	5950	6325	6673.3	6800	6950	7573.3	7725	7906.6
4280	5437.5	5725	5852.5	5973.3	6350	6675	6806.6	6975	7575	7773.3	7925
4397.5	5485	5740	5873.5	6240	6373.3	6700	6825	7450	7606.6	7775	7973.3
4490	5500	5750	5875	6250	6375	6706.6	6850	7473.3	7625	7806.6	7975

CR-1A Lots of 10 or more. Ea. **69c**
 Lots of 5 or more. Ea. 74c
 Individually. Ea. 99c

6350	6510	6740	7010	7180	7670	8013	8250	8290	8374
6380	6530	6750	7020	7200	7730	8015.7	8272	8308	8392
6450	6550	6800	7160	7550	8007	8200	8284	8340	8400

FT-171 Lots of 10 or more. Ea. **79c**
 Lots of 5 or more. Ea. 89c
 Individually. Ea. 99c

1151.8	1940	2045	2191	2340	2445	2940	3250	3570	3790	3966.5	4110	4400	9200
1562.5	2010	2065	2220	2360	2550	2967	3322.5	3580	3807.5	3970	4112	4735	9590
1738	2030	2082	2258	2390	2557	2990	3400	3637.5	3810	3975	4177.5	5200	
1746	2040	2105	2260	2405	2582	3010	3422.5	3660	3812.5	3980	4245	5225	

TERMS All items subject to prior sale and change of price without notice. MINIMUM ORDER: \$2.50. All CRYSTAL orders MUST be accompanied by check, cash or M.O. WITH PAYMENT IN FULL. NO C.O.D. CALIFORNIA BUYERS add sales tax. INCLUDE APPROXIMATELY 5c PER CRYSTAL FOR POSTAGE. ALL CRYSTAL ORDERS INDICATE SECOND CHOICE FREQUENCIES WHEREVER SUBSTITUTION MAY BE MADE.

ALL CRYSTALS TESTED FOR ACTIVITY!
 1-DAY SERVICE FOR EVERYTHING IN STOCK!

NOVICE FT-243 FUNDAMENTAL FREQUENCIES BAND

Lots of 10 or more. Ea. **99c**
 Individually. Ea. \$1.25
YOUR CHOICE OF FREQUENCIES!

80 METERS 3701, 3702, 3703 through 3748
 in steps of 1 KC.

40 METERS 7176, 7177, 7178 through 7198
 in steps of 1 KC.

DOUBLING T 3588, 3589, 3590 through 3599
40 METERS : in steps of 1 KC.

SINGLE SIDE BAND—FT-241-A



Low Frequency Crystals **79c**

Lots of 10 or more. Each. 89c
 Individually. Each. 99c

400	442	446	450	453	456	459	463	466	470	474	477
440	444	447	451	454	457	461	464	468	472	475	479
441	445	448	452	455	458	462	465	469	473	476	480

MISCELLANEOUS & SHIP BAND FREQUENCIES

81.95 KC. Octal tube type (Used in SCR-584 & SPM-1).....	\$3.99	2670 KC. DC-34.....	2.99
200 KC. FT-241 CR2/U.....	1.99	2738 KC. type 1-C.....	2.99
200 KC. Type DC-15 in octal tube base type holder.....	1.99	2738 KC. FT-243.....	2.99
327.8 KC. No. D-168342. (Used in TS-102/AP).....	9.95	2801 KC. DC-34.....	2.99
500 KC. FT-241.....	1.99	2801 KC. FT-243.....	2.99
1000 KC. Type DC-9 in octal tube base type holder.....	3.45	2807 KC. DC-34.....	2.99
2000 KC. FT-243.....	1.99	2807 KC. FT-243.....	2.99
2009 KC. DC-34.....	2.99	3000 KC. DC-34.....	2.99
2110 KC. DC-34.....	2.99	3023 KC. DC-34.....	2.99
2126 KC. DC-34.....	2.99	3043 KC. DC-34.....	2.99
2142 KC. DC-34.....	2.99	3053 KC. DC-34.....	2.99
2166 KC. DC-34.....	2.99	3053 KC. FT-243.....	2.99
2174 KC. DC-34.....	2.99	3088 KC. FT-243.....	2.99
2182 KC. DC-34.....	2.99	3088 KC. DC-34.....	2.99
2192 KC. FT-243.....	2.99	3093 KC. FT-243.....	2.99
2206 KC. DC-34.....	2.99	3098 KC. FT-243.....	2.99
2200 KC. FT-243.....	1.99	3103 KC. FT-243.....	2.99
2209 KC. DC-34.....	2.99	3125 KC. DC-34.....	2.99
2267 KC. DC-34.....	2.99	3125 KC. DC-34.....	2.99
2629 KC. DC-34.....	2.99	3188 KC. FT-243.....	2.99
2632 KC. FT-243.....	2.99	3193 KC. DC-34.....	2.99
2637 KC. DC-34.....	2.99	3193 KC. FT-243.....	2.99
2637 KC. FT-243.....	2.99	3198 KC. FT-243.....	2.99
2638 KC. DC-34.....	2.99	3200 KC. FT-243.....	2.99
2638 KC. FT-243.....	2.99	5000 KC. FT-243.....	1.99
2670 KC. FT-243.....	2.99	10,000 KC. Type SR-5 Bilitee, in CR-1 holder.....	1.99
2847 KC. FT-243.....	2.99		

COMPLETE SETS!

SCR-508 Set of 80 FT-241 crystals	\$25.00	SCR-609 Set of 120 FT-243 Xtals.	\$48.00
SCR-509 Set of 80 FT-243 crystals	\$32.00	SCR-610 Set of 120 FT-243 Xtals.	\$48.00
SCR-510 Set of 80 FT-243 crystals	\$32.00	TRC-1, TRC-3, TRC-4.....	P.U.R.
SCR-536 Set of 2 FT-243 crystals	P.U.R.	SCR-608 Set of 120 FT-241 Xtals.	\$48.00

DC-34 & DC-35 CRYSTALS Your Choice. Ea. only 99c

Pin Spacing 3/4". Pin Diameter .1875".											
2240	2415	2643	2894	3161	3480	3750	3905	4055	4215	4435	
2255	242										

U.S. CRYSTALS SMASH ANNIVERSARY SALE!

100 GOVERNMENT SURPLUS CRYSTALS ASSORTED FREQUENCIES



SPECIAL PACKAGE DEAL \$9.95

PACKAGE CONSISTS OF

- 80 FT-243
- 10 FT-171
- 10 DC-34-35

IMMEDIATE SERVICE!

SAME DAY SHIPMENT!
(Shipping weight: 5¾ lbs.)

100 CRYSTALS MIXED FREQUENCIES!

AT LEAST **20** HAM BAND FREQUENCIES! TO OPERATE ON 160, 80, 40, 20, 10, 6 AND 2 METERS FOR OPERATION ON FUNDAMENTAL OR HARMONIC FREQUENCY.

With these low, give-away prices, these crystals are not subject to operational guarantee.

RK-65

PENTODE TRANSMITTING TUBE

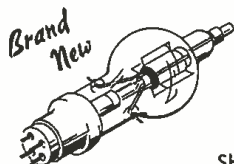

\$9.95

Shipping weight: 3 lbs.

500 WATT CARRIER OUTPUT

REQUIRES ONLY 6 WATTS GRID DRIVING POWER . . .

Operates Similar To Types 4-125A & 4-250A

Fil. Volts 5.0	Class C Amp.
Fil. Amp. 14.0	Telegraphy Telephone
Plate Voltage 3000	2500
Screen Voltage 400	—
Screen Resistor, Ohms —	30,000
Grid Voltage —100	—150
Plate Current, Ma. 240	200
Screen Current, Ma. 70	60
Grid Ma. 22	10
Approximate Grid Driving Power, Watts 6.0	6.3
Approximate Output Power Watts 510	380

Buy Now and Save!



78-B MEASUREMENTS CORP. TEST SET

Modulation 400 and 8200 cycles. Two Bands: 15-25 MC and 190-230 MC. Operates on 117 V AC—25 to 60 cycles. **\$49.95**
NEW CONDITION

Shipping wt. 29 lbs.



LELAND ELECTRIC MOTOR

Complete with Reduction Gear Box; reduces to 60 R.P.M. Motor Rating 110/220 V AC **\$29.95**
60 Cycles, 1725 R.P.M.
¼ h.p. BRAND NEW
Shipping wt. 63 lbs.

Sensational package offer of 3 RECEIVERS! Complete With Tubes & Dynamotors!

75 MC. RECEIVER Shipping wt. 13 lbs. Used, clean. Ea. \$4.95
RU-17 RECEIVER T.R.F. Medium freq. Shipping wt. 12 lbs. Used. Ea. \$2.95
ARC-5 RECEIVER 3 to 6 MC. Less dial plate. Shipping wt. 10 lbs. Used, clean. Ea. \$4.95

ALL THREE RECEIVERS \$8.95

Shipping wt. 41 lbs.

MISCELLANEOUS SPECIALS!

2 MFD. 6,000 V. CONDENSER. Used. Ea. \$6.95
2 MFD. 5,000 V. CONDENSER. G.E. Pyranol. BRAND NEW. Each. \$5.95

PLATE TRANSFORMER

American Trans. Co. INPUT: 115 VAC, 60 cycles, 525 KVA. 2240/1120 V. SEC. 500 MA. Brand new!
Shipping wt. 55 lbs. **\$14.95**

ZENITH MODEL DC-18-A 1,000 KC CRYSTAL

Built-in 12 V. automatic thermostatic controlled heating unit. 8-pin octal base. Ea. **\$5.95**

NOTE: All orders must be accompanied by check, cash or money order with payment in full. No C.O.D. California buyers: Add sales tax. Check your postal zone and add sufficient postage. For items weighing more than parcel post limit (30 lbs.) shipment will be made via railway express freight collect.

NEW CODE PRACTICE TAPE! Reduced!
REELS NO. 10, 13, 14. Ea. \$99c
PACKAGE DEAL! ALL 3 REELS. **\$1.75**
Shipping wt. 5 lbs.

U. S. CRYSTALS, INC.,

805 S. UNION AVE.,
LOS ANGELES 17, CALIF.



Now!

KAY-TOWNES

brings you complete

Protection from the Rear

Plus

Quick Rig!

THE *first*

SNAP-OUT

ANTENNA WITH THE

EXCLUSIVE  DOUBLE LOCK

FEATURE!

Boom also folds to take less room in storage and for ease of installation. Sure-grip mast clamp holds in gale-force winds... will not slip or crush.



Exclusive with KAY-TOWNES Elements will not droop, sag or fold up on a Kay-Townes Antenna... they're nested and double locked in position to stay in position.



New features that make the K-T "REAR-GUARD" America's most advanced TV Antenna!

- ★ Completely Preassembled, it's mechanically safe!
- ★ It snaps in place to stay in place! Elements are double locked in position! A K-T Exclusive!
- ★ No bolts or nuts to tighten on elements!

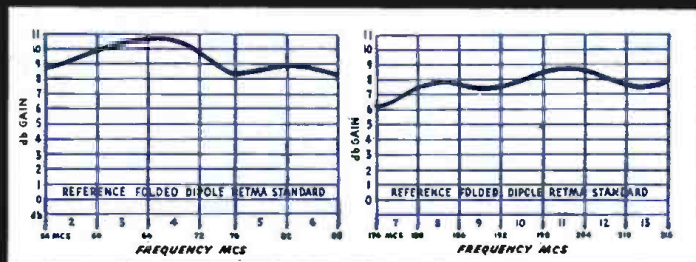

Front to back ratio is better than 25/1 forward lobe 30° or better standing wave ratio 1.2:1 average.



CHANNEL 2 THROUGH 13
RADIATION CURVE
REPRESENTING ALL
VHF CHANNELS

Over 20 to 1 ratio on ALL Channels

For Quality...

Manufactured and distributed in Canada by Delhi Metal Products, Ltd., Delhi, Ontario

REAR GUARD

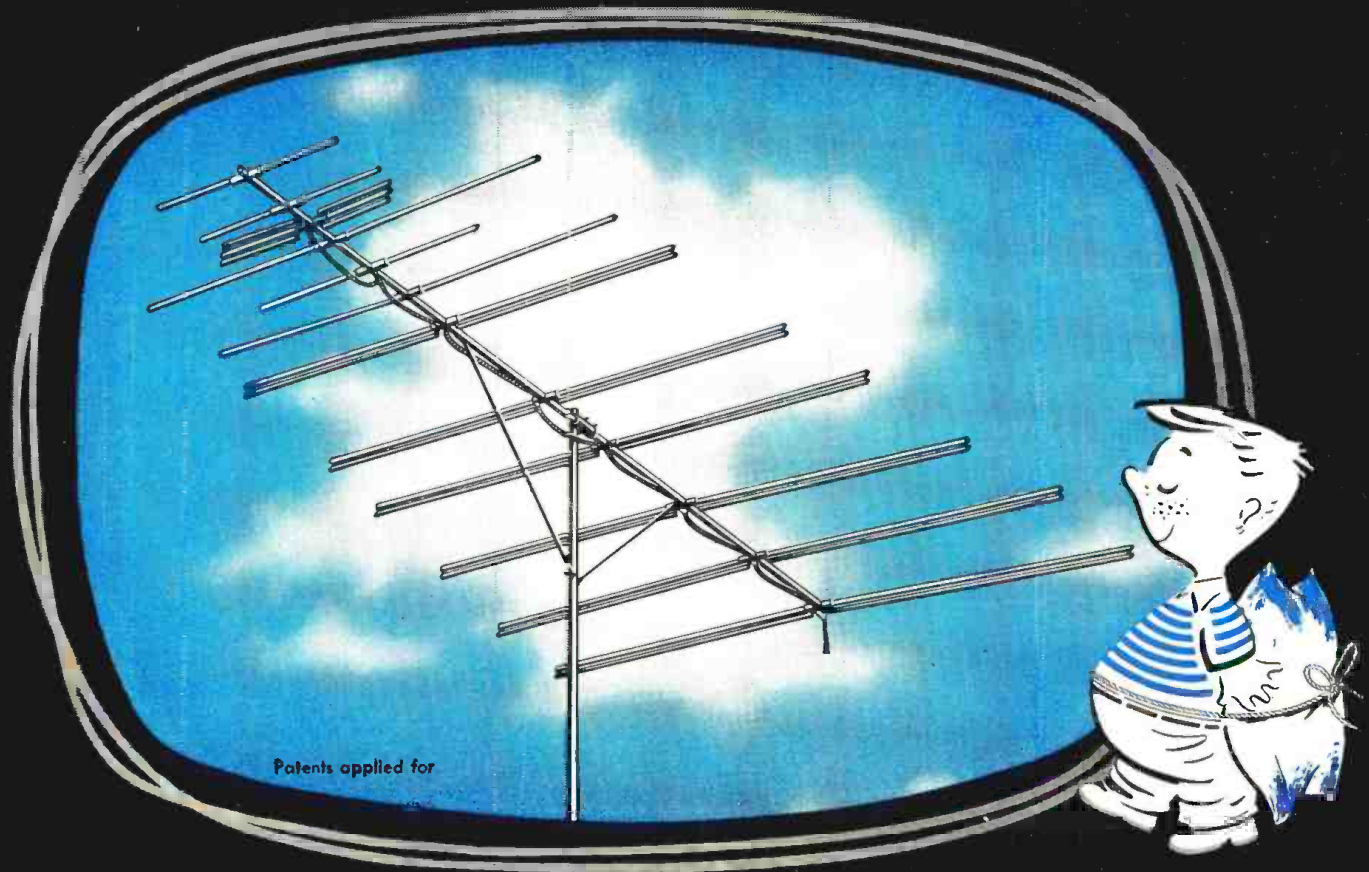

THE ANTENNA DESIGNED TO REJECT UNWANTED SIGNALS FROM REAR AND SIDES!

In areas where many local stations or stations from near-by cities interfere with reception, ordinary antennas cannot filter out unwanted signals from sides and rear ... BUT the KAY-TOWNES REAR-GUARD, with a front to back ratio far in excess of 20 to 1, is designed for *this* particular job ... to give quality reception even in problem areas.

Add to the REAR-GUARD'S pin point selectivity such exclusive K-T features as double locked and nested elements that cannot droop or sag, Sure-Grip Mast Clamp that holds in gale-force winds without slipping or crushing, extra rigid construction and wood dowel pins and crimped ends that relieve metal fatigue due to vibration ... they all add up to *America's most wanted TV Antenna.*

... for Performance look to KAY-TOWNES!

The First Name in TV Antennas

KAY-TOWNES

ANTENNA COMPANY

BOX 593B, ROME, GEORGIA

*Use the K-T Line
of television
accessories*

**LEARN basic electricity
THE EASY "PICTURE BOOK" WAY!**



**Just Released:
The fabulous new
ILLUSTRATED
Training Course
now used by
the U. S. Navy!**

You Learn by Pictures

Over 25,000 Navy trainees have already learned Basic Electricity this easy, "Picture Book" way! Now, for the first time, YOU can master the basics of Electricity with this same "Learn-by-Pictures" training course! Over 900 simple, easy-to-understand drawings explain every section—these "teaching" pictures actually make up more than half the entire course! No other Basic Electricity course in America uses this revolutionary illustrative technique! You learn Basic Electricity faster and easier than you'd ever dream possible!

A Complete Idea on Every Page

Here's how this easy, illustrated course works: every page covers the complete idea! There's at least one big illustration on that same page to explain it! What's more, an imaginary instructor stands figuratively at your elbow, doing "demonstrations" that make it even easier for you to understand. Then, at the end of every section, you'll find review pages that highlight the important topics you've just covered. You build a thorough, step-by-step knowledge at your own pace — as fast or as slow as you yourself want to go!

**Everyday English — A Course
Anyone Can Understand**

Sponsored by the Navy to turn out trained technicians in record time, this modern course presents Basic Electricity in a simple way that everyone can grasp — regardless of previous education! Every phase is made instantly clear — explained in plain, down to earth English — with hundreds of easy-to-understand illustrations to help you!

5 Complete Volumes

Volumes 1 and 2 of this outstanding illustrated course cover DC components and circuits; Volumes 3 and 4 cover AC components and circuits; Volume 5 covers AC and DC motors and machinery.

Home Study Without Correspondence

This course is so different, so complete — there's no need for the usual letter writing, test taking, question and answer correspondence! You learn at home — at your own pace!

**10 Day Examination —
Money Back Guarantee**

Send today for this exciting new Basic Electricity training course — you risk nothing! When you receive the 5 volumes, examine them in your own home for 10 full days. If, at the end of that time, you're not completely satisfied, simply return the books to us and we'll gladly refund your full purchase price! Total cost for the 5-volume course is only \$9.00! In Canada, prices approximately 5% higher.

ORDER TODAY!

"Basic Electricity" is sold by most parts jobs and book stores. If YOUR dealer doesn't have these books, mail this coupon to us!

**JOHN F. RIDER PUBLISHER, INC.
480 Canal Street, N.Y.C.**

Please RUSH me.....sets of "Basic Electricity" @ \$9.00 per set. I understand that I may return the books within 10 days and receive a complete refund of my full purchase price.

Name
Address
City & State

"SATELLITE" TV TRANSMISSION SYSTEM

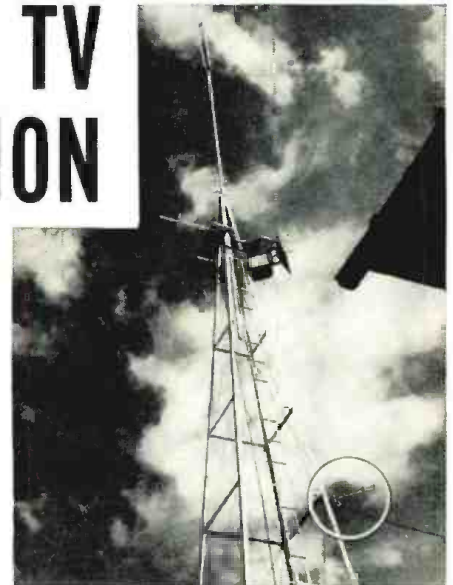

The 60-foot tower used to mount Sylvania's "satellite" TV antennas. The structure carries a microwave receiving dish, a u.h.f. (channel 82) transmitting antenna, and two channel 22 receiving antennas for feeding television receivers in the laboratories.

A RESEARCH program, originally designed to provide the answers to some of the u.h.f. transmission and reception problems, shows promise of "paying off" in the low-cost TV station field.

Sylvania Electric Products Inc. of Emporium, Pa. has successfully developed an experimental "satellite" TV transmission system which is designed to provide video reception in areas where good signals are now blocked by mountains, hills, etc.

Under the satellite system of television, transmitted signals are picked up from one or more distant television stations. Those signals are amplified by the satellite station, and then are re-transmitted on a different television channel.

As a result of this successful experimentation, Sylvania some time ago petitioned the FCC to adopt rules, regulations, and standards for satellite TV broadcast stations.

At the present time the company has a satellite system in operation at Emporium, a hilly community of 3600 population in north-central Pennsylvania. The antenna is fixed 1000 feet above the community and 1½ miles, line-of-sight, from the town proper. Transmission equipment was installed and, with FCC approval, the first unattended satellite operation of experimental KG2XDU began transmitting to Emporium.

Since the original station was set up two years ago, the station has made

direct off-the-air pickups of the regular broadcast signals on experimental u.h.f. satellite channel 22. Since March 1953, Sylvania has also operated a second u.h.f. satellite station in downtown Emporium (KG2XEL operating on channel 82), which, via microwave beam from the tower on the hill, has rebroadcast the programs from WJAC-TV. Occasionally, programs of WBen-TV (Buffalo) and WFBG-TV (Altoona) are rebroadcast. Both KG2XDU and KG2XEL are low-powered stations with a nominal 10-watt transmitter output.

These experiments have indicated that satellite transmitters operating with 10 watts output power and approximately 175 watts e.r.p. will provide acceptable broadcast service within a radius of six miles without any appreciable change in the interference conditions of existing stations. —30—

Sylvania's tower for its satellite TV operation in Emporium, Pa. The tower supports the channel 22 transmitting antenna, a channel 6 (Johnstown, Pa.) receiving antenna, and a microwave link transmitting antenna. The small box directly behind the parabolic antenna contains the microwave transmitter used with this satellite system.

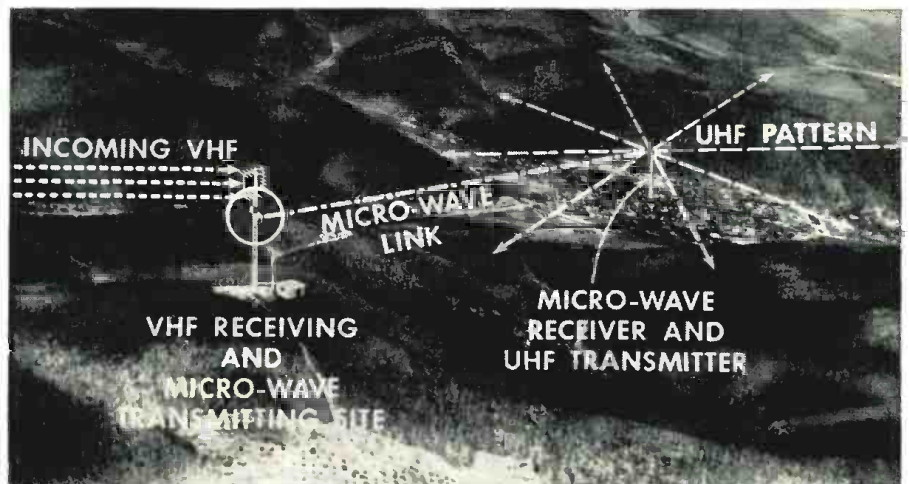



G-C RADIO-TV SERVICE CEMENT
Repair speaker cones, voice coils, etc. Waterproof.
No. 34-2 2 oz. tube List \$0.60



G-C BAKELITE CEMENT
Cement broken cabinets, knobs, panels, all plastics.
No. 32-2 2 oz. bottle List \$0.85



G-C FABRIC & GRILLE CLOTH CEMENT
Cement cloth to metal, plastic or wood. Fast-drying.
No. 22-2 2 oz. bottle List \$0.65



G-C ACRYLIC CEMENT
Cement Lucite, Plexiglas, other acrylics. Fast-drying.
No. 40-2 2 oz. bottle List \$0.65



G-C TELEVISION TUBE KOAT
Recoat scratched or peeling picture tubes. Fast-drying.
No. 49-2 2 oz. bottle List \$0.95



G-C RED-X TV CORONA DOPE
Prevents TV high voltage corona shorts. Fast-drying.
No. 50-2 2 oz. bottle List \$1.20



G-C KOLLOID ACRYLIC SPRAY
For UHF-VHF TV and other high frequencies.
No. 8665 12 oz. can List \$1.79



G-C LIQUIDOPE
Coil dope for all-wave coil windings. Fast-drying.
No. 36-2 2 oz. bottle List \$0.65



G-C PORCELAIN PATCH STICK
For scratches on refrigerators, sinks, etc. Easy to use.
No. 908 List \$0.50



G-C SHELLAC STICK KIT
Kit of 10 assorted colors; for all woods. Easy to use.
No. 925 List \$2.25



G-C TV ROLL-AROUND
Fits all console TV sets, ball-bearing, easy to move.
No. 8957 List \$9.95



G-C No. 71-42-STRAND BRONZE CABLE
Twisted phosphor bronze cable for dials; .040" dia.
No. 71-25 25 ft. spool List \$1.65

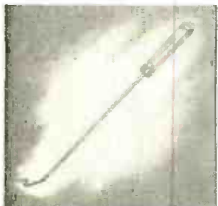

G-C DIAL CABLE TOOL
Handy for replacing cables or dial springs.
No. 5096 List \$0.85

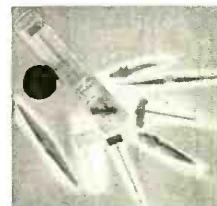

G-C DIAL POINTER KIT
Kit of 10 assorted dial pointers.
No. 6810 List \$3.25



Ask For These

RADIO-TV SERVICE AIDS

at Your Jobber



G-C TV-RADIO KNOB FELTS
Brown felt washers to prevent scratches. Envelope of 50.
No. 1065-E List \$0.45



G-C TV-RADIO KNOB SET SCREWS
Assorted lengths, slotted, cup point.
No. 1060 50 assorted List \$1.10



G-C TV-RADIO KNOB PULLER
Saves time, protects the cabinet.
No. 1063 List \$0.50



G-C PHONO NEEDLE SET SCREWS
Assorted replacements for all cartridges.
No. 1052-E 7 assorted List \$0.45



G-C FYBEROID FISH PAPER
For many electrical uses around the shop.
.10"—240 sq. in. roll.
No. 560 List \$0.55



G-C MINI-MAX STRIP
For connecting 67½ volt "B" batteries.
No. 8115 List \$0.30



G-C PLASTIC TUBING KIT
Kit of assorted Genflex colors and sizes.
No. 635 25 ft. assorted List \$1.00



G-C TV LINE PROTECTIVE TUBING
Protects 300-ohm flat line from damage.
No. 625 Box of 8 ft. List \$1.10



G-C BASEBOARD CLIPS
Handy to run wire safely around room. Envelope of 20.
No. 8345-E List \$0.45

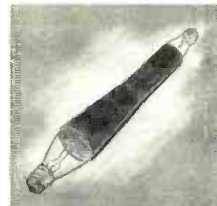

G-C PILOT LAMP INSTALLER
Handy rubber tool for 211 small lamps.
No. 7935 List \$0.65



G-C PICK-UP TOOL
Reaches into difficult places easily.
No. 5089 List \$1.65



G-C THIN TYPE TEST LEADS
Slim handles and test prods, 50" wire.
No. 8465 List \$2.10



G-C ALLIGATOR & WRENCH ALIGNING TOOL
Combination alligator and 1/4" hex wrench.
No. 5012 List \$0.55



G-C LONG NOSE CLAMP PLIERS
Jaws closed unless handles are squeezed. Straight nose.
No. 5192 List \$1.00

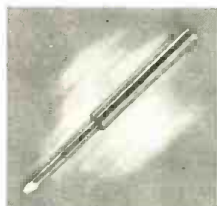

G-C SPEEDEX SOLDER IRON TIPS
High heat, turn-down tip; fits 3/4" irons.
No. 8741 List \$1.00



G-C TWEEZER KIT
Handy set of 3 tweezers for service work. Leatherette case.
No. 7950 List \$3.55

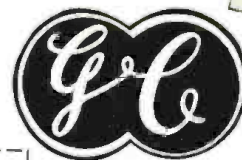

FREE!
Your Copy of the big illustrated G-C Catalog. Send postcard today!



GENERAL CEMENT MFG. CO.

919 Taylor Avenue • Rockford, Illinois

ASK YOUR JOBBER FOR THE **G-C** SPECIALS OF THE MONTH

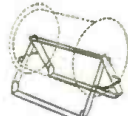
 G-C SPRA-KLEEN	 G-C TV CHASSIS SUPPORT	 G-C REAR SPEAKER KIT	 G-C PORTABLE WIRE REE.
---	---	---	---

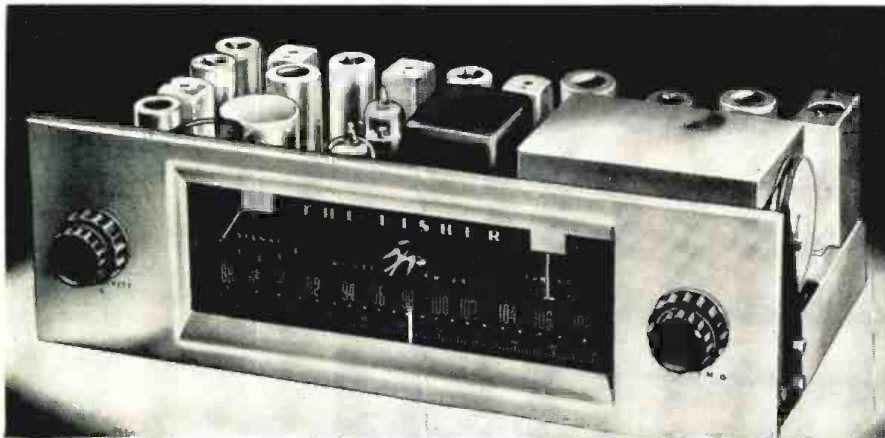

Now! Micro-Tuning!

THE 
FISHER

FM TUNER MODEL FM-80

World's Best by I. R. E. Standards

NEVER before in the history of Frequency Modulation has there been a tuner to match the remarkable, new FISHER FM-80. Equipped with TWO meters, it will outperform any existing FM tuner, *regardless of price!* The FM-80 combines extreme sensitivity, flexibility, and micro-accurate tuning. It has an unusually *compact*, beautifully designed chassis. Like its renowned companions, the FISHER FM-AM Tuners, Models 50-R and 70-RT, we predict the FM-80 will be widely imitated, but never equalled. Be sure; buy THE FISHER. **Only \$139.50**

Outstanding Features of THE FISHER FM-80

- TWO meters; one to indicate sensitivity, one to indicate center-of-channel for micro-accurate tuning.
- Armstrong system, with two IF stages, dual limiters and a cascode RF stage.
- Full limiting even on signals as weak as one microv.t.
- Dual antenna inputs: 72 ohms and 300 ohms balanced (*exclusive!*)
- Sensitivity: 1½ microvolts for 20 db of quieting on 72-ohm input; 3 microvolts for 20 db of quieting on 300-ohm input.
- Chassis *completely* shielded and shock-mounted, including tuning condenser, to eliminate microphonics, and noise from otherwise accumulated dust.
- Three controls — Variable AFC/Line-Switch, Sensitivity, and Station Selector PLUS an exclusive Output Level Control.
- Two bridged outputs. Low-impedance, cathode-follower type, permitting output leads up to 200 feet.
- 11 tubes.
- Dipole antenna supplied. Beautiful, brushed-brass front panel.
- Self-powered.
- WEIGHT: 15 pounds.
- SIZE: 12¾" wide, 4" high, 8½" deep including control knobs.

Price Slightly Higher West of the Rockies

WRITE TODAY FOR COMPLETE SPECIFICATIONS

FISHER RADIO CORP. • 21-23 44th DRIVE • L. I. CITY 1, N. Y.

Certified Record Revue (Continued from page 48)

quent wiriness in the strings and occasional transient distortion to mar an otherwise good engineering job. If you are in the mood for some light musical fare, try this recording. A little cut in the treble and a slight boost in the bass helped the NARTB curve and made the disc sound better to *my* ears. Good surfaces in my copy.

OFFENBACH

SUITE FROM BLUEBEARD
SUITE FROM HELEN OF TROY
Ballet Theatre Orchestra conducted by Joseph Levine. Capitol P8277, RIAA curve. Price \$5.95.

This disc will be warmly welcomed by balletomanes who have been lamenting the non-existence of a recording of "Bluebeard," and who want a little more sonic splendor for their "Helen of Troy." Two of the most amusing ballets ever written, the music of which is full of gaiety and excitement. Dorati has expertly arranged Offenbach's scores for adoption to the ballet, with highly listenable results. "Helen of Troy" receives a better performance from Dorati in the earlier *Victor* disc, but Levine is no slouch and he has the advantage of a more modern sound. In "Bluebeard," Levine shows that deft touch, that light-handedness which endows his ballet readings with such charm and grace. Excellent sound in both ballets, with nice clean string tone and superb woodwind reproduction, especially outstanding. The RIAA curve did not need adjustment.

COOK ROAD RECORDINGS

CARIBEANA (No. 8003)
MARIMBA BAND (No. 5007)
AMERICAN STORYTELLERS
(No. 5009)
CAMP HAS A BALL (No. 5005)
CALLIOPE AND CAROUSEL
(No. 5010)
VOICE OF THE SEA (No. 5011)

This is a group of most unusual recordings from Emory Cook, the "Sounds of our Time" man. Recorded by Cook on travels from Maine to Mexico, it is material far off the beaten track to put it mildly! A lot of the recording was done with spring drive tape recorders, and other equipment of lesser quality than is usual with Mr. Cook. However, he is honest enough to state on the back of his amusing record jackets that the fidelity is highly variable. He uses a coding system so you can ascertain before you buy if the subject is "low-fidelity" or otherwise. Frankly, much of the material holds little interest for me, but don't let that deter you. These require subjective listening to the nth degree. I find the most listenable and interesting of the group is the "Marimba Band," "American Storytellers" and the "Voice of the Sea." The "Marimba" in this case is a 23-foot monster played by six men! In a group of traditional Latin-American scores the quite-hi-fi sound of this instrument is something to experience. In "American Storytellers" you have some rambling tales of whaling and shipwreck by a couple of real salty old "down-easters". Nothing here but voice and the atmospheric ticking of the ship's clock, but the colorful dialogue spoken and the "down-east" accent weave quite a spell. The *piece de resistance* is the "Voice of the Sea." This recording started a near riot at the N. Y. Audio Fair. Positively the greatest record for practical jokers in existence. Dig this dirty deal! . . . invite some quiet, culture-loving friends (preferably those belonging to your wife) over to your home for an evening of classical music. When they are nicely settled and

glowing from a few dollops of "Old Stepfather," furtively place the "Voice of the Sea" on the turntable of your super-Razzmatazz Sound System, and just as furtively, turn the gain on your 60-watt amplifier all the way up! Now watch the fun! As your friends listen attentively for the first notes of a nice quiet Mozart piano sonata, a series of terrifying blasts smite them! When you have finished scraping them off the wall, and have calmed their nerves with some more of "Old Stepfather," explain quietly to them that your amplifier didn't blow up . . . it was merely the Queen Mary's whistle sounding as she left her pier and headed to sea! Yessir, if your sound system is big enough and rugged enough, this is the doggondest sound ever. The rest of the disc has other harbor whistles and sounds of the sea, including the deafening whine of blowers in a U. S. Navy cruiser. Crazy man, crazy! The other side of the disc is devoted to the sounds of waves on different kinds of beaches, including the highly dramatic thunder of storm waves. All in all, if you can overlook possible divorce actions growing out of your playing this disc, it is quite an adventure in sound!

PROKOFIEV

ALEXANDER NEVSKY
Vienna State Opera Orchestra and Chorus, Ana Maria Iriarte, mezzo-soprano conducted by Mario Rossi. Vanguard VRS451, NARTB curve. Price \$5.95.

Here is an absolutely astonishing recording, ranking in quality with the finest work being done today. If you are not familiar with this incredible score, listen to it for a thrilling experience. Those of you who know the work will be glad to learn that this is in every aspect a worthy successor to the old Ormandy-Columbia version. There may be those who would have preferred a new English version, but listen to this disc in the original Russian and see how much better this language is suited to the music. Ana Maria Iriarte, who did such fine work in the *Angel* "El Amor Brujo," is heard on this disc in the same role sung by Jennie Tourel in the earlier version. Miss Iriarte may not have the great power and resonance, the vocalism of a Jennie Tourel, but in beauty of tone and in dramatic expressiveness she need bow to no one. Mario Rossi seems to have a natural affinity for modern scores and, as far as I'm concerned, gives a more fluent, more cohesive reading than does Ormandy. And if Mr. Rossi's orchestra has less polish and precision than the fabulous Philadelphia, it makes up for this in spirit and enthusiasm. The old Columbia was a good recording for its day, but the sound on this Vanguard is outstanding, a veritable *tour-de-force*. From what I hear, I surmise that a variation of the microphone-suspended-over-the-podium technique has been used. The microphone employed is the new Siemens variable pattern condenser type, and I would guess it was set for omnidirectional pickup. This mike is similar to the *Telefunken* in characteristics, and is considered by some to be superior. One thing is very apparent . . . Vanguard engineers know how to get the best from this mike. Superbly clean string tone is a feature of this disc as is the super brilliant brass. Some of the brass sonorities, especially those at the beginning of the first movement, and before the "Battle on the Ice" scene are fantastic. Percussion is tremendous, very sharp and accurate. Snare, tympani, and above all . . . the bass drum, are reproduced with startling clarity. The over-all sound is very wide range, virtually distortion-free. Dynamic range is among the greatest on records. Choral work was excellent and a good balance between vocal and orchestral elements was carefully maintained. Acoustic perspective was proper for maximum "presence" with a minimum of reverberatory blur

February, 1955

SWEEPING THE COUNTRY

The Greatest Advance

IN AMPLIFIER DESIGN
IN TWENTY YEARS!

FISHER

Z-MATIC

PAT. PEND.

THE unusual, the choice—both are a regular and traditional product of our engineering laboratories. But never before have we offered a technological advance so obviously needed, so long overdue, as the exclusive FISHER Z-Matic. Regardless of the speaker system, be it a modest 8" unit or a giant assembly, the vast acoustic improvement contributed by FISHER Z-Matic is instantly apparent and truly astonishing. For Z-Matic has at one stroke eliminated the energy-wasting, distortion-producing mismatch that has prevented the *complete* union of speaker and amplifier ever since the advent of electronic sound reproduction. Z-Matic is now standard equipment on all FISHER amplifiers.



50-Watt Amplifier • Model 50-AZ

100 watts peak! World's finest all-triode amplifier. Uniform within 1 db, 5 to 100,000 cycles. Less than 1% distortion at 50 watts. Hum and noise 96 db below full output. Oversize, quality components and finest workmanship. \$159.50



Master Audio Control • Series 50-C

"Finest unit yet offered." — *Radio and TV News*. 25 choices of record equalization, separate bass and treble tone controls, loudness balance control. 5 inputs and 5 independent input level controls, two cathode follower outputs.

Chassis, \$89.50 • With cabinet, \$97.50

What Z-Matic Does

- Multiplies the efficiency and effective audible range of any speaker system, regardless of size.
- The continuously variable Z-Matic control permits any setting, according to personal taste or the requirements of the speaker system.
- Eliminates need for oversize speaker enclosures and automatically corrects inherent deficiencies in speaker or speaker housing.
- Z-Matic must not be confused with tone, equalization, loudness balance or damping factor controls. It is an entirely new development.
- Only FISHER amplifiers have Z-Matic.

A Word to Our Patrons

Your FISHER 50-A or 70-A amplifier can be readily equipped with Z-Matic. A complete kit of parts and easy-to-follow instructions are available at a cost of only \$2.50 to cover handling. Give serial number and model.

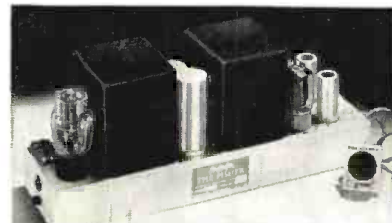

25-Watt Amplifier • Model 70-AZ

50-watts peak! More clean watts per dollar. Less than 1/2% distortion at 25 watts (0.05% at 10 watts.) Response within 0.1 db, 20-20,000 cycles; 1 db, 10 to 50,000 cycles. Hum and noise virtually non-measurable! \$99.50

Prices Slightly Higher West of the Rockies

WRITE TODAY FOR COMPLETE SPECIFICATIONS

FISHER RADIO CORP. • 21-23 44th DRIVE • L. I. CITY 1, N. Y.

Fine Additions

TO COMPLETE YOUR
HOME MUSIC SYSTEM

FISHER ACCESSORIES



MIXER-FADER • Model 50-M

NEW! Electronic mixing or fading of any two signal sources (such as microphone, phono, radio, etc.) No insertion loss. Extremely low hum and noise level. High impedance input; cathode follower output. 12AX7 tube. Self-powered. Beautiful plastic cabinet. **Only \$19.95**



PREAMPLIFIER-EQUALIZER • 50-PR

Professional phono equalization. Separate switches for HF roll-off and LF turn-over; 16 combinations. Handles any magnetic cartridge. Extremely low hum. Uniform response, 20 to 20,000 cycles. Two triode stages. Fully shielded. Beautiful cabinet. Self-powered. **\$22.95**

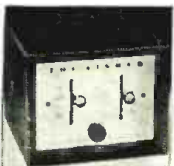

PREAMPLIFIER-EQUALIZER • 50-PR-C WITH VOLUME CONTROL

50-PR-C. This unit is identical to the 50-PR but is equipped with a volume control to eliminate the need for a separate audio control chassis. It can be connected directly to a basic power amplifier and is perfect for a high quality phonograph at the lowest possible cost. **\$23.95**



HI-LO FILTER SYSTEM • Model 50-F

Electronic, sharp cut-off filter system for suppression of turntable rumble, record scratch and high frequency distortion — with absolute minimum loss of tonal range. Independent switches for high and low frequency cut-off. Use with any tuner, amplifier, etc. **\$29.95**



PREAMPLIFIER • Model PR-5

A self-powered unit of excellent quality, yet moderate cost. Can be used with any low-level magnetic cartridge, or as a microphone preamplifier. Two triode stages. High gain. Exclusive feedback circuit permits long output leads. Fully shielded. Uniform response, 20 to 20,000 cycles. **\$12.57**

FLASH!

At the historic High Fidelity Concert given by the National Symphony Orchestra in Constitution Hall, November 13th, 1954, FISHER 50-AZ Amplifiers and a FISHER Master Audio Control were used to play back the tape recordings made on the spot for the thrilled audience. "Listeners could hardly tell the difference between real and electronic."—TIME MAGAZINE. See next page for FISHER amplifiers.▶

WRITE TODAY FOR COMPLETE SPECIFICATIONS

FISHER RADIO CORP. • 21-23 44th DRIVE • L. I. CITY 1, N. Y.

and fusion. This recording is a prime example of the kind of quality that can be obtained by a small company willing to properly utilize the tools and techniques which are available today. There are several big companies whose recorded sound is badly in need of renovation, who could profit by this example . . . if they would bring their heads out of the political sand. This recording is unreservedly recommended.

WILLIAMS, VAUGHN

SYMPHONIES #1, #4, #5, #6
London Philharmonic Orchestra conducted by Sir Adrian Boult. London LL972/3, 974, 975, 976. RIAA curve. Price \$5.95 each disc.

A few months back London issued its monumental limited edition of all the symphonies of Vaughn Williams. They have now made the symphonies separately available, which will be good news to all those who couldn't plunk down the \$55.00 for the limited edition. I reviewed the great "Sinfonia Antarctica" last month and now will take up the matter of the remaining symphonies. The first or "Sea Symphony," one of Vaughn Williams most robust works, is also the only symphony in which he employs chorus and soloists (unless one includes the brief wordless choruses of the "Sinfonia Antarctica"). There is in fact some question as to whether the "Sea Symphony" is a symphony at all, but rather a cantata. Arguments aside, it is a profoundly beautiful work, based on the poems of Walt Whitman. The choral work of the London Philharmonic Choir is magnificent and an excellent job is done by soloists Isobel Baillie and John Cameron. The 4th Symphony is the most "modern" of Vaughn Williams' works. Violence is its theme, the anger of the composer at the senselessness of war, the motive force. A bitter and an accusing work, its almost unrelenting discord is terrifying in its passionate intensity. The 5th Symphony has peace as its theme, but paradoxically was written during the war years. Perhaps the simplest and yet the most complex of the philosophies of Vaughn Williams, it is seldom performed in this country. This in itself is strange, since the work has a great appeal and some of Vaughn Williams' most supremely beautiful writing. The finale is one of the most moving in all symphonic literature. The 6th Symphony is perhaps the best known of Vaughn Williams' works in this country. This is probably due to the championing of the work by Leopold Stokowski, and his recording of it early in the LP era. Again we have a work of violence which is, however, tempered by the quiet serene mysticism of the finale-epilogue. I most heartily agree with Dr. Stokowski when he says, "the epilogue of the Vaughn Williams 6th Symphony is one of the great experiences in music." Once you hear it, you will never forget it. There is something basic, something elemental and almost "other worldly" in the hushed measures. Practically the whole of the epilogue is played pianissimo, getting softer and softer, until it trails off into nothingness. Needless to say, a quiet copy, and hum and hiss-free amplifier is a great asset in listening to this passage. The musicianship in the entire series is exemplary. The composer was in attendance at all of the recording sessions and perhaps in tribute to him, everyone concerned went "all out" and gave of their best. Sir Adrian's conducting is an absolute marvel, considering the musical range and complexities of these widely varied symphonies. His sense of balance is uncanny and his handling of dynamics (one of the most important elements in Vaughn Williams' works) contributes much to the success of his readings. The orchestra played as if inspired, and truly, this might have been the case. London has given all of these symphonies the benefit of

their best engineering. String tone has evidently been given special attention, as it is so important in these works. Really clean and wide range with none of the harsh "phony-fi" edginess. Big sonorous brass sounds and splendidly "live" woodwinds throughout the symphonies. High percussion, especially cymbals, come through with crystal clarity. Tympani and bass drum are clearly reproduced, and the bass drum in the "Scherzo" of the 6th symphony is especially notable for its impact and realism. As you may have guessed, I am a devotee of Vaughn Williams, hence this rather long review. It takes a little time to acclimate one's self to this great composer, but once you do, his hold is extraordinary. By any and all means, try to listen with an open mind to these symphonies. I think you will find it an ultimately rewarding experience. None of the discs required curve adjustment and, generally, surfaces were good.

CORELLI
CONCERTO GROSSO IN D
VIVALDI
CONCERTO IN F
CLEMENTI
SYMPHONY IN D

Virtuosi di Roma conducted by Renato Fasano. His Master's Voice, LMIV-2, RIAA curve. Price \$5.95.

It's kind of hard to keep up with the Virtuosi di Roma. They were first heard on the old *Cetra-Soria* label, then on *Decca*, and here they are on a new orthophonic *HMV*. The one thing that has remained constant, however, is their incomparable skill and artistry. On this disc they play works by three of the great Italian composers whose musical contributions are just now being realized. A virtual renaissance is taking place with these composer as discoveries of much of their work is now being catalogued and published. The music here is all charm and grace, and highly listenable. Fasano has not lost his magic touch with his men, and the performances are truly miracles of tone and precision. Some of the most extraordinary string tone ever engraved on a disc. Sweet, clean, edgeless strings, very wide range and blessed with near perfect acoustics, this is the kind of string tone one wants in all recordings and which one is so seldom granted. The album is beautifully packaged and deserves mention. A beautiful full color reproduction of a Madonna and Child painted by Crivelli is included. RIAA curve was OK.

HAYDN
SYMPHONY #100
SYMPHONY #102

London Philharmonic Orchestra conducted by George Solti. London LL-1043, RIAA curve. Price \$5.95.

London is once more to be commended for "upgrading" their catalogue. This disc represents a more modern sound than their earlier version with Edward Van Beinum. Of course, I am referring here to the "Military" symphony, as the previous disc had Haydn's 104th rather than the present 102nd symphony. While the 102nd receives a splendid reading at the hands of Solti and the sound is of the highest quality, it is the "Military" symphony that most people will be interested to hear. Why? Because any version of this work will inevitably be compared to one of the most famous recordings in the LP catalogue, namely the *Westminster* edition with Hermann Scherchen. At the time of issue, the *Westminster* disc was a "hi-fi" miracle. The famous tympani and triangle section of the second movement was used to demonstrate countless thousands of sound systems. Whether this percussion should be played forte, as it was in the *Westminster*, is open to debate and the controversy still

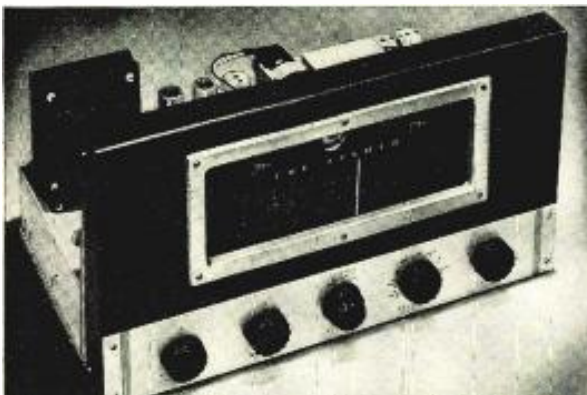

MODEL 70-RT

World's
Finest

BY I. R. E.
STANDARDS

FISHER

Professional

FM-AM TUNERS

THE truest index to the quality of FISHER Tuners is the roster of its exacting users. An Eastern FM station chose the FISHER to pick up selected New York and Washington programs *direct*, for rebroadcast to its own community. Reception of FM stations over 150 miles distant, terrain permitting, is a regular occurrence, if you own a FISHER Professional FM-AM Tuner, 70-RT or 50-R.

MODEL 70-RT

■ Features *extreme sensitivity* (1.5 mv for 20 db of quieting); works where others fail. Armstrong system, *adjustable AFC* on switch, *adjustable AM selectivity*, separate FM and AM front ends. Complete shielding and shock-mounting on main and subchassis. Distortion below 0.04% for 1 volt output. Hum level: better than 90 db below 2 volts output on radio, better than 62 db below output with 10 mv input on phono. Two inputs. Two cathode follower outputs. Self-powered. Exceptional phono preamplifier with enough gain for even lowest-level magnetic pickup. Full, phono equalization facilities. 15 tubes. Six controls, including Bass, Treble, Volume, Channel/Phono-Equalization, Tuning and Loudness Balance. Beautiful Control Panel. SIZE: 14 3/4" wide, 8 1/2" high, 9 1/4" deep.

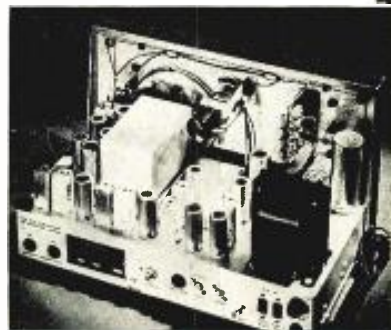

MASTERPIECE OF TUNER DESIGN

MODEL 50-R

■ Identical to the 70-RT but designed for use with an *external* preamplifier-equalizer, such as the FISHER Series 50-C.

MODEL 50-R

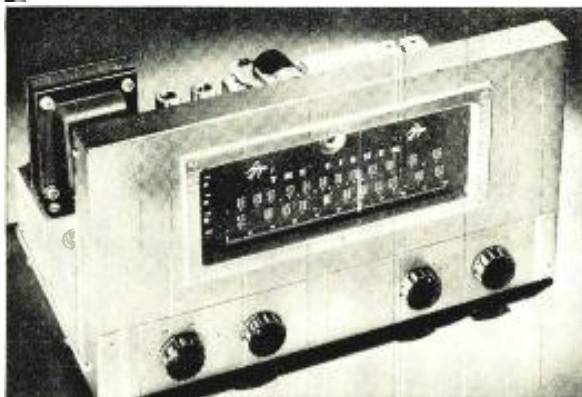

MODEL 70-RT

\$184⁵⁰

MODEL 50-R

\$164⁵⁰

PRICES SLIGHTLY HIGHER
WEST OF THE ROCKIES

Write for Full Details

FISHER RADIO CORP.

21-23 44th DRIVE
LONG ISLAND CITY 1, N. Y.

'SCOPES ARE "GOLD MINES"

... when you know how
to use them fully on all
types of service jobs

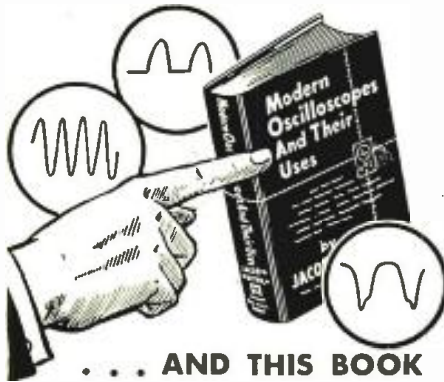

... AND THIS BOOK
MAKES IT EASY TO LEARN
ALL ABOUT THEM!

No question about it! The cathode ray oscilloscope is the handiest, most useful instrument in radio-TV servicing today. Servicemen who master it get the best jobs—make the most money—work lots faster—and are headed for even bigger things in the future!

MODERN OSCILLOSCOPES AND THEIR USES

By Jacob H. Ruiters, Jr.

of Allen B. DuMont Laboratories, Inc.
326 pages. 370 illustrations. \$6.00

- ✓ Tells you when, where, why and exactly how to use oscilloscopes
- ✓ How to interpret patterns
- ✓ How to handle tough jobs easier and faster

Now the oscilloscope won't "stump" you—not when you have the clear explanations given by this famous book! It contains no involved mathematics—no puzzling and complicated discussions. Instead, it goes right to work explaining oscilloscopes fully and showing you exactly how to use them in lab work and on AM, FM and TV service work—from locating troubles to handling tough realignment jobs. Each operation is carefully explained including determining where and how to use the 'scope; making connections, adjusting circuit components, setting the controls and analyzing patterns fast and accurately. About 370 illustrations including pattern photos make things doubly clear.

No other type of specific service method training can mean so much to you in terms of efficiency and greater earning power! Send for it today. See for yourself how this book can help you—before you buy!

READ IT 10 DAYS . . . at our risk!

Dept. RN-25 RINEHART & COMPANY, Inc.,
232 Madison Ave., New York 16, N. Y.

Send MODERN OSCILLOSCOPES AND THEIR USES for 10-DAY EXAMINATION. If I decide to keep the book, I will then remit \$6.00 plus a few cents postage in full payment. If not, I will return book postpaid and owe you nothing.

Name.....
Address.....
City, Zone, State.....
Employer's Name & Address.....

OUTSIDE U. S. A.—Price \$6.50 each only.
Money back if book is returned in 30 days.

rages. I liked the disc when it was first issued. If Dr. Scherchen was wrong or right, the sound was thrilling and a refreshing change if nothing else. But time and techniques march on, and the second movement is not the whole ball of wax. On over-all quality of sound, this London version is certainly the best available. Much wider in range, virtually distortion-free and with superior acoustic perspective, this will probably appeal to those who like their Haydn "straight." The tympani and triangle are in the second movement all right. And they are very clean and accurate, but not obtrusive. Solti continues to amaze with his versatility. He seems equally at home and at ease with this Haydn as he is with Bartok. His reading is more graceful and free-flowing than Scherchen's and he maintains a better orchestral balance. If you don't own this work, try this and the Westminster, too.

SAINT SAENS SYMPHONY #3

Hague Philharmonic Orchestra, F. Asma, organist, conducted by Willem Van Otterloo. Epic LC3077, NARTB curve. Price \$5.95.

Thousands of hi-fi fans have been eagerly awaiting a new modern-sounding recording of this work. Well, here is modern wide range sound, but I'm afraid it will have little attraction for these people. You see, the old Charles Munch-Columbia version was one of the most famous demonstration records in the early days of LP. Principal reason for this was some extremely low organ pedal in the first movement. The hi-fi boys were pretty proud when their speaker systems would reproduce these great, but rather low-level pedals. Outside of the fact that I like the Munch reading better, this is a much cleaner, more wide range sound than the Columbia; but alas, and alack, no big pedals newly revealed in the richness of modern hi-fi. Whether the organist in the Columbia overplayed them, or the organist in this disc underplayed them; or whether the organ is not right for the same sound or the acoustics of the hall not right, the fact remains . . . they just don't sound out on this disc. However, if the pedals are not the be all-end all sort of thing with you, this recording is quite enjoyable. Strings are little wiry at times, and some distortion creeps in here and there. but these are minor annoyances. If you are not familiar with his music, I can recommend it to you for some very exciting listening. Some treble cut and bass boost helped the NARTB curve considerably.

BEETHOVEN FIDELIO

NBC Symphony Orchestra conducted by Arturo Toscanini with Rose Bampton, Jan Peerce, Eleanor Steber. Victor LM-6025, RIAA curve. Price \$11.90.

Those people who have been patiently waiting for Victor to release the December 1944 broadcast performance of this work will find that their wait has been most worthwhile. Victor has accomplished a minor miracle in making this disc quite modern sounding. Sure, you can tell that the range is restricted and dynamics not what they should be, but at least there is no dead sounding "Studio 8H" to contend with! Vocal and instrumental definition is more than acceptable. The performance needs little recommendation. It blazes with the power of a Toscanini at the height of his interpretive genius. It has been a long time since I have heard the "Leonore" overtures sound so "right." Jan Peerce and Eleanor Steber never sang better, and it is a pity Miss Bampton is so poorly represented in the LP catalogue. She had quite a voice! Those of you who have been struggling along with the old Oceanic recording, will find this superior in every

See
the New
LA-75
Arrester



List \$1.35

Make installations the easiest,
fastest ever.

Slip any standard lead-in
under its new twin-lead grip,
tighten wing nut—the job is
done. Another Radion first.
Ask your distributor now.



The Radion Corp., Dept. S.
1130 W. Wisconsin Ave., Chicago 14, Ill.

Servicemen • Technicians • TV Dealers

Which Tube is Bad??

Here's How to Quickly Find Bad
Tube in New Series Filament TV Sets



IT'S EASY...
QUICK and SURE!

Senco

Series Filament TUBE CHECKER

Quick continuity check. no shock hazard. Also voltage indicator when line cord is shorted. No switches or instructions—merely plug in any TV tube, also used for AC-DC RADIOS and PORTABLES.

Carried by leading Jobbers
write for Information TODAY!

Mfg by
SERVICE Instruments
Company
422 S. Dearborn St • Chicago 5

NOW! 3

ARROW SALES OFFICES!



**FASTER SERVICE!
LOWER SHIPPING COSTS!
BIGGER SELECTION OF ELECTRONIC EQUIPMENT**

3 LOCATIONS FOR EVERYTHING IN ELECTRONICS!

- ★ 7460 VARNA AVE., NORTH HOLLYWOOD, CALIFORNIA (Mailing address: Box 3878 N. Hollywood, Cal.)
 - ★ 2441 SOUTH MICHIGAN AVENUE, CHICAGO 16, ILLINOIS
 - ★ 2005 EMPIRE AVENUE, BURBANK, CALIFORNIA
- Mail order buyers: direct your mail to either the North Hollywood or Chicago mailing address—whichever is closer.

UHF TRANSMITTER-RECEIVER APS-13 \$395

Freq. range 415-420 MC. 5 stages of 30 MC. 1P amplifier. Complete with H.F. and I.F. sections. Less dynamotor, tubes, and tube shields, with schematic. Excel. cond. Weight 14 lbs.



3 TUBES—PRESELECTOR

Frequency range: 550 kc to 32 MC in 6 bands. Includes internal rectifier for operation from 110V 60 cps. Mounted in steel cabinet. Used cond. Wt. Approx. 22 lbs. **\$695**

BC-610 TUNING UNITS

TU-49: 3.2-4.0 MC. Wt. 4 lbs. \$2.95
TU-50: 4.0-5.0 MC. Wt. 4 lbs. 2.95

RG-7/U CO-AXIAL CABLE

Co-axial RF transmission line for military laboratory, police, broadcast and other industrial purposes. 37.5 ohms imp. dia. .370 new cable, special in 100 ft. rolls or 500 ft. reels.
100 ft. Roll. Ea. \$ 3.95
500 ft. Reel. Ea. 14.95

COMMAND EQUIPMENT

TRANSMITTERS	USED
BC-457 4 to 5.3 MC.	\$ 6.95
BC-458 5.3 to 7 MC with tubes.	5.95
The above pair.	11.90
RECEIVERS	
RD to 550 KC Famous Lazy 5 Q'er.	10.95
BC-494 3 to 6 MC.	7.95
BC-455 6 to 4.1 MC.	7.95

MICA CAPACITOR

.00005 MFD. 300V. Made by Cornell-Dubitter Co. Ideal cap. for lab. and experimental use. Wt. 3 lbs. New. **\$2.95**

MR-28C CONTROL BOX. New. \$12.50
MR-9B CONTROL BOX. New. 14.95

BC-191 TRANSMITTER

100 W. With tubes, modulation section, speech amplifier for P-22 mike, RF meter, 0-500 MA meter, 0-15 DC filament meter. Plus schematic for converting this transmitter for AC operation. FREE! ONE TUNING UNIT with each transmitter! Excellent cond. \$24.95
T-32 CARBON MIKE: Used, good cond. \$2.95
ONE SET PLUGS: For BC-191. New. \$1.95

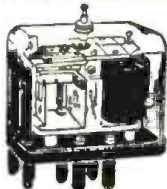

**SPECIAL PURPOSE
TYPE NO. SC-M
CURRENT RELAY**

Relay adjustable from 0.2 to 1.0 amps. External push-button reset. Enclosed in glass case. Hand calibrated adjustments. Wt. 4 lbs. NEW. Ea. **\$4.95**
2 for \$8.00

INDICATOR SCOPE ID6A/APN4



Made to operate in conjunction with Radio Receiver RM/APN-4. Unit includes one 5" scope tube, crystal controlled standard oscillator, sweep circuits, marker pulses. Good cond. Weight 30 lbs.

WITH 27 TUBES & CRYSTAL. **\$19.95**

WHAT A BARGAIN!

APX-2 IFF EQUIPMENT. This transceiver is a treasure-house of tube sockets, relays, coaxial fittings, resistors, condensers, microswitches, amphenol connectors and a raft of other parts. Less tubes, with 24 V. blower motor and 24 V. gear train motor. Wt. Approx. 30 lbs. **\$6.95**
A HOT VALUE. ONLY.

MOBILE POWER SUPPLY—HEAVY DUTY
PE-125 dynamotor, complete with filter base, starting relay and fuses. 12-24 V.D.C. input, output 400 V.D.C. @ 300 ma. New. **\$1295**
F.O.B. Chicago only

RT-7/APN-1

Transmitter-receiver unit with a frequency range of 420-460 mc FM. Ideal set for getting started in frequency-modulation theory. This set uses 14 tubes including a voltage regulator circuit, counter circuit. Many precision resistors, relays and tube sockets. Real buy for experimental use. LESS TUBES, DYNAMOTOR AND VIBRATOR. With schematic. Wt. **\$4.95**
18 lbs. Excellent condition.

ARB NAVY RECEIVER

105 to 9050 KC. Four Bands, Calibrated Dial, I.F. Shim-15C—80 & 40 Meier—Complete with Tubes and Dynamotor. For 24 Volt operation: easily converted to 110 V.—12 or 0 Volt. Size 9 1/2" x 7 1/2" x 15 1/2". Excellent cond. With schematic. Weight 30 lbs. **\$19.95**

5BP1 5" SCOPE TUBE. Ea. \$1.95
3 for \$4.95

5000 POWERED HANDSET. Ex. cond. Ea. \$ 5.50
2 for \$ 10.00
T-26 CHEST MIKE. New. 1.45

FL-8 RANGE FILTER. NEW. 79c 6 for 4.95
FL-5 RANGE FILTER. NEW. 79c 6 for 3.00

ARC-4 MOBILE TRANSCEIVER

140-144 MC. Complete with control box, tubes, 12/24 VDC dynamotor with schematic. Excel. cond. **\$32.50**
Wt. 38 lbs. \$24.95
Less dynamotor

WIRE-WOUND POWER RESISTORS

2500 Ohms 75 W. Ohmite. Adj.	Ea. 85c 10 for \$7.50
25 Ohms 75 W. Ohmite. Adj.	Ea. 85c 10 for 7.50
100 Ohms 100 W. I.R.C. Adj.	Ea. 85c 10 for 7.50
25 Ohms 50 W. Ohmite. Adj.	Ea. 85c 10 for 7.50
300 Ohms 50 W. Ohmite. Adj.	Ea. 85c 10 for 7.50
100 Ohms 25 W. 9 taps. Ea.	.69c 10 for 5.95
1500 Ohms 40 W. 9 taps. Ea.	.69c 10 for 5.95

234-258 MC RECEIVER



11-tube UHF tunable receiver with schematic. Like new. **\$14.95**
Wt. 10 lbs.
Rack \$3.50
Control Box 1.50

CRYSTAL CALIBRATED COLOR TV FREQ. METER

This is the BC-771 Freq. Meter, originally in the RC-100 IFF system on 470/495.5 MC. Is completely self contained unit with own 110 v. 60 cy AC power supply. Beautiful steel cabinet, 10" deep. Panel size 9" x 15 1/2". Smooth action 5:1 vernier dial assembly. THIS IS A PERFECT SET-UP FOR THAT COMMUNICATIONS RECEIVER OR TEST INSTRUMENT YOU'VE BEEN PLANNING. Includes following tubes: 1—84, 3—7A4, 1—7C6, 2—955, 2—956; also detail base 4700 KC xtal. Dozens of useful capacitors, resistors, etc. With schematic and parts list. **Now \$2450**
weight—28 lbs.). (Shipping Brand new

MODULATOR-POWER SUPPLY

4-tube modulator-power supply for the TA-12 100 W. transmitter. 2 ea. 807 in push-pull circuit. Complete with speech amplifier, 24 VDC dynamotor which supplies 540 VDC @ 450 ma., microphone transformer, driver transformer with side-tone winding. **\$14.95**
Wt. approx. 23 lbs. New. LESS DYNAMOTOR. Wt. approx. 13 lbs. \$9.95

HORSIE TALKIE BC-745

Low powered, portable, amplitude-modulated voice communication sets. Powered by either wet or dry battery. Freq. range: 2,000-6,000 Kc. Operating range about 5 miles. Set is turned on by fully extendable telescopic antenna rod; when retracted, set is turned off. With one tuning unit. Weight: 10 lbs. SPECIAL. **\$7.95**



R.F. Modulator

Complete Tunable 205 MC. Test Set. With 110 V. 60 cps. power supply, 3-stage audio amplifier. Terrific chassis for experimentation. With schematic. Like new. **\$12.95**
F.O.B. Chicago only

TRANSMITTER-RECEIVER

Complete unit with 0 v. DC input dynamotor to supply the necessary 450 v. DC @ 75 ma. Frequency range 160-211 MC. Set has 13 tubes, high voltage power supply. In like new condition. Wt. 43 lbs. A real buy. **\$14.95**

TG-10 CODE KEYS

Self-Contained Automatic unit for code practice signals from an inked type recording. Complete with 7 tubes and electric 60c. Audio level output of 800 CPS. Size: 11 x 24 x 18 1/2"—110-220 VAC 60 cps.—78 RPM motor can be used for a turntable—Power unit can be used for a P.A. system—Wt. **\$14.95**
85 lbs. Used, clean cond.

ECHO BOX

A hand tuned ring box with an associated dipole which picks up the RF energy from the radar set. Frequency range of 3140-3640 MC. Ideal unit for experimental lab. Wt. 7 lbs. **\$4.95**
New Condition

UHF TRANSMITTER

1 tube. Frequency range: 397 MC. For remote control of model boats, planes, etc. With tube, antenna, less battery. Size of transmitter: 4 1/2" x 2 1/4" x 6". New. **\$2.95**

NEW HAM CIRCULAR!

Ask for your FREE copy!
Drastic reductions on selected hot items!

All shpts. F.O.B. wsho., N. Hollywood or Chicago. Calif. or Illinois residents add sales tax, 25% deposit required on C.O.D. orders. Specify shipping instructions and ADD SHIPPING COSTS TO EACH ORDER. All items subject to prior sale and change of price without notice. Direct all mail to N. Hollywood or Chicago mailing address.

ARROW SALES, INCORPORATED

Western Mailing Address

P. O. BOX 3878, NORTH HOLLYWOOD, CAL.
Office-Warehouse: 7460 Varna Ave., N. Hollywood, Cal.
Phones: Stanley 7-6005, Poplar 5-1810

Central Mailing Address

2441 S. MICHIGAN AVE., CHICAGO 16, ILL.
Phone: CAfun 5-9313
(CABLE ADDRESS: ARROWSALES, N. HOLLYWOOD
TELEGRAPH ADDRESS: WUX, N. HOLLYWOOD, CAL.)

Visit our sales-showroom at 2005 EMPIRE AVE., BURBANK, CAL. Phone: Victoria 9-2834

In the Chicago area, visit sales showroom at 2441 S. Michigan Ave., Chicago, Illinois.

NEW! SHOW-HOW BOOK

BRINGS YOU PRACTICAL

SERVICING KNOW-HOW

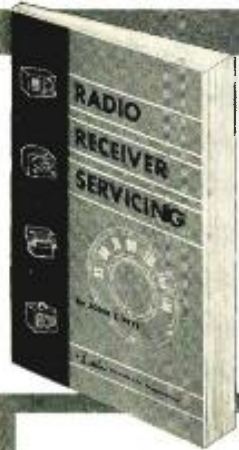

Saves Your Time So You

EARN MORE DAILY

ONLY \$2.50

JOHN T. FRYE'S

"Radio Receiver Servicing"

A new book with the practical slant on servicing for which this author is noted. Covers each of the three common types of radio receivers: the power-transformer set, the AC-DC series-filament type and the 3-way portable type. Each is discussed separately, since many troubles are peculiar to only one type of receiver. Each basic trouble (dead set, weak set, intermittent set, noisy set, etc.) is separately treated. Clear organization and discussion makes it easy to refer to specific trouble. Another desirable feature is the progression from easy-to-solve problems to those that are more difficult. Special receivers, such as FM sets, all-wave sets, auto radios and storage battery portables are covered in separate chapters.

Servicing Through Symptoms:

Invaluable time-saving hints, such as easy trouble-shooting through reference to symptoms, make this book a real "right hand" for busy servicemen. You'll save time. you'll earn more with this latest Howard W. Sams' publication. 192 pages. 5½ x 8½". You'll want it for quick help on shop and outside repairs.

ORDER RS-1 **\$2.50**
Only.....

ORDER TODAY

HOWARD W. SAMS & CO., INC.

Order from your Parts Jobber today, or write to Howard W. Sams & Co., Inc., 2203 East 46th St., Indianapolis 5, Ind. My [check] (money order) for \$_____ enclosed. Send _____ copy(ies) of "Radio Receiver Servicing" (RS-1, \$2.50)

Name _____

Address _____

City _____ Zone _____ State _____
(outside U.S.A. priced slightly higher)

aspect. A wonderful performance, which causes one to reflect, rather sadly, that we are nearing the end of the supply of Toscanini treasures.

BIZET CARMEN SUITE GOUNOD

BALLET MUSIC FROM FAUST
St. Louis Symphony Orchestra conducted by Vladimir Golschmann. Capitol P8288, RIAA curve. Price \$5.95.

This is the 8th recording of the "Carmen Suite," and in most respects the best. I still prefer the Beecham reading, but Golschmann does an excellent job, and I am really splitting hairs on this choice. Soundwise this must be judged the best available, in spite of the good quality of the recent Kostelanetz, which strictly speaking is not "the suite from Carmen," but (as *Columbia* terms it) an "orchestral scenario." In the "Faust" ballet music, Golschmann has no competition whatsoever. To his excellent sense of balance and rhythm, he adds a splendid knowledge of the dynamics involved in this score. In both the "Carmen" and the "Faust," string tone is quite clean, there is some superb brass playing and reproduction, and plenty of rousing percussion of notable accuracy. The RIAA curve did not require adjustment. Typical quiet *Capitol* surfaces.

BAND MUSIC LA FIESTA MEXICANO WORKS BY MENNIN, PERISCHETTI, VIRGIL THOMSON, HOWARD HANSON

Eastman Symphonic Wind Ensemble conducted by Frederick Fennell. Mercury MG40011, RIAA curve. Price \$5.95.

Calling all hi-fi bugs, aficionados, audiophiles, and just plain music lovers! This recording is guaranteed to separate the men from the boys. If your equipment is the McCoy, you've nothing to worry about. If your equipment is "phony-fi," watch out! Fred Fennell and his band have whipped up their greatest hi-fi storm yet. Positively awe-inspiring dynamics. Shattering percussion, especially the bells in the "Fiesta Mexicana." Huge brass sonorities and miraculous woodwind reproduction of great precision and articulation. I had a tape of the "Fiesta" at the N. Y. Audio Fair, and some of the more "gone" bugs would sit by the hour listening to it, a glazed look in their eyes. The "Fiesta Mexicana" is an extremely colorful work, based on Mexican folk material and with an absolutely fascinating Aztec derivation, employing a fabulous variety of percussion instruments. The other works are highly listenable, and receive the same meticulous attention and superb musicianship from Mr. Fennell and his extraordinary group. Nuff said! If you are a lover of the hi and the fi, this is a *must!*

VERDI MISSA DA REQUIEM

Orchestra and Chorus of La Scala conducted by Victor De Sabata with Elizabeth Schwarzkopf, Oralia Dominguez, Giuseppe Di Stefano, and Cesare Siepi. Angel 3520-B, RIAA curve. Price \$11.90.

It never rains, but it pours in this LP era. Here we have the extraordinary situation of *three* new performances of Verdi's great "Requiem" in the space of two months! In spite of the fine Toscanini performance and the praise that has been lavished on it, I am going to strike out boldly and state my preference for this *Angel* recording. If De Sabata has not the incandescence of Toscanini, his drive and energy is still more than adequate, and he has blessings not af-

Electron

Tube

Technicians

We now have openings for work in the fabrication and processing of experimental electron tubes.

Applicants should be high school graduates with a natural aptitude for working with small parts. Experience in electronics, precision benchwork and experimental tube work is desirable.

Address resume of experience and training to...

Hughes

RESEARCH AND DEVELOPMENT LABORATORIES

TECHNICAL PERSONNEL DEPARTMENT

Culver City, Los Angeles County, California

Relocation of applicant must not disrupt urgent military project.

RADIO & TELEVISION NEWS

forded Toscanini. For one thing, I like the soloists in the *Angel* version better than those on the *Victor*. Choral honors are about evenly divided. Toscanini has the edge with his magnificent NBC Symphony, but the La Scala orchestra is not far behind. It is in the sound department where the superiority of the *Angel* is most apparent. A remarkable recording, with beautifully clean strings, richly resonant brass. The much greater frequency response of the *Angel* is probably responsible for the much more articulate vocal sections. Schwarzkopf sounds like an "angel" (no pun intended) and Siep's voice shows up to great advantage. The "Dies Irae" section is one of the most heart-stopping things ever recorded! The tremendous blasts of percussion, the vast energy of the chorus and the awe-inspiring dynamics are quite overwhelming.

**SHOSTAKOVICH
SYMPHONY #10**

New York Philharmonic Orchestra conducted by Dimitri Mitropoulos. Columbia ML4959, NARTB curve. Price \$5.95.

I do not intend to discuss this work from any standpoint of ideology *versus* music. I leave that to the pedantic. I have always liked the strength and vigor of this composer's works, and this new symphony is no exception. It has all of Shostakovich's familiar devices . . . the powerful largo, the spritely scherzo and the whirlwind of his prestofinales. Much more pedal writing in this than in his other works, and this heavy bass line has been a challenge to the Columbia engineers who have met it quite successfully. This disc contains some of the finest sound Columbia has yet recorded. Splendid string tone, the frequent contrabass coming through quite cleanly. Brass is bright and punchy, percussion sharp and accurate. The dynamic range is impressive and the work is afforded nice "live" acoustics. As far as I'm concerned this recording is in every way superior to the Russian effort on *Concert Hall Society*. Mitropoulos is a wizard with complex modern scores, such as this, and he seems surer of his ground than Mravinsky, the conductor on the *Concert Hall* disc. The NARTB curve was adequate as is. Good surfaces.

Tape Review

**BLOCH
BALLET CONCERTO FOR PIANO
AND ORCHESTRA
PROKOFIEV
CLASSICAL SYMPHONY**

Hamburg Philharmonic Orchestra conducted by Hans-Jurgen Walther with Sondra Bianco pianist. AudioVideo AV-1511, 5" reel, 7½ ips, half-track.

The first in a new series by a pioneer in the pre-recorded tape field, this is one of the best tapes I have heard from a commercial source. All the material is very wide in frequency and dynamic range. I could detect no distortion, other than an occasional overload. Tape background hiss was high enough to notice, but not really annoying. The Bloch work is quite interesting and is well played by Miss Bianco. The sound of the piano is remarkably life-like. Bright and clean, with transients reproduced better than I have yet to hear on a disc. The Prokofiev work is afforded the same splendid reproduction. Strings have that fabulous cleanness and lack of edginess which is a characteristic of their sound from tape. Unhappily, the performance of the "Classical Symphony" leaves much to be desired, but if your interest is primarily in the sound, this will suit your needs perfectly. Tape was packaged neatly, but lack of a printed leader could cause a lot of confusion. More of the new A-V material next month.

**WHEN CORROSION ATTACKS
PERMA-TUBE STAYS CLEAN**

... and so does your reputation

**J&L
M**

Look for this brand mark
—only genuine Perma-Tube
gives you this protection

Here's why PERMA-TUBE backs up quality service:

1. PERMA-TUBE IS CORROSION-PROOF . . . it's treated with vinylite—then coated *inside and outside* with a metallic vinyl resin base. It's guaranteed to be free from rust in a salt spray test of 500 hours minimum to an American Society of Testing Materials Specification B117-49T. This assures long life.
2. PERMA-TUBE IS STURDY . . . it's made of special, high-strength J&L Steel.
3. PERMA-TUBE IS EASILY INSTALLED . . . it's the only mast with *both ends* of the joint machine fitted.

Here's proof of how PERMA-TUBE resists corrosion:

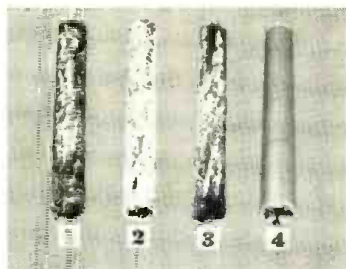

Test samples after 1440 hours
ASTM salt spray test

1. Coated Mechanical Tubing . . . note that galvanized coating is gone and underlying steel is severely corroded.
2. Coated Mechanical Tubing . . . note that paint coating is nearly destroyed and zinc coating is corroded.
3. Galvanized Mechanical Tubing . . . note zinc and steel are corroded.
4. PERMA-TUBE . . . note that Perma-Tube is relatively unharmed.



For further details on product and installation, write for a copy of the Perma-Tube booklet. Jones & Laughlin Steel Corporation, Dept. 495, 3 Gateway Center, Pittsburgh 30, Pa.

Jones & Laughlin
STEEL CORPORATION — Pittsburgh

Become an
ELECTRICAL ENGINEER



 **Major in Electronics or Power BS Degree in 36 months**
Prepare now for a career as an electrical engineer or engineering technician — and take advantage of the many opportunities in these expanding fields.

You can save a year by optional year 'round study. Previous military, academic, or practical training may be evaluated for advanced credit.

Enter Radio and Television — courses 12 to 18 months

You can be a radio technician in 12 months. In an additional 6-months you can become a radio-television technician with Associate in Applied Science degree. Color television instruction is included in this program.

These technician courses may form the first third of the program leading to a degree in Electrical Engineering. Twenty-one subjects in electronics, electronic engineering and electronic design are included in these courses.

Courses also offered: radio-television service (12 mos.); electrical service (6 mos.); general preparatory (3 mos.).

Terms—April, July, September, January

Faculty of specialists. 50,000 former students — annual enrolment from 48 states, 23 foreign countries. Non-profit institution. 52nd year. Courses approved for veterans. Residence courses only.

MS-6A



MILWAUKEE SCHOOL OF ENGINEERING

MILWAUKEE SCHOOL OF ENGINEERING
Dept. RT-255, 1025 N. Milwaukee Street
Milwaukee 1, Wisconsin

Send FREE illustrated booklets
 Career in Electrical Engineering.
 Career in Radio-Television.

I am interested in.....
(name of course)

Name.....Age.....

Address.....

City.....Zone.....State.....

If veteran, indicate date of discharge.....

MANUFACTURERS' LITERATURE

The various listings presented in this section are for your convenience. The bulletins, unless otherwise indicated, are available to all our readers. For prompt attention write directly to the manufacturer for this literature.

STROMBERG-CARLSON FOLDERS

The Sales Promotion Department of *Stromberg-Carlson Company's* Sound Equipment Division, Rochester 21, New York has issued two printed pieces for audio dealers.

The colorful consumer folder, H-16, is in envelope stuffer size and illustrates and describes the complete line of "Custom 400" hi-fi components and cabinets. The second publication, S-102, is a 6-page catalogue-folder featuring the division's full line of amplifiers, microphones, speakers, housings, re-entrant horns, drivers, and other packaged sound equipment items sold over the counter.

TIME DELAY RELAY

Complete details on the new *A. W. Haydon Co.* line of special time delay relays are given in the new bulletin just released by the firm.

Technical data and specifications on these motor-driven, adjustable relays are included in Bulletin A.W.H. TD500 which is available from the company at 232 N. Elm Street, Waterbury, Conn.

DYNAMOTOR DATA

A condensed catalogue covering the company's line of commercial, military, and mobile dynamotors is now being offered by *Gothard Manufacturing Company*, 2110 Clear Lake Avenue, Springfield, Illinois.

This new publication, Bulletin No. 410, contains much valuable information on d.c.-to-d.c. power conversions as provided by the various units in the line.

A copy of the catalogue is available without charge by writing to Howard B. Elder, sales manager of the firm.

SPECIAL AMATEUR CATALOGUE

Harvey Radio Company, Inc. of 103 West 43rd Street, New York 36, N. Y. has recently issued a compact 100-page catalogue designed especially for the amateur radio fraternity.

In addition to listing thousands of ham items, ranging from transmitters to solder, this booklet also carries details on multi-band antenna construction (which originally appeared in *RADIO & TELEVISION NEWS*), an article on mobile noise suppression, control circuits for mobile operation, and circuit details on an antenna coupler.

SIGHTMASTER HI-FI DATA

Sightmaster Corp., New Rochelle, N. Y. has released its new "1955 High-Fidelity" catalogue and unit plan program.

The "do-it-yourself" matched unit

plan of the company provides an amplifier, record player with diamond needle, and deluxe speaker system for a package price. These matched units fit into each other as do all accessory items incorporated in the line.

The catalogue pictures and describes all of the items currently available in the line.

CLOSED-CIRCUIT TELEVISION

The Engineering Products Division, *Radio Corporation of America*, Camden, N. J. has just issued a 4-page folder entitled "How to Read a Blueprint at 500 Feet."

The new publication tells how closed-circuit television is applied to achieve effective work coordination and two-way visual communication between widely separated buildings.

The folder describes the simplicity and functions of the "TV Eye", a low-cost closed-circuit television system made by the company. Several applications for such a system are outlined along with details on accessory equipment required for special applications.

Copies of the folder are available from the company. Specify Form 3R2436.

CATALOGUE SHEETS

Cinema Engineering Company, division of *Aerovox Corp.*, 1100 Chestnut Street, Burbank, California has issued two new catalogue sheets for the trade.

One of the sheets covers the company's sealed resistor networks and includes descriptive and illustrative material as well as application data. The second bulletin describes the line of "PW" resistors for automation and printed wiring.

The bulletins are obtainable from the factory or the company's factory representatives.

RAYTHEON TUBE DATA

The Receiving Tube Division of *Raytheon Manufacturing Company*, Newton 58, Massachusetts has announced the availability of its new *Industrial Tube Characteristics* booklet.

The new publication includes details on 450 industrial type tubes comprising 17 distinct tube classes ranging from subminiature and miniature tubes to transistors. The booklet contains over 20 pages of technical data and basing information.

B-A'S NEW CATALOGUE

Burstein-Applebee Co., 1012-14 McGee Street, Kansas City, Missouri has released its 1955 catalogue covering

Compare...
**prove EMC
 superiority**

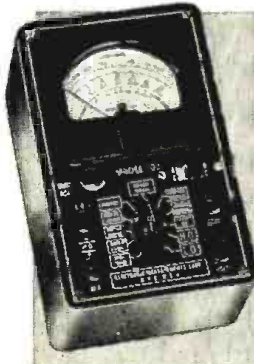

model 102
 (1000 ohms per volt meter) • 3" SQUARE METER • 3 AC CURRENT RANGES (0-30/150/600 ma.) • Same zero adjustment for both resistance ranges (0-1000 ohms, 0-1 megohms) • 5 DC & 5 AC Voltage Ranges to 3,000 volts • Also 4 DC Current Ranges **\$14.90**



model 103
 (1000 ohms per volt meter) 4 1/2" SQUARE METER • 3 AC CURRENT RANGES (0-30/150/600 ma.) • Same zero adjustment for both resistance ranges (0-1000 ohms, 0-1 megohms) • Same Ranges as Model 102 • Also 5 DB Ranges **\$18.75**
 Model 103-S with plastic carrying strap..... **\$19.25**

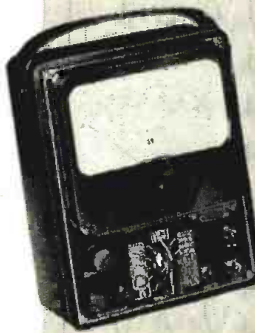

model 104
 (20,000 ohms per volt meter) 4 1/2" SQUARE METER (50 micro-amperes-Alnico magnet) • Includes carrying strap • 5 DC Voltage Ranges at 20,000 ohms volt to 3,000 V.; 5 AC Voltage Ranges to 3,000 V.; 3 Resistance Ranges to 20 megs • Also 3 AC & DC Current Ranges • 5 DB Ranges **\$26.95**
 HVT 30,000 Volt Probe for Model 104 **\$7.95**

EMC

RN-2

ELECTRONIC MEASUREMENTS CORPORATION
 280 LAFAYETTE STREET • NEW YORK 12, N. Y.

EXPORT DEPARTMENT 136 LIBERTY STREET, N.Y.C. 6, N.Y.

BUILD 15 RADIOS
AT HOME ONLY **\$19.95**
 With the New Improved 1955

Progressive Radio "EDU-KIT" Complete

NOW INCLUDES
**High Fidelity,
 Signal Tracer, and
 Code Oscillator**



- ATTRACTIVELY GIFT PACKED
- FREE SOLDERING IRON
- NO ADDITIONAL PARTS NEEDED
- EXCELLENT BACKGROUND FOR TV
- 10 DAY MONEY-BACK GUARANTEE
- SCHOOL INQUIRIES INVITED
- ABSOLUTELY NO KNOWLEDGE OF RADIO NECESSARY

WHAT THE PROGRESSIVE RADIO "EDU-KIT" OFFERS YOU

The Progressive Radio "Edu-Kit" offers you a home study course at a rock bottom price. Our Kit is designed to train Radio Technicians, with the basic facts of Radio Theory and Construction Practice expressed simply and clearly. You will gain a knowledge of basic Radio Principles involved in Radio Reception, Radio Transmission and Audio Amplification.

You will learn how to identify Radio Symbols and Diagrams; how to build radios, using regular radio circuit schematics; how to mount various radio parts; how to wire and solder in a professional manner. You will learn how to operate Receivers, Transmitters, and Audio Amplifiers. You will learn how to service and trouble-shoot radios. You will learn code. You will receive training for F.C.C. license. You will learn High-Fidelity.

In brief, you will receive a practical basic education in Radio, worth many times the small price you pay.

THE KIT FOR EVERYONE

The Progressive Radio "Edu-Kit" was specifically prepared for any person who has a desire to learn Radio. The Kit has been used successfully by young and old in all parts of the world. It is not necessary that you have even the slightest background in science or radio.

The Progressives Radio "Edu-Kit" is used by many Radio Schools and Clubs in this country and abroad. It is used for training and rehabilitation of Armed Forces Personnel and Veterans throughout the world.

The Progressive Radio "Edu-Kit" requires no instructor. All instructions are included. All parts are individually boxed, and identified by name, illustration and diagram. Every step involved in building these sets is carefully explained. You cannot make a mistake.

PROGRESSIVE TEACHING METHOD

The Progressive Radio "Edu-Kit" comes complete with instructions. These instructions are arranged in a clear, simple and progressive manner. The theory of Radio Transmission, Radio Reception, Audio Amplification and servicing by Signal Tracing is clearly explained. Every part is identified by illustration and diagram. You will learn the function and theory of every part used.

The Progressive Radio "Edu-Kit" uses the principle of "Learn by Doing." Therefore you will build radios, perform jobs, and conduct experiments to illustrate the principles which you learn. These radios are designed in a modern manner, according to the best principles of present-day educational practice. You begin by building a simple radio. The next set that you build is slightly more advanced. Gradually, in a progressive manner, you will find yourself constructing still more advanced multi-tube radio sets, and doing work like a professional Radio Technician. Altogether you will build fifteen radios, including Receivers, Transmitters, Amplifiers, Code Oscillator and Signal Tracer. These sets operate on 105-125 V. AC/DC. An Adaptor for 210-250 V. AC/DC operation is available.

THE PROGRESSIVE RADIO "EDU-KIT" IS COMPLETE

You will receive every part necessary to build 15 different radio sets. Our kits contain tubes, tube sockets, chassis, variable condensers, electrolytic condensers, mica condensers, paper condensers, resistors, line cords, selenium rectifiers, tie strips, coils, hardware, tubing, etc.

Every part that you need is included. These parts are individually packaged, so that you can easily identify every item. A soldering iron is included, as well as an Electrical and Radio Tester. Complete, easy-to-follow instructions are provided. All parts are guaranteed, brand new, carefully selected and matched.

In addition, the "Edu-Kit" now contains lessons for servicing with the progressive Signal Tracer, F.C.C. instructions, quizzes, High-Fidelity Instructions. The "Edu-Kit" is a complete radio course, down to the smallest detail.

TROUBLE-SHOOTING LESSONS

Trouble-shooting and servicing are included. You will be taught to recognize and repair troubles. You will build and learn to operate a Professional Signal Tracer. You receive an Electrical and Radio Tester, and learn to use it for radio repairs. While you are learning in this practical way, you will be able to do many a repair job for your neighbors and friends, and charge fees which will far exceed the small cost of the "Edu-Kit." Here is your opportunity to learn radio quickly and easily, and have others pay for it. Our Consultation Service will help you with any technical problems which you may have.

FREE EXTRAS

- ELECTRICAL & RADIO TESTER • ELECTRIC SOLDERING IRON • TV BOOK • RADIO TROUBLE-SHOOTING GUIDE • CONSULTATION SERVICE • QUIZZES • F.C.C. TRAINING
- Progressive "Edu-Kits" Inc., 497 Union Ave., Dept. RN-38, Brooklyn 11, N.Y.

MAIL TODAY—Order shipped same day received.

10-Day Money-Back Guarantee. Include ALL FREE EXTRAS

- Send "Edu-Kit" Postpaid. I enclose full payment of \$19.95 (U.S.A. only).
- Send "Edu-Kit" Postpaid. I enclose full payment of \$20.95 (Outside U.S.A.).
- 210-250 V. Adapter for "Edu-Kit"—\$2.50.
- Send "Edu-Kit" C.O.D. I will pay \$19.95 plus postage (U.S.A. only).
- I wish additional information describing "Edu-Kit". No Obligation.
- Send me FREE Radio-TV Servicing Literature. No Obligation.

Name

Address

PROGRESSIVE "EDU-KITS" INC.

497 UNION AVE. Dept. RN-38 Brooklyn 11, N. Y.

Flyweight Magnemite*



**Electric-Motor
Battery-Operated
Portable Tape Recorder**

The ideal recorder for newspaper reporting, recording lectures, telephone monitoring, field reports, traveling secretary, on-the-spot interviews, reference recording, customer interviews, salesmen reports and secret recording.

Combines for the first time, ease and efficiency of operation with maximum reduction of weight. Performs anywhere, producing professional results under adverse conditions. Fully shielded, fly-ball governor-controlled electric motor assures constant speed and freedom from hash. Weather-tight, satin-finished, aluminum alloy case gives complete protection to recorder.

Electrically rewinds a reel of tape in less than two minutes. Immediate playback through earphones or external amplifier. 6 Single speed and 3 two-speed models available. Speeds range from 1 1/16 ips. to 15 ips. Recorders weigh only 8 lbs. with batteries and measure 5 1/2" x 9" x 12"

New VU Magnemite*



**Spring-Motor
Battery-Operated
Portable Tape Recorder**

Now you can consistently make professional recordings under the most gruelling field conditions. Tapes will faultlessly play back on all professional and home recorders. Ruggedly designed for maximum dependability and top-notch efficiency. Combines unlimited versatility of performance with extreme simplicity of operation. Choice of fourteen models available for every conceivable application.

Incorporates a multi-purpose VU monitoring meter for precise setting of recording level without earphone monitoring. Meter also accurately indicates condition of "A" and "B" batteries. Five single speeds as well as two, three and 4-speed models available. Units weigh only 19 lbs. with batteries and measure 6 1/2" x 9 1/2" x 14 1/4". Higher speed models meet NARTB standards. All recorders are guaranteed for One Full Year.

Write for complete technical specifications and direct factory prices to Dept. RT

AMPLIFIER CORP. of AMERICA 398 Broadway, New York 13
*T. M. REG. U. S. PAT. OFF.

SAVE \$\$\$
THOUSANDS OF BARGAINS
Send Stamp for our
GIANT CATALOG
UNITED RADIO CO.
58A MARKET ST. NEWARK, N. J.

TV TUNER REPAIRS
48-HOUR SERVICE
Defective tuners rebuilt to factory standards.
New tuner guarantee. Ship prepaid.
RADIO PRODUCTS CO.
College Point 56 • New York

SURPRISE KIT

10 lbs. of Radio and TV parts includes cabinet for 5—7 tube Radio... \$1.98

Premier Unconditionally Guarantees All Tubes For One Full Year
VERY BEST BRANDS AVAILABLE FOR IMMEDIATE DELIVERY. INDIVIDUALLY BOXED.

0Z4... .59	5X4G... 97c	6BD5GT... .89	6K7GT... .69	6Y6G... 69c	12AL5... 59c	12SQ7GT... .69
1A7GT... .79	5Z3... .89	6BE... .59	6K8GT... 1.19	7A4/84... .89	12AT5... .89	14A7... .95
1B3GT... .59	5L5G... .89	6BF... 69c	6L6G... .95	7A7... .89	12AU6... .69	14B7... .95
1H5GT... .59	6ASGT... 1.29	6BF6... 69c	6L6G... 1.39	7A8... 79c	12AU7... .79	14B8... 89c
1L... 1.29	6AB4... .69	6BG6G... 1.89	6P5GT... .69	7B4... .89	12AV6... .59	14C5... 1.19
1LA4... 1.19	6AB7... 1.19	6BH6... 69c	6Q7GT... .59	7B5... .89	12AV7... .49	14C7... 95c
1LA6... 1.19	6ACS... .89	6B7... .69	6S4... .59	7B6... .89	12AW6... 1.19	14F7... .89
1LCS... .69	6AC7... 1.49	6BK7... 1.19	6S4... .59	7B7... .89	12AX4... .69	14F8... .89
1LC6... .69	6AF4... 1.76	6BL7... .79	6S8GT... 1.19	7B8... 89c	12AX7... .69	14H7... 1.29
1LD5... 1.19	6AG5... .99	6BN6... 1.19	6SA7GT... 69c	7C4... 1.29	12AY7... 1.89	14Q7... .95
1LE3... 1.19	6AG7... 1.49	6BQ6GT... 39	6SD7GT... .99	7C5... .89	12BA6... .59	19B6G6... 1.89
1LH4... 1.19	6AM6... 1.89	6BQ7... .79	6SF5... .59	7C6... .89	12BA7... 1.19	19T6... .89
1LN5... 1.19	6AK5... .89	6BZ7... 1.29	6SFGT... .59	7C7... 79c	12BE7... .69	25A5GT... 1.19
1NSGT... .79	6AK6... 1.19	6C4... .59	6SG7... 69c	7E5... 79c	12BF6... 69c	25BQ6... 1.19
1PSGT... .79	6AL5... .69	6CSGT... 69c	6SH7... 69c	7E6... 79c	12BH7... .89	25L6GT... .59
1Q5GT... 79c	6AQ5... 69c	6CSGT... 69c	6SJ7GT... 59c	7E7... .89	12BY7... .89	25W4GT... .69
1R5... .59	6AQ6... .79	6CB6... 69c	6SL7GT... .69	7F7... .89	12CZ7... 1.19	25Z6GT... .69
1S4... .79	6AQ7... 1.19	6CD6... 69c	6SN7GT... 39	7H7... .95	12J5GT... 69c	32L7GT... .95
1S5... .59	6AR5... .79	6CD6G... 1.89	6SQT... .59	7H7... .95	12K8... .89	35A5... .95
1T4... 69c	6AT5... .89	6CF6... 1.19	6T8... .89	7I7... .79	12Q7GT... .89	35B5... .95
1U4... .59	6AS5... .59	6D9G... 1.19	6U5... .89	7J7... .79	12S6... .89	35C5... 69c
1U5... .59	6AUSGT... 1.29	6E5... .59	6USGT... .89	7K7... .79	12S7GT... .69	35L6... .69
1X2A... .89	6AUS... .59	6F3GT... .59	6V3... 1.29	7L7... .79	12S7GT... .69	35W4... .59
3LF4... 1.29	6AV5GT... .89	6F6GT... 59c	6V6GT... .69	7M7... .79	12S7GT... .69	35W4... .59
3Q4... .69	6AV6... .59	6F8G... 1.59	6W4GT... .59	7N7... .79	12S7GT... .69	35W4... .59
3Q5GT... .89	6AX4... .69	6G6G... .95	6W6... .69	7P7... .79	12S7GT... .69	35W4... .59
3VA... .89	6AX5... .79	6GGT... .89	6X4... 59c	7Q7... .79	12S7GT... .69	35W4... .59
5U4G... .69	6AX6... .69	6J5GT... .59	6X4... 59c	7R7... .79	12S7GT... .69	35W4... .59
5V4G... .89	6AY5GT... .89	6J6... .39	6X8... 1.29	7S7... .79	12S7GT... .69	35W4... .59
5W4GT... .59	6BA6... .59	6J7G... .69	6X8... 1.29	7T7... .79	12S7GT... .69	35W4... .59
5Y3GT... .49	6BA7... .89	6K5GT... .69	6X8... 1.29	7U7... .79	12S7GT... .69	35W4... .59
5Y4G... .59	6BC5... .69	6K6GT... .59	6X8... 1.29	7V7... .79	12S7GT... .69	35W4... .59

10% DISCOUNT ON ORDERS OF 100 TUBES OR MORE—
5% DISCOUNT ON 50 TUBE ORDERS

TERMS: 25% DEPOSIT with order, balance C.O.D. ALL shipments F.O.B. Chicago. ORDERS LESS THAN \$5.00—\$1.00 SERVICE CHARGE. CABLE ADDRESS: CONTULAB. These prices supersede all previously advertised prices, subject to change.

PREMIER TV RADIO SUPPLY 3239 West North Avenue, Chicago 47, Illinois
ARmitage 6-5550

Write for Free Catalog Flyers

an extensive line of components for the dealer, technician, radio amateur, experimenter, engineer, and laboratory technician.

This 164-page publication is lavishly illustrated with photographs and line drawings of the products. A complete index facilitates location of specific components.

"BUSINESS BUILDERS"

The second edition of the "Business Builders Catalogue," an expanded issue featuring more than 50 items essential to radio and television service dealers, has been announced by CBS-Hytron of Danvers, Mass.

The 12-page catalogue covers all types of items from service tags to shop tools, from stationery to signs. Among the new "business builders" listed are two illuminated signs, one outdoor and one indoor, a 4-way tool, etc.

The catalogue, PA-37, is available without charge from distributors or the company direct.

STEPPING RELAY BULLETIN

Guardian Electric Manufacturing Company has announced the publication of its completely new "Stepping Relay Bulletin," P-84.

This 12-page booklet contains illustrations, dimensional drawings, technical chart data, and general information on 12 new steppers, including midget, high speed, vibration resistant, and interlock types for add-subtract, continuous rotation, electrical reset, and other applications.

Copies of the new bulletin are available from the firm at 1621 W. Walnut Street, Chicago 12, Illinois.

NEWARK CATALOGUE

A new, 196-page components catalogue has been announced by Newark Electric Company, 223 West Madison Street, Chicago 6, Illinois.

This listing of thousands of electronic products, components, and equipment also includes a 64-page high-fidelity section and the largest listing of electronics items in the company's 20-year history.

The catalogue is bound in varnished stock for durability. It is available free on request.

ROTATOR BROCHURE

An 8-page, 2-color brochure, complete with photographs, diagrams, and charts has just been released by JFD Manufacturing Co., Inc., 6101 16th Ave., Brooklyn 4, N. Y.

The report evaluates engineering efficiency, construction, and design of the company's "Roto-King" rotator. The brochure is available without charge. Specify form #288 when writing for this publication.

TV COIL REPLACEMENTS

J. W. Miller Company, 5917 S. Main Street, Los Angeles 3, California is now offering copies of the new "TV Technician's Coil Replacement Guide #155." This 20-page publication cross-refer-

FIRST INDOOR ANTENNA DESIGNED FOR COLOR!



COLORTENNA

ONLY THE
JFD COLORTENNA
GIVES YOU THESE
3 ENGINEERING FIRSTS.

1

ADJUSTS
FOR MAXIMUM
VHF
RECEPTION

2

ADJUSTS
FOR MAXIMUM
UHF
RECEPTION

EXCLUSIVE NEW
CHANNEL RESONATOR
plus 6-POSITION ELECTRONIC
PHASING SWITCH
provides widest adjustment range

3

ADJUSTS
FOR
FULL
FIDELITY
COLOR



MODEL **TA150**

\$9.95 LIST



MANUFACTURING Co., Inc., 6101 16th Ave., BROOKLYN 4, N. Y.

LOOK TO JFD FOR ENGINEERING LEADERSHIP

NEW

AGAIN, FIRST WITH THE LATEST!

What's a reputation worth?

It's priceless since Hallicrafters' reputation, firmly built on over twenty years of electronic leadership reflects our craftsmanship and our future. These new models, in keeping with Hallicrafters' high standards, uphold this tradition of quality.

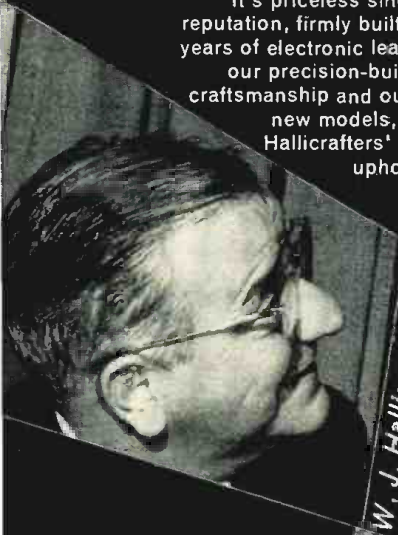

W. J. Halligan

Low cost unit with high priced performance over Broadcast Band 540-1650 kc plus three short-wave bands from 1650 kc—32 Mc. Electrical band-spread operates over large easy-to-read dial. Headphone tip jacks on rear and powerful built-in PM speaker. Oscillator for reception of code signals. Four tubes plus rectifier. 105/125 V. 50/60 cycle AC/DC \$49.95



Bill Halligan, Jr.



Model S-38D

These two new Civic Patrol receivers are over 10 times as sensitive as previous models, greater increased audio power output and built-in relay squelch system. Perfect for monitoring, police, fire, taxicab, telephone-mobile, forestry, Civil Defense. The S-94 covers 30-50 Mc and the S-95 150-173 Mc. Built-in speaker and provisions for headphones. Eight tubes plus rectifier. 105/125 V. 50/60 cycle AC/DC \$59.95

Write for complete specifications.



Model S-94 (S-95)

hallicrafters

CHICAGO 24, ILLINOIS

ences all of the set manufacturers' coil numbers with the *Miller* replacement numbers. Included in this catalogue are listings for picture i.f. transformers, sound i.f. transformers, horizontal oscillator and sync control coils, adjustable ion traps, video peaking coils, and adjustable linearity and width controls.

The company will forward a copy of this guide without charge upon written request.

TURNER PRODUCTS

Turner Company, 900 17th Street N.E., Cedar Rapids, Iowa has announced publication of its new general catalogue covering microphones, phonograph pickup cartridges, microphone interiors, and microphone accessories.

Catalogue No. 961-A lists the names and addresses of all the company's representatives on the front cover. In addition, the publication provides detailed ordering information on dynamic, carbon, crystal, and ceramic replacement cartridges for the company's microphones.

In all, 40 models of various types and impedances are described, with stock numbers assigned for ease in ordering.

ELECTRONICS DICTIONARY

Allied Radio Corporation has announced publication of a completely revised edition of "A Dictionary of Electronic Terms," containing over 3500 terms used in television, radio, and industrial electronics.

The new publication, edited by Gordon R. Partridge, associate professor of electrical engineering, Purdue University, answers the need for an accurate, up-to-date reference source of words used in the rapidly expanding electronics field.

Over 150 illustrations and diagrams of components, equipment, and electronic circuits are included. The book, which measures 6" x 9" and runs 72 pages, is available from the company at 100 N. Western Ave., Chicago 80, Illinois. Specify stock number 37 K 756 and enclose 25 cents to cover handling and mailing costs.

TUBE DESIGNATIONS FOR HAMS

The November-December issue of "G-E Ham News" carries an article on tube type designation systems for receiving, cathode-ray, industrial, and transmitting tubes as established by a joint committee of the RETMA and the NEMA.

Also included is a section on designations for germanium diodes and transistors. This material has been prepared for the radio amateur. Copies of this particular issue are available from the company's tube distributors or from the "G-E Ham News," *General Electric Tube Department*, Schenectady 5, N. Y.

MOSLEY BOOKLETS AND CATALOGUE

Mosley Electronics Inc., 8622 St. Charles Rock Road, St. Louis 14, Mo. has issued two new booklets of interest to the industry as well as a new gen-

eral catalogue which covers its line.

The booklet, "TV Outlets and Wiring Supplies," lists and describes the company's line of TV accessories such as lead-in entrance insulators, line connectors, wall outlet plates, and wiring supplies.

The second publication, "Amateur Radio Equipment and Electronic Components", covers crystal adapters, plugs, sockets, line connectors, etc. in addition to details on the company's two- and three-element 20-meter "Vest Pocket Beams" and the new two-element 40-meter version of this antenna.

The new '54-'55 general catalogue, "TV Antenna Accessories", includes data on several new items recently added to the firm's line, including a complete series of wall outlets which provide terminal facilities for two antenna lead-ins plus rotator control terminals for four-, five-, or eight-wire cable; a new single wall plate which accommodates three separate lead-ins, and many others.

RMS INDOOR ANTENNAS

A multi-colored, 8-page catalogue devoted exclusively to its line of indoor antennas is now being offered to jobbers by *Radio Merchandise Sales, Inc.*, 2016 Bronxdale Ave., New York 62, N. Y.

This catalogue illustrates the complete indoor antenna line and includes list prices. Quantities of this catalogue, for distribution, are available from the *RMS* director of advertising.

TRIAD REPLACEMENT DATA

Triad Transformer Corporation, 4055 Redwood Ave., Venice, California has issued a new TV guide listing its replacement transformers for television use.

The catalogue recommends the company's correct replacement items for receivers made by over 100 manufacturers and covers 5800 models. Copies of catalogue TV-55 are available from the company's jobbers or the company direct.

#190 TAPE

The story of "190 Tape," the new "Extra-Play" magnetic recording tape, is contained in Bulletin 30 of "Sound Talk," available from *Minnesota Mining & Manufacturing Co.*, St. Paul 6, Minnesota.

This bulletin traces the history of the tape's development and provides physical specifications, magnetic specifications, frequency response graphs, and data on layer-to-layer signal transfer.

A copy of Bulletin 30 is available on request.

1955 HEATH CATALOGUE

Heath Company, Benton Harbor, Michigan is now offering copies of its new 1955 catalogue.

As compared to last year, the new catalogue features seven new "Heath-kits," four radically redesigned kit models, and color and control knob restyling of most of the remaining instruments. In all, the new catalogue

describes more than 55 kits, including test instruments, amateur equipment, audio equipment, etc.

Numbering 48 pages, this publication contains complete technical specifications and schematics for the full line of "Heathkits".

DUBBINGS AUDIO SERVICES

A new 12-page bulletin has been issued by *The Dubbings Company*, 21-10 45th Street, Long Island City 4, New York.

Bulletin C describes the complete range of tape and disc recording services offered by the company's audio laboratory for broadcast stations, sound studios, businesses, record companies, pre-recorded tape firms, and hi-fi enthusiasts.

The bulletin covers the various types of dubbings in use, and presents price lists for small and large quantities. Included are tape recording, multiple tape duplication, disc recording, disc

masters and pressings, off-air monitoring, and editing.

The company's line of audio test products is also described. These include test records, test tapes, and test level indicators.

PERMO NEEDLE GUIDE

Permo Incorporated, 6401-33 Ravenswood Ave., Chicago 26, Ill. is now offering copies of its "Cross Reference and Needle Guide" for the replacement phono needle trade.

The 12-page folder includes an illustrated index with the needles pictured and information on what cartridge each of the needles fits. The guide is complete and "industry-wide" in that the products of *Permo*, *Fidelitone*, *Duotone*, *Jensen*, *Miller*, *Recoton*, and *Walco* are all listed.

Copies of this handy reference are available without charge.

For your copy, write the company or contact a *Permo* distributor. -30-

GIVE YOUR THUMB A REST

By DONALD H. ROGERS, ex-W2MLF

PUSH-TO-TALK operation is one of the simplest operating conveniences that can be designed for a phone transmitter. It does have the one drawback, however, often lamented on the air, that your thumb gets tired and produces an occasional interruption of carrier by slipping off the button.

Three ways of solving this problem were found after a little casting around and experimenting. They all afford quick-change conversation, and one of them is pretty sure to suit the requirements of the average ham station.

The first way is to mount an ordinary toggle or slide switch on the handle of the microphone, instead of a push-button. It should be clamped on in a good position for the thumb of your microphone hand; a short trial will show just where. This system has the one disadvantage that the throw of the switch usually jars the microphone slightly, so that your carrier comes on the air with a ringing sound, and possibly an over-modulation peak. A little rubber padding will reduce the effect.

The second way is to use two buttons arranged in a standard motor starter circuit, as shown in Fig. 1. This circuit requires the relay which you will probably use anyway in order to limit either the current or the voltage present on the mike. It is arranged so that pressing the "Start" button momentarily closes

the relay, which locks itself up through the parallel pair of contacts and stays closed until the circuit is broken by pressing the "Stop" button. The two buttons should be clamped at a convenient point on the mike stand.

The third system is to change the mechanical adjustment of your present push-to-talk switch so that it becomes a toggle switch with two positions, one each side of dead center. Fig. 2 shows a typical war surplus desk stand mike and the simple conversion required for toggle action. It has a rocking thumb piece whose leverage is transferred through a link in the stem to the contact springs below. Adding a small saddle of sheet metal at the right point on the spring as a new pivot causes the arm to go past dead center when operated. Then adding an extension on the button provides a surface to press on for return to the "Off" position. The rocking action is very easily mastered and quite convenient.

It will usually pay to connect the switch leads to the transmitter through a suitable plug, so that the mike can be disconnected easily.

Once you have used one of these systems you will never again be without the rag-chewer's delight, a push-to-talk button that stays pushed. The only thing that could beat it would be a self-pushing button. -30-

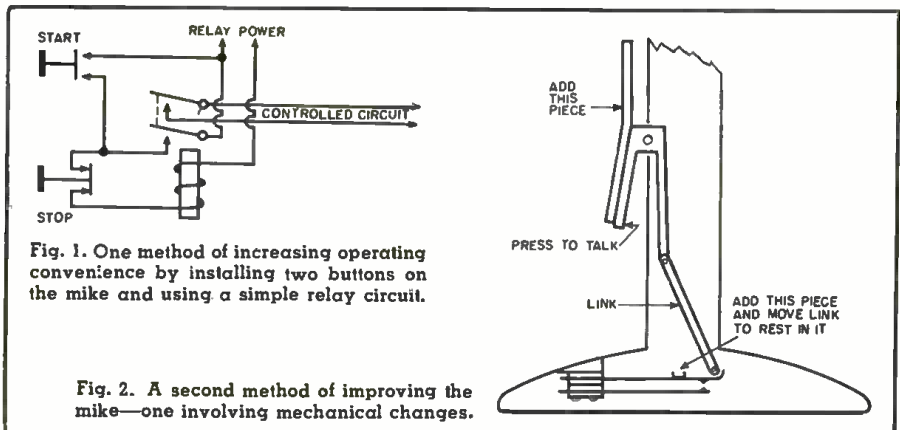

Fig. 1. One method of increasing operating convenience by installing two buttons on the mike and using a simple relay circuit.

Fig. 2. A second method of improving the mike—one involving mechanical changes.

TRANSVISION

Now brings you a compact
**Flyback—Yoke—Continuity
Tester...in 1 low cost unit**

for only

\$24⁹⁵

(A \$59 value!)

- Checks low and high impedance yokes and flybacks.
- Detects even one shorted turn.
- An improved Continuity Checker: Checks condensers for opens, electric



cal shorts, or leakage. Ordinary continuity testers will not do this.

TV Component Tester

PERFORMS
**SIX
VITAL
FUNCTIONS**

You get \$176 worth of Testing and Repair Instrumentation in 1 compact unit for the amazing low price of only . . .

\$49⁹⁵



It's terrific as a

- PICTURE TUBE TESTER
- FLYBACK & YOKE TESTER
- SELENIUM RECTIFIER TESTER
- CONDENSER TESTER
- CONTINUITY TESTER
- PICTURE TUBE REACTIVATOR

FIELD STRENGTH METER

For Battery Operation and 110V AC

Saves 50% of Installation cost . . . Measures pic signal strength directly from antenna . . . Identifies TV, FM, TVI signals . . . Has 12 channel selector; multiplier switch for weak signal areas . . . Range, 10-50,000 microvolts . . . A must in fringe areas, UHF or VHF . . .



Money Back Guarantee

Model FSM-5B, for Battery Operation and 110V AC. Weight 22 lbs. . . . net \$89

TRANSVISION, Inc., New Rochelle, N. Y.
JOBBER INQUIRIES INVITED

New Year's News from Hallicrafters

CHICAGO 24, ILLINOIS

IN CANADA: BOX 27
TORONTO 17, ONTARIO

Model SX-99 RECEIVER

Here is everything you could wish for in a DX receiver. Covers Broadcast Band 540-1680 kc plus three short-wave bands 1680 kc-34 Mc calibrated for the 10, 11, 15, 20, 40 and 80 meter amateur bands over a large easy-to-read dial. Features for the amateur—"S" meter, separate bandspread tuning condenser, crystal filter, antenna trimmer, one r-f, two i-f plus 3.2 and 500 ohm speaker terminals.

Gray-black steel cabinet with brushed chrome trim and piano hinge top, 18 1/2" x 8 1/2" x 11". Shipping weight 36 lbs.

Seven tubes plus rectifier. 105/125 V. 50/60 cycle AC. \$149.95 (less speaker). Use Hallicrafters R-46A Speaker.



Add One More Band (Continued from page 53)

coils, connect a fairly heavy piece of copper braid, with a copper plated alligator clip at the end. This braid should be long enough to reach the extreme end of either coil. Now, finish assembling the antenna, installing the top section and the can, if one is used. The coils are now ready for checking and tuning.

This modification should have no appreciable effect on the performance of the original coil. This may be easily checked. Attach the alligator clip to the bottom screw on the lower coil; this shorts out the lower coil, and permits the top low-frequency coil to operate normally. Turn on the transmitter and check the loading. If the system loads much differently than before the lower coil was added, check continuity through the system, and check to make certain all connections have been made as prescribed. When satisfied with the operation of the original coil, proceed to tune the new high-frequency coil. Attach the alligator clip to the top of the low-frequency coil—in the case of the "canned" *Master-Mobile* type coil, the bottom of the can is already connected to the top of the coil, and makes a convenient point for this connection. This shorts out the upper coil. Now, with the transmitter operating on the band for which the new coil was wound, carefully prune the coil, one turn at a time, until the transmitter starts to load properly. When the point has been reached where the loading is beginning to increase, try adjusting the turns spacing to complete the loading, for a point will be found where the removal of one more turn might be one turn too many!

That's all there is to it. To change bands, it is only necessary to change the alligator clip from the end of one coil to the other. With this coil, on 20 meters, under a 75-meter *Master-Mobile* coil, and a 20 watt transmitter in the car; some surprising reports have been had from Canada while operating along the Overseas Highway through the Florida Keys, and the writer works KZ and other Central American stations as readily as any W contacts are made. From the standpoint of low cost, ease of construction, and efficient operation, you'll not find any easier way to add one more band to your mobile antenna!

Some experimenters frequently experience considerable difficulty in getting their mobile antennas to load on one or more bands, although they may load well on others. This can usually be traced to the fact that the coax transmission line is of such a length that it acts as a 1/4 wave transformer, which will be the case if the line is near any odd multiple of a quarter wave long. Since mobile whips are quite low impedance, and most mobile transmitter output circuits are de-

FAMOUS BC-645 XMITTER-RECEIVER



BRAND NEW

Makes wonderful mobile rig for 420-500 Mc. Easy to convert for phone or CW 2-way communication. CONVERSION DIAGRAM INCLUDED. This swell rig originally cost over \$1000—yours for practically a song! You get it all in original factory carton. BRAND NEW, complete with 17 tubes, less power supply. Shipped wt. 25 lbs. **\$29.50**
PE-10IC DYNAMOTOR for BC-645, has 12-24V input (easy to convert for 6V Battery operation) only **\$4.85**
UHF ANTENNA ASSEMBLY, for BC-645 **\$2.45**
CONVERSION BOOKLET. Instructions for most useful surplus rigs. **\$2.50**

TG-34A CODE KEYS



Self-contained automatic unit, reproduces code practice signals recorded on paper tape. By use of built-in speaker, provides code-practice signals to one or more persons at speeds from 5 to 25 WPM. BRAND NEW, in original carton. **\$18.95**
"Used Cond. As Is" **\$11.95**

TELEGRAPH KEYS

J-37 Navy Type 99c
J-38 Sir. Corps Type 85c
FL8-A RADIO FILTER **\$1.59**

HEADPHONES

Model	Description	Excellent Used	BRAND NEW
H5-23	High Impedance	\$2.25	\$4.35
H5-33	Low Impedance	1.79	4.65
H5-30	Low Imp. (feathered)	1.49	1.85
H-16/U	High Imp. (2 units)	2.75	7.95
CD-307A	cords, with PL55 Plug and JK26 Jack		.88

MICROPHONES

Model	Description	Excellent Used	BRAND NEW
T-17	Carbon Hand Mike	\$5.45	\$7.95
T-30	Carbon Throat Mike	.35	1.25
T-45	Low Lip Mike	1.49	1.85
RS-38	Navy Type	1.95	5.95
T-24	Carbon Mike		3.95

CRADLE TYPE HANDSETS \$2.95

SCR-274 COMMAND EQUIPMENT

Type	USED	Excellent	BRAND NEW
BC-453 Revr.	190-550 Kc. \$18.50	\$21.50	\$37.50
BC-454 Revr.	3-6 Mc. 8.25	11.25	19.50
BC-455 Revr.	6-9 Mc. 7.95	10.95	15.45
BC-456	Modulator 2.75		4.65
BC-457 Xmtr.	4-5.3 Mc. 11.95	14.50	22.95
BC-458 Xmtr.	5.3-7 Mc. 7.95	9.75	21.95
BC-459 Xmtr.	7.9-1 Mc. 11.95	12.95	21.25
BC-696 Xmtr.	3-4 Mc. 18.95	27.95	
BC-450 3-Rev.	Control Box. 1.49		1.95
BC-451 Xmtr.	Control Box. 1.25		1.49
3-Receiver Rack		1.79	2.95
2-Transmitter Rack		1.59	3.25
Single Transmitter Rack			3.25

BC-375 TRANSMITTER, with Tubes \$29.50

DYNAMOTORS

Type	Input	Output	Excellent Used	BRAND NEW
DM-40	14V 3.4A	172V .138A	1.95	3.95
DM-42A	14V 46A	515/1030/2/8 MA 215/260	12.95	16.95
DM-43A	28V 23A	515/1030/2/8 MA 215/260	29.50	
DM-32A	28V 1.1A	250V .05A	2.95	7.50
DM-34D	12V 2.8A	220V .080A	11.95	
DM-35D	12.5V 18.7A	625V .225A	9.95	
DM-36	28V 1.4A	220V .080A	9.95	
DM-37	25.5V 9.2A	625V .225A	12.95	
DM-28	28V	224V .07A	1.95	4.95
DM-53A	28V 1.4A	220V .080A	2.95	6.95
DM-33A	28V 5A	575V .16A		
	28V 7A	540V .25A	1.95	3.95

NAVY RECEIVER TYPE ARB

Four Band, 105 to 9050 kc. Low Freq. Ship. Broadcast-40 and 80 meters. Includes tubes and dynamotor, for 24 volt operation. Easily converted for 110 V., 12 V. or 6 V. Schematic Included. Excellent Condition. Overall: 8 1/4" x 7 1/4" x 13 1/4". Wt. 30 lbs. Special **\$18.65**

GOULD 6-VOLT STORAGE BATTERY

15 Amp. Hour Rating. Navy Standard. Black Rubber Case, BRAND NEW \$5.95

WILLARD 6-VOLT MIDGET STORAGE BATTERY

3 Amp. Hour. BRAND NEW. 3 5/8" x 1-13/16" x 2 3/8". Uses Standard Electrolyte. Only \$1.95

20 Amp. Hour. BRAND NEW. Transparent Plastic Case \$1.95

1-QUART ELECTROLYTE, enough for two cells. Bottle \$1.45

Please include 25% Deposit with order—Balance C.O.D. MINIMUM ORDER \$3.00. All Shipments F.O.B. Our Warehouse N.Y.C.

G & G Radio Supply Co.
Dept. N-1
51 Vesey St., New York 7, N. Y., CO 7-4605

signed to work into low impedance loads, a step-up transformer between transmitter and antenna will effectively prevent loading.

In cases where difficulty is experienced, the length of the coax should be checked. A quarter wavelength of coax line can be found from the formula:

$Line\ length\ (in\ inches) = 1948/f\ (in\ mc.)$ A coax line which figures within a foot or so of any odd multiple of this value, on any band which you intend to work, should be carefully avoided. -30-

Limiting Amplifier
(Continued from page 63)

a certain fraction of the output voltage and is re-inserted in the cathode circuit of the first stage. The actual fraction is determined by the proportions of the resistor making up the voltage divider consisting of the series 30,000 ohm resistor and the 1500 ohm cathode resistor. Roughly 5% of the output voltage to ground appears at this cathode. Since the feedback voltage must not exceed the cathode-to-ground voltage of the stage in which it is inserted, this fraction cannot exceed approximately 3 volts. Thus the source used to derive this fraction cannot then exceed approximately 60 volts. The output consists of the total of both halves, so there is then effectively a maximum of 120 volts peak-to-peak available. The gain of the following speech amplifier or modulator should be adjusted so that less than 55 volts r.m.s. sine wave is required to completely modulate the transmitter.

The meter circuit is similar to the usual bridge type, upward-reading "S" meters used on communications receivers. It is so connected that it will swing upward when the plate current on the 6L7 tubes decreases with limiting action. This indicator should be calibrated and adjusted so that with 10 db of measured compression, it will read half scale. Actual compression is the measured difference in change of level occurring in the output for a given change in input level. For instance, if the input level is raised 20 db and the output level increases only 15 db, the unit has gone into 5 db of compression. This meter sensitivity is adjustable by means of R_{21} and R_{22} . The two adjustments interlock, so that changing the sensitivity by adjustment of R_{22} necessitates a re-adjustment of R_{21} to set the electrical zero scale when the unit is not under compression. The resulting scale will be nearly logarithmic in nature.

The unit is housed in a small cabinet that can rest on the operating table next to the receiver. The power supply is mounted remotely along with other supplies in the transmitter so no trouble would be experienced with hum induction from the transformers and chokes.

Parts layout is not critical but should follow conventional wiring practice and
February, 1955

Announcing the NEW

SANGAMO Type 36

PLUG-IN TUBULAR PAPER CAPACITOR



Your answer to those calls for a PRINTED CIRCUIT REPLACEMENT CAPACITOR

Perhaps you've already had calls for printed circuit replacement capacitors. Now you can offer your customers the first mass produced capacitors for printed circuit chassis. Remember, the new Type 36 plug-in tubular is an exact replacement for most of today's new printed circuit chassis. To stock up now, see your Sangamo jobber or write direct.

WATER TEST

**MOISTURE-RESISTANT
END FILL**

**BAKELITE
MOLDED CASE**

**LEADS ARE CUT
AND PROPERLY
SPACED TO FIT**

Those who know *choose Sangamo*

SANGAMO ELECTRIC COMPANY

MARION, ILLINOIS

New Year's News from Hallicrafters

CHICAGO 24, ILLINOIS

IN CANADA: BOX 27
TORONTO 17, ONTARIO

Model SX-96 SELECTABLE SIDEBAND RECEIVER

- Covers Broadcast 538-1580 kc plus three S/W 1720 kc—34 Mc.
- Full precision gear drive dial system.
- Double conversion with second oscillator crystal controlled.
- Selectable side band reception of both suppressed carrier and full carrier transmissions.
- Mixer type second detector.
- CW operation with AVC on.
- Delayed AVC.
- Calibrated bandspread — "S" meter — double superhet.
- 10 tubes, 1 rectifier and voltage regulator.



placement of parts typical of audio amplifiers. It is advisable to keep lead lengths short.

All resistors in the push-pull stages should be accurately matched with an ohmmeter as closely as possible. Substitute values may be used for those shown if the exact resistor values are unobtainable except in the case of certain resistors so indicated in the parts list. In general, however, the values chosen should not depart more than 20% from the values given and in particular no substitutions should be attempted that will drastically affect the feedback loop. Deviations in this part of the circuit will create distortion characteristics that are unpredictable and will affect circuit stability. Operating voltages should be adhered to exactly. For slightly different supply voltage, adjust the operating circuit voltages to the same *percentage* of the total supply voltage available.

Tubes should be chosen, for exact match, with a transconductance tube checker. The 6L7 tubes in particular should be chosen for the same gain characteristics for each corresponding control grid.

A power supply of extremely low source impedance is required, preferably regulated. Common coupling from a supply of high source impedance will result in a low-frequency oscillation having a repetition rate of about 1 cps or longer. A suggested regulating arrangement is shown in Fig. 6.

For proper operation, the initial adjustment to be made after the circuit voltages have been proportioned to the values shown, is that of the proper adjustment of the balance control in the cathode circuit of the 6L7 tubes. This resistor, R_1 , is to provide dynamic balance so that control surges will not appear as thumps in the output. At extreme settings or with poorly matched tubes it is possible that the amplifier will oscillate. Through a suitable voltage divider, arrange to sample about 1 volt of 60-cycle a.c. from the 6.3 v. heater supply. With one side grounded, put this test voltage on the plate pin of V_1 , or on the secondary center tap of T_1 , whichever is more accessible. Simply adjust R_1 for minimum output of the limiting amplifier. After completing this adjustment, remove the test voltage. This adjustment may require touching up from time to time as the tubes age.

Finally, as discussed previously, the speech waveform polarity should be observed throughout the system so that (1) the peaked side of the wave goes through the limiter on the uncontrolled side of the amplifier, i.e., the part of the wave having the shallow side most consistently should be the one that feeds through the half-wave control rectifier. This is done simply by selecting the correct choice of polarity of the microphone leads. (2) The peaked side of the wave after compression should be polarized so that it modulates the transmitter in the *upward* direction. This is done by revers-

PHOTO FLASH

100 W. SEC. STROBE OUTFIT

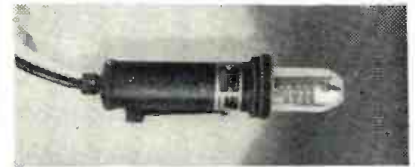
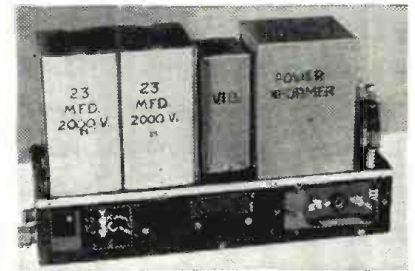

LAMP ASS'Y & FLASH BULB

Ideal for outdoor photography by attaching to auto battery on 8/12 or 12/24 VDC source or used indoor for studio—Complete w/Lamp ass'y, Ignition coil & trigger housing & 20 Ft. cord—Uses Sylvania A-1073 200 W.S. Bulb (similar to Sylvania 4330 but has Pyrex covering) BRAND-NEW ready to operate w/instruction manual—Sh. Wt. 50 lbs. \$24.95

INDIVIDUAL PARTS AVAILABLE—WRITE TODAY!

- "IDEAL" MODEL 5 C SOLDERING PLIERS & TRANSFORMER—Thermogrip carbon pliers & connecting cable—115 VAC 60 cy 10 amps input—OUTPUT: 3.5/4.5 V @ 60 amps Int. or 60 amps cont. duty —In metal carrying case which can be used for tool box—BRAND-NEW—Wt. approx. 25 lbs. \$24.95
- 3 to 5 H/500 ma Choke—100 ohms—2500 V Ins. New \$4.95
- 15 H/200 ma (ICAS)—125 ohm Choke—New \$2.95
- RHEOSTAT—4500 ohms 150 Watt—Ohmite Model L—Open case—4" dia. x 2"—W.W. Linear taper—New \$3.95
- RHEOSTAT—8 ohms 50 Watt—IRC PR-50—Metal case 2 3/4 x 1 3/4—W.W. linear taper—New \$1.50
- BC-221 TECHNICAL MANUAL—NEW—Prepaid \$1.25

SPECIAL NEW SHIPMENT JUST ARRIVED

TG-34-A CODE KEYS—115/230 VAC 50-60 cycle. Has self-contained oscillator for hand keying or use with paper tape. Complete with tubes, photo-cell & manual in compact carrying case 10 9/16 x 10 1/2 x 15 13/16". Sh. Wt. 45 lbs.

BRAND-NEW \$16.95
LIMITED QUANTITY

TG-10 CODE KEYS—similar to above but more audio output—mtg. in 11 x 24 x 18 1/2" metal cabinet. Used, excellent. \$14.95

- INDIVIDUAL TAPES for the following lessons—
- 23, 23, 211—New in metal containers—ea. \$1.25
 - WESTINGHOUSE PX-14 D.C. AMMETER—1% accuracy. 1-1-10 amps. Open face portable, P.M. moving coil. .005 ohms—3 3/4" meter face—4 1/4 x 3 1/4 x 1 1/2"—with test leads & leather carrying case. BRAND-NEW in orig. box \$9.95
 - 0-200 DC U.A. METER—960 ohm per .1 V—D'Arsonval movement—2 3/4" round body—4 x 4 5/8 x 10/32" rect. flange. New—boxed \$6.95
 - 0-200 DC U.A.—Triplett 2 inch New \$5.50
 - 0-150 VAC—Stark 47 M—3" square New 4.95

25% WITH ORDER. BAL. INCL. POSTAGE C.O.D. MICHIGAN RESIDENTS ADD 5% SALES TAX. PRICES SUBJECT TO CHANGE WITHOUT NOTICE. ALL MERCHANDISE SUBJECT TO PRIOR SALE.

AARON ELECTRONIC SALES
3830 Chene Street Detroit 7, Michigan

MORE JOBS than graduates

Demand for our engineering graduates exceeds supply. Effective placement. Study in this world-famed college established 1884. Quarters start March, June, Sept., Jan. Approved for Korean Vets.

Bach. Sci. degree in 27 months
Complete Radio Eng. courses . . . TV, UHF and FM. Also Mech., Civil, Elec., Chem., Aero. and Adm. Eng., Bus. Adm., Acct. Small classes. Well-equipped labs. Modest costs. Prep. courses. Write Jean McCarthy, Director of Admissions for Catalog and Campus View Book.

TRI-STATE COLLEGE
1625 College Avenue, Angola, Indiana

ing the connections to one winding of the modulation transformer, if necessary. These polarities can easily be seen in a scope presentation by observing the audio waveform while sounding a vowel such as "Oh" or "Ah," which are excellent test units for checking the limiting amplifier.

In use, the output gain control sets the absolute modulation percentage of the transmitter. An input volume control in the microphone preamplifier stages of the speech system will set the input level to the compressor and thus determine the amount of compression that takes place. If the microphone preamplifier is arranged to suppress the low frequencies and emphasize the speech frequencies, it will be possible to take advantage of as much as 20 db of indicated compression without any ill effects. With flat amplification it will be necessary, or at least advisable, to limit the indicated compression to only 10 db.

This circuit will compress up to better than 30 db without distortion and the output rise is less than 1 db at 30 db of compression, or a control ratio of better than 30 to 1 for any level above the threshold point.

EDITOR'S NOTE: You will note that in the schematic diagram of the power supply, Fig. 6, the 6.3 volt winding is floating and is not tied to ground. In the author's model, he had one side of the filament winding grounded. This, of course, does not follow sound engineering practice because under this condition the potential between cathode and heater of V_2 would be 305 volts. The maximum rated potential is supposedly 300 volts. Again, the potential difference between the cathode and heater of V_2 is 150 volts while the maximum allowable rating in this case is approximately 90 volts. In both cases the author has not designed his unit within specified ratings. He has, however, operated his unit under the grounded condition for some 5 years and hasn't lost any tubes as yet. There is no reason to believe that anyone following his idea would run into any particular trouble.

For good design practice, however, this should be corrected. There are several ways in which this condition can be overcome. One way would be to operate the heaters at a potential of 75 volts above ground. This would place all tubes within their ratings and would also have the added advantages of biasing the low-level heaters for hum reduction. The simplest way to achieve this condition is to return the heater winding center-tap to a point 75 or 80 volts above ground on the main bleeder. In doing this, connect a 100,000 ohm isolating resistor in series with the center-tap of the heater winding to the 75 or 80 volt point on the main bleeder.

If this suggestion is followed, it would make it necessary to obtain test a.c. voltage, mentioned under the adjustment procedure, from a separate source so that one side would be at ground potential.

precise

says: Ask ANY
Engineer or Serviceman,
"WHAT'S THE TOUGHEST
TEST OF ALL?"

YOUR test . . . the way the equipment works in actual use . . . under actual conditions. PRECISE test equipment has passed that test countless times . . . every instrument fully proven. That is why YOU and thousands like you have made PRECISE the fastest growing line of test instruments in America today!

Remember, too, PRECISE uses no surplus. See the complete line of PRECISE quality instruments at your jobber now—and save!

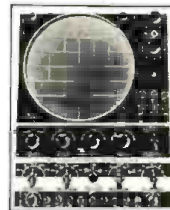

EXCLUSIVE PRECISE 8½" OSCILLOSCOPE
#308K kit form \$129.50
#308W factory wired \$229.50

PRECISE 7" OSCILLOSCOPE
#300K kit form \$94.95
#300W factory wired \$199.50

precise ★ precise ★



EXCLUSIVE PRECISE VOLT. REG. V.T.V.M.
#9071K kit form \$35.95
#9071W factory wired \$49.95

precise ★ precise ★ precise



PRECISE RESISTANCE
DECADE BOX
#468K kit form \$18.95
#468W factory wired \$24.95

PRECISE CAPACITY DECADE BOX
#478K kit form \$18.95
#478W factory wired \$24.95



NEW PRECISE VOLTAGE REG. POWER SUPPLY
#760K kit form \$39.95
#760W factory wired \$59.95

precise ★ precise ★ precise ★ precise ★ precise

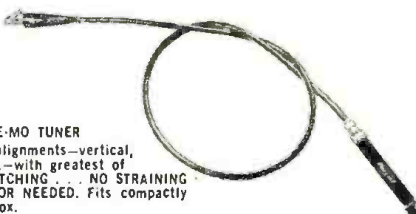

PRECISE TV RE-MO TUNER
Allows finest alignments—vertical, horizontal, etc.—with greatest of ease. NO STRETCHING . . . NO STRAINING . . . NO MIRROR NEEDED. Fits compactly into any tool box.
#SMK wired only \$2.95



NEW PRECISE Em. & MUT. COND. TUBE TESTER
#111K kit form \$69.95
#111W factory wired \$139.95

★ precise ★ precise ★ precise ★ precise ★ pr



PRECISE RF-TV & MARKER GENERATOR
#630K kit form \$33.95
#630KA pre-assembled head \$38.95
#630W factory wired \$53.95



PRECISE RF SIGNAL GENERATOR
#610K kit form \$23.95
#610KA pre-assembled head \$28.95
#610W factory wired \$39.95



NEW PRECISE VACUUM TUBE VOLTMETER
#909K kit form \$25.98
#909W factory wired \$37.50

precise ★ precise

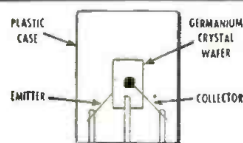

PRECISE NEW T1 TRANSISTOR KIT
PRECISE offers a simple and direct approach to the understanding of transistors. The instruction book covers the physics and practical applications in simple and non-mathematical terms. Two transistors, one germanium diode, transformer, electrolytics, coils, resistors, condensers, chassis, etc. are supplied.
Model T1 kit only \$17.95

precise

DEVELOPMENT CORP.
OCEANSIDE, NEW YORK

Prices slightly higher in the West. Prices and specifications subject to change without notice.

SEND FOR NEWEST PRECISE CATALOG—DEPT. RN-2

**FREE ALLIED'S
SPECIAL 64-PAGE
HI-FI CATALOG**



Your guide to an easy understanding of Hi-Fi—plus the world's largest selection of Hi-Fi systems and components

send for it

This 64-page book shows you how to select a Hi-Fi music system at lowest cost. Tells you what to look for in each unit and shows many handsome, practical installation ideas. Offers you the world's largest selection of complete systems and individual units from which to make your money-saving choice. To understand Hi-Fi, to own the best for less, you'll want this Free book. Write for it today.

ALLIED RADIO

America's Hi-Fi Center

ALLIED RADIO CORP., Dept. B-25
100 N. Western Ave., Chicago 80, Ill.

Send FREE High Fidelity Catalog

Name

Address

City Zone State

ARKAY KITS WORLD'S FINEST

RADIOS PHONOGRAPHS TV
TEST EQUIPMENT HI-FI
Write for FREE Brochure

RADIO KITS, INC. • 120 Cedar St., N. Y. 6

WHAT'S New in Radio

The products described in this column are for your convenience in keeping up-to-date on the new equipment being offered by manufacturers. For more complete information on any of these products, write direct to the company involved.

CIRCUIT SOCKET

Methode Mfg. Corp., 2021 Churchill, Chicago, Illinois has announced the availability of a newly-designed laminated tube socket for printed circuit applications.

The sockets utilize twin wafers supporting contacts with vertical terminals which snap into individual holes in the circuit panel. This permits the printing of jumpers on the circuit panel to connect different pin positions.

The socket has particular advantages from the service and replacement standpoint, since solder connections between terminals and pads may be rapidly and individually wiped away with a pencil iron after which the socket is easily pulled from the board. Sockets are available in seven- and nine-pin types and can be used with or without tube shields.

SMALL WIREWOUND CONTROL

Clarostat Mfg. Co., Inc., Dover, N. H. has developed a small wirewound control which measures just 1 1/8".

Designated as the Series 43c, this new version is distinguished from the previous Series 43 by an improved wiper arm that contacts the edge rather than the side of the resistance winding. This contact allows higher resolution, more intricate tapers, and closer tolerances in over-all resistance and linearity.

The new series is available in standard ohmages from 1 to 50,000 ohms with electrical tolerance of $\pm 5\%$ and independent linearity to $\pm 2\%$. The

units are rated at 2 watts and are available with taps and various tapers.

For further information, request Form No. 753805.

HEATH OSCILLOSCOPE

A new model oscilloscope, the Model O-10, has been announced by *Heath Company*, Benton Harbor, Michigan.

Designed especially for the professional service technician or engineer, the new instrument has features that make it suitable for color TV work. Vertical channel response is virtually

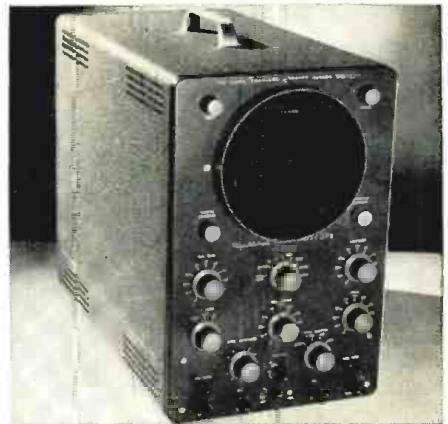

flat from 5 cps to 5 mc. It is down only 1 1/2 db at 3.58 mc. (the color TV sync burst frequency).

The Model O-10 employs printed circuit boards for reduced kit construction time and stable circuit operation. It uses a full 5" cathode-ray tube and employs a newly designed linear sweep



Regency

Day by day more and more people are making High Fidelity a part of their everyday life.

These handsome River Edge cabinets have been designed to make it effortless to assimilate High Fidelity equipment into any home decor.

RIVER EDGE CABINETS DESIGNED EXPRESSLY FOR REGENCY HIGH FIDELITY COMPONENTS



MODEL TM—Table model cabinet for HF-80 or HE-150 amplifiers or any Regency tuner.

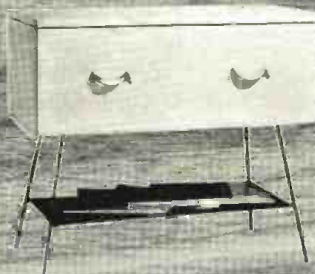

MODEL CYC—Console cabinet for combination of changer, AF-220 tuner and HF-80 or HE-150 amplifiers.

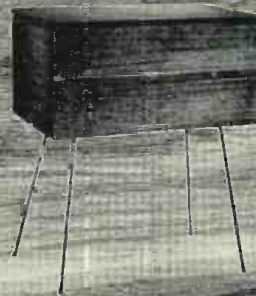

MODEL TAC—Table model or a chairside console for changer and HF-80 or HE-150 amplifiers or AF-220 tuner.

River Edge cabinets are priced from \$17.50 to \$85.55. Pre-cut, pre-drilled panels are available to specifications at nominal charge.

REGENCY DIVISION, I.R.E.A., Inc., 7900 Pendleton Pike, Indianapolis 26, Indiana

generator circuit which will produce stable, linear sweeps up to 500,000 cps.

Full price information and technical specifications on this instrument are available on request.

"MULTIVOLTER POWER SUPPLY"

Authorized Manufacturing Company, 919 Wyckoff Avenue, Brooklyn 27, N. Y. has released a new addition to its line of service instrument tools, the Model #301 "Multivolter Power Supply."

Fitting in a pocket, tool box, or tube caddy, this unit provides a range of



variable d.c. voltage from -135 through 0 to +135 volts as well as an a.c. range of 0 to 135 volts. An added feature provides one ampere of 6.3 filament voltage at separate terminals. A neon indicator provides indication of current output, extinguishing when 20 ma. is drawn.

The instrument is housed in a molded phenolic case which measures 3 3/4" x 6 1/4" x 2" with an anodized aluminum panel. It also comes with a UL-approved line cord.

NEW ERIE PRODUCTS

Erie Resistor Corporation, Erie, Pa. has announced that the complete line of its "Teflon" products is now available at distributors.

These "Chemelec Teflon" products include stand-off and feed-through in-



sulators, miniature tube sockets (seven- and nine-pin in "Teflon" and "Kel-F"), crystal sockets, fifteen- and eighteen-pin connectors, and five sizes of spaghetti in three colors.

A complete catalogue and price sheet on these products is available at electronic distributors stocking these products or by writing the distributor sales division of the company.

PISTON CAPACITOR

The Electronics Division of JFD Manufacturing Company, 6101 16th Ave., Brooklyn 4, N. Y. has developed a new variable trimmer piston capacitor, the Model VC-13G.

The expansion piston has a traverse

February, 1955



\$23.50
including sturdy
metal cabinet
Suggested net price

**New Centralab
service kit saves time,
saves job delays**

Centralab's handy **Fastatch® FR-22A Kit** gives you a practical, working stock of carbon dual-concentric control replacements for all popular TV, radio, and auto sets

At your fingertips — everything you need to replace the carbon dual-concentric controls you run up against most often. You get 11 Fastatch front units, 11 Fastatch rear units, 4 Fastatch switches, and 2 auto-type adapter bushings — all 100% tested and guaranteed by Centralab.

The front and rear units snap together to give you 11 controls out of a possible 121 combinations of resistance and taper. So, now, you never have to be out of the right replacements for "hot" jobs.

See the FR-22A at your Centralab distributor. Or, send coupon for bulletin 42-223.



It's a snap to get the right replacement for practically any dual control

No loose parts! No lugs to bend! No tricky assembling!

SNAP FRONT UNIT...
(with outer shaft cut to length)



TO REAR UNIT...
(with blue shaft cut to length)

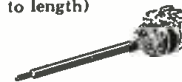

SNAP ON SWITCH...
(from Fastatch KB series)



ADD THE KNOBS
— and there's your custom dual

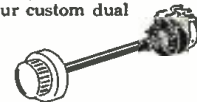

Centralab

A DIVISION OF GLOBE-UNION Inc.
910B E. Keefe Ave., Milwaukee 1, Wis.

The Fastatch FR-22A Kit sounds like a good deal. Send me bulletin 42-223 that describes it further.

Name.....
Company.....
Address.....
City..... Zone..... State.....

B-455

for only \$60⁰⁰_{net}

own a turntable
comparable
to the finest!

THORENS

E-53 PA



TRANSCRIPTION TURNTABLE

professional gear-drive model

Here's the turntable that is the fast-growing choice of discriminating music lovers and technicians. It has all the quality of turntables costing twice as much. The cast-aluminum table, with foam rubber cover, is powered by the modern Thorens direct-drive motor... world's most silent phono motor. A mechanical filter assures continued silent operation... an electronically-balanced rotor shaft eliminates undesirable waver and wow. In standard signal-to-dead-groove noise level checks, the E-53 PA maintains a noise level of -48 db. Has convenient speed change.

SEE YOUR DEALER...
for the E-53 PA, as well as
Thorens automatic and
manual record players, and
record changer — or write:

THORENS
NEW HYDE PARK NEW YORK

Music Boxes
Hi-Fi Components
Spring-Powered Shavers
Lighters

SWISS
MADE

motion, free from mechanical backlash, giving smooth capacitance tracking over the complete range. There is rigid grip between the piston and inner wall of the dielectric tube. As a result, this capacitor is relatively free from the effect of vibration and shock. Positive wipe, due to constant spring tension of the moving parts, assures good r.f. contact and low noise ratio, according to the company.

Voltages in excess of 10,000 volts d.c. can be withstood because the unit has a long flashover path from the outer electrode to the mounting base. Provision can be made for anti-corona protection.

Free technical bulletins on this unit are available on request.

SELENIUM RECTIFIERS

Pyramid Electric Company, 1445 Hudson Blvd., North Bergen, N. J. has announced a new design in selenium rectifiers which features edge-mounting plates providing full air circulation between plates; light, constant contact pressure which eliminates center hot spots; rigid construction eliminating loose plates; smaller over-all size per rating; and simpler mounting.

The rectifiers, which are available in all current ratings, can be used in all types of electrical and electronic

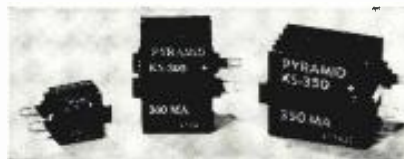

equipment, including radio and television circuits. They can be used as replacements for all existing standard rectifiers.

Complete engineering data is available from the Rectifier Sales Engineering Department of the company.

POCKET-SIZE V.O.M.

Superior Instruments Company, 2435 White Plains Road, New York 67, N. Y. is now offering a new volt-ohm-milliammeter which has 71 per-cent more scale area than the usual pocket-sized instrument of this type.

The Model 770-A is built around a 850 microampere, D'Arsonval meter of 2 per-cent accuracy. It is housed in a 3 1/8" x 5 7/8" x 2 1/4" molded Bakelite case. It has six a.c. voltage ranges, six d.c. voltage ranges, two resistance ranges, three d.c. current ranges, and three decibel ranges.

The instrument comes complete with batteries, test leads, and operating instructions.

ELECTRONIC RELAY

Servo-Tek Products Co., 1086 Goffle Road, Hawthorne, N. J. is in production on a new "ultra-sensitive electronic relay" of simplified design.

Relay action is initiated by external contact as high as one-half megohm with current as low as 1/10,000 ampere. The unit mounts on a standard 4-inch electrical connector box.

High contact pressure on the silver

contacts allows conservative rating of four amperes with a choice of either opening or closing a circuit or simultaneously opening one and closing an-



other. Power input is 115 volts, 25-60 cycles, single phase. Other voltages and frequencies are available on a custom basis.

V.T.V.M. KIT

Franklin Electronics, King Street, Franklin Park, Illinois is now offering its Model FV-1 vacuum-tube voltmeter kit direct to service technicians.

The instrument features a 4 1/2" meter for easy reading, a carrying handle which completely recesses into the top of the case to allow stacking, and smooth etched rub-proof panel on which markings remain clearly legible throughout long service.

The kit includes tubes, assembly material, test leads, and detailed assembly manual.

VARIABLES FOR COLOR TV

A new line of variable resistors for all color TV applications is now available from *Chicago Telephone Supply Corporation*, Elkhart, Indiana.

The complete color TV line includes 3/4" to 2 1/2" diameter controls with wattages from 2/10 watt to 4 watts. Control types are carbon and wire-wound with and without an attached switch.

Mountings are conventional bushing, twist ear, and snap-in bracket for

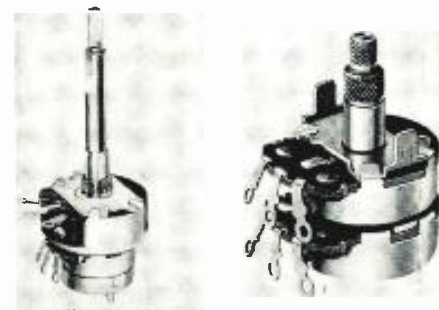

printed circuits. Terminal styles are for conventional soldering, printed circuits, and wire wrap. An endless combination of tandems with both single and dual shaft is possible.

The company will supply data on the complete line upon request.

MULTI-POSITION COAX SWITCH

Barker & Williamson, Inc., 237 Fairfield Avenue, Upper Darby, Pa. is now offering a new, inexpensive, multi-position coaxial type switch which enables the operator to select antennas,

(Continued on page 139)

O. F. Jester

replaced with a

WARD TELE-VANE

Oden F. Jester, Distributor Sales Manager
Standard Coil Products Co., Inc.
Melrose Park, Illinois

Every home owner has pride in the appearance of his home—
WARD Tele-Vane antennas add to the beauty of any home,
add to the performance of any TV set.

Your WARD jobber has full information on how to make
quicker sales and longer profit with locally promoted WARD
Tele-Vanes—nationally advertised in LIFE, SATURDAY
EVENING POST, BETTER HOMES and GARDENS,
HOUSE BEAUTIFUL, HOUSE and GARDEN.

Also, conventional Ward antennas
cost no more than copies of them.

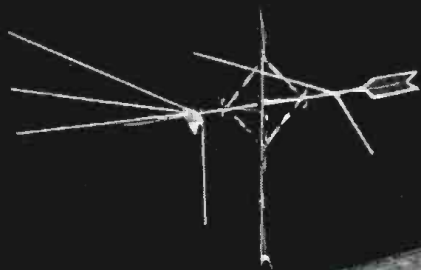

WARD PRODUCTS CORPORATION, Cleveland 15, Ohio

www.americanradiohistory.com

ATR SHAV-PAK NEW, LOW PRICE!



An ATR SHAV-PAK will solve this predicament!

SHAVE IN THE COMFORT OF YOUR CAR, Boat or Plane!

Specially Designed for Operating Standard A.C. Electric Shavers in Automobiles, Buses, Trucks, Boats, and Planes.

\$ **9.95** LIST PRICE

Plugs into Cigarette Lighter Receptacle on Dash

TYPE	INPUT D.C. VOLTS	A.C. OUTPUT 60 CYCLES	OUTPUT WATTAGE	LIST PRICE
6-SPB	6	115 volts	15	9.95
12-SPB	12	115	15	9.95

Introducing ATR MIGHTY MIDGET portable INVERTER WITH GREATER OUTPUT

Dictate reports accurately—promptly!

make your car, boat or plane a "rolling office" with ATR INVERTERS



Plugs into Cigarette Lighter Receptacle on Dash

\$ **19.95** AND UP LIST PRICE ATR INVERTERS . . .

especially designed for operating standard 110 volt A. C. . . .

- DICTATING MACHINES • TAPE RECORDER
- ELECTRIC RAZORS • WIRE RECORDERS

TYPE	INPUT D.C. VOLTS	A.C. OUTPUT 60 CYCLES	OUTPUT WATTAGE	LIST PRICE
6-DME	6	115 volts	30-40	19.95
6H-DME	6	115 volts	60-75	29.95

See your jobber or write factory today for complete information

AMERICAN TELEVISION & RADIO CO.
Quality Products Since 1931
SAINT PAUL 1, MINNESOTA—U. S. A.

A SINGLE-STAGE TAPE RECORDER MONITOR

The author's home-built monitoring amplifier and speaker. It is designed to fit into the carrying case of his recorder.

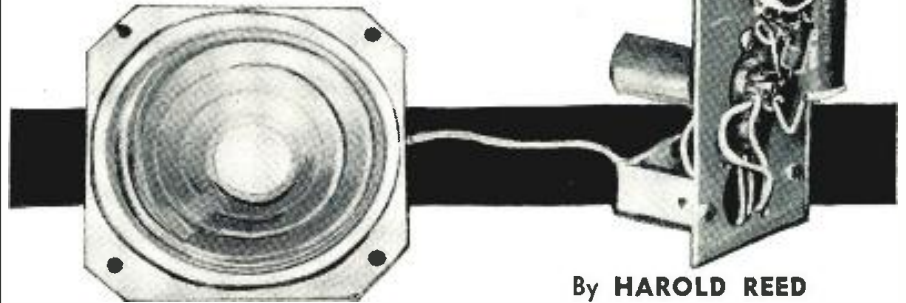

By HAROLD REED
Electronics Engineer
U.S. Recording Company

Details on a compact, 1-tube amplifier that is small enough to be tucked into the recorder's carrying case.

THERE are commercially available today, several good tape recorders which, although satisfactory in most other respects, have the annoying disadvantage of not being equipped with a monitoring amplifier and loud-speaker. The *Magnecord* "Voyager," PT6-VAH is an example of such equipment.

Manufacturers have several good reasons for not including these desirable items in their products. First, these recorders are built to meet a certain price level, therefore, all the advantages of costlier machines cannot be included. Secondly, these units are designed with compactness and portability in mind. Third, and this ties in with the first and second reasons, if the manufacturer included a monitor amplifier and loudspeaker he would want

to meet certain specifications, similar to those of the rest of his circuitry, particularly in the matter of low noise and distortion figures which would necessitate more than a single stage in order to obtain the necessary beneficial feedback requirements.

The individual electronics constructor, however, can build a monitor of the type described in this article and, keeping its limitations in mind, will find that its advantages greatly outweigh any disadvantages even though it may not be the highest of hi-fi. Its principal purpose, of course, in this case, is to eliminate the wearing of headphones when making a recording or playing back a tape for checking or editing.

This little unit was designed especially to be used with the *Magnecord* "Voyager" but, of course, could be adapted as well to other recorders. The photograph shows the experimental model constructed on a sheet of aluminum 3 by 5 inches, and the 4-inch loudspeaker used with it. The component parts can be built into a small "Minibox" and because no very low signal levels or high a.c. fields are involved the parts placement is non-critical.

The circuit diagram is given in Fig. 1. As can be seen in this schematic, a single 6AK6 pentode tube is used. The tube heaters in the "Voyager" are supplied through a selenium rectifier with 12 volts d.c., that is, all but the 6X4 high voltage rectifier tube. Heater supply for the 6AK6 which draws only 0.15 ampere was, therefore, taken off the 6X4 filament winding of the transformer. No hum pickup was encountered.

Plate and screen voltage for the
RADIO & TELEVISION NEWS

Fig. 1. Schematic of tape recorder monitor.

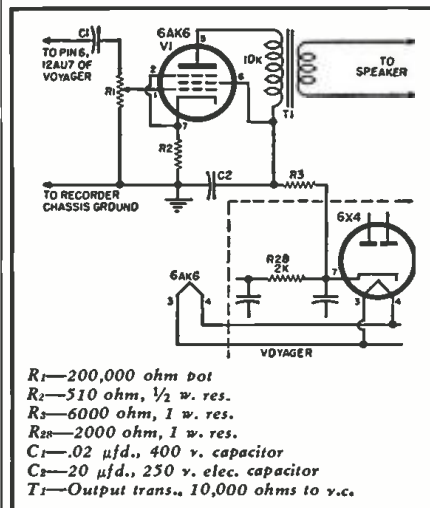

"MUST" READING . . . FOR THE SERVICE TECHNICIAN



MARCH SPECIAL SERVICE FEATURE ISSUE

Designed exclusively to meet the needs of the service technician

DON'T MISS IT!

Here are just a few of the many up-to-the-minute, authoritative articles on all phases of service in video . . . audio . . . Hi-Fi . . . electronics.

- **SIMPLIFIED RCA COLOR RECEIVER . . .** a complete discussion of the new circuit used in the revolutionary 28-tube RCA color TV set . . . expected to be the "630" of the color TV industry.
- **SERVICING AUTO RADIO SETS . . .** the three main troubles to look for in auto receivers and how to repair them.
- **NEW TV AND RADIO TEST EQUIPMENT . . .** a resume of new equipment on the market for the radio and TV service technician.
- **STREAMLINED AC-DC SERVICING . . .** the most common troubles in radio sets—and how to fix them.
- **LICENSING TV SERVICE TECHNICIANS . . .** a discussion of the pros and cons of licensing.
- **NEW TV CIRCUITS . . .** the new circuits used by TV manufacturers—how they operate and what can go wrong with them.
- **UHF DEVELOPMENTS . . .** latest information on new accessories for improved UHF.

This issue—like every issue of RADIO & TELEVISION NEWS—will be invaluable to you in your job or career.

WATCH FOR IT ON YOUR NEWSSTAND

ON SALE FEBRUARY 24



366 MADISON AVENUE • NEW YORK 17, N. Y.

February, 1955

137

**beyond
a shadow
of a doubt**

**the most versatile
78 rpm
crystal phono cartridge
of them all!**



**THIS DUAL-WEIGHT, DUAL-VOLT
PICKUP CARTRIDGE
REPLACES 149 DIFFERENT MODELS
OF 78-RPM CARTRIDGES!**

The W78 Dual-Weight, Dual-Volt Phono Cartridge replaces 149 different steel and aluminum case cartridges currently found in 78 rpm equipment! This versatility shows beyond a shadow of a doubt that the W78 is the most useful crystal phono cartridge ever designed for 78 rpm cartridge replacement business! Actual sales to servicemen prove that the versatile W78 cartridge is a replacement sensation—prove indeed that the W78 fills a great need—for here in one cartridge model is the answer to servicemen's inventory problems for 78 rpm cartridges!

MODEL NO.	TYPE	LIST PRICE	OUTPUT LEVEL	MIN. NEEDLE FORCE	RESPONSE TO	NET WT.	SHURE NEEDLE NO.
W78c	Crystal	\$5.55	4.0V or 2.0V	1 oz.	6,000 c.p.s.	Dual-Weight 25 grams or 12 grams	None

Dual-Weight, Dual-Volt Cartridge. Has weight slug secured by shrink-on band. With lead weight, net weight of cartridge is 25 grams. If 12 gram weight is desired, the shrink-on band can be cut off and the lead weight removed. In addition Model W78 has capacitor, furnished as accessory. Without capacitor output is 4.0 volts; with capacitor output is 2.0 volts.

See your Shure Distributor or write the factory for Replacement Chart which lists the 149 crystal phono cartridges replaced by Model W78

SHURE *The Mark of Quality*

SHURE BROTHERS, INC. • 225 W. HURON ST. • CHICAGO 10

6AK6 was obtained directly from the 6X4 rectifier output prior to the filter section. Taking this voltage off at the input side of the rectifier filter will prevent the additional current drain of the 6AK6 from passing through the filter with the resulting greater voltage drop which would occur across the filter resistor. A separate filter section is provided for the 6AK6 by the resistor R_2 and capacitor C_2 although the filtering requirements in this case are not too great.

Signal voltage for the monitor is obtained at the plate of the 12AU7 output stage of the "Voyager" and coupled to the grid of the 6AK6 through a .02 μ f. capacitor and the 200,000 ohm potentiometer which serves as a volume control. This connection provides for loudspeaker monitoring during recording as well as playback operation. The output from the 6AK6 is coupled to a loudspeaker through T_1 , a small plate-to-voice coil transformer.

Frequency response and distortion measurements were made on the "Voyager" before and after the monitor was connected. With the 6AK6 monitor in operation no deterioration in the recorder characteristics was observed.

With normal recording and playback levels the power output of the monitor is approximately 1 watt. Setting the monitor volume control to obtain $\frac{1}{2}$ watt output gave ample loudspeaker output for average monitoring requirements. Although the only negative feedback available is obtained across the unbypassed cathode resistor, which contributes slightly more than 2 db, the distortion at $\frac{1}{2}$ watt output is just 2%, while at 1 watt output it increases to 3% at 1000 cycles.

Ample space was found available in the "Voyager" carrying case for both this small amplifier and the 4-inch loudspeaker.

SMALL TROUBLE LAMP

By HUGH LINEBACK
Oklahoma A & M College

A NEAT trouble lamp for lighting dark corners of equipment cabinets can be improvised by using a night-light, obtainable from the five-and-ten-cent store. Just plug the lamp into the end of an extension cord.

Night-lights from the dime store make good trouble lamps for small cabinets or chassis.

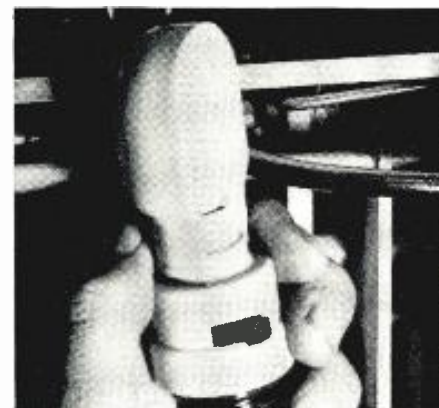

EXCEPTIONAL BUYS!

Our good fortune in buying the products listed below at the right prices assures you of great savings!

G. E. TRANSFORMERS

KVA	Prt.	Sec.	Price
0.100	150	90	\$ 3.98
0.090	460	2.5/5	3.98
1.0	230/115	23/11.5	12.50
1.0	460/230	46/23	12.50
1.0	920	21/10.5	35.00
1.6	437/460/483	230/115	18.75
2.5	430	100	25.00
4.0	460	100/82/50	45.00
5.0	480	100/83/70	35.00
3.0	460/230	230/115	50.00
5.0	240/120	2400	50.00
7.5	460/230	230/115	75.00

Also GE Transformers No. 35058, wt. 35 lb., ea. output volts 4 1/2/8/17 1/2/200 . . . \$5.98

KUHLMAN OIL COOLED TRANSFORMERS
37.5 7820/13200 120/240 \$200.00

SOLA CONSTANT VOLTAGE TRANSFORMERS

0.500	95-135	115	\$30.00
1.000	95-135	115	60.00
2.000	95-135	115	100.00

Also 250VA 95-135 115V Cat. 5005 for low Harmonic distortion (Wave form corrected) . . . \$30.00

G. E. AUTO TRANSFORMERS

Type KT Form CR 11 ratios from 1:1 to 1:0.762 . . . \$100.00

G. E. VOLTAGE DIVIDER

Ratio 70:1. 17.25 Megohm 35KV . . . \$50.00

G. E. SATURABLE REACTORS

(For best power control) (Use instead of variable transformers)

KVA	AC Volts	DC Volts	PH	PRICE
2.5	460	60	1	\$35.00
2.5	460	60	1	35.00
3.0	265	125	3	35.00
4.0	460	79	1	45.00
6.0	460	125	1	60.00

G. E. INDUCTION REGULATORS

(With motor for remote control)

AMPS	VOLTS	PH	PRICE
3.5	460	3	\$50.00
6.25	440	1	50.00

Also others from 1 to 20 KVA.

TUBES

GL 8020 . . . \$ 1.00

250R GE Mercury Vapor Rectifier List \$14.00

Special . . . 4.98

G. E. METERS

5 Amp. AC Model 8AD7AAL33 . . . \$ 4.98

10 Amp. AC Model 8AD7AAR33 . . . 4.98

500 Volts AC Type A058 . . . 4.98

GE Phrase Sequence and Undervoltage Relay . . . 25.00

G. E. MAGNETIC SWITCHES

(600 Volt, not encased, 110 volt control)

1 1/2 HP 110 Volt 1 Ph to 7 1/2 HP 440 Volt 3 Ph Magnetic Contactor . . . \$ 2.98

50 Amp. Magnetic Contactor . . . 7.95

150 Amp. Magnetic Contactor . . . 18.75

Class 5 for 50 to 300 HP Motor starting . . . 35.00

Manual control gage switch 600 V, 12 heavy contacts (for 8 wire break) . . . 2.98

G. E. CONDENSERS

4 MFD 1000 VDC . . . \$1.00

1 MFD 1000 VAC . . . 1.00

10 MFD 600 VDC . . . 1.00

G. E. RESISTORS

22000 Ohm 0.85 Amp. . . \$1.25

COPPER OXIDE RECTIFIERS

GE Model 6RC9K152V . . . \$10.00

POWER SUPPLY

Input 230/115 VAC 17 1/2 VDC at 2.4 Amp. \$ 15.00

Input 115 V. Output 15,000 V. at 0.800 Amp. size about 4"x4"x6". wt. about 1200 lbs.

Mfg. American Transformer Co. U. S. Army Signal Corps. Rectifier No. RA-38 . . . 500.00

MOTOR GENERATORS

1 HP DC Motor 125 V Generator 115/160 0.5 KVA

10 HP Motor 440/3/60 Generator 440/3/120 7 1/2 KVA . . . \$ 75.00

100.00

MOTORS

1/50 to 30 HP Motors. Example: 1 1/2 HP 220V 60 cy. AC . . . \$25.00

Request complete list. Write for quantity discount. Prices F.O.B. Oak Ridge, Tenn. Satisfaction guaranteed.

SCIENTIFIC EQUIPMENT DISTRIBUTORS

106 Verbena Road Oak Ridge, Tennessee

FREE: \$1 MILLION

Worth of Quality When You Buy:

- 12LP4A: \$10.95—17BP4: \$13.95—20CP4: \$16.95—21EP4: \$17.95
- 12AT7: 75¢. 6T8: 85¢. 6Y6: 75¢
- Sel. Rectifiers: 250 mil \$1.19; 350 mil \$1.49; 400 mil \$1.65; 500 mil \$1.85
- 6x9" PM. hvy. Al. 5 mgt. \$2.99
- Parallel pix tube briteners: 98¢
- Bulbs: Nos. 44, 46, 47, 51: \$5.25 per 100
- Ram-type X-032 and X-035 Flybacks: \$3.95
- Yokes, dir. replacement (send us set model No.): \$3.95

All items new, best brands, made in USA, guar. 1 yr. Export Orders Solicited.

Min. Order \$5. Send 25¢ dep., Bal. C.O.D. MONEY-BACK GUARANTEE. Write our Catalog.

DURO ELECTRONICS CO.

78 Atwells Avenue Providence 3, R. I.

RADIO & TELEVISION NEWS

What's New in Radio

(Continued from page 134)

transmitters, exciters, receivers, and other r.f. generating devices using 52- or 75-ohm coaxial line.

The Model 550 is equipped with six SO239 type connectors which permits the immediate selection of any one of five 52- or 75-ohm lines. It will handle 1 kw. of modulated power with a maximum crosstalk of -45 db at 30 mc.

Housed in a 2 3/4" diameter aluminum case, the Model 550 is made for single hole mounting. Complete details are provided in Bulletin 550 which is available from the manufacturer.

NEW G-E TRANSISTOR

Development of a new, low-cost, fused-junction transistor has been announced by the Germanium Products



Division of General Electric Company, Syracuse, N. Y.

Designated as the 2N76, the new transistor was designed to cover a broad specification range so that designers and hobbyists interested in developing and experimenting with transistor circuits will have available a stable, relatively inexpensive component.

Like the other p-n-p fused junction types in production by the company, the new 2N76 is hermetically sealed. The transistor is developed for use in audio and ultrasonic frequency stages. It has a maximum frequency cut-off at 2.5 mc. with the design center at 1 mc.

FLYBACK AND YOKE CHECKER

Cornell-Dubilier Electric Corporation, South Plainfield, N. J. has developed a new flyback transformer and yoke checker especially for television service work.

This extremely sensitive unit can detect even a single short-circuited turn



in the windings by indicating inductance change. Known as the Model BF-80, the new unit employs an oscillator circuit, a 6V6 tube, and a 4 1/2" microammeter with separate indicator

From NEWCOMB'S Big, NEW HI-FI LINE

The two new Compacts, with amplifier, preamplifier and control unit all in one... the new Classic 200 FM-AM Tuner, the answer to years of demand... just three of the twelve all new components in the Newcomb line—a line which offers an amplifier for every hi-fi need. All twelve reflect the engineering leadership for which Newcomb has been famous since 1937. Visit your dealer... see and hear the full Newcomb line and you'll understand why Newcomb is your best buy in hi-fi!



HI-FI COMPLICATED? EXPENSIVE? NOT WITH NEWCOMB'S COMPACT 12!

Newcomb offers every music lover authentic high fidelity with a minimum of expense and trouble in the new Compact 12. Provides unequalled flexibility and range of sound control. Needs no cabinet. Just plug it in, connect it to a record changer and speaker. But if you prefer to use cabinetry, it includes Newcomb's exclusive "Adjusta-Panel" feature for easy installation. Simple to move—ideal for apartments! U/L approved.

Compact 12 Specifications

Compact 10—A simplified 10-watt version of exceptional performance.



12-watt high fidelity amplifier—preamplifier—control unit • less than 1% distortion at 12 watts • response ± 1 db 20 to 20,000 cycles • separate crossover and rolloff controls give 36 different recording curves • input selector and rumble filter • 7 inputs • mike input • tape input • output to tape • wide range separate bass and treble tone controls, bass range -15 db to +18 db, treble range -18 db to +16 db • hum balance control • new level control • advanced design loudness control • size only 4 1/8" high x 12 1/2" x 9".

FOR SUPERIOR RADIO RECEPTION NEW Classic 200—2 knob FM-AM Tuner

For years now, satisfied Newcomb amplifier owners have asked for a tuner by Newcomb. Here it is—the Classic 200 high fidelity tuner to deliver the utmost to a fine amplifier! It, too, is compact in size.

Designed for use with any amplifier having its own controls. Fully enclosed, beautifully finished to use as is, or the exclusive "Adjusta-Panel" makes cabinet installation simple. U/L approved. Output is 10 volts at less than 1/4%. 1 volt at less than 4/100%. Effective to 200 feet from amplifier. Many new circuit advances in both FM and AM sections. Results: 30 db of quieting with only 1 1/2 microvolts input on FM. 1 microvolt AM sensitivity for 1 volt output. Only 6 3/8" high x 11 1/2" x 11 1/2".



HI-FI GUIDEBOOK

"Hi-Fi Is For Everybody" Explains the how and why of authentic high fidelity • How to buy and install economically • Informative and thoroughly illustrated • Not a catalog



NEWCOMB® SINCE 1937

High Fidelity Amplifiers and Tuners

- Here's 25c for new book, "Hi-Fi Is For Everybody."
- Please send free catalog of Newcomb's complete line of 12 new hi-fi products, plus name of my nearest Newcomb dealer.

NEWCOMB, Dept. F-2
6824 Lexington Ave., Hollywood 38, California

Name _____

Address _____

City _____ Zone _____ State _____

A TOWER OF STRENGTH

- Safe in gales up to 80 m.p.h. without ugly, hazardous guy wires
- Free-standing to 50 feet high
- No rusting, ripping or weakened holes
- Big, safe, steel gird-around ties
- Easy installation and dismantling
- Sturdy, safe... on roof or ground
- Thick, baked-on-steel aluminum finish

Kuehne*

TELEVISION TOWERS

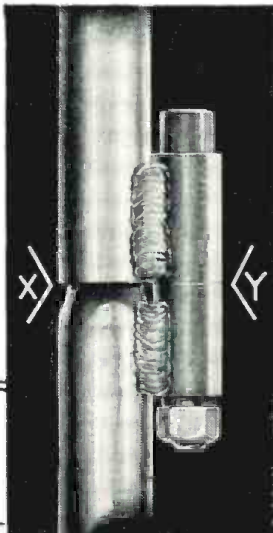

Exclusive! LATERAL LOAD-BEARING JOINTS

No dangerous rust. Arrow "X" shows open-joint section. Moisture cannot get in tubing to cause interior rust.

No hazardous holes. Arrow "Y" shows lateral load bearers lifetime welded to side of each section leg with twin 1 1/8" fillets. Sections are bolted vertically. Bear 100% of load! No load on joints. No horizontal bolts to tear through. Nothing stronger or safer. Only Kuehne has it!

KUEHNE MFG. CO.
TV TOWER DIVISION
MATTOON, ILLINOIS

* Say "Kee Nee"

For catalog sheets, see your "Kee Nee" Man or write direct.

scales for short tests, continuity tests, and yoke tests. Open-circuited conditions are also quickly detected in transformers, coils, and switches, or shorted elements in vacuum tubes. The instrument is portable and weighs only 8 1/2 pounds complete.

CBS TUBE TESTER

The Special Contracts Division of CBS-Columbia, 170 53rd Street, Brooklyn, N. Y. has announced the availability of a mutual conductance and plate current electronic tube tester which has been designed especially for electronic manufacturers and laboratories. The unit, Model VT T-1, is capable



of checking all tubes normally used in electronic work, including commercial and television types, subminiature, ruggedized, and hearing aid types. The tester has independent adjustments of plate, screen, filament, signal, and bias voltages which enables the tubes to be tested under operating conditions as determined by the circuit applications.

The VT T-1 is completely self-contained with no adapters or external meters required. It measures 17-11/16" x 15-1/2" x 6-13/16".

PUSH-BUTTON SWITCHES

Hetherington, Incorporated, Sharon Hill, Pa. has announced the availability of a line of small, rugged push-button switches which is suitable for a wide variety of electronic assemblies, control systems, appliances, and toys.

The new "B1000" series uses a unique precision snap-action mechanism whose fast action greatly reduces arcing and contact wear and provides for greater current-carrying capacity than the small size and low cost of these switches would indicate.

These switches are rated for resistive loads of 10 amperes or inductive loads of 3 amperes at 115 volts a.c. or d.c. Complete specifications on the switches in s.p.s.t. normally-open or normally-closed circuit arrangements are available on letterhead request to the manufacturer.

MINIATURE TUBE SOCKETS

A hermetically-sealed miniature socket which extends only 5/16" above the chassis and less than 3/8" below chassis, including solder-type terminals, has been announced by Livingston Electronic Corporation, Livingston, N. J. Made in 7-pin miniature (Model

Every ELECTRONIC TUBE IN 3 MANUALS



BRAND NEW
WORLD'S TELEVISION TUBES

(TELEVISION TUBES VADE MECUM)
Characteristics of all TV picture and cathode ray tubes. Also special purpose electronic tubes. Invaluable to technicians and all specialists in the electronic field. **\$5.00**



WORLD'S RADIO TUBES

(RADIO TUBES VADE MECUM)
Characteristics of all existing radio tubes made in all countries. The world's most authoritative tube book. All types classified numerically and alphabetically. To find a given tube is only a matter of seconds! Also complete section on base connections. **\$5.00**



WORLD'S EQUIVALENT TUBES

(EQUIVALENT TUBES VADE MECUM)
All replacement tubes for a given type, both exact and near-equivalents (with points of difference detailed). From normal tubes to the most advanced comparisons. Also military tubes of 7 nations, with commercial equivalents. Over 43,900 comparisons! **\$5.00**

ALL THREE \$12.50

Distributed in North America by

Editors and Engineers, LTD.

Summerland 2, California

RCA MI-2475 SOUND POWERED PHONES NEW EXPORT PACKED

complete with 22' rubber covered cable press to talk switch are light weight the mic is on a swivel boom that can be moved to any position in front of face. Press to talk switch clips on jacket front can be locked in on position.

NO BATTERIES or other volt-just connect to two conductor wires—good over mile or longer.

Brand new. **\$13.95 Ea.**
Gov't Cost, \$62. Shipping weight 4 lbs.



PLUS THESE EXTRA SPECIALS

TV PICTURE TUBES 14DP4 \$16.00. 16RP4 16KP4. 16TP4 Raytheon SVL brand new. Guar. . 18.95
SCOPE TUBE 5BP4. RCA. Dumont. SVL. New. . 2.95
HEADSET TELEX monost Mod. 2370 rec. 14.00 3.95
MICROPHONE SHURE 707A & S34B desk stand 3.95
WIRE HOOKUP — 18 solid grey W.E. 1200 ft. roll 2.95
L&S Navy Waterproof speakers brand new each 9.95
RM-29A REMOTE TEL. new W/convs case. . 5.95
TEST SET I-236 for AC DC and Ohms with brods 3.95
MN-26C DF RECEIVER 150 to 1500 KC with 12 tubes d'n. and tuning motor new condition. . 18.95
BC1023A 75 meg beacon rec. W/tubes sensitive relay shock mount brand new W/inst. book. . 8.95
Include postage with order. Min. order \$3.00

New Address: BARTO, PA.
McCONNELL'S Phone: BALLY 5-3621

RADIO & TELEVISION NEWS

M-730) and 9-pin miniature (Model M-930) sizes, these sockets make it possible to seal components for high altitude or other uses and at the same time be able to replace tubes without



breaking the seal. Sealed chambers may be pressurized, evacuated, or filled with Silicone oil or inert gas as the sockets are guaranteed vacuum tight.

The company will supply complete specifications on request.

MINIATURE VARIABLES

McCoy Electronics Co., Mt. Holly Springs, Pa. is now offering a "Mini-Dual" variable capacitor which has been designed especially for subminiature receivers and transmitters.

The new unit has a capacitance range up to 385 μ fd. per section with at least a 10:1 ratio from maximum to minimum. Both rotors and both stators in the unit are isolated for greater flexibility of circuitry.

Dimensions, exclusive of shaft, are only 13/16" x 11/16" x 1-1/16". Shaft diameter is 3/16" or 1/4", standard shaft length is 3/8" and the capacitor weighs 1/2 oz.

-30-

International Short-Wave

(Continued from page 64)

news 2000. (Kippel, Colo.) CBUX, 6.160, Vancouver, B. C., noted with news 0100. (Cox, Dela.) Heard 1000 with weather report. (Mike Christie, Calif.) *Radio Canada* noted with German 1130-1145 over CKNC, 17.82, CKCS, 15.32; at 1500-1530 over CHOL, 11.72, CKLO, 9.63. (Schwartz, D. C.)

Canary Islands — EA8AB, 7.510A, Tenerife, noted at poor level 1520 with Spanish music, CWQRM. (Cox, Dela.)

Cape Verde Islands—CR4AA, 7.398, Praia, noted 1615 to closedown 1658. (Ferguson, N. C.; Mathieu, Mass.) Signs off with "A Portuguesa."

Ceylon—Commercial Service of *Radio Ceylon*, 9.520, noted 1114 tune-in to 1230 sign-off, good level in Manitoba. (Bulmur) Noted QSA4-5, QSB, in Sweden 1030. (Tellus Radio Club) Heard announcing 6.004 is now used instead of 6.006 in "morning" (local time) transmission. (Saylor, Va.) Heard on 17.820 at 0600. (Sanderson, Australia)

China—*Radio Peking* noted on 9.663A with *English* 0930-1000. (Stark, Texas, others) And parallel over 11.330. (Sutton, Ohio) Noted on 9.663A at 1745-1800 in oriental language, music; at 1800 played interval signal, had pips, and identified as "Radio Peking," followed by "Red" march. (Niblack, Ind.) *Radio Peking* opens Home Service 0355 on 9.560, parallel 9.08, 7.50, 6.23, 6.12, 6.155, 6.10, 6.015; at 0600 noted on 11.65, 11.33, 10.26, 11.83, 3.915 in parallel, with separate program on 9.04,

FULL VIEW FULL VALUE

WITH A
**HYCON
OSCILLOSCOPE
MODEL 617**



\$269.50

SHARP UNDISTORTED TRACE EDGE TO EDGE

You get more for your scope dollar in a Model 617 Oscilloscope, because Hycon's special flat face 3-inch tube eliminates fringe distortion. You pay for \pm 3-inch scope—you get 3 inches of sharp, usable trace. And this precision scope meets all requirements for color TV servicing. So before you buy any scope, compare it to the Model 617 feature by feature.

For full view—full value you'll buy Hycon... setting the standards "where accuracy counts."

- 4.5 MC BANDPASS WITHIN \pm 1 DB (VERTICAL AMPLIFIER)
- HIGH DEFLECTION SENSITIVITY (.01 V/RMS PER INCH)
- INTERNAL CALIBRATING VOLTAGES
- EDGE LIGHTED BEZEL
- STURDY, LIGHTWEIGHT CONSTRUCTION



See Hycon's line of matched, bench-stacking test instruments at your Electronic Parts Jobber's.



Service facilities in your area.
Hycon Mfg. Company

2961 EAST COLORADO STREET PASADENA 8, CALIFORNIA

"Where Accuracy Counts"

TERMINAL CONTINUES TO SET THE PACE...

with
SWEET and LOW Hi-Fi PRICES!



NEW! TERMINAL'S '3-STAR ECLIPSE' FM-AM RADIO-PHONO ENSEMBLE

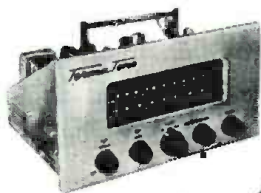

TERMATONE FM-AM Radio Model 921
10 Watt Push-Pull Audio Output

Model 956GE
3-Speed AUTOMATIC RECORD CHANGER



Model 1201A
12" GENERAL ELECTRIC HIGH FIDELITY SPEAKER

READY TO PLUG TOGETHER AND PLAY!

This amazing 3-Star System is loaded with high price features. "Has Everything" for the lifelike reproduction of radio and records superior to some systems that cost up to twice as much. Features: Fully Guaranteed Famous Termatone... Sensitive and Stable FM... Selective AM • Tone correcting phono with MAGNETIC Pickup • 25 Watt GE 12" wide range Speaker • The VM Voice of Music Record Changer with heavy duty four pole motor drive.

You get all these fine Full Size Components for only a little more than the cost of a self contained so called Hi-Fi mass produced phonograph. This complete system prepared for quick, easy plug together installation. Yours for

Only \$145. f.o.b. our store

MAIL ORDERS FILLED WITHIN 48 HOURS
If you cannot come to our store for this sensational value, order by mail. Send full remittance or \$25.00 on account. Balance C.O.D.
Every item FULLY GUARANTEED.

FREE! Yours for the asking! Terminal's Brochure featuring fine Hi-Fi Systems at Sweet and Low prices from \$95
Ask for Bulletin RT-2

Phone: WOrth 4-3311

Terminal Radio
CORP.

85 CORTLANDT STREET, NEW YORK 7, N. Y.

6.78 (latter may not be Peking but Outer Mongolia). (Balbi, Calif.)

Colombia—HJKH, 5.075, Sutatenza, noted 1840-1900 at strong level, all-Spanish; verified with QSL card. (Machajewski, N. Y.)

Costa Rica—TIFC, 9.647, San Jose, is good after 2200 to 2400 closedown; and parallel on 6.037. (Arthurs, Pa., others)

Cuba—Radio Salas, COBZ, noted on 17.810 at 1015 with classical music. (Morgan, Calif.)

Cyprus—ZJM7, 11.720, Limassol, noted with Arabic chanting at strong level, man identified with "Mahattat a Sharq-al-Adna" at 1145, and followed with news or talk in Arabic 1152-1156, then had more music. (Cox, Dela.) Heard in Australia on 6.790 at good strength to 1500 closedown. (Radio Australia)

Czechoslovakia—Prague, 7.256A, noted at good level in English to North America 1930-200. (Churchill, Va.; Lilly, Md.) Noted relaying Moscow 1800. (Welch, Mass.) Heard with English for Europe 1400-1430, starting with news, on 9.504. (Sutton, Ohio) And parallel over 7.256A. (Hardwick, N. Z.; Pearce, England)

Denmark—OZH4, 15.165, Copenhagen, noted 0940 in English to 1001 when went into another language session; program is Tue., Thur., Sat. (Ferguson, N. C.)

Dominican Republic—HI9T, 6.195A, Broadcasting Tropical, Puerto Plata, observed at good level but with lots of QRM 1815-1835. (Niblack, Ind.) HI2T, 9.735A, noted 1900 with world news in Spanish. (Weaver, Va.) HI4T, 5.970, good 2100. (Backus, Va.)

El Salvador—YSS, 9.555, San Salvador, noted to 2310A closedown with all-Spanish sessions. (Foster, Ill.)

Fiji Islands—VRH4, 3.980, Suva, heard 0443 with concert, poor level. (Morgan, Calif.)

France—Paris heard opening on 6.200 at 0100 with fair to good level; 7.220 outlet noted around 0300 in French. (Balbi, Calif.)

French Cameroons—Radio Douala has settled down on 6.115, daily 1230-1500; Sun. also 0500-0600. (Mercier, France, via WRH)

French Equatorial Africa—Radio Brazzaville, 11.970, 9.440, noted with news 1545 and 1745 at good level. (Argus, Ohio; Marsh, Pa.; Parker, N. H., others) Radio Chad has been discontinued. (WRH) Radio Brazzaville's 11.970 channel noted with news 0015-0030. (Faulk, Ala.)

French West Africa—At times, Radio Dakar has been noted on 4.898, parallel 4.950, around 1615, closing 1730A with "La Marseillaise;" at other times these outlets carry separate programs. (Cox, Dela.) A much improved signal is reported from the 11.896A transmitter since power was increased to 25 kw. Excellent around 1730. (Niblack, Ind., others) Noted opening 0200 in French on 11.896A, 9.560A, off 0330. (Balbi, Calif.)

French Morocco—Rabat, 6.006, heard 0200 in French. (Sutton, Ohio)

SPECIAL PURCHASE!
NEW RCA TV CAMERAS
Just Received!
\$19750

Hundreds of Used Models Sold at \$225 and Up! Never before a buy like this! Rig up your own TV watchdog for swim pools and other uses—Plus training and experimental work. 1846 Iconoscope, 6-stage video amplifier and clipper. Write for complete tech. data.

TN-65/APQ-15 for a 2-METER XMTR. With 6J6, 2-6C4's, less \$32. With schematics \$7.95 and conversion sheet.
MICRO SWITCH BZ-7RDT. New. 5 for \$2 postpaid
51.5 OHM COAX. CABLE \$4.50
100' roll
RG34U 71 OHM COAX, .825 dia. 5 KW rating. 85' roll with pl-173 plug at one end. \$7.95 New

MINIATURE LINE MATCHING TRANSFORMER. \$1 plus 25c postage. For blocking oscillators on TV Revers. & camera input circuits, tone oscillator transformer for electric organ, for digital computer systems. 1000's plus 25c postage \$1.00

24 V TRANSFORMER & RECTIFIER COMB. a basic 24VDC power supply of 110 V AC primary. 24V secondary and Rectox Rectifier. Operates intermittently up to 3 or 4 amps. \$2.95

APS 13 makes a 420 MC **RADIOPHONE** when converted. Range in most cases equal to 2 meters. Complete with RF sections, conversion booklet and 30 MC I.F. strip, less tubes, dynamotor and minor parts not needed for conversion. Shp. wt. 13 lbs. \$3.95
New APS 13... \$19.95

Please send check with order (no C.O.D.'s)
Prices F.O.B. Wsnc.

Harjo Sales Co.

Dept. RO-4109 Burbank Blvd., Burbank, Calif.
WRITE for FREE CATALOG

HERE IS AN UNBEATABLE VALUE!

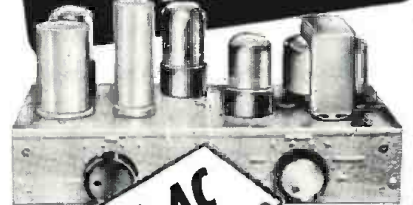

5 WATT AC AMPLIFIER
Complete, ready to play

Yes, a top quality AC Amplifier, fully equipped with two inputs — one for Reluctance or Microphone — the other for Crystal Pickup... for the unbelievable price of \$17.99. And the unit is supplied with all parts, including tubes. Amplifier uses three tubes — 1-6X5; 1-6V6; 1-6SL7. 117 Volts, 50-60 cycles, two controls — volume and bass compensation control that lessens needle noise.

Complete with tubes, only **17.99**
Order while they last. No more after they're gone.

New catalog FREE. Write Dept. RN-2

STEVE-EL Electronics Corp.

61 Reade St. New York 7, N. Y.

RADIO & TELEVISION NEWS

Germany — RIAS, 6006, Berlin, excellent with dance music 1735, announcements in German. Stuttgart, 6.030, fair 0120 with classical music, man announcer in German. (Cox, Dela.) Leipzig, 9.730A, heard opening 0200 in German. (Balbi, Calif.) AFN, 3.188, Frankfurt, noted 1800 with news. (Pearce, England) The *Overseas Service* from Cologne to North America 2030-2330 is definitely now on three channels—5.980 (best), 7.290, 9.735; news 2130A. (Niblack, Ind., others) Noted with news 11.795 at 0630, fair level. (Hardwick, N. Z.) And 1030 on 11.795, 9.640. (Morgan, Calif.)

Greece — *Radio Athens*, 9.607, fair level with woman in French 1230-1244A, then news in *English* to 1257; slight heterodyne noted from *Radio Free Europe* on 9.606A. (Cox, Dela.) Noted opening to Cyprus 0215A. (Pearce, England) Larissa, 6.745A, noted at fair level some days 2345-0200 sign-off with native music; at times has heavy QRM. (Saylor, Va.)

Guatemala—TGWA. 9.760, noted at strong level 1850 with music.

Haiti—*Radio Commerce*, 9.485, noted recently with religious program in *English* 0845. (Anderson, Texas) Is strong level in French from 0630A opening. (Kippel, Colo., others) Noted opening 1900 over 4VB, 6.091A, still good level 2230. (Arthurs, Pa.) *Radio Haiti* noted on *measured* 6.216 at 1803 sign-off. (Parsons, Pa.) On *Thursdays* noted ending *English* session ("Musical Caravan") at 2242A; announced in French and closed 2245. (Chamberlayne, Va.)

Hawaii—VOA relay, Honolulu, noted on *new* channel 11.890, good level 1300. (Balbi, Calif.)

Holland — *Radio Nederland*, 6.025, Hilversum, noted with *English* for North America 2130-2210. (Hartle, Pa.)

Honduras — HRN, *measured* 5.873, noted 1900-2130 with bad CWQRM and heterodyne. (Parsons, Pa.)

Hong-Kong—ZBW3, 9.525, Victoria, heard 0600 with weather report, BBC news relay, music. (Sanderson, Australia)

Hungary — *Radio Budapest*, 6.248, 9.833, noted with *English* for North America 1930-2000, 2300-2330. (Hatter, N. Y., others)

India—Calcutta, 7.210, noted 0720 at fair level, native vocal music, through ham QRM (Morgan, Calif.) Delhi noted on 11.850 opening 1830 to West Indies; should have news 1930. (Niblack, Ind.) Madras, 9.590, strong level 1202 with native music. (Cox, Dela.) Delhi noted on 21.510 at 0515 with Home Service, music. (Sanderson, Australia) Opens in *English* 0230 over 15.225, excellent level (Hardwick, N. Z.)

Indo-China — *Radio France - Asie*, 9.770A, Saigon, noted 0900 with news, fair level. (Balbi, Calif.) Heard on 7.230 with news 1830. (Morgan, Calif.) At 0500 on 15.420 with *English* program of news, music. "Voice of Vietnam," noted on 11.830A at 0600 with news in Vietnamese and music; on



GET BETTER HIGH-FIDELITY RESULTS ...at less cost!

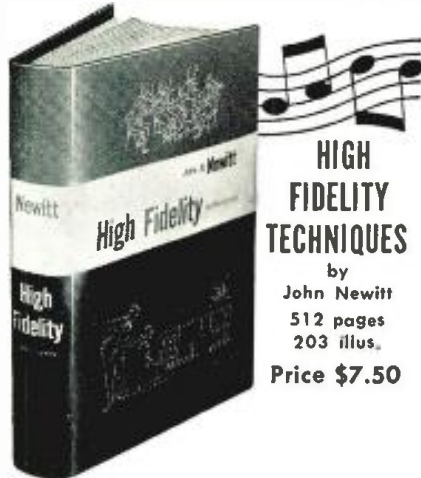

**HIGH
FIDELITY
TECHNIQUES**

by
John Newitt
512 pages
203 illus.
Price \$7.50

A COMPLETE GUIDE TO HI-FI EQUIPMENT AND METHODS

Here, by one of the nation's leading experts, is the complete "know how" of high fidelity . . . from theory and circuits to commercial equipment . . . from methods and technical data to home-building, custom-building and service tips and ideas galore.

Whether you specialize in Hi-fi work or simply want to build a first-class outfit for your own use, HIGH FIDELITY TECHNIQUES guides you every step of the way. It helps you get better results at less cost . . . choose the best equipment for your needs . . . have a clear understanding of the methods, components and equipment that are debated wherever hi-fi fans and specialists get together. Throughout, the book is chock-full of how-to-do-it building tips, service data, performance charts, schematics . . . the real "know how" of this vast new hobby that is sweeping the nation.

THE BOOK THAT SHOWS YOU HOW!

Here are a few of the subjects: Judging hi-fi equipment; What to avoid; Loudspeakers; Bass-reflex; Distortion; Baffles; Overhang; Woofer-tweeters; Sound-proofing; Output Transformers; some unusual hi-fi combinations; a novel horn system; a good tone control; amplifier construction hints; judging commercial amplifiers; Grillwork; Circuits; Cross-over frequencies; Volume expansion; Noise suppression; Negative feedback; Pre-amps; Equalizers; F-M tuners; Records; Recording; Avoiding Chatter; Turntables; pick-ups; Design charts; Building tips . . . and dozens more.

Read this great new book 10 days AT OUR RISK. You be the judge.

**10-Day Free
Examination**

Dept. RN-25, RINEHART & CO., INC.
232 Madison Ave., New York 16, N. Y.

Send Newitt's 512-page HIGH FIDELITY TECHNIQUES book for 10-day FREE EXAMINATION. If I like book, I will then promptly send \$7.50 (plus a few cents postage) in full payment. Otherwise, I will return book postpaid and owe you nothing.

Name

Address

City, Zone, State

OUTSIDE U.S.A.—Cash with order, price \$8.00.
Money back if book is returned in 10 days.

15.018 at 0545 with French news and music. (Sanderson, Australia)

Iraq—HNG, *Radio Baghdad*, 11.702A, logged 1150 with native music; at 1159 man identified with "Huna Baghdad," and followed 1200-1215 with news in Arabic; faded out by 1230. (Cox, Dela.) Heard at 0015 with Arabic program of news and music. (Sanderson, Australia) Heard on 3.297 with *English* 1415-1500 closedown. (ISWL, Pearce, England)

Israel—Tel Aviv, 9.008, noted with "Voice of Zion" session in *English* 1615-1700 closedown (some days runs longer). (Machajewski, N. Y., others)

Italy—Rome, 11.810, noted with news 1240-1250. (Sutton, Ohio) Noted on 9.63 strong 0400 with news in French to 0420, then *English*; announced 6.010 as parallel in this transmission. (Balbi, Calif.) Noted to Britain-Ireland with news 1330 on 7.290. (Pearce, England) Uses 9.570A and 6.010A for *English* to North America now 1915A and 2130A. (Scheiner, N. J., others)

Ivory Coast—In verifying, *Radio Abidjan* listed 495 kc., 1 kw., and 4.945, 5 kw., 0145-0900, 1330-1630; however, has been heard with *Sun.* opening 0215. (Cox, Dela.) Is best in eastern U.S. around 1530-1630.

Jamaica—*Radio Jamaica*, 3.360, noted at fair level 1845. (Welch, Mass.) Heard on 4.950 at 0615 with "Wake Up, Jamaica!" session. (Chamberlayne, Va.) With news 0730. (Cox, Dela.)

Japan—*Far East Network*, AFRS, 11.750, Tokyo, heard with fairly good level 1630, news 1700. (Balbi, Calif.) Noted on 6.160 at 0600 with news, music. (Sanderson, Australia) *British Commonwealth Forces Station*, 6.105, Kure, tuned 0340 with religious service; ABC news relay from Australia 0400; in verifying, listed schedule of 1630-1000. (Pearce, England)

Kenya Colony—Nairobi, 4.885, noted from 1452 tune-in to 1459 when closed with "God Save the Queen." Poor level, only partly readable. (Cox, Dela.)

Kuwait—*Radio Kuwait*, noted 1415 when MSF, England, is off for five minutes. (ISWL, England)

Lebanon—*Radio Beirut*, 8.036A, noted closing 1636A. Also noted with news in Arabic read by man 0000-0015, then with native music; heavy CWQRM at times. (Cox, Dela.) Has returned to old 1000-1100 schedule for *English*. (Pearce, England)

Libya—*Forces Broadcasting Service, North Africa* (new call), 3.305, noted from around 1130 to closedown 1600; opens 2300 on 7.220. (Pearce, England) Location is Benghazi.

Liberia—ELBC, 6.025A, Monrovia, noted to closedown with Anthem 1846; QRM'd at times by Moscow and *Radio Nederland*. (Cox, Dela.) Uses *English*.

Malaya—BFEB, 17.755, Singapore, logged with BBC news relay 0800 at poor level, some QSB. (Cox, Dela.) Noted on 7.120 at 1030-1045 with request recordings. (Mike Christie, Calif.) *Forces Broadcasting Service*, 5.010, noted 0820 at poor level, native

musical program. (Morgan, Calif.) *Radio Malaya*, 6.025, Kuala Lumpur, noted 0900 with news by man, then music to 0930; fair signal in Ohio. (Sutton) Singapore heard on 4.820 with news 0900, good level in N. Z. (Hardwick)

Mauritius—Forest Side has been logged in Sweden around 1105 with weak level on 15.090. (Radio Sweden)

Mexico—XEFT, 9.545, Vera Cruz, noted 1900-1917 on a *Fri.* with *English-Spanish* lesson; may be other days, too; lesson prepared by BBC. (Niblack, Ind.)

Mozambique—CR7BF, 11.742AV, Lourenco Marques, noted 0015 with usual recorded program, at times solid level. (Niblack, Ind.) Noted opening 2300 with announcement for 6 a.m. (Ferguson, N. C.)

New Caledonia—*Radio Noumea*, 6.035, noted opening 0200 in French at good strength. (Van Vranken, Calif.)

Nigeria—Kaduna, 3.326, heard with native music 1440, weak, CWQRM. (Hardwick, N. Z.) Lagos, 4.800, is good level to 1700 when closes with "God Save the Queen." (Chamberlayne, Va., others) Is one of best signals from Africa now. (Cox, Dela.)

Norway—*Radio Norway*, 7.210, noted opening to North America 2000; closing 2058 when asked for reports to Radio Norway, Oslo, Norway. (Ferguson, N. C.)

Pakistan—*Radio Pakistan*, 15.135, Karachi, noted in 0745-0830 beam to Indonesia. (Ferguson, N. C.) Heard on 11.726A with news 2100. (Sanderson, Australia) Has moved to 6.235 from 9.484, parallel 7.010, for news 0945-1000. (Morgan, Calif., others)

Panama—Colon's HOLA, 9.505, noted on a *Sun.* 1630-1705 tune-out with religious program in *English*; heard another day 1805 with *English*. (Niblack, Ind.)

Peru—OAX4T, 6.082A, Lima, noted with news 2330A (Buehler, Ohio)

Philippines—DZH7, 9.730, Manila, noted at fair level with Mailbag session 1000-1030. (Daniel, Idaho) This may not be daily. Noted by Winch, Calif., in *English* 1158.

DZH2, 9.640, Manila, heard after 0200, fair signal; DZH9, 11.855, audible after 1800, weak signal, in parallel with DZH8, 15.300. (Balbi, Calif.) DZI6, 17.805, Manila, noted 2345 with organ music. (Sanderson, Australia)

Poland—*Radio Warsaw*, 6.025, noted in *English* 0030, good level; on 11.740 in *English* 0715, fair. (Hardwick, N. Z.) Heard on 9.555 at 0147 with *English*. (Morgan, Calif.)

Portugal—Lisbon noted on 4.880A at 1600 with identity in Portuguese and music; poor level, heavy QRM. (Cox, Dela.) Heard on 15.040A and 12.130 to 1200 closedown; noted opening 1230 on 11.996, 9.775; opening 1600 on 9.775, 11.915A (Pearce, England) Good over the 9.775A outlet 1520. (Parker, N. H.)

Roumania—Bucharest, 6.210A, noted closing with musical chimes 2030. (Buehler, Ohio) Heard on 9.254 with musical concert 1730-1750; identified

1800. (Sutton, Ohio) Heard on 5.980 with *English* 1430, weak level in N. Z. (Hardwick)

Sao Tome—CR5SC, 4.807, noted from 1530 to sign-off with "A Portuguesa" 1558A. (Cox, Dela.)

Sarawak—Radio Sarawak, Kuching, noted 0800 with news on 4.870. (Mike Christie, Calif.) Closes 05830A but last announcement in *English* is 0814A. (Morgan, Calif.)

South Korea—HLKA, 2.510, Seoul, noted 0836 with talk by man in Korean; is *improving in strength*. (Morgan, Calif.) Schedule on 2.510, 7.935 is 1530-1830, 2200-0000, 0400-1030, according to station officials; each program ends with "HLKA, Seoul, Korea." (Pearce, England)

Spain—"La Voz de Falange," Madrid, *measured* 7.378, tuned 1725 with program of Spanish music; signed off 1853 with march and "Viva Franco! Arriba Espana!" (Ferguson, N. C.) A station announcing as "Radio Salamanca" is noted opening 1500 on 6.390A. (ISWL, England)

Sweden—Radio Sweden, 9.535, good level with news 1100-1115. (Bulmur, Manitoba, others) Heard with news on 11.705 at 0700-0715. (Rosener, Ill.) Heard with *English* 1315-1330 on 9.620, then into Swedish. (Richardson, Va.) Good level on this channel 2100 in *English* for North America. (Himber, Calif., others)

Switzerland—Berne is good signal on HER3, 6.165, and HER2, 6.055 in the 2315-2400 beam to Western North America. (Arthurs, Pa.) Good over the 6.165 outlet in Eastern North American beam 2030-2215. (Backus, Va.) Berne noted on 11.865 at 1345-1415 to United Kingdom-Ireland in *English*, news 1345, fair level but with VOA QRM. (Daniel, Idaho) And on 9.665, fair level in B. C.

Syria—Damascus, 9.555, noted some days in Spanish to Latin America around 2000. Transmission runs 1900-2100. (Kinge, N. Y.) Has *English* yet 1630-1730 closedown. (Pearce, England)

Tahiti—Radio Tahiti, 7.025, Papeete, noted at fair level 0000-0130 sign-off in French. (Saylor, Va.)

Taiwan (Formosa)—BED7, *measured* 7.129, Taipeh, noted 0649 with band number, followed with oriental—
(Continued on page 146)

For **SATISFIED CUSTOMERS**
and **PROFITS too!**

INSTALL

Mosley
TV ANTENNA
ACCESSORIES



Wall-Thru

Cat. No. 625
List Price \$1.95

- New, improved tube is semi-flexible — bends without breaking for easy insertion into wall openings drilled out of line!
- Neat, Convenient, Efficient! Appeals to ALL TV Owners because it's Practical!
- A Sure-Fire Profit Maker For TV Installers!

Ask your Parts Jobber or write direct for your
Free copy of the new MOSLEY Catalog 54-55.

MOSLEY ELECTRONICS, Inc.
8622 St. Charles Rock Rd., St. Louis 14, Missouri

THIS IS IT!

TEST EQUIPMENT YOU CAN'T BEAT FOR
VALUE — PERFORMANCE — PRICE

RCP

ONLY
\$39⁷⁵
net

Fast, reliable testing
of flyback transformers
and yokes

The original
FLYBACKER

Incredibly sensitive, the model 123 Flybacker, made ONLY by RCP, immediately shows up a shorted turn in a flyback transformer or yoke. The light, portable design serves to advantage in the home as well as the shop. All tests can be carried out under operating conditions with the common substitutes in place in the TV receiver. Accept Flybacker. . . . only RCP makes the



RCP

MODEL 123

ONLY
\$14⁸⁵
net

All molded—
unequaled

by any other in its class

ready to operate

AC-DC **MULTI-TESTER**

Greater multimeter value than ever before at a far lower price. 3" square meter with 800 ampere D'Arsonval movement gives 1000 ohms per volt sensitivity on DC. Battery for ohmmeter circuit is readily removable and replaceable without soldering or unsoldering. Truly a must for every laboratory, shop and serviceman's kit; its smart appearance is matched only by its high performance.



RCP

MODEL 480

ONLY
\$51⁹⁵
net

Meets all today's needs . . .

plus tomorrow's color requirements

Portable
TUBE TESTER

Positively the greatest testing performance ever built into a tube tester. Tests all tubes in current radio and television receivers, as well as in color TV receivers. Checks transmitting, hearing aids, ballasts, gaseous rectifiers and tuning indicators. With CR adapter cable (available at slight additional cost), will check CR picture tubes . . . both black and white and color.

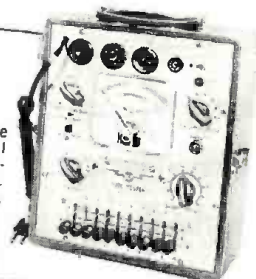

RCP

MODEL 327P

See your local parts distributor or write Dept. RN-2
for latest RCP catalog.

RADIO CITY PRODUCTS CO., INC.



EASTON, PENNSYLVANIA

**Now, try
FAIRCHILD'S
new Series 220,
and...**



**Hear what you've
been missing!**

Only Fairchild's newly-improved *moving coil design* as featured in this brand new cartridge Series 220, can offer such outstanding performance. Only this amazingly accurate, high-compliance cartridge can bring your records to such full, dramatic life!

LOOK AT THIS
FREQUENCY RESPONSE CURVE!

\$37.50

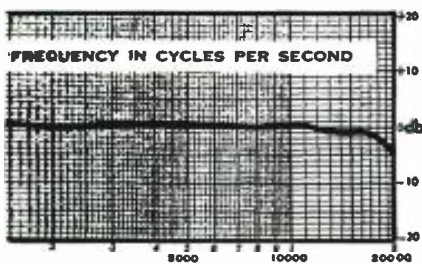

Virtually no distortion—uniform response up to 17,000 cycles, with slow roll-off beyond. No peaks or jagged response curves mean no rough sound or unnatural harshness.

**And, a
perfect mate...**



**280 Series
Transcription
Arm**

Match your cartridge to the finest arm! Low-mass and resonance-free, Fairchild's 280 Transcription Arm allows the cartridge alone to lift all the tone color from your recordings. Superb precision balance and engineering assure perfect mid-groove tracking, always. And, any standard cartridge plugs in easily—performs better—with this versatile Fairchild 280!

\$29.50



language broadcast, good signal in N.C.

BED36, 7.300, noted 0600 with National Hymn, news in Chinese, and then Western music; BEC24, 9.810V, heard 0645 with Chinese news and music; BED6, 11.920, logged 0235 with *English* session of news, music, parallel BED4, 11.736; BED26, 10.080V, checked 0430, good signal in Chinese news, music; BED32, 9.778A, heard 0500 with Western music, and then news in Chinese. (Sanderson, Australia)

Tangier—A new "Swedish" radio station is planned in Tangier, to open in early February; will be called "The Voice of Days" or "Pingst-Radion." (Olsson, Sweden, others) WTAN, 7.175, noted in *English* 1730; wants reports to "Voice of Tangier," British P.O. Box 219, Tangier, Morocco, North Africa. (Pearce, England)

Thailand—Bangkok's HSK9 still measured 11.670 despite "Down Under" sources listing it widely as on 11.690. (Ferguson, N. C.) Heard at 2330 with news and music in beam for USA. (Sanderson, Australia) After months of unsuccessful checking, finally caught this transmission around 2325, weak and with QRM. Noted opening 0430 to Thai Forces in Korea; with news 0530. (Morgan, Calif.)

Uruguay—CXA13, 6.155, *Radio Carve*, Montevideo, noted at excellent level at 1815 check. (Niblack, Ind.)

USA—WRUL excellent 1838 on 6.140, 9.585, 11.780, good on 9.700. (Chamberlayne, Va.)

USI (Indonesia)—YDF, 6.045, Djakarta, noted weak to fair with choral music 0738 in Home Service. (Cox, Dela.) YDF2, 11.770, Djakarta, noted in *English* 1400-1500 at excellent level; announces YDF6, 9.710, as parallel, but is actually then using YDF6 on 9.585 (good signal). (Hardwick, N. Z.) Djakarta is again heard on 7.250 opening 0430 in Home Service. (Balbi, Calif.) YDQ, 9.553A, Makassar, Celebes, noted 0748 with native choral music; clock chimes 0800; *signal improving*. (Cox, Dela.)

USSR—*Radio Moscow* noted now to North America in *English* 1800A-0100A on such channels as 6.07, 6.24, 7.13, 7.15, 7.16, 7.17, 7.20, 7.23, 7.24, 7.25, 7.27, 7.29, 7.35, 9.57, 9.66, 9.70, 9.83, 15.11; some of these are obviously satellite relays by countries within the Soviet orbit. (Machajewski, N. Y.)

Moscow, 7.230A, noted at strong level 1800-2100. (Scott, Ga.) Alma-Ata, 9.340, noted in Sweden 1000. (Skoog) Kiev, 6.020, strong level in native language by woman 0210 tune-in. (Cox, Dela.)

Vatican—HYJ, 9.646, noted with news 1000-1015, then news in Polish to 1030. (Mike Christie, Calif., others) Should be parallel over 7.280, 11.685; the 1315-1330 *English* period is now scheduled for 7.280, 9.646, 11.685, 15.120; has *English* also *Tue.* at 1100-1115 on 11.685, 21.740. (Radio Sweden)

Venezuela—YVME, 4.800A, Maracaibo, is fair level in Spanish 1900. (Rosen, Ill.) YVLK, 4.970, Caracas, *Radio Rumbos*, noted 1800-1900 with "Supper Club" in *English*; seems to

have Mailbag *Thur.*; good volume in Pa. (Jones, others)

Yugoslavia—*Radio Belgrade* has news 1330 on 6.100, 7.200; at 1715 on 6.100. (Pearce, England, others)

Press Time Flashes

4VEH, Haiti, has been noted on measured 6.242 testing 1750-1759 when announced in *English* and asked for reports. (Ferguson, N. C.) An outlet heard on 6.780 from around 0230 with Asiatic-type programs may be Outer Mongolia; parallels Peking *only* when latter carries home news sessions. The Japanese commercial broadcasters, JOZ, 3.925, and JOZ2, 6.055, are noted *irregularly* with *English* lesson 0300-0330. (Balbi, Calif.) The Technical Staff of *Radio Nederland* has published a new booklet, "Improvement of Short-Wave Reception," available from Radio Nederland, Postbus 137, Hilversum, Holland. (ISWC, London)

The World Friendship Society of Radio Amateurs has just issued new membership certificates for both junior and senior members. This club desires more members. House organ is called "Bee-Kay." Full particulars are available from Bob Kenney, Hon. Secretary, WFSRA, c/o Mrs. S. Cain, R.R. 1, Kleinburg, Ontario, Canada.

A station noted on 11.753 at 2220 with recordings and occasional announcements in Spanish of "Radio Crystal de Guatemala," has not been fully identified; still on when tuned out 2259, good level. (Ferguson, N. C.) Latest revised schedule of *Radio New Zealand* is to Australia 1500-0100, ZL19, 11.830, 0115-closedown, ZL18, 9.520. To Pacific Islands 1200-0100, ZL3, 11.780, 0115-closedown, ZL7, 6.080. Closedown times are 0545 *weekdays*, 0620 *Sat.*, 0500 *Sun.* (Radio Australia)

Cologne, Germany, is carrying out tests to the Near East on 3.970 at 0930-1230. (ISWC, London) Latest schedule for *English* from *Radio Bucharest*, Roumania, is to North America 2200-2230, 2330-2400 on 6.210, 9.570; to Great Britain 1430-1500, 5.980, 6.210, 9.254, 9.570, and 1730-1800, 6.210, 9.570. (Hardwick, N. Z.)

Direct from station officials, Mathieu, Mass., learns that Radio Montserrat, Box 201, Plymouth, Montserrat, B.W.I., is a semi-official station, established Nov. 9, 1952; it provides (1) weekly Sunday broadcasts of a religious program and a "magazine"-type program, and (2) educational programs to school children and teachers each Wednesday during school session. It is non-commercial and is essentially a public-service venture, supervised by a Broadcasting Committee endorsed by the Government which contributes a small appropriation towards its operation. Transmitter power (unmodulated carrier power at output) is 40 watts; operates on 3.255 with satisfactory regular coverage of 50 miles, using center-fed doublet, *Sun.* 1130-1200, 1500-1530, and *Wed.* 1315-1330, 1400-1430.

Latest announced schedule for *Eng-*

lish from Radio Peking is 2200-2230, 9.665, 11.330, 11.650, 11.960, 15.060, 15.105; 0400-0430, 9.665, 11.330, 11.650, 15.060, 15.105; 0930, 9.080, 9.665, 11.330, 11.650, 15.060; some of these channels vary in frequency. (Morgan, Calif.) AIR, Delhi, India, is now using 9.840, 11.640 for English to Asia 0830-0945. (Morgan) The 9.840 channel is good level in West Virginia but with moderate heterodyne. (Boord)

WTAN, Tangier, is scheduled 0800-0830, Sun. 0800-0900 on 6.025; English, Mon., Wed., Fri. 1530-1600; French, Sat. 1545-1600; Czech, Thur. 1530-1600; Portuguese, Tue. 0805-0830, Sat. 1530-1545; German, Tue., 1530-1600; Spanish 0800-0830. Wants reports on new English session which is daily 1700-1730 over 7.175; all "morning" programs are over 6.025 and all "afternoon" sessions are on 7.175. (Pearce, England)

A new station in the Canary Islands, "Radio Atlantico," has been testing on frequencies varying 9.427, 9.485, 9.490, around 1700-1900 closedown; another session is audible around 0900-1000; asks for reports to Radio Atlantico, Buenos Aires 26, Las Palmas, Gran Canaria, Isles Canarias. (Mercier, France, via ISWC, London; others)

* * *

Acknowledgment

Thanks for the FB reports, follows! Keep them coming to Kenneth R. Boord, 948 Stewartstown Road, Morgantown, W. Va., USA. . . . K.R.B.

Westinghouse Factory-Boxed Tubes

Latest Code	Dates—Full RTMA Guarantee
5U46 .59	6BQ6GT 1.39 12AU7 .88
1B3GT .99	6BG6G 1.99 35W4 .55
6AU6 .65	6W4GT .69 35Z5GT .55

Send for complete listing
ELECTRONICS DISTRIBUTORS
 726 Arch St., Philadelphia 6, Pa.

BARGAIN HUNTING? RADIO SERVICEMEN!

Write for SENSATIONAL CATALOG
HENSHAW RADIO SUPPLY
 3619 TROOST KANSAS CITY, MO.

SCHEMATICS—CONVERSIONS FOR SURPLUS GEAR

NEW LIST! MANY ADDITIONS!
 Send stamped, self addressed envelope for List C. Add 25c for chart explaining AN nomenclature.

R. E. BOX 1220
GOODHEART BEVERLY HILLS, CAL.

Say You Saw It In
RADIO & TELEVISION NEWS

"SNOOPER" GEIGER COUNTER

Super-sensitive! Only 1½ lbs. Fits pocket—uses flashlight battery. Find a fortune in uranium. Order Now! Send \$5.00, balance C.O.D. MONEY BACK GUARANTEE. FREE CATALOG—scintillator and larger uranium and metal detectors. DEALERS WANTED.

29⁹⁵ COMPLETE
PRECISION RADIATION INSTRUMENTS
 2235 RT S. La Brea, Los Angeles 16, Calif.

Switching

(Continued from page 69)

been worked out pretty carefully for the frequencies used (33 and 45 kc.). If changes are made, some experimentation may be necessary to secure best oscillator operation. Plate and screen together should draw about 36 ma., which represents just over 5 watts input. If for any reason it is desired to cut transmitter power, this is best accomplished by increasing the value of the grid resistor.

Turning to the receiver, the only problem encountered, aside from the choice of a satisfactory resonant-circuit inductor, is the fact that the relay must operate on half-cycle rectified a.c. pulses. Of course a d.c. relay can be used if filtering can be provided for it. Even an a.c. relay will chatter on make and break without the aid of a capacitor to smooth things out a bit. But beware of just slapping a capacitor across the relay winding. If you do that, as soon as the gas triode fires, the charging current for the capacitor will overwhelm it. In order to limit the charging current to a safe maximum, R_3 (see Fig. 1) must be included. Almost any plate-circuit-style relay will work in the circuit, as long as it has at least 1200 ohms resistance. If it has less than this, but is sensitive enough, you can still use it by moving the connection of one wind-

ing terminal, the upper one in the diagram, to a tap on R_3 far enough down to keep a safe 1200 ohms between line and tube. The lower the current on the 0A4G, the longer it lasts.

With these solutions to the problems mentioned, the results are all anyone could ask. Around 30 volts peak of r.f. must be applied across the control elements of the receiver gas triode in order to secure reliable operation. This seems like a pretty hefty signal to be received with no amplification, but the setup described here is capable of producing a signal ten times that large! The result is that there is ample margin of power for periods of peak line loading and for operation over long distances. There seems to be no practical limit to the distance over which control is possible, provided only that the transmitter and receiver are hooked up to the same side or "phase" of the same power company transformer. Sometimes operation can be secured across phases or even across transformers via the high line, but this cannot be relied upon.

There is nothing critical about actual construction of either transmitter or receivers. If you favor a portable control unit, you may like the cabinet construction of Fig. 4. Here ventilation is secured through the panel itself. Standard ½ in. perforated hardboard is used for the purpose. More hardboard is used for the bottom of the box, with all mounting-screw heads countersunk on the bottom side and a

THE FINEST OUTPUT TRANSFORMERS

Acrosound Ultra-Linear*



TO-330 Transformer for high powered high fidelity circuits

- ✓ ± 1 db 10 cps to 100 kc
- ✓ Over 50 watts clean at any frequency 20 cps to 20 kc
- ✓ Makes the finest amplifier obtainable using pp par. KT66's or pp 6550's
- ✓ \$39.75 net at leading distributors everywhere

FOR LOWER POWER CIRCUITS

- TO-300 for Ultra-Linear Williamson Circuits. \$24.75
- TO-310 for Ultra-Linear operation of 6Y6 tubes. 18.75
- TO-320 for Ultra-Linear operation of 6Y6 tubes. 18.75

Send for FREE 16 page booklet which tells why ACRO ULTRA-LINEAR is the best. Contains 7 full pages of the finest high fidelity circuits available.

Prices slightly higher in the West

ACRO PRODUCTS CO.

369 SHURS LANE, PHILADELPHIA 28, PA.

Let's Talk Ceramic Capacitors...

and the most
complete standard
stock line...

ERIE
TEMPERATURE COMPENSATING
TUBULAR CERAMICONS

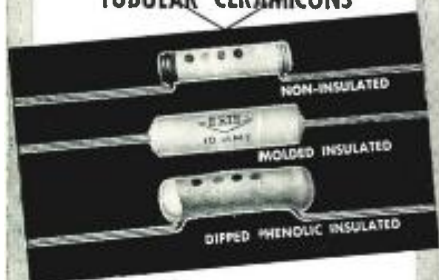

- Three Temperature Coefficients: NPO, N330, N750: Close tolerance on all temperature coefficients.
- Non-insulated, Molded insulated, Dipped Phenolic Insulated.
- Wide range of capacity values, close tolerance on all capacity values.
- Provide commercial equivalents of many often used JAN types.

One purpose of the three temperature coefficients is to provide the means of combining in parallel, various combinations of NPO and N330; and NPO and N750 to obtain intermediate temperature coefficients. Formulae for computing these values as well as a simple nomograph for quick computations will be afforded in service information.

The range of capacity values is the most complete offered as standard stock by any ceramic capacitor manufacturer. Servicemen and engineers... Your distributor has these capacitors to meet your requirements for TV replacements, laboratory work, and prototype development.

Write for complete list of capacity values available JAN equivalent table, and nomograph.

ERIE components are stocked at leading electronic distributors everywhere.

**ELECTRONICS DISTRIBUTOR DIVISION
ERIE RESISTOR CORPORATION**

Main Offices: ERIE, PA.

Factories: ERIE, PA. • LONDON, ENGLAND
TRENTON, ONTARIO

piece of felt cemented over all. It is not necessary to mount the pilot light on the panel. The bulb is colored and shines brightly through the panel perforations from its more convenient mounting on the chassis-board. Things are roomy and uncluttered with the interior dimensions of $3\frac{1}{8} \times 5\frac{1}{2} \times 5\frac{1}{2}$ inches. The cabinets shown in the photographs were built for the purpose some time ago. A small cabinet has since appeared on the market that, by coincidence, has a perforated panel and almost the same inside dimensions. It is the *Acousti-Craft* model 705B, really intended to house a small speaker.

For safety's sake, both control unit and remote units should be housed, like an a.c.-d.c. set, so that the user can touch no metal. In the case of the units described here, we add "Except UL approved toggle switches, which in turn touch no metal." You can mount the fuses wherever you want to. Personally, I like them in the plug. Since so many fires are started from damaged and frayed cords, one might as well protect the cords, too, while he's at it.

Remote units are shown in Fig. 1. Boxes were made by gluing wood veneer sides to rabbeted $\frac{1}{2}$ in. thick

bottoms. Parts are mounted on top piece cut same as bottom. Small metal boxes would work just as well; they could be covered with leatherette for safety. The coils are here mounted so that tuning slug can be adjusted from exterior with box closed. However, the best way to tune receiver circuit is by watching the glow in the tube. Tuning will normally be very broad. To weaken signal to permit sharper tuning adjustment, plug control and remote units into opposite "phases" of a three-wire power circuit. It may also be necessary to shunt or short R_2 in the remote unit in order to temporarily cut receiver sensitivity.

By the way, both transmitter and receiver coils should be operated with their slugs nearly all of the way in, in order to maintain maximum "Q." If it is necessary to trim tank circuits a little by juggling capacitors in order to effect this, it is worthwhile.

A portable carrier-control outfit can be a lot of fun. Take it with you on visits and trips. People are much more impressed by something being turned off and on than they are by the operation of a carrier-type intercom outfit. Radio and television have made them pretty blasé about mere communication.

-30-

A SIMPLE BIAS SUPPLY

By ROBERT J. ROPES, W9PAP

THIS fully adjustable bias supply is intended to provide bias voltage for power amplifiers requiring up to 90 volts bias. This covers such tubes as the popular 807, 6146, etc.

The circuit is self-explanatory, but a word of caution is in order regarding the filtering of the bias supply. Do not "skimp" on the filter here, since it is possible that the 60-cycle ripple frequency will grid-modulate the stage being biased.

A desirable feature of this supply is the ease with which it may be added to the driver supply at an additional load of only 15 ma. or so. The bias control may be set for any value of bias (up to the maximum output, of course), and

thus the "static" current of the power amplifier may be left at some value which will definitely improve the regulation quality of most power supplies.

None of the values is critical; however care must be taken not to overload the power transformer. The series resistor between the 6X5 cathode and the plate transformer must be chosen to provide only enough current to ignite the VR tube, plus the 10 ma. bleeder current through the control.

Do not substitute a selenium rectifier for the 6X5 tube, as the inverse voltage will quickly ruin the selenium rectifier, and possibly the transformer winding will be damaged.

-30-

Circuit diagram of the simple bias supply. Output bias is taken from point "A" on the diagram. If a lower maximum bias voltage is desired, use a VR75. Similarly, if a higher bias voltage is required, an 0B3 may be used. A VR150 can be used only if there is no danger of exceeding the transformer rating. The 5000 ohm resistor, R_1 , between 6X5 cathodes and high voltage winding will have to be changed to 3000 ohms.

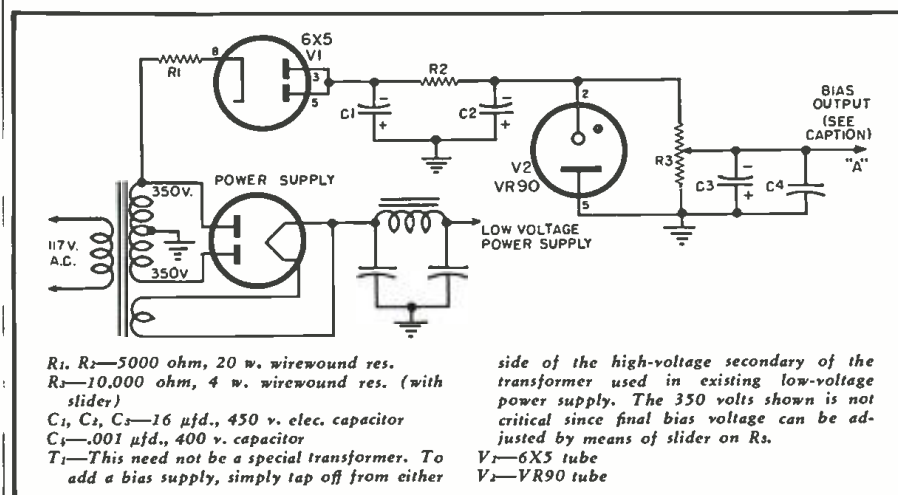

R_1 , R_2 —5000 ohm, 20 w. wirewound res.
 R_3 —10,000 ohm, 4 w. wirewound res. (with slider)
 C_1 , C_2 , C_3 —16 μ d., 450 v. elec. capacitor
 C_4 —.001 μ d., 400 v. capacitor
 T_1 —This need not be a special transformer. To add a bias supply, simply tap off from either

side of the high-voltage secondary of the transformer used in existing low-voltage power supply. The 350 volts shown is not critical since final bias voltage can be adjusted by means of slider on R_3 .

V_1 —6X5 tube
 V_2 —VR90 tube

Radio Licensing
(Continued from page 52)

a separate antenna form is required. The FCC supplies this.

Therefore if you want to control a garage door or play with remote control of airplanes, etc., you apply for a simple Citizens Band license when you purchase your FCC-approved transmitter.

Commercial Licenses

It is within the commercial field that radio licenses do the most economic good for the operator. Positions as wireless operators in the Merchant Marine service now bring the operator officer status with good pay and a future, not to mention the chance to see the world. Radio operators in the broadcast service come under station engineer classification. It is possible to get a good job as broadcast engineer with no experience at all, as long as you possess a satisfactory FCC license.

In the order of simplicity these commercial licenses are:

Aircraft radiotelephone operator authorization: No written examination is required. This authorization may be obtained from Commission examining offices or from Commission authorized examiners at airports. It permits operation of radiotelephone in aircraft. You are required to know very elementary radio law, such as restrictions against profanity, false distress messages, and abuse of privilege and equipment. The examiner at the point will have such a pamphlet for study at the time you apply for authorization. He may charge you up to one dollar as his service fee.

Restricted radiotelephone operator permit: This is equivalent to the aircraft operator license, meant for use in taxicab fleets, etc. This permit is obtained by declaration rather than examination, and may be applied for in person or by mail. If requesting it by mail ask for form 756 from nearest FCC field office.

Temporary limited radiotelegraph second class operator license: This is for special cases where telegraph operation is required, but equipment adjustments are limited. No written examination is required. If the job calls for this license and applicant has held a prior license meeting certain conditions with specified prior service he may apply for this license. This may be at any FCC Field Office. While there he will be given a 16 wpm code test in code groups.

The commercial permits may be taken in sequence at your convenience. Each grade permit carries credit for its portions of the next higher grade, so that when applying for a higher grade only the additional elements of the examination need be taken. It is recommended that a study guide be obtained for thorough review before attempting any FCC exam. Then only

February, 1955

NOW! YOU SAVE UP TO \$50

WHEN YOU BUY A REALIST

HI-FI TUNER AT RADIO SHACK

1955 MODELS! HUNDREDS SOLD TO ENTHUSIASTIC USERS!



FM TUNER \$39.95

- ARMSTRONG FM WITH FOSTER-SEELEY DISCRIMINATOR!
- 5 MICROVOLT SENSITIVITY FOR 30 DB QUIETING!
- TUNED RF STAGE! DOUBLE-TUNED LIMITER! AC SUPPLY!
- AUTOMATIC FREQUENCY CONTROL (AFC)! 180kc BANDWIDTH!
- AUDIO OUTPUT 1V FOR 100% MODULATION! HUM 60 DB DOWN!
- FREQUENCY RESPONSE 20-20,000 CYCLES PLUS-MINUS 1/2 DB!
- DIRECT-FEED TAPE RECORDER JACK! AUX. PHONO INPUT!
- POWER AND TUNING CONTROLS — USE WITH ANY AMPLIFIER!
- ULTRA-COMPACT 4 1/4" H x 9 1/2" W x 6 3/8" D! COMPLETE!
- ORDER NO. 36-888M BY MAIL! ADD POSTAGE FOR 6 1/4 LBS.



AM TUNER \$29.95

- EXACT MATCH OF REALIST FM TUNER! SAME COMPACT SIZE!
- TUNED RF STAGE! AC SUPERHET CIRCUIT! AC SUPPLY!
- 5 MICROVOLT SENSITIVITY! 8kc BANDWIDTH 6 DB DOWN!
- BUILT-IN FERRITE STICK ANTENNA! BUILT-IN TAPE JACK!
- PLUS-MINUS 3 DB 20-5000 CYCLES! HUM 60 DB DOWN!
- POWER AND TUNING CONTROLS — USE WITH ANY AMPLIFIER!
- ORDER NO. 36-887M BY MAIL! ADD POSTAGE FOR 6 1/4 LBS.



REALIST 10 WATT HI-FI AMPLIFIER!

- BUILT-IN RIAA-EQUALIZED PREAMP!
- 20-20,000 CPS ±1 DB AT 3 WATTS!
- SEPARATE BASS AND TREBLE CONTROLS!
- 5 TUBES! PUSH-PULL TWO 6V6GT!
- ORDER NO. 33-303M BY MAIL! 10 LBS.

\$29⁹⁵

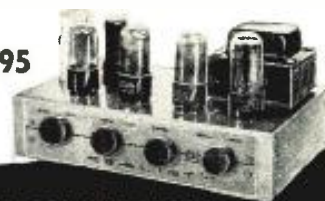

RADIO SHACK CORPORATION

167 Washington Street, Boston 8, Massachusetts

and 230-234 Crown St., New Haven 10, Conn.

Quality Features OF TUNG-SOL PICTURE TUBES



Gun made of best grade non-magnetic steel.

Glass bead type assembly is stronger both mechanically and electrically—gives greater protection against electrical leakage.

Rolled edges in gun minimize corona.

Custom built stem with greater spacing between leads assures minimum leakage.

Low resistance of outside conductive coating minimizes radiation of horizontal oscillator sweep frequency.

Double cathode tab provides double protection against cathode circuit failure.

Selected screen composition resists burning (X pattern).

Rigid control of internal conductive coating provides utmost service reliability.

Designed for use with single or double field ion trap designs.

One-piece construction of parts assures better alignment.

Maximum dispersion of screen coating assures uniform screen distribution.

Tung-Sol makes All-Glass Sealed Beam Lamps, Miniature Lamps, Signal Flashers, Picture Tubes, Radio, TV and Special Purpose Electron Tubes and Semiconductor Products.

TUNG-SOL ELECTRIC INC., Newark 4, N. J. Sales Offices: Atlanta, Chicago, Columbus, Culver City (Los Angeles), Dallas, Denver, Detroit, Newark, Seattle.

TUNG-SOL® RADIO AND TV TUBES

You Can Build a Reputation On Tung-Sol Quality

such elements as are required for the next higher license should be taken. This will assure you a minimum of study, with the chance of earning a certificate of accomplishment for at least some grade, rather than overdoing it, cramming for the hardest license at one time.

You may purchase Part 13 containing the "FCC Rules Governing Commercial Radio Operators" from the Superintendent of Documents, U. S. Government Printing Office, Washington 25, D. C. for five cents. Don't send stamps! The FCC has prepared the "Study Guide and Reference Material for Commercial Radio Operator Examinations" showing the scope of questions used in commercial operator exams, but it doesn't give the answers. This may also be purchased from the Superintendent of Documents. It's far better to buy a commercial (not FCC) study guide. It will have the rules in addition to the commercial material, giving sample questions and correct answers.

Complete study guides are not cheap. If you consider them as an investment, possibly pooling your money with that of a friend or two you find it worthwhile to pay the \$6.00 to \$7.00 required for one of these up-to-date commercial guides. Get one printed within the last two years or it may be obsolete. Make certain the guide you select covers all the commercial radio licenses or you may find you'll have to buy another guide later.

There are no physical restrictions for operators other than minimum age of 21 years for radiotelegraph first class operator and minimum age of 18 years for aircraft radiotelegraph endorsement. In other words, the broadcast engineer who puts the station on the air Sunday morning, waking you with your radio-alarm with early morning music may be a 16-year-old high-school student working at the station part-time and weekends.

After you have purchased your study guide, concentrate on elements one and two only. These cover basic law and basic operating practice. Here is a clear-cut case of memory. Just memorize all the questions and their appropriate answers. No technical knowledge or previous training is required. When a friend can ask you the questions in elements one and two and get a reasonably correct answer from you on all the questions, proceed without delay to contact the nearest FCC Field Office for appointment to take the test.

When you arrive at the examining room you will be asked to prepare an application for Radiotelephone Third Class Operator Permit (or any other license you seek.) This can be performed in a few minutes right there. Then you will be given a sealed packet containing element one. When you sit down and open it you'll find a single sheet with ten questions. You will be required to write out the answers directly upon the question sheet. Write fully. The FCC supplies you with pen

NEW! EICO FLYBACK & YOKE TESTER KIT

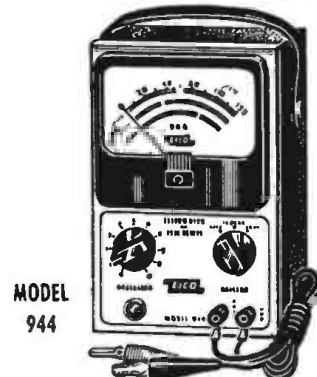

MODEL
944

LOWEST
PRICED
KIT
\$23.95
Wired
\$34.95

Checks all flybacks & yokes instantly—in or out of set!

- Detects even 1 shorted turn!
- Exclusive separate calibration for air & iron-core flybacks for accurate testing of all types.
- Tests continuity of coils, speakers, switches, etc.
- Large 4½" meter, 3 colored scales.
- Complete with easy instructions.
- Compact, rugged, smartly styled.

See it at your jobber today. Write for FREE Catalog RF-2 describing EICO's 38 Kits and 42 Wired Instruments. Prices 5% higher on West Coast.

EICO ELECTRONIC INSTRUMENT CO., Inc.
84 Withers Street, Brooklyn, N. Y. © 54

AUDEL'S TV-RADIO SERVICE LIBRARY

HERE IS LATE INFORMATION IN A HANDY FORM FOR RADIO AND TELEVISION REPAIRMEN, SERVICEMEN AND STUDENTS



2 VOLS. \$6 COMPLETE \$1 A MONTH PAY ONLY 1 MO.

AUDELS T.V.-RADIO SERVICE LIBRARY—Highly Endorsed—1001 Facts—Over 1552 Pages—625 Illustrations, Diagrams of Parts. Presents Important Subjects of Modern Radio, Television, Industrial Electronics, F.M., Public Address Systems, Auto, Marine & Aircraft Radio, Phonograph Pick-Ups, etc.

IT PAYS TO KNOW!

The Basic Principles—Construction—Installation—Operation—Repairs—Trouble Shooting. Shows How to get Sharp, Clear T.V. Pictures. Install Aerials—How to Test. Explains Color Systems, Methods of Conversion, Terms, etc. Includes Ultra High Frequency (U.H.F.)—Valuable for Quick Ready Reference & Home Study. Tells How to Solve T.V. & Radio Troubles—Answers Your Questions.

Get this Information for Yourself.
7 DAY TEST—ASK TO SEE IT!

MAIL ORDER
AUDEL, Publishers, 49 W. 23 St., N.Y. 10, N.Y.
Mail AUDELS T.V. RADIO SERVICE LIBRARY 2 Vols. \$6 on 7 days free trial. If O. K. I will remit \$1 in 7 days and \$1 monthly until \$6 is paid. Otherwise I will return them.

Name _____
Address _____
Occupation _____
Employed by _____ RN

and paper. This is the only element of the commercial exams requiring "essay" answers in full.

As soon as you finish, take your test paper to the examiner who will grade it. Up to now, you've spent an hour or less at the FCC examination room. If you've failed to pass (75% grade) you'll be cheerfully told to return after two months to try again. If you pass you'll be given element two. Go back to your desk and work.

This will take an hour or so. There will be 50 questions of the multiple choice type. Take your time. Select the answer from those given. Take only the one most correct. The partially-correct/partially-wrong answers are considered wrong. Remember to sign your name to each sheet. When you're through, take your exam sheet back to the examiner.

He will check your test in a few minutes. Wait for his answer. He'll tell you only if you've passed or failed. Generally he won't give you your exact grade. If you pass, you'll be told the permit will be sent to your home by mail. This takes a week or so.

Now go right back to the study guide and work on element three. This is harder than everything else you've studied so far. Really study. Get another radioman to help if you don't understand the theory involved. While it is possible to get by if you study and memorize the questions and answers, it is usually necessary to understand the reasoning behind the answers as well since it is unlikely that the questions will be worded exactly the same as shown in the study guide.

When you're ready, take a trip to the FCC examiner. Take your permit with you to turn in if they ask for it. Fill out the application for Radiotelephone Second Class Operator Permit. The examiner will give you element three and you're on your own.

It should take from one to three hours to answer the 100 questions. Fortunately, they are multiple choice. All you have to do is select the right answer from those given. Where you have to work out a problem, use the paper the examiner gives you. Turn in your scrap paper with the exam. If you pass, you're a licensed Second Class Radiotelephone Operator.

Go back home and study element four. This is the element that qualifies you to be chief engineer of a broadcast station so study hard. While the exam carries only 50 questions, and multiple choice at that, you'll have to work out arithmetic problems before you know which choice to make in several of the questions. When you pass you're a First Class Phone Operator.

Failure of any single element delays you only two months before you may take the test again, without penalty. Your certificate of any grade is good for five years, so you have plenty of time to take the advanced elements.

If you want to take any of the telegraph licenses you must be prepared

February, 1955

a new experience In INTEGRATED SOUND



THE FAIRCHILD 240 Balanced-Bar PREAMPLIFIER

This amazing preamplifier lets you custom-tailor sound to fit the exact acoustical characteristics of your own listening room!

Just recently perfected by Fairchild, this brand-new Balanced-Bar 240 brings professional quality, and outstanding adaptability to home systems. Balance-Bar control integrates the tonal quality of your high fidelity systems with the particular require-

ments of your home. You can be sure that your records will receive the most accurate, most satisfying equalization possible.

Also, the Fairchild 240 features an extraordinary Listening Level Control. Operating independently of volume control, the LLC provides pleasant low-level listening and *correctly balanced* normal listening levels—all easily, without complex adjustments.

\$98.50

HIGHEST LEVEL — LOWEST NOISE: Fairchild 240 is capable of higher gain than any other preamplifier designed for home use. Voltage gain of 68 db drives your power amplifier to full output with one millivolt input signal! The famous Cascode design, in use in radar and television, offers an inherently quieter circuit.

ATTRACTIVE DESIGN: Graceful and fashion wise, this exciting cabinet matches any decor, any interior styling.

SIMPLICITY OF OPERATION: The Fairchild 240 performs every function of the high quality preamplifier-equalizer, using only two control knobs in normal operation. Yet, it features a complete range of controls with flexibility to satisfy the most avid audio fan.

**LOOK
at these
additional
features . .**

Performance guaranteed!

FAIRCHILD 50 watt AUDIO AMPLIFIER

Fairchild's new 260 Power Amplifier is so stable that it is unconditionally guaranteed not to ring at any loading condition!

Full 50 watts of undistorted power is continuously available to accommodate crescendos and peaks which overload ordinary amplifiers. Yet, this compact Fairchild 260 is a single unit easy to install almost anywhere.

\$149.50

- * No ringing at any level
- * Output unaffected by load power factor
- * Exceptional stability
- * Exclusive distortion-cancelling adjustment



FAIRCHILD RECORDING EQUIPMENT

8th Ave. & 154th St., Whitestone, N. Y.

SURPLUS BARGAINS

Cornell-Dubilier, 70 MFD, 220 VAC (660 VDC) Oil Condenser. Brand New **\$4.75 ea.**

100,000 Ohm, 100 Watt Wire Wound Adjustable Slider Resistor. **59c ea.**
3 for \$1.49

OIL CONDENSER SPECIALS

Brand New. Ceramic Ins.

1 MFD 3000 VDC.....\$1.85
6 MFD 1500 VDC.....2.25
2 MFD 2000 VDC.....1.50

MINIATURE METER

0-500 Microamps, 1 1/2" scale, Bakelite case. An accurate tiny meter ideal for GD meters, SWR Bridges, etc. BRAND NEW. **\$3.75 ea.**
3 for \$9.50

AMERTRON PLATE TRANSFORMER

Pri. 115 V, 60 cy, Sec. 1120-0-1120 Volts @ 650 ma, CCS, Full cast aluminum case. BRAND NEW **\$14.95**

EIMAC VACUUM CONDENSERS

32,000 Vdc
12 MMF (VC 12-32).....\$8.50
50 MMF (VC 50-32).....9.50

MOBILE DYNAMOTOR

6 Volt DC Input, 425 Volts @ 375 ma Output. Made by Eicor and Pioneer **\$27.95 ea.**

PANEL METERS

GOV'T SURPLUS, G.E., WESTINGHOUSE, WESTERN ELECTRIC, SIMPSON, ETC.

2" METERS **3" METERS**
0-4 amp RF.....\$2.95 0-500 Microamps ..\$5.95
0-80 ma DC.....2.95 0-10 ma DC.....2.95
0-10 ma DC.....2.95 0-50 Mill.3.95
0-15 ma DC.....2.95 0-80 Mill.4.50
2" METERS **3" METERS**
0-200 Microamps ..\$6.95 0-150 Volts AC... 4.95
0-400 Microamps .. 5.95 0-750 Volts DC... 5.95
0-500 Microamps .. 5.95 0-15 Volts DC... 4.95
0-200 Milliamp .. 4.50 0-1.5 Mill.3.95
0-250 Milliamp .. 4.50
0-3 Milliamp .. 3.95

THE GREATEST METER BUY EVER!

READ THIS: Westinghouse 3" Meter, Standard Type NX35, Round Bakelite Case, 0-2 amps DC, Basic 10 ma, can be easily converted to other mill ranges. OUR PRICE ONLY..... **\$2.49**

OIL CONDENSERS

4 MFD-600VDC \$ 9.95 4 MFD-2000VDC \$3.95
10 MFD-600VDC 1.50 6 MFD-2000VDC 4.95
2 MFD-1000VDC .95 2 MFD-2500VDC 3.95
3 MFD-1000VDC 1.25 4 MFD-2500VDC 5.95
3 MFD-1500VDC 2.65 4 MFD-3000VDC 8.95
5 MFD-1500VDC 2.85 .1 MFD-7500VDC 1.75
5 MFD-1500VDC 2.95 3 MFD-8000VDC 24.95
10 MFD-1500VDC 3.75 .00025 MFD-25KV 5.50
3 MFD-2000VDC 2.95 5 MFD-660VAC 2.95

G. E. RELAY CONTROL

(Ideal for Model Controls, Etc.)

Contains a sigma midget 8,000 ohm, relay (trips at less than 2 MA), high impedance choke, bi-metal strip, neon pilot and many useful parts. The sensitive relay alone is worth much more than the total low price of. **\$1.25 Each** 10 for **\$9.90**

G. E. TEST INSTRUMENT

Contains General Electric 0-100 microampere meter. Portable metal case 8"x4 1/2"x3 3/4". Ideal for conversion to grid dip meter, field strength meter, antennoscope, etc. BRAND NEW **\$7.95**

MOBILE RELAY

6 VDC Coil SPST, 30 amp contact for Dynamotor starting plus extra contacts for silencing receiver. SPST normally closed. Made by Struthers Dunn. Specially priced at **89c ea.**

WIRE WOUND RESISTOR KIT, 25 popular assorted-5, 10, 20, 50, 100 watt.....Kit **\$1.95**

READ 'N' SAVE BARGAINS

6 Henry 80 ma chokes85
9 ohm 100 watt non-inductive resistor, 35c ea.; 10 for 2.50
35 ohm 25 watt non-inductive resistor, 25c ea.; 10 for 1.95
Erie 500 mmf ceramicons.....10 for 1.50
15V AC relay SPST 15 Amp contacts.....1.75
220V AC relay SPST 15 Amp contacts.....1.75
.01 mmf, 1000 VDC Micacs.....5 for .95
.0004 2500 VDC Micacs.....5 for .95
.04 600 V Micacs.....5 for .95
100,000 ohm, 100 Watt resist.....45
250 ohm 100 W. non ind. resistor.....59

Min. Order \$3.00-25% with Order-F.O.B. New York.

PEAK ELECTRONICS CO.

66 West Broadway, New York 7, N. Y.
Phone WOrth 2-5439

to take a code test first. When you've passed the 16 wpm test of code groups you take elements one, two, and five for the Radiotelegraph Third Class Operator Permit. (It's a little harder than the phone set-up.)

The next time you take only element six. That gives you the Radiotelegraph Second Class Operator Permit. (You will be given credit for any element passed for any other current commercial permit. Thus, if you have the Radiotelephone Third Class Operator Permit you need only take the code test and element five for your Third Class Telegraph ticket.)

From Second to First Class Telegraph you take another code test, consisting of 20 code groups per minute plus 25 wpm plain language followed by element six, passing which you are awarded the coveted First Class ticket only if in addition you are:

At least 21 years of age and have had an aggregate of one year of satisfactory service as a radiotelegraph operator manipulating the key of a manually-operated radiotelegraph station on board ship or in a manually-operated coast station using c.w.

First or Second Class Telegraph Operators may take element seven as a Special Endorsement Aircraft Radiotelegraph if they desire. This covers 100 questions, multiple choice plus code test of 20 code groups per minute plus 25 wpm plain language. Applicant must also be at least 18 years old and must present a CAA Flight Officer's Certificate with other proof of aircraft telegraph experience.

First or Second Class Phone operators or Telegraph operators may take element eight as a Special Endorsement Ship Radar Techniques if they desire. This covers 50 multiple-choice questions.

FCC exams may be taken at any of the Field Offices listed in the table. In metropolitan centers like New York City the FCC offers exams daily without appointment. It's best to check first, however, since the office you want may have a definite exam schedule established.

In the amateur radio service the novice class is the simplest grade. A one-year non-renewable license is issued by mail to applicants passing a 5 wpm code test (as checked by your local volunteer examiner) and a simple examination on basic radio law. If you want an instruction pamphlet for amateur radio write: The American Radio Relay League, West Hartford, Conn. They will send you a list of their latest low-price manuals on the subject.

The technician class permits operation only above 220 mc. and is designed for amateurs interested in the technical and experimental aspects of radio. The novice class leads to this class when an additional (mailed) test on basic amateur practice and general regulations is passed.

If you have a currently valid com-

quality control of

JIM LANSING

signature

speakers by

B1 testing

One of the final inspections given all Jim Lansing Signature Speakers is made with a B1 tester. This instrument gives a direct, accurate measurement of each unit's electrical quality.

Magnet size and flux density alone do not determine speaker efficiency. The force available to move the dynamic assembly in any speaker is proportional to: — the flux density surrounding the voice coil, the length of conductor uniformly

subjected to lines of force, the current flowing through the wire. This total relationship (B1 factor) can be measured by applying a voltage to the voice coil and measuring the force exerted by the dynamic assembly.

In the Signature B1 tester a speaker's ability to support a known weight is read directly on a calibrated watt meter. No other commercially produced speakers have a higher B1 factor than do Signature units with their edge-wound wire ribbon 4" voice coils. And, before being released, every Signature Speaker must meet the same high standards.



JAMES B. LANSING SOUND, INC.

manufacturers of precision transducers

2439 FLETCHER DR. LOS ANGELES 39, CALIFORNIA

WRITE FOR OUR LATEST CATALOG

General Radio 7S3A Output Power Meter Exc. **\$175.00**
General Radio 720 Heterodyne Frequency Meter 10-3000 MC..... Exc. **250.00**
General Radio 620A Heterodyne Frequency Meter Panel Mounting 33 KC-33 MC..... Exc. **375.00**
170A Boonton Q-Meter 30 MC-200 MC..... Exc. **250.00**
TS-323/UR Frequency Meter 20-480 MC..... Exc. **PUR***
TS-173/UR Frequency Meter with 110 VAC. Supply, 90-450 MC..... Exc. **350.00**
RT18/ARC1 Transmitter/Receiver with Tubes and Dynamotor 100-156 MC, 10 Channel..... Exc. **PUR***
BC-348 Receivers 200-500 KC, 1.5-18 MC, 28V. DC. Input..... Exc. **99.50**
TCS Transmitter-Receiver, 12V. DC., 1.5-12 MC., Complete..... Exc. **PUR***
T67/ARC3 Transceiver with J68 Mod/Dyn..... Exc. **PUR***
APA10 Pan Oscilloscope Receiver 115 VAC, I.F., 405-505 KC, 4.75-5.75 MC, 29-31 MC..... Exc. **150.00**
T47A/ART13 Transmitter 11 Channels 0.2-1/5, 2-18.1 MC..... New **PUR***
AN/APN4B with I66B Indicator, 9RB Receiver-Power Supply, Crystal, Tubes, Mounts, and Plugs..... New **129.95**
PE-206 Inverter..... New **14.95**
TS62/AP Echo Box..... Exc. **200.00**
1E-19A Test Set 100-156 MC..... Exc. **200.00**
General Radio 723A 1000 Cycle Vacuum Tube Fork with Power Supply..... New **75.00**
TS33/AP Test Set Frequency Range 8700-9500 MC..... Exc. **150.00**
*PUR—Price Upon Request.

WANTED!

All Types of Radio and Electronic Surplus

PHOTOCON SALES

417 N. Foothill Blvd. SY camore 2-4131
Pasadena 8, Calif. RY an 1-6751
CABLE: Photocon, Pasadena

mercial radio license, visit the Civil Service Commission office nearest you (generally in federal buildings or post offices) for announcements of positions in radio operating. You may also write to the Civil Service Commission, Washington 25, D. C. For employment in private industry in the radio service write to the U. S. Employment Service, Washington 25, D. C. or to State employment offices. If you are a veteran see your local V.A. or write: Veterans Administration, Washington 25, D. C.

TV Signal Tracer
(Continued from page 59)

fier input and connect the amplifier output into the tester through the pin jacks. Set switch S_1 so that the pin jacks connect to the horizontal plates, and leave switches S_2 and S_3 open. Touch the diode load or video amplifier output in the set under observation with the probe. The blanking pulses and video will appear on the vertical trace of the tester and will appear to be lying on their sides. This is because the amplifier output is being impressed on the horizontal plates and swept out vertically at 60 cycles per second. A slight adjustment of the vertical hold control in the rear of the tester will stop the blanking pulse or, if desired, cause two blanking pulses to be displayed. All wave shapes of the vertical sync circuit, vertical multivibrator, and vertical output can be observed with no further adjustment.

For observation of horizontal wave shapes, the amplifier output is switched to the vertical plates and switch S_3 is closed, grounding the vertical output grid. Switch S_1 is set to connect the horizontal saw-tooth to the deflection plates of the CRT. The output of the sync and horizontal circuit may now be observed. Pulses or wave shapes at 7875 cps may also be observed but now two wave shapes will appear on the trace, one superimposed on the other.

Construction Hints

If the set to be converted to a tester uses a voltage doubler circuit with a rectifier type of power supply, care must be taken in servicing a set which has the same type of power supply. Before connecting the probe ground clip, check for a.c. between the tester chassis and the set chassis with a v.o.m. or neon tester. If a.c. is present between the chassis simply reverse one of the line cord plugs.

The probe used by the author is a standard test prod with a 1000 μfd . capacitor in series with about a four foot length of coax. This will be found satisfactory for any frequencies normally encountered.

By using a diode probe, the video and blanking pulses may be observed through the i.f. strip; however, since the actual picture may be observed, this feature is not needed.

**BE YOUR OWN
AUDIO ENGINEER**

MODEL 80
MODEL 8112
MODEL 8115



CABINART

H I F I EQUIPMENT CABINET
H I F I SPEAKER CABINET

Model 80 has lift lid, removable panels, Bass reflex tuned for 12" or 15" speakers. Overall dimensions: 33 1/2"H, 23"W, 16"D. M80 tuner section, inside: 20"H, 21 1/4"W, 15 1/2"D. M8112, M8115 baffle volume: 6 cubic feet. 5/8" white pine

80	equipment cabinet kit	\$27.00
8112	12" speaker cabinet kit	18.00
8115	15" speaker cabinet kit	18.00

K I T S

ACOUSTICALLY ENGINEERED — ASSEMBLED WITH ONLY A SCREWDRIVER!

FEATURING
THE KLIPSCH-DESIGNED

Rebel* 4
KITS

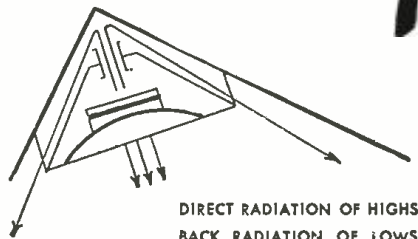

DIRECT RADIATION OF HIGHS
BACK RADIATION OF LOWS



ready-to-finish birch

MODEL K-12
MODEL K-15

K. 12	36.00
K. 15	42.00

All kits precision-cut to size, baffles pre-cut for 12" or 15" speakers, Kits include Saran plastic acoustic cloth, glue, sandpaper, plastic wood, hardware, assembly instructions and finishing instructions. Write for complete catalogs and nearest Cabinart kit dealer.

Model 61, Model 63
corner horn



12" speaker — \$19.95
15" speaker — \$23.95

all prices slightly higher west and south

* Trade Mark

KITFORMS BY



75 North 11th Street
Brooklyn, N. Y.

**INTERNATIONAL
RECTIFIER
CORPORATION**

EL SEGUNDO
CALIFORNIA

**RADIO TV
TYPE
SELENIUM
RECTIFIERS**



**NOW
AVAILABLE
AT
YOUR
FAVORITE
JOBBER**

**Widest Range
in the Industry**

Ask for Bulletin JRP-2

**INTERNATIONAL RECTIFIER
CORPORATION**

1521 E. Grand Ave., El Segundo, Calif. - Phone: ORegon 9-6281
CHICAGO: 205 W. Wacker Drive - Phone: Franklin 2-3889
NEW YORK: 501 Madison Avenue - Phone: Plaza 5-8655

TIME SIGNALS AVAILABLE FROM CANADIAN SOURCES

RADIO amateur operators and others interested in obtaining accurate time signals will be interested in learning that such time signals are available from several Canadian sources, in addition to the time signals that are broadcast from the Washington Naval Observatory. Canada has four sources for these time signals: Dominion Observatory station CHU, Ottawa; the coast-to-coast Canadian network known as the Canadian Broadcasting Company (CBC); station CFH, Halifax; and the telegraph transmissions of the two railroads, *Canadian National* and *Canadian Pacific*. Details are given.

CHU Time Signals

The Dominion Observatory station CHU sends time seconds beats continuously with identifications similar to those used by the Washington Naval Observatory station, but after the hour dash, the letters "CHU Canada CHU" are sent twice in Morse Code during the first minute after the hour.

Modulation is 1000 cycles and beats are about .25-second duration. Frequencies used are 3330 kc. at a power of 0.3 kw., 7335 kc. at a power of 3.0 kw., and 14,670 kc. (14.67 mc.) at a power of 0.3 kw.

The beginnings of the beats mark the exact seconds and are reliable to a few hundredths of a second of true time. Intervals between beats are accurate to better than one-thousandth of a second. The beginning of each minute is the first beat following the long pause.

Time is controlled by quartz clocks corrected from Photographic Zenith Tube star observations every clear night. The 1000 cycle modulation is also from a crystal source.

The Canadian time signals are broadcast according to the 5-minute period coding established originally by the Naval Observatory at Washington, D. C. Identification of each minute of any 5-minute group is determined by the omission of seconds beats at the end of each minute:

- 1st minute—29, 51, 56-59
- 2nd minute—29, 52, 56-59
- 3rd minute—29, 53, 56-59
- 4th minute—29, 54, 56-59
- 5th minute—29, 51-59.

Alternatively, this may be shown as in the table below, remembering that the 29th second is omitted from every minute.

It can be seen that when the 51st second is omitted and 4 more beats are sent, it indicates that there will be 4 more minutes to a 5-minute interval. At the end of the 2nd minute, 52 is omitted and 3 more beats are sent, indicating that there are 3 more minutes to the 5-minute interval, etc. The end of the 5th minute has the long gap from the 51st to the 59th beats. During the first minute of each hour, the call "CHU Canada CHU" is sent in Morse Code twice in place of the seconds.

CBC Broadcast Signals

At present a network of over sixty broadcast stations, located across Canada from coast to coast, transmits time signals at 1300 hours Eastern time. This time refers to standard or daylight saving, whichever prevails at Ottawa. Seconds beats with a musical pitch of approximately 800 cycles per second commence at 12^h 59^m 20^s and continue to the hour.

CFH Halifax Broadcasts

CFH (115 kc. and several high frequency bands) is connected by direct wire with the Dominion Observatory for 5 minutes before 10 and 22 hours of EST each day, and transmits observatory time signals during these two intervals. The type of connection to CFH involves a time delay of about one-tenth of a second.

C.N. and C.P. Telegraphs

For two minutes each day, individually coded signals are transmitted, Canada-wide, by *Canadian National* telegraph at 1058 to 1100 hours, EST, and by *Canadian Pacific* telegraph at 1154 to 1156 hours EST. —50—

This table shows the time seconds beat plan used by station CHU, Dominion Observatory, Ottawa, Canada. Each dash represents about .25-second tone at 1000 cycles.

Minute	Seconds Beats										
	50	51	52	53	54	55	56	57	58	59	60
1st	—	—	—	—	—	—	—	—	—	—	—
2nd	—	—	—	—	—	—	—	—	—	—	—
3rd	—	—	—	—	—	—	—	—	—	—	—
4th	—	—	—	—	—	—	—	—	—	—	—
5th	—	—	—	—	—	—	—	—	—	—	—

Spot Radio News
(Continued from page 18)

nals from an aircraft communications transmitter, operating in the very-high band, was tested at the Kingman, Arizona airport. The tests were very successful, and it was therefore decided to make an exhaustive study of this technique for field-light control from aircraft, in the interest of providing such a service at airports which are unattended. The results of this survey were detailed recently and reviewed (supplemented by recommendations) in a report prepared by the Radio Technical Commission for Aeronautics in Washington.

According to RTC, the greatest potential application of the activation system appears to be for private aircraft and for the airports which they use. It is recognized, the authorities added, that in those areas where private aircraft operate extensively at night, the use of a 122.8-megacycle band (available to private aircraft) for communications could interfere with the use of the same frequency for activation. However, it was felt that the possibility of such interference could be minimized through the use of signaling codes for activating lights, and by limiting the aircraft distance and altitude from the desired airport before transmitting on this frequency.

Use of only one frequency (122.8 or 121.7 or 121.9) was desirable, the experts found, wherever the operational requirements of the users of the airport could be met. However, since air carrier aircraft are not authorized to use the 122.8 mc. band, it might be necessary to operate the activation system on this band, and either of the other two alternates to meet the operational requirements of the airports. Consequently, the RTC report said, the 121.7 and 121.9-megacycle bands should be made available to all aircraft and the 122.8-megacycle band should be set aside for private aircraft.

Analyzing the problems of interference, the report said that the activation signal should not be transmitted at greater distances from nor at higher altitudes above the airport than are required operationally. For most airport areas, a maximum distance of 10 miles and a maximum altitude of 2000 feet above the earth would suffice. Detailing system requirements and characteristics, the aircraft study said that the activation signal shall be a series of dashes of radio-frequency energy, produced by pressing and releasing the microphone button of the aircraft very-high transmitter. The radio-frequency dash duration and the space between dashes shall be $\frac{1}{4}$ to $\frac{1}{2}$ second, and a given number of dashes shall constitute a code: *A* = 4 dashes; *B* = 5 dashes; *C* = 6 dashes; *D* = 7 dashes; and *E* = 8 dashes.

Commenting on the relative costs or economics of operation of the unattended plan, the RTC report said that

G. L.'s FABULOUS FEB. FLYER!

★★★ We ship all items in left column PREPAID! You pay no shipping costs! Brochures, descriptive literature available on request!

WANT \$10,000? NUTS TO RADIO!

Go prospecting instead! Get government bonus by locating uranium ore! PROSPECTORS! IF YOU ARE GOING TO HUNT FOR URANIUM, STOP KIDDING AROUND LOOKING FOR THE CHEAPEST UNIT YOU CAN BUY! In this business, it pays like anything to GET THE BEST—AND THESE ARE THEM!
FREE! With order, 143 p. book with full color illustrations on uranium prospecting.

MODEL 111—The "Scintillator"
AEC No. SPX11A—Portable Scintillation Counter. Many times more sensitive than Geiger Counters. Lightweight, simple to operate. Detects at depths of a few feet to a few hundred feet depending on conditions. Primarily for URANIUM detection. Shockproof, Waterproof, Tropicalized.

SPECIFICATIONS
Probe size.....3" x 13"
Probe weight.....2½ lbs.
Box weight.....4 lbs.
Ranges......025, .05, .25, .5, 2.5 and 5 MR/HR
Price complete, PREPAID..... **\$49500**

MODEL 117—"Special Scintillator"
A highly sensitive Scintillation Counter at a moderate price. An ideal field instrument because of its ruggedness, compactness and light weight. Industrial, Laboratory, or Uranium use.

SPECIFICATIONS
Ranges......025, .05, .25, .5, 2.5 and 5 MR/HR
Size.....4½" x 7¼" x 7"
Weight.....6¾ lbs.
Price complete, PREPAID..... **\$29950**

MODEL 107—"Professional Geiger Counter"
AEC No. SGM49B—A Geiger Counter of the highest sensitivity, accuracy and stability. Has external probe. The best Geiger Counter made for field work. For use in Uranium detection, Civil Defense and Laboratory.

SPECIFICATIONS
Size approx.....3½" x 4½" x 6½"
Weight approx.....6 lbs.
Ranges......20, 2, and 2 MR/HR
Price complete, PREPAID..... **\$13950**

The New PENTRON! A Miracle in Hi-Fi at Low Price!

Sensational New CT-1 Recorder
MONOMATIC single-knob control! Your kids can work it! 7½ and 3¾ inches/sec., record and play back forward and backward (dual track). Instantaneous automatic breaking on both reels. Fast forward, fast rewind. Flutter less than 0.5% at 7½ IPS. Exclusive new heads. Two-hour capacity, in attractive 2-tone leatherette carrying case. Records and plays in any position, even while carrying it!
Audiophile's net..... **\$9950**

3-Speaker Hi-Fi Model HT-225
Clear and undistorted with unequalled brilliance and resonance! The Stradivarius of moderate-priced tape recorders! Ideal for Voice and Music Teachers. Dimensional sound presence effect from the two woofers and a tweeter. Freq. response to 10,000 cps! Flutter less than 0.5%. Positive safety interlock switching. Editing key. Amplifier automatically equalizes for both 7½ and 3 inches/sec. 2-hour capacity. Fast forward, fast rewind. Signal-to-noise ratio—50 db. Separate record-play heads. Audiophile's net..... **\$13950**

NEW MODEL 27-C TESTER
\$9.49
(Postage paid)
RANGES: AC and DC volts 0-5/25/250/1000, DC MA 0-1/10/100, ohms 0-10K, 100K, Grey bakelite panel, metal case. Our tests show them to be within 1%. With test lead and standard penlight battery.

FREE VHF RECEIVER!
R-28/ARC-5. Excellent condition, with tubes. 100-156 MC. With schematic and conversion dope. WE WILL RETURN YOUR \$14.95 if yours is the 12th, 24th, 36th, etc. order received THIS MONTH ONLY, in sequence as we open the mail. So send in your \$14.95 and keep your fingers crossed. **2-METER CLUBS:** buy 12 units for the price of 11!

CRYSTAL CALIBRATED COLOR TV FREQ. METER
This is the BC-771 Freq. Meter originally used in the KC-100 IFF system on 470/493.5 MC. Is completely self contained unit with own 110 v. 60 cy AC power supply. Beautiful steel cabinet, 10" deep. Panel size 9" x 15½". Smooth action 5:1 vernier dial assembly. THIS IS A PERFECT SET-UP FOR THAT COMMUNICATIONS RECEIVER OR TEST INSTRUMENT YOU'VE BEEN PLANNING. Includes following tubes: 1-84, 3-7A1, 1-7C6, 2-6X5, 2-856; also octal base 4700 KC xtal. Dozens of useful capacitors, resistors, etc. With schematic and parts list.
Was \$47.50.....NOW **\$2750**
(Shipping weight—28 lbs.) **BRAND NEW**

HYDRAULIC ACTUATOR: 6" linear motion, Brand New, Ea.....\$1.95; 3 for \$5.00
CRYSTAL MIKE GIVEAWAY! Sensitive hearing-aid capsule sealed in compact, flat container with lined terminals. Crisp, clear hi-level output. Ideal for labels, ties, tuckaways. Individually tested, guaranteed. Only..... **\$2.95**

24-HOUR TIME CLOCK SWITCH 90% DISCOUNT!
HEAVY DUTY SANGAMO MECHANISM: 115 or 230 V. 60 cycles. Up to 3 "ON" and "OFF" hrs. Skip "OFF" any one or two days you wish. 30A DPST Switch. Controls lawn sprinklers, neon signs, hen-house lights, etc. With instructions. Guaranteed..... **\$5.95**
(Dealers: Write for quantity discounts.)
¾" PIPE SIZE SOLENOID VALVE. 18-24 VDC. .3 amp. New, Ea..... **\$2.95**
TRANSFORMER, 115 V., 60 cycles to 24 V., .6A. for above solenoid & many other uses. 98¢
SELENIUM RECTIFIER. 30 VAC max. 1.2A, full wave. For above transformer & solenoid..... **\$1.98**

POWER FROM THE SUN
Brand new development, brand new units (not surplus). Thumbail size SUN BATTERY puts out 2 ma into 10 ohms in average sunlight. Series-parallel them for greater output. With data sheet..... **\$1.98; 3 for \$5.00**

DC ROTARY VOLTAGE CHANGER. 6 VDC to 12 VDC @ 10 A.; 12-24 VDC @ 5 A.; 24-12 VDC @ 10 A.; 12-6 VDC @ 15 A. Suitable for car, marine, aircraft, radio receivers. No need to change dynamotor band change motor, relays, etc. New, each..... **\$12.95**

1 & 3 PHASE INVERTER: 400 Cy. Icland 10285. Input 27.5 V. 60 A. Cont. duty. 3 Phase Output 115 750 V.A. 1 Phase Output 28 V. With carbon-Pile-and-Rectifier type adjustable regulator.
New, clean, ONLY..... **\$49.50**
SCOOP! SCOOP! 2 to 10 WAY INTERCOM! Needs no power, no batteries! TV Inst. men note—leaves both hands free! Genuine U. S. Navy Sound Powered Head and Chest set. 2 wires! Connect as many as you like in parallel. Or rebuild to handset. Good, used, tested and guar.
PAIR (2 comp. sets)..... **\$4.95**
Each additional unit..... **\$2.25**

BABY WINCH
Highly versatile. Use as winch, barbecue spit drive, beam rotator, or any other use which requires a low speed, high torque source of power.
Has two output drives. One is sprocket-toothed wheel, other is ratchet-coupled cable drum. Both reversible by electric switching.
24 VDC motor runs perfectly on 8 to 24 V., 60 cy AC. Complete with simple instructions. NEW..... **\$9.95**

\$45.00 HI-FI HEADSET AT \$7.95
Uses annular grooved plastic fibre cones with voice coils as in speakers, and padded chamois ear muffs to obtain spacing for correct acoustical load. Gives finest music reproduction, 600 ohms. Checked out with freshly laundered ear pads and long flexible fabric cord with phone tips. (Std. wt. 3 lbs.)..... **\$7.95**

G. L. ELECTRONICS, INC. 905 S. Vermont Ave., Los Angeles 6, Calif.

Minimum order \$2.50 total. 25% deposit required. All prices F.O.B. Los Angeles. Calif. buyers add sales tax.

Television Servicing Course
PRACTICAL TELEVISION TRAINING FOR HOME-STUDY
Compiled by M. N. BELTMAN, radio engineer, teacher, author, and serviceman.
COMPLETE \$3 ONLY

NEW TELEVISION COURSE
Amazing Bargain, Complete, Only \$3

NEW PRACTICAL COURSE
Here is your complete training in television servicing. Amazing value at only \$3 complete. These new lessons cover every fact, adjustment and repair of all types and makes of TV receivers. Giant in size, mammoth in scope, topics just like correspondence courses selling for over \$150.00. Our amazing offer permits you to obtain the course complete for only \$3.

COVERS EVERYTHING IN TV
Let these course-lessons take you into TV servicing the easy way. The very first lesson of this sensational course tells how to do simple repairs. You can start earning money immediately. Second lesson tells you what is wrong, by just looking at the picture—no instruments used. Lesson 4 has 32 large, 8½ x 11" pages and 28 large illustrations on antenna installations and improvements. Another 12 lessons deal with trouble-shooting, alignment, UHF converters, test equipment, picture analysis, and all types of new circuits.

COMPLETE TV TRAINING
New, easy-to-follow, well illustrated 14 lessons on circuits, picture faults, adjustments, short cuts, about CHF, alignment, antenna problems, trouble-shooting, service hints, how to use test equipment. Many large practical sections prepared by leading manufacturers. Recently published. Send trial coupon today and use the complete Television Servicing Course at our risk.

AMAZING BARGAIN VALUE
With this new course you will find yourself doing TV repairs in minutes—instantly finding faults. Most amazing bargain. Examine this course for 10 days. Look over this material, read a few lessons, apply some of the hints. Then decide to keep the lessons at the bargain cost of \$3 (full price), or return the material.

RADIO and TV Manuals
Your complete, best source for all needed RADIO and TV diagrams and servicing data. Most amazing values. Still sold at pre-Korean prices. Only \$2 to \$3 per volume. Every Radio manual contains large schematics, all needed alignment facts, parts lists, voltage values, trimmers, dial strapping, and many repair hints. Each TV volume is a practical treatise on servicing a full year's sets, with glantz blueprints, waveforms, hints, alignment and voltage charts, production changes. See coupon at right for a complete list of these low-priced Supreme service manuals.

Supreme Publications
Sold by All Leading Parts Jobbers

NO-RISK TRIAL ORDER COUPON
SUPREME PUBLICATIONS, 1760 Balsam Rd., Highland Park, ILL.

Rush today TV manuals checked below and Radio manuals at left. Satisfaction guaranteed.

New Television Servicing Course, complete..... \$3.
 New 1955 Television Manual, \$3. 1954 TV, \$3.
 1953 TV Manual, \$3. UHF Units, \$1.50.
 1952 Television Manual, \$3. 1951 TV, \$3.
 1950 Television Manual, \$3. 1949 TV, \$3.
 1948 TV, \$3. 1947 TV & FM, only \$2.

I am enclosing \$..... Send postpaid.
 Send C.O.D. I am enclosing \$..... deposit.

Name:
Address:

Pay less

for the
radio and TV controls
you use most often

...get
Centralab's
extra
quality

**Centralab
Blue Shaft
Radiohms**

Models B-60 and B-70
—popular 1/2- and 1-meg.

NEW TV GRANTS SINCE FREEZE LIFT

Continuing the listing of construction permits granted by FCC since lifting of freeze. Additional stations will be carried next month.

STATE	CITY	CALL	CHANNEL	FREQUENCY	POWER*
Arkansas	Little Rock	KTVH	11	198-204	316
Texas	Lufkin	KTRE-TV	9	186-192	10.7

NEW CALL LETTER ASSIGNMENTS

STATE	CITY	CALL	CHANNEL	FREQUENCY
Ohio	Toledo	WTOH-TV	79	860-866
Michigan	Detroit	WBID-TV	62	758-764
Nebraska	Lincoln	KUON-TV	12	204-210
Texas	San Antonio	KENS-TV	5	76-82
Virginia	Petersburg	WPRG	8	180-186
Washington	Pasco	KPKR-TV	19	500-506
West Virginia	Bluefield	WHIS-TV	6	82-88

*ERP=(effective radiated power, kw.)

it has been shown that for some airports and with given traffic densities, there may be little difference between the cost of leaving the lights on all night long and the over-all cost of the light-control system. Because of the many variables, it was added, such as traffic density, availability and cost of control equipment and problems at airports having multiple runways, the

In the design of direct-coupled circuits, the establishment of the required d.c. operating potentials for tubes is a troublesome problem. One solution is a battery in series with the signal source. However, it has been found that the replacement or maintenance required of a battery, especially in cases where it must supply appreciable power, is a serious disadvantage. And a conven-

NEW EQUIPMENT FOR THE AUDIO TECHNICIAN

ELECTROSTATIC SPEAKERS

A.R.F. Products, Inc., 7627 Lake Street, River Forest, Illinois has introduced an electrostatic high-frequency loudspeaker in a separate package which is compatible with the equip-

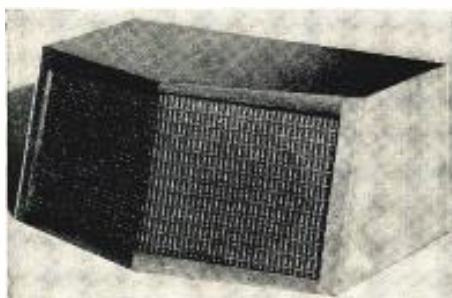

ment with which it may be associated.

In order to make it fully adaptable to existing high-fidelity installations, the electrostatic speaker system is offered in six different arrangements. The simplest design includes a single electrostatic unit with a matching transformer and network components, for installation in existing loudspeaker cabinets or on a separate panel.

The most elaborate design consists of two electrostatic units mounted in a specially designed cabinet at angles which afford optimum distribution of the higher audio frequencies throughout the room. This cabinet also contains a matching transformer, network components, and a power supply to provide polarizing voltage. Other designs consist of various combinations of single and dual tweeter units with or without power supplies and with or without cabinets.

TAPE CUTTER-SPLICER

Robins Industries Corp., 82-09 251st Street, Bellerose 26, N. Y. has added a deluxe model to its line of "Gibson Girl" tape cutters-splacers.

The Model TS-4DLX not only miter cuts the recording tape and trims the



spliced joint with a unique indented "Gibson Girl" waist, but also carries a roll of splicing tape which is fed through to the point of application. Professional splices can now be made in five seconds and no other equipment is needed to make the splice.

The splicer, designed for fast precise professional tape editing and re-

pairing, may be removed from its plastic base and mounted directly on any tape recorder. The splicer works on the principle of the steel rule die and has a cutter cartridge which houses three long life blades. Movement of the unit's knob is all that is necessary to change from miter cut to the trim cut.

STROMBERG AMPLIFIER

A new amplifier has been added to the "Custom 400" line of high-fidelity sound equipment made by Stromberg-Carlson Company, Rochester 21, N. Y.

Designated as the Model AR-420, this new amplifier has a frequency response of 20 to 20,000 cps and provides a power output of 25 watts at less than 1 per-cent total harmonic distortion.

The unit features continuously variable record equalization controls which make possible the precise equalization of any record irrespective of make, size, speed, or recording characteristic. Turnover and de-emphasis controls



permit the selection of any turnover equalization point between 250 and 1500 cps and any degree of de-emphasis from 0 to 21 db.

A switchable rumble-suppression filter is also included. Tonal balance is provided by continuously variable bass and treble controls which give better than 15 db boost or reduction, measured at 50 and 10,000 cps.

TAPE REEL INDEXER

Halvick Industries, 189 Miller Ave., Mill Valley, California has introduced a novel unit for indexing the program material on tape reels.

Known as the "Atta-Glance Fidelity Index," the unit consists of cardboard discs which are placed over the reel. With dual-track recordings, a disc is placed on each reel. The position of the tape is marked at the edge of the slot before recording (the disc revolves with the reels during recording or playback) then without regard to time lapse or tape footage used, the recording is finished and that spot marked on the same slot in its final position of the tape. The subject matter is in-

Air Surplus Force

Marine or Airborne LONG RANGE Navigational equipment! Determine the exact geographic position of your boat or airplane!

AN/APN4 Loran set. Frequency range 1700-2000 KC. complete with 10GB/APN4 indicator, R9B/APN4 receiver, crystal and plugs. Brand New **\$129.50**

R-65/APN-9 LORAN Indicator. LATEST MODEL UNIT. Complete in one light weight case. Accurate on a maximum range of up to 1600 statute miles, within 1% of the distance from the ground transmitter. The finest unit available at any price!! **\$295.00**
BRAND NEW. Only

160 METER RECEIVER

High Voltage Power Supply; can be easily converted for 110 VAC, 60 cycle operation, complete with instructions, brand new, less tubes...ea. **\$9.95**

100 KC crystal NEW\$4.95 Ea.

RL-42 BEAM ROTATOR—Used, good—
\$1.95 ea; 3 for \$4.25

3" DUAL SCALE PANEL METER—0.1 KV **\$1.95**
and 0-10MA

CORDS FOR BCG60 CD-513 and 515...ea. **\$2.50**

SURPRISE PACKAGE

20 lbs. of MISCELLANEOUS ELECTRONIC EQUIPMENT—WORTH MUCH MORE THAN this low price of ONLY **\$1.95**

1-70 "5" METER—New **89c**

ARC-5/R-28 2 MTR RCVR—2 meter superbet, absolutely one of the BEST available today! Tunes from 100 to 156 mcs. in four crystal channels. (Easily converted to continuous tuning.) Complete with 10 tubes. Excellent. **\$15.95**

APN-1 Magnetic Units. You can build "Versatile Sweep Frequency Generator." These units are used with instructions **\$5.95**

BC 654 TRANSMITTER-RECEIVER

This medium power transmitter and the accompanying 7-tube very sensitive receiver are naturals for 80 or 40 meter operation (phone or CW), on either fixed stations or mobile applications. These units are used exc. and come complete with 17 tubes, key, microphone, 200 KC calibrating crystal and instructions and diagrams for use with up to 100 watts input to the final stage on 40 or 80 meters for either phone or CW, using vehicle or 110 Volt power supply **\$29.50**

PE103 Excellent 22.50

PE104 Vibrator Supply 9.95

UHF RECEIVER—234-258 MC, used exc. **\$7.95**
LESS TUBES

4 for \$10.00

2 Meter Converter—Easily converted to two meters—Used—Excellent, complete with conversion instructionsea. **\$3.95**

2 METER OUTBOARD AMPLIFIER—Easily converted to 2 meters—Used—Excellent, complete with conversion instructionsea. **\$3.95**

RT/34 APS 13 TRANSCEIVER—Used as a tall warning radar on 415 MC. Containing a 30 MC IF strip, RF section and various other parts, are an excellent buy if only for parts and IF strip. Usedea. **\$3.95**

R-1/AR-1—220 MC converted with minor alterations becomes a high gain converter with two stages of RF amplification—(complete with diagrams). Newea. **\$3.95**

BC 1033 75 MC RECEIVER, less tubes, ea. **\$3.95**

BC-455, Rec., 6-9MC—as is. **\$3.95**

4 for **\$10.00**

MOBILE HEAVY DUTY DYNAMOTOR: 14 V. INPUT—output: 1030 VDC 280 MA. Tapped 515 V. 215 MA. use @ 6 V DC INPUT—500 V. 175 MA. **\$8.45**
While they last—DMI-42-Excel. Condition....

NAVY ARB RECEIVER

195 KC thru 9 MC. Includes broadcast band. Excellent **\$19.95**
Complete with tubes and dynamotor.

BROADCAST BAND RECEIVER

Navy ADF Receiver DZ-1, made by RCA. Continuous 15 to 1750 kc in 6 bands. Rear-train tuning with vernier and coarse scales, broad or sharp band-pass. CW or MCW. All controls on front panel. No headaches of mechanical or electrical control interconnections. Beautifully built with 5-gang tuning capacitor, shielded tubes and coils. 8 tubes: 3-6D6, 2-76, 2-6C6, 1-41. Complete with tubes, less power supply **\$24.95**

DZ-1 direction finder, complete with all connection, cables & loop. Brand New **\$44.95**

A sweet oscilloscope deal. INDICATOR UNIT. For conversion to test scope, panadapter, analyzer, etc. Double deck chassis. 5CP1 mounted in tube shield. Less small tubes, but complete with **\$9.95**

5CP1each

12V DYNAMOTOR input 375V **\$1.95**
150MA; complete with filter base, used, ea.

WRITE FOR NEW BULLETIN AND PRICES.

R W ELECTRONICS

Dept. N, 2430 S. Michigan Ave., Chicago 16, Ill.
PHONE: CAIumet 5-1281-2-3

ALL ITEMS F.O.B. CHICAGO
25% Deposit required with orders

scribed on the disc and bracketed to indicate the amount of tape encompassed by the subject.

Room is provided for a wide variety of notations and indications which can be inserted at the option of the user.

For full details on these discs, price information, etc., write the company direct.

NEW BOZAK ENCLOSURE

A new speaker enclosure, designed specifically for infinite-baffling of the company's B-207A coaxial speaker, has been announced by the R. T. Bozak Company, P.O. Box 966, Darien, Conn.

The E-300 cabinet has 5 cubic feet of completely-enclosed space and heavy acoustical damping, minimum wall and cavity resonance, and inherently-perfect transient response.

The cabinet measures 24" x 17" on the floor and is 30½" high. It weighs

about 50 pounds without speakers. Finishes are mahogany, walnut, and birch with harmonizing wrap-around grille-cloth. The speaker panel has pre-cut holes for the B-207A and (closed with a removable panel) for the B-209.

Further data on this enclosure and the speakers with which it is designed to be used is available from the company.

LEADER AND TIMING TAPE

A leader and timing tape has been added to its line by Reeves Soundcraft Corp.

Spliced at both ends of a magnetic recording tape, it saves wear and tear in repeated threading. It is marked every seven and one-half inches, which permits accurate timing and splicing of timed intervals between selections.

The 150-foot roll comes in a handy

dispenser pack which makes it convenient to pull out a suitable length and tear it off.

AMPLIFIER-PREAMPLIFIER

Newcomb, 6824 Lexington Avenue, Hollywood 38, California is now offering a new remote-controlled amplifier and preamplifier unit which has been designated as the "Classic 2500-R."

In addition to complete sound control, this amplifier offers the company's exclusive distortion control feature, "Audio-Balance." This control assures the user of minimum distortion for the life of the unit by giving him complete control over "unbalance distortion." Replacement of tubes frequently makes this type of distortion worse as new pairs are almost never identical nor do matched pairs necessarily remain matched.

The new unit includes a remote con-

Ruth Sez:

"LOOK These Over!"

BC-212G Amplifier 2/6C5 Tubes—N:	\$3.95.	U:	\$1.95
BC-216A Amplifier 6F7 & 39/44 Tubes.....	U:	1.95	
BC-229/429 Receiver 2500-7700 KC w/Coils...	U:	5.95	
BC-230 Transmitter 2500-7700 KC w/Coils...	U:	6.95	
BC-347 Amplifier 1/6F8G Tube—N:	\$3.95.	U:	1.95
BC-357 Marker Beacon Receiver.....	U:	4.95	
BC-367 Amplifier 2/6V6GT Tubes—N:	\$1.95.	U:	3.05
BC-375 TRANSMITTER.....	U:	29.95	
BC-453 Receiver 190 to 550 KC.....	U:	14.95	
BC-455 Receiver 6 to 9 MC.....	U:	8.95	
BC-459 Transmitter 6 to 9 MC.....	U:	8.95	
BC-463 Transmitter & Modulator 67 to 74 MC.	U:	16.95	
BC-603 FM Receiver 20 to 28 MC.....	U:	24.95	
BC-604 FM Transmitter 20 to 28 MC.....	U:	11.95	
BC-605 Amplifier 2/1619 Tubes.....	U:	3.95	
BC-620 FM Transceiver 20 to 28 MC.....	U:	24.95	
BC-645 Transceiver—Converts 420 to 500 MC.	N:	24.95	
BC-654 Transceiver 3800 to 5800 KC.....	U:	34.95	
BC-659 FM Transceiver 27 to 39 MC.....	U:	24.95	
BC-683 FM Receiver 27 to 39 MC.....	U:	34.95	
BC-684 FM Transmitter 27 to 39 MC.....	U:	19.95	
BC-709 Amplifier Batt. Op. 1 Tube—N:	\$3.95.	U:	1.95
BC-745 Transceiver 3 to 6 MC.....	U:	14.95	
BC-745 Transceiver Chassis Only.....	N:	5.95	
BC-791 Code Tape Recorder.....	U:	4.95	
BC-966 IFF SET 160 to 211 MC. 13 Tubes.			
Less Dyn.....	LN:	8.95	
BC-1206 Receiver 280 to 400 KC—Less Tubes.	U:	6.95	
R-25/ARC-5 Revr. 1.5 to 3 MC—Less Tubes	U:	0.95	
R-27/ARC-5 Revr. 6 to 9 MC—Less Tubes...	U:	4.95	
R-1/ARR-1 Receiver—Converts 2 or 6 Meters...	N:	3.95	
RT-7/APN-1 Altimeter.....	N:	\$19.95—U:	9.95
RT-34/APS-13 Transcvr—Complete less tubes	U:	3.95	
BD-72 Switchboard—Portable—12 Line.....	U:	39.95	
FL-8A Range Filter—\$1.49; FL-5 Filter.....	U:	1.00	
TS-9 Carbon Hndset—U: \$3.95; TS-13 Hndset	U:	6.95	
TS-10 Soundpwr Handset or Head&Chest Set		3.95	

DYNAMOTORS:

HEAVY DUTY MOBILE DYNAMOTOR:

DM-42—14 V. input; output 1830 VDC—260 MA. & 515 V. 215 MA. @ 6 VDC. Approx. half of Volt-age. NEW: \$12.95—USED: \$8.95

INPUT VOLTS:	OUTPUT VOLTS:	STOCK MA.	NO. USED:	PRICES NEW:
14 VDC	230	90	DM-21	\$6.95
14	330	150	BD-87	3.95 5.95
14	250	50	DM-25	6.95 8.95
14	1000	350	BD-77	14.95 29.95
28	1000	350	PE-73	8.95
12 or 24	500	50	USA/0515	4.95
12 or 24	275	110	USA/0516	4.95
12	230	90	PE-133	4.05 6.95
14 VDC	350	175	BD-83	3.95 4.95

POWER SUPPLY—24 VDC—3 Amp output; 115 Volt 60 cycle input. Completely filtered with 0-75 VDC Output Meter & 2 Tungar Bulbs—Used. Tested..\$12.95

TG-34A KEYSER

New—\$1695

TG-34A KEYSER—115 or 230 V. @ 50 to 60 cycles—an automatic unit for reproducing audible code practice signals previously recorded in ink on paper tape. By use of the self contained speaker, the unit will provide code practice signals to one or more persons— or provide a keying oscillator for use with a hand key. Unit is compact, in portable carrying case, and complete with tubes, photo cell, and operating manual. Size: 10-9/16" x 10 1/2" x 15-13/16". Shipping weight: 45 lbs. NEW—While They Last—

ONLY \$16.95
TG-10 KEYSER—Used. Tested—Only.....\$17.95
PRACTICE CODE TAPES: For use with either TG-34A or TG-10 Keyers—Inked paper tapes on 16 MM 400 Ft. Reels: Tape #2—Receiving—Tape #8—Code Groups— and Tape #11—Traffic..... EA. \$1.25
Each in metal container.....

BLOWERS:



BLOWER AND HEATING ELEMENT

115 Volt 60 cycle—Blower 100 CFM; Heating Element can be turned on and off separately from Blower. Used to pre-heat transmitter tubes. Gov't. Surplus—#2570..... \$10.95

115 VAC 60 cycle SINGLE TYPE—100 CFM: 2 1/2" intake; 2" outlet. Complete size: 5" x 6" No. 1C939..... \$8.95

115 VAC 60 cycle DUAL TYPE—100 CFM: 4" intake; 2" Dis. Each Side. Complete size: 8" x 6"—No. 1C880..... \$13.95

115 VAC 60 cycle COMPACT TYPE—108 CFM: Motor built inside squirrel cage; 4 1/2" intake; 3 3/4" Dis. Complete size: 4 1/4" W x 8 3/4" H x 8 3/4" D—No. 2C067..... \$14.50

115 VAC 60 cycle FLANGE TYPE—140 CFM: 3 1/2" intake; 2 1/2" Dis. Complete size 7 1/2" W x 7 1/2" H x 8 3/4" D—No. 1C807..... \$13.95

115 VAC 60 cycle FLANGE TWIN—275 CFM: 4 1/2" intake; 3 1/4" x 3" Dis. Complete size: 11 3/4" W x 8 3/4" H x 8-1/16" D—No. 2C069..... \$21.95

6VDC SINGLE—100 CFM—No. 6100.....\$4.95
6 VDC FLANGE—150 CFM—No. 6150.....\$6.95
12 VDC SINGLE—10 CFM—Min.—No. 1210.....\$7.95
24 VDC SINGLE—10 CFM—Min.—No. 2410.....\$5.95
24 VDC DUAL—20 CFM—Min.—No. 2420.....\$7.95
12/24 VDC AC Cast Aluminum Blower—100 CFM: 3" intake; 2" outlet. Shunt Motor 4" x 2" 3000 RPM @ 24 VDC.....\$5.95

ANTENNA EQUIPMENT



MAST BASES—INSULATED: MP-22 BASE—(Illustrated) Ins. spring action; direction of bracket can be raised or lowered easily..... \$2.95

MP-S-33 BASE—Insulated type with heavy coil spring and 5" dia. Ins. Requires 2" hole for mounting. Weight: 9 lbs..... \$5.95

MP-37 BASE—Insulated type with heavy coil spring. 7" dia. insulator; requires 1 3/4" hole for mounting. Weight: Approx. 10 lbs..... \$8.95

MAST SECTIONS FOR ABOVE BASES:

Tubular steel, copper coated, painted in 3 ft. sections, screw-in type. MS-53 can be used to make any length with MS-52-51-50-49 for taper. Any section Larger Diameter Section: MS-54.....@ 50¢ Each.....75¢

BC-375 TRANSMITTER

100 Watt—Voice—CW—Freq. 200—500 KC—1500—12500 KC. By use of Plug-in Units \$29.95
listed below.....Used:

TUNING UNITS For BC-375 & BC-191	
NEW USKD	NEW USED
TU-5 1.5	TU-8 6.2—
MC-3 MC \$5.95 4.95	7.7 MC \$3.95 2.95
TU-6 3—	TU-9 7.7—
4.5 MC \$3.95 3.95	10 MC \$3.95 2.95
TU-7 4.5—	TU-10 10—
6.2 MC 3.95 2.95	12.5 MC \$3.95 2.95
BC-306 Antenna Tuner.....New: \$3.95—Used: \$2.95	
CABLES PL-64-61 or PL-59 Each end.....	Each: \$2.75

METERS:

WESTON AC METER:

(Pictured) In portable leather case, with Test Leads. 2 1/2", 0-15 AC and 0-3 AC Scale..... \$5.95



DC AMMETER HOYT: In portable metal case, with Test Leads. 4 1/4". Fan. Mirrored Scale 0-15 ADC.....\$4.95
0-3 RF AMMETER IS-128: 2 1/2" Rd.....NEW: 2.95
0-500 MICROAMMETER: TRIPLET. 2 1/2" Sq..... 4.95
0-5 MA DC WESTINGHOUSE: 2 1/2" Sq..... 3.95
0-10 METER: 10 to Plus 6—G. E.—3 1/2" Rd..... 4.15
TS-29/10 VOLT OHMMETER.....NEW: 7.95

TRANSFORMERS—115 V. 60 CYCLE PRI:

600 VCT/100 MA—6.3 V/5 A; 5 V/3 A.....\$4.95
850 VCT/50 MA—6.3 V/2.5 A; 6.3 V/1.6 (Rect. 6x5) 1.95
350 VCT/40 MA—6.3 V/2.4 A; 6.3 V/1.6 (Rect. 6x5) 1.75
2500 V/015 A; 2.5 V/175 A; 6.3 V/6A..... 5.95
1890 V/12.6 MA Tapped 2.5 V. 2 A..... 5.95
1100 V/80 MA; 7.5 VCT/3.25 A..... 5.95
5 Volt CT-25 A; 10,000 V. Ins. Open Frame.....\$7.95
9 Volt CT-35 Amp. Tapped 4.5 V..... 7.95
12 Volt—Two separate windings—4 Amp each..... 5.95
28 Volt 8 Amp Tapped 4 Volt..... 5.95
5 V/2 A; 5 V/2 A; 5 V/2 A; & 5 V/6 A..... 2.95
600-0-600 VAC—200 MA. (2.5 V. 2 A.; 12.5 V. 2 A.; 5 V. 2 A.) @ 3 A.: 115 Volt Primary. H-108. Price.....\$8.95
250-0-250 VAC—50 MA. 24 V. 1 A.; & 6.3 V. 1 A.: 115 Volt Primary, H 100—Price.....\$3.95
Current Transformer: Ratio 150 to 5; 25 to 60 cycle. West. Style 81R691.....\$8.95

Choke 12.5 Hy/100 MA.....\$1.95
Choke 12Hy/250 MA., 180 Ohm..... 4.95
Choke 15 Hy/165 MA., 125 Ohm..... 1.95
Choke 5 Hy/150 MA. 85 Ohm..... 1.50

CORDS—CABLES—PLUGS:

CD-605 w/C-410 Trans. & PL-55 F/HS-30.....\$0.79
CD-504 w/C-410 Trans. & PL-54..... .79
CD-874 w/JB-47 Box & PL-55..... .79
CD-265 w/PL-68 Ea. End..... .79
CD-501 BC-654 to PE-103 Dynamotor..... 2.75
CD-280 15 Ft. Single #8 Shielded—15 Ft..... 1.50
CABLE—F/BC-375-191—PL-59-64 or 61 Ea. End Each 2.75
CABLE—TCS—Rec. to P.S. or Trans. to PS. Each 3.00

COAXIAL CABLE & CONNECTORS

CD-1071 CORD—With PL-259 Plugs each end. 50 ohm coax 2 Ft. long. Prices: 50¢ Each—Dr in Lots of 10 @ 50¢ Ea.
PL-259—Plug, Ea. End & 32"—RG-54/U—58 ohm. 50¢
SD-239 Chassis Conn. F/PL-259 (Removed). 3 for 1.00
UG-21/U—Plug ea, end & 32"—RG-11/U—75 ohm. 50¢
UG-22/U—Whf 4" Coaxial Cable.....50¢
COAXIAL CABLE: Price Per Ft. 100 500 1000
RG-8/U 51.5 Ohm (Special)..... .17 .00 3/4 .00
RG-34 71 Ohms—145 Ft. Length.....\$15.00 Per Lth.

SYMBOLS: N Means NEW—LN Means LIKE NEW—U Means USED.

Address Dept. RN • \$5.00 Order Minimum, and 25% Deposit on C.O.D. Orders • Prices F.O.B., Lima, Ohio

FAIR RADIO SALES 132 SOUTH MAIN ST. LIMA, OHIO

THERE ARE 3

New
REK-O-KUT
Rondine
TURNTABLES

The Rondine Deluxe

3-speed with hysteresis motor..... **\$119⁹⁵**

The Rondine

3-speed with 4-pole induction motor..... **69⁹⁵**

The Rondine Jr.

2-speed with 4-pole induction motor..... **49⁹⁵**

Each is the Finest of its kind

Which one belongs in your home music system?

Mail this coupon today!



REK-O-KUT Company
Dept. WB-12, 38-01 Queens Blvd.
Long Island City 1, N. Y.

I would like to know how the Rek-O-Kut Rondine Turntables can fit into my high fidelity plans. Also send me FREE Strobe Disc to check my present equipment.

Name _____
Address _____
City _____ Zone _____ State _____
My dealer is _____

trol unit which has been designed to fit any decor. It can be placed up to 100 feet away from all other equipment.

Technical specifications include: less



than .1 per-cent distortion up to 10 watts, less than .2 per-cent at 20 watts; 10 to 100,000 cps response within $\pm .1$ db from 10 to 30,000 cps.

PILLOW SPEAKER

General Phones Corporation, 5711 Howe Street, Pittsburgh 32, Pa. is in production on a miniature speaker suitable for many different applications.

The unit is housed in a hermetically-sealed steel case, weighing one ounce, and uses the magnetic flux principle. The principle involves opposed *Alnico* magnets mounted on a fiber tone platform, which has a flat coil on its reverse side.

The speaker has no moving parts. It incorporates a very low impedance device to match any radio or television receiver without the use of capacitors or resistors.

"TRANS LINEAR" TONE ARM

Kral Products, 1704 Walnut Street, Philadelphia, Pa. has developed a new tone arm which plays back records in a straight line—the same way in which the records were originally cut.

The new "Trans Linear" tone arm is currently available in two models—one a 12" and the other 16" to provide complete coverage of all turntables on the market. The all-steel constructed arm with brass carriage can be easily installed on any turntable. No soldering is necessary to connect



the arm to the hi-fi system. A standard phono cord is used to plug the arm into the system. Height adjustment is accomplished by a handy thumb screw. The arm will accommodate most standard cartridges. An adjustable counterweight is furnished for use where necessary.

NEW TAPE DECK

Fenton Company, 15 Moore Street, New York 4, N. Y. is now offering the "Motek" audiophile tape deck which has separate capstan, take-off, and take-up motors yet remains in the moderate price class.

The unit's electrically interlocked

STAN-BURN
SPARKS

CATHODE RAY TUBE SPECIALS

One Year Guarantee		G. E.		STAN-BURN	
* 10BP4A \$14.95	10BP4 \$10.20		
* 10FP4A 21.10	12LP4 11.90		
* 12KP4A 24.45	12LP4A 13.95		
* 12LP4A 18.75	12QP4 11.90		
* 12QP4A/1014 21.00	12UP4A 14.50		
* 12UP4A 22.75	14CP4 15.60		
* 14CP4 24.50	14CP4 15.60		
* 15DP4/1014 23.75	15DP4 17.50		
* Dumont 30.95	16KP4 or A 17.50		
* 16AP4A 25.25	16JP4 or A 17.50		
* 16DP4 (N.U.) 31.25	16CP4 or A 17.50		
* 16GP4 or B 24.20	16FP4 17.50		
* 16KP4/16RP4 28.35	16WP4 17.50		
* 16KP4A 25.25	16WP4 17.50		
* 16JP4A (N.U.) 26.50	16AP4A 23.00		
* 16LP4A 31.25	16EP4A 19.00		
* 16WP4A 24.25	16CP4A 23.50		
* 17BP4A 30.30	17CP4A 21.00		
* 17BP4B 34.00	17BP4 18.50		
* 17CP4A 38.50	17CP4B 22.60		
* (Aluminum) 41.50	19FP4 23.00		
* 19AP4A 30.00	19AP4 23.90		
* 20CP4 37.50	19AP4A 24.90		
* 20LP4 42.00	20CP4A 23.95		
* 21EP4 31.80	21EP4 23.50		
* 21EP4A 36.35	21AP4 26.50		
* 24AP4 78.50	24AP4 49.00		

PRICES SUBJECT TO CHANGE WITHOUT NOTICE

AUTHORIZED DISTRIBUTORS for General Electric, Kenrad, Tung-Sol, National Union, De Wald, Regal, Automatic and General Motors.

Automatic Custom-Built Radios for Plymouth, Ford, Chevrolet and many others, always in stock.
We carry a Complete line of HI-FIDELITY and sound equipment. Send us your requests.
We also carry a complete line of popular makes of Radio Tubes at 50/10 discount. Also many other special purpose and transmitting types, and all electronic parts and equipment at lowest prices. Send us a list of your requirements for prompt quotations.
Terms: 20% with order. Balance C.O.D. All prices F.O.B., NEW YORK Warehouse. Minimum order \$5.00.
Write for our latest price list and Hi-Fi catalog to Dept. RN-2.

STAN-BURN RADIO and ELECTRONICS CO.
1697 BROADWAY • NEW YORK 19, N.Y.

EARN MORE MONEY—
BE A PROFESSIONAL
TELEVISION
SERVICE
TECHNICIAN



Get down-to-earth practical TV training with WT1 experts for the top paying \$5,000-\$10,000 per year jobs.

UHF—COLOR—VHF SEND FOR Master the latest, up-to-the-minute FREE TV and Color TV developments. BOOK TODAY!

WESTERN TV offers real experience on live equipment in our BIG SHOPS AND LABORATORIES in the shortest practical time under expert instructors. Graduates are in big demand because they have the "field experience" necessary for immediate "bench" or supervisory positions. You learn every phase of Radio and TV servicing (AM, FM, VHF, UHF). WT1 men win fast promotion can demand better pay... develop highly profitable businesses of their own with the latest and most PRACTICAL PERSONALIZED TRAINING BEHIND THEM. You concentrate all your time on being a PROFESSIONAL TV SERVICE TECHNICIAN—non-essential math and engineering theory omitted. YOU CAN EARN WHILE YOU LEARN. Special Finance Plan. APPROVED FOR VETERANS. Find out how you can get into the TOP PAY GROUP—Send for this fact-packed book NOW!

WESTERN TELEVISION INSTITUTE America's Leading Television Servicing School

Western Television Institute, Dept. R-125
341 W. 18th St., Los Angeles 15, Calif.
Without obligation, please send FREE fully illustrated booklet. (No salesman will call.)
NAME _____ AGE _____
ADDRESS _____
CITY _____ ZONE _____ STATE _____

switch and brake system reduces the moving parts of the whole transport mechanism to the motor rotors, the flywheel-capstan axis assembly, and the tape pressure pad and pinch roller assembly.

Response with a suitable amplifier is better than 50 to 10,000 cps. Wow and flutter are less than .3 per-cent. Half track working on standard 1/4" tape gives 32 minutes of playing time on each track at 7 1/2 ips.

The deck is shipped with full instructions and circuit diagram for preamplifier and oscillator stages or the unit is available as a complete tape recorder and audio amplifier with separate power pack for remote installation.

STYLUS PRESSURE TESTER

Audak Company, 500 Fifth Avenue, New York 36, N. Y. has devised a new instrument which is designed to reveal quickly and simply whether stylus pressure is either too light or too heavy.

The "Micro-Poise" is designed to perform the sole function of telling whether stylus pressure is correct.

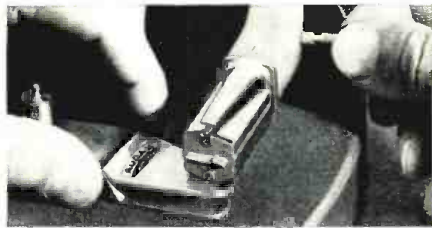

Too light pressure, as well as too heavy pressure, can harm disc grooves—the more so because a difference of only two or three grams one way or the other means as high as 50 per-cent off-correct in view of the feather-touch point pressure necessary with today's microgroove discs.

An interesting booklet on the "Micro-Poise" is available from the company on request.

COAXIAL-TUNED FM RADIO

Granco Products Inc., 36-17 20th Ave., Long Island City 5, N. Y. has recently introduced an FM receiver that is no bigger than the usual table model radio and is in the same price class.

The Model 610 FM radio, with self-contained antenna, is said to have excellent sensitivity, stability, tuning ease, low hum level, good tone quality and volume.

The receiver measures only 7 1/2" x 4 3/4" x 4 1/2" and weighs 5 pounds. It is available in ebony, blonde, and walnut plastic cabinets. The tuner covers the 88-108 mc. FM spectrum. The 300-ohm FM antenna is incorporated in the power cord so that no special installation is required. The set uses six tubes and operates on a.c. or d.c.

AUDIO ANALYZER KIT

Heath Company, Benton Harbor, Michigan has announced a new addition to its 1955 test equipment line.

The Model AA-1 audio analyzer

February, 1955

Just what the TV Doctor ordered...

R STANCOR EXACT REPLACEMENT FLYBACKS

Whether the "patient" is a Crosley, a Muntz, an RCA, or any other brand, you can be sure of a prompt recovery when the prescription reads "STANCOR"



Patient: **RCA**

Stancor A-8244

New Exact Replacement Flyback for RCA 78201 and RCA 78810. Used in 67 models and chassis. List Price . . . \$10.00

Patient: **Muntz**

Stancor A-8242

New Exact Replacement Flyback for Muntz TO-0028 and TO-0029 List Price . . . \$9.00

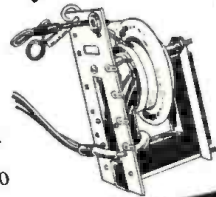

Patient: **Crosley Super V, Hallicrafters**

Stancor A-8241

New Exact Replacement Flyback for Crosley 157820 and Hallicrafters 550251 List Price . . . \$8.10

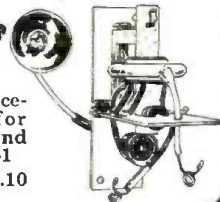

FREE—HIGH FIDELITY, Ultra-Linear Amplifier Bulletin 479 describing performance and construction of the 24 watt Stancor-Williamson Amplifier, using Stancor Ultra-Linear Output Transformer A-8072 (\$15.00 net). Available from your distributor.



CHICAGO STANDARD TRANSFORMER CORPORATION

3584 ELSTON AVENUE • CHICAGO 18, ILLINOIS

EXPORT SALES: Roburn Agencies, Inc. • 431 Greenwich Street • New York 13, N. Y.

Stancor transformers are listed in Photo-fact Folders, Counter-facts, Radio's Master, and File-O-Matic.

STOP

CONTAINS THE AMAZING NEW PERMA-FILM!

"NO NOISE"

New 6 oz. Spray Can Net to Servicemen . . . \$2.25

Available in 8 oz. bottles and quart cans. Nearest distributor — or write us today.



VOLUME CONTROL NOISE!

PERFECT CONTACT RESTORER...

Cleans & restores volume controls, band switches, push button assemblies, electrical contacts. NO NOISE is not a carbon tet solution.



- ★ CLEANS! . . . dirt and oxidation immediately on contact.
- ★ LUBRICATES! . . . one drop eliminates scratch, hum and noise.
- ★ PROTECTS! . . . assures continued top performance.

"NO NOISE"

2 oz. bottle, Net to Servicemen . . . \$1.00

ELECTRONIC CHEMICAL CORP.

813 Communipaw Ave.

Jersey City 4, N. J.

HARVEY

for **MOBILE** and **FIXED GEAR**

**COMPLETE STOCKS ON HAND
FOR IMMEDIATE DELIVERIES**

Here is a Partial Listing of
POPULAR UNITS
Preferred by Most of Our Customers

B & W 5100.....	\$442.50
Collins 32V3	775.00
Collins 75A3 & speaker.....	550.00
Central Electronics 20A kit.....	199.50
Central Electronics 20A factory wired	249.50
Central Electronics 10B kit.....	129.50
Central Electronics 10B factory wired	179.50
Central Electronics Sideband Slicer kit	49.50
Central Electronics Sideband Slicer factory wired	74.50
Elmac PMR6A or PMR12A.....	134.50
Elmac AF67	177.00
Gonset Super-6	52.50
Gonset Super-Ceiver	119.50
Gonset Communicator II.....	229.50
Hallicrafter SX88	595.00
Hallicrafter SX71	249.95
Hallicrafter S76	199.95
Hallicrafter S85 or S86	119.95
Hammerlund HQ140X	264.50
Morrow 5BR	74.95
Morrow 5BRF	67.95
Morrow FTR	128.40
National NC98	149.95
National NC88	119.95
National NC125	199.95
National NC183D	383.50
National HRO60	533.50
Sonar SRT-120 kit.....	159.50
Sonar SRT-120 factory wired....	198.50
Viking II kit	279.50
Viking II factory wired.....	337.00
Viking Ranger kit.....	179.50
Viking Ranger factory wired....	258.00

**Generous Trade-In Allowances
On Your Present Equipment**

Anywhere in the world —

order by mail direct from Harvey. Enclose estimated shipping charge. Excess will be refunded.

NOTE: Prices Net, F.O.B., N.Y.C.
Subject to change without notice.



Harvey

RADIO COMPANY, INC.

103 W. 43rd St., N.Y. 36, N.Y. • JU 2-1500

functions as three instruments in one: an a.c. vacuum-tube voltmeter, a wattmeter, and a complete intermodulation distortion analyzer.

Featuring built-in load resistors of 4, 8, 16, and 600 ohms and built-in low- and high-frequency oscillators,



this new kit retails for less than the cost of three separate instruments. This is made possible by the consolidation of circuit functions and the resultant elimination of duplicate components. One set of input and output connectors serves for all functions, and comprehensive audio testing is simplified through this combination of instruments.

Complete specifications and price information on the Model AA-1 are available from the company on request.

TEST TAPE SAMPLER

A handy reel of pre-recorded tape which enables the user to test his tape recorder and also enjoy some choice musical selections is now available from *The Dubbings Company*, 41-10 45th Street, Long Island City 4, N. Y.

Designated as the D-210 and called the "Plus-50 Music and Test Tape Sampler," the 3" reel provides two timing beeps accurately spaced 7 minutes apart for measuring tape speed and a 15 second 5000 cps tone for aligning the playback head. The 7½" recording is full track and consequently may be used on either full-track or half-track machines.

"TABLE-TOP" AMPLIFIER

The Radio Craftsmen, Inc., 4401 N. Ravenswood Ave., Chicago 40, Illinois has developed a complete "table-top" high-fidelity music control center which has been tradenamed the "Solitaire."

The new unit combines a 20-watt amplifier, a preamp-equalizer, and



dual filter systems in a cabinet measuring just 4" high by 11½" by 14½". It is housed in a leather-etched steel cabinet.

Features include six positions of record equalization; four inputs for records, radio tuners, television, and

Airex's New Auto-Focus 1955 CHANNELLOC 630FA4

Up To 200 Miles Reception • HI Gain
Cascode Tuner • 4 Microvolt Sensitivity

*The Perfect Chassis for Fringe Areas
New Exclusive Advancements*

• Pictures always in focus • HI & Low sync. Amplifiers • Channelloc-Locks Picture & sound together • Drift free operation • Automatic Freq. Control • Gated A.G.C. • Fringe Area Control • Full & MC. Picture Bandwidth • Phono connection & Switch • Efficient Retrace Blanking • Automatic Brightness Control • Full Focus Cosine Yoke • Fused HV Power Supply • Molded Plastic Condensers • 6CB6 Tubes in Video I.F. • Handles up to 24" Rnd • Improved Sync System • Auto Former Fly Back • Improved Video amplification • Heavy Duty Power Transformer • Improved Horizontal Sweep • Full range 12" Loudspeaker • 4 Microvolt Sensitivity • Ready for UHF Stations • Size 22" x 22" x 24" with 21" tube mounted.

\$149⁹⁵

Less CR Tube & Brackets
12" Hi-Fi Speaker
Tube Misc. Brackets—
56.50

Detailed Service Manual & Schematic—\$1.00

Combination Saving
FA-1 Chassis
21" Tube
Mah. Cons.
Cabinet.

\$224⁹⁵

TV Picture Tubes

Standard Brands, Aluminized, New. Guar. 3 year.

• 21" Tube\$34.95
• 24" Tube Rect. \$59.95
• 27" Tube Rect. \$74.95

PLASTIC MASKS

20" and 21"\$ 7.95
24"\$14.95
27"\$17.95

Send for Cabinet & Hi-Fi
Parts Catalog

630-9 TV Chassis for 24" & 27" Tube

• Channelloc-Picture & sound locked together • No drift • Reception up to 200 miles • 90 degree deflection • 22 kv high voltage power supply • For 24" & 27" rect. tubes • Phono connection & switch on chassis • Adaptable for color • RMA guarantee.

\$179⁹⁵

With 12" TUBE MTG.
HI-FI RCA BRACKETS
Speaker \$9.95

RECORD CHANGER SAVINGS

• VM 1955 Model, with turnover titone dual sapphire cart.\$26.50
• Webster-Chicago, 1121 type series with turnover crystal cart. 26.95
• Webster-Chicago, 1121 type series with G.E. RFX 050 Reluctance cart. 32.50
• Garrard, RC 80 with 2 plug-in heads. 42.75
• Garrard, RC 90 with 2 plug-in heads. 59.95
• 45 RPM spindle for Garrard 3.37
• G.E. RFX050 dual sapphire Reluctance cart. 6.49

All merchandise is brand new, fact. fresh & guar. Mail & phone orders filled on receipt of certified check or MO of 20% of items as a deposit. Balance COD FOB fact. N. Y. Prices & specifications subject to change without notice.

AIREX RADIO CORP.

171 Washington St., N. Y. 7 CO 7-5218

110V, AC POWER SUPPLY FOR ANY 274-N RECEIVER

Just plug it into the rear of your 274-N RECEIVER . . . any model. Complete kit and black metal case, with ALL parts and diagrams, simple and easy to build wiring changes to be made. Designed especially for the 274-N receiver. Only \$8.95.

Filament trans. for 274N receivers. Pri. 110V, 60 cy. AC. Sec. 24V @ .6A. An excellent buy at \$1.95 ea.

SPLINED TUNING KNOB FOR 274N RECEIVERS

An exclusive O-R item manufactured for us. Fits BC-453, BC-454 and other 274N receivers. This is a really hard-to-obtain item. Only .89c ea.



OFFENBACH-REIMUS

1564 Market Street, San Francisco, Calif.

TELEVISION

PREPARE FOR A GOOD JOB!
BROADCAST ENGINEER
ELECTRONICS RADIO SERVICING

Television Servicing

(Approved for Veterans)
SEND FOR FREE LITERATURE
BALTIMORE TECHNICAL INSTITUTE
1425 EUTAW PLACE, BALT. 17, MD.

tape; plus a cathode-follower output for tape recording. The exclusive dual filters eliminate turntable rumble and spurious high and low frequencies from the amplifier.

NEW RECORD CHANGER

The Collaro division of *Rockbar Corporation*, 215 E. 37th Street, New York 16, N. Y. has recently introduced a new three-speed, fully-automatic record changer, the Model RC-54.

The unit automatically intermixes all size records. 7, 10, and 12 inch records can be stacked in any order of play without any adjustment or pre-setting, provided they are of the same speed. The complete changing cycle takes only 6 seconds, irrespective of the speed at which the records are being played.

Only two knobs are required to control the unit, one knob sets the speed and the other is for "on," "off," and "reject." The changer measures 12" by 13½".

REPLACEMENT CARTRIDGE

The *Turner Company*, 900 17th Street, N.E., Cedar Rapids, Iowa has introduced a universal phonograph pickup replacement cartridge that can be used to replace 95 per-cent of all 78 rpm pickups now in use.

The cartridge is available in two models, AU and A. The Model AU is furnished with an externally mounted capacitor for low voltage (2 volts or lower output) replacement. The capacitor may be slipped off for high-voltage replacements. The Model A is the same cartridge as the AU but is furnished without the special low-voltage capacitor.

For complete information, write for Bulletin No. 962. -30-

For the first time in the history of the event, a Canadian amateur radio operator has won the W/VE contest. This international goodwill competition among hams in the U.S. and Canada is designed to promote increased radio communications between amateurs. Russ Wilson, VE6VK, of Calgary was this year's winner with a total of 37,725 points. The new cup, which was presented by Emerson Radio of Canada, was presented to the Montreal Amateur Radio Club, sponsors of the competition, by Rupert K. Grant, sales manager of Emerson and accepted by H. M. Ward, president of the Club. A miniature trophy will be presented to Russ Wilson. Alex Reid, Canadian general manager of the ARRL, represented that body at the ceremonies, while Carl Lockhart (right) of Emerson of Canada watched the proceedings with interest.



February, 1955

NEW STOCK OF FIRST QUALITY TELTRON TUBES GUARANTEED! . . . LOWEST PRICES EVER!

All tubes individually boxed . . . unconditionally guaranteed for one year!

GIFT OFFER!
One 6BG6G tube will be shipped FREE with any order accompanying this ad.

FREE BONUS OFFER!



MODEL 625K

- Illum. gear-driven "Speed Rollchart"
- New lever-action switches for individual testing of every element
- Tests all conventional and TV tubes

This Eico Tube Tester is yours FREE when you buy \$199 worth of tubes or more within 60 days at Teltron.

May be bought outright from Teltron for \$34.95

Type	Price	Type	Price	Type	Price	Type	Price
1A7GT	.53	6AQ5	.48	6F5GT	.44	12AZ7	.65
1H5GT	.51	6AR5	.48	6H6	.50	12B4	.72
1L4	.51	6AT6	.37	6J5GT	.49	12AL5	.48
1L6	.51	6AU5GT	.60	6K6GT	.39	12BA7	.58
1LC6	.49	6AV5GT	.60	6L6	.78	12BY7	.65
1N5GT	.51	6AV6	.37	6Q7	.40	12BZ7	.63
1R5	.51	6AX4GT	.60	6S4	.41	12K7	.40
1T4	.51	6AX5GT	.60	6S8GT	.65	12SL7GT	.60
1U5	.43	6BA6	.56	6SA7GT	.45	12SN7GT	.56
2A3	.35	6BA7	.58	6SK7GT	.45	12SN7GT	.56
2A7	.35	6BC5	.48	6SL7GT	.60	19BG6G	1.48
3Q4	.53	6BE6	.46	6SQ7GT	.38	19T8	.71
3Q5GT	.61	6BF5	.48	6T8	.71	25BQ6GT	.82
3S4	.48	6BF6	.48	6V3	.80	25L6GT	.55
3V4	.48	6BG6G	1.18	6V6GT	.48	25Z5	.55
5U4G	.43	6BK5	.75	6W6GT	.53	25Z6GT	.36
5V4G	.49	6BJ6	.51	6X4	.37	35B5	.48
5Y3GT	.30	6BH6	.51	6X5GT	.38	35C5	.48
5Y4G	.40	6BK7	.78	6X8	.80	35W4	.33
5Z3	.42	6BL7GT	.78	7F8	.49	35Y4	.42
6A8	.40	6BN6	.90	7N7	.49	35Z5GT	.33
6AC7	.65	6BQ7	.85	12AL5	.43	50A5	.49
6K7	.40	6BY5G	.60	12AT6	.37	50B5	.48
6AB4	.43	6BZ7	.95	12AT7	.71	50C5	.48
6AF4	1.02	6C4	.41	12AU6	.43	50L6GT	.50
6AG5	.52	6CB6	.51	12AV6	.42	TYPE 80	.40
6AH4GT	.65	6CD6G	1.63	12AV7	.73	117Z3	.33
6AJ5	.96	6CU6	.95	12AX4GT	.60	117Z6GT	.65
6AK5	.96	6F6	.42	12AX7	.61		

FREE \$7.20 list value Bonus Box of three 6SN7 tubes and 25 assorted resistors with each order of \$25 or more.

SAME DAY SERVICE

48 Hour Postal Delivery To West Coast
TERMS: Save all freight and postage charges. All orders accompanied by full remittance will be shipped POSTAGE PAID anywhere in the continental U.S.A. 25% deposit required on C.O.D.'s. Minimum order \$10.00. Open accounts to rated firms only.

Send for Free complete tube listing and monthly specials! Get on our mailing list.

SPECIALS!—till MAR. 1st

1B3GT	.58	6W4GT	.35
1U4	.42	12AU7	.50
1X2	.58	12BA6	.39
6AL5	.32	12BE6	.39
6AU6	.35	12BH7	.55
6BQ6GT	.75	12SA7	.40
6J6	.52	12SK7	.40
6SN7GT	.48	12SQ7	.35
6U8	.69	35L6GT	.38

TELTRON ELECTRIC COMPANY

428 Harrison Ave.,

Harrison, N. J.

Dept. RN-2

Phone Humboldt 4-9848

PREMAX

"CA" BUMPER MOUNTING FITS ANY CAR!

without DRILLING or MARRING!

Even the massive bumpers of new 1955 cars can be outfitted with Premax's newly improved "CA" mobile antenna. No drilling of bumper or splash-pan necessary. Fully adjustable with 9 links of chain. Braided copper wire ground lead included. Ask your dealer or jobber—or write

PREMAX PRODUCTS

Division Chisholm-Ryder Co. Inc.
5587 Highland Ave., Niagara Falls, N. Y.



NEW! 10 WATT Hi-Fi AMPLIFIER KIT 21.95 Model A-10

Completely NEW Arkay Hi-Fi Amplifier in Kit Form. Less than 3% distortion. 20 to 20,000 cps \pm 1 db. Bass boost of + 8 db at 10 cps. Treble boost + 10 db at 10,000 cycles. Inputs: Reluctance and crystal pickup, mic., radio. Hum—70 db below rated output. Tubes: 6SC7, 6SL7, 5Y3GT and 2 6V6GT.

5 WATT HI-FI AMPLIFIER KIT

High quality Phono-Amplifier Kit at extremely low cost. Will operate 2 speakers for new 3-dimension sound effect. Push-pull circuit, inverse feed back brings out full brilliance of new recordings. Arkay Model A-5.

9.95

ATTENTION HAMS!

Mobile Antenna Bargain!

Brand new, Heavy Duty Army Signal Corps whip antenna. Ideal for fixed or mobile use. 82 inches extended, 12 inches collapsed. Complete with bracket (less lead). A \$25 value, sensationally priced.

1.95

Write for FREE FYI Bulletin 211

WHOLESALE RADIO PARTS CO., Inc.

311 W. Baltimore St. Baltimore 1, Md.

Your Distributor Has The New EASY-STRIP JSC TV Wire

A secret process plus pure polyethylene makes JSC's 300 ohm cable easiest to strip. Try it!

Available on cards in 100 ft. lengths, on spools in 500 and 1,000 ft. lengths



Look For This Carton At Your Distributor

JERSEY SPECIALTY CO., INC.
Burgess Place, Mountain View, N. J.
Phones: Little Falls 4-0784-1404-1405

Radio Intermittents (Continued from page 44)

row the field down to one or two units which is all that the troubleshooter needs for his final testing. He then can, for example, disconnect a capacitor for a running test in order to prove whether or not the capacitor is at fault.

Fuse Ratings

Proper rating of the fuses is the most important part of the method.

Ampere	Milliamperes
1/500	2
1/200	5
1/100	10
1/32	31+
1/16	66+
1/10	100
15/100	150
1/8	125
2/10	200
1/4	250
3/10	300
3/8	375
4/10	400
1/2	500
6/10	600
3/4	750
8/10	800
1	1000

(For values above 1 ampere simply add the fraction in milliamperes to 1000 times the number of amperes)

Table 1. Conversion of fractional ampere fuse sizes to the milliamperage equivalents.

The rating should be as close to the normal current drain as available commercial fuse sizes will permit. For example, a 35L6 audio output tube will draw about 45 milliamperes at 110 volts, and fuse F_2 of Fig. 2 should be rated at 50 milliamperes or so. However, the nearest commercial size is 1/16 ampere or 62.5 ma., which could be used. A listing of the commercial fuse sizes in amperes and milliamperes appears in Table 1.

The many sizes of fuses permit the troubleshooter to use a fuse only slightly larger than the current drain of the circuit, which will insure that

Fig. 3. Two inexpensive fuses are shown being used to monitor a small a.c.-d.c. radio receiver for an intermittent. The fuse holders are mounted on a small piece of insulating material and chassis contact is avoided. The fuses are clipped into progressive stages with the set on.



!!T. V. CABINETS!!



Beautiful Mahogany wood veneer table models. Inside: 19 1/2" x 15 1/2" H. x 19" deep. Opening: 13 1/4" x 10 1/2" H. With safety glass & 1 1/2" mask. Adaptable to larger screen sets or Console. Makes handsome Hi-Fi 15" SPEAKER Baffle.

\$5.95

2000 OHM LAB. POTENTIOMETER (DeJur)—3% precision; 8 watt, 3" O.D., W.W. . . . ea. 98¢; 6/35.00
"GUNNER" OUTPUT XFMR (1 1/2" x 1/2")—Beam power tube (50L6, etc.) to voice coil 79¢
CRYSTAL HAND MIKE—Hi-impedance. Rugged, moulded bakelite case; 6 ft. shld. cable. . . . \$3.95
12" NON-METALLIC SCREW DRIVER—dble. ended. Durable 1/2" bakelite. ea. 49¢; 12/55.00
RG-8/U CO-AXIAL CABLE (50 ohm) 20 ft. ltrh. . . . \$1.69
RG-58A (58 ohm)—25 ft. ltrh. \$1.49
MC-211A ANGLE DRIVE (ARC-5). . . ea. 39¢; 12/53.98
HS-30 HEADSET complete with matching XFMR. \$2.49
HS-30 HEADBANDS—for HS-30. ea. 19¢; 12/31.98
CD-620E DOUBLE PHONE CORDS w/clip (HS-30). . . . ea. 29¢; 10/52.49
HS-30 MATCHING XFMR—to-hi impedance. ea. 59¢
PL54/JK26 CONNECTORS—2 wire. set 39¢; 6/51.98

!!REPAIR YOUR OWN SPEAKERS!!

SAVE TIME—SAVE MONEY! Clear, simple instructions supplied with every Cone or Repair Kit order. Kit "A"—SPEAKER CONES—An assortment of popular sizes 4" to 12", incl. oval. Less voice coils. **\$1.98**
Kit of 12 assorted. \$2.98
Kit "B"—DE LUXE "CONE" KIT—Same as above, but containing larger variety of 20 asstd. **\$2.98**
Kit "C"—SPEAKER REPAIR KIT—professional assortment of: Voice Coil Forms, Spiders, Rings, Felt, Chamois Lthr, Shim Kit, Cement & **\$2.49**
Instructions—BOTH KITS "A" & "B" FOR ONLY **\$.95**

! STOP! LOOK! & PROFIT! !

The "JUMBO RADIO-ELECTRONICS PARTS KIT" is BIGGER & BETTER THAN EVER! Check-full of new & surplus components WORTH MANY TIMES THE PRICE! 17 FULL LBS. of: SWITCHES, CONTROLS, WIRE, RESISTORS, CONDENSERS, SPEAKER REPLACEMENT PARTS, COILS, SOCKETS, PHOTOFACTS, PLUS DOZENS OF OTHER ITEMS (shpg. wt. 20 lbs.). **\$3.95**

BALLAST TUBE ASSORTMENT—Kit of 8 replacement types, including JFD. **\$2.98**
ALNICO MAGNET KIT—Powerful Bar, Block. **\$1.98**
"U", Rod, etc. Kit of 10 assorted. \$2.49
MOULDED PLASTIC CONDENSERS—Omni to .2mf, 200-600V. Pictal leads. 50 asstd./\$1.98; 100/\$2.98
MIN. ORDER \$3.00—20% DEP. REQ.

LEOTONE RADIO CORP.
67 Day Street
New York 7, N. Y.



EASY TO LEARN CODE

It is easy to learn or increase speed with an Instructograph Code Teacher. Affords the quickest and most practical method yet developed. For beginners or advanced students. Available tapes from beginner's alphabet to typical messages on all subjects. Speed range 5 to 40 WPM. Always ready—no QRM.

ENDORSED BY THOUSANDS!

The Instructograph Code Teacher literally takes the place of an operator-instructor and enables anyone to learn and master code without further assistance. Thousands of successful operators have "acquired the code" with the Instructograph System. Write today for convenient rental and purchase plans.

INSTRUCTOGRAPH COMPANY
4711 SHERIDAN ROAD, CHICAGO 40, ILLINOIS

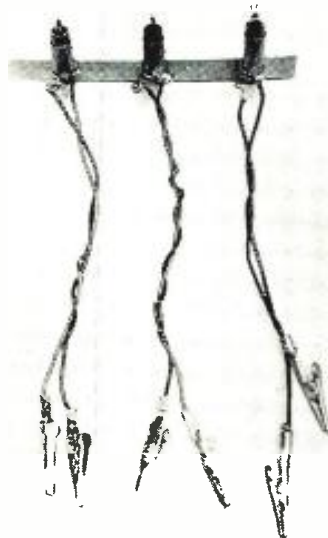

Fig. 4. Three panel lamp sockets with flexible leads and clips for testing for partial short circuits in a.c.-d.c. sets.

the fuse will blow if a heavy short circuit occurs.

A typical hookup showing the use of two fuseholders with a midget a.c.-d.c. set is given in Fig. 3. The fuse *F*₁ in this instance is a surge-limiting resistor which would act as a fuse if the current to the rectifier plate became excessive.

Partial Short Circuits

The partial short circuit presents another problem which is solved by the use of panel lamps as combination fuse-indicator devices. As the reader has probably experienced, a slight overload will quickly blow a panel or pilot lamp. A *Mazda* 44 requires 250 milliamperes (¼ amp.) to light it up to its full brilliancy and will blow rapidly with 400 milliamperes; it will glow a dull red with a current as low as 100 milliamperes. The *Mazda* 47 requires 150 milliamperes for full brilliancy, will blow at about 250 milliamperes, and will glow at about 60-65 milliamperes.

Panel lamps are very cheap and if one does blow, the cost is just about the same as a fuse. The glow of the lamp varies with the current passing through it. There is no exact proportional relationship; however, the relation is close enough. The amount of current for normal operation will cause a certain glow and more will make the lamp burn brighter—the eye can detect very readily small changes in brilliancy of such a lamp. In fact, the eye can do almost as good a job as a meter in this case.

The lamps are inserted into different circuits in the same manner as the fuses were in the cases previously described. Long flexible leads are necessary so that the panel lamps may be supported away from the set or apparatus under test, making it possible for the troubleshooter to observe them at a distance.

Fig. 4 shows three such lamps mounted on a piece of fiber or plastic for insulation. The tape around the

February, 1955

For QUALITY - PERFORMANCE - DEPENDABILITY

Rad-Tel Tubes Guaranteed 1 FULL YEAR



70% to 90% OFF

- Same Day Service
- All Tubes Individually Boxed
- 300 Types Always in Stock

TYPE	PRICE	TYPE	PRICE	TYPE	PRICE	TYPE	PRICE	TYPE	PRICE
0Z4M	.65	6A8	.62	6BC5	.54	6T8	.80	12BA6	.49
1A7GT	.47	6AB4	.44	6BE6	.51	6U8	.78	12BE6	.51
1AX2	.62	6AC7M	.86	6BG6G	1.25	6V6GT	.50	12BH7	.63
1B3GT	.73	6AF4	.90	6BH6	.53	6W4GT	.47	12BY7	.65
1E7	.29	6AG5	.56	6BJ6	.49	6W6GT	.57	12SA7GT	.65
1H4	.30	6AG7M	.99	6BK7	.80	6X4	.37	12SK7GT	.63
1H5GT	.49	6AH4	.57	6BL7GT	.83	6X5GT	.37	12SL7GT	.57
1LA6	.69	6AH6	.73	6BN6	.74	6X8	.75	12SN7GT	.52
1LH4	.69	6AK5	.55	6BQ6GT	.98	7A7	.69	12SQ7GT	.56
1LN5	.59	6AK6	.59	6BQ7	.90	7A8	.68	12V6GT	.46
1N5GT	.67	6AL5	.42	6BZ7	.90	7B7	.49	12X4	.38
1R5	.62	6AM8	.78	6C4	.40	7C5	.69	14A7	.63
1S5	.51	6AQ5	.50	6CB6	.54	7C6	.59	14B6	.63
1T4	.58	6AQ6	.37	6CD6	1.11	7F7	.79	14R7	.79
1U4	.57	6AQ7	.70	6H6GT	.41	7H7	.59	19T8	.69
1U5	.50	6AR5	.45	6J5GT	.43	7N7	.69	25AV5GT	.83
1X2A	.63	6AS5	.50	6J6	.52	7Q7	.66	25BQ6GT	.98
3AU6	.46	6AS6	1.49	6K6GT	.45	7Y4	.69	25L6GT	.51
3BC5	.54	6AT6	.41	6L6	.84	12AL5	.37	35B5	.52
3BN6	.74	6AU4GT	.68	6S4	.48	12AT6	.41	35C5	.51
3CB6	.54	6AU5GT	.82	6SA7GT	.55	12AT7	.72	35L6GT	.51
3Q4	.48	6AU6	.46	6SK7GT	.53	12AU6	.46	35W4	.47
3Q5GT	.69	6AV5GT	.83	6SL7GT	.48	12AU7	.60	35Y4	.54
3S4	.58	6AV6	.40	6SN7GT	.59	12AV6	.39	35Z3	.59
3V4	.58	6AX4GT	.65	6SQ7GT	.46	12AV7	.73	35Z5GT	.47
5J6	.64	6BA6	.49	6T4	.99	12AX7	.63	50A5	.55
5T4	.79							50B5	.52
5U4G	.55							50C5	.51
5U8	.75							50L6GT	.61
5V4	.71							80	.43
5Y3GT	.37							117Z3	.37



Selenium Rectifiers Mfd. by FEDERAL

DC-Ma.	Ea.	DC-Ma.	Ea.
65	.59	250	1.39
75	.69	300	1.49
100	.79	350	1.59
150	.84	400	1.69
200	1.25	500	1.79

COMPLETE TUBE LIST OF OVER 300 TYPES IN STOCK!

TERMS: A 25% deposit must accompany all orders —balance C.O.D. All shipments F.O.B. Irvington warehouse. ORDERS UNDER \$10—\$100 HANDLING CHARGE . . . Subject to prior sale.

PLEASE: Send full remittance . . . allow for postage and save C.O.D. charges! We refund all unused money! Dept. RN-2 Phone: Essex 5-2947

Rad-Tel TUBE CO. *'Integrity Is Our Chief Asset'*
115 COIT ST., IRVINGTON II, N. J.

Another Fabulous YAGI VALUE!!

Delco Aluminum 5 Element BROADBAND Yagis
Covers Channels 2 to 6

Now only **\$6.95 ea.** Reg. \$34.50
\$6.50 ea. — lots of 3

You've never seen an antenna value as sensational as this Delco Ultra Sensitive Broadband Yagi. Will receive Channels 2 to 6 with Razor Sharp clarity at distances of 125 miles or more. Excellent front-to-back ratio helps to prevent "ghosting." Extremely simple to assemble. Complete with mounting hardware and instructions. Shpg. wt 12 lbs

Stock No. 99-B-BD56

CONCORD RADIO 53 Vesey St., N Y 7
Dept. N 2 MINIMUM ORDER \$5.00
20% deposit with C.O.D. Please send NEW 1955 CONCORD Catalog!

NAME _____
ADDRESS _____
CITY _____ ZONE _____ STATE _____

CONCORD RADIO • 53 VESEY ST. • NEW YORK 7, N. Y. • Digby 9-1132



**JUST A
SAMPLE of the
complete choice of fine
XCELITE TOOLS**



Screwdriver



Regular Slotted



Combination Detachable Screwdriver



Stubby Combination Detachable



Regular Nut Driver



Stubby Nut Driver



Hollow Shaft



No. 137 Bench Nut Driver Set



No. 99 Roll Kit Set 13 combination tools

- screwdrivers
- screwdrivers
- nut drivers with handles color-coded-to-size
- pliers
- electricians' knives
- reamers
- tool kits

**READY TO MAKE
LIFE EASIER FOR YOU!**

(Why be without 'em? Check with your supplier soon and see the **WHOLE** line!)

XCELITE, INCORPORATED
(formerly Park Metalware Co., Inc.)
Dept. E, Orchard Park, N. Y.



lamps (to insulate them from chassis contact) has been removed for photography. In use, the equipment is turned on and the lamps may be watched from a distance while other work is being done. If the circuit trouble disables the device, the lamps should be inspected to discover which is now glowing more brightly than prior to the development of the trouble. The circuit in which this lamp is connected should then be investigated further, using the methods described previously in this article.

The methods of detecting intermittents described here may also be applied to television sets and to other electrical or electronic devices; appropriate values for the fuses or lamps must, of course, be used for the circuits under examination.

Improving Audio Quality
(Continued from page 70)

In some sets, one terminal of the speaker is grounded to the chassis, as is one side of the output transformer. These grounds should be removed.

Solder two suitable lengths of wire to each speaker terminal, running one wire to the circuit ground. Attach a 20- to 30-ohm resistor to the other wire and touch it to the cathode of the first audio tube, pin 2 of the 12AT6, with the radio on and playing. If this connection results in a reduction of volume, the feedback circuit is correctly installed. If a "howl" or whistle results the feedback circuit is reversed so you must reverse the two wires attached to the speaker. It was found that 22 ohms gave just about the right amount of feedback for the circuit of Fig. 1.

It is imperative that the .01- μ fd. capacitor from the 50C5 output tube plate to "B+" be in good condition, otherwise high-frequency oscillation will result. It was found that .01 μ fd. seemed to be the minimum size necessary to prevent oscillation. The high-to-low frequency balance of the circuit can be varied by varying the capacitor. In one set modified, this unit was increased to .05 μ fd. for proper balance.

Fig. 2 illustrates the frequency response of the set diagrammed in Fig. 1, before and after the changes. The response curves were taken at a little over one-half watt output to the speaker, which is somewhat higher than normal listening level, but also a much more critical test for the circuit to meet, in view of the output transformer quality. It is interesting to note that there is a difference of 9 db at 60 cps and approximately the same improvement at the top end. Note also that the points at which the response is 3 db down before feedback are at 400 and 4000 cps; after feedback, the response at this power improves to 90 and 9000 cps.

Square waves were introduced into the circuit not only as a rough means of observing frequency response, but also as a check on listening quality in

in stock at ARROW



**Acrosound
Ultra-Linear
OUTPUT TRANSFORMERS**

- TO-330 for push pull parallel Ultra-Linear operation of KT-66 tubes. **\$39.75 net**
- TO-300 for Ultra-Linear Amplifiers. **\$24.75 net**
- TO-310 for Ultra-Linear operation of 6V6 tubes. **\$18.75 net**

FREE Audio Handbook
104 pages of down-to-earth Hi-Fi information the Audiophile should know. Plus illustrations and specifications of all quality Hi-Fi equipment. Write to Dept. R. or visit our Sound Studios for your Free copy.



**MOBILE EQUIPMENT
SPECIALS**

- Late design mobile Federal Radio-Tel. Model FT-110 and FT-125 FM transmitter units in unused clean condition. Fixed tuned for 30-44 and 150-156 mc. transmitters less cabinets, tubes and dyn. **\$ 39.50**
- Receivers mfd. in station desk type consoles grey wrinkle finish w/speakers, less tubes but w/special 8 mc. xtal **89.50**
- Several sets available w/tubes **124.50**
- New Telephonic Corp. Hand Set w/push-to-talk button and Coiled Cord, just the thing for your mobile rig. Earphone unit low impedance to match your receiver output transformer. Less hang hook. **7.95**
- With hang hook **8.95**
- Sensitive 6V Kerman Relay operates on 3-6 VDC low current SPDT **2.95**
- Heavy duty SPDT 20 amp. cont. 6V DC Relay, ideal for control of dyn. etc. **2.95**
- Philtral Mfr.
- PE-101C 6-12-24 V dynamotor. Brand new orig. factory pick. etns. **4.95**
- New mfd. Portable Vibrator Power Supply 2 volt input 180 V/40 ma. output built-in charger for 2V cell operates from 110 VAC or 6V auto bat. Connect 4 X 5 X 3 inc. wt. 3 lbs.. ideal unit to supply B power for many types equipment special **19.95**

**ELECTRONIC SPECIALTY
SUPPLY CO.**
58 Walker St., New York City 13, N. Y.

GET YOUR F.C.C. LICENSE QUICKLY!

Correspondence or residence preparation for F.C.C. examinations. Results guaranteed.
An FCC commercial operator license means greater opportunities and higher pay. We are specialists in preparing you, in a MINIMUM OF TIME, to pass FCC examinations for all classes of licenses. Beginners get 2nd class license in 5 weeks and 1st class in 3 additional weeks. Write for free booklet.
GRANTHAM SCHOOL OF ELECTRONICS
Dept. 103-E, 6064 Hollywood Blvd., Hollywood 28, Calif.

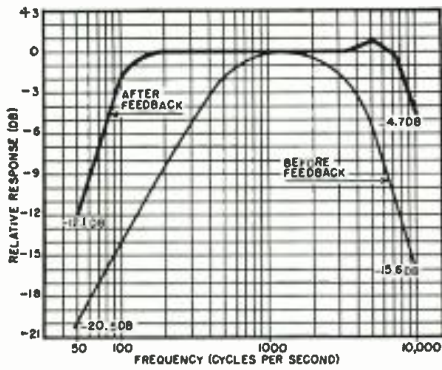

Fig. 2. The frequency response curves of the receiver in Fig. 1, before and after the feedback loop was added. The audio output of the radio was 1/2 watt.

terms of transient response. Frequencies of 100, 1000, and 5000 cps were chosen for illustration. The results of these tests are recorded in Fig. 3. It will be noticed that there is not only a great improvement in the general form of the wave at both 100 and 5000 cps, but also that the feedback has now produced some ringing which can be attributed to circuit capacities. This ringing cannot be considered a serious drawback for this circuit, and in most cases cannot be detected by the ear. An indication of this ringing can be seen from the slight peak in output on the frequency response curve in Fig. 2. The inductive load of the voice coil also tends to produce this effect.

An additional modification which may be tried is to slot and dampen the speaker cone. The method of slotting a cone is not new, and it is found that the resonant frequency can be lowered substantially by the change. It is only necessary to make cuts along the outer roll of the cone, perpendicular to the circumference, and spaced every 3/4 of an inch along the circumference. Cut only the suspension roll. The cone, along the width of these cuts in the roll, is then painted with three coats or so of rubber cement to apply some damping to its movement. This treatment, when applied to the 5-inch speaker of the set diagrammed in Fig. 1, lowered its resonant frequency response from 200 to 145 cps, a sufficient amount to warrant the change. If the speaker size can be increased or the baffle size increased or improved even with the existing speaker, considerable improvement will be noticed of course.

-30-

Fig. 3. These curves indicate the improved response of the radio to square waves and transients after modification.

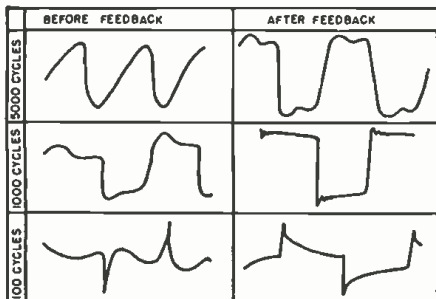

for Master TV Systems

MORE POWER

with the *Masterline*

Model MLA Line Amplifier and Model MAGC Automatic Gain Control

The MASTERLINE MLA makes more signal power available for distribution than has been possible with any single amplifier. And when used with the auxiliary, plug-in Model MAGC Automatic Gain Control, gives constant signal output on all channels received.

MORE POWER MEANS

LOWER COST—one amplifier now serves where at least two were previously required.

BETTER SIGNAL AT SET OUTLETS—fewer cascaded amplifiers for higher signal-to-noise ratio.



Masterline

AMPLIFIER Model MLA

Improved, broad-band, cascade circuit—covers all VHF channels and converted UHF.

- Gain—37 db (70 times) • Separate, variable gain controls for low and high bands • Flat response for color TV installations • Coax connectors on input and output —75 ohms.

List price . . . \$119.50

Masterline

AUTOMATIC GAIN CONTROL Model MAGC

A plug-in unit for use with the MLA. Maintains constant output signal level on all channels received.

- Positive protection against overload • Coax connectors at input and output —75 ohms • Obtains power from Model MLA.

List price . . . \$59.50

For installation and operating instructions, write Dept. BB-4

BLONDER-TONGUE LABORATORIES, INC., Westfield, N. J.

Manufacturers of TV Amplifiers, Boosters, UHF Converters, Accessories, and Originators of the Masterline and 'Add-A-Unit' Master TV Systems.



RECEIVING TUBES

THREE TOP BRANDS ONLY! AT TREMENDOUS SAVINGS OVER REGULAR WHOLESALE

EXTRA SPECIAL!! C.B.S. HYTRON

10BP4 11.95
12LP4 12.95

OTHER TUBES AVAILABLE AT SAME LOW, LOW PRICES

STUART ELECTRONICS DISTRIBUTORS

Dept. R-2 Minimum Order \$10.00
TERMS: 25% Check or Money Order, Balance C.O.D., F.O.B. New York. Satisfaction Guaranteed or money back in 10 days.

Check These BIG BARGAIN Prices Brand New Pix Tubes Full One Year Guarantee DU MONT AND R.G.A. LICENSED

With Old Tube		With Old Tube	
10BP4	11.50 11.20	16GP4	20.95 17.95
12LP4	12.95 11.95	16RP4	18.95 15.95
12LP4A	14.50 11.95	17BP4	19.95 16.95
12QP4	12.95 11.95	17CP4	20.95 18.95
14CP4	14.95 13.95	19AP4A	23.95 20.95
15AP4	15.95 14.95	20CP4	25.95 19.95
16AP4	20.95 17.95	20HP4	26.95 20.95
16CP4A	19.45 15.95	21EP4	26.95 20.95
16DP4A	17.95 15.95	21AP4	28.95 23.95
16EP4A	20.95 17.95	21FP4	27.95 21.95
16FP4	17.45 15.95	24AP4	59.95 44.95

149-09 Union Turnpike Flushing 67, N. Y.

Olympia 8-3553, 4352

**PLANNING TO BUILD A
60 WATT** ULTRA LINEAR
WILLIAMSON
AMPLIFIER
**ORDER BY MAIL
RESCO HAS THE
COMPONENTS**



Power Rating: 50 watts 20 cps. to 20 kc.; 100 watts 30 cps. to 15 kc.
Frequency Response: ± 1 db 10 cps. to 100 kc.
Application: For ultra linear operation using 4 KT66's or 807's, to deliver 60 watts, or 2 6550's to deliver 50 watts.
Shipping weight 15 lbs.

Order by mail, only **39.75** net



Complete set of four matched tubes from Great Britain's leading maker. These famous output tubes are recommended to make possible the full potential of the Ultra Linear circuit. Shipping weight 1 lb.

Set of 2 matched tubes, only **9.00** net
Set of 4 matched tubes, only **18.00** net

**RESCO MAKES IT EASY!
BUILD A 30 WATT AMPLIFIER**



Everything you need to build the finest 30 watt amplifier ever developed. RESCO's new kit has all the components including punched chassis and the easiest-to-follow instructions and diagrams you've ever seen. Acclaimed by hundreds of satisfied customers. Shipping weight 25 lbs.

A RESCO exclusive, only **74.50** net



Power Rating: 20 watts 20 cps. to 30 kc.; 40 watts 30 cps. to 20 kc.
Frequency Response: ± 1 db. 10 cps to 100 kc.
Application: For use with 2 KT66's, 807's or 5881's. Shipping weight 7 lbs.
Order from RESCO, only **24.75** net

Write for free hi-fi catalog and spec. sheets

ORDER BY MAIL

Send check or M.O. Include postage.



RADIO-TV Service Industry News

AS REPORTED BY THE
TELEVISION TECHNICIANS LECTURE BUREAU

A LARGE NUMBER of letters from readers to the editors of this department come from technicians who are planning to start their own full-time service businesses. The most commonly asked questions in these requests for information are: (1) What are the charges that service businesses make for various types of TV and radio repairs; (2) Have service operations on TV sets been standardized (along the line of automobile repairs) to provide a uniform pattern for itemizing the various services that might be required in repairing a TV set; (3) Is it better to start a service shop on a part-time basis or go into it immediately as a full-time activity; (4) Is a business location preferable to operating a service business from your home; and (5) What are the minimum investment requirements for stock and test equipment for a new full-time service business.

It has been interesting to observe from these letters that technicians who are planning to start their own service businesses never ask a question about the most important and fundamental factor that underlies the success or failure of any business. That factor is the maintenance of a uniform volume of business that will provide enough profit to pay all costs of operating the business and give the owner a better income than he could get by working for someone else plus a fair return on his investment. Any business, regardless of whether it is selling goods or services, has a major problem to keep its volume of business above the "break-even" point. This factor should be one of deep concern to every man who starts a new business.

Recently an executive of a large appliance manufacturing concern made the remark that "Big business is getting bigger and little business is getting smaller." During the past two years the mortality rate among small businesses, particularly the so-called one-man type engaged in all types of activity, has increased steadily. A study of the factors involved in these disclosures indicates that it is a normal development brought about by current economic conditions together with a steady shift in the buying habits of the public.

While space does not permit a broad discussion of the forces at work that have brought about these pressures, the elements that affect one- and two-man electronic service shops can be identified and explained. The increasingly complex problems involved in selling either products or services to the general public and the high costs of operating—and making a living—place a heavy burden on the shoulders of the individual who is trying to carry the entire weight of the business.

There are many very small service shops, of course, that have been operating in the same location since the radio service days of the nineteen thirties that continue to do all right. However, these businesses were started during a period when it was possible to start a radio service business on a "shoe-string." The five-tube table model a.c.-d.c. sets that made up eighty per cent of the service volume were easy to transport and owners thought nothing of dropping them off at a service shop for repairs. A versatile technician who knew how to maintain good customer relations would pick up income from servicing a wide variety of electronic devices like p. a. systems, auto radios, battery portables, etc. The business became known to thousands of set owners down through the years and when television came along these established shops were able to take on as much of the available video service as they felt capable of handling.

These established small service shops, however, are not a criterion of what technicians can do in today's market. The new shop today must make itself known to thousands of television set owners in a short period of time. It must have dependable transportation facilities, a substantial amount of test equipment, and a good inventory of replacement tubes, parts, and supplies. Further, and vitally important, it must operate on a system that will permit the owner-technician to spend a maximum amount of his time in productive work.

During the thirties, it was not uncommon for the average radio service dealer to spend most of the daytime hours promoting business and handling whatever commercial and industrial

work on sound equipment he had to do while the businesses were open. Then he would close his shop at six and spend four or five hours earning the bread-and-butter income of the business. These evening hours would be spent at the work bench repairing the a.c.-d.c. sets that had been brought to the shop for repairs.

Since eighty per-cent of the television service is performed in the homes, the operator of a new service business faces the very serious problem of getting enough calls for service every day to provide at least the minimum income necessary to meet his business and personal obligations. If *all* of the actual costs of operating are not earned by the volume of business handled, the service technician becomes so involved financially within a matter of six months or less that he finds it impossible to continue to operate.

Financing a New Service Business

Most small businesses are started on the false premise that if there is enough money or credit available to open a shop, put up a few signs, and get a telephone directory listing, enough business can be promoted during the first month to make the activity self-supporting. The money consuming factors that are involved in the operation of any business in today's economy are seldom appraised realistically by the people who optimistically start small business enterprises.

A TV service technician may have the required technical know-how, management ability, and basic experience, but he must have enough money at the outset if he is to be successful in starting his own service business. Of course, there are the exceptional individuals who do start on a "shoestring" and build successful businesses. But statistics of the United States Department of Commerce show that one out of every three business failures are due to lack of adequate capital.

A bank will not usually lend money to any businessman not already properly financed with equity capital. If the embryonic service business operator is unable to supply a certain amount of risk capital from his own savings, he will be sadly mistaken if he expects to borrow from a bank or hopes to get long-term credit from manufacturers, distributors, and jobbers.

Every business must observe certain fundamental principles if it is to survive in a competitive world. One of the most basic principles is that the amount of capital representing fixed assets such as testing equipment, car or truck, fixtures, working inventory, etc., and working capital needed permanently should be furnished by the proprietor of the business. It should be pointed out, too, that if the car or truck to be used in the business is being financed, the monthly payments will be an immediate burden on the business. The funds required for this essential equipment are the initial cap-

IRE National Convention

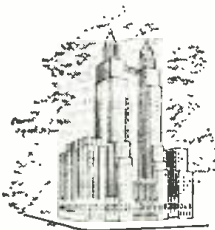

and

Radio Engineering Show



At both the Waldorf-Astoria (convention headquarters) and Kingsbridge Armory, you'll attend what actually amounts to 22 conventions fused into one. Hundreds of scientific and engineering papers will be presented during the many technical sessions, a large number of which are organized by IRE professional groups. You'll meet with the industry's leaders—enjoy the finest meeting and recreational facilities in New York.

At the Kingsbridge Armory and Kingsbridge Palace, you'll walk through a vast panorama of over 700 exhibits, displaying the latest and the newest in radio-electronics. You'll talk shop with the industry's top manufacturers—enjoy the conveniences provided for you in the world's finest exhibition halls, easily reached by subway and special bus service.

Admission by registration only. \$1.00 for IRE members, \$3.00 for non-members. Social events extra.



The Institute of Radio Engineers
1 East 79 Street, New York

WORLD'S LARGEST MANUFACTURER
OF CUSTOM BUILT TELEVISION

MATTISON

SILVER ROCKET 630 CHASSIS
• with TUNEABLE •

BUILT-IN BOOSTER
for Better DX Reception

Featuring Syncromatic Tuning

Tube
Complement:
28 tubes
3 rectifiers
1 CRT

Select Your
Channel . . .
SOUND IS
AUTOMATIC!

32



Tuneable Booster

• Broad band single knob control pre-amplifier built in to eliminate long leads which may cause regeneration and attenuation of signal.

• ONLY THE MATTISON 630 CHASSIS HAS AN ALL CHANNEL TUNEABLE BUILT-IN BOOSTER THAT INCREASES SIGNAL STRENGTH UP TO 10 TIMES.

Also Available The World Reknown

• MATTISON 630 SILVER ROCKET CHASSIS without built-in booster.

• MATTISON 630 SILVER ROCKET CHASSIS with BUILT-IN UHF TUNER

ALL CABINETS MADE IN MATTISON'S OWN CABINET FACTORY. AVAILABLE IN EVERY FINISH AND STYLE. WRITE FOR COMPLETE CATALOG.

DEALERS! SERVICE MEN! . . . FREE!! Write for Mattison's merchandising portfolio explaining the "UNASSEMBLED PLAN" and "\$1,000,000 FLOOR PLAN."



When you buy from Mattison you need only one source of supply! You can buy a Mattison Chassis, a Mattison Cabinet or a complete Mattison TV Set!

Manufactured with integrity

Mattison Television & Radio Corp.
10 West 181st St., Dept. RN, N. Y. 53, N. Y.

GET INTO ELECTRONICS



You can enter this uncrowded, interesting field. Defense expansion, new developments demand trained specialists. Study all phases radio & electronics theory and practice: TV; FM; broadcasting; servicing; aviation, marine, police radio. 18-month course. Prepare for good pay. Graduates in demand by major companies. High School or equivalent required. Begin Jan., March, June, Sept. Campus life. Write for catalog.

VALPARAISO TECHNICAL INSTITUTE
Dept. RD Valparaiso, Indiana

ital requirements. The available capital must be in excess of this initial capital because it may be several months before income exceeds outgo.

During the first several months after a service business is newly started the owner will need sufficient working capital to:

1. Pay his own living expenses
2. Buy tubes, parts, and supplies
3. Take advantage of discounts offered
4. Pay the landlord
5. Pay telephone bills and all other operating expenses
6. Provide a "cushion" to withstand a dull summer or a temporary slump in business

All too often a competent service technician will give up a good job to start a service business of his own without fully appraising the terrific expense burden he is assuming as an independent business operator. The following list represents the income-consuming items that make up the operating expenses of any electronic service business:

1. Auto expenses: operating, maintenance, and depreciation.
2. Insurance: auto liability, auto fire and theft, liability for damage to property in customers' homes, liability for various hazards in shop location, and fire and theft of stock and equipment.
3. Rent.
4. Depreciation: shop equipment, furniture, and fixtures.
5. Electricity, heat, and telephone.
6. Stationery, printing, and postage.
7. Advertising.
8. Local, state, and federal taxes.

These expenses will range from 18% to 50% of the gross income of the business depending upon the service volume accomplished, ratio of shop work to field service income, location of shop, etc. They are part of the machinery of a business and a heavy burden for one man to carry by himself. Since most of these operating expenses would not be increased appreciably for a three- or five-man service company, it adds up that the one-man shop is at a serious competitive disadvantage to the shops that have developed enough volume to support the activities of from three to five men.

Business Promotion

The basic advantage a multiple-man service company has is that it frees the manager from most of the routine technical work and permits him to give concentrated attention to the problems of selling the company's facilities. Dealer contacts are vitally important. A high percentage of the retail establishments that sell radio and TV sets do not employ technical help. They rely on specializing service shops to handle in-warranty service and when experience teaches them that they are working with a technically competent service company, they make their out-of-warranty service referrals to that company.

Dealer service can be developed and maintained only through frequent contacts with non-servicing dealers. The

one-man service shop operator, who is hard-pressed for time to accomplish income-producing work, finds it difficult to maintain these essential dealer contacts.

The conventional advertising programs of small shops consists of a listing in the classified section of the telephone directory and perhaps a small ad in a local or community newspaper. While there is nothing wrong with this type of promotion, the volume and character of business that is developed from these media is highly questionable. There are fringe service customers just as there are fringe service shops and technicians. The fringe service customer is the one who constantly shops to buy service at a price. They are hard people to satisfy and are the users who wear heavily on the nerves of the technicians who handle their service work.

The service companies that built mailing lists of their service customers from the in-warranty service they handled for dealers derive a high percentage of their C.O.D. business from their continual contact by mail with these set owners. As established service companies add to their services to handle AM radio, air conditioning, and other home appliances, they continually entrench themselves with the better type of customers. This makes it difficult for a new TV service business to break into the business satisfactorily handled by established service companies.

Perhaps the worst fallacy in the reasoning of most men who get into the electronic service business is that they can provide service at a lower cost than the larger, established service shops, and still pay all of their operating expenses and take out a good income for themselves. Of course, there are many foolish technicians who advertise service calls at a low charge and then make up the difference in padded parts charges. A man can get away with unscrupulous practices like that for a while but sooner or later his customers will catch up with his machinations. These practices do not provide a sound basis on which to build a permanent, growing business and the men who engage in them eventually quietly pass out of the service picture completely.

A careful study of the actual costs of operating a service business will show clearly that one man working alone will have to get more money for his time (a higher rate per call) than a five-man service company if he expects to take an income from the business comparable to that earned by the men in the larger and busier television service company.

It is obvious that the education of the set-owning public about what constitutes fair and adequate labor charges for competent technical service is primarily a responsibility of the men who operate service businesses. It is the independent service shop that stands to gain most by the general acceptance of the philosophy that capable service cannot be cheap service.

RADIO & TELEVISION NEWS

The standard operational and labor charges charts for television, radio, and phono service have been very helpful to service people in all sections of the country by giving them a pattern for determining adequate charges and one which could be explained to service customers. The service operations they set up reflect the pattern used by hundreds of service shops. The charges for the various operations are national averages to be used as a guide in checking the adequacy of charges in any locality where an electronic service shop is located. Such charts are available to readers of RADIO & TELEVISION NEWS for \$1.00. —30—

UNIQUE B.F.O. ADDITION

By CLYDE ADAMS

AFTER several weeks of listening to short-wave signals on my little table model Emerson 729 to which hand-wound coils had been added, I decided on the addition of a b.f.o. in order to receive c.w. signals.

When the chassis of the little set was pulled from the cabinet I knew right then that it was impossible to even think of having the pleasure of receiving code on the set. There was barely enough room on the chassis for the 5-tubes without adding another tube, socket, and other required parts. The underneath of the chassis was as crowded as the top and nowhere could a coil be squeezed in.

After several days of brooding my hopes soared when I ran across a schematic of a set, made by a well-known manufacturer, incorporating a novel b.f.o. arrangement whereby no tube, coil, or control is used. This circuit was tried on the Emerson and worked perfectly. Experimenters will be interested in this b.f.o. addition and the circuit shown in Fig. 1 is for your benefit.

Shown in the circuit is the i.f. stage of present-day midgets. Only a single 470-ohm resistor and s.p.d.t. switch are needed for c.w. signals. The capacitors C_1 and C_2 can either be $1 \mu\mu\text{fd.}$ ceramic units or two or three turns of wire wrapped around the leads to plate and grid of the 12BA6 i.f. tube.

When the switch is in the "c.w." position, the i.f. amplifier oscillates because of feedback from plate to grid through capacitors C_1 and C_2 . The a.v.c. line is grounded through the cathode resistor to prevent the oscillations from increasing the a.v.c. voltage and reducing the gain of the set. In the "phone" position, C_1 and C_2 are grounded so that the set will operate normally. The switch on my set was mounted on the back of the set alongside the s.w. coils. The circuit works fine especially on the ham bands. Try it!

—30—

Fig. 1. The i.f. stage of a present-day midget set showing parts added for c.w. use.

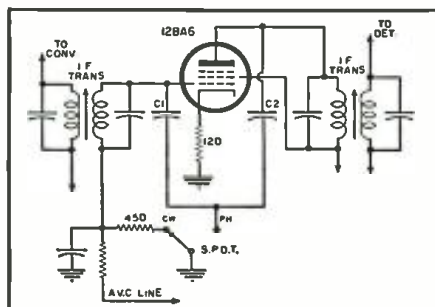

February, 1955

ELECTRICAL ENGINEERS

or

PHYSICS GRADUATES

with experience in

RADAR or ELECTRONICS

or those desiring to enter these areas...

The time was never more opportune than now for becoming associated with the field of advanced electronics.

Because of military emphasis this is the most rapidly growing and promising sphere of endeavor for the young electrical engineer or physicist.

Since 1948 Hughes Research and Development Laboratories have been engaged in an expanding program for design, development and manufacture of highly complex radar fire control systems for fighter and interceptor aircraft. This requires Hughes technical advisors in the field to serve companies and military agencies employing the equipment.

As one of these field engineers you will become familiar with the entire systems in-

involved, including the most advanced electronic computers. With this advantage you will be ideally situated to broaden your experience and learning more quickly for future application to advanced electronics activity in either the military or the commercial field.

Positions are available in the continental United States for married and single men under 35 years of age. Overseas assignments are open to single men only.



Hughes Field Engineer H. Heaton Barker (right) discusses operation of fire control system with Royal Canadian Air Force technicians. Avro Canada CF-100 shown at right.

Relocation of applicant: must not cause disruption of an urgent military project.



Scientific
and
Engineering
Staff

HUGHES

RESEARCH
AND
DEVELOPMENT
LABORATORIES

Culver City,
Los Angeles
County,
California

BUY-OF-THE-MONTH!! SCR-522 TRANSMITTER

less freq. shifter & tubes, but contains most all other component parts—such as transformers, relays, coils, cond., resistors and other valuable parts. **SPECIALLY PRICED.....\$6.95**

SAVE! SCR-522 RECEIVERS

less oscillator assembly, frequency shifter and tubes. Contains all coils, transformers, resistors, condensers and other valuable parts. each **\$4.95**
SPECIAL! 2 for \$8.00

TUBES 60% TO 90% OFF LIST!

SPECIAL-OF-THE-MONTH! 12L8-20c ea. 6 for \$1.00 Same as 1644 tube.			
1832.....	.98	15R.....	.35
2822.....	.29	39/44.....	.19
2C22.....	.09	114B.....	.19
2C26.....	.09	211.....	.75
2C26A.....	.09	215A.....	.09
3822.....	.89	221A.....	.19
306.....	.29	316A.....	.19
3FP7.....	1.99	386A.....	.49
3HP7.....	2.95	471A.....	.99
6J5.....	.49	532A.....	.99
7C4.....	.29	722A.....	.79
12L8.....	.20	836.....	3.50
837.....	.99	841.....	.19
843.....	.19	864.....	.19
955.....	.39	7193.....	.19
1626.....	.19	E1148.....	.39
GL471A.....	1.49	HY615.....	.11
RK34.....	.79	VT127.....	.09

PRICES SLASHED!!

HS-33 HEADSET used.....	\$1.49
ENGLISH TYPE, TL-55.....	.10
FL-5 RADIO FILTER used.....	.49
CR-1A/AR CRYSTAL 9036.25KC. 8001.43KC.....	.49
8258.57KC—Brand New.....	each .49
BC-434 Control Box.....	New 3.95

CHECK OUR NEW LOWER PRICES!

SCR-274N COMMAND and ARC-5 EQUIPMENT RECEIVERS

	USED	EXCELLENT USED	NEW
BC-453—190 to 550 KC.....		\$19.95	\$39.95
BC-454—3 to 6 MC.....		12.95	19.95
BC-455—6 to 9 MC.....		9.95	17.95
1.5 to 3.....		19.95	

TRANSMITTERS

A-95A—2.1 to 3 MC.....		24.95
BC-457—4 to 5.3 MC.....		12.95
BC-458—3 to 7 MC.....	\$7.95	11.95
BC-459—7 to 9.1 MC.....		19.95
T-15 ARC 5—500 to 800 KC.....		19.95

ADDITIONAL EQUIPMENT

BC-456 Modulator.....		4.95
BC-450 Control Box (3 Receiver).....		2.75
BC-451 Control Box (Transmitter).....	.99	1.49
BC-442 Relay Unit (ANT).....		4.95
Flexible Shafting with gear to fit receivers.....		1.75
3 Receiver Rack.....	1.49	1.99
Shock Mount for Receiver Rack.....		2.75
2 Transmitter Rack.....	.99	
Single Transmitter Rack.....		3.49
DM-33 Dynamotor for Conn. and Set.....		2.99
		3.95

BC-706 IMPACT SWITCHBOX—A Sensational Buy..... each **39c**

HEADSETS

HS-23 high impedance, BRAND NEW with ear pads.....	\$4.65
HS-33 low impedance, BRAND NEW with ear pads, cord and PL54 plug.....	5.65
CD-307A Cords, 6 ft.....	1.10
HS-16 high impedance—used.....	.98

MICROPHONE SUPER-SALE

T-44 MIKE—magnetic type consisting of Mike Unit MC-253, Cord CO-287, Plug PL-179 and Jack JK-20.....	\$1.00
T-45 MIKE—Carbon 1 in. Mike, Navy Type.....	2.00
T-17 MIKE—Carbon—Excellent Cond.....	6.95

Field Telephones

Army surplus, completely reconditioned and electrically tested using 2 flashlight cells and a pair of interconnecting wires, GUARANTEED LIKE NEW

\$19.95

J37..... \$.99
J41..... .99
J45..... 2.99

TELEGRAPH KEYS



Servicing Color TV (Continued from page 51)

follows it. Hence, no 3.58-mc. oscillations would be generated, either. The complete color section would be totally isolated from the incoming signals.

Consider now the circuit shown in Fig. 6. The first chroma amplifier, which is the bandpass stage, receives its signals from the video cathode follower and serves only to forward the color sidebands to the I and Q demodulators. The burst amplifier obtains its signals separately from the video cathode follower. Thus, the burst amplifier would not ordinarily be affected by any failure in the bandpass stage. This means that the 3.58-mc. ringing circuit would be suitably triggered and 3.58-mc. oscillations would be developed and forwarded to the I and Q demodulators. Also, since the color killer circuit is associated with the 3.58-mc. limiter, it, too, would be activated, leading to the removal of its cut-off bias from the two color demodulator stages. All we need, then, to produce colored confetti on the screen are noise or other extraneous voltages either in the second chroma amplifier circuit or in the grid circuit of the demodulators. It is quite possible that under these conditions this will happen.

Thus, whether a defective bandpass amplifier leads to a colorless picture or one which has random color, depends upon the relationship between the color sync section and the chrominance section.

A defective color killer can also be the cause of no color in a picture. If the killer cut-off bias is on at all times, irrespective of whether or not color burst signals are being received, then no signals will pass through the chrominance section and none will reach the picture tube. It is also true that if the receiver employs a separate detector for the color portion of the signal, as the circuit of Fig. 7 does, any failure here would likewise result in no color. This same set also has a germanium detector for the Y signal and consequently, this signal would appear on the screen.

Thus far, we have covered the troubles that may cause a poor black-and-white picture to appear on a color TV receiver screen and the troubles that would cause no picture or an incorrect raster. This article covered also, some of the causes of an incorrect color picture. Despite the trouble, however, it is interesting to note that our servicing procedure is much like what we use for monochrome set servicing, i.e., we are using the picture tube as our primary trouble indicator.

Next month's article will conclude this series. (To be continued)

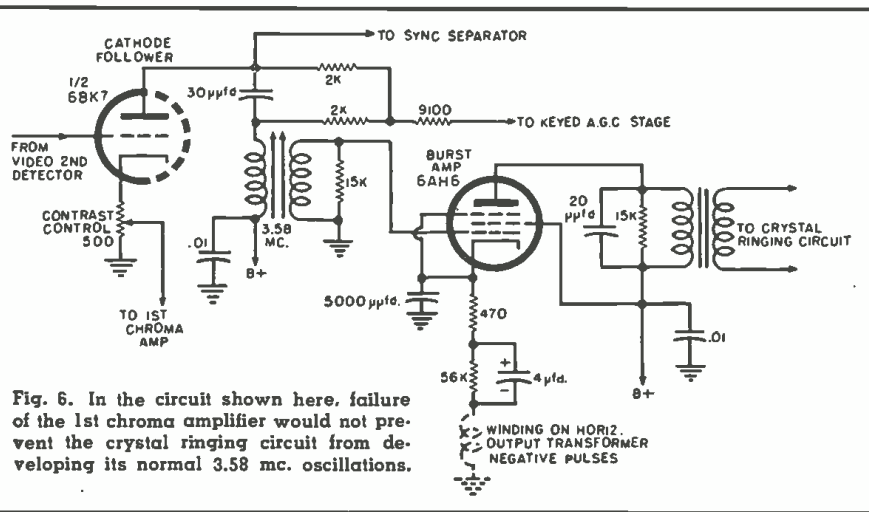
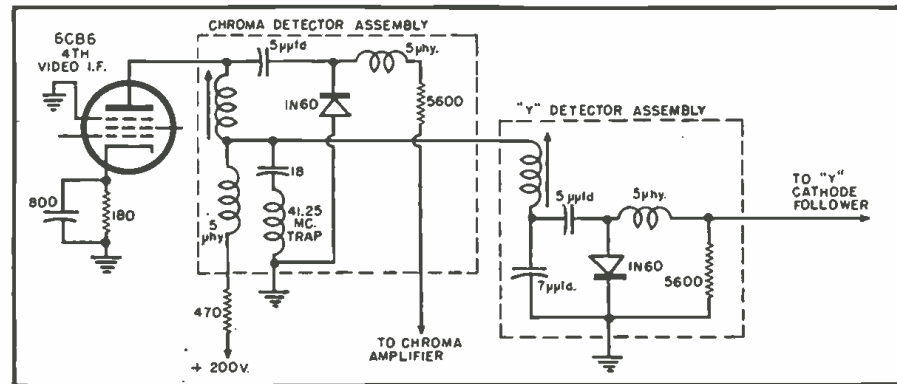

Fig. 6. In the circuit shown here, failure of the 1st chroma amplifier would not prevent the crystal ringing circuit from developing its normal 3.58 mc. oscillations.

Fig. 7. Any failure of the chroma germanium crystal in this circuit would remove color from the picture, but would not affect the monochrome presentation.



BC-221 Frequency Meier
Real Value! QUANTITY IS LIMITED
—so first come, first served. They are just like new, with original calibration charts. Range 125-20,000 KC with crystal check points in all ranges. Comes with crystal and tubes..... **\$139.50**
Standard with AC power supply..... \$159.50
MODULATED TYPE..... \$179.50
MODULATED TYPE with AC Power Supply..... \$199.50
Limited quantity of BRAND NEW MODULATED FRQ. METERS..... \$210.00
These Frequency Meters are factory treated, checked for frequency alignment and GUARANTEED.

MINIMUM ORDER \$2.00

Immediate delivery—send 25% deposit on C.O.D. orders. If sending full remittance, allow for postage and save C.O.D. charges. All shipments F.O.B., N.Y.C. warehouse. (N.Y.C. residents add sales tax.)

PLATT ELECTRONICS CORP.

Dept. A, 125 West 17th St., N. Y. 11, N. Y.
PHONE: CHelsea 2-1100

A.... Always
B.... Buy
C.... Columbia

PE-55 DYNAMOTOR
 12 V. Input; 500 V. output @ 200 mls. WITH filter box & relays. Excel. cond. \$25.50

4-CHANNEL PUSH-BUTTON FRONT END, P/O HC-728 Receiver, 2-G MC. Makes swell Walkie-Talkie base. New, \$99 ea.; 2 for \$1.69
 NEW T-17-B BATTERY: EA. \$7.50
 Excellent. Used Ea. \$3.95

TV TUNER
 Continuous tuning. Channels: 2-13. 54-216 MC. Ideal 2 meter converter, etc. Good cond. WITH FULL SCHEMATIC 3 for \$1.25

FEIN TICS EDWARD TRANSMITTER 2-3 MC. Great for conversion to 75 or 80 meters. Excellent condition \$8.95

ARC-5 3-6 MC RECEIVER
 Fine for aircraft, 75 and 80 meters. Clean checked out. Ea. \$7.95

MELLOY CODE MACHINE: Complete with wheel and perforator. New in overseas pack. 3-piece set. \$19.95

TC-10 CODE KEYS: Push-pull 610 amplifier, vacuum shield. Complete with tubes and key. Approx. wt. 65 lbs. Excellent cond. 14.95

TC-34 CODE KEYS: Used. 14.95

DUAL VOLTAGE GENERATOR
 Operates @ 2700 rpm. Output voltage 14 VDC @ 25 amps. 1,000 VDC @ 120 rpm. New in overseas pack. \$14.95

R-150 CRW RECEIVER: 65-92 MC. Complete with all tubes, dynamotor and 10,000 ohm relay. New, boxed. 4.95

I-83 DYNAMOTOR TEST SET
 12 or 24 V. Has 5 matched 3" meters; 2 of which are sensitive; one is 100 microamp, the other MA. 0-75 VDC; 0-2 VAC; 0-10 AMP DC; 0-200 VDC; 0-250 MA DC. Plus good variety of switches and other components. Excellent condition. LOW PRICE. SPECIAL. \$14.95

J-38 TELEGRAPH KEY: New, boxed. Ea. \$5.49

SPARK PLUG SUPPRESSORS FOR YOUR MOBILE RIG: 6 for 75c; 8 for \$1.00
 Continental 10 000 wire wound

COMMUNICATIONS RECEIVER
 Model AHB. Freq. range: 100-050 Kc. Complete with al. tubes but less 24 V. dyn. Excel. cond. \$18.95

OHMITE RHEOSTAT MODEL "K": 100 W. 500 ohm. New, boxed. \$1.49

TRANSFORMERS
 New! Boxed: 110 V. 60 cycle.
 375-0-375 @ 250 ma. 5 V. @ 4 amps. 1-3 V. @ 5 amp. \$4.95
 6-3 V. CT @ 5 amp. \$4.95

TUBE TESTER PLATE & FILAMENT TRANSFORMER: Used in I-177. Multi-tapped for all voltages. \$3.95

VIBRATOR TRANSFORMER: 6-12-24 V. with 200 cycle vibrator. 120 V. @ 150 ma; 120 V. @ 150 Ma; 4-60 ma 98c

RT-48/TPX-1 TRANSMITTER-RECEIVER
 Makes hottest 2-METER RECEIVER in the country! 150-190 MC. 17 tubes. Contains HF mixer, HF-HF adjustment for peak video receiver oscillator. Like new in carrying case, with schematic. \$12.95

TOP-\$\$\$ BUYS IN METERS!
HALLICRAFTERS "S" CARRIER LEVEL METER: 3" round. 0-5 mil. basic movement. DB over 80. New, boxed. \$5.95

SIMPSON METER: 3" round. 0-15 mil. New, boxed. \$3.95

0-2 AMPS. DC: 2" round. New. \$2.95 boxed

NEW BULLETIN! GET YOUR FREE COPY
NOTE: All items subject to prior sale and change of price without notice. 2 1/2% deposit required on A.L. orders. balance C.O.D. Minimum order: \$2.00.
 SEND FOR NEW PRICE CATALOGUE!

Columbia ELECTRONICS
 2251 W. WASHINGTON BLVD.
 LOS ANGELES 18, CALIFORNIA

FOR The Finest MASTER AMPLIFIED AND COMMUNITY TV ANTENNA SYSTEMS-

- Send Us Your Problem for FREE Engineering Advice.

FREE: Important Technical Manual for Community and Master TV Systems

FIELD STRENGTH METER, operates both on Battery and AC . . . \$89.

Write today for:
TRANSVISION, INC. NEW ROCHELLE, N. Y.

"Universal" Counter
 (Continued from page 55)

prefers to solder the transistor directly into the circuit, he should exercise special care to avoid overheating this component. Do not cut the leads any shorter than necessary, and complete the soldering as quickly as possible.

Assembling the Accessories

The versatility of the "universal" counter depends not only on the counter circuit proper, but on the choice and use of various accessory "control" units. While the number of possible accessory control units is limited only by the imagination and requirements of the individual user, the group of four shown with the counter in Fig. 1 should give the reader some idea of the possibilities.

Reading from left-to-right, the accessories shown in Fig. 1 are as follows: (a) selenium photocell, (b) mercury switch, (c) "Microswitch," and (d) push-button switch.

The photocell is typical of a current generating type of accessory and is equipped with a phone plug to fit in the proper "control line" jack (J₁). The selenium cell used is of the type employed in exposure meters. It has been mounted in a small plastic box. The connections for the photocell are given in Fig. 5.

The other three accessories are typical of "simple switch" controls. Each has been equipped with a short flexible line and spade lugs, for easy connection to the screw-type "A" terminals (see Fig. 3).

Typical applications of these accessories will be discussed later.

Adjustment and Operation

Once the wiring is completed and checked, the counter may be tested for proper operation. The first step, however, is to identify the various screw-terminals on the back panel. The connections used in the author's model are apparent when Figs. 2, 3, and 6 are compared.

Without plugging the line-cord into a wall socket, turn the instrument "on." Next, with R₂ set in its maximum resistance position, temporarily short out the "A" terminals (Fig. 3). Gradually adjust R₂ until the relay (RL₁) clicks as it is pulled in. Remove the short from the "A" terminals and the relay armature should drop out.

If the outlined action is not obtained as each step is carried out, it indicates either a defective part in the

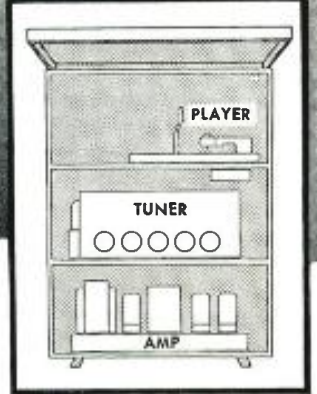

NEW 3-in-1 CONSOLETTA lowers HI-FI cost

At last—the answer to the question, "Where do I put the components?" Its low cost delights everyone. Takes all components—any make or model—as desired.

Also matching cabinets for speakers. Ask wherever high fidelity equipment is sold, or write direct for catalog.

Fig. 5. How the photocell, one of the accessories, can be connected to counter.

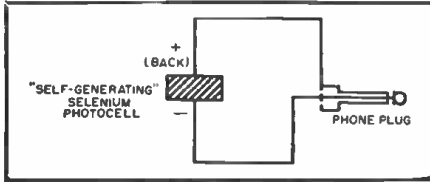

ARGOS PRODUCTS COMPANY
 10 MAIN STREET - GENOA, ILLINOIS
Craftsmanship in Cabinets



QUIETROLE
Reg. U. S. Pat. Off.
The ORIGINAL
NON-INFLAMMABLE
NON-CONDUCTIVE
LUBRICANT CLEANER



CONTROLS & SWITCHES like new by the BASKETFUL for only a few PENNIES . . . that's what QUIETROLE can do for you, and only QUIETROLE will give that long lasting smooth, quiet operation . . . even new controls last longer and operate quieter when treated with QUIETROLE . . . the original and most reliable product of its kind.

THE CHOICE OF BETTER SERVICEMEN "EVERYWHERE"
Supplied in 2, 4, and 8 oz. sizes. Ask for it at your distributor.

manufactured by



QUIETROLE
COMPANY
Spartanburg, South Carolina

Cash in on Color!

Exclusive Details on RCA 21" Color Set Revealed for First Time in

ELEMENTS of TELEVISION SERVICING

By Abraham Marcus (co-author of famous "Elements of Radio" which has sold over 1,000,000 copies) and Samuel E. Gendler.

Gives New Money-Making Tips, Time-Saving Methods of TV Repair and Servicing. Covers in Detail all Phases of Black-and-White and Color Installations!

In 544 pages—packed with diagrams, tables, charts, circuitry—this clearly-written book wraps up the whole subject of TV servicing so that anyone can make money in it! You see how to rig an antenna quickly . . . how to cure picture troubles fast . . . valuable service hints . . . how to trouble-shoot . . . how to get and keep customers . . . tips for profitable bench servicing . . . and many more. COLOR CHAPTERS ALONE ARE WORTH MANY TIMES PRICE OF BOOK: Color TV theory . . . color transmission . . . components of color receiver explained . . . comparison of color and Black-and-White systems . . . blueprint of color picture tubes.

USE 10 DAYS FREE! Coupon below brings you "Elements of TV Servicing" on FREE trial for 10 days, without obligation. But you must mail now! Offer Limited!

Prentice-Hall, Inc., Dept. M-RTN-255
Englewood Cliffs, N. J.

Send me for 10 DAYS' FREE TRIAL "Elements of TV Servicing." I will return it in 10 days and pay nothing—or keep it and send \$7.35 (plus small postage).

Name

Address

City.....Zone... State.....

SAVE! Send \$7.35 with coupon, we'll pay postage & handling! Same return privilege.

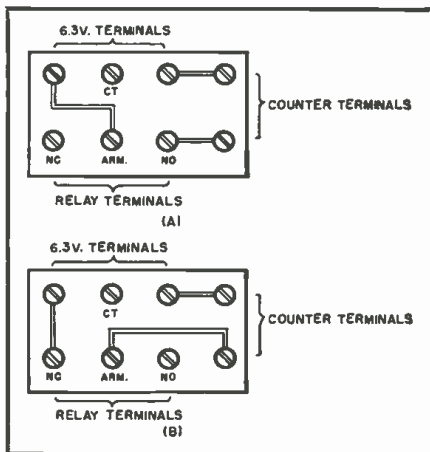

Fig. 6. Two ways of connecting the electromagnetic counter: (A) if relay is normally held open. (B) relay normally closed.

circuit or an error in wiring. Carefully recheck all connections and parts.

Once the relay circuit is operating properly, the rest of the counter may be checked. This will require connecting the electromagnetic counter, the 6-volt a.c. power source, and the relay circuit together properly. Use the relay contacts to switch the a.c. voltage so that it is applied to the electromagnetic counter whenever a counting operation is to take place.

Two connections are possible, and both are illustrated in Fig. 6. If the relay is normally to be held open, and to close for each count, the armature (Arm.) and "normally open" (NO) contacts are used. This connection is shown in Figs. 2 and 6A.

A typical example where this connection might be employed is where a s.p.s.t. push-button switch is connected across the "control line" ("A" terminals), with a count being registered each time the button is depressed and released.

On the other hand, if the relay is normally to be held closed, and to open for each count, the armature (Arm.) and "normally closed" (NC) contacts are used. This connection is shown in Fig. 6B.

An example of the second case is where the photocell accessory is used to count the number of objects moving along an industrial assembly line. The photocell is plugged into the J_1 jack and set up on one side of the line. A good light source is arranged on the other side of the line so as to strike the photocell.

Under such conditions, the relay is pulled in and held in until a moving object interrupts the light beam, allowing the relay to drop out and register a count.

A minor circuit modification: The electromagnetic counter used is also available with a 115-volt coil. If the builder prefers to use the 115-volt unit, the transformer (T_1) may be omitted from the circuit. The pilot light may then either be left out or a 115-volt unit used instead.

Should the builder decide to use a 115-volt coil, a cover should be ar-

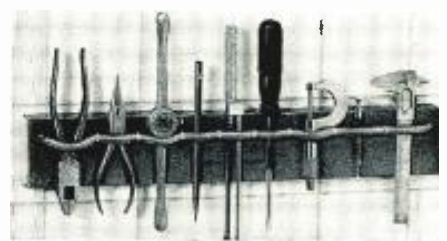

GRIP-R tool and utensil holder

Holds Anything With or Without Handles
RadioMen, Machinists, Hobbyists, Supply Stores
Flexible spring with adjustable clips—grips tools of various sizes and shapes, with or without handles. Holds smallest drill, bits or taps. Keeps your valuable tools from getting lost by rolling off bench. GRIP-R will pay for itself in no time at all. Will not magnetize your tools. Made for fast manipulation—for work bench, table, wall, or may be mounted in series. Finished in baked hammered enamel.
Size: 18" x 2 3/4" wide. Price each \$1.29 shipped prepaid. Money Back Guarantee.

SEARLE OF CHICAGO Dept.
RT-1
216 West Jackson Blvd., Chicago 6, Ill.

TEST EQUIPMENT REPAIRED

Contractors to U. S. Government
Repairs and calibration by skilled craftsmen on all makes of Meters, Testers, Sig. Gen., V. T. V. M's, Scopes. Our nineteenth year. Low Factory prices. Stock of genuine parts. Prompt service. All work guaranteed. Write for estimate—or ship P.P. Ins. to:

DOUGLAS INSTRUMENT LABORATORY
Electronic Instrument Repairers
176 Norfolk Avenue Boston 19, Mass.

SAVE MONEY.. MAKE MONEY..

LEARN TV

the practical way..

17", 21" and 27"
ASSEMBLE A
TRANSVISION
TV KIT
Pay as You Wire \$39

WE WILL HELP YOU to start learning TV the practical way—by assembling a TRANSVISION TV KIT in EASY STAGES. For only \$39 you get PACKAGE #1 (standard first pks. for all of our kits). This package gives you the BASIC CHASSIS and over 450 TV COMPONENTS with complete instructions, Drawings, Photos, and Service Booklet. When ready, you order the next stage (pkg. #2), etc. Low prices make your complete kit a terrific buy.



Shows 6 Great TV Kits:

EXCLUSIVE: Only Transvision TV Kits are adaptable to D.H.F. Ideal for FRINGE AREAS. No Previous Technical Knowledge required. Write now!

FREE CATALOG TRANSVISION
THE CHEAPEST LEARNING TV KIT

NEW ROCHELLE, N. Y.

MAIL THIS COUPON TODAY

Educational Director
TRANSVISION, INC., NEW ROCHELLE, N. Y. Dept. RN-2

I'm enclosing \$_____ deposit. Send standard kit PACKAGE #1, with all instruction Material. Balance C.O.D.

Send FREE copy of your new TV Kit Catalog.

Name _____

Address _____

City _____ State _____

ranged for the back panel of the instrument to avoid accidental short circuits or electrical shock from the exposed terminals.

Applications

As mentioned previously, the possible applications of the "universal" counter are almost unlimited. However, reviewing a few typical applications should give the reader a sufficient understanding of the potentialities of the unit so that he will have no difficulty in devising other applications of his own.

The photocell accessory might be used for counting the number of objects passing a given point on a production line, or the number of persons entering or leaving a specific area or room. The mercury switch could be used for counting the number of times the lid on a tool box or supply cabinet is opened and closed. The "Micro-switch" might be used in a similar application, or could also be used for recording the number of times a door is opened or shut.

The push-button switch could be used advantageously at inventory time. Held in the hand, it might be used for quickly recording the number of objects on a merchant's shelves. For each count, the user simply depresses and releases the button.

In addition to its uses just as a counter, the completed instrument has other possible applications. For example, the relay and amplifier circuit, used alone, could well serve for remote or automatic control of solenoids, motors, lights, or similar equipment. Any of the accessories may be used as the basic control device in such an application.

A SERVICE HINT

By JOHN B. LEDBETTER

HERE is a tip on the Motorola TS-95 when the brightness is normal but the sound is weak and there is no video except noise streaks across the screen.

Check for an open 2.2 μ hy. cathode choke in the 12AT7 converter stage. The d.c. resistance should read 1.8 ohms on an accurate v.t.v.m. In most cases a replacement choke is difficult to obtain but a satisfactory choke can be constructed if a little care is used.

Select a length of #22 d.s.c. or enameled wire which measures approximately 2 ohms and scramble-wind this length on a 1/2-watt carbon resistor (4.9 meg-ohms or higher as this value is sufficient to prevent interaction and the 1/2-watt size makes a good coil form).

Since the coil value is rather critical on the high channels it may be necessary to add or remove several turns to obtain proper response on channels 7, 9, 11, and 13. For example, if channel 13 is satisfactory but channel 7 is poor, the number of turns should be increased. If channels 11 and 13 are not received or if 13, 11, and 9 are received one channel lower than normal, decrease the number of turns.

Use only high-frequency dope to cement the winding or the whole process may have to be repeated.

February, 1955

RECOTON magnetic turnover cartridge

Goldring

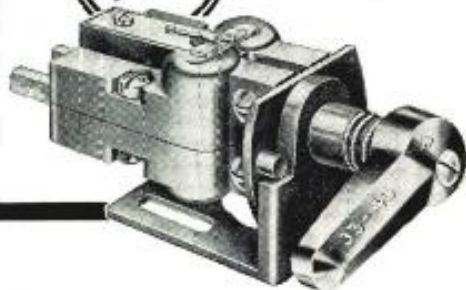

gives you
unsurpassed
audio
performance!

Name your own standards! There is no cartridge made that excels the new RECOTON-GOLDRING.

You can enjoy all the advantages of low output while eliminating hum pickup from changer motor, transformer, etc. The answer is in Recoton's newly developed push pull coil assembly. So thrill to a new experience in listening pleasure with this amazing turnover cartridge. It gives a performance that will satisfy even the most critical hi-fi enthusiast! And its modest price of \$9.90 (including 2 sapphire styli) comes as a pleasant surprise!

Recoton features:

- Replaceable diamond or sapphire styli.
- Frequency response of 20 to 16,000 cps.
- Added shielding
- High compliance and low mass
- Independent safety stylus assembly
- Minimum vertical motion
- Simple installation

Sold by all leading hi-fi distributors. For more detailed literature and name and address of distributor nearest you, write to Dept. R

RECOTON CORPORATION • 147 W. 22nd Street • New York 11, N. Y.
Manufacturers of World Famous Diamond, Sapphire, Osmium Phono Styli

NOW
HENRY DARES TO
GIVE YOU THIS
GUARANTEE

100% SATISFACTION
or Your Money Back at end of 10 day Trial

Bob Henry,
W0ARA
Butler, Mo.

Ted Henry
W6UOU
Los Angeles



New NC98

National



18
Cash Monthly Cash
Down Payments Price

SW-54	\$5.00	\$2.61	\$49.95
NC-88	12.00	6.54	119.95
NC-125	20.00	10.89	199.95
NC-183D	40.00	21.77	399.50
HRO-60	54.00	29.00	533.50

\$1500
DOWN

18 monthly payments of \$8.00
Cash price \$149.95

Now for the first time, a crystal filter, an S-Meter, choice of electrical bandspread on amateur or SWL bands, an RF stage and 2 IF stages.

We Give...
LONG LONG TRADES
LOW LOW TERMS
10 DAY TRIAL
FAST PERSONAL
SERVICE

We WANT you to be SATISFIED

Ask any Ham about Henry

We have All National Receivers in stock for immediate delivery, also National parts.

Write, wire, phone or visit either store today.

Butler 1, Missouri
Phone 395



Henry Radio Stores

Bradshaw 2-2917

11240 West Olympic Blvd. Los Angeles 64





**SAVE \$10
ON THESE
5 BOOKS**

**SPECIAL OFFER on this
COMPLETE RADIO
ENGINEERING
LIBRARY**

• 5 Volumes • 3872 Pages • Illustrations

THIS new, up-to-date edition of a famous, 5-volume library covers the whole field of radio engineering . . . includes latest facts, standards, data, and practice to help you solve hundreds of problems in any field based on radio. Books cover circuit phenomena, networks, tube theory, amplification, measurements, etc.—give specialized treatment of all fields of practical design and application.

SET INCLUDES: *Eastman's* Fundamentals of Vacuum Tubes, 3rd Ed.; *Terman's* Radio Engineering, 3rd Ed.; *Everitt's* Communication Engineering, 2nd Ed.; *Hund's* High Frequency Measurements, 2nd Ed.; and *Henney's* Radio Engineering Handbook, 4th Ed.

SPECIAL LOW PRICE—EASY TERMS

SAVE \$10.00—Regular price of books is \$48.00; when bought as a set, you pay only \$38.00, and on easy terms.

10-DAY FREE TRIAL

McGraw-Hill Book Co., Dept. RTN-2
330 W. 42nd St., N. Y. C. 36

Send me for 10 days' FREE trial, the RADIO ENGINEERING LIBRARY. If not satisfied I will return books. (Otherwise I will send \$8.00 plus delivery charges, then; and \$6 a month for 5 months. (We pay delivery if you send \$8.00 first payment WITH coupon; same return privilege.)

Name

Street

City Zone State

Employed by RTN-2
This offer applies to U. S. only



the "Video Probe Meter"

- Is it an accurate instrument made with precision?
- Can the Meter trace the R.F. & I.F. & Video Signal from Tuner to Pix Tube? Can it measure voltage?
- With the attached coil, can the Meter show the signal by placing coil over I.F. or Video Tube? Is a ground return necessary? Who manufactures the Meter? What is the price of the meter?

RESEARCH, INVENTIONS & MFG.
617 "F" ST. N. W., WASHINGTON 1, D. C.

NOW! Fold Your Own

CHASSIS - BRACKETS
CHANNELS - BOXES

with the A.B. Parker
sheet metal folding machine

Save dollars! Fold your own chassis, brackets, and boxes with this famous English-made sheet metal brake. Forms any metal up to 18 gauge mild steel by 24 inches wide with a simple pull of the handle. Portable vise model—perfect for home, service shops, schools, and laboratories. Price: only \$12.95 plus small duty charge. Write today for catalog sheet and order form!

TELVAC Dept. 28 Box 6001 Arlington 6, Va.

Within the Industry
(Continued from page 28)

opened a factory and warehouse at 15204 Oxnard St., Van Nuys, California . . . **TRAV-LER RADIO CORPORATION** has opened a factory distributing branch in San Francisco at 1251 Folsom Street . . . **INSULINE CORPORATION OF AMERICA** dedicated a new plant at 186 Granite St., Manchester, N. H. recently . . . **CBC ELECTRONICS CO., INC.** has moved to new quarters at 2601 N. Howard St., Philadelphia. The new plant has approximately six times the area of the firm's old facilities . . . **MAGNETIC RESEARCH CORPORATION** of El Segundo, California has moved to a larger location at 200 Center Street . . . Construction of a new plant building, comprising 27,000 square feet, on its present site, has been announced by **PYRAMID ELECTRIC COMPANY** of North Bergen, N. J. . . . **RAYTHEON MANUFACTURING COMPANY** has started construction on an electronics laboratory for engineering and research in Wayland, Mass., 20 miles from Boston. The building will have approximately 150,000 square feet of floor area . . . **KAY LAB** has started construction of a 150 x 200 foot building eight miles from the San Diego business district. The plant and site will include parking facilities for 300 cars . . . The purchase of 60,000 square feet of car radio tuner manufacturing facilities from **LEE J. DRENNAN, INC.** of Arcade, N. Y. has been announced by **MOTOROLA INC.**

ROBERT G. MARCHISIO has been appointed to the post of vice-president of **CBS-Hytron** and will have general authority in all phases of the company's operations.



He joined the company in 1951 as assistant to President Charles F. Stromeier, who was then a vice-president. He previously had worked at *Sylvania Electric Products Inc.*, first as assistant chief engineer for proximity fuses, and later as chief engineer of the fixture division at Ipswich.

Mr. Marchisio is a graduate of MIT in electrical engineering.

GUDEMAN COMPANY, Chicago manufacturer of electronic components, has purchased **DILECTRON, INC.**, 2661 S. Myrtle St., Monrovia, California, manufacturer of ceramic capacitors. The new acquisition gives the parent firm its fifth plant and will be operated as a division of the company . . . **CLAROSTAT MFG. CO., INC.** has completed arrangements for the purchase of **CAMPBELL INDUSTRIES INC.**, Chattanooga, Tenn. manufacturer of highly specialized resistance products . . . All of the outstanding capital stock of **DOELCAM CORPORATION** of Boston has been purchased by **MINNEAPOLIS-HONEYWELL REGULATOR COMPANY**

INSIST ON THE GENUINE **NEW INCA QUICKIE #2**

the 10 WAY WRENCH
WITH 1,001 USES!

ONLY **98¢** Slightly higher W. of Miss.

Small head for hard-to-reach places . . . Fits all hex nuts & bolts from 1/4" to 1/2", plus 1/4" sq. Finest made, rugged, alloy construction, hard chrome finish. 4" x 1" overall

AT YOUR JOBBER
If he cannot supply, write to
J.E.S. CO.
111-51 Lefferts Blvd.
S. Ozone Park 20, L. I., N. Y.

MOBILE AMPLIFIER

IDEAL FOR CIVIL DEFENSE, POLICE, FIRE, GENERAL PURPOSE P. A.

An extremely compact and durable 12 watt amplifier for 6 and/or 12 volts. 2 inputs, one mike, one phono. 2 output connections. 6 volt model list \$89.95.

PLUG IN TUNERS
AM—FM—SHORTWAVE

Connect to any TV set, Hi Fi or PA Amplifier, or Tape Recorder in a few minutes. FM unit (only \$13.95) will work in automobile and can be easily connected to car radio. AM broadcast model \$14.95. Balanced heaters no carrier hum. Fractional power requirements.

Write for literature

KUHN ELECTRONICS
20 GLENWOOD CINCINNATI 17, OHIO

NEW! FREE CATALOGUE!

For bargains in surplus that can't be beat
Get Your Free Copy Today!

MONTHLY SPECIAL: 2 SPEED HOBBY MOTOR. With oscillating arm. 12 or 24 VDC or 110 VAC. . . . \$3.95

J. J. GLASS ELECTRONICS CO.
1615 S. Main St. Los Angeles 15, Calif.

RADIO and TELEVISION ELECTRONICS

RCA in all Technical Phases New Classes (Day and Evening) Start 1st of Dec., Mar., June, Sept.

Free Placement Service for Graduates For Free Catalog write Dept. RN55

RCA INSTITUTES, INC.
A Service of Radio Corporation of America
350 WEST 4TH ST., NEW YORK 14, N. Y.

TAPE SALE
WESCOTT NEW PLASTIC RECORDING TAPE

1200' roll (in boxes) \$1.65 6 rolls \$9.50
Also Milax 1 mil tape 1800' roll \$4.65 each
EXCESS POSTAGE REFUNDED
MONEY BACK GUARANTEE

WESCOTT TAPE
P. O. Box 1153, Dept. R, Columbus, Georgia

who will operate it as a division of the parent firm. The new division has a main plant in Boston and another plant and engineering laboratories in Newton, Mass. . . . **AEROVOX CORPORATION** of New Bedford, Mass. has acquired all of the outstanding stock of **HENRY L. CROWLEY & COMPANY, INC.** of West Orange, N. J., manufacturers of powdered-iron and steatite products . . . **SYLVANIA ELECTRIC PRODUCTS INC.** has purchased the television picture tube manufacturing facilities of **NATIONAL UNION ELECTRIC CORPORATION** in Hatboro, Pa.

LOUIS M. PARK has been appointed to the executive position of co-ordinator of sales, advertising, and management of the television and radio operations of *Raytheon Manufacturing Company*.



Mr. Park was formerly executive assistant to the vice-president in charge of sales at *Admiral Corporation* for 10 years and for 17 years prior to that he was with *Stewart-Warner Corporation*.

In his new post with *Raytheon*, he will serve as executive assistant to D. O. Klein, assistant vice-president and manager of marketing.

JFD MANUFACTURING COMPANY, INC. is celebrating its 25th anniversary on February 18th.

A large fund has been appropriated for year-long advertising and promotion. As part of the anniversary celebration, there will be testimonial banquets, awards, contests, and supplementary advertising. All packaging during this year will carry the company's anniversary seal and there will be special sales opportunities for the firm's distributors and dealers. -30-

PHOTO CREDITS

Page	Credit
37	Philo Corporation
45, 47	Acro Products Company
49	Westinghouse Electric Corp.
50 (Fig. 3)	Radio Corporation of America
64	Belgian National Broadcasting Service
72, 73	Motorola Inc.
112	Sylvania Electric Products Inc.
163	Emerson Radio of Canada

ERRATA

In Fig. 5 of the article "Acoustic Measurements for the Audiophile" in the September issue (page 112), one of the rectifiers was drawn with the wrong polarity. One of the 1N34's should be connected with its "anode" toward the meter, the other with its "cathode" toward the meter.

In the parts list accompanying the article "A Tone-Compensating Preamp," October issue, the value of R₁₁ is incorrectly given as 750,000 ohms rather than 75,000 ohms. The Clarostat part number for R₁₁ is, however, correct.

Also in the October issue (page 55), terminals 2 and 4 of the 6E5 in the schematic accompanying the "Economy Model Grid Dipper" should be reversed.

TOP QUALITY TUBES ONE YEAR GUARANTEE BELOW MFRS' PRICES!

Type	Price	Type	Price	Type	Price	Type	Price	Type	Price
OBE279	5T41.28	6BZ792	6SQ745	12A659
OZ454	5U4G55	6C441	6SR745	12AL549
1A753	5V482	6C539	6SS760	12AT641
1AX269	5Y3GT39	6C6G57	6ST749	12AT768
1B369	5Z344	6C8G85	6T495	12AU645
1D8GT77	6A869	6CB657	6T7G79	12AU753
1G449	6AB451	6CD699	6T879	12AV644
1G6GT54	6AC5GT99	6CF664	6U7G45	12AV772
1H5GT43	6AC789	6CS651	6U879	12AX4GT68
1L449	6AF489	6D669	6V6GT41	12AX753
1LA459	6AG556	6E538	6W4GT39	12AY789
1LA679	6AG795	6F549	6X444	12B649
1LC559	6AH685	6F645	6X444	12BA649
1LD552	6AJ589	6F869	6X5GT29	12BA759
1LE378	6AK579	6G6G65	6X879	12BD649
1LN557	6AL589	6H632	7A454	12BE639
1P5GT56	6AL789	6J659	7A669	12BH759
1Q5GT57	6AM869	6J749	7A769	12BY769
1R554	6AN879	6K6GT45	7A859	12BZ765
1S458	6AQ539	6K739	7B444	12C834
1S545	6AR545	6K8G65	7B559	12F5GT35
1T455	6AS548	6L7G59	7B659	12H645
1U439	6AT641	6N798	7C458	12J5GT45
1U548	6AU646	6R749	7C549	12J7GT58
1V69	6AV634	6S449	7C765	12K858
1X2A59	6AX4GT59	6S7G59	7E559	12O7GT59
2A395	6B8G53	6SA754	7F895	12SA7GT64
2A649	6BA639	6SB7Y89	7H759	12SC769
2A764	6BA756	6SC779	7I775	12SF549
2X239	6BC554	6SF545	7L759	12SG775
2X2A1.85	6BD649	6SF759	7R765	12SH775
3A444	6BE639	6SG7GT49	7S785	12SJ759
3A590	6BG61.24	6SH760	7V791	12SK744
3A860	6BH648	6SH7GT50	7W785	12SL7GT57
3B739	6BJ649	6SJ750	7X770	12SL7GT57
3B839	6BK569	6SK749	7Y444	12SQ7GT56
3D639	6BK7A72	6SL7GT59	7Z449	12SR749
3LF479	6BL7GT89	6SN7GT59	10Y69	12Z339
3Q455	6BN669					14A469
3Q5GT69	6BQ695					71A54
3S456	6BQ7A99					7549
3V458							7643

FREE OFFER!
7 Assorted 12, 7, 6, 1 and 2 volt type tubes. List Value approx. \$23. FREE with every order for \$25.00 or more!

SEND FOR OUR FREE LISTING!
EXPORT INQUIRIES INVITED

ELECTRON TUBE WHOLESALERS, INC.
140 DUANE STREET • NEW YORK 13, N. Y. • Phone: BArdoy 7-7616

SEE THE LATEST IN **Electronics EQUIPMENT**

FREE

Send for **Newark's 1955 Catalog**

Select the fast, easy, dependable way from the New Electronics Reference Book — full of the latest releases and largest selections of High Fidelity, Radio, TV, Amateur and Electronics equipment.

NEWARK
ELECTRIC COMPANY

Dept. R-2 223 W. Madison, Chicago 6, Ill.

COLOR TV EXPERIMENTERS!

Look What You Get for the Remarkably Low Price of **\$99.50** Only

(See Dec. '54 Radio & Television News article on Color TV Conversion)

A COMPLETELY OPERATING PHILIPS PROTELGRAM TV SYSTEM

BRAND NEW—
shipped in original factory sealed container

YOU GET A COMPLETE PACKAGE INCLUDING:

- Chassis completely wired and ready for use, including 23 tubes plus one diode
- Protelgram projection unit including picture tube
- 25,000 volt power supply
- 8" dynamic Hi-Fi speaker on large baffle
- 23" flat viewing screen and full size reflecting mirror

NOTE: Chassis circuitry includes . . . Automatic beam suppressor . . . High Fidelity sound system . . . Automatic gain control . . . "Standard Coil" tuner, etc. \$400.00 original cost of parts, units and accessories to experiment with.

EDUCATIONAL . . . ENTERTAINING . . .

TERMS: F.O.B. N.Y.C. Full remittance with order or 25%. Balance C.O.D.—10 day money back guarantee.

ELECTRONIC SPECIALTY SUPPLY CO.
58 Walker St., N. Y. 13, N. Y. Phone: WA. 5-8187

STANDARD BRAND TUBES

- Individually boxed. • Only 1st quality.
- Latest Dating—
- No private label, electrical or mechanical rejects.
- No rebrands or rewashed "barbins."
- Write for Free 1955 New Air-Mail Handy-Order Blank.
- Lists ALL Popular TV & Radio Types.
- Makes Mail-Order a Pleasure.
- All Tube Orders Over \$25.00 (with full remittance) —POSTPAID.

SPECIAL-PURPOSE TUBES

Write for our complete listing on XMTG, Industrial, Special-Purpose and Crystal Diodes. We stock over 2,000 types at excellent prices.

Type	Price	Type	Price	Type	Price
D24	.70	6BE6	.70	7L7	.15
IA5GT	.80	6BF5	.85	7L7	.95
IA7GT	1.00	6BF6	.70	7Q7	1.00
IB3GT	.85	6BG6G	1.80	7R7	1.30
IH5GT	.75	6BH6	.80	7S7	1.25
IL4	.85	6BJ6	.70	7V7	1.30
IL6	1.10	6BK5	.90	7W7	1.30
IL4A	1.00	6BK7A	1.10	7X6	.85
IL6A	1.00	6BL7GT	1.15	7X7	1.00
IL8A	1.00	6BN6	1.15	7Y4	.70
ILC5	1.00	6BQ6GT	1.20	7Z4	.70
ILD5	1.00	6BQ7A	1.20	12A1L5	.70
ILE3	1.00	6BX7GT	1.25	12A1T6	.50
ILG5	1.00	6BY5G	1.30	12A1T7	1.00
ILH4	1.00	6BZ7	1.25	12A1U6	.60
ILN5	.85	6C4	.50	12A1U7	.80
IN5GT	.90	6CB6	.70	12A1V6	.55
IQSGT	1.15	6CD6G	1.75	12A1V7	.95
IR4	1.00	6CF6	1.00	12A1W6	.85
IR5	.70	6CL6	1.10	12AX4GT	.85
IS4	.90	6CM6	.90	12AX7	.80
ISS	.70	6CS6	.70	12AY7	1.75
IT4	.70	6CU6	1.70	12AZ7	.90
IT5GT	1.05	6E7	1.00	12B1GT	.70
IU4	.70	6F5	.90	12BA6	.65
IU5	.65	6F6M	1.00	12BA7	.95
IV	.95	6F6G	.80	12BE6	.70
IY2	.70	6H6	.50	12BH7	.95
IX2B	.85	6J4	4.95	12BY7	.95
2D21	1.00	6J5	.50	12BZ7	1.00
2X2	1.00	6J6	.75	12L5GT	.70
3A4	.55	6J7	.75	12K7GT	.90
3A5	.90	6K6GT	.60	12K8GT	1.10
3LF4	1.15	6K7M	.80	12Q7GT	.80
3Q4	.90	6K8	1.20	12SA7GT	.65
3Q5	1.00	6L6G	1.15	12SG7	.90
3S4	.85	6L6GA	1.30	12SH7	.95
3V4	1.35	6L6M	1.50	12SJ7	.70
5AW4	1.35	6L7G	.95	12SK7GT	.65
5R4GY	1.55	6N7	1.15	12SL7GT	1.00
5U4G	.55	6Q7M	.95	12SN7GT	.80
5V4G	.90	6Q7G	.80	12SQ7GT	.60
5W4GT	.70	6Q7GT	.80	14A4	1.00
5X4G	.80	6S4	.60	14A5	1.50
5Y3GT	.45	6S8	1.10	14A7	.85
5Y4G	.80	6SA7GT	.60	14J7	1.35
5Z3	.80	6SC7	.75	14L7	.95
5Z4	1.25	6SF5	.75	14Q7	.95
6A8M	1.00	6SG7	.70	14R7	1.30
6A8GT	1.05	6SH7	.80	14S7	1.25
6A8A	.85	6SJ7M	.70	14W7	1.35
6A8B	1.35	6SK7GT	.65	19B6G6	2.00
6AC5GT	1.15	6SL7GT	.80	19T8	1.20
6AC7	1.10	6SN7GT	.75	25AV5	1.20
6AD7G	1.45	6SQ7GT	.60	25B06GT	.30
6AF4	1.30	6SS7	.85	25L6GT	.65
6AF6	1.20	6T4	1.30	25W4GT	.70
6AG5	.75	6T8	.95	25Z5	.70
6AG7	1.20	6U5	.90	25Z6GT	.65
6AH4GT	.85	6U8	1.00	35A5	.70
6AH6	.90	6V3A	1.30	35B5	.65
6AJ5	1.75	6V8GT	.65	35C5	.65
6AK5	.75	6V6M	1.30	35L6GT	.65
6AK6	.80	6W4GT	.60	35W4	.45
6AL5	.60	6W6GT	.80	35Z5GT	.45
6AL7	1.50	6X4	.50	50A5	.70
6AM8	1.25	6X5GT	.50	50B5	.70
6AN4	1.50	6X8	.95	50CB5	.70
6AN5	3.50	6Y6G	1.00	56L6GT	.65
6AN8	1.20	7A4	.95	50X6	.90
6AQ5	.70	7A5	.80	70L7	1.55
6AQ6	.55	7A6	.85	80	.60
6AQ7	1.20	7A7	.80	83	1.15
6AR5	.65	7A8	.85	117L7GT	2.50
6AR6	2.75	7B4	.80	117N7GT	1.95
6AS5	.75	7B5	.70	117P7GT	1.95
6AS6	2.50	7B6	.75	117Z3	.70
6AS7G	3.75	7B7	.80	117Z4GT	1.15
6AT6	.55	7C4	1.25	117Z6GT	1.00
6AU4GT	.95	7C5	.80	211	.65
6AU5GT	1.10	7C6	.70	803	1.90
6AU6	.60	7C7	.65	838	1.90
6AV5GT	1.05	7E5	1.10	872-A	
6AV6	.55	7E7	1.15	(GE)	2.75
6AX1GT	.80	7E7	1.20	5642	1.00
6AX5GT	.75	7F7	.90	5654	1.75
6BA6	.65	7F8	1.20	6096	1.85
6BA7	.90	7G7	1.15	8008	4.40
6BC5	.70	7H7	.75	And Others—	
6BD3	1.40	7J7	1.35		
6BD6	.75	7K7	1.20		

TWO-COLORED TUBE CARTONS, with new Safety Partitions. Prevents Tube Breakage. This Super-Gloss Red and Black Carton is the Most Distinctive Box Available Today! Minimum: 100 any one size. Quantity prices on request. Cartons F.O.B., N.Y., N.J. EACH SIZE

Miniature (6AUG, 6ALS, etc.) \$0.12
 C (6SN7, 6W4, etc.) 0.125
 LARGE GT. (185, 600GT, etc.) 0.15
 LARGE G. (SU3G, 68G6G, etc.) 0.2

Terms, 25% with order, balance C.O.D. All merchandise guaranteed. F.O.B., N.Y.C. New phone and address Phone: Walker 5-7000

BARRY ELECTRONICS CORP.
 512 Broadway N. Y. 12, N. Y.

INDEX OF Advertisers

FEBRUARY 1955

While every precaution is taken to insure accuracy, we cannot guarantee against the possibility of an occasional change or omission in the preparation of this index.

ADVERTISER	PAGE	ADVERTISER	PAGE
Aaron Electronic Sales	130	McGraw-Hill Book Co.	176
Acro Products Company	147	Milwaukee School of Engineering	122
Airex Radio Corp.	162	Mosley Electronics, Inc.	145
All Channel Antenna Corp.	15	Mass Electronic Distributing Co., Inc.	104, 105
Allied Radio Corp.	9, 132	Musical Masterpiece Society, Inc., The	16
American Phenolic Corporation	28		
American Television & Radio Co.	136	National Electronics of Cleveland	124
Amplifier Corp. of America	100	National Radio Institute	3, 19, 20
Approved Electronic Instrument Corp.	96	National Schools	75
Argos Products	173	Newark Electric Company	177
Arkay Radio Kits	132	Newcomb	133
Arrow Electronics	166		
Arrow Sales, Incorporated	119	Offenbach-Reimus	162
Ashe Radio, Walter	77	Olson Radio Warehouse	103
Audel Publishers	150	Onan & Sons, Inc., D. W.	92
Baltimore Technical Institute	162	Peak Electronics Co.	152
Barry Electronics Corp.	178	Photocon Sales	152
Belden	93	Pickering and Company, Incorporated	6
Bell Telephone Laboratories	30	Platt Electronics Corp.	172
Blonder-Tongue Labs	167	Precise Development Corp.	131
Burstein-Applebee Co.	94	Precision Radiation Instruments, Inc.	147
		Premax Products	163
CBS-Hytron	17	Premier Radio Tube Co.	124
Cabinet	153	Prentice Hall	174
Cal Tech Sales Company	100	Probesco Co.	94
Capital Radio Engineering Institute	29	Progressive "Edu-Kits", Inc.	123
Centrablab	139, 156	Pyramid Electric Co.	24
Channel Master Corp.	22, 23		
Chicago Standard Transformer Corporation	161	Quietrol Company	174
Cleveland Institute of Radio Electronics	35		
Columbia Electronics	173	R.C.A. Institutes, Inc.	27, 176
Concord Radio	165	R. W. Electronics	158
Cornell-Dubilier	14	Radiart Corp., The	12
Coyne Electrical School	101, 157	Radio City Products Company	145
		Radio Corporation of America	13, 34
Delco Radio	32	Radio Electric Service Co.	168
DeVry Technical Institute	5	Radio Products Co.	124
Douglas Instrument Laboratory	174	Radio Shack Corporation	149
Dumont Laboratories, Inc., Allen B.	7	Radio & Television News	137
Duro Electronics Company	138	Radio-Television Training Association	25
		Radion Corp., The	118
Editors & Engineers, Ltd.	140	Rad-Tel Tube Co.	179
Electronic Chemical Corp.	161	Rathyon Manufacturing Company	2nd Cover
Electronic Instrument Co., Inc.		Recoton Corp.	175
(EICO)	36, 92, 150	Reeves Soundcraft Corp.	78
Electronic Measurement Corporation	123	Regency	132
Electronic Specialty Supply Co.	166, 177	Rek-O-Kut Co., Inc.	160
Electro-Voice	8	Research Invention & Mfg. Co.	176
Electron Tube Wholesalers, Inc.	177	Rex Radio Supply Co.	102
Erie Resistor Corporation	148	Rider, Publisher, Inc., John F.	112
		Rinehart & Co., Inc.	91, 100, 118, 144
Fairchild Recording Equipment	146, 151	Rohn Manufacturing Company	33
Fair Radio Sales	159		
Fisher Radio Corp.	114, 115, 116, 117	Sams & Co., Inc., Howard W.	120
		Sam's Surplus	107
G & G Radio Supply Co.	128	Sangamo Electric Company	129
G. L. Electronics, Inc.	155	Sarkes-Tarjian, Inc.	143
General Cement Mfg. Co.	113	Scientific Equipment Distributors	138
Goodheart, R. E.	147	Scott, Inc., H. H.	18
Grantham School of Electronics	166	Searle of Chicago	174
		Service Instruments Co.	118
Hallcrafters	126, 128, 130	Shure	138
Harjo Sales Co.	142	Sonex, Inc.	162
Harvey Radio Co.	162	Sprague Products Company	106
Heath Company		Sprayberry Academy of Radio	31
79, 80, 81, 82, 83, 84, 85, 86, 87, 88, 89, 90		Stan Burn Radio & Electronics Co.	160
Henry Radio Stores	175	Steve-El Electronics Corp.	142
Henshaw Radio Supply	147	Stevens Walden, Inc.	102
Hughes Research and Development Laboratories	120, 171	Stuart Electronics Distributors	167
Hycon Manufacturing Co.	141	Sun Parts Distributors, Ltd.	78
		Supreme Publications	157
Indiana Technical College	102	Sylvania Electric Products, Inc.	10, 11
Institute of Radio Engineers	169		
Instructograph Company	164	"TAB"	180
International Rectifier Corporation	154	Tele-Marine Communications Co.	95
International Resistance Company	3rd Cover	Teltron Electric Company	163
		Telvac	176
J. E. S. Company	176	Terminal Radio Corp.	142
JFD Manufacturing Co., Inc.	125	Thorns Company	134
J. J. Glass Electronics Co.	176	Transamerica Electronics	92
Jerrold Electronics Corporation	21	Transvision, Inc.	127, 173, 174
Jersey Specialty Co.	164	Tri-State College	130
Jones & Laughlin Steel Corporation	121	Tung-Sol Electric, Inc.	150
Kay-Townes Antenna Company	110, 111	U. S. Crystals, Inc.	108, 109
Kuehne Manufacturing Company	140	United Radio Co.	124
Kuhn Electronics	176	University Loudspeakers, Inc.	14
Lafayette Radio Corp.	97	Valparaiso Technical Institute	170
Lansing Sound, Inc., James B.	152		
Lelectronics Distributors	147	Ward Products Corporation	135
Leonard Radio, Inc.	78	Wescott Tape	176
Leotone Radio Co.	164	Western Television Institute	160
		Wholesale Radio Parts Co., Inc.	164
Mallory & Co., Inc., P. R.	4th Cover	Winston Electronics, Inc.	26
Mattison Television & Radio Corp.	170	World Radio Laboratories	165
McConnell's	140		
McGee Radio Company	98, 99	Xcelite, Incorporated	166

Classified

Rate 50c per word. Minimum 10 words

RADIO ENGINEERING

COMPLETE radio, electronics theory & practice; television; broadcasting; servicing; aviation, marine, police radio. 12 or 18 months. Catalog. Valparaiso Technical Institute, Dept. N, Valparaiso, Ind.

FOR SALE

CRYSTALS: FT-243's—3500 to 8700 KC. .01% setting, \$2.00 each. Hundley Crystal Co., 2951 North 36th, Kansas City 4, Kansas.

DIAGRAMS—Radio \$1.00; record changers, recorders \$1.25. Television with service data \$2.00. Where model unknown, give part numbers. Kramer's Radio Service, Dept. S53, 36 Columbus Ave., New York 23, N. Y.

TAPE Recorders, Tapes, Accessories. Unusual Values. Dressner, Box 66k, Peter Stuyvesant Station, N. Y. 9.

CODE Practice Electronic Oscillators, new. Guaranteed. Not a kit. \$1.00 postpaid. Details free. Stout 2211 E. Broadway, Muskegon, Michigan.

TELEVISION, Working. \$30 up. WIAPI, 1420 South Randolph, Arlington 4, Virginia.

OSCILLOSCOPES: Triplett 3141. All New. \$169.50. Faith Radio-TV, Montpelier, Ohio.

TV-FM antennas. All types including UHF. Mounts, Accessories. Lowest prices. Wholesale Supply Co., Dept. H, Lunenburg, Mass.

AN/APR-4, other "APR," "ARR," "TS," "IB," ARC-1, ARC-3, ART-13, everything surplus; Tubes, Manuals, Laboratory equipment. Describe, price in first letter. Engineering Associates, 431 Patterson Rd., Dayton 9, Ohio.

TUBES and equipment bought, sold, and exchanged. For action and a fair deal write B. N. Gensler, W2LN1, 136F Liberty, N. Y. 6, N. Y.

FREE: Get our monthly electronic lists. Dick Rose, Everett, Wash.

ALUMINUM Tubing, Angle and Channel, Plain and Perforated Sheet. Willard Radcliff, Postoria, Ohio.

FORTY Complete VHF Radio Terminals. These are designed for telephone service in the 72-76 mc. band, and are ideal for setting up a communication system along a pipeline, railroad, or in mountainous or bush country. Each terminal consists of the following: 1—Link Radio Type 1498T Transmitter; 1—Link Radio Type 1498T Power Supply; 1—Link Radio Type 1498R Receiver; 1—Budelman 200 watt Power Amplifier; 1—Type P13 Power Supply; 1—Federal Type 101B V-F Ringer; 500 ft.—Type RG 8U Coaxial Cable; 2—Welded steel Yagi Antennas—5 element; 1—Lister Diesel-Generator set, 2 KW. P. J. Plishner, 550 Fifth Avenue, New York City.

RADIO Diagrams \$1.00 Television \$2.00. Give make, Model. Diagram Service, Box 672-RN, Hartford 1, Conn.

TV sets \$17 tubes 39c. Jones, 1115 Rambler, Pottstown, Pa.

WANTED

WANTED—Lear 12 Volt T-30-AB transmitter. RCBB receiver, G30AB power unit. Advise lowest price and condition. Don Neal, Box 1002, Douglas, Alaska.

USED Television Receivers. No Junk. Seale Corporation, Plain Dealing, Louisiana.

WILL Buy All Art-13/type T-47A \$200.00. Art-13/type T-17 \$150.00. BC-788C Altimeters \$100. R5/ARN7 Radio Compass \$125. ARC-3 Complete \$185.00. BC-318 Rec'r Modified \$35. BC-318 Rec'r unmodified \$70. ARC-1 Radio \$150.00. BC-312 Rec'r \$10.00. BC-342 Rec'r \$50.00. Ship Via Express C.O.D.. Subject to inspection to: H. Finnegan, 49-57 Washington Ave., Little Ferry, New Jersey.

WANTED: Type R19/TRC-1 Receivers. Box 543, Radio & Television News.

TOP Dollar Paid for Art-13's, dynamotors, parts racks and all other component parts. Write: Harjo Sales Co., 4109 Burbank Blvd., Burbank, Calif.

BUSINESS OPPORTUNITIES

BUY Wholesale—25,000 items—catalog 25c. Matthews, 1172-R5 Broadway, NYC 36.

HELP WANTED

TELEVISION Jobs—Names and addresses of companies to contact. \$1.00. Fitzgerald, Dept. A-14, 3038 West Wellington Avenue, Chicago 18, Illinois.

INSTRUCTORS, well-versed in Radio and Television. Send complete resume of education and experience to Educational Director, Electronics Institute, Inc., 21 Henry Street, Detroit 1, Michigan.

CORRESPONDENCE COURSES

USED Correspondence Courses, Books Bought, Sold, Rented. Catalog Free. Educational Exchange, Summerville, Ga.

USED correspondence Courses and Books sold and rented. Money back guarantee. Catalog free. (Courses bought.) Lee Mountain, Pisgah, Ala.

RECORDS

25-50% DISCOUNT on guaranteed factory fresh LP records, and pre-recorded tape. Send 20¢ for complete LP catalogue. Record Sales, 4710 Caroline, Houston 4, Texas.

MISCELLANEOUS

200 UNMARKED ceramics. Mixed values \$1.00. Schneider, Box 214, Seaford, N. Y.

ALL makes speakers repaired. Amprite Speaker Service, 70 Vesey St., New York City 7.

"URANIUM Detector" Scintillator & Geiger counter diagrams. Send \$1.00 to: Uranium, 13833 San Antonio, Norwalk, Calif.

URANIUM Scintillation and Geiger counters. Free Booklets Radiated Clinic, 2320 Burbank Blvd., Burbank, Calif.

COLOR Television from standard TV using color wheel, simple converter. Details, Colordaptor, 3471 Ramona, Palo Alto, Calif.

RECORDING Fans: Swap tape everywhere. Details Free. Box 1404-G, San Francisco 1.





AT **WRL** THE WORLD'S LARGEST DISTRIBUTOR OF AMATEUR RADIO EQUIPMENT

ONLY
10%
DOWN

will do the job on these hallicrafters!

S-85
Pay just 10% down



ONLY
\$9.54
per month
\$11995
CASH

SX-96
Pay just 10% down



ONLY \$13.62
per month
\$24995
CASH

FREE 1955 CATALOG
Listing over 15,000 items!
Send For Yours Today!

The Hallicrafter S-85

Receiver with the 10, 11, 15, 20, 40 and 80M amateur bands. Has tuned RF stage, two IF stages for better selectivity, BFO pitch control, AVC-noise limiter and receiver standby. Seven tubes plus rectifier. Broadcast band: 540-1680 Kc. Short Wave bands: 1680 Kc - 34 Mc. Grey-black steel cabinet. Shipping wt.: 36 lbs.

The Hallicrafter SX-96

Selectable side band receiver with improved stability through temperature compensation of the HF oscillator circuits. Precision gear drive dial system on main tuning and bandspread dials. Includes 50 Kc. highly selective IF system, AVC-noise limiter, eleven tubes plus rectifier and voltage regulator. Tuning range: 538-1580 Kc. and 1720 KC - 34 MC, covering 10, 20, 40 and 80M. Grey-black cabinet with brushed chrome trim. Shipping wt.: 43 lbs.

Send for full information on:

- ★ WRL's 500 watt Globe King bandswitching xmtr.
- ★ WRL's 65 watt Globe Scout bandswitching xmtr.
- ★ Latest reconditioned equipment list.

ALL PRICES SUBJECT TO CHANGE WITHOUT NOTICE.

Please rush me: FREE 1955 Catalog, and information on items checked below! Quote your top-trade offer for my: _____ (present equipment)

on your _____ (New WRL Eqpt. Desired)

SX-96 S-85 Other

Globe King Globe Scout

Recond. Eqpt. List Radio Map (25c)

Name: _____

Address: _____

City and State: _____



WORLD'S MOST PERSONALIZED RADIO SUPPLY HOUSE

3415 W. BROADWAY, CO. BLUFFS, IA. Phone 2-0277

NEW



Here are wire wound power resistors designed for today's servicing requirements. New, rectangular design is more compact. Famous IRC element is sealed in ceramic case for complete insulation and protection. Axial leads are easily soldered and speed replacement. Clear, permanent markings give full identification.

- 2 SIZES—PW-7 seven watts; PW-10 ten watts.
- COST LESS—new, low price for IRC Power Resistors.
- FULL POWER—Conservative ratings permit continuous operation at full power.
- NEW VALUES—in keeping with today's needs.

WIRE WOUND POWER RESISTORS

in handy Resist-O-Card Assortments



IRC Resist-O-Cards are easier to buy, stock and use. Values are printed on each card—you always know what you have, and you always have what you need. Assortments are based on popular usage.

- ASSORTMENT # 19—Twenty 7 watt resistors. Dealer Price \$6.20
- ASSORTMENT # 20—Twenty 10 watt resistors. Dealer Price \$6.60
- ORDER NOW—From your IRC Distributor

NEW



INTERNATIONAL RESISTANCE COMPANY

401 N. BROAD STREET, PHILADELPHIA 8, PA.

Wherever the Circuit Says

P. R. MALLORY & CO. INC.
MALLORY
APPROVED PRECISION PRODUCTS

P. R. MALLORY & CO. INC.
MALLORY
APPROVED PRECISION PRODUCTS

P. R. MALLORY & CO. INC.
MALLORY
APPROVED PRECISION PRODUCTS



The simplest — and best
— control replacements
you can install

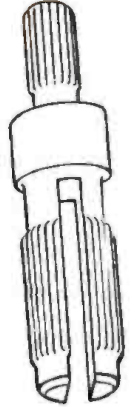
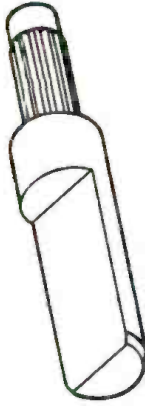

SAVE YOURSELF TIME with Mallory Midgetrols®—the carbon controls designed for *both* you and your customers. Features like the easily-cut tubular shaft that fits split-knurl or flatted knobs . . . line switches that you attach without disassembling the unit . . . will save valuable minutes of your shop work.

GIVE CUSTOMERS THE BEST with Midgetrols—the control that's engineered to equal or exceed the performance of original components. Their precise tapers, noise-free operation and excellent stability add up to the kind of performance that prevents call-backs . . . builds customer good-will.

ORDER YOUR STOCK TODAY Your nearby Mallory distributor is ready to supply you with a Control Kit that will equip you to replace controls in 90 per cent of the radio and TV sets in your area.

BE SURE TO USE . . .



MALLORY WIRE WOUND CONTROLS . . . a wide selection of resistance, wattages from 2 to 500, and variety of tapers . . . all designed for cool operation and long life.

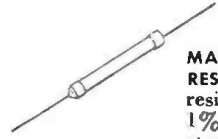

MALLORY DEPOSITED CARBON RESISTORS . . . high stability resistors with tolerances of 1% or 10% . . . at cost substantially lower than wire wounds.

P. R. MALLORY & CO. INC.
MALLORY
CAPACITORS • CONTROLS • VIBRATORS • SWITCHES • RESISTORS
RECTIFIERS • POWER SUPPLIES & FILTERS • MERCURY BATTERIES
APPROVED PRECISION PRODUCTS
P. R. MALLORY & CO. Inc., INDIANAPOLIS 6, INDIANA

P. R. MALLORY & CO. INC.
MALLORY
APPROVED PRECISION PRODUCTS

P. R. MALLORY & CO. INC.
MALLORY
APPROVED PRECISION PRODUCTS

P. R. MALLORY & CO. INC.
MALLORY
APPROVED PRECISION PRODUCTS