

RADIO & TELEVISION NEWS

MARCH
1952
35¢
in Canada 40¢

Library
Southern State Teachers College
Springfield, South Dakota

PRE-FABRICATED AM-FM TUNERS SEE PAGE 52
A MIDGET V. F. O. ★ ★ AUDIO SIMPLIFIED

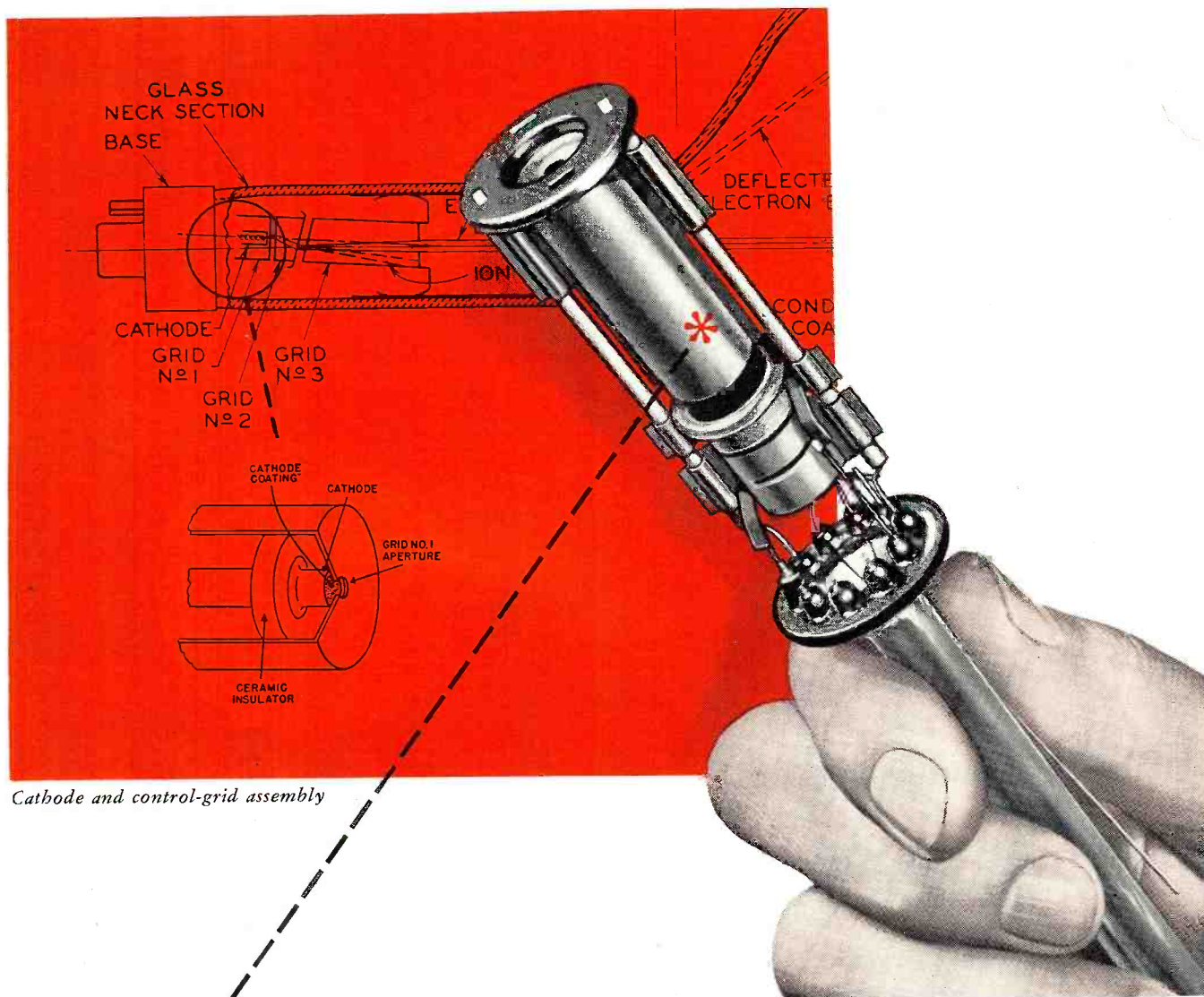

Cathode and control-grid assembly

The gun that looked 100% "perfect" ...yet never "fired a shot"

The electron gun you see looks perfect, but actually it "never fired a shot." You see, RCA rejected it because the spacing between grid No. 1 and the cathode was out of bounds. Only a 0.001" departure from the design value for this spacing is sufficient cause for gun rejections in RCA factories.

Why does RCA prescribe such a close tolerance? Simply because RCA engineers have found that if the cathode-to-grid spacing is too small, or too large, the grid would have faulty "control." Such tubes, when installed in TV receivers, may be

the cause of poor picture performance, and may result in troublesome and time-consuming service problems and call-backs.

RCA takes no chances with its reputation for quality. You get the benefit of RCA's quality reputation when you use RCA tubes. Constant vigilance and quality control at all stages of manufacture assure meeting RCA standards on the final production line. That's why RCA picture tubes are unmatched for reliability and uniformity.

In RCA picture tubes, the difference is

top-quality control. That's why, dollar for dollar, RCA picture tubes have no equal.

With RCA Receiving Tubes, as well as RCA kinescopes, TOP-QUALITY CONTROL makes the difference.



RADIO CORPORATION of AMERICA
ELECTRON TUBES
HARRISON, N. J.

Practice COMMUNICATIONS

parts to build
transmitter



As part of my Communications Course you build this low power broadcasting transmitter, learn how to put a station "on the air," perform procedures demanded of Broadcast Station operators, make many tests.

This is just part of the equipment my students build. You keep all parts I send.

You Practice Radio SERVICING

on this modern radio you
build with parts I send

As part of my Servicing Course, I send you the speaker, tubes, chassis, transformer, loop antenna, EVERYTHING you need to build this modern, powerful Radio Receiver! I also send parts to build many other Radio circuits. You use equipment for practical experience and to earn EXTRA money in spare time.

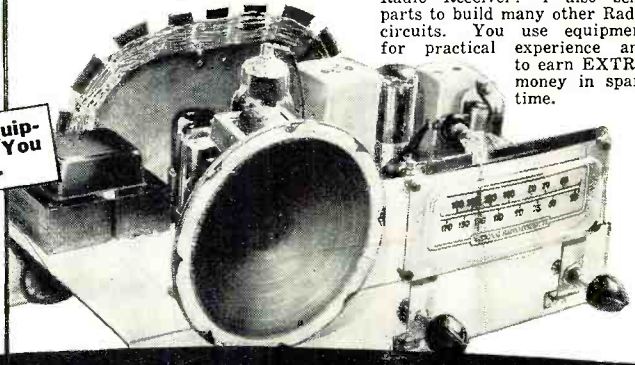

BE A RADIO-TELEVISION TECHNICIAN

NOW! Advanced Television Practice

New, special TV kits furnished to build high-definition SCOPE . . . RF OSCILLATOR with flyback power supply . . . complete TV set . . . many other units. You see pulse, trapezoidal, saw-tooth wave forms. Get valuable PRACTICAL EXPERIENCE locating and correcting TV troubles. Pictures and prices!

Learn Servicing or Communications Practice at Home in Spare Time



J. E. SMITH, President
National Radio Institute

Do you want good pay, a job with a bright future and security? Would you like to have a profitable shop or store of your own? If so, find out how you can realize your ambition in the fast growing, prosperous RADIO-TELEVISION industry. Even without Television, the industry is bigger than ever before. 90 million home and auto Radios, 3100 Broadcasting Stations, expanding use of Aviation and Police Radio, Micro-wave Relay, Two-way Radio for buses, taxis, etc., are making opportunities for Servicing and Communications Technicians and FCC-Licensed Operators.

Television is TODAY'S Good Job Maker

In 1950, over 5,000,000 TV sets sold. By 1954, 25,000,000 TV sets estimated. Over 100 TV Stations now operating. Authorities predict 1,000 TV Stations. This means more jobs, good pay for qualified men all over the United States and Canada.

Many Make \$10 Extra a Week in Spare Time

Keep your job while training. Hundreds of successful RADIO-TELEVISION TECHNICIANS I trained had no previous experience, some only a grammar school education. Learn Radio-Television principles from illustrated lessons. Get PRACTICAL EXPERIENCE—build valuable multimeter—experiment with circuits common to Radio and Television. Keep all equipment. Many students make \$5, \$10 extra a week fixing neighbors' Radios in spare time. SPECIAL BOOKLETS start teaching you the day you enroll.

Send Now For 2 Books FREE—Mail Coupon

Send now for my FREE DOUBLE OFFER. You get actual Servicing lesson to show you how you learn at home. Also my 64-page book, "How to Be a Success in Radio-Television." Read what my graduates are doing, earning; see equipment you practice with at home. Send coupon in envelope or paste on postal. J. E. SMITH, President, Dept. 2CE, National Radio Institute, Washington 9, D. C. Our 39th Year.

Good for Both—FREE

MR. J. E. SMITH, President, Dept. 2CE
National Radio Institute, Washington 9, D. C.

Mail me Sample Lesson and 64-page Book about How to Win Success in Radio-Television. Both FREE. (No Salesman will call. Please write plainly.)

Name.....Age.....

Address.....

City.....Zone.....State.....

Approved for training under G. I. Bill

The ABC's of
SERVICING

How to Be a
Success
in RADIO-
TELEVISION

I TRAINED THESE MEN



"I have been operating my own Servicing business. In two years I did \$14,000 worth of business; net profit \$6,550. Have one full time employee, an NRI student."—PHILLIP G. BROGAN, Louisville, Ky.



"Four years ago, I was a bookkeeper, with a hand-to-mouth salary. Now I am a Radio Engineer with a key station of the American Broadcasting Company network."—NORMAN H. WARD, Ridgefield Park, New Jersey.



"When halfway through the NRI course, I made \$5 to \$8 a week fixing sets in my spare time. Am now selling and installing Television sets and antennas."—E. J. STREITBERGER, New Boston, O.



"My first job was operator with KDLR, obtained for me by your Graduate Service Dept. I am now Chief Engineer of Police Radio Station WQOX. I never hesitate to endorse NRI."—T. S. NORTON, Hamilton, Ohio.



EXTRA PAY IN ARMY, NAVY, AIR FORCE

Knowing Radio, TV, Electronics can help you get extra rank, extra prestige, more interesting duty at pay up to several times a private's base pay. You are also prepared for good Radio-TV jobs upon leaving service. Mail Coupon TODAY.

Have Your Own Business

Many N.R.I. trained men start their own Radio-Television sales and service business without capital. Let me show you how you, too, can be your own boss, have a good income from your own shop. Send coupon for FREE book now!

Tested Way to Better Pay

Editor
OLIVER READ, D.Sc., D.Litt.

Managing Editor
WM. A. STOCKLIN, B.S.

Technical Editor
H. S. RENNE, M.S.

Associate Editor
HAROLD BECKER

Midwest Editor
RAY FRANK, W9JU

Assistant Editor
P. B. HOEFER

Television Consultant
WALTER H. BUCHSBAUM

Short-Wave Editor
KENNETH R. BOORD

Staff Artist
FRANK SAYLES

Chief Draftsman
B. L. NEWMAN, W9ROB

Advertising Manager
L. L. OSTEN

Midwest Adv. Manager
JOHN A. RONAN, JR.

Western Adv. Manager
JOHN E. PAYNE

Color Art Editor
HERMAN R. BOLLIN



COVER PHOTO: Assembling a Collins "Pre-Fab" unit. Pre-punched chassis and pre-assembled circuits simplify the construction, particularly for the beginner.
 (Anso color photo by R. E. Collins)

Chairman of the Board and Publisher
WILLIAM B. ZIFF

President
B. G. DAVIS

Secretary-Treasurer
G. E. CARNEY

Vice-Presidents
M. H. FROELICH
H. J. MORGANROTH
Production Director
LYNN PHILLIPS, JR.
Advertising Director

H. G. STRONG
Circulation Director
LOUIS ZARA

BRANCH OFFICES
 CHICAGO (11)
 185 N. Wabash, AN 3-5200
 LOS ANGELES (14)
 815 S. Hill St., Uicker 9213

RADIO TELEVISION NEWS

First in
radio-television-electronics
 Average Paid Circulation over 200,000

Radio News Trademark Reg. U. S. Pat. Office • Television News Trademark Reg. U.S. Pat. Office

CONTENTS

MARCH, 1952

Radio Control on the Citizens Band.....	Vernon C. MacNabb	35
The Loudness Control—An Aid to Higher Fidelity.....	Ron Pickett	38
Selling Maintenance—And Yourself.....	Yvon O. Johnson	40
Problems of Indoor Antenna Reception.....	E. M. Noll & M. Mandl	42
A Midget V.F.O.	W. W. Purvis, W3QQA	43
The Electronic Brain "Codetyper".....	Nathaniel G. A. Dorfman	46
Corner Loudspeaker Enclosure.....	Richard H. Dorf	48
A Low-Cost Audio Amplifier.....	Frederic T. C. Brewer	50
"Pre-Fab" Tuners	W. H. Collins	52
150-Watt Universal R.F. Amplifier.....	John F. Clemens, W9ERN	53
Crystal Diodes in Modern Electronics (Part 6).....	David T. Armstrong	56
High Quality 50-Watt Amplifier.....	James Baumgardner	58
Electrostatic Focus for Picture Tubes.....	Walter H. Buchsbaum	62
Interlacing Troubles and Vertical Sync Circuits.....	John K. Frieborn	64
A Dual-Channel AM Receiver.....	Glen Southworth	66
Saturable Reactors	Erwin Levey	68
Mac's Radio Service Shop.....	John T. Frye	70
Audio Simplified (Part 7).....	David Fidelman	72
Check That Picture Tube.....	F. C. Kroeger	84
Radio-TV Service Industry News.....		100
Folded Long Wires.....	Bob Perthel, W9MWD	125

DEPARTMENTS

For the Record.....	The Editor	8	What's New in Radio.....	94
Spot Radio News.....		16	Technical Books.....	131
Within the Industry.....		24	Manufacturers' Literature.....	134
Short-Wave.....	K. R. Boord	71	New TV Products.....	156



VOLUME 47 • NUMBER 3



Member
 Audit Bureau of
 Circulations

Editorial and Executive Offices, 366 Madison Ave., New York 17, N. Y.

RADIO & TELEVISION NEWS is published monthly by the Ziff-Davis Publishing Company at 185 N. Wabash Ave., Chicago 1, Illinois. Entered as second-class matter July 21, 1948, at the Post Office, Chicago, Ill., under the act of March 3, 1879. Entered as second-class matter at the Post Office Department, Ottawa, Canada. Postmaster—Please return undelivered copies under form 3589 to 64 E. Lake St., Chicago 1, Ill.

SUBSCRIPTION RATES: **RADIO & TELEVISION NEWS**—in U.S., Canada, Mexico, South and Central America, and U.S. Possessions, \$4.00 for twelve issues; in British Empire, \$5.00; all other foreign countries, \$5.00 for twelve issues. **RADIO-ELECTRONIC ENGINEERING EDITION**—in U.S., Canada, Mexico, South and Central America, and U.S. Possessions, \$6.00 for twelve issues; in British Empire, \$7.00; in all other foreign countries, \$7.00 for twelve issues. **SUBSCRIPTION SERVICE:** All communications concerning subscriptions should be addressed to Circulation Dept., 64 E. Lake St., Chicago 1, Ill. Subscribers should allow at least two weeks for change of address.

CONTRIBUTIONS: Contributors are advised to retain a copy of their manuscripts and illustrations. Contributions should be mailed to the New York Editorial Office and must be accompanied by return postage. Contributions will be handled with reasonable care, but this magazine assumes no responsibility for their safety. Any copy accepted is subject to whatever adaptations and revisions are necessary to meet the requirements of this publication. Payment covers all author's, contributor's, and content's rights, title, and interest in and to the material accepted and will be made at our current rates upon acceptance. All photos and drawings will be considered as part of the material purchased.

Copyright 1952 by Ziff-Davis Publishing Company. All rights reserved.

RADIO & TELEVISION NEWS

**... GET EVERYTHING YOU
NEED TO LEARN AND MASTER
TELEVISION
RADIO-ELECTRONICS
.AT HOME!**

**Use REAL commercial-type equip-
ment to get practical experience**

Your future deserves and needs every advantage you can give it! That's why you owe it to yourself to find out about one of the most COMPLETE, practical and effective ways now available to prepare AT HOME for America's billion dollar opportunity field of TELEVISION-RADIO-ELECTRONICS. See how you may get and keep the same type of basic training equipment used in one of the nation's finest training laboratories . . . how you may get real STARTING HELP toward a good job or your own business in Television-Radio-Electronics. Mail the coupon today for complete facts — including 89 ways to earn money in this thrilling, newer field.

D.T.I., ALONE, INCLUDES BOTH MOVIES and HOME LABORATORY In addition to easy-to-read lessons, you get the use of HOME MOVIES — an outstanding training advantage — plus 16 big shipments of Electronic parts. Perform over 300 fascinating experiments for

**Get BOTH of these
Information packed
publications FREE!**

**89 WAYS
TO
EARN
MONEY
IN TELEVISION
RADIO-ELECTRONICS**

**YOU GET
ALL 6**

practical experience. Build and keep real commercial-type test equipment shown at right

MODERN LABORATORIES

If you prefer, get all your preparation in our new Chicago Training Laboratories—one of the finest of its kind. Ample instructors, modern equipment. Write for details!

MILITARY SERVICE!

If you're subject to military service, the information we have for you should prove very helpful. Mail coupon today.

ACT NOW! MAIL COUPON TODAY!

DE FOREST'S TRAINING, INC. Dept. RN-3-1
2533 N. Ashland Ave., Chicago 14, Ill.

Without obligation, I would like your Opportunity News Bulletin showing "89 Ways to Earn Money in Television-Radio-Electronics"; also, the folder showing how I may prepare to get started in this thrilling field.

Name.....Age.....
Address.....Apt.....
City.....Zone.....State.....



17 INCH TUBE

**Here's the
REAL THING!**

**SET UP YOUR OWN
HOME LABORATORY**

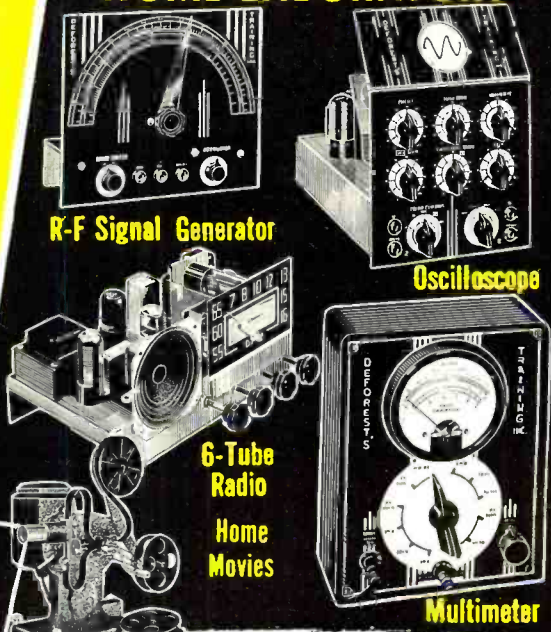

R-F Signal Generator

Oscilloscope

**6-Tube
Radio
Home
Movies**

Multimeter

**"ONE OF AMERICA'S FOREMOST
TELEVISION TRAINING CENTERS"**

DeFOREST'S TRAINING, INC.
CHICAGO 14, ILLINOIS
A DeVRY INSTITUTION

LOOK CLOSELY

and you'll see why
They outperform all others!



Available in 1/2, 1,
and 2-watt sizes

OHMITE
Little Devil
INSULATED
COMPOSITION
RESISTORS

**INDIVIDUALLY
MARKED AND
COLOR-CODED**

Each unit is marked with resistance and wattage values, in addition to the color coding. Quick, positive identification — no guesswork or mistaken identity!

**RATED AT
70C (158F)**

Built to withstand extremes of heat, pressure, and humidity without deterioration. Under full continuous load for 1000 hours, resistance change is less than 5%.

**MOLDED PLASTIC
COMPLETELY SEALS
AND INSULATES**

Solid-molded body has high mechanical and insulating strength. Units meet JAN-R-11 requirements, including salt-water immersion and humidity tests.

COMPACT SIZE

ONE - HALF WATT size is only 3/8" long, 9/64" in diameter; ONE WATT is 9/16" long, 7/32" diameter; TWO WATT is 11/16" long, 5/16" diameter.

**TEMPERED COPPER
LEADS IMBEDDED
DEEP IN THE BODY**

Differential tempering of leads near body prevents sharp bends and resistor damage. Copper leads are locked in — anchored deep in the body for permanence.



**SEND FOR
BULLETIN 135**

Gives complete data and list of RMA values. Includes dimensional drawings and handy color codes.

Look inside an OHMITE Little Devil resistor, then you'll begin to understand why these tiny composition units have become the standard for *dependable performance* among design engineers, servicemen, and amateurs the world over. Packed into each unit is a ruggedness, stability, and current-carrying capacity unmatched by any other on the market. Little Devils come in 1/2, 1, and 2-watt sizes in $\pm 5\%$ or $\pm 10\%$ tolerance. Furnished in standard RTMA values, 10 ohms to 22 megohms. In 1-watt size, $\pm 10\%$ tolerance, values as low as 2.7 ohms are available.

AVAILABLE ONLY FROM YOUR DISTRIBUTOR
OHMITE MANUFACTURING COMPANY
4884 Flournoy Street, Chicago 44, Illinois

Be Right with **OHMITE**
RHEOSTATS • RESISTORS • TAP SWITCHES

RADIO & TELEVISION NEWS



Service Clinic!

Engineering information to help you better service Raytheon

VIDEO "PUNCH" AND "SNAP"

The Video Amplifier Response must be capable of resolving the finest picture detail contained in the video signal at present standards. The video amplifier is to respond with uniform gain as near to 4.5 MC as the art will permit. This provides the "snap" in the picture detail. A non-uniform response will cause a phase shift "smear."

The Video Capability must fully drive the picture tube (with full rated HV) from black to maximum brilliance at picture whites. This gives the picture that "punch" that is needed for a full contrast range even in bright daylight. A two stage video insures the necessary drive.

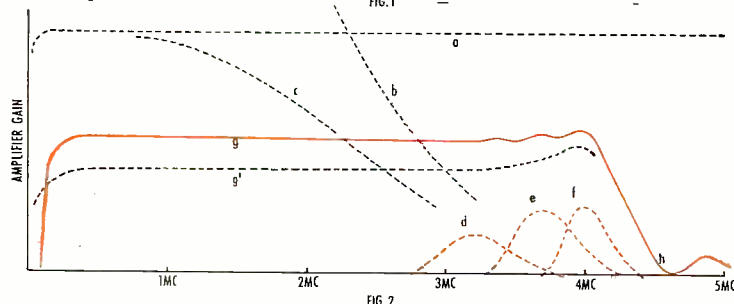
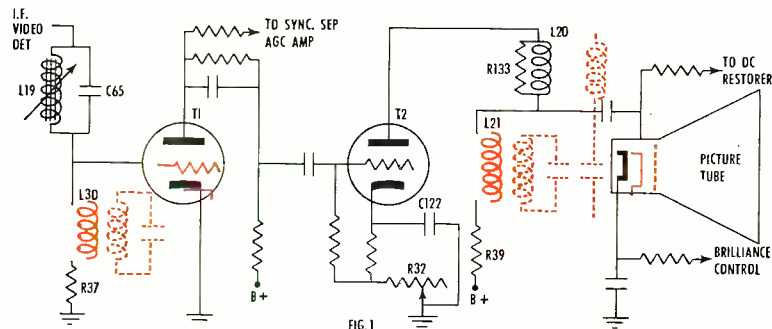

Video Peaking networks are used to extend the frequency range of a resistance coupled amplifier. The amplifier gain as illustrated in Fig. 2 (Curve a) will be shunted by the capacity at the input grid of the picture tube, Curve b, to form a falling off response (Curve c). A low plate load resistor will extend the response but the stage gain is reduced. However, the tube capacity may be used in series (L 20 and Curve f) or shunt (parallel) resonance (L 21, L 30, Curve e and d) to extend the range of a practical plate load resistor (R 39) to form Curve g. Point h is the 4.5 MC sound trap (L 19 and C 65).

The Plate Load Resistors (R 39 and R 37) will determine the Q or the effecting range of the shunt peaking coils. In series peaking, damping (R 133) may be required to keep the Q down so as to prevent "ringing." A cathode feed-back contrast control (shunted by C 122) will provide added "snap" to the high frequency detail when the contrast control (R 32) is reduced as shown in Curve g.

Improved Circuitry such as this is one of many reasons why you can feel free to recommend Raytheon TV to a friend or customer.

Raytheon TV Presents JOHN CAMERON SWAYZE Sundays on NBC. See local paper for time and station.

© BELMONT RADIO CORP.



Belmont Radio Corp., 5291 W. Dickens Ave., Chicago 39, Ill.
Subsidiary of Raytheon Manufacturing Co.

March, 1952



Dependably Built for Dependable Performance



THE STARLIGHT—Model RC-1720

For the RECORD.

BY THE EDITOR

PRE-RECORDED MAGNETIC TAPE

NEW! 2ND EDITION
of the only complete
reference on **AUDIO!**

"The Recording & Reproduction of SOUND"

by OLIVER READ

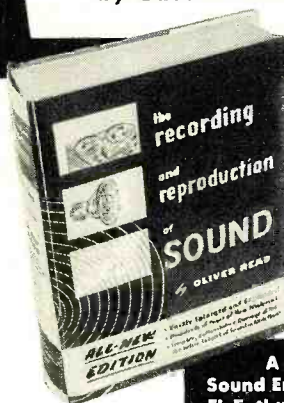

Completely revised and vastly enlarged new edition
OVER 800 PAGES

A "Must" for Sound Engineers, Hi-Fi Enthusiasts, P. A. Men, Broadcasting Stations, Recording Studios, Students

largest selling book in its field

CONTENTS:

A Partial List of Authoritative Chapters:

Behavior of Sound Waves; Basic Recording Methods; Lateral Disc Recording; Microgroove Recording; The Decibel; Phono Reproducers; Stylis; Microphones; Loudspeakers and Enclosures; Dividing Networks and Filters; Attenuators and Mixers; Home Music Systems; P.A. Systems; Amplifiers; AM and FM Tuners—PLUS HUNDREDS OF OTHER SUBJECTS

Now you can have all the *right* answers to any subject in the field of Audio. Learn how to select and get the most out of recording equipment. Tells you how to select the proper amplifier for given applications, how to test amplifier performance, how to eliminate hum. Explains microphone, speaker and pickup principles and selection factors. Shows how to utilize inverse feed-back, expanders and compressors. Covers hundreds of subjects—a vast wealth of reliable information found in no other single volume. If you work in the field of Audio, this book belongs in your library. Order your copy today!

6" x 9" **ONLY \$7.95**
Hard Covers 800 pages 700 illustrations

ORDER TODAY

Order from your Parts Jobber, or write direct to HOWARD W. SAMS & CO., INC. 2201 E. 46th St., Indianapolis 5, Ind.

My (check) (money order) for \$..... is enclosed.

Send copy(ies) of *The Recording & Reproduction of Sound (RR-2)*. \$7.95 per copy.

Name.....

Address.....

City..... State.....

THE production of pre-recorded magnetic tape is analogous to music on records only in that an original must be reproduced in great quantity and with a minimum of loss in fidelity with respect to the original. We all know how the multiplication of an original disc is achieved through quality-control pressing processes and injection molds. Some twenty million turntables now in use attest to the acceptance of the phono-record. But you can't duplicate an original tape in a pressing machine or in an injection mold.

Up to a year ago there were two or three attempts to market music which was pre-recorded on magnetic tape. Unfortunately for the industry as well as the entrepreneur the products were poor and the enterprises failed. One venture which reached catalogue proportions failed because its production fell far short of the high fidelity standards now demanded of any pre-recorded music.

Industry is literally crying for a tape multiplication technique which is economical in its use of labor time.

The catalogue of tape music which we mentioned before as having failed made use of a technique evolved with the assistance of a development laboratory. The company achieved some interesting results—interesting in that it did turn out copies. The quality of these copies might have been adequate if another phenomenon in American life had not taken place. And that phenomenon is the growth of the high fidelity market—music lovers who insist on distortionless reproduction. With the advent of this phenomenon and the "discriminating ear" which is now in itself a rapidly growing industry, the quality of that pre-recorded tape music caused a public rejection.

Well, what is one to do? Should one invent the barrow before discovering the wheel? If there is no barrow, what good is the wheel? If there is a wheel and no barrow, what to do with the wheel? The analogy is: If there is no one who wants to create a catalogue of pre-recorded magnetic tape music and who is willing to invest in the introduction and marketing of a quality catalogue, how is either the wheel or the barrow to come about? What would then be the encouragement or stimulus for the invention of a tape multiplication technique?

Or, look at it this way: If there had been no such thing as a phonograph record to be played, there would not have been a phonograph player. If there had not been a phonograph play-

er, there would not have been a reason to invent a record presser. When it became practicable to press records economically in quantity, it became commercially feasible to produce record players which were within the means of the general public, again increasing the demand for records and bigger and better process facilities, a cycle that is profitable to industry.

Even though several past attempts to pre-record on magnetic tape have failed, at least one company has invested time, effort, and money with the firm belief that from continued pioneering there would evolve a workable technique that could produce limited quantities of high fidelity tape. *A-V Tape Libraries, Inc.*, New York is doing such a pioneering job. This technique, while not the final answer, does produce copies of original masters that are indistinguishable from the master in fidelity. The technique is, briefly, one of direct, high-speed re-recording from a tape playback machine to a bank of studio tape recorders. The major disadvantage is that the process is long, tedious, and not the most economical way of making long-runs of thousands of copies of one original recording.

We have run tests on and have listened to these pre-recorded tapes and can attest to their excellence. Believing that there will be an ever increasing demand for this medium of recorded music, we are making a complete study of ways and means to promote pre-recorded magnetic tape as the ultimate medium for high fidelity music.

One or two others have already taken steps to develop new processes and techniques for the mass production of tapes. The *Tape Recording Industries* of Lansing, Michigan have submitted selections for our review. Using high-speed re-recording techniques it will be interesting to compare their products with those produced by *A-V Tape Libraries* or by others entering this new field.

Audio enthusiasts will welcome the feature article next month describing and illustrating the technique employed by *A-V Tape Libraries*.

The public has been honestly and well educated to the advantages of magnetic tape. Even before the availability of pre-recorded magnetic tape they had bought over a half million recorders. It will be interesting to chart future sales of record players and tape machines to see how they compete with one another in dollar volume. O. R.

RADIO & TELEVISION NEWS

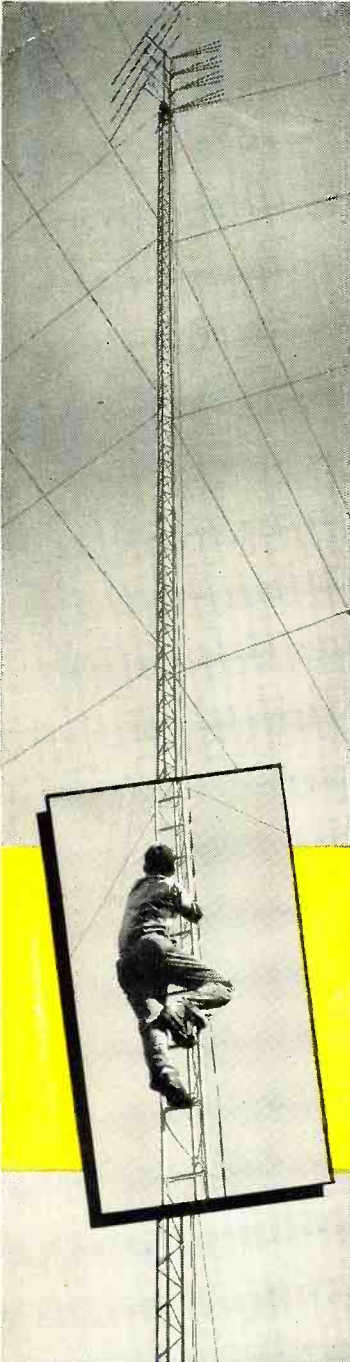

new!
TOWERS
 by Channel Master

- Steel tubular uprights.
- Built-in ladder with no obstructions.
- One standard interchangeable section which can be used as a top, middle or bottom section.
- Universal base mount.
- Dual purpose mast or rotor mounting brackets.

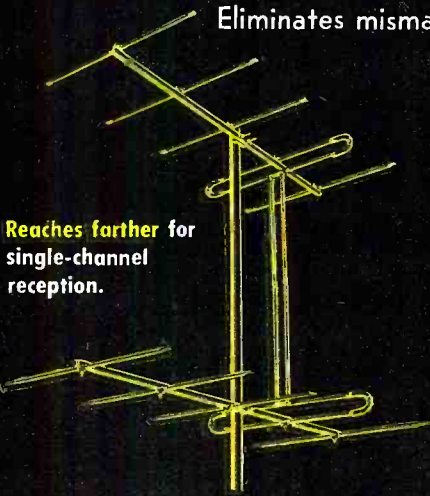

Reaches farther for single-channel reception.

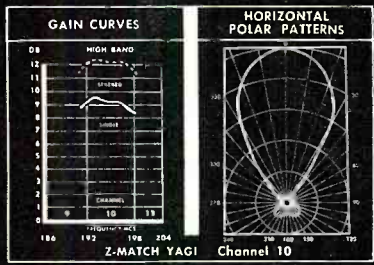

*Patent Applied For

Eliminates mismatch! Outperforms standard Yagis!

Z-MATCH YAGI*

600 Series

- Perfect match to 300 ohm line, single or stacked.
- Wider spaced elements for higher gain.
- 100% gain in stacking!
- Completely preassembled.

How The Z-Match Yagi Works

When antennas are stacked, the center feed bars of the folded dipoles are removed, automatically creating a perfect 300 ohm match for the entire stacked Yagi array. These same center bars are then used as half-wave connecting rods. This means

YOU DON'T PAY FOR STACKING BARS!

developed by

CHANNEL MASTER



For "Far Reaching" Results

There's only ONE

SUPER FAN

313 Series

The most widely used antenna in the nation.

The highest gain broad-band antenna ever developed.

New reinforced fibreglas inserts in all elements and reflectors.

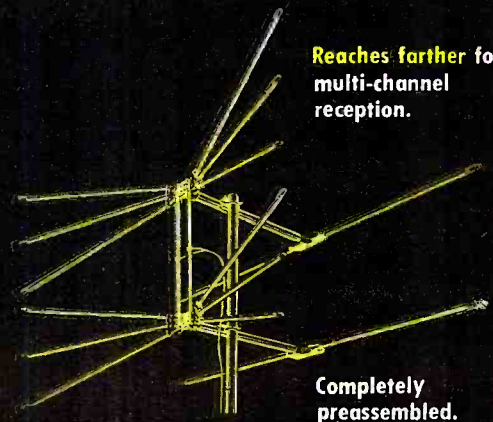

Reaches farther for multi-channel reception.

Completely preassembled.

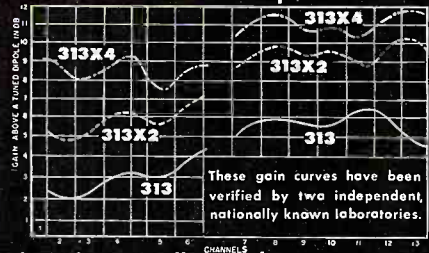

These gain curves have been verified by two independent, nationally known laboratories.

Write for technical literature on these 3 outstanding products.

CHANNEL MASTER CORP. ELLENVILLE, N. Y.



IMPORTANT ANNOUNCEMENT TO SERVICE DEALERS!

Your used
PICTURE TUBES are
 now worth **\$2.25 to \$5.25**

Sylvania Tube Distributors offer trade-in allowance on more than 40 picture tube types . . . of any make.

Here's the best picture tube news you ever heard. It's the Sylvania GLASS ALLOWANCE PROGRAM. You can make \$2.25 to \$5.25 more on every picture tube you sell.

You also protect your reputation by installing only new, fully guaranteed Sylvania Picture Tubes in your customers' sets. The process is simple! No strings attached!

Here's all you do!

1. Return old picture tubes to your Sylvania tube distributor. Sylvania has made it possible for him to give you a GLASS ALLOWANCE CREDIT of from \$2.25 to \$5.25 per used tube on the purchase of any new Sylvania picture tube.
2. Return tubes may be of ANY MAKE but must be types shown on the suggested Sylvania Glass Allowance Price List. (See list below.)
3. Returned tubes must be under vacuum and free from chips, scratches, etc.
4. New tubes purchased need not be the same as those returned. You may choose any type Sylvania has for sale.

Sylvania reserves the right to change cash values or tubes shown on the suggested Glass Allowance Price List. SO ACT NOW. Take your used picture tubes to your Sylvania Dis-

tributor . . . TODAY! For further details call your Sylvania Representative or Sylvania Electric Products Inc., Glass Department, Seneca Falls, New York.



Here's your Suggested Glass Allowance PRICE LIST

(Clip this list and keep it handy)

12KP4A	\$2.25	17AP4	\$2.25	20CP4	\$4.25
12LP4A	2.25	17BP4	2.25	20CP4A	4.25
12VP4	2.25	17BP4A	2.25	20DP4	4.25
		17BP4B	2.25	20DP4A	4.25
16JP4A	3.25	17FP4	2.25	20FP4	4.25
16KP4	3.25	17FP4A	2.25	20GP4	4.25
16KP4A	3.25	17HP4	2.25	20HP4	4.25
16LP4A	3.25	17HP4A	2.25	20HP4A	4.25
16QP4	3.25	17JP4	2.25	20JP4	4.25
16RP4	3.25	17KP4	2.25		
16TP4	3.25	17LP4	2.25	21EP4	5.25
16UP4	3.25	17QP4	2.25	21EP4A	5.25
16XP4	3.25	17RP4	2.25	21FP4	5.25
16ZP4	3.25	17SP4	2.25	21FP4A	5.25
				21KP4	5.25
				21KP4A	5.25

SYLVANIA



RADIO TUBES; TELEVISION PICTURE TUBES; ELECTRONIC PRODUCTS; ELECTRONIC TEST EQUIPMENT; FLUORESCENT TUBES; FIXTURES; SIGN TUBING; WIRING DEVICES; LIGHT BULBS; PHOTOLAMPS; TELEVISION SETS

TRAIN

for Security! Good-Paying Jobs!

MAKE THE MONEY YOU'VE ALWAYS DREAMED OF!

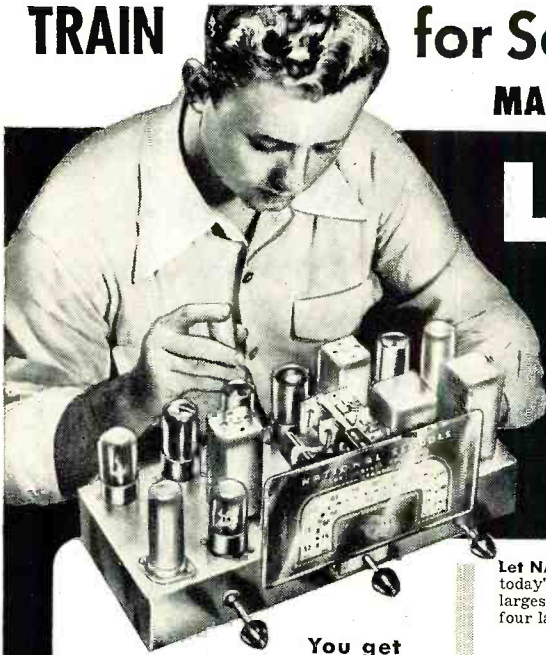

LEARN RADIO -TELEVISION AND ELECTRONICS BY EASY SHOP METHOD TRAINING AT HOME!

You get all the parts—even tubes!— for this modern Superheterodyne Receiver. You learn to build it step by step. And you keep it! Get all the facts. Mail coupon now.

Let **NATIONAL SCHOOLS**—a resident-training school for nearly 50 years—train you at home for today's unlimited opportunities in Radio-Television-Electronics. National Schools is one of the largest schools of its kind. It is located in Los Angeles—the center of Radio and TV world! It has four large buildings of modern shops and labs. Its faculty is considered tops in the business.



You learn from lessons prepared by experienced instructors and engineers. Men who are successful Radio and Television technicians. Men who have trained 1000's of men like YOU!



FREE BOOK TELLS YOU HOW!

Page after page—in color—tells you everything you want to know. Mail the coupon. Get this valuable book today. And if you hurry—YOU GET A FREE SAMPLE LESSON TOO! Shows how easy National Schools Home Training is. Mail the coupon today.

You Train At Home—In Your Spare Time

National Schools Shop Method Home Training gives you basic and advanced instruction in all phases of Radio-TV-Electronics. And remember—your training is based on resident school training principles. You learn fast from hundreds of diagrams and pictures. All instructions are written by experienced technicians who work in Radio and TV every day. All instructions have been developed and tested in National Schools' own labs and studios, which are equipped with the latest RCA equipment. No wonder this National Schools course is so up-to-date, practical, interesting. And so easy to learn! And no wonder it is held in such high regard by leaders of American industry! Approved for eligible Veterans.

We Teach You How To Make Welcome Extra Money—While You Learn!

Many National Schools students—men like you—make plenty of extra dollars each week in spare time! Fixing neighbors' radios, appliances—and other ways we teach you. You start learning and earning from the day you enroll. From the very first lesson!

WE SEND YOU LOTS OF PARTS LIKE THIS!

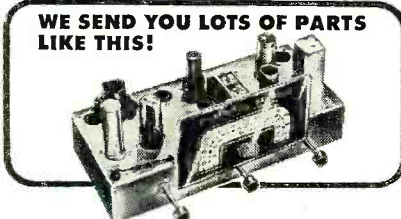

With National Schools Shop Method Home Training, you get basic principles and plenty of practical training. You learn by doing. No wonder you learn so fast! We send you many parts—all of professional, modern quality. You do lots of practical experiments. You advance day by day, step by step. Until you can even build the modern Superheterodyne Receiver you see above—plus other important testing units. The free book tells you all about it. The free sample lesson shows how easy the training is. Use the coupon. Send today—without fail!

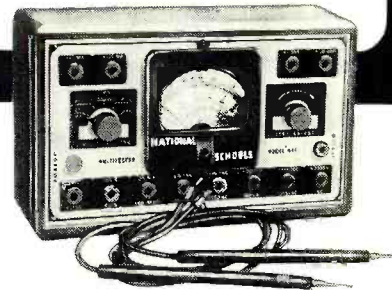

Only National Schools Gives You This Professional Multi-Tester!

You get this amazing, new testing instrument—factory-made and tested—complete—ready to use! Simple to operate. Accurate and dependable. An instrument every Radio-TV man needs. Light enough to carry around—so you can use it at home or on service calls. You'll be proud to own this valuable equipment.

Here are only a few of the Good-Paying Jobs You Can Choose

Radio Station Engineer, District Service Manager, Aircraft Radio Inspector, Own Your Own Repair Shop, Inspector Technician, Service Specialist, Special Government Jobs, Complete TV Service, Sound Truck Operator. Many more! National Schools graduates have secure, good-paying jobs like these! So don't wait—mail the coupon today. Now—while you're thinking about it!

Attention! Men Going into Service Soon!

National Schools' course quickly prepares you for many important jobs in the Armed Services. With National Schools Training you have an opportunity to get into special service classifications—with higher pay and grade—immediately!

FREE SERVICE FOR GRADUATES

National Schools uses its great influence and prestige to help you find your place in the field of your choice. Don't put it off! Start yourself toward a skilled trade! Get the big pay you've always wanted!

NATIONAL SCHOOLS
LOS ANGELES 37, CALIFORNIA • ESTABLISHED 1905
In Canada: 193 Hastings St., Vancouver 4, B.C.

Today's Shortage of Trained Technicians Creates Chance of a Lifetime For You!

Think of it! With guided missiles, radar, and other electronic devices so important to national defense! With big, new developments in TV. With over 90,000,000 home and auto radios, over 12,000,000 TV sets. With more than 3100 radio stations...over 100 TV stations—and more building every day...yes, imagine the great opportunity you have today! YOU are wanted in Radio-Television-Electronics! America's fastest-growing field. High-pay jobs—the kind you've always wanted—are waiting for YOU!

Job Security! Big Money! For YOU! in Today's Expanding Industries!

Trained Radio and Television technicians really make important money these days. Thousands of National Schools graduates—men just like you—are earning good money all over the country. Why not you? And—National Schools graduates get the personal satisfaction of being highly-skilled technicians. Men people respect. Men who enjoy their work—rather than having to drag along in just any old job.

National Schools Has Trained 1000's of Successful Men! Why Not YOU?

In almost every state—and many foreign countries—National Schools graduates are filling big jobs with famous companies. Or running their own successful businesses. What are YOU waiting for? National Schools training is complete training. So when you graduate you can take advantage of today's big opportunities in Radio-Television-Electronics—fast.

**DON'T PUT IT OFF!
GET THE BIG SALARY YOU HAVE ALWAYS WANTED!**

MAIL THIS COUPON TODAY—WITHOUT FAIL!

NATIONAL SCHOOLS, Dept. HR-32
4000 South Figueroa Street
Los Angeles 37, California

Mail in envelope or paste on penny post card.

Mail me FREE the book mentioned in this ad. Also a free sample lesson. I understand no salesman will call on me.

NAME _____ AGE _____

ADDRESS _____

CITY _____ ZONE _____ STATE _____

Check here if you were released from the Service less than 4 years ago.

What
kind
of
men?

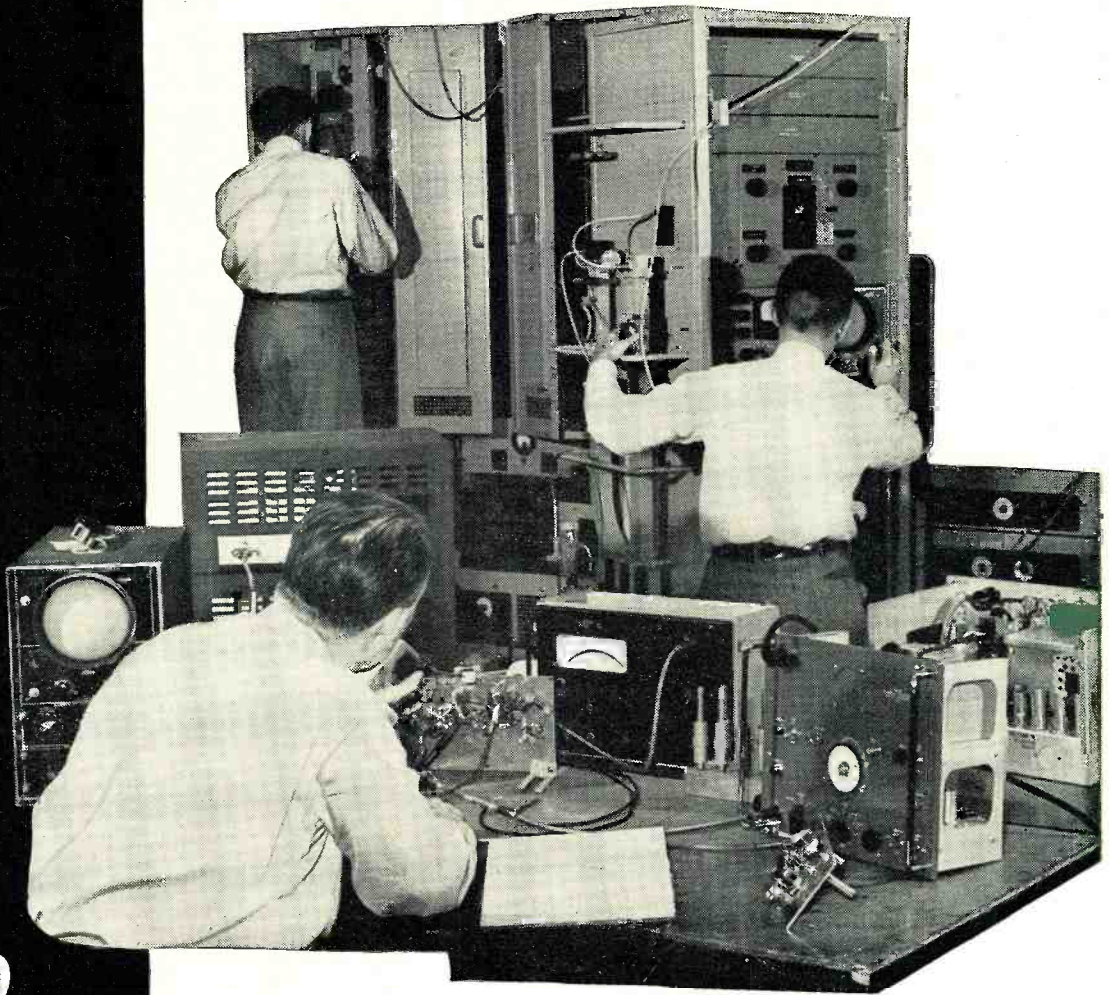

What kind of men are the 2500 scientists and engineers of Bell Telephone Laboratories?

They are men of many types, yet they work well together, for all have good minds as a foundation, years of study in the fundamentals of their science and in the methods of research and design. Vital, too, is their teamwork — for without the co-operation of many individuals the products of research and development could never be perfected.

Above all else these men have “the spirit to adventure, the wit to question, and the wisdom to accept and use.”

Such men can develop the world’s finest telephone systems — and have done so.

Perhaps there is a place among them for you. Write the Employment Director, Bell Telephone Laboratories, New York 14.



BELL TELEPHONE LABORATORIES

• EXPLORING AND INVENTING, DEVISING AND PERFECTING FOR CONTINUED IMPROVEMENTS AND ECONOMIES IN TELEPHONE SERVICE

RADIO & TELEVISION NEWS



Aluminum Voice Coil SPEAKERS



DAVE MARKS, President
Fort Orange Radio Distributing Company, Inc.
Albany, New York

"OUR FASTEST SELLING SPEAKER LINE FOR THE PAST 7 YEARS!"

Quality Product Plus Smart Promotion Spell Success for Aggressive Parts Jobber

"MY dealer customers don't bother to open the cartons — as they do with other brands — before buying G-E speakers. They know that General Electric factory-packed Alnico units come to them in perfect shape, ready for use. Customer confidence pays off. Because I stock all 27 G-E models, my dealers know I can fill any speaker need."

What Dave Marks does not mention is that his merchandising skill has made him one of the top parts distributors in the East. He makes frequent and profitable use of all G-E sales tools: catalogs, booklets, envelope stuffers, display pieces of all kinds. They're available to you, too, through your General Electric distributor or representative. Call him today for your share of these sales helps.



Drive-In Theatre Speaker Sales Hot! With G.E.'s special weather-tested outdoor speaker, Dave Marks, shown here with general manager Ted Sharaf, has increased his drive-in business four times over in two years!

DEALERS AND SERVICEMEN



Here's a complete new service manual on all General Electric television receivers — 102 models manufactured since 1945! You get 80 pages packed with circuit diagrams, symbols and numbers, tube locations, top and bottom chassis views. Plus photographs and lists of service aids. Mail coupon for it today. Only \$1.00.



GENERAL ELECTRIC

General Electric Company, Section 932
Electronics Park, Syracuse, New York

Send me.....copies of the new 80-page service manual on General Electric TV receivers at \$1.00 each. I enclose \$.....

Check Money Order

NAME.....

ADDRESS.....

CITY..... STATE.....

PRESENTING COLLINS AM-FM "PRE-FAB" TUNERS

NOW you can
build a Collins
AM-FM tuner from
the Pre-Fab units
shown below!

COMPLETE VERSATILITY is the byword in this new tuner design. Through the addition of the AM circuit, the Collins tuner will meet all requirements for home music systems and installations where a fine tuner is required.

ECONOMY: The very finest in tuner design is offered you at exceptionally low prices. Collins quality is your assurance of a fine product that will work to your complete satisfaction. You cannot duplicate this tuner in its completed form at twice the price!

**3 Ways to purchase
COLLINS Tuner . . .**

1. As an AM tuner kit
2. As an FM tuner kit
3. As an AM-FM tuner kit

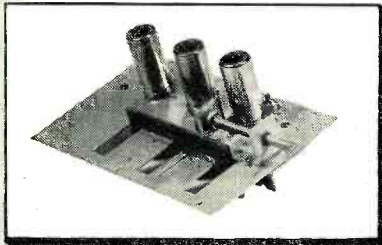

FM Tuning Unit **\$15.25**

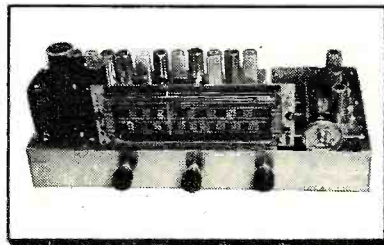

The Collins FM-AM Pre-Fab Tuner Kit As It Looks
After You Assemble It (Total Kit Cost **\$69.00**)

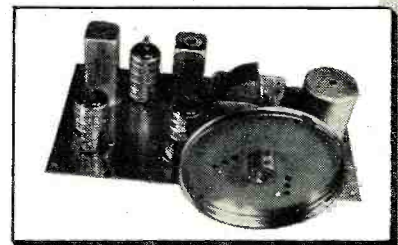

AM Tuning Unit
(Includes IF and Audio Amplifier) **\$19.25**



FM IF Amplifier **\$19.75**

Tuning Eye Kit
Available At

\$2.85

UC-2 Universal Chassis Kit **\$14.75**

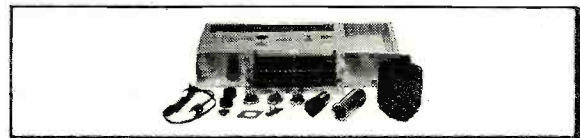

ALL PRE-FAB UNITS ARE ASSEMBLED, WIRED, TESTED, AND ALIGNED AT FACTORY. PRICES SHOWN INCLUDE TUBES.

The FM tuning unit employs a 6J6 dual triode RF amplifier; 6AG5 converter, and 6C4 oscillator. Permeability tuned, stable, and drift-free. High sensitivity of between 6 and 10 microvolts. Dimensions: 7 1/4" x 4 1/2". The IF amplifier for FM uses 6 tubes! 6BA6, (4) 6AU6, and 6AL5 discriminator. High gain, wide band response for highest fidelity reception. Frequency response of FM section, plus or minus 2 DB, 20 to 20,000 cycles. Distortion less than 1/2 of 1%. Dimensions: 11 3/16" x 2 1/2".

The AM tuning unit utilizes a super-het circuit employing three tubes: 6BE6 converter, 6BA6 IF amplifier, and 6AT6 detector. Extremely high sensitivity and selectivity is accomplished through the use of new, high gain iron-core transformers. Careful alignment provides widest response available from this type of circuit. If builder desires, triode amplifier section of 6AT6 tube may be used as first audio stage.

Chassis Kit includes all necessary parts. Nothing else to buy! Instruction Manual included with detailed, step-by-step procedure, pictures and schematic diagrams. Chassis measures 8" x 17" x 2 1/2". Overall, the tuner, when assembled, measures 8" x 17" x 6".

**MAIL ORDER COUPON
TODAY!**

TO: COLLINS AUDIO PRODUCTS CO. INC.
P.O. Box 368, Westfield, N.J.

Enclosed Find Check Money Order For

AM Tuning Unit

FM Tuning Unit

FM IF Amplifier

UC-2 Chassis Kit

M-1 Tuning Eye Kit

NAME _____

ADDRESS _____

CITY _____

STATE _____

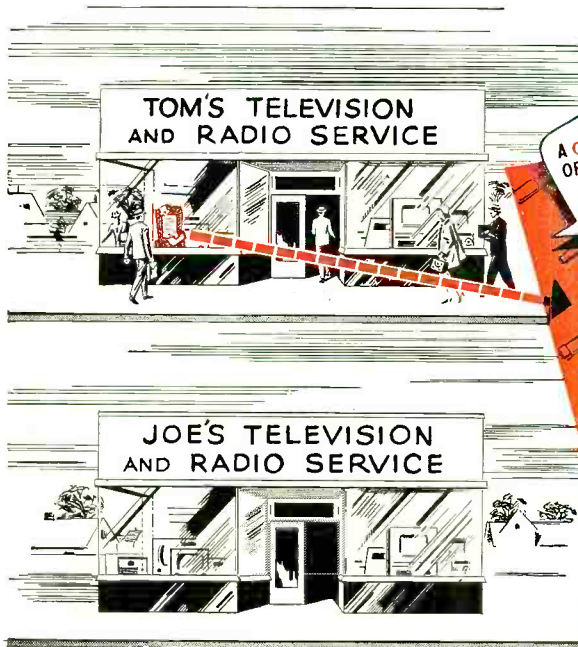

A CASH BOND OF PROTECTION
for You!

In Guarantee of Efficient Dependable Television and Radio Repair Work

- THIS REPAIR SHOP IS BONDED TO...
- 1 Guarantee all **radio** and **television** repair work for 90 days.
 - 2 Use only parts of recognized quality.
 - 3 Charge not over established prices for parts.
 - 4 Test customers' tubes as accurately as possible.
 - 5 Keep labor charges at a reasonable level.
 - 6 Perform only such work as is necessary.
 - 7 Maintain proper equipment for good repair work.
 - 8 Maintain high quality service.

RAYTHEON
BONDED
ELECTRONIC TECHNICIANS

Right... for Sound and Sight



"Here's why Tom gets my service business!"

Today's wary customers want to know *how you do business* as well as *how capable a technician you are*. That's why thousands of Radio and Television Service Dealers across the nation are discovering that, all other things being equal, their status as RAYTHEON *Bonded Electronic Technicians* tips the scales in their favor.

If you don't know how this exclusive Raytheon *Bonded Program* builds customer confidence and good will by cash-protecting your radio and television service 90-day guarantee, *at no cost to you*, you'd better get in touch with your Raytheon Tube Distributor. He'll be happy to tell you whether you can qualify for this important sales aid.



RIGHT... FOR SOUND AND SIGHT



RAYTHEON MANUFACTURING COMPANY

Receiving Tube Division

Newton, Mass., Chicago, Ill., Atlanta, Ga., Los Angeles, Calif.

RECEIVING AND PICTURE TUBES • RELIABLE SUBMINIATURE AND MINIATURE TUBES • GERMANIUM DIODES AND TRANSISTORS • RADIAC TUBES • MICROWAVE TUBES

Excellence in Electronics

VEE-D-X

Single Channel BOOSTERS

Engineered for
GREATER POWER
and
SUPERIOR PERFORMANCE

The Sensational MAST-MOUNTED ROCKET

- 18 DB Gain
- Easy to Install
- Low in Price



Amplifies signal at antenna height where most favorable signal-to-noise ratio exists. Delivers 18 db gain. Easy to install and low priced. Uses 300 ohm transmission line. Compact control unit fits snugly against back of TV set.

\$34⁹⁵ LIST

original OUTBOARD BOOSTER

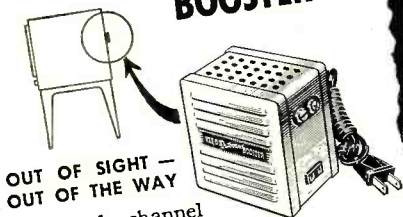

OUT OF SIGHT —
OUT OF THE WAY

For single channel use. Delivers powerful 18 db gain with full 5 megacycle band width. No special tuning tool required.

\$19⁹⁵ LIST

THE LaPOINTE-PLASCOMOLD CORP.
Windsor Locks, Conn.

Gentlemen:
Please send me details onthe Rocket
.....the Outboard.

NAME
STREET
CITY ZONE ... STATE

Spot Radio News

★ Presenting latest information on the Radio Industry.

By RADIO & TELEVISION NEWS'
WASHINGTON EDITOR

TV AND RADIO, which have become such vital forces in our way of life, and won a pre-eminent position in Washington where their power and influence are deeply respected, was accorded a vibrant welcome in the Capitol as Congress reconvened for the new year. Not only were the legislators concerned with the growing strength and effect of the sight and sound arts, but with several pending measures which sought to introduce new types of control. Among the items which seemed to interest most representatives and senators was Senator William Benton's proposal for a National Citizen's Advisory Board on Radio and Television, and Senator Ernest W. McFarland's bill to streamline the FCC. Both had been introduced in earlier sessions with impressive results. The McFarland measure had been "ayed" by the Senate and was up for House approval, when the '51 session concluded. Senator Benton's plan, which had been presented to the Senate Interstate and Foreign Commerce Committees, was slated for many more review conferences.

The advisory board idea has been and still is strongly opposed by many industry groups which have described the suggestion as contrary to American principles of freedom and absolutely unnecessary in the light of the stern new code recently adopted by the broadcasters. One of the strongest opponents of the measure is Dr. Du Mont, who has bitterly criticized the plan on many occasions, noting that station operators are fully capable of policing their programming departments. Describing the care applied in this direction in the *Du Mont* television station operation, the eminent pioneer declared during a hearing on license renewals that . . . "We shall always be alert to the fact that our programs are 'guests' in the homes of viewers, and shall always be guided by principles of programming which will make our programs acceptable and satisfying to families and their components insofar as their interests extend. . . . We shall abide by the television broadcasting code, but this shall not be restrictive in terms of expenditure of efforts to make our standards even higher." He cited the special attention given to programming for children . . . "to encourage a healthy orientation for a child to his social surroundings and develop a respect for his parents." De-

scribing the continuing need for the highest moral standards in all programming formats, Dr. Du Mont said that the policy of *Du Mont* will be . . . "to raise and never lower the educational, moral, cultural, political, and entertainment standards of the average home."

Acknowledging that television was in its infancy and subject to many variables, the picture-tube authority declared that broadcasters have and will continue to adhere to the cardinal principles of diligently serving the public interests.

Not only have many members of industry censured the government-control idea of Senator Benton, but some members of the Commission have voiced their opposition, too. It is believed that these blasts of discontent may alter the views of some of the committee members and perhaps effect a shelving of the move.

A budget problem, circling the TV-radio world, also faced Congress as it got together. The FCC spiraled a request at the legislators that prompted many frowns. They asked for about two million dollars more than they received for the fiscal year '52, or about eight-million as a total appropriation. About \$600,000 of this money was needed, it was said, for additional hearing examiners and staff to handle the expected increase in filings and applications for new stations which will certainly result as soon as the freeze is ended. The remainder of the extra dollars was required, explained the Commission, for monitoring stations; a request that had been relayed to the budget committee last summer and denied because of military-fund requirements.

Congressional committees have quite a whirling agenda before them to complete before the hectic presidential-campaign days appear on the scene.

THE EMERGENCY COMMUNICATIONS PLAN, which was approved by the President shortly before the Christmas holidays of '51 and entered in the books as the law of land, has become a priority project of all broadcasters who will be required to obey a series of strict regulations involving perhaps complete silencing when the Air Force believes an air attack is imminent.

Presently, two sets of techniques have been suggested for broadcast sta-

RADIO & TELEVISION NEWS

UHF



*All UHF channels...
for all TV sets*

MALLORY UHF CONVERTER

The Mallory UHF converter is right for *all* your TV customers because it can be used with *any* TV set... in *any* UHF broadcast area. And it's easy to install—no adjustments or connections to make in the TV set... just connect power lines and antenna leads.

These Mallory features mean real customer satisfaction... real sales for you in the new UHF market—

- Reception of all UHF channels
- No sacrifice of VHF channels
- Built-in UHF antenna
- High quality picture definition
- Fast, easy installation

No larger than a small portable radio, the Mallory UHF converter is precision-built for long, trouble-free service. Get complete details today on the Mallory UHF converter from your Mallory distributor.

P. R. MALLORY & CO., Inc.
MALLORY CAPACITORS... CONTROLS... VIBRATORS...
 SWITCHES... RESISTORS... RECTIFIERS...
 VIBRAPACK* POWER SUPPLIES... FILTERS

APPROVED PRECISION PRODUCTS

P. R. MALLORY & CO., Inc., INDIANAPOLIS 6, INDIANA

*Make Sure...
Make it Mallory*

Famous Guns

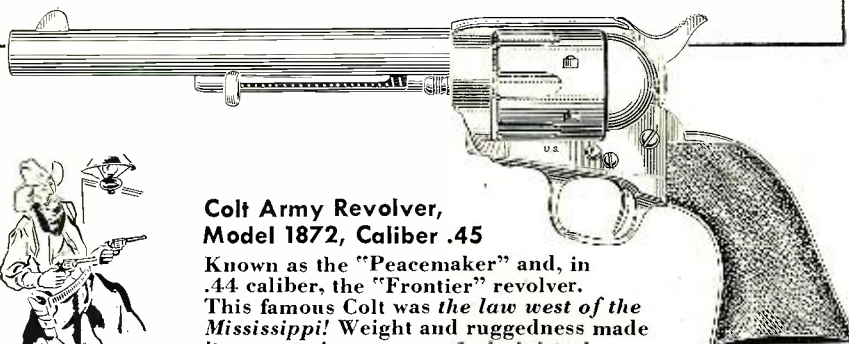

Colt Army Revolver, Model 1872, Caliber .45

Known as the "Peacemaker" and, in .44 caliber, the "Frontier" revolver. This famous Colt was the law west of the Mississippi! Weight and ruggedness made it a convenient means of administering a "pistol whipping".

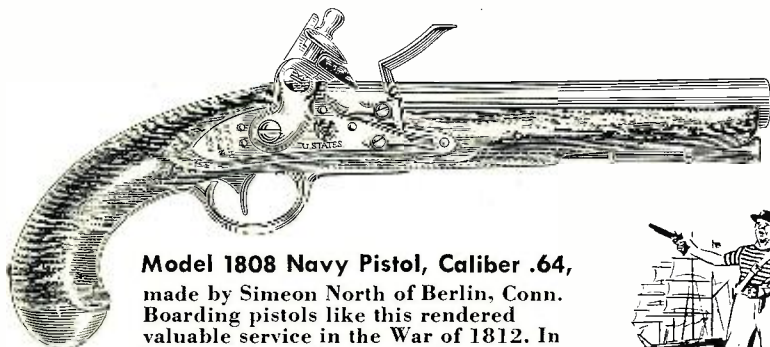

Model 1808 Navy Pistol, Caliber .64,

made by Simeon North of Berlin, Conn. Boarding pistols like this rendered valuable service in the War of 1812. In building them, North actually used a modern mass production technique—standardized parts!



Instant-heating

Weller Soldering Gun for light or heavy work. Dual heat greatly increases tip life. Switch instantly to high or low heat as job requires. Pre-focused spotlights end "blind soldering". Exclusive tip-fastening arrangement assures full, constant heat. High-impact plastic housing. Perfect balance. Low-cost replaceable tips. Pays for itself in a few months. See at your Distributor or write for Bulletin direct.

Get **SOLDERING TIPS**, new Weller Handy Guide to faster, easier soldering. 20 pages fully illustrated. Price 10c at your Distributor or order direct.

Weller BETTER FROM GRIP TO TIP

SOLDERING GUNS 810 Packer Street, Easton, Pa.

The Finest Soldering Tool for the Finest Craftsmen

tion procedure involving reduction of power and frequency stages, the latter to be used by stations in single-market areas, and the former to be effected by clusters of stations operating in multiple-transmitter areas. Stations may be obliged to alter their setups through the installation of new crystals and modification of their antennas. It will also be necessary to have emergency standby power. Most operators have indicated that the changes should not be too difficult to make. Since standby power is a feature at most transmitter plants, no difficulties are anticipated.

Amateurs will also play quite a role in the emergency plan. The Commission has proposed a Civil Emergency Service for the hams which would permit the boys to provide radio communication for civil defense purposes on a local, area, and national basis. The new rules state that those now holding ham tickets should apply for additional authorization to operate in the new service. Authorizations will be granted upon the express understanding that the grant is subject to change or cancellation at any time, without hearing, if at the discretion of the Commission, the action is necessary for national defense and security.

In Philadelphia, a striking demonstration of the operation of one of the key links in the communication plan, civil defense mobile radio, was offered recently. On view was a bomb-proof, insulated, air-conditioned 28-foot van, equipped with a 10-kilowatt emergency power supply, 70-watt public-address system, a two-way system, four sets of antennas, walkie-talkies, a sixteen-line-phone board, cables, and transmission-line reels. The two-way setup provided contact to all police cars and also with police headquarters. In addition, it was possible to make contact with fire equipment and fire base stations. Even planes, flying overhead, could be reached on a special CAA-assigned frequency. Hams operating mobile transmitters were also contacted. According to the CD authorities, it will be possible to receive and transmit on three amateur channels and reach over one-hundred hams who operate mobile facilities within the city, and a hundred-odd more who are just beyond the city limits. Contact with broadcast stations operating AM, FM, and TV facilities was also described as being possible from the emergency center, believed to be the first of its kind in the country.

COMPONENT SHORTAGES, particularly on the resistor and selenium-rectifier front, which it has been said may become acute, received a bright, hopeful appraisal recently in Washington, when it was disclosed that European sources could supply millions of resistors, potentiometers, and rheostats, and a substantial supply of selenium cells, too. The surprising information was uncovered by Ed Morris, Jr., serving as chairman of the

(Continued on page 96)

RADIO & TELEVISION NEWS



earn RAD O TELEVISION

**-New Package Unit Plan- PAY AS YOU LEARN
NO MONTHLY PAYMENT CONTRACT TO SIGN!**

**I Send You
18 BIG
KITS
OF RADIO-
TELEVISION
EQUIPMENT**

**TRAIN IN 10 MONTHS OR LESS
At Home in Your Spare Time**

Now . . . be ready for Radio-Television's big pay opportunities in a few short MONTHS! Frank L. Sprayberry's completely new "Package" training unit plan prepares you in just 10 MONTHS . . . or even less! Equally important, there is NO monthly payment contract to sign . . . thus NO RISK to you! This is America's finest, most complete, practical training—gets you ready to handle any practical job in the booming Radio-Television industry. In just 10 months you may start your own profitable Radio-Television shop . . . or accept a good paying job in this fascinating expanding field at work you've always wanted to do. Mr. Sprayberry has trained hundreds of successful Radio-Television technicians—and stands ready to train you in less than one year, even if you have no previous experience. You learn by DOING . . . actually working with your hands with equipment of special design to illustrate basic theory instead of relying on books alone.

VALUABLE EQUIPMENT INCLUDED WITH TRAINING

The new Sprayberry "package" plan includes many big kits of genuine, professional Radio-Television equipment. While training you actually perform over 300 demonstrations, experiments and construction projects. In addition, you build a powerful 6-tube standard and short wave radio set, a multi-range test meter, a signal generator, signal tracer, many other projects. All equipment is yours to keep . . . you have practically everything you need to set up your own service shop. The interesting Sprayberry book-bound lessons and other training materials . . . all are yours to keep.

EARN EXTRA MONEY WHILE YOU LEARN!

All your 10 months of training is AT YOUR HOME in spare hours. Keep on with your present job and income while learning . . . and earn EXTRA CASH in addition. With each training "package" unit, you receive extra plans and ideas for spare time Radio-Television jobs. Many students pay for their entire training this way. You get priceless practical experience and earn generous service fees from grateful customers. Just one more reason why the Sprayberry new 10 MONTH-OR-LESS training plan is the best Radio-Television training in America today. If you expect to be in the armed forces later, there is no better preparation than good Radio-Television training.

FREE 3 BIG RADIO TELEVISION BOOKS

I want you to have ALL the facts about my new 10-MONTH Radio-Television Training—without cost! Act now! Rush the coupon for my three big Radio-Television books: "How to Make Money in Radio-Television," PLUS my new illustrated Television Bulletin PLUS an actual sample Sprayberry Lesson—all FREE with my compliments. No obligation and no salesman will call on you. Send the coupon in an envelope or paste on back of post card. I will rush all three books at once!

SPRAYBERRY ACADEMY OF RADIO
Dept. 25-G, 111 North Canal St., Chicago 6, Ill.

**Mail
Coupon
Today!**

**SPRAYBERRY ACADEMY OF RADIO, Dept. 25-G
111 North Canal St., Chicago 6, Ill.**

Please rush to me all information on your 10-MONTH Radio-Television Training Plan. I understand this does not obligate me and that no salesman will call upon me.

Name.....Age.....

Address.....

City.....Zone.....State.....

Please check Below About Your Experience
 Are You Experienced? No Experience

Approved for
Veterans Under
the G. I. Bill

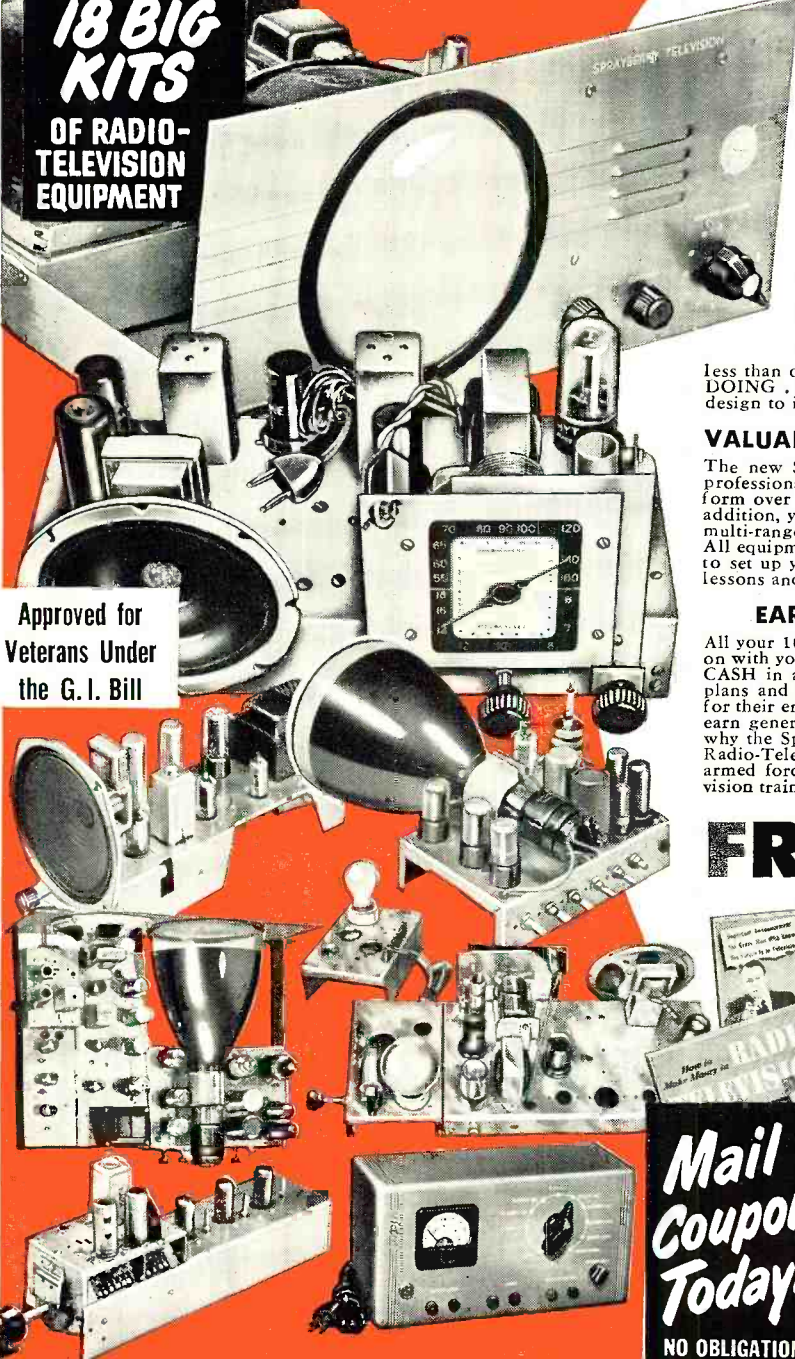

**IF YOU ARE
EXPERIENCED IN RADIO**

Men already in Radio who seek a short intensive 100% TELEVISION Training with FULL EQUIPMENT INCLUDED are invited to check and mail the coupon at the right.

**NO OBLIGATION
No Salesman
Will Call**

TRIPLETT

Load-Chek introduces Servicing by Power Consumption

MODEL 660

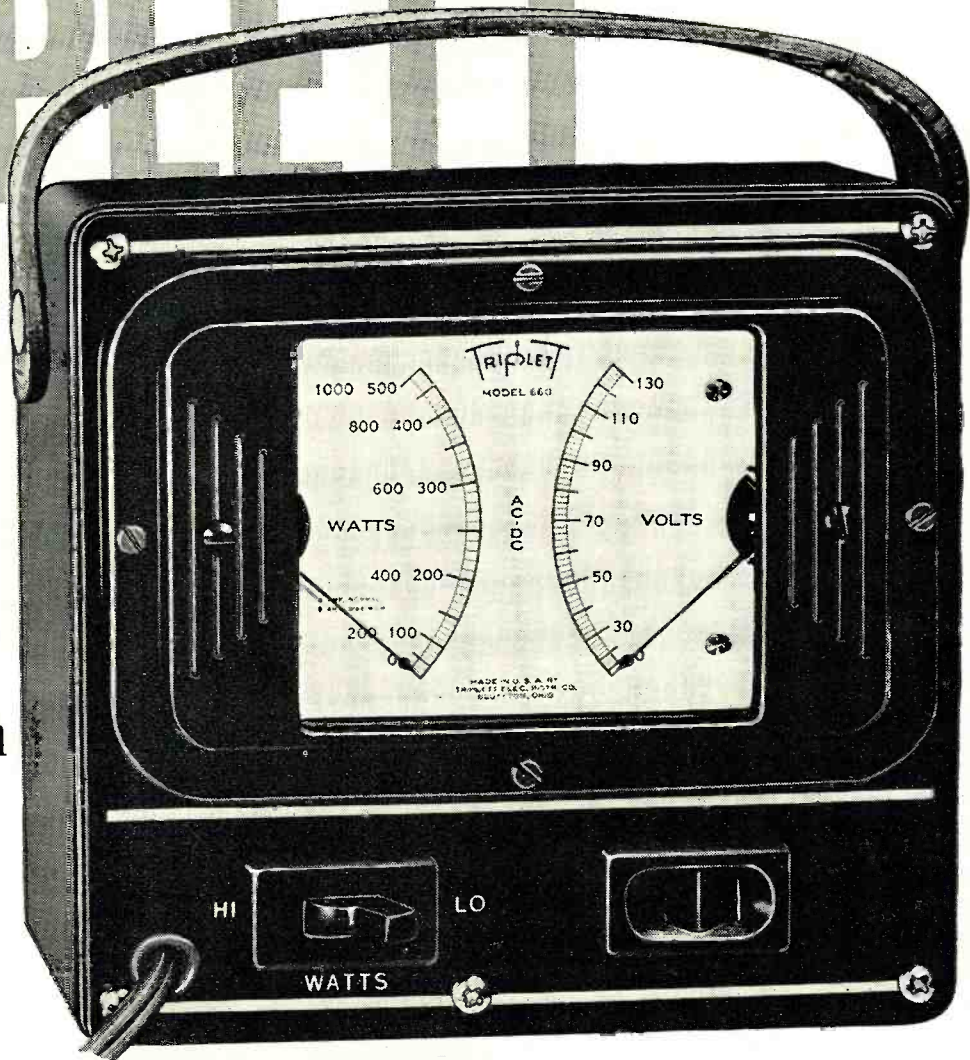

LOAD-CHEK for the first time makes it possible for every technician to utilize what is perhaps the simplest and quickest of all service methods—Servicing by Power Consumption Measurements.

Power consumption measurement has long been proved by auto-radio servicemen as a rapid method of localizing troubles in auto radios. But Triplet's new **LOAD-CHEK** is the first Wattmeter to be produced at moderate cost, and with the proper ranges, to bring this short-cut method within the reach of every radio and TV service man.

Basis of the **LOAD-CHEK** method is the tag or label on every radio and TV chassis which shows the normal power consumption. The following examples are only two of many time-saving uses of this new instrument.

LOCATING A SHORT—The chassis tag may show a normal consumption of 225 Watts. Simply plug the power cord of the chassis into **LOAD-CHEK** (there are no loose ends to connect or be in the way). Note the reading—which should be possibly 350 Watts. By removing the

rectifier tube you can determine at once which side of the tube the short is on. With a soldering iron and long-nosed pliers you can check through the chassis, locate and correct the trouble without having to lay down tools or to check with lead wires!

REPLACING BURNED OUT RESISTORS—With the chassis to be repaired plugged into a **LOAD-CHEK MODEL 660**, note the wattage reading with the burned out resistor circuit open. Now replace the resistor. Should the increase in watts be greater than that of the resistor rating being installed, it indicates that an extra load has caused the trouble which has not been cleared.

LOAD-CHEK is made-to-order for the busy service man and can help stop costly "come back" repair jobs. It's a profit-maker because it's a Time-Saver. And at its moderate cost **LOAD-CHEK** can be standard equipment on every service bench. *By all means*, inspect this versatile instrument at your distributor and place your order, for under present conditions we must fill all orders on a basis of "First Come, First Served."

SEE MODEL 660 LOAD-CHEK AT YOUR DISTRIBUTOR'S

FOR THE MAN WHO TAKES PRIDE IN HIS WORK

Triplet

TRIPLETT ELECTRICAL INSTRUMENT COMPANY - BLUFFTON, OHIO U.S.A.

RADIO & TELEVISION NEWS

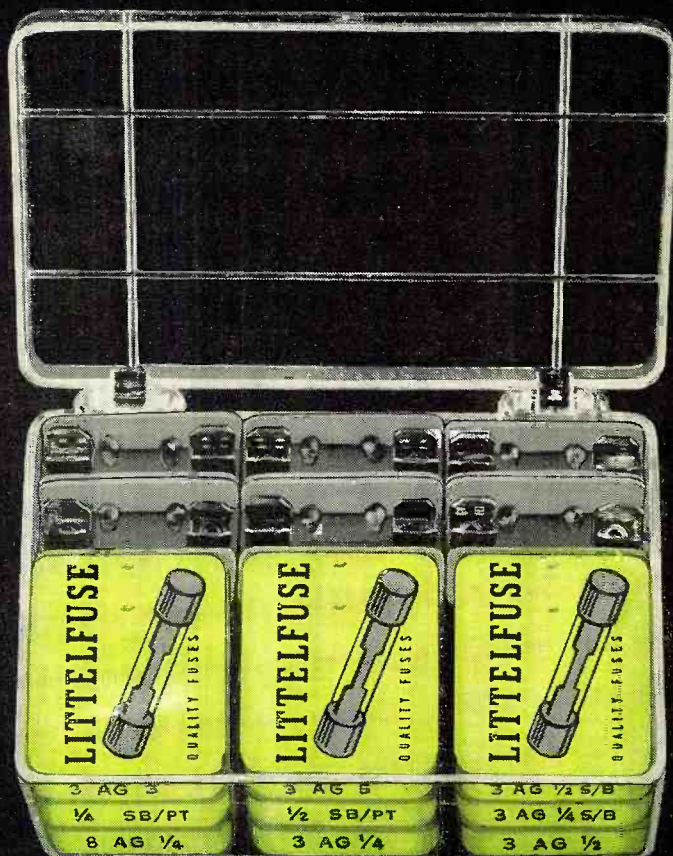

Servicemen can cover 94% of fuse replacements with this kit



*One-Call Kit Contains 45 TV fuses
(6 most in demand types) and 6 TV
snap on fuse holders in a clear
plastic hinged-cover bench box.
Another **LITTELFUSE** first.
Call your jobber today. Littelfuse, Inc.,
4757 Ravenswood, Chicago 40.
Longbeach 1-4970.*

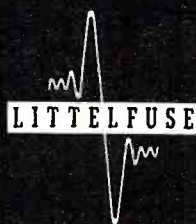

BURTON BROWNE ADVERTISING

Hallicrafters

**GUARANTEES
150-MILE T-V
RECEPTION!**

Model 1005—20" Mahogany, Smart new showpiece, with Full-View "Super Dynamic Tuner" control.
Model 1006—Same model, in Blond.



**NO "NAMBY-PAMBY" CLAIMS!
NO WEAK-KNEED PROMISES!**

A MUST FOR YOU IN '52... FOR EXPANDING SALES!

The latest market studies show television sales saturations up to 71 per cent. That means you must "beat the bushes" for fringe business if you want to expand your sales during 1952. You need Hallicrafters... the **ONLY** television that **GUARANTEES 150-MILE PERFORMANCE!** Remember, Hallicrafters has the **EXCLUSIVE, \$2,000,000 Dynamic Tuner.** This famous tuner, with its precision photo-etched circuits, delivers a clearness of picture and long-range performance unmatched by any other set!

Hallicrafters

WORLD'S LEADING MANUFACTURER OF PRECISION RADIO & TELEVISION • CHICAGO 24



*How come you
sell so many
picture
tubes,
Sam?*

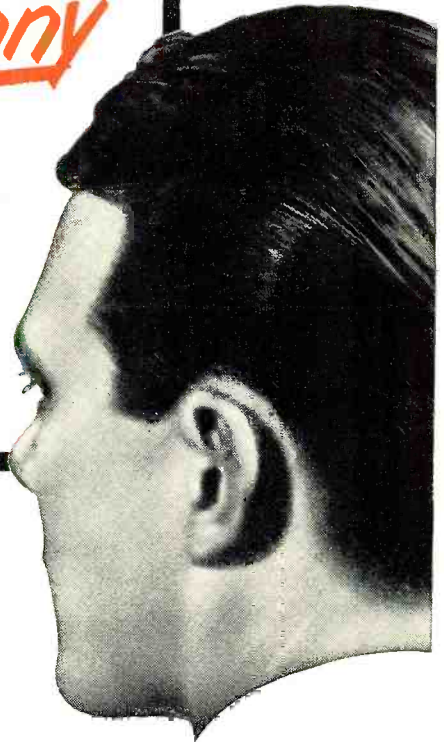

"I'm using the CBS-Hytron Easy Budget Plan, Joe. My CBS-Hytron distributor gave it to me."



"Tell me more."

"Well, CBS-Hytron's Plan helps me sell TV picture tubes and service to many a customer who just doesn't have \$50 cash. Now I make sales I'd lose otherwise. My customer pays for the job painlessly a few dollars a month. Yet I get my cash right away — and can discount my bills with my distributor."



"Fine! How does it work, Sam?"

"Simple. I introduce my customer to the finance company authorized by CBS-Hytron. The finance company does the rest. Acts as my credit department to secure me against losses. Takes care of all the details . . . paper work, collections, etc. My customer gets his tube and I get my cash — at once."



"That's swell, Sam. Now I can see why you always have plenty of working capital."

"That's right. And talk about service! This CBS-Hytron Easy Budget Plan has even brought me immediate cash from old accounts I'd written off as bad debts. CBS-Hytron is perfectly willing, too, that my regular budget loans include my service work and other components besides CBS-Hytron tubes. I owe my CBS-Hytron distributor a vote of thanks for letting me in on this wonderful Plan."



"Fair enough! I've sure been losing sales I shouldn't, Sam. I need the CBS-Hytron Easy Budget Plan. CBS-Hytron tubes are tops, too. Thanks for the tip. I'll see my CBS-Hytron distributor today."

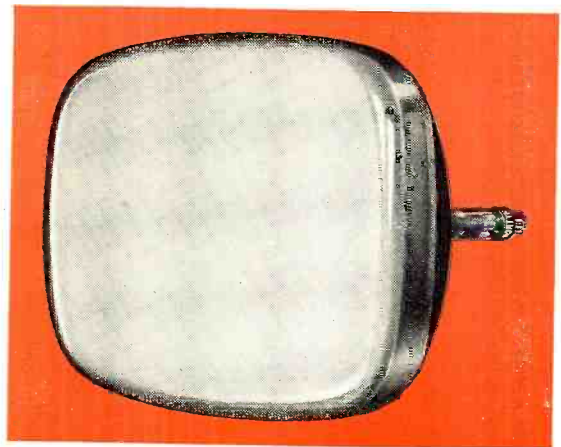

SAVE THE SALE No need for you to miss a single profitable picture-tube sale . . . just because your customer does not have the cash. Get the details on this original CBS-Hytron service for you. See your CBS-Hytron jobber . . . or mail this coupon . . . today!



MAIN OFFICE: SALEM, MASSACHUSETTS

HYTRON RADIO & ELECTRONICS CO.
SALEM, MASSACHUSETTS

Please rush me details on the CBS-Hytron Easy Budget Plan.

NAME.....
(Please print)

STREET.....

CITY.....STATE.....

FAST

TELEVISION

Tuner Alignment

to Crystal Accuracy

HICKOK



MODEL 680

**R. F. MARKER and
CRYSTAL CALIBRATOR**

EXCLUSIVE — Contains Magic Eye circuit for calibrating and crystal accuracy.

FEATURES

- Provides accurate alignment of RF and overall sections of a TV receiver. 53-89 MC and 173-217 MC on fundamentals.
- Harmonic output on UHF and VHF.
- Will calibrate any other generator to crystal accuracy by means of a built-in magic eye zero-beat indicator.
- 2.5 MC crystal supplied — 2 other crystal holders provided.
- Permits adjustment of frequency of TV local oscillators to crystal accuracy.
- Moderately priced — the 680 will prove to be a valuable investment in modern TV equipment.

See the 680 at your jobber's today, or write for full details.

THE HICKOK ELECTRICAL INSTRUMENT CO.
10524 Dupont Ave. • Cleveland 8, Ohio

Within the INDUSTRY

BERNARD TULLIUS was recently appointed sales engineer for the transmitter division of the *Allen B. Du Mont Laboratories, Inc.*



In his new post Mr. Tullius will act as a sales and technical counselor to *Du Mont* clients, aiding them in planning, laying out, and installing u.h.f. and v.h.f. transmitter equipment, coordinating transmitter design and construction work, and supervising field work of many kinds.

He has a comprehensive background in both AM and TV broadcasting and in engineering fields. He was formerly station and transmitter engineer for several Oklahoma City stations, has served as a field engineer for *Hazeltine Electronics*, and has been an instructor in television at the *Eastern School of Radio and Television*. Before joining *Du Mont*, he was a senior engineer at *Radio Engineering Labs* in Long Island City, N. Y.

ADMIRAL CORPORATION of Chicago has purchased the **MOLDED PRODUCTS CORP.**, one of the largest custom molders of plastics in the country. The plastics firm, which is located at 4533 W. Harrison Street in Chicago, will be operated as an **ADMIRAL** subsidiary.

RTMA's Transmitter Division has been reorganized to better serve the expanding electronics industry, according to H. J. Hoffman, *Machlett Laboratories, Inc.*, chairman of the division.

The division's executive committee has voted to recommend to the RTMA board of directors that the name of the Transmitter Division be changed to Technical Products Division. They also established a government relations section, under Ben Edelman of *Western Electric Co.*, to deal with problems of electronics manufacturers handling government contracts. In addition, the committee established a new general communications section, under James D. McLean of *Philco Corp.*, which will absorb the former marine and aviation sections as well as the former general communications section.

ELECTRONIC INSTRUMENT CO., INC., has purchased a six-story plant at 84-86 Withers Street, Brooklyn 11, New York, which will add more than 30,000 square feet of factory and office space to the company's facilities for producing "*Eico*" test equipment kits and instruments. . . . **BENDIX RADIO DIVISION** has opened offices at 261

McDougall Avenue in Detroit to enable the company to work more closely with auto manufacturers in the design and production of auto radios. V. C. Judd is in charge of the new office which will also handle the company's entirely new line of mobile communications equipment. . . . **BURLINGAME ASSOCIATES**, 103 Lafayette Street, New York, N. Y., has acquired an additional floor at that address to handle its increased business as representatives of some of the country's leading electronics manufacturers. . . .

RCA VICTOR DIVISION has established a West Central Region with headquarters in Kansas City. The new regional office, which is in charge of V. A. Kamin, will handle the Denver, St. Louis, Omaha, Des Moines, Sioux Falls, and Kansas City distributing areas. . . . To house its rapidly growing Communications and Electronics Division, **MOTOROLA INC.** of Chicago has purchased a new 200,000 square foot plant at 4501 Augusta Blvd. in Chicago. The new plant is immediately adjacent to the company's main radio and television factory. . . . **INSTRUMENT CORPORATION OF AMERICA** has opened a new and modern plant in Blacksburg, Va. to handle the production of miniature slip ring and commutator assemblies.

EDWIN D. FOSTER has been elected to the post of vice-president and director of planning for the *RCA Victor Division of Radio Corporation of America*.



The postwar growth and rapid expansion of the company's production facilities, brought about by the increasing demands for military electronic equipment as well as consumer products and services, has led to the establishment of a separate department devoted to business and economic planning.

As director of this new department, Vice-Admiral Foster (U.S. Navy, Ret.), will consult with product department executives on business and economic trends as they affect long-range planning of products, services, and markets.

Prior to this new assignment, Vice-Admiral Foster served as director of the company's mobilization planning department.

THE ELECTRONIC PARTS SHOW'S 1952 program is being planned to give the country's electronics parts distributors a role in determining what subjects they wish discussed at the semi-

Walter Ashe

HEADQUARTERS FOR

National

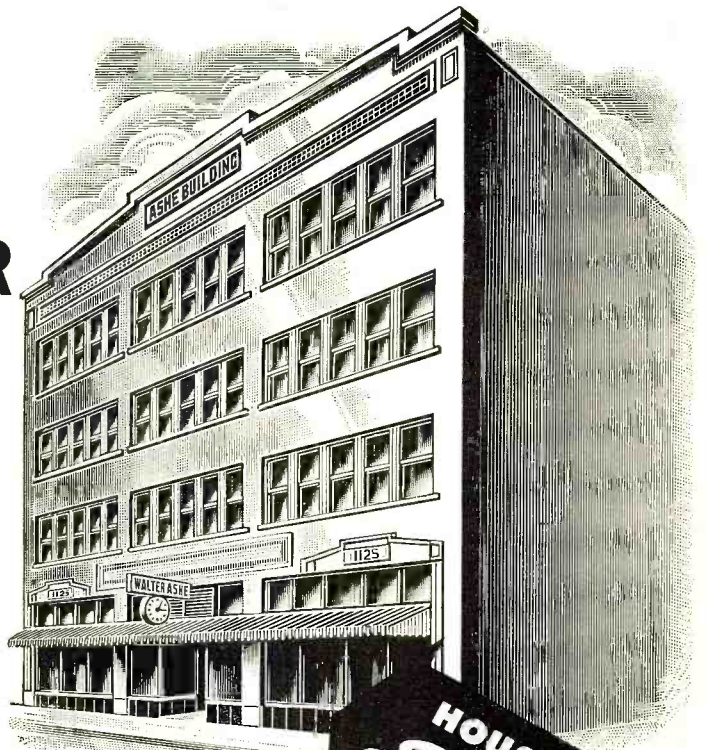
Whether you are a beginner or an old-timer, National is the equipment for you and Walter Ashe is the place where you can buy it at a record-breaking saving with a "Surprise" trade-in allowance. Trade used factory-built test or communication equipment now. What have you got to trade? Wire, write, phone or mail the handy coupon today.

A COMPLETE SERVICE

Our 4-story building is stocked with everything in Radio, Electronics, Parts and Supplies for Industry — Schools — Gov't Agencies and Research Laboratories.



NATIONAL NC-183
Shpg. wt. 64 lbs.
Only \$279.00 less speaker



NATIONAL HRO-50T1
Shpg. wt. 88 lbs.
Less speaker Only \$383.50



NATIONAL SW-54
Shpg. wt. 10 lbs.
Only \$49.95



NATIONAL NC-125
Shpg. wt. 36 lbs.
Less speaker Only \$149.50

FREE CATALOG!

164 value-crammed pages of everything in Radio and Electronics for Industry, Schools, Laboratories, Radio Stations, Service Technicians and Amateurs. The "treasure chest" of values.

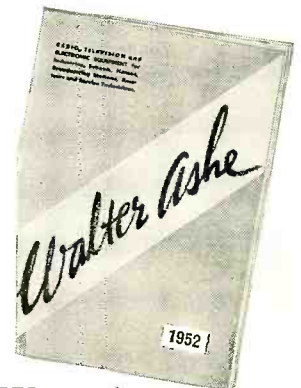

ALL PRICES F. O. B. ST. LOUIS • PHONE: CHESTNUT 1125

Walter Ashe
RADIO CO.
1125 PINE ST. • ST. LOUIS 1, MO.

Walter Ashe Radio Co. RTN-52:3
1125 Pine St., St. Louis 1, Mo.
 O. K. Walter, Rush "Surprise" Trade-in-offer on my _____
for _____
(show make and model No. of new equipment desired)
 Rush Free Copy of your new Catalog.
NAME _____ ADDRESS _____
CITY _____ Zone _____ STATE _____

SEND FOR YOUR COPY TODAY!



**AMPHENOL
-INLINE-
ANTENNA**

Be Sure
ANTENNA INSTALLATIONS
are Safe

Safety is a factor too often overlooked in many TV antenna installations. Bent or broken antennas are a constant menace and antennas that break off or topple over under any undue strain can cause serious damage. Installing an Amphenol Inline Antenna is your guarantee of all-around quality! Not only does the Inline Antenna present the best possible TV picture, but it is safe! The Inline Antenna is constructed of aluminum for light weight and strength, and is engineered to withstand winds up to 70 miles per hour. In addition, it will bear up to one-half inch annular ice loadings without bending or breaking.

LIGHTNING ARRESTOR

Using an Amphenol Lightning Arrestor on the lead-in from your Inline Antenna makes your antenna installation secure in all ways. It provides real protection to your home and TV set from lightning damage and carries off the minor static discharges which interfere with good picture reception. The Amphenol Lightning Arrestor is of the type approved by the National Electric Code and is also approved by the Underwriters' Laboratories.

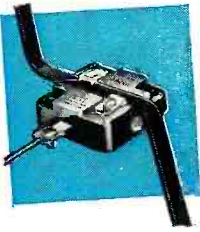

See your regular Amphenol Distributor now for your copy of this 20-page book containing all the factors which determine Better TV Picture Quality and safe antenna installation.

AMERICAN PHENOLIC CORPORATION
1830 SOUTH 54th AVENUE • CHICAGO 50, ILLINOIS



nars and group educational meetings to be held May 20 and 21 in connection with the Show.

Questionnaires have been forwarded to distributors and the committee, headed by Jack A. Berman of *Shure Brothers, Inc.*, will consider the replies carefully in making up the two-day agenda of seminars and discussion periods. To assist the distributors in evaluating the various topics under consideration for discussion at the seminars, the educational committee listed a number of major proposed subjects. On the basis of the distributors' judgment as to their timeliness, the proposed topics or those suggested by the distributors themselves will be offered on the program.

The 1952 Electronics Parts Show will be held at the Conrad Hilton Hotel in Chicago from May 19 through 22.

* * *

PHILIP BARNES is the new director of the *Weston Electrical Instrument Corporation's* sales division.

Formerly general sales manager of the company, Mr. Barnes has been associated with *Weston* for 16 years. Following his return from active duty in the U. S. Navy during World War II, he became advertising manager and then general sales manager for the firm.



At the same time Mr. Barnes' new appointment was made public, the company announced that Hubert M. Ricks had been named general sales manager, succeeding Mr. Barnes. Mr. Ricks has been associated with the company for 26 years.

* * *

INDIA'S INTERNATIONAL RADIO AND ELECTRONICS EXHIBITION which had been scheduled to take place during February 9th to 29th has been postponed to November 10th to 30th, 1952.

Further details about the exhibition are available from The Secretary, International Radio & Electronics Exhibition of India, Fateh Manzil, Opera House, Bombay, India.

* * *

FRITZ A. FRANKE is the new assistant radio sales manager for *The Hallicrafters Co.* . . . **NICHOLAS DEFALCO** has been appointed manager of the receiver quality control department of *Allen B. DuMont Laboratories, Inc.* . . . **IVOR M. LESLIE** has been elected to the dual post of vice-president and director of *Crosley Radio and Television, Ltd.*, Canadian subsidiary of *Avco*. His new title is that of general manager . . . *E. I. Guthman Company, Inc.* has added two men to its Attica, Indiana factory staff. **A. SCHWARZKOPF** is the new plant manager and **ROBERT MOORE** has taken over the job of production engineer . . . **ARMIN P. BUETOW**, general manager of *Magnecord, Inc.*, has been named executive vice-president of the organization. He joined the company in January of 1951 . . . **IRWIN WEINSTEIN**, formerly assistant chief engineer of the *Sarkes Tarzian* rectifier division, has joined the staff of *Electronic Devices, Inc.* as assistant sales manager . . . **ROGER BROWN** is the new national sales manager of *Emerson Radio and Phonograph Corporation* . . . **HENRY C. ROEMER**, executive vice-president of *Federal Telephone and Radio Corporation* since September, 1950, has been elected president of the firm, the manufacturing associate of *I. T. & T.* . . . **IRVING G. ROSENBERG** has been appointed director of operations for *Allen B. DuMont Laboratories, Inc.'s* television receiver and cathode-ray tube divisions. He has been with the company since 1942 . . . **FERDINAND W. SCHOR** has been named chief engineer in charge of military engineering for *Motorola, Inc.* of Chicago . . . The appointment of **DR. COURTNEY PITT** to the post of vice-president-finance has been announced by *Philco Corporation* . . . **ROBERT E. LEE**, manager of finance for the *General Electric Tube Department* in Schenectady, has been appointed assistant manager of the company's cathode-ray tube operations . . . **FRED T. CALDWELL**, for many years a senior officer and director of *International Telephone and Telegraph Corporation*, passed away recently in New York City. He had been associated with *I. T. & T.* in various capacities since its founding in 1920 . . . **IRVING ROBBINS** has been named vice-president and general manager of

(Continued on page 88)

the only complete catalog
for everything in Radio,
TV & Industrial Electronics

your 1952 **free!**
ALLIED 212-page
value-packed catalog



Send for it today!

Here's the *one* authoritative, complete, up-to-date Buying Guide to TV, Radio and Industrial Electronics. Make your selections from the world's largest stocks of quality equipment at lowest, money-saving prices. See the latest and most complete presentation of electronic apparatus: new TV, AM and FM receivers; High-Fidelity Custom Sound components; latest P.A. Systems and accessories; recorders; fullest selections of Amateur receivers and station gear; specialized industrial electronic equipment; test instruments; builders' kits; huge listings of parts, tubes, tools, books—the world's *most complete stocks* of quality equipment.

ALLIED gives you *every* buying advantage: speedy delivery, expert personal help, lowest prices, liberal time payment terms, assured satisfaction. Get the latest 1952 ALLIED Catalog. Keep it handy—and save time and money. Send for your FREE copy today!

**the world's
largest stocks**

- Radio Parts Unlimited
- Test Instruments
- Television & Home Radios
- P.A. and Hi-Fi Equipment
- Amateur Station Gear
- Builders' Supplies
- Equipment for Industry

quick, expert service

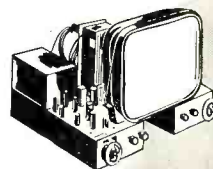

ALLIED IS YOUR TV and HI-FI HEADQUARTERS



Count on ALLIED for the latest in TV! If it's made—we have it for quick delivery. We specialize, too, in High-Fidelity sound components—everything in amplifiers, speakers, tuners, phono gear and accessories. For TV or Hi-Fi—think of ALLIED!



ALLIED RADIO
the World's Largest Radio Supply House
EVERYTHING IN ELECTRONICS

free

**SEND TODAY FOR RADIO'S
LEADING BUYING GUIDE**

ALLIED RADIO CORP., Dept. 1-C-2
833 W. Jackson Blvd., Chicago 7, Illinois

Send FREE 212-page 1952 ALLIED Catalog No. 127.

Name _____

Address _____

City _____ Zone _____ State _____

TRAIN AT HOME FOR



DO BETTER WORK...MAKE MORE MONEY with modern service methods!



The New Ghirardi RADIO & TELEVISION RECEIVER Troubleshooting and Repair

820 pages, 417 clear illustrations, price only \$6.75

A complete,
1-volume
service training
course in
time-saving
professional
methods

only \$6.75

Here's the book you've been waiting for... the new Ghirardi guide to servicing by professional methods!

In a way that could only be matched by having one of the world's greatest instructors at your side, it explains every phase of modern servicing procedure. Fully modern, profusely illustrated, RADIO AND TV TROUBLESHOOTING AND REPAIR covers all TV, FM, AM, Phonograph and recorder servicing procedures. For the beginner, it is a complete training course. For the busy serviceman, it is a quick way to brush up on specific types of work or to find fast answers to puzzling service problems.

THE GREATEST HOW-TO-DO-IT SERVICE BOOK EVER WRITTEN!

First you get a full analysis of components and why they fail. Next you learn the most modern servicing methods—from static tests to dynamic tests using signal tracing and injection techniques. You'll learn how to set up a basic servicing procedure and to interpret performance data. Four big chapters show how to re-align TV, FM, and AM receivers with a minimum of tools and equipment. Now that components are becoming scarce, you'll appreciate the chapters on how to repair as well as to replace defective transformers, chokes, loud-

speakers, coils, controls, resistors, etc. You learn how a glance at a TV receiver may quickly tell you what is wrong; how to understand 3-way portable radio filament circuits; what to do about intermittent troubles; how to check ac/dc and transformerless power supply heaters professionally; how to handle fading and propagation troubles... and dozens of others. In short, no really practical service procedure has been omitted from this great book—and all are handled so that you can't fail to understand them!

Money-saving Combination Offer



Have the service data you need at your fingertips when you need it! Make your service library complete! Get both the new Ghirardi Radio & Television Receiver TROUBLESHOOTING AND REPAIR (\$6.75) and the Ghirardi Radio & Television Receiver CIRCUITRY AND OPERATION (\$6.00) at the special price of only \$12 for the two books. Check SPECIAL COMBINATION OFFER in coupon for 10-day examination privilege. You don't risk a cent.

PASS SERVICE LICENSE EXAMINATIONS!

Many cities now require servicemen to pass rigid license examinations. Let these two great new Ghirardi books help prepare you today to pass any such examinations with flying colors!

LEARN BASIC RADIO and TV CIRCUITS from A to Z ... and watch service troubles disappear

Actually, there are only a few really basic circuits in radio and TV receivers. Learn these from A to Z and even the most complicated of the countless modern circuit variations won't bother you. You'll work faster, better—more profitably!

HANDLE TOUGH JOBS IN ½ THE USUAL TIME!

Backed with what you can learn from A. A. Ghirardi's great new book, RADIO AND TELEVISION RECEIVER CIRCUITRY AND OPERATION, you'll find that nine out of ten difficult service jobs are tremendously simplified.

Starting with a clear explanation of AM and FM processes and characteristics, it pro-

gresses to a complete understanding of ALL basic circuits, shows how they operate, teaches you to recognize them quickly. Guesswork is eliminated. Laborious testing is greatly minimized. By making it easy for you to understand each circuit and its relation to other circuits, Mr. Ghirardi helps you go right to the seat of the trouble with far less time and effort. You'll know what to look for—and you'll have what it takes to enable you to repair troubles faster and more efficiently.

RADIO AND TELEVISION RECEIVER Circuitry and Operation

669 pages, 417 illustrations, price \$6.00

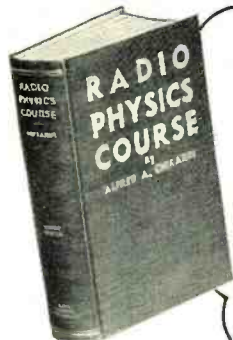

36 COURSES IN ONE

Ghirardi's world famous
RADIO PHYSICS COURSE
972 pages, 508 illus.
856 self-test review
questions. Price only \$5

COMPLETE BASIC TRAINING for BEGINNERS

More people now in Radio-TV got their basic training from this book than any other book or course of its type!

"The most complete training course in radio fundamentals ever offered"—that's what the experts say about Ghirardi's world-famous RADIO PHYSICS COURSE. More widely used by Signal Corps, Navy, etc., in World War II, than any other basic radio training text. Everything is explained so clearly that you can understand every word without previous radio training of any kind. Ghirardi's Radio Physics Course starts with Basic Electricity. Then it takes you step by step through the entire field of Radio-Electronics from simple circuits showing the basic functions of resistors, condensers, coils, transformers, etc., to the final

applications of these circuits in home, auto, and aircraft radios, public address systems, sound motion pictures, etc. Subjects covered include Sound, Speech, Music, Electron Theory, Electric Circuits, Current, Resistance, Capacitance, Inductance, Transformers, Filters, Radio Waves, Vacuum Tubes, Radio Circuits, Loudspeakers and dozens of others. You get exactly the training you need—at a price you can afford to pay. If broken into "course" form and sent as monthly lessons, you'd regard it as a bargain at \$50.00 or more. Instead you buy it for only \$5.00—and you progress as fast as spare reading time permits.

Let these great books give YOUR earning power

HIGHER PAY in 1952!

Read any of these 12 great money-making books for 10 days AT OUR RISK . . . You be the judge!

IT PAYS TO KNOW HOW TO USE THE OSCILLOSCOPE



Modern Oscilloscopes and Their Uses

by Jacob H. Ruiter, Jr.

326 pages, 370 illustrations, dozens of pattern photos. \$6.00

Now you'll really know how to use the greatest, most versatile service instrument of all—the oscilloscope! MODERN OSCILLOSCOPES AND THEIR USES gives you expert knowledge of 'scopes, helps you work faster, more accurately and more profitably on all sorts of service and laboratory jobs. No involved mathematics or theory! First, the author explains the construction and operation of cathode ray tubes and basic oscilloscope circuits. Then he gets right down to earth in telling exactly how to use a 'scope for AM, FM, and TV service work—from locating receiver troubles to aligning and adjusting the most complicated circuits. Dozens of actual pattern photos plus an unusually descriptive text teach you exactly how to analyze and interpret various patterns.

Don't let the oscilloscope "stump" you! Learn to use it fully for top notch service efficiency

MAKES AUTO RADIO REPAIR twice as easy!

SERVICING THE MODERN CAR RADIO

by A. L. Hurlbut

2nd Edition, 702 pages, 222 illus., 8 1/2x11, Price \$7.50

Used either as a text book or bench manual, Hurlbut's famous SERVICING THE MODERN CAR RADIO is a complete, easily understood guide to fast, accurate installation and servicing of all types of auto radios. Covering every type of auto radio from the mid-1930's, this compact book gives you complete installation, troubleshooting and repair procedures plus tips on how to set up shop and get business. Subjects include differences between car and ordinary radios; antennas; antenna input circuits; power supplies; circuit features; automotive electrical systems; installations; loudspeakers; interference; vibrator maintenance; alignment; push-button tuning and many others. Over 500 actual circuit diagrams and mounting drawings for car radios alone can save you many times the cost of the book.



Includes OVER 500 CAR RADIO CIRCUIT DIAGRAMS and mounting drawings

CUT SERVICE TIME IN 1/2 on hundreds of jobs

RADIO TROUBLESHOOTER'S HANDBOOK

by A. A. Ghirardi

744 Manual-size pages. Over 4800 Radio Models listed. Price \$5.00.

This big book makes it easy to make prompt repairs on over 4800 radio models WITHOUT expensive test equipment, or long hours of study. Ghirardi's RADIO TROUBLESHOOTER'S HANDBOOK lists Home and Auto receivers and Automatic Record Changers of 202 manufacturers, together with common trouble-symptoms and exactly where to locate and how to repair the defects. This is not a "study" book. Simply look up the make, model, and trouble symptom of the set you want to repair and go to work. Ideal for older sets where data is so often lacking. Hundreds of additional pages contain valuable data on tubes, parts and equipment, plus graphs, diagrams and money-making service hints.



Get off the beaten path! Start training now for the more interesting Radio-TV jobs that most students overlook! Let the following four books teach you at home. Each is complete, fully authentic. Each is endorsed by leading experts and educators in its field.

BE A SOUND EFFECTS EXPERT!

. . . The noise of a creaky door—wind—rain—wagon wheels—and dozens of other sound effects play big parts in almost every radio and TV program. This unique book, RADIO AND TV SOUND EFFECTS tells the whole story of sound effects—even down to slowing you how to make creakers, "boing" boxes, glass crashers, splashers, rain machines, thunder machines and much other special equipment for this work. Written by Robert B. Turnbull, of the Don Lee Mutual Broadcasting System, it is a complete guide to this fascinating phase of Radio-TV work. 334 pages—profusely illustrated. Price \$4.50. (Order RADIO AND TV SOUND EFFECTS in coupon.)

LEARN RADIO-TV ANNOUNCING

. . . Let the big, manual-size RADIO ANNOUNCERS' HANDBOOK by Ben G. Henneke help you train for this interesting, well-paid work! Subjects include The Announcers' Qualifications; The Announcers' Skills; The Announcers' Work; Audition Tests; Vocabulary Exercises—and over 300 pages of actual radio copy, commercials, newscasts and script shows for test and practice. More widely used than any other book of its kind. Price \$4.25. (Use coupon to read RADIO ANNOUNCERS' HANDBOOK for 10 days at OUR RISK.)

FREQUENCY MODULATION

. . . Ever increasing uses for FM in mobile radio, television sound, and home receivers open new fields for profitable service work. Written by a well-known expert, this book implies a clear understanding of FM fundamentals, equipment and servicing procedures. You'll learn basic FM theory, transmitters, circuits and their peculiarities, R-F, I-F, limiters, discriminators, ratio-detectors, squelch, AFC circuits, and tuning indicators are fully explained. Equally important is a thorough description of antenna construction, troubleshooting methods, alignment, repair and other servicing procedures. 448 pages, over 300 illustrations. Price \$5.00.

LEARN ELECTRIC MOTOR REPAIR

. . . There's big money in installing, maintaining and rewinding electric motors—and here is a big book to help you train for this fast-growing field! Every type of motor work is explained both in text and also by more than 900 helpful drawings, photos and diagrams. ELECTRIC MOTOR REPAIR book includes complete details of troubleshooting, repair and rewinding of all a-c and d-c motor types in common use plus motor control systems. Quick reference guides show how to handle specific jobs. Practice from this book for 10 days at our risk. Order ELECTRIC MOTOR REPAIR in coupon. Price \$6.00.

Get this COMPLETE GUIDE TO TELEVISION SERVICE

PRACTICAL TELEVISION SERVICING

by J. R. Johnson & J. H. Newitt
334 pages, 253 illustrations, \$4.00

Here—at only a fraction of the price you might expect to pay—is complete, intensely practical training in every phase of television receiver service procedure. You learn how TV differs from radio; how receivers operate; how to locate troubles quickly with a minimum of testing; and how to make repairs fast and profitably.

Dozens of actual service case histories help simplify your training, make even the most puzzling jobs far easier to handle. Clear illustrations and pattern photos explain details step by step. Other subjects include component replacement data, wiring details, tips on testing, and a wealth of data on fringe area reception, improving picture linearity and many other vital TV service subjects.



All about TV Components Construction Operation Troubleshooting— In language YOU can understand!

THERE'S FUN AND PROFIT in Magnetic Recording

MAGNETIC RECORDING

by S. J. Begun

242 pages, 146 illustrations, 6x9, Price \$5.00

Get started on the "ground floor" of this fast-growing business that will eventually replace the modern phonograph! MAGNETIC RECORDING brings you specific details on every phase of wire and tape recording from its history, basic acoustic and magnetic theories, through the components, circuits, and equipment in current use. Then, the author describes the many applications of magnetic recording and its use for home entertainment, motion pictures, broadcasting, amateur radio, secret communications (speech scrambling), and the rapidly expanding field of industrial sound and noise measurements. Standard equipment is fully discussed along with the instruments needed to evaluate recording performance.



LEARN NEW USES FOR MAGNETIC RECORDING IN: High-Fidelity Sound Broadcasting Industrial Measurements Sound Pictures Home Entertainment

Mail Order — 10 DAY EXAMINATION OFFER

Dept. RN-32, RINEHART BOOKS, Inc., Technical Division
232 Madison Ave., New York 16, N. Y.

Send the books checked below for 10-day FREE examination. In 10 days, I will either remit the price indicated or return books postpaid in good condition and owe you nothing.

- | | |
|---|---|
| <input type="checkbox"/> Ghirardi's Radio & TV Receiver TROUBLESHOOTING & REPAIR, \$6.75 | <input type="checkbox"/> SERVICING THE MODERN CAR RADIO, \$7.50 |
| <input type="checkbox"/> Ghirardi's Radio & TV Receiver CIRCUITRY & OPERATION, \$6.00 | <input type="checkbox"/> Ghirardi's RADIO TROUBLESHOOTER'S HANDBOOK, \$5.00 |
| <input type="checkbox"/> COMBINATION OFFER: Both of above new Ghirardi books, \$12.00 (Outside U.S.A., \$13.00) | <input type="checkbox"/> PRACTICAL TELEVISION SERVICING, \$4.00 |
| <input type="checkbox"/> Ghirardi's RADIO PHYSICS COURSE, \$5.00 | <input type="checkbox"/> MAGNETIC RECORDING, \$5.00 |
| <input type="checkbox"/> Modern OSCILLOSCOPES AND THEIR USES, \$6.00 | <input type="checkbox"/> FREQUENCY MODULATION, \$5.00 |
| | <input type="checkbox"/> Radio & TV SOUND EFFECTS, \$4.50 |
| | <input type="checkbox"/> RADIO-TV ANNOUNCERS' HANDBOOK, \$4.25 |
| | <input type="checkbox"/> ELECTRIC MOTOR REPAIR, \$6.00 |

TO ORDER BOOKS OUTSIDE U.S.A.—Add 50c to price of each book for handling through customs, etc. Cash only. Same 10-day return privilege with money refunded.

Name.....
Address.....
City, Zone, State.....
Employers' Name and Address.....

a big boost!

March, 1952

STIKIT-UP!

*the NEW
AMAZING*

INDOOR Directronic TV AERIAL SYSTEM

- ALL CHANNELS
- ANYONE CAN INSTALL
- ADHERES TO ANY SURFACE
- 360° ELECTRONICALLY-SWITCHED BEAM
- FLICK OF SWITCH CLEARS PICTURE

995 LIST



SNYDER MFG. CO. PHILADELPHIA

DALIS, New York • ALMO, Philadelphia • RADIO PARTS, Chicago
 FRESHMAN, Cleveland • WHOLESALE RADIO, Baltimore • KAEMPER & BARRETT, San Francisco
 VAN DER HOUT, Canada • Export: ROBURN AGENCIES, New York • AND OTHER DISTRIBUTORS, EVERYWHERE
 RADIO & TELEVISION NEWS

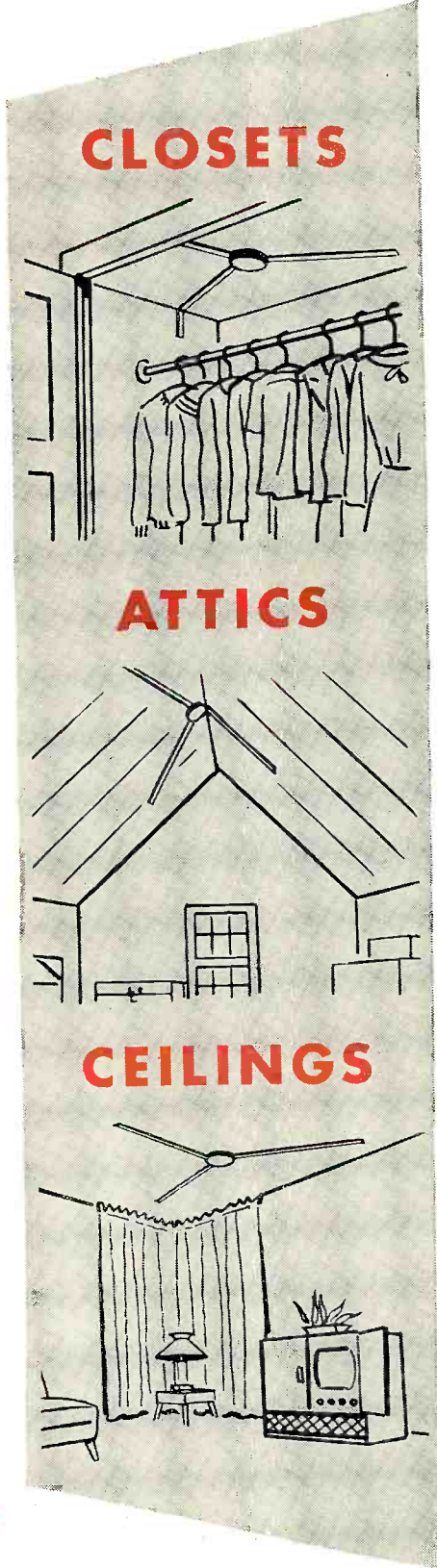

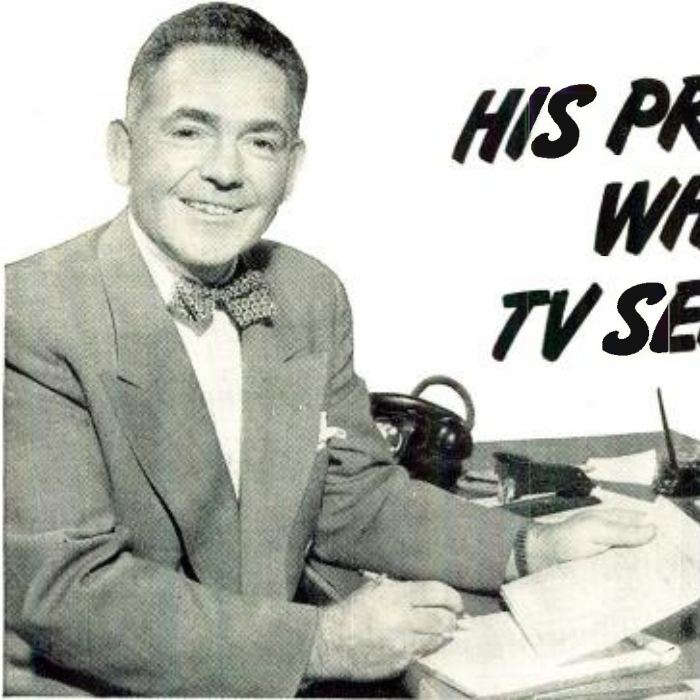

HIS PROFITS CLIMBED WHEN HE CUT TV SERVICE COSTS!

"With No Increase In Overhead," says Phil Rudden, "we've tripled our service volume this past year. This progress started when we bought G-E test equipment. In my business, there's no investment that pays off faster."

California Dealer Reports G-E Test Equipment Is Big Factor in Lower Bills to Customers, Increased Volume and Higher Net Profit

"A BREAK FOR THE CUSTOMER" is the motto that has helped make Phil Rudden's TV Lab one of the fastest-growing service shops in the San Jose area. By scientifically streamlining his operation, he drives his costs down, keeps customer goodwill by presenting repair bills that are rock bottom.

"Because the best test equipment was our first concern, we've built our whole operation around General Electric units. They shorten the time it takes to do a job, and they pinpoint circuit troubles accurately. Above all, these units are *reliable*."

Your G-E distributor can show you how to improve your TV service business. Why not call him today while the matter is fresh in your mind?



No Training Problem—When you install G-E units, your technicians need not be intensively schooled in use of the equipment. Easy to operate, these instruments do the work for you. They are fast, accurate, and reliable, and cover both VHF and UHF servicing.



2-in-1 Operation Triples Volume—Any type of chassis servicing, from complex head-end adjustments to locating a faulty resistor in a video IF stage, can be handled by the G-E scopes, markers and sweeps in this twin-bench setup. Work output per man has tripled in one year.



General Electric Co., Section 932
Electronics Park, Syracuse, N. Y.

Rush me your new bulletins on the
G-E Test Equipment Package.



NAME.....

ADDRESS.....

CITY.....STATE.....

TV TEST EQUIPMENT THAT COVERS BOTH VHF AND UHF

GENERAL ELECTRIC



**Airex... WHERE MERCHANDISE IS TOPS...
PRICES ARE LOW... VALUES THE GREATEST**

Sorry, No Fees • Our Prices Are Too Low • Value Our Specialty

**NOW—THE FINEST "630" TV CHASSIS EVER—WITH
THE AMAZING CASCODE TUNER**

Reception up to 200 miles • 4 microvolt sensitivity

This wonderful new Super DX handles all tubes from 10" to 24" . . . will bring in better reception up to 200 miles without the use of boosters and will work where other sets have failed. The NEW STANDARD COIL CASCODE tuner gives you greater sensitivity with less snow. This tuner utilizes the newly developed 6BK7 tube with the gold-plated grid . . . is fully shielded against radiation and has a newly designed converter circuit. Has new improved Mark flyback with keyed AGC for better picture control; 15 KV output; 3-stage sync separator; 5-hour minimum heat run at factory. Moulded plastic condensers; syncro lock; improved new Ferrite core width coil, for greater range of width. Armstrong FM sound system; improved linearity control. Factory wired, aligned and tested before shipment. Phono connection and switch on chassis. Complete with RCA Hi-Fi 12" Speaker. DIRECTLY ADAPTABLE FOR COLOR AND UHF STATIONS.

\$ 49⁹⁵
Complete with
Fed. Tax. Less
Picture Tube.

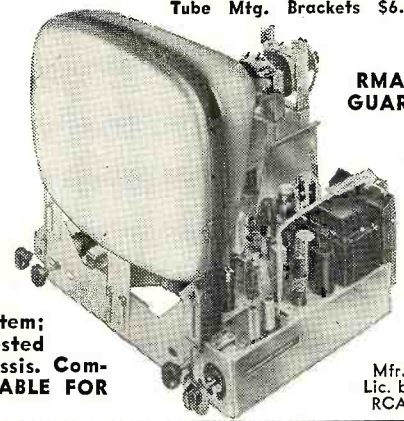

Tube Mtg. Brackets \$6.50

RMA
GUAR.

Mfr.
Lic. by
RCA

**SENSATIONAL SPECIAL OFFER OF THE
AIREX SUPER DX COMPLETE TV SETS . . .
THE FINEST SET VALUE IN ITS PRICE CLASS**

These outstanding sets were specially designed to meet our rigid specifications to assure you many pleasant hours of trouble free TV at an unequalled price. The mfr. is licensed by RCA. RMA guarantee. All you have to do is plug in and play.



17"—\$154.95
20"—\$179.95

24" TV CONSOLE

1 Year Warrantee \$**299⁹⁵**
on Tubes and Parts

✓ Check These Features

- Has standard coil Cascode tuner that brings in reception up to 200 miles • 22 tubes • Large HI-FI speaker • Hand rubbed, satin finished genuine mahogany cabinet • AGC • Moulded plastic condensers • Black, glareless picture tube, guaranteed for 6 months • Adaptable for UHF and color • Synchronized FM audio system • 5 hour heat run at factory • Factory wired, aligned and tested • Mounted in cabinet.



17"—\$174.95
20"—\$199.95

Price Smashing Values in TV Cabinets for "630" Chassis

Beautiful, richly finished, hand rubbed mahogany cabinets to suit every taste. They are designed to house the "630" chassis, 12" speaker and up to 20" TV tube. The combination cabinets will hold up to a 20" TV tube, radio and Webster record changer, with ample record space.

All cabinets are equipped with mask and mounting brackets. The perfect chassis deserves a perfect cabinet. It will be a focal point of beauty in your home. Other models in stock. When ordering chassis and cabinet, no tube mounting brackets needed. Send for FREE circular.

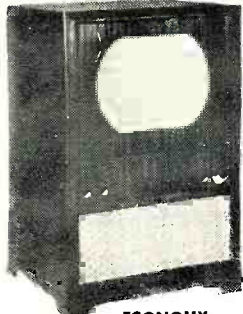

ECONOMY

8x22 1/2 x 22 1/2—16" and 17" tube . . . \$49.95
41x25x23—16" to 20" . . . 59.95
45x28x25—24" tube . . . 74.95
Blonde \$10 Additional

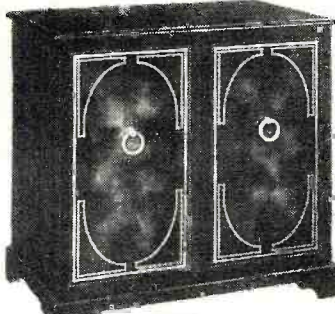

ELITE

Combination—39x40x23 1/2. Red antique gen. leather. Gold leaf hand tooling . . . \$149.95
In lined oak, gold colored leather . . . 159.95



STRATFORD

40x28 1/2 x 23 1/2. Genuine crotch Mahogany doors . . . \$89.95

All merchandise is brand new, factory fresh & fully guaranteed. Mail & phone orders filled upon receipt of certified check or money order for \$25 as deposit on TV chassis, 20% on other items. Balance C.O.D., F.O.B. N. Y. Prices subject to change without notice. No Fed. taxes to pay. Prices lower than OPS Regs.

AIREX RADIO CORP. 171 Washington St., N.Y.C. 7, N.Y.
Phone WOrth 2-4029

TV TUBE EXTRA

Standard Brands
BLACK-GLARELESS
Factory New—1st Quality
Guaranteed 1 Year

- 14" Rectangular \$26.95
 - 17" Rectangular \$32.95
 - 16" Rectangular 29.95
 - 20" Rectangular 39.95
 - 16" Round . . . 33.50
 - 24" Round Metal 69.95
- Ring and sleeve for 24" . . . \$7.50

**ESPEY
FM-AM
RADIO**

12 Tubes
Push pull
Output \$**69⁹⁵**

**300 OHM
TV WIRE**

1000 ft. spool \$**17⁹⁵**
100 ft. spool \$**2⁰⁰**

AIR KING RADIO CHASSIS

6 tube super-het, AC-DC for custom installation. Complete with loop antenna, tubes and extra RF stage. Reg. \$25. \$**11⁹⁵**
MATCHING CABINET . . . \$3.95

**Webster "Webcor"
Tape Recorder**

Portable • Limited Quantity. Regularly \$187.50. \$**149⁵⁰**

RCA
HI-FI
Speaker \$**4.95**

Airex Special 5-Watt Amplifier

Phono and Mike input, tone control. Complete with tubes, 1—6X5; 1—6SL7; 1—6V6. Reg. \$29.95. \$**19⁹⁵**

"Approved" 10-Watt Amplifier

Hi-fidelity, 50-10,000 CPS. Separate bass and treble boost complete with tubes, 1—5Y3; 2—7F7; 2—7C5. Regularly \$69.95. \$**34⁵⁰**

- Standard Coil Cascode Tuner . . . \$24.95
- Super Sonic Booster, MDL107 . . . 14.95
- Regency Booster, Mdl DB410 . . . 19.11
- TV Masks—16" and 17" \$4.95; 20" \$7.95; 24" \$14.95

COMPLETE LINE 630 PARTS
RADIO TUBES 40% TO 60% OFF LIST

"NOW YOU CAN FIX YOUR OWN TV SET"
Simplified book. Fix over 1,000 models by 89 manufacturers \$**1⁰⁰**

SEND POSTCARD TO BE
PUT ON FREE MAILING LIST



NANTOOK MOOK WALSCO ONKO

(translation)

“BETTER FRINGE AREA RECEPTION WITH WALSCO MODEL M ANTENNA”

There's a magical difference in WALSCO Model M Signal King performance almost *anywhere*. In the fringe areas, or wherever weather is the roughest, the Model M will out-perform, out-last any competitive antenna.

Once you install... *that's all*. No costly call-backs that steal your profit. Model M is guaranteed sturdier, more dependable in *any climate*. Chromate-coated magnesium cross-arms have a structural strength almost equal to steel, yet $\frac{1}{3}$ lighter than aluminum. Positive corrosion resistance even in severest weather. Elements are made of high-conductivity, super strength aluminum alloy reinforced with Swiss "Permalum." WALSCO Model M is quality you can trust *anywhere*.

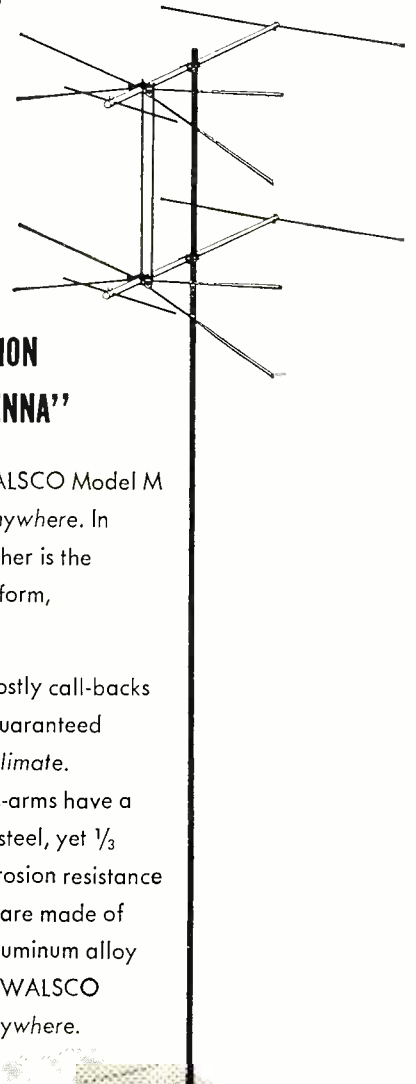

Walsco quality earned its reputation

WALTER L. SCHOTT CO.

3225 Exposition Place, Los Angeles 18, Calif
Branch: Chicago 6, Illinois

DEDICATED TO YOU!

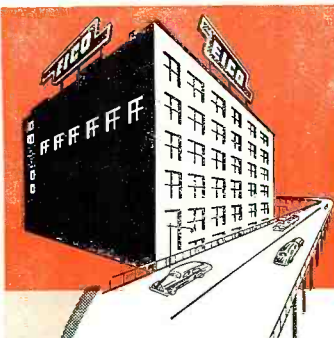

This great new **EICO** **FACTORY...** these **NEWEST EICO INSTRUMENTS...**

YOU made them possible with your **CONFIDENCE** in EICO. We pledge to strive with all our power, product-wise and service-wise, to continue to merit your trust in us.

Harry R. Ashley
President



6 NEW V-O-M KITS and Instruments

FOR LABORATORY PRECISION AT LOWEST COST

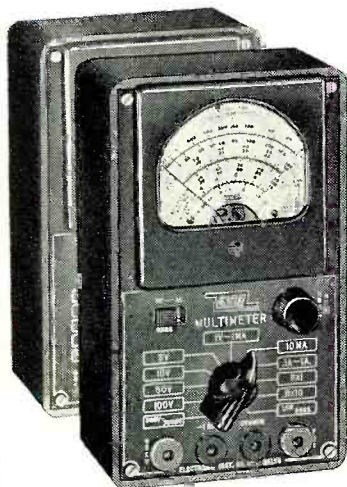

EICO New Model 536 — 1000 Ohms-Per-Volt Multimeter KIT \$12.90. Wired \$14.90.

- 31 1000 ohms/volt full scale ranges!
- DC/AC Volts: Zero to 1, 5, 10, 50, 500, 5000.
- DC/AC Current: 0-1, 10 ma; 0.1, 1 Amp.
- Ohms: 0-500, 100K, 1 meg.
- 6 DB Ranges: -20 to +69.
- Large 3½" 400 ua meter movement.
- High-impact Bakelite case. 6¼ x 3¼ x 2".

EICO New Model 526 1000 Ohms-Per-Volt Multimeter KIT \$13.90. Wired \$16.90. As above, with 1% precision resistors.



EICO New Model 555 20,000 Ohms-Per-Volt Multimeter KIT \$24.95. Wired \$29.95.

- 31 full scale ranges!
- DC/AC/Output Volts: 0-2.5, 10, 50, 250, 1000, 5000.
- DC Current: 0-100 ua; 10, 100, 500 ma; 10 Amp.
- Ohms: 0-2000, 200K, 20 meg.
- 5 DB Ranges: -12 to +55.
- Large 4½" 50 ua meter movement.
- High-impact Bakelite case. 6¼ x 5¼ x 3".

EICO New Model 555 20,000 Ohms-Per-Volt Multimeter KIT \$29.95. Wired \$34.95. As above with 1% precision resistors.

EICO New Model 556 1000 Ohms-Per-Volt Multimeter KIT \$14.90. Wired \$18.95. Same as Model 536, with 4½" 400 ua meter movement.

EICO New Model 556 1000 Ohms-Per-Volt Multimeter KIT \$16.90. Wired \$23.50. Same as Model 526, with 4½" 400 ua meter movement.

ONLY EICO GIVES YOU ALL TO EICONOMICAL FEATURES

- Laboratory Precision • Lowest Cost • Lifetime Dependability
- Speedy Operation • Rugged Construction • Quality Components
- Latest Engineering • Super-Simplified Assembly & Use Instructions • Laboratory-Styled Appearance • Exclusive EICO Make-Good Guarantee.

Compare these value-crammed EICO V-O-Ms with any others at any price—at your local jobber—and SAVE! Write NOW for FREE newest Catalog 3RA

— See the photographic proof of EICO's Performance Leadership on the Inside Back Cover of this magazine.



Prices 5% higher on West Coast. Due to unstable conditions, prices and specifications are subject to change without notice.

ELECTRONIC INSTRUMENT CO., Inc. 84 Withers Street, Brooklyn 11, New York

Radio Control

On The Citizens Band

Although designed primarily for controlling planes, this unit may be used with ships and other models.

By
VERNON C. MACNABB*

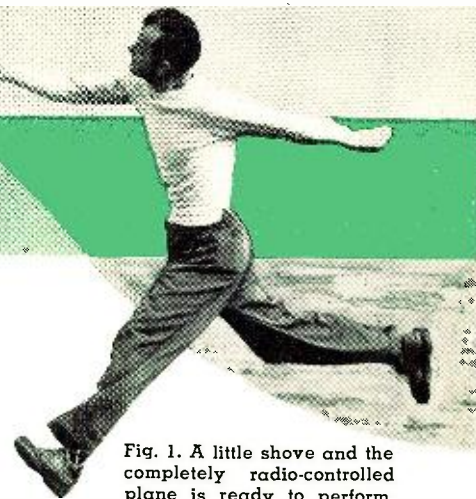

Fig. 1. A little shove and the completely radio-controlled plane is ready to perform.

ANYONE can now control model airplanes and boats by radio. Some readers may wonder why such an obvious statement is made. You always could control anything by radio within certain limits. Control of mobile or distant objects by radio is as old as radio itself, but for the average citizen, a limitation existed in that he had to be a radio amateur, which today means learn the code and pass a technical examination.

In June 1949, the Federal Communications Commission, realizing the necessity for a band of frequencies which would allow the average citizen to operate a transmitter without technical knowledge or ability to read code, opened a band of frequencies known as the Citizens Band, running from 460 to 470 megacycles. This band of frequencies falls somewhere near the indistinct dividing line between what is known as very-high frequencies and ultra-high frequencies. It presents a serious problem in making equipment work on these frequencies because it is close to the limit possible with conventional tubes and tuned circuits and at the same time it is so low in terms of ultra-high frequencies, that short-wave plumbing or waveguides have large and rather unwieldy dimensions. Some recent technical developments, however, have produced some subminiature tubes which will function properly at this frequency so the equipment described in this article is more or less conventional in that it uses tuned circuits instead of cavity resonators.

The photographs, Figs. 4 and 7, show the transmitter and receiver. The transmitter dimensions are 9"x4"x

2¾", and the batteries are self-contained. The weight of the complete unit with batteries installed is less than four (4) pounds. The receiver itself weighs five (5) ounces and the recommended batteries to use with this receiver will weigh an additional nine (9) ounces, making the total weight less than one (1) pound. Dimensions are 3¾"x2½".

The accompanying photo (Fig. 1) of a model builder hand-launching a plane illustrates the size airplane that will readily carry this equipment. This plane is powered by a .019 engine. The closeup view of the cabin (Fig. 6) shows the receiver installed in a plane.

The transmitter is a self-excited oscillator with a directly coupled antenna and the problem in designing this unit was one of stability. The circuit diagram, Fig. 2A, looks like any conventional single tube unmodulated transmitter but the chassis, shown outside the case in Fig. 3, shows that mechanically it is a rather radical departure. The tuned circuit and antenna coupling coil is punched out of the chassis for rigidity and grounding reasons. As a result the chassis is connected to "B+." The comb-like piece reduces capacity coupling between the tuned circuit and antenna pickup coil to help pass FCC frequency stability requirements. A piece of bi-metal is used to form a small capacity which varies with temperature across the tuned circuit to provide temperature stability. The transmitter had to be approved by the Federal Commu-

nications Commission before it could be manufactured, and the requirements were that it should not drift more than 0.4 per-cent from 465 megacycles under a number of conditions, such as tube warm up, decline in battery voltage, and temperature change. It took over eighteen months of development work to satisfy the FCC on these rigid requirements. An individual will find it impractical to try and design a transmitter for his own use as the FCC will not undertake approval tests unless 100 units are to be manufactured.

The folded dipole and reflector which plugs into the top of the transmitter allows the small output of the transmitter to be concentrated in one direction and the reflector also serves the purpose of making the box cold as far as r.f. is concerned. The transmitter operates with 6 volts of filament power and 135 volts of "B" battery. The filament draws 200 milliamperes and the plate current, when the transmitter button is pushed, is 20 milliamperes.

To operate the transmitter, the filament switch is turned to "On" and a minute allowed for tube warm up. A conveniently placed *Micro Switch* is then depressed as the unit is held in the hands to apply "B" voltage and send out the signal.

The function of the receiver is to close a relay when the signal is received from the transmitter. In order to make it suitable for model planes, the weight must be kept to a minimum and one tube is all that is used in the circuit. A superregenerative type of circuit, Fig. 2B, is used which is so sensitive that even when a very weak sig-

* President, Vernon C. MacNabb Company, 915 Westfield Blvd., Indianapolis 20, Ind., manufacturers of "Citizen-Ship" radio control equipment.

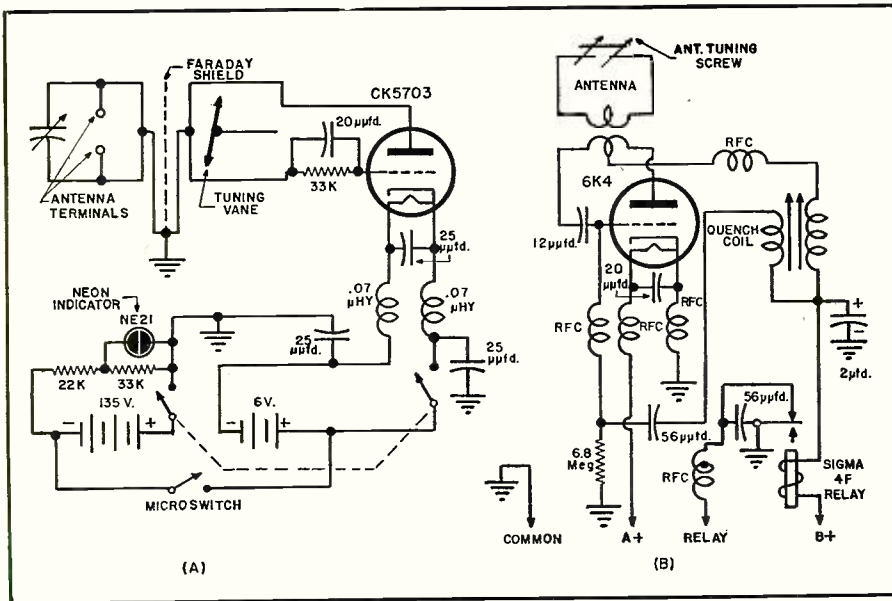

Fig. 2. (A) Complete schematic diagram of the transmitter portion of the radio-control unit. (B) The unusually sensitive superregenerative-type receiver section.

nal is received from the transmitter the plate current change is approximately ten to one. The normal idling current is 0.1 milliamperes and when the transmitted signal is received the plate current jumps to 1.0 milliamperes, or more. The sensitive relay is set to operate at about 0.3 milliamperes therefore it has a large factor of safety and extreme reliability. This action takes place over distances in excess of one-half mile when carried by a plane in the air so that ground reflections and absorptions are not present. At waist heights along the ground, the equipment will work at approximately three-fourths of a mile. Because the plate current is so low, two hearing aid type "B" batteries delivering 60 volts may be used to supply the "B" voltage and their life is as long as their shelf life. The tube in the re-

ceiver is a 6K4 subminiature and uses 6 volt filament supply at 150 milliamperes. The intermediate sized flashlight batteries will operate the unit for about an hour.

Looking at the receiver, Fig. 7, it will be noticed that there is a square or rectangular band of aluminum underneath the main chassis base. This is the antenna which is a dipole folded into an approximate square so it is not directional. The tuned circuit is a copper band at the left end of the chassis and the relay is in the right foreground. Four Fahnestock clips are provided for connections, "plus A," "plus B," "ground," and the fourth clip for connection to the escapement, motor, or any other device used to control the airplane or boat. The Fahnestock clips on the receiver also serve the purpose of mounting the receiver

on rubber bands to avoid engine vibration and shock.

Radio control of model planes is not new as they have been flown for approximately fifteen (15) years by such pioneers as Clinton DeSoto and the Good Brothers. The Good Brothers are the most famous for their contributions in this field. One of the simplest means of controlling a model plane in flight is by controlling the rudder only. Most model planes are self-stable, that is, they fly level or return to level flight if disturbed from their normal course without correction of elevators or ailerons. Therefore, all that is necessary to control flight is a rudder, which will cause the plane to turn and return to the operator at will. They are also designed to climb slowly while the motor is running and to glide to earth gently after the motor has run out of gas or is shut off.

It is surprising the number of maneuvers that can be performed by rudder alone. Not only can all types of turns be executed, such as square patterns, figure eights, etc., but by properly setting the amount of rudder control, the planes can be made to spiral dive and at the end of a spiral dive, by giving opposite rudder, it can be made to loop. The spiral dive, of course, is useful in losing altitude in case the plane is climbing too high under power.

The most common method of obtaining rudder control is by a sequential device known as an escapement as shown in the photograph of Fig. 5. It is a small electromagnetic device weighing only one-half ounce, which is driven by a rubber band and triggered by the closing of the relay in the receiver. The escapement moves the rudder from neutral to right, back to neutral, to left, always returning to neutral when the transmitter is off. If right rudder has just been used and the rudder is back to neutral, one pulse

Fig. 4. Over-all view of transmitter with antenna. The entire radio-control unit weighs less than four lbs. including batteries. →

↓ Fig. 3. Transmitter removed from case and showing the unusual way that the unit is constructed.

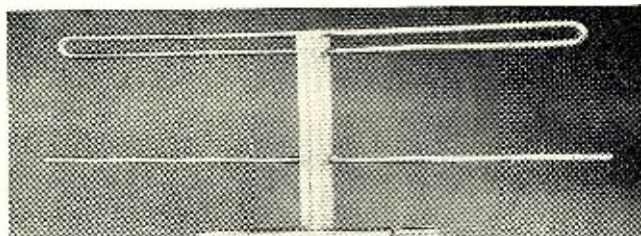
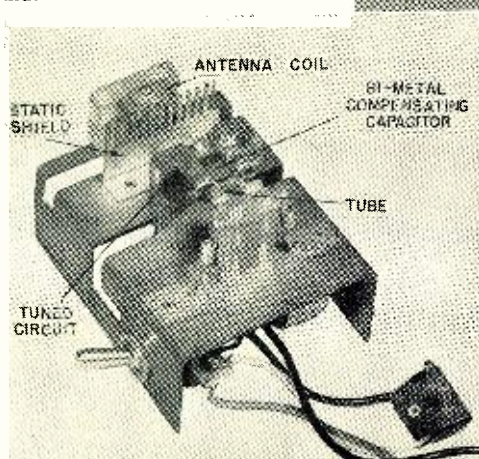

↓ Fig. 5. The most common method of obtaining rudder control. This sequential device, known as an "escapement," moves rudder left, neutral, right.

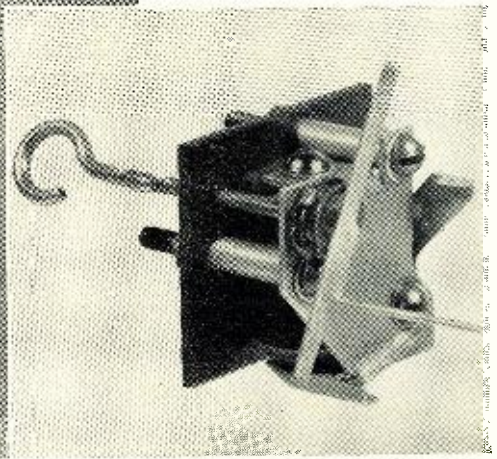

gives left rudder, two pulses right rudder.

The work of the Good Brothers and early experimenters was done in the 5 meter ham band. The receiver was a superregenerative set which normally drew about 1.5 milliamperes. This plate current dropped to about half that value when the signal was sent to it. It was necessary, therefore, to cause a relay to function within a two-to-one change of plate current. There was another limitation; with this constant "B" battery drain, as the plate voltage fell the plate current itself declined and the relay setting might have to be changed.

Strangely enough, in spite of all the difficulties encountered in making the system operate at 465 megacycles in the Citizens Band, one advantage is outstanding. Because of the extremely high radio frequency in comparison to the low audio frequency in the conventional superregenerative circuits, the plate current increases instead of decreases, and because of the large safety factor on plate current change as mentioned before, decline in "B" voltage does not cause marginal operation of the relay. In addition, because the current is low with no transmitted signal, economy of "B" power is obtained which obviously saves weight.

Further convenience contributed by the 465 megacycles is the small dimensions of the half-wave dipole that makes the transmitter completely portable. It is only one foot long. The transmitters working on 54 megacycles require the erection of an approximate 8 foot dipole which anchors the operator to one spot.

The best example of the reliability of this equipment, which is commercially called "Citizen-Ship Radio Control," is the fact that the first production units to leave the factory were used in competition at the National Model Airplane Meet in Dallas, Texas, in July 1950, and the model builder who incorporated this equipment in his ship won first place. It is obvious that the radio alone was not the sole reason for winning, but without equipment that was absolutely reliable, it would have been impossible. Never once did the radio system fail to respond when the transmitter was actuated. There were many cases of other contestants, some of whom had home-made equipment and on the ham band, who would lose control of their planes and they would fly away, resulting in not only loss of points, but sometimes a damaged plane when recovered.

"Citizen-Ship Radio Control" equipment is virtually license-free, as no examination or code test is required. A federal form is packed with each transmitter and it is only necessary for the purchaser to fill out this form and send it to his nearest FCC Field Engineering Office and a portion of the form is stamped with a number and returned to the purchaser. This becomes the radio transmitter's license. With this license, anyone can use the

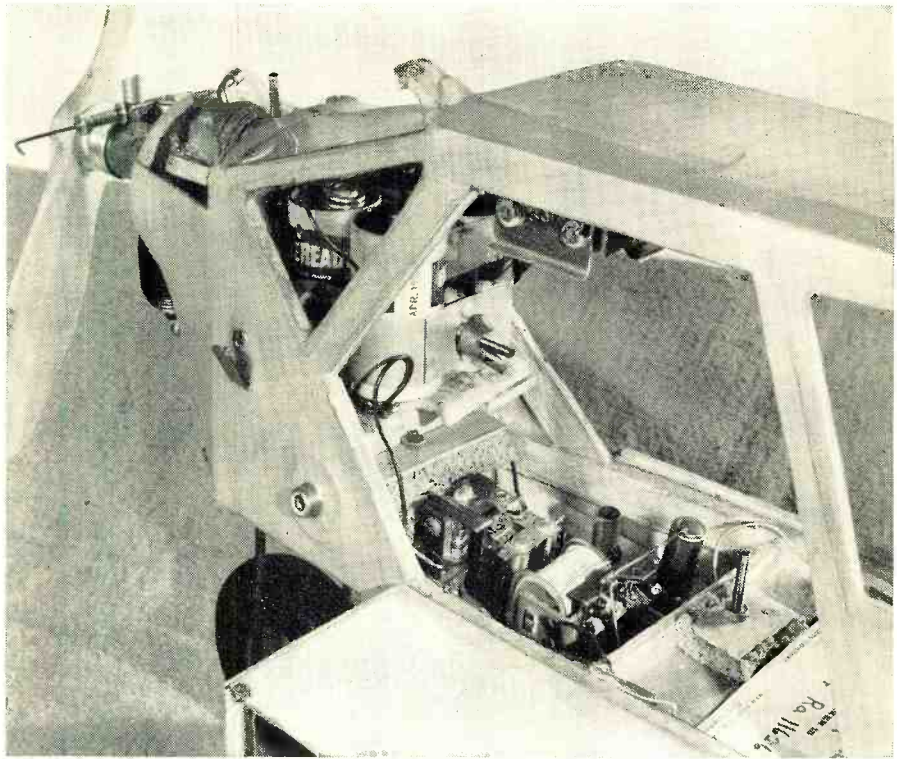

Fig. 6. Close-up view of the cabin showing the receiver installed in the plane.

transmitter. The only limitation is that any individual less than 18 years old cannot obtain a license, but it is permissible for him to use the equipment if one of his parents obtains the license.

This virtually license-free equipment opens up a new field to hobbyists. The equipment is designed, engineered, and manufactured so that no knowledge of radio is required to use it. If a person is capable of connecting up a simple electrical circuit, which means connecting up the batteries, the equipment is guaranteed to operate. With this equipment in the hands of ingenious hobbyists and model builders, it may soon be possible to control

a model plane in as complex a manner as though a pilot were in the plane itself. One manufacturer already has a device which requires a very simple accessory to the transmitter and in place of the escapement a selective mechanism in the plane attached to the receiver, which will give as many as twenty-four (24) different functions. With this number of controls, anything is possible. The air over vacant lots may soon be filled with model planes zooming over the heads of spellbound spectators.

Editor's Note: The home construction of the transmitter described is not advisable, as FCC approval cannot be obtained for such units.

-30-

Fig. 7. Receiver section with the dipole antenna folded into a non-directional square.

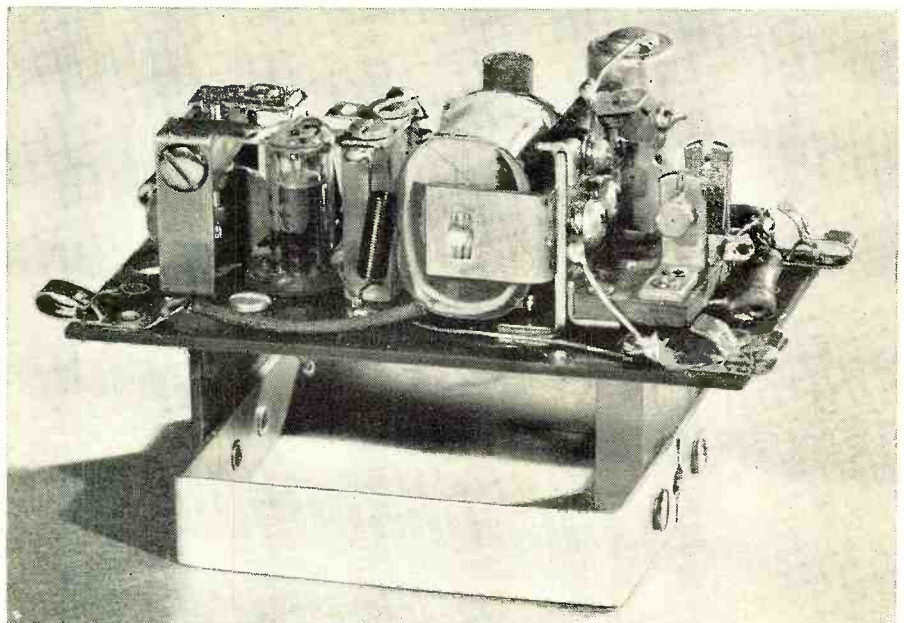

THE LOUDNESS CONTROL— An Aid To Higher Fidelity

By
RON PICKETT

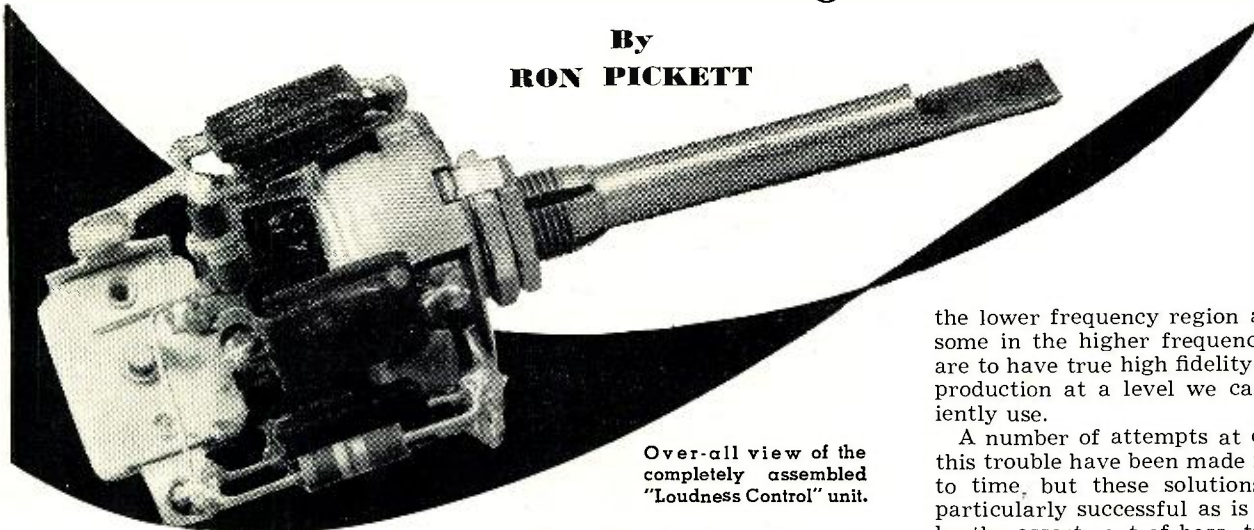

Over-all view of the completely assembled "Loudness Control" unit.

Although quite often overlooked, compensation for the frequency characteristic of the human ear is a very important factor in better quality audio.

ONE of the factors in the design of high quality audio equipment which is all too often neglected is the frequency response characteristic of the human ear. We take great pains to see that our sound equipment is capable of flat response throughout the audible range, and that harmonic and intermodulation distortion are within reason, yet we pay little or no heed to the manner in which the ear responds to various frequencies.

The work of H. Fletcher and W. A. Munson¹ should be familiar to all audio designers, but unfortunately, little emphasis appears to have been placed on the importance of their findings.

Fig. 1 shows some of their findings, in graphical form. These curves were prepared from averaged measurements taken with a large number of individuals, and each curve represents the intensity of a pure tone judged by the individual to be the same intensity as a pure tone of 1000 cycles, the reference frequency. The curves, then, show the remarkable inability of the human ear to respond to all frequencies alike. For example, a pure tone of 1000 cycles, produced at a level of 20 db sounds as loud as a pure tone of 100 cycles produced with 30 db greater intensity.

It is easy to see why our sound equipment is unsatisfactory at low levels, appearing to lose bass response, and to a lesser degree, the high frequency response also suffers. In spite of the fact that an uncompensated amplifier and speaker system may be measured to show a uniform response from 20 to 20,000 cycles at any level, it will sound

good only when reproducing at a level comparable to that of the original source. For example, a full symphony orchestra may require as much as 50 to 60 watts, and it is doubtful if many of our wives (or neighbors, for that matter) would permit us to use an acoustical power output of this magnitude for very long. But if, with an ordinary volume control, we reproduce the orchestra at the much more comfortable level of 50 to 60 milliwatts, then the loss of bass response is so apparent to our ears that the quality suffers greatly. We are thus torn between the desires of keeping the naturalness in our musical reproduction and keeping the neighborhood peace.

A little study of the curves of Fig. 1 will show that our audio equipment, particularly that used in the home, requires a great deal of compensation in

the lower frequency region as well as some in the higher frequencies, if we are to have true high fidelity sound reproduction at a level we can conveniently use.

A number of attempts at correcting this trouble have been made from time to time, but these solutions are not particularly successful as is evidenced by the assortment of bass, treble, and volume controls with which our equipment is customarily burdened. The shunt condenser type of tone control and the tapped volume control, both shown in Fig. 2 are, of course, steps in the right direction, but their effectiveness is necessarily limited. The complexity to which bass and treble compensation controls can grow is easily seen in modern audio circuitry.

Recently, a number of compensated volume controls have appeared^{2,3,4} which offer advantages not previously obtainable. These are called "Loudness Controls" because they closely approach the compensation required to match the equal loudness curves shown in Fig. 1, at least in the low frequency region. Thus, the bass compensation and volume controls are combined.

In practice, however, all these controls suffer from one or more of the following defects which contribute to something less than enjoyable listening.

First, two of the three "Loudness Controls" described use switch or step-type attenuators, which are confusing to the average user, since most of us are not accustomed to handling this type of control. Second, none of the three provide any high frequency compensation, even though the Fletcher-Munson curves indicate the need for this, especially at the lower intensity levels. Third, none of the controls provide a sufficient range of attenuation so that they can replace an existing volume control directly, thus making necessary an additional control for level-setting, from which the "Loudness Control" operates.

The validity of the last point may be debatable, but most will agree that additional controls are undesirable. The range of attenuation required is dictated by both the maximum output

Fig. 1. The Fletcher-Munson curves.

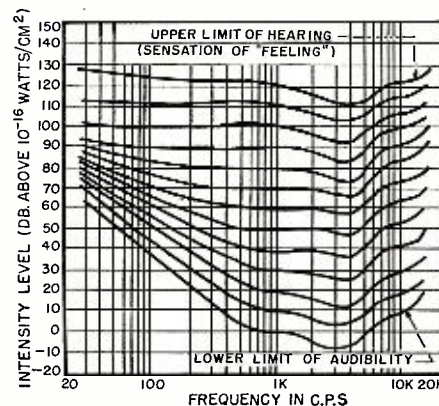

of the equipment in use, say 10 to 15 watts, and the minimum usable output for a comfortable background of music. The minimum usable output then determines the range of attenuation required. Some studies have shown that average residences have a sound intensity level of about 40 db above the threshold of hearing, which is the 0 db curve in Fig. 1 for normal ears. If we are to match the maximum average power output of a large orchestra at the high end of our attenuation range, say 100 db on the same scale, then 60 db total attenuation is required in a "Loudness Control" to reduce the orchestra to a level corresponding to the background which is present in our homes.

In the "Loudness Control" to be described, an attempt is made to overcome the faults of its predecessors as outlined before. Fig. 3 is the schematic of the unit, together with the values of the components used. Fig. 5 shows the performance characteristics, as measured with laboratory equipment. It can be seen that a total of 60 db attenuation is provided at 1000 cycles, while both high and low frequencies are compensated as necessary to give natural reproduction at any level.

Calculation of the values of the components in a network such as this is tedious, but can be considerably simplified by a few practical assumptions. If we consider the output of our control to be unloaded, as it is when feeding a class A grid, and further if we choose values such that each section of the complete control will not appreciably load the preceding section, it is then possible to consider each section separately.

Fig. 4 shows one section of the "Loudness Control" alone. Since there are five such sections in the complete control, a total of 60 db attenuation at 1000 cycles means that each section must contribute 12 db at this frequency. The curves of Fig. 1 show that 9 db attenuation is required in the first section at 100 cycles when we have 12 db at 1000 cycles. These attenuations correspond to voltage ratios of 2.8 and 4.0 respectively.

It can be shown, then, that in Fig. 4,

$$4.0 = \frac{\sqrt{(200K + R)^2 + X^2}}{\sqrt{R^2 + X^2}}$$

at 1000 cycles

and

$$2.8 = \frac{\sqrt{(200K + R)^2 + 100X^2}}{\sqrt{R^2 + 100X^2}}$$

at 100 cycles.

Solving these as simultaneous equations gives the values of X and R for the first section. Similarly, X and R for each succeeding section can be found, considering the additional attenuation required in each section at 100 cycles for the 12 db steps at 1000 cycles. The capacitance value is, of course, computed from the relation $X = 1/2\pi fC$.

The high frequency compensating condenser, C_1 in Fig. 3, should be chosen so that it represents a higher

reactance at 1000 cycles than the portion of the potentiometer across which it is connected, but compares with or is nearly equal to the resistance at 10,000 cycles. A 3-30 $\mu\mu\text{fd}$. trimmer is adequate here, and allows enough adjustment so that the effect of stray wiring capacitance can be eliminated.

The component values, as given in Fig. 3, yield an effective input impedance for the "Loudness Control" of about 250,000 ohms, and it may therefore be used as a direct replacement for any existing grid circuit volume control whose total resistance is between 100,000 ohms and one megohm. The output of the "Loudness Control" is intended to feed the extremely high impedance we find at the grid of a class A amplifier, and the purpose of the one megohm resistor R_7 is to complete the grid circuit to ground. It would not be advisable to attempt to feed a transformer from the output of the "Loudness Control," because the reactance of the transformer is likely to upset the attenuation characteristics.

Mechanically, this "Loudness Control" is built around a standard linear taper *Ohmite* or *Allen-Bradley* potentiometer which has been modified in much the same way as one of the previously described units⁴. This type of potentiometer was chosen because of the sturdy mechanical characteristics of its resistance element. It is necessary to provide four taps on the control. These were made in the following manner. Four holes were drilled into the side of the potentiometer base at convenient points. These holes should be just large enough so that a piece of solid tinned hook-up wire can

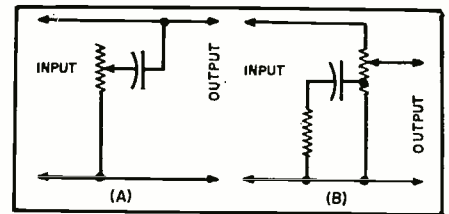

Fig. 2. (A) The shunt condenser-resistor type tone control and (B) the tapped volume control. Their effectiveness in obtaining correct compensation is limited.

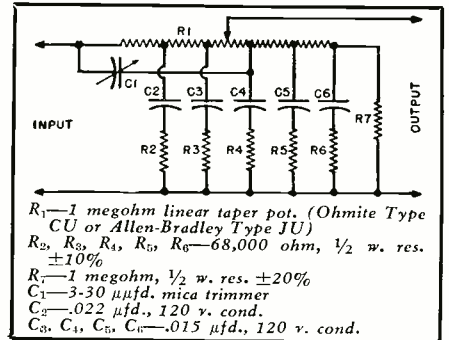

Fig. 3. Wiring diagram of "Loudness Control."

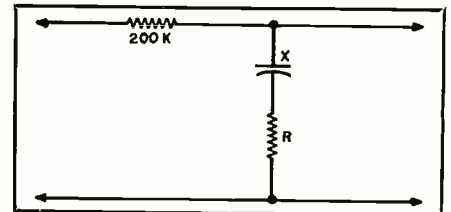
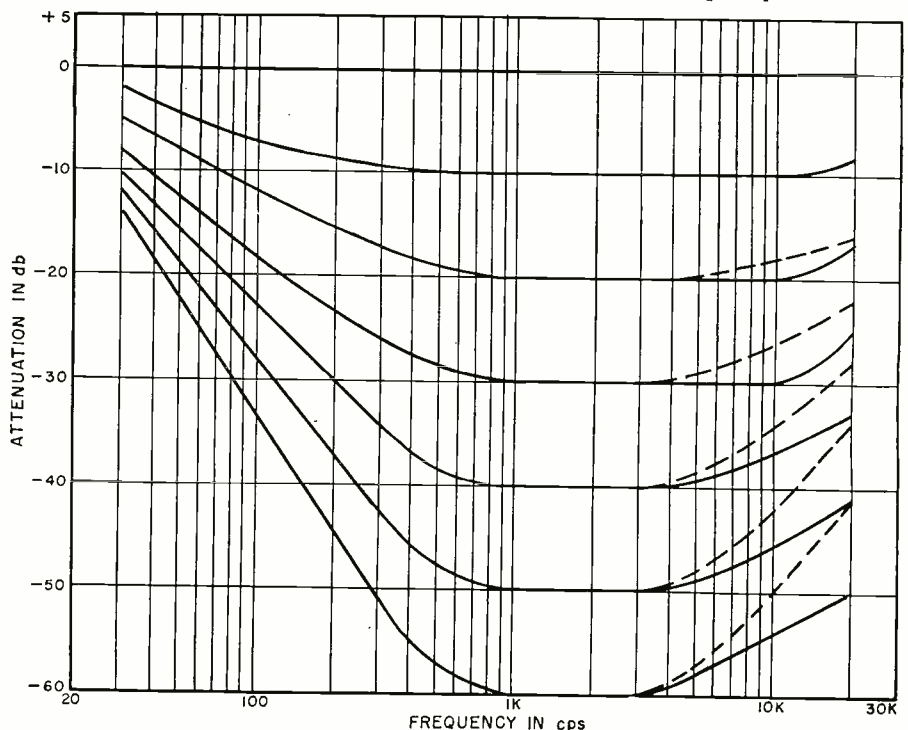

Fig. 4. One section of the "Loudness Control."

be inserted to fit snugly. The depth
(Continued on page 161)

Fig. 5. Measured response curves. The solid lines indicate the high frequency compensation obtained with the variable trimmer condenser set at minimum and the dashed lines the compensation with the condenser at maximum. As mentioned in text, stray capacitance between input and output leads produced by wiring the "Loudness Control" into an amplifier will give rise to additional high frequency compensation.



SELLING MAINTENANCE and YOURSELF

By
YVON O. JOHNSON

YOU may be so wrapped up in the technical aspects of radio and TV servicing that you may not realize that you are actually selling two things: maintenance and, more important, yourself.

Selling yourself implies that you are able to get along well with your customers; it means that you create a good impression for yourself and your firm; it means that customers think that you are the only one who will ever fix their sets.

You can be one of the best radio and TV troubleshooters in town but you can get into more trouble if you rub your customers the wrong way. You can make your day more pleasant and profitable by observing a few rules that are almost as important as circuit diagrams in servicing TV and radio for a living. Don't neglect your technical ability, however.

The technician who handles customers in a salesman-like way will find himself considered a valuable asset to his company; often, a firm will be willing to pay premium wages for his services. Conversely, a company will soon lose patience with a man who creates more trouble than he solves on a service call.

Technicians often bemoan the lack of confidence that the general public has in the service industry. While this situation is to be deplored and combated by every member of the industry, you will find that it can help you instead of hinder you! Here's how it works to your advantage: When a customer finds that you are thoroughly honest and competent he will come back again and will recommend you to his friends because he knows that you are trustworthy and he doesn't know that the next technician will be equally trustworthy.

A Good Impression

You are no more than your customer's impression of you. He has no meter to measure your ability to fix his set. He knows only what he thinks of you. You may be tops in servicing



Technical "know-how" is important but don't forget those vital "extras."

Your livelihood depends as much on pleasing your customers as your ability to repair sets properly.

ability but he may not think so; you may be average, but he may think you are the best. This occurs because of the fact that customers usually have no understanding of the work involved in diagnosing and repairing a set.

Your customer wants you to be honest, truthful, efficient, and competent. Your first step is to *be* these things. Your next step is to let the customer see these characteristics for himself. That is your problem. Here are some suggestions to help you solve that problem for yourself.

Be on time. You'll start off on the wrong foot if you are late for the service call. Phone the customer in advance if you know that you will be late. This may seem to be rather obvious to you, but customers will tell you of other technicians who failed to show up at all on the day of the scheduled call.

Be courteous. Courtesy begins when the customer opens the door. Have a friendly greeting announcing your firm's name. The customer will then ask you to come inside. By all means, say: "Thank you." Already the customer will think of you as a very nice person.

You should remain courteous through the entire call regardless of what the customer says that might irritate you; be above giving sharp replies. Of course, you should thank the customer pleasantly when you leave.

Be neat in appearance. Your appearance must coincide with the idea that the average customer has of a competent technician. That is, look the part and you will be playing it in the customer's mind.

What would you, if you were a customer, expect a technician to look like? Probably you'll come up with an answer like this: hair cut and combed, clean shaven, and dressed in clean work clothing. You should neither look as if you have just crawled out from beneath your car nor as if you are going out on a heavy date. You don't want to be sloppily dressed, yet you should look as if you aren't afraid of a little hard work.

Carry professional equipment. If you carry professional-looking equipment, you will have the look of a thoroughly competent technician. Tools in good shape and an attractive case in which to carry them will make the customer think well of you.

You may be pleasantly surprised to realize that the quality of your tools will impress two widely separated groups of customers: the man who works at a trade and the housewife. The man who has tools of his own that he uses in his daily work will look with a critical eye at your own collection of tools. They had better pass his inspection; if they do, he'll consider you a master craftsman like himself.

You will receive a lot of favorable

RADIO & TELEVISION NEWS

comment from housewives over attractive rolls of screwdrivers and socket wrenches. If you carry a mirror which is adjustable on a stand you'll appear to be one of the best equipped technicians who ever worked on the set. The customer may not say it, but he thinks that you have his best interests at heart when you come properly equipped.

Act decisively. Almost any TV owner can tell you about a technician who looked at the set, scratched his head and said, "I've never seen this make of set before." That technician, certainly, did not act decisively.

You should have a definite approach to the set. As you switch the set on, ask the customer: "What has it been doing?" Don't say: "What's wrong with the set?" That'll get you: "You tell me!"

Try all front controls briefly. Next, remove vases and figurines from the top of the set before you try to move it. If you don't, an accident may happen. It is wise to let the customer remove these things if he volunteers to do so. It's also best to place the indoor antenna control box on the floor out of the way. This will save getting your feet tangled in the cables and causing the unit to crash to the floor.

If possible, fold back a small part of the rug so that you can swing the set around to work inside of it. Beware of a table model TV set on a table with thin, unbraced legs. The legs will sometimes snap off if you push the set and table when the legs are on a rug. It helps to lift up slightly at the same time that you move the set.

Place your mirror in front of the TV set, remove the back of the cabinet and you are ready for work. If it turns out to be tube trouble only, don't just stick in a new tube and then run out of the house. Adjust the rear controls for a linear picture of the correct size. The customer will appreciate it. If you have removed the chassis for some reason, buff the tuner contacts with a clean, dry cloth if the tuner was a bit noisy. Wipe the inside of the cabinet's glass and clean the picture tube.

Regardless of how much or how little you do, follow a regular routine and act as if you know what you are doing. The customer will appreciate the professional way that you go about your business.

End up by leaving the old tubes and the cartons from the new ones. This helps to show your honesty to the customer.

Be neat. A good rule is to leave the customer's home as neat as you found it. Better yet, be neat as you work so that the customer does not worry about having to clean up after you have left.

Neatness as you work saves you time and money. You save time by not having to waste it cleaning up after yourself. You save money by always replacing tools in their proper places in the tool kit as you finish using each one, rather than trying to find all the tools when it is time to leave.

Choose words carefully. Every word that you say to the customer about his set and antenna will be remembered by him. It will be quoted by him, correctly or incorrectly, to your company in case of future difficulties. Customers are prone to read meanings into your words that you did not intend. Be careful and choosy in what you say. It is generally best to say as little as possible until you know the entire history of the set and of the customer's relations with your firm. Don't make commitments for your company unless you are specifically authorized to do so. If the customer wants something done that you are not certain about, it is usually best to say: "I have no authority concerning that, but I'll be glad to speak to the manager when I get back to the shop and have him call you." This gives you and the manager a chance to get in a huddle over the matter.

In connection with using the proper words, be very careful not to criticize his set. You may not like it, but he does.

Maintenance vs. Service

If you have succeeded in selling yourself by creating a good impression and getting along well with the customer, your next step is to sell maintenance. Here are some suggestions.

Talk maintenance. A customer usually wants to know how long his TV set will run until it needs repairs again. Don't make promises that will bounce back on you. It's much better to honestly say: "We've corrected all the troubles that have shown up while we've had it in the shop. It's impossible to tell when a case of trouble might occur again. All your tubes are working fine right now. I can't predict which will be the next one to go out. But you will have, on the average, 3 or 4 of the small tubes go out each year. That isn't trouble or repairs; it's just normal maintenance."

Be sure to get the point across that tube replacements are to be expected and that they are no reflection on the quality of the set. Building up the idea of tube replacements as maintenance instead of service trouble helps you in many ways: you are not criticized when you are called in to replace one tube after another; the customer

expects to see you several times a year; you become a permanent fixture in the maintenance of his TV.

Today's family budgets are relatively inelastic and television servicing and maintenance must, of necessity, compete with fixed living costs like food, rent, clothing, etc.

Tactfully handled, the subject of television maintenance can be sold as an "essential" part of the family's entertainment budget.

Tell your story completely but don't over-sell as there may be financial difficulties facing the customer about which you can have no inkling. If you can sell the *idea*, you'll get the business when and if the family can afford it.

Point out troubles. Sometimes it is necessary to leave a set with some troubles in it other than the trouble you corrected. The customer may want to wait until later to have the additional work done. To protect yourself, make a note on all copies of the work tag of the fact that the set needs to go into the shop to have the additional trouble corrected. The desirable customer will appreciate your telling him of the condition of his set. This note will keep the undesirable customer from telephoning the shop the next day to say that his set has developed some new troubles because of the work you did on it.

You'll find that you will usually get the job of correcting the additional trouble as soon as the customer is able to pay for it.

How Are You Doing?

Did you check the statements in the box below before you read this article? If you didn't, it will be worth your while to do so. These statements with your checkmarks will help to indicate to you that you may need to work a little more effectively on selling both maintenance and yourself to the public.

The best answers as to how you are doing actually come from the customers themselves. If you find that they ask for your name when you leave, if they request you when they phone the shop to place a service call, and if they give you a friendly reception when you come in the door, then you know that you are doing an effective job of selling yourself.

-30-

HOW ARE YOU GETTING ALONG WITH CUSTOMERS?

Place a check mark under the appropriate frequency column opposite each statement.

	Often	Sometimes	Never
Customers don't recognize your ability.....	<input type="checkbox"/>	<input type="checkbox"/>	<input type="checkbox"/>
Customers don't thank you when you leave.....	<input type="checkbox"/>	<input type="checkbox"/>	<input type="checkbox"/>
You aren't dressed as neatly as you should be.....	<input type="checkbox"/>	<input type="checkbox"/>	<input type="checkbox"/>
You carry all your tools in your pocket.....	<input type="checkbox"/>	<input type="checkbox"/>	<input type="checkbox"/>
You tell customers you haven't worked on that brand of set before.....	<input type="checkbox"/>	<input type="checkbox"/>	<input type="checkbox"/>
You spread your tools all over the floor.....	<input type="checkbox"/>	<input type="checkbox"/>	<input type="checkbox"/>
Customers accuse you of saying things you did not mean.....	<input type="checkbox"/>	<input type="checkbox"/>	<input type="checkbox"/>
Customers think it is your fault when a tube burns out.....	<input type="checkbox"/>	<input type="checkbox"/>	<input type="checkbox"/>

If you have all "Never's" you probably haven't been out on a service call in months; a column of checks under "Sometimes" indicates that you could do a little constructive work on yourself; several "Often's" may mean that you need to put forth some effort to sell yourself before your income suffers.

Problems of INDOOR ANTENNA RECEPTION

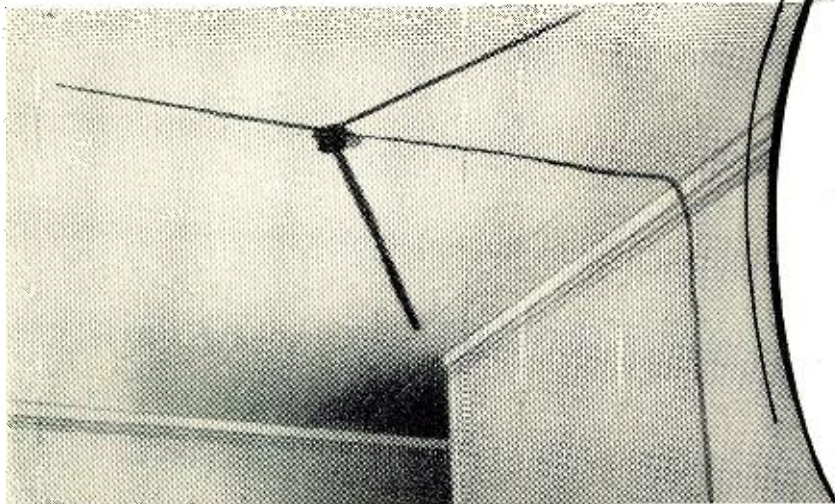

Ceiling mounting position for antenna. Elements are spaced 120° apart.

THE conventional indoor television antenna is economical and is convenient only to the extent that no outdoor antenna need be erected. However, its electrical performance and operating characteristics are, in general, *much* poorer than a proper outdoor type. An indoor antenna system is afflicted with numerous defects and problems—orientation, smear, reflections, weak signals, noise, signal interference, and instability. These inconveniences and defects mean picture quality, clarity, and stability are compromised on some and perhaps all channels. Nevertheless, there are many metropolitan and suburban sites such as hotels, apartments, and special housing projects where outdoor antennas are not convenient or are prohibited. Even in residential areas it would be nice to be able to dispense with the unsightly outdoor antenna. A convenient and effective indoor antenna would be a significant contribution to improved reception for many TV homes.

Orientation

Antenna orientation has always been a major indoor antenna problem and nuisance. The indoor "rabbit-ear" is versatile in this respect because it can be oriented and its length adjusted. However, to obtain optimum performance on each channel with stations in different directions, it is necessary to readjust orientation when

switching channels. Even with stations in the same direction from a given site, the presence of multiple indoor reflections and multiple high-band lobes often requires orientation from channel to channel if peak performance is to be obtained.

Improper orientation can cause pic-

Fig. 1. An indoor "Directronic" type antenna with aluminum tape adhesive elements and circuit of switching device.

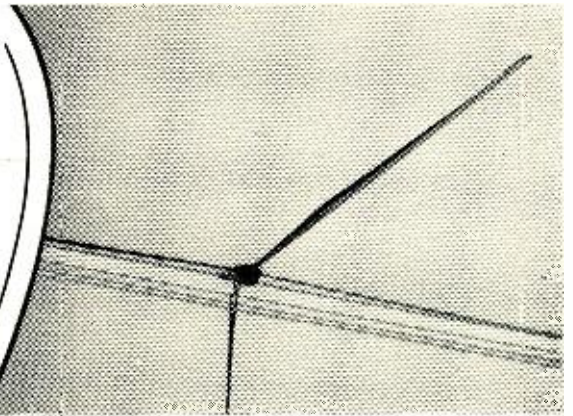
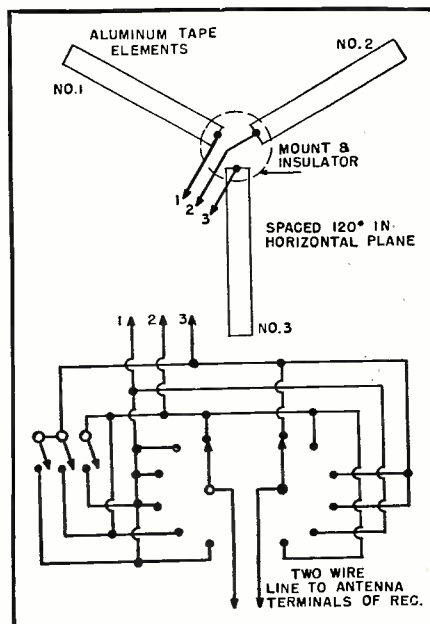

An alternative ceiling type mount.

By

E. M. NOLL and M. MANDL

**Simple switching unit permits
omni-directional reception
without rotating the antenna.**

ture smear, sync instability, and ghosts. When an indoor antenna is oriented away from true direction, the picture first begins to smear (presence of weaker direct signal and slightly delayed reflections). As orientation is continued in the same direction, the picture becomes weaker and sync stability poorer (reflected signals have more influence on sync system). Finally, a number of pictures are seen on a very shaky raster (indicating multiple signal reception with sync control shifting between the now much weaker direct signal and reflected components).

Reflections

Indoor multiple reflections cause three types of picture disturbance. When the preponderance of reflected signals arrive at the antenna just slightly displaced in time with respect to the direct signal (time delay comparable to partial period of r.f. cycle) the resultant signal delivered to the receiver input can be additive or subtractive as a function of phase relations between r.f. cycles of reflected and direct signal. Consequently, as the antenna is moved about the room there are definite points of strong and weak picture for each channel. It is quite difficult to locate one spot where peak performance is obtained on each channel.

In the case of a built-in antenna or indoor antenna with just a few feet of line between it and the receiver, it means the receiver has to be moved to

(Continued on page 111)

A MIDGET V. F. O.

By
W. W. PURVIS, W3QQA

**Covers 20, 40, 80 meters, is compact,
and features clickless, chirpless
keying and narrow-band FM phone.**

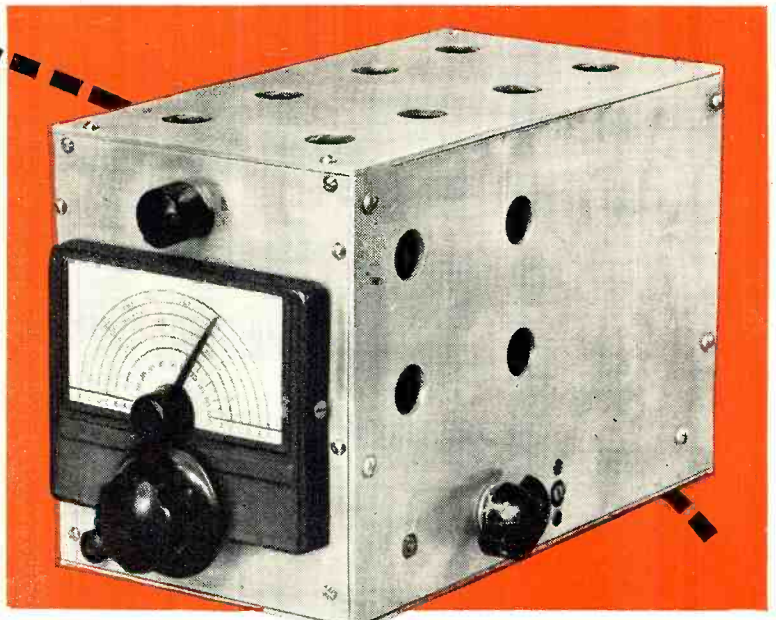

Over-all view of variable frequency exciter unit. In addition to fixed station use, it is suitable for many mobile applications.

IN VIEW of the difficulties involved in building extremely small variable frequency exciters with good inherent stability, most designers of amateur portable or miniature sized radio transmitters have employed crystal control and the equipment was, therefore, limited to single or fixed frequency operation. Crystal controlled carriers are of course rendered practically useless at times, due to the crowded conditions on the ham bands. Every amateur radio operator recognizes the variable frequency oscillator as an essential part of the modern ham station, for the purpose of shifting the transmitter carrier away from interfering signals and into clear channels. The v.f.o. is also used for spotting DX; in other words for shifting the carrier so as to zero-beat it with the incoming signal of the distant station. The latter method of signal spotting is also used for local contacts, as practically all hams are now in the habit of tuning their receivers so as to hear only those stations calling on the exact frequency to which their transmitters are tuned.

In designing the v.f.o. herein described, the writer has solved some of the problems relative to building midget sized equipment. Approaching the handie-talkie in size, this unit incorporates slightly new and different methods of construction and it is hoped that these methods will prove helpful to amateurs desiring to build equipment perhaps even smaller than that shown here.

A good compact unit, with regulated power supply, this v.f.o. operates well on three bands. It is a complete exciter/transmitter and is a handy unit for those who want to transport their equipment from place to place. The unit operates on 20, 40, and 80 meters (the old reliable bands where DX is

ever-present), and will drive the necessary frequency multipliers, making it possible to double to almost any other amateur frequency.

Unique in design, this unit uses a 3-gang receiving type of midget tuning condenser. Without regard for certain established methods of construction, this set has a power output on the three bands comparable to that obtained with almost any other type of design. The cabinet measures only 5 3/4" high, 4 7/8" wide, and 8 1/2" long and the entire set weighs 11 1/4 pounds, including the eight miniature type tubes. Should another type of power supply be employed and if the power transformer is replaced by selenium rectifier voltage doublers, a considerable reduction in the size of this unit

would be possible. The entire transmitter/exciter minus the power supply would measure only one-half of its present length, or 4 1/4 inches.

Contrary to the general practice of spacing the stages far apart to avoid interaction or feedback, this exciter's stages are jammed as closely together as possible. The r.f. feedback is eliminated entirely by shielding the lead from the tuning condenser C_{23} (Figs. 1 and 2), throughout its entire length, from the stator side of C_{23} to the switch S_{1A} . Also of importance is the method of supplying the screens of the 6AQ5's

Top view with cover removed to show the proper location of above-chassis parts.

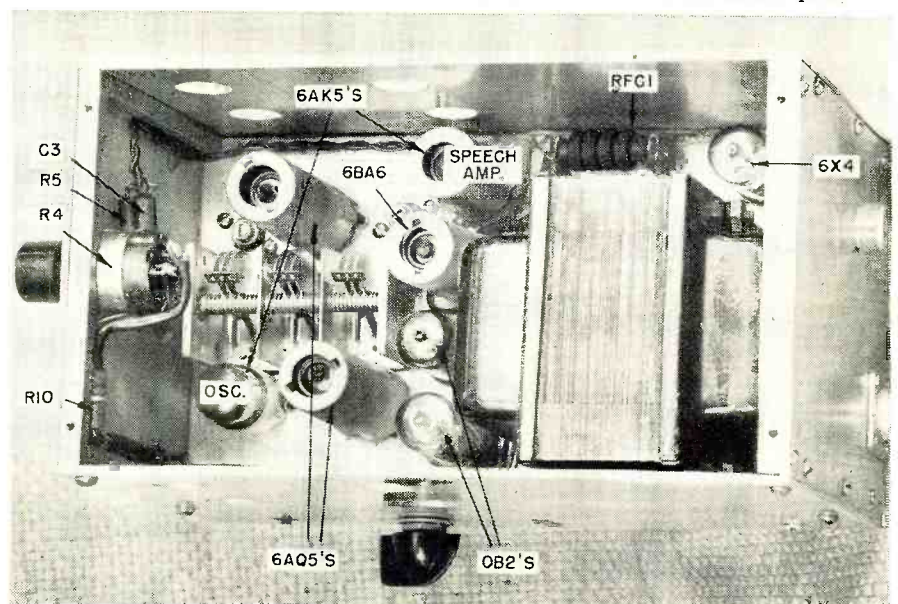

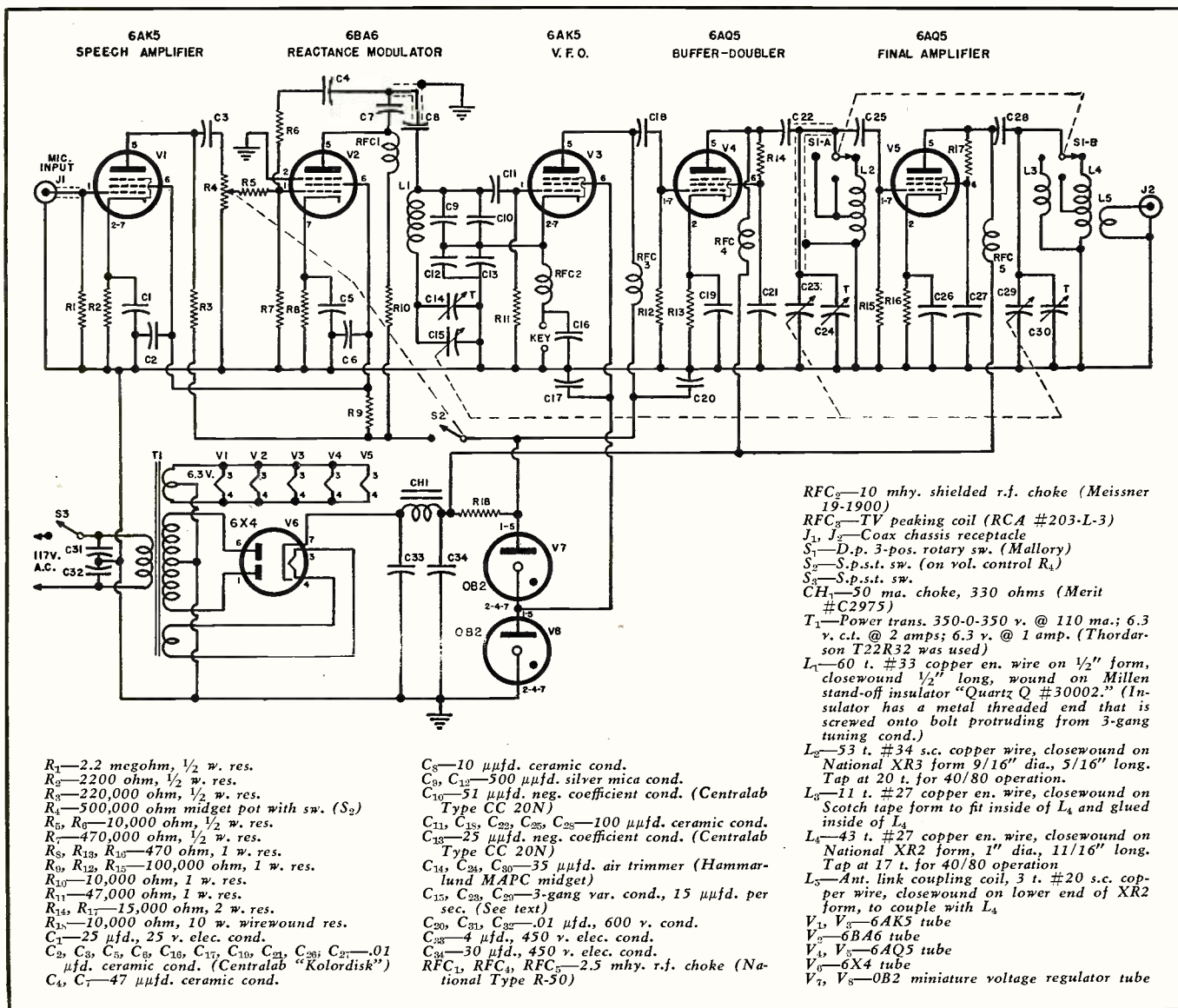

Fig. 1. Schematic diagram of the variable frequency exciter. The circuit is straightforward and easy to duplicate.

directly from the tube plates through the 15,000 ohm, 2 watt resistors, R₁₄ and R₁₇.

This v.f.o., when keyed, transmits a signal of excellent quality. Many radio amateurs have reported its signals to be the best quality heard on the air. Every critical report on its reception claims the signals sound crystal controlled.

After more than a year and a half of daily operation this unit continues to be trouble free, transmitting very stable, clickless and chirpless signals. The frequency modulated signals are also exceptionally good. This exciter performs in a smaller space and on more frequencies than other amateur v.f.o.'s seen heretofore.

No television interference has been encountered, even when this exciter is operated right on the top of a TV receiver. At several locations, this unit is used by the writer to drive 2E25 and/or 2E26 type tubes which, in turn, drive the output stages of medium powered transmitters. Over two hundred watts input is used at these locations with class B modulation,

without TVI. The narrow band FM works well, but AM causes no TVI and is used in preference.

The output of the 6AQ5 final stage on 40 and 80 meters is sufficient to light a seven watt lamp brightly and on 20 meters the seven watt lamp shows slightly less brilliance. With a half-wave dipole antenna indoors, operating on 40 meters, very good results were obtained while using this unit solo, and on 20, employing a flat-top beam, distances up to 3600 miles were worked with little difficulty.

Although it may appear that feeding the screens as described would cause the 6AQ5's to operate as triodes, this is not the case because resistors R₁₄ and R₁₇ act as r.f. chokes. The screens of these tubes are bypassed to ground through condensers C₂₁ and C₂₇. Fig. 2 shows the chassis layout with reference to the d.c. plate and screen leads to the tubes.

A tuning condenser of the type used in the old FM broadcast tuners with 15 μfd. per gang section and with 3 rotor and 2 stator plates per section is employed. A condenser of this type

can be obtained from All Star Products Inc., Defiance, Ohio.

An electro-zinc plated, open-ended chassis measuring 4 1/2" by 7 3/4" by 1 1/2" is used. The steatite tube sockets, shielded type, are riveted to the chassis and all grounds connected to the socket center posts which are, in turn, grounded to the chassis with soldered connections. Panels are of 1/16 inch aluminum. The front and rear panels measure 4 1/2" by 5 1/2" and are fastened to the chassis with small self-tapping screws. One quarter inch square brass rods are used to fasten the top and side covers. The brass is drilled and tapped to accommodate 6-32 screws. Vent holes, shown in the photographs, are punched into the side and top covers with the aid of a small tube socket punch. Large rubber shock mounts (large grommets 3/4" round, one end of which has been molded to fit a 1/2" hole, 1/16" deep), are glued into 1/2" holes drilled into the bottom panel.

If the parts are arranged as shown in the photographs and in Fig. 2 there should be no r.f. feedback problems.

Only two leads in addition to the one to C_{21} mentioned previously are shielded, i.e., the speech input lead from the microphone jack and the one from the phase modulator to the oscillator (6AK5) grid. Shielded cable, such as is used for phonograph pickups, is employed throughout, with the shielding grounded to the chassis as often as possible. RFC_1 in the plate circuit of the reactance modulator, is mounted on the top of the chassis as shown in the photograph on page 43. In order to avoid further crowding of parts beneath the chassis, the 500,000 ohm potentiometer R_1 , resistors R_2 and R_{10} , and condenser C_3 , are mounted on the top of the chassis.

The frequency range of the oscillator is wide enough to permit coverage of most of the amateur bands, since it tunes from 3.3 mc. to well above 4.0 mc. The TV peaking coil RFC_{11} , shown in Fig. 1, in the plate circuit of the oscillator appears small, but when larger chokes were tried, there was no noticeable change in the output or stability of the unit. By keying the oscillator cathode circuit (keying pin jacks shown in photographs, lower left hand corner of front panel), the latter is silenced when the key is opened, thus making break-in operation possible.

A Millen stand-off insulator #30002 "Quartz Q" is sawed off to fit under the 1½" chassis and is used for the oscillator coil form L_1 , Fig. 1. Although this type of insulator resembles lucite in appearance and cannot be used for the other stages due to the low temperature at which it melts; it was found to work satisfactorily for the oscillator coil. Other coil forms were tried, such as National XR2, and various kinds of wire were used. However, the Millen form, wound with #33 copper enameled wire produced the most stable results when the turns were covered with several thick coats of Duco household cement. (Duco was found to be a very good insulator when thoroughly dried.) When checking the fourth harmonic of the oscillator on 15 mc., beating it with WWV, there was no audible drift in frequency after the tubes were allowed to warm up. The amount of drift during the warm up period is almost negligible. Stability was found to be slightly improved by leaving the oscillator tube shield can off.

With 360 volts on the plates of the 6AQ5's, the plate current never exceeds 26 milliamperes input to each tube. Thus by putting 9.3 watts into them, their maximum plate dissipation is not exceeded. The 6AQ5's get very hot which is characteristic of the tubes, but nothing inside the small cabinet becomes overheated. The plate voltage of the 6AK5 oscillator tube is approximately 212 volts, while the screen voltage remains 100 volts, as regulated by the OB2 tubes.

While operating on 80 meters, the oscillator, buffer/doubler, and output stages are all on the same frequency, but no chirps are picked up in the

monitor when the unit is keyed. The "Q" of the coils is kept high with the lengths of the windings measuring less than the diameters of the coil forms.

A phase-modulated type 6BA6 tube is coupled to the oscillator through the 10 μ fd. condenser C_5 . Larger condensers, when used for this purpose, tend to overload the oscillator and cause too much frequency deviation; while a smaller capacity gives insufficient modulation swing. The switch, S_2 Fig. 1, on the FM volume control, cuts the plate supply to the speech amplifier and modulator tubes when the FM is switched off.

Bandswitching is accomplished by means of switch S_1 , which is shown in photographs mounted on the right side of the cabinet. Both the doubler/buffer and final plate coils are center-tapped, so as to work on either 40 or 80 meters. With S_1 in the first position, or for 80 meter operation, L_2 and L_1 full coils are switched into the tube circuits. In the second, or 40 meter band position, the switch connects the lower taps of L_2 and L_1 to the 6AQ5 plates when L_2 doubles to the 40 meter band and L_1 acts as a straight amplifier. The third position of S_1 , for twenty meter operation, places the lower tap of L_2 in the plate circuit of the second stage, which is doubling to 40 meters, and L_3 is switched into the final stage so that the output stage is also doubling. The plate coil L_3 is wound on a Scotch tape form, just large enough to make a tight fit inside of L_4 and is glued inside of the latter after it has been adjusted for maximum transfer of r.f. energy to the antenna link coil L_5 .

After the r.f. stages are lined up cold with a grid dip meter to track with the oscillator tuning they are retuned after the metal cabinet cover plates are screwed on. It will be noted from the photograph, below, that the oscillator trimmer (C_{11}) plates are

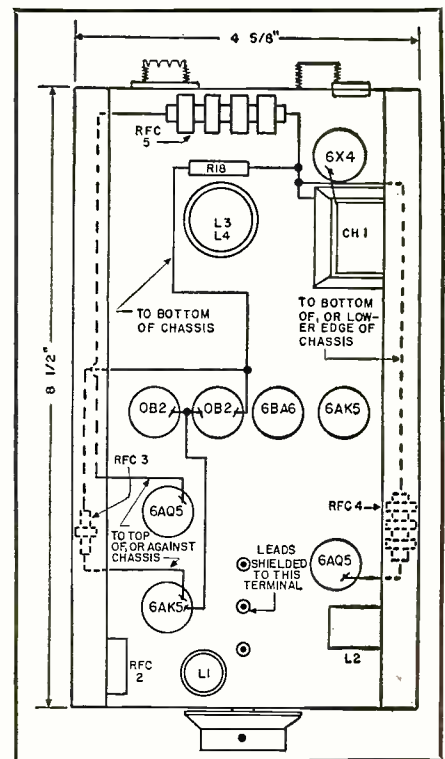
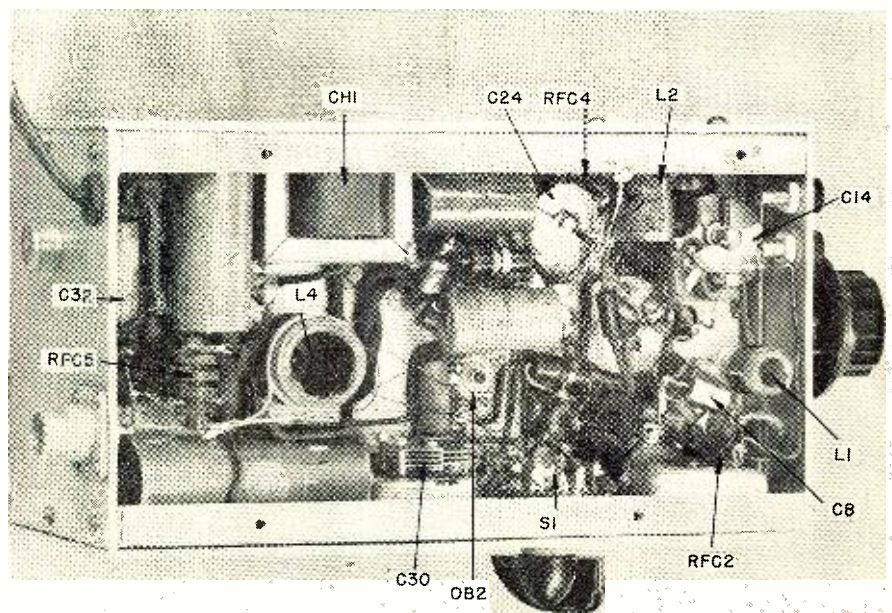

Fig. 2. Underchassis diagram showing location of the d.c. leads and r.f. chokes.

tuned half way out, or half of maximum capacity while C_{21} and C_{30} are almost all the way out, or minimum capacity. By holding a small neon lamp near the tuning condensers, on the top of the chassis, each r.f. stage is tuned for maximum brightness of the neon by adjusting C_{21} and C_{30} . C_{30} , the output tuning trimmer, can be reached through the hole in the right side of the chassis. Fine tuning adjustments are made with the aid of a field strength meter.

-30-

Underchassis view of variable frequency exciter. For parts identification, see Fig. 1.



The Electronic Brain

"CODETYPER"

Details on a completely automatic unit which requires no knowledge of code nor typing yet permits transmissions of from 10 to 75 wpm.

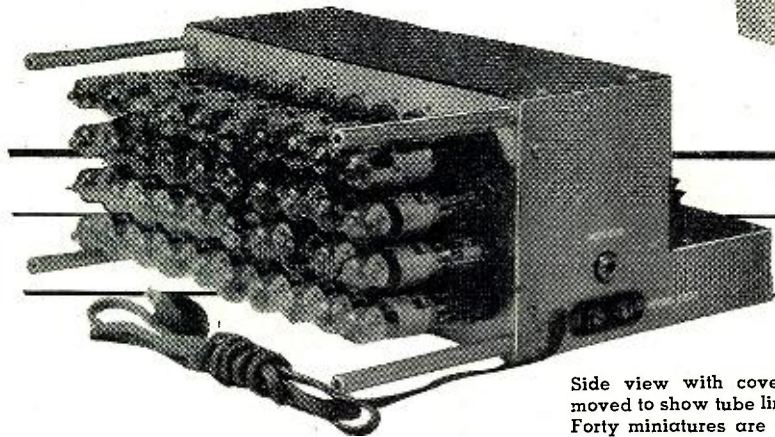

Side view with cover removed to show tube lineup. Forty miniatures are used.

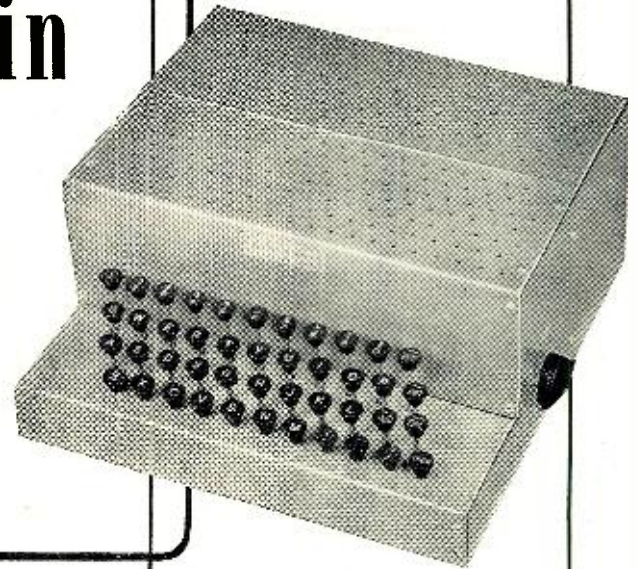

Front view of the "Codetyper" showing the typewriter-type keyboard with telegraphic symbols.

By
NATHANIEL G. A. DORFMAN
President, Codetyper Laboratories*

ANOTHER advance in the field of automatic and semi-automatic communications equipment has been made with the development of the "Codetyper." This new instrument provides a method whereby Morse code signals can be transmitted automatically by pressing the correct key on a typewriter-like keyboard.

This new device eliminates two of the bugaboos of transmitting, *i.e.*, "glass fist" and "signature" sending. While the first of these drawbacks is a handicap to the sender, "signature" sending can be of utmost importance in military transmissions where the enemy can use the distinctive sending style of an operator to identify troop units.

While there have been attempts in the past to eliminate the human element in code transmissions most of the instruments devised for the purpose have been complicated and costly. With equipment of this type the use of automatic code units was more or less confined to large or permanent installations.

There are, however, many thousands of transmitters being operated by individuals, and it is for persons such as these that the new "Electronic Brain Codetyper" was developed. It is operated simply by depressing a letter on a standard typewriter keyboard which forms part of the machine. When the key is depressed the "electronic brain" thinks up all the various timing combinations that are needed,

assembles the correct number, puts them in the proper sequence, and then sends them out so that they can be used to key the transmitter. The "Codetyper" directly replaces the usual hand key and is simply clipped across the key that is normally in use, or rather that was in use as it won't be needed with this new unit.

An instrument of this type must be suitable for use at all of the code speeds normally employed, so accordingly this unit is adjustable for speeds from 10 to 75 words-per-minute. No knowledge of code or typing is required to use the "Codetyper." One finger is adequate for the most commonly used code speeds but if the machine is to operate into some recording device at the receiving end, the operator can use touch typing and send speeds of 50, 60, or 75 words-per-minute and up. The unit can also be supplied with speeds from 75 to 125 wpm. Two models cover the machine's range of from 5 to 125 wpm—the slow speed model from 10 to 75 wpm and the high speed model from 50 to 125 wpm.

The design of the "Codetyper" presented a number of interesting problems. The random nature of the International Morse code makes it difficult to supply all of the various waveforms that are needed. The information which is contained in Morse code characters varies in many ways. In all of the letters, numerals, and punctuation

marks there are different over-all time intervals involved in forming the characters. Since the characters are composed of dots and dashes, the number of dots and dashes within the over-all time interval will vary considerably. The sequence of dots and dashes within a character also varies widely.

To meet these problems, this system works on the principle of a single information-forming channel which may be instantaneously triggered into many different states depending on which part of its memory connections is activated. In the static condition the channel is non-operative, but it can assume any random combination of time units in a dynamic state which can be used to generate the proper number and arrangements of pulses which are then used to activate a relay to key the transmitter. This method eliminates many of the complexities that would be imposed by a system which called for intermixing marking and spacing intervals as well as controlling the length of the letter. With this system letter length timing is automatic and no dash marking generators are required as the unit automatically scales the dash marking intervals down as controlled by dot marking intervals and the intermixing operation does not have a timing component.

There is a basic code for the arrangement of the units of the Morse code. The system by which this is done has been reformulated into a system

* 550 Fifth Ave., New York 19, N. Y.

suitable for use by the "Codetyper." The Morse code, made up of dots and dashes, can be considered to consist of different time intervals within the character to be formed. The dot has the smallest interval. It can, then, be used as a base and assigned the number 1. Counting up all the other characters, there are 19 units in all, figuring all spaces within the character to be formed as 1 unit. If a "unit code" is set up, each character will have a different number of units. Under the system by which the "Codetyper" operates there has to be a common reference point irrespective of the length of the letter. The first step is to set down the Morse code according to "units" but instead of starting from the number 1, it was decided to start from number 19 and work backwards. For example, the letter "E" is represented by the number 19. The letter "S," on the other hand, is represented by three units, 19, 17, and 15. The spacing interval within the character is figured into the over-all units so that the letter "S" would be a 5 unit letter—3 marking and 2 spacing intervals. The letter "S" as well as all other letters irrespective of length, will terminate on unit 19. The basic principle of the "Codetyper" is to take a single information-forming chain and derive from it as many units as are needed to complete the letter.

In addition to this information-forming chain, which collectively is known as the "unit interval generators," there are several other parts to the circuit. The "unit interval generators" are 19 in number since it is necessary to generate 19 intervals. The output of these generators consists of pulses which are fed to a keying relay which operates the transmitter. It is necessary that the keying

relay be activated by all of the "unit interval generators" in time series yet be able to receive pulses from all of the "unit interval generators" at a common point. In order to accomplish this there are keyers in the "Codetyper" consisting of a series of tubes arranged with their inputs in series and their outputs in parallel. Since no dash markers are generated, a definite system for forming dash markers is needed in the keyer section, thus this section is used for that purpose as well.

To form the dash markers on the keyers, there has been incorporated another section which has been designated "sequence selectors." These units are used to gate on any number or combination of keyers so that whenever the "sequence selectors" are operated they are able to provide dash markers as needed within the train of pulses constituting the character. The operation of the "sequence selectors" which help to form the dash markers is under the control of the keyboard. The keyboard will turn on as many of the "sequence selectors" as are needed by means of the associated "phantom switch network."

The "phantom switch network" consists of a group of resistors and neon bulbs arranged in such a way as to allow an extremely simple single-pole, momentary-contact switch to initiate as many as six circuits simultaneously, which means in effect that a single-pole switch acts as a six-pole switch because of the action of the circuit of the "phantom switch network." This network has two functions. The first is to turn on as many of the "sequence selectors" as are needed to form the dashes required by a particular character. The second function is to take a voltage from the network

and trigger the proper "unit interval generator" so as to provide the total number of pulses needed.

When the keyboard is depressed, the proper number of "sequence selectors" operated, and a particular "unit interval generator" triggered, the character starts to form, travels down the chain of "unit interval generators," and activates the keyers. The complete code character has now opened and closed the keying relay so that the Morse code is formed.

In analyzing the operation of the "Codetyper" it is well to examine the functioning of the "unit interval generator" (UIG) of which there are 19. Normally, the entire chain is held at cut-off, that is, all the pulse generators are biased so that there is no pulse output. The pulse generators incorporate 6J6 tubes in a univibrator circuit and all of the generators are identical. Triggering the first univibrator in the chain gives two output pulses. One pulse is used to feed the keyer and the other is used to trigger the next UIG. These two pulses are of two different waveforms—the one that activates the keyer is substantially a square wave of a time duration that is under the control of the speed control, the other pulse which is used to trigger the next UIG is a sharp spike which is caused by differentiating the trailing edge of the square wave pulse appearing across the cathode resistor of the UIG. This pulse is applied to the grid of the next "unit interval generator."

The pulse which is taken off the plate of UIG #1 is coupled directly, through an isolating resistor, to the grid of keyer #1 by d.c. coupling in order to avoid time constants.

To allow UIG #1 to deliver its pulse
(Continued on page 163)

Top view with cover removed to show mechanism.

Under chassis view with the base plate removed.

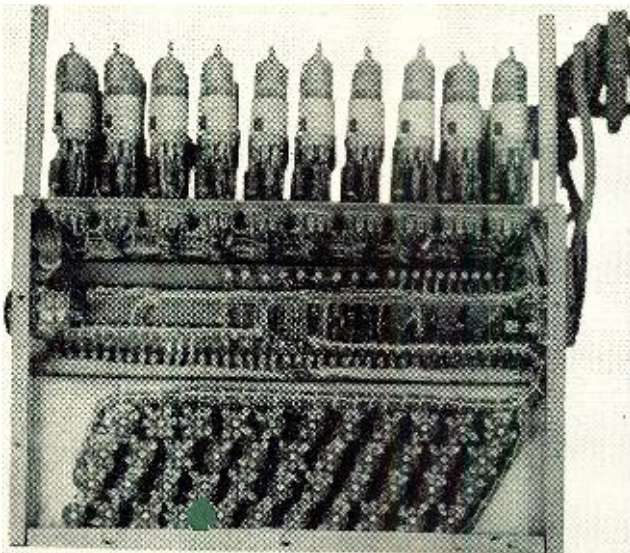

CORNER LOUDSPEAKER ENCLOSURE

By
RICHARD H. DORE
Audio Consultant

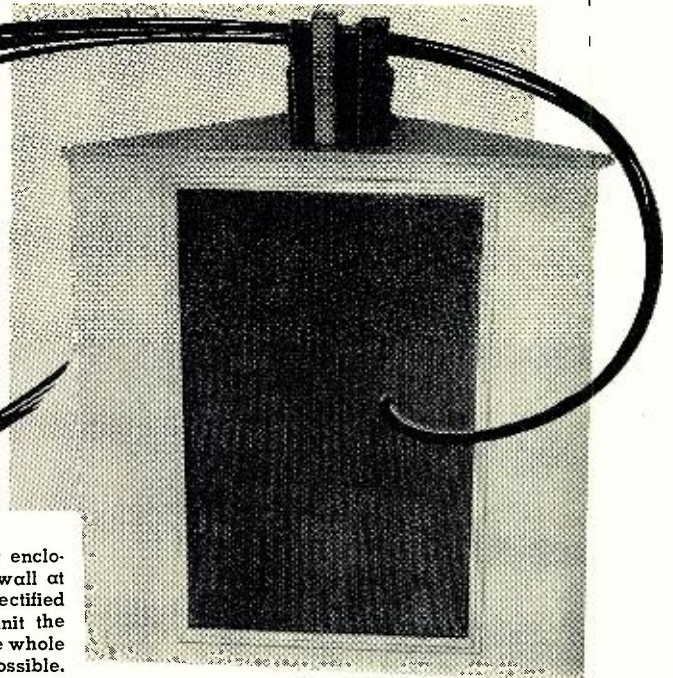

Fig. 1. Completed corner speaker enclosure. It is carefully fitted to the wall at edges where any errors can be rectified with a little plaster. Paint the unit the same color as the wall to make the whole installation as inconspicuous as possible.

Designed to accommodate both woofer and tweeter speakers — cabinet can be home-built for \$10.00.

EVERY audio authority agrees that placing the speaker of a high-quality system in a separate cabinet from that in which the amplifier and record player are mounted is the best practice. But a good reason why it is not done more often is that the lady of the house objects to having *another* big piece of furniture in a room already full of furniture. Another reason is that very few cabinetmakers will make a really good enclosure for less than about \$100, including a genuine furniture finish.

There is, however, a good way to get around both difficulties. First, however, to convince the lady that a separate enclosure is needed, you can cite the following facts:

1. If the system is any good at all, the sound coming from a speaker in the same cabinet will vibrate the wood; the phonograph pickup (or perhaps a microphonic tube) will pick up the vibrations, feed them into the amplifier again, and create a continuous and nerve-wracking steamboat-whistle effect. The only two solutions to that are (a) to build the cabinet of concrete or (b) to play the instrument so softly you can't hear it.

2. You need a big cabinet to get good bass, unless you want to play with tuned ports, a trick that may make a symphony orchestra sound as though it were playing in a barrel. To get 10 cubic feet of air behind the speaker and *also* mount turntable, amplifier, power supply, and tuner in the same cabinet, you will need a box big enough to live in.

3. This one is a little more subtle and must be explained just right. When the sound comes from the same place where you know the record to be, you have a mental picture all during the music of a disc whirling around. As a result, your own mind gives the music

a "canned" feeling, no matter how good it really sounds. On the other hand, when the speaker is in a different place, that effect is no longer present. With your attention on the music, you can ignore the whirling record because the music and the disc are no longer in the same place. This may sound fantastic if you've never heard a separately placed speaker, but the first time you try it, the meaning will hit you with a bang!

4. Everybody says the speaker should be separate. (This argument is only a last resort, to be used when your own prestige has failed and you need to call on the "Authorities.")

A good deal of the pain and expense can be taken out of the separate cabinet idea, however, by the simple device of using a corner for it. A speaker system placed in a corner is in the best possible position to cover the entire room with sound, especially at the higher frequencies.

The simple corner cabinet shown in the photo requires exactly two pieces

of wood, 3/4-inch plywood. One is cut out for the woofer and tweeter and placed across the corner to form the front of the enclosure. The other is triangular and forms the top. The two intersecting walls are the remaining two sides and the floor of the room is the bottom. Total cost of the unit pictured, including having a local cabinetmaker cut the two pieces (and the speaker holes) on his rotary saw, was about \$10. Soundwise, you couldn't buy a better enclosure. And almost any living room has a corner that isn't doing anything.

The basic requirement for an "infinite" baffle is infinite isolation between the front and the back of the speaker. Since that isn't possible, the idea is to get as much air as possible behind the speaker and still isolate the front from the back. As a rule of thumb, 10 cubic feet of air within the enclosure is about the minimum for really good reproduction.

That makes calculation of the measurements simple. Fig. 4A is a mechanical drawing of a corner enclosure like the one in the photo. The three important dimensions for calculation purposes are *a*, *b*, and *d*. Note that *c* does not count at this time. Dimension *c* is just the board width but unless you want to get more complicated than necessary, don't use it in figuring the volume. The following simple formulas give volume in terms of the *a*, *b*, and *d* dimensions and also each dimension when the others are known:

$$\begin{aligned} V &= abd/2 \dots\dots\dots (1) \\ d &= 2V/ab \dots\dots\dots (2) \\ b &= 2V/ad \dots\dots\dots (3) \\ a &= 2V/bd \dots\dots\dots (4) \end{aligned}$$

Fig. 2. Graph for determining dimension "c" when "a" and "b" (Fig. 4) are equal. Three-place accuracy is not necessary if instructions are followed. Errors are compensated.

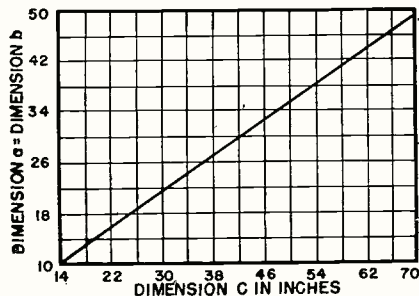

Suppose $a = 3$, $b = 3$, and $d = 3$. Then $V = 3 \times 3 \times 3/2 = 13.5$ cubic feet, the volume of the enclosure. Or suppose you want a volume of 10 cubic feet; a is 2, b is 2. What is d ? Using formula (2), $d = 2 \times 10/2 \times 2 = 5$ feet. And so on.

You may be afflicted, as I am, with corners that look like that in Fig. 4B. If so, make the calculations as before, just as if the gadget in the corner weren't there. To do that use the measurements shown in Fig. 4B with the formulas above. For a substitute $a' + b''$, and for b substitute $b' + a''$. Then figure the volume of the corner projection and subtract it from the total.

The next order of business is to get or cut the two pieces of wood. For the front the height is simply dimension d . The width of the front can be found by the empirical method if you have long enough arms but a graph (Fig. 2) is given to save you the trouble. It is based on the fact that, according to Euclid, the square of the hypotenuse of a right triangle is equal to the sum of the squares of the other two sides. This graph will work only if dimensions a and b are identical in Figs. 4A and 4B. You will get the best coverage of the room if they are, but sometimes you will have to make them unequal because of the way the room is built. Don't try to read between the graph calibration marks too exactly; it isn't necessary, especially if you figure the enclosure for a little more than the volume you want.

When you have dimensions c and d , cut the board for the front. Do not cut the side edges straight, however, but at a 45-degree angle so that when the board is placed against the wall its edges will blend into the wall.

For the top, the safest way to cut is illustrated in Fig. 4C, if you have provided for equal lengths for a and b . First cut a board to the width of dimension c and match it to the already prepared front piece to see that they are the same. Then set the tri-square for 45 degrees and draw a line from each end of the front inward until they intersect, as shown. Cut along the lines and you have the top. If your corner looks like Fig. 4B make the necessary cutout in the top, as indicated by the dashed lines in Fig. 4C. Complete the heavy work by cutting out holes in the front piece for the woofer and tweeter. The holes need not be smooth, for they will be hidden.

There are two ways to fasten the front piece to the wall. The easiest is to place it in position, then drill through both board and wall the four holes indicated at S in Fig. 4A. Long toggle bolts can then be pushed through the wood and plaster and tightened. The other method is to nail or bolt long strips of 1-inch-square wood to the wall and, in turn, fasten the front board to them.

The top piece sits on top of the front board, which then supports its front edge. The other two edges are supported by two pieces of 1 x 1 fastened

to the wall at the right height. It is not necessary to fasten the top in place. Three-quarter-inch plywood is heavy enough to stay put and the top is easy to remove when adjustments are to be made inside.

If, as in the enclosure pictured, the woofer and tweeter holes are near enough to the top, the speakers can be mounted after the front is in place. If there is any doubt, however, fasten them in before the board is fastened to the wall. In any case, line the entire surface of the enclosure's inside—wall and floor as well as the two pieces of wood—with soft padding. *Ozite*, usually used as a base for rugs, is perfect for the job, but cotton batting from the drug store will do, too.

If there is any possibility that children, dogs, or careless adults may poke something through the woofer cone, get some galvanized screening with about 1/2-inch spacing and place it between woofer and cabinet. To complete the construction job, get a piece of molding 3/4 inch wide and nail it in place across the outer edge of the top piece. (See Fig. 1.)

Now the finishing touches. Get either a can of plastic wood or a bag of plaster. The latter, mixed to about the consistency of cold cream, seems to be easiest to handle. With a wide putty knife work it in along the side edges of the front piece so that when you are finished the front blends in smoothly with the wall. If your wall

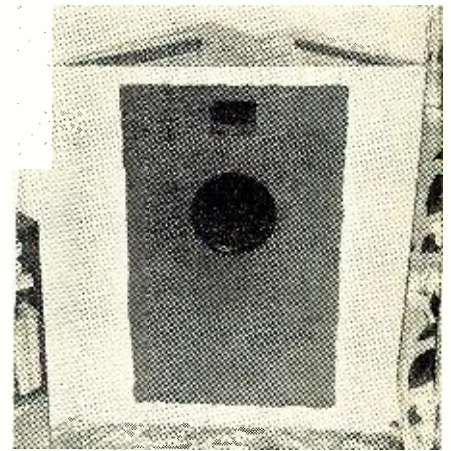

Fig. 3. After the front board is in place, nail a pair of 1 x 1 inch strips to wall to support the top, then paint the area to be covered by the grille cloth with a dark paint so holes do not show through the cloth. Dark green was used by author.

has very fancy woodwork along the bottom edge as did the writer's, the front piece will have been cut roughly to conform with the shape of that woodwork. Plaster is then used to fill any gaps between board and woodwork.

The next job is to make a simple frame of four lengths of molding. The size should be enough to more than cover the two speaker holes. Now put the frame in place over the front and

(Continued on page 126)

Fig. 4. (A) Sketch of enclosure for a clear corner showing dimensions of two pieces required. (B) When corner has a post, the top must be cut out. Dimension (a) becomes (a') plus (b'') and (b) becomes (b') plus (a''). (C) To make top, cut a rectangular piece of wood to dimension (c), then draw lines at 45 degrees from each corner with carpenter's square. If lines are correct, intersection will be a right angle.

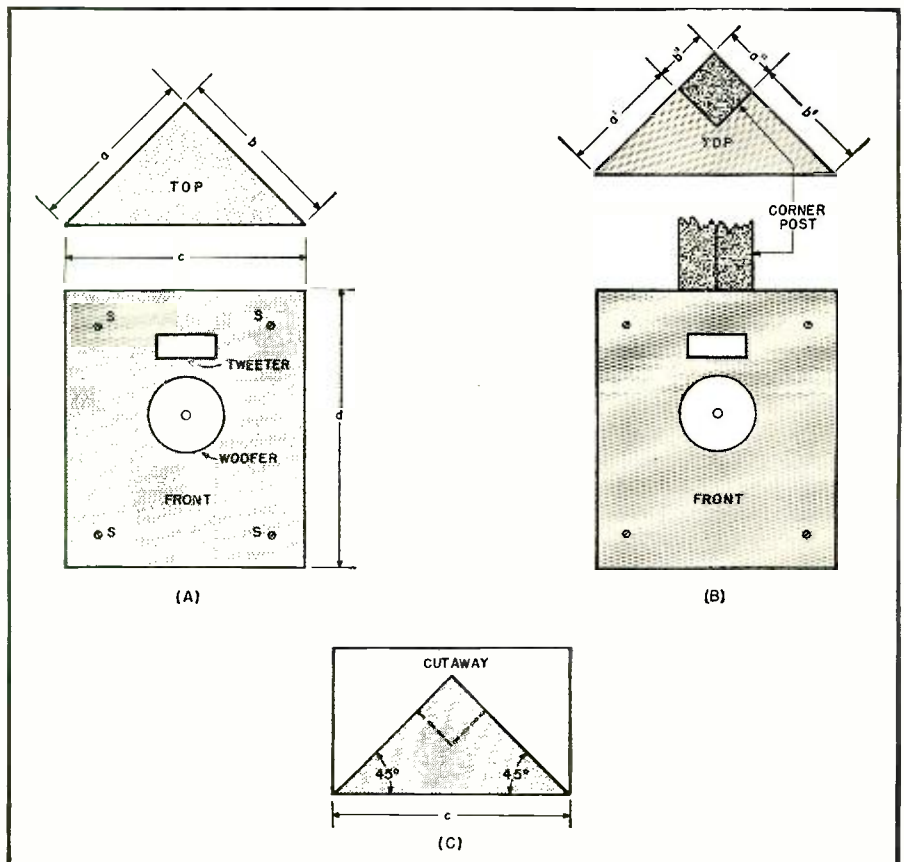

A Low-Cost AUDIO AMPLIFIER



By
FREDERIC T. C. BREWER

Fig. 1. Top and under chassis views of the low-cost amplifier. Entire unit is built in 4" x 3" x 5" box.

Less than ten dollars for a complete audio amplifier that boasts a frequency range of from 50-20,000 cps.

AUDIO holds a fascination for a variety of enthusiasts, including the engineer, musician, and the hobbyist. Any and every phase of the art seems to interest them as evidenced by the increasing number of audio articles appearing in magazines. However, many are not content to just read about the new devices and circuits, but long to try them out. You have probably picked up this magazine many times and found a super fidelity amplifier described and have had to be content with reading superlatives about its performance simply because the necessary parts would cost a small fortune—not to mention the time that would have to be spent duplicating it. Do not interpret this to mean that I am against such articles—far from it—for I am one of those self-same enthusiasts. This article is written with the purpose of presenting an audio amplifier that can not only be talked about but that can be duplicated in about an hour's time for less than ten dollars.

Even though the circuit incorporates three feedback loops, it will give no trouble. Even the novice can anticipate results comparable to those obtained by persons more experienced in electronics.

Construction Hints

As can be seen from the photograph of Fig. 1, the amplifier is compact, being entirely constructed in a 4"x3"x5" steel utility cabinet.

None of the parts is critical and wide variations in values can be tolerated without loss in performance.

Most, if not all, of the parts can be found in the proverbial junk box. Even if all new parts are used, the cost should be under ten dollars.

Remove the top plate of the utility cabinet. Then make the holes for the three tubes, the filter condenser can, and the input and output jacks. Next mount those parts. The electrolytic condenser can we used was a *Mallory* four-section, 20 μ fd.-per-section condenser, rated at 450 volts. Of course 150 volt condensers may be used. We used the 450 volt condenser because it was on hand, and by using it we were sure of the wide safety margin that we wanted in order to insure continuous, uninterrupted service. We mounted the can condenser so that it was insulated from the top plate. This was accomplished by placing the fiber mounting template on top of the top plate making sure that the prongs did not touch the top plate when the condenser was inserted.

Two sections of this condenser are wired in parallel in order to obtain a value of 40 μ fd. for the filter-input condenser. The tubes, a 12SH7, 50L6, and 35Z5, because of their wide use, are relatively cheap. Male, non-shorting chassis mounts were used for the input and output jacks. Again, any type of jack might be used.

The fiber washers that keep these mounts from shorting to chassis were removed from the input mount, and it became the only ground point for the amplifier. A bus wire was run from this ground point to a prong on the insulated electrolytic can, and all grounds were brought to this bus.

With the top and bottom plates of the utility cabinet removed, it is relatively easy to mount the filter choke, output transformer, pilot light assembly, loudness control, power switch, and fuse holder. The output transformer is mounted on the left face of the utility cabinet directly below the output jack. The filter choke is mounted on the right face of the utility cabinet under the rectifier tube and filter condenser. This arrangement keeps leads short and fields to a minimum. The power cord is brought in through a rubber grommet on the back face next to the fuse holder. We wired the top plate, leaving until last leads that went to the components inside the cabinet. After all wiring was done, except the connections between the top plate and the parts mounted in the cabinet, we mounted the top plate. Since these connecting wires were already wired to their respective points on the top plate, the remaining connections were made with ease.

All the components in the parts list are standard items and judicious substitution of parts on hand can be made without fear of complications. As an example, the output transformer is listed as a *Stancor* A3876; however, an output transformer from any radio or amplifier using a 50L6 or equivalent output tube will do just as well.

To keep hum to the vanishing point, it is recommended that the pilot light be connected as shown in Fig. 2 (instead of the usual method employed when a 35Z5 rectifier tube is used). While we are on the subject of hum, it might be pointed out that by having the feedback loops connected as they are, practically all hum in the output due to "B+" ripple is canceled out. Since the loudness control is returned to ground through the secondary of the

output transformer, especially good results are obtained when the amplifier is operated at low levels in extremely quiet surroundings.

Certain precautions should be taken when this amplifier is put into use. The amplifier is of the a.c.-d.c. type, and since no power transformer is used, a certain danger exists. We recommend that the entire amplifier be enclosed in, or behind, a cabinet or partition of some insulating material, i.e., wood or plastic. No metal parts which are connected to the chassis should be exposed, since the chassis is connected directly to one side of the line. One method of overcoming this problem would be to use a polarized plug, so that the chassis would always be at ground potential. Another would be to connect the chassis directly to a good external ground, and then connect only the "hot" lead to the appliance plug. The amplifier would not operate if the plug were inserted with the wrong polarity.

Feedback Loops

To get the feedback loops working correctly does not require instruments. It can easily be accomplished as follows: ground either side of the secondary of the output transformer and wire it as shown in Fig. 2. Should the amplifier begin to squeal when you first turn it on, turn it off and interchange the two leads from the secondary of the output transformer. Turn on the amplifier again, for nothing more need be done. The positive feedback loop does not require any change or adjustment.

The feedback loop provided by connecting the volume control in series with the secondary of the output transformer is somewhat unorthodox, but produces exceptionally good results. The amount of feedback varies with the setting of the volume control, being maximum at the minimum setting of the control. With the control set at the point where a 1 volt input produces a 1 watt output at 1000 cps, there is 30 db of negative feedback. Connecting the cathode of the 50L6 in series with the output transformer secondary adds about 2 db, and the 12SH7 screen bypass connection adds another 4 db of negative feedback. The resistor between the cathodes of the 12SH7 and the 50L6 provides 10 db of positive feedback.

Performance

I would like to describe first the results of testing with instruments. I know those of you who believe in listening tests are saying, "Here we go again!" However, most of us like to see in the form of graphs, etc., what our "golden ears" tell us is perfection.

The frequency response at moderate power levels, adequate for normal room listening, is shown in Fig. 3, both with a 5-inch speaker load and with a 4-ohm resistance load. At lower power levels, the response is essentially a straight line from 40 to 40,000 cps, while at higher power levels the response drops off somewhat at the higher frequencies and drops off quite rap-

idly at lower frequencies, due to saturation of the small output transformer. Greater power output at the lower frequencies could readily be obtained by using a larger and more expensive output transformer. It was not felt that the slight improvement in performance justified the additional bulk and expense in this case, since performance with the transformer indicated was so highly satisfactory on the basis of listening tests. Maximum power output at reasonable distortion is about 1.2 watts.

Before you pass judgment on what seems like inadequate power output, remember the millions of sets using the same output tube and a small 5 inch speaker, or re-read James A. Mitchell's article "Loudness and Power in Audio Systems," which appeared in the February, 1951, issue of this magazine.

The internal impedance is 0.27 ohm at 60 cps, and since at this frequency the output, as shown by the frequency response curve, is near its lowest value, it is evident that at higher frequencies the internal impedance will drop even lower. However, we are more interested in the damping out of the large cone excursions of our speaker at low frequencies. We believe the low internal impedance partly accounts for that intangible "presence" effect experienced when listening to this amplifier.

Listening tests were made with speakers ranging in size and quality from a single 4 inch unit to an elaborate *Tru-Sonic* two-way theater system. When the amplifier was used with the *Tru-Sonic* system and fed with program material from an FM tuner the results were exceptional. Results from other combinations were also completely satisfactory.

As a further test of the hum content (our instruments did not register any value at hum frequency) we turned the loudness control up full, with an open input, and listened at close range to an efficient speaker. It was absolutely dead. When used with a tuner, if there is any hum, reverse the power plug of the tuner or amplifier socket.

The 12SH7 input tube was chosen because of its high gain. However, in some cases it is possible to secure a slight reduction in hum by substituting a 12SJ7 for the 12SH7. This will result in some decrease in over-all gain, but in most cases this reduction will be insignificant. By connecting pins 3 and 5 of the 12SH7 socket together, the 12SJ7 may be inserted directly without further changes.

Conclusion

The construction hints given in this article are just that; it is not necessary

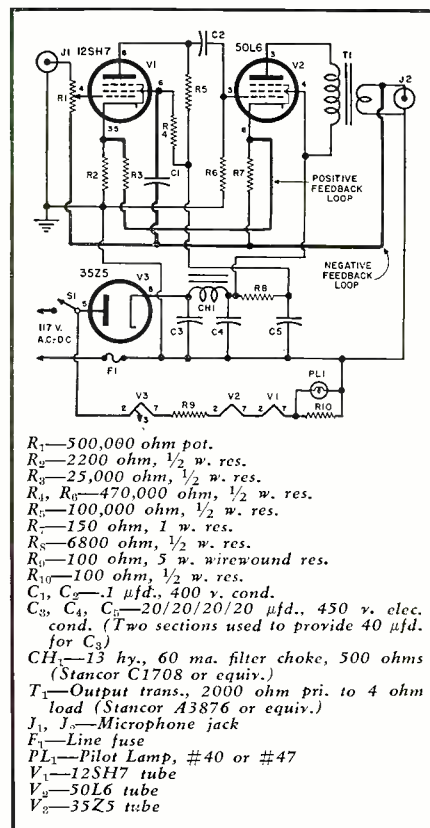

Fig. 2. Schematic diagram and parts list for low-cost amplifier. The several feedback loops that author used are quite novel. The positive loop is used to increase over-all gain of the unit. Negative feedback to the screen grid of the 12SH7 maintains over-all negative feedback when the volume control is in its maximum position. The feedback circuit to the lower end of the volume control serves a dual purpose. It is relatively ineffective when volume control is at maximum position. Maximum gain is therefore obtained where it is required. As the volume control is decreased, the effect of feedback is increased, thus providing maximum feedback at the minimum setting of the control.

to follow them exactly. The author, over a period of time, has constructed numerous amplifiers based on the design outlined in this article with variations as to shape and size but all of them have worked exceptionally well. I know that those who take the time to duplicate this amplifier will be well rewarded by its performance.

REFERENCES

- Smith, F. L., "Radiotron Designer's Handbook," Third Edition, The Wireless Press.
 Cooper, George Fletcher, "Audio Feedback Design," Radio-Electronics, October, 1950 through November, 1951.
 Terman, F. E., "Radio Engineering," Third Edition, McGraw-Hill Book Company.

—30—

Fig. 3. Frequency response at medium power levels. Dotted line is response with 3.2 ohm, 5" speaker load. Solid line shows response with 4 ohm resistance load. Ordinate scale is arbitrary, based on 0 db representing 1 watt output at 1000 cycles.

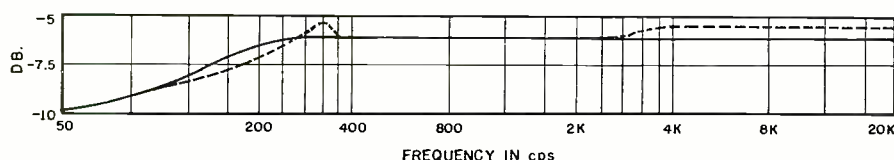

Completed assembly built from "Pre-Fab" units.

"PRE-FAB" TUNERS

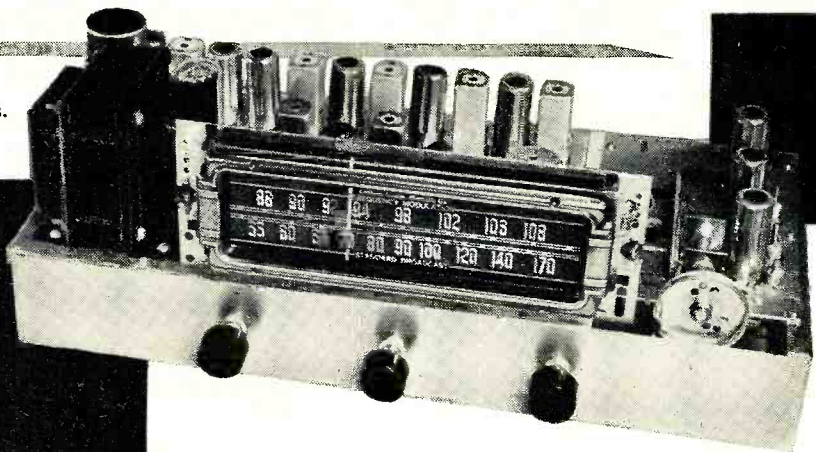

By

W. H. COLLINS

Collins Audio Products Co. Inc.

Pre-assembled units simplify construction, particularly for the inexperienced radio builder.

found what they have been seeking—true and faithful audio reproduction in the home!

Purchasing completed components can be costly if one's taste demands perfection. In this connection though, *Collins Audio Products* figured that it was possible to provide high grade equipment at moderate cost if the purchaser were willing to do a little work himself. Since there is only a relatively small group of people in the country who understand the technical aspects of radio, *Collins* kept this in mind in designing the "Pre-Fabs."

By making up the basic circuit components separately, an inexperienced person can put them together, connect an absolute minimum of wires, and obtain performance comparable to that available from a factory-built, completely assembled job. By so doing, the builder saves many dollars in addition to having the satisfaction and feeling of accomplishment which comes from contributing personally to his radio system.

The "Pre-Fab" kit is composed of four basic units: (1) The FM r.f. tuning unit, (2) the FM intermediate frequency amplifier, (3) the AM tuning unit, and (4) the chassis kit, which includes the power supply, dial assembly, and necessary hardware (Continued on page 124)

PACE with the rapid advances television has made in the past five years, radio too has forged ahead, ably supported by high-fidelity FM reception and topnotch programming by the stations. An innovation in the radio field is the *Collins* "Pre-Fab" tuner, recently introduced as an FM tuner kit and later expanded to include AM. This design represents an entirely new approach to kits in that the tuner is broken down into its basic circuits for ease and accuracy in manufacture, as well as facility in assembly for the user.

Current design for home listening of high-fidelity reception prescribes an integrated system composed of a radio tuner (FM and AM), a wide-range audio amplifier, quality record changer, and separate loudspeaker unit. People interested in providing their homes with fine entertainment equipment are rapidly turning toward this new medium. Much standardization has taken place in recent years and it is a relatively simple matter for even an inexperienced person to assemble the units of his selection without specialized technical knowledge.

Modern design in the contemporary living room dictates that the radio and phonograph equipment be "built-in" wherever possible or installed in choice furniture pieces. In addition, much fine audio equipment has been made available and is being purchased in an ever increasing volume by an eager and interested public. At last they have

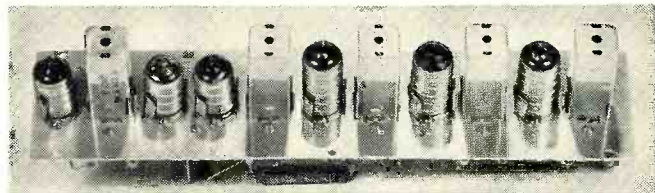

Chassis strip carrying the FM i.f. amplifier unit.

View of the AM tuner and its accompanying i.f. unit.

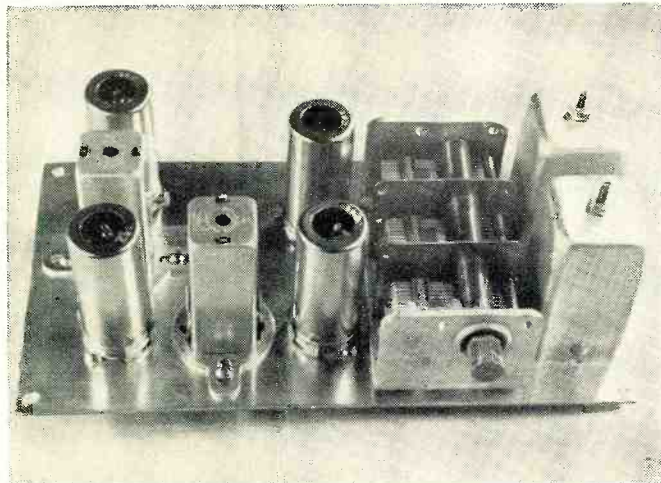

The Collins "Pre-Fab" FM tuning unit chassis strip.

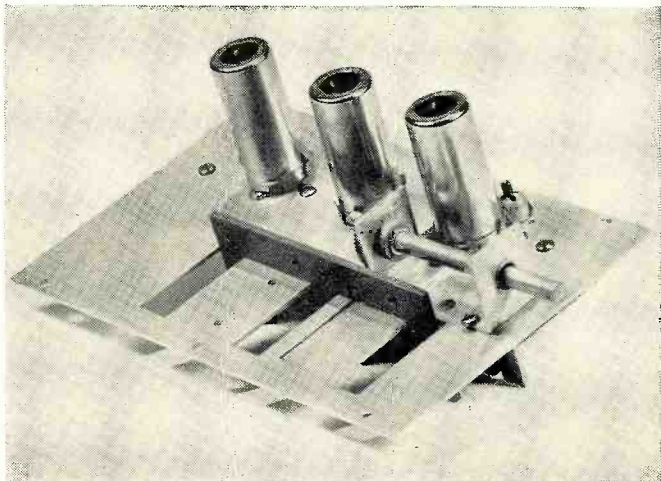

150-Watt Universal

R. F. Amplifier

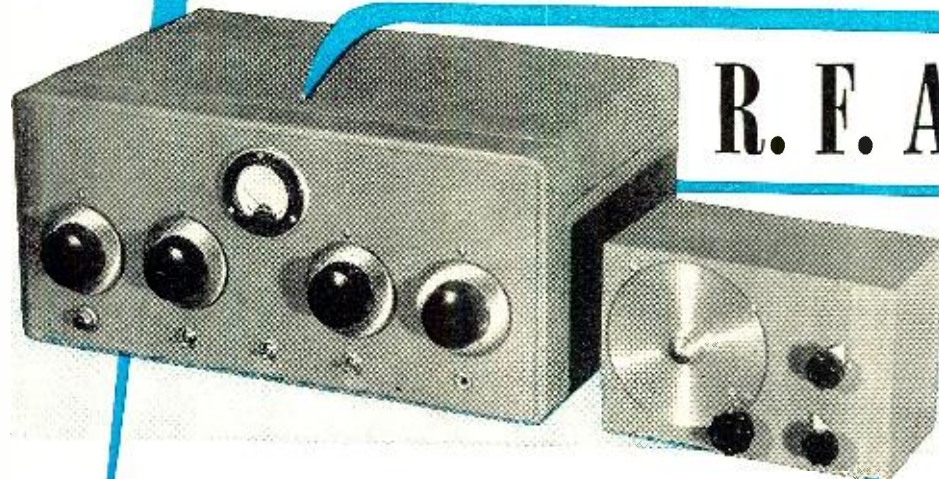

By
JOHN F. CLEMENS,
W9ERN

Take your pick of C.W., FM, AM, or SSSC—this unit handles them all on any band—and without any TVI.

A MODERN amateur transmitter must meet a variety of specifications. It must operate over a wide frequency range as a first requirement and practically every amateur desires a transmitter which will give him the choice of phone or c.w. Experience has shown that it is usually unwise to try to incorporate too many features into one piece of equipment. It is necessary instead to compromise somewhat, retaining those features which operating experience has shown to be desirable, and eliminating the "gingerbread" features. The design of this equipment was an attempt to follow this policy and in over a year of use on the air, on all bands from 80 to 10 meters, on phone and c.w., it has justified its builder's confidence.

The amplifier is "universal" in the sense that it will amplify any sort of r.f. signal of approximately one-fourth watt to two watts on any of the commonly-used bands. Instead of the usual class C amplifier, the two stages are operated as class A and class B linear amplifiers. Thus, the unit may be used to amplify any type of signal, whether it be c.w., AM or FM phone, or single-sideband. Don't let that "linear amplifier" idea scare you—this transmitter is no more difficult to adjust than any conventional class C rig. The tube electrode voltages are set to the proper handbook values and from there on it is merely a matter of setting the input signal level and the output coupling. Two dials on the front panel

make these adjustments and the plate meter is all you have to watch in tuning up.

All bands are covered by means of plug-in coils. Bandswitching was not included in the interest of compactness, efficiency, and good layout from the TVI suppression standpoint.

A great deal of attention was given to the very important problem of eliminating spurious radiations which cause BCI and TVI, with the result that careful measurements show the strongest harmonic to be 72 db below the carrier when operating on ten meters. This is considerably better than the FCC requirement of -60 db for a transmitter of this power. This harmonic suppression has been achieved without *tuned* traps or filters which would be effective at only one frequency. Shielding has been the principal means of reducing unwanted radiations plus a mode of operation which generates weak harmonics.

An elaborate shielding job usually requires a great deal of special sheet metal work which the average ham cannot perform with hand tools. Standard utility boxes are used in this design with a standard chassis and a standard-size cabinet. The cabinet shown is from a *Hallicrafters* S-56 receiver, which has the same nominal dimensions as the *NC-100X* receiver. The chassis measures 11" x 17" x 2" and a heavy-duty plated (not painted) steel type is recommended. After the shield boxes have been laid out on the chassis, the mating areas of the chassis

Front view of amplifier, shown with the exciter unit described by the author in last month's issue. The power supply for the amplifier is also used to operate the exciter section.

are masked with tape to keep them clean and the chassis is painted to improve its appearance and prevent rust. The two shield boxes are steel utility boxes, the one housing the final amplifier tubes and tank circuit measuring 9" x 5" x 6" and the smaller one which houses the 6AG7 stage components measuring 3" x 4" x 5". The flanges of these boxes should be sanded bright before they are mounted on the chassis with self-tapping screws. The two 807 sockets are submounted approximately one inch below the chassis by means of inverted *Eby* base-mounting shells. This drops the tube plate caps about $\frac{3}{4}$ inch below the copper screen shields over the top of the box. Aluminum shields are used inside the box around each 807 to reduce feedback to the grids. Neutralization of the final amplifier has been found unnecessary. A small aluminum panel was used to replace the steel lid supplied with the smaller shield box to avoid the labor of sanding off the heavy crackle finish. An aluminum coil shield is used over the plug-in coil which is the final amplifier grid coil as well as the driver stage plate coil.

To make the shielding effective it is important that no ungrounded metal shafts pass through the shield wall. Insulated shaft extensions are used on all the controls to the dials on the front panel.

The front panel controls, as seen in the amplifier pictured above, include output coupling, plate tuning, final grid tuning, and r.f. excitation. The switches on the front panel control power "on" and "off," exciter "on" and "off," and high voltage "on" and "off." The keying jack is located below the r.f. excitation dial.

Push-pull 807's are unbeatable in a transmitter of this type. The driving power is very low, the tubes are inexpensive, and the push-pull connection reduces harmonic content in the plate circuit. Class B operation has other

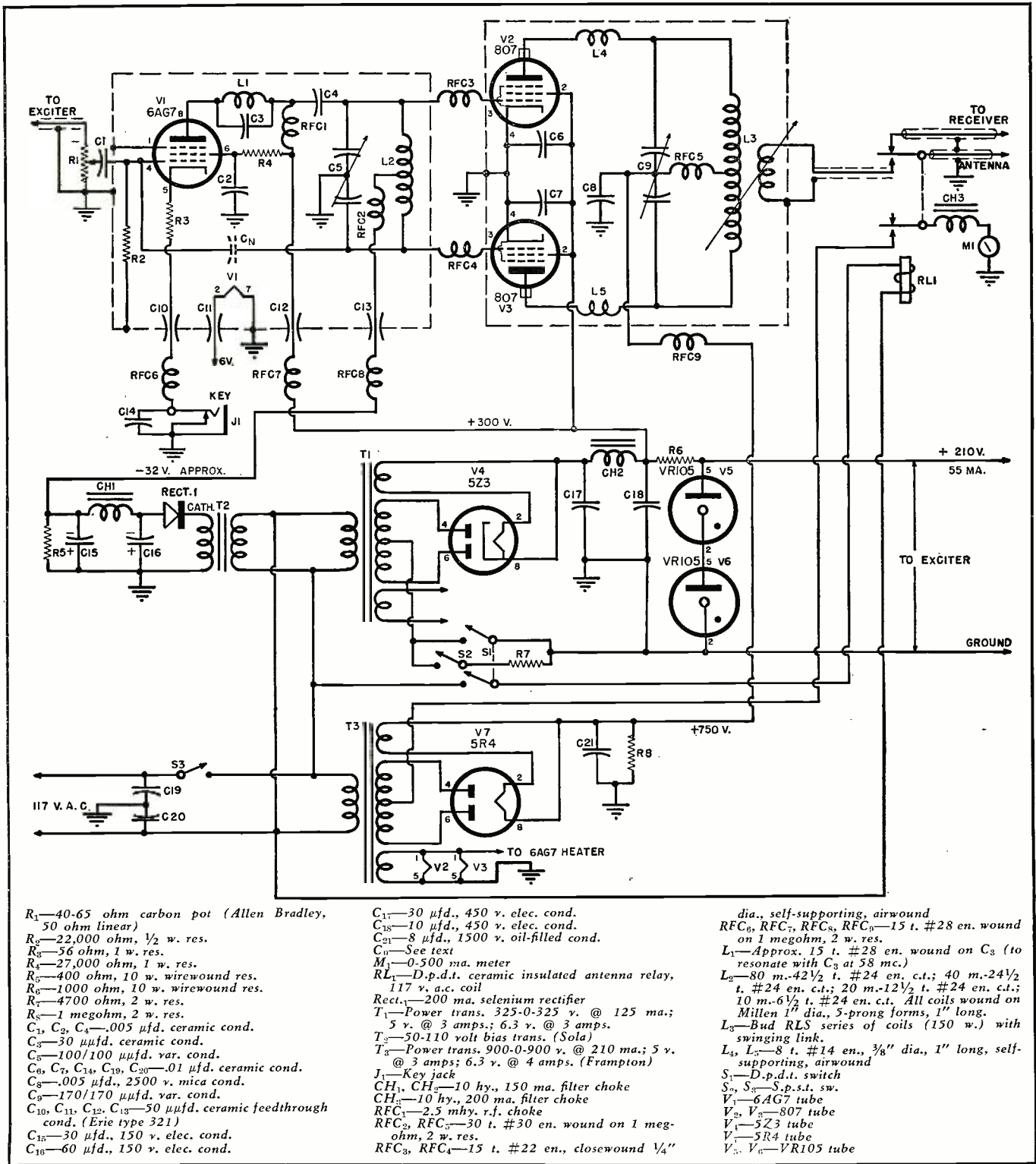

Complete schematic diagram of the 150-watt universal r.f. amplifier unit.

advantages than the ability to amplify modulated signals. The harmonic content of the class B stage (even without push-pull connection) is lower than in a class C stage, an important consideration in reducing TVI. Also, the class B stage amplifies a keyed c.w. signal without acting as a pulse-sharpener and key click generator. A keying jack on the front panel is arranged to key the cathode of the class A driver stage and the keying is truly beautiful. Parasitic chokes are used in both grid

and plate leads of the final amplifier tubes rendering them completely stable on all bands, key up or key down.

The 6AG7 driver is operated in rather unorthodox style. The tube is neutralized, not to prevent self-oscillation which is virtually impossible under the operating conditions, but to reduce the strength of the backwave radiated when the key is up. The neutralization condenser is merely a piece of well-insulated hook-up wire connected to the stator plate of C₃ and

brought near or wrapped around the grid terminal of the tube socket. This adjustment may be made before the 6AG7 subassembly is mounted on the chassis. While listening to the signal in a receiver with an exciter driving the 6AG7 and all voltages applied to the 6AG7, but with the keying circuit open, the capacity of the hook-up wire condenser is varied by moving it closer to the grid terminal by means of an insulated stick. As the neutralized point is passed, a definite null will be noticed

in the receiver. The wire should be secured in this position and the adjustment is complete. L_1 and C_3 form the one resonant trap in the unit. They are tuned to approximately 58 mc. to reduce the harmonic output of the 6AG7 in this region. If a grid dip meter is available it may be used to trim this coil and condenser combination to resonance at this frequency, although this adjustment is not essential. Inverse feedback improves the stability of this stage due to the unby-passed cathode resistor, R_3 , a further deterrent to oscillation or parasitics in the 6AG7 stage. This type of inverse feedback has the effect of increasing the output impedance of the tube which is undesirable in driving a class B amplifier. To stabilize the load on the 6AG7 and compensate for this increased plate impedance, a resistor may be shunted across L_2 . The value of this resistor should be chosen so that the 807's will be fully driven (to 300 ma. or so off-resonance plate current) with the r.f. gain control about three-quarters on. The value of this resistor will vary from about 15,000 ohms on 80 meters to about 50,000 ohms on 20 meters and will probably not be needed on ten meters at all where circuit losses will replace it. Suitable resistors may be mounted on the coils and changed with the coils.

The r.f. gain control is a carbon potentiometer of about 50 ohms which terminates the coaxial cable from the exciter. This resistor dissipates all the driving power supplied by the exciter since the 6AG7 requires only voltage drive. R_1 , therefore, functions as the r.f. gain or excitation control and is a continuously variable transmitter power control so that the output may be set at any desired value from zero to the full power capability. Since the exciter cable is always terminated in its characteristic impedance, no reflections from the amplifier occur with the result that amplifier tuning adjustments are completely separate from the exciter tuning. A change in the length of the coaxial interconnecting cable between exciter and amplifier has absolutely no effect on the tuning of either. One watt of r.f. input will be more than enough on any band to completely excite the 6AG7. The r.f. gain potentiometer is mounted on a small plate of aluminum on the side of the small shield and is therefore outside the shield. C_1 connects the potentiometer arm to the grid of the 6AG7 through a feed-through bushing in the shield. Break-in operation is not possible with this rig because the driver stage is keyed, but this seems to be the price that must be paid for perfect keying. The keying of the 6AG7 may be easily controlled by adding a small inductance in series with the key lead and a small capacity across the key, to produce any desired softness. Backwave radiation is undetectable a few hundred yards from the transmitter, thanks to the neutralization in the keyed stage.

(Continued on page 138)

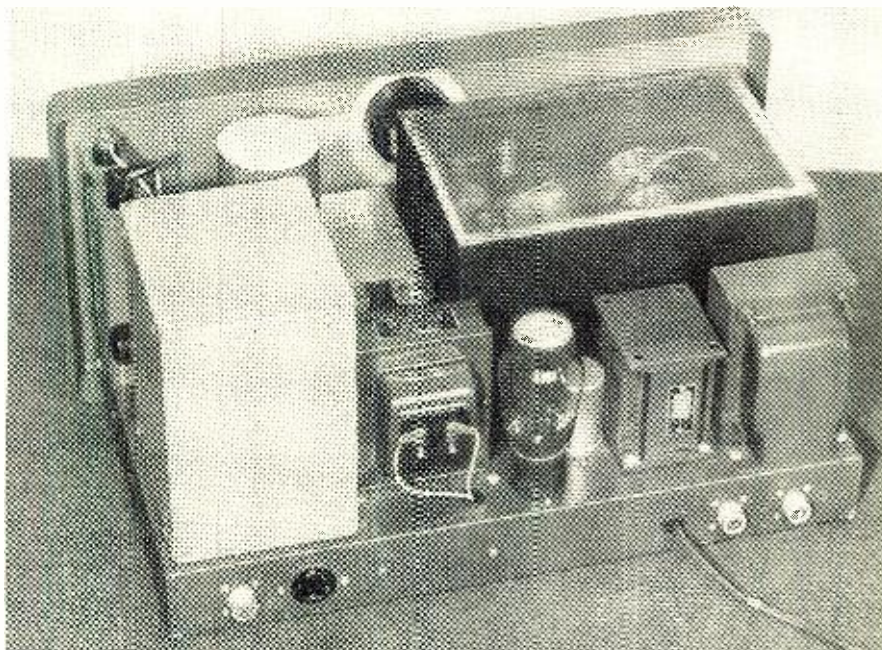

Rear chassis view. The r.f. input is to the coaxial connector on the left. The antenna and receiver connect to the two coax connectors on the right. The exciter power supply connections are made through the five-prong socket on chassis lip.

TYPE OF EXCITATION	807 TOTAL PLATE MA.	WATTS INPUT	APPROX. OUTPUT WATTS	PLATE MA. WITHOUT MODULATION
C.W.	240	180	100	60 (key-up)
FM	200	150	90	200
AM	120	90	30	120
SSSC	240 (on peaks)	180 (on peaks)	110 (on peaks)	60

Note: 807's: Plate—750 volts, Screen—300 volts, Bias Adjustment for 60 ma. total resting plate current.

Table 1. Operating conditions for the 150 watt universal r.f. amplifier unit.

Top view. The copper screen wire shield has been removed to show interior of final amplifier compartment. The 6AG7 is mounted horizontally on small shield compartment.

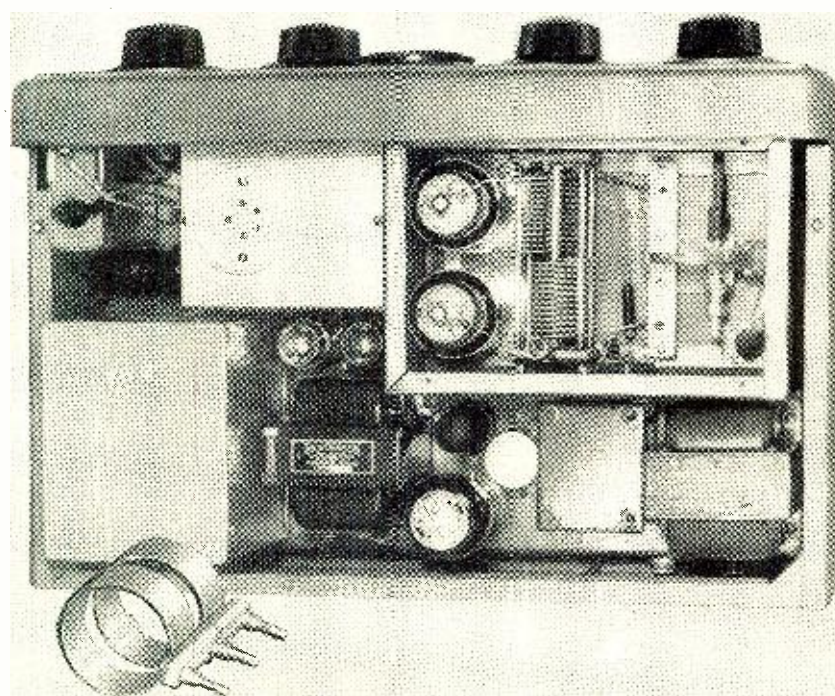

CRYSTAL DIODES In Modern Electronics

By
DAVID T. ARMSTRONG



**Part 6. Covering the use of
crystal diodes in d.c. restorer
circuits as found in modern TV receivers.**

LAST month we noted in connection with the elimination of one-half the 6AL5 that there is a problem of eliminating the other half in some simple manner. Many design engineers have found it convenient to use a second germanium diode for d.c. restoration and thus eliminate the 6AL5 entirely from the circuit.

The function of the d.c. restorer is to re-establish the correct d.c. operating level of the video signal arriving at the picture tube grid in order to maintain a uniformity of background illumination in the picture. Capacity coupling of the video amplifier to the detector removes the d.c. level of the signal that was established at the transmitter. When a germanium diode is designed into a circuit as the peak rectifier in the grid circuit of the picture tube, as illustrated in Fig. 1, it will add a d.c. bias dependent upon the peak voltage of the synchronizing pulses and maintain the tips of these pulses at some fixed d.c. level. The operating point of the picture tube is then established by the brightness control.

In the absence of the germanium crystal diode, the video signal would vary about an a.c. axis. Inserting the diode into the circuit will permit the .05 μ fd. condenser, C_1 , to charge to a voltage proportional to the synchronizing pulse voltage; this adds a d.c. voltage to the video components and maintains a constant reference level.

In the operation of this circuit best performance will be obtained with a diode that has low forward resistance and high back resistance. We noted before that this is characteristic of diode crystals; when the back resistance is high the forward resistance is low.

The *G-E* 1N65 or the *Sylvania* 1N55 and 1N58 are specifically adapted for this particular use. Because the forward dynamic resistance of germanium crystal diodes is lower than the forward dynamic resistance of vacuum tubes, there is the possibility of improvement in the performance of crystals over tubes in this application.

It should be borne in mind, however, that only those diodes selected for high back resistance will perform properly. For the *G-E* 1N65 it is recommended that a resistor of approximately $\frac{1}{2}$ megohm be used in parallel with the diode to minimize the effect of variation of the back resistance between individual diodes in order to maintain uniform performance for all receivers on a given assembly line. The individual experimenter may ignore this for he will achieve the best d.c. restoration by securing a diode with a very high back resistance characteristic and low forward dynamic resistance.

As pointed out in the section on the video detector it is possible to use the d.c. component at the detector output to fix the light cut-off point of the picture tube at the blanking level. To achieve this it is necessary that d.c. coupling be used between the detector and the video amplifier as well as between the video amplifier and the control electrode of the picture tube. Since it is not always convenient to design a d.c. coupled amplifier, some other method of d.c. insertion is desirable. The use of the d.c. component at the detector output produces the best results, but it is possible to achieve good results with a special d.c. reinsertion diode.

The term "d.c. restoration" is applied

One of the test stages through which all diodes pass. This operation separates diodes into eight classifications according to forward and back resistance limits.

to the circuit which sets the brightness level for any given scene. The average of the picture signal, which determines the average brightness, is the d.c. component; the signal variations are referred to as the a.c. component. Whenever the video signal must pass through coupling or blocking condensers, such as those present in typical *RC* video amplifiers, the d.c. component is lost; the entire signal is averaged around the a.c. axis. Blanking and sync pulses will not line up and the background lighting will be darker. It is the purpose of the d.c. restorer circuit to eliminate these defects. It does so by selecting, automatically, either the blanking pedestal or the sync pulse level for use as a reference axis.

There are several methods of d.c. restoration. Among the more common are the grid leak restorer, the diode tube, and the germanium crystal. The grid leak restorer method is economical in that the amplifier tube is used as the diode; however, the results obtained with either a diode tube or germanium crystal are believed to be superior.

The presence of the d.c. component in the video signal makes it possible to distinguish between a black line on a gray field, and a gray line on a white field, although the a.c. component is exactly the same for both. Preservation of the d.c. component at the control element of the picture tube is essential if the transmitted scene is to be reproduced with the correct photographic gamma, contrast, and shading.

In the present standardized negative

system of transmission the black level corresponds to 75% modulation; the tips of the sync pulses extend to 100% and are what is known as "blacker than black." The camera signal usually lies between 15% modulation (maximum white), and 75% modulation (black level). Thus, d.c. reinsertion resolves itself into maintaining the blanking level contained in the transmitted signal at the light cut-off point (75% modulation, or black level) of the picture tube. Hence the camera signal components act against a fixed point in such a manner that their long time average level causes the over-all background illumination to vary in accordance with the background illumination of the transmitted scene. The d.c. reinsertion reproduces accurately only those changes in video level which occur at a rate slower than approximately 50 cycles-per-second.

A reinsertion diode functions essentially as a peak detector with a long time constant load circuit. The condenser charges during the sync pulses and discharges into the load resistor during the line scanning interval. When operating conditions in a diode circuit are correct, not only is there d.c. reinsertion, but the tips of all the sync pulses are of the same amplitude, regardless of irregularities in the transmitted signal. This lining up of the tips of the sync pulses at the grid of the picture tube materially improves the operation of any sync separating circuit connected at this point. When d.c. reinsertion diode circuits are used this is the best point at which to connect the sync circuit.

Fig. 1 shows a typical d.c. reinsertion circuit. Here it is possible to substitute the crystal for the diode directly since the other component values remain the same for either crystal or diode. The ratio of the load resistor R_5 to the diode resistance of the tube or crystal should be as large as possible because the larger the ratio the more constant the blanking level and the sync pulse amplitude. With a crystal this ratio is very good because the diode resistance is low. But the value of the load resistance may not usually be greater than one megohm because larger resistance values are apt to introduce gas current difficulties into a cathode-ray tube. For this reason, in order to obtain a high ratio of load to diode resistance, the diode should have as low a dynamic resistance as possible. This is one reason why a crystal is better than a vacuum tube for this application.

A comparative set of curves for a 1N34 crystal and one-half a 6AL5 are relatively the same for d.c. volts across the diode load plotted against rms signal voltage, see Fig. 2. With a one megohm load the rectification efficiencies for these components do not differ greatly. The crystal has a slightly greater output at low levels. Use of a germanium diode for d.c. reinsertion results in general over-all improvement of the circuit. This is due to the fact that the dynamic re-

sistance of the diode is materially lower than the dynamic resistance of a vacuum tube. Further, with the crystal there is more secure clamp at the blanking level and more even alignment of the sync pulses.

The action of the circuit in Fig. 3A is as follows. With a positive-going signal on the plate of the video output amplifier the cathode of the diode becomes positive and passes no current. When the output signal swings negative, the cathode of the diode becomes negative and current flows through the diode and the 1 megohm resistor, R_5 . This causes the cathode of the diode to become positive and condenser C_1 is charged. The positive voltage, determined by the signal, is applied through resistor R_1 to the grid of the picture tube. The one megohm load resistor for the diode is in series with the 100,000 ohm grid return resistor of the picture tube; therefore, any bias set up by the reinsertion diode acts in conjunction with whatever grid bias is already present.

This positive voltage is added to the grid across resistance R_1 and, since it is proportional to the signal, the sync tips will be aligned and the d.c. component, or the average brightness, will be automatically restored to the picture. So that the average brightness of the picture will not change so rapidly as to affect the eyes, the time constant of C_1 and R_{diode} , R_2 is made many times longer than the duration of one horizontal line, say 500 times, or approximately one frame. In this manner, scene lighting will be truthfully reproduced and extremely rapid changes making up the detail of the picture will be faithfully reproduced. Note that in this basic circuit the diode may be either $\frac{1}{2}$ a 6AL5 or a germanium crystal such as the 1N34, 1N55, 1N58, or 1N65.

This is a difficult circuit to explain simply. Here is a slightly different approach to analysis of the functions of the separate components. With a positive-going signal on the plate of the video output amplifier, the cathode of the diode is positive and passes very little current. This small current, however, is sufficient to charge C_1 and C_2 eventually to the lowest plate voltage

Fig. 2. Curves showing d.c. reinsertion operation, comparing a 1N34 with $\frac{1}{2}$ of 6AL5.

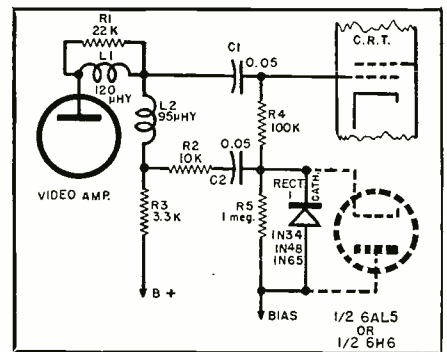
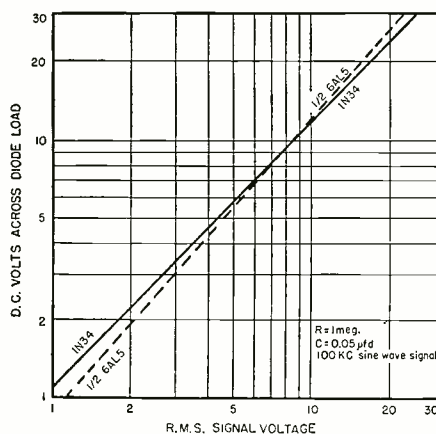

Fig. 1. A crystal d.c. restorer. The capacitive coupling, C_1 , between the video amplifier and picture tube makes d.c. reinsertion necessary. The value of C_2 depends on the value of R_5 since R_5C_2 has a time-constant relationship. The diode may be a crystal, $\frac{1}{2}$ a 6H6 or $\frac{1}{2}$ a 6AL5. R_5 , the diode load resistance, is 1 to 2.2 megohms, depending on the crystal and gas current difficulties in picture tube.

(equal to the sync pulse tips) of the video output tube.

When the output signal swings negative to the height of the sync pulses, the cathode of the diode becomes negative and the diode conducts. Because the forward resistance of the diode is low, condensers C_1 and C_2 quickly discharge any extra charge accumulated during the positive voltage swing. The current through R_1 and the diode therefore quickly becomes zero, and hence the voltage applied to the picture tube grid during the sync pulses is always held at zero. The CRT bias is then set so that with zero input volt-

(Continued on page 127)

Fig. 3. Operation of a d.c. restorer. (B) Signal voltages which exist in (A). E_{1-1} represents the voltage across points 1 and 4 in the circuit, E_{1-2} across points 1 and 2, and E_{2-1} across points 2 and 4.

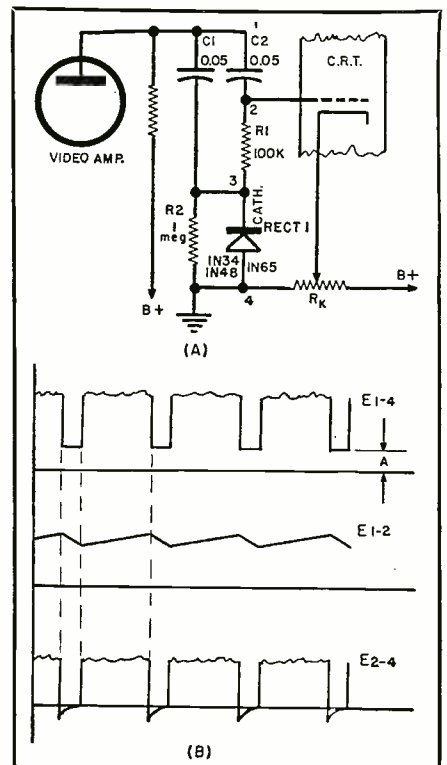

High Quality 50-WATT AMPLIFIER

In addition to amplifier unit, author covers construction of an accompanying preamplifier.

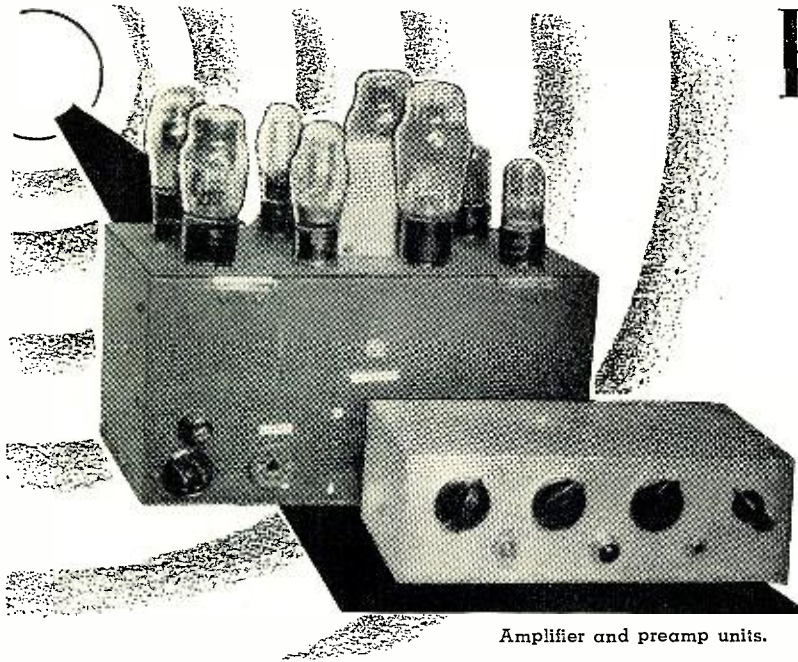

Amplifier and preamp units.

By
JAMES BAUMGARDNER

THE faithful reproduction of music places many stringent requirements on the equipment designed for this purpose. In particular, the audio amplifier must be capable of meeting certain definite specifications. An ideal amplifier for driving a loudspeaker may be characterized as follows: It should supply ample power to the load at any frequency in the audible range with negligible distortion and uniform gain, and should have a low internal impedance to provide good damping of the loudspeaker cone. To further qualify these statements, the audible range can be set at from 20 to 20,000 cps, and the gain should be sufficient to provide full power output from the currently available sources of high quality program material, such as low level magnetic phonograph pickups and tape playback heads, and FM tuners. Negligible distortion is not as easy to qualify, due to discrepancies in test procedures and methods of rating

amplifier output and distortion. The usual procedure is to rate the power output for a total harmonic content of 5% at a frequency of 400 or 1000 cps. With most amplifiers, however, this is the point of maximum output and minimum distortion. The ratings do not usually specify the amount of power available or the distortion percentages at the extremes of frequency where it is most difficult to obtain high power with low distortion. One of the notable exceptions to this is the *McIntosh* unit, which delivers full rated power at any frequency within the above mentioned range with low distortion.¹ To accomplish this, however, special output and interstage coupling transformers are required which are costly and not available to the individual builder.

The purpose of the design to be described in this article was to obtain as nearly an ideal unit as possible using standard components. It is based on the principle of obtaining the maximum power possible from a given power supply so as to insure low distortion at moderate power levels. An efficiency of 50% was required in the power amplifier with a power input of 100 watts

available, providing 50 watts output. It should be pointed out that this power output is taken to mean the power that can be delivered to a load placed across the secondary of the output transformer and includes losses from this source. This efficiency dictates the use of a push-pull class AB power stage employing tetrodes, while the requirement for low internal resistance indicates the use of negative voltage feedback. Accordingly, it was decided to use two 6L6 beam tetrodes in the output circuit, operating with a plate voltage of 450 v., screen voltage of 300 v., and a grid bias of -30 v. To insure adequate grid driving signal at low distortion, a push-pull cathode follower is direct-coupled to the 6L6 grids. A separate negative power supply of about -80 v. supplies fixed bias for the output stage and the cathode-follower driver. To keep the d.c. resistance in the 6L6 grid circuits to a minimum, a center-tapped coil is used as the cathode follower load. Plate voltage for the driver as well as the 6L6 screen voltage is regulated at 300 v. by the use of two VR150 voltage regulator tubes connected in series. The cathode follower is driven by a split load phase inverter using one half of a 6SL7. Adequate output voltage swing is insured by the fact that this stage operates into the high impedance of the cathode follower input and further by virtue of the high plate supply voltage made available to this stage by the circuit arrangement. The grid and cathode resistors for this section of the 6SL7 are returned to the negative supply voltage, while the plate load resistor is connected to 420 volts. The remaining section of the 6SL7 is operated as a straightforward voltage amplifier and completes the basic circuit. To provide 20 db of negative feedback, the 16 ohm output winding of the output transformer is connected through a suitable resistor to the cathode of the first section of the 6SL7. With this

(A) This curve shows the maximum power output across a 15 ohm resistive load without departure from the sine wave as a function of frequency. (B) The frequency response of the high quality 50-watt amplifier at 10 watts output.

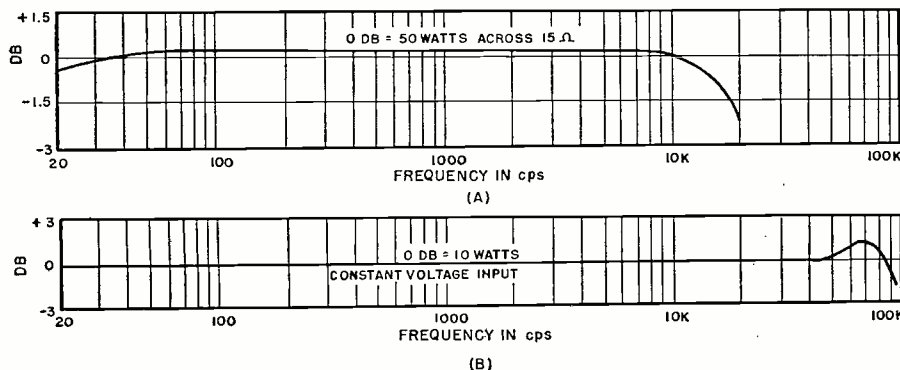

amount of feedback, about 8 volts signal is required at the input grid to provide full output.

Several features of the circuit outlined combine to place severe demands on the output coupling transformer. The requirement for a relatively large amount of feedback means that the output transformer should have minimum phase shift in order to avoid instability at the extremes of frequency. Good primary-to-secondary efficiency is required to provide 50 watts output with a minimum of coupling loss. Leakage inductance must be small to minimize distortion caused by switching of the plate current from one half of the primary to the other—an inevitable condition of class AB operation.² An investigation of the various transformers available disclosed that the *Stancor* A-8050 series appeared to be the most promising. The A-8053 unit was tried and has proved very satisfactory.

The preamplifier designed for use with this circuit employs three miniature duo-triodes. The first is used as a preamp for magnetic pickups, tape playback, and microphone input. Feedback equalization is used to provide bass-boost for the two former functions, while the latter is arranged to provide flat response. Suitable switching of components in the feedback circuit is accomplished by a section of the input selector switch. Either a 12AX7 or a 12AY7 may be used in this position, the latter providing somewhat lower noise and less microphonics. The second duo-triode is a straight two-stage amplifier with the tone controls in the plate circuit of the first stage. In the units built so far, 12AX7 tubes have been used for this position. With the gain thus provided, however, considerable attenuation of high level inputs (FM, etc.) as well as some attenuation of phono inputs is necessary to bring them down to the level of the tape input with the particular tape playback head used. Output level data is not readily available on tape heads, and there is considerable variation among the units on the market. If a tape input is not required, a 12AU7 may be substituted for the 12AX7 in this second position, leaving ample gain for magnetic phono pickups and tuner inputs. No circuit value changes are necessary. The third duo-triode has its two sections in parallel and serves as a conventional cathode follower. Either a 12AX7 or 12AU7 may be used in this position. If the cable to the main amplifier is over 20 feet in length, or is of excessively high capacity, a 12AT7 may be used to provide somewhat lower impedance to drive the higher capacity. The latter tube has a higher mutual conductance and will, therefore, provide a lower output impedance when used as a cathode follower. A step-type equalized volume control is employed to assure proper tonal balance at low volume levels. The pots connected to the various input jacks should be adjusted to provide the same volume level from all of the input positions on the selector switch.

The tone controls are arranged to give independent boost or attenuation of lows and highs. The bass control varies the level at 40 cps from -18 to plus 16 db, while the treble control changes the 10 kc. response from -14 db to plus 16 db, all relative to the response at 1000 cycles. The theory of operation of these controls has been described elsewhere.³

To provide for feeding the selected program source to a tape recorder amplifier, a jack is connected to the input terminal of the volume control and may be connected to any high impedance recording amplifier input. Since the level at this jack is not affected by the setting of the volume control, the amplifier may be used for monitoring

at any desired volume level while recording proceeds.

As may be seen in the photographs of the unit, the main amplifier and power supply are housed in a 6" x 7" x 12" metal cabinet, with all transformers, except the input coil, mounted inside. The top of the cabinet, containing the tube sockets and the input coil, is hinged at the rear for easy access to all components. The preamplifier is built in a 3" x 5" x 9½" chassis with controls along the front drop and tube recess, and input connections as well as power cable connection on the rear drop. The compact construction thus obtained makes the preamplifier easy to mount in cabinets with a minimum of space requirements.

Complete wiring diagram and parts list for the 50-watt amplifier. Although the author used push-pull 6L6's in the output stage, 807's could be substituted. It may be advantageous to do so in view of the fact that 807's have higher ratings.

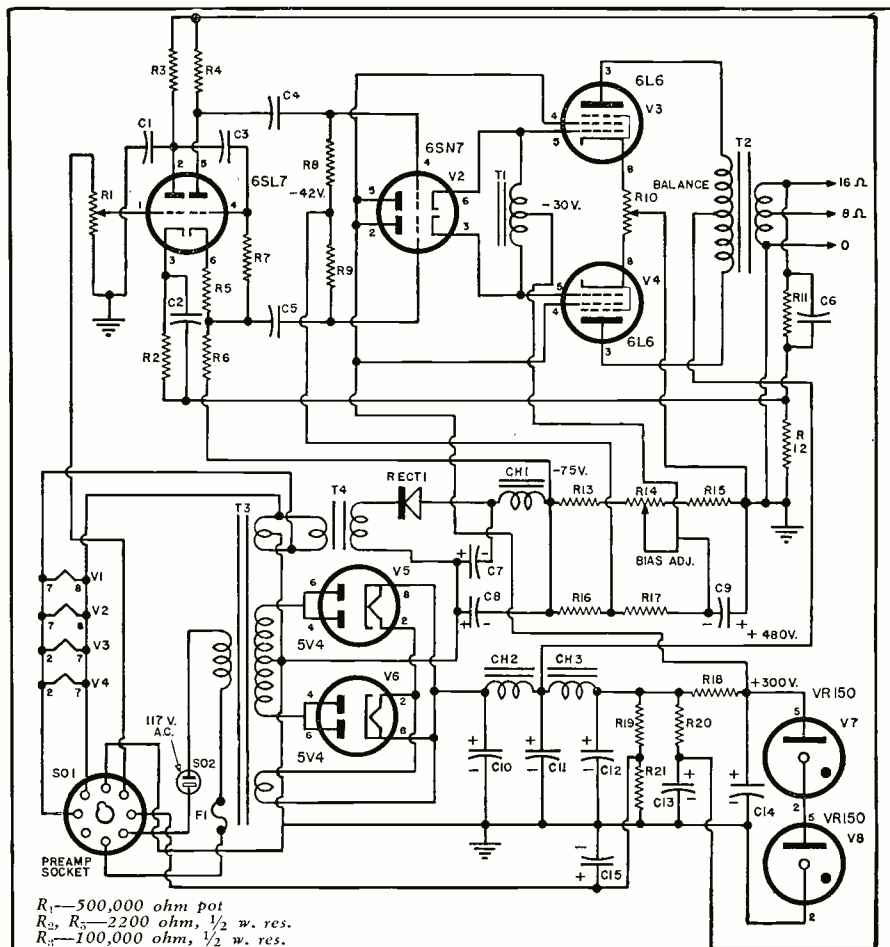

- R₁—500,000 ohm pot
- R₂, R₅—2200 ohm, ½ w. res.
- R₃—100,000 ohm, ½ w. res.
- R₄, R₆—120,000 ohm, ½ w. res.
- R₇, R₈, R₉—1 megohm, ½ w. res.
- R₁₀—50 ohm, 5 w. wirewound pot
- R₁₁—2500 ohm, ½ w. res.
- R₁₂—820 ohm, ½ w. res.
- R₁₃—1500 ohm, 5 w. res.
- R₁₄—1000 ohm, 5 w. wirewound pot
- R₁₅—500 ohm, 5 w. res.
- R₁₆—68,000 ohm, ½ w. res.
- R₁₇—10,000 ohm, ½ w. res.
- R₁₈—2500 ohm, 20 w. wirewound res.
- R₁₉—15,000 ohm, 2 w. res.
- R₂₀—10,000 ohm, ½ w. res.
- R₂₁—100,000 ohm, 2 w. res.
- C₁—100 µfd. mica cond.
- C₂—25 µfd., 25 v. elec. cond.
- C₃—.05 µfd., 600 v. cond.
- C₄, C₅—1 µfd., 600 v. cond.
- C₆—500 µfd. mica cond.
- C₇, C₈—50 µfd., 150 v. elec. cond.
- C₉—50 µfd., 50 v. elec. cond.
- C₁₀, C₁₁, C₁₂—16 µfd., 600 v. elec. cond.
- C₁₃, C₁₄—20 µfd., 450 v. elec. cond.
- C₁₅—8 µfd., 450 v. elec. cond.

- CH₁, CH₂—3.5 hy., 50 ma., 200 ohm filter choke (*Stancor* C-1080 or equiv.)
- CH₃—4 hy., 250 ma., 60 ohm filter choke (*Stancor* C-1412 or equiv.)
- T₁—Output trans. push-pull plates, 4000 to 14,000 ohms to v.c., primary only used. (*Stancor* A-3823 or equiv.)
- T₂—Output trans. 5000 ohm pri., 8, 16 ohm sec. push-pull 6L6's. (*Stancor* A-8053 or equiv.)
- T₃—Power trans. 400-0-400 v. @ 250 ma.; 5 v. @ 4 amps; 6.3 v. c.t. @ 5 amps. (*Stancor* PC-8413 or equiv.)
- T₄—Fil. trans. 6.3 v. @ 3 amps. (*Stancor* P-5014 or equiv.)
- SO—Octal socket
- SO₂—117 v. power line socket
- F₁—3 amp. line fuse
- Rect.₁—75 ma. selenium rectifier
- V₁—6SL7 tube
- V₂—6SN7 tube
- V₃, V₄—6L6 tube
- V₅, V₆—5V4 tube
- V₇, V₈—VR150 tube

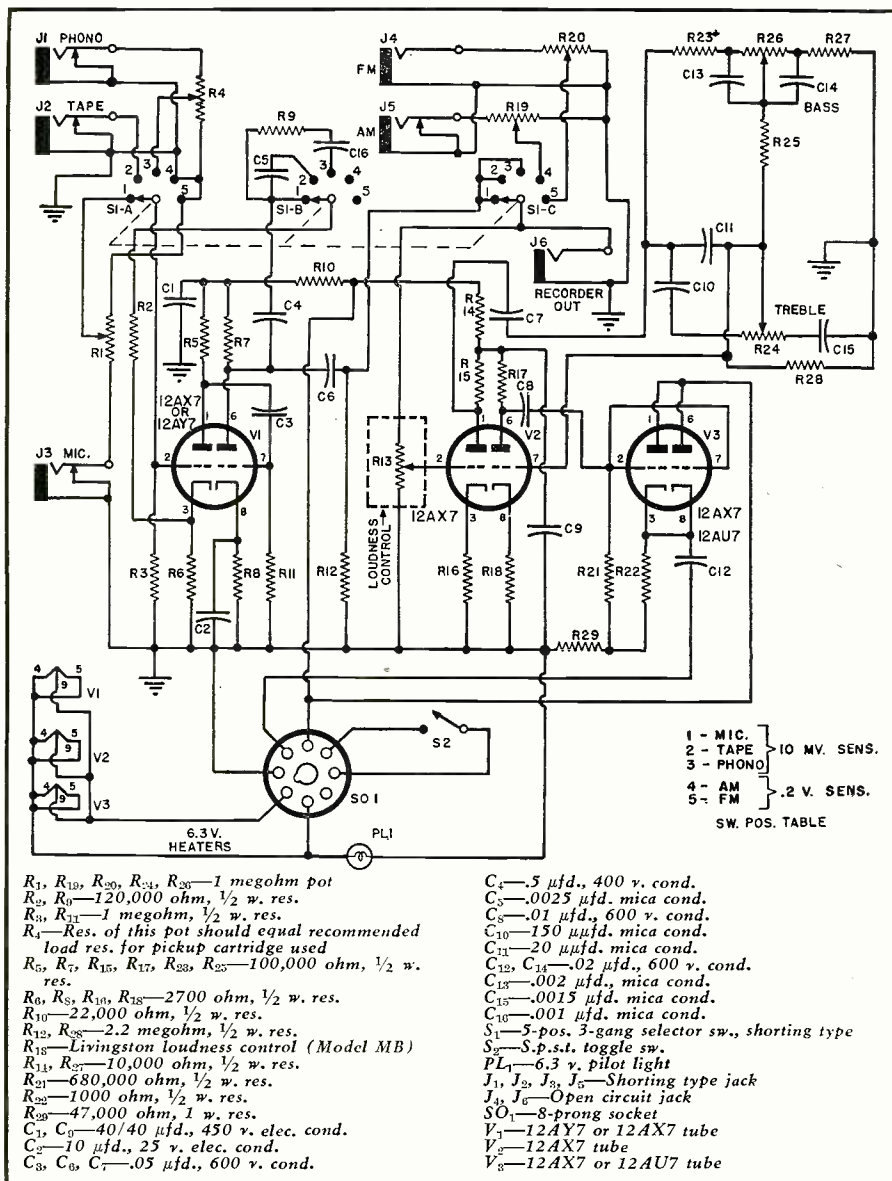

Wiring diagram and parts list covering the preamplifier used with 50-watt amplifier.

Since the photographs were taken, a row of 3/4 inch diameter holes has been added near the top of the cabinet containing the amplifier. Small rubber feet have also been placed on the bottom of the unit, with several holes cut in the bottom. This gives a chimney effect and aids materially in cooling the power transformer and other components.

The circuit described was carefully checked for performance. Preliminary measurements were made of power output, frequency response, total harmonic content at various output levels and at various frequencies, linearity between input and output signals, and damping factor. The maximum power output depends upon the full-load power supply voltage, which, in turn, depends on the line voltage. Measurements were made at a line voltage of 114 v. At 400 cycles, the maximum power output is 50 watts at 1% total harmonic content. The same is true at 40 cps, while at 50 watts output at 10,000 cps the total distortion is about 3%. At an output level of eight watts,

the frequency response is flat from 20 cps to 50 kilocycles. No departure from linearity is observed up to 50 watts output, using either sine wave input or music. Square wave tests indicate that the circuit is free from ringing or overshoot. Several units built thus far have displayed no instability due to the feedback loop, even with the secondary winding of the output transformer unloaded. The effective internal resistance measured at the 16 ohm output terminals is 1.5 ohms, providing a damping factor of 10. This measurement was made at 40, 400, and 10,000 cps with the same result. The zero signal plate current of the two 6L6's is about 60 ma., providing a plate dissipation of 15 watts per tube. At 50 watts output, the total plate current is 180 ma., plus 20 ma. of screen current, providing a total input power of 86 watts. This represents an efficiency of 58%, while the plate dissipation at full output is only 18 watts per tube.

Perhaps the most significant of the tests made were the listening tests in

which the amplifier was used to drive a high quality speaker system and was supplied with live FM programs and the best available LP and tape recordings. Initial listening tests quickly indicated that the quality was excellent at all volume levels up to the maximum that could be handled by the particular speaker system employed (25 watts). Therefore, a comparative test was set up in which two amplifiers could be bridged to the same input line and their outputs fed to a selector switch connected to the speaker system so that instantaneous switchover from one amplifier to the other could be accomplished. With the volume controls of the two units set to provide the same volume level, it was then possible to compare the two units directly. In all cases one of the amplifiers was the one described here, while the other was one of several high quality units selected for comparison on the basis of excellence of published data and popularity. Among them was the *Williamson* unit and another highly regarded circuit using push-pull 6B4G triodes in class A. Results showed that at low and moderate volume levels there was no detectable difference when switching from one unit to the other. At higher volumes, however, the difference was marked, particularly at low frequencies where considerable power peaks are encountered. The clean, solid reproduction of the circuit described at high volume levels is remarkable and is only possible where relatively large reserves of sine wave handling power are available. The speaker system used for the tests consisted of a *Stevens* two-way reproducer employing a 15" cone woofer and a coaxially mounted multicellular high frequency horn, with electrical crossover at 1200 cps. This unit is mounted in a corner type enclosure employing horn loading of the low frequency cone to provide response down to 40 cycles.

While considerable attention has been given recently to the problem of transient or "switching" distortion caused by leakage inductance in the output transformer when class AB operation is employed, it does not appear to be too serious when high quality output transformers are used. In the circuit described, this effect is observable as a notch in the sine wave as can be seen at either plate of the output stage, occurring at relatively high output levels and at frequencies above about 8 kc. It should be noted, however, that this distortion must become very severe before there is any noticeable departure from a sine wave in the combined signal as observed at the secondary winding of the output transformer. This may be noted by the photograph showing the output waveform at 50 watts and 10 kc. It should also be noted that frequencies of this order are not found in music except as harmonics and overtones which are considerably down in power from the average level. Listening tests indicate that the quality of reproduction depends to a far greater extent upon the ability



Over-all view of the high quality 50-watt amplifier. The power supply and main amplifier are housed in a 6" x 7" x 12" metal cabinet. All transformers, except the input coil, are mounted inside the cabinet. In later models the author added a row of cooling vents at the top and bottom of the housing.

Internal view of the main amplifier-power supply cabinet. By using a hinged-type cabinet easy access to all component parts is provided, making any changes and servicing easy to handle.

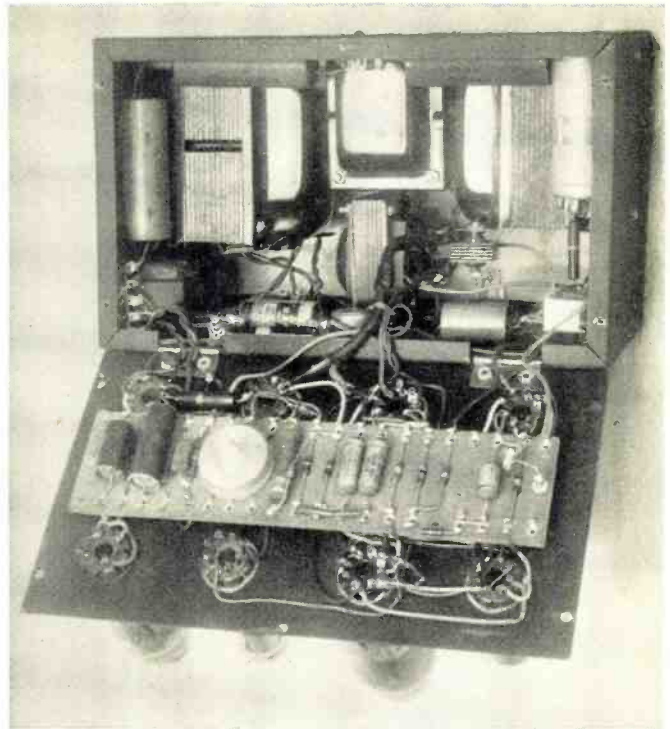

of the amplifier to deliver full power with low distortion at low frequencies than at extremely high frequencies, and this is borne out by tests showing linearity between input and output signals of an amplifier handling music at high power levels.

Some readers may question the need for a fifty watt amplifier for home use. Although many tests have shown that the majority of home listening is done at an average level of one-tenth of a watt, the peak passages can be as high as forty watts, even though this is an instantaneous figure.

Amplifiers of ten watt rating can give very satisfactory performance in the majority of listening tests, but it is the few occasions when the peak power of the amplifier is exceeded, where the reserve power of this amplifier tends to separate the men from the boys.

If the full benefit is to be derived from this amplifier, a speaker system to handle the peak power must be used. Unfortunately, good speaker systems to handle fifty watts are rather expensive, but in any event it is advisable to buy the best you can afford.

In selecting a speaker system from the catalogues, remember that the majority of manufacturers rate their speakers at the maximum power they can handle without serious distortion and the music will sound much cleaner if the speaker is not pushed to its limit.

If the optimum results are desired, it is advisable to use a speaker system or a group of speakers having a power rating equal to the maximum output of the amplifier, or fifty watts.

Another factor that must be considered in a high quality installation is the proper speaker enclosure. Many different types of speaker enclosures have been designed, and all have certain advantages.

Speaker enclosures of various types have been described in past issues of this and other magazines.

The room acoustics will also have a considerable bearing on the ultimate results, and due consideration should be given to this factor in judging any sound system. The only fair way to compare systems is under identical room conditions.

Other mechanical arrangements will undoubtedly suggest themselves to the constructor; but in any event it is desirable to take every precaution to avoid hum by the use of a single ground bus to which all ground returns are made. This precaution, more than any other, will eliminate hum.

In the event that there is objectionable hum when all precautions are taken, this can frequently be reduced or eliminated by careful selection of tubes in the preamplifier portion.

To sum up, this design represents an opposite approach to the problem of designing a high quality music amplifier from that used in the *Williamson* circuit, in which tubes having comparable power ratings are used with a similar power supply to provide less than one third the useful power output. The circuit is not complex, and

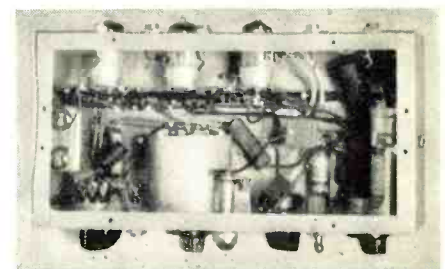

Bottom view of the preamplifier chassis. Unit is built on a 3" x 5" x 9 1/2" chassis.

the components are relatively inexpensive. The most costly single item is the output transformer, which can be purchased for less than \$12. Several units using this circuit have been built, and all have proved highly satisfactory, more than justifying the effort that has gone into the design, construction, and testing of this amplifier.

REFERENCES

1. McIntosh, Frank H. and Gow, Gordon J.; "New 50-Watt Amplifier Circuit," *Audio Engineering*, Dec., 1949.
2. Sah, A. P.; "Quasi-Transients in Class B Audio Frequency Amplifiers," *Proc. IRE*, Nov., 1936.
3. Sterling, Howard T.; "Flexible Dual Control System," *Audio Engineering*, Feb., 1949.

-30-

Scope patterns. (Left) 25 watt output, 2 kc. square wave. (Center) 50 watt output at 10 kc. with 15 ohm resistive load. (Right) 50 watt output at 40 cps with 15 ohm load.

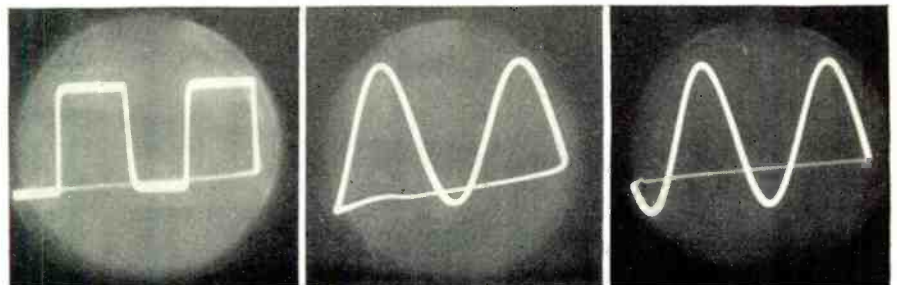

ELECTROSTATIC FOCUS

For Picture Tubes

Born of necessity, this new focusing system is, in most cases, equal or better than old method.

IN MOST 1952 TV receivers one familiar major component is missing. Most of the new picture tubes operate without a focus coil or PM focusing ring. Although this important device is omitted, focus on the screen will be excellent, much better in many instances than with the conventional magnetic focusing system. Starting January 1st, all major picture tube manufacturers have swung over to the new, electrostatic focus type tube.

Born of the impending shortage of copper and cobalt for magnetic devices, the use of electrostatic focus is an important stride towards simplifying TV receivers. The old type focus coil used about 3 pounds of copper and at least 100 ma. of d.c. to focus the picture sharply. A large wattage potentiometer and some series resistors were needed to provide focusing adjustment. The position of the focus coil on the neck of the picture tube was fairly critical, requiring an elaborate set of brackets, mounting bolts, etc. The PM type of focusing ring did not use any current from the receiver, but its adjustment was often tricky and mounting it required special brackets. The PM material, usually a high grade of Alnico, used cobalt which is one of the most critically needed materials in our defense effort. All these expensive and cumbersome features are eliminated in the newest electrostatic focus tubes. Small screen picture tubes and most oscilloscope cathode-ray tubes have always used electrostatic focusing, but until the beginning of 1951 it had not been considered practical to apply the same system to large picture tubes. In small cathode-ray tubes the accelerating anode serves as the focusing element, but for present day large screen picture tubes a separate element in the electron gun does the focusing. The first electrostatically focused picture tubes designed in early 1951 used a focusing potential of 3000 to 5000 volts and are referred to as high voltage focus tubes. A later model used no external focusing voltage but em-

ployed an internal connection from the focus element to the cathode. The most widely used type is really a compromise design which allows for small errors in gun structure and variations in the voltages in the TV receiver. This last type is called a low voltage focus tube. Before discussing the merits and application of each of these three types of picture tubes a short description of the operation of an electrostatically focused tube seems to be in order.

Principle of Electrostatic Focus

Five separate elements make up the electron gun inside the picture tube. The filaments heat the cathode so that its coated surface will emit electrons. The control grid surrounds the cathode with a negative field, reducing the number of electrons that can travel towards the anode. Placed next to the cathode-grid structure is the accelerating anode, often called the accelerating grid because its function is similar to that of the screen grid in a pentode amplifier. The accelerating grid, G_1 , is at a fixed positive voltage and it helps to keep the electron beam constant during slight variations in second anode voltage. The second anode contains the highest potential, usually over 10 kv., and is the final goal of the electrons after they have bounced off the screen. Aside from deflecting the electron beam to "paint" a raster on the screen, a focusing device is required to concentrate the electrons into one small spot on the screen. In magnetic focusing systems the electrons enter a magnetic field at a certain angle and are deflected by this field to converge in one spot on the screen. This magnetic field is at right angles to the center of the electron path and only those electrons in the center of the beam cross the field at a right angle and therefore are not deflected. All other electrons enter at some other angle and are then deflected so as to hit the screen close to the center.

A system of electrostatic focusing is shown in Fig. 1. In addition to the ele-

By
WALTER H. BUCHSBAUM
Author, "Television Servicing"

ments listed in the preceding paragraph the focusing element is now part of the electron gun structure. Instead of a magnetic field the electrostatic field between two elements of different potential is used to converge the electron beam. The focus element and the second anode in Fig. 1 have a potential difference between them just as two opposite charges in electrical theory. One, the focus element, has a negative potential and the other a high positive potential. Between these two potentials electrostatic lines of force exist. These lines vary in both density and in force as shown in Fig. 2. Any electron passing in the center will not be affected in its path, but those electrons entering the field at some angle will be forced back towards the center of the field. That, in principle, is the operation of electrostatic focusing or any other electron lens.

As we see in Fig. 1, the electron gun structure really contains two separate electronic lenses. The first is the field between the control grid and G_1 . The second is the field between the focus anode and the second anode. The first lens is relatively fixed although, on close observation, it is apparent that the focus and the spot size change with changes in control grid voltage. In a picture the bright portions of a single line will appear thicker than the darker parts and this is due to the variation in the voltage difference in the first lens, control grid, and G_1 . The second lens is adjusted by varying either of the two voltages. Since it would not be practical to vary the second anode voltage, the potential on the focusing element is adjusted. It might be pointed out right here that no substantial change in focus is obtained by this method, simply because, compared to the 12 kv. of the second anode, a 400 volt change in the focus element does not greatly change the electrostatic field between the two elements.

In actual operation the voltages between cathode, control grid, and G_1 are the most critical ones. Once they are adjusted, slight variations in focus or second anode voltage will have little effect on the electron beam and it would be possible to set them all to a fixed potential. Unfortunately it is not economical to mass-produce picture

tubes so accurately that the spacing of all the elements in the electron gun is held to zero tolerances. Voltages may vary in TV receivers, even among identical models. For this reason most of the new electrostatic tubes permit some adjustment of the focusing voltage. It is apparent from the electron optics presented here that the spacing, especially of the focus anode, is quite critical. Electrically, a high potential difference exists between the focus anode and the second anode, but the actual metal sleeves are placed fairly close together and are mounted on the same ceramic sleeve which holds all other elements together. The major difficulty with earlier models was the arc-over from the focus anode to the second anode through the mounting sleeve. This has now been overcome by placing glass beads at the most likely arc-over points. The limitation of arcing still remains, however, and none of the low voltage focus tubes can be operated at more than 16 kv. If this is exceeded, internal arcing is likely to occur.

Of the three types of electrostatically focused picture tubes only the low voltage and zero voltage focus tubes are easily used in place of an old style magnetic focus picture tube. The HV focus tubes require a focus voltage which is approximately 22% of the second anode voltage. For a 12 kv. second anode voltage the focus voltage must be about 3 kv., with some adjustment provided. Several different TV receivers made in 1951 are using this HV focus type picture tube with special circuits and parts to obtain and vary the focusing potential.

HV Focus Picture Tubes

The 17GP4 and the 21DP4 are both HV focus tubes having a rectangular metal shell and are most widely used in the 1951 RCA TV receivers. Other HV focus types are the 17FP4A, 20GP4, and 20FP4, all rectangular glass picture tubes. The focusing anode is brought out at the kinescope socket on pin #6, which is an isolated pin, not found in any of the magnetic focus type tubes. The socket used for these tubes must be a circular one and the inexpensive half round type used in many older receivers cannot be used. Since the voltage on pin #6 will be about 3 kv. a HV insulation wire must be used.

Fig. 3A shows a simple but effective circuit for obtaining focusing voltage for a HV focus tube. In this circuit, which is used in the RCA and some other sets, the high positive pulse on the plate of the horizontal output tube is applied to the plate of an additional HV rectifier, usually a miniature type like the 1V2 or the 1X2. A second filament loop for this rectifier is wrapped around the flyback transformer core. The output of this rectifier is usually about 4500 volts d.c. which is reduced through a bleeder network to the desired focusing voltage. The focusing control forms part of the bleeder network and a 500 μ fd. HV condenser

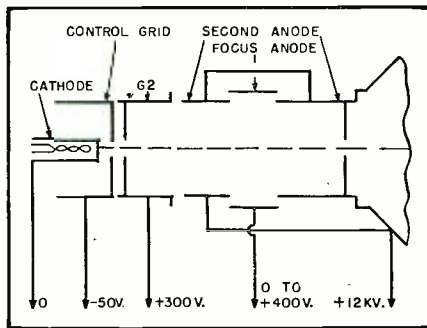

Fig. 1. Detailed plan of an electron gun for a low-voltage electrostatic focus tube.

provides the filtering action. Conventional potentiometers have a grounded case and shaft and are not designed to withstand several thousand volts from the resistance element to the case. To give adequate focusing range a bleeder of about 25-30 megohms is used with the focus control ranging to about 15 megohms. A special potentiometer was developed for this purpose, featuring a molded plastic case and insulated shaft and having a diameter of almost 2 inches.

In the RCA models featuring HV focus the entire circuit is mounted inside the HV compartment with the focus control shaft protruding at the rear of the chassis. This elaborate system eliminates the focus coil or focusing magnet, but provides no economy because the additional tube, condenser, and resistors add up to as much as the conventional focus coil. Since it was found practical to manufacture low voltage focus tubes by mass production, HV focusing has been largely abandoned in favor of the former method.

Low or Fixed Voltage Focusing

Compare the circuit in Fig. 3A with the circuit in Fig. 3B, and the advantages of low voltage focus tubes will be obvious. All that is required is a conventional potentiometer of about 1 megohm, 1/2 watt which costs only a few cents. The "B plus" voltage available in the TV receiver and the cathode voltage of the picture tube are important factors but in almost all present TV sets correct focusing voltage can be obtained. Before going into details on low voltage focus the difference between it and fixed or zero voltage focusing merits attention. The latter type requires extreme accuracy in manufacturing, and shrinkage among this type is quite high. As a result the cost of a zero focus tube is over a dollar more at the manufacturer's level than a low voltage focus tube. The price of a potentiometer and wiring often is less than the additional cost of a zero voltage tube. In addition, the zero voltage types will not give good focus if any of the other voltages on the picture tube are off by more than about 5%. For these reasons many TV manufacturers have swung over to the low voltage focus tubes. The only zero voltage types available, which require no adjustment

at all and have no external connection for the focus element, are the 17KP4, 20JP4, and 21KP4, all rectangular glass picture tubes.

As mentioned before, different TV receivers use different voltage values in their "B plus" supply and when it is desired to replace an old magnetic focus type with a low voltage focus tube, the correct voltages and the right tube type must be chosen. Table 1 shows various values commonly found in present TV models. The second anode voltages are measured with respect to chassis, but all other voltages are with respect to the cathode of the picture tube. If the cathode receives the picture signal it is frequently at the potential of the video amplifier plate which will be slightly lower than the video amplifier "B plus" supply and the cathode voltage will vary with the picture signal. In this instance the value of the cathode voltage should be taken as half way between the zero and maximum signal value. From Table 1, it appears that occasionally a "B plus" higher than the

(Continued on page 130)

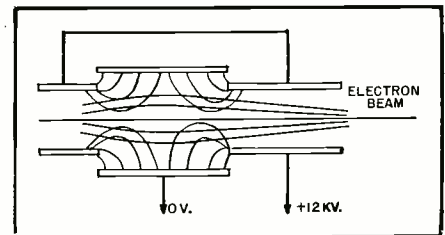
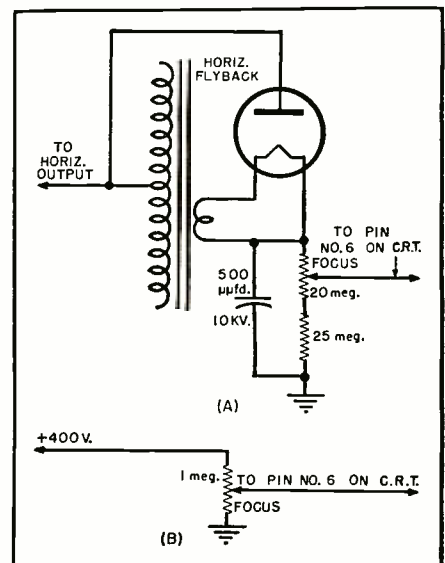

Fig. 2. Symbolizing an electrostatic lens.

	17HP4 or 20HP4	17RP4 or 20LP4
Second Anode	11-12 kv. 12-14 kv.	10-12 kv. 12-14 kv.
G ₂	300 300-420	250-300 300-420
First Anode	200 ± 200 100 ± 100	0 ± 100 0 ± 400

Table 1. Voltage range of most TV models.

Fig. 3. Diagram of (A) high-voltage and (B) low-voltage electrostatic focus control.



INTERLACING TROUBLES and VERTICAL SYNC CIRCUITS

By
JOHN K. FRIEBORN

The causes of interlacing troubles, methods of tracing them, and details on improved vertical separator which is impervious to such troubles.

INTERLACING troubles and their correction are becoming more important to the technician than they once were. Imperfect interlacing has always existed to some extent on most receivers, but it is not particularly noticeable on small picture tubes. With larger picture tubes becoming common, set owners are more likely to be aware of it.

This article will examine interlacing problems more thoroughly than is usually done in general treatments of synchronization. In particular, it will show how imperfect interlacing may occur even with a normal signal being obtained from the integrator, suggest means of identifying and tracing faults, and bring to the reader's attention several circuits which avoid the faults of the integrator as a vertical sync separator.

The general nature of interlacing and the part played by the integrator and the equalizing pulses have been discussed in many books and magazine articles (for example, the articles in *RADIO & TELEVISION NEWS* by Solomon Heller and Peter Orne, "Servicing TV Sync Circuits," August and September 1950, and "Servicing Intersync Circuits," March 1951). This discussion of principles is intended to supplement such treatments.

On the television picture, the basic effect of interlacing is to double the number of scanning lines which would otherwise appear. That it does this can be verified by switching from a raster to a picture while keeping approximately the same horizontal and vertical scanning frequencies. For reasons which are explained in standard textbooks, if a saw-tooth oscillator is synchronized by a direct application of sync pulses, the free-running frequency is equal to or less than the synchronized frequency, but not greater. On the other hand, a saw-tooth oscillator controlled by flywheel synchronization (also called automatic frequency control) has about the same frequency when controlled as it has free-running. In most receivers the horizontal oscillator has flywheel sync while the vertical is directly synchronized. Therefore, in making the check mentioned, the vertical oscillator must be specially adjusted to have a frequency of about 60 cycles on the raster as it does on

the picture, but it probably will not be necessary to take any precautions with regard to the horizontal oscillator.

The most convenient method of adjusting the vertical oscillator to a free-running frequency of 60 cycles-per-second is to set the vertical hold control for a normal picture, readjust it so the picture rolls downward (frequency higher than 60 cycles), then turn the control back just enough to make the picture stationary again (frequency just 60 cycles). With the vertical hold control adjusted, adjust the other controls on the receiver to obtain an unsynchronized raster and count the scanning lines in one inch or half an inch. Readjust the controls to obtain a picture and count the number of lines in the same space. It may be found that by moving the vertical hold control very slightly the number of lines and the spacing between them can be changed, without causing the picture to roll. The proper adjustment is for the greatest number of lines, spaced as nearly equally as possible. If the number of lines on the picture cannot be made twice as great as on the raster, interlacing is not being accomplished in the receiver and the experiment should be repeated on another set.

The reason for twice as many lines appearing on the picture is that the horizontal and vertical frequencies are maintained in the ratio of 262.5 to 1, so that the lines of each field are scanned half-way between those of the previous field and the last two fields scanned are visible simultaneously at any given time. On the raster there is nothing to keep the two frequencies in exactly that ratio, but there will be a tendency for the vertical oscillator to be triggered at the end of a line on every field by a horizontal retrace pulse coupled to the vertical circuit. The ratio between the two frequencies will, therefore, be a whole number, each field being scanned over the previous one, and only the last field scanned will be visible at one time.

If the interlacing is not perfect, that is, the ratio of the horizontal and vertical frequencies is not always 262.5 to 1 and the fields are alternately

longer and shorter than normal, lines in one field will be shifted up or down with respect to the lines in the other field. Instead of the spaces between lines being equal, they will be alternately large and small. In an extreme case, complete loss of interlacing, the fields are alternately longer and shorter than normal by a sufficient amount to cause the lines of one field to be superimposed upon the other.

If the scanning lines are not equally spaced, but overlap more or less, there is obviously a loss of vertical resolution. There are fewer separate horizontal lines, so fewer changes in brightness are possible from top to bottom of the picture. It is less obvious, but equally true, that imperfect interlacing may cause a loss of horizontal resolution. This may be seen by considering what would happen in the special case where a dark spot followed by a bright one along a line in one field were directly above a bright spot followed by a dark one along a line in the other field. If the two lines became superimposed, a line would result in which the two spots were each a combination of bright and dark spots, that is, the two spots would be of about the same brightness, so that both of the original brightness changes along the individual lines would be lost.

Imperfect Interlacing

Many things can disturb the synchronizing of the vertical oscillator, such as: misadjustment of the vertical hold control; faulty components or improper applied d.c. voltages in the vertical oscillator circuit changing the free-running frequency so much that it cannot be corrected by the hold control; distortion of the video signal before sync separation by overloading in an amplifier stage causing clipping and reduction of sync pulse amplitude, or by loss of low frequencies so that the vertical oscillator can be triggered by the blanking pulse instead of the synchronizing signal; hum due to heater-cathode leakage in a vertical deflection, sync, or video channel tube, or to insufficient power supply filtering; picture signal interference due to a fault in the sync separator over-

By

GLEN SOUTHWORTH

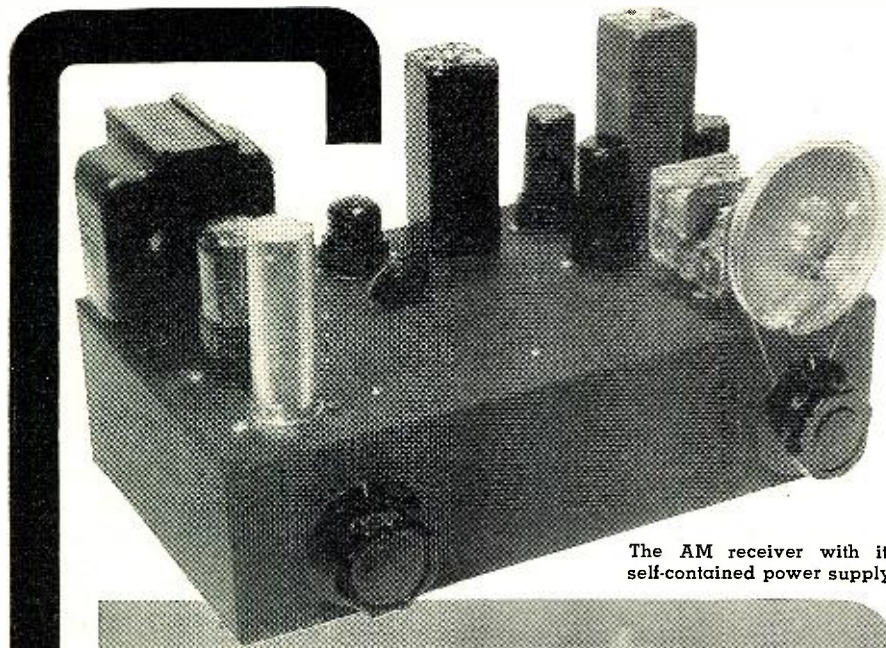

The AM receiver with its self-contained power supply.

A DUAL - CHANNEL AM RECEIVER

Designed specifically for reception of high quality musical programs—this receiver is a conventional superheterodyne employing two separate i.f. channels. One channel has high gain and good selectivity for distant stations while the other has low gain and broad tuning for local reception.

harmonic and other distortions to a very low level in equipment designed to handle audio frequencies, a similar interest hasn't developed in the design of equipment for the amplification and detection of modulated radio frequencies. Probably the most important potential sources of audio distortion in the conventional AM receiver are the last intermediate frequency amplifier stage and the diode detector. The combination of these two factors may tend to produce a receiver with a distortion vs input signal level similar to that shown in Fig. 2. At low signal intensities the contact potential developed by a thermionic type of diode, such as the 6H6, may cause the detector to fail to fully rectify the incoming signal, with resultant distortion or even failure to detect very weak signals. At high input signal intensities, such as produced by local stations, the last or even the preceding i.f. stages may be overloaded, thus producing a limiting action which may greatly distort the modulation envelope and result in poor audio quality.

Distortion in the tuner circuits may occur in a variety of other ways. These include misalignment, unwanted regeneration in the i.f. or r.f. circuits, hum or noise modulation of the signal by the receiver elements, and the presence of serious non-linearity in the high frequency amplifier stages. In addition, sometimes serious problems may be encountered due to the use of certain types of associated audio equipment, notably power amplifiers, in which case ultrasonic feedback may occur between the audio system and the tuner input. Distortions of this nature may be produced due to high frequency parasitic oscillations in the amplifier output stages (in the case of either triodes or beam power tubes), however it might be noted that the 455 kc. intermediate frequency of the conventional superheterodyne may feed through to the input of the first stage of the audio amplifier and care should be taken to filter out stray radio frequency components from the amplifier input.

Adjacent channel interference and excessive noise or static can mar the enjoyment of the program being received, and both are closely related to the selectivity of the receiver. Fig. 1 shows typical selectivity curves for three different types of tuners: the sharply peaked superheterodyne, the stagger-tuned superheterodyne, and the t.r.f. The more selective the receiver, the greater its ability to reject unwanted adjacent signals. Similarly, the greater the selectivity of the receiver, the greater is the ratio between the response to the peak amplitude of random noise compared to the response to a continuous carrier frequency. Unfortunately, both superior selectivity and consequent improved

A NUMBER of characteristics are desirable in broadcast band receiving equipment designed to be used primarily for the reception of high quality musical programs. Among the most important of these is the ability of the equipment to accurately reproduce the full range of audio frequencies present in the transmitted signal. Similarly, unwanted distortions of the audio envelope should not be introduced in the high frequency or detector portions of the receiver. Of like importance is the ability of the set to discriminate against interference from stations other than the one tuned in, the ability to reduce static and atmospheric disturbances, and the presence of a low noise level inherent in the receiver's own circuits.

The audio frequency response of a receiver is most frequently determined by the selective tuned circuits of the radio frequency and intermediate frequency stages. In conventional, sharply peaked, superheterodyne receivers, this may mean a high frequency roll-off commencing at about one or two thousand cycles, with consequent ad-

verse effect in the quality of even those broadcast stations limiting their modulation ranges to about five thousand cycles. This loss of high frequency intelligence may be compensated in three ways; the use of audio equalization to restore attenuated highs, the use of fewer tuned circuits in the path of the signal, and the broadening of the response of the tuned circuits in the receiver, either by stagger tuning or by lowering the effective "Q" of the coils through use of shunting resistances.

Although great interest has been shown recently in the reduction of

Fig. 1. Selectivity curves for different types of receivers. (A) Sharply peaked superheterodyne. (B) Stagger-tuned superhet. (C) Tuned radio frequency or t.r.f. receiver. The width of the top of the curve determines the h.f. response of receiver.

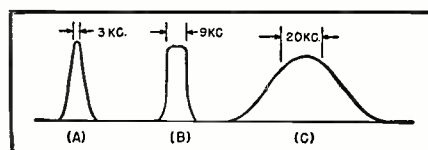

signal-to-noise ratio are accompanied by the attenuation or loss of the higher audio frequencies impressed upon the carrier.

In general, the requirements of a good receiver indicate a system with high gain and good selectivity for the reception of distant stations, where interference rejection and noise reduction are of great importance, while for the reception of local stations capable of overriding both interference and noise a broadly tuned receiver of low gain is desirable in order to reproduce the full range of modulation frequencies with minimum distortion. A number of solutions to these requirements have been devised, including superheterodynes with variably selective i.f. circuits and the use of two separate tuners, one a broad tuning t.r.f. and the other a sharply peaked superheterodyne. A simple and uncomplicated design, favored by the author, uses a conventional superheterodyne circuit employing two separate intermediate frequency channels. One of these consists of four tuned i.f. coils and provides a highly selective branch of the circuit. The other channel consists of only two i.f. coils in combination with a untuned amplifier stage, and the coils of this channel may be loaded by means of parallel resistances to provide additional broad tuning.

A circuit diagram of a two-channel tuner is shown in the schematic and is such that a conventional receiver may be easily adapted, providing sufficient chassis space is available for the additional components. Alignment procedure is relatively simple and consists of placing a d.c. voltmeter across the second detector diode load, R_3 , which is fed by the high selectivity channel and adjusting the four tuned i.f. circuits for maximum deflection of the meter. This process aligns both channels simultaneously and makes it possible to switch from the high selectivity channel to the low selectivity channel without the necessity of re-tuning the set. The alignment process may then be completed by adjusting the oscillator trimmer condenser for proper high frequency tracking and the antenna coil trimmer for correct resonance at about 1400 kc.

A number of slight variations from conventional practice are found in the tuner circuit. Among these is the use of lower than normal filament voltage on the heater of the 6H6 dual diode in order to reduce possible unwanted cathode emission. The i.f. coil in the plate circuit of the 6SA7 mixer tube is shunted by a 75,000 ohm resistor in order to broaden the tuning slightly and to reduce noise and instability which might occur in the circuit. No automatic volume control is used in the design for two reasons. The first reason is that most circuits of this nature cause the direct current resistance in the amplifier grid circuits to be on the order of several megohms and can aggravate the tendency of the tubes to gas up, with resultant instability. Likewise, a.v.c. voltage may

tend to aggravate distortion occurring in the last i.f. amplifier stage when a strong signal is being received and it is generally more desirable to reduce the effective length of the antenna than to depend upon a.v.c. action. However, if desired, a.v.c. voltage may be easily obtained from the detector output of the sharply tuned channel and applied to the preceding stages. It should be noted though, that this will cause a sudden decrease in audio output from the broadly tuned channel at the point of exact resonance.

An alternate form of second detector, known as the "infinite impedance" type, is illustrated. This type of detector has good characteristics and loads the associated radio frequency circuits to a lesser degree than the diode detector, however, it is more susceptible to overload from strong signals and a.v.c. voltage is not easily derived from it. With either type of detector it was considered desirable to use a separate detector for each channel in order to minimize switching complexity and prevent possible pops or clicks which might result from switching other portions of the circuit.

In constructing the tuner, the main precaution to be taken is to insure good shielding and separation of circuits carrying high frequency voltages. Leads should be kept as short as practical, and it should be noted that ground loops are often as serious a problem in r.f. circuitry as in audio circuitry. The writer prefers to use a separate ground system, when practical, with the various shields con-

(Continued on page 90)

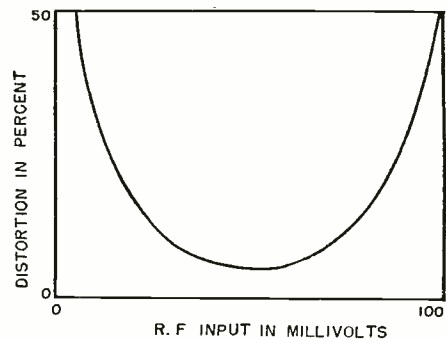

Fig. 2. Typical distortion vs input signal intensity of a receiver. Large amounts of audio distortion occur on either very weak or very strong signals.

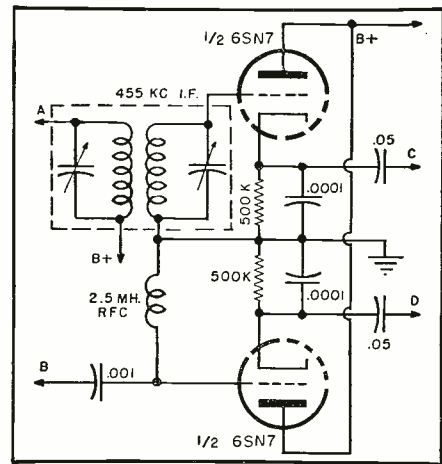
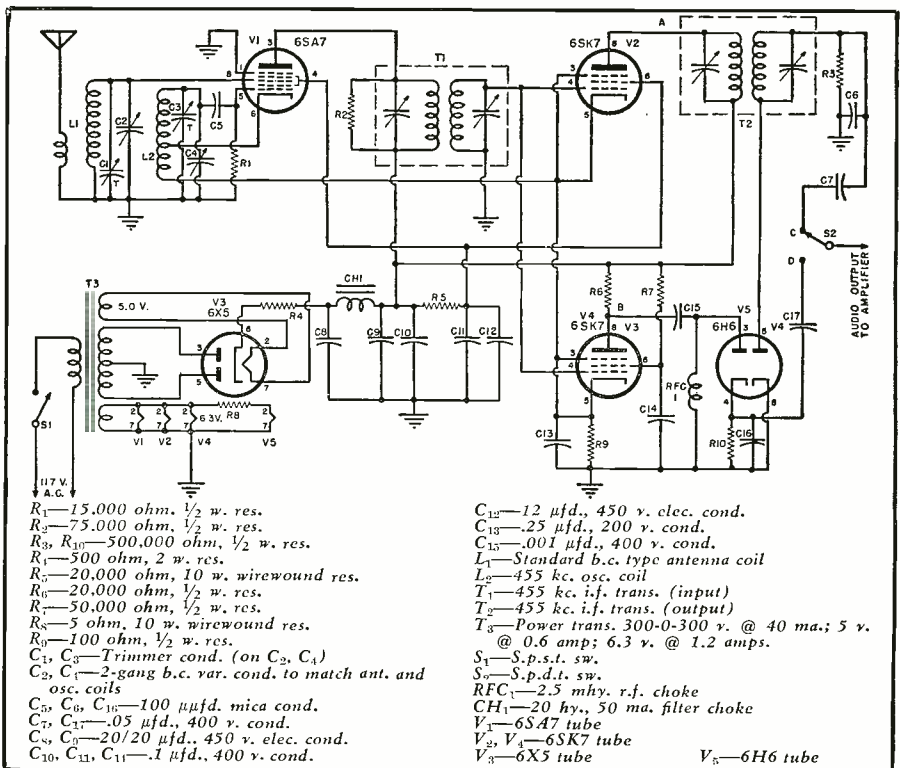

Fig. 3. Alternate form of second detector that may be used in the tuner circuit. Terminals A, B, C, and D connect to corresponding terminals shown in diagram of Fig. 4.

Fig. 4. Diagram of two-channel receiver. A loop antenna may be used in place of antenna coil shown. Note that the 6H6 heater is operating below its normal 6.3 v. This is done to minimize spurious cathode emission under no-signal conditions. The 6X5 is operated at a lower heater voltage because the power transformer used had a separate 5 volt winding. The 6X5 may be operated at 6.3 volts if desired.



SATURABLE REACTORS

By
ERWIN LEVEY

Details on a saturable reactor that can be quickly assembled using two standard power transformers.

THE operating principles of saturable reactors have been known for quite a long time, but it is only within the past few years that these units have come into general use. Considering the reactor's versatility, the number of ways in which it can be used is almost unlimited. Basically it is a magnetic device which functions as a variable inductance. It has a d.c. winding which is used for control and an a.c. winding which is connected in series with the load to be controlled. There is no direct connection between the two circuits, the only linkage is through the magnetic properties of the core on which they are both wound.

Operation is based on the phenomenon that the permeability of a magnetic material is not constant. It varies with the strength of the magnetizing force applied. Since the inductance of a coil is directly proportional to the permeability of its core material, it also will vary. When the d.c. control current is zero the permeability of the core is extremely high, therefore the inductance of the a.c. coils is large. Since they are connected in series with the load current is extremely low. As the d.c. control current is increased the magnetizing force through the core is increased. This causes the permeability and therefore the inductance of the a.c. coils to decrease. This, in turn, means that the load current will also increase.

As the d.c. current increases further the inductance is proportionately decreased with a corresponding increase in load current. When the core is fully saturated with full d.c. current the inductance of the a.c. coils is minimum. Therefore it can be seen that the control effect is secured by means of d.c.

core saturation. Since the d.c. power required for control is less than the a.c. power used in the load circuit the unit has a certain amount of gain or amplification.

Physically a saturable reactor has the same general type of construction as a transformer although several different types of core arrangements are possible. The one described here is extremely simple and is assembled by using only two standard transformers.

Fig. 5 is a photograph of a unit which was assembled breadboard style for ease of construction. The two small transformers on the left are used as the saturable reactor, the small motor being the controlled unit. The chassis on the right is the variable d.c. power

Fig. 1. Terminal connections of saturable reactor using two separate transformer cores.

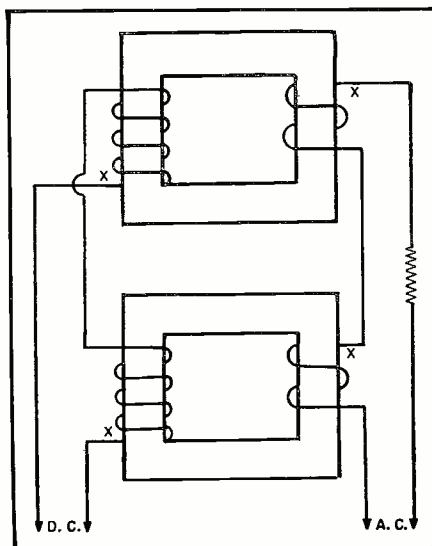

supply used for control purposes. Fig. 4 gives a close-up of the reactor unit alone, from which it can be seen that the transformer windings are connected to a screw-type terminal strip. This procedure facilitates connections and requires only a screwdriver for assembly.

Before proceeding further, several terms which identify multiple coil connections will be explained in order to clarify the main explanation to follow. In a "series-aiding" connection two coils are connected together so that their relative winding directions are the same. The net result is that the voltage induced in each is in the same direction, while the total terminal voltage equals the sum of the two individual voltages. In a "series-opposing" connection the two coils are connected so that the relative winding directions are opposite, producing voltages in opposite directions. Here the total terminal voltage is equal to the difference of the two individual voltages. It is important to note that these relative winding directions are given from an electrical viewpoint, and not in terms of the actual physical windings as they are placed on the core.

Terminals of similar polarity or winding direction are indicated by means of an X. This end is called the "start," the other end is the "finish." The conventions that will be used throughout this article are illustrated in Fig. 3, which also shows the proper type of parallel connection. To avoid confusion they are defined specifically at this point.

As pointed out earlier in the article several different types of core arrangements are possible. The one which will be explained here as the basis for the unit to be constructed is the simplest type from an experimental viewpoint. A schematic of the unit is shown in Fig. 1.

Two separate, identical cores are used, each having a d.c. and an a.c. winding. Both a.c. windings are identical, so are both d.c. windings. However, the d.c. windings differ in physical characteristics from the a.c. windings. Since each d.c. coil is on a core with an a.c. winding there will be an a.c. voltage induced in the d.c. windings due to transformer action. Now, if the two d.c. coils are connected in series-opposing, the a.c. voltage induced in each will cancel, as a result of their being equal in magnitude but opposite in polarity. This is the only permissible connection for the d.c. coils. But the series-aiding connection for the a.c. coils, as shown in the diagram, is only one of the possible connections for them. The unit to be described here is based on this type of arrangement, as explained before.

For this purpose, two identical 40 ma. power transformers were used, each having the following windings: primary (117 v.), high voltage (480 v.), 5 v. filament, and 6.3 v. filament. All the secondaries had center taps but they were taped up since they were not used. Actually, for the construc-

tion of a simple unit only the primary and high voltage windings are needed but the low voltage windings can be used to show some further interesting control possibilities. The primary is used as the a.c. coil and the high voltage winding as the d.c. coil.

Once the transformers and terminal strips have been mounted the windings are connected in the following order: primary, high voltage, 6.3 v. filament, and 5 v. filament. The order is the same for each transformer. At this point actual physical order of the two leads of a particular winding do not matter.

The next and most important step is to properly phase all the windings, that is, to determine their winding directions with respect to the primary as the standard. The procedure will be explained first for transformer #1 separately. Since the primary is used as the starting point the connection to the first terminal is called the start, the second connection, the finish.

Connect the finish of the primary to the high voltage lead immediately adjacent to it. Then connect the primary leads to 117 volts and read the voltage appearing across the two coils which are now in series. If the reading is the sum of the two individual voltages the coils are connected in series-aiding, this being the condition desired and indicating that the high voltage leads are in the proper physical order. On the other hand, if the difference of the two voltages is indicated, the connection is series-opposing. If this is the case, reverse the positions of the high voltage leads and repeat the test. The reading will then indicate a series-aiding connection. For each set of winding leads, the first one in physical order should be the start; the second, the finish. If low voltage windings are present repeat the procedure exactly as described using the primary and each winding individually. The complete procedure should be repeated step-by-step for the windings of transformer #2.

The purpose of this test can be seen by referring to the schematic diagram in Fig. 2. The windings are laid out in standard order to facilitate the actual interconnection of the units as a saturable reactor. This is the most crucial step in the whole procedure and a

double check should be made to make sure that no errors exist. Otherwise the unit will either operate improperly or not at all.

As explained previously, the d.c. coils (high voltage windings) must be connected in series-opposing. Following the original definition this is done by connecting the finish of high voltage #1 to the finish of high voltage #2. The d.c. voltage source is then connected to the two remaining leads, which are the start of high voltage #1 and high voltage #2. In this simple arrangement the unit is not polarity sensitive, that is, the positive lead could be connected to either end. However, to keep a standard procedure (necessary for later arrangements), start high voltage #1 will be designated the plus terminal and start high voltage #2 the negative terminal. Next, the two a.c. coils (primaries) are to be connected in series-aiding. Therefore connect finish of primary #1 to start of primary #2. These coils are then connected in series with the load to be controlled. The actual schematic of this set-up is shown in Fig. 6A.

At this point it is necessary to determine the range of the unit. The size of the wire in the primary windings (a.c. coils) is determined by the power (actually current) used under actual load conditions for which the transformer was originally designed. This is done in the following manner: Total secondary power equals power of each individual winding.

HV—480 v. x .04 amps.....	19.20 watts
6.3 v.—6.3 v. x 2 amps.....	12.6 watts
5 v.—5 v. x 2 amps.....	10 watts
Total 41.8 watts	

The assumption will be made that this is the same as the input power. This is not exactly true in the case of an actual transformer but it is found that the assumption is close enough to give an idea of the range, which is all that is necessary. Thus it is shown that 40 watts is the limit due to the physical properties of the unit. The actual amount of power that can be controlled is somewhat less, approximately 30 watts. From experimental results it was found that the d.c. current necessary for complete control when the high voltage windings are used as the d.c. coils was equal to the current rating of

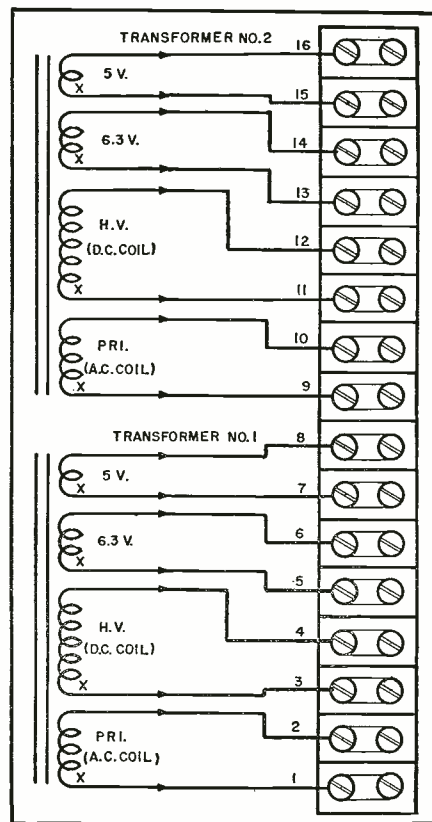

Fig. 2. Transformer winding connections.

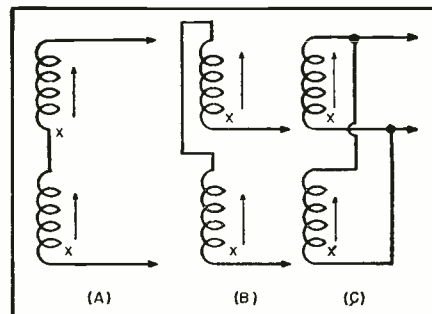

Fig. 3. Coil connections. (A) series-aiding, (B) series-opposing, and (C) parallel.

the high voltage windings plus 10% of that amount, in this particular case, 44 ma. The unit used for control was a regular variable power supply rated at 300 volts with no load. It is best to use a
(Continued on page 150)

Fig. 4. Close-up of reactor. Two small transformers are used.

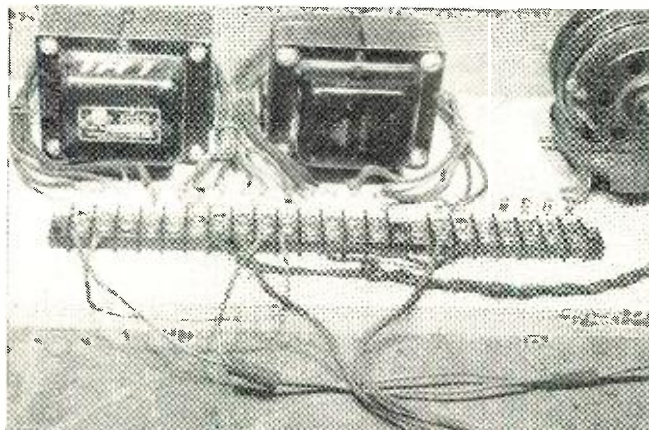
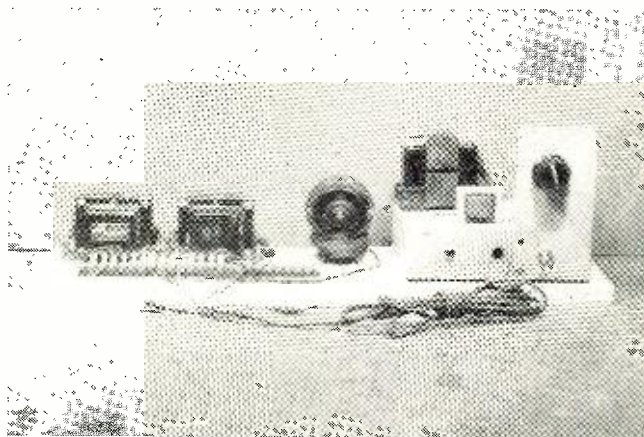
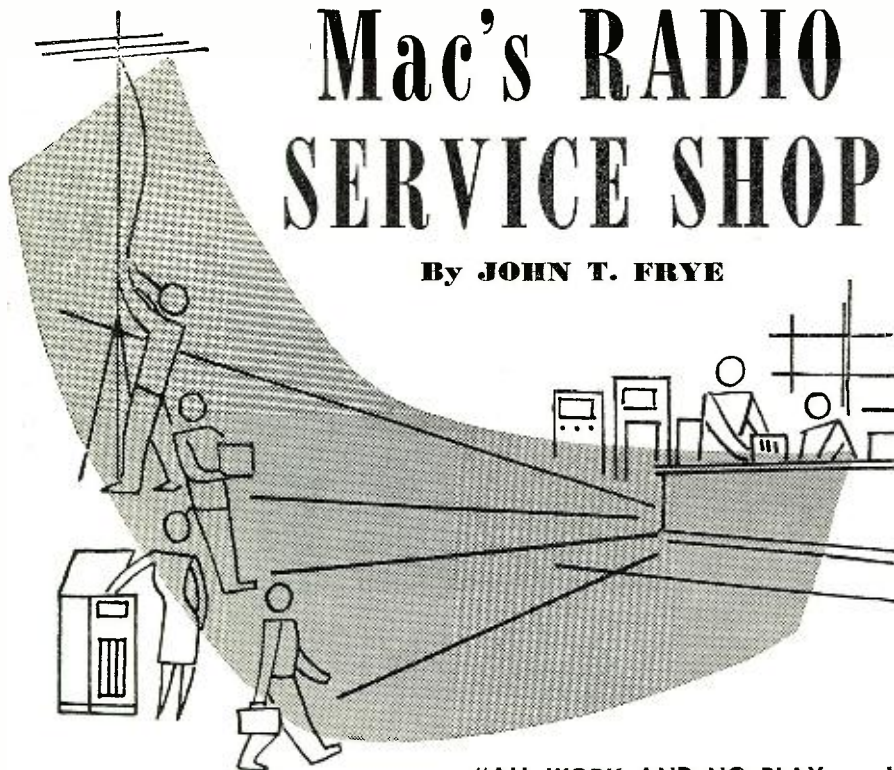

Fig. 5. Breadboard assembly of saturable reactor motor control.



Mac's RADIO SERVICE SHOP

By JOHN T. FRYE



BARNEY stood looking out of the window of Mac's Radio Service Shop at the big fat snowflakes just starting to drift down from the dark sky overhead.

"Is this winter going to last forever?" he asked morosely as he walked back into the service department. "I don't think I ever had such a bad attack of winter willies before."

Mac glanced up questioningly from the TV chassis on which he was working and then said quickly, "Know exactly how you feel, Red, for I feel the same way myself. Guess we need a little vacation of some kind."

"I've got proof I need a vacation," Barney said with a ghost of his old grin. "The other morning I was using a test pattern to adjust the focus on a TV set when suddenly the pattern was cut off and a program started in which Dagmar was a visiting celebrity. For a few minutes I was actually *mad* because the test pattern had disappeared! Now any old time a red-blooded American boy like me would rather look at the curves of a test pattern than those of Dagmar—well, there can be no doubt but that he needs a vacation from service work!"

"You are so right!" Mac agreed with a chuckle. "We really have been hitting the ball pretty hard here in the shop this past six months; but I do not think the amount of work we have been doing is altogether to blame for this sudden I'm-fed-up-to-here feeling that we both have. Part of the trouble comes from the *way* we have been working. When you first started here, we did a lot of talking as we worked because I was trying to teach you as much as I could as we went along. Then you reached the point where I wanted you to gain self-confidence by

"ALL WORK AND NO PLAY . . ."

licking the problems all by yourself, and we quit talking. Whole hours go by now without our saying a word to each other."

"I know it," Barney quickly replied, "and it is not near as much fun as it used to be. I'm gaining self-confidence, all right, but I certainly miss talking over the sets with you and having you give me heck for overlooking something that is obvious or giving me a pat on the back when I pull a bright one."

"I miss our chatter, too," Mac confessed; "and I can tell you now that you would be astonished if you knew how often your prying questions prodded me into seeing what was wrong with the set when my mind was a complete blank just before your question nudged me in the right direction."

"Well okay then!" Barney exclaimed. "Let's stop 'holding Quaker meeting' and go back to the good old days. You can start right now by telling me what makes this set whistle so loudly on 910 kilocycles. It works all OK on the rest of the band, but it makes so much fuss on the University station on that one frequency that you can't listen to it."

Mac flipped over the complaint card attached to the set and glanced at it. "Hm-m-m," he hm-m-med, "says here the customer never noticed the trouble until after he had the phono jack installed on the back. Does that tell you anything, Sherlock?"

Barney looked as blank as Laurie Anders of "The Wide Open Spaces" fame.

"What's half of 910?" Mac asked.

"455, but what's that—say, that's about the i.f. frequency."

"And the phono jack is probably connected across the volume control,

which, in turn, is connected to the diode plate circuit of the second detector. At the same time the jack is very near the loop antenna that is resonated to whatever station is being received. When we tune to 910 kc., the strong field about the loop is connected through the lead from the jack directly to the diode plate circuit. Here it mixes with the second harmonic of the i.f. frequency and produces the strong heterodyne whistle as the two slightly-different frequencies are combined by the rectifying action of the diode. The process is exactly the same as is used when you employ a beat frequency oscillator for receiving c.w. stations, except in that case the b.f.o. is fixed-tuned to about the i.f. fundamental frequency and is loosely coupled to the diode circuit so that it produces a whistle on every station received."

"That's the cause; what's the cure?" Barney wanted to know.

"There are several different ways you can go at correcting the trouble. The main thing is to reduce the coupling between the loop antenna and the second detector diode plate circuit. An r.f. choke in the lead from the phono jack to the volume control would do this, or you might try shielding this lead and moving the jack down into the corner of the back cover so it will be as far as possible from the field of the loop. In general, if you want to avoid birdies in the set, it is a good idea to avoid increasing the possibility of direct pickup by any circuit carrying the i.f. frequency. That's what the person who installed the phono jack forgot when he tied that long lead to the bottom of the secondary of the i.f. output transformer. He would have gotten away with it, though, if we had not had a strong station on approximately twice the i.f. frequency."

Barney soon had the jack moved and the lead from it to the hot side of the volume control shielded. This cured the trouble completely.

"And now you may return my help—if you can," Mac told him. "See if you have any bright suggestions about this little a.c.-d.c. puzzler. When I first turn it on, it plays with good volume and has good sensitivity; but after it runs a few minutes, the volume slowly dies away, and the only station I can pick up is the local one. I checked the tubes the first thing, and they are all right. Plate and screen voltages stay right up close to the recommended values. The change in volume is far too gradual for it to be condenser trouble."

"Did you check the filament voltages?" Barney asked with a smug look.

"No, but the filament current seems to be about normal as near as I can see by looking at the brightness of the 50B5."

Barney switched off the bench lights and looked closely at the set. Then he switched the lights back on.

(Continued on page 132)



International SHORT-WAVE

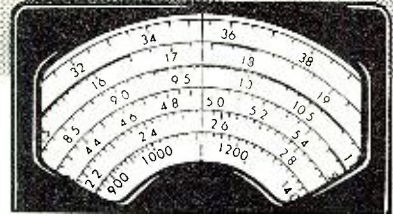

Compiled by **KENNETH R. BOORD**

▶ LAVIO Serrano, Brazil, airmails this data about prospective *new* high-powered transmitters for certain countries:

"Radio Tupi, Rio de Janeiro, Brazil, has purchased a 100 kw. short-wave transmitter from *Brown-Boveri*, a Swiss manufacturer. This transmitter will be ready in late 1952 and will be the world's most powerful 'commercial' short-wave station; it is Model SK-51-A3. Both r.f. and modulator stages will use a push-pull *Brown-Boveri* type ATW-50-1 and have a spare tube which is placed in the circuit automatically when a failure occurs. The transmitter can operate from 6 to 22 mc. and also can be operated with 10 kw. output during an emergency. Tentative channel for *Radio Tupi* is 6.200.

"Representatives of the Swiss firm in Rio de Janeiro inform me that a similar transmitter is already installed in Yugoslavia and will begin operations shortly. Belgium has two such transmitters under installation for the *Institute Nationale de Radiodiffusion* which probably will be ready in mid-1952."

The two *new* 100 kw. short-wave transmitters of *Radio Sweden* at Horby should be in regular operation by this time carrying programs from Stockholm.

According to a *World Radio Handbook* Bulletin, Italy should now be using a short-wave transmitter located at Palermo on a channel of 6.260; a channel of 3.930 for a Rome transmitter, and 5.980 for a Milan station. From April 1, the National Program of *Radio Italiana* is to be radiated from a short-wave transmitter at Caltanissetta on 6.240.

YOUR ISW DEPARTMENT editor will welcome further news about forthcoming transmitters.—KRB.

* * *

Radio Club Notes

England—The International Short Wave Club, London, has just concluded its annual DX Contest for listeners to (1) the short-wave broadcast bands and (2) the amateur bands. Results of the competition will be announced in the May issue of the club's bulletin. Last year's awards went to all parts of the world, according to Arthur E. Bear, secretary of ISWC.

The International Short Wave League, London, is now an independent organization and no longer has any connection with *Short Wave News*,

London. Headquarters of ISWL now is 123, Starla Road, Chatham, Kent, England; QSL Bureau is at 86, Barringer Road, London, N. 10, England. Is publishing its own monthly bulletin called "*Monitor*." (*Short Wave News*, London)

USA—The Universal Radio DX Club recently observed its 18th anniversary. This is one of the few short-wave clubs that issues a short-wave log regularly. The winter edition (which goes to *members only*) was compiled by Weldon Wilson. Short-wave editor of URDXC is Donald C. Gross; ham band editor is Ralph W. Kastner; the certificate and award section of URDXC's bulletin "*Universalite*" is compiled by Don Martinez; president of the club is Charles Norton; QRA of URDXC is 21446 Birch Street, Hayward, Calif.

Harold Buchart, Box 76, Piketon, Ohio, president of the new club USWLW says that organization now has 40 members; wants more. Don Alexander, 1136 North 10th Street, Abilene, Texas, has been named short-wave editor and the club has started a monthly bulletin. A Canadian Chap-

ter is being organized with John Impy as director. The club is making plans to award three trophies for outstanding efforts in the world of short-wave listening. Has its first DX Contest slated for the latter part of March.

* * *

This Month's Schedules

Andorra—*Radio Andorra*, 5.990, noted 1750 with identification by woman as "Aquí Radio Andorra," followed by semi-classical music. (Machwart, Mich.) Noted in England 1030 with announcements in French, Spanish. (Pearce)

Anglo-Egyptian Sudan—*Radio Omdurman* is using 9.737 in its "early morning" transmission in Arabic 2315-2345; stringed instrument is used as interval signal; still uses 17.94 in Arabic weekdays; Fridays has *English* on 17.94 at 1230-1300. (Ridgeway, South Africa) The *English* session is likely also carried over 9.737—KRB.

Angola—*Radio Clube do Cuanza-Sul*, CR6RP, Redondo, is on the air daily 0600-0745, 1230-1445 on 7.806, according to verification; power is 0.25 kw. (*Radio Sweden*) *Radio Clube do Benguela*, CR6RB, is again using its 9.163 channel with good signal in South Africa 1230-1630 closedown (Sundays to *only* 1430). (Ridgeway)

Radio Clube do Angola, 11.865A, Luanda, noted 1445; announces two channels. (Pearce, England) This one is still good signal in Conn. to 1530

(Continued on page 107)

(Note: Unless otherwise indicated, all time is expressed in American EST; add 5 hours for G.C.T. "News" refers to newscasts in the English language. In order to avoid confusion, the 24 hour clock has been used in designating the times of broadcasts. The hours from midnight until noon are shown as 0000 to 1200 while from 1 p.m. to midnight are shown as 1300 to 2400.)

The symbol "V" following a listed frequency indicates "varying." The station may operate either above or below the frequency given. "A" means frequency is approximate.

This attractive Listening Post belongs to John C. Catch, South Shields, Durham, England. Equipment includes a "Commander" receiver, a tape recorder, and a frequency measuring device. John is a regular contributor to the ISW Department.



A J I I

Simplified

By
DAVID FIDELMAN

An installation where the record changer and preamp control circuit are mounted in a table and connected to other units in the system by a cable.



Part 7. A discussion of audio frequency networks and corrective circuits as used in high quality sound reproducing systems.

THE most widely accepted criterion of performance in the design and setup of sound reproducing systems is that the reproduction sound exactly the same as the original program material. However, this does not mean that the signal at all points in the system must correspond exactly with the original sound—it means only that the sound reaching the listener's ear from the loudspeaker should reproduce accurately the sound reaching the microphone from the original source. The proper application of this principle has caused considerable confusion in the field of sound reproduction, and its meaning should be clearly understood by anyone who is designing or setting up any sound reproducing system.

There is no necessity for making the signal at all points in the system reproduce exactly with the original sound, provided that any alterations which are made in the signal are corrected before they reach the ear from the loudspeaker. In fact, the limitations of practical recording, transmission, and reproduction systems make it almost imperative that certain changes be made in the signal in order to obtain the best quality of reproduction. These limitations are related primarily to questions of noise level and dynamic range. The actual dynamic range of orchestral music is approximately 75 db, which cannot be reproduced by modern equipment—especially when phonograph records are included in the system. The major factor which prevents the reproducing system from attaining the required dynamic range is the inherent noise level of the system, which is considered to be good if it is more than -60 db below full output, while -50 db is considered acceptable. Therefore, as might be expected, most of the changes which are made in the signal are intended to reduce the noise level.

This article will discuss the various methods which can be used to reduce

the noise level and increase the dynamic range of the reproduced sound. These methods include the use of tone controls and equalizers, volume compressors and expanders, and various types of noise suppressors. The fundamental principles of operation will be described, with a discussion of the important factors which must be kept in mind for their proper use and to prevent their misuse, and a number of basic practical circuits which can be included in the reproducing system.

The use of tone controls for reduction of noise depends upon the fact

that the noise is not dependent upon frequency in quite the same way that the ear perceives speech and music as a function of frequency. Sound is heard by the ear in a logarithmic manner—with respect to frequency as well as volume. The logarithmic frequency response of the ear may be illustrated by the use of the term *octave* to denote a frequency range of 2:1 regardless of the absolute frequency, and musical scales are always written in terms of octaves from a particular reference frequency. The noise, on the other hand, is generally a direct function of frequency. Therefore, since an octave at higher frequencies covers a greater absolute frequency range than an octave at lower frequencies, the effects of noise are relatively more important at high frequencies than at low frequencies.

This property of noise is realized instinctively by those people who listen to their phonograph records with the tone controls set to decrease the high-frequency response and thereby reduce the record scratch. This method of reducing the record noise is not a desirable one, since the higher frequencies are lost from the reproduced sound, but to these listeners the effects of the noise are more objectionable than the loss of high frequencies.

However, even without reducing the high-frequency range of the system it is possible, because of the different frequency characteristics of the noise and of the reproduced sound, to reduce the reproduced noise level by the use of *pre-emphasis*. The relative frequency distribution of sound energy in orchestral music is shown in curve A of Fig. 1. This curve shows that there is considerably less sound energy

Fig. 1. Use of pre-emphasis to reduce reproduction noise. Curve A is most probable distribution of frequency components in music at high levels. B is frequency spectrum of random noise. C is FM pre-emphasis characteristic and D is NAB recording characteristic and E is reproduced noise when the proper de-emphasis characteristic is used in the playback channel.

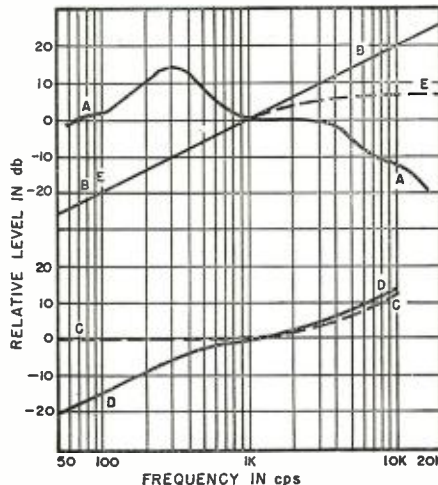

at the higher frequencies than at the lower. Curve *B* shows the sound spectrum of a random noise plotted to the same frequency scale (and at an arbitrary 0 db level), and shows its relatively greater effect at the higher frequencies. It must be noted that such noise is generally introduced into the signal *after* the sound has been transmitted or recorded. Therefore, the most basic and simplest method of reducing the reproduced noise level is to increase the amplitude of the high frequencies in the channel before recording (that is, before the introduction of the noise), and then to decrease the high-frequency level by the corresponding amount in playback (which is after the introduction of the noise). The net effect is to decrease the noise level by the amount the high frequencies have been pre-emphasized.

This system of pre-emphasis is in use in FM broadcasting, and accounts for a considerable amount of the noise superiority of FM over AM. If pre-emphasis were used in AM broadcasting, the received signal would contain a much lower noise component than it does with the present method. The technique of pre-emphasis is also used in disc and tape recording to reduce the effects of playback noise. The frequency response curve which is used to achieve this effect in FM broadcasting is shown in curve *C* of Fig. 1, and the standard NAB recording curve is shown as *D*. (In the curve used for recording, the drop at the low-frequency end is necessary because of the practical limitations on the amplitude of motion of the recording stylus.) The effective decrease in noise level by the use of this technique in recording is shown by curve *E* in Fig. 1.

The basic methods of obtaining the frequency-response curves required for pre-emphasis and de-emphasis make use of *RC*, *RL*, and *RLC* circuits. The circuits which are of most interest to the audio experimenter are those for de-emphasis in playback, and these usually make use of simple *RC* networks to obtain the required curves. The basic *RC* tone control and equalizer circuits are shown in Fig. 2. They depend for their operation upon the fact that a resistance is constant independent of frequency, while the reactance of a condenser decreases as the frequency increases. Thus, in the simple series attenuator shown in Fig. 2, when the two impedances are pure resistances the output level does not change with frequency, remaining a constant percentage of the input voltage. However, when either of the two impedances is a capacity the output level will change with frequency—increasing at the higher frequencies to give treble boost when the series impedance is a capacity, and increasing at the lower frequencies to give bass boost when the shunt impedance is a capacity.

The general frequency correction circuit, which can be used as a basis for the practical design of all types of equalizers with a constant voltage in-

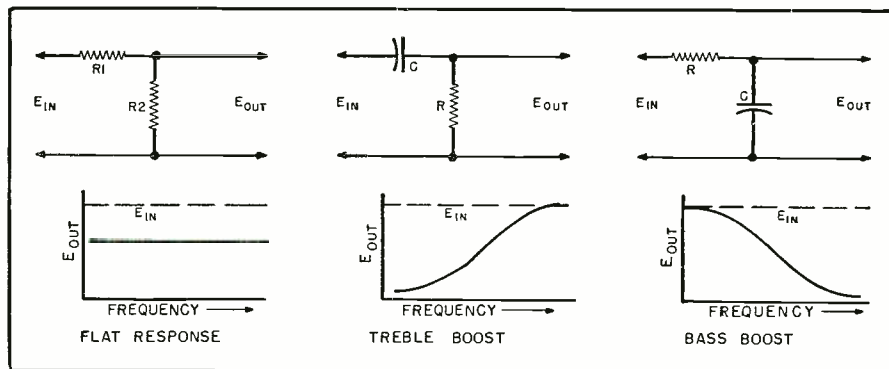
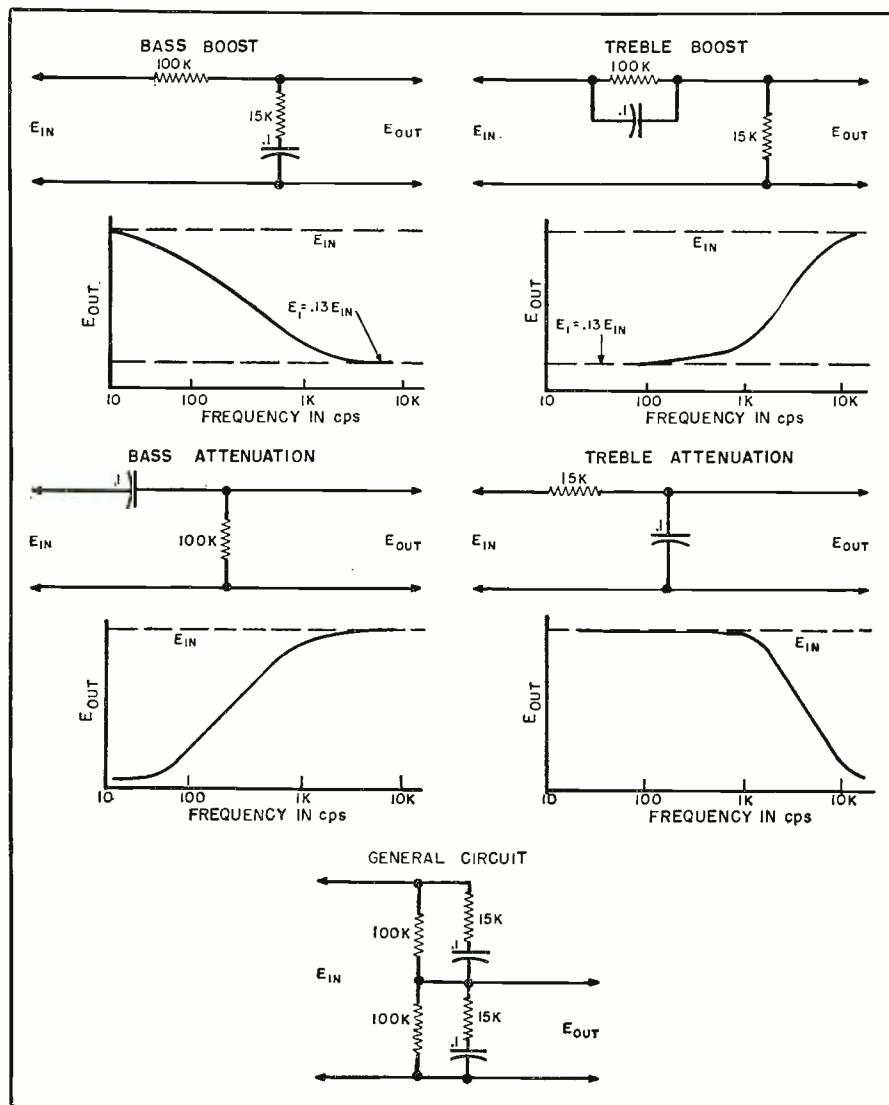

Fig. 2. Basic RC tone control and equalizer circuits for three different conditions.

put, is shown in Fig. 3. Some of the most useful tone control circuits based upon this general circuit are also shown in Fig. 3, together with typical frequency response curves which are obtained. It can readily be seen how the variation of capacitive reactance with frequency (that is, becoming very large at low frequencies, and very small at high frequencies), results in the indicated response. Circuits very similar to those shown are used in the majority of sound systems.

In many cases the pre-emphasis curves in recording and the de-emphasis curves in playback may not always be properly matched to one another, and in the resulting reproduced sound either the high frequencies or the low frequencies may be overemphasized or underemphasized. An adjustable equalizer or *tone-control* network should be included in the reproduction channel to provide for frequency-response correction when the reproduced sound does not have the

Fig. 3. RC tone control and equalizer circuits including suitable parts values.



proper balance between high frequencies and low frequencies. A flexible tone-control circuit should have a high-frequency control which could be set for either boost or attenuation of the highs, and a low-frequency control which is capable of either boost or attenuation of the lows.

The circuit of a simple network which serves as a variable tone control is shown in Fig. 4. This network has independent bass and treble controls which are capable of giving the range of frequency response curves shown in C of Fig. 4. The treble control can be adjusted over the complete range of settings from 15 db boost to 15 db attenuation at 20,000 cps, while the bass control may be set to give from 13 db accentuation to 13 db attenuation at 50 cps. Since the controls are continuously adjustable, any intermediate setting between these two extremes may be obtained—including a flat-frequency-response position. The principle of operation of this circuit may be more clearly understood from the simplified circuits shown in Fig. 4B, which show the equivalent circuits in the *maximum bass and treble* positions, and by comparing them with the basic tone control circuit of Fig. 3.

The circuits which have been described are high-impedance networks and should have a constant-voltage input, therefore the method of their connection into the playback circuit is somewhat critical. For best results, the tone control circuit should be isolated by a triode amplifier stage

(such as the 6J5, ½-6SN7, ½-6SL7, ½-12AT7, etc.), and should feed directly into the high-impedance grid of the following stage. The method of isolating the tone control network by a triode amplifier stage is shown in the circuit of Fig. 4A.

It should be kept in mind that all equalizer networks operate on the principle of attenuating certain frequencies to give their frequency response—since they obviously cannot deliver a greater voltage than is applied to their input. Therefore an equalizer which gives a 15 db bass boost actually attenuates all frequencies but the bass by 15 db, and leaves the bass level unchanged. The usual tone control network will thus have an insertion loss of about 15 to 20 db at the middle frequencies, and must therefore be inserted in the playback amplifier circuit at a point where this insertion loss can be handled properly—where the level is sufficiently high that noise will not be a problem after the 20 db attenuation, and where the level is still not so high the tube overloads.

Compression and Expansion

Even with the use of pre-emphasis techniques, an over-all noise level of better than -60 db below full output is fairly difficult to attain. When reproduction from records or AM broadcasting is included in the channel the noise level will generally be considerably higher—as high as -40 db below peak signal or even more for bad records. Since the actual dynamic range

to be reproduced may be as high as 75 db, the noise level (even assuming the -60 db figure) prevents the reproduction of this entire dynamic range of signals. Thus, if the output is set for maximum at the highest signal level, the low-level signals will be lost in the noise. Furthermore, the maximum output of the system may be too loud for comfortable listening.

To improve this condition, the sound signal is usually monitored during recording or transmission, and the gain in the channel is adjusted to reduce the dynamic range. This function may be performed either manually by an operator who watches a signal-level meter and adjusts a gain control to keep the signal peaks within specified limits, or automatically by electronic gain-adjusting circuits. The automatic electronic units need just be set up properly for the particular signal being transmitted or recorded, and then observed periodically to insure proper operation.

The functioning of the electronic units for automatic gain adjustment is based upon two different principles:

(a) *Volume compression* in which the channel gain is reduced in proportion as the signal level increases so that the resulting dynamic range of the signal is the same as that of the reproducing system. The operation of this system is based upon approximately the same principle as that of manual gain adjustment, in which the operator decreases the gain for loud signals to keep them below some specified maximum, and increases the gain for low levels to keep them above some specified minimum.

(b) *Peak limiting* in which the channel gain is adjusted to keep all low-level signals above the noise level, and gain control is applied only to the loud peaks. The high levels are then transmitted at their normal level as long as they are not greater than some fixed maximum which can be handled by the system without excessive distortion. Whenever the signal has a greater amplitude, the gain is reduced enough to bring this amplitude down to this same maximum amplitude.

Thus, the volume compression method decreases the dynamic range gradually for signals of all levels, whereas the peak limiting method does not affect signals below the channel maximum and limits high-level peaks to this maximum. In playback, a *volume expander* circuit which performs the inverse function may be used to restore the dynamic range of the original signal. The curves in Fig. 5 illustrate the basic functions of these units by showing typical curves of output signal levels for various input levels. If a volume expander circuit is used with a signal which has been compressed, the original dynamic range is restored accurately; if a peak limiter has been used in transmitting the signal, the reproduced dynamic range is increased but the relative signal levels are altered.

(Continued on page 116)

Fig. 4. (A) Variable tone control circuit, showing method of matching into amplifier circuit. (B) Simplified schematics showing operation of circuit at extreme control settings—maximum bass and maximum treble (left) and minimum bass and minimum treble (right). (C) Frequency response curves obtained with circuit shown in (A).

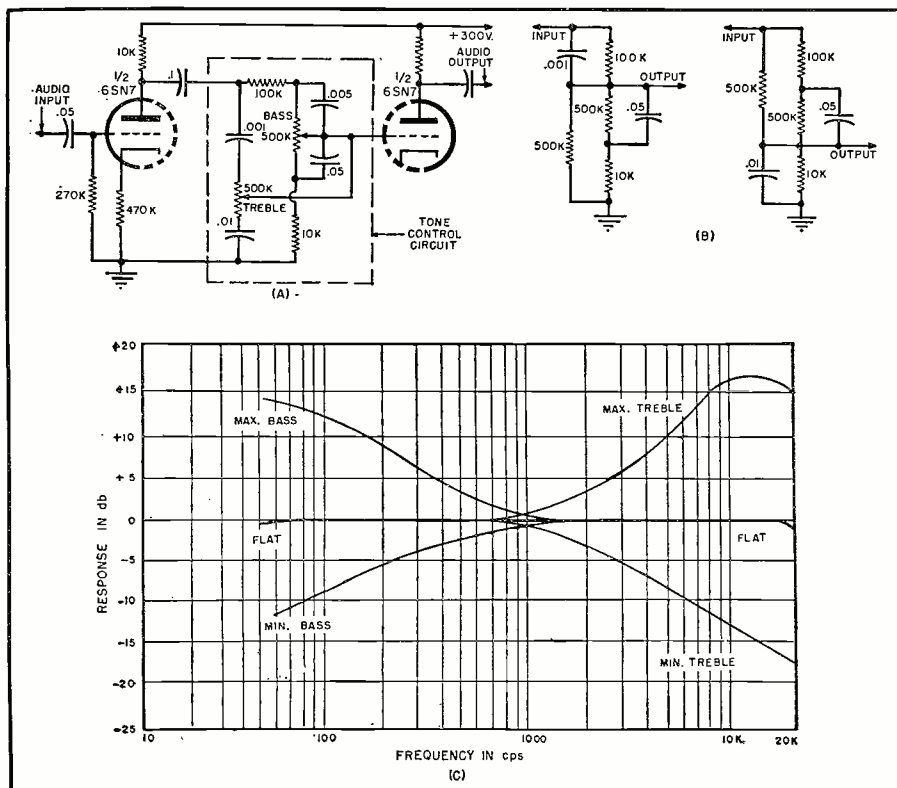

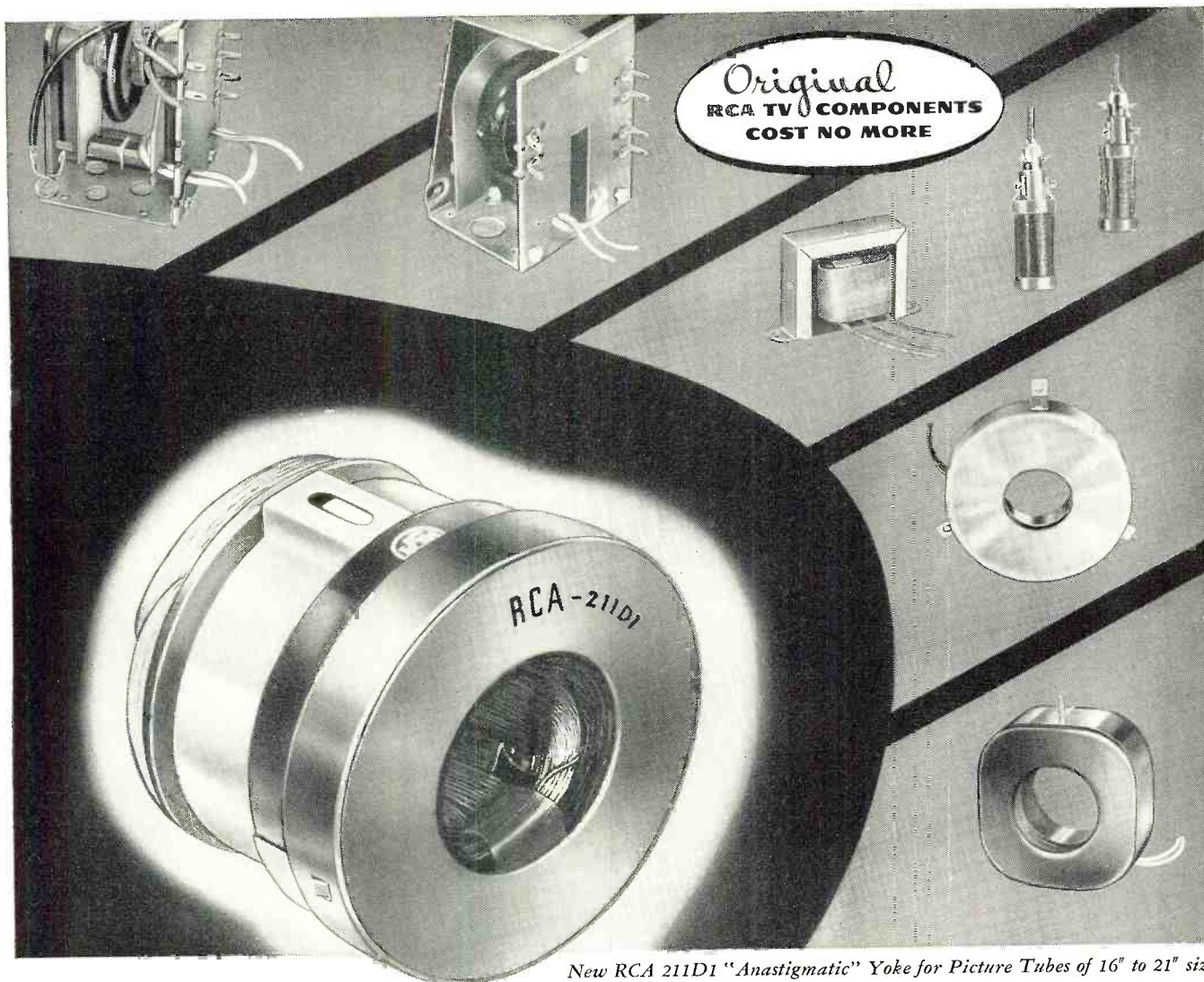

New RCA 211D1 "Anastigmatic" Yoke for Picture Tubes of 16" to 21" size

For best results use the yoke that's tailored to the tube

Check these features . . .

- ✓ Distributed windings of modified "cosine" design for sharp corner focus
- ✓ Negligible pattern distortion
- ✓ Freedom from insulation breakdown
- ✓ Terminals securely mounted
- ✓ Sturdy molded housing

Why take chances with "compromise" yokes when RCA "originals" cost no more?

Remember—RCA deflecting yokes set the engineering standards of the field. That's because RCA deflecting yokes and RCA picture tubes are designed to work as a team. Mechanically and electrically, RCA yokes "fit like a glove". . . work best with the picture tubes they're specifically designed for.

Always the leader—RCA deflecting yokes were the first to use Ferrite cores . . . first to use distributed windings

providing negligible barrel and pin-cushion distortion. And . . . RCA yokes were the first to be constructed with a molded housing of solid plastic that affords increased insulation between windings and core, insures high resistance to humidity, and holds terminal lugs firmly.

RCA yokes are best fitted to restore original performance in the many makes of TV receivers you service. When a replacement is called for, play safe . . . use the yoke that "fits the tube." *That's RCA!*

See your local RCA Parts Distributor for "Original" RCA TV Components.



RADIO CORPORATION of AMERICA
ELECTRONIC COMPONENTS
HARRISON, N. J.

Features OF THE NEW 1952

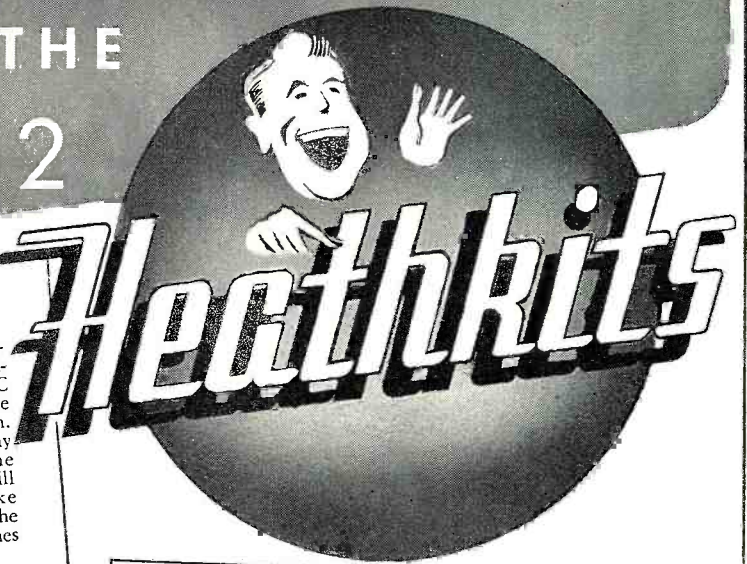

PROOF OF THE NEW O-7 OSCILLOSCOPE'S OUTSTANDING PERFORMANCE

Below are actual, unretouched photographs showing the outstanding frequency response characteristics of the NEW 1952 HEATH-KIT OSCILLOSCOPE, MODEL O-7. To the left is a 10 KC square wave — to the right a 4 MC sine wave as they actually appear on the screen. Two highly severe tests to make on any scope (only the best of scopes will show traces like these) — and the O-7 really comes through.

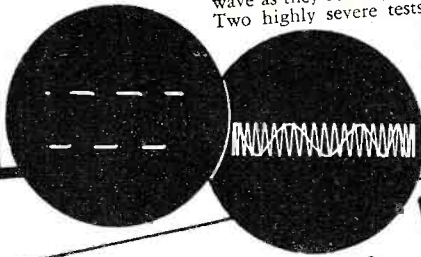

COMPANION VACUUM TUBE VOLTMETERS

Here are the two NEW 1952 VACUUM TUBE VOLTMETER COMPANION PIECES. Matched instruments of new design to open up the whole field of DC, AC, and resistance measurements for you. The new greatly reduced size combines style, beauty, and compactness — The V-5 and AV-1 have the new panel and cabinet construction as shown on the right. A tremendous pair of voltmeters. Small in size but virtual giants in the range of measurements they make.



NEW STYLE AND BEAUTY

Style that's modern, yet functional — that's the trend of today — and Heathkits are right up to the minute. Note the cut showing the new V-5 and AV-1 cabinet and panel construction. The front panel and rear cover slide right over the recessed flange of the case thereby eliminating sharp edges and pointed corners. The voltmeter kits aren't "shelf" or "mounted" instruments — they're moved about on the bench a lot and thus the new compact size and specially designed cabinets — Another 1952 Heathkit feature.

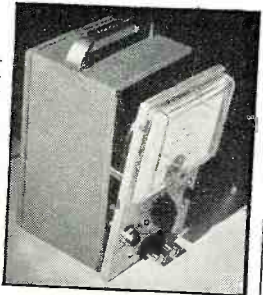

A STATEMENT FROM SIMPSON ELECTRIC CO.

In choosing Simpson Meters for their Heathkit VFVM, the Heath Co. has set a new high standard of kit meter quality. The same high quality of material, workmanship and design that has given Simpson the reputation for building "Instruments That Stay Accurate" is found in the Heathkit Meter Movement.

SIGNED
SIMPSON ELECTRIC CO.

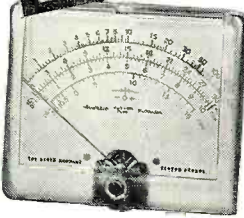

A STATEMENT FROM CHICAGO TRANSFORMER

It is indeed gratifying to note the outstanding sales records you are building with you Heathkits.

This sales success is readily understandable, since we are cognizant of the high quality standards you have established for your component suppliers.

We at Chicago Transformer are proud that our product has contributed to the recognized quality and increasing popularity of Heathkits.

CHICAGO TRANSFORMER DIVISION
Essex Wire Corporation

L. S. RACINE
Vice-President and Sales Manager

HEATHKIT PRECISION RESISTORS

Where exact resistance values are required for instrument accuracy, the Heath Co. has spared no effort in supplying the finest resistors available. Precision resistors as manufactured by Continental Carbon Inc., and Wilcor Corp., meet the rigorous JAN (Joint Army-Navy) specifications and are small in size, extremely non-inductive, highly stable, have a low temperature coefficient, and can be held to great accuracy. You'll find quality components in Heathkits.

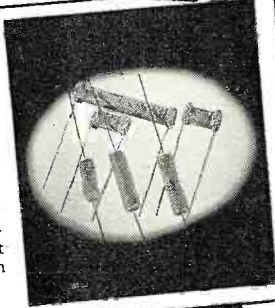

COLLEGES USE HEATHKITS

Colleges and Universities throughout the country are using Heathkits in their electrical engineering, radio, and physics laboratories — Heathkits are the answer to good test equipment at low cost, plus being rugged, dependable, and accurate. Trade schools are having their students build Heathkits to obtain a first hand working knowledge of test equipment and to get the practical experience gained by construction. Heathkits fill school needs.

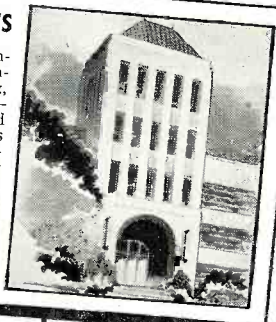

YOU SAVE BY ORDERING DIRECT FROM MANUFACTURER—USE ORDER BLANK ON LAST PAGE

EXPORT AGENT
ROCKE INTERNATIONAL CORP.
12 E. 40th ST.
NEW YORK CITY (16)
CABLE: ARLAB-N.Y.

The HEATH COMPANY

... BENTON HARBOR 15, MICHIGAN

New LABORATORY LINE HEATHKITS

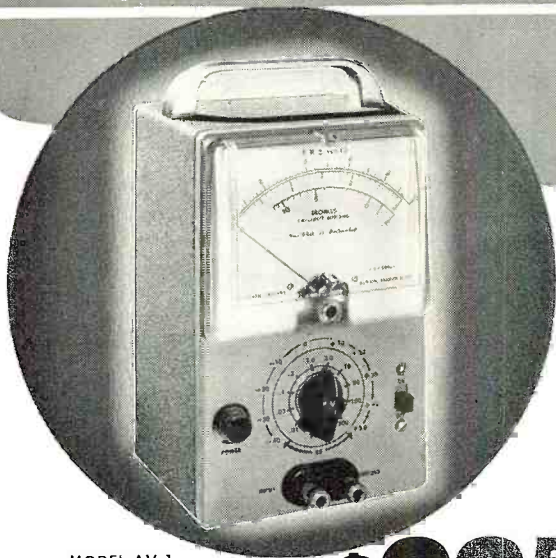

MODEL AV-1
Shipping weight 5 lbs.

NEW *Heathkit* A.C. VACUUM TUBE VOLTMETER KIT

Now — as a Heathkit — at a price anyone can afford, an AC VTVM. A new kit to make possible those sensitive AC measurements required by audio enthusiasts, laboratories, and experimentors. Here is the kit that the audio men have been looking for. Its tremendous range of coverage makes possible measurements of audio amplifier frequency response — gain or loss of audio stages — characteristics of audio filters and attenuators — hum investigation — and literally a multitude of others. Ten ranges consisting of full scale .01, .05, .1, .3, 1, 3, 10, 30, 100, 300 volts RMS assure easy and more accurate readings. Ten ranges on DB provide for measurements from -52 to +52 DB. Frequency response within 1 DB from 20 cycles to 50 KC.

The ingenious circuitry incorporates precision multiplier resistors for accuracy, two amplifier stages using miniature tubes, a unique bridge rectifier meter circuit, quality Simpson meter with 200 microampere movement, and a clean layout of parts for easy wiring. A high degree of inverse feedback provides for stability and linearity.

Simple operation is accomplished by the use of only one control, a range switch which changes the voltage ranges in multiples of 1 and 3, and DB ranges in steps of 10.

The instrument is extremely compact, cabinet size — 4 1/8" deep x 4-11/16" wide x 7 3/8" high, and the newly designed cabinet makes this the companion piece to the VTVM. For audio work, this kit is a natural.

\$29⁵⁰

NEW *Heathkit* AUDIO FREQUENCY METER KIT

MODEL AF-1
Shipping weight 12 lbs.



\$34⁵⁰

A NEW Heathkit Audio Frequency Meter — the ideal instrument for determining frequencies from 20 cycles to 100 KC. Set the selector switch to the proper range — feed the signal into the input terminals — and read the frequency from the meter — completely simple to operate, and yet dependable results.

Quality Simpson 200 microampere meter has two plainly marked scales (0-100 0-300). These scales, read in conjunction with the seven position selector switch, give full scale readings of 100, 300, 1000, 3000, 10,000, 30,000, and 100,000 cycles. Convenient ranges for fast and easy readings.

For greatest accuracy, the 1-3-10 ratio of ranges is maintained, and each range has individual calibrating control.

Input impedance is high (1 megohm) for negligible circuit loading. A signal voltage anywhere between 2 and 300V can be fed directly into the instrument reading. In addition, input wave shape is not critical (the unit will read the frequency of either sine wave or square wave input).

The tube complement consists of a 6SJ7 amplifier and clipper, 6V6 amplifier and clipper, 6H6 meter pulse rectifier, 6X5 power supply rectifier, and OD3/VR150 voltage regulator.

Construction is simple, and quality components are used throughout.

NEW *Heathkit* INTERMODULATION ANALYZER KIT

Intermodulation testing of audio equipment is rapidly being accepted by more and more engineers and audio experts as the best way to determine the characteristics of audio amplifiers, recording systems, networks, etc. — shows up those undesirable characteristics which contribute to listening fatigue when all other methods fail.

The Heathkit Intermodulation Analyzer supplies a choice of two high frequencies (3000 cycles and a higher frequency (60 cycles). Both 1:1 or 4:1 ratios of low cycles). Both 1:1 or 4:1 ratios can be set up for high frequencies can be easily set by means of a panel control and the instrument's own VTVM. An output level control supplies the mixed signal at the desired level with an output impedance of two thousand ohms. The Analyzer section has input level control and proper filter circuits feeding the instrument's VTVM to read intermodulation directly on full scale ranges of 30%, 10% and 3%. Built-in power supply furnishes all necessary voltages for operating the instrument.

You won't want to be without this new and efficient means of testing.

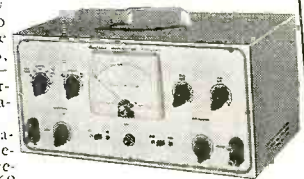

MODEL IM-1
Shipping wt. 18 lbs.

\$39⁵⁰

NEW *Heathkit* SQUARE WAVE GENERATOR KIT

The new Heathkit Square Wave Generator Kit with its 100 KC square wave opens an entirely new field of audio testing. Square wave testing over this wide range will quickly show high and low frequency response characteristics of circuits — permit easy adjustment of high frequency compensating networks used in video amplifiers — identify ringing in circuits — demonstrate transformer characteristics, etc.

The circuitry consists of a multivibrator stage, a clipping and squaring stage, and a cathode follower output stage. The power supply is transformer operated and utilizes a full wave rectifier tube with 2 sections of LC filtering.

As a multivibrator cannot be accurately calibrated, a provision is provided to allow the instrument to be accurately synchronized with an accurate external source when extreme accuracy is required.

The low impedance output is continuously variable between 0 and 25 volts and operation is simple. You'll really appreciate the wide range of this instrument, 10 cycles to 100 kilocycles — continuously variable. Kit is complete with all parts and instruction manual, and is easy to build.

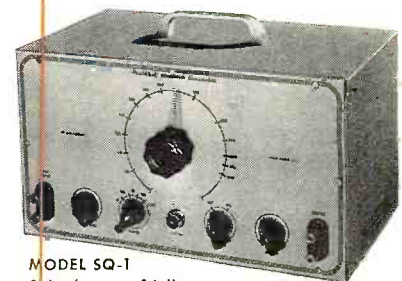

MODEL SQ-1
Shipping wt. 14 lbs.

\$29⁵⁰

YOU SAVE BY ORDERING DIRECT FROM MANUFACTURER—USE ORDER BLANK ON LAST PAGE

EXPORT AGENT
ROCKE INTERNATIONAL CORP.
12 E. 40th ST.
NEW YORK CITY (16)
CABLE: ARLAB-N.Y.

The **HEATH COMPANY**

... BENTON HARBOR 15, MICHIGAN

THE *New* 1952
Heathkit
**OSCILLOSCOPE
 KIT**

MODEL O-7
 SHIPPING WEIGHT 24 LBS.

\$43⁵⁰

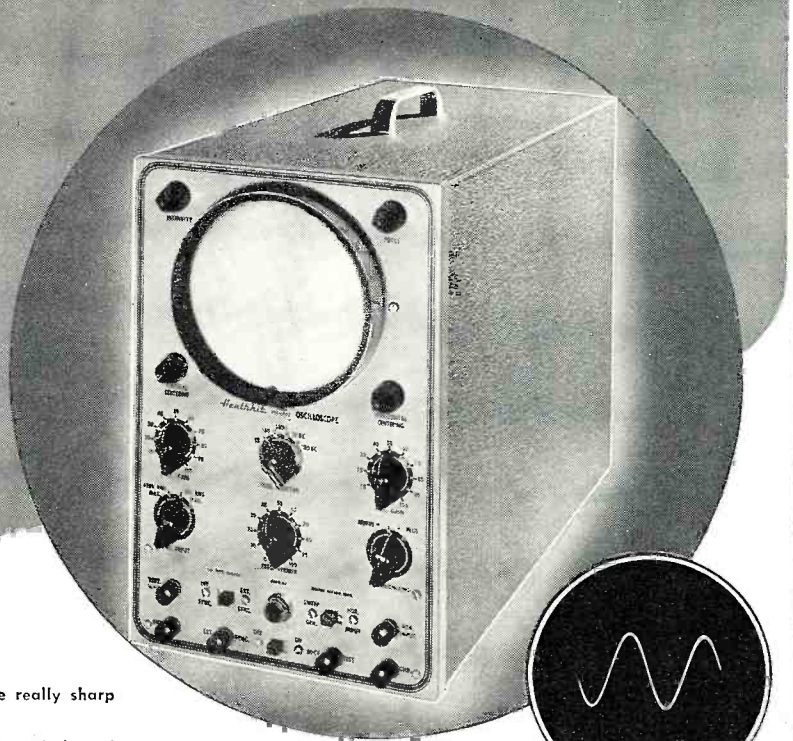

Features

- New "spot shape" control for spot adjustment — to give really sharp focusing.
- A total of ten tubes including CR tube and five miniatures.
- Cascaded vertical amplifiers followed by phase splitter and balanced push-pull deflection amplifiers.
- Greatly reduced retrace time.
- Step attenuated — frequency compensated — cathode follower vertical input.
- Low impedance vertical gain control for minimum distortion.
- New mounting of phase splitter and deflection amplifier tubes near CR tube base.
- Greatly simplified wiring layout.
- Increased frequency response — useful to 5 Mc.
- Tremendous sensitivity .03V RMS per inch Vertical — .6V RMS per inch Horizontal.
- Dual control in vernier sweep frequency circuit — smoother acting.
- Positive or negative peak internal synchronization.

The performance of the NEW, IMPROVED, HEATHKIT 5" OSCILLOSCOPE KIT is truly amazing. The O-7 not only compares favorably with equipment costing 4 and 5 times as much, but in many cases literally surpasses the really expensive equipment. The new, and carefully engineered circuit incorporates the best in electronic design — and a multitude of excellent features all contribute to the outstanding performance of the new scope.

The VERTICAL CHANNEL has a step attenuated, frequency compensated vertical input which feeds a cathode follower stage — this accomplishes improved frequency response, presents a high impedance input, and places the vertical gain control in a low impedance circuit for minimum distortion. Following the cathode follower stage is a twin triode — cascaded amplifiers to contribute to the scope's extremely high sensitivity. Next comes a phase splitter stage which properly drives the push-pull, hi-gain, deflection amplifiers (whose plates are directly coupled to the vertical deflection plates). This fine tube lineup and circuitry give a sensitivity of .03V per inch RMS vertical and useful frequency response to 5 Mc.

The HORIZONTAL CHANNEL consists of a triode phase splitter with a dual potentiometer (horizontal gain control) in its plate and cathode circuits for smooth, proper driving of the push-pull horizontal deflection amplifiers. As in the vertical channel, horizontal deflection amplifier plates are direct coupled to the CR tube horizontal deflection plates (for improved frequency response).

The WIDE-RANGE SWEEP GENERATOR circuit incorporates a twin triode multivibrator stage for producing a good saw-tooth sweep frequency (with faster retrace time). Has both coarse and vernier sweep frequency controls.

And the scope has internal synchronization which operates on either positive or negative peaks of the input signal — both high and low voltage rectifiers — Z axis modulation (intensity modulation) — new spot shape (astigmatism) control for spot adjustment — provisions for external synchronization — vertical centering and horizontal centering controls, wide range focus control — and an intensity control for giving plenty of trace brilliance.

The Model O-7 EVEN HAS GREAT NEW MECHANICAL FEATURES — A special extra-wide CR tube mounting bracket is provided so that the vertical cascade amplifier, vertical phase splitter, vertical deflection amplifier, and horizontal deflection amplifier can mount near the base of the CR tube. This permits close connection between the above stages and to the deflection plates; distributed wiring capacity is greatly reduced, thereby affording increased high frequency response.

The power transformer is specially designed so as to keep its electrostatic and electromagnetic fields to a minimum — also has an internal shield with external ground lead.

You'll like the complete instructions showing all details for easily building the kit — includes pictorials, step-by-step construction procedure, numerous sketches, schematic, circuit description. All necessary components included — transformer, cabinet, all tubes (including CR tube), completely punched and formed chassis — nothing else to buy

NEW INEXPENSIVE *Heathkit*
ELECTRONIC SWITCH KIT

The companion piece to a scope — Feed two different signals into the switch, connect its output to a scope, and you can observe both signals — each as an individual trace. Gain of each input is easily set (gain A and gain B controls), the switching frequency is simple to adjust (coarse and fine frequency controls) and the traces can be superimposed for comparison or separated for individual study (position control).

Use the switch to see distortion, phase shift, clipping due to improper bias, both the input and output traces of an amplifier — as a square wave generator over limited range.

The kit is complete; all tubes, switches, cabinet, power transformer and all other parts, plus a clear detailed construction manual.

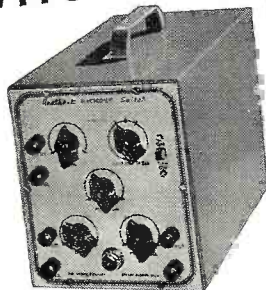

Model S-2
 Shipping Wt. 11 lbs.

Only
\$19⁵⁰

YOU SAVE BY ORDERING DIRECT FROM MANUFACTURER — USE ORDER BLANK ON LAST PAGE

EXPORT AGENT
ROCKE INTERNATIONAL CORP.
 13 E. 40th ST.
 NEW YORK CITY (16)
 CABLE: ARLAB-N.Y.

The **HEATH COMPANY**

... BENTON HARBOR 15, MICHIGAN

THE *New* 1952

Heathkit VTVM KIT

MODEL V-5
SHIPPING WT. 5 LBS.

\$24.50

Features

- New styling, — formed case for beauty.
- New truly compact size. Cabinet $3\frac{1}{8}$ " deep by $4\text{-}11\frac{1}{16}$ " wide by $7\frac{3}{8}$ " high.
- Quality 200 microamp meter.
- New ohms battery holding clamp and spring clip — assurance of good electrical contact.
- Highest quality precision resistors in multiplier circuit.
- Calibrates on both AC and DC for maximum accuracy.
- Terrific coverage — reads from $\frac{1}{2}$ V to 1000V AC, $\frac{1}{2}$ V to 1000V DC, and .1 to over 1 billion ohms resistance.
- Large, clearly marked meter scales indicate ohms, AC Volts, DC Volts, and DB — has zero set mark for FM alignment.
- New styling presents attractive and professional appearance.

A real beauty — you'll have only highest praise for this NEW MODEL VACUUM TUBE VOLTMETER. Truly a beautiful little instrument — and it's more compact than any of our previous models. Note the new rounded edges on the front panel and rear cover. The size is greatly reduced to occupy a minimum of space on your workbench — yet the meter remains the same large size with plainly marked scales.

A set of specially designed control mounting brackets permit calibration to be performed with greatest ease — also makes for ease in wiring. New battery mounting clamp holds ohms battery tightly into place, and base spring clip insures a good connection to the ohms string of resistors.

The circuitry employs two vacuum tubes — A duo diode operating when AC voltage measurements are taken, and a twin triode in the circuit at all times. The cathode balancing circuit of the twin triode assures sensitive measurements, and yet offers complete protection to the meter movement. Makes the meter burn-out proof in a properly constructed instrument.

Quality components are used throughout — 1% precision resistors in the multiplier circuit — conservatively rated power transformer — Simpson meter movement — excellent positive detent, smooth acting switches — sturdy cabinet, etc.

And you can make a tremendous range of measurements — $\frac{1}{2}$ V to 1000V AC, $\frac{1}{2}$ V to 1000V DC, .1 to over 1 billion ohms, and DB. Has mid-scale zero level marking for quick FM alignment. DB scale in red for easy identification — all other scales a sharp, crisp black for easy reading.

A four position selector switch allows operator to rapidly set the instrument for type or reading desired — positions include ACV, DC+V, DC-V, and Ohms. DC- position allows negative voltage to be rapidly taken. Zero adjust and ohms adjust controls are conveniently located on front panel.

Enjoy the numerous advantages of using a VTVM. Its high input impedance doesn't "load" circuits under test — therefore, assures more accurate and dependable readings in high impedance circuits such as resistance coupled amplifiers, AVC circuits, etc. Note the 30,000 VDC probe kit and the RF probe kit — available at low extra cost and specially designed for use with this instrument. With these two probes, you can make DC voltage measurements up to 30,000V, or make RF measurements — added usefulness to an already highly useful instrument.

The instruction manual is absolutely complete — contains a host of figures, pictorials, schematic, detailed step-by-step instructions, and circuit description. These clear, detailed instructions make assembly a cinch.

And every part is included — meter, all controls, pilot light, switches, test leads, cabinet, instruction manual, etc.

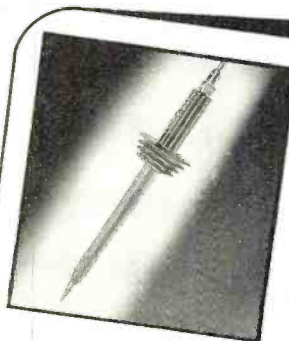

Heathkit 30,000V DC
PROBE KIT
A new 30,000 V DC Probe Kit to handle high voltages with safety. For TV service work and all other high voltage applications. Sleek looking — and guard — jet black plastic — Red body with connector, cable, and PL55 type 300V scale is conveniently multiplied by 100. Can be used with any standard 11 megohm VTVM.

\$5.50

No. 336 High Voltage Probe Kit
Shipping Wt. 2 lbs.

Heathkit
RF PROBE KIT
This RF Probe Kit comes complete with probe housing, crystal diode detector, connector, lead and plug and all other parts plus clear assembly instructions. Extends range of Heathkit VTVM to 250 Mc. \pm 10%. Works on any 11 megohm input VTVM. Specify No. 309 RF Probe Kit.

\$5.50

Shp. Wt. 1 lb.

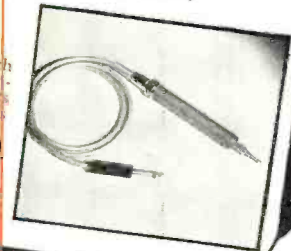

YOU SAVE BY ORDERING DIRECT FROM MANUFACTURER—USE ORDER BLANK ON LAST PAGE

EXPORT AGENT
ROCKE INTERNATIONAL CORP.
132 E. 40th ST.
NEW YORK CITY (16)
CALIF., ARIZ., N.Y.

The HEATH COMPANY

... BENTON HARBOR 15, MICHIGAN

Heathkit SIGNAL GENERATOR KIT

Model SG-6
Shipping Wt. 7 lbs.

The new Heathkit Signal Generator Kit has dozens of improvements. Covers the extended range of 160 Kc to 50 megacycles on fundamentals and up to 150 megacycles on useful calibrated harmonics; makes this Heathkit ideal as a marker oscillator for TV. Output level can be conveniently set by means of both step attenuator and continuously variable output controls. Instrument has new miniature HF tubes to easily handle the high frequencies covered.

Uses 6C4 master oscillator and 6C4 sine wave audio oscillator. The kit is transformer operated and a husky selenium rectifier is used in the power supply. All coils are precision wound and checked for calibration making only one adjustment necessary for all bands.

New sine wave audio oscillator provides internal modulation and is also available for external audio testing. Switch provided allows the oscillator to be modulated by an external audio oscillator for fidelity testing of receivers. Comes complete, all tubes, cabinet, test leads, every part. The instruction manual has step-by-step instructions and pictorials. It's easy and fun to build a Heathkit Model SG-6 Signal Generator.



Heathkit CONDENSER CHECKER KIT

Only
\$19.50

Model C-2
Shipping Wt. 6 lbs.



Checks all types of condensers — paper — mica — ceramic — electrolytic. All condenser scales are direct reading and require no charts or multipliers. Covers range of .00001 MFD to 1000 MFD. A Condenser Checker that anyone can read. A leakage test and polarizing voltage for 20 to 500 V provided. Measures power factor of electrolytics between 0% and 50% and reads resistance from 100 ohms to 5 megohms. The magic eye indicator makes testing easy.

The kit is 110V 60 cycle transformer operated and comes complete with rectifier tube, magic eye tube, cabinet, calibrated panel and all other parts. Has clear detailed instructions for assembly and use.

NEW Heathkit SIGNAL TRACER AND UNIVERSAL TEST SPEAKER KIT

\$19.50

Model T-2
Shipping Wt. 7 lbs.

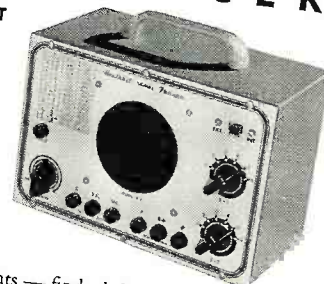

The popular Heathkit Signal Tracer has now been combined with a universal test speaker at no increase in price. The same high quality tracer follows signal from antenna — locates intermittents — saves valuable service time — finds defective parts quicker — gives greater income per service hour. Works equally well on broadcast, FM, or TV receivers. The test speaker has an assortment of switching ranges to match either push-pull or single output impedances. Also tests microphones, pickups and PA systems. Comes complete: cabinet, 110V 60 cycle power transformer, tubes, test probe, all necessary parts, and detailed instructions for assembly and use.



Model TC-1
Shipping Wt. 12 lbs.

\$29.50

Heathkit TUBE CHECKER KIT

The Tube Checker is a MUST for radio repair men. Often customers want to SEE tubes checked, and a checker like this builds customer confidence. In your repairing, you will have a multitude of tubes to check — quickly. The Heathkit tube checker will serve all these functions — it's good looking (with a polished birch cabinet and an attractive two color panel) — checks 4, 5, 6, 7 prong Octals, Loctals, 7 prong miniatures, 9 prong miniatures, pilot lights, and the Hytron 5 prong types. AND IT'S FAST TO OPERATE — the gear driven, free-running roll chart lists hundreds of tubes, and the smooth acting, simplified switching arrangement gives really rapid set-ups.

The testing arrangement is designed so that you will be able to test new tubes of the future — without even waiting for factory data — protection against obsolescence.

You can give tubes a thorough testing — checks for opens, shorts, each element individually, emission, and for filament continuity. A large BAD-?-GOOD meter scale is in three colors for easy reading and also has a "line-set" mark.

You'll find this tube checker kit a good investment — and it's only \$29.50.

YOU SAVE BY ORDERING DIRECT FROM MANUFACTURER—USE ORDER BLANK ON LAST PAGE

EXPORT AGENT
ROCKE INTERNATIONAL CORP.
13 E. 40th ST.
NEW YORK CITY (16)
CABLE: ARLAB-N.Y.

The **HEATH COMPANY**

... BENTON HARBOR 15, MICHIGAN

NEW 1952 *Heathkit* BATTERY ELIMINATOR KIT



Model BE-3
Shipping Wt. 17 lbs.

- Can be used as battery charger.
- Continuously variable output 0 - 8 Volts — not switch type.
- Heavy duty Mallory 17 disk type magnesium copper sulfide rectifier.
- Automatic overload relay for maximum protection. Self-resetting type.
- Ideal for battery, aircraft and marine radios.
- Dual Volt and Ammeters read both voltage and amperage continually — no switching.

The new Heathkit Model BE-2 incorporates the best. Continuously variable output control is of the variable transformer type with smooth wiper type contacts. There are no switches or steps and voltage between 0 and 8 Volts is available at 10 Amperes continuous and 15 Amperes intermittent. Maximum safety from overloads and shorts provided by automatic overload relay which resets itself when overload is removed.

The new rectifier is a 17 plate Mallory magnesium copper sulfide type. This is the most rugged type available for long trouble-free use.

Output is continuously metered by both a 0-10 Volt Voltmeter and a 0-15 Amp Ammeter. Shorted vibrators indicated instantly by ammeter.

Equip now for all types of service — aircraft — marine — auto and battery radios — this inexpensive instrument vastly increases service possibilities — better be ready when the customer walks in.

NEW *Heathkit* SINE AND SQUARE WAVE AUDIO GENERATOR KIT

Designed with versatility, usefulness, and dependability in mind, the AG-7 gives you the two most needed wave shapes right at your fingertips — the sine wave and the square wave.

The range switch and plainly calibrated frequency scale give rapid and easy frequency selection, and the output control permits setting the output to any desired level.

A high-low impedance switch sets the instrument for either high or low impedance output — on high to connect a high impedance load, and on low to work into a low impedance transformer with negligible DC resistance.

Coverage is from 20 to 20,000 cycles, and distortion is at a minimum — you can really trust the output wave shape.

Six tubes, quality 4 gang tuning condenser, power transformer, metal cased filter condenser, 1% precision resistors in the frequency determining circuit, and all other parts come with the kit — plus, a complete construction manual — A tremendous kit, and the price is truly low.

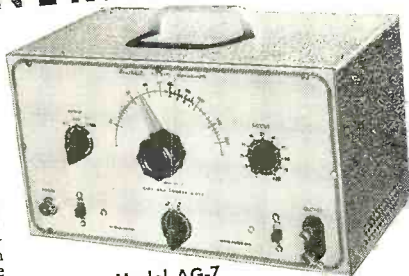

Model AG-7
Shipping Wt. 15 lbs.

\$34.50

THE NEW *Heathkit* HANDITESTER KIT

A precision portable volt-ohm milliammeter. Uses only high quality parts — All precision 1% resistors, three deck switch for trouble-free mounting of parts, specially designed battery mounting bracket, smooth acting ohm adjust control, beautiful molded bakelite case, 400 micro-amp meter movement, etc.

DC and AC voltage ranges 10 - 30 - 300 - 1000 - 5000V. Ohms range 0 - 3000 and 0 - 300,000. Range Milliampers 0 - 10 Ma, 0 - 100 Ma. Easily assembled from complete instructions and pictorial diagrams.

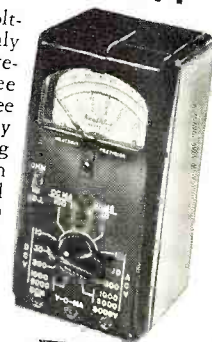

Model M-1
Shipping Wt. 3 lbs.

\$13.50

NEW *Heathkit* T.V. ALIGNMENT GENERATOR KIT

Here is an excellent TV Alignment Generator designed to do TV service work quickly, easily, and properly. The Model TS-2 when used in conjunction with an oscilloscope provides a means of correctly aligning television receivers.

The instrument provides a frequency modulated signal covering, in two bands, the range of 10 to 90 Mc. and 150 to 230 Mc. — ALL ALLOCATED TV CHANNELS AS WELL AS IF FREQUENCIES ARE COVERED.

An absorption type frequency marker covers from 20 to 75 Mc. in two ranges — therefore, you have a simple, convenient means of frequency checking of IF's, independent of oscillator calibration.

Sweep width is controlled from the front panel and covers a sweep deviation of 0-12 Mc. — all the sweep you could possibly need or want.

And still other excellent features are: Horizontal sweep voltage available at the front panel (and controlled with a phasing control) — both step and continuously variable attenuation for setting the output signal to the desired level — a convenient instrument stand-by position — vernier drive of both oscillator and marker tuning condensers — and blanking for establishing a single trace with base reference level. Make your work easier, save time, and repair with confidence — order your Heathkit TV Alignment Generator now!

Model TS-2
Shipping Wt. 20 lbs.

\$39.50

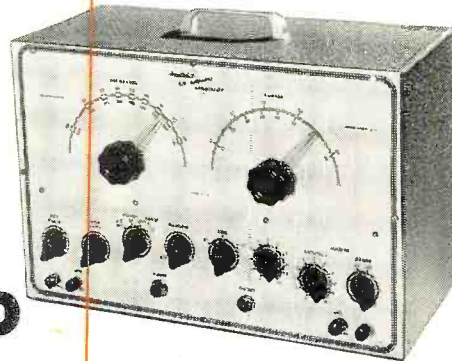

YOU SAVE BY ORDERING DIRECT FROM MANUFACTURER — USE ORDER BLANK ON LAST PAGE

EXPORT AGENT
ROCKE INTERNATIONAL CORP.
13 E. 40th ST.
NEW YORK CITY (16)
CABLE: ARIAS-N.Y.

The HEATH COMPANY

... BE TON HARBOR 15, MICHIGAN

Heathkit IMPEDANCE BRIDGE KIT



Model 1B-1B
Shipping Wt. 15 lbs.

\$69.50

This Impedance Bridge Kit is really a favorite with schools, industrial laboratories, and serious experimenters. An invaluable instrument for those doing electrical measurements work. Reads resistance from .01 Ohms to 10 meg., capacitance from .00001 to 100 MFD, inductance from 10 microhenries to 100 henries, dissipation factor from .002 to 1, and storage factor from 1 to 1000. And you don't have to worry about selecting the proper bridge circuit for the various measurements — the instrument automatically makes the correct circuit when you set up for taking the measurement you want. Bridge utilizes Wheatstone, Hay, Maxwell, and capacitance comparison circuits for the wide range and types of measurements possible. And it's self powered — has internal battery and 1000 cycle hummer. No external generator required — has provisions for external generator if measurements at other than 1000 cycles are desired. Kit utilizes only highest quality parts, General Radio main calibrated control. Mallory ceramic switches, excellent 200 microamp zero center galvanometer, laboratory type binding posts with standard 3/4 inch centers, 1% precision ceramic-body type multiplier resistors, beautiful birch cabinet and ready calibrated panel. (Headphones not included.)

Take the guesswork out of electrical measurements — order your Heathkit Impedance Bridge kit today — you'll like it.

Heathkit LABORATORY RESISTANCE DECADE KIT



\$19.50

Shipping Wt. 4 lbs.

An indispensable piece of laboratory equipment — the Heathkit Resistance Decade Kit gives you resistance settings from 1 to 99,999 ohms IN ONE OHM STEPS. For greatest accuracy, 1% precision ceramic-body type resistors and highest quality ceramic wafer switches are used.

Designed to match the Impedance Bridge above, the Resistance Decade Kit has a beautiful birch cabinet and attractive panel. It's easy to build, and comes complete with all parts and construction manual.

Heathkit LABORATORY POWER SUPPLY KITS

Limits:

No load	Variable	150-400V DC
25 MA	Variable	30-310V DC
50 MA	Variable	25-250V DC

Higher loads: Voltage drops off proportionally

Every experimenter needs a good power supply for electronic setups of all kinds. This unit has been expressly designed to act as a HV supply and a 6.3 V filament voltage source. Voltage control allows selection of HV output desired (continuously variable within limits outlined), and a Volts-Ma switch provides choice of output metering. A large plainly marked and direct reading meter scale indicates either DC voltage output in Volts or DC current output in Ma. (Range of meter 0-500V D.C., 0-200 Ma.)

Comes with power transformer, filament transformer, meter, 5Y3 rectifier, two 1619 control tubes, completely punched and formed chassis, panel, cabinet, detailed construction manual, and all other parts to make the kit complete.

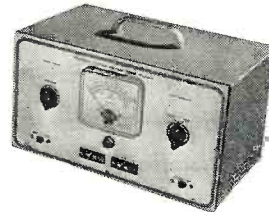

\$29.50

Model PS-1...Ship. Wt. 20 lbs.

Heathkit ECONOMY . . . 6 WATT AMPLIFIER KIT



Model A-4
Ship. Wt. 8 lbs.

\$12.50

No. 304 12 inch speaker . . . **\$6.95**

This fine Heathkit Amplifier was designed to give quality reproduction and yet remain low in price. Has two preamp stages, phase inverter stage, and push-pull beam

power output. Comes complete with six tubes, quality output transformer (to 3-4 ohm voice coil), husky cased power transformer and all other parts. Has tone and volume controls. Instruction manual has pictorial for easy assembly. Six watts output with response flat $\pm 1\frac{1}{2}$ db from 50 to 15,000 cycles. A quality amplifier kit at a low price. Better build one.

Heathkit HIGH FIDELITY . . . 20 WATT AMPLIFIER KIT

Our latest and finest amplifier — the model A-6 (or A-6A) is capable of a full 20 Watts of high fidelity output — good faithful reproduction made possible through careful circuit design and the use of only highest quality components. Frequency response within ± 1 db from 20-20,000 cycles. Distortion at 3 db below maximum power output (at 1000 cycles) is only .8%. The power transformer is rugged and conservatively rated and will deliver full plate and filament supply with ease. The output transformer was selected because of its exceptionally good frequency response and wide range of output impedances (4-8-16-150-600 ohms). Both are Chicago Transformers in drawn steel case for shielding and maximum protection to windings. The unit has dual tone controls to set the output for the tonal quality desired — treble control attenuates up to 15 db at 10,000 cycles — bass control gives bass boost up to 10 db at 50 cycles.

Tube complement consists of 5U4G rectifier, 6SJ7 voltage amplifier, 6SN7 amplifier and phase splitter, and two 6L6's in push-pull output. Comes complete with all parts and detailed construction manual. (Speaker not included.)

MODEL A-6: For tuner and crystal phono inputs. Has two position selector switch for convenient switching to type of input desired.

MODEL A-6A: Features an added 6SJ7 stage (preamplifier) for operating from variable reluctance cartridge phono pickup, mike input, and either tuner or standard crystal phono pickup. A three position selector switch provides flexible switching. **\$35.50**

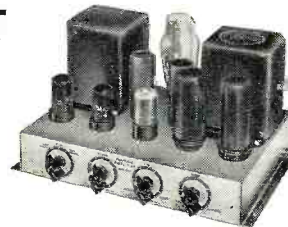

\$33.50

Shipping Wt. 18 lbs.

YOU SAVE BY ORDERING DIRECT FROM MANUFACTURER—USE ORDER BLANK ON LAST PAGE

EXPORT AGENT
ROCKE INTERNATIONAL CORP.
13 E. 40th ST.
NEW YORK CITY (16)
CABLE: RIB-1-N.Y.

The HEATH COMPANY

. . . BENTON HARBOR 15, MICHIGAN

Heathkit RECEIVER & TUNER KITS for AM and FM

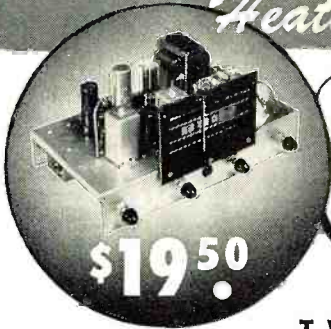

Model BR-1 Broadcast Model Kit covers 550 to 1600 Kc. Shipping Wt. 10 lbs.

\$19.50

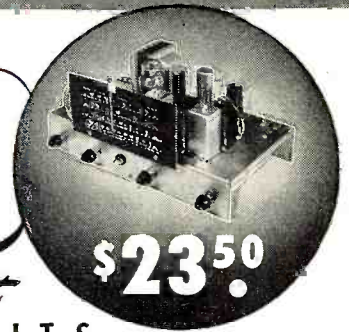

Model AR-1 3 Band Receiver Kit covers 550 Kc. to over 20 Mc. continuous. Extremely high sensitivity. Shipping Wt. 10 lbs.

\$23.50

TWO HIGH QUALITY *Heathkit* SUPERHETERODYNE RECEIVER KITS

Two excellent Heathkits. Ideal for schools, replacement of worn out receivers, amateur and custom installations.

Both are transformer operated quality units. The best of materials used throughout—six inch calibrated slide rule dial—quality power output transformers—dual iron core shielded. I.F. coils—metal cased filter condenser. The chassis has phono input jacks, 110 Volt output for phono motor and there is a phono-radio switch on panel. A large metal panel simplifying installation in used console cabinets is included. Comes complete with tubes and instruction manual incorporating pictorials and step-by-step instructions (less speaker and cabinet). The three band model has simple coil turret which is assembled separately for ease of construction.

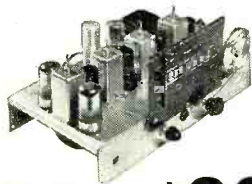

Model FM-2
Ship. Wt. 9 lbs.

\$22.50

TRUE FM FROM

Heathkit

FM TUNER KIT

The Heathkit FM Tuner Model FM-2 was designed for best tonal reproduction. The circuit incorporates the most desirable FM features—true FM.

Utilizes 8 tubes: 7E5 Oscillator, 6SH7 mixer, two 6SH7 IF amplifiers, 6SH7 limiter, two 7C4 diodes as discriminator, and 6X5 rectifier.

The instrument is transformer operated making it safe for connection to any type receiver or amplifier. Has ready wound and adjusted RF coils, and 2 stages of 10.7 Mc IF (including limiter). A calibrated six inch slide rule dial has vernier drive for easy tuning. All parts and complete construction manual furnished.



MAIL TO THE
HEATH COMPANY
BENTON HARBOR 15,
MICHIGAN

ORDER BLANK

From _____

SHIP VIA

- Parcel Post
 Express
 Freight
 Best Way

Quantity	Item	Price	Quantity	Item	Price
	Heathkit Oscilloscope Kit — Model O-7			Heathkit H.V. Probe Kit — No. 336	
	Heathkit VTVM Kit — Model V-5			Heathkit R.F. Signal Gen. Kit — Model SG-6	
	Heathkit FM Tuner Kit — FM-2			Heathkit Condenser Checker Kit — Model C-2	
	Heathkit Broadcast Receiver Kit — Model BR-1			Heathkit Handitester Kit — Model M-1	
	Heathkit Three Band Receiver Kit—Model AR-1			Heathkit Power Supply Kit — Model PS-1	
	Heathkit Amplifier Kit — Model A-4			Heathkit Resistance Decade Kit — Model RD-1	
	Heathkit Amplifier Kit — Model A-6 (or A-6A)			Heathkit Impedance Bridge Kit — Model IB-1B	
	Heathkit Tube Checker Kit — Model TC-1			Heathkit A.C. VTVM-KIT — Model AV-1	
	Heathkit Audio Generator Kit — Model AG-7			Heathkit Intermodul. Analyzer Kit—Model IM-1	
	Heathkit Battery Eliminator Kit — Model BE-2			Heathkit Audio Freq. Meter Kit — Model AF-1	
	Heathkit Electronic Switch Kit — Model S-2			Heathkit Square Wave Gen. Kit — Model SQ-1	
	Heathkit T.V. Alignment Gen. Kit — TS-2				
	Heathkit Signal Tracer Kit — Model T-2				
	Heathkit R.F. Probe Kit — No. 309				

On Parcel Post Orders, include postage for weight shown and insurance. (We insure all shipments.)

On Express Orders, do not include transportation charges—they will be collected by the Express Agency at time of delivery.

Enclosed find Check Money Order for _____

Please ship C.O.D Postage enclosed for _____ lbs.

ALL PRICES SUBJECT TO CHANGE WITHOUT NOTICE

EXPORT AGENT
ROCKE INTERNATIONAL CORP.
15 E. 40th St.
NEW YORK CITY (16)
CABLE: ARLAB-N.Y.

The **HEATH COMPANY**

... BENTON HARBOR 15, MICHIGAN

WINTER SAL PRICES SLASHED

Don't Buy Tubes until you get our prices.
Quantities Limited. Prices Subject to Change
Without Notice. Low Prices.

GLASS RADIO & TELEVISION TUBES

These prices apply only on orders for 12 or more tubes. Orders for less than 12, write for quotation.

1B3—\$.88	6BA6—\$.63	6X4—\$.48
1L4—.68	6BA7—.85	12AT6—.53
1R5—.70	6BE6—.63	12AT7—.99
1S5—.70	6BG6—1.18	12AU6—.88
1T4—.70	6BH6—.70	12AU7—.78
1U4—.68	6BQ6—1.10	12AX7—.85
1U5—.60	6CB6—.70	12BA6—.78
3Q4—.78	6CD6—1.65	12BE6—.62
3S4—.78	6C4—.66	198G6—1.78
3V4—.78	6S4—.72	19T8—.99
6AK5—1.38	6SD7—.98	25BQ6—1.10
6AL5—.68	6SK7—.70	25L6—.68
6AQ5—.68	6SN7—.78	35C5—.68
6AT6—.58	6T8—1.08	50C5—.68
6AU6—.68	6V6—.68	117Z3—.58
6AV6—.58	6W4—.64	50B5—.71

All Other Types at Vast Reductions

Westinghouse Kuprox Rectifier 0.64 Amp. 28 Volts Reg. \$11.00 ea. Special	\$1.95
TUBE SALES—247-30-27-33-31-56-57. No Mixed Ass't. 6 of Any Type	2.25
12 BRAND NEW 10" PHONO RECORDS—Ass't. Jazz—Popular. Please specify	\$1.79
Single Pole—10 Pos. 2 Gang Switch	29c
2 piece, 5 pole Male and Female separable Amphenol plugs. Both with Flex. shielded cables. Approx. 5 ft. long. 35c pair	3 pr. for \$1.00
Grind your own Crystals. Pure Brazilian Quartz. Various sizes and thicknesses. 1/2 lb. pkg.	\$1.00
4 Tube Drilled Chassis, 4 1/2"x6 1/2"x1 1/2". 29c each IN LOTS OF SIX	25c each
4 inch P.M. SPEAKER	\$1.50
5 in. 450 ohm Dynamic Speaker	\$1.35
Signal Corps Phones—2 M. Ohms (8 M. Ohms Imp.)	\$1.25
2 Ft. Ext. Cord (and Plug)	40c
2 MFD—1000 V Upright Bottom Lug Oil Cond.	89c

TOBE TUBULAR ELECTROLYTICS

20-20 MFD. 150 V. .49c	30-30 MFD. 150 V. .57c
40-40 MFD. 150 V. .59c	

Low-Loss Short Wave Lock Type Air Trimmer Variable Condensers

3 Pl.—20Mmfd.14c	3 GANG T.R.F. VARIABLE CONDENSER S .000365 Con. 65c
7 Pl.—25-30 Mmfd.15c	D.P.D.T. SLIDE TOGGLE SWITCH15c
8 Pl.—30-35 Mmfd.15c	
14 Pl.—56 Mmfd.24c	

4 PR. WAFER SOCKETS—\$1.49 per C. each	.3c
5-6 PRONG WAFER SOCKETS	\$2.50 per C
100 ASST. SOCKETS—4-5-6-7	\$3.50 per C
1 000 OHM WIRE WOUND POTENTIOMETER	15c
30 HV-FILTER CHOKES SHIELDED	3 for \$1.25
UNSHIELDED	3 for 1.00
2 000 ohm Wire Wound Rheostats	.51 per doz.
CARTER WIRE WOUND C.T. VARIABLE	20 OHM RESISTORS .85c per doz.

PIEZO CRYSTAL HOLDERS

12 for \$1.00—\$5.00 per hundred—\$50.00 per 1,000

RCA Band Switches—3 gang, 3 pos. 3 band. 30c 6 gang. 4 pos. 4-5 band. 40c	
Trimmer-Padder Asst.—all isolantite—singles, dual-triples—100 asst. pieces.	\$2.25
Philco push button Rotary Switch Double Pole	35c

ATTENTION: Prospectors, Explorers for Hidden Treasures! Construct a U.S. Army Type of Metallic Mine Detector Amplifier. Amplifier unit only (less tubes and batteries) with cables, headphone cord, and jack. Army wiring diagram. Type AN/PRS-1. \$1.95

RCA Ass't. Mica By-Pass Cond. .001. 100 for	.95c
8 or 9 Gang Push Button Switch	.49c

DRILLED CHASSIS FOR 5-6 tubes 5"x10"x1 1/2"	.25c
PHONE JACKS—OPEN & CLOSED AUTO	12c
EBY SPEAKER VOL. CONTROL—60 OHMS	15c
SALE—PHONO RECORD ALBUMS—12"—3 comp. 15c; 10"—3 comp.—15c; 4 comp. 20c; 12 comp. 65c	

6 Prong Amphenol Sockets	\$4.00 per C
--------------------------	--------------

AMERTRAN FILAMENT TRANSFORMER—6.3 V. 1 Amp. Encased Isolantite Terminal Posts \$1.50

VULCAN HEAVY DUTY 100 WATT SOLDERING IRON. Built for U.S.N.—Brand New—Equiv. sells for \$8.50. OUR PRICE \$2.99

AMERTRAN AUDIO OUTPUT XFORMER—Pri. 10,000 @ 15 MA; Sec. 300, 6-1 Ratio \$1.49

AMERTRAN MIXER AUDIO XFORMER—Pri. 600-10,000 Ohms \$1.00

156-1 RATIO VERNIER DIALS—4 in. 3/8 in. Hub. 35c

LINE VOLTAGE NOISE ELIMINATOR—Plugs in Between Radio and Elec. Socket. 35c

HEARING AID CORDS—Assortment of 12 for \$1.00

BY-PASS COND. ASST.—25 Cans. Bake., Paper, etc. \$1.00

MINIMUM ORDER \$3.00—NO C.O.D. SHIPMENTS—PLEASE INCLUDE POSTAGE

**NEWARK
SURPLUS MATERIALS CO.**
Dep't. MA
324 Plane Street NEWARK 1, N. J.

CHECK THAT PICTURE TUBE

By

F. C. KROEGER

**Details on a simple adapter that can be used
in conjunction with your regular tube tester.**

ONE of the most useful and handy devices for the TV technician is a means for checking the picture tube. TV has been in our community two and a half years and we are beginning to have an increasing number of kinescope replacements due to length of service as well as the seemingly early failure of the rectangular types. These faults may often appear as trouble in some other section of the receiver and after wasting time in a vain attempt to repair the set CRT substitution is resorted to in a last effort. Remember, as a service technician your time is your most precious commodity. It must be utilized intelligently if you are to realize your maximum profit.

Kinescope troubles may be divided into the following categories: burned out filaments and defective picture screen are both visible to the eye when the set is in operation; shorts and leakage, defects in the electron gun may often be found with an ohmmeter, but most likely are only present when the cathode is heated. The most difficult trouble to spot without a kinescope checker is, of course, low emission. If this is suspected and you have no checker your only recourse is tube substitution. There are now several excellent makes of checkers on the market, but by using a special adapter, I have found that my conventional tube checker will give equal results. Not only has this spared me the expense of a separate CRT checker, but also eliminates one more item to be carried in the car or truck. This adapter will work, not only with our conventional magnetic type tubes, but also with the new electrostatic focus tubes such as the 17FP4. However, no attempt has been made to check electrostatic deflection tubes, as we have found that customers are no longer interested in repairing this type set when it involves a major expenditure.

Because anode current is so very low and the meter in the conventional tube checker (we use a *Hickok*) is one ma. or more it is necessary to use an external meter with a sensitive 150 to 200 microampere movement. The schematic of this adapter is self-explanatory. I use an octal plug hooked to a regular kinescope socket with a 150 microampere meter in series with the accelerating anode lead. The switch is used for checking the new type electrostatic focus tubes for shorts and to protect the meter during short tests. When the switch is in

"quality" position, pin 6 of the picture tube socket is connected to pin 10. I selected the 6SK7 setting of my tube checker to provide the necessary voltages to the picture tube socket. The operation of the adapter is quite simple.

First, set your tube checker for a 6SK7 with the "bias" setting (*Hickok* only) on 35, "English" on zero, and the "micromhos" switch control to "English". The bias for a 50 degree deflection type tube must be set at 25 instead of 35. Then, without removing tube from chassis, connect the tube to the checker through the adapter. The adapter switch should be on "short test". Allow a reasonable warm up period, then check for shorts. If there are none, throw the adapter switch and check for anode current. I usually remove the ion trap because we have found that if it is improperly set, readings are often false. The anode current of a new tube should be 100 microamperes plus or minus ten per cent. A tube is still usable from 40 to 60 microamperes. You may set up your own standard of good, bad, and doubtful by taking readings on sets going through your own shop. Be sure your filament switch is at 6.3 volts and not left on 35 or 50 volts from checking an a.c.-d.c. blooper.

This adapter is quite simple to make and will repay you many times for the slight effort necessary. While this one was used for my own particular make of tube checker it may be used with any other that checks the individual tube elements. Good luck and faster servicing!

Wiring diagram of the simple adapter used with a tube tester to check the kinescopes.

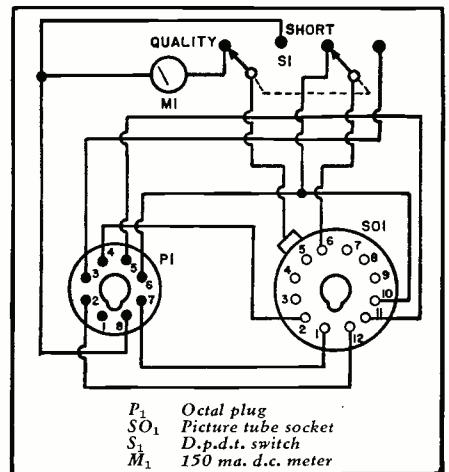

Here's your Opportunity

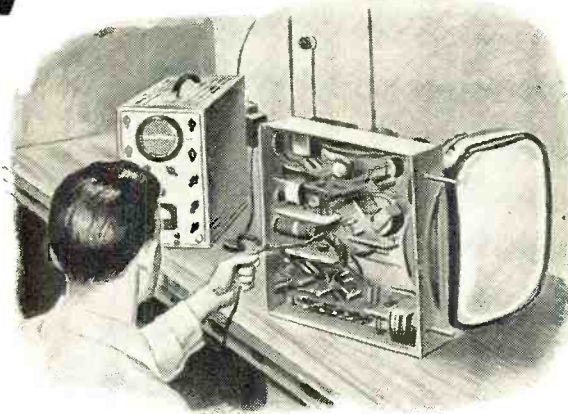

to prepare for a good job or a business of your own in TV SERVICING

There are today more good jobs open in TV Servicing than there are trained and experienced men to fill them. Yes, thousands of opportunities exist now for good-pay jobs offering employment security for years and years to come. Thousands of TV Servicing jobs are going begging. Do you want one of them?

Experts agree, that because of the critical shortage of trained and experienced TV Servicemen, and the tremendous future growth of the industry, no vocational field today offers more opportunities than TV Servicing.

The Big New Industry with a Great Future

Television is just in the beginning stages of its big industrial boom. Look at these amazing facts:

- Lifting the freeze on new TV stations will open many new TV areas and will improve the coverage of existing areas. The result will be an enormous demand for TV receivers.

- Within a few years over 1000 TV stations will be telecasting compared with 108 TV stations now on the air.
- Nearly one-half of all families living within the present TV areas do not yet own TV receivers.
- The new trans-continental video network plus better and more interesting programs plus larger viewing screens and color TV will increase the installation of new receivers, will induce present owners of 12-inch and smaller size viewing screens to buy newer model receivers.
- The power increases of many existing stations and improved reception range of current receivers will result in receivers being installed and serviced in the fringe areas of present stations.
- Under the FCC proposal, over 70 per cent of all communities will be served by UHF channels exclusively. This means TV servicemen must know UHF receivers before the new UHF stations in their area are opened.

- No one yet knows how great the industrial TV market will be.

RCA Institutes Home Study Course prepares you for a Career in TV Servicing

The addition of the RCA Institutes TV Service Training to your present radio-electronics experience will qualify you to step out and grasp the golden opportunities that now exist in television—America's fastest growing industry.

Learn at home—in your spare time—while you study the practical *how-to-do-it* techniques with *how-it-works* information. Easy-to-read and easy-to-understand lessons under the supervision of RCA engineers and experienced instructors quickly train you to qualify for the many good jobs now waiting for trained TV servicemen. Don't pass up this lifetime opportunity for financial security and a bright future in TV. Learn TV Servicing from RCA—pioneers and leaders in radio, television and electronic developments.

RCA Institutes conducts a resident school in New York City offering day and evening courses in Radio and TV Servicing, Radio Code and Radio Operating, Radio Broadcasting, Advanced Technology. Write for free catalog on resident courses.



RCA INSTITUTE, INC.
A SERVICE OF RADIO CORPORATION of AMERICA
350 WEST FOURTH STREET, NEW YORK 14, N.Y.

Send for FREE BOOKLET

Mail the coupon—today. Get complete information on the RCA INSTITUTES Home Study Course in Television Servicing. Booklet gives you a general outline of the course by units. See how this practical home study course trains you quickly, easily. Mail coupon in envelope or paste on postal card.

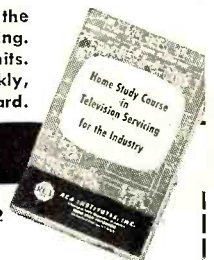

MAIL COUPON NOW!

RCA INSTITUTES, INC., Home Study Department RN-352
350 West Fourth Street, New York 14, N. Y.

Without obligation on my part, please send me copy of booklet "RCA INSTITUTES Home Study Course in TELEVISION SERVICING." (No salesman will call.)

Name _____ (Please print)
Address _____
City _____ Zone _____ State _____

COMPLETE TV CONICAL ANTENNA KIT

Nothing More to Buy

STOCK NO. AU-67

\$16.99

Latest model Genuine Aircraft Aluminum Tubing. Everything you need to erect a high gain 20 element (two-bay) antenna. Here's what you get: 1 stacked deluxe 20 element approved twinline lightning arrester; 1 steel chimney mounting assembly with necessary strapping; 75-ft. 300 ohm twinline; 6 insulated screw-eye standoffs; and 2 insulated mast support insulators.

The antenna has a conical pattern providing high gain on ALL channels. All the necessary installation parts are packed with the antenna. Here's the economical way to buy. Have everything at hand for that installation. Order these kits NOW. This is real Olson Value. Shpg. wt. 25 lbs.

STACKED CONICALS FULL ELEMENT

20 ELEMENT

IN LOTS OF 3, EACH \$7.99

With matching Q bars and high frequency stubs Genuine Aircraft Aluminum elements. High gain stacked conical. Will pull in those stations in "Fringe Areas." Works on all channels. Easily assembled.

THIS IS A TERRIFIC VALUE!

Each antenna consists of two conical bays plus a pair of matching Q bars. These mast sections are packed in a carton. This gives you six bays and 3 matching Q bars. Sold Only in Boxes of 3 Antennas

AU-66. col. Shpg. wt. 9 lbs. \$14.50

Carton Weight 25 lbs. **\$23.97**

TWIN LINE

300 Ohm Poly Twinline High quality, low loss. For all TV and FM installations. Shpg. wt. 2 lbs.

Stock No. W-73. 100 ft. coil. **\$1.99**

Lots of 10, ea. \$2.99

OPEN WIRE TV LINE

Use in Place of 300 Ohm Line

Ideal for fringe area installations. Not affected by moisture or sun. Made of 18 copperweld wire with genuine polystyrene insulators spaced 3" apart. Tensile strength 400 lbs.

Stock No. 1U-78. 100 ft. coil. Shpg. wt. 4 lbs. \$5.95

Stock No. W-79. 250 ft. coil. Shpg. wt. 9 lbs. \$14.50

OLSON SMASHES KINESCOPE PRICES!

Every Tube Brand New and Guaranteed

16GP4A	Round, Dark Face, Metal Envelope. Retail Price \$51.00.	\$24.95
17B4PA	Rectangular, Dark Face, Glass Envelope. Retail Price \$37.50.	19.95
19AP4B	Round, Etched Dark Face, Metal Env. Retail Price \$32.00.	29.95
20CP4	Rectangular Dark Face, Glass Envelope. Retail Price \$59.00.	29.95

here for a long time. We had to make one promise when we bought this deal. We promised not to advertise the manufacturer's name. However every tube is in the original carton and bears the manufacturer's name.

Build a Receiver Set of Basic Components

Kit of 5 parts AS-38 \$1.89

You get this kit of 5 basic parts to build an AC-DC set or portable:

Parts	Reg. List Price
Loop	\$0.95
R. F. Coil	1.10
I.F. Transformer (456 KC)	1.80
Output	1.75
Oscillator Coil	.75
List Price of Set	6.00

Use any 365 mfd variable for tuning. Covers 535-1625 KC.

PRESTO—Call Intercom

The Modern Electronic Communication System

Now talk with anyone, anywhere at the mere flick of a button! All electric master station and sub-station give clear, powerful voice reproduction to rooms or other buildings up to 1000 ft. away. Thousands have been sold for use in restaurants, on farms, in offices, stockrooms, factories and in homes. Just plug master station into any 110 V AC electrical outlet—connect 3 wires and you're operating. Modern design. Each unit measures 4 1/2 x 4 1/2 x 5 1/2. Equipped with rubber feet and easy slide switches. Handsome appearance—gray crackle finish. High amplification—use 3 tubes. Power output 2 1/2 watts. Regular list price is \$37.50. You get the master station, substation and 50 ft. of 3 conductor cable. Complete with tubes. Shpg. wt. 8 lbs.

Stock No. RA-86. Olson Special Price for Master Station, Substation and 50 ft. of cable only **\$19.83**

IT'S OLSON FOR SPEAKERS

Don't hesitate—here's that opportunity to buy quality speakers at less than jobbers' cost. Again Olson was Johnny-on-the-spot. We had the cash and made the deal. Now you can get your share of the Olson's savings.

Stock No.	Size	Shpg. Wt.	Price	Ing.
S-4	4"	2 lb	\$1.69	Allare
S-5	5"	2 lb	1.79	PM
S-7	6"	3 lb	2.29	w/1h
S-96	7"	3 lb	3.39	8.2
S-123	8"	5 lb	2.99	0 m m
S-167	10"	5 lb	3.95	voice
S-167	12"	7 lb	4.95	coils.

DO YOU LIVE IN A TV FRINGE AREA?

- Amazing manufacturer's close-out
- Regular retail price \$32.50

Model No. 107—Complete with tubes. Ready to work. Not a kit. **\$10.95**

Continuous tuning for TV and FM through all channels. Coils wound with PURE SILVER wire. Improves TV reception and reduces noise and "snow." Housed in beautiful plastic case 5 1/2 x 7 1/2 x 3 1/2. Tube is 6J6 push-pull triode amplifier. Operates on 115 volts. In original factory sealed carton. Shpg. wt. 5 lbs.

CLOSE-OUT

Special close-out price while they last

★ 12" Wide Range Co-Axial Speaker

★ 40 to 17,500 CPS Response

Stock No. S-160

\$10.95

MAKE WAY FOR NEW MODEL. Closing out reg. \$32.50 retail hi-fi, 20 watts speaker. Thousands sold at \$13.95. This is the same type of speaker you will find in \$300.00 combination radios. Each speaker consists of a 12" woofer section driven by a heavy 2 lb. magnet and this part delivers the bass notes. The 3" tweeter speaker is built into the center of the speaker and is driven by a 2.15 oz. Alnico 5 magnet delivering the treble notes. High pass filter is built into speaker and entire combination gives tones you never dreamed possible. Only two wires to connect to any radio or amplifier and speaker is ready to play. Voice coil impedance is 8 ohms. Shpg. wt. 10 lbs.

PHONO CARTRIDGES

Take your pick of these two types of cartridges. . . . Astatic flip over crystal and General Electric dual. Variable Reluctance magnet. Both are bargains. Get yours while they last.

Astatic LQD Turnover Model

Popular "turnover" Type crystal cartridge for 33 1/3, 45 and 78 RPM discs. Excellent frequency response. 50-7000 cycles. Equipped with 2 precious tip needles which are removable. Stamped aluminum housing with needle guards, mounting bracket and turnover knob. Reg. list price is \$10.00.

Stock No. XC-46. Single, ea. **\$3.98**

Lots of 10 \$3.50 ea.

G-E Magnetic Cartridges Triple Play—RPX-050

Variable reluctance cartridge that plays all records. Equipped with baton style dual sapphire-tipped needle .001" tip for 33 1/3 and 45 RPM. Also .003" tip for 78 RPM. Requires pre-amplifier. Not affected by humidity and high temperatures. Supplied with knob to fit most tone arms. Complete with dual needle. Reg. list price \$13.95.

Stock No. KC-47. **\$5.99** each

BUILD YOUR OWN VIBRATOR POWER SUPPLY

Build your own vibrator power supply and get 150 volts DC from any 6 volt storage battery. Use it to furnish "B" power for portable radios, aircraft and marine receivers. Ideal for experiments. No tube needed. In this kit you get:

- 1 Mallory Type 45 Sync. Vibrator
- 1 Power Transformer

These are the main components. A simple diagram is included so you can build the supply easily in less than half an hour. The Mallory vibrator fits a standard 5 prong socket and the can measures 1 1/2 x 3/4". This is the same as Mallory number 245. The transformer is fully shielded and measures 1 3/4 x 1 3/4 x 2". The genuine Mallory vibrator lists at \$7.70 and the transformer at \$3.00. Shpg. wt. 3 lbs.

Stock No. X-272—You get both for only **\$1.49**

BIG VALUES AT OLSON'S

Stock No.	Description	Olson's Price
T-80	TV Focus Coil. Replaces RCA 202D1. For magnetically deflected 55" kinescopes.	\$179
T-90	TV Focus Coil, EM-PM Type. Used on 16"-70" and 19"-66" kinescopes.	\$298
T-91	Ion Trap with 2 powerful Alnico 5 magnets. Bronze clamp keeps it firm.	.98
X-263	Ion Trap single magnet type. Most popular in use. Order plenty.	.49
T-94	GE Type Universal Flyback Trans. similar RTO-085. 77J1 for all 65"-70" kinescopes. Ferrite core supplies 14,000 volts. Single ea. \$3.99. Lots of 3, each.	\$3.49
T-93	70" TV Yoke. Similar to RCA 209D1. Use on kinescopes up to 19" single ea. \$3.49. Lots of 3, each.	\$2.99
T-82	55" TV Flyback Trans. Similar to RCA 211T1. For all 10" and 12" kinescopes. Single ea. \$2.99. Lots of 3, each.	\$1.99
T-84	55" TV Yoke. Similar to RCA 205D1. For 10", 12" and 16" kinescopes. Single ea. \$2.79. Lots of 3, each.	\$1.99
C-256	500 MMFD 10KV Ceramic TV Condenser. With threaded terminals. Single ea. 79c. Lots of 10, each.	.49
C-399	500 MMFD 20KV Ceramic TV Condenser with threaded terminals, single. Lots of 10, each.	.85
R-14	TV Carbonfilm Resistor. 2 meg. For practically all TV sets.	.59
W-75	TV Anode Connector. Phosphor Bronze plug, rubber shield and polyethylene cord	.49
X-197	JFD Lightning Arrestor. UL approved. For all 300 ohm TV lines.	\$1.32
X-207	TV Antenna Chimney Mount. Attaches to chimney. Takes mast 3/8" to 1 1/2" diam.	\$1.79
X-165	Recording Wire. Stainless Steel. Excellent frequency response, 1/2 hr. spool.	\$1.98
X-166	Recording Wire. Stainless Steel. Excellent frequency response, 1 hr. spool.	\$2.98
Y-41	Recording Discs. 6" size Aluminum base, smooth coating. Pkg. of 5 discs.	\$1.20
Y-42	Recording Discs. 8" size Aluminum base, smooth coating. Pkg. of 5 discs.	\$1.50
Y-43	Recording Discs. 10" size Aluminum base, smooth coating. Pkg. of 5 discs.	\$2.40
W-53	AC Lamp Cord. Zips apart. 2 conductor copper tough insulation. 250' spool.	\$4.99
K-14	Speaker Baffle. For 5" and 6" speakers. Sloping front. Fine walnut finish.	\$3.45
K-15	Speaker Baffle. For 8" speakers. Sloping front. Fine walnut finish.	\$3.95
K-16	Speaker Baffle. For 10" speakers. Sloping front. Fine walnut finish.	\$4.45
K-17	Speaker Baffle. For 12" speakers. Sloping front. Fine walnut finish.	\$5.45
AS-44	Volume Control Kit. Contains 10 popular single, dual controls. Many with switch.	\$2.99
AS-45	Condenser Kit. Contains between 40 and 50 electrolytic and By-pass condenser.	\$3.95
X-191	Service Call Tags. 3 sections, claim check. Identity, Billing, with wires. Per 100.	\$1.19

INDISPENSABLE—Sam's Photofact Books

Photofact Television Course. Covers TV principles, operation and practice. 210 pages; profusely illustrated; 8 1/2 x 11". Order TV-1. . . . Only **\$3.00**

Television Antennas. New 2nd edition. Describes all TV antenna types; tells how to select, install, solve troubles. Saves time; helps you earn more. 200 pages; illustrated. Order TAG-1. . . . Only **\$2.00**

Television Tube Location Guide, Volume 2. Accurate diagrams show position and function of all tubes in hundreds of TV sets; helps you diagnose trouble without removing chassis. 224 pages; pocket-size. Order TGL-2. . . . Only **\$2.00**

Television Tube Location Guide, Vol. 3. Over 200 pages of TV receiver tube position diagrams on hundreds of models. Order TGL-1. . . . Only **\$1.50**

1949-1950 Record Changer Manual, Vol. 3. Covers 44 models made in 1949, including multi-speed changers and wire and tape recorders. Original data based on actual analysis of equipment. 286 pages; 8 1/2 x 11"; paper-bound. Order CM-3. . . . Only **\$3.00**

1948-1949 Changer Manual, Vol. 2. Covers 45 models made in 1948-49. Paper bound. Order CM-2. . . . Only **\$4.95**

1947-1948 Changer Manual, Vol. 1. Covers 40 post-war models up to 1948. Order CM-1. . . . Only **\$3.95**

Audio Amplifiers, Vol. 3. Clear, uniform, accurate data on 50 important audio amplifiers, plus full coverage of 22FM and AM tuners, produced during 1950. 362 pages, 8 1/2 x 11". Order AA-3. . . . Only **\$3.95**

Audio Amplifiers, Vol. 2. A complete analysis of 104 well-known audio amplifiers and 12 tuners made 1949-50. 368 pages, 8 1/2 x 11". Order AA-2. . . . Only **\$3.95**

Audio Amplifiers, Vol. 1. 102 amplifiers and FM tuners made through 1948. 352 p. Order AA-1. . . . Only **\$3.95**

Auto Radio Manual. Complete service data on more than 100 post-war auto radio models. Covers over 24 mfrs. 350 pages, 8 1/2 x 11". Order AR-1. . . . Only **\$4.95**

Radio Receiver Tube Placement Guide. Accurate diagrams show where to replace each tube in 5000 radio models, covering 1938-1947 receivers. 192 pages, pocket-size. Order TP-1. . . . Only **\$1.25**

Dial Cord Strapping Guide, Vol. 2. Covers receivers made from 1947 through 1949. Shows you the one right way to string a dial cord in thousands of models. Pocket-size. Order DC-2. . . . Only **\$1.00**

Dial Cord Guide, Vol. 1. Covers sets produced 1938 through 1946. Order DC-1. . . . Only **\$1.00**

LOW FACTORY PRICES

Sensationally New For 1952!
MIDWEST Television
 and
5 Wave Band RADIOS



EASY TERMS

20-INCH
 Rectangular
 PICTURE

Beautiful console and complete chassis for easy installation in your own cabinet.

30 DAYS TRIAL - FACTORY-TO-YOU
WE PAY TRANSPORTATION CHARGES.

Special Bonus Gift!
Illuminated TELEVISION CLOCK
 Given With Every Purchase of a **MIDWEST RADIO or TELEVISION**
LIMITED TIME ONLY!



Phone For **FREE 1952 MIDWEST CATALOG**
 IN NEW YORK Murray Hill 2-5810 IN CHICAGO State 2-5600
 IN CLEVELAND Prospect 1-7450 IN PITTSBURGH Grant 1-0609
 IN DETROIT Woodward 3-1233 IN ST. LOUIS Grand 1161
 IN PHILADELPHIA Locust 4-1035 ... or send coupon below

SEND THIS COUPON TO: **MIDWEST RADIO & TELEVISION CORP.**
 Dept. 378 909 Broadway, Cincinnati 2, Ohio

For **FREE** NAME _____
MIDWEST ADDRESS _____
1952 Catalog CITY _____ ZONE _____ STATE _____

GROUND RADIO OPERATORS AND RADIO TECHNICIANS
TRANS WORLD AIRLINES

First or Second phone license required. Ground Radio Operators, able type 35 words per minute, needed several domestic stations. Radio Technicians needed Kansas City Base and should have two years experience radio repair. Write RTN-TWA, Employment Manager, Kansas City 6, Missouri.

THIS AD MAY BE SMALL—BUT IT CAN MEAN B-I-G MONEY TO YOU!

I want to buy BC-348, BC-342, BC-312, ARC-1, ART-13, BC-221 or any parts thereof, no matter how small. In fact, I'll buy anything. I'm not kidding! Let me prove it!

Wire or write: **ROBERT SANETT**
 4668 Dockweiler, Los Angeles, Calif.
 Telephone: YOrk 4637

Within the Industry

(Continued from page 26)

Starrett Television Corporation of New York. He was formerly special consultant to the company's board of directors in the fields of procurement and finance . . . **WILLIAM W. TAYLOR** is the new sales promotion manager of the Capacitor Division of *Sangamo Electric Company*. He will make his headquarters at the Marion, Illinois, plant of the firm . . . **MANFRED E. PHILIP** has been appointed controller and director of purchases for *Telrex, Inc.* . . . **MARTIN F. SHEA**, veteran *Philco* employee, has been named vice-president of the Auto-Radio Division in charge of car radio manufacturing sales and head of the company's Detroit operation . . . **DAVID S. RAU** has been elected vice-president and chief engineer of *RCA Communications, Inc.*, while **C. W. LATIMER**, formerly vice-president in charge of engineering, has been named vice-president and chief technical consultant of the firm . . . **S. I. NEIMAN** has been named executive secretary of *Radar-Radio Industries of Chicago, Inc.*, while **KENNETH C. PRINCE** has been retained as general counsel of the trade group . . . **EDWARD A. ROPPEL**, quality control engineer at *Packard-Bell Company*, has assumed his new post of supervisor of government production . . . **MARVIN L. BRUCKNER** has been named assistant sales manager of the jobber division for *Quam Nichols Co.*, Chicago speaker and electronics manufacturer.

* * *

ALBERT COUMONT has been appointed service manager of the Radio-Television Manufacturers Association, succeeding E. W. Merriam who held the post previously on a temporary basis. Mr. Coumont was formerly sales manager, Electronics Section, *Internation-*

tional General Electric Co., Inc. and prior to that gained wide experience in his own service business and in the service divisions of various manufacturers.

He will make his headquarters at the new RTMA offices, 777 14th St., Washington 5, D. C.

* * *

DOUGLAS Y. SMITH, veteran of nearly a quarter-century of service in the engineering, merchandising, and sales activities of *RCA*, has been promoted to the post of manager of sales operations for the Tube Department of *Radio Corporation of America*.



Earl M. Wood, for the past 10 years manager of manufacturing at the Tube Department's Lancaster, Pa., plant, will succeed Mr. Smith as plant manager in Lancaster.

In his new post Mr. Smith will be responsible for the coordination of the department's renewal and equipment sales activities and of the tube parts and machinery sales.

He joined the company as a tube design engineer in 1930, shortly after his graduation from Cooper Union College.

-50-

NEATER DRILLING

By MORRIS DORSEY

NEATER, quicker drilling of aluminum, metal, and plastic can be accomplished by placing a small piece of cellophane tape over the spot to be drilled.

The tape seems to provide a "bite" for the drill point and at the same time prevents the usual burrs which have to be reamed or filed out. In addition, the tape keeps the drill from slipping and marring an otherwise good-looking panel.

-50-

Largest Selling Booster

AT ANY PRICE !

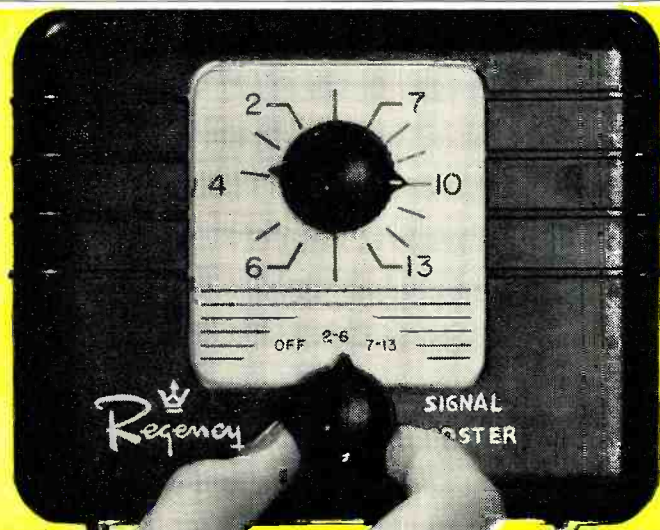

Regency

SPECIAL MOTORS

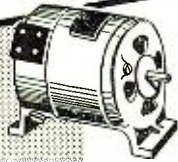

SELSYNS



DYNAMOTORS



POWER UNITS

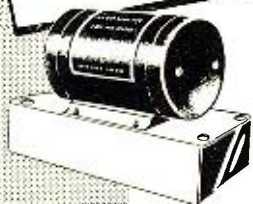

BLOWERS



WELLS
SALES, INC.

THIS EQUIPMENT IS THE FINEST AVAILABLE, BUILT BY LEADING MANUFACTURERS AND UNCONDITIONALLY GUARANTEED BY WELLS. MANY TYPES NOT LISTED ARE IN STOCK. SEND US YOUR REQUIREMENTS FOR IMMEDIATE QUOTATION.

MOTORS AND SELSYNS

MANUFACTURER	TYPE OR NO.	VOLTAGE	RPM	DIMENSIONS	SPECIAL INFORMATION
Stewart Warner	6VDC	2 1/4" x 3 3/4"	1/4" x 1/2" Lg. shaft
John Oster	B-9-2	12VDC 1.4A	5600	2 1/4" x 3 3/4"	1/4" x 1/2" Lg. shaft. Shunt Wd.
General Ind.	62800	13VDC 9A	6800	2 1/2" x 4"	1/4" x 3/4" Lg. shaft. 1/12 HP
Emerson	D-26-BT	24VDC 24A	100	2 1/4" x 3 1/4"	160 Ft.-Oz. torque
Redmond	7-N	24VDC .95A	6000	2 3/4" x 3 1/4"	Complete blower assembly
F. A. Smith	40H	115VAC 60 Cy	6" x 5 1/2" x 5"	100 CFM blower (\$12.95)
Western Elect.	FL	115VAC 400 Cy	6700	3 1/4" x 4" x 4 1/2"	25 CFM blower
Signal Elect.	D-4272	24VDC .66A	2100	2 1/4" x 2 7/8"	1/4" x 1" shaft. 1/190 HP
Stromberg	D-4436	24VDC .45A	2 1/2" x 3 1/8"	1/4" x 3/4" shaft. .003 HP
Amglo	24VDC	1 1/2" x 2 1/2"	Telephone ringing circuit motor
John Oster	A-16B-26R	26VDC	1 1/2" x 1 1/2"	3/8" x 5/8" shaft. Series Rev.
John Oster	DEST-8-1R	27VDC 1.4A	3800	2 1/4" x 3 1/2"	3/8" x 3/4" shaft. 1/40 HP
Delco	5069267	27.5VDC .25A	6000	1 1/2" x 1 1/2"	1/4" x 1 1/2" shaft. 1 1/2 Oz.-In Tq.
Western Elect.	KS5996-L04	28VDC	2" x 2 7/8"	3/16" x 1 1/2" shaft. Series Rev.
Bendix	M05B	28VDC 1.75A	3200	1 1/2" x 1 1/2"	1/4" x 1 1/2" shaft. Series Rev.
Bendix	E-11500-1	28VDC 1A	9000	1 1/2" x 1 1/2"	1/4" x 1 1/2" shaft. Series Rev.
Fractional Mtrs.	SH-280	28VDC 3.1A	3900	3 3/4" x 1 1/2"	1/4" x 3/8" shaft. Used in ART 13
Electrolux	20100	28VDC .1A	2" x 2 1/8"	3/8" x 3/8" shaft. 20 Deg. rotation
John Oster	A-21-E-12R	28VDC .4A	1 1/2" x 2 3/8"	3/16" x 3/8" shaft. Series Rev.
Emerson	D-26-BV	28VDC 3.1A	3900	2 1/2" x 1 1/2"	1/4" x 3/8" shaft. 1/20 HP
Electrolux	16876	28.5VDC 1.8A	2200	3 3/4" x 3"	1/4" x 1 3/4" shaft. 1/35 HP
General Elect.	2J1G1	57.5VAC 400 Cy	2 1/4" x 1 1/2"	Selsyn transmitter
General Elect.	5BN38HA10	80VDC .25A	3000	2 1/2" x 1 1/2"	1/4" x 3/4" lg. shaft
General Elect.	2J1F1	115VAC 400 Cy	2 1/4" x 3"	Selsyn generator
Diehl	11-1	110VAC 60 Cy	4" x 5 1/2"	Synchro repeater selsyn
Bendix	110VAC 60 Cy	3 3/4" x 5 1/2"	Synchro differential selsyn
Bendix	110VAC 60 Cy	3 3/4" x 5 1/2"	Synchro transmitter selsyn

DYNAMOTORS AND POWER UNITS

MANUFACTURER	TYPE OR NO.	INPUT	OUTPUT	DIA.	LGTH.	SPECIAL INFORMATION
Eicor	ML3415-254	27.5VDC 1.5A	250VDC .060A	4"	8 3/8"	With bracket mounting
Eicor	ML3412-42	13.8VDC 2.45A	220VDC .070A	3 3/8"	5 1/2"	No mounting
Western Elect.	DM53AZ	14VDC 2.8A	220VDC .080A	2 3/4"	4 1/2"	With base plate
Westinghouse	1171187A	27VDC 1.4A	285VDC .060A	2 1/2"	4 1/2"	No mounting
General Elect.	5DY82AB52	27VDC 1.5A	285VDC .060A	2 1/2"	4 1/2"	No mounting
Western Elect.	1171091B	27VDC 1.6A	285VDC .075A	2 3/4"	4 1/2"	No mounting
Redmond	5047	27VDC 1.75A	285VDC .075A	2 3/4"	4 1/2"	No mounting
Eicor	ML3415-254	27.5VDC 1.5A	100VDC .150A	3 1/2"	5 1/2"	With base plate
Eicor	ML3420-194	27.5VDC 4.0A	325VDC .200A	3 3/8"	6 1/2"	With base plate
C.Q.R.	355D2BA	27.9VDC 1.25A	220VDC .070A	3 3/8"	5 1/2"	No mounting
Continental	DM310A	28VDC .5A	100VDC .01A	2 3/4"	4 1/2"	No mounting
C.A.Y.	DM32A	28VDC 1.1A	250VDC .060A	2 3/4"	4 1/2"	With base plate
Pioneer	PE86M	28VDC 1.25A	250VDC .060A	2 3/4"	4 1/2"	With base and filter
Bendix	DA-1A	28VDC 1.6A	230VDC .100A	3 3/8"	5 1/2"	No mounting
Redmond	DM5 3A	28VDC 1.4A	220VDC .080A	2 3/4"	4 1/2"	With base plate
Redmond	5056	28VDC 1.4A	250VDC .060A	2 3/4"	4 1/2"	With base plate
Eicor	ML-3420-90	28VDC 3.3A	400VDC .125 A	3 1/2"	6 1/2"	With base plate
Continental	DM33A	28VDC 5A	575VDC .160A	3 1/2"	7 1/2"	Cont. duty. No mounting
Winco	41S6	13VDC 13A	250VDC .060A	4 1/2"	8 3/8"	With base plate
		13VDC	300VDC .225A	Intermittent
Continental	DMX310A	12VDC 2.8A	150VDC .100A	2 3/4"	4 1/2"	Cont. Duty. No mounting
				DIMENSIONS		
Pioneer	PE 55	12VDC .16A	500VDC 0.2A Cont.	7 1/4" x 12 1/2" x 13 1/2"		Pwr. Unit W/DM 19G DYN, Filter and Mounting
Westinghouse	PE 94C	28VDC 10.5A	300VDC .260A 150VDC .010A 14.5VDC 10A	8 1/2" x 6 1/2" x 12 1/2"		Pwr. Unit W/DA3A DYN, Filter and Mounting

ADEL CLAMPS—LARGE STOCK—SEND US YOUR REQUIREMENTS

CHECK WELLS' HUGE STOCK FOR IMMEDIATE DELIVERY OF QUALITY COMPONENTS AT SUBSTANTIALLY LOWER COST

- Resistors • Condensers • Wire and Cable • Relays
- Co-ax Connectors • Rectifiers • Transformers • Chokes
- Micro Switches, Toggles • Antennas • Accessories
- Electronic Assemblies • Dial Light Assemblies

Seeley 8-4143

MANUFACTURERS AND DISTRIBUTORS: WRITE FOR CATALOG

ORDER DIRECT OR THROUGH YOUR LOCAL PARTS JOBBER

833 W. CHICAGO AVE., DEPT. R CHICAGO 22, ILL.

Dual-Channel Receiver

(Continued from page 67)

ned to the chassis which is tied to the separate electrical ground at some point. Instability or regeneration often shows up in the form of distorted audio and critical tuning. The previously mentioned procedure of shunting the tuned circuits with resistances of from 50,000 ohms to .5 megohm often tends to reduce these effects, but likewise lowers the gain of the system and makes tuning broader.

It is usually considered that high selectivity means lower noise in reception. There seems to be at least one possible exception to this, however, as far as AM reception is concerned. Noise, consisting of single pulses, will tend to shock excite tuned circuits, producing a damped wave train of a duration depending upon the "Q" of the circuit. A rough relationship appears to be that a coil with a "Q" of ten will ring for ten cycles before the amplitude level drops to one-tenth of its initial value. As a result, the "hangover" produced by highly selective tuned circuits may cause noise impulses, when detected, to fall well within the audio range, while in the case of low "Q," broadly tuned circuits the resultant noise may fall largely in the ultrasonic range and is therefore not as objectionable even though of considerably greater amplitude than would be the case with a highly selective system. Consequently, the author prefers relatively low "Q" input circuits as a means of reducing audible noise in the reception. In the tuner design shown this appeared to work very well, with background noise and hiss being reduced to a low level with the audio gain control fully open.

In conclusion, it seems that a dual channel tuner represents a good solution to the problem of enjoyable reception of amplitude modulated signals. It is simple both in design and construction and requires no elaborate equipment for alignment and adjustment.

-30-



RADIO & TELEVISION NEWS

NEW DYNAMIC

Dynaset*

BY TELEX

NEW UNDER-THE-CHIN
DYNAMIC HEADPHONE

MONOSET*

Original under chin headphone of high impedance. Magnetic.

Telex DYNASET*

Built for user comfort and top quality reception, the Telex Dynamic Dynaset is popular in both offices and Radio-TV studios because it provides clear reproduction of both speech and music. Its higher fidelity range brings more lows and highs to your ears making it especially desirable for all types of telecasting and radio monitoring. Secretaries appreciate its lightweight (1.25 oz.) and comfortable under-the-chin styling for office transcription use. Dynamic driver in plug makes anodized aluminum tone arms extremely lightweight.

EARSET*

Single-phone headset that slips onto the ear.

TWINSET*

CAA approved headset that rests lightly on sides of head. Nothing touches ear.

Write on your business letterhead for a complete TELEX Dynaset which will be sent to you on a 20-day Approval Plan.

TELEX hearing at its best

ELECTRO-ACOUSTIC DIV. • DEPT. E-16
TELEX PARK — ST. PAUL 1, MINN.
In Canada, Atlas Radio Corp., Toronto
STANDARD OF THE WORLD FOR QUALITY HEADSETS

*TRADEMARK

SELL **Jensen**
PHONO NEEDLES
For Any Type
Record Player

Please send me FREE Jenselector. Picks the proper replacement needle.

Name _____
Address _____
City _____ State _____

Jensen Industries, Inc., 336 S. Wood St., Chicago 12

EASY TO LEARN CODE

It is easy to learn or increase speed with an Instructograph Code Teacher. Affords the quickest and most practical method yet developed. For beginners or advanced students. Available tapes from beginner's alphabet to typical messages on all subjects. Speed range 5 to 40 WPM. Always ready—no QRM.



ENDORSED BY THOUSANDS!

The Instructograph Code Teacher literally takes the place of an operator-instructor and enables anyone to learn and master code without further assistance. Thousands of successful operators have "acquired the code" with the Instructograph System. Write today for convenient rental and purchase plans.

INSTRUCTOGRAPH COMPANY

4711 SHERIDAN ROAD, CHICAGO 40, ILLINOIS



*How far ahead can you be
next year . . .*

IN TV AND ELECTRONICS?

◀ **Send for this free CREI booklet today . . .
and find out!**

▶ **THIS BOOKLET** can mean the difference between small, w-i-d-e-l-y s-p-a-c-e-d salary increases—and rapid advancement. Between routine work—and challenging opportunity. Between constantly defending your job against better-trained men—and dynamic confidence. Between short-circuited hopes—and high-powered ambition.

An exciting new world has opened up with such super-speed that even the most optimistic electronic experts fall short in their predictions of expansion.

Think of the 1,500 TV stations within the next 5 years and the 2,500 stations within 10 years, as predicted by the Chairman of the FCC. Think of the 13,000,000 TV sets now in use. *Remember that we weren't supposed to reach that figure until 1954.* Think of the 100,000,000 radios in current operation. (95% of the nation's homes have one or more sets.) Think of the tremendous defense orders now being placed for electronic equipment and installations.

Think of the thousands of radio-equipped fire and police departments throughout the U.S. Of the many radio-equipped railroads, of the hundreds of cities with 2-way radio service for cars and cabs. Think of the wide-ranging field of aviation communications—radio-controlled aircraft, navigation-and-traffic control, airport stations.

Think of the maritime world with its navigational aids, fathometers, ship-to-shore and ship-to-ship communications and radar. Think of electronic heating, fax and ultra-fax, of electronic medicine, and all the other applications of electronic know-how.

Countless positions must be filled—in development, research, design, production, testing and inspection, manufacture, broadcasting, telecasting and servicing. Who will get those positions? You—if you prepare today—if you are alert and have the ambition to advance your knowledge. You—if you take 2 minutes to send for a free copy of "Your Future in the New World of Electronics."

This helpful book shows you how CREI Home Study leads the way to greater earnings through the inviting opportunities described above.

However, being an accredited technical school, CREI does not promise you a "bed-of-roses." You have to translate your willingness to learn into saleable technical

knowledge—via *study*. Since its founding in 1927, CREI has provided thousands of professional radiomen with technical educations. During World War II, CREI trained thousands for the Armed Services. Leading firms choose CREI courses for group training in electronics at company expense, among them United Air Lines, Canadian Broadcasting Corporation, Trans Canada Airlines, Sears Roebuck & Co., Bendix Products Division, All-American Cables and Radio, Inc., and RCA-Victor Division.

CREI courses are prepared by recognized experts, in a practical, easily-understood manner. You get the benefit of time-tested materials, under the personal supervision of a CREI Staff Instructor. This complete training is the reason why CREI graduates find their diplomas keys-to-success in Radio, TV and Electronics. CREI alumni hold top positions in America's leading firms.

At your service is the CREI Placement Bureau, which finds positions for students and graduates. Although CREI does not guarantee jobs, requests for personnel currently exceed supply by far.

Talk to men in the field and check up on CREI's high standing in electronics instruction. Determine for yourself right now that your earnings are going to rise with your knowledge—and that you get your rightful place in the Age of Electronics. All this CREI can promise you, provided you sincerely want to learn. Fill out the coupon and mail it today. We'll promptly send you your free copy of "Your Future in the New World of Electronics." The rest—the future—is up to you.

MAIL COUPON FOR FREE BOOKLET

CAPITOL RADIO ENGINEERING INSTITUTE

Dept. 113D, 16th & Park Rd., N.W., Washington 10, D. C.

Send booklet "Your Future in the New World of Electronics" and course outline.

CHECK TV, FM & Advanced AM Servicing Aeronautical Radio

FIELD OF Practical Television Engineering Engineering

GREATEST Broadcast Radio Engineering (AM, FM, TV)

INTEREST Practical Radio Engineering

Name

Street

City Zone State

If residence school in Wash., D. C., preferred, check here

IT'S HERE! McGee New 1952 Model 12 Inch Coaxial Speaker for \$12⁹⁵

BUY YOUR WIDE-RANGE COAXIAL SPEAKER AT McGEE



**NEW 1952 MODEL
12" COAXIAL P.M.**

\$12⁹⁵

**WHY PAY
MORE?**

McGee offers its new 1952 model 12" coaxial PM speaker. The finest that we have ever offered. Quality you would put in your finest sets if you were a manufacturer. Genuine Alnico V magnet 6.8 oz. in the 12" woofer. The tweeter is coaxially suspended inside the 12" and has a metal diffuser attached. The high pass filter is concealed under the pot cover, leaving only two wires to connect to your radio or audio amplifier. Why buy an ordinary speaker when you can have a 12" coaxial PM for only \$12.95? It works as well as the best and 10 watts average. Shipping weight 8 lbs. Response from 30 to 17,500 cps. McGee's finest speaker value. Stock No. CU-14Y. Sale price, \$12.55 each.

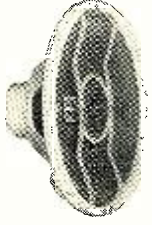

**15"
COAXIAL
P.M.
SPEAKER**

\$19⁹⁵

Only \$19.95 buys a full 15" 20 watt coaxial PM speaker, with built-in high pass filter. Hook to any 8 ohm output of radio or amplifier. Response below 20 to above 17,500 cps. Good bass response. A lucky purchase, price as low as possible. Full 32 oz. magnet in the woofer. 5" tweeter. Model P15-9. Ship. wt. 11 lbs. Sale price, \$19.95.

**HALLICRAFTERS S-78
11-TUBE FM-AM CHASSIS**

**ONLY \$89⁵⁰ WITH \$99⁵⁰
LESS SPEAKER 12" COAXIAL SPEAKER**

★ PUSH-PULL WIDE RANGE AUDIO

Hallcrafters S-78, 11-tube AM-FM radio receiver chassis, with push-pull 6K6 high fidelity audio system. A new model chassis for custom installation. Full range tone control, with bass boost. Input for automatic record changer. Output transformer has 8 ohm and 500 ohm connections. Chassis size, 12 3/4" x 10" x 7 3/4" high. Knobs and escutcheon plate are furnished. Receives standard broadcast and FM. 88 to 108 mc. Shipping weight, 25 lbs. Model S-78, priced less speaker at \$89.50 net.

S-78, 11-tube AM-FM chassis with our 12" coaxial PM speaker, both for \$99.50. S-78 with 15" coaxial PM speaker, both for \$107.95. If you want a record changer, see our special listing below. If changer with variable reluctance cartridge is desired, add \$8.95 for a pre-amplifier, as the S-78 is designed for use with a crystal pick-up.

DELUXE CAPEHART CABINET \$99.95

Beautiful, top quality, walnut combination radio-phono cabinet. 42" high, 42" wide and 22" deep. Made for Capehart's finest combination. Highly polished matched walnut panels. Cabinet top is 1 1/2" thick. This cabinet weighs approximately 180 lbs. Both the radio and changer compartments and speaker grill have hinged doors. Radio compartment on the right-hand side is 14" high and 11 1/2" wide. Made to mount chassis vertically. This changer compartment is 14" high and 26 1/2" wide. Large enough to hold any record changer or recorder mechanism. Front 10" of top over the changer compartment is hinged to fold back for easy access to the changer. Both radio and changer compartments come with uncut panels. Speaker baffle is cut for a 12" speaker and the compartment is completely enclosed. Shipping weight, 275 lbs. Stock No. K-275, Capehart combination cabinet. Net price, \$99.95.

ELECTRONIC RADIO and TV TUBES

• 6 MONTHS' GUARANTEE • INDIVIDUALLY CARTONED
• IN RED AND BLUE DELUXE VARNISHED CARTONS
• EVERY TUBE SET TESTED FOR YOUR PROTECTION

ORDER 50 ASSORTED—TAKE 10% OFF. Prices as Low as 39¢

024	\$.50	6AV6	\$.49	6SA7GT	\$.59	12BA7	\$.69
1H5GT	\$.59	6BA6	\$.59	6SK7	\$.59	12AX4	\$.69
1R5	\$.59	6BC5	\$.59	6SN7GT	\$.59	12AY7	\$.69
1U4	\$.59	6BG6G	1.29	6U8	\$.79	125K7	\$.59
1U5	\$.59	6BH6	\$.59	6V6GT	\$.59	12SQ7	\$.59
3A4	\$.69	6BJ6	\$.59	6W4GT	\$.59	25B8GT	\$.59
304	\$.69	6BQ6GT	\$.99	6X4	\$.49	25L6GT	\$.59
5U4C	\$.49	6C8A	\$.59	6X5GT	\$.49	35W4	\$.49
5Y3GT	\$.39	6C8B	\$.59	12AT6	\$.49	35W4	\$.49
6AB4	\$.69	6C6D6	1.50	12AT7	\$.69	35Z5GT	\$.49
6AK5	\$.99	6HE6T	\$.59	12AU7	\$.69	50B5	\$.59
6AL5	\$.79	6H6GT	\$.59	12AX7	\$.69	50B5	\$.59
6AQ5	\$.59	6L6G	\$.59	12AX7	\$.69	50L6GT	\$.49
6AT6	\$.49	654	\$.59	12BA6	\$.59	117Z3	\$.49
6AU6	\$.59						

3-SPEED CHANGERS ON SALE AT McGEE

WEBSTER CHICAGO 3-SPEED \$24⁹⁵
Regular \$47.50 List Only

Webster Chicago Model 100-16 3 speed automatic record changer with crystal cartridge and all speed Sapphire needles. (1 needle plays all records). Base size 12x12 3/4". Shipping weight 14 lbs. This offer good only as long as our stock lasts. A special purchase makes this offer possible. Webster Chicago 3 speed changer, Model 100-16. Sale price \$24.95.

WEBSTER CHICAGO MODEL 100-2 ONLY \$26.95

For the first time we offer the world famous Webster-Chicago, model 100-2. Features a newly designed spindle, that drops the records fast; air-cushioned to the turntable. Pickup arm sets down automatically after the last record plays. Plays all records automatically. 33 1/2 and 45 rpm. New balanced tone arm with Electro-Voice Tilt-A-Matic cartridge with dual needles. Ordinarily cost over \$37.00. McGee offers them for only \$26.95 each. Base size 12"x12 3/4". Shipping weight 14 lbs.

V.M. 3-SPEED MODEL 406 \$22.95

VM model 406, deluxe 3 speed automatic record changer. Plays them all. Internex records of the same speed. Equipped with a flip over crystal pickup with twin needles. Base size, 12 1/2"x13". Shipping weight 12 lbs. VM-406. Net price \$22.95.

GENERAL INSTRUMENT 3-SPEED \$19.95

Another tremendous McGee record changer scoop. Only 500 to sell. General Instrument, 3 speed automatic record changer with standard crystal cartridge and all purpose permanent needles. Brand spanking new. Our first offering of a 3 speed changer at less than \$20.00. We purchased a large quantity and pass our savings on to you. Stock No. GI-3334. Sale price \$19.95 each. Price to the small manufacturer in lots of 48 or more, \$19.50 each.

**New Versatile Espey
12-TUBE FM-AM CHASSIS**

\$64.50

★ BUILT IN PRE-AMPLIFIER FOR G.E. VARIABLE RELUCTANCE PICKUP
★ WIDE RANGE AUDIO
★ MAY BE USED WITH A CRYSTAL MIKE AS A HOME P.A. SYSTEM

McGee's new 1951 model 12 tube FM/AM chassis. Latest design with phono inputs for all types of record players, crystal or G.E. variable reluctance. Receives standard broadcast 520 to 1700 cps. Wide range audio. Push-pull 6K6 tubes (push-pull 7C5) and bass boost tone control. Loop antenna for broadcast and 300 ohm line type antenna, may be stayed in cabinet. Attractive lighted slide rule dial. Chassis size, 13 1/2" high and 9" deep. Shipping weight 20 lbs. Stock No. 7-CX. Made to sell at a much higher price. McGee's sale price is \$64.50, less speaker. Matches 8 ohms). 7-CX chassis with our 12" coaxial PM, CU-14Y, both \$74.50. Espey 7-C chassis, 12" coaxial PM speaker and 3 speed VM changer with G.E. variable reluctance cartridge. \$104.95.

TERRIFIC RADIO-PHONO SALE

**12-TUBE ESPEY CHASSIS
2-12" P.M. SPEAKERS
\$200.00 VALUE WALNUT CABINET \$179⁹⁵
GE 2-SPEED CHANGER**

Buy this combination offer and have a fine radio-phono combination for less than the value of one cabinet alone. This beautiful walnut cabinet was intended for a Capehart \$800.00 combination and is the finest possible. Furniture quality cabinet workmanship. 37" high, 40" wide and 21" front to back. Hinged top lifts in two sections. 25 1/2" lid covers leg panel is furnished big and 1 1/2" covers the radio compartment. Changer mounting and 1 1/2" covers the radio compartment. Changer mount—General Electric 33 1/2 and 78 rpm. 2 speed automatic changer with two plug-in G.E. variable reluctance cartridges. Stock No. MBD-375 cabinet. Espey 7-C chassis, 2 speed G.E. changer and 2 12" speakers. Sale price, \$179.95. 3 speed VM automatic changer with G.E. variable reluctance turnabout cartridge furnished for \$15.00 extra. Shipping weight 200 lbs. Shipped via truck, rail or express only. Capehart cabinet described above, furnished cut to fit the Espey 7-C chassis, cabinet only \$79.95.

100 Molded Plastic Bypasses \$9⁹⁵

100 molded plastic tubular by-pass condensers. All 600 volt. And all by the same nationally known mfg. Regular dealers' net is over two and one-half times our price. Any quantity sale price. You'll chuckle when you look these over. Here's what you get: 10—.001, 10—.002, 20—.005, 20—.01, 20—.02, 10—.05 and 10—.1. Our big deal No. RN-202, 100 plastic tubulars. Shipping weight 2 lbs. Net price, \$9.95.

100 600 VOLT TUBULARS \$6⁹⁵

100 top quality 600 volt tubular by-pass condensers. Made this year by a famous condenser factory. Don't confuse these with grab-bag surplus. McGee's deals are guaranteed to please you. Here's what you get: 10—.001, 10—.002, 20—.005, 20—.01, 10—.02, 20—.05 and 10—.1 600 volt condensers. Our big deal No. RN-203. Shipping weight 2 lbs. Net price, \$6.95.

**50-W. OUTPUT TRANS.
ONLY \$7⁵⁰ WHY PAY MORE**

50-watt super quality high fidelity output transformer. Matches push-pull parallel or push-pull 6L6 tubes to 4/8/16-ohm voice coil, also 60 and 250 ohm line. Very efficient winding construction only 140 ohms, total resistance in primary, and 8-ohm voice coil tap only 2 of an ohm. The output transformer wastes a minimum amount of audio power due to heat loss within the transformer. Very ideal for public address amps. Stock No. 50-JB, net weight 5 1/2 lbs. Barcan price \$7.50 ea., 2 for \$13.95.

**McGee's Super High Fidelity Best Value in U. S. A.
OUTPUT TRANS. \$7⁹⁵
20-20,000 CPS.**

Model A-403 High fidelity output transformer. Why pay \$20 or \$30 for an output, when our A-403 is available at \$7.95? Impedance, 6600 ohms plate to plate (for PP 6L6 or 6V6), 10% feedback winding, 4-8-15-250, and 500 ohm secondary. Housed in a portable case. Net weight 6 lbs. Recommended for all amplifiers up to 34 watts.

10" SPEAKER AND BAFFLE \$6.95

Stock No. CA-10, Tan leatherette covered plywood slant type wall baffle; plus 10" magnet PM speaker. A red hot McGee special for only \$4.95 each, or \$4.70 each in lots of 3 or more.

**SPEAKER AND BAFFLE SALE
8" SPEAKER AND BAFFLE \$4.95**

Stock No. 818, Tan leatherette covered, plywood slant type wall baffle; plus an 8" Oxford, 2.15 oz. Alnico V magnet PM speaker. A red hot McGee special for only \$4.95 each, or \$4.70 each in lots of 3 or more.

12" SPEAKER AND BAFFLE \$6.95

Stock No. CA-12, Tan leatherette covered plywood slant type wall baffle; plus a 12" Qiam, 4.64 oz. Alnico V magnet, PM speaker. (Popular Adustacon model). A terrific McGee value for only \$6.95 each, or \$6.60 each in lots of 3 or more.

50-WATT BOOSTER AMPLIFIER—\$39.95

25-Watt Horn \$28.95 **50-Watt Booster \$39.95**

2-Mike Pre-Amp. \$10.00 Extra.

50-WATT BOOSTER A sensational value, 50 watt booster amplifier with push-pull parallel 6L6 output tubes. Connect to your present amplifier as a booster or use with the PR-2X Pre-amp to add the use of 2 mikes and one low level input. The booster amplifier has one input jack and with 1 volt input gives 50 watts of audio. Booster has a 6 lb. note case high fidelity output transformer, matches speaker with 4-8-16 ohm voice coil, also 60 ohm and 250 ohm line. Booster has a 225 mill power supply with 5U4 rectifier. Price includes tubes: 4 6L6, 7N7, and 5U4. The two variable volume controls for master volume control and base boost tone control. Size 8 x 6 1/2 x 1 1/2. Stock No. PA-55X. Shipping weight 26 lbs. Sale price \$39.95 ea.

2-MIKE PRE-AMP. Pre-amplifier plugs in directly to the PA-55X Booster amplifier. It enables use of 2. Crystal or Dynamic Mikes plus one low level input. Furnished with 4 foot cables and plugs for remote control of the 50 watt Booster Amplifier. Small chassis size 5 x 3 1/4 x 4". Stock No. PR-2X, with tubes 7E7 and 7N7. Net price \$10.00 ea.

25-WATT HORN 25-Watt Driver and 3 1/2-foot air column re-entrant Trumpet. The standard type trumpet and driver you see the most. Drivers are 100% weatherproof, horn is spun aluminum, offered to you at a considerable savings. Stock No. MA-33. Shipping weight 20 lbs. Net price \$28.95.

ALWAYS LOOK TO McGEE FOR UNCOMPARABLE VALUES!

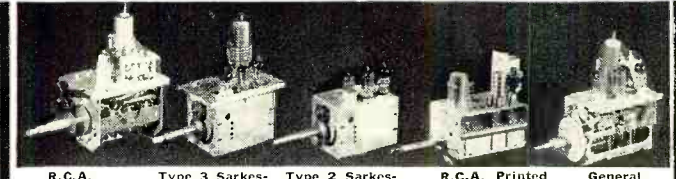

R.C.A. Type 3 Sarkes-Tarzian Type 2 Sarkes-Tarzian R.C.A. Printed General
\$9.95 \$9.95 \$7.95 \$19.95 Inst. \$2.95

RCA TV FRONT END WITH TUBES \$9.95

Terrific buy on this RCA TV tuner. We have a limited quantity of the famous original 20E11, 13 channel completely wired and tested TV front end tuners. Ready to connect to your TV video I.F. strip. Offered at a sacrifice. Price was originally \$14.00. Now only \$9.95 each, with tubes. You'll save plenty on this item. No. RCA-13P TV front end tuner. Shaft length 3 3/4" from base of tuner. Converter coil type for separate sound, as used in the famous 630 chassis. Net price \$9.95 each, two for \$19.00, complete with 3-6J6 tubes.

SARKES-TARZIAN TYPE 3-TUNER WITH TUBES \$9.95

This popular Sarkes-Tarzian TV front end is widely used today. 13 channel rotary type switch with individually tuned coils. Price includes a schematic diagram and 3 tubes: 6C4 osc., 6B16 RF and 6A5 mixer. Regular factory cost is twice our price. Each tuner and its own tube sockets are wired, ready to hook up to a video and sound I.F. strip. May be used with either inter-carrier or separate sound I.F. circuits. Built in fine frequency control. Shipping weight 3 lbs. Type 3 Sarkes-Tarzian TV tuner with tubes. Net price \$9.95. Type 3 tuner and 205-XX video coil kit, both for \$16.95.

SARKES-TARZIAN TYPE 2-TUNER WITH TUBES \$7.95

Type 2 Sarkes-Tarzian TV tuner, same as Type 3 listed above, except does not have input I.F. coil built on. Complete with 3 tubes. Net price \$7.95. Type 2 tuner and 205-XX video coil kit, both for \$14.95.

RCA 12-CHANNEL PRINTED CIRCUIT TV TUNER \$19.95

Latest design RCA 12 channel printed circuit TV tuner. Rotary switch with snap-in printed circuit strip principle. This popular tuner used by Hallcrafters in inter-carrier circuit sets. Shaft length 3 3/4". Built in fine frequency control. Price includes tubes, 6A6 and 6CB6. A terrific value at \$19.95 each.

GENERAL INSTRUMENT TV TUNER, LESS TUBES \$2.95

Completely wired, 13 channel selector incorporating fixed inductance and variable capacitance. Converter output transformer is attached. To be coupled direct to separate sound and video I.F.'s, 3 6J6 tubes are required. Shaft length 2 3/4". Built in fine frequency control. Original cost over \$20.00. Weight 4 lbs. Have been in sets, but guaranteed to be a good value. Stock No. GI-13PX, General Instrument TV tuner, less tubes. Net price \$2.95 each.

2-TUBE SARKES-TARZIAN TUNER LESS TUBES \$7.95

Sarkes-Tarzian new two tube model, type TT-3A, 12 channel television tuner. This is the new 2 tube model requiring a 6J6 plus 6AK5, or 6AG5, or 6CB6 or 6AU6 RF tube.

Pre-aligned by trained factory personnel. Input feeds 21 mc broad band. Fine tuning control is over the channel selector shaft. Power requirements 120 to 140 volts DC at 17 mills, plus 6.3 volts filament. This tuner is offered at a terrific saving to you. Stock No. TT-3A. Net price \$7.95, two for \$15.00, less tubes. Available with 2 1/2", 5 1/2" or 7 1/2" shaft. Specify shaft length desired. 6J6 and 6AU6 tubes for above tuner, both for \$2.39 extra.

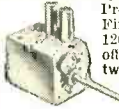

T.V. FRINGE AREA DEALERS—ATTENTION

FM AND TELEVISION BOOSTER SALE

ANOTHER McGEE SCOOP \$10.95

WHY PAY MORE?

NOT A KIT BUT A FACTORY-BUILT BOOSTER

Sensational value. Continuously variable inductance type tuner, from channel 2, including the FM band, through channel 13. Output transformer for 110 Volt AC operation. Incorporates a 6J6 tube. Input for 300 ohm TV line and 300 ohm output to the TV set. Single knob tuner. Attractive plastic case. McMurdo-Silver Super Somic TV-FM booster, Stock No. GB-6B. Shipping weight 5 lbs. McGee's terrific sale price, \$10.95 each, two for \$20.00.



COMPLETE 17" TO 20" T.V. KIT

- ★ AC-TRANS-TYPE
- ★ CONVENTIONAL CIRCUIT
- ★ READY WIRE 12 CHANNEL T.V. FRONT END
- ★ 70° DEFLECTION
- ★ KIT OF TUBES EXCEPT KINE \$16.95
- ★ CERAMIC FLYBACK
- ★ 17B4A \$21.95 EXTRA

\$59.95 LESS TUBES



A complete kit of parts to build an AC transformer operated television chassis for use with a 16, 17 or 20 inch rectangular picture tube. The 12 channel Sarkes-Tarzian tuner is ready wired. The 4 tube video IF accepted design, with latest ceramic type flyback high voltage supply. Chassis is ready punched. Warning: Do not buy this kit unless you understand Television and electronics. It is difficult to wire. We furnish schematic and photos. Kit new with 19 tubes but less picture tube \$16.95 extra. 17 inch 17B4A \$21.95 extra. 20CP4 inch rect. tube \$39.95 extra.

CONVERT YOUR T.V. TO A LARGER PICTURE TUBE

LOOK—6" RECTANGULAR CONVERSION KIT \$28.95



With each conversion kit you get a plastic mask, 70 degree deflection yoke, 90 day guaranteed black face picture tube, plus our new 7J1-X 14,000 Volt Universal Fly-back and horizontal output transformer that works on any output tube and any single rectifier (1B3 or 1X2). A suggested diagram is furnished for use of the transformer with several different output tubes and rectifiers. We think this is the finest and best priced conversion kit in the country. Shipped Truck or Express, only.

Kit No. TCK-14, with 14BP4A 14" rectangular tube, Net price, \$27.95
Kit No. TCK-16, with 16RP4A 16" rectangular tube, Net price, \$28.95
Kit No. TCK-17, with 17BP4A 17" rectangular tube, Net price, \$29.95
Kit No. TCK-20, with 20CP4A 20" rectangular tube, Net price, \$49.95

REGENCY T.V. BOOSTER \$19.10

McGee has the famous Regency DB-410 TV booster. Order yours from McGee. Shipping weight 6 lbs. Sale price, \$19.10 each.



Video Coil Kit \$7.95
20 matched TV video and sound I.F. coils, intended for use with the RCA circuit. You get 6 peaking coils, 4-25-75 mc picture I.F.'s, 2-21.25 mc sound I.F.'s, discriminator and control coil and 5 filament chokes. Stock No. 20V-XX, weight 3 lbs. Net price, \$7.95. \$6.95 if purchased with ANY TV tuner; all coils identified.

SENSATIONAL NEW 2-BAND RADIO KIT ONLY \$14.95

10-WATT HIGH FIDELITY AMPLIFIER KIT \$14.95

- ★ MIKE INPUT
- ★ PHONO INPUT
- ★ BASE AND TREBLE BOOSTER



A complete kit of parts, including tubes, diagram and instructions, to build a 10 watt high fidelity twin tone control audio amplifier, with bass and treble boost. Inputs for radio tuner, crystal mike and crystal phono pickup. Output transformer matches 4-8-250 ohms. Use with our 12" coaxial PM speaker, or any good PM and have a beautiful sounding, yet low cost amplifier. Response from 50 to 15,000 cps. Chassis is ready punched and a ventilated cover is furnished. A straight forward circuit with twin triode gain stages and 2-50L6 tubes in push-pull. New twin 150 ma. selenium rectifier voltage doubler; television type power supply. Price includes tubes; 12AX7, 12AU7 and 2-50L6, plus rectifiers. A good quality kit with matching parts. Size, 5 1/4" x 4 1/2" x 5 1/2" high, including cover. Stock No. A1P-10R, shipping weight 8 lbs. Sale price \$14.95 each. 12" coaxial PM speaker, \$12.95, extra.

MODEL ME6-2 \$14.95

NEW MODEL 6-TUBE, 2-BAND RADIO KIT
A FULL 2-GANG SUPERHET KIT
RECEIVES 550-1600 KC PLUS 6-18 M.C.



McGee's new 1951, 6 tube, AC-DC 2 band radio kit. Receives broadcast, 550 to 1600 kc and short wave, 6 to 18 mc. A straight forward superhet circuit with 2 gang tuning condenser, 456 kc I.F. transformers, etc. 5" speaker illuminated slide rule dial. Everything furnished, including tubes, 12SK7, R.F., 12K8 mixer, 12SK7 I.F., 12SQ7 detector, 1st audio, 35Z6 output, 35Z5 rectifier, diagram and a photo showing view of underside of completely wired chassis. The chassis pan and dial parts are factory production. With this kit, you can build a commercial looking and factory quality 2 band radio, housed in a streamlined plastic cabinet. Size: 13 x 6 1/2 x 6 1/2". Stock No. ME6-2, shipping weight 10 lbs. Net \$14.95.

SELF POWERED AC Broadcast Tuner Kit, 3-Gang Tuning, Complete Kit, \$12.95



A self-powered, 3-gang superhet tuner kit with R-F stage. When wired according to our diagram will make a top quality broadcast tuner (550 to 1650 kc), for use with any amplifier. Don't class this with ordinary tuners; this has its own power transformer. This complete kit is furnished with a diagram, photos and tubes. 6AU6 R.F., 6BE6 oscillator R.F., 6AU6 I.F. detector, 6AL5 diode, AVC, plus rectifier. Connect to any audio amplifier. Ideal for use with our S-2020, TM-16 or 7X5 amplifier kits. Chassis size, 9 1/2 x 4 1/2" high. Shipping weight, 7 lbs. Broadcast tuner kit Model BT-38X. Net price, \$12.95.

8-TUBE 22 WATT Wide Range Amp. Model 7x5 Kit Only \$37.95

A complete kit, including tubes (3-7E5, 2-7F7, 2-6A3, plus rectifier), diagram and photos. All triode circuit makes for minimum harmonic distortion. Inputs for radio tuner any kind of phono pickup (crystal or G.E. variable reluctance) and either crystal or dynamic mike. Output transformer matches 8 ohm voice coil. Includes electronic tone controls, bass and treble with range selector switch for either juke box quality with heavy bass response or brilliant symphonic range. The best quality amplifier kit we know how to make. Has a very wide range output and heavy power transformer. Response 18 to 20,000 CPS. 8 tube all triode amplifier kit, complete with tubes. Weight 25 lbs. Net \$37.95.



10-TUBE RADIO KIT \$29.95

3-GANG TUNING

- MIKE INPUT
- 12 WATT
- HI-FI AUDIO
- BASS-TREBLE BOOST



A NEW 1951 ALL-PURPOSE RADIO KIT

10-Tube Broadcast (550 to 1700 kc) Radio Kit for custom builders. Features 3-gang superhet circuit with A.V.C., high gain I.F. circuit, 8" slide rule dial. Chassis size 12 1/2" long, 10" front to back, 6 1/2" high. Audio inputs for a crystal or dynamic mike, and record changer or player. Tone compensation for standard crystal pick-up or General Electric variable reluctance. Push-pull 6V6 output tubes, shielded high fidelity output transformer matches 8 ohm PM speaker, husky power transformer, 2 tone control for separate bass and treble boost. A complete kit, including tubes 6SK7 R.F., 6SA7 mixer, 6SK7 I.F., 6SQ detector, AVC, 6SQ7 1st audio, 12AX7 variable reluctance and mike amplifier, 12AX7 phase inverter, 2-6V6 outputs, plus rectifier, diagram and instructions. Shipping weight 18 lbs. Stock No. BK-R10. Net price \$29.95. 10" PM speaker, \$6.95 extra. Crystal mike and desk stand, \$4.95 extra. 12" coaxial speaker \$12.95 extra.

5-Tube Broadcast SUPERHET RADIO KIT \$12.95



Model RS-5 tube AC-DC superheterodyne radio kit. Has loop antenna and 2 gang condenser, with lighted slide rule dial and attractive plastic cabinet. Receives broadcast, 550 to 1650 kc. Full size dynamic speaker, matched 456 I.F.'s, automatic volume control. This is a complete radio kit. Everything furnished, including diagram, photos and tubes: 12K8 mixer, 12SK7 I.F., 12SQ7 detector, 1st audio, 50L6 output, 35Z5 rectifier. Shipping weight 7 lbs. Stock No. RS-5. Net price \$12.95.

Build Your Own Phono-Mike Broadcaster \$7.95



Kit Model DE-6R. With this simple kit, you can build a 3-tube phono oscillator that also has a mike input. Will broadcast over any radio, within your home, (about 75 feet) from 1000 to 1500 kc. Inputs for crystal mike or crystal phono pickup. Slider control fades from mike to record. Ideal for a home P.A. system, baby listener and home entertainment. A complete kit of parts including tubes. Kit Model DE-6R. Net price, \$7.95. DE-6RWT, wired and tested. Net price, \$9.95. Crystal mike and desk stand, \$4.95 extra. Coiled microphone unit, only 1" in diameter and 1/4" thick. Specially hidden mike when ordering. Stock No. T-001. Net, \$3.95 extra.

McGEE HAS EICO TEST EQUIPMENT KITS

- Model 145-K, Multi-Signal tracer, Net \$19.95
- Model 221-K Vacuum Tube Volt-meter, Net 25.95
- Model 315-K Signal Generator, Net 39.95
- Model 320-K Signal Generator, Net 19.95
- Model 425-K 5" Oscilloscope, Net 44.95
- Kit Model 625-K Tube Tester Kit, Net 34.95
- Model 360-K Sweep Generator, Net 34.95
- Model 950-K Cond. Res. Comp. Bridge Kit, Net 19.95
- Model 1040-K Battery Eliminator Kit, Net 25.95

McGEE RADIO COMPANY

Prices F.O.B. K.C. Send 25% Deposit with Order, Balance Sent C.O.D. With Parcel Post Orders, Include Postage.

TELEPHONE VICTOR 9045. WRITE FOR FLYER
1422 GRAND AVE., KANSAS CITY, MISSOURI

For additional information on any of the items described herein, readers are asked to write direct to the manufacturer. By mentioning RADIO & TELEVISION NEWS, the page, and the issue number, delay will be avoided.

CABLE CONNECTOR

Alden Products Company, 117 North Main Street, Brockton 64, Massachusetts, has developed a new octal type 9-pin connector for use with TV color

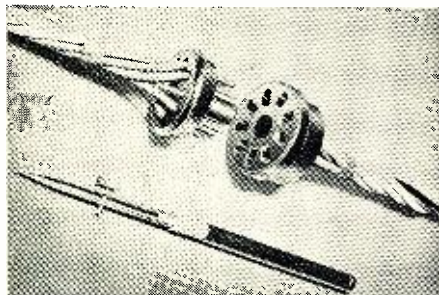

adapters, u.h.f. converters, and other applications requiring a rugged, small connector.

The connector (209FEC) and plug (109C) unit feature leads attached directly to the contact with no projecting solder terminals, 100 per-cent molded insulation around each contact and lead, individual strain relief for each lead, and the wire tip crimped firmly to eliminate the danger of cold solder joints.

PREAMP-EQUALIZERS

Brociner Electronics Laboratory, 1546 Second Avenue, New York 28, New York, is currently marketing two new preamplifier-equalizers, the Models A100 and the A100P.

Correct equalization is provided for all makes of microgroove records as well as for the older 78 rpm discs. Included are the original Columbia LP curve and the very different characteristic used by RCA for its LP's and 45's. The AES recommended playback curve is obtainable with one of the indicated dial settings.

Both units are supplied with brushed-brass designation plates for front panel mounting and both are



housed in chassis measuring 3" high and 8½" long at the panel and 7½" deep behind the panel.

The Model A100 has an adapter power plug to fit under the beam power output tubes while the A100P has an integral power supply.

A data sheet on these new units is available from the company on request.

COAXIAL SPEAKER

Oxford Electric Corporation, 3911 South Michigan Avenue, Chicago 15, Illinois, has added another speaker to its line—a 12" coaxial unit.

The new speaker, the Model CO12JB, has been designed for quality AM, FM, and TV receivers as well as for monitoring, recording applications, and other sound installations.

Frequency range is 65 to 15,000 cps, the network crossover is at 4000 cycles, power rating is 10 to 12 watts, input impedance -8 ohms, while the woofer magnet measures 12" and weighs 6.3 ounces and the tweeter magnet is 3" and weighs 1.47 ounces.

WIDE-RANGE SPEAKER

University Loudspeakers, Inc., has added a new 12" wide-range, wide-dispersion cone speaker to its line.

The "Diffusicone-12" features a dual

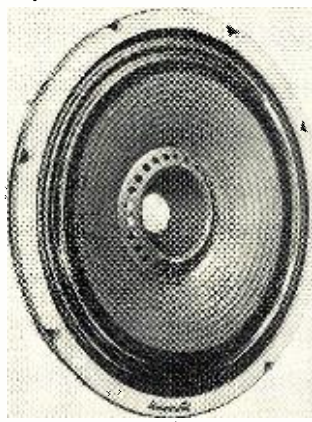

concentric apex horn which both extends the high frequency response to over 13,000 cps and disperses these normally beam-like frequencies uniformly throughout the listening area. The "diffusor" element used provides dual horn loading of the speaker apex, substantially increasing high frequency efficiency, and combines both radial projection and aperture diffusion of the high frequencies to assure reception of the speaker's complete range of reproduction.

Of special interest to the service technician and custom installer is the company's exclusive "bi-sectional" construction of this unit which enables replacement of either the entire basket/diaphragm assembly or the magnet mechanism in the field without special tools.

A specially prepared catalogue sheet, together with complete cabinet prints,

is available by writing direct to the company at 80 S. Kensico Avenue, White Plains, N. Y.

NEW "LOOPSTICK"

Grayburne Corporation of 103 Lafayette Street, New York 13, New York has come out with a companion unit to its "Ferri-Loopstick"—the "Vari-Loopstick."

The new unit retains all of the features of the "Ferri-Loopstick" but has,



in addition, micrometer adjustment. This new feature has been incorporated for the benefit of technicians and hobbyists who are "station jumpers" and "DX hounds" and for those who want to peak-resonate for a series of stations at will.

Both the new and the older unit can be used to replace older type loop antennas in any broadcast receiver.

FOLDED HORN BLUEPRINTS

Jensen Manufacturing Company, 6601 S. Laramie Avenue, Chicago 37, Illinois, is offering without charge blueprints and instructions for building the new backloading folded horn which was recently demonstrated in conjunction with the company's G-610 "tri-axial" speaker at the Audio Fair in New York.

This 30 cubic foot enclosure, developed by D. J. Plach and P. B. Williams, is of particular interest to professional sound men and high fidelity enthusiasts because of its moderate cost.

Compactly arranged in a cabinet 5 x 3 x 2 feet, the new horn design reduces the loudspeaker resonant frequency by almost one octave, increases efficiency 4 to 6 db over the entire piston range, improves transient performance, and allows doubling the loudspeaker power rating for a given amount of distortion.

For details on how to secure the building plans for the cabinet write the company direct.

PICKUP CARTRIDGES

The Astatic Corporation of Conneaut, Ohio, has developed a new turn-over pickup cartridge which is said to

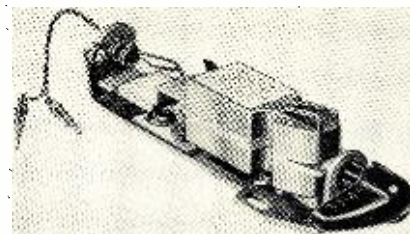

provide performance quality equal to that obtainable from single-needle units.

The cartridge uses two complete
(Continued on page 120)



EDW. H. GUILFORD
Vice President

I can train you to pass your FCC License Exams in a minimum of time if you've had any practical radio experience—amateur, Army, Navy, radio servicing, or other. My time-proved plan can help put you, too, on the road to success.

Let me send you FREE the entire story

Just fill out the coupon and mail it. I will send you, free of charge, a copy of "How to Pass FCC License Exams," plus a sample FCC-type Exam, and the amazing new booklet, "Money-Making FCC License Information."

How to Pass FCC License Exams

**Commercial
Radio Operator**

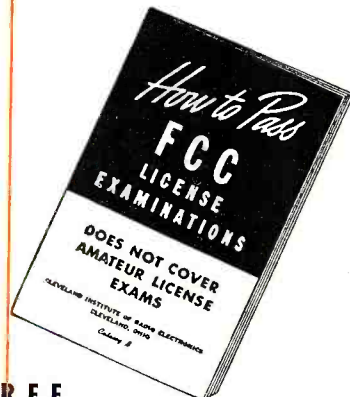

FREE

Tells where to apply and take FCC examinations, location of examining offices, scope of knowledge required, approved way to prepare for FCC examinations, positive method of checking your knowledge before taking the examination.

Get Your FCC Ticket in a Minimum of Time

Get this Amazing Booklet FREE

TELLS HOW—

**WE GUARANTEE
TO TRAIN AND COACH YOU AT HOME
IN SPARE TIME UNTIL YOU GET
YOUR FCC LICENSE**

If you have had any practical experience—Amateur, Army, Navy, radio repair, or experimenting

TELLS HOW—

**Employers make
JOB OFFERS Like These
to Our Graduates Every Month**

Letter, October 11, 1951, from Chief Engineer, Broadcast Station, North Carolina, "Need men with radiotelephone 1st class licenses, no experience necessary. Will learn more than at average station for we are equipped with Diesel Electric power, transmitting and studio equipment."

Telegram, October 2, 1951, from Chief Engineer, Broadcast Station, Wyoming. "Please send latest list available first class operators. Have November 10th opening for two combo men."

These are just a few examples of the job offers that come to our office periodically. Some licensed radioman filled each of these jobs . . . it might have been you!

HERE'S PROOF FCC LICENSES ARE OFTEN SECURED IN A FEW HOURS OF STUDY WITH OUR COACHING AT HOME IN SPARE TIME

Name and Address	License	Lessons
Lee Worthy 2210 1/2 Wilshire St., Bakersfield, Cal.	2nd Phone	16
Clifford E. Vogt Box 1016, Dania, Fla.	1st Phone	20
Francois X. Forch 38 Beucler Pl., Bergenfield, N. J.	1st Phone	38
S/Sgt. Ben H. Davis 317 North Roosevelt, Lebanon, Ill.	1st Phone	28
Albert Schoell 110 West 11th St., Escondido, Cal.	2nd Phone	23

CLEVELAND INSTITUTE OF RADIO ELECTRONICS
Desk RN-39—4900 Euclid Bldg., Cleveland 3, Ohio

TELLS HOW—

**Our Amazingly Effective
JOB-FINDING SERVICE**

Helps CIRE Students Get Better Jobs

Here are a few recent examples of Job-Finding results

GETS FIVE JOB-OFFERS FROM BROADCAST STATIONS
"Your 'Chief Engineer's Bulletin' is a grand way of obtaining employment for our graduates who have obtained their 1st class license. Since my name has been on the list I have received calls or letters from five stations in the southern states, and am now employed as Transmitting Engineer at WMMT."

Elmer Powell, Box 274, Sparta, Tenn.

GETS CIVIL SERVICE JOB
"I have obtained a position at Wright-Patterson Air Force Base, Dayton, Ohio, as Junior Electronic Equipment Repairman. The Employment Application you prepared for me had a lot to do with my landing this desirable position."

Charles E. Loomis, 4516 Genessee Ave., Dayton 6, Ohio.

GETS JOB WITH CAA
"I have had half a dozen or so offers since I mailed some fifty of the two hundred employment applications your school forwarded me. I accepted a position with the Civil Aeronautics Administration as Maintenance Technician. Thank you very much for the fine cooperation and help your organization has given me in finding a job in the radio field."

Dale E. Young, 122 Robbins St., Owosso, Mich.

Your FCC Ticket is recognized in all radio fields as proof of your technical ability.

Get All 3 FREE

MAIL COUPON NOW

CLEVELAND INSTITUTE OF RADIO ELECTRONICS

Desk RN-39, 4900 Euclid Bldg., Cleveland 3, Ohio
(Address to Desk No. to avoid delay)

I want to know how I can get my FCC ticket in a minimum of time. Send me your FREE booklet, "How to Pass FCC License Examinations" (does not cover exams for Amateur License), as well as a sample FCC-type exam and the amazing new booklet, "Money-Making FCC License Information."
 Tell me how I can get your Free Television Course.

NAME
ADDRESS
CITY ZONE STATE

Paste on penny post card or send air mail

Special Purchase FM Radio Chassis

88-108 MC

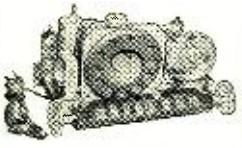

Complete with 6 tubes. Built-in Antenna and Speaker. Product of Famous Radio & TV Manufacturer whose name we promised not to mention.

TUBE LINEUP

1-12BA7 1-12S8
2-12BA6 1-35W4
1-35B5

Regularly \$29.95
Brand New

May also be used as an FM Tuner by picking signal off detector.

\$16.95

SPECIAL PURCHASE!

GENERAL INSTRUMENTS 3-SPEED AUTOMATIC RECORD CHANGER

REGULARLY
\$34.95
BRAND
NEW



\$19.97

With all-purpose cartridge and needle. Plays 33 1/2, 45, and 78 RPM records automatically.

NOTE: Do not send money for postage on above items, we ship best way—charges collect.

LOW FREQ. XTALS-Ft 241A

For SSB, lattice filter, etc. 1/2" spc. 54th or 72nd harmonic channels listed by fundamentals. Fractions omitted.

372 404 435 506	400 462 4910	2030 2042
374 405 437 507	440 463 4370	2045 2532
375 407 439 509	441 464 6490	2105 2545
377 408 441 511	442 466 6470	2125 2557
379 409 443 513	444 468 6497	2145 3207
381 411 445 515	446 469 6522	2155 3215
383 412 447 517	447 470 6547	2220 3233
384 413 448 518	448 472 6530	2258 3250
385 415 450 518	450 474 7350	2280 3322
386 416 451 519	451 475 7480	2282 3510
387 418 453 520	452 476 7580	2290 3520
388 419 454 522	455 477 7810	2310 3550
390 420 456 525	457 479 7930	2310 3670
391 422 458 526	459 480	2320 3680
392 423 459 530	461	2360 3945
393 424 461 531		2390 3955
394 425 462 533		2415 3965
395 426 463 537		2435 3965
396 427 504 532		
397 429		
398 431		
401 433		
422 434		
423 435		

SCR 522

Xtals
1/2" spc.

99c ea.	\$1.29
10 for	each
\$9.00	

BC-610

Xtals
2 banana plugs
3/4" spc.

2030	2042
2045	2532
2105	2545
2125	2557
2145	3207
2155	3215
2220	3233
2258	3250
2280	3322
2282	3510
2290	3520
2310	3550
2310	3670
2320	3680
2360	3945
2390	3955
2415	3965
2435	3965

SPECIAL

200 Kc xtals
without holders
69c Each
3 for \$2.00

\$1.29

each

HAM XTALS-Ft 243 HOLDERS—1/2" pin spc.

4190 6773 7840	1015 5773 6273 6540 7440 7650
5030 6873 7873	1129 5800 6306 6573 7473 7673
5485 6906 7906	2045 5806 6325 6575 7506 7706
6040 6973 7940	3735 5825 6340 6600 7540 8240
6073 7740 7973	5305 5840 6373 6606 7573 8340
6106 7773 8273	5677 5850 6406 6625 7606 8400
6125 7806 8306	5706 5873 6440 6640 7640
6140	5725 5875 6450 6673
6173	5740 5906 6473 6706
6175	5750 5940 6475 6740
6206	5760 5973 6506 7340

49c Ea.
10 for
\$4.50

99c Ea.
10 for
\$9.00

Add 20c for each 10 xtals or less for postage and handling.

VARIABLE CONDENSERS

From SCR-522 2
Gang—25 MMF per
section **\$1.29**

From SCR-522 3
Gang—25 MMF per
section **\$1.59**

BRAND NEW with
CONCENTRIC
AIR TRIMMERS



TERMS: All items F. O. B., Washington, D. C. All orders \$30.00 or less, cash with order. Above \$30.00, 25 per cent with order, balance C. O. D. Foreign orders cash with orders, plus exchange rate.

SUN RADIO

OF WASHINGTON, D. C.
938 F STREET, N. W. WASH. 4 D. C.

Spot Radio News

(Continued from page 18)

Electronics Production Board, and Lieutenant Colonel Carl B. Lindstrand of the Electronics Production Resources Agency, in the Department of Defense, during a visit to the facilities of twelve companies in Western Germany and Milan, Italy.

The purpose of the trip, it was revealed, was to survey possible sources for electronic parts in Europe to determine the availability of certain items, considered to be critically short here. The investigation indicated that generally .05 to 3 watt resistors were in common production, while some companies produced sizes up to 50 watt capacity. Production in this country has been limited to .5-2 watt types. It was pointed out that the small-size resistors, between .05 and .25 watt, could be considered by the military for their gear. Facilities for precision wire-wound resistors were also located, although the outputs were small. Fine enameled-resistance wire, as small as .0012 inch, was also found to be available. Two plants were found to be capable of producing selenium rectifiers, using selenium imported from Sweden. One manufacturer said that he was making a rod-type rectifier with ratings from 20 volts at 5 milliamperes to 5000 volts at 3 milliamperes. Also being processed are the conventional disc-type assemblies.

Reviewing the facilities and equipment employed at these foreign sources, a detailed report indicated that one organization was producing deposited carbon resistors using automatic spiraling machines featuring a magazine feed and having a spiraling capacity of from 600 to 3500 resistors an hour, depending on the values. In addition, lead wires could be automatically attached by a machine having a capacity of 2000 resistors an hour.

The trip to the plant of the selenium disc manufacturer revealed that the company is currently producing 100,000 square inches of processed selenium rectifier plates a day. Because of the scarcity of selenium it is expected that this rate will be reduced by fifty per cent. However, it was said, production could be increased to 160,000 square inches within six months, if material became available. When the report was prepared, late last year, it was noted that up to 50,000 discs (125 ma. or equivalent) could be delivered in approximately six to eight weeks. The cells produced in this plant were described as being of the nickel-plate iron plate type, with a layer of selenium. For passing current, an opposite electrode, composed of a special alloy, was said to be provided. This method of making contact was cited by the manufacturer as being superior to the pressure technique, assuring reliable contacts. The rectifiers were said to be usable in all of the popular applications such as for the charging

and floating of batteries, d.c. supply in a.c.-d.c. chassis, excitation of electromagnets, etc.

The rod-type rectifiers were noted as being unique in their structure, an entirely new design making it possible to reduce the length of the element in tube form to less than that of any rod unit made. It was said that a peak inverse voltage of 930/cm., or 2350 volts-per-inch, had been attained. The construction of the elements in tubes made of an insulating material was cited as insurance against discharge and flashover at very high voltages. The rectifiers were said to be usable as a d.c. supply for condenser testing; d.c. supply for TV units; and d.c. supply for all types of high-voltage testing gear.

The complete report, including all this extremely valuable data, is available for inspection in either room 2314, Temporary T building, 14th and Constitution, N.W., or room 4H4, GAO Building, 443 G Street, N.W., Washington, D. C.

TWO NEW SHIP-TO-SHORE channels may become the official frequencies of the maritime radiotelephone service, if the proposals offered by the Commission are accepted by rail and ship operators: 162 megacycles (coast) paired with 157.3 megacycles (ship) and 161.9 megacycles (coast) paired with 157.4 megacycles (ship).

It is hoped that these standardized frequencies will be adopted since it is felt that they will serve to simplify not only the operational problems confronting those in the Great Lakes area, but the equipment used on the lakes and connecting waterways.

The Commission has also suggested that the 157.1 megacycle channel be assigned to the government, so that ship-to-shore operators might have two adjacent channels: 157.3 (which now is a government channel) and 157.4. In the event the maritime mobile service finds in the future that it can utilize 50 kilocycle channel separation, in lieu of the present 100 kilocycle separation, the way is left open whereby an additional public correspondence pair or two additional operational frequencies can be utilized.

THE GEOGRAPHICAL, GEOLOGICAL and geophysical radiolocation services, which during the past five years have soared in importance, particularly in the southwest, have won a new band: 1750 to 1800 kilocycles.

Analyzing the reasons for the assignment of the new frequency, the Commission said that experience has indicated that, except for petroleum exploration operations in the Continental Shelf area, line-of-sight ranging would not fall short. The maximum dependable surveying range of an ultra-high frequency system limits the direct operational range of the practical exploration system to an off-shore distance on the order of 15 to 25 miles. On the other hand, there appear to be areas in the Shelf area considered commercially exploitable for oil at dis-

BUY TEST EQUIPMENT ON THIS RADICALLY NEW TIME PAYMENT PLAN

NO INTEREST!! - NO CARRYING CHARGES!!

USE CONVENIENT TIME PAYMENT ORDER BLANK BELOW

Superior's New

UNIOR SUPER-METER

MOST COMPLETE AND COMPACT MULTI-SERVICE INSTRUMENT EVER DESIGNED

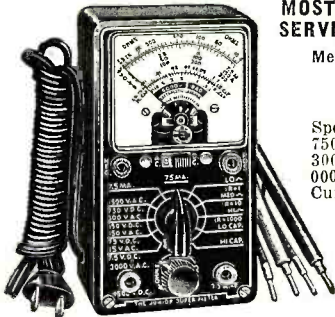

Measures: * Voltage * Decibels
* Capacity * Resistance
* Current * Inductance
* Reactance

Specifications: D.C. Volts: 0-7.5/75/150/750/1500 Volts. A.C. Volts: 0.15/150/300/1500/3000 Volts. Resistance: 0-10,000/100,000 ohms. 0-10 Megohms. D.C. Current: 0-7.5/75 Ma. 0-7.5 amps. Capacity: .001 Mfd.—2 Mfd. .1 Mfd.—20 Mfd. Electrolytic Leakage: Reads quality of electrolytics at 150 Volt test potential. Decibels: -10 Db to +18 Db. +10 Db. to +38 Db. +38 Db. to +58 Db. Reactance: 15 ohms—25 K ohms 15 K ohms—2.5 Megohms. Inductance: .5 Henry—50 Henries 30 Henries—10 K Henries. Plus Good-Bad scale for checking the quality of electrolytic condensers.

Handsome round cornered molded bakelite case 3 1/2" x 5 7/8" x 2 1/2" complete with all test leads and instructions

\$2140 NET

Superior's New

Model CA-12 SIGNAL TRACER



The well known Model CA-12 is the only signal tracer in the low price range including both meter and speaker!!!

SPECIFICATIONS: • Comparative Intensity of the signal is read directly on the meter—quality of the signal is heard in the speaker. • Simple to Operate—only one connecting cable—no tuning controls. • Highly Sensitive—uses an improved vacuum-tube voltmeter circuit. • Tube and Resistor Capacity Network are built into the detector probe. • Built-In High Gain Amplifier—Alnico V Speaker.

Completely Portable—weighs 8 pounds—measures 5 1/2" x 6 1/2" x 9".

Model CA-12 comes complete with all leads and operating instructions

\$3395 NET

Superior's New Model 660—AN AC OPERATED

SIGNAL GENERATOR

Provides Complete Coverage for A.M.-F.M. and TV Alignment

• Generates Radio Frequencies from 100 Kilocycles to 60 Megacycles on fundamentals and from 60 Megacycles to 240 Megacycles on powerful harmonics. • Accuracy and stability assured by use of permeability trimmed HI-Q coils. • R.F. available or modulated by the internal audio oscillator. • Built in 400 Cycle sine wave audio oscillator used to modulate the R.F. signal also available separately for audio testing of receivers, amplifiers, etc. • Oscillator Circuit: Uses a miniature high frequency type of acorn triode in a Hartley circuit to insure a high degree of stability. By using the same type of triode as a buffer amplifier, complete and positive isolation between the R.F. oscillator and the attenuator is attained. • Attenuator: a 3 step ladder type of attenuator is used. Each step of the attenuator is controlled by a separate attenuator control thus providing intermediate level steps. • Tubes used: 955, as R.F. Oscillator, 955 as Modulated Buffer Amplifier,



6SN7 as Audio Oscillator and Power Rectifier.

The Model 660 comes complete with coaxial cable test lead and instructions

\$4295 NET

Superior's New

Model TV-11 TUBE TESTER



Operates on 105-130 Volt 60 Cycles A.C. Hand-rubbed oak cabinet complete with portable cover

\$4750 NET

• Uses the new self-cleaning Lever Action Switches for individual element testing. Because all elements are numbered according to pin number in the RMA base numbering system, the user can instantly identify which element is under test. Tubes having tapped filaments and tubes with filaments terminating in more than one pin are truly tested with the Model TV-11 as any of the pins may be placed in the neutral position when necessary. • Uses no combination type sockets. Instead individual sockets are used for each type of tube. Thus it is impossible to damage a tube by inserting it in the wrong socket. • Free-moving built-in roll chart provides complete data for all tubes. • Phono jack on front panel for plugging in either phones or external amplifier detects microphonic tubes or noise due to faulty elements and loose external connections.

Superior's New

TV BAR GENERATOR

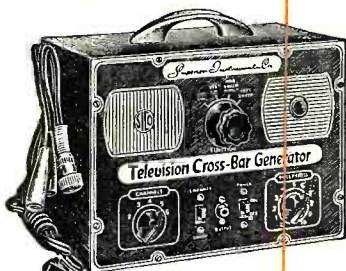

Power Supply: 105-125 Volt 60 Cycles. Power Consumption: 20 Watts. Channels: 2-3 on panel, 7-13 by harmonics. Horizontal lines: 4 to 12 (Variable). Vertical lines: 12 (Fixed). Vertical sweep output: 60 cycles. Horizontal sweep output: 15,750 Cycles.

Throws an Actual Bar Pattern on Any TV Receiver Screen!!!

Two Simple Steps:

1. Connect Bar Generator to Antenna Post of any TV Receiver.
2. Plug Line Cord into A.C. Outlet and Throw Switch.

RESULT: A stable never-shifting vertical or horizontal pattern projected on the screen of the TV

receiver under test. TV Bar Generator comes complete with shielded leads and detailed operating instructions. Only

\$3995 NET

NEW TIME PAYMENT PLAN ORDER BLANK

MOSS ELECTRONIC DISTRIBUTING CO., INC. Dept. B-19, 38 Murray Street, New York 7, N. Y. B-19

Please send me the units checked below. I am enclosing the down payment with order and agree to pay the monthly balance as shown. It is understood there will be no carrying interest or any other charges, provided I send my monthly payments when due. It is further understood that should I fail to make payment when due, the full unpaid balance shall become immediately due and payable.

JUNIOR SUPER METER Total Price \$21.40
\$5.40 down payment. Balance \$4.00 monthly for 4 months.

MODEL TV-11 Total Price \$47.50
\$11.50 down payment. Balance \$6.00 monthly for 6 months.

MODEL CA-12 Total Price \$33.95
\$9.95 down payment. Balance \$4.00 monthly for 6 months.

TELEVISION BAR GENERATOR Total Price \$39.95
\$9.95 down payment. Balance \$5.00 monthly for 6 months.

MODEL 660 Total Price \$42.95
\$12.95 down payment. Balance \$5.00 monthly for 6 months.

I enclose \$..... as down payment.

Ship C.O.D. for the down payment.

Signature

Name

Address

City Zone..... State.....

All Channel Reception

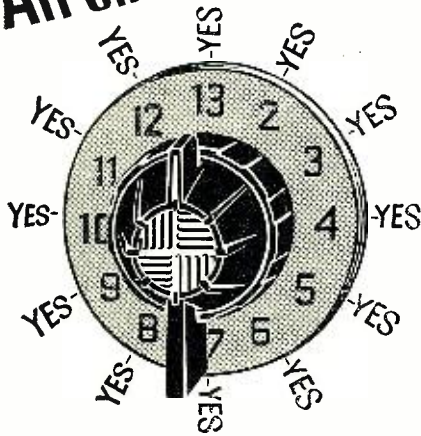

With Extra Performance

WHERE YOU NEED IT

WITH **DUBL-VEE**

BY **WORKSHOP**

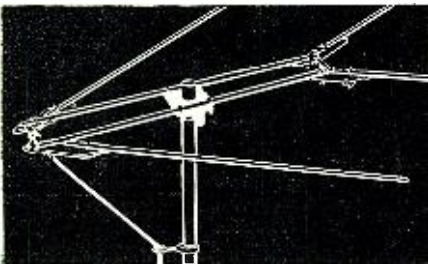

In the high bands . . . it's the original patented DUBL-VEE specially designed by WORKSHOP engineers to "bring-in" extra signal on channels 7 thru 13, while retaining excellent reception on channels 2 thru 6.

Gains up to 8 db for single bays and 10 db for double bays assure maximum signal. Rugged, streamlined construction cuts wind resistance. Only the DUBL-VEE gives these performance extras . . . tops for signal and tops for strength. On your next installation, install the WORKSHOP DUBL-VEE . . . the original DUBL-VEE designed and patented by WORKSHOP . . . at radio parts distributors everywhere.

THE **WORKSHOP ASSOCIATES**
Division of the Gabriel Co.
135 Crescent Road
Needham Heights 94, Mass.

tances of 40 to 70 miles from the Gulf of Mexico coastline. The use of the customary survey procedures to carry the survey stepwise in the water to offshore distances much greater than 15 to 25 miles appears to be neither reliable nor economically practical. Accordingly, the Commission felt that there was a definite need for a radiolocation service which is not subject to the line-of-sight limitations of the frequencies on the higher bands, as an aid in the development of the oil resources lying beneath the waters of the Gulf of Mexico.

A normal maximum bandwidth was also prescribed in the new ruling: 3 kilocycles. No definite prohibition was imposed against exceeding this bandwidth because it appears as if the question of lane identification or means of obtaining spot positioning has not as yet been satisfactorily resolved. During the hearings there were described phase-comparison methods which permit the use of low or medium frequencies and the elimination of the line-of-sight limitation as a radiolocation technique. However, *with this method*, within the limits of the space available, it has not been possible to develop an adequate system of lane identification, and thus mobile craft must enter the hyperbolic grid system at a known point, and thereafter maintain continuous operation throughout the duration of the survey. This lack of an adequate method of spot positioning has been found to be one of the chief stumbling blocks to the development of an all-purpose radiolocation system. Present methods involve the use of either additional 3 kilocycle channels or the use of a wider bandwidth. Accordingly, the Commission noted that a bandwidth greater than 3 kilocycles will normally not be authorized, except where additional space is needed for lane identification purposes.

Since there does not appear to be any single radiolocation system which has been found to be satisfactory in all respects, all stations licensed under the new regulations will be on a developmental basis only.

DURING WORLD WAR II, radio proved itself to be a dynamic aid in psychological warfare. Since then, broadcasting has played a roaring role in this direction in a multi-million dollar campaign, here and overseas, through the facilities of the Voice of America and stations in occupied zones in Europe.

To provide flexibility to the program and permit the transmission of psychological warfare messages into enemy territory, there has been produced a complete mobile broadcast system which can be carried by truck and trailer on land, by cargo planes aloft, and by ships at sea. Housed in a pair of 26-foot trailers and three eleven-foot shelters designed by the Army Signal Corps Engineering Labs at Fort Monmouth and the Department of the Army, the station is as complete as a modern fixed station. The broadcast

DOW SURPLUS

TELECHRON SYNCHRONOUS MOTOR

Type C2M 115V-60 cycle Model 822 M, 1915
—RPM 6—Removed from new Surplus \$4.95

MISCELLANEOUS ITEMS

Rubber Grommets—100 asst. \$0.89
EC 457—Xmitters 4 to 5. 3 mc new. 9.95
EC 461 control box with counter. 1.49 ea.
144 mike and plug.95 ea.
Hook-up Wire approx. 400 ft. 2 to 4 ft. lengths and longer.98
APC condensers all sizes.98
1250 ft. \pm WL130 twisted Telephone wire. 4.50
50 Watt—Tube Sockets—new.95 ea.
Antenna Insulators—10 for.60
3 Asst. 24V Relays. 1.00
FILAMENT TRANSFORMERS—110V—60 cycle input, output 9V to 13V in 1V steps—output, rated 3 amps. 1.89
G.E. Solenoids—14V DC—25 ohms—Mycalex arm, many applications—new.49

GP7 TUNING UNITS, A TO F, for ECO, \$3.95 ea.

PANEL METERS
NEW SURPLUS
STANDARD BRANDS
★ SPECIAL SCALE
SQ—SQUARE CASE

3" METERS
0-8V AC \$3.95
0-130V AC 5.95
0-150V AC 5.95
0-15V AC 3.95
0-1.5V DC 3.95
0-2V DC 3.95
0-1 Mill DC SQ. 6.95
100-0-100 DC Mill. 4.95
0-800 Mill DC SQ. 4.95

RHEOSTATS

Watts Resistance ea.
225 1 ohm \$0.98
225 18 .98
225 25 .98
225 30 .98
225 100 .98
225 145 .98
225 150 .98
225 370 .98
225 500 .98
225 1000 .98
225 5000 .98
225 5000 2.50
150 100 2.50
150 500 3.95
150 5000 3.95

2" METERS
0-1 RF Amp. \$5.95
0-8 RF Amp. 5.95
0-3 DC Mill. 3.95

RF CHOKES

2 1/2 MH—100 mill. 29c
2 1/2 MH—500 mill. 59c
2 1/2 MH—1000 mill. 59c

TUBES

SURPLUS	ea.	BARGAIN	ea.
13-4	\$0.19	15E	\$1.19
801A	\$0.39	807	1.95
843	.39	3HP7	1.95
1625	.39	5RP7	1.95
1626	.39	1616	1.95
1629	.39	8012	2.75
HY615	.39	RK39	3.25
RK73	.79	833	3.95
558A	.79	860	4.90
615GT	.79	2121A	4.25
6S17	.79	5BP1	4.95
6AL5	.79	304TL	6.95
11D5	.79	11B5	4.95
41	.79	250R	6.95
RKR73	.79	804	8.75
HYK5	1.19	4E27/257	5.00
2051	1.19	861	19.95
837	1.49	849	19.95

OIL CONDENSERS

10 mfd 600V \$3.95
2X 1 mfd 600V Round.89
1 mfd 6000V 4.95
2 mfd 4000V oil
GZ2F47 Pryn. 6.95
90 mfd 120V AC
GZ2F68 Pryn. 7.95
oil 7.95

SPRAGUE #4884

Four 8 mfd Sections in
One Can. 600V—oil—
P r e f e r e n t f o r
amplifiers \$4.95

NEON INDICATORS

NE 210c ea.
NE 48 29c ea.
NE 3037c ea.

VARIABLE CONDENSERS

Dual-100 mmfd \$1.49
Dual 35 mmfd per Section. Miniature.98
3 Gang 365 per Section.98
4 Gang 150 per Section.98
5 Gang 365 per Section. 1.95

FUSES

Amp.	Type	Each	10 for	100 for
1/2	8AG	\$0.03	\$0.25	\$2.00
1	3AG	.03	.25	2.00
1/8	3AG	.03	.25	2.00
3/16	3AG	.03	.25	2.00
1	3AG	.03	.25	2.00
2	3AG	.03	.25	2.00
10	3AG	.02	.25	2.00
15	3AG	.02	.25	2.00
20	3AG	.02	.25	2.00
1	4AG	.05	.40	2.95
4	4AG	.05	.40	2.95
10	4AG	.05	.40	2.95
15	4AG	.05	.40	2.95
20	4AG	.05	.40	2.95
35	4AG	.05	.40	2.95
40	4AG	.05	.40	2.95
70	ACL	.05	.40	2.95
20	5AG	.05	.40	2.95
40	5AG	.05	.40	2.95
70	5AG	.05	.40	2.95

KEYS

J-5A \$0.95
J-30 1.25
J-32 1.25
J-38 1.25
J-41A89
J-47 1.25
J-48 1.25

EDWARDS BUZZERS

#189—115 V—60 cycle
#195—115 V—60 cycle
#15—size O—12V DC
works on 6V less cover.
Fine for Code Practice
Sets69

Open Circuit Jacks. Standard. 10 for \$1.50
JK 26 and PL 54 per set .49
3 AG fuse post25
4 AG fuse post25
3 AG type \$1.00
30 ft. Hook-up wire.10
Luminous Paint Kit. For Dusting, Painting or
Mixing. Glows in the Dark.79
6 ft. ac line cords ea. .15
Single Hole mtg. Push Button Switch.19
T51 Hand Sets 6.95
B9A toggle SW—SPDT—center off 2/ 1.00
Resistor Kit 100/ 2.89
A62 Phantom Antenna—new75
35 FOOT STEEL ANTENNA MAST KIT. 7—Five
foot sections—new 12.95

Write us for your meter wants. Over 3,000 in stock. Write for Our 16-Page Bulletin.

DOW RADIO, INC.

1759 E. Colorado St. Pasadena 4, Calif.

PHONE: SYcamore 3-1196

\$1.50 min. order 25% deposit with orders

Send full remittance to save C.O.D. charges

All merchandise fully guaranteed. Subject to prior sale.

RADIO & TELEVISION NEWS

studio and control room are soundproof and air conditioned. Equipment includes the latest control consoles, magnetic tape recorder-reproducer units, turntables, and remote pickup units for on-the-spot broadcasts away from the studio. The range of the station is said to be several hundred miles.

By the time this column appears in print, it is expected that the station will have been placed in operation by psychological warfare teams overseas.

WHEN THE PRESIDENT enters the remodeled White House, he will find that he will be able to tune in his favorite radio stations with a telephonedial system. Sound will emanate from ceiling or wall units.

The President will also be able to listen to network programs not being broadcast locally, for they will be available through a telephone line system, directly tied into the facilities of the four network stations represented in Washington.

FM BROADCASTING has finally found itself approved by the BBC in Great Britain. After almost five years of exhaustive tests and surveys, it has been decided to set up a chain of FM stations operating in the 88 to 100 megacycle band. The final decision to accept this medium was due to a lack of standard broadcast bands, poor quality due to fading, increasing interference from foreign stations, and particularly the striking quality results achieved in difficult receiving areas. A report on these results, which appeared in the "BBC Quarterly," indicated that the sound quality was much better and there was generally less background noise, facts with which many hi-fi conscious listeners over here are quite familiar.

The introduction of the very-high frequencies and FM in England, featuring specially prepared BBC programs, will undoubtedly create a new family of high-fidelity enthusiasts whose reactions will probably be watched closely by the rabid wide-range fans over here. . . . L.W.

LEAD-IN CLEARANCE

FROM Guy F. Butts, 320 Lakewood Drive, Asheville, North Carolina comes a worthwhile service suggestion which we would like to pass on to technicians.

Mr. Butts warns that often lead-in clearance at the mast, near metal tension screens, metal casement windows, metal foundation ventilator grilles, basement pipes, and heating air ducts is inadequate and is responsible for a lot of service headaches.

He cites two recent cases of "snow" that were traced to a foundation grille and a metal casement window. Vibration had cut through the insulation in the first case and closing pressure had destroyed the insulation in the second case. He suggests that what was true in these two cases could also apply to tension window screens or ordinary screen wire used on enclosed porches if the lead-in comes in contact with those surfaces.

-30-

March, 1952

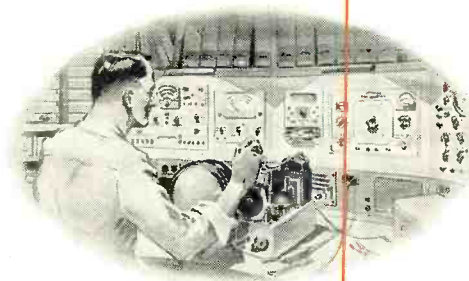

Send 10c to
Sprague for
window-size
blow-ups of
this message

ARE SERVICEMEN GYPS?

Every so often, some national magazine sounds off about radio-television servicemen.

"Servicemen are a bunch of gyps," is the general theme. "They'll clip you if you don't watch out."

They might just as well write the same thing of doctors, lawyers, storekeepers, auto mechanics—or anyone else. There are gyps in every line. Actually, the percentage in radio is far lower than in most.

The average serviceman—and I have met thousands during 30 years in radio parts manufacture—is a hard-working, straight-shooting individual. Rather than gyp customers, he is far more likely to spend more time on a job than he knows he will be paid for—simply as a matter of personal pride in doing things right.

The other evening, a friend's TV set went bad. A serviceman called for it in his truck and returned it in good working condition within 48 hours. His bill came to \$10 for service plus \$2.68 for replacement parts.

My friend argued that this was too much—yet he would never dream of complaining to the medical specialist who charged him \$10 for a 15-minute office visit; the lawyer whose bill for writing a simple will was \$75; or the garage man who, as my friend laughingly admits, charges \$5 for "just raising the hood" of his car.

In a large Eastern city having over 800,000 TV receivers, the Better Business Bureau received complaints about service on only 1/10 of 1% of the sets in a year. Investigation showed that most of these came from folks who

expected first-class reception in doubtful fringe areas; who tried to operate their sets without suitable antennas, or who had bought sets "wholesale" or at ridiculously low prices from cut-rate dealers who could offer little or no service.

Actually, it takes almost as long to become a good serviceman as it does to train for any other profession. Beyond this, it calls for regular study to keep up with the constant stream of new developments. Also, it requires a surprisingly big investment in test instruments, manuals and other shop equipment. The modern radio or TV receiver is by far the most intricate piece of equipment the average person ever owns or uses.

Servicemen are not fly-by-night businessmen. Ninety-nine out of 100 radio-television servicemen run their businesses properly. The other one per cent—the gyps—can usually be spotted a mile away. Nine times out of ten, they are the shops that feature "bargain" prices and ridiculously liberal service contracts. And their victims are generally set owners who expect to beat the game by "getting something for nothing."

Good television sets or good TV service are not things to be bought on a "bargain counter" basis. Set owners who recognize this aren't likely to get gypped.

Instead, they'll find that they get more real value for their television entertainment dollars than for almost any other dollars they spend!

Harry Nathan
PRESIDENT

SPRAGUE PRODUCTS COMPANY
(Distributors' Division of the Sprague Electric Company)
North Adams, Mass.



WORLD'S LARGEST CAPACITOR MANUFACTURER

ATR

Makes
it easy
to DEMONSTRATE
AND TEST
D.C. APPARATUS
FROM A.C. LINES



"A" BATTERY ELIMINATORS

For DEMONSTRATING AND TESTING
AUTO RADIOS

New Models . . . Designed for testing D.C.
Electrical Apparatus on Regular A.C. Lines.
Equipped with Full-Wave Dry Disc Type
Rectifier, Assuring Noise-less, Interfer-
ence-Free Operation and Extreme
Long Life and Reliability.

ATR

✓ NEW MODELS

✓ NEW DESIGNS

✓ NEW LITERATURE

"A" Battery Eliminators, DC-AC Inverters
Auto Radio Vibrators

See your jobber or write factory

AMERICAN TELEVISION & RADIO CO.

Quality Products Since 1931

SAINT PAUL 1, MINNESOTA-U.S.A.

RADIO-TV Service Industry News

AS REPORTED BY THE
TELEVISION TECHNICIANS LECTURE BUREAU

WHEN major changes occur in a basic business activity they seldom happen with dramatic speed. This is especially true when the affected business is a supplementary part or function of a development of first magnitude such as occurred with the widespread public acceptance of the automobile, electric refrigerator, the self-service cash-and-carry grocery store, and recently, of course, television. Each of these developments gradually brought about tremendous changes in our pattern of living and in so doing they created a myriad of new types of businesses with their inherent opportunities. At the same time they smothered the businesses that had been serving the out-moded method that the new development had displaced.

The transition of a business activity to meet the peculiar needs of the market for newly created products occurs subtly and comparatively slowly. When something radically new is created it first seeks its markets through existing business channels. From this it gradually expands to create its own economic pattern and in so doing remains profitable only to those business enterprises which are able to adjust their methods of operation to meet its individual needs. In the early days of the automobile, gasoline was handled by drug stores and automobiles were repaired by blacksmiths.

The statistics that eventually give us the true picture of what has been a major business transition usually lag so far behind the development that when they are published we learn what has *happened* instead of what is *happening*.

However, spot surveys that are being made at regular intervals by competent market analysts will often disclose a definite trend which, to the alert businessman, can be of invaluable assistance in helping him to project long-range plans.

As an example of how statistics definitely indicate a trend, back in 1948 the "Service Trades" bulletin included in the U. S. Census of Business for that year, in referring to "radio repair shops," showed that in 1939 there were 10,732 shops operated by 11,000 active

proprietors with 2842 employees. In 1948 there were 12,588 shops operated by 12,955 active proprietors with 10,262 employees. Gross receipts per shop increased from \$21,687 in 1939 to \$100,679 in 1948. Payrolls increased from \$2004 per shop in 1939 to \$20,791 per shop in 1948.

From these figures it is evident that while the number of shops increased only a scant 20%, the number of paid employees increased nearly five times or at about the same rate as gross income. The number of proprietors increased at a slower rate than the number of shops. These figures bring the situation up only to 1948, however, when the greatest swing in the transition of the service business had not yet come about.

Since then it has become increasingly evident that the television service business has not only shown a definite pattern of growth but that it is also following, to a recognizable degree, the pattern of other large service industries.

The new stature of television service as a business was succinctly described by Louis J. Smith, a prominent television service contractor in Philadelphia, Pa., during a recent interview on the "People's Forum" program aired by radio station KYW of Philadelphia. In reply to questions about the Television Contractors Association (TCA) and its function in the radio and television service business, Mr. Smith said:

"TCA is a group of television and radio service contractors who, in this complex electronics age, are most intelligently geared to provide the best and the maximum in service to the consumer. They have office staffs to handle customer requests and to dispatch service calls. They have complete libraries of all diagrams necessary to guide the competent technician in doing a good job. They have vehicles specially fitted to provide speedy transportation for the technician, his equipment, and spare parts so that the consumer is most efficiently served. They have completely fitted service shops that have all of the test equipment that is needed, together with a well-stocked parts department which contains the most needed parts.

"With the advent of television, an

RADIO & TELEVISION NEWS

NIAGARA TOPS 'EM ALL!



SYNCHRO-SELSYNS

All Brand New

Machine aluminum housing and case. Bakelite end cap with coded screw terminals. 1/4" shaft.

C-78249 Cal. 11280 Synchro Differential 100 V. 60 Cycle. Price \$3.75
 C-78473 Cal. 13920 Repeater type XX 50 V. 50 Cycle. Price 3.75
 C-78411 Cal. 11925 Transmitter 50 V. 50 Cycle. Price 3.75

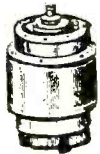

The below listed type is similar to above, but contained in a solid machined bronze housing. 5 leads 5 ft. long, of color coded fiber glass insulation are provided.

C-56776-1 Ca-4460A-1 Repeater type 11-5 110 V. 50 Cycle. Price \$7.50

National



SW-54

\$49⁹⁵



Sleek, Low-Priced, Beauty in a Compact General Coverage Receiver.

11" x 7" x 7"

NATIONAL SW54 IN STOCK

WRITE FOR FREE LITERATURE

REMOTE CONTROL

FOR THE

?? THING! ??

(Plus \$1.00 Book FREE!)

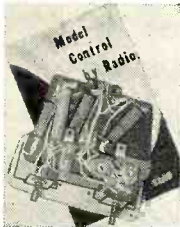

The answer to the "Remote Control" Experimenters' dream! A completely wired, 3-tube Remote Control Unit, originally used as ELECTRONIC BRAIN for remote thermostatic control of electric blankets. Can be used, with slight modification, to control model trains, planes, trucks, remote on-off for radios, doors, open and close garage doors from your car, or to remotely control any device in accordance with your own ingenuity. AND THAT'S NOT ALL! With each unit

we will give you, ABSOLUTELY FREE, one copy of Gernsback Library's popular new book "Model Control by Radio." 112 pages containing more than 125 illustrations, diagrams, tables, formulas, crammed full of theory and practical uses for electronic remote control. Remote control unit, including fil. ximur, 3000 ohm plate circuit "trigger" relay, completely wired with circuit diagram, and above described book, less \$5.50 tubes. Shug. wt. 3 lbs. All for only

WHEELER

Sound Powered HANDSETS



Model SPT-102

\$9⁶²

EACH

NO BATTERIES

NO OUTSIDE POWER

NO HAZARD

NO MAINTENANCE

\$36⁹⁶

EACH

MODEL SPS-205 MI 12 STATION MASTER Selective Ringing Intercom

IF YOU are involved in the present rapidly expanding range of electrical and mechanical control and communication products, we have something that may be extremely interesting to you. Wheeler Voice Powered Telephone Systems represent a considerable background of pioneer research and development. Today, this product, technically and commercially mature, has broad uses in both military and civilian fields. But over and beyond these standardized designs and applications they make many special high level handset units and signaling components for "built-in" applications. Further information on request.

WRITE FOR FREE COMPLETE WHEELER CATALOG.

ARC-5/R-28 RECEIVER

100-156 Mcs.

New or Used

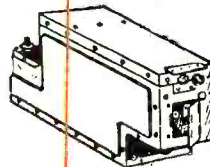

Here is the aircraft superhet you have been looking for. Absolutely one of the best available today. Tunes from 100 to 156 mcs. in four crystal channels. Accurately calibrated dial on front panel.

Contains the following tubes: 717a—R.F., 717a—Mixer, 2—12SH7—1st and 2nd I.F. (16.9 mc.), 12SL7—Det., AVC, Squelch, 12SL7—1st audio, and squelch amplifier, 12A6—2nd audio, 12SH7—R.F. Osc. and 4th harmonic gen., 717a—trip. 12th Harmonic gen., 717a—Dblr. 24th Harmonic gen. (all tubes are included.)

\$24.95

New, in sealed cartons. \$20.95 Used, excellent condition

T23/ARC-5 TRANSMITTER

FAMOUS AIRCRAFT TRANSMITTER. COMPANION TO ABOVE RECEIVER.

A desirable VHF transmitter with turret switching coils for all stages. Uses the following tubes: 1625 Osc., 1625 Tripler, 832 Tripler. 832 Final amplifier. Range: 100 to 156 Mcs. Four crystal channels are provided.

Brand new with all tubes, less crystals

\$39.95

A HIGH PRECISION VTVM KIT By



TOPS ON ANY WORK BENCH!

Versatility plus! 15 different ranges. Resistance ranges from .2 ohms to 1000 megohms in 5 steps! Exceptionally accurate. Big 4 1/2" fused meter. Dozens of features too numerous to mention. Sum it up in one word.

TERRIFIC!

EICO VTVM Kit No. 221 \$25.95
 EICO VTVM, wired and tested. \$49.95



Write for Free EICO Catalogue

HEART OF THE BC-221

FREQ. METER

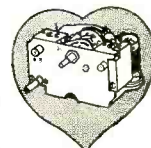

This VFO Sub-Assembly, used in BC-221 Freq. Meter, is ideally suited for home construction of: 1—Amateur V.F.O., 2—Freq. Mtr. Foundation, 3—Portable Transmitter, 4—Replacement for BC-221. Unit contains two temperature and moisture compensating coils, water switch, 3 variable condensers, carbon resistors and silver mica condensers. FULLY WIRED and mounted on sturdy aluminum sub-chassis, ready for installation. Brand new—in original packing. New Low Price \$4.95

WEBSTER CHICAGO

AUTOMATIC RECORD CHANGER 3-SPEED



SERIES 100-75

WITH FLIP-OVER CARTRIDGE

Fine, new record changers at less than regular manufacturer's cost. Made by Webster-Chicago and only introduced on the market a few months ago as one of their latest models. Plays 12, 10 or 7 inch records at 33 1/3, 45, or 78 R.P.M. New spindle carefully lowers unplayed record stack. Balanced arm assures light needle pressure and long wear. Needle-tip (included) for standard or micro-groove records. Inside-out records played without any adjustment. Pickup arm comes to rest position after last record has played. Complete factory packed and sealed record changers, normally listing at \$47.50—While they last \$24.85 last. Shipping Wgt. 15 lbs.

Niagara

ONE OF AMERICA'S GREAT RADIO STORES

RADIO SUPPLY CORP. R-3-2

160 Greenwich Street, New York 6, N. Y.

Digby 9-1132-3-4

TYPE C SQUARE OR RECTANGULAR FINISH—GIFT OF 10" SPEAKERS
TYPE D BROWN OR LACQUER FINISH—GIFT OF 10" SPEAKERS

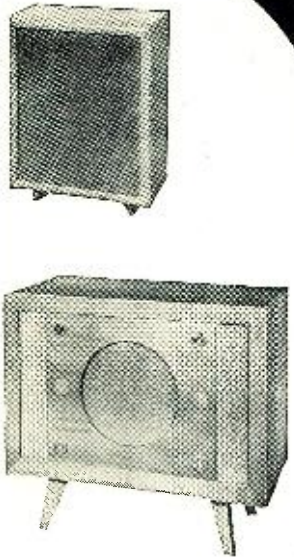

acoustically-correct
handsomely styled
durably constructed

BASS REFLEX CABINETS by ensen

JENSEN MANUFACTURING COMPANY
DIVISION OF THE MUTER COMPANY
6601 S. LARAMIE AVENUE • CHICAGO 38, ILLINOIS

WRITE FOR
DATA SHEET 162

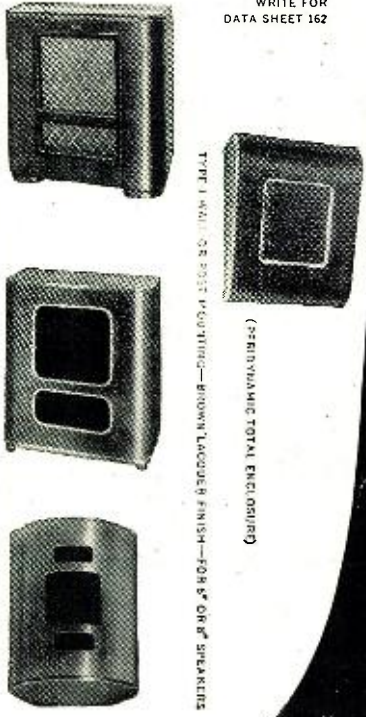

TYPE D BROWN OR LACQUER FINISH—GIFT OF 10" SPEAKERS
TYPE B BROWN LACQUER FINISH—GIFT OF 10" SPEAKERS
TYPE A BROWN LACQUER FINISH FOR 5" SPEAKERS

(SERVING MUSIC TOTAL ENCLOSURE)
TYPE A WALL OR POST MOUNTING—BROWN LACQUER FINISH—FOR 5" OR 6" SPEAKERS

instrument that has six to ten times the parts of an average radio, combining audio and video (voice and sound), we found that many more facilities, test instruments, and non-technical people (such as clerks, dispatchers, cost accountants, supervisors, etc.) were needed to conduct an efficient, consistently reliable service business. The radio technician who, in addition to his technical qualifications, possessed the business qualifications needed to operate such a business soon developed into what is known as a 'service contractor.' This new businessman-technician soon found that the major part of his activity was concerned with the details of business management of the operations. He hired a service manager to take care of technical problems.

"With business problems his foremost interest the service contractor, like businessmen in other fields, observed the need for a trade association which would enable him to exchange information and knowledge with his competitors on common problems for their mutual good and for better service to the consumer. The natural culmination of this thought was the organization of the Television Contractors Association."

The business aspects of television servicing are clearly reflected in the following statement about television servicing business possibilities in 1952 which was made recently by a prominent TV market research specialist:

"There will be plenty of business for the TV serviceman in 1952. The rapid growth of television markets will make his business more active but it will also create tremendous problems. He will face new financing problems, will probably have to expand the space his business occupies. He will find that expanding operations will mean he will have to hire more help, find and train salesmen. He will also be faced with problems of supervising expanded operations and will have to assume the moral obligation that goes with assisting in the training of repairmen in problems pertaining to technical knowledge, business knowledge, and business ethics."

Turning again to statistics to get a clear picture of the reasons for this vast transition in the service business, the following figures from the 1951 edition of "National Income" published by the Bureau of Foreign and Domestic Commerce, Office of Business Economics, U. S. Department of Commerce depict the tremendous increase in dollar volume of business that has occurred in the radio-television servicing industry during the past ten years:

(These represent over-all expenditures in millions of dollars.)

1941	\$ 36
1942	46
1943	59
1944	70
1945	84
1946	114
1947	135
1948	172
1949	206
1950	272

These figures indicate that during

PHOTOCON SALES

1062 N. Allen Ave. SYcamore 4-7156
Pasadena 7, Calif. RYan 1-8271

WRITE FOR OUR WINTER SURPLUS SALES CATALOGUE

WE WILL BUY YOUR NEW OR CLEAN USED ELECTRONIC SURPLUS: ARC-1, ARC-3, BC-224, BC-348, BC-312, BC-342, ATC, ART-13, APS-13, BC-221, LM's, TS-12, TS-13, TS-23, TS-34, TS-35, IE-19A, I-222, SCR-522, TS-100, or any BC, I, IE, TS, APR.

WRITE FOR PRICES:
APR4, TS13/AP, TS34/AP, TS148/UP, ARC1, ART13, APA11, TS184, TS251, etc.

DuMont 208 5" OscilloscopeEXCELLENT	\$225.00
804B General Radio Signal Generator 8-330 mc.EXCELLENT	300.00
APN-1 Altimeter Indicator 0-1 ma. shunt, 250° dial.NEW	2.95
LM & BC-221 Frequency Meter with cal. book, crystal, and tubes.EXCELLENT	99.50
SCR-625 Mine Detector.NEW	69.50
	USED	39.50
AN/APN4B CompleteEXCELLENT	150.00
PE-218 Inverter 400NNEW	29.50
Weston Model 545 Tachometer MeterNEW	17.50
HS-33 600 ohm Headsets.USED	3.50
NEW	5.95
400 cycle Inverters—G.E. 5D21NJ3A Input 24V. DC. Output 115V. AC. 400 cycles 485 V.A.NEW	24.50
DuMont 241 Oscilloscope.EXCELLENT	300.00
G.E. Oscilloscope CRO5Y.EXCELLENT	225.00
Drafting Machine single scale 16" Fulcrum less scale. Exc.	35.00
CRT-3 Two-Channel Gibson Girl.NEW	75.00
DuMont 224 Oscilloscope less front cover.EXCELLENT	125.00
TS173/UP Freq. MeterEXCELLENT COND.	600.00
Genescope—Superior 480NEW	340.00
I-96A Signal Generator.LIKE NEW	375.00

NOTE: One of the largest and most complete electronic surplus stocks in the country. We have thousands of tubes, capacitors, plugs, accessories, transmitters-receivers, test equipment, etc. Send us your requirements.

TERMS: Prices F.O.B. Pasadena, California. 25% on all C.O.D. orders. Californians add 3% Sales Tax. Prices subject to change without notice.

There is Nothing for us to Add...

...when BROOK AMPLIFIER owners tell the story so much better.

"...absolutely tremendous"
"It is excellent...better than I had anticipated."
"In years of building amplifiers, trying out almost every quality unit on the market, I still have yet to find any unit that even comes close in performance and pure enjoyment...consistent enjoyment to the BROOK."
"I still think there is nothing quite like the BROOK."

May we suggest that you assemble your home music system around

THE **BROOK**

ALL TRIODE HIGH QUALITY
AUDIO AMPLIFIER

Write for detailed information, free booklet, *Better Listening*, and name of dealer in your locality. Dept. RC-2

BROOK ELECTRONICS, INC.
34 DeHART PLACE, ELIZABETH 2, N.J.

the past ten years the dollar volume of business flowing into radio-television service shops increased more than seven and one-half times. They also show that the increase has been getting greater each year and especially so since 1948. This fact alone is quite interesting in view of the station construction freeze which prevented the opening of new television receiver markets during the same period.

On the basis of these statistics it is obvious, too, that the opening of new telecasting areas after the station construction freeze has been lifted, will greatly accelerate the increase in the dollar volume of service business in the years immediately ahead.

The conclusion to be drawn from these figures is simply that present television service businesses must prepare to expand their facilities and personnel to handle a growing volume of business or new radio-television service businesses will come into being to handle the growth.

New TV Areas

The green light on the construction of u.h.f. telecasting stations will immediately create a potential of more than one thousand new cities and towns that will be primary signal areas. At the present time a large percentage of these areas are fringe, far fringe, or completely out of the signal areas of present telecasting stations. They will be, in effect, brand new television markets and provide very fertile ground for new television service businesses.

Television at the ultra highs will present many new problems to the service forces of the industry that they have not had to contend with in the present v.h.f. ranges. It is quite probable that every u.h.f.-v.h.f. television receiver sold in a primary u.h.f. signal area will include an outdoor antenna installation, a rotator, and perhaps a booster. The reason for this is that the majority of cities and towns where new u.h.f. television stations are constructed will also be in the fringe areas of other u.h.f. as well as v.h.f. stations. Customers who purchase receivers with facilities for tuning in twelve stations will want to get the maximum number of stations possible in the area in which they live. Alert set retailers and servicing contractors in those areas will quickly learn to take the same advantage of this potential market for supplementary sales as the service contractors have done in the fringe and far-fringe areas of present telecasting stations.

Radio service operators whose businesses are located in cities where the first local telecasting station will operate on a u.h.f. channel can probably anticipate installation requirements in their localities by studying the v.h.f. and u.h.f. channel allocations for nearby cities.

The Television Technicians Lecture Bureau has prepared a lecture on u.h.f. television which covers complete conversion and alignment instructions on
March, 1952

In Sales...
PENN TOWERS
above all others



PRODUCT DEVELOPMENT ENGINEERING

will keep it that way

You have less sales resistance to overcome when you sell Teletowers. You offer a product that "towers" above all competition in consumer acceptance. Teletowers lead in sales because Teletowers lead in product development engineering.

Here are just a few of the popular and effective engineering features developed by Teletowers (1) The straight top section (2) The adjustable roof mount (3) The built-in base (4) The universal motor mount.

Remember—Teletowers top your "roof-top market" . . . and since they're going to stay up there . . . it will pay you to stay tuned in with Teletowers!

CANADIAN REPRESENTATIVE:
Atlas Radio Corp., Ltd., 560 King Street,
W. Toronto. Canada.

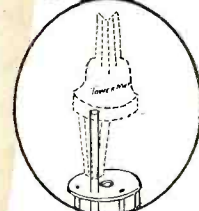

Penn's Universal Motor Mount is easily and quickly adapted to all antennarotors.

PENN

*Teletowers
Rooftowers
Antenna-Mast
Hardware*

PENN BOILER & BURNER MFG. CORP., LANCASTER, PA.

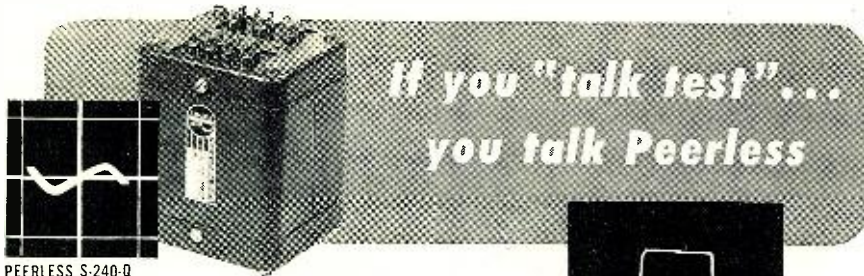

PEERLESS S-240-Q

all tests demonstrate
PEERLESS
superiority

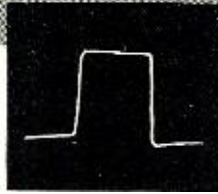

Square Wave



Competitor No. 1



Competitor No. 2



Competitor No. 3



Competitor No. 4

Comparative square wave tests on transformers shown all over the country have demonstrated Peerless superiority... Now Peerless emphasizes another very important property of transformers as shown by the "exciting current test." An output transformer's ability to deliver plenty of clean, low-frequency power (the goal of every music lover) is inversely proportional to the amplitude and distortion of its exciting current.

PEERLESS superior low-frequency power handling capacity is illustrated in these comparative oscillograms.

Write for complete data.

PEERLESS
Electrical Products

9356 Santa Monica Blvd.
Beverly Hills, Calif.

161 Sixth Avenue
New York 13, N.Y.



Division



u.h.f. tuners and demonstrations. This lecture is now available for presentation in any community in the United States. Information on this non-commercial presentation of u.h.f. television may be obtained from local radio parts distributors or by writing the Bureau at P. O. Box 1321, Indianapolis 6, Indiana.

It has been interesting to observe that, where they have been competently managed, TV installation and service businesses in the fringe and far-fringe areas of present v.h.f. stations have generally been very successful and profitable. There is a two-fold reason for this. In selling receivers in fringe areas set dealers learned early in the game that it was business suicide to over-sell the reception that could be consistently expected in a fringe location. They also found that it was not necessary to over-sell the performance of the receiver when the buyer was properly sold on the wonders of television itself.

In far-fringe and many fringe areas the cost of a satisfactory antenna installation with a mast or tower, rotator, and one or two boosters, sometimes equals the cost of the receiver itself.

The set dealer or installation and service contractor who handles this class of business has to make a substantial investment in installation and servicing equipment. This requirement shuts out the shoestring operator and leaves this business in the hands of businessmen who know that consistent and satisfactory television service can be maintained only when such service businesses are operated at a profit.

A television service business capable of handling the installation and servicing requirements of receivers in these new u.h.f. areas will require a substantial investment in automotive equipment, tools, supplies, and replacement parts and accessories. It will also require the services of skilled installation technicians as well as shop and field servicing technicians to carry out the business at a profit.

As each new u.h.f. television area is opened there will be a minor boom in receiver sales and in installation and servicing business. After this initial boom has subsided, managers of the television service businesses that it created will be faced with the same problems of maintaining a satisfactory volume of business, as the service contractors in present v.h.f. areas.

Service Salesmanship

There are three basic ways to operate a retail business and radio-television service is a retail business with the profitable sale of labor as its major product.

The first way is to open a store or shop and depend upon street traffic, a listing in the telephone directory, and an occasional small-sized ad in the local paper to bring in the work needed to keep the business going. This is definitely a negative approach to running a business because the most im-

**For High Fidelity
Multiple Speaker Installations
You Must Have
CROSSOVER
NETWORKS**

General Apparatus specializes in low cost, low frequency crossover networks and high inductance air core chokes, not available elsewhere at anything like our prices. For instance, here are X-over frequencies and prices for our 8-ohm networks:

85 CYCLES	\$26.50
175 CYCLES	\$24.00
350 CYCLES	\$17.50
550 CYCLES	\$13.00
1100 CYCLES	\$12.00
2200 CYCLES	\$11.00

These are sharp attenuation networks (12 db) and are complete with TWO coils, capacitors, and level controls. Coils are wound with heavy No. 17 enameled copper wire. They are available separately at the following prices per coil: 10.2 Mh, \$10; 5.1 Mh, \$6; 1.6 Mh, \$3.50; and 0.8 Mh, \$3.00. Order directly from this advertisement or send 10c for instruction sheet giving complete details. All shipments C.O.D. unless accompanied by remittance in full plus 75c for postage and insurance.

General Apparatus Co.
Dept. D P.O. Box 182
SOUTH EGREMONT, MASS.

IT'S A SALES NATURAL
Because It's

TIP-PROOF



Tip-Proof

Model No. TA 135

**INDOOR TV
ANTENNA**

Complete with
twin lead.

Closes TV set sales
on-the-spot. One reason
why over 1,000,000 have
already been sold!

See Your Jobber or
Write for Brochure No. 16



MANUFACTURING CO., INC.

6129 16th Ave. Brooklyn 4, New York

First in Television Antennas and Accessories



BC605 INTERPHONE AMPLIFIER
Easily converted to an ideal inter-communications set for office—home—factory. Complete w/conversion diagram for 110V operation. **\$4.75**
Brand New.....

DYNAMOTORS

Type	Input Volts	Input Amps	Output Volts	Output Amps	Radio Set
PE86	28	1.25	250	.060	RC36
DM416	14	6.2	330	.170	RU 19
DM33A	28	7	540	.250	BC 456
PE101C	13/26	12.6	400	.135	SCR 515
BD AR 93	28	3.25	800	.020	
23350	27	1.75	375	.150	
ZA0515	12/24	4/2	500	.050	APN-1
B-19 pack	12	9.4	275	.110	MARK II
DA-104	12		500	.050	
			225	.100	
D-3A	28	10	440	.200	SCR 522
			300	.060	
			150	.010	
			14.5	.5	
S053	28	1.4	250	.060	APN-1
PT33CM	28	19	1000	.350	BC 375
CW21AAX	13	12.6	400	.135	
	26	6.3	800	.020	
			9	1.12	
PE94	28	10	300	.200	SCR 522
			150	.101	
			14.5	.5	

INVERTERS

PE-218-E: Input: 25 28 vdc. 92 amp. Output: 115v. 350-500 cy, 1500 volt-amperes. Dim: 17"x6 1/2"x10". New..... **\$34.50**
PE-218-H: Same as above, except size: 16"x6 1/2"x10". New..... **\$34.50**
PE-206: Input: 28 vdc. 38 amps. Output: 80 v 800 cy. 500 volt amps. Dim: 13"x5 1/2"x10 1/2". Sec: 50..... **\$22.50**

FULL WAVE BRIDGE SELENIUM RECTIFIERS

Up to 18v. RMS a.c. Input—Up to 14v. d.c. output	Price
2	\$ 2.50
4	4.00
6	6.00
10	7.50
12	9.00
20	15.00
24	18.00
30	21.00
36	27.00

Up to 36v. RMS a.c. Input—Up to 28v. d.c. output	Price
1	3.00
2	4.00
4	8.00
10	14.50
12	18.00
20	28.00
24	36.00
30	42.00
36	54.00

Up to 54v. RMS a.c. Input—Up to 42v. d.c. output	Price
2	6.50
4	8.50

Up to 115 v. RMS a.c. Input—Up to 100v. d.c. output	Price
2	11.00
10	48.00
12	60.00

SPECIAL RECTIFIERS ON REQUEST

Low-Voltage Transformers Primaries
115v., 60 Cycle

36V-40V at 3.5amps	\$3.75
24V-1.5A.....	1.95
8V-1.5A.....	.98
16V-4.5A.....	2.69

HI CAP. FILTER CONDENSERS

Cap. Mfd.	VVDC	Price
2000	6	\$1.85
500	20	2.00
250	150	1.45

VARISTORS

D-167176.....	\$.95
D-172155.....	2.25
D-168887.....	.95
D-171812.....	.95
D-171528.....	.95
D-162356 (308A).....	1.50

LINE FILTERS

LINE FILTER, GE 100 Amp Filter w/2x5 Mfd 50 μ oil cond. Operates on 110VAC DC..... **\$1.39**

1KW LINE FILTER, clean up BC1 & TV1. Easy to Mount..... **\$3.95**

Noise Filter, Jx51E, 10 Amp..... **\$1.29**
Noise Filter, Jx55D, 4 Amp..... **.35c**

A.C. ELECTROLYTICS

CAP.	VAC.	PRICE
13-15	220-	\$ 1.20
20-24	110	1.00
26-30	220-	1.35
43-65	110-	1.25
50-75	110-	1.25
53-60	220-	1.50
61-69	320-	1.60
64-72	110-	1.25
72-87	110-	1.25
75-84	110-	1.25
88-106	110-	1.50
107-129	110-	1.65
130-157	110-	1.75
130-150	70-	1.50
130-180	110-	1.85
158-191	110-	1.85
161-130	110-	1.75
189-210	110-	1.95
200-220	110-	1.95
201-210	110-	2.10
324-360	110-	2.40
378-420	175-	3.00
432-480	110-	2.75
485-540	110-	2.85

OIL CONDENSERS

Mfd.	Volt	Price
5	50	\$ 0.45
650	110	1.95
1.5	220 AC	2.20
0.5	750 AC	1.59
0.5	1000	.69
2x0.5	1000	.70
1	1000	.75
1.5	1000	.85
2	1000	.90
4	1000	1.75
3x.01	1200	1.35
1	1500	1.30
1.5	1500	1.40
2	1500	1.45
0.15	4000	1.20
2x0.1	4800	1.20
0.1	6000	2.39
1.5	6000	17.50
2x0.1	7000	2.95
0.015	16000	3.95
.25	20000	5.95
1	25000	
1.5	25000	
1	7500	

MANY OTHERS

THERMISTORS

D-166228.....	\$ 1.50
D-167332 (tube).....	1.50
D-170396 (button).....	1.50
D-167813 (button).....	1.50
D-164699 for MTG.....	
X band Guide. \$2.50	

932 PHOTO TUBE

Gas Photo-tube having S1 response, particularly sensitive to Red and Near Infrared Radiation. Can be used with incandescent light source. Send for Data. Price..... **75c**

POWER TRANSFORMERS

Comb. Transformers—115V/50-60 cps input.

CT-77B	5500V/002A 2.5V/2A, 12KV TEST	\$12.95
CT-75B	1200VCT/600MA, 2X5VCT/6.2A	14.95
CT-825	360VCT .340	
CT-626	1500V .160	6.3VCT/3A 3.95
XT-15A	350VCT .070	2.5/12, 30/100 9.95
		6.3/6, 6.3/1.8, 3 lbs. 2.95
CT-071	110V .200	33/200, 5V/10 4.95
		2.5/10 4.95
CT-378	2300V .4 MA	2.5/2 6.95
CT-367	580VCT .050	5VCT/3A 2.25
CT-721	550VCT .100	6.3/1, 2.5VCT/ 2. 2.95
CT-99A	2x110VCT .010	6.3/1A, 2.5 VCT/7A..... 3.25
CT-403	350VCT .026 MA	5V/3A, 6.3V/ 3A..... 2.75
CT-931	585VCT .036	5V/3A, 6.3V/ 6A..... 2.45
CT-610	1250 .002 MA	2.5/2.1A, 2.5 V/1.75A..... 4.95
CT-137	350VCT .026 MA	5V/3A..... 2.75
CT-866	330V .065	6.3V/1.2, 6.3V/ 600 MA..... 1.75
CT-456	390VCT 30 MA	6.3V/1.3A, 5V/ 3A..... 3.45
CT-160	800VCT .100 MA	6.3V/1.2A, 5V/ 3A..... 4.95
CT-931	585VCT 86 MA	5V/3A, 6.3V/ 6A..... 4.95
CT-442	525VCT 75 MA	5V/2A, 10VCT 2A, 50V/200 MA..... 3.85

Filament Transformers—115V/50-60 cps input.

Item	Rating	Each
FTG-31	2.5V/2.5, 7V/7A (Tape @ 2.5V/2.5A)	\$ 9.95
FT-674	8.1V/1.5A	1.10
FT-157	4V/16A, 2.5V/1.75A	2.95
FT-101	6V/25A	.79
FT-924	5.25V/21A, 2x7.5V/6.5A	17.95
FT-104	6V, 3A	4.79
FT-824	2x3V/2.5A, 16V/1A, 7.2V/7A, 6.4V/ 10A, 6.4V/2A..... 12.95	
FT-463	6.3VCT/1A, 5VCT/3A, 5VCT/3A..... 5.49	
FT-55-2	7.2V/21.5A, 6.5V/6.85A, 5V/6A, 5V/ 3A..... 8.95	
FT-986	10V @ 4.5A or 12V @ 4.5A	2.69
FT-38A	6.3/2.5A, 2x2.5V/7A	4.19
FT-A27	2x3V/2.5A, 7V/7A, TAP 2.5V/2.5A, 16KV TEST	18.95
FT-340	2x2.5V/3A, 7V/7A—23KV TEST	24.95
FT-038	6.3V/500A WELD	29.45

Plate Transformers—115V/50-60 cps input.

Item	Rating	Each
PT-919	1200—0-1200 200 MA	\$ 8.95
PT-976	Auto: 120VCT/10 MA	.69
PT-31A	2x300V/5 MA	.79
PT-46A	408VCT N.L. 3% to 18" Hx6" Wx7" L, 20 lbs.	29.95
PT-75-2	3780/3446/3112VCT/77MA	10.95
PT-28-1	4600VCT/0.77	12.95
PT-403	Auto: 70V/1A	2.29
PT-160	1120VCT/770 MA, 590VCT/82 MA, 23 lbs.	24.95
PT-170	Auto: 156/146/137/128—.71A	3.29
PT-31A	2x300V/5 MA	.79
PT-976	120VCT/10 MA	.79
PT-12A	280VCT/1.2A	2.95
PT-614	4730VCT/500MA, 12KV INS	29.95

Special Filament Transformers

Item	Pri.	Output	Price
STF-05A	115/230	2x5V/7.57" Hx7"x5" D.....	\$ 4.25
STF-96B	230	2.5V/6.3A.....	1.45
STF-37A	220/440	3x2.5V/37, 2.5V/15A, 5 1/2" x5 1/4".....	5.25
STF-11A	220	2x40V/.05/2x5V/6A, 12.6/1A.....	2.95
STF-631	230	2x5V/27A, 2x5V/9A, 100/4Hx5.57" 30 lbs.....	24.95
STF-370	220/440V	3x2.5V/3A, 2.5V/15A.....	9.95
STF-085	220/440V	2.5V/60 ACT.....	15.95
STF-083	220/440V	5VCT/30A, 3000V TEST.....	17.50

115 V-400CY XFMR'S

Stock	Ratings	Price
901699-501	2.77V @ 4.25A	\$ 3.45
901698-501	900V/75 MA, 100V/04A.....	4.29
UX8855C	900VCT/067A, 5V/3A.....	3.79
RA6405-1	800VCT/65MA, 5VCT/3A.....	3.59
T-4852	700VCT/80 MA, 5V/3A, 6V/1.75A.....	4.25
352-7098	2500V/6MA, 300VCT/135 MA, 5.95	
KS-9336	1100V/50MA TAPPED 625V, 2.5V/ 3A.....	3.95
M-7474319	6.3V/2.7A, 6.3V/ 66A, 6.3VCT/21A 27V/4.3A, 6.3V/2.9A, 1.25V/.02A.....	4.25
KS-898A	326VCT/50MA, 6.3VCT/2A, 5VCT/ 2A.....	2.95
52C080	400VCT/35MA, 6.4V/2.5A, 6.4V/ 1.5A.....	3.75
32332	1150-0-1150V.....	3.85
68G631	6VCT, 00006 KVA.....	1.75
80G198	6.4V/8A, 6.4V/1A.....	2.79
D-167254	6.3V/9.1A, 6.3VCT/6.5A, 2.5V/ 3.5A, 2.5V/3.5A.....	4.85
KS-9445	59.2VCT/118MA, 6.3V/S.I.A., 5V/ 2A.....	5.39
KS-9685	6.4V/7.5A, 6.4V/3.8A, 6.4V/2.5A.....	4.79
ALL CT		
70G30G1	600 VCT/36 MA.....	2.65
M-7474318	210V/10A.....	4.95
95-G-45	2000V/002A, 2000V/NL, 465V/6A 44V/10A, 6.3V/23.5A, 6.3V/1.8A, 5V/9A, 2x2.5V/1.75A.....	17.95

SPECIALS

Time Delay Relay—45 Sec. 115VAC-DC 10A..... **\$ 2.29**
Carbon Pile Reg., 18V—5V—35X025.....
ART 13 Driver Trans. 6V6 to P-P 811's..... **1.29**
D M34 Dynamotor, 14V In, 220V, 80 Ma out..... **8.95**
Sens. Relay: 3.5 MA, 13K ohms, 2PST, 2A..... **1.29**
Klixon Breaker: Thermo 35A..... **.69**
T 30 Carbon Mikes—New..... **.89**
Screen Mod. Trans. for 807's..... **1.19**
3 4 MC coils for ARC-5 Trans. #6020, #7247, Set..... **2.79**
RI-7 Interphone Amplifier..... **2.39**
Filter, 10Pass, 10,000 ohm imp.—20 db. down at 6000 CPS GR 330-404.....
Photo-Print Paper 35 MM. Strip, 250 Ft. Roll, #2 contrast Vacuum Pack—Guaranteed, 79c each or 3 Rolls for..... **2.00**
Teletype Tape, 3/8" W x 4" Rolls, 12c Each, 10/..... **1.00**
5 1/2 Rolls, 23c Each or 5 for..... **1.00**
BC 30A ATFLNNA TUNING UNIT, NEW..... **6.95**
R9/APN-4, 6w. With Tubes..... **75.00**
ID6/APN-4, New, With Tubes..... **75.00**
A-62 Phantom Antennae..... **8.50**
2 Meter Choke, 1000 MA, ZO-144..... **1.00**
Supersonic Crystal Head, Model I..... **27.45**
Underwater Microphone, Model JR..... **24.50**
Dynam. Mike & Headset Combo. B-19..... **3.75**
HS-30 Inserts, M-300..... **1000/ 3.50**
Motors, 3 RPM, 115V, 60 cy..... **1.85**

POWER EQUIPMENT

STEP DOWN TRANSFORMER: Pri. 440/220110 volts a.c. 60 cycles. 3KVA. Sec. 115v. 2500 volt insulation. Size 12"x12"x7"..... **\$40.00**
PLATE TRANSFORMER: Pri: 117v. 60 cy. Sec: 17,600 @ 144 ma. with choke. Oil immersed. Size: 20"x30"x13" American..... **\$120.00**
FIL. TRANS. UX6899: Pri: 115 v. 60 cy. Sec. Two 5v. .5 amp. wdgs. 29 KV test..... **\$24.50**
VOLTAGE REG. Transtat. Amertran type RH 2 KV, load, input: 90/130 v. 50-60 cy., output 115 V..... **\$40.00**
UX 6301 (Raytheon): Pri: 110 v. 60 cy. i. pl. Sec: 22,000 v. 234 ma., 5.35 KVA., Dim: 23"x24"x10 1/2". Low capacitance..... **\$185.00**
FIL XFMR: Kenyon: Pri: 210/215/220/225/230V/ 235/240 vac. 60 cy. Sec: 11 v., 35 amp; 10 1. 35 amp; ct; 7.5 v. 35 amp; ct; 5v. 35 amp; ct; #8-10768..... **\$37.50**
FIL TRANS. KS876: Pri: 115 v. 60 cy. Sec: 2 windings. @ 3 amps each 15 KV test..... **\$150.00**

A/N TEST SETS

TS 564/AP 1-158	TS 47/APR	TS 250/APN
CW60/ABM 1-222	TS 56/ABP	TS 89
LU-1	1-185	TS 12 UNIT 2
LU-3	1-185	Q. METER
TS 159	TS 268/U	TS 69/AP
CS-60/ABW	TS 102/AP	TS 226
		BC 438

SEND FOR FURTHER INFORMATION AND PRICES

B-19 MK11 TRANS-RECEIVER \$32.50
Less Power Pack..... **8.95**
B 19 Power Pack..... **8.95**

ARC-5 MOD. LATOR MD7/ARCS Plate Modulator w/dynamotor complete w/Tubes 1-12J5, 2-1625, 1-VR50. Good cond. Price..... **\$7.95**

FILTER CHOKES

Stock	Description	Price
CH-250		

Successful TV Service Men MUST Be Good Business Men

In operating a TV Service Shop, the technician finds himself called upon to be a business man—in charge of a complex, major operation. For this reason, SERVICE MANAGEMENT MAGAZINE places great emphasis on the vitally essential *business* fundamentals—including the knack of getting along with the public.

TV Service Demands Sound Management

To survive, to thrive, to make money, the TV Service Man needs a grasp of salesmanship, advertising, financing, accounting, stock purchasing. He must know how to hire and train the right kind of personnel. He must watch collections, carefully maintain his credit-rating. He should know how to apportion his available capital, how to get along with his banker.

Realizing that business skill is as important as technical talent, SERVICE MANAGEMENT MAGAZINE includes valuable articles monthly on business procedures.

Why not send for a sample copy? Or, better still, send \$3.00 for a full year's subscription. Use the convenient coupon—*now*.

SERVICE MANAGEMENT

The Business Magazine of the
Radio-Electronics Industry

161 Luckie St. Atlanta, Georgia

Service Management, 161 Luckie St.
Atlanta, Georgia

Enclosed find \$3.00 for which enter a
year's subscription.

Name

Address

City..... State.....

portant factor in the business—volume of service work—is left purely to chance.

The second way is to add a sales and advertising touch to the business by contacting set retailers regularly to handle their service work and that of their customers. The business promotion through advertising is accomplished by maintaining a mailing list of set owners and sending them appropriate service business solicitation cards at regular intervals.

The cards that are supplied by the various tube manufacturers for direct-mail solicitation of service work are exceptionally good for this purpose. However, to accomplish the purpose for which they were intended it is necessary to carry out a continuing program by mailing the various cards in a series at regular intervals.

These personal contacts with set retailers and the use of a regular direct mail program represent aggressive selling tactics that are necessary to create business. However, they do take time.

The third method of operating a retail service business is the retail merchandiser's way of conducting a business. It is based on a survey of the maximum service business potential in a given area and the creation of a selling program that will bring in a substantial part of that service volume. Where a market is given that kind of a study it is entirely possible to develop sales campaigns that will bring in service business during those periods when radio and television repair business normally is slack.

In present TV areas the average television-equipped home also has a radio-phonograph combination and several table model and portable radios. In addition, the family automobile is usually radio equipped and there is probably a battery-operated portable or two stored away in a closet after the "B" batteries went dead. In the average home where there are three or more table model radios, surveys consistently show that at least two of them, while still operating after a fashion, could use some repair.

In other words, the average home in a TV area today has from five to ten pieces of equipment that should have regular maintenance and service attention. The well-equipped radio-television service shop has the equipment, the personnel, and the "know-how" to keep all of those radio-electronic devices in top operating condition.

The radio-television service businessman who is willing to stake out an area of one thousand television-equipped homes and develop a program designed to make his organization the maintenance company for keeping all radio, television, and other electronic products in those homes in good operating condition would entrench his business in that community so solidly that neither competition nor seasonal slumps would have any serious effect on his business at any time.

ACORN HAS A NEW LOOK



Welcome to our friends, far and near to visit and browse at our completely renovated shop, conveniently located in the heart of downtown New York. Whether you visit in person or shop by mail, you can be sure of prompt and courteous attention.

DUMONT 4-CIRCUIT INPUTUNER

Featuring FM BAND reception, as well as 13 TV channels. Fits into dual channel IF system Type 630 Receivers without alteration. Higher gain 2-1 ratio on high channels, low noise, input impedance 300 ohms. 21.25 mc. sound center IF. Continuous tuning. Complete with TUBES and KNOBS. Dramatically reduced to..... **\$1995**

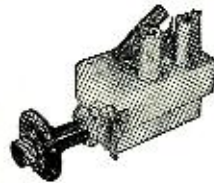

STANDARD Turret Type **\$1895** FRONT END

TYPE TV 201: 21.25 sound, for 630 chassis, etc.
TYPE TV 303: for all inter-carrier systems.

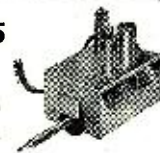

New Standard CASCO TUNER

Type 2027 for 630 TV Chassis, etc. Has greater sensitivity than any previous tuner. Uses 6BK7..... **\$2289**

CARTER DYNAMOTOR

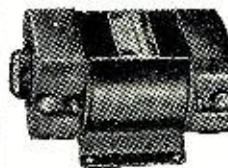

BRAND NEW
Stock No. 4037AS
DC input 6VDC
output 400 V @
375 m f i s. DC.
Perfect for mobile
communications in car,
plane or boat.
List price \$71.40
NEW
LOW
PRICE **\$2695**

OIL-FILLED CONDENSERS
Made by Nationally Known
Manufacturers **99c**
10 mfd, 600 V DC, 220 V AC, ea.
Mounting Bracket 15c ea.
Write for Quantity Prices

OUNCER TRANSFORMER C-429

Push-pull primary 85 ohms DC resistance, secondary resistance 10 ohms and 20 ohms..... **99c** each
3 for \$2.75

G.E. 12" SPEAKER

1201D-Alnico V Magnet-14.5 oz., Extended Range 50-15,000 cy. 25 watt..... **\$16.95**

TERMS: 20% cash with order, balance C.O.D. unless rated. Prices F.O.B. our warehouse in N. Y. C. Minimum order \$3. NOTE: Due to conditions beyond our control, prices are subject to change.

Phone WOrth 4-3270

ACORN ELECTRONICS CORP.

76 Vesey St., Dept. N-3, New York 7, N. Y.



RADIO ENGINEERING TELEVISION ELECTRONICS

Thorough training in all phases of radio and electronics, open to high school and junior college graduates. Old established school specializing in Radio training exclusively. Modern laboratories and courses. Enrollments limited. Approved veteran training.

VALPARAISO TECHNICAL INSTITUTE
Dept. RD Valparaiso, Ind.

International Short-Wave

(Continued from page 71)

sign-off. (Boice) Heard in New York as early as 1353 tune-in; signs off *without* playing "A Portuguesa;" seems to have news session in Portuguese 1420-1430 given by man and woman alternately; plays mostly classical music. (Bellington) A station believed CR6RN is noted on 9.635 with Portuguese music and announcements 1600; signs off 1630. CR6RD, *measured* 9.7047 at 1410, had musical program and heavy QRM. (Oskay, N. J.) This one noted recently with "mid-day" session 0630, good level in South Africa. A station noted on 7.764 probably is Silvo Porto; all-Portuguese programs noted through bad QRN 1515. (Ridgeway)

Argentina—LRX verified with a white card with LR1 on it in blue letters; listed LR1, 1070 kc., 50 kw.; LRX, 9.66, 7 kw., and LRX1, 6.120, 6 kw.; listed daily programs as "usually" 0530-2235. (Machwart, Mich.) LRT, 11.84, Tucuman, noted 1918 with North American recordings. LRS2, 9.320A, Buenos Aires, heard 2048 with music. (Winch, Calif.) LRS, 11.881, noted 1750 with good signal in England. (Catch) LRU, 15.29, noted signing off 1545, weak. (Niblack, Ind.)

Australia—Radio Australia's beam to Britain at 0245-0345 is carried over 9.580 and 11.760 (latter may be used for only part of this session); "Australian DX-ers Calling" on Sundays is now 0245 on both channels.

VLM4, 4.9175, Brisbane, noted 0340-0400 with music. (Eccles, Minn.)

Austria—Blue Danube Network, Salzburg, noted on approximately 6.06 at 0200; at 0300 was audible in parallel on 9.617 (old channel); noted another day 2255 with news and closing 1802 with "Star-Spangled Banner." (Pearce, England)

Azores—Ponta Delgada, 11.090, was noted recently (on a Sunday) signing off 1620; normal schedule in winter is 1500-1600. (Bishop, Ohio)

Bechuanaland—GDX-aren, Sweden, says ZNB, 8.230, Mafeking, is noted 1200-1400 and that news in *English* is relayed from Johannesburg, South Africa, during the first 10 minutes of the session, after which has music.

Belgium—Ruyssede is again using 17.946 in its "Calling Leopoldville" (Belgian Congo) session 1030-1130. (Ridgeway, South Africa)

Brazil—A new Brazilian station is Radio Poti in Natal, state of Rio Grande do Norte, using 4.935 to 1930; QRA is Avenida Deodoro 245, Natal, Rio Grande do Norte, Brazil. ZYZ20, Radio Relogio Federal, 4.905, Rio de Janeiro, by this time should be on the air. Radio Tupi, Rio de Janeiro, is currently operating on m.w. 1280 kc. with 50 kw.; on FM and on TV; the m.w. and FM programs at 0400-2130 are relayed by ZYC9, Radio Tamoio, 15.37, listed 25 kw. but using only approximately 13 kw. Brazil is now on Summer Time (3 hours *ahead* of EST) but

March, 1952



Alprodco Towers

MEAN A
SATISFIED CUSTOMER
EVERY TIME!

• As an experienced television dealer, you know the troubles you've had with customers in fringe areas and other difficult locations. But no longer! Alprodco Towers now offer you—for the first time... for every time—a sure-fire antenna mounting system that will really get that picture. Keep your customers satisfied—keep those TV sales sold—with Alprodco! Write today for full details.

Exclusive! ALPRODCO'S
New Portable EREC-TOWER

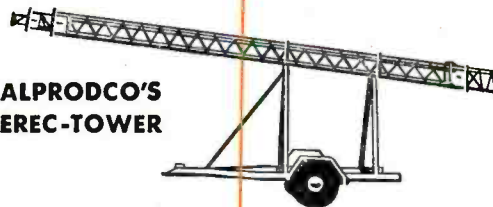

Test TV signal strength anywhere with this new Alprodco rig... use it also to raise a 100 ft. Alprodco Tower into position! Erec-Tower rises to 80 feet, is foolproof and quickly, easily portable. Requires only two men to operate. A good traveling ad for you... be the first in your area with Erec-Tower.

Send for Literature. Dept. B

Alprodco, Inc.

KEMPTON, INDIANA
MINERAL WELLS, TEXAS
DUBLIN, GEORGIA



HARVEY

Features the Finest Brands
At Most Reasonable Prices!

WILLIAMSON HR-15 AMPLIFIER KIT

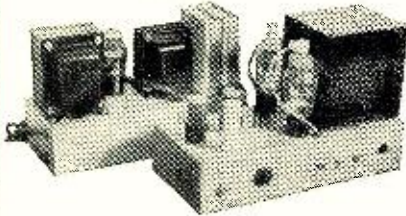

The famous Williamson HR-15 amplifier circuit... now available with the original Partridge transformers built to Williamson's specifications. Build this kit in 3 hours or less, and enjoy sound of a quality you never heard before. The HR-15 is a 2-Chassis power amplifier for use with tuners or other front ends having own volume and tone controls. All American triodes, 2-6SN7GT, 2-807 or 6BG6G in PP output, 5V4G rectifier. Response $\pm .5$ db, 10-100,000 cycles. Output impedances 1.7 to 109 ohms in 8 steps. Absolute gain 70.8 db. 20 db. of feedback around 4 stages and the output transformers. Kit is Complete with Tubes, Punched Chassis, Pre-wired Resistor Board, Sockets, Genuine Partridge Output Transformer, and All Necessary Parts.....\$76.50

As Above, with CFB Transformer.....\$90.00
PARTRIDGE Output Transformers available separately WWFB, as used in above kit.....\$26.00
CFB Transformer, Hermetically sealed.....\$40.00

HR-15T A Williamson Kit with all TRIAD TRANSFORMERS... including power transformer, chokes and specially designed output transformer which is completely sealed in tar. ± 2 db. 10-100,000 cps. Harmonic Distortion less than .1% - 10 watts output. Output impedances 4-8-16 ohms.....\$69.50
Both HR-15 and HR-15T Kits available with KT-66 tubes for \$3.00 extra.



NEW RCA MASTER VOLTOHMYST



A measuring and test instrument that is unexcelled in its ability to cope with a large variety of electronic applications where direct readings of circuit performance must be made rapidly with a high degree of accuracy.

- ★ peak-to-peak values of unsymmetrical complex waves from 0.2 to 2,000 volts
 - ★ Peak-to-peak values of symmetrical complex waves from 0.2 to 4,200 volts
 - ★ rms values of sine waves from 0.1 to 1,500 volts
 - ★ dc voltages from 0.02 to 1,500 volts
 - ★ resistance over the range of 0.2 ohm to 1,000 megohms
 - ★ small currents from 10 microamperes to 500 milliamperes, dc
 - ★ large currents from 500 ma to 15 amperes, dc
- Extra-size 8½ inch meter with expanded scales for quick, easy readability. A portable instrument... well suited to permanent or rack mounting in service shop, lab or factory.
- WV-87A Complete with Direct Probe and cable, DC Probe, Ohms Probe and Cable, Positive Current Cable, Ground Cable.
Net.....\$112.50
Accessory Probes available for measuring ac voltages at frequencies to 250mc and for increasing dc voltage range to 50,000 and input resistance to 1,100 megohms.

NOTE: In view of the rapidly changing market conditions, all prices shown are subject to change without notice and are net, F.O.B., N.Y.C.

Telephone



Luxemburg 2-1500

HARVEY

RADIO COMPANY, INC.

103 West 43rd St., New York 18, N. Y.

will return to Standard Time on March 31. (Serrano, Brazil)

PRAS, 6.015, Recife, noted 1659 with identification by man as "Radio Clube de Pernambuco"; continued with popular recordings to 1725. (Machwart, Mich.) PSL, 7.930, Rio de Janeiro, noted 1630-1700 with musical program. (Sutton, Ohio) ZYK2, 15.145, noted 1055 with usual Brazilian-type music and call of "Radio Jornal do Comercio;" QRM from YDC, Djakarta, Indonesia, 15.150. (Catch, England)

British Guiana—ZFY, 5.98A, opens weekdays 0443, Sundays 0543. (Bellington, N. Y.)

British New Guinea—VLT7, 7.280, Port Moresby, noted 0623-0700 at good level in Georgia. (Patterson)

Bulgaria—Radio Sofia, 7.672, noted in Portuguese 1330; at 1400 in another foreign language; still noted with English on 6.07 at 1600 with woman announcer. (Ridgeway, South Africa) The 6.07 channel is partly readable in Ohio during 1500 news session. (Sutton) The 9.705A channel noted with news 2000-2015 and 2300-2315 to North America; at other times evenings (EST) takes relays from Radio Moscow. (Saylor, Va.)

Burma—Burma Broadcasting Service, 28, Windemere Crescent, Rangoon, Burma, is reported widely with English 0915-1015 sign-off; woman announcer gives the next day's schedule at closedown. (ISWC, London) Has been heard in Sweden on 4.775 with news 1000; announces "This is the Burma Broadcasting Service calling from Rangoon." (Nattugglan, Sweden)

Canada—At sign-off recently, VED, Edmonton, Alberta, gave power as 5 kw., frequency as 7.320; said is on the air daily 17 hours (0900-0200); however, does run later than 0200 some days when has special relays or personal messages for listeners in the Northwest Territories. (Rosenauer, Calif.)

CBFY, 11.705, Montreal, noted opening 0700 with announcement for CBM, m.w., and CBFY, short-wave. (Ferguson, N. C.) Usually has religious service 0815.

Ceylon—Radio Ceylon, 15.120, noted recently 0815-0830 sign-off; bad QRM from Radio Moscow on same channel. (Catch, England) Noted on 11.975 mornings from 0830. (Niblack, Ind.) Heard on this frequency lately to 1145 sign-off. (Kelting, N. Y.)

Chile—CE622, 6.220, Santiago, noted 2323 with identification by man, then popular recordings. (Machwart, Mich.) CE920, 9.200A, Punta Arenas, heard 2130 and signing off 2200. (Sutton, Ohio) CE1180, 11.999A, Santiago, noted 1800. (Catch, England) CE1174, 11.740, Santiago, noted 1900-1930 with good signal; all-Spanish; announces "Santiago de Chile" and/or "Republica de Chile." (Niblack, Ind.)

China—When this was compiled, Radio Peking had moved from 10.360A to its old 10.260A channel.

ISWC, London, lists these "complete" schedules for Radio Peking, 3, Si-chang An Chieh, Peking, China—11.690,

15.060, at 1900 Amoy dialect, 1915 Chaochou, 1930 Siamese, 2000 Burmese; 6.100, 7.500, 10.260, 15.170, at 0300 Mongolian; 6.100, 10.260, at 0330-0400 Korean; 6.100, 10.260, 11.690, 15.060, 15.170, at 0400-0425 English; 11.690, 15.060, at 0430 Ke-chia dialect, 0500 Amoy, 0530 Indonesian, 0600 Japanese, 0630 Cantonese dialect; 6.100, 7.500, 9.040, 10.260, 11.690, 15.060, 15.170, at 0700-0730 Standard Chinese; 11.690, 15.060, at 0800 Vietnamese, 0830-0900 English, 0900 Siamese, 0930 Chaochou dialect, 1000 Burmese; 6.100, 10.260, 11.690, 15.060, at 1600-1630 Japanese; 6.100, 10.260, at 1630 Korean; 6.100, 10.260, 11.690, 15.060, 15.170, at 1700-1730 English; 11.690, 15.060, at 1730 Cantonese dialect, 1745 Ke-chia, 1800 Indonesia, 1830 Vietnamese, 1900 closedown. POW messages recorded in Korea are given during the three English periods which begin 0400, 0830, 1700. (I believe there are additional transmissions not listed above.—KRB.)

A Chinese has been noted recently around 1800 on 9.026A; seems to have setting-up exercises 1815. (Stark, Texas) Also noted 1800-1845 fade-out by Foerster, Ill.

Colombia—HJCT, 6.201, noted to 2355 sign-off. (Leary, Ind.) HJCW, 4.945, Bogota, heard 2236-2313 sign-off; relays HJCO, m.w., according to announcement; identifies as "Emisoras Sur America" or "Transmitiendo para todo La America desde Bogota;" at sign-off man identifies in English and requests reports; anthem follows. HJKE, 4.834, Bogota, noted 2059 with identification by man as "Radio Continental," followed by native music. (Machwart, Mich.) Latter noted in Georgia 2221-2255; male announcer; all-Spanish. (Patterson, Ga.)

HJFB, 6.225, Manizales, noted with call 2000 and commercial announcement at 2014. (Catch, England) Bogota on 6.018 is noted with English announcement and sign-off 2330. (Niblack, Ind.) HJGF, 4.847, Bucaramanga, noted 2135-2202. (Patterson, Ga.)

Cyprus—ZJM8, 9.650, Limassol, is heard in Sweden 0655-0830. (Nattugglan, Sweden)

Denmark—OZF, 9.52, Copenhagen, noted 2130 and again 2250. (Lund, Iowa)

Dominican Republic—HI2A, 9.68, Santiago de los Caballeros, is heard regularly in South Africa from 1600 onwards; improves by 1615. (Ridgeway) HI8Z, 5.030, Santiago de los Caballeros, noted 1850-1920; all-Spanish. (Patterson, Ga.) HI4T, 5.970, noted opening 0600. (Glick, Ind.) HI1J, 6.025, San Pedro de Macoris, heard 2114 tune-in with native music; signed off 2116A; fair level and no QRM. (Bellington, N. Y.)

Ecuador—Quito, 4.928, noted with identification by man, followed by chimes and sign-off. HC4EB, 6.871, Manta, heard 2231 with identification of "Radio Manta," followed by native music. (Machwart, Mich.) HCJB, 17.890, noted strong but with QSB at 1215 in Spanish. (Kessel, Quebec)

NEW SPRING ITEMS AT LOWEST PRICES

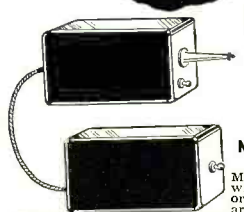

HOTTEST ITEM FOR 1952 160-80 METER MOBILE RECEIVERS

MOBILE RECEIVER which will operate in your boat or car from 6 Volts D.C. and will cover the 160 METER HAND. Ship to Shore and Police Bands. Frequency Range 1600 KC. to 2500 KC. Can be used on a fixed frequency only or by slugging will cover its complete frequency range. Comes in 2 separate units; Receiver and 6 Volt Vibrator Power Supply Unit. The equipment is used, but is in excellent condition complete with tubes.

PRICE FOR COMPLETE UNIT WITH POWER SUPPLY **\$24.95**
RECEIVER **\$22.50**
6 VOLT POWER SUPPLY **7.95**

COAXIAL CABLE

52 OHM Transmission Cable. Made to J.A.N. Specification. 1F549. Same as RG-8U. All unused, on reels of approximately 1,000 Ft.

100 Ft. **9c per Ft.**
1,000 Ft. **8c per Ft.**
10,000 Ft. **7c per Ft.**

ARC-4 TRANSCEIVER

100-156 MCS. Complete with all tubes and 12 Volt Dynamotor. For Planes or Mobile. 2 Mc. **\$39.95**

ARC 5 EQUIPMENT:

TRANSMITTERS

3 to 4 MCS. **\$14.95**
4 to 5.3 MCS. **8.95**
5.3 to 7 MCS. **7.95**

All above complete with all tubes and crystal. In excellent condition.

T-23 ARC-5 VHF TRANSMITTER-100-156 MCS Chassis. Less Tubes and Crystals. Each **\$12.95**

SCR-522 TRANSCEIVER

100-156 MCS-HOTTEST 2 METER BUY OF THE YEAR. VHF MOBILE or FIXED. Complete with all Tubes and 24 Volt Supply. Excellent Cond. **\$62.50**

CAPACITORS * FIXED * OIL FILLED

Solar, Pyramel, C.D., Etc.

ALL D.C. VOLTAGE RATINGS

2 MFD. 400 V. 50.79	4 MFD. 1000 V. \$1.75
3X3 MFD. 400 V. 1.95	8 MFD. 1000 V. 3.95
10 MFD. 400 V. 2.95	10 MFD. 1000 V. 4.95
1 MFD. 600 V. .75	1 MFD. 1500 V. 1.50
4 MFD. 600 V. 1.95	4 MFD. 1500 V. 2.25
5 MFD. 600 V. 1.95	6 MFD. 1500 V. 2.95
6 MFD. 600 V. 1.95	1 MFD. 2000 V. 1.95
7 MFD. 600 V. 1.95	2 MFD. 2000 V. 1.95
8 MFD. 600 V. 1.95	3 MFD. 2000 V. 3.50
10 MFD. 600 V. 2.25	4 MFD. 2000 V. 3.95
15 MFD. 600 V. 2.95	4 MFD. 3000 V. 3.95
20 MFD. 600 V. 2.95	4 MFD. 3000 V. 5.95
1 MFD. 1000 V. 1.00	1 MFD. 5000 V. 5.95
2 MFD. 1000 V. 1.25	

CAPACITORS TRANSMITTING VARIABLE

K 1 MMFD. to 75 MMFD. 1/2" Spacing **\$1.95**
D 12 MMFD. to 125 MMFD. 3000 V. Peak **3.50**
1-28 MMFD. to 110 MMFD. 5000 V. Peak **3.95**
*F 12 MMFD. to 150 MMFD. 3000 V. Peak **3.50**
A 7 MMFD. to 80 MMFD. 1500 V. Peak **1.00**
* With National "Velvet-Terminal" Dial. All New Hammerlund, Cardwell, Etc.

RADIO DIRECTION FINDER

MODEL DZ-2. Tunes from 15-70 KC and 100-1750 KC. Complete Radio Direction Finder Unit ready for installation and operation on 28 Volts D.C. Receiver Loop Assembly and Pedestal and 28 Volt Dynamotor. **\$95.00** Set

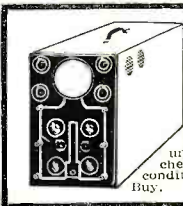

3" TRIUMPH OSCILLOGRAPH

Complete Test Scope, with built-in Wobbulator, so as to be used on TV or FM servicing. Operates from 110 V. 60 Cy. A.C. Limited Supply. All these units have been carefully checked and are in excellent condition. A Real Buy. **\$34.95** Ea.

PE 110 POWER SUPPLY

This unit was used as part of BC669 transmitter. Input 110 volts 60 watts; Output 543 volt @ 153 ma for transmitter and low voltage supply for Receiver and Filaments. Uses 4-5Z3 tubes for high voltage and 1-80 tube for low voltage. Also contains a 12 volt vibrator pack for Receiver voltages. This supply is well filtered and regulated and is ideal for **\$34.95** your Ham transmitter. Low priced at.

All Mail Orders Promptly Filled, F.O.B. San Francisco listing our stock and prices on Radio, Electronics, Tools, Hardware, Motors, Wire, Meters, Batteries, Aluminum Sheets, etc. 20% Dep. on all C.O.D. orders. All items subject to prior sale, and prices subject to change without notice.

TELEGRAPH KEYS
J-48 Standard Hand Keys enclosed in box with cord and PL 55 Plug. All New **1.25** Ea.
J-5A Flameproof Key. **\$0.79** Ea.



BRASS SELSYNS

Heavy Duty Bendix Selsyns, 110 volts 60 Cycles AC.
Type II-2 similar to type 6 Selsyns-New Cond. **Pr. \$35.00**

TG-5 CODE OSCILLATOR

Battery operated Code Practice Oscillator. Use singly for practice or can be used in pairs for practice or sending messages over wire between two points. Uses a 22 1/2 volt dry cell battery and 2 flashlight cells. Contains keying relay and 1000 Cy. tone buzzer and head set. All brand new, with canvas carrying case. **Ea. \$9.95**

RU 16 RECEIVERS

RU 16 RECEIVERS **\$5.95** Ea.
Plug-in Coils for above Receivers.
9 Ranges 190-1370 KC. **1.50** Ea.
RG 430 Transmitter. **5.95** Ea.
Plug-in Coils for Trans.
2 MEG-9 MEG. **1.50** Ea.
12 Volt Dynamotor for above. **7.95** Ea.
330 Volt @ 170 MA. **1.00** Ea.
RU-19 Control box. **1.00** Ea.



REVERSIBLE MOTOR

1/40 H.P. Blast-bearing 3450 R.P.M. in Brass-proof case. Needs only a capacitor for starting. All Brand New. 110 V. **\$4.95** Ea.
Cy. Special Low price. **\$0.69** Ea.
Starting Capacitor.

RECEIVERS

190 to 550 KC. **\$16.95**
3 to 6 MCS. **9.95**
6 to 9 MCS. **9.95**

All above Receivers complete with all tubes and dynamotor. In excellent condition.

R-4/ARR-2 RECEIVER-234-258 MCS Complete with all tubes and dynamotor. Excellent condition. **\$19.95**



FL-8 FILTER

Range or Voice for 1020 cycles Audio. Switch mounted on Filter. Excellent for C.W. **Ea. \$1.25**

WALKIE TALKIE BATTERIES

BA 37-1 1/2 ve-A. **\$0.50**
BA 38-10 1/2-B **1.29**
Both for **1.50**

12 VOLT STORAGE BATTERY

Aircraft Type, 12 Volt, 34 Amp. HR. Made by Exide. Completely inclosed with removable top. Dry Charged. All Brand New. **\$14.95**



PROP PITCH MOTORS

For your Beam Antenna: 20 Prop. 3/2 H.P. A.C. or D.C.
1/2 H.P. Motor: 1/2 RPM Gear Reduction, 7000 to 1. ALL BRAND NEW. Each **\$13.95**

3/4 H.P. PROP PITCH MOTORS (Small Size)
30 to 32 Volt A.C. or D.C. Gear Ratio: 9000 to 1. All Brand New. **\$16.95**

GYRO MOTOR UNITS

Dual gyro unit. Both gyro motors mounted on single base. Wired in parallel for 12 or 24 volts. Excellent condition. (Please specify if you wish the 12 or 24 volt.) **Set \$4.95**

MISCELLANEOUS SPECIALS

9 Channel Push Button Switch, spring-back type **\$1.00**
300 OHM Twin Lead. **.04** per Ft.
67 1/2 Volt Radio "B" Batt. **1.04** Ea.
1 Lb. Roll Rosin Core Solder. **.95** Roll
BC606G Interphone Switch Box. **.59** Ea.
RG 7U COAX 95 OHM. **.06** per Ft.
RG 59U COAX 52 OHM. **.08** per Ft.

DYNAMOTORS

DM-19-C, 12 Volt DC. Input 16 Amps. Output 500 V. at 200 MA. Cont., 500 V. at 400 MA. Int. Ea. **\$19.95**

BC 456 MODULATION UNIT

Part of SCR274N. Equipment contains Relays. Transformers and 12J5, 1625 and VR. 150 (OD3 Tubes).
Less Tubes **\$1.50**
With Tubes **2.95**

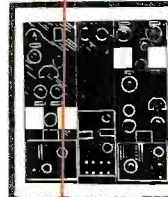

MODEL GO-9 TRANSMITTER

All brand New. 100 Watts CW or MCW emission. Operates from 110 V., 60 Cycle. Easily converted to 60 Cycle operation. Low frequency range, 300 KC. to 600 KC. High frequency 3,000 KC. to 18,000 KC. using an E.C.O. We furnish complete conversion details with each transmitter. Complete with test schematics. **\$59.95**

BC 375 TUNING UNITS FREQUENCY RANGES AVAILABLE

200 KC-500 KC; 1500 KC-3000 KC; 3000 KC-4500 KC; 4500 KC-6200 KC; 6200 KC-7700 KC; 7700 KC-10000 KC; 10000 KC-12500 KC. With Vernier Dial and many parts which alone are worth 5 times our low price of **\$2.95** per unit

SOUND POWERED HAND SETS

TS-10 type-Variety manufacturers. No batteries needed for operation. Use in pairs with wire. Audible up to 10 miles. Ideal for TV antenna installations. Excellent condition. **Pair \$17.95**

SOUND POWERED HEAD AND CHEST SET

Use same way as Hand Set except you have freedom of hands. No Batteries or power source required for operation. Excellent Condition. **\$11.95**

2 VOLT VIBRATORS

VB5A Synchronous Type. Used for portable radios having 2 Volt wet cell supply. All new. **Ea. \$1.50**

TANK PERISCOPS

Type 89 Contains 2 glass prisms, one at each end of the periscope. Use them for looking over crowds, at parades, ball games, races, etc., or use prisms separately for optical work. Low priced. All Brand New. **\$1.95**

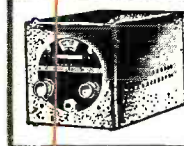

BC-1206 BEACON RECEIVERS

Manufactured by Detroit Radio. 200 to 500 KC. For Direction Finder. Contains 2-251G, 1-6X4, 1-6SF7, 1-6SK7, 1-6A7. Excellent condition. Complete. **\$7.95**

MIDGET SELSYNS

AY6 type operates from 6-12 Volts 60 Cycle. Use as both transmitter and receiver. These compact little units are almost no current and work fine for all remote position indicating applications. OD 2 1/2 x 2 1/2". Has spring return shaft. All New (Appr. wt. **\$2.50** Ea.)

AY-1 Type or AY-5 Type, same as above but has a continuous rotating shaft. These compact units are **\$4.95** NOW

G.P.7 TUNING UNITS

5 Ranges: A-350-500 KC., B-800-1500 KC., D-3000-4525 KC., E-4525-6500 KC., F-6200-9070 KC. Also contains Capacitors, Resistors, Vernier Dials and many other parts. A REAL BUY while they last. Each unit **\$4.95** range



DU-1 MANUAL DIRECTION FINDERS

Tunes to broadcast, lighthouse and beacon bands-easy to convert for use on marine bands. True bearing indicated immediately. For use with any loop input receiver. Complete with 2 tube pre-amplifier. Used, good condition. Specify 12 V. D.C. or 24 V. D.C. Excellent Condition. **Each \$19.95**



TUBES

8025 \$4.95	6F6 \$1.00
3BP7 1.25	6N7 1.00
5BP4 12.50	8020 2.95
6S77 1.00	6SL7 1.00
12SN7 .90	6V6G 1.25
6AG5 1.00	608 .75
6AK5 1.25	6B8 .75
6AC7 1.00	83V 1.25
4E27 12.95	6SH7 .50
3E27 8.95	7193 .90
VR-90 1.00	6SN7 .90

304TL

\$7.95

TAPE

CANNED FRICTION TAPE, 3/4", 82 1/2 Ft., 6 Rolls to Can **\$1.25** per Can

TAPE IN INDIVIDUAL BOXES

RUBBER TAPE, 3/4", 15 Ft., 15c Roll, SCOTCH TAPE, 1", 50 Yds., 35c Can. FRICTION TAPE, 3/4", 82 1/2 Ft., 15c Roll, MICA TAPE, 1/2", 25c Roll

Do not send postage stamps. Write for our new 1952 free booklet listing our stock and prices on Radio, Electronics, Tools, Hardware, Motors, Wire, Meters, Batteries, Aluminum Sheets, etc. 20% Dep. on all C.O.D. orders. All items subject to prior sale, and prices subject to change without notice.

STANDARD SURPLUS 1230 Market St., San Francisco 3, Cal. Telephone HEMlock 1-3106

YOU GET REAL VALUE FROM PLATT ELECTRONICS



SENSATIONAL SAVING! DYNAMOTOR

For DY-12 Power Supply for ART-13.

NOW ONLY **\$24.95** complete



SCR-27N COMMAND and ARC-5 Equipment



RECEIVERS

	USED	NEW
BC-453-190 to 550 KC.....	\$22.95	\$42.50
BC-454-3 to 6 MC.....	11.95	18.95
BC-455-6 to 9 MC.....	11.95	18.95

TRANSMITTERS

BC-457-4 to 5.3 MC.....	12.95	21.95
BC-458-5.3 to 7 MC.....	1.49	21.95
BC-696-3 to 4 MC.....	20.95	39.95
BC-459-7 to 9.1 MC.....	16.95	27.50

ADDITIONAL EQUIPMENT

BC-456 Modulator.....	3.95	6.95
BC-459 Control Box (3 Receiver).....	1.29	2.49
BC-451 Control Box (Transmitter).....	1.29	2.49
HC-442 Relay Unit (ANT).....	2.95	3.95
Plugs: PL-147, 148, 151, 152, 153, 154, 156—EACH.....	1.25	
Flexible Shafting with gear to fit Receivers.....		1.69
3 Receiver Rack.....	2.25	
2 Transmitter Rack.....	1.69	

BC-221 Frequency Meter

Real Value! QUANTITY IS LIMITED—so first come, first served. They are just like new, with original calibration charts. Range 125-20,000 KC with crystal check points in all ranges. Complete with crystal and tubes.....

\$119.50



TIME CLOCKS

12 and 24 hour cycle timing. Unlimited uses. Needs minor repairs. AN EXCELLENT BUY—HOW CAN YOU GO WRONG!

ONLY **\$9.95**



20 POUNDS ASSORTED RADIO PARTS

A TERRIFIC BUY AT ONLY **\$2.79**

HEADSETS

HS-33 low impedance with cord and plug, used, fine condition.....	\$3.29
HS-25 high impedance, BRAND NEW with ear pads.....	4.25
HS-33 low impedance, BRAND NEW with ear pads, cord and PL54 plug.....	4.95
HS-30 with ear plug, low impedance, used, good condition.....	1.69
CD-307A Cords, 6 ft. NEW.....	.89
H-16/U high impedance. Includes two receiving units.....	\$3.95



VHF Excellently Reconditioned Guaranteed

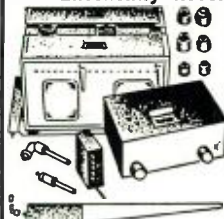

SCR-522

AIRBORNE COMMAND EQUIPMENT

Frequency Range 100 to 156 mcs. in 4 channels receiver and transmitter. Crystal controlled. Complete equipment. Consists of trans/rec, control box BC-602, dynamotor PE-94, AN104A antenna, plugs, etc. Power input with PE-94 is 28 v.

Electrically Tested—Complete as Shown. Only **\$129.50**
BRAND NEW—PRICES ON REQUEST

NOW! Fill Your Battery Only Twice a Year

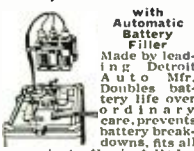

With Automatic Battery Filter
Made by leading Detroit Auto Mfr. Doubles battery life over ordinary battery care, prevents battery breakdown, fits all cars. Instantly installed.
ONLY **\$1.95**
COMPLETE

DUAL PURPOSE EMERGENCY UNIT



• Fire Extinguisher
• Tire Inflator
Made by leading Detroit Auto Mfr. Especially recommended for oil, gas and electrical fires. Guaranteed by mfr. against defects. Order two—one for your home, one for your car in case of flats or fires.
ONLY **2.29** each

MINIMUM ORDER \$2.00

Immediate Delivery—Send 25% deposit on C.O.D. orders. All shipments F.O.B. N.Y.C. (N.Y.C. residents add sales tax to your remittance.)

PLATT ELECTRONICS CORP.

Dept. A, 489 Broome St., N. Y. 13, N. Y.
PHONES: WO 4-0821 and WO 4-0828

HC1AC, Quito, "La Voz de la Democracia," noted on 6.210 signing on 0640; news in Spanish 0645; fair level in Calif. (Rosenauer)

Egypt—Cairo, 9.555A, noted from 1443 tune-in to 1611 sign-off with march, probably anthem; had news 1601-1605 by man; French news 1530; at 1545 played some popular American recordings. (Bellington, N. Y.) This one noted in England 1430 with *English*; signs on 1345; has news in French 1400. (Pearce)

France—Paris, 7.24, noted 0311 with "The French Have a Word For It," fair to good level, sometimes excellent. (Winch, Calif.) Paris heard on 9.560 at 2006 with news in French to 2029 when signed with "La Marseillaise" and signature of notes played on oboe. (Niblack, Ind.) Heard on 9.68 in Czech 1445 and in Arabic on 9.755; at 1500 the 9.68 channel gave call in French followed by news in that language; also noted signing on again on this channel 1730 (in French). (Pearce, England)

Paris, 17.85, noted 1115 sign-on to

after 1230. (Bishop, Ohio) Heard on 9.966A at 1628-1646 with severe CWQRM; used French and Portuguese; signed off 1646. (Patterson, Ga.) Noted relaying *United Nations Radio* on 9.755 at 1430. (Golden, Mass.) Heard parallel on 9.56 and 11.915 with Arabic around 1230; closed 1300. (Bellington, N. Y.)

Germany—Hamburg's "Nordwestdeutscher Rundfunk" is now operating on 7.290, 11.795, 15.275, 17.815, 17.845, Sundays 0000-1900, Sundays 2300-2200; Tuesdays 0000-1900; Tuesdays 2300-1900; Wednesdays and Thursdays 2300-1900; Fridays 2300-2000 (EST). (ISWC, London) Heard on 7.29 with news in German 0700 in parallel with 11.795. (Pearce, England)

AFN, 5.470, Giessen, noted 1745 with poor level and much QRM. (Catch, England) Heard 1445 with songs and 1500 with news. (Pearce, England) RIAS, 6.005, Berlin, noted with religious program 0255 recently, followed by orchestral music; at 1800 with news in German. (Pearce, England)

(Continued on page 141)

EMPIRE STATE BUILDING MULTIPLE TV TOWER COMPLETED

The world's first multiple transmission center for commercial use, is now in operation with the completion of the Empire State Building Multiple Television Tower.

Seventeen months' time and one-hundred thousand manhours went into the construction of the new tower. Five broadcasters are now on the air with better signals as a result of this new installation.

Thirteen high power, high frequency transmitters, including three FM, five TV picture, and five TV sound, are now radiating signals simultaneously from the 222 foot steel structure atop the world's tallest building without the slightest interference.

The cost of the project has been estimated at about \$875,000 of which approximately \$560,000 was the cost to the Empire State Building for erecting the steel structure, and \$315,000 the cost to Empire State and the five broadcasters for electronic development. In addition, each broadcaster spent about \$400,000 for installing transmitters and lines.

From an average service radius of 38 miles before the Empire State project, the TV broadcasters now reach a radius of about 70 miles, an area with an estimated audience of 17 million people. The extended coverage is due to a combination of the increased height afforded by transmission from Empire State and increased power permitted by the FCC.

On the tower are eight separate antenna systems, 116 radiating elements or dipoles, feed cables, transmission lines, transformers, and junction boxes. More than 60 pipes, coaxial lines, and conduits go up into the base of the tower.

The basic tower, which weighs about 60 tons, was designed to withstand wind velocity up to 150 miles per hour. Two special Pyrex bulb beacon lights were developed for the top of the tower by General Electric when ordinary lamps kept shattering. After a year of use, a lightning rod which tops the tower is

already pitted in more than a hundred places where the lightning bolts have landed.

The five stations transmitting from this tower include WJZ-TV (Channel 7), WCBS-TV (Channel 2), WABD (Channel 5), WNBT (Channel 4), and WPIX (Channel 11). Station WATV (Channel 13) may also transfer to the Empire State Building during 1952.

Close-up view of the multiple television transmitting tower atop the Empire State Building in New York. Five TV stations are using these facilities at the present.

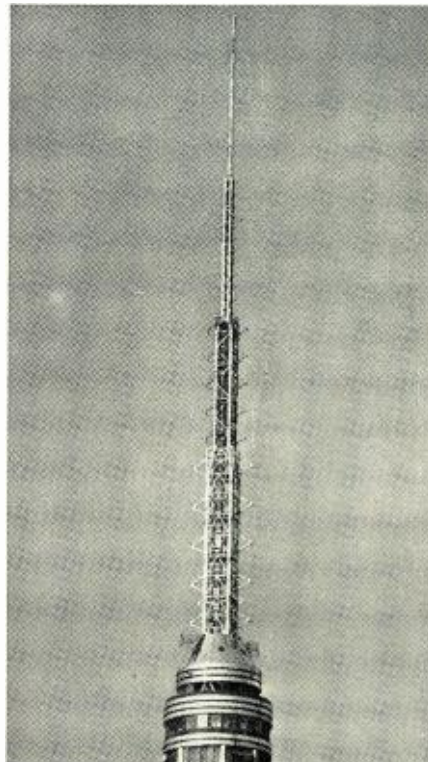

RADIO & TELEVISION NEWS

Indoor Antennas
(Continued from page 42)

various sections of the room until a good location for it is found. Once a suitable spot is located, the housewife is restricted in the arrangement of her furniture thereafter. A person moving about in the room or a change in position of a metallic or electrical obstacle in the room can alter the relative relation between direct and reflected signals and influence effective signal strength at the receiver input. In one location it was found that the position of the telephone on a table-top adjacent to a TV receiver with a built-in antenna had a very great influence on the quality of a high-band station.

When there is a somewhat greater delay between direct and a preponderance of the reflected signals (fractional part of a microsecond), picture smear results. This is caused by close picture displacement between direct and reflected components on the tube screen. Smear also results when certain sideband frequency bands in the 4 mc. video span reach the receiver at stronger relative levels than others. Additive and subtractive relations between sideband components can be such that direct and reflected signals add for some sideband components and cancel for others. We anticipate this relation when we consider that picture and sound are not always minimum at the same angle of departure from the correct antenna orientation.

A third defect occurs when a preponderance of the reflected signals reach a comparable signal level as a direct signal and/or are delayed an appreciable time with respect to the direct signal. Usually, an unstable raster occurs because of poor sync stability. Continuous shifting of sync control between the various signal components (direct and reflected) sets up a number of pictures displaced with respect to each other. Appearance (except for instability) can be likened to reception of a number of ghosts from a range of hills.

It is apparent that reflection and orientation defects make it difficult to obtain optimum orientation for each channel when stations are in different directions. Difficulties can be encountered at many sites when stations are all in the same direction. At some indoor locations and on certain channels, peak results are often obtained when the antenna is not oriented in the direction of a station.

Signal Levels and Noise

The indoor antenna must function under very trying conditions. An indoor location means a low signal level; a low indoor location means a still weaker signal. The antenna, therefore, has a weaker signal to work with and is nearer to sources of noise and interference. Thus, signal-to-noise ratio is substantially poorer. Insofar as im-

world's toughest transformers

CHICAGO "SEALED-IN-STEEL"
New Equipment Line

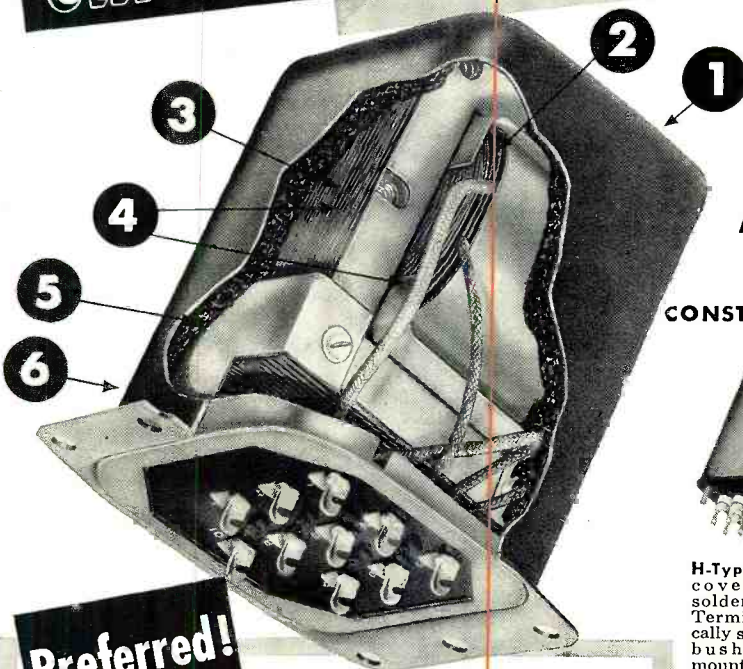

AVAILABLE
IN THREE
VERSATILE
CONSTRUCTIONS



H-Type. Steel base cover deep-seal soldered into case. Terminals hermetically sealed. Ceramic bushings. Stud-mounted unit. Meets MIL-T-27 Specifications.



S-Type. Steel base cover fitted with phenolic terminal board. Convenient numbered solder lug terminals. Flange-mounted unit.

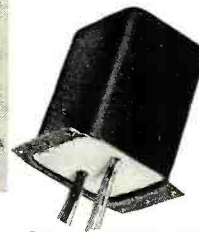

C-Type. With 10" color-coded stripped and tinned leads brought out through fibre board base cover. Flange-mounted unit.

Preferred!

the INSIDE STORY tells why!

The proof of toughness is on the inside—the actual proof that demonstrates why CHICAGO Transformers are preferred by engineers, why they fully meet the express requirements of today's tubes and circuits. Here are the "inside facts" of CHICAGO "Sealed-in-Steel" design:

- 1 Exclusive one-piece drawn-steel case, unsurpassed for strength, moisture-resistance, better electrostatic and magnetic shielding, mounting ease, and streamlined appearance.
- 2 Uniformly-wound precise coil structures—cooler operation and better electrostatic shielding in power units—minimum leakage, optimum coupling in audio units.
- 3 Core of high-grade non-aging silicon steel brought to high efficiency by scientific heat-treating in CHICAGO'S own annealing ovens.
- 4 Core and coil vacuum-impregnated with varnish. Final high-temperature baking achieves a perfectly impregnated coil and core locked against vibration.
- 5 All internal free space is filled by special, moisture-resistant compound. Prevents corrosion and helps maintain far cooler operation than in conventional air-surrounded mountings.
- 6 Checked by quality controls at every stage of manufacture, rigidly inspected, "torture-chamber"-tested to insure long, dependable life in actual service.



SEND FOR "NEW EQUIPMENT LINE" CATALOG

You'll want the full details on CHICAGO'S New Equipment Line—the famous Sealed-in-Steel line that offers advanced engineering design to fit today's circuits. Lists units for all purposes: Power, Bias, Filament, Filter Reactor, Audio, MIL-T-27, Modulation, Stepdown and Isolation. Write for your FREE catalog today—or get a copy from your distributor.

CHICAGO TRANSFORMER
DIVISION OF ESSEX WIRE CORPORATION
3501 ADDISON STREET • CHICAGO 18, ILLINOIS

RADIOTELEPHONE LICENSE MANUAL

RADIOTELEPHONE OPERATOR'S
QUESTIONS AND ANSWERS
STUDY GUIDE

GET YOUR COMMERCIAL RADIOTELEPHONE LICENSE

WITH THIS BRAND NEW BOOK

Now in one convenient volume,
everything you need to obtain
your license. Contains the
following elements:

- ELEMENT I:
Questions On Basic Law
- ELEMENT II:
Basic Operating Practice
- ELEMENT III:
Basic Radiotelephone
- ELEMENT IV:
Advanced Radiotelephone

\$3.75 FROM YOUR DISTRIBUTOR

ADD 10% ON DIRECT MAIL ORDERS TO

EDITORS AND ENGINEERS, LTD., 1302 KENWOOD ROAD, SANTA BARBARA, CALIF.
Bookstores order from BAKER AND TAYLOR CO., Hillside, New Jersey

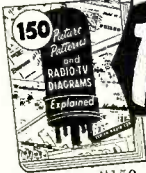

FREE!

Just For
Examining

COYNE'S

New 6-Volume Set

**APPLIED
PRACTICAL
RADIO-
TELEVISION**

Get This New Book FREE—Radio-Television Picture Patterns and Diagrams Explained. Gives wiring circuits and diagrams on latest Radio and Television sets. Also dozens of TV Test Patterns and trouble-shooting short cuts. A "must" in every serviceman's kit. It's yours FREE!

Helps You Get Ahead!

This book is our gift to you for examining Coyne's brand new 6-volume set, APPLIED PRACTICAL RADIO-TELEVISION. Here is the most up-to-date set of reference books in America! 2350 easy-to-understand pages; 1200 illustrations. Covers all phases of radio and television. Tells you how to install, service, shoot trouble, align all types of radio and television sets. "Break-down" photos help you understand quicker. Set includes new 762 page quick reference Cyclopedic of Television Servicing.



**Sensational
Free Book Offer — Send No Money!**

Mail coupon now to get this great new 6-volume set and the FREE Book of Radio-TV Diagrams and Test Patterns. Use the set 7 days. If you keep the set, pay just \$2.00 after 7 days and \$3.00 a month until \$23.00 plus postage is paid. (Cash price \$22.00.) If not 100% satisfied with set send it back and owe us nothing. EITHER WAY THE BOOK ON TV PICTURE PATTERNS AND DIAGRAMS IS YOURS FREE. Coupon is just a request to see set and get Free book. This offer is limited. ACT NOW!

**FREE
ON
7 DAYS
TRIAL**

MAIL COUPON NOW!

COYNE ELECTRICAL & TELEVISION-RADIO SCHOOL
500 S. Paulina St., Dept. 32-T3, Chicago 12, Ill.
Rush "APPLIED PRACTICAL RADIO-TELEVISION" on
7 days' FREE TRIAL per offer above. Include FREE
Book.

NAME..... Age.....
Address.....
City..... Zone..... State.....

Where Employed.....
() Check here if you want set sent C.O.D. You pay
postman \$22.00 plus C.O.D. postage. Same money-
back guarantee of satisfaction.

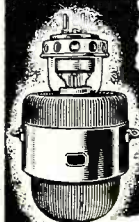

**MANUFACTURERS!
EXPORTERS!
PURCHASING AGENTS!**
•HONESTY•INTEGRITY
•QUALITY OF
PRODUCT

- Radio and Receiving Tubes
- Transmitting & Special Purpose Tubes
- Radio and Electronics Parts and Equipment
- All Types of Electrical Wire, Magnet Wire, and Cable

Write — Wire — Phone
For Your Special Needs

We are also bonafide
General Purchasing Agents.

CAN WE HELP YOU?

References: Dun & Bradstreet.

Electronic Expeditors

225 N. Wabash Ave., Dept. R, Chicago 1, Ill.

Phone ANdover 3-0841

BRANCH OFFICES

9015 Wilshire Blvd., Beverly Hills, Cal., CR 4-6237
507 Fifth Ave., New York 17, New York, MU 7-0084

pulse interference is concerned, the weaker signal means the receiver is made more subject to sync instability from car ignition and electrical appliance noises.

A trying defect of receivers with indoor antennas in certain television areas is local oscillator interference. Again the defect is pronounced because of a weaker signal and the location of the antenna nearer to offending receivers in neighborhood. This defect is prevalent in areas assigned the following channels: 2—5, 3—6, 7—11, 8—12, or 9—13.

Often the indoor signal levels are so poor that snow or salt-and-pepper effect is apparent. This condition destroys the resolution and clarity of the picture and is extremely annoying to a person accustomed to a clear, well-defined picture. This is a very obvious defect. However, the picture often is afflicted with a more obscure trouble resulting from a less serious loss in signal level and/or improper antenna orientation. Noise components in the video signal cause a constant wiggling in the background of the picture. This motion, however slight, has an apparent effect on the picture quality. It is often not so severe that a person will criticize the picture and often it goes unrecognized. Rather it is a type of subtle defect that when it is not present and picture background is rigid and steady, a person is likely to remark "That is the best picture I've ever seen," or "It's just like a movie." Proper orientation and peak signal-to-noise permit this type of picture.

Not only is attainment of a high signal-to-noise ratio hampered by orientation, weak signal level, and proximity of noise sources, but space limitations prevent use of directional parasitic elements and often dipole elements cannot be fully extended to intercept a half-wavelength on the low band. Consequently, it is difficult to obtain a steady, clear, motionless-background picture.

Inconvenience

Many indoor antennas are inconvenient—even to the extent that some families pass over certain channels because elements must be changed or the antenna moved. For example, in one home, the antenna is moved from the top of the TV set to the top of the piano when a specific channel is to be received.

The indoor antenna is not an appealing article of furniture. When extended it is annoying and can be a hazard. It limits living room styling if there are bad reception areas in the room.

Idealized Indoor Antenna

The ideal indoor antenna would permit optimum signal-to-noise conditions from each station in accordance with its energy level. It would attain this objective with as little inconvenience as possible.

What factors, then, contribute to good indoor antenna performance?

FAIR RADIO SALES

132 SOUTH MAIN ST.
LIMA, OHIO

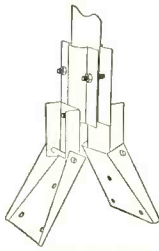

Television Accessories:

Universal flat and peak roof mount made of heavy gauge steel, aluminum finish. Adjustable flaps provide easy means for mounting on any peak regardless of roof pitch. Swivel mast holder takes up to 1 1/2" pipe and can be raised easily.

PRICES: Each: \$1.69. Box of 12: \$17.50

GUY CLAMP'S up to 1 1/2" Pipe.....25c
GUY RINGS—1 1/2" Pipe.....1.49

TURNBUCKLES:

Dia.	Total L.	Open L.	Closed L.	Pa.	Doz.
#14	1 1/2"	2 3/8"	7 5/8"	5 1/2"	18c
#15	1 1/2"	2 3/8"	9 1/2"	6 1/2"	20c

HOOKS: #187 3/8" x 5" Galvanized; 6c Each; Box of 24 \$1.30

AIRCRAFT CABLE: 1/8" x 7 x 7 strands, Weather-proofed, 47 Foot Lengths only at 75c Ea.
GUY CABLE CLAMPS: 1/8" 10c Ea. Box of 25...\$2.25

DELCO GASOLINE ENGINE GENERATOR

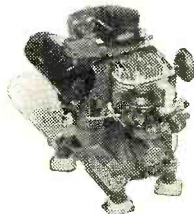

12 Volt DC 750 Watt generator driven by a one cylinder four cycle air-cooled gas engine, approx. 2 HP, with self starter, output meter, and on-off switch. Rope or electric start. Gov't surplus, reconditioned.....**\$79.50**

HRRU-28 Homelite Gasoline Engine Generator, 28 VDC, 2000 Watt output, Used, Tested.....**\$89.50**

ANTENNA EQUIPMENT

MAST BASE—INSULATED

MP-132 BASE—as illustrated at left. 1" heavy coil spring, 2" insulator. Overall length 11 1/2". Weight: 2 1/2 lbs. Price.....**\$3.95**

MAST SECTIONS FOR ABOVE BASE—Tubular steel, copper coated, painted, in 3 foot sections, screw-in type. MS-55 caps used to make any length, with MS-52-51-50-49 for taper. Price for any section.....**50c Ea.**

AN-104A Antenna—100-150 MC.....**\$2.00**
AN-117 Whip Steel—6 Ft. length.....**1.50**
AN-109A Whip Steel, 5 Ft. w/Base.....**1.50**
AS-27/ARN-5 Ram's Horn, 110 MC—USED.....**5.95**
LP-21-A Loop for ADP—Used, tested.....**9.95**
AT-37/APT Stub—113-150 MC.....**6.95**
AT-42/APT-3 or APT-1 Stub—113-150 MC.....**6.95**
AS-97/ARQ-8 Spike with coaxial lead in base.....**4.95**
AS-61/ARN-5 Half-Wave Dipole—335 MC.....**3.95**

AERIAL WIRE

Aerial Wire—Phosphorous Bronze #16 Stranded, 200 lb. test. Weather-proof, 150 feet on Reel. RL-3 with Clips.....**\$1.50**

WIRE—HEAVY DUTY RUBBER COVERED

2/16—10—20 Ft. Length.....**\$1.25**
2/12—10—20 Ft. Length.....**1.00**
1/8—Shielded, 15 Ft.....**1.50**
1/8—Shielded, 7 1/2 Ft.....**.75**
1/2—Shielded, 8 Ft.....**1.00**
1/2—Cotton covered—Per Foot.....**.06**
1/2—Shielded, Rubber Covered, 50 Ft. Length.....**\$2.75**
Or Per Foot, at.....**.06**

INVERTERS:

NUMBER:	INPUT:	OUTPUT:	PRICE:
5-D21-N33A	27 VDC 35Amp	115 V—400 cycle 485 VA. USED: NEW:	\$14.95 \$24.95
PE-118	26 VDC 100Amp	115 V—400 cycle 1 Ph. 1500 VA. USED:	\$19.95
PE-218	28 VDC 92Amp	115 V—400 cycle 1 Ph. 1500 VA. USED:	\$19.95
PE-115	28 VDC 36Amp	80 V—800 cycle 1 Ph. 7.2 A. L.N.:	\$5.95
PE-206A	27.5VDC 38Amp	80 V—800 cycle 1 Ph. 7.2 A. L.N.:	\$5.95
MG-153F	24 VDC 115 V—400 cycle 1 Ph. 7.2 A. L.N.:	750 VA 26 V—400 cycle 1 Ph. 250 VA. USED:	\$69.50
MG-Type A-1	200 V—400 cycle 3 Ph.	30 VDC 200 A.	\$49.50
CM-93 Alt.	6000 RPM output	120-208 3 Ph. 400 cycle 30 KW	\$69.50

MISCELLANEOUS:

24 VDC Circuit Breaker—30 Amp—Heinemann.....**\$1.50**
125 VAC Circuit Breaker—12 Amp—Heinemann.....**2.95**
FL-8 Audio Filter—1020 cycle.....Used **1.50**
Leg and Seat Assy. for Hand Generator.....**3.50**

TRANSMITTERS:

BC-230 with Tubes.....**\$ 4.95**
TA-12H Transmitter, with Tubes.....USED: **29.95**
TC-20 ARC/BC-457—4 to 5.5 MC.....NEW: **14.95**
BC-459 Transmitter—7 to 9 MC.....NEW: **29.95**
274N—As is—No Tubes—No Returns—BC-457 or 458.....**3.95**
BC-375 Trans.—As is—No Tubes—No Meters—No Returns.....**10.00**

RECEIVERS:

R-1/ART-1 for conversion to 220 MC.....**\$ 4.95**
RA-10 Receiver with Tubes & Dyn.....USED: **24.95**
BC-455 Receiver—6 to 9.1 MC.....**7.95**
274N—As is—No Tubes—No Returns—BC-453.....**8.00**
BC-454 or 455.....**3.95**

CORDS—CABLES

CD-501 Cord f/GN-45 Generator.....**\$2.00**
CD-218 Cord w/PL-68 & SW-141 & JK-48F f/Throat or Lip Mic.....**.89**
CD-307 Cord—3.5 Ft. w/PL-55 & JK-26W.....**.89**
CD-604 Cord w/C-110 Trans. & PL-54 Plug.....**.89**
BC-375 or 191 Cable w/IL-64, 61, or 59 each end.....**2.50**
CD-365 Cord for LP-21 Loop.....**1.75**
MC-215 Tuning Shaft for 274N.....**2.00**

CONTROL BOXES:

	NEW:	USED:
C-87/ART-13—f/ART-13 Trans.....	\$ 6.95	\$4.95
MR-9C/Control Box f/RA-10 Rec. w/Mic.....	12.95	9.95
BC-434 for ADP.....	2.95	1.95
BC-732 for Localizer.....	2.00	1.95
BC-646 Control Box f/BC-645.....	2.00	1.95
BC-461 Reel Control Box w/Counter.....	2.95	

HEADSETS—MICROPHONES:

Head & Chest Set for EE-8.....Used: **\$2.95**
Dynamic Microphone & Headset for Mark II.....**2.95**
HS-30 Headset.....New: **1.95**

TUNING UNITS COILS

TU-7-8-9-10-26 for BC-191-375.....Used: **\$3.95**
IF Transformers f/274N—85 KC—1415 or 500 KC.....Ea. **1.50**

AMPLIFIERS:

BC-605 Amplifier.....Used: **\$3.95**
BC-347 Amplifier with Tube.....**2.95**
BC-709 Amplifier.....**4.95**

PLUGS AND CONNECTORS:

PL-112 Plug for LP-21 Loop.....**\$1.25**
PL-P-103 Plug for BC-348.....**1.50**
MC-211 Rightangle Adapter for Comm. Sets.....**.25**
M-359 Rightangle Coaxial Connector.....**.25**

MOUNTINGS AND CLAMPS:

FT-154 for BC-348 Receiver.....**\$2.50**
FT-170 Mounting & Clamp.....**1.00**
MC-176 Marble Ball for above—f/Fairlead.....**1.00**
MC-396 Wood Clamp for Fairlead.....**.75**
M-235 Lobbins & 250 Ft. W-106 Antenna Wire.....**3.50**
WT-7 Weight for Trailing Antenna.....**1.50**

AUTOSYN TRANSMITTER:

Autosyn Transmitter from LP-21A Loops, used with I-81 or I-82 Indicators. Operates from 26 Volt 400 cycle. With calibrated Dial and Correction Pointer.
MC-507.....**\$6.95** MC-217.....**\$5.95**

GEAR TRAIN MOTOR



Ball bearing, low inertia reversible type, 588 RPM. Extra large gear, 12 RPM operates 26 Volt 400 cycle or 12 Volt 60 cycle. Removed from LP-21 Loops. Type 10047-2A.....**\$4.95**

BAND SWITCH MOTOR and Switching Assy for MN-26 Compass.....**\$5.95**

AIRCRAFT KITCHEN GALLEY—Type C-2, 24 Volt DC operation complete w/Food Warmers, Grill & Soup Can.....**\$34.95**

NOTICE

NEW POSTAL REGULATIONS, effective January, 1952, place 20 lb. weight limit on parcel post shipments. All shipments over 20 lbs. accordingly shipped via Motor Freight or Express. C.O.D. and postal M.O. Fees up to \$35. 40c—\$10; 55c—\$25; 85c—\$50; 95c. When ordering, SEND ENOUGH MONEY AND SAVE! ANY BALANCE WILL BE REFUNDED IN CASH AT ONCE!

Address Dept. RN • Minimum Order \$5.00 • Prices F.O.B., Lima, O. • 25% Deposit on C.O.D. Orders

DYNAMOTORS:



DYNAMOTOR And BLOWER
9 Volts DC input, output 450 Volts 60 MA., 4500 RPM. At 6 Volts DC input, output 260 Volts 65 MA., 3000 RPM.
PRICE.....**\$4.95**

INPUT:	OUTPUT:	STOCK No.:	PRICE:
14 V. DC	600 V. 300 MA.	BD-86	\$9.95
12 V. DC	220 V. 70 MA.	DM-24	6.95
12 V. DC	220 V. 100 MA.	DM-18	4.95
12 or 24 V. DC	440 V. 260 MA. & 220 V. 100 MA.	D-104	9.95
14 V. DC	375 V. 150 MA.	DM-375	8.95
14 V. DC	330 V. 135 MA.	DM-330	7.95
14 V. DC	500 V. 500 MA.	PE-59	14.95
12 or 24 V. DC	275 V. 110 MA.	USA/0516	3.95

ALSO—PE-73; PE-86; DM-53; DM-33; 5053; DM-416; PE-101, etc.

BLOWERS:

115 Volt 60 cycle BLOWER (pictured), approx. 100 CFM Dis. 2 1/2" intake; 2" outlet. Quiet running. Motor size: 2 1/2" x 3 1/4". NEW—not Gov't surplus.
Order No. RN-520.....**\$7.99**



DUAL BLOWER—Same as RN-520 above, except has blower assembly on each side of motor. Order No. RN-800.....**\$12.95**

METERS:

0-150 Volt, 400 cycle, 2 1/2" Rd.....**\$3.95**
0-5 Amp. AC, 3" Rd., 0-75A Scale.....**3.95**
0-5 Milliamp DC, 2 1/2" Sq., 0-5 Scale.....**3.95**
0-1 Milliamp DC, 2 1/2" Rd., 0-150 Scale.....**3.95**
0-500 Microamp, 2 1/2" Rd., 0-15 & 0-600 DC Volt Scale.....**3.95**
TUNING METER I-70B Reverse Scale, Weston = 60" for Compass Control Boxes.....**3.95**

POWER SUPPLIES:

VIBRATOR TYPE—6 Volt DC input; output 230 Volt DC 50 MA. filtered w/tube. Size: 6 1/2" x 4" x 5 1/2". Price.....\$6.95
VIBRATOR TYPE—6 Volt DC input; output 230 Volt DC 50 MA.—not filtered—w/tube. Ideal for Command Receiver operation as receiver is filtered internally. Size: 7 1/2" x 4 1/2" x 3 1/2". \$4.95
PE-157 POWER SUPPLY—2 Volt Vibrator Supply, operated from BB-54 2 Volt Battery mounted in Case. Output voltage 1.4 V. 1/2 Amp 125 V. 50 MA. Less Battery, Speaker & External Power Cord—with Vibrator.....\$4.95
BB-54 2 Volt Dry Battery.....**2.95**

BC-223 TRANSMITTER



30 Watt transmitter with Crystal or MO control on four pre-selected channels. CW. ICW cover frequency range 2000-5200 KC. Complete with tubes and choice of one Tuning Unit (listed below). Less Mtg.—Price: NEW: **\$32.50**

USED (Gov't. Reconditioned) **\$26.50**

CABLE—Trans. to Power Supply.....**\$2.00**
TUNING UNITS: TU-17—2000-5000 KC. TU-18—3000-500 KC. TU-25—3500-5250 KC. **\$3.50 EACH**
Spare VIBRATOR & TUBE KIT f/PE-125EX.....\$ 5.95
PE-125BX POWER SUPPLY f/BC-223—12/24 Volt input; output 475 Volts 150 MA. NEW: 14.95
SPARE TUBE KIT in metal box, f/BC-223: 5.95
OPERATING MANUAL for BC-223: 2.50
SHOCK MOUNTING for PE-125: 1.50
FT-173 MOUNTING for BC-223: 2.50
BC-223 TRANSMITTER—Incomplete, for parts, No front panel or meters. Price—As is: \$4.95

TRANSFORMERS AND CHOKES

TRANSFORMERS—110 V. 60 CYCLE PRIMARIES:
Sec. 6.3 Volt 1 Amp.....**\$1.25**
Sec. 24 Volt 1/2 Amp.....**1.50**
Sec. 24 Volt 1 Amp.....**1.95**
Sec. Two 12 V. 4 A. windings—gives 12 V. 8 A. or 24 V. 4 A.....**5.95**

CHOKES:

H-115 8 Henries 500 MA Filter, 5000 V. Ins.....**\$10.95**
H-121 13 Hy. 250 MA Filter, 1500 V. Ins.....**4.95**
H-412 4-12 Hy. Swinging, 300MA, 2500V. Ins.....**4.95**

FAIR RADIO SALES

132 SOUTH MAIN ST.
LIMA, OHIO

**AT LAST! TV RECEPTION
 UP TO 200 MILES**

ON ACTUAL FIELD TESTS WITH
NEW DX630 CHASSIS
 USING THE CASCODE TUNER

will operate in fringe areas or in localities
 remote from TV broadcast stations
 up to 200 miles.

HAS 4 MICROVOLT SENSITIVITY—10 times any
 other TV receiver. Will pick up distant stations
 without use of boosters or special antenna arrays
 and with less noise. Will operate any tube in-
 cluding 24", greater brilliance, improved keyed
 AGC circuit, (eliminating flickering and fading)
 Uses the best materials with a high factor of
 safety to insure trouble-free operation. STD
 RTMA GUARANTEE free replacement of defec-
 tive parts or tubes for 90 days. Completely fac-
 tory wired chassis ready to operate with 12" P.M.
 Speaker.
 Price including excise tax..... **\$148.95**

TELEVISION PICTURE TUBES

Standard makes, 1 year guarantee, all prices
 include 10% excise tax. (See ad for prices.)

TELEVISION CABINETS

We have a large variety of table model, consoles
 and combination cabinets DESIGNED TO PLEASE
 the most discriminating tastes. Beautifully fin-
 ished, mostly handrubbed available in mahogany,
 walnut, and blond colors. Table model (outside
 dimensions 23 3/4" x 24" x 24") price in mahogany
 for all sizes up to 20", including **\$34.95**
 mask, and 10% excise tax.
 Extra for glass.....\$2.75

Console cabinet of beautiful design made of
 the finest veneers and good finish. Size 39" high
 x 24" wide x 22 3/4" deep finished. In mahogany
 or walnut. Cut for 630 chassis with 12" speaker
 will take either 16, 17, or 20" tube. **\$43.95**
 Price including mask and excise tax.
 Extra for glass.....\$2.75

For the various other cabinets in our large selection
 we will furnish photos and other NECESSARY
 INFORMATION, ON REQUEST. New Dumont
 conversion kit. Send for Free Catalog.

TELEVISION PICTURE TUBES

Standard Brands		ONE YEAR GUARANTEE	
12 1/2" (Black or White).....	\$23.95	Glass 16" Round (Black).....	\$34.50
Glass 14" Rectangular (Blk.).....	\$23.50	Glass 16" Rectangular (Blk.).....	\$34.50
17" Rectangular (Blk.).....	\$31.95		
19" Round (Blk.).....	\$39.95		
20" Rectangular (Blk.).....	\$39.95		
21" Rectangular (Blk.).....	\$42.95		
24" Metal.....	\$69.95		

New—Dumont True Focus Conversion Kit
 Convert your old set for even focus over entire screen!
 Dumont 70" Yoke, Model Y2A—distributed winding.....\$6.57
 Dumont 70" Flyback Transformer, Model H1A1..... 6.57
 Dumont Linearity control—for above units..... .75
 Dumont Width Coil for above units..... .75

TELEVISION COMPONENT SPECIALS

**NEW STANDARD COIL
 CASCODE TUNER**

Uses I-6J6 and I-6BK7
 Intercarrier..... **\$19.95**

New Dumont 3c Tuners Sound Center
 I.F. 21.25 or 21.75..... **\$23.40**
 Plus your old Tuner

TELEVISION HI-PASS FILTER

Cuts off at 50 Mc with a high attenuation at approx. 40 Mc. Eliminates interference from electrical appliances, short wave, and Amateur radio transmitters, diathermy and x-ray machines..... **\$3.34**

All Merchandise Subject to Prior Sale. All Prices
 Subject to Change without Notice.

WRITE FOR COMPLETE CATALOG N-3

EDLIE ELECTRONICS INC.

154 Greenwich St. New York 6, New York

A. *Orientation.* A simple means of antenna orientation is important if optimum signal-to-noise ratio is to be obtained on each channel. Proper orientation facility minimizes picture smear, the influence of reflections, impulse noises, and local oscillator radiation. It permits better raster stability and a more motionless background.

B. High erection is important at a vast majority of sites from the standpoint of peak signal and keeping the antenna above obstacles and room activity.

C. To intercept a peak signal, it should be possible to fully extend the elements. It should be possible perhaps to derive some gain from the antenna on the high band.

D. Antenna should be designed so it can be mounted in an out-of-way or hidden position. The antenna for a television receiver is a utilitarian device and doesn't lend itself too well to ornamentation if effective performance is to be attained.

Indoor "Directronic"

An indoor "Directronic" type of antenna displays excellent indoor characteristics. The basic type used for indoor application consists of three quarter-wave elements spaced in 120 degree relation (can be mounted at other angles to fit space available) and feeds a three-wire transmission line, Fig. 1. The three-wire line connects to a six-position switch mounted at the receiver (near antenna terminals) while an ordinary 300 ohm two-wire line connects the switch and receiver input. The switch, Fig. 1, chooses the elements in pairs, (1-2, 2-3, 1-3) or chooses two elements to work with a single (1, 2-3; 2, 1-3; 3, 1-2). A wafer-type of ganged switch is used, so arranged that the two six-pole portions operate together. In the three lower positions, the corresponding single-pole switch shown at the left in the diagram is also closed. For example, in the bottom switch position, the left-hand single-pole switch is closed; the next position up closes the center single-pole switch, and the third position up closes the right-hand switch. This arrangement allows six orientation possibilities—more than enough to fit the orientation requirements. The orientation feature is not only advantageous as a signal level adjustment, but it permits orientation away from interference and changing directions of interference arrival (such as local oscillator radiation in a crowded neighborhood). The forward tilt of elements permits some high-band gain.

The antenna elements are standard 46 inch lengths made of *aluminum tape*. The tape can be made to adhere firmly to painted surfaces, wallpaper, etc. The antenna can be mounted on the ceiling or, better still, hidden away on a closet ceiling. The antenna itself need not be oriented physically and the benefit of a full length element can be obtained. It is mounted at ceiling level and is little influenced by receiver positioning and room activity.

**FOR FRINGE AREA & DX
 the New DAVIS
 SUPER-VISION
 ANTENNA**

Built to the same Davis High-Quality Reception Standards which have made Davis Electronics Products so popular with users and the trade. Backed by over a quarter of a century of electronic experience.

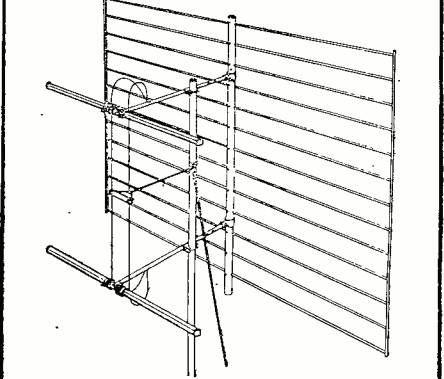

MANY OUTSTANDING FEATURES:

- Broad-Band Receiving—Channels 2 to 13.
- Eliminates or Greatly Reduces "Ghosting" Problems.
- Provides 10 DB or More Gain on High Channels—where gain is most needed.
- Excellent Front-to-Back—on all channels.
- Minimizes Interference: Airplane Flutter—Diathermy and Ignition—F. M.—Neon Signs—X-Ray—Industrial—Etc.
- Can Be Tipped WITHOUT Tilting Mast.
- Jiffy Assembly. Light-weight rugged construction.

AT YOUR JOBBERS, OR WRITE TO:

DAVIS ELECTRONICS 1-3
 3047 W. Olympic Blvd., Los Angeles 6, California
 SIRS: RUSH INFORMATION TO ME AS CHECKED BELOW:
 Send Free Technical Data on new SUPER-VISION ANTENNA.
 Send Name and Address of NEAREST JOBBER.

Name _____
 Street _____
 City _____ State _____

**No Experience Needed To
 PRINT YOUR OWN
 POST CARDS**

The GEM STENCIL DUPLICATOR saves money... gets results quickly! Hundreds of uses for every type of business and organization. We ship the GEM complete with all supplies, Guide Board for accurate printing and 60-page Book of Ideas at the special low price of only **\$8.50** (a \$15.00 value) *Our 21st Year*

FREE INFORMATION

Use the GEM FREE at our expense! SEND NO MONEY. Write and complete GEM outfit will be sent you postpaid. After ten days, send us only **\$8.50** or return the GEM. You must be satisfied! WRITE TODAY.

BOND EQUIPMENT CO. Dept. 52
 6633 Enright • St. Louis 5, Mo.

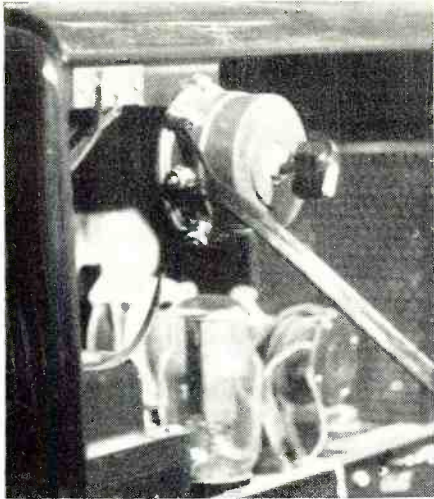

"Directronic" switch installed in TV set.

An indoor "Directronic" is able to take effective advantage of whatever signal levels are present. It will not be able to deliver as strong a signal as a proper outdoor antenna because, generally speaking, the signal levels are substantially weaker indoors. Nevertheless, recent increases in transmitter power and more sensitive tuners are used to advantage in a well-planned, versatile indoor antenna installation. An antenna of this type installed on an attic ceiling approaches the performance of a good outdoor antenna and is better than the poorer outdoor installations.

Typical mounting sites (see page 42) include a room ceiling, closet ceiling, or attic ceiling. A room ceiling mount can be made presentable if installed neatly—it should be very satisfactory for a den, recreation room, bedroom, hall, etc. Closet ceiling mounting is ideal from the standpoint of appearance and performance. Tape elements can be made to follow the contours of a small closet, running down corners or sides—full length elements being more important than the fact that the elements do not remain strictly in a horizontal plane.

The indoor "Directronic" is convenient for attic ceiling mounting and for mounting on ceilings of unfinished second floors.

Indoor tape antennas of the "Directronic" type have among their features: high and hidden mounting possibilities, electronic orientation, full length elements, high signal level, and interference rejection possibility by pattern orientation.

HANDY TEST LEADS

By HUGH LINEBACK
Oklahoma A & M College

SERVICEABLE and convenient test leads may be made by using ordinary parallel conductor, rubber-covered lampeord.

By adding the desired terminals and splitting the ends for a short distance, there is really only one wire to worry about instead of two separate ones. Bands of tape are used to keep the cord from separating too far.

March, 1952

LOOK—NO NOISE!

Boosts the signal . . .
not local lead-in noise!

Gives higher signal-to-
overall-noise ratio!

Exclusive broadband
circuit gives uniformly
high all-channel gain!

Eliminates
effect of
external
interference

SINGLE TWIN-LEAD LINE*
CARRIES POWER UP—
AND SIGNAL DOWN

Pictures are Sharper, Brighter! Sound is Clearer!

You can *see* and *hear* the difference when you hook up the TENNA-TOP. Because it is mounted at the antenna ahead of the lead-in...it amplifies only the wanted TV signals, not any local noise interference produced by automobile ignition systems, neon signs, diathermy, or other external noise picked up by the lead-in. You have the further advantage of E-V low-noise circuit. All this guarantees the best possible results with any TV set anywhere...even in toughest fringe areas or in all noisy locations. The TENNA-TOP is completely automatic. Turns "On" or "Off" with the TV receiver switch. It is easy to install, highly stable, trouble-free.

Model 3010 Tenna-Top TV Booster. List Price . . . \$88.00



Tune-o-Matic TV BOOSTER

Famous E-V broadband booster—proved in thousands of installations! Uniform high gain—low noise circuit. Automatic self-tuning for all channels. Easily concealed.
Model 3000, 4-stage, List \$57.50
Model 3002, 2-stage, List \$39.50

Electro-Voice

TV BOOSTERS • MICROPHONES • HI-FI SPEAKERS • PHONO-PICKUPS

Send for Free Bulletin

Electro-Voice, Inc., Dept. N3-52
410 Carroll St., Buchanan, Michigan
Send Free Bulletins 163-165

Name _____ (PLEASE PRINT)

Address _____

City _____ Zone _____ State _____

Serviceman Installer Dealer TV Fan

*Patent Pending

STEEL TOWERS and MASTS Tubing - Roof Mounts - Guy Rings PRODUCTS for T-V and ELECTRONICS



**Model 100 —
Kwik Clim Tower**

This light weight tubular steel tower comes in 10' sections with slip joints that require no bolting. Safe and easy to climb. Top section has sleeves for up to 2 1/4" mast. Base adaptable to any pitch roof. Additional sections may be added to 100 feet. 30' tower complete with base weighs 80 lbs. Additional sections 22 lbs. each.

MODELS 130 and 140, 30 foot and 40 foot Manually Telescoping Masts. Priced for that inexpensive installation.



**Model 115 —
Krank Up Mast**

27' telescoping crank up mast complete with all hardware. Cranks to any positive position from 10' to 27'. Made of sturdy 2", 1 1/2" and 1 1/4" tubing. Easily installed.

**Model 125 —
Krank Up Mast**

47' telescoping crank up mast complete with all hardware. Same as Model 115 in construction. Will telescope to any positive position from 20' to 47'. Weight 45 lbs. A locking device on both of the above models removes all the strain from the cable.

Pat. Pending

ROOF MOUNTS



Model A-5 — Apex Roof Mount
A sturdily constructed Roof Mount with 4-way swivel. Fully adaptable to any type of mounting. Will take up to 2 1/4 inch tubing.

ALSO

MODEL S, Rotary 4-way T-V mast base mount
MODEL P, 2-way swivel T-V mast base mount
RUGGEDLY CONSTRUCTED MOUNTS - LOW PRICED

QUALITY PRODUCTS SOLD THRU
RECOGNIZED JOBBERS

JOBBERS and DISTRIBUTORS
WRITE FOR PRICES AND LITERATURE

JONTZ MANUFACTURING CO.
1101 E. MCKINLEY AVE.
MISHAWAKA, INDIANA

Audio Simplified (Continued from page 74)

The basic principle of operation of the volume compressor or expander is shown in the block diagram of Fig. 6. The audio signal is amplified to a sufficiently high level, and then rectified to give a d.c. voltage proportional to the signal level. This voltage controls the gain of a variable-gain stage in such a manner that the gain may be either reduced or increased as the signal voltage increases, depending upon whether the circuit is to be a compressor or an expander. A gain control in the amplifier-rectifier circuit can be used to control the amount of compressor or expander action, and a delay voltage can be introduced into the rectifier circuit so that the action only occurs above a certain level.

The circuit of a simple compressor or expander is shown in Fig. 7A, and the principle of its operation may be seen most clearly from the simplified diagram and equivalent circuit shown in Fig. 7B. The input signal is rectified, and the developed voltage applied to the grid of a triode whose plate resistance forms the shunt resistor in an audio-frequency voltage divider network. The equivalent circuit shows this principle of operation, and it can be seen that with proper selection of the resistor values, if the plate resistance of the tube is made to vary properly, the output signal level can be controlled over a wide range of input levels.

A simple practical circuit based on this principle is shown in Fig. 9A. The input signal is amplified by one-half of the 6SL7 dual triode, whose output is rectified by the second half of the tube connected as a diode. The voltage from the diode rectifier is then a measure of the signal level. This voltage is properly filtered and applied to the grid of one-half of a 6SN7 tube to control its plate resistance, which is used as the variable resistance in the audio voltage divider circuit. The voltages are chosen so that for high signal levels a positive voltage is applied to the grid of the variable-resistor tube, which lowers its plate resistance and therefore decreases the gain of the channel. This compression circuit is capable of giving a compression up to 10 to 15 db with 0.5 volt rms applied to the input.

The operation of a peak limiter may

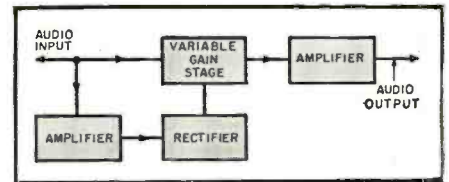

Fig. 6. Basic block diagram of volume compressor, peak limiter, and expander unit.

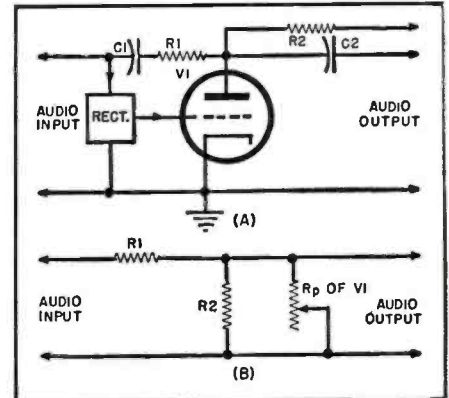

Fig. 7. Simple basic circuit for volume compression or expansion (A) and equivalent circuit of (A) for audio signal (B).

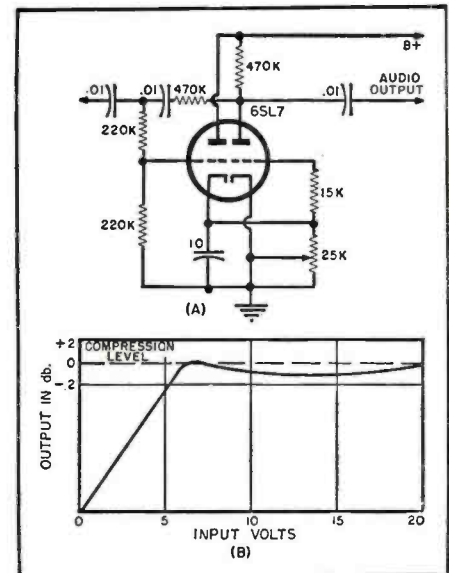
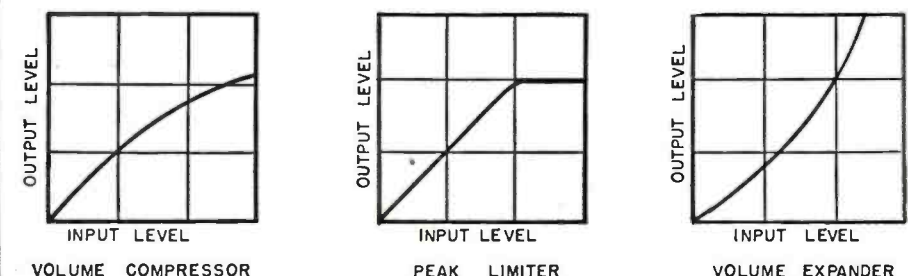

Fig. 8. (A) Peak limiter circuit, and (B) the amplitude response of peak limiter circuit.

be compared to that of the compressor, and may be considered as having a very high degree of compression which takes place only when the input signal becomes greater than some specified level. The circuit of a peak limiter whose operation is based upon the

Fig. 5. Amplitude response curves of volume compressor, peak limiter, and expander.



**Lowest Prices
Largest Stock**

TUBES and PARTS

All TUBES are guaranteed for one year . . individually boxed. **10% DISCOUNT** on orders of 100 tubes or more, all brands. **USE THIS ORDER BLANK—**

Quantity	Quantity	Quantity	Quantity	Quantity	Quantity						
0Z4	59c	6AB7	\$1.15	6J5GT	\$.54	7A6	81c	12BE6	\$.65	35B5	72c
0Z4G		6AC5GT	1.31	6J6	1.04	7A7		12BF6	.59	35C5	.59
1A5GT	.65	6AC7	1.19	6J7G	.79	7A8		12BH7	1.08	35L6	.45
1A7	.99	6AG5	1.44	6J8G	.87	7B4		12C8	1.15	35W4	.59
1B3GT	.95	6AG7	1.40	6K5GT	.59	7B5		12F5GT	.81	35Y4	.45
1B5		6AH6	1.08	6K6GT	.79	7B6		12H6	.81	35Z3	.99c
1C7G	29c	6AK5	72c	6K7GT	.87	7B7		12J5GT	.81	35Z4	.54c
1E7		6AK6		6K8GT	.87	7B8		12K7GT	.81	35Z5	.95
1H6		6AL5		6L5G	.95	7C4		12Q7GT	1.44	35Z6G	.79
1H5GT	.65	6AQ5	.81	6L7	.87	7C5		12SA7G	.72	35Z51	.42
1H6G	1.15	6AQ6	.74	6N6G	1.40	7C6		12SC7	.79	41	.79
1J5GT	.95	6AR5	.54	6N7GT	1.08	7C7		12SF5GT	.99	42	72c
1L4	.29	6AT6	.90	6P5GT	.65	7E6		12SF7	.99	43	
1LA4		6AS5	1.45	6Q7GT	.65	7E7		12SH7GT	1.19	45	
1LA6	1.19	6AU5GT	59c	6R7GT	.95	7F7		12S7GT	.99	45Z5	.59
1LC5		6AU6	1.44	6S4	.65	7F8		12SK7GT	1.76	46	1.04
1LC6		6AV6	59c	6S7GT	1.15	7G7		12SL7GT	1.19	47	1.21
1LD5	.95	6B4G	1.44	6S8GT	.95	7H7		12SN7GT	.90	50A5	.59
1LE3	1.19	6B5	72c	6SA7GT	.72	7J7		12SQ7	.59	50B5	72c
1LH4	1.19	6B6G	.79	6SC7	.79	7K7		12SQ7GT	.59	50C5	1.04
1LN5	1.19	6B8GT	1.15	6SD7GT	.65	7L7		12SR7GT	.79	50C6G	.59
1N5GT	.72	6BA6	.87	6SF5	.59	7N7		12Z3	.95	50L6	.79
1P5GT	95c	6BA7	.72	6SF5GT	.65	7Q7		14A7	.95	50X6	.59
1Q5GT	72c	6BC5	.79	6SF7	.72	7R7		14AF7	.99c	50Y6	1.40
1R5		6BC7	1.15	6SH7GT	.65	7S7		14B6	.77	50Y7	.87
1S5		6BD5GT	.99	6S7	.58	7V7		14B8	1.19	75	1.10
1T4		6BE6	.59	6S7GT	.79	7W7		14C5	1.08	77	.61
1U4	.65	6BF5	.73	6S7GT	.79	7X6		14C7	.99	80	1.45
1U5	.95	6BF6	.54	6SN7GT	.54	7X7		14F7	1.44	83	.79
1X2A	1.15	6BG6G	.85	6SQ7	.59	7Y4		14F8	1.15	85	1.40
2A3	.79	6BH6	.72c	6SQ7GT	.65	7Z4		19B6G	.79	117L7	.54
2A5	1.19	6BJ6	.85	6SR7GT	.72	12A7		19T8	1.40	117N7	1.08
3LF4	1.08	6BN6	1.15	6SS7	1.15	12A8		20	.54	117P7	1.55
3Q4		6BQ6	59c	6T7G	1.10	12AH7		24A	.79	117Z3	1.08
3Q5GT		6BQ7	79c	6T8	.79	12AT6		25AC5GT	1.04	117Z6	1.55
3S4		6C4		6U5	.79	12AT7		25BQ6GT	.72	807	8.95
3V4		6C5GT		6U6GT	.65	12AU6		25L6GT	.59	813	29c
5T4		6C6		6U7G	.59	12AU7		25W4GT	1.15	1294	.45
5U4G		6C8G		6V6GT	.65	12AV6		25X5	.95	1299	.29
5V4G		6CB6		6W4GT	.54	12AV7		25Y5	.87	1619	2.00
5W4		6CD6G		6X4	.68	12AW6		25Z6GT	.79	1629	1.15
5W4GT		6D6		6X5GT	.87	12AX7		32L7GT	1.15	2050	.87
5X4G		6D8G		6Y6G	.90	12BA6		35A5	.87	2051	.87
5Y3GT		6E5		7A4	.99	12BA7				7193	29c
5Y4G		6F5GT		7A5						VT51	
5X4G		6F6GT								VT52	
5Z3		6F8G									
6A3		6G6G									
6A7		6H6									
6A8GT		6H6GT									

TUBE SPECIALS!

6AU6	ea. 59c	6SK7GT	ea. 58c
6V6GT	ea. 59c	6BQ6GT	ea. 85c
12AU7	ea. 65c	6CD6G	ea. \$1.69

TUBE KITS

BEST BRANDS at BEST PRICES

3Q4, 1T4, 1R5, 1S5. List Value \$8.00. Tube Kit only	\$2.39
3S4, 1T4, 1S5, 1R5. List Value \$7.80. 4 Tube Kit	\$2.39
1U4, 3S4, 1S5, 1R5. List Value \$7.80. All Four Tubes for	\$2.39
3V4, 1R5, 1S5, 1T4. List Value \$7.80. All for	\$2.39
117Z3, 1U5, 3V4, 1R5, 1T4. AC-DC Portable Kit. All for	\$2.89
12AT6, 12BA6, 12BE6, 35W4, 50B5. 5 Tubes for	\$2.95
50L6GT, 35Z5GT, 12SQ7GT, 12SK7G, 12SA7G. 5 Tubes for	\$3.22

TV PICTURE TUBES

Six month guarantee

10BP4	\$1295	16JP4	\$2995
12LP4	\$1695	16RP4	\$2995
12LP4A	\$1695	16TP4	\$2995
14BP4	\$2295	17BP4A	\$3195
7JP4	\$1795	19AP4A	\$3995

TWIN LEAD

300 ohm twin lead 55 Web virgin polyethylene, in either clear or brown, the finest available.

1000 ft. \$1850 | 100 ft. \$195

6 FOOT LINE CORD

will be scarce — UL approved cord and plug—10 for \$195

Get our special sales bulletins . . . write TODAY!

TUBULAR ELECTROLYTIC FILTER

40-20 mfd., 150 V—with 20 mfd., 15V . . . 20c ea. TUBULAR MOLDFR—8 mfd., 400V . . . 16c ea.

TV INLINE FOLDED DIPOLE ANTENNA
At this price we cannot mention manufacturer's name, complete with mast, ind. boxed. \$7.98 each

RESISTOR KITS

Insulated 1/2, 1 and 2 watt assortment of most used values, best brands. 100 for \$4.95

50 asst.—\$2.95

JOBBERS: Write for quantity discounts

RESISTORS

You pick them, we ship them. Insulated—best U. S. brands. ANY RESISTANCE

In lots of 10

1/2 watt (20% 3 1/2c ea. 10% 5c ea. 5% 9 1/2c ea.)	1 watt (20% 4 1/2c ea. 10% 7 1/2c ea. 5% 15c ea.)
2 watt—20% 10 for 60c	2 watt—10% 10 for 95c
2 watt—5% 10 for \$2.15	

Premier RADIO TUBE CO. 551 W. Randolph St. Chicago 6, Illinois ANdover 3-1590

TRIAD General Purpose POWER Transformers

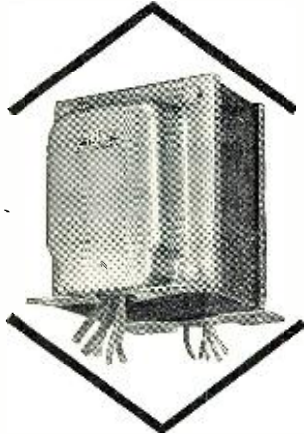

Tested... to meet
your requirements
and excel in
performance...

TRIAD general purpose Power Transformers are specially designed, not only for replacement, but for use in electronic equipment for industry, for PA amplifiers, and for amateur gear.

All types are "Climatite" treated, both coil and core, for protection against moisture and for elimination of lamination chatter. Laminations are painted to prevent rust. Although small in size, the high quality materials used in these transformers keep losses to a minimum. Only copper coils for static shields, grounded to case and core, are used. Leads are UL approved for high temperature operation. Final tests include checking for correct operation and stressing in all ways beyond maximum operating potential. Beautifully finished in gray enamel with all specifications on decal on the case.

Remember! Only Triad Transformers are "Climatite" treated

Available from stock at leading jobbers

Write for Catalog
TR-51

2256 Sepulveda Blvd.
Los Angeles 64, Calif.

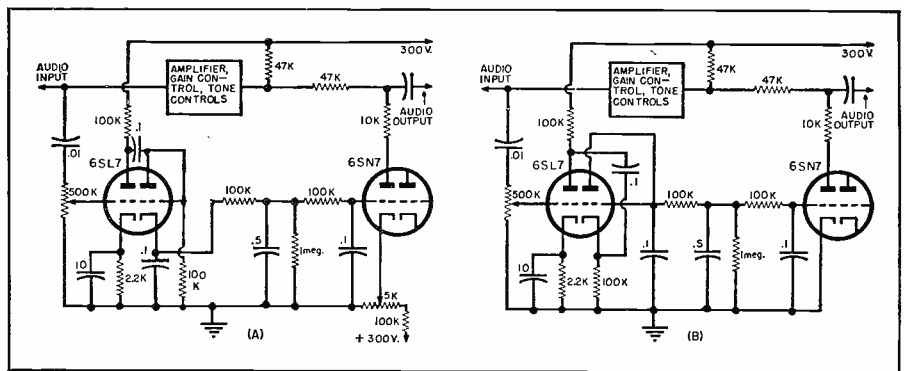

Fig. 9. (A) Conventional volume compressor circuit and (B) volume expander circuit.

same audio voltage-divider principle of Fig. 7 is shown in Fig. 8. The input signal is rectified by a high-impedance cathode detector which is the first section of the 6SL7, and the developed voltage is applied between the grid and cathode of the second section of the 6SL7 which acts as the variable shunt resistance of the voltage divider. The values of the components have been selected to give the best voltage/signal-level characteristic to result in a linear compression curve. This circuit gives a peak-limiting curve similar to that shown in Fig. 8B, and is capable of 15 to 20 db limiting with an output level change of less than 1 db. The limiting action is initially adjusted by means of the 25,000 ohm cathode resistor, and then the degree of limiting for any transmitted audio signal is adjusted by controlling the level of the signal applied to the input of the limiter circuit.

A volume expander is essentially the reverse of the compressor circuit which has already been described. The major difference between the two is that the diode rectifier must be reversed and the voltage levels reset, so that for high signal levels the channel

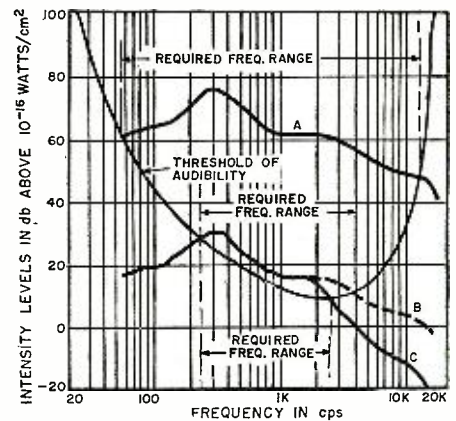
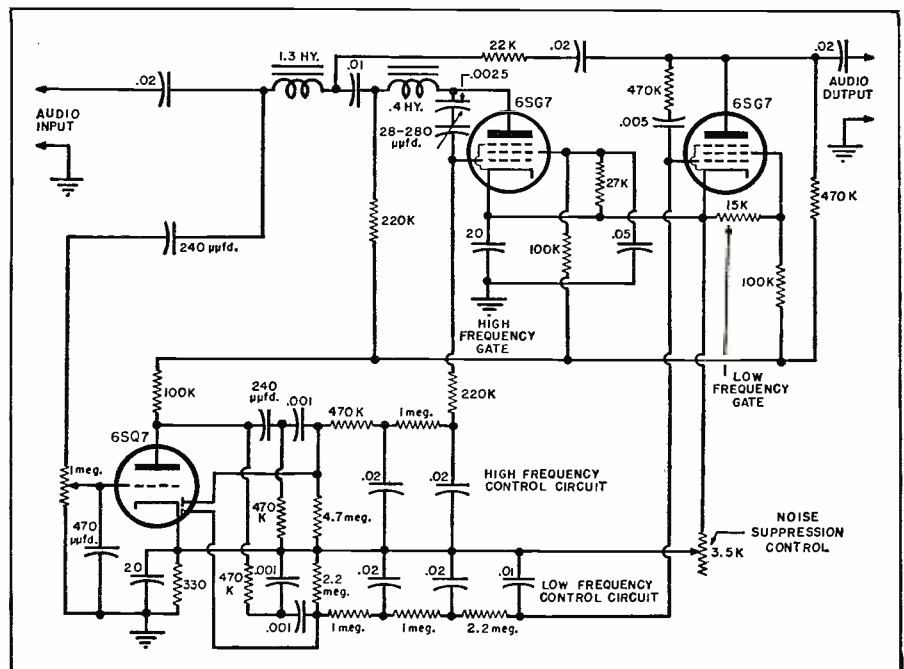

Fig. 10. Required frequency range for music at different levels. Curve A is the most probable frequency distribution in music at high levels. Curve B is same as A at lower volume. Curve C is the most probable frequency distribution with the orchestra playing soft passages.

gain is increased. Thus, the circuit of Fig. 9B is essentially the compressor circuit of Fig. 9A with the rectifier connections reversed to give a negative voltage when the audio level increases, and the cathode of the variable-resistance tube connected directly to ground

Fig. 11. Circuit diagram of the Hermon Hosmer Scott dynamic noise suppressor which is particularly well adapted for use in a sound reproducing channel.



so that the plate resistance is low for low-level signals and high for high-level signals. The gain therefore increases as the audio level increases. This circuit is capable of giving up to 10 db expansion, and component values may be selected to give greater expansion if desired.

In the use of volume compression and expansion circuits, the time constants of operation are extremely important, and generally represent a compromise of several factors. The time of initial operation should be rapid to act properly on the initial peaks, but the release time presents a more difficult problem. If the release time is too short, a sort of "pumping" effect is obtained in which the gain is constantly adjusting to rapid changes in level; while if it is too long, sharp dynamic effects in the program material will suffer. Optimum conditions are a very rapid initial operation time, and a release time of about one-half second to one second.

The units which have been described can either be included directly in the amplifier, or be constructed on a separate chassis with the gains and levels adjusted for unity gain at some specified level (which will require the inclusion of additional amplification), and switched into the channel whenever they are required.

Noise Suppression

Another approach to the problem of background noise has been to attempt actually to remove the noise which has been introduced into the reproduced sound. A number of different methods have been developed for this purpose. The most widely accepted of these methods is the *dynamic noise suppressor*, whose operation is based essentially upon the fact that the frequency response of the ear changes with sound level.

Detailed curves which have already been reproduced in Part 1 (Fig. 4, page 50, September 1951 issue) of this series show the effects of different loudness levels on the human ear. The ear does not have the same frequency response for different acoustic levels, that is, at high levels its response is approximately flat, while at low levels the sensitivity to high and low frequencies is considerably reduced. The basic data from these curves is reproduced in Fig. 10, which shows the curve for the lowest levels which can be heard by the ear at each frequency. On the same graph are also shown the most probable frequency distribution in music at high levels (curve A), this same distribution at about a 25 db lower level (curve B), and the frequency distribution when the orchestra is playing softly (curve C) showing that the production of harmonics in soft playing is less than in loud. These curves show that all components which are outside the intersections of these curves with the hearing threshold curve are not perceived by the ear, and if a filter which cuts off at these frequencies is inserted in the channel

WHAT is TEK-FILE

- 1 Tek-File is Rider service data in package form.
- 2 New Tek-File packs are available every month.
- 3 Tek-File's contents are grouped according to manufacturers.
- 4 All Tek-File data is the official, complete factory-issued data direct from the manufacturer.
- 5 Tek-File folders are packed one or more to a box . . . a minimum of 128 (8½ X 11") pages for only \$2.00. The cumulative index covering all issued Tek-Files is available *free* from your distributor.
- 6 With Tek-File you buy only the servicing data you need to match the set you're working on . . . and it's complete data! Includes chassis views, voltages, resistance readings, troubleshooting test patterns, complete alignment procedures, waveforms, circuit action descriptions, complete parts lists and values, coverage of all models and circuit changes, plus all unpackaging and installation data . . . and much, much more.
- 7 Tek-File gives you *extras!* A free coupon, 15 of which entitle you to a free hard-cover, permanent Rider manual binder for Tek-File shelf use . . . plus Tek-File Handies, 3 X 5" index cards containing trouble cures based on manufacturer's changes for his set.

Remember all this for only \$2.00 — buy it from your jobber today!



JOHN F. RIDER

PUBLISHER, INC.
480 Canal St., N. Y. 13, N. Y.

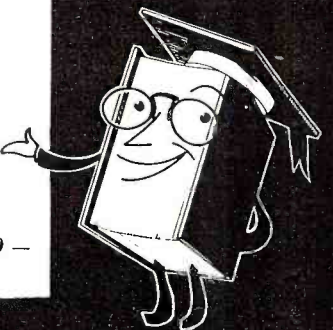

The man
who uses Tek-File
finds
servicing easier

Now Available Separately

TRIO Phasitron

makes every TV antenna more efficient . . .

The TRIO PHASITRON, originally sold only as part of the TRIO Controlled Pattern TV Antenna System, is now available separately for set owners who want the very best performance from their sets and antennas.

PHASITRON acts as a continuously variable tuning stub, provides exact impedance match between transmission line and booster or set. Helpful in matching booster output to set input. Because of exact matching—provided by PHASITRON—line losses become negligible and set performance greatly improved. Use also to coordinate input from two or more antennas to provide added balanced output to set.

ELIMINATES CO-CHANNEL INTERFERENCE

PHASITRON, when used with the amazing TRIO "CONTROLLED PATTERN" Antenna System, actually tunes out interference from stations on same channel as the one desired. Thus, Venetian Blind Effect—when caused by co-channel interference—is completely eliminated; a great benefit in many fringe areas!

IDEAL FOR HAMS, EXPERIMENTERS

PHASITRON, for the first time, provides a line matching device of laboratory precision at a price everyone can afford. Hams and experimenters will find the PHASITRON of utmost value in obtaining increased transmission line efficiency.

Available at your jobber or write for details.

TRIO  **Manufacturing Company**
GRIGGSVILLE, ILLINOIS

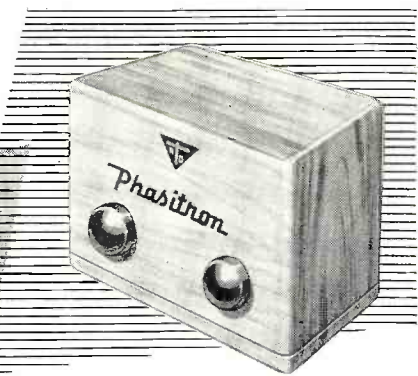

it will have no effect on the music. However, it will result in a tremendous decrease in the high-frequency and low-frequency noise, whose levels are well above the threshold of hearing. Of course, as the sound levels change, the cut-off frequencies will change correspondingly. A filter of this sort whose cut-off frequencies are controlled by the level of the reproduced sound forms the basis of the dynamic noise suppressor. Although it is extremely difficult to evaluate the degree of noise reduction resulting from such a circuit, it may be estimated to be in the neighborhood of approximately 20 db.

The circuit of a simple noise suppressor of this type is shown in Fig. 11. The audio signal is passed through a single section of low-pass and a single section of high-pass filter, each of which has a reactance tube forming one of its components. It is also amplified in an auxiliary amplifier whose output is rectified in two diode detectors to give a d.c. voltage proportional to signal level. These voltages are then filtered and applied to the control grids of the reactance tubes to control the cut-offs to the frequencies required by the signal level.

This circuit may be used either alone in the channel, or as part of a more elaborate preamplifier and tone-control unit.

(To be continued)

What's New in Radio

(Continued from page 94)

cartridge assemblies which are mounted back-to-back on a common plate. A unique switching device is used in the turnover mechanism. As the turnover knob is operated, the cartridge or side which has been in the playing position automatically disconnects and the side to be used makes connection with the amplifier phonograph input.

Output of the new "Twin CAC" is .8 volt at 1 kc. on the Audiotone 78-1 test record and .7 volt on the RCA 12-5-31-V. The frequency range is 30 to 11,000 cycles.

SMALL METERS

Sterling Mfg. Co., 9212 Detroit Avenue, Cleveland, Ohio, is in production

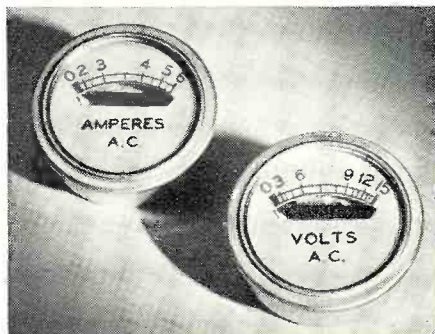

on a newly designed, small-sized indication meter which is approximately 40% smaller than former models.

RADIO & TELEVISION NEWS

SELLS ON DEMONSTRATION
DuKANE
MAGNETIC TAPE RECORDER



THE FINEST IN
HIGH FIDELITY
RECORDING

at
**LOW
COST!**

DEALERSHIPS AVAILABLE NOW!
MAIL COUPON FOR INFORMATION TODAY!

DUKANE CORP. Dept. RTN-32, St. Charles, Ill.

Please send information on the DuKane Magnetic Tape Recorder.

I am interested in a dealership.

Name _____

Address _____

City _____

State _____

ESTABLISHED AS "OPERADIO" 1922

SCARCE SURPLUS PANADATOR NAVY TYPE RBU-2

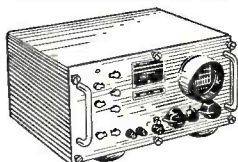

A precision instrument built to the highest standards of quality to insure long dependable service. Input frequency modification instruction for 455-475 Kc included with manual. Characteristics: Screen size—3 inches; 115/230 V.A.C. 50-70 cye. 60 Watts; Max. sweep width—50 Kc.; Inpt. freq.—400 Kc.; Input imp.—50 ohms; Sensitivity—10 Microvolts; I.F. freq.—202 Kc. (Appr.); OSC. mean freq.—625 Kc. (Appr.); OSC. swing—25 Kc.; Sweep freq. adj.—30 cye.; Sweep wave form—Linear saw tooth. Complete with tubes and manual. **BRAND NEW! QUANTITY LIMITED!**

Shpg. wt. appr. 45 lbs. ONLY \$169.50
OSCILLOSCOPE POWER SUPPLY KIT
For 3 to 5 inch tubes. Hermetically sealed transformer has high and low plate voltage and necessary filament windings. Kit includes transformer, choke, filters, rectifier tubes, tube sockets, and schematic. 115/230 V. @ 50-70 cye. New \$10.00

GYRO MOTOR ASSEMBLY
High speed 12 volt D.C. motor has heavy flywheel on shaft protected by metal enclosure. Removed from new equipment. Like New \$1.19

COMMAND RECEIVER IF TRANSFORMERS
1415 Kc. Set of three. New \$1.00
BC-455 GANG CONDENSER New \$1.00

BATTERY CHARGING PANEL TYPE BD-61
Has 3 G.E. 3" 0-15 Amps. D.C. and 1 G.E. 3" 0-50 Volts D.C. meters. 3 Rheostats (W-L) Rated: 12.50 ohms at 3 to 10 Amps., 3 40 V. 10 Amp. magnetic circuit breakers, and five automatic switches. Mounted in heavy gauge steel cabinet with hinged doors. Size: 22" x 22" x 11". Shpg. wt. (Appr.) 100 lbs. New \$19.50

ARC 5 COMMAND TRANSMITTERS
T-15 .5 Mc. to .8 Mc. \$19.95
T-16 .8 Mc. to 1.3 Mc. \$21.50
New, with tubes & crystals.

DYNAMOTORS—PE-86
Inpt.: 28V. D.C. @ 1.25A. Output: 250V. D.C. @ 60 Ma.
New—with shielded filter base & spare brushes. \$3.95

CARBON MICROPHONE UNITS
W.E. #F-1 \$0.98
Kellogg \$1.95
Used, good condition.

HEADSETS
Military type, 20,000 Ohms Imp. 8 ft. rubber cord with PL-55 plug. Slightly used, ex. condition. \$2.39

PILOT LAMPS (Special)
3 V. Grain of Wheat 7 for \$1.00
24 V. Switchboard Type (W.E.) 5 for \$1.00

28 V. Type #313 Bayonet 13c ea. 8 for \$1.00
Neon Type RB-2 1/25 W. 12 for \$1.00
Material subject to prior sale. 25% dep. with all orders. Bal. C.O.D. Orders received less postage, shipped express. Minimum order \$3.00.

FOREST SALES CO., Inc.
702 MADISON ST. EU. 6-1663 OAK PARK, ILL.

WANTED! WANTED!

MILITARY TEST SETS & EQUIPMENT
 TS-12, 13, 35, 14, 15, 146, 174, 175, 263, 268, etc. APR. ARC. ART. APS. APA. SCR. BC equipment and parts. Also TUBES, any quantity. WRITE, WIRE OR CALL.



Coaxial Relay K-101 SPDT-24v DC5	\$ 4.95
Set of 12 1/2 Pin Connectors for Above	1.35
1000 K Crystal BT cut	3.95
Vs-2 Vacuum Switch	6.95
Sigma Rate Relay 3000 ohm SPDT	2.49
RG49 Coaxial Cable 75 Ohm	
150' roll	\$11.95
300' roll	22.50
3" Scope Shield	
2000 Ohm V @ 500 MA transformer	24.95
15 HY @ 500 MA Choke	6.95
2 mid 3000 V Condenser	4.25

TUBES!! BRAND NEW! STANDARD BRANDS! NO SECONDS! COMPARE! TUBES!!

0A3/VR75 51.69	3C24 52.25	217C 58.95	812H 56.90	8008 57.95	WL616 \$37.50	5Y4G \$0.73	6SL7GT \$0.98	12SL7 \$1.05
0B3/VR90 1.29	3C27 5.25	217A 5C27 5.95	813 8.95	8011 1.78	WL616 18.95	5Z4 8.89	6SX7GT .98	12SN7 .98
0C3/VR105 1.29	3C30 3.95	240R 3.95	815 2.95	8012 3.95	WL617 34.50	6A3 1.25	6S7GT .75	12SQ7 .85
0D3/VR150 1.29	3C45 19.95	250R 3.95	816 1.30	8013 2.95	W1681 22.50	6BLA 1.95	6SR7GT .85	12SW7 .85
1B2 3.45	3CP1 2.25	250TH 22.50	817 2.95	8014 29.95	0A2 1.55	6B6 1.95	6ST7 1.10	14A4 .98
1B3 2.25	3CP1S1 4.95	276A 3.95	818 2.95	8015 2.95	0A3 1.55	6B7 1.95	6SU7GT 2.15	14A7 .95
1B21 19.95	3D1 2.74A 5.50	274A 5.50	819 2.95	8016 5.95	0A4 1.55	6B8 1.95	6SV7 1.25	14B6 .95
1B26 3.95	3DP1A 6.95	274B 2.65	820 12.95	8017 9.95	0A5 1.55	6B9 1.95	6S7GT 1.10	14F7 .95
1B27 24.55	3DP1S2A 2.95	276A 9.95	820B 14.95	8018 9.95	0A6 1.55	6C 1.95	6S8GT 1.18	14F8 .95
1B29 2.75	3D21A 1.98	293A 2.98	830B 3.95	8019 2.25	0A7 1.55	6C3 1.95	6S9GT 1.20	14P7 .95
1B32 8.95	3E29 14.95	294A 5.75	832 12.95	8020 2.25	0A8 1.55	6C4 1.95	6S9GT 1.18	14P8 .95
1B36 3.95	3E37 2.95	276A 9.95	833A 14.95	8021 2.25	0A9 1.55	6C5 1.95	6S9GT 1.18	14P9 .95
1B38 32.50	3GP1 4.75	804TH 14.95	833A 41.50	8022 2.25	0A10 1.55	6C6 1.95	6S9GT 1.18	14P9 .95
1N21 Xtal 1.25	3HP7 3.95	304TL 14.95	836A 3.95	8023 2.25	0A11 1.55	6C7 1.95	6S9GT 1.18	14P9 .95
1N21A 1.25	4-653 2.95	305A 3.95	837 2.95	8024 2.25	0A12 1.55	6C8 1.95	6S9GT 1.18	14P9 .95
1N22 1.35	4-654 2.95	305A 3.95	874 1.85	8025 2.25	0A13 1.55	6C9 1.95	6S9GT 1.18	14P9 .95
1N23 3.25	4-655 2.95	305A 3.95	874 1.85	8026 2.25	0A14 1.55	6C10 1.95	6S9GT 1.18	14P9 .95
1N23B 3.25	4-656 2.95	305A 3.95	874 1.85	8027 2.25	0A15 1.55	6C11 1.95	6S9GT 1.18	14P9 .95
1N23C 3.25	4-657 2.95	305A 3.95	874 1.85	8028 2.25	0A16 1.55	6C12 1.95	6S9GT 1.18	14P9 .95
1N23D 3.25	4-658 2.95	305A 3.95	874 1.85	8029 2.25	0A17 1.55	6C13 1.95	6S9GT 1.18	14P9 .95
1N23E 3.25	4-659 2.95	305A 3.95	874 1.85	8030 2.25	0A18 1.55	6C14 1.95	6S9GT 1.18	14P9 .95
1N23F 3.25	4-660 2.95	305A 3.95	874 1.85	8031 2.25	0A19 1.55	6C15 1.95	6S9GT 1.18	14P9 .95
1N23G 3.25	4-661 2.95	305A 3.95	874 1.85	8032 2.25	0A20 1.55	6C16 1.95	6S9GT 1.18	14P9 .95
1N23H 3.25	4-662 2.95	305A 3.95	874 1.85	8033 2.25	0A21 1.55	6C17 1.95	6S9GT 1.18	14P9 .95
1N23I 3.25	4-663 2.95	305A 3.95	874 1.85	8034 2.25	0A22 1.55	6C18 1.95	6S9GT 1.18	14P9 .95
1N23J 3.25	4-664 2.95	305A 3.95	874 1.85	8035 2.25	0A23 1.55	6C19 1.95	6S9GT 1.18	14P9 .95
1N23K 3.25	4-665 2.95	305A 3.95	874 1.85	8036 2.25	0A24 1.55	6C20 1.95	6S9GT 1.18	14P9 .95
1N23L 3.25	4-666 2.95	305A 3.95	874 1.85	8037 2.25	0A25 1.55	6C21 1.95	6S9GT 1.18	14P9 .95
1N23M 3.25	4-667 2.95	305A 3.95	874 1.85	8038 2.25	0A26 1.55	6C22 1.95	6S9GT 1.18	14P9 .95
1N23N 3.25	4-668 2.95	305A 3.95	874 1.85	8039 2.25	0A27 1.55	6C23 1.95	6S9GT 1.18	14P9 .95
1N23O 3.25	4-669 2.95	305A 3.95	874 1.85	8040 2.25	0A28 1.55	6C24 1.95	6S9GT 1.18	14P9 .95
1N23P 3.25	4-670 2.95	305A 3.95	874 1.85	8041 2.25	0A29 1.55	6C25 1.95	6S9GT 1.18	14P9 .95
1N23Q 3.25	4-671 2.95	305A 3.95	874 1.85	8042 2.25	0A30 1.55	6C26 1.95	6S9GT 1.18	14P9 .95
1N23R 3.25	4-672 2.95	305A 3.95	874 1.85	8043 2.25	0A31 1.55	6C27 1.95	6S9GT 1.18	14P9 .95
1N23S 3.25	4-673 2.95	305A 3.95	874 1.85	8044 2.25	0A32 1.55	6C28 1.95	6S9GT 1.18	14P9 .95
1N23T 3.25	4-674 2.95	305A 3.95	874 1.85	8045 2.25	0A33 1.55	6C29 1.95	6S9GT 1.18	14P9 .95
1N23U 3.25	4-675 2.95	305A 3.95	874 1.85	8046 2.25	0A34 1.55	6C30 1.95	6S9GT 1.18	14P9 .95
1N23V 3.25	4-676 2.95	305A 3.95	874 1.85	8047 2.25	0A35 1.55	6C31 1.95	6S9GT 1.18	14P9 .95
1N23W 3.25	4-677 2.95	305A 3.95	874 1.85	8048 2.25	0A36 1.55	6C32 1.95	6S9GT 1.18	14P9 .95
1N23X 3.25	4-678 2.95	305A 3.95	874 1.85	8049 2.25	0A37 1.55	6C33 1.95	6S9GT 1.18	14P9 .95
1N23Y 3.25	4-679 2.95	305A 3.95	874 1.85	8050 2.25	0A38 1.55	6C34 1.95	6S9GT 1.18	14P9 .95
1N23Z 3.25	4-680 2.95	305A 3.95	874 1.85	8051 2.25	0A39 1.55	6C35 1.95	6S9GT 1.18	14P9 .95
1N24 1.40	4B28 4.95	350A 8.95	860 6.95	8052 2.25	0A40 1.55	6C36 1.95	6S9GT 1.18	14P9 .95
1N24A 1.40	4B29 4.95	350A 8.95	861 6.95	8053 2.25	0A41 1.55	6C37 1.95	6S9GT 1.18	14P9 .95
1N24B 1.40	4B30 4.95	350A 8.95	862 6.95	8054 2.25	0A42 1.55	6C38 1.95	6S9GT 1.18	14P9 .95
1N24C 1.40	4B31 4.95	350A 8.95	863 6.95	8055 2.25	0A43 1.55	6C39 1.95	6S9GT 1.18	14P9 .95
1N24D 1.40	4B32 4.95	350A 8.95	864 6.95	8056 2.25	0A44 1.55	6C40 1.95	6S9GT 1.18	14P9 .95
1N24E 1.40	4B33 4.95	350A 8.95	865 6.95	8057 2.25	0A45 1.55	6C41 1.95	6S9GT 1.18	14P9 .95
1N24F 1.40	4B34 4.95	350A 8.95	866 6.95	8058 2.25	0A46 1.55	6C42 1.95	6S9GT 1.18	14P9 .95
1N24G 1.40	4B35 4.95	350A 8.95	867 6.95	8059 2.25	0A47 1.55	6C43 1.95	6S9GT 1.18	14P9 .95
1N24H 1.40	4B36 4.95	350A 8.95	868 6.95	8060 2.25	0A48 1.55	6C44 1.95	6S9GT 1.18	14P9 .95
1N24I 1.40	4B37 4.95	350A 8.95	869 6.95	8061 2.25	0A49 1.55	6C45 1.95	6S9GT 1.18	14P9 .95
1N24J 1.40	4B38 4.95	350A 8.95	870 6.95	8062 2.25	0A50 1.55	6C46 1.95	6S9GT 1.18	14P9 .95
1N24K 1.40	4B39 4.95	350A 8.95	871 6.95	8063 2.25	0A51 1.55	6C47 1.95	6S9GT 1.18	14P9 .95
1N24L 1.40	4B40 4.95	350A 8.95	872 6.95	8064 2.25	0A52 1.55	6C48 1.95	6S9GT 1.18	14P9 .95
1N24M 1.40	4B41 4.95	350A 8.95	873 6.95	8065 2.25	0A53 1.55	6C49 1.95	6S9GT 1.18	14P9 .95
1N24N 1.40	4B42 4.95	350A 8.95	874 6.95	8066 2.25	0A54 1.55	6C50 1.95	6S9GT 1.18	14P9 .95
1N24O 1.40	4B43 4.95	350A 8.95	875 6.95	8067 2.25	0A55 1.55	6C51 1.95	6S9GT 1.18	14P9 .95
1N24P 1.40	4B44 4.95	350A 8.95	876 6.95	8068 2.25	0A56 1.55	6C52 1.95	6S9GT 1.18	14P9 .95
1N24Q 1.40	4B45 4.95	350A 8.95	877 6.95	8069 2.25	0A57 1.55	6C53 1.95	6S9GT 1.18	14P9 .95
1N24R 1.40	4B46 4.95	350A 8.95	878 6.95	8070 2.25	0A58 1.55	6C54 1.95	6S9GT 1.18	14P9 .95
1N24S 1.40	4B47 4.95	350A 8.95	879 6.95	8071 2.25	0A59 1.55	6C55 1.95	6S9GT 1.18	14P9 .95
1N24T 1.40	4B48 4.95	350A 8.95	880 6.95	8072 2.25	0A60 1.55	6C56 1.95	6S9GT 1.18	14P9 .95
1N24U 1.40	4B49 4.95	350A 8.95	881 6.95	8073 2.25	0A61 1.55	6C57 1.95	6S9GT 1.18	14P9 .95
1N24V 1.40	4B50 4.95	350A 8.95	882 6.95	8074 2.25	0A62 1.55	6C58 1.95	6S9GT 1.18	14P9 .95
1N24W 1.40	4B51 4.95	350A 8.95	883 6.95	8075 2.25	0A63 1.55	6C59 1.95	6S9GT 1.18	14P9 .95
1N24X 1.40	4B52 4.95	350A 8.95	884 6.95	8076 2.25	0A64 1.55	6C60 1.95	6S9GT 1.18	14P9 .95
1N24Y 1.40	4B53 4.95	350A 8.95	885 6.95	8077 2.25	0A65 1.55	6C61 1.95	6S9GT 1.18	14P9 .95
1N24Z 1.40	4B54 4.95	350A 8.95	886 6.95	8078 2.25	0A66 1.55	6C62 1.95	6S9GT 1.18	14P9 .95
1N25 1.40	4B55 4.95	350A 8.95	887 6.95	8079 2.25	0A67 1.55	6C63 1.95	6S9GT 1.18	14P9 .95
1N25A 1.40	4B56 4.95	350A 8.95	888 6.95	8080 2.25	0A68 1.55	6C64 1.95	6S9GT 1.18	14P9 .95
1N25B 1.40	4B57 4.95	350A 8.95	889 6.95	8081 2.25	0A69 1.55	6C65 1.95	6S9GT 1.18	14P9 .95
1N25C 1.40	4B58 4.95	350A 8.95	890 6.95	8082 2.25	0A70 1.55	6C66 1.95	6S9GT 1.18	14P9 .95
1N25D 1.40	4B59 4.95	350A 8.95	891 6.95	8083 2.25	0A71 1.55	6C67 1.95	6S9GT 1.18	14P9 .95
1N25E 1.40	4B60 4.95	350A 8.95	892 6.95	8084 2.25	0A72 1.55	6C68 1.95	6S9GT 1.18	14P9 .95
1N25F 1.40	4B61 4.95	350A 8.95	893 6.95	8085 2.25	0A73 1.55	6C69 1.95	6S9GT 1.18	14P9 .95
1N25G 1.40	4B62 4.95	350A 8.95	894 6.95	8086 2.25	0A74 1.55	6C70 1.95	6S9GT 1.18	14P9 .95
1N25H 1.40	4B63 4.95	350A 8.95	895 6.95	8087 2.25	0A75 1.55	6C71 1.95	6S9GT 1.18	14P9 .95
1N25I 1.40	4B64 4.95	350A 8.95	896 6.95	8088 2.25	0A76 1.55	6C72 1.95	6S9GT 1.18	14P9 .95
1N25J 1.40	4B65 4.95	350A 8.95	897 6.95	8089 2.25	0A77 1.55	6C73 1.95	6S9GT 1.18	14P9 .95
1N25K 1.40	4B66 4.95	350A 8.95	898 6.95	8090 2.25	0A78 1.55	6C74 1.95	6S9GT 1.18	14P9 .95
1N25L 1.40	4B67 4.95	350A 8.95	899 6.95	8091 2.25	0A79 1.55	6C75 1.95	6S9GT 1.18	14P9 .95
1N25M 1.40	4B68 4.95	350A 8.95	900 6.95	8092 2.25	0A80 1.55	6C76 1.95	6S9	

LOW FREQUENCY CRYSTALS

FT-241A (Brown) Holders. Channel spacing, 1.388 kcs. All frequencies in kilocycles.89¢ ea.

375	440.277	430.555	458.333	486.111	513.888
376.388	404.166	431.944	459.722	487.500	515.277
377.777	405.555	433.333	461.111	488.888	516.666
379.166	406.944	434.722	462.490	490.277	518.055
380.555	408.333	436.111	463.878	491.666	519.444
381.944	409.722	437.500	465.277	493.055	520.833
383.333	411.111	438.888	466.666	494.444	522.222
384.722	412.500	440.277	468.055	495.833	523.611
386.111	413.888	441.666	469.444	497.222	525.000
387.500	415.277	443.055	470.833	498.611	526.388
388.888	416.666	444.444	472.222	500.000	527.777
390.277	418.055	445.833	473.611	501.388	529.166
391.666	419.444	447.222	475.000	502.777	530.555
393.055	420.833	448.611	476.388	504.166	531.944
394.444	422.222	450.000	477.777	505.555	533.333
395.833	423.611	451.388	479.166	506.944	534.722
397.222	425.000	452.777	480.555	508.333	536.111
398.611	426.388	454.166	481.944	509.722	537.500
400.000	427.777	455.555	483.333	511.111	538.888
401.388	429.166	456.944	484.722	512.500	540.277

Power Supply for Any 274-N Receiver

Just plug it into the rear of your 274-N RECEIVER . . . any model. Complete kit and black metal case, with ALL parts and diagrams. Simple and easy to build in a jiffy. Delivers 24 volts plus B voltage. No wiring changes to be made. Designed especially for the 274-N receiver. All necessary parts for conversion of rest of receiver also included. ONLY \$8.95.

CONDENSER TESTER

• One of our best sellers! Useful, versatile laboratory item, in kit form. Simple, and easy to build in less than an hour. Checks condenser leakage and continuity up to 8 megs. Will test any paper, electrolytic, mica or oil capacitor from 50 mmf. to 50 mfd. Self-contained power supply and neon bulb indicator with socket and bezel. Drilled metal cabinet. Complete instructions and diagrams included with each kit. Only \$5.00.

U-V LIGHT SOURCE

8 watt ultra-violet light source. In kit form including Sylvania black-light tube, (for U-V light in the 3660 Angstrom unit region) ballast, starter, mounting panel, reflector, line cord/plug, hardware, instructions. An invaluable device for schools, labs, service shops, home workshop, etc. Here is a genuine value. Complete kit, (less outer housing) . . . only \$4.95

TU-10B Tuning units. This is the hi-freq. tuning unit with the excellent variable condensers as well as loads of micas, coils, worm drive, etc. Only \$1.75 ea.

LOOK! NO HANDS!

This mike leaves both hands free for mobile QSO's. Fastens to operator by simple snap strap. Adjustable. Double action sw. operates push-to-talk or holds on. Only \$2.00 ea. POSTPAID in U.S.A. and CANADA.

NEW PHONE PATCH

Now redesigned into more compact and convenient housing, the #6000S phone patch retains all of its excellent characteristics. Provides you with exactly what you need to patch your phone into transmitter or receiver. Features include hi-impedance input suitable for xtl mike and both hi and low impedance inputs to insure proper match to your particular receiver. Unit is complete . . . "Sure-fire" ready to go to work for you. Only \$4.95 ea.

TRANSFORMERS-CHOKES:

5V, 25A. Pri. 115V, 60 cy. AC. A real rugged job excellent for 304TL-4-250A etc. Limited quantity. Only \$4.50 ea.

10H, 200 ma choke. Hermetically-sealed steel case. Also has hum-bucking tap. A beautiful item only \$1.98.

Power Transf. 350-0-350 @ 70 ma. 5V @ 3A. 6.3 @ 3A. Pri. 110V, 60 cy. AC. Up-right mtg. \$3.25 ea.

Power transf. Pri. 115V, AC. 60 cy. Sec. 520-0-520 @ 200 ma. \$5.25 ea.

350-0-350 @ 300 ma. 6.3 @ 4A. 6.3 @ 8A. 5V @ 3A. Pri. 115V, 60 cy. AC. only \$7.95 ea.

450-0-450 @ 200 ma. Pri. 115V, 60 cy. AC. 5V @ 3A. 6.3 @ 5 amp. In shielded case. Only \$8.90 ea.

350-0-350 @ 350 ma. 6.3 @ 10A. 5V @ 6A. Pri. 115V, 60 cycle. Only \$8.95 ea.

Minimum order \$2.00. All items subject to prior sale. All prices subject to change without notice. 20% deposit must accompany all orders, balance C.O.D.

OFFENBACH & REIMUS CO.

1564 MARKET ST.
SAN FRANCISCO, CALIF.

The new meter fits a 1 1/8" mounting hole while a back panel clearance of 1" from the flange is needed. These meters are available in ranges of 1 to 50 volts, 1 to 30 amperes, and 10 to 100 ma. They are designed to give a reading accuracy of 5 per-cent at any given point on the scale with a 10 per-cent over-all accuracy. Both a.c. and d.c. models are available.

HANDY SCREWDRIVER

Continental Screw Company, New Bedford, Massachusetts, is distributing



an ingenious and handy screwdriver which features removable low-cost Phillips insert bits for driving screws with Phillips recessed heads.

Designed to be used on the factory line or in the home workshop, the new screwdriver takes interchangeable bits. When one wears out it can easily be removed and replaced. Four different sizes of bits are available but the #2 size will drive from 75 to 80 per-cent of all screws with Phillips recessed-type heads.

AUDIO OSCILLATOR

Waveforms, Inc., 333 Sixth Avenue, New York 14, New York, is now marketing an extended range audio oscillator, the Model 510-B.

Small in size, the new instrument has a frequency coverage of from 18 cycles to 1.2 mc. in five overlapping ranges, low distortion (less than .2 per-cent over most of the useful range), constant output ± .5 db from 18 cycles to 100 kc., calibrated output voltage, 300 degree vernier-drive dial, and accuracy and stability ± 2 per-cent ±



1 cycle for all conditions of line voltage variation (± 10 volts) to 210 kc.

The TURNTABLE is the HEART OF YOUR HIGH FIDELITY SYSTEM

You may own the finest pickup, amplifier and speaker that money can buy . . . yet you'll get poor reproduction if your TURNTABLE has excessive wow, hum or rumble! Rek-O-Kut offers a complete range of 12" Turntable models to match your present high-fidelity equipment and your own pocketbook. Not every sound system requires the most expensive turntable . . . your turntable must be chosen to complement your other components. Each REK-O-KUT Turntable carries an engineering specification which enables you to select the appropriate unit to match your other components. Quality and workmanship of every REK-O-KUT Turntable is identical . . . price differential depends solely on type of materials used.

MODEL LP-743

3-Speed 12" Turntable

Induction type motor, designed for smooth, vibration-free operation. Instantaneous speed changes without stopping turntable or removing disc. \$54.95 Net

MODELS T-12H & T-43H - 2-Speed 12" Turntables

Recommended for use with ULTRA HIGH FIDELITY Amplifiers and Speaker Systems. The only 12" Turntable that meets N.A.B. specifications for speed regulations and Wow content.

MODELS	MOTOR	DB Noise Level	SPEED	PRICE
T-12 H*	Hysteresis Synchronous	-50DB	78-33 1/2	\$119.95
T-43 H*	Hysteresis Synchronous	-50DB	45-33 1/2	\$119.95
T-12	4 Pole Induction	-40DB	78-33 1/2	\$84.95
T-43	4 Pole Induction	-40DB	45-33 1/2	\$84.95

*Delivery limited due to short supply of Hysteresis motors.

REK-O-KUT CO.

38-05 Queens Blvd., Long Island City, N.Y.
EXPORT DIVISION: 458 Broadway, New York City, U.S.A.
CANADA: ATLAS RADIO CORP., LTD., 560 King St. W., Toronto 28, Ontario

DID YOU GET IT? IF NOT . . .
SEND NOW FOR B-A's 136 BIG PAGE FREE CATALOG

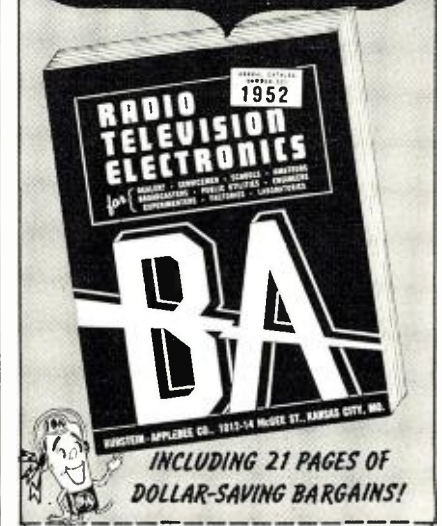

INCLUDING 21 PAGES OF DOLLAR-SAVING BARGAINS!

BURSTEIN-APPLEBEE CO.
1012-14 McGee St.
Kansas City 6, Mo.
Send your 1952 catalog to:
Name
Address
City State

BURSTEIN-APPLEBEE CO.

RADIO & TELEVISION NEWS

The entire unit measures 6" x 4 1/4" x 5 1/4". A type T-10 matching transformer is available for operation with balanced output permitting its use on balanced lines.

SPRAGUE FEEDTHROUGHS

Sprague Electric Company, North Adams, Massachusetts has announced the availability of a new feedthrough ceramic condenser for filtering leads passing through a chassis or shield partition.

The Type 503C has the small ceramic disc element resin-sealed in a recessed cup at the top of the metal ferrule in order to provide maximum protection against humidity. The through-lead passes through a hole in the center of this dielectric disc. Thus, there is equal radial distribution to the grounded outer shell for all high frequencies being bypassed resulting in low inductance.

Rated at 50 volts d.c., capacitance values of the new units range up to 100 $\mu\mu\text{f}$.

Full details on the Type 503C are contained in the company's Engineering Bulletin 605 which is available to interested persons on letterhead request.

TRIPLETT SCOPE

The *Triplet Electrical Instrument Co.* of Bluffton, Ohio, is currently introducing a new 5" oscilloscope which

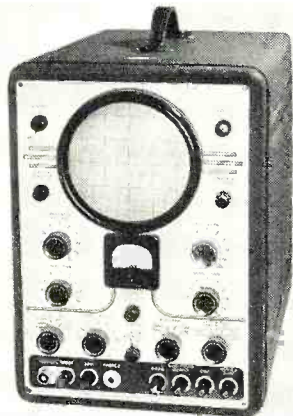

has been designed for TV, FM, and a variety of industrial testing applications.

The Model 3441 features an illuminated calibration meter which makes it possible to view the percentage of positive and negative peak-to-peak volts in addition to reading peak-to-peak voltage directly in 8 ranges from 0 to 1000 volts. The frequency range of the horizontal amplifier is flat within ± 20 per-cent from 20 cycles to 150 kc., deflection sensitivity is .15 rms volt/inch. The response of the vertical amplifier is usable to beyond 4 megacycles.

The unit is furnished in a black suede-finished metal case which measures 15 1/2" x 11 1/2" x 16". Accessories include coaxial cables, a probe, and instruction booklet. A crystal signal tracing probe is available as an extra accessory and adapts the unit for a variety of r.f. uses.

Announcing

ADVANCED SERIES 400 RECORDERS

MODEL 400-A
with
Half-Track Head

MODEL 401-A
with
Full-Track Head

15 & 7 1/2
Inches Per Sec.

Full REMOTE CONTROL

Solenoid operated mechanisms for all mechanical motions.



also *Featuring*

- **UNIFORM RESPONSE** . . . to 15,000 cps at 7 1/2 ins. per sec.
- **LOW NOISE & DISTORTION LEVEL** . . . signal-to-noise ratio over 55 db at either tape speed (as defined by NARTB).
- **PUSH BUTTON OPERATION**
- **LONG LIFE** . . . precision built.
- **LOW MAINTENANCE** . . . even with continuous use.



4 to 1 TAPE SAVING

The valuable tape saving ability of Series 400 Recorders is clearly illustrated above — the young lady holds four reels which contain the identical program formerly requiring the sixteen reels shown on table. No other recorder can give this remarkable tape saving because no other recorder is capable of 15,000 cycle performance at 7 1/2 ins. per sec.; on but half the width of the tape!

PORTABLE IN SINGLE CASE or for RACK MOUNTING

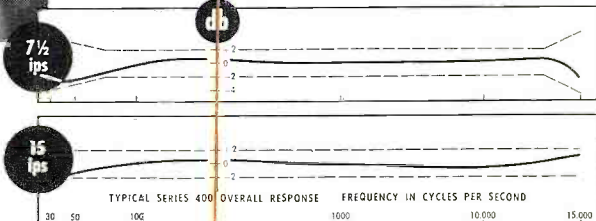

PERFORMANCE . . . beyond comparison!

Published specifications of Ampex Recorders are conservative as these typical check-out graphs on Series 400 show. Ampex check-outs always exceed guaranteed performance but even the guaranteed performance is sufficient to make Ampex the world's finest recorder!

INTERCHANGEABILITY OF TAPES . . . another unrivalled superiority of Ampex. This means that recordings made on any Ampex can be played back on any other Ampex (of like speed) with identical high fidelity and timing.

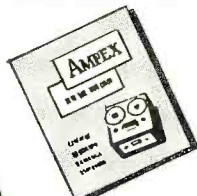

ASK FOR BULLETIN A-211

. . . gives complete description and specifications of the Series 400 Ampex Magnetic Tape Recorders.

AMPEX
Magnetic



AMPEX ELECTRIC CORPORATION
Redwood City, California
Distributors in Principal Cities

RECORDERS

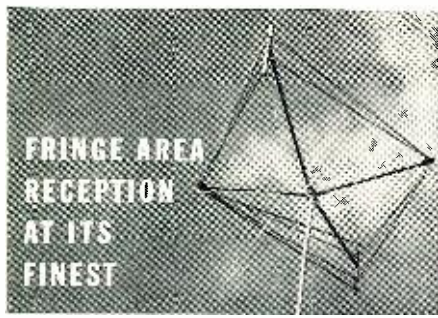

WITH THE RHOMBIC

Phillips DX-er

Actually proven in field tests to have higher gain in fringe areas than any other antenna in use today.

- NON-RESONANT... 14DB GAIN
- COMPLETE COVERAGE... CHANNELS 2-13
- REDUCES OR ENTIRELY ELIMINATES GHOSTS
- SHARP DIRECTIVITY... LOBE WIDTH 20°
- PRE-ASSEMBLED · WIND RESISTANT

Pot. Pend.

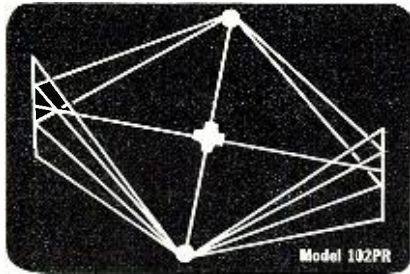

For High and Low Bands (2-13)

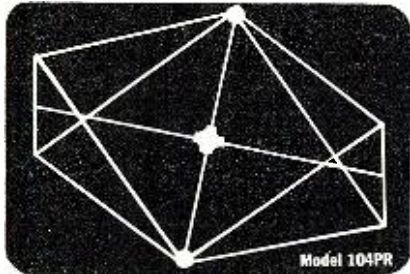

High Band Only (7-13)

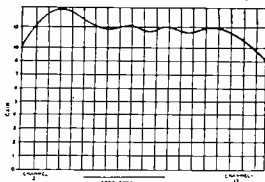

Gain vs. Frequency Response

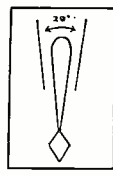

Response Pattern

Write Today for Technical Literature on this Outstanding Rhombic Antenna.

Roger-Phillips
RESEARCH LABORATORIES
717-RM NO. LAKE AVE., PASADENA 6, CALIF.

"Pre-Fab" Tuners

(Continued from page 52)

for assembling the kit. The chassis is completely prepared, with all cut-outs and screw holes drilled so that no work with a file or drill is necessary.

Each circuit or assembly is mounted, wired, tested, and aligned at the factory, and the same tubes that are used during the test are included with the kit when it is shipped. This precludes the necessity of intricate alignment procedures when the proper test equipment is not available.

Some of the design features include a heavy-duty power transformer, with a 30% safety factor, which delivers 220 volts of plate voltage instead of the usual 250 to 275 volts. This allows the tuner to operate much "cooler," which adds to the stability, lengthens the life of the tubes, and generally provides better performance. Heavy filtering is used for the absolute minimum of hum.

Physically, the tuner is well proportioned. It measures only eight inches in depth and is but a fraction over six inches in height. The chassis is seventeen inches long and is equipped with a large, easy-to-read slide rule dial.

The FM tuning unit is extremely stable, making it unnecessary to use a.f.c. on the oscillator. Drift is barely noticeable three to five minutes after the tuner is switched on. By not using a.f.c., a greater degree of selectivity is achieved, which allows the full sensitivity to be realized. For example, tests in our laboratory showed that the tuner was able to completely separate two stations, one channel apart, with acceptable performance from each; the one having a signal strength of 5000 microvolts being fifteen miles away and the other having a signal strength of 20 microvolts, located at a distance of seventy miles from the receiving point.

The tuning unit was specially designed for the ultimate in performance at FM frequencies. Permeability tuning, known for its superior performance at high frequencies, is used in this unit. The electroplated glass coils and tuning cores are held within 1% tolerance. The oscillator operates 10.7 mc. higher in frequency than the signal circuits and its stability is exceptionally good.

The mixer, or converter stage, is of conventional design. The oscillator voltage is injected directly into the mixer grid through a 68 $\mu\text{mfd.}$ ceramic condenser from the oscillator plate.

The r.f. stage employs a 6J6 dual triode in a grounded grid circuit. At very high frequencies this type of circuit offers considerable advantage over the more conventional pentode stage. The loading effect of the tube on the coils is many times less than a pentode at these frequencies. Consequently, the "Q" of the circuit is improved, which increases both the sensitivity and image ratio.

With these design features, excellent sensitivity has also been achieved. An average sensitivity of 6 to 10 microvolts is realized which often places FM stations, which heretofore were out of range, within reach.

I.F. Amplifier

To provide top performance, there was no skimping in the design of the i.f. amplifier. Six tubes are used: Three i.f. amplifiers, two limiters, and a discriminator type of detector. The operating frequency is 10.7 megacycles. Distortion measurements show less than $\frac{1}{2}$ of 1% harmonic content, and the frequency range includes 20 to 20,000 cycles with a variation of only 2 db. The de-emphasis network uses a 500 $\mu\text{mfd.}$ condenser with a 100,000 ohm resistor giving a time constant factor of 50 microseconds. Although the standard FM de-emphasis characteristic is 75 microseconds, it was felt that a little advantage on the high frequency end was desirable, due to capacity effects in shielded wires used to couple the tuner to the amplifying equipment.

A "Pre-Fab" tuner, in combination with one of the better audio amplifiers now being produced, leaves little to be desired from a reproduction standpoint. The design of this tuner had the home builder and audio enthusiast in mind in presenting this versatile chassis for all applications from the laboratory of the experimenter to the control panel of a radio station.

-30-

TV ANTENNA COUPLER

By WILBUR J. HANTZ

AFTER considerable experimenting to find some means of providing adequate isolation between television receivers when they are operated from the same antenna, I finally came up with the idea shown in the schematic.

In addition to providing a good impedance match between the two TV receivers and the transmission line, this gadget also prevents oscillator radiation from feeding back through the receivers. The 1N56 crystal diodes are strictly one-way devices as far as the signal is concerned but they present a very high impedance to any signal trying to come back from the receivers.

When constructing the unit, it is advisable to isolate each low-pass filter section in an individual can, grounded to each receiver's chassis. If the receivers are of the transformerless type, then ground through a 100 $\mu\text{mfd.}$ mica condenser.

-30-

Antenna coupler for two TV receivers.

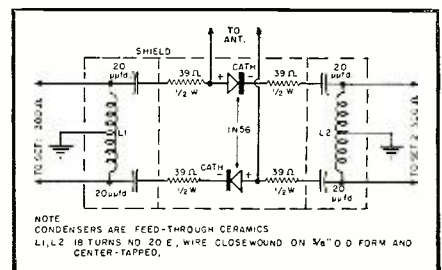

FOLDED LONG WIRES

By **BOB PERTHEL, W9MWD**

Solve the problem of feeding long lines without resorting to complicated matching or end feeding.

JUST what to do about an antenna for 20 meters if you can't put up a good beam because of space limitations has bothered me for some time just as I imagine it must be bothering other city dwelling hams, or those with cramped spaces.

The antenna I was using was a 20-meter half-wave doublet, with length determined by formula, fed with 50 feet of 75 ohm coax. Careful examination proved that great standing waves existed. Further observation led me to believe that the proximity of two houses and a tree were affecting the electrical length, and probably to a greater degree on one side of the feedline than the other.

A folded half-wave doublet could be expected to be broad tuning and, as a consequence, not affected as much by trees and houses. So up went a folded dipole, but a little more in the clear this time. It worked well, but only in two directions. It was observed during two months of operation that although the pattern was what might be expected locally, this did not hold true on skip and the only directions that could be worked consistently were directly broadside to the antenna. See Fig. 1A. Why a half wave should show such marked directional characteristics is probably because the vertical angles of the power radiated due to ground reflection vary throughout the normally expected pattern, but directly broadside to the antenna all desirable vertical angles are present in the pattern. Incidentally, this effect holds true for lobes of long wires.

The particular folded dipole that I used ran directly east and west, permitting reliable communication with only a few stations because of my central U.S. location. Since it was impossible to change the direction of the dipole, the possibility of using folded antennas of other than a half wave to obtain a different pattern was pondered. Folding a half-wave antenna broadens its resonance and multiplies its radiation resistance by a factor of 4. These characteristics hold true for folded antennas of other lengths too. The curve in Fig. 2 shows how radiation resistance varies with the length.

Fig. 1. Angles of maximum radiation to be used in orienting folded long wire units.

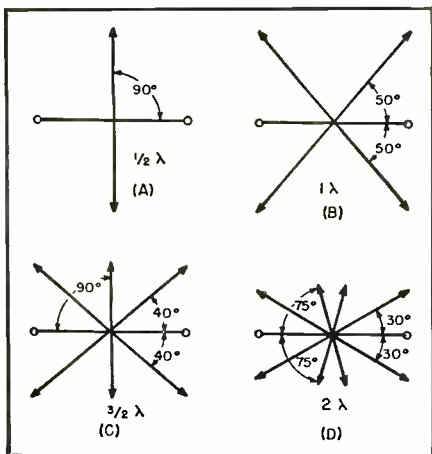

Folded antennas of 1, and 3/2 waves were tried at W9MWD and these, too, showed marked directional effects as shown by Figs. 1B and 1C. In addition to permitting operation in desirable directions these antennas also have a slight gain over a half-wave antenna.

Another nice thing about these an-

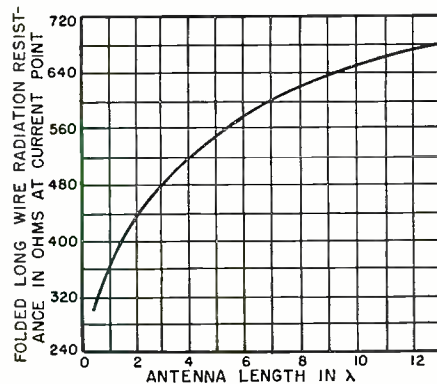

Fig. 2. Radiation resistance curve.

tennas is that the lengths can be calculated by formula and fed with a flat line that requires no tuning, just link it to the final. On even harmonics these antennas can also be worked by using voltage feed and tuning the feed line in the conventional manner but, of course, with standing waves on the feedline and a different radiation pattern. When voltage-feeding an antenna of this sort its radiation pattern is difficult to predict as the waveforms on it may differ in regard to phase from what might normally be expected.

The folded antennas used at W9MWD were all for 20 meters and constructed of number 16 wire spaced 4 inches by 6-inch lengths of plastic tubing at 3-foot intervals. The insulation need not be the best and even wood would do. Plastic tubing was used only because it was the lightest material available. Regular 300-ohm line was used to feed these antennas, and it provided a satisfactory flat line in all cases. Open wire line could be constructed to match the impedance with less line loss but the line loss with 300-ohm line is so low that it wasn't considered worth the added effort. With folded antennas longer than 3/2 waves, an open wire line of the proper impedance should be constructed to prevent standing waves on the feed line. Since end effects occur only once, the formula, $L \text{ (feet)} = 492 (N - .05) / f$

(mc.), where N is the number of half-waves, must be used to determine the length. In order to current-feed these antennas properly, which can be at any convenient current loop, the fact that end effects occur only at the end must again be considered. Start at the center and using the free space formula $L \text{ (feet)} = 492 / 2f \text{ (mc.)}$ calculate the distance to the current loop.

There is no reason why folded long wire antennas couldn't be designed for use on any of the amateur bands with equal success, however different spacing of the antenna itself would probably be better than the 4 inches used on 20; 8 inches for 80 and 2 inches for 10 meters is suggested. Varying the spacing does not affect the radiation resistance of the antenna. The step-up in impedance is due to the current dividing between the two conductors of the antenna.

A folded full wave is in use at the present time on 14,206 kc. This antenna provides lobes through Central Europe, Eastern South America and Africa, Alaska, and Australia, and long 100% QSO's to all these places have become a reality with only 90 watts input to the transmitter on 20 meter fone. -50-

Fig. 3. Construction details. Note that (D) shows method of drilling plastic tubing so that tension of antenna will hold spacers.

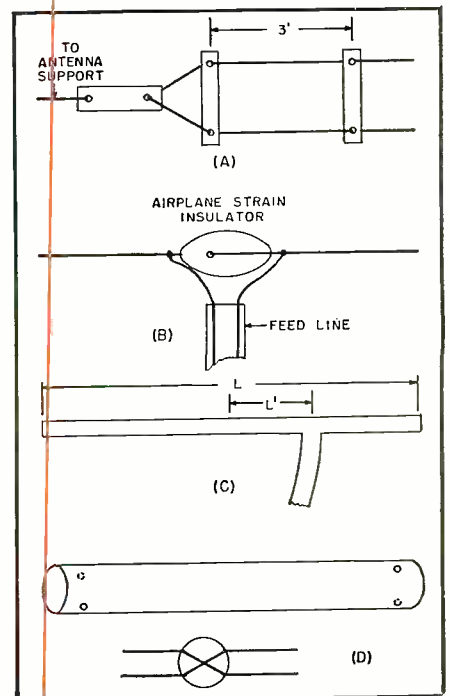



FOR PERFECTION



in TV INSTALLATIONS
in any locality use the new

Simpson MODEL 488 TV FIELD STRENGTH METER

Ideal for antenna orientation, comparison of antenna systems, adjustment of TV signal boosters, checking antenna and lead-in installations and many other functions . . . the 50 microvolt full scale range is an outstanding feature for those concerned with fringe area installations where maximum efficiency must be attained . . . the 500, 5,000 and 50,000 microvolt ranges extend the usefulness of the Simpson Model 488 into areas of higher signal strength.

SIMPSON ELECTRIC COMPANY
5200 WEST KINZIE STREET, CHICAGO 44, ILL.
Phone: COlumbus 1-1221
In Canada: Bach-Simpson, Ltd., London, Ontario

SHOOT TV TROUBLE FAST!

With H. G. Cisin's Copyrighted RAPID "TV TROUBLE SHOOTING METHOD"

Without experience or knowledge, this guaranteed new method of servicing TV sets enables you to DIAGNOSE TV troubles as rapidly as an expert. NO THEORY—NO MATH—you can locate all faults in record-breaking time, regardless of make or model.

"TV TROUBLE SHOOTING METHOD" is the most valuable aid to TV servicing ever written. Be a TV Trouble Diagnostician. Increase your present earnings. Open your own profitable business or get a high-paying skilled job.

It's all in this book . . .

Nothing more to Pay—Nothing else to Buy
Alphabetically listed, there are 85 picture troubles, over 58 raster and 17 sound troubles and by this unique copyrighted method you know EXACTLY WHERE the trouble is; plus step-by-step instructions, including 69 RAPID CHECKS, enabling you to find the faulty part.

13 IMPORTANT PRELIMINARY CHECKS NEED NO INSTRUMENTS! Of the 69 Rapid Checks, **OVER 65 ALSO REQUIRE NO INSTRUMENTS!** Rapid checks include emergency checks for distorted pictures, defective tubes including PIX tube, plus 57 others. **ALL EXPLAINED IN SIMPLE LANGUAGE. PERFORMED WITHOUT INSTRUMENTS. MANY CHECKS USE THE PICTURE TUBE AS A GUIDE.**

H. G. Cisin, the author, is the inventor of the AC/DC midjet radio. He licenses RCA, AT&T, etc. He has also trained thousands of technicians now owning their own prosperous TV service organizations or holding highly paid TV positions. His years of experience are embodied in this remarkable new TV TROUBLE SHOOTING METHOD.

Guaranteed. Money Back in 5 Days if Not Satisfied!
Send your name and address today with \$1 for your post-paid copy; you'll say it's worth hundreds!

H. G. CISIN—CONSULTING ENGINEER
(Dept. N-5), 200 Clinton St., Brooklyn 2, N. Y.

Name
Address
City Zone State

FOR THE "GOLDEN EAR" CROWD THE PFAN-TONE STRAIN-SENSITIVE PICKUP

Here's why this truly faithful reproducer appeals to people gifted with the "Golden Ear" . . . why the PFAN-TONE STRAIN-SENSITIVE PICKUP brings out the brilliance of great voices and orchestras . . . the latent music on your records that other pickups leave untouched.

- The PFAN-TONE STRAIN-SENSITIVE PICKUP is an amplitude transducer with a **CONSTANT RESISTANCE** of about 250,000 ohms.
- Signal output is at a practically **CONSTANT IMPEDANCE LEVEL**.
- Excellent Transient Response.
- **NO DISTORTION**, phase shift or evidence of intermodulation is audible.
- **LINEAR RESPONSE**, free from peaks or resonances.

Cartridges are available for both standard and micro-groove, and can be had with Famous PFANSTIEHL M47B Precious Metal Alloy or diamond tipped styl.

A special preamplifier is necessary to provide the correct D.C. voltage for the pickup element and to provide the first stages of signal gain. Four styles are ready, or, if you prefer, you can build your own from the circuit in the literature.

Ask your radio supply man, or write today for complete FREE INFORMATION.

PFANSTIEHL
CHEMICAL COMPANY
101 Lake View Avenue, Waukegan, Illinois

Speaker Enclosure

(Continued from page 49)

with a pencil draw the inside outline of the frame on the front piece.

Probably the neatest way to finish the enclosure is to paint it exactly the same color as the wall. If that is not possible or desirable, it can be painted some other color or an ambitious builder can put a furniture finish on it. Matching it to the wall, however, as was done here, makes it most unobtrusive and eliminates the necessity for furniture finish without giving the job a "homemade" look.

In any case, paint the area of the front that will be within the frame a dark color. Then when a cloth is put in the frame and the frame mounted, the outlines of the speaker holes will not show.

Lumite, a plastic cloth made especially for this purpose is ideal; it can be obtained from parts suppliers. Another cloth can be used, however, with the proviso that it should (a) not be soft and (b) have a very loose weave. Soft cloth will absorb highs and tight weaves will block off the sound. If in doubt, try sample pieces, placing them by hand in front of the speaker and then removing them. They should not alter the sound quality.

One hint for those not familiar with painting wood. Before painting apply a coat of shellac—very, very thin shellac—and let it dry for a couple of hours. This fills the wood so it does not absorb the paint and require several coats. The paint itself can be flat wall paint of good (not ordinary apartment-house) quality to match the wall exactly, but easier and better results are obtained with enamels such as the painter uses on doorframes and other woodwork. The enclosure in the photos was painted flat, however (three coats) and turned out nicely.

Mount the crossover network and any other parts such as the high-frequency volume control inside the enclosure on the front panel or perhaps on the woofer frame. Lead the audio line out through a small hole at one bottom corner of the front piece.

The lady of the house should now be properly impressed.



"I keep telling you, Madge . . . that antenna is a dipole, not a didy-pole!"

Crystal Diodes
(Continued from page 57)

age the tube is cut off. Thus the sync pulses will always cut off the picture and variations in signal strength will always adjust automatically to this condition. An attempt is made to help you visualize what happens in the diagram of Fig. 3B.

Fig. 4 shows a comparative set of current-voltage curves for the 1N34, 1N65, and 1/2 a 6AL5. The slopes of the crystal diode characteristics are materially greater than the slope of the 6AL5 characteristic at any com-

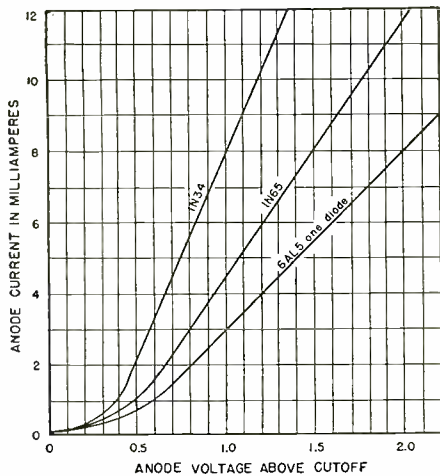

Fig. 4. Characteristics of the 1N34 and 1N65 crystal diodes and one-half of a 6AL5 tube.

parable point on the graph, including the low signal levels from .5 to .05 volts.

Fig. 5 is a circuit used in a number of modern receivers and employs a 1N65 germanium diode for d.c. restoration. Note that the germanium diode is not placed across the entire output of the video amplifier, but only across the portion obtained from R_2 . Any variations of the video signal extending below the a.c. axis would result in a current flow through the d.c. reinsertion diode, charging condenser C_c to the peak level of the applied voltage. During the positive portions of the signal the charge accumulated on C_c may discharge through R_1 to ground, but it is likely to hold its charge or most of it.

The time constant of the C_c, R_1 com-

Fig. 5. The G-E Model 10T1 d.c. restorer.

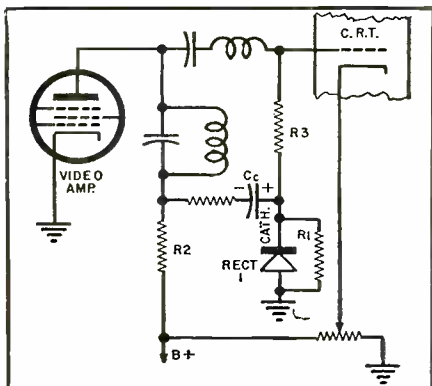

March, 1952

direct

FACTORY TO YOU PRICES

Ken-Way

BOOSTER
\$14.95

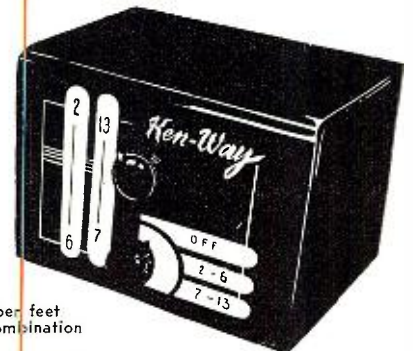

MODEL 6J1

- Balanced Input (72-300 Ohms)
- Balanced Output (72-300 Ohms)
- Balanced Amplifier
- Metal Cabinet-Rubber feet
- Variable tuning, combination on-off/Band switch
- Signal bypasses Booster in off position

1. Push Pull Neutralized 6J6 Triode
2. High Signal to Noise Ratio
3. Reduced Internal Circuit Noise

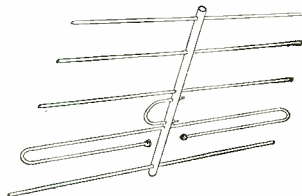

MODEL LK (7-13*)

Ken-Way

FIVE ELEMENT HIGH CHANNEL CLOSE SPACED YAGI \$2.95

- Cut the channel
- Sturdy aluminum construction
- Folded dipole
- Easy to stack
- 9 DB Gain

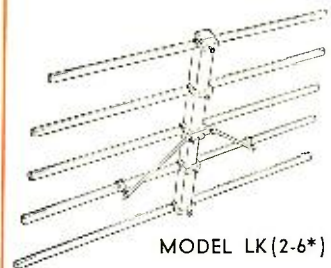

MODEL LK (2-6*)

Ken-Way
FIVE ELEMENT LOW CHANNEL CLOSE SPACED YAGI \$5.95

- Low channel
- Close space
- Five element Yagi
- Cut the channel
- Easy to assemble

- Sturdy aluminum elements
- Seasoned aluminized Hardwood Boom
- 9 DB Gain
- Sensational "Delta" match to dipole
- Easy to stack

***Antennas are cut to channel—please specify channel desired on order.**

We ship cash with order or 25% deposit for C.O.D. shipments.

STANDARD RTMA WARRANTY PLUS SAMPLE ORDER PROTECTION SATISFACTORY GUARANTEE OR YOUR MONEY BACK.



PRODUCTS INCORPORATED

BOX 220, OWENSBORO, KENTUCKY

NEW a "must" book
for every
TV Service Technician

**"Servicing TV
in the
Customer's Home"**



**SAVES TIME
SAVES WORK
Earns More
for You
on Outside
Service Calls**

shows how
to diagnose trouble using
capacitor probe and VTVM

Here's the book you've been asking for—practical, proved help to make your outside TV servicing really effective and profitable. Saves time, work and chassis hauling... shows you how to make successful repairs on the spot. You learn the following: 1. A simple, effective method for tracing down trouble, using your VTVM and a simple capacitor probe. 2. Methods for finding your way around a strange circuit—shows you how to "pull tubes" and diagnose trouble by observing audio and picture effects. 3. How to judge TV set performance by analysis of the test pattern. 4. Methods for making adjustments in the field. You'll want this essential, profit-building book. Handy pocket size; sturdy cover.

\$1.50

ORDER TC-1. Only.....

Pays for itself on the very first job.

HOWARD W. SAMS & CO., INC.

Order from your Parts
Jobber, or write direct to
HOWARD W. SAMS & CO.,
2201 E. 46th St., Indianapolis 5, Ind.

**ORDER
TODAY**

Send... copy(ies) of "SERVICING TV IN THE
CUSTOMER'S HOME," \$1.50 per copy.

(Check) (money order) for \$.....enclosed

Name.....

Address.....

City.....State.....

bination is long enough for the voltage on C_1 to remain practically constant throughout each horizontal line. This biases the picture tube in series with the picture signal as it varies with the height of the pulse peaks. Thus all the pulse peaks are lined up at the picture tube grid. R_3 is used to isolate the diode from the cathode of the picture tube so that the diode capacity will not reduce the high frequency response of the video output.

Defective restorer action is not usually apparent unless there is considerable change in background during a program. The usual sign of trouble is that the brightness control must be readjusted continually. Try a new diode first, then check the resistors and condensers.

A factor in favor of diode use is the interpretation of maximum crystal ratings in connection with their application as d.c. restorers. Since the published ratings are in terms of d.c. conditions, which imply a duty factor of unity, these ratings may be exceeded by a large percentage in pulse operation with no detrimental effects. This holds particularly true with respect to the maximum peak inverse voltage rating.

Some engineers disagree with this concept but since reverse current dur-

ing a break-down of the crystal is limited by the circuit, it probably will not hurt the crystal too much to exceed the peak inverse voltage rating.

The peak signal available at the grid of the picture tube is usually about 40 volts, of which 10 volts is in sync and the other 30 represents video signal. Under the worst possible condition with an all white field prevailing the restored d.c. is approximately 24 volts; this, plus the sync pulse of 10 volts, subjects the diode to a maximum peak inverse voltage of 34 volts. Germanium diodes will easily withstand this type of service use provided certain precautions are taken regarding temperature.

The temperature rise in the hottest portions of the television receiver seldom exceeds 40 degrees Centigrade, or 104 degrees Fahrenheit. Above 55 degrees Centigrade, or 131 degrees Fahrenheit, the change in d.c. output becomes an appreciable percentage of the initial voltage. Therefore, it is advisable to locate a reinsertion diode (or any crystal, for that matter) at some point on the chassis where the temperature rise will be at a minimum. Below 40 degrees Centigrade, the changes in germanium diode characteristics are not a problem.

-50-

OSCILLOSCOPE PATTERNS QUIZ

By ED BUKSTEIN

Northwestern Vocational Institute, St. Paul, Minn.

(For Answers to the Quiz, See Page 137)

THE cathode-ray oscilloscope is to the radio-electronic technician what the stethoscope is to the doctor. Both of these instruments reveal, to the trained observer, vital information concerning the condition of the circuit or organ in question.

The technician works with invisible forces. He cannot see the high frequency currents surging back and forth in the tank circuits, he cannot see a charge of electrons accumulating on a condenser plate, he cannot see the counter e.m.f. generated in an inductance—he cannot see these things unless he uses an oscilloscope. To work without this instrument is to work blindfolded and handicapped.

The technician who has mastered the

use of the oscilloscope, who has learned to interpret its patterns, who knows its capabilities and limitations, is a competent technician. He can "diagnose" an ailing circuit with the rapidity and sureness of an experienced physician diagnosing an organic disorder.

You can check your knowledge of the applications of the oscilloscope by pairing the words and definitions listed below with the patterns they suggest. Record your answers in the boxes provided and then check your score against the correct answers given on page 137. Your numerical score can be translated into its verbal equivalent as follows: 10 correct is excellent; 9 correct is very good; 8 correct is good; 7 correct is fair; and 6 or less correct is poor.

-50-

<input type="checkbox"/>	1. Hysteresis measurement	
<input type="checkbox"/>	2. Power supply ripple	
<input type="checkbox"/>	3. Overmodulation	
<input type="checkbox"/>	4. Phase measurement, 90° angle	
<input type="checkbox"/>	5. Frequency comparison, 2:1 ratio	
<input type="checkbox"/>	6. Overcoupling	
<input type="checkbox"/>	7. TV alignment	
<input type="checkbox"/>	8. Electronic switch	
<input type="checkbox"/>	9. Audio amplifier testing	
<input type="checkbox"/>	10. Discriminator alignment	

LEARN Practical RADIO AT HOME



COMPLETE ONLY... **\$19⁹⁵**

BUILD 15 RADIOS

ABSOLUTELY NO PREVIOUS TRAINING NEEDED
EXCELLENT BACKGROUND FOR TELEVISION

10-DAY MONEY-BACK GUARANTEE

WHAT THE 1952 PROGRESSIVE RADIO "EDU-KIT" OFFERS YOU:

This is a practical home radio course. You learn theory, construction, operation, trouble shooting, code. You build RECEIVERS, TRANSMITTERS, AMPLIFIERS, CODE OSCILLATOR, SIGNAL TRACER.

You start with a simple radio circuit, and gradually advance to more complex circuits. No previous background is required. No instructor is needed. All parts and instructions are included and every single step is clearly explained.

All parts are guaranteed, individually packaged, identified, and explained.

There is nothing extra to buy. You receive all parts, tools and instructions at once. You keep everything; there is absolutely nothing you return to us.

You can easily pay for the kit in a short time by repairing radios. Use the tester and signal tracer for servicing. The signal tracer alone is worth more than the price of the entire kit.

USED BY RADIO SCHOOLS AND GOVERNMENT AGENCIES!

The Progressive Radio "Edu-Kit" includes tubes, paper condensers, mica condensers, electrolytic condensers, variable condensers, selenium rectifiers, chassis, hardware, tie strips, tube sockets, solder, wire, soldering iron, tubing, coils, instruction book, radio trouble-shooting guide, radio tester, television trouble-shooting manual, etc.; in brief, everything you need in a practical radio course.

Order your "Edu-Kit" today, or send for further information.

Postage prepaid on Cash orders—C.O.D. orders accepted in U.S.A.

PROGRESSIVE ELECTRONICS CO.

497 UNION AVE. DEPT. RN-3 BROOKLYN, NEW YORK

FREE RADIO TESTER & SOLDERING IRON

GET A WELL-PAYING JOB

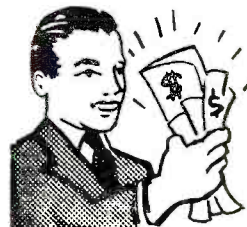

GO INTO A PROFITABLE BUSINESS AND PLAN FOR A FUTURE

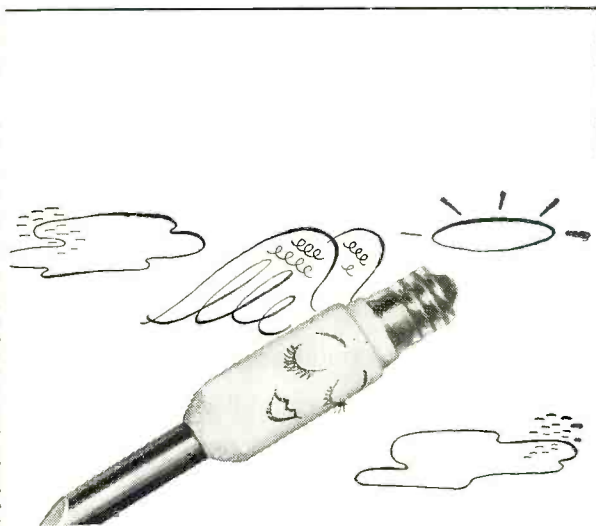

For a Heavenly Soldering Job, Insist on

Ungar's little Angels

Need we say more?

Write for Catalog No. 400

Ungar ELECTRIC TOOLS, INC., Los Angeles 54, Calif.

WOW!

JUST
A FEW
OF

AMERICA'S
GREATEST
BUYS

NAME BRAND TUBES

Joseph's makes the most amazing tube offer in history! First-line, guaranteed tubes for as low as 46¢ each! All are name brand such as Sylvania, G.E., R.C.A., etc. Some bear set manufacturer's names, all tubes beautifully cartoned. For the best at lowest prices order from Joseph's now!

1B3GT	... \$.91	6SN7GT	... \$.88	12SA7GT	... \$.73
1X2A91	6T8	... 1.13	12SK7GT73
5U4G61	6V6GT70	12SQ7GT61
5Y3GT46	6W4GT65	25L6GT74
6AL558	6X5GT52	35W446
6AU664	12AT655	3Z5GT54
6AV655	12AT7	... 1.04	50B574
6BG6G	... 1.92	12AU780	50C574
6BQ6GT	... 1.28	12BA665	50C574
6C454	12BE670	50L6GT74

TUBULAR ELECTROLYTICS

CORONET "BLU-KAPS"—Every "Blu-Kap" guaranteed for one year! Small size for efficient, easy replacements. Try some now; you'll use them regularly!

8 mfd. 450V 10 for \$2.40	20 mfd. 150V 10 for \$2.30
16 mfd. 450V 10 for \$3.20	20-50 mfd. 150V 10 for \$3.40
30 mfd. 450V 10 for \$4.10	50-80 mfd. 150V 10 for \$3.90
8-8 mfd. 450V 10 for \$4.50	

ORDER NOW AND SAVE!

TERMS: Min. Order \$5.00. F.O.B. Chicago, Ill. 25% deposit on C.O.D.'s. Prices subject to change without notice. Merchandise subject to prior sale.

FROM **JOSEPH'S** great new **FREE** **SERVICEMAN'S BUYERS GUIDE**

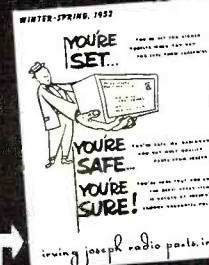

IRVING JOSEPH RADIO PARTS INC.
215 S. HALSTED ST., CHICAGO 6, ILL.

Yes, send me the new Servicemen's Buyers Guide.

NAME _____
FIRM NAME _____
CITY _____ ZONE _____ STATE _____

IRVING JOSEPH RADIO PARTS, INC.
215 S. HALSTED ST., CHICAGO 6, ILL.

FREE

POWER SUPPLY KITS

1 ea. PLATE TRANS. 750-600-0-600-750VDC 225 MA.	1 ea. 15 HY 250 MA CHOKE	1 ea. 6.3V 4A. 6.3V4A DUAL FIL. TRANSFORMER	1 ea. 5V 3A FIL. TRANS. F	1 ea. 2MF 1500VDC. 1 ea. 4MF 1000VDC
WHILE THEY LAST \$22.50				
1 ea. 740VCT 150MA 6.3V 4A. 5V 3A TRANS.	2 ea. 10 HY 150 MA CHOKE	1 ea. 8X8MF 600V DUAL OIL CAPACITOR	WHILE THEY LAST \$9.95	

METER BARGAINS

3" RD 0-20 ua dc. \$14.95	3" RD 0-300MA dc. \$4.50
4" SQ 0-50 ua dc. 12.95	3" RD 0-500 MA dc. 4.50
2" RD 0-1 MA dc. 4.50	3" RD 0-1000MA dc. 4.50
3" RD 0-50MASpScale 2.25	2" Altercat 0-30 A. 1.98
3" SQ 0-50MASpScale 4.50	3" RD 30-0-30 Adc. 5.50
3" RD 0-100MA dc. 4.50	2" RD 0-150 VAC. 1.45
3" RD 0-200MA dc. 4.50	3" SQ -10-6DB. 14.50
2" SQ 0-3 VDC27SQ 0-100 ADC with shunt, both 1.99	
3" RD JBT Freq. meter 40-400 KHz. 48-52&58-62 cycles. 14.50	
4" SQ. 0-100 ua dc. 10.95	

COMPONENT BARGAINS

CW-3 Receiver, Near New Condition.....	\$89.50
Superior, Type 20 Toverstat.....	12.55
Superior, Type 116U Powerstat.....	18.00
Min. Tube Shield for 6AQ5, 2E30, etc.....	10/.70
Min. Tube Shield 6AL5, 6AK5, etc.....	10/.50
Min. Tube Shield 6AR5, etc.....	10/.40
5x9 1/2x3 Aluminum Chassis.....	1.30
7x11 1/2 Aluminum Chassis.....	1.35
4x2 1/2x1 1/2 Aluminum Box.....	1.75
3x4 1/2 Aluminum Box.....	.95
=45 Peewee Battery Clips.....	10/.50
=85 Crocodile Battery Clips.....	10/.55
Superior 5-Way Binding Post, Red, Black, ea.....	.40
Ceramic Pillars SQ 7/8x3/8x3/8 8-32 Tap.....	.10
Ceramic Pillars SQ 1 1/4x3/8x3/8 8-32 Tap.....	.15
Ceramic Pillars RD 1 1/4x3/8x3/8 8-32 Tap.....	.10
Ceramic Beads, up to #14 Wire.....	100/.25
7/8" Fluted Knobs for 1/4" Shaft.....	10/1.00
Pilot Light, #44, #47, #47.....	10 of a No. .69
Four Quadrant Phasing Capacitor.....	4.95
Red, Green, Amber, White Dimmer Type Pilot Light Assembly.....	.24
Cramer Time Delay Relay, TD-150S.....	14.95
SCR322 XMT-RVCR.....	60.00
Plug in Relay 2000 ohm 5 MA SPDT.....	2.95
5 Screw Terminal 6/32 Screw 6/32 Term.....	10/.20
Barrier Strip, Yellow Bakelite, 6 term.....	10/1.50
7 pin min. wafer socket.....	10/.60
7 pin min. molded sock, base shield.....	10/.75
7 pin min. molded sock, base shield.....	10/.95
7 pin min. steatite sock, base shield.....	10/2.50
4 prong steatite socket.....	10/1.00
Octal sock, mica filled or Steatite.....	10/1.00
6 prong, MIP 6 socket.....	10/.85
1CA Phone Plug & Jack =2383-2385.....	10/1.50
1/4" Panel Binding.....	10/1.50
7 ft. rubber line cord & mold, plug.....	.35
1/4" Green 110V Pilot Light assembly.....	.39
SPST EA 125V.....	ea. .25
SPST as above, momentary only.....	ea. .35
SPST as above, neutral center.....	ea. .49
SPST Rotary Switch, wafer type.....	2/.25
6 pos., Ceramic Switch.....	10/1.50
Milfen Flex. comp (39002).....	.20
JK34 Jack (PL55) 18, JK33 (PL-68).....	.05
2 cell penlite bulb (222), 3V.....	.15
Mazda S-6 115V 6W bulb.....	.21
STEATITE Plate Caps-807 17c, 866.....	3.95
Johnson 210 Sock, 65c, 212 Sock.....	22 oz. 9.95
New Soldering Gun, Balanced Grip, heats in 5 sec., alloy tip never needs retinning, weight	

CHOKES

60 HY 50 MA.....	\$.39
9 HY 90 MA, 100 Ohm.....	1.49
7 HY 125 MA, Cased.....	1.49
10 HY 150 MA, 140 Ohm.....	1.69
6 HY 200 MA, Cased.....	5.10
4-16 HY 200 MA, 140 Ohm, Cased.....	3.49
15 HY 250 MA, 65 Ohm, Cased.....	6.50
5-25 HY 300 MA, 120 Ohm, SW CH, Cased.....	6.50
8 HY 300 MA, Cased, 85 Ohms.....	6.50
6 HY 450 MA, 30 Ohm, Cased, Herm. Seal.....	4.95
6 HY 300 MA, Cased.....	7.95
5-30 HY 500 MA, SW CH, Cased.....	11.50
3.5 HY 950 MA, 25 Ohm, Cased.....	29.50
7 HY 1 Amp, Cased.....	37.50
2-10 HY 1 Amp, Cased.....	42.50
6 HY 1.5 A, Cased.....	

115V FILAMENT TRANSFORMERS 60 CY

2.5 VCT 10A, 10 KV Insulation, Cased.....	\$4.50
2.5 V @ 6A, 2.5 KV Insulation, Cased.....	3.45
5 VCT 3A, 2.5 KV Insulation.....	2.95
5 V @ 3A, 6.3 VCT @ 3.5A.....	2.95
5 VCT 12A, 2.5 KV Insulation.....	5.95
5 VCT 20A, 2.5 KV Insulation.....	6.85
6.3 VCT 1A, 2.5 KV Insulation.....	1.99
6.3 VCT 3A, 2.5 KV Insulation.....	1.99
6.3 V @ 4A, 6.3 V @ 4A, Cased.....	2.95
6.3 V @ 6A, 5V 3A.....	3.00
6.3 VCT @ 6A, 2.5 KV Insulation.....	2.95
6.3 V 10A, Cased.....	6.00
10 VCT 10A, 2.5 KV Insulation.....	3.95
24 V 1A, 2 KV Insulation.....	1.95
32 V 1amp, 2 KV Insulation.....	

115V POWER TRANSFORMERS 60 CY

6S to 83 V Half Wave, 1.5A.....	\$1.25
300 V 20 MA (Half Wave).....	\$1.25 ea. 2/ 2.00
435 VCT 145 MA, 6.3 V 3A, 5 V 3A.....	2.49
630 VCT 40 MA, 6.3 V 2A, 5 V 2A.....	3.25
680 VCT 250 MA.....	2.95
700 VCT 90 MA, 5V 3A.....	2.25
700 VCT 90 MA, 6.3 V 3A, 5 V 3A.....	3.00
740 VCT 185 MA, 6.3 V 4A, 5 V 3A.....	3.95
800 VCT 200 MA, 6.3 V 3A, 5 V 3A.....	5.95
800 VCT 300 MA, 6.3 V 10A, 5 V 6A, 5 V 2A.....	9.50
750-600-0-600-750 VDC, 25 MA.....	2.95
5400, 5800, 6200 VCT 110 MA.....	29.50
2500 VDC 1A, Pr. 230 V 3ph 60 Cy.....	125.00

OIL CAPACITORS

3mf 330VAC.....	4/51.00	4mf 1.5KVDC.....	5 2.95
14mf 275VAC.....	3.95	16mf 1.5KVDC.....	6.95
2mf 600VDC.....	.75	2mf 2KVDC.....	1.95
5mf 600VDC.....	1.10	2mf 3KVDC.....	1.95
8mf 600VDC.....	1.10	4mf 4KVDC.....	10.50
8x8mf 600VDC.....	2.75	2mf 5KVDC.....	4.95
50mf 600VDC.....	1.85	1mf 5KVDC.....	10.50
2mf 1KVDC.....	1.25	1mf 5KVDC.....	.95
2mf 1KVDC.....	1.25	1mf 5KVDC.....	.95
8mf 1KVDC.....	3.95	3000MFD 3V Elect.....	.39

POLY-TECH

919 Dawson St., New York 59, N. Y.
Tel. Murray Hill 6-2650

Electrostatic Focus

(Continued from page 63)

accelerating grid, G_2 , is recommended for the focusing anode. To obtain this higher voltage it may be necessary to connect the focus control to the horizontal boost voltage. Actual practice has shown that the first value, the approximate center of the voltages shown in Table 1, gives the best focus and the entire range indicated here is hardly needed. The table also shows that there are two types of low voltage focus tubes available and their major difference is the focusing voltages required. The 17RP4 and 20LP4, for example, would best be used in a receiver where the cathode of the picture tube is close to ground potential and the "B plus" supply has a negative bus which is below ground potential. However, the intelligent technician will be able to determine the best tube type for each replacement job by checking the d.c. voltages on the picture tube elements and referring to Table 1 for the closest approximation to the receiver voltages.

To make the actual installation an additional wire must be brought to the picture tube socket and a new prong must be fitted to make contact with pin #6. If a half round type socket is used it is usually better to install an entirely new, circular type socket than to hook up some makeshift arrangement.

In general, the problems of servicing electrostatically focused picture tubes will be less than for the magnetic types. Such common defects as a burnt focusing control or a shorted focus coil will not be found in the new type tubes. But some new and peculiar features deserve special attention.

The ion trap used in all electrostatic focus tubes is of the single magnet type. Its adjustment on the neck of the tube is much more critical than on magnetic focus tubes because the ion trap location can influence the focus to a large extent. The ion trap should be adjusted only for maximum brightness and when all other tube elements are functioning properly, good focus will be obtainable by adjusting the focus control only. In an electrostatically focused tube it is possible to obtain brightness with incorrect voltages on G_2 and the focusing anode, if the ion trap is also misadjusted slightly. The resulting picture may have some focus in the very center of the screen, but the edges certainly will appear fuzzy. If improper focus is observed at any time with an electrostatic focus picture tube, measure not only the focusing voltage but the voltage on G_2 and the second anode as well and remember that they should be measured with respect to the cathode of the tube.

In magnetic focus tubes the centering of the picture is often accomplished by tilting the focus coil or otherwise varying the symmetry of the

magnetic field. For electrostatic focus tubes a small PM centering device is usually employed to provide the centering action. Various types of PM rings, small PM tabs on cardboard discs, and similar devices are used by different manufacturers. The correct location for this centering device is as close to the deflection yoke and as far from the ion trap as possible. More centering action will be obtained if the magnets are closer to the ion trap, but at the same time some interaction takes place between the two magnetic fields resulting in less brightness, corners cut off, or even poor focus.

All of the new electrostatic focus tubes use a wide deflection angle, 66 degrees horizontally and 70 degrees diagonally, and this requires a short, wide angle deflection yoke. In most 1952 receivers these deflection yokes feature a special winding system which provides even focus over the entire screen area. Sometimes these "Anastigmatic," "Cosine," or "True-focus" yokes cause pincushioning at the top and bottom of the screen. To overcome this effect several manufacturers use small correcting magnets on the top and bottom of the deflection yoke. These anti-pincushioning magnets are currently found in some Philco, RCA, and similar models.

Aside from defective focus, the electrostatic focus tubes are subject to all of the usual picture tube defects such as becoming gassy, losing their vacuum, or going "soft." Internal arcing can occur on even the latest models if the second anode voltage is excessive or is not properly filtered d.c. For example, if the HV filter condenser were open the anode voltage would contain large positive pulses exceeding the 16 kv. limitation. Arc-over could then occur from the second anode to the focusing element. On checking the HV with a d.c. meter, only the average value would be read, giving no indication of the trouble. The only method of approaching this sort of defect is to replace the HV condenser and again measure the d.c. voltage across it. With a good filter condenser the arcing should then stop, unless the defect is due to the picture tube itself. In the HV type of electrostatic focus tube internal arcing is less likely but additional HV troubles can be encountered in the focus control circuit. Defects in any of the components in the control circuits, failure of the HV rectifier, etc., can result in loss of focus or, if the focus element were grounded, internal arc-over could occur. Measuring the voltage and resistance values in this section will invariably show up the defect at once.

All-in-all the new electrostatically focused picture tubes promise no additional burden on the service technician and certainly represent a reduction in the weight and complexity of TV sets. Born of the necessity for conserving scarce materials, these new picture tubes are a major advance towards better, cheaper, and simpler television receivers.

Technical BOOKS

"REFERENCE DATA FOR RADIO ENGINEERS" by Federal Telephone and Radio Corporation Staff. Published by *Federal Telephone and Radio Corporation*, New York. 640 pages. Price \$3.75. Third Edition.

The third edition of this popular reference work is the largest and best of the series. It is more than twice the size of the preceding edition and is three times as large as the initial publication.

The book is packed cover-to-cover with pertinent data which has been set up, in most cases, in tabular form to facilitate its use. The book is divided into twenty chapters which cover such subjects as frequency data; units, constants, and conversion factors; properties of materials; components; fundamentals of networks; selective circuits; filter networks; attenuators; bridges and impedance measurements; rectifiers and filters; iron core transformers and reactors; electron tubes; amplifiers and oscillators; modulation; Fourier waveform analysis; transmission lines; wave guides and resonators; antennas; radio wave propagation; radio noise and interference; radar fundamentals; broadcasting; wire transmission; electroacoustics; servomechanisms; miscellaneous data; Maxwell's equations; mathematical formulas; and mathematical tables.

* * *

"TELEVISION ENGINEERING" by Donald G. Fink. Published by *McGraw-Hill Book Company*, New York. 702 pages. Price \$8.50. Second Edition.

Although technically designated a "second edition," this volume is an almost completely rewritten version of the author's "Principles of Television Engineering" which appeared some 12 years ago.

The author has followed the same basic pattern in preparing this material that prevailed in the first edition. He has assumed that the reader is familiar with the elementary principles of vacuum tube circuits and the processes of amplification, modulation, carrier transmission, and demodulation. Circuits and theories that are peculiar to television are covered thoroughly, beginning with the basic concepts.

The text material is divided into eleven major categories covering the television system as a whole, analysis and synthesis of images, cameras and picture tubes, scanning and synchronization methods, transmission of the video signal, video amplification, carrier transmission of picture and sound signals, color fundamentals, color TV systems, television broadcasting equipment, and television receiving equipment. An appendix carries the FCC "Standards of Good Engineering Practice" in abbreviated form as a reference.

-30-

March, 1952

TV DIRECT FROM THIS GREAT FACTORY TO YOU

BRINGS YOU

Finest Quality at Lowest Prices

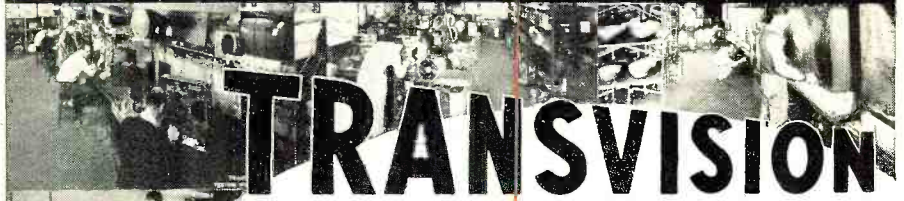

TRANSVISION

TV KITS, WIRED CHASSIS, and SETS
CABINETS, COMPONENTS, INSTRUMENTS, and ACCESSORIES



SPECIAL!



REMOTE CONTROL TV CHASSIS

Here's the finest buy in Remote Control TV. Unit is all-electronic; no troublesome mechanical parts. Gives complete operating control of set. Plus—the latest *Transvision A-4 Wired TV Chassis*; completely aligned; ready to plug in. Has AFC and AGC. Top quality reception, even in fringe areas. 17" A-4 TV Chassis, remote control, and CRT, net \$199. 20" A-4 TV Chassis, remote control, and CRT, net 219. With Du Mont Tuner and FM radio, add..... 10

BEAUTIFUL TV CONSOLES

Ideal for Custom-Building or Conversion. Factory prices start from \$49. Send for Cabinet Catalog now.

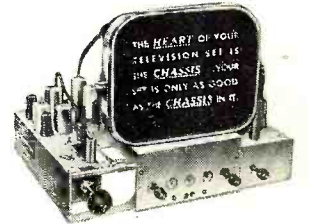

CR TUBE TESTER-REACTIVATOR

Tests Picture Tubes and Renews Brightness of Many Dim Picture Tubes. Without removing picture tube from set, measure Cathode emission . . . locate shorts between elements . . . locate high resistance shorts or leakage as high as 3 megohms. Then, REACTIVATE dim picture tubes if there's no mechanical defect in tube. 110V-60 cycles; weighs 3 lbs.

\$19⁹⁵ net
Fully Guaranteed.

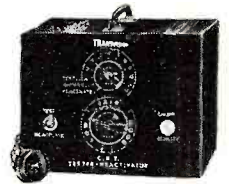

FIELD STRENGTH METER AT NEW LOW PRICE

Improve TV installations; save half the work with the Transvision Field Strength Meter. **\$59** net Model FSM-1, complete with tubes.



SAVE ON PICTURE TUBES

Direct from Factory!

2 Year Factory Guarantee!

Amazing new LOW PRICES on all size Picture Tubes with Transvision's 2-Year Guarantee, prorated. Send for Price List now.

MULTI-SET CONNECTORS

feed up to 5 TV Sets from 1 Antenna
Prices: Multi-Set Conn. for 2 sets . . . \$4.95 list*
For 3 or 4 sets . . . 7.95 list*
*Dealers, write for discounts

Write for Price List on TV COMPONENTS.

Want to Make More Money in TV?

Write for the Transvision Factory Agent Plan.



FREE BOOKLET:

"INSIDE CRT, or What You Should Know about Picture Tubes." Written by CRT experts, illustrated. It will MAKE MONEY FOR YOU. WRITE FOR IT NOW.

FREE: EXTRA INCOME EVERY MONTH from hints in "TV and Electronics Notes." Request sample copy, plate and mailing for FREE Subscription. Monthly issues are gold mines of info on New Products, Sales Service, Conversion, etc. WRITE FOR IT TODAY!

TRANSVISION, INC. NEW ROCHELLE, N. Y.

Columbia

GEM OF THE SURPLUS

HAM WINS SUIT!

Yup! Hundreds of hams all over U.S. have earned free suits of clothes just by selling their new and used radio gear to COLUMBIA. WHY NOT YOU? Round up everything you have in electronics. Tell us what you've got. WARNING: We can't be held responsible if you faint with surprise when you see the sizzling high prices we pay!
DO IT UP RIGHT—WRITE RIGHT NOW!

LIMITED QUANTITY SALE!

Short on quantity—but long on savings!

- MINE DETECTOR: SCR-625. Excel. cond. \$55.00
- FREQUENCY METER: BC-221. Excel. shape. 79.95
- WALKIE-TALKIE TRANSMITTER: BC-322. Excel. cond. 24.95
- ARB-RADIO COMPASS RECEIVER: 24 V. in. Freq. range: 190-9,000 kc. For marine or aircraft. Complete, with flex cable, plugs, control box. NEW. Only 79.95

AIRCRAFT EQUIPMENT

New shipment just in! WRITE FOR PRICES

- ARC-3 TRANSMITTER HS-33 HEADSETS
- ARR-5 VHF RECEIVER ARR-7 VHF RECEIVER
- ARR-7 RADIO COMPASS. Complete installation.
- SCR-522 VHF TRANSMITTER & RECEIVER, comp. inst.
- APR-4 RECEIVER with TU-16, 17 & 18. Brand new.

- MOBILE TRANSCEIVER: BC-659. 10-meter. FM. With all tubes, G, 12, or 24 V. power supply. Includes mike, headset, and antenna. Fair condition but sensational price. \$85.00
- BC-689 TRANSMITTER & BC-688 RECEIVER: Cover 420 mc. band. Less tubes, fair cond. EACH UNIT \$3.50
- Buy both to SAVE! Both for only \$5.49
- PE-73 DYNAMOTOR: 24 V. input, 1,000 V. output @ 250 mls. Same as BD-77. Good cond. THIS MONTH ONLY \$5.95

MARINE GEAR SPECIALS!

Sailors Ahoy! A Cargo of Money-Savers!
5 W. MARINE RADIO TELEPHONE

- Jefferson-Travis Emerson Radio Corp. Freq. 2-3 mcs. 2-channel, x-tal control. Complete with mike, speaker, 110 V. charging unit, all tubes and instructions. 6 V. input or will run 8-10 hrs. on own battery pack. BRAND NEW, BOXED (Less xtals & batteries). ONLY \$89.95
- MN26-C RADIO COMPASS: Complete with tubes, loop, flex cables, plugs and control box. Excel. cond. \$89.95
- BC-375 100 W. TRANSMITTER: Easily converted to xtal control. With tubes, cables, dynamotor, marine tuning unit. Excel. cond. THE WHOLE DEAL ONLY \$42.50

NEW TRANSFORMERS 110 V. 60 CYCLES

Look at these sensational buys!

- STANCO P4079, 700 V. Center tap, 90 ma. 6.3 V. @ 3.5 amps & 5 V. @ 3 amps. \$3.25
- THORDARSON TV Filter Choke, T-1704, 1500 h. 3 ma. 12K insulation 700 V. Center tap \$1.79
- THORDARSON T-1310S, 700 V. Center tap \$1.90
- ma.; 2.5 V. Center tap @ 6 amp.; 6.3 V. Center tap @ 3.5 amp. \$3.25
- THORDARSON 15A6R CHT audio xfmr. Dynamic mike or line-to-grid. Pri.: 60/38/30/22/15/10/5.5/2.2 ohms. Sec.: 60,000, 13,000 ohms 2.95
- HALICRAFTER 110 V. or 220 V. input, 580 V. center tap @ 273 ma. 6.3 V. @ 5.5 amp., 3 V. @ 3 amp. 4.95

CONDENSER SPECIALS

- .1 mfd. @ 400 VDC. Ea. 10c. 10 for 69c
- 16 mfd. @ 400 VDC. Paper electrolytic. Ea. 30c. 5 for \$1.00
- .05 mfd. @ 5000 VDC. Paper. Ea. 39c. 3 for 1.00

4 V. BATTERY PACK

For TBY Walkie-Talkie. New, in original boxes \$4.95

PE-103 DYNAMOTOR

With filter base and cords. 6 or 12 V. input; 500 V. output. Excel. cond. limited quantity \$24.95

ARC-5 OR 274-N TRANSMITTERS

- 2-1.3 mcs. New \$19.95
- 2-4 mcs. Used, excel. cond. 14.95
- 2-5.3 mcs. Used, good cond. 6.95
- 2-3.7 mcs. 5.99
- 7-9.1 12.50

ARC-5 OR 274-N RECEIVERS

- .55-1.5 mcs. Brand new \$49.50
- 1.3-3 mcs. Brand new 24.50
- 6-9.1 mcs. Used 7.95
- 6-9.1 mcs. Brand new 11.95

- 28 V. RECEIVER DYNAMOTOR 1.00
- 14 V. RECEIVER DYNAMOTOR 9.95
- RACK FOR DUAL TRANSMITTER (274-N) 2.95
- TRIPLE RECEIVER RACK 5.00
- BC-442-A ANTENNA RELAY w/ 1 th 50 mfd. condenser. Excel. cond. 3.95

All orders F.O.B. Los Angeles. 25% deposit required. All items subject to prior sale.

COLUMBIA ELECTRONIC SALES
522 South San Pedro Street
LOS ANGELES 13, CALIFORNIA

Mac's Service Shop

(Continued from page 70)

"Check the filament drop across that 12BA6," he ordered importantly.

Mac turned his head aside to conceal a grin as he obediently hooked the v.t.v.m. across the filament prongs of the tube. "Well I'll be—" he exclaimed. "There's only about five volts drop here."

"I thought so," Barney said complacently. "I had one just like that the other day except that a 12BE6 was the joker then."

"What do you think happens?"

"I think that a loop of the filament shorts out after the tube reaches a certain temperature. That cuts down the heat delivered to the cathode and reduces the emission."

"Why didn't the tube checker burn out the part of the filament being heated?"

"Because you checked the tube the first thing, before it got hot enough to short out. I'll bet if you yank it out of the set and pop it into the checker before it has time to cool down it will burn out now."

Mac quickly jerked the tube from the set and stuck it into the tube tester. The filament glowed brilliantly for a second or so and then went dark.

"Aw, quit trying to look as though you just invented perpetual motion," Mac said in mock disgust at the self-satisfied look on Barney's face.

"Say, Boss, not to change the subject," Barney said with more interest and enthusiasm than he had shown in weeks, "but where were you last night? I called and called because I wanted to double-check with you on some transmitter trouble on Channel 6 that was making the picture cut some funny didoes, but nobody was home."

"I was over fixing Old Man Bennett up with an earphone on his TV set. He is pretty hard of hearing, you know, and all he was getting out of his set was what he could see. Wrestling matches and prize fights were about all that made sense to him."

"Couldn't he listen with his hearing aid?"

"Not to do any good. If you ever played with one of those things, you would know that the microphones they use do the same thing any microphone does: exaggerates echoes. You've doubtless noticed that a person standing a few feet away from a broadcast microphone in any room except a studio always sounds as though he were talking in a huge hall, even though the room may be quite small. Exactly the same thing happens when you talk to a person wearing a hearing aid from a few feet away from him, and this echo is just enough to confuse a person whose hearing is not up to par. When Mr. Bennett sat right up against his TV set, he could hear pretty well; but when he backed off far enough so that the picture looked good, he could

TELEPHONE EQUIPMENT & PARTS

- Brand New RM29A Remote control units, export packed, with carrying bag, each \$16.00
- Reconditioned & tested Army EEB field tele-phones each 20.00
- Like New Sound Power field telephones 101-ca New T59 handsets with flip switch for EEB each 22.00
- Rebuilt T59 handsets with new shell each 6.50
- Rebuilt like new solid handsets, A.E., W.E., Kellogg, new 3 Conductor cord each 4.95
- New Receiver & Transmitter elements, low impedance, interchangeable & like the W.E. HA1 & F1 elements each 1.00
- New W.E. Operator's Head & Chest sets each 6.00
- New W.E. Chest Sets with F1 transmitter—T-26 each 4.00
- New W.E. T-30Q Throat Mikes each .50
- A.E. Type 41 Receiver elements for TS13 handset each .75
- New Cranks G69 for EEB field telephone each .25
- New Capacitors CA-35 for EEB each .50
- New T59 switches for handset each .30
- New C-105 Induction Coils each .75
- New C-158 holding Coils each .45
- Lever switches complete with C.B. & L.B. screw switch each .30
- C-161 Repeaters each 2.00
- C-114 Loading Coils each 1.00
- TM-184 terminal strips, for pole line, etc. each 2.00
- W.E. 706A receivers with HA1 element—Less cord each 2.00
- New W.E. B-365 Relays each 2.95
- New W.E. 3A varistors each .90
- New W.E. 44A Connector Blocks each .50
- New W.E. Equalizers D-164752B each 7.00
- New W.E. A2 switchboard lamps per 100 10.00
- New Kellogg 40 Volt switchboard lamps per 100 10.00
- New Kellogg, white opal, lamp caps 279 per 100 10.00
- New A.E. type 41 transmitters, low impedance each 1.50
- W.E. Dial blanks each .90
- W.E. #26 protector blocks per 100 10.00
- New A.E. Sound power transmitters each 3.00
- Rebuilt Sound power handsets with new cord with alligator clips each 5.50
- New Kellogg 4 Conductor cords for tele-phones handset each \$0.60; 3 Cond. each .50
- New Rubber Switchboard cords 2 Conductor—605 each .35
- Upright desk telephones, tested, reconditioned, for intercom extensions, etc. each 2.95
- Ringer boxes for above desk telephones each 2.00
- New receiver elements interchangeable with W.E. Holzer Cabot-Connecticut handsets each 1.00
- Control Boxes—BC-309 each 4.50
- 5-Bar generators each 29.50
- Battery eliminators. New for intercom-unication systems, etc. 115 V.A.C. input, output, 6-8 V.D.C. for talking, 8-12 V.C. for ringing each .50
- W.E. transmitter for up-right telephones each 5.00
- New Kellogg R2A induction coils 5 for 5.00
- PLQ-103 PLUGS, new each .90
- Control Boxes—BC-309 each 1.00
- New Allen Bradley relays 24V-50 amps D.C. each 1.00
- New W.E. Electrolytic condensers 250 V.D.C. 0-65C (7.5MFD-115MFD) each .40
- New Paper Capacitors 4MF each .90
- Cook Relays, New—turns 2200-Ohms 12 2.50
- Springs—6 Make One Break each 6.50
- TS-15A handsets with rubber cord & PL 68 & PL55 plugs each 6.50
- Capacitor Kellogg 1 & 2 Mfd.'s each 5.00
- New Canvas Carrying Bags for RM 29A remote control units each 1.75
- CA-389 .50MFD-1MFD . . . 600V.D.C. each .90
- CA-275 4MFD.50V.D.C. each .75
- C-280 transformers each 1.00
- JK54A each .50
- JK-37 each .75
- New 41" Rubber cords with PL68 each \$1.00
- Same with PL55 each 1.00
- Switch SW 175 each .80
- Switch SW 185 each .90
- New BD62C switchboards each 25.00
- New Capacitors . . . 100MFD.50V.V. 8 for 5.50
- Switchboards BD 129 each 60.00
- Canvas & Leather bags for EEB Field tele- phone.

Many, many more items.

Terms: Check with Order F.O.B., Brooklyn 5, N. Y.

EASTERN TELEPHONE CO.

321 Vanderbilt Ave. Brooklyn 5, N. Y.

RADIO and TELEVISION ELECTRONICS



Thorough training for men and women in all technical phases

Enroll NOW for New Classes (Day & Eve.) which start 1st of Mar., June, Sept. & Dec.

Free Placement Service For Graduates
For Free Catalog write Dept. RN-52
RCA INSTITUTES, INC.

A Service of Radio Corporation of America

350 West 4th St., New York 14, N. Y.

Another Outstanding Jobber

LIFETIME ELECTRONICS

1501 ADAMS STREET • TOLEDO, OHIO

has all 17 KITS & INSTRUMENTS in stock!

221K VITVM KIT \$23.95 See EICO ad on Page 171

not understand what was being said."
 "What kind of an earphone did you use?"

"A regular hearing-aid earphone that would snap into the moulded plastic earpiece he has. It so happened that he had an old hearing aid he no longer uses, and I got the earphone from that. I measured it and found that it had a d.c. resistance of about 30 ohms; so I tried it right across the voice coil of the speaker, and it worked beautifully. When the set is adjusted to just normal room volume from the speaker it is also just right for Mr. Bennett and his earphone, and the extra load represented by the earphone is so light that you cannot notice any difference when it is connected across the speaker. I ran a couple of leads from the voice coil to a jack on the back of the cabinet. From a plug in this jack a length of lampcord runs down through a small hole in the floor behind the cabinet, across the joists in the basement, and then back up through another small hole in the floor to a jack mounted on the baseboard right beside Mr. Bennett's favorite chair across from the TV receiver. A few feet of flexible cord and a plug allows him to plug his earphone into either this jack by his chair or the one on the set."

"Why both jacks?"

"Well, usually his wife tunes the TV set, but there might be times when he will have to do this for himself. Then all he has to do is pull the earphone plug from the jack beside his chair and walk over and plug into the jack on the receiver. When he has the set correctly tuned, he can replace the lampcord plug in the cabinet jack and go back and plug his earphone into the baseboard jack. On top of that, the jack on the cabinet allows the lampcord to be disconnected when it is necessary to pull the set away from the wall."

"What did he think of it?"

Mac smiled reminiscently as he replied, "Barney, when I saw that old man sitting there chuckling and slapping his leg at some of Bob Hope's fast-talking nonsense, I felt I had been repaid for all of the headaches we have in this wacky business. The few minutes spent attaching that earphone to the TV set meant hours and hours of pleasure and entertainment for that old fellow."

"Yep, Boss," Barney agreed, "this radio and television game is a pretty good one at that. There are times, of course, when a fellow feels a little low and discouraged as I did a couple of hours ago—although I'll be darned if I can see *why* now—but most of the time I feel as I do right this minute when I can hardly wait to get at the next set."

"Hold that mood!" Mac shouted as he dashed across the room, snatched a small set from the set-to-be-repaired group, and rushed back to place it on the bench in front of his broadly-grinning, red-headed assistant.

-30-

March, 1952



MODEL KXLP-30

Years ahead in listening pleasure

When you own a Newcomb amplifier you own more than just a carefully built piece of electronic equipment that measures up to the most exacting mechanical requirements. You also own... what you *really* want... the phonograph amplifier that's designed to give you *the most in listening quality*.

Let your own ears be the judge. When you listen to a Newcomb you hear your favorite recordings or radio and television shows come gloriously to life. These superb amplifiers are subjected to rigorous testing procedures throughout their production to insure mechanical and electrical perfection. BUT... *more than that*... they must meet the most critical *listening quality* tests.

Newcomb Model KXLP-30 is a 20-20,000 cycle, low distortion, 30 watt phonograph amplifier providing the reserve power to make full use of its special tone control circuits. Superbly balanced electrical design, the result of many years experience, gives you remarkable *listening quality*. The *Magic Red Knob* four stage record condition compensator frees tone controls from the function of controlling surface noise. Thus any desired tonal balance may be obtained under any condition of operation at any volume level. Adaptable for use with AM-FM radio tuners, TV, wide range loudspeakers and magnetic or crystal pickups, it is engineered for *your listening pleasure*.

Write for complete descriptive literature

Newcomb

THE SOUND THAT QUALITY BUILT



Model HLP-14, 14 watt
Phonograph Amplifier



Model P-10A, 10 watt
Phonograph Amplifier



Model R-12, Three Speed
Portable Phonograph



Model RC-12, Three Speed
Portable Phonograph



Model B-100 Radio

NEWCOMB AUDIO PRODUCTS CO., DEPT. F, 6824 LEXINGTON AVENUE, HOLLYWOOD 36, CALIFORNIA
 MANUFACTURERS OF P.A., PHONOGRAPH, MOBILE, INSTRUMENT AND WIRED MUSIC AMPLIFIERS
 PORTABLE SYSTEMS, PHONOGRAPHS, RADIOS, TRANSCRIPTION PLAYERS AND RACK EQUIPMENT

Become an Electrical Engineer

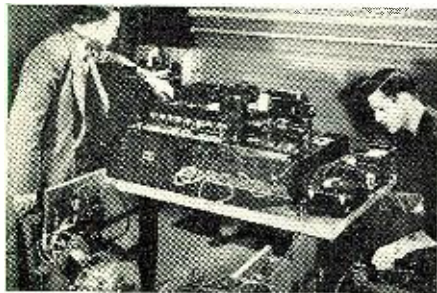

MAJOR IN ELECTRONICS



- B. S. Degree in 36 Months
- Radio-Television Technician Certificate in 18 Months

By 1954 there will be at least two positions for every engineering and technician graduate. This College offers a tested plan that permits you to enter these vast employment opportunities at an early date. First—you save a valuable year through optional year-round study. Second—you can receive advanced credit for prior training gained in the armed forces, other schools or field experience.

Enter Both Radio and Television Through This Plan

12 months or one-third of the B. S. degree course (Electronics major) — also brings you the Radio Technician's certificate. An added 6-month course qualifies you for the Radio-TV Technician's Certificate.

The Proven "UNIT CHASSIS SYSTEM"



of teaching was developed here. It "breaks down" the TV set by stages. You learn every component of all types and makes — and are prepared for future design changes, including the advent of color.

SPECIAL! Television Clinics

Ambitious Radio and TV Servicemen can enroll now in special one-month spring or summer clinics—to handle latest field service problems. Combine education and vacation.

Over 48,000 former students from all states and 23 overseas countries. Faculty of trained specialists. Modern laboratories and equipment. Nonprofit technical institute and college 49th year.

MILWAUKEE SCHOOL OF ENGINEERING

Founded 1903—Milwaukee, Wis.

Terms open April, July, October, January

FREE — Write for "Occupational Guidance Bulletin," "Your Career" booklet, and Catalog.

Milwaukee School of Engineering
Dept. RN 352, 1025 N. Milwaukee
Milwaukee, Wisconsin

Without obligation send Catalog for
Electrical Engineering, B. S. Degree,
major in Electronics; Power; "Your
Career"; Occupational Guidance Bulletin
on: Radio-TV; Electrical Power;
 Welding; Heating, Refrigeration Air Conditioning.
 TV Service Clinic.

Name.....Age.....
Address.....
City.....Zone.....State.....
If veteran, indicate date of discharge.....

Manufacturers' Literature

Readers are asked to write directly to the manufacturer for the literature. By mentioning RADIO & TELEVISION NEWS, the issue and page, and enclosing the proper amount, when indicated, delay will be prevented.

RECTIFIER REPLACEMENT

The Selenium-Intelin Division of Federal Telephone and Radio Corporation, 100 Kingsland Road, Clifton, New Jersey has just issued a "Selenium Rectifier Replacement Guide" designed to facilitate receiver servicing.

This 32-page book is divided into nine sections covering TV replacement part numbers, radio replacement part numbers, code numbers and miscellaneous replacements, operating characteristics of Federal units, fundamental circuits and servicing information on Federal rectifiers, servicing information, data on how to replace the 35Z5 with the company's 100 ma. selenium rectifier, "packaged power," and a cross index of part numbers.

Copies of this guide are available from the company at a charge of 50 cents each.

"REPS" DIRECTORY

The Los Angeles Chapter of "Representatives, Inc." has issued its 1952 directory, containing 40 pages and covers.

This seventh edition carries a comprehensive product index with 310 sub-heads and upwards of 4000 listings under various classifications. The data includes an alphabetical list of manufacturers represented, the officers and committeemen for 1952, and a list of senior members and associates.

Copies of this new directory are available from the chapter's publication office at 767 Castelar Street, Los Angeles 12, California. Requests should be addressed to the attention of the executive secretary-treasurer, Dr. Ralph L. Power.

RCA TV BOOKLETS

The Tube Department of Radio Corporation of America, Harrison, New Jersey has released two of its new television data books to all technicians.

The first booklet, "RCA Kinescopes," is a comprehensive manual containing data on more than 100 different kinescope types now in use. The publication provides such reference information as characteristics of the company's complete line of kinescopes, a replacement directory listing competitive units and the corresponding RCA "direct replacement" type or the company's "similar type," and a picture tube conversion chart. This book is listed at 25 cents.

The second publication is entitled "Television Servicing" and comprises a collection of special articles prepared by RCA's John Meagher and Art Lieb-scher. In addition to new articles on

TV servicing by Mr. Meagher and a new paper on TV tuner alignment by Mr. Liebscher, the book contains all of the Meagher articles on TV servicing which originally appeared in the "RCA Radio Service News." Subjects covered include r.f.-i.f. alignment, troubleshooting, and circuit analysis. This book sells for 35 cents.

Either or both of these new publications are available from the company's tube distributors or from the Commercial Engineering Section of the Tube Department.

DESIGN INDEX

Thordarson Meissner Manufacturing Division, Mt. Carmel, Illinois has issued a comprehensive reference work covering more than fifty-thousand field-proved transformer designs.

The new publication, which covers virtually the entire field of filters, chokes, and transformers presently required by the industry, has been issued in book form and is available to engineers.

Inquiries regarding this new "Transformer Design Index" should be addressed to the company at Mt. Carmel.

NEW ASA STANDARD

The American Standards Association, 70 East 45th Street, New York 17, N. Y. has released its new standard covering "Graphical Symbols for Single Line Electrical Engineering Diagrams."

The new standard (Z32.1.1-1951) coordinates and modifies the single line diagrams contained in the "American Standard Graphical Symbols for Electrical Power and Control (Z32.3-1946) and for "Telephone, Telegraph and Radio Use" (Z32.5-1944).

For the first time single-line diagrams for use in both power and communication work are combined and contained in one volume. They represent an agreement reached by representatives of the electric, telephone and telegraph, radio, public utilities, and the government on standard single-line symbols.

Copies of this new standard are available from the ASA at \$1.40 per copy.

COAX CONNECTORS

Transradio Ltd., 138A, Cromwell Road, London, S.W.7, England has issued a bulletin describing its line of precision coaxial connectors.

The publication, which has been designated TR-7B, pictures several different types of units and provides comprehensive data on the company's

complete line in tabular form. A few types of U.S. JAN connectors are also listed on this data sheet.

Requests for copies of publication TR-7B should be sent direct to the company.

WRL 1952 CATALOGUE

World Radio Laboratories, Inc., 744 W. Broadway, Council Bluffs, Iowa is now offering copies of its new 1952 catalogue to interested persons.

Designated Catalogue No. 12, this new 140-page publication lists transmitting equipment, converters, tubes, amateur gear, test equipment, television accessories, books, service manuals, etc. It also carries a listing of reconditioned equipment available from the company.

The catalogue is indexed by both manufacturer and product to facilitate reference. Copies of this publication are available without charge.

HIGH-MU POWER TRIODE

Lewis and Kaufman, Inc., Los Gatos, California now has available a technical data sheet describing its Type 100TH high-mu power triode.

The tube is illustrated and described with dimensions, operating curves, and electrical characteristics. Typical operation and maximum ratings are given for the tube in service as a class AB audio frequency power amplifier and a class C power amplifier and oscillator.

SURVEY OF LUMINESCENCE THEORIES

The possibility of better television tubes and fluorescent lamps is suggested in a survey by Navy researchers on the theories of luminescence which is now available in booklet form from the Office of Technical Services of the U.S. Department of Commerce, Washington 25, D. C.

The report provides a fairly extensive theoretical background based on existing theories as they apply to individual systems of luminescence. These theories reveal how luminescence problems have been treated generally. (Continued on page 136)

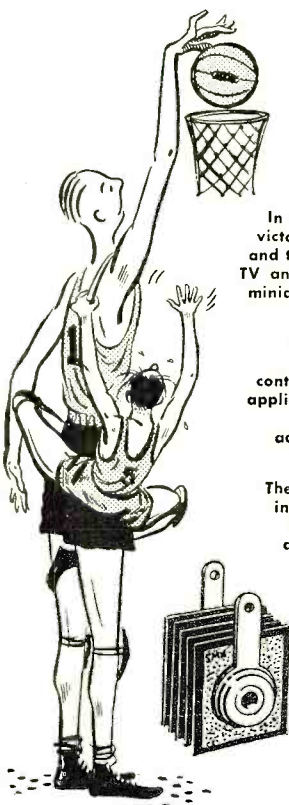

High score every time with "Safe Centers!"

In Basketball there's no better assurance of victory than a lengthy lead jumping center... and there is nothing that scores higher in radio, TV and other electronic circuits than SELETRON miniature rectifiers with "Safe Center" plates.

When you specify SELETRON Selenium Rectifiers you eliminate arc-over danger, short circuits and heating at the center contact point. Assembly pressure, or pressure applied in mounting the rectifier cannot affect its performance — a SELETRON feature accomplished by deactivating the area of the plate under the contact washer.

The millions of SELETRON Selenium Rectifiers in satisfactory service as original equipment in the products of leading manufacturers are millions of reasons why you can specify SELETRON and be safe!

Look for Howard W. Sam's Red Book Supplement listing SELETRON replacements... and write for Bulletin No. 104-N-1



SELETRON DIVISION
RADIO RECEPTOR COMPANY, INC.
Since 1922 in Radio and Electronics
Factory: 84 North 9th St., Brooklyn 11, N. Y. • Sales Department: 351 West 19th St., New York 11, N. Y.

March, 1952

more TV set outlets per dollar!

with easy-to-install
Blonder-Tongue

ALL-CHANNEL MASTER ANTENNA SYSTEMS



Distribution Amplifier
8 TV Set Outlets
Model #DA8-1-M List Price \$87.50

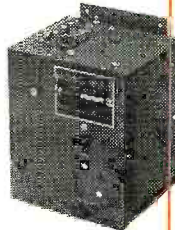

Distribution Amplifier
2 TV Set Outlets
Model #DA2-1-M List Price \$39.50



Commercial Antensifier (30 Times Gain) Use As Pre-Amplifier, Line Amplifier or de-luxe Booster
Model #CA-1-M List Price \$77.50

More Gain Per Dollar!

B-T Home Antensifier Model HA-2-M
Finest All-Channel TV Booster. Fully Automatic, 16 Times Gain. In Metal Cabinet
List Price \$57.50

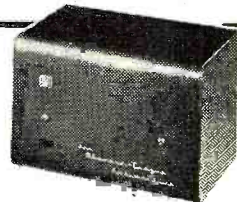

Literature on Request write Dept. E3

Blonder-Tongue Labs., Inc. Mt. Vernon, N. Y.

SAVE

THAT GOOD LOOKING OLD CONSOLE—
REPLACE YOUR OBSOLETE RADIO
with a modern, easily installed

ESPEY AM/FM CHASSIS

and your favorite console is "right-up-to-date"

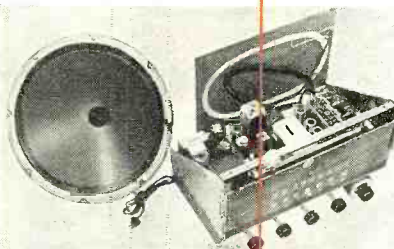

Rated an excellent instrument by America's foremost electronic engineers. Fully licensed under RCA and Hazeltine patents. The photo shows the Espey Model 511-C, supplied ready to play. Equipped with tubes, antenna, speaker, and all necessary hardware for mounting.

NEW FEATURES—Improved Frequency modulation circuit, drift compensated • 12 tubes plus rectifier, and pre-amplifier pick-up tubes • 4 dual purpose tubes • High quality AM-FM reception • Push-pull beam power audio output 10 watts • Switch for easy changing to crystal or variable reluctance pick-ups • Multi-tap audio output transformer supplying 4—8—500 ohms.

Makers of fine radios since 1928.

Write Dept. RN-3 for literature and complete specifications on Model 511-C and others.

ESPEY
MANUFACTURING COMPANY, INC.
528 EAST 72nd STREET, NEW YORK 21, N. Y.
TEL. TRafalgar 9-7000

NOW!

The Sensational New WEATHERS One-Gram Capacitance Pick-Up (Cartridge Form)

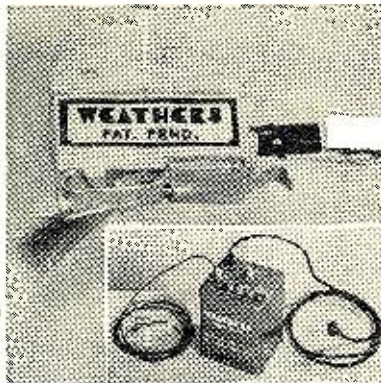

AT LONG LAST! — REALISM without noise
20 TO 20,000 CYCLES

Adjudged Sen-
sation at No-
vember New
York Audio
Show.

Will Improve and Replace Any Modern Phonograph Pickup

- ✓ One gram stylus pressure with ideal tone arm
- ✓ Two grams pressure on modern Webster changers
- ✓ Very low pressures with other players, including RCA 45 changer
- ✓ Will operate properly with most good quality tone arms

Constant Amplitude Response, 20 to 20,000 cps.
1 volt into 1/2 megohm at 1000 cps.
AES Response Equalization from separate out-
put connection, for LP records.

Replaceable 1-mil sapphire stylus (choice of
1-mil or 3-mil sapphire stylus on request).
Records last thousands of plays. One sapphire
plays thousands of records.

WEATHERS CARTRIDGE
AT A NEW LOW PRICE

WEATHERS power supply, complete with power
cord, for 117 volts, 60 cps.net **\$14.50**

Complete with ultra-flexible
cable, oscillator unit, tube,
installation hardware and
instructions.net

\$37.50

Oscillator requires 6.3 volts ac at 0.3 amp, and 250
volts dc at 2ma. Available from most amplifiers.

Check or Money Order. No. C.O.D.'s Please
Shipments postpaid in U.S.

WEATHERS INDUSTRIES
510 RICHEY AVE., W. COLLINGSWOOD 6, N. J.

Attractive
Low Cost
Easily Installed

**LOWELL
INTERCOM
LOUVRES**



For Multiple Apartment, Homes, Hospitals

Here's a low-cost intercom louvre, complete with pushbutton, that will satisfy the most exacting customer, yet keep your installation time and costs down to a minimum!

The Lowell Model C3 is a flush-mounting louvre stamped from 16-gauge steel equipped with pushbutton, and finished in white. Dimensions: 7" x 4 1/2".

The Lowell Model CB3X is a heavy steel box with 3/4" knockouts, used with the C3 louvre for protection of the speaker. All hardware furnished, for mounting plate to box. Dimensions: 4" wide x 6" high x 2" deep. Finished in Zinc Chromate.

LOWELL MANUFACTURING CO.

Mfrs. of Lowell Speaker Baffles—"Heard Everywhere"
3030 Laclede Station Road Maplewood 17, Missouri
Canadian Representative:
ATLAS RADIO CORPORATION LIMITED
560 King Street W., Toronto, Ontario

LEARN CODE NOW!!!

BE A RADIOMAN . . . Code ability recognized by all Service Branches. Here is an Electronic Code Trainer complete with Army Key-Tube-Phone-Variable Note. Simply plug in A.C. or D.C. and use. Instructions and simplified code training course included. Factory Guaranteed . . . Complete as advertised. Nothing else to buy. We pay postage. Send Check. Money Order. **\$5.95**
For Group Training, Deluxe model with 5" Speaker, \$7.75.
Additional Keys, for either unit, each \$1.00.



GREENWICH SALES CO. 57 CORTLANDT ST. NEW YORK 7, N. Y.

IF YOU BUY ON SPECIFICATIONS



and tops in value, you'll buy the

TWIN-TRAX* TAPE RECORDER
"Choice of Engineers Everywhere"

Compare the guaranteed specifications of a Twin-Trax Tape Recorder with any other recorder in any price class. You'll find that Twin-Trax gives you more features, better all-around performance and more value for your money. Complete specifications, performance ratings and direct factory prices in our catalog 5109. Send for it today.

*Trademark Reg.

AMPLIFIER CORP. of AMERICA

398 Broadway, New York 13, N. Y.

erally and may be used as a guide in understanding the processes involved.

Major subjects covered include activators, electron traps, efficiency of luminescent materials, etc.

Orders for report PB 102 597 must be accompanied by check or money order for \$1.00, made payable to the Treasurer of the United States.

SHOCK TESTING

Haines Designed Products Corporation, 117 North Findlay Street, Dayton 3, Ohio has available copies of its 4-page technical bulletin, "Instrument Shock Testing Theory and Measurement" which it will distribute to interested persons.

The booklet describes in detail the use of the company's shock testing mechanism (conforming to JAN-S-44 specification). Calculations, operation, and instrumentation are fully covered.

REPLACEMENT CONDENSERS

Cornell-Dubilier Electric Corporation, South Plainfield, New Jersey has just released its 28-page catalogue covering service replacement condensers.

Known as Catalogue 200C, the new publication lists several new C-D condenser types, extends the regular listings to include additional popular sizes and values, and carries data on the company's complete line of electrolytic photoflash units and commercial mica transmitting and replacement transmitting condensers.

Indexing and listings have been simplified, making for quicker and easier identification of the products.

Copies of this catalogue are available from C-D jobbers or from the Jobber Division of the company at South Plainfield. Specify Catalogue 200C.

CABINET DATA

G. & H. Wood Products Company, 75 North 11th Street, Brooklyn 11, New York now has available for distribution a folder covering its "Cabinart" line of cabinets for radio and television.

Twelve individual sheets are included in the folder which provide complete data on a wide variety of cabinet units. Speaker housings, radio-phonograph cabinets, television cabinets, and combination units are included.

Copies of this folder and data sheets on the company's corner folded horn enclosures (both assembled and in kit form) are available from the company.

ASTRON CATALOGUE

Astron Corporation, 255 Grant Avenue, East Newark, New Jersey has issued a new catalogue which gives performance data and test characteristics on its line of condensers and r.f. interference filters.

Designated Catalogue AC-3, the new publication lists and illustrates a comprehensive line of dry electrolytics, along with all applicable engineering data. The "Metalite" section covers, in addition to pertinent data, the history of the use of metallized paper in

condensers, advantages, and engineering performance data, curves, and test procedures.

A request on organization letterhead will bring a copy of Catalogue AC-3.

RADIO-RECORDER SLIDES

Grant Pulley & Hardware Company, 31-85 Whitestone Parkway, Flushing, N. Y. is currently offering a new, four-page circular describing the uses, application, and installation of the company's "radio-recorder slides."

These slides enable the radio, recorder, or phonograph unit of a console to slide in or out of its cabinet. The booklet describes the two different models that are currently available—one for underneath mounting and one for side mounting.

JOHNSON CATALOGUE

E. F. Johnson Company, Waseca, Minnesota has announced the availability of its new "General Products Catalogue #972."

Products listed for the first time include the company's "Viking 1" transmitter, the "Viking" v.f.o., the Faraday shield for the company's plug-in links, #229-201 rotary inductor, #126-105 crystal socket, and the company's new knob and dial line.

NEEDLE GUIDE

M. A. Miller Manufacturing Company, 1169 East 43rd Street, Chicago 15, Illinois has issued a revised needle replacement cross reference guide which has been brought up-to-date as of December 1951.

The guide clearly presents the catalogue numbers of all cartridges and correlated needles. Included are the company's catalogue numbers and also catalogue numbers of other leading needle manufacturers.

The material is presented in tabular form to facilitate the use of the catalogue by dealers, service technicians, and jobbers.

MOTOR GENERATORS

A copy of Bulletin 440 describing the company's complete line of 400 cycle motor generator sets is now available without charge from Bogue Electric Manufacturing Company, 52 Iowa Avenue, Paterson 3, N. J.

These motor generator sets, which have been designed for use in laboratories, factories, in industrial operations for testing electronic equipment, and operating high frequency motors and radar equipment, are comprehensively discussed in this new publication.

Requests for copies should be addressed to L. G. Sands, general sales manager of the company. —30—

ANSWERS TO QUIZ

(See page 128)

1 C	4 G	8 F
2 I	5 E	9 D
3 A	6 H	10 B
	7 J	

FREE GIFT

4 in 1 SCREW DRIVER

(Four different drivers in one holder)

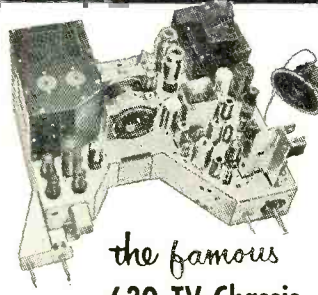

the famous 630 TV Chassis World's Finest TV RECEIVER

The New and Improved Super Famous "630" T.V. Chassis, is a 30 tube high quality television receiver (including 3 rectifiers) manufactured under license by the Radio Corporation of America. This chassis is the standard by which all other T.V. chassis are measured. Standard R.M.A. Guarantee! FREE replacement on all defective tubes and parts.

FEATURES:

- Full channel coverage.
- Discriminator-type FM sound system.
- Improved picture brilliance.
- AFC horizontal hold.
- Keyed AGC.
- Stabilized vertical hold.
- 3 stage sync. separator and clipper.
- Automatic brightness control.
- 1 Mc band width.
- Highest quality parts used.
- All standard tubes.
- For all Cathode Ray tube sizes and types. 16", 17", 19", 20", 21" Tubes. Perfect for Fringe Area Reception.—Will work where most sets fail to operate.
- With HiGain standard coil tuner and R.C.A. Hi-Fi 12" Speaker, complete with knobs and hardware. Complete with Fed. Taxes Paid.

Less Cathode Ray Tube... **\$141.50**
630 DX Chassis—Extra power for fringe areas. Can be operated without booster or complicated antenna. Complete with Fed. Taxes Paid. Less Cathode Ray Tube... **\$151.50**
Available with DuMont Input Tuner FM Radio, less Cathode Ray Tube... **\$148.50**
Chassis Mounting Brackets when ordered with chassis... **\$4.95**

BRAND NEW STANDARD BRAND TUBES— Individually Boxed and Guaranteed

02A59	6BN6	1.32	7J7	1.19
1A389	6CQ6	1.44	7K7	1.19
1A689	6C476	7L7	1.19
1A798	6C579	7N799
1B3	1.02	6C685	7Q789
1E5/25S	1.09	6CB686	7T7	1.19
1H589	6CD6	2.49	7Y486
1J674	6D6	1.09	7Z484
1L3	1.39	6D8	1.24	12A679
1LA4	1.12	6F688	12A886
1LA6	1.12	6F8	1.49	12A1586
1LC5	1.12	6H676	12AT665
1LC6	1.12	6J569	12AT7	1.09
1LD5	1.12	6J6	1.09	12AU689
1LW5	1.12	6L781	12A796
1N587	6K666	12AV679
1R582	6K771	12AV7	1.21
1S579	6L5	1.39	12AX799
1T483	6L6A	1.69	12BA679
1U479	6L7	1.19	12BE679
1U578	6N7	1.19	12H689
1V269	6Q788	12H779
1X2A96	6S476	12Q779
2A4G84	6SA776	12SA777
2A584	6SF799	12S1778
3A489	6SG799	12SK777
3C489	6SH789	12SL7	1.09
3O5	1.02	6SJ776	12SN7	1.09
3S188	6SK779	12SQ768
3V499	6SL7	1.19	14A7	1.03
5L465	6SN789	14B6	1.03
5V4	1.10	6SR786	14B8	1.03
5W483	6SQ772	14N7	1.07
5Y347	6T8	1.19	6T8	1.02
5Y475	6V6	1.69	6V6	1.09
5Z389	6V6GT86	19T8	1.31
5Z4	1.12	6W466	25A6	1.09
6A3	1.59	6W689	25B06	1.49
6A7	1.39	6X474	25L685
6A7C	1.21	6X574	25W488
6AF6	1.18	6Y696	25Z674
6AG586	7A489	32L7	1.49
6AG7	1.59	7A599	35L686
6AH6	1.49	7A686	35W488
6AK5	1.49	7A786	35Y486
6AL568	7AD7	1.92	35Z557
6AQ572	7AF789	47	1.34
6AR567	7AG7	1.05	50A596
6AS599	7B5	1.05	50B586
6AS7	5.39	7B689	50C586
6AT688	7B899	50L672
6AU5	1.59	7C479	50Y699
6AU676	7C589	56L766
6AV667	7C699	70L7	1.69
6EA669	7E599	7779
6EA7	1.16	7E699	8079
6EC586	7E799	11Z2378
6E692	7F798	2051	1.22
6E6G	1.76	7H798	117N7	1.79
6E8686	7G7	1.21			

TV CONSOLE CABINETS

Designed and built by master cabinet makers. Genuine Mahogany wood with hand-rubbed piano finish. All panels 1/2". Supplied complete with tube mounts, speaker grille and back. (Masks extra, see below for prices). Dimensions—23" wide x 39 1/2" high x 23" deep.



- No. 1 Cabinet—For 630 chassis with all holes drilled on front panel for controls and 17" or 20" tube opening. (Specify size wanted.)
- No. 2 Cabinet—Blank front panel to accommodate any make TV chassis. Tube openings for 17" or 20". (Specify size wanted.) Special Price **\$47.95**
- 17" LUCITE MASK \$5.95
- 20" LUCITE MASK 6.95

TERMS: 20% cash with order, balance C.O.D. Prices F.O.B. N. Y. City warehouse. Min. order \$5 (allow for postage). Prices in this ad supersede all others published.

TV PICTURE TUBES

ONE YEAR UNCONDITIONAL GUARANTEE.
All black faced-non glare—SHELDON, THOMAS, and other famous makes.

10BP4	\$22.95	17BP4	\$25.90
12LP4	22.95	17HP4	27.90
14BP4	23.95	19AP4	35.90
16HP4	31.95	19EP4	35.90
16KP4	28.95	19DP4	55.00
16GP4	31.95	20CP4	35.95
16LP4	31.95	24AP4	69.90

free

CATALOG

UP-TO-THE-MINUTE selection of merchandise including TV antennas, cabinets, parts, hardware and accessories.

STEVE-EL ELECTRONICS CORP. VISIT OUR NEW STORE

Dept. N-3 61 Reade St., New York 7, N. Y. COntlandt 7-0086

CATALOGUE SPECIALS

NOVICE CW TRANSMITTER

Here's a neat and compact surplus item which converts very simply to 3700-3750 KC crystal controlled Condition? Guaranteed suitable. Instructions? Yes, we furnish them! Complete, comprehensive, step-by-step, nothing left to the operator. Is BC-458, the command transmitter which has been such a favorite with old-timers. By the time this ad appears, the BC-457, described in our QST, will be all gone, so we worked out the conversion on BC-458. Don't wait until these are all gone! ONLY...\$7.95

APN-1 WOBBULATOR

(See Dec. Radio & TV News)
Now you can build the "VERSATOR" SWEET FREQUENCY GENERATOR!! We've managed to acquire only 100 of the APN-1 magnetic units. So HURRY! With reprint of the article.....\$6.95

BROADCAST BAND & AERO

MN-26-C Remote Controlled navigational direction finder and communications receiver. Manual DF in any one of three freq. bands, 150 to 1500 KC. 24 V. Self contained dynamotor supply. Complete installation including receiver, control box, loop, azimuth control, Left-Right Indicator, plugs, loop transmission line, and flex. shafts. **\$69.50**
BRAND NEW, ORIG. PACK.....
MN-26-C alone, New.....\$39.50

MN-20-E BENDIX LOOP

Here is a dandy! Use as a remote-controlled loop with MC-124 flexible shaft, or mount a lightweight beam on the loop and use the slip-rings to feed it. Inside gears are 1:1 ratio. Originally used with MN-26 or RA-10-DB. BRAND NEW and CLEAN. Special, ONLY...\$6.95
MC-124 flexshaft, with slip rings, closed to your specs.....\$30c ft.
MN 52 crank drive with azimuth scale, for above loop, 15:1 ratio.....\$2.50

MARINE RADIOMEN

Send now for our latest Marine Catalogue describing and pricing the complete installation of transmitters, receivers, and Direction Finders.

4 USES—4 DOLLARS

The most versatile dynamotor in surplus! The best dynamotor for conversion to 6 v. Multiple windings! After conversion you get choice of 190 or 350 v at 50 MA or 250 v at 100 MA. No brushes to shift around, no mechanical work. Or use it as a 2:1 or 1:2 step-up or step-down transformer for DC voltage! Changes 6 to 12, or 12 to 24, or vice versa, up to 3 A. Or use it as a GENERATOR. Turn with motor, get 12 v DC at 12.6 A or 24 v DC at 6.3 A, plus high voltage. Includes easily removed 1500 ohm scale. Reel-wound oil gear reduction unit. Complete dope sheet furnished. BRAND NEW.....\$4.00

PRECISION CALIBRATED TUNER

Build a Q-meter or an audio oscillator, a signal generator, a VFO, an ultra-stable reference, or name it! Lab-standard accuracy and resetability. 3 gang condenser assembly with 4 precision dial etched 1.5-12 mc in 3 bands. Triangular scale. Triangular plastic hairline indicator. 50:1 ratio drive assembly, all gears spring-loaded double-section. Has tuning lock. Plates for 100-150 mc. New design and one double-spaced 260 turn section. Use double spaced section to eliminate drift. All are ceramic insulated. Neat and compact. Uncle paid a lot of money for this baby! New. Plans to talk switch. New shipment. Was the VFO tuner for Collins TCS xmt. We furnish free schematic complete TCS-12 with this. \$4.95 ONLY.....

NEW CARBON MIKE

A little gem! Same impedance as T-17, but hold in the palm of your hand. Nice flexible cord with standard 3-circuit plug. Plans to talk switch. New shipment. BRAND NEW.....\$2.79

COMMAND EQUIPMENT

With free dope sheets and schematics

BC-455, 6-9 mc. NEW \$12.95. GOOD USED...\$7.95
TRANSmitters
T-19/ARC-5, 3-4 mc. Excellent...\$17.95
BC-457 or **T-20/ARC-5**, 4-5.3 mc. Like new...12.95
BC-458 or **T-21/ARC-5**, 5-3-7 mc. Excellent used...7.95
T-23/ARC-5, VHF, 100-150 mc. Excellent used...24.95
Good used, less tubes.....9.95
MOD BC-456, Brand new \$5.95. Excellent used...2.49
As is for parts.....1.29
274N PLUG, 7-prong male plug to fit back of command revrs. and xmters. This is the same plug as used in the racks. NEW, each 2c, five for \$1.00
Local Control Adapter Parts for 274N or ARC-5 revr. Exact pot, switch, knobs, etched plate, and instruction data. Ready to mount.....\$1.29
SPLINE TUNING KNOB......79c

9 TO 13 VOLT TRANSFORMER OR LINE VOLTAGE BOOSTER

Tapped transformer. Input 115 v 60 cy, 9 to 13 volts out in 1 volt steps at 3 amps. Our free schematic shows lots of uses. NEW.....\$1.89

HI-FI DYNAMIC HEADSET!

A lucky purchase from Uncle! This is the DYNAMIC set, using waterproof fiber cones, which gives absolutely best music reproduction, flat from almost nothing to beyond 10,000 CPS. Permoflux net price new is \$49.95 per set! These have large chamolite cushion ear muffs, and headband pad snaps off and on with do fasteners for cleaning. Mis-matching impedance 1:2 makes no difference with these babies. Bass notes come out like a 15" speaker. Don't miss these! 400 ohms impedance. Checked out.....\$4.95

FREE! NEW CATALOGUE!

Interesting, Descriptive. Nothing but Bargains! Send for It Now!

AUDIO SUPER-SPECIALS

SUPER HI-Q high cut choke, 0.65 H, 55 ohms DC. Tune with .001-.0004 MF. ONLY......98c
LOW CUT, 3 H, 284 ohms. Tune with 1 MF. Or use as 50 ma filter choke. ONLY......98c
OUNGER Transformers, one for mike to push-pull grids, flat 30 to 15,000 CPS; other for push-pull output, tapped sec., turns 1:1. In unit with resistors, condensers, etc. BOTH FOR ONLY.....\$2.29
PHASE SPLITTER, or low-level mixer, or hybrid, or push-pull unit. Has 3 windings, each exactly 1:1 to any other; essentially flat 100-15,000 CPS......69c
BRAND NEW ONLY.....\$4.69
ONE OF EACH OF ABOVE, ALL FOR.....

G.L. ELECTRONICS

905 S. Vermont Ave., Los Angeles 6, Calif.
All Prices F.O.B. Los Angeles. Calif. Buyers Add Sales Tax

R. F. Amplifier

(Continued from page 55)

The three self-contained power supplies furnish all operating voltages, plus regulated power for the exciter. The high voltage power supply uses a single 5R4GY, the high vacuum type being preferred over mercury vapor rectifiers to prevent the radiation of "hash." The filter choke and plate meter are connected in the "B-minus" lead to reduce the shock hazard. A double-pole, double-throw antenna relay is installed under the chassis to switch the antenna to the receiver coax and open the high voltage transformer center tap when S_1 is thrown. The output condenser, C_{21} , on the high voltage power supply should have a capacity of at least 8 μ d., not because of hum, but to assure low output impedance to supply the peak currents to the class B r.f. amplifier. The high voltage should measure 750 volts.

The low voltage supply delivers 300 volts to the 6AG7 and the 807 screens. It is important that this voltage be within five per-cent of this value. The transformer used in this unit had a rather low a.c. voltage output, so a 5Z4 rectifier was used. This tube has a very low internal voltage drop. Most small transformers of the type suitable for T_1 deliver about 350 volts a.c. each side of center tap, so the d.c. output would probably exceed 300 volts. If this is the case, a 5Y3 rectifier could be substituted to reduce the d.c. output. S_1 opens the center tap of the low voltage supply on standby. An additional switch, S_2 , closes only the low voltage supply center tap through a resistor, leaving the high voltage off. This gives a low voltage to the exciter for spotting the exciter signal in the receiver, while the voltage is too low to harm the screens of the final ampli-

Under chassis view. The selenium rectifier disc is mounted under the chassis with the antenna-power supply switching relay. An unpainted chassis is recommended.

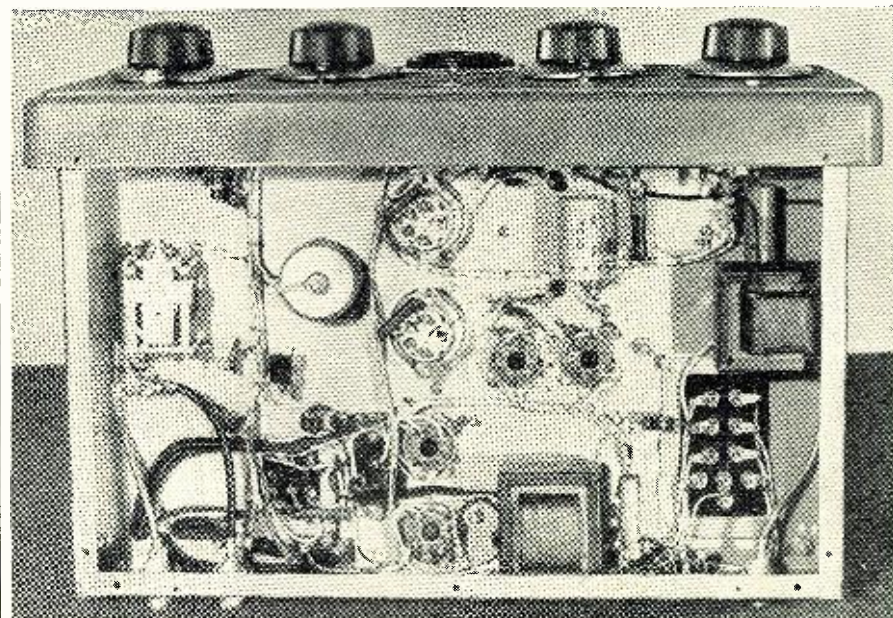

fier. Two VR105 tubes are used to stabilize the exciter "B" supply voltage.

The bias supply is turned on by the line switch, S_3 , and remains on at all times. This supply uses a half-wave selenium rectifier so the bias appears almost instantly when the transmitter is turned on. T_2 should have a secondary voltage of between 50 and 110 volts. Because of the half-wave rectifier, it is possible to vary the bias over a wide range merely by adjusting the load resistor, R_5 . Transformers of this type are rather scarce, but a filament transformer operated backwards from the filament supply will make a satisfactory substitute. The value of R_5 is adjusted to provide a bias voltage of approximately 30 volts on the 807's. The best way to adjust this resistor is to set its value at the point where the total plate current with no excitation is 60 ma. to the two final tubes. The plate voltage should be 750 or near this value, and the screens should be set at 300 volts. A variable slider type resistor may be used for R_5 in determining this resistance, after which a fixed resistor of the proper value may be permanently wired in. About 500 ohms is the maximum value of resistance which should be used to avoid poor regulation of the bias voltage.

Tuning the transmitter is quite simple. One precaution—don't try to operate the 6AG7 as a doubler. The harmonic output of a class A stage is practically nil and if you are getting excitation to the final from the driver as a doubler you have too much excitation to the 6AG7. Of course you cannot double an AM signal. For c.w. and FM, the transmitter is tuned in the usual manner, adjusting the swinging link to load the final to about 200 ma. or 150 watts input. After the rig is tuned up it is good practice to reduce the r.f. gain control until the output just begins to drop off. This will in-

what's wrong

with this picture?

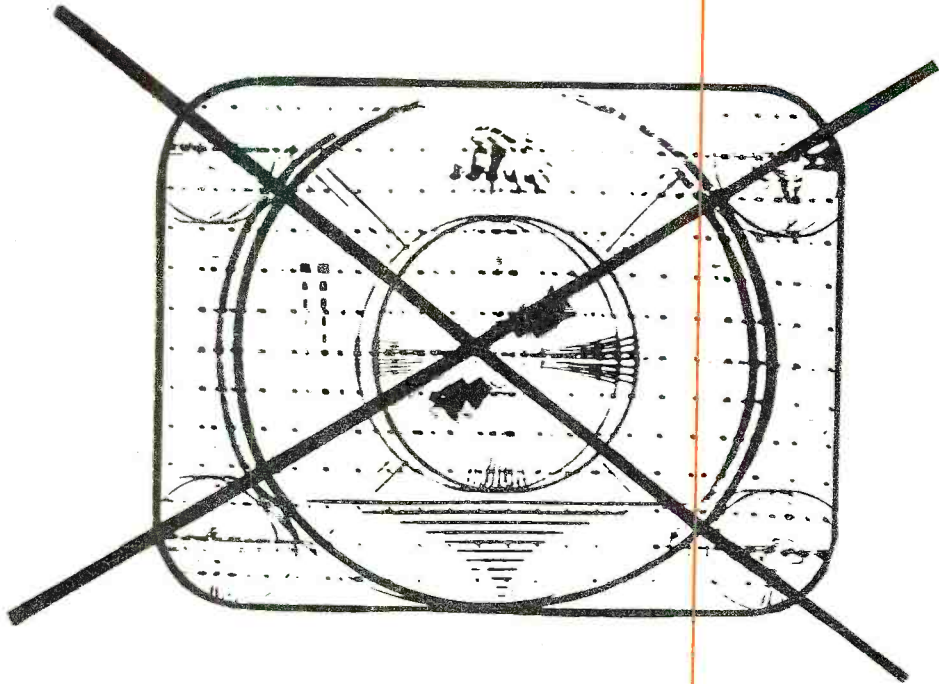

subscribe
today
use the order card
facing this page

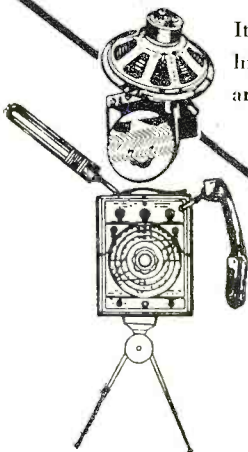

It's your lowest-cost invitation to highest-caliber electronics guidance: in Radio, Television, Servicing, Research, Amateur, Radar.

**RADIO &
TELEVISION
NEWS**



Television service can be speeded up by correct diagnosis of test patterns. **HOW TO INTERPRET WHAT YOU SEE** reveals how one leading manufacturer has obtained good results from this type of circuit analysis. Actual photographs illustrate effects of circuit faults on picture quality.

plus—in the big April Issue:

14 other important articles, including:

A SINGLE-SIDEBAND TRANSMITTER ADAPTER which can be used as a companion unit to the "Low-Cost Exciter Unit," and the "150-Watt Universal R. F. Amplifier" as discussed on page 53 of this March issue.

CRYSTAL DIODES IN MODERN ELECTRONICS. A continuation of the series on crystal diodes. This article deals with their use for sync stripping in television receiver circuits.

SERVICING NOISE-REJECTION CIRCUITS. Down-to-earth, "how to fix it" instructions covering one important television receiver servicing problem.

A HIGH QUALITY AUDITORIUM AMPLIFIER. Construction data on a p.a. unit which features two mike inputs, a radio input, and a master mixer.

A MOBILE 75 METER V.F.O. For the ham who operates mobile. This article gives complete construction details on a compact unit which covers the 75 meter band.

Publishers also of: RADIO-ELECTRONIC ENGINEERING Edition of RADIO & TELEVISION NEWS • PHOTOGRAPHY PHOTOGRAPHY ANNUAL • FLYING • MODERN BRIDE • FICTION GROUP • ZIFF-DAVIS COMICS

March, 1952

139

get the best in Hi-Fi

get a BROOK

...at

ALLIED



BROOK 12A3 AMPLIFIER AND PREAMP

10-watt amplifier. Low mu triodes in all stages. Response: ± 0.5 db, 20-20,000 cps; hum, 75 db below 10 watts. Brook transient peak circuit permits high output (over 10 watts) without increase in distortion. Distortion at full output: 1.21% total harmonic, 2.56% intermodulation. Controls: Bass (26 db boost) and treble; input selector switch; gain. Pre-amplifier, controls and inputs housed in separate remote consolette. Inputs: 1 tuner or TV; 2 magnetic phono. Outputs: 1.5 to 24 ohms tapped, with separate 500-ohm winding. With 9 tubes and 5U4G rect.; 6-ft. cable. For 110-125 volts, 50-60 cycles AC. Drain, 110 watts. Size: amplifier, 17 x 6 $\frac{3}{4}$ x 8 $\frac{1}{8}$ "; preamp., 12 $\frac{3}{4}$ x 6 $\frac{1}{2}$ x 3 $\frac{3}{4}$ " Wt., 28 lbs. **97-866. Brook Model 12A3 complete. Net. . . \$198.00**
Easy terms: \$29.70 down, \$14.88 mo. for 12 mos.



BROOK 10C3 AMPLIFIER AND PREAMP

30-watt, ALL-TRIODE amplifier. Main unit consists of amplifier with power supply; remote control consolette contains pre-amplifier with controls, inputs and power switch. Response overall: within 0.5 db, 20-20,000 cps at all levels. Distortion at 30 watts: 1.30% total harmonic; 1.69% intermodulation. Hum level 75 db below full output. Controls: Separate bass (26 db boost) and treble; input selector; gain. Inputs: 2 for tuners, 2 with equalized preamp for magnetic cartridges, 1 high-gain for mike. Outputs: Tapped from 1.5 to 30 ohms with separate 500-ohm winding. With 13 tubes and 5U4G rectifier; 6-ft. cable. Amplifier, 17 x 8 $\frac{1}{2}$ x 8"; preamp., 13 x 6 $\frac{1}{2}$ x 4". For 110-125 v., 50-60 cycles AC. Drain, 125 watts. Shpg. wt., 50 lbs. **97-865. Brook Model 10C3 complete. Net. . . \$315.00**
Easy terms: \$47.25 down, \$23.66 mo. for 12 mos.

FREE 212-PAGE CATALOG

Send for Radio's leading Buying Guide featuring world's largest stocks of high-fidelity components, plus everything in Radio, TV and Industrial Electronics.

ALLIED RADIO

ALLIED RADIO CORP., Dept. 1-CB-2
833 W. Jackson Blvd., Chicago 7, Illinois

- Send FREE 212-Page ALLIED Catalog
- Ship the following Brook equipment:

\$ _____ enclosed (Full Payment).
 Down Payment enclosed

Name _____

Address _____

City _____ Zone _____ State _____

sure low harmonic output. To adjust the transmitter to amplify AM, excitation without modulation is first applied and the transmitter adjusted for maximum output with plate current of not over 240 ma. The r.f. gain control is then reduced until the plate current drops to 120 ma. and the adjustment is complete. Modulation of the input signal with speech should cause the r.f. output to increase approximately 25 per-cent as indicated by a pilot bulb coupled to the antenna tuner. Power input when amplifying AM is limited to about 90 watts. To amplify single-sideband, the transmitter is first tuned up with carrier input only to an input of 180 watts. The carrier injection is then reduced to completely balance out so that the resting plate current of the 807's is 60 ma. The single-sideband signal is then set at the proper level with the r.f. gain control so that voice peaks will give peak currents of 240 ma.

The universal amplifier has been very satisfactory in operation on 80, 40, and 20 meters with the "A Low Cost Exciter Unit" described in the February, 1952 issue of RADIO & TELEVISION NEWS. On ten meters, the TVI-proofed FM exciter described in February, 1951 "CQ" has been used with excellent results. The SSSC adapter, for use on 20 and 75 meters, is inserted between the exciter and the universal amplifier. This unit will be described in a forthcoming article. -30-

EXTENSION TEST LEADS

By H. LEEPER

WHILE certain loosely coiled test leads are on the market, for a real compact set of leads try a short length of coiled cable, obtainable from some representative of Western Electric Company.

The coiled cable shown in the photograph is only 7 inches in length and was purchased at a camera shop, which sells the cord for flash guns.

With proper terminals and test prods attached, such twin conductor cable may be pulled out as much as 30 inches and it will then return to original form keeping leads from under foot as ordinary leads usually are found. -30-

Coiled cords make handy service test leads.

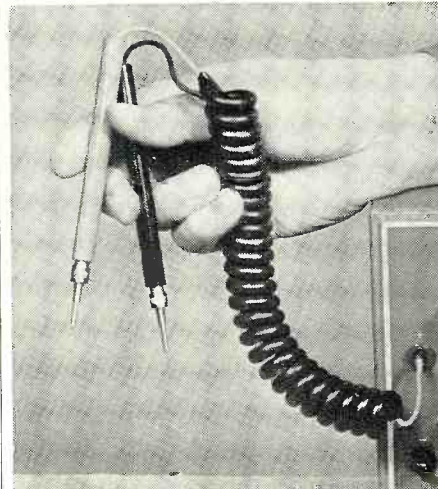

RADIO Surplus Buys

CRYSTALS



... in FT 241-A Holders— $\frac{1}{2}$ " Pin SPC. Marked in 54th OR 72nd Harmonic MC Freq. Listed below by fundamental frequency with fractions omitted.
500 KC Crystals only. **\$1.95**
Limited Quantity...ea.

372	411	487	400	462
374	412	488	440	463
375	413	490	442	464
377	414	491	444	466
379	416	492	446	468
381	418	493	448	470
383	420	494	450	472
384	422	495	451	474
385	423	496	452	475
386	424	497	453	476
388	425	498	455	477
390	427	503	456	479
391	429	504	457	480
392	431	507	459	501
394	433	509	461	505
396	435	511		
398	437	512		
401	438	514		
403	441	514		
405	483	523		
407	484			
409	485			

49c ea. or 10 for \$4.50 99c ea. or 10 for \$9.00

TUNER FROM NAVY "BN" EQUIPMENT

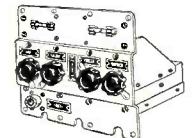

Simply modified into 2-meter converter for car or communications receiver. Uses 1-6J6, 1-6SH7, 1-9006, 1-6J5 (Not Furnished). Slug is tuned from 157 to 187 Megacycles. Includes schematic diagram for "BN" equipment.
Now—A New LOW Price... **\$4.95**

SENSITIVE ALTIMETERS



Pioneer, Kollsman, and Bendix Sensitive Altimeters. Range 0-35,000 ft., calibrated in 100's of feet. Barometric setting adjustment. No hook-up required. . . mounts easily in auto or aircraft. **\$12.95**
Used, Good..... Each Postpaid

ALTIMETER, AIRCRAFT



U. S. Navy surplus Altimeters, range 0-10,000 feet. Adjusts to sea level setting of terrain. Simply installed, requires no hook-up . . . for auto or aircraft installation. **\$7.95**
BRAND NEW..... Each Postpaid

POWER TRANSFORMER

Primary 125 volts tapped at 105 and 115 volts, 50 to 425 cycles. Secondaries: 5.1 v. at 3.0 amps, 325-0-325 v. at 0.175 amp., 5.4 v. at 3 amp., 6.4 v. at 10.3 amp., 2.5 v. at 3.0 amp., 4500 v. at .005 amp., 2.5 v. and 4500 volt windings insulated for 6000 volts. All other windings insulated for 1500 volts. Cost government more than \$42.00—a real bargain **\$4.95**

ALL EQUIPMENT F.O.B. PASADENA UNLESS OTHERWISE SPECIFIED. PLEASE ENCLOSE FULL AMOUNT WITH ORDER

C & H SALES CO.

BOX 356-.MT, East Pasadena Station, Pasadena 8, Calif.

Another Outstanding Jobber
THE LUKKO SALES CORP.
5024 IRVING PARK RD, CHICAGO 41, ILL.
has all 17 KITS & INSTRUMENTS in stock!
EICO
425K 5" SCORE KIT \$44.95 See EICO ad on Page 171

CODE SENDING RECEIVING SPEED
HIGH SPEED WITHOUT NERVOUS TENSION
REVEALING BOOK shows how "crack" operators develop high speed and proficiency. Learn code for Amateur or Commercial Radiotelegraph License, or improve your sending and receiving
with the Candler System which develops radio-telegram experts and code champions.
CANDLER SYSTEM CO. **FREE BOOK!**
Box 928, Dept. 2-C, Denver, Colo.

RADIO & TELEVISION NEWS

International Short-Wave
(Continued from page 110)

Gold Coast—Although some sources report Accra using 15.43, in a recent QSL the station said is using *only* 6.049, 4.915; 6.049 is scheduled 0528-0700 and 4.915 at 1013-1330 (Saturday 1043-1330). (Ridgeway, South Africa) Pearce, England, reports the 4.915 channel now closing 1300; has Gold Coast news 1245. According to a station announcement, Gold Coast Time now is the same as GMT (5 hours ahead of EST), Pearce reports; formerly was GMT plus 30 minutes.

Greece—A new Armed Forces Station at Khios has been heard in Sweden on 6.590 at 1400-1700. "The Voice of Greece," Athens, now broadcasts to North America 2000-2100 on 7.300, with news 2035-2045A. Programs in Russian are transmitted on 15.345 at 0915-0930; these additional programs are radiated on 7.300—1030-1300 Greek; 1300-1400 Balkan languages; 1430-1445 English; 1445-1500 French, and 1530-1700 Greek. (Radio Sweden)

Greenland—Radio Sweden says Gronlands Radio, Godthaab, has replaced 5.942 with 7.094 according to verification card recently received; programs are daily 1630-1845.

Guatemala—TGDA, 7.471, Quetzaltenango, noted with announcement by man as "Radio La Voz de Occidente;" signed off 2203; is audible almost every evening after 1900 but is difficult to find due to QRM. (Machwart, Mich.) TGTA, 6.335, noted with musical program 2130-2200. (Sutton, Ohio) TGWA, 9.758, noted ending English programs Mon., Wed., Fri. at 1930. (Niblack, Ind.) TGLA, 6.295, Guatemala City, heard 1950-2035; all-Spanish. (Patterson, Ga.) TGNA, 11.85, is fine level in Mass. in English 2200-2230. (Van Gilder) Still noted on 9.668 (parallel 11.85) on Wednesdays with Mail Bag in English 2230-2300A. (Hoffman, N. Y.)

Haiti—4V2S, 5.950, Port-au-Prince, heard 1900-2000 with fair level but some QRM. (URDXC) Leary, Ind., reports 4VRW, Port-au-Prince, now on 9.965A at 1800. Also is noted mornings; is a "wanderer."

4VPL, Radio Petionville, is still using 8.995; is heard by 1600 and probably still signs off 2200; weak with much QRM. (Stark, Texas) 4VWA, 6.300, Cap-Haitien, noted recently 1800-2100 sign-off; 4VCN, 6.406, Radio Fides, Port-au-Prince, noted at fine level 1830-2100 sign-off. (Saylor, Va.)

Holland—Latest Hilversum schedules for English broadcasts are 0530-0610 to Australia, New Zealand, Pacific Area, 21.48, 17.775, 15.22, 6.025; 1100-1140 to South Asia, 11.73, 9.59, 6.025; 1500-1540 to Africa, Great Britain, Ireland, Continental Europe, 11.73, 9.59, 6.025; 2130-2310 to United States, Canada, 9.59, 6.025. The "Happy Station Programs," produced and presented by Eddie Startz, are Sundays (only) at 0530-0700 to Far East Pacific Area,

March, 1952

For Direct Drive Circuits... New STANCOR

TELEVISION REPLACEMENT COMPONENTS

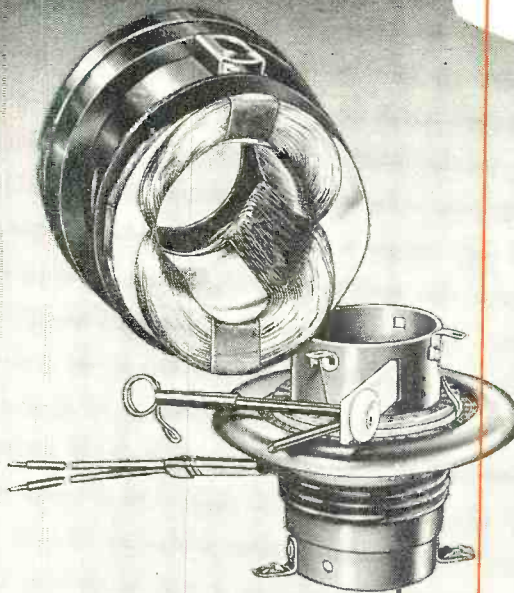

DY-10
ANTI-ASTIGMATIC DEFLECTION YOKE
A high efficiency yoke with cosine distributed windings, ferrite core and nylon bobbins. Replacement in 34 RCA TV models, 30 Emerson models and 7 Capehart models.
A-8131 AIR CORE "FLYBACK"
Companion unit to DY-10 in direct drive circuits and used in same models. See Stancor Bulletin No. 389 for a complete list of these 71 models.

A-8140 VERTICAL OUTPUT TRANSFORMER
Has primary:secondary ratio of 44:1. Replaces RCA No. 74950 in 35 TV models, Emerson No. 738034 in 30 models and Capehart No. 650238A-1 in 7 models. These models are listed in Stancor Bulletin No. 390. Ask your distributor for a free copy.

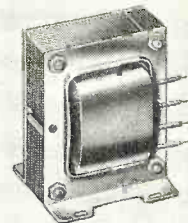

Stancor transformers are listed in Howard Sams' Photofacts Folders

STANDARD TRANSFORMER CORPORATION

3584 ELSTON AVENUE • CHICAGO 18, ILLINOIS

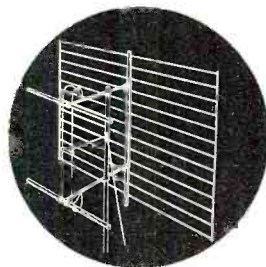

"Positively Amazing Performance!"

is what they are all saying about the new ALL-CHANNEL

GONSET "RADARRAY"

"Model C"

High gain and front-to-back ratio on all 12 channels. No side lobes. Ideally suited where maximum gain is required on several channels, or where ghosts, co-channel or adjacent channel interference problems exist in combination. Eliminates or greatly reduces oscillator interference troubles.

Ruggedly constructed yet light enough to be used on a rotor. Another engineering achievement by the originators of prefabricated open-wire line for T.V. Write for our "Fringe Area" brochure.

available at most dealers

GONSET CO. 801 S. MAIN ST BURBANK, CALIF.

PRECISE EXCLUSIVE

deluxe VTVM with 7 1/2" meter

for Horizontal or Vertical
construction

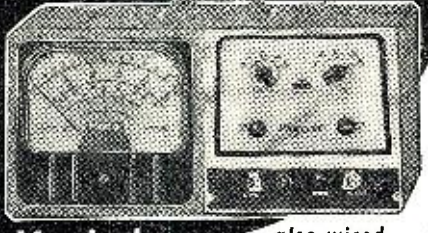

also wired

Only PRECISE makes this deluxe VTVM KIT! Includes famous PRECISE Reflex Circuit for increased stability and greater accuracy. Build it horizontally or vertically to fit your own bench requirements.

Etched panel; 1% ceramic resistors; amphenol connectors; separate 5 V. AC scale; Tubes: 6AL5, 6X5, 6SN7; true zero adjust; huge 7 1/2" meter for more accurate readings; 3-color rapid construction book explains each step. Complete with btry. & test lead.

Ranges: DC: 0-5-25-250-500-1000 V.
DC: 0-5-25-250-500-1000 V.
AC: 0-5-25-250-500-1000 V.
Ohms: Rx1, Rx10, Rx1,000, Rx10,000, Rx1,000,000 ohms.
DB: From -20 to +55 DB.

PRECISE Kit Model 907-K **\$3898***
Factory Wired, Model 907 **\$57.98***

Lowest Price for this LARGE METER!

PRECISE High Voltage Probe has no equal! No other probe offers so much: every feature . . . PRECISE exclusives . . . makes it the most practical, foolproof and sturdy High Voltage Probe in the industry today. Multiple insulation; Mechanically shockproof construction; Interchangeable tips; Swivel lead connection; Interchangeable resistors; Triple flash guards; Sturdy non-porous shell.

PRECISE Model 999 (Wired only) **\$698***
Complete

New **PRECISE Vacuum Tube Voltmeter**. By comparison your best value. All the unusual advantages of the PRECISE Model 907 (above) with 4 1/2" meter. Complete with btry. & test lead.

PRECISE Kit Model 909-K **\$2598***
Factory Wired, Model 909 . . . \$44.98*

Newest R.F. Probe! Lowest Price! Greatest Value! Time-tested circuit; Special non-porous case; Uses germanium crystal rectifier up thru 250 mcs.; Probe handle terminated in an amphenol connector—other end of shielded cable available in either amphenol, phone plug or phone tip type fitting at no added cost. Individually instrument tested.

PRECISE Model 912 (Wired only) **\$425***

All instruments carry the PRECISE Guarantee: components protected by RMA Warranty . . . Write for FREE catalog N-6!
BE SURE TO SEE THE COMPLETE PRECISE LINE AT YOUR JOBBER NOW!
*Prices slightly higher in the West

PRECISE PRECISE DEVELOPMENT CORP.
An Engineered Product Oceanside, L. I., New York

It COUNTS and CARRIES your TUBES

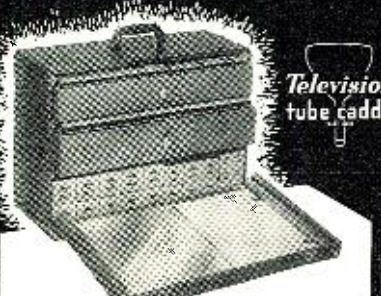

Television tube caddy

Specially designed for the television serviceman. Make work easier and quicker—and YOU more efficient. You take INVENTORY AT A GLANCE—and always have the right tube with you. Thin, easy-to-carry leatherette cabinet, 20 1/2"x14"x9" deep. Holds up to 249 tubes, or less with space for TOOLS and METER. Clips in cover for price list or mirror. Ask your parts jobber how it can PAY FOR ITSELF in 3 WEEKS, or write

\$13.50 Mel To Dealer—Higher on West Coast

Also TV Cabinets, Wall Baffles

ARGOS PRODUCTS CO.

310 MAIN STREET • GENOA, ILLINOIS

LEARN CODE

TWO DOTS MAKE LETTER 'I'

No matter how difficult it has been for you to learn code before, I guarantee that you will memorize the Morse International Code in two hours or return method within 5 days and I will refund your money. Get in on the fun of "easy license" civilian radio. Send one dollar for complete method. **NOTHING ELSE TO BUY!**

OTTO LUTHER, NEW PRESTON, CONN.

New Low Prices On WELLER SOLDERING GUN

Now you can have instant heat at the moment you pull the trigger. No waiting. No wasted time or current. And look at these new low prices!

MODEL	WATTS	CYCLES	VOLTS	NET PRICE	TYP. OF TIP
WS-100	single heat 100	60	115	\$8.77	STURDITIP No. 7135 Package of 2—25c
WD-135	dual heat 100 135	60	115	\$10.73	
WS-200	single heat 200	60	115	\$9.76	RIGIDTIP No. 7250 Package of 2—35c
WD-250	dual heat 200/250	60	115	\$11.71	

10% CASH WITH ORDERS

ALMO RADIO CO.

509 ARCH ST. & 6205 MARKET ST.
Philadelphia, Pa.
6th & ORANGE STS. • Wilmington, Del.
4401 VENTNOR AVE. • Atlantic City, N. J.
1133 HADDON AVE. • Camden, N. J.

Europe, 21.48, 17.775, 15.22, 6.025; 1100-1230 to Near and Middle East, Europe, 11.73, 9.59, 6.025; 1630-1800 to South and Central America, 11.73, 9.59, 6.025, and 2130-2300 to North America, 9.59, 6.025.

Honduras—HRP1, 6.351, San Pedro Sula, noted with good level when tuned 2245; announcements in *English* with North American recordings; at 2256 had closing announcements and asked for reports; strong signal in North Carolina. (Ferguson) La Ceiba, 6.235A, signs off 2200. (Stark, Texas) HRXW, 8.982A, Camayagua, noted 1730-1800. (Foerster, Ill.) HRA, 5.925, Tegucigalpa, heard 2000-2245 with music and speech; all-Spanish. (URDXC)

Hong Kong—ZBW3, 9.525, noted 0500 in language by man; heavy QRM. (Winch, Calif.) Heard in South Africa 0900 relaying Radio Newsreel from the BBC, London; closes 1030 with weather report and "God Save the King." (Ridgeway)

Hungary—Radio Budapest noted 1615 in *English* on 6.247A and 7.222A. (Leary, Ind.) Other channel in use is 9.833A which usually has bad QRM from Cuban now on that spot.

Iceland—TFJ, 12.174, noted a recent Sunday signing off 1124. (Catch, England) Is now scheduled (Sundays only) at 1115-1130A. Formerly ran 1115-1145. (Oskey, N. J.)

India—AIR is now sending out a QSL card showing the Parliament Building. (Machwart, Mich.) The 1030 news noted on 4.940; 3.495 carries native at that time; noted closing on 4.940 at 1330; and signing on in *English* for Europe 1400 (runs to 1515 now) on 5.990, 7.190, 7.170. Heard on 9.72 with Indonesian music at 1745 tune-in; closed 1800 after announcements in *English*. (Pearce, England) AIR noted on 7.21 at 0345-0415; at 0334-0345 played interval song repeatedly. (Stein, Calif.) Heard on 7.18A around 0730 with woman announcer in *English*, fairly strong signal in New York State. (Chatfield) Leary, Ind., reports AIR on 15.160 at 1630 with good level.

The 0730 news on *measured* 15.380. (Ferguson, N. C.) And heard here in West Virginia parallel on 17.740.

New channels for AIR's External Services include 3.250, 5.960, 7.125, 9.530. (*WRH Bulletin*) AIR, 21.70, has news 0300, is high level in South Africa. (Ridgeway)

Indo-China (Vietnam)—"La Voix du Vietnam" noted near 7.090 from 1800 when has news in French; in oriental language 1830. (Pearce, England) This one noted 0645 at good level. (Ferguson, N. C.) Saylor, Va., reports *Radio Dalat* 0130-0145 sign-off, good level on occasion.

Iran—Radio Tabriz is again noted on 6.090A with *English* lesson weekdays 1215-1230. (*WRH Bulletin*) Heard in New York 2340 in native. (Bellington)

Iraq—Radio Baghdad, 11.724, noted 2300 signing on, S7 with preamplification in use; man chanting; good to 2330. (Oskey, N. J.)

Israel—"Voice of Israel," Israeli

Broadcasting Service, Box 1082, Jerusalem, Israel, now has an attractive verification card. (ISWC, London) Tel-Aviv, 9.010A, noted in *English* 1630-1715 sign-off. (Hoffman, N. Y., others) Has news 1430 now on both 9.010A, 6.833. (Pearce, England)

Italian Somaliland—Mogadishu, 7.383, is broadcasting daily 1115-1300 and is heard in South Africa; Arabic 1115-1200 when goes into Italian after set of two-toned chimes; chimes strike 7 o'clock local time; plays recordings 1200-1225 when woman gives news in Italian; continues with recordings to closedown 1300 after station call; identifies in Italian 1115, 1200, 1225, 1300 sign-off; sometimes has QRN but usually is in clear. (Ridgeway)

Italy—Rome has been noted afternoons in Italian on 7.10A; strong signal when has no CWQRN; no *English* noted. (Chatfield, N. Y., others) Heard with *English* 1400-1430 on 11.810. (Sutton, Ohio) Rome noted with *English* for South Africa on 11.81, 9.63 at 1505, off 1530 in *English*; heard on 11.91 with *English* for Far East 0515-0615, another day noted signing on to Far East at 0545 on 11.91, 15.400, 17.80, had news 0600. (Pearce, England)

Jamaica—Radio *Jamaica*, 4.950, signs on around 0630 with march; a program of popular recordings follows. (Newcomb, Mo.) The 3.360 outlet is good evenings; runs to 2300A. (Leary, Ind.)

Japan—At the time this was compiled, *Radio Tokyo* had not yet resumed its Overseas Services although press dispatches from Tokyo indicated resumption was to have been effected not later than late December. According to *Radio Australia*, plans call for two 50 kw. transmitters for the Overseas Services; tentative schedules call for 0000-0100 to North America in the 49- and 31-m. bands; 0600-0700 to North China and 0700-0800 to Central China on two channels in the 49-m. band; 0900-1000 to Philippines and Indonesia in the 31- and 25-m. bands; 1040-1140 to India in the 25- and 31-m. bands.

JBD3, 15.225, and JBD4, 15.235, noted in parallel with "NHK" programs around 2330-2345. (Ridgeway, South Africa) JKI, 4.910, noted 0530 with "NHK" identification; JKJ, 7.285, heard 0355 with operatic recordings and announcing "NHK" at 0359. (Winch, Calif.)

Kashmir—Radio *Kashmir*, Srinagar, which recently changed frequencies, now can be heard 2130-2330, 0630-1200 on 3.335 and 0100-0230 on 6.110, according to a *WRH Bulletin*.

Kenya—Nairobi, 4.855, now appears to close at 1500; ends session with "God Save the King" after time pips; formerly ran to only 1400 except on Wed., Sat. (Pearce, England)

Korea (South)—HLKA, 7.933A, noted recently 0700-0730 with weak signal, in native. (Stein, Calif.)

Lebanon—Beirut, 8.035A, is audible with recorded music 1455-1515; has bad CWQRN. (Sutton, Ohio)

Liberia—ELBC, 6.025, Monrovia, still

March, 1952

NEW Automatic Radio CUSTOM-BUILT AUTO RADIOS

RECORD SMASHING VALUES!

SPECIAL

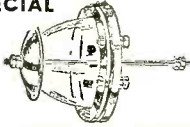

Navy entering type insulator. Porcelain flanged bowl with brass rod and fittings and aluminum shield. Dimensions: 4 3/8" high, 4 1/2" 16" O.D. at base. NEW with Spare Bowl... \$4.50

1949-1950-1951
CUSTOM-BUILT AUTO RADIOS

LIST PRICE—\$59.95

Ford, Chevrolet, Plymouth, Dodge, Henry J, Hudson, Studebaker. Each radio is a six tube superheterodyne six volt battery operation—three gang tuning condenser and tuned RF stage PM speaker Ahico No. 5, wt. 10 lbs.—easy installation.

ATTRACTIVE DISCOUNTS TO DEALERS

TUBES Prices Slashed

2C34	\$.08	6AL5	..	.66
2X2/879	..	6AQ5	..	.77
3C24	1.95	6AR5	..	.79
7C4/1203A	..	6AT6	..	.59
10Y	..	6AU6	..	.99
151R	..	6AV6	..	.69
30 SPEC	..	6AV6	..	.75
39/44	..	6BA6	..	.69
45 SPEC	..	6BE6	..	.73
WE 303A	8.80	6BE6	..	.99
316A	..	6B6GT	1.29	.99
W1531	4.95	6B6GT	..	.63
713A	1.00	6B7	..	1.29
801A	..	6C7	..	.85
803	4.45	6L7	..	.98
824	..	6ND7GT	..	.90
931A	..	6SN7GT	..	.79
804	..	6U5G	..	.95
CK1005	..	6V6	..	.98
CK1007	1.20	6W4GT	..	.66
1626	..	6X4	..	.75
1629	..	6X5GT	..	.70
2051	1.15	7C8	..	.90
7193	..	7Z1	..	.85
8011	1.70	12AU6	..	.59
9006	..	12AT6	..	.75
C58	9.75	12AV6	..	.73
CK72	..	12BA6	..	.88
CK70	4.25	12BE6	..	.89
CK72	1.30	12SN7	..	.85
CK72	..	12SQ7	..	.75
HY-615	..	23Z5	..	.95
RK1R-72	1.30	33	..	.90
RK1R-73	..	35W4	..	.59
RK1R-74	..	50B5	..	.96
1167	..	60C5	..	.89
1167	..	50L6GT	..	.99
5U4G	..	75	..	1.15
5W4	..	85	..	.85

MICROWAVE EQUIPMENT

- 10CM Echo Box Frequency Range 2890Mc-3170Mc. Direct Reading Micrometer Head Ring Prediction Scale Plus 9% to Minus 3% Type "N" Input. Resonance Indicator Meter with Accessories and Spares—Brand New.
- 50 Radar, 10CM Rotating Antenna 24" Parabola in Turret 360° Span—Brand New So-3 Bearing Control.

PRICES UPON REQUEST
All Sizes of Crystal Electrodes.

CAPACITORS

TRANSMITTING MICA

.003 MFD	2500 WVDC	.50
.0004 MFD	2500 WVDC	.40
.0005 MFD	2500 WVDC	.35
.0010 MFD	2500 WVDC	.35
.003 MFD	2500 WVDC	.35
.00075 MFD	2500 WVDC	.95
.00075 MFD	3000 WVDC	1.30
.003 MFD	3000 WVDC	1.50
.0003 MFD	5000 WVDC	2.65
.0002 MFD	5000 WVDC	2.85
.001 MFD	5000 WVDC	3.25
.001 MFD	6000 WVDC	3.75
.002 MFD	6000 WVDC	5.95

UPRIGHT MOUNT

25 MFD	600 VDC	.EA.	TEN
2X.1 MFD	600 VDC	.45	.40
1 MFD	600 VDC	.45	.40
1 MFD	600 VDC	.50	.45

BATH TUBS

4 MFD	50 VDC	.45	.45
1 MFD	100 VDC	.55	.50
3X.1 MFD	600 VDC	.45	.40
2 MFD	400 VDC	.40	.35
.25 MFD	600 VDC	.40	.40
.5 MFD	600 VDC	.40	.40
2X1 MFD	600 VDC	.40	.35
.05 MFD	1000 VDC	.65	.65
2X.1 MFD	1000 VDC	.65	.60
1 MFD	1000 VDC	.65	.60

OIL-FILLED AND GE PYRANOL

1 MFD	600 VDC	.85	.80
2 MFD	600 VDC	.95	.95
4 MFD	600 VDC	1.40	1.40
5 MFD	600 VDC	1.65	1.60
1.8 MFD	600 VDC	2.50	2.35
2 MFD	1000 VDC	1.65	1.60
.5 MFD	2000 VDC	2.00	1.90
1 MFD	3000 VDC	2.85	2.80
1 MFD	7500 VDC	7.50	7.00
1 MFD	7500 VDC	12.50	12.00
1 MFD	12000 VDC	14.95	14.90
.0008MFD	15000 VDC	12.50	11.75
.045 MFD	16000 VDC	12.95	12.50

PAPER

8-S MFD	600 VDC	2.25	2.15
3X8 MFD	600 VDC	2.55	2.40
8-S-4 MFD	650 VDC	2.45	2.25

ELECTROLYTIC

2500 MFD	3 VDC	.40	.40
500 MFD	12 VDC	.90	.85
25 MFD	25 VDC	.40	.35
40 MFD	25 VDC	.60	.55
50 MFD	50 VDC	.60	.55
1000 MFD	25 VDC	1.25	1.15
150 MFD	50 VDC	.50	.45
160-160MFD	150 VDC	1.50	1.25

LINEAR POTENTIOMETERS WW

Ohms	Watts	Ea.	Ten
500	2	\$.45	\$.40
1000	2
3000	2	\$.55	.50
10,000	2
5000	3
7500 Dual	3
10,000	3
25,000	3
50,000	4
15	25
20	25
25	25
50	25
100	25
200	25
500	25
1000	25
3000	25
15,000	25
20,000	25
150/Switch	50 AN 3155-50	2.15	2.00
200/W Switch	50	2.15	2.00
800	50	2.65	2.50
15,000	50	2.95	2.75
60	60	2.95	2.75
15	75	2.95	2.75

TIME DELAY SWITCHES

- 1 Minute 115 VAC 60 C. Enc. in Waterproof Metal Case. New \$5.25
- 3 Micro Switches Make Contact at 40-114 Sec. Time Delay 110 VAC Motor. New 4.50
- Thermin Switch 50° to 3100° F. 115 VAC @ 6A. 230 VAC @ 5A Breaks Contact with Increase of Temperature. Time Delay 110 VAC AD-lake. New 7.50

SPECIALS

- 80.86KC Crystal with Holder. \$2.50
- CD-501A Cord for BC-654 to CN-652 1.95
- Balloon with Hydrogen Gen. 2.50
- 300-Pt. Aerial Wire. 2.00
- Box Kit 17-17-33 2.25
- 33-440 MMF Variable Condenser 1.10
- 7-100 MMF Variable Condenser .95
- 24-750 MMF Tapered Rotor Plates 1.25

TOGGLE-ROTARY SWITCHES

Pole	Position	Sec. tion	Shaft	Price
1	3		15/16"	\$0.35
1	4		5/8"	.50
1	3		7/8"	.60
2	4		1"	.60
2	8		2 1/2"	.55
2	8		30A 9KVA	Flash Over

*Ceramic
DPST 3A 250 Volt W/Hard. ware. 1 Throw DPDT Center "OFF" 1 Throw Momentary 20A 125VAC. 1.15 3PDT 10A-250 VAC. 1.25 DPST 5A 250VAC. 1.30 DPST C-H AN3023-2.95

TERMS: Minimum order \$5.00—Mail orders promptly filled—All prices F.O.B. Boston, Mass. Send M.O. or check. Shipping charges sent C.O.D. 25% deposit required with all C.O.D. orders.

Prices Subject to Change without Notice
SEND FOR OUR CATALOGUE
Inquiries from Dealers, Schools and Industrial Firms Invited

COMET ELECTRONIC SALES CO.

22 Washington St. • Beacon 2-7863 • Brighton 35, Mass.

MAKE THIS YOUR HOME FOR IMPORTANT WORK UNDER IDEAL CONDITIONS!

- TEST & INSPECTION ENGINEERS
- ELECTRONIC ENGINEERS
- TV RECEIVER DESIGN ENGINEERS

- FIELD ENGINEERS
- LAB. TECHNICIANS
- BENDIX ENGINEERS

NEEDED TO WORK ON: Radar, G. C. A., Mobile Radio, Auto Radio, Airborne Communication & Navigation Equipment, Television, Antennas, Microwave Equipment, Servo Mechanisms and Guided Missiles.

YOU BENEFIT FROM: high wages, a modern, air-conditioned plant, paid vacations and holidays, group insurance and a good chance for advancement. Housing immediately available in the beautiful suburban and country areas that surround the Bendix Radio plant.

Write, Phone or Wire Mr. E. O. COLE, Dept. O

Bendix Radio

DIVISION OF BENDIX AVIATION CORPORATION
BALTIMORE 4, MARYLAND

NOW! BECOME EXPERT AT RADIO- TELEVISION IN 4 EASY STEPS!

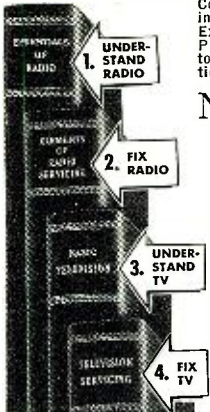

Complete Self-Training Course in RADIO and TV by Famous Experts — Takes You BY SIMPLE STEPS From Basic Theory to Problems of Repair, Installation, Color TV, etc.

NOW you can do ANY Radio-TV installation, service, or repair job like an expert; operate field-testing equipment; understand problems of TV, FM-AM transmission, etc. Step into a good-paying job—or start your own service business. Train yourself AT HOME . . . IN SPARE TIME . . . with the McGraw-Hill Basic Course in Radio and TV.

2296 Pages—
1611 Illustrations

The men who wrote this complete 4-volume course are among the outstanding radio and TV instructors in America today. Every detail is clearly explained in over TWO THOUSAND PAGES of step-by-step instruction and over SIXTEEN HUNDRED "how-to-do-it" illustrations, cross-section diagrams, etc. The review questions and answers "nail down" everything you learn. At-a-glance "trouble-shooting" charts show how to diagnose instantly any radio or TV breakdown . . . and how to repair it expertly and quickly. The course will pay for itself many times over. It can qualify a beginner for FCC's 1st-Class License test; gives an experienced technician more confidence and skill.

SEND NO MONEY

Mail coupon below to examine complete four-volume course FREE for 10 days. No obligation. Or you may examine individual books FREE for 10 days by checking the proper boxes in coupon.

PARTIAL CONTENTS ESSENTIALS OF RADIO.

800 pages, 433 illus. Circuit Analysis • Vacuum Tubes • Circuits: Detector • Amplifier • Tube Oscillator • Power Supply • Transmitting, Receiving • Etc.
ELEMENTS OF RADIO SERVICING. 475 pages, 375 illus. Multimeters • AC Power Supply • Speakers • Antennas • Auto Radios • Push-Pull Output Stage
BASIC TELEVISION. 592 pages, 415 illus. Scanning • Synchronizing • Video Signal • Brightness Control • DC Reinsertion • Picture • FM Alignment • Picture Tubes • VHF and UHF transmission • Reception
TELEVISION SERVICING. 429 pages, 388 illus. Antennas • Transmission Lines • Test-pattern and Picture Analysis • Localizing Reception Troubles • Interference Remedies • Deflection Circuits . . . AND MUCH MORE!

FREE 10-DAY TRIAL COUPON

McGraw-Hill Book Co., Inc., Dept. RTN-3-52
327 West 41st St., New York 18, N. Y.

Send me for 10 day free examination the Basic Course in Radio and TV, 4 Vols. (Regular retail price is \$26.00; Special Course Price only \$21.95 in easy installments.) If not satisfied with Course, I will return it, pay nothing. Otherwise, I'll send \$1.95 plus delivery then and only \$4.00 in monthly installments.

If you wish to examine any of these books individually, check below the ones you wish us to send you for 10 Days' FREE EXAMINATION:

- | | |
|--|--|
| <input type="checkbox"/> Essentials of Radio, \$6.75 | <input type="checkbox"/> Elements of Radio Servicing, \$5.25 |
| <input type="checkbox"/> Basic Television, \$7.50 | <input type="checkbox"/> Television Servicing, \$6.50 |

For any book I keep, I'll send \$2.00 plus delivery in 10 days, balance in easy monthly installments.

Name
Address
City Zone State
Position
RTN-3-52

Company

WE PAY FOR DELIVERY if you send first payment of \$1.95 when ordering Course or full price when ordering individual books (prices above). Same return privilege.

noted to 1845 sign-off. (Saylor, Va.) Usually has bad QRM; some days is buried completely.

Madagascar—Radio Tananarive, 9.515, noted from around 1100 to after 1230; uses French. (Pearce, England) **GDX-aren**, Sweden, says this one signs off 1430.

Mauritius—Forest Side, 15.100A, now has its "morning" session 2200-2315. (Ridgeway, South Africa, via Radio Australia)

Mexico—XEQQ, 9.68, noted in South Africa from 2230-0000; at 2300 gives call preceded by 4 chimes. (Ridgeway)

Monaco—Radio Monte Carlo, 6.035, 9.785, noted on Fridays around 1745 with "Back to the Bible" program in *English*. (Pearce, England) This feature ends around 1800 and station usually signs off (Fridays) 1803. (Boice, Conn., others)

Mozambique—Lourenco Marques, 9.720A, is widely reported afternoons in *English* to 1600A sign-off, good signal in most areas of USA. (Dalton, W. Va.; Stark, Texas; Bellington, N. Y., others) Heard with Portuguese programs from 0000 on 9.850A. (Sutton, Ohio; Niblack, Ind., others) Catch, England, says CR7BV has again moved to 4.830 where is noted with chimes and call 1215 after giving African news in Portuguese; fair level; CR7BG, 15.283, noted 1220 in parallel with CR7BV with all-Portuguese program; popular recordings (mainly *English*) until after 1330. Bellington, N. Y., reports Lourenco Marques heard recently on 15.27 from 1310 tune-in to 1500 when closed with "A Portuguesa;" all-Portuguese session. Pearce, England, says Lourenco Marques is heard on 15.275A at 1200 with news in Portuguese, chimes; call at 1210; he also notes Lourenco Marques on 4.925A at 1245.

New Caledonia—Radio Noumea, 6.034A, is coming through at nice level around 0330-0530A sign-off. (Saylor, Va.)

New Zealand—ZL2, 9.54, and ZL3, 11.78, noted 0250. (Pearce, England) ZL4, 15.280, heard 2135 recently with cricket results; signal still good 2205. (Ferguson, N. C.)

Nicaragua—YNZZ, 6.464, Managua, Radio Mundial, noted 2112-2146 with moderate QRM from COCY, 6.450, Havana, Cuba; all-Spanish; YNHB, 6.550, Managua, Radio Panamericana, heard 2208-2245. (Patterson, Ga.) YNVP, 6.760, Managua, heard 1900-2245 with music and speech in Spanish. (URDXC) A station on measured 7.8489 has been identified as Managua; may be YNSO, listed 7.860; noted 1946. (Oskay, N. J.)

Nigeria—Radio Nigeria, 7.255, Lagos, noted with interval tune around 2329 prior to 2330 sign-on. (Bellington, N. Y.)

Northern Rhodesia—ZQP, Lusaka, transmits on Sundays a "morning" program on 9.710 at 0300; announcements are in *English* with native recordings and BBC-transcribed programs; has South African news 0500 followed by talk in *English*; closes 0545 after playing "God Save the King;" broadcasts

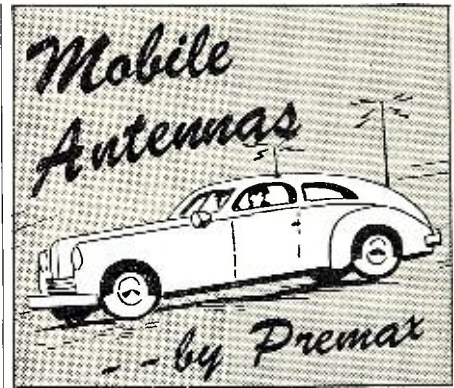

From 2 to 75 Meters

Tested and proven Antennas for the 1¼, 2, 6, 10, 11, up to 75-meter mobile installations—designed to increase the signal strength and yet offer low-cost equipment for amateurs and Civil Defense Corps.

Send for special Bulletin and prices.

PREMAX PRODUCTS
DIVISION CHISHOLM-RYDER CO., INC.

5205 Highland Ave., Niagara Falls, N. Y.

Brooks LIFE-SIZE Edition

#630 TV KIT BUILDER - SET OF INSTRUCTIONS

Instructions by WALTER H. BUCHSBAUM
Layouts and Artwork by GEORGE MILLER
Practical Applications . by IGNAZIO MERCANTE
Compiled and Edited . . by MORRIS BROOKS

Everything at a glance on 4—GIANT
25" x 38" Charts

INDISPENSABLE—for building, converting, modernizing or even trouble shooting any #630 TV RECEIVER.

Popular priced \$2.49 Plus postage,
at only first class . . .36c
air mail . . .72c

BROOKS, 84 Vesey St., N. Y. 7, N. Y.

Unlimited Opportunities in RADIO ENGINEERING

DEGREE IN 27 MONTHS

Complete Radio Engineering course, including Telev., U.H.F. and F.M. Bachelor of Science Degree, also in Mech., Civil, Elect., Chem., and Aero. Eng.; Bus. Adm. Acct. Extensive campus modern buildings, well equipped labs. Low cost. Prep courses. Personalized, practical instruction. Founded 1884. Placement service. Growing shortage of engineers. Prepare now for unlimited opportunities ahead. Enter September, January, March, June. Write for catalog.



TRI-STATE COLLEGE

1632 College Ave. ANGOLA, INDIANA

RADIO & TELEVISION NEWS

daily on 7.220 and 3.914 at 0900-1230. (Ridgeway, South Africa, via Radio Australia)

Norway—Oslo, 11.735, noted signing off 2100 in Norwegian and English. (Stein, Calif.)

Pakistan—Radio Pakistan, 6.234, is heard at high level in South Africa 1130 in foreign language; closes 1200 after identification. The 1210-1230 news at dictation speed is now noted on 9.478A. (Ridgeway, South Africa) Noted 1015 with news on 11.675. (Sutton, Ohio) And in parallel then on 4.805. (Pearce, England)

Panama—HOLA, 9.505, Colon, heard with English request program 2118-2136. (Machwart, Mich.) HP5B, 6.030, Panama City, heard opening 0615 with announcement in Spanish that is relaying HOX. Radio Mirimar, P.O. Box No. 124. (Ferguson, N. C.)

Paraguay—Radio Nacional de Paraguay, 6.270, Asuncion, goes off the air just after 2200; has local clock striking 11 p.m., then identifies as ZP1 and ZPA1. (Stark, Texas) ZPA3, 11.850, noted 1900-1945. (Sutton, Ohio)

Peru—OAX1A, 6.155, Radio Delcar, Chiclayo, noted to 2330 sign-off. (Stark, Texas) OAX4Z, 5.887, Lima, Radio Nacional del Peru, heard 1915-1930; all-Spanish; QRM. (Patterson, Ga.) OAX4W, 9.4045V, Lima, noted 2205 with weak signal; had news in Spanish. (Oskay, N. J.) OAX4Z, Radio El Sol, listed 15.105, is heard 2300-0100 some days but appears to be on approximately 15.112. (Ridgeway, South Africa)

Philippines—When this was compiled, WEH Bulletin reported that the short-wave transmitter of "The Voice of Davao," Davao City, Mindanao, DXH2, 7.280, was off the air, and that the station was broadcasting only on m.w. 900 kc. with call DXMC.

The Far East Broadcasting Co., Manila, now uses 3.320, 6.030, 9.730, 11.855, and 15.300 with English weekdays 0000-0100, 0300-0515, 0700-0900, 1830-2030, Sundays 0030-0530, 0630-1100, 1800-2330. (Radio Sweden)

Poland—Warsaw noted on 6.115 at 2314 with interval signal, music, then start of English session. (Machwart, Mich.) Current schedule for English broadcasts to North America is 1700, 1730, 2315, and 0030 on 6.115. Asks for reports and comments to Polskie Radio, English Language Transmissions to North America, Aleja Stalina 21, Warsaw, Poland.

Portugal—Leary, Ind., reports Lisbon on 15.125 to 0945 sign-off. Noted by Niblack, Ind., to 1530 closedown on 11.996A, usually excellent volume.

Lisbon noted on 15.130 signing off 1130 with "A Portuguesa" after clock chimes; heard another day signing on with "A Portuguesa" 0915; noted 1700 on 11.96A and leaving the air 1800 with "A Portuguesa." parallel with 9.740; noted on 11.99 at 1445 with a broadcast in Portuguese for Angola-Mozambique and signing off on that channel with "A Portuguesa" at 1530, in parallel with 9.740. (Pearce, England)

Radio Free Europe, 6.095, heard with

Sam's Surplus Sells For Less

COMMAND AND/OR ARCS TRANSMITTERS and RECEIVERS

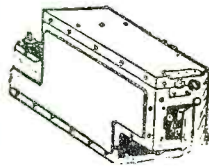

- 3-6 MC Receiver. Used \$ 6.95 New 17.95
- 6-9.1 Receiver. Used \$ 6.95 New 12.95
- Triple Receiver Rack \$1.95
- V.H.F. ARC5 Transmitter or Receiver, Complete w/tubes Used \$24.95 New

- 2.1-3 MC Transmitter with tubes 14.95
- 4.5-3 MC Transmitter with tubes 6.95
- 5.3-7 MC Transmitter with tubes 6.95
- 7-9.1 MC Transmitter with tubes 9.95 \$19.95
- 3-4 MC Transmitter with tubes 18.95
- 28V Receiver Command Dynamotors \$0.97

MODULATORS

- BC-456 with Tubes, less dyn. 2.95
- MD-7/ARC5 Plate Modulator. 8.95
- MD-7 Modulator Dynamotor, 28V 2.95
- BC-433 Receiver—with tubes. \$24.95
- MN-26C Compass Receiver. 24.95 \$39.50
- MN-26Y Compass Receiver. 24.95 \$39.50
- BC-357 Marker Beacon Rec. W.O. Tube 5.95

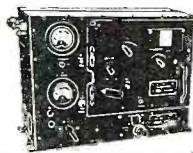

BC-223 Transmitter. 30 watt. Ideal for Ship-to-Shore or Ham Rig. Crystal or MO control on four pre-selected channels. 2000 to 5250 KC. Use of 3 plug-in coils. Five tubes: 2-801, and 3-36, and TU 17-18-25 tuning units.

Transmitter—\$39.95. Tubes—5.75. Tuning Units—\$2.25. Amp Meter. No. 60.0-60. New—1.29.

CIVIL AIR DEFENSE or 2 METERS

- ARC-4. W/tubes. Good, used \$29.95
- 522 Trans.-Receiver. W/tubes. Good, used 69.50
- Modulation Transformer. BC-375. New. 2.49
- BC-375 Trans. 100 Watt Voice, CW, MCW, freq. range 200 kc to 12 mc, uses Plug-in Tuning Units listed complete with tubes, less Tuning Units. \$29.95

- Tuning Units for BC-375 or 191 Trans:
 - TU- 7 4500-6200 kc. \$2.49
 - TU- 8 6200-7700 kc. 2.49
 - TU- 9 7700-10000 2.49
 - TU- 10 10000-12500 2.49
 - TU- 22 & TU-26 200-500 kc. each 4.50
 - FT-151 Shock Mounting for BC-375 or 191. 2.95
 - BC-306 Antenna Loading 1.95
 - GP-7 Navy Transmitter: 100 watt master os. Can use on any freq. from 350-9050 kc. by using proper plug-in. With 1 tuning unit. \$13.33

LOOP ANTENNAS

- DU-1 2 tube amplifier. New \$25.95
- MM-20-E New 7.95
- LP-21 A New 16.95
- Rotatable Loop Unit—Type MN-20E, 8" diameter—used with MN-26 Compass and RA 10 DB. By Bendix. Only \$7.95
- FL8 Filters—A's, B's, C's New 1.95
- FL5 Filters New 95
- Hand Keys—J-38 New 1.19

- TSC Transmitter & Receiver with 12V Power Supply and Cables. Good—used—\$179.50
- Heineman Circuit 115 V., 20 amp. 1.39
- Breakers 115 V., 5 amp. .97
- Prop Pitch Transformer, only new 6.95
- RT-7PN-1 Transceiver w/o tubes. Used 9.95

Cash with order. Prices subject to change without notice. California orders please include 3 1/2% Sales Tax. Please include approximate postage—Excess will be refunded. What Have You in Surplus? Submit 1306 BOND STREET, at PICO

ESEGE SALES COMPANY INC. LOS ANGELES 15, CALIFORNIA

"S" METER

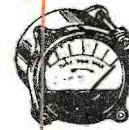

"S" METER

"S" METER — SAM'S SPECIAL. Illuminated face (supplied with miniature lamp). Full scale reading of 5 ma. A standard value for most "S" Meter Circuits. Dia. across face — 2 3/8". Black bakelite face. Reverse-set pointer. New \$2.49

TRANSFORMERS

- 12V 24V 2am 110V primary. \$2.95
- ARC-4 2 Meter Transceiver, tubes, good used \$29.95
- BC-34 Control. Used—\$1.95 New 2.95
- Code Tapes for TG-10 15 rolls. New. 7.95
- BC-906 Absorption Type Freq. Meter Range 150-225 mc. 0.500 DC Microm. Used \$11.50
- Field Phones E-E 8's. Used \$19.95 pr. New \$34.50 pr.
- Relay. SP-ST. Leach 6 V or 12 V. New 1.49

CRYSTALS—CR IA / AR

- 8150.000—8036.25—8001.43 \$1.19 ea. 3 for \$2.95

DYNAMOTORS

- PE103 New Case \$29.95
- PE-103 New, Less Base. 19.95
- DM-32A Input 28V. Output 250 DC. .06 amps. Used 1.95
- PE-73 29V @ 20 amps. output 1000V @ .350 amps. New 8.95
- PE-77 14V @ 40 amps output 1000V @ .350 amps. New 19.95
- SPEC. 27V @ 400V 7.50 mil 750V 350 mil. New 12.95
- PE-94 or SCR—522 24V. Used—\$5.95 New 14.95
- PE-94 Dynamotor only 4.95
- DM-34 12V @ 2.8 amps. Output 220V @ 150 amps. New 9.95
- SPEC. 9V @ 450V output @ 80 ma. New 5.95
- SPEC. 12V @ 320V output @ 80 ma. New 4.95
- SPEC. 6V @ 250V output @ 80 ma. New 6.95
- SPEC. 12V @ 440V output @ 200 ma. New 12.95
- ARC-1 DY-9/ARC-1 Used 11.50
- 14 Volt Input—425 Volt Output at 163 mils. Starting Filter and Relays in base. Like New 3.95
- RL-42B Antenna Rel. Ass. Less wire. New 9.95



OIL CONDENSERS

- Standard Makes—New
 - 2 mfd 600V \$0.49
 - 4 mfd 600V 1.39
 - 1 mfd 1000V .69
 - 3 mfd 4000V 7.95
 - 5 mfd 2500V 1.49
 - 10 mfd 600V 7.95
 - 2 mfd 2500V 3.95
- 2 mfd 5000V \$ 8.95 2 mfd 7500V 29.59
- T-30 Throat Mikes. Used—3 for \$0.50
- CD 307 Head Set Extension Cord. 1.19



HEAD SETS

- HS-30 New \$1.95
- HS-23 Used—\$1.95; New 2.95
- Matching Transformer for HS-30 .69
- BC-348 Mounting Base. 2.49
- RG-7U Coax Cable, 97.5 ohms. foot .08
- MIKE CHEST SET "F-1" button. New 2.95



DECK INSULATORS

- Bowl & Flange type. Heavy galv. metal flange—10 1/2" dia. Porc. bowl set in rubber gaskets. Top bell—7 3/8" dia. Brass feed thru rod L. insul. dist. between top bell and flange—6 1/2". New \$2.95

RMC TRANSCRIPTION PLAYER



16" Synchronous
Model TP16E \$126.00
Model TP16D \$84.00
Model TP12H \$58.50
(F.O.B. Port Chester, N. Y.)

Export: Rocke International Corporation, 13 East 40th Street New York 16, N. Y.

FOR HIGH FIDELITY RECORD REPRODUCTION

Meets the rigid demands of Army-Navy requirements, even Navy salt-spray test. Used by U. S. Signal Corps all around the world. Standard equipment in Veterans' Hospitals, and most radio stations, transcription services, etc., for realistic reproduction of transcription records up to 16 inches, 78 and 33 1/3 r.p.m.

Descriptive Bulletin HS3-1, upon request. Available Through Authorized Jobbers.

RADIO-MUSIC CORPORATION

PORT CHESTER NEW YORK

TELE-EX-PAND Deluxe Series TV TOWERS

When You Install!!!
Use The Best - Use Tele-Ex-Pand

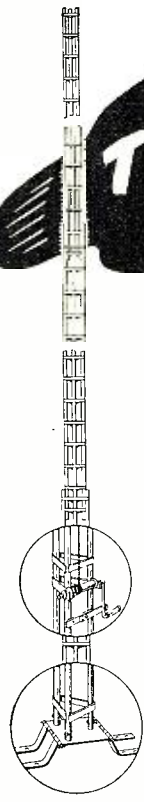

- ENGINEERED WITH THE FUTURE IN MIND IDEAL FOR USE AS:
- (1) PERMANENT HOME INSTALLATIONS
From the ground up with Tele-Ex-Pand is by far the easiest and safest way to install.
 - (2) AS A PROBE TOWER
Mounted on a Pick-up or panel truck, at a cost the dealer can afford to pay.
 - (3) AS A DEPENDABLE INSTALLATION FOR HAM OPERATORS AND SHORT-WAVE INSTALLATIONS
Taxicab Companies, Fire Departments and Police Units, are but a few in this field.
 - (4) UN-PARALLELED FOR "COMMUNITY TOWER" USE
Where mountainous terrain must be overcome, Tele-Ex-Pand can be used effectively, one to each channel to be received.
 - (5) ADAPTABILITY FOR USE AS SUPPORTING STANDARDS FOR, FLOOD LIGHTS AT, DRIVE-INS, USED CAR LOTS, AND DRIVING RANGES

WRITE US, OR CONTACT YOUR NEAREST JOBBER FOR PRICES

FOUR MODELS

	Collapsed	Expanded
M-20	10 ft.	18 ft.
M-30	15 ft.	28 ft.
M-40	20 ft.	38 ft.
M-60	20 ft.	55 ft.

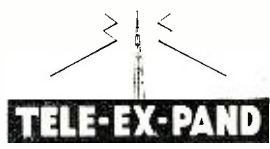

TELE-EX-PAND PRODUCTS SALES CORP. BERWICK NATIONAL BANK BLDG. BERWICK, PENNSYLVANIA

AUDELS TV SERVICE TELS HOW TO SOLVE TV TROUBLES AND ANSWERS TV QUESTIONS

AUDELS TELEVISION SERVICE MANUAL covers T.V. information at your finger ends. Shows good receiver adjustment and How to Get Sharp, Clear Pictures, How to Install Aerials—Avoid Blurs, Smears, Interference and How to Test. Explains Color Systems and Methods of Conversion. IT PAYS TO KNOW! Over 380 PAGES & 225 ILLUSTRATIONS explaining operating principles of Modern Television Receivers.

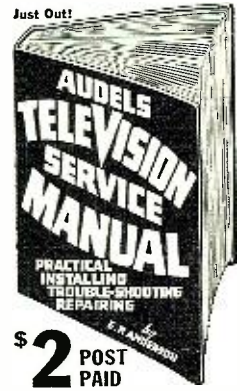

- 1001 FACTS
19 CHAPTERS**
- Placement of Television Receivers—
Receiver Controls,
Test Patterns & Adjustments—Television Interference—
Interference Traps—
Television Antennas & Transmission Lines—Master Antenna Systems—
Antenna Installation Procedure—
Television Broadcasting—Television Receiver Fundamentals—Circuit Description of Typical Receiver—Television Picture Tubes—
Projection Type Receivers—Television Testing Instruments—Television Servicing—Trouble Shooting—Color Television—Servicing Terms.

\$2 POST PAID

7 DAYS FREE TRIAL
GET THIS PRACTICAL ASSISTANCE FOR YOURSELF
MAIL COUPON TODAY

AUDEL, Publishers, 49 W. 23rd St., N.Y.
Mail me postpaid for 7 days examination
AUDELS TELEVISION SERVICE MANUAL (Price \$2).
If O.K. I will mail you \$2, otherwise I will return book.

Name _____
Address _____
Employed by _____ TV.3

BUY WITH CONFIDENCE 5 DAY MONEY BACK GUARANTEE ELECTRONIC SURPLUS MATERIALS

Type	Coil	Contacts	Features	PRICE
Sigma 4F	8000	SPDT	1 ma plate	\$2.95
Sigma 5	65 (2)	SPDT	2-24 VDC	2.45
Leach 1077BF	160	DPDT	ANTENNA TYPE	2.45
Clare Type C	400	DPST	makes 11V	1.25
Clare Type C	3500	DPDT	3 ma plate	1.85
Allied FID	42	SPNO	6 VDC MINI	.75
Allied BN	200	4PDT	10 AMP. CONT.	3.25
Allied 80	14	3PDT	6 VDC 10 A CONT.	2.15
Rotary Relay, 14 v operation / remote model trains, etc.				2.45
Klixon Type ER Thermal Relay, 110/220VAC				1.35
1 RPM 110 V 60 cy Instrument Motor, Hi Gear Ratio				1.85
G.E. Thyristor volt reg. 3rd harmon. generator, 5-40 ma. @ 21-33 volts, pkg. of 5.				1.45
OIL CAPACITORS				
2 MFD 600V VDC side term. bathtub, new.				\$0.85
4 MFD 600 VDC with mtg. hwe.				1.35
4 MFD 600 VDC upright with spade bolt bkts.				1.65
6 MFD 600 VDC upright with spade bolt bkts.				2.65
10 MFD 600 VDC upright with spade bolt bkts.				4.75
2 MFD 1000 VDC upright with mtg. bkts.				1.65
4 MFD 1000 VDC upright with mtg. bkts.				2.35
1 MFD 1500 VDC upright with mtg. bkts.				1.65
1 MFD 5000 VDC upright with mtg. bkts.				6.25
MANY OTHER VALUES & TYPES STOCKED. CHECK WITH US FOR PRICES, ETC.				
LIP MIKES ARMY T-45				\$1.00
THROAT MIKES ARMY T-30V				.85
CARRIER CURRENT REC. IPS, 239kc set of 3.				1.75
HAND DRIVE GENERATOR/portable rigs 6V/3A & 315V/200 ma.				6.95
110 VAC sander buzzer				.39
MOBILE G.E. ROOF-TOP ANTENNA				3.75

ELECTRONIC SPECIALTY SUPPLY CO. 56-B Lispenard Street New York 13, N. Y.



Eastern European languages 0155 tune-in; leaves the air 0203-0205 and has no signature tune then; also heard 1500 and still on the air 1805. (Pearce, England)

Portuguese China—Serrano, Brazil, airmails that he has definitely confirmed that a short-wave station called *Radio Vila Verde* is now operating from Macau, probably around 9.500. He hopes to have further data on this one soon.

Sao Tome—The 17.6775 channel noted a recent Sunday with light recordings 0750, program details in Portuguese with guitar musical background 0800, and closing 0803 with "A Portuguesa." (Pearce, England) Also heard in North Carolina. (Ferguson)

Saudi-Arabia—Djeddah, 5.975, noted signing on 2306 recently, in the clear. (Bellington, N. Y.) This one heard in Virginia in Arabic 0300-0400 sign-off. (Saylor)

Sierra Leone—GDX-aren, Sweden, says Freetown has an experimental station of 0.3 kw. sending on 9.630; noted with BBC's General Overseas Service from London to 1700 sign-off. Not confirmed.—KRB.

South Africa—SABC's African Service noted from Johannesburg, 15.230, at 1000 with light music and opera; closed 1045; poor level and jamming QRM. (Catch, England) Heard in *English* 1130 on 11.937. (Pearce, England)

Southern Rhodesia—Salisbury, 3.320, noted closing 1500; has BBC news relay 1300; home news 1310; weather forecast, local, and South African news 1315. (Pearce, England)

Spain—Radio Nacional de Espana en Malaga, 7.01A, noted with call 1340. (Pearce, England) Cadiz, 7.200A, heard most days around 1700-1800; plays many North American dance and popular tunes with *English* lyrics from 1730. When this was compiled, Radio S.E.U., Madrid, was still operating near 7.09; Radio Tullent Murcia near 7.105, and Radio Merida between them. (Pearce, England)

Spanish Morocco—Radio Tetuan heard recently on 6.063A at 1755 with program preview for next day; off 1800; heard another day as early as 1700. (Pearce, England)

Surinam—PZX5, 15.405, Paramaribo, noted recently with good level in Eastern-type musical program when tuned 1520; at 1531 had announcement followed by a VOA program. (Ferguson, N. C.)

Switzerland—United Nations Radio, 6.672, is heard daily 1330 with news in *English*; news in French 1345; leaves air 1400; has woman announcer. (Ridgeway, South Africa) Berne, 15.305, has fine level in *English* for India-Pakistan 0945.

Syria—Damascus, 11.913A, still noted to 1735 sign-off; asks for reports to SBS, English Section, Damascus, Syria. (Leary, Ind.) Last hour is in *English*.

Tahiti—Radio Tahiti, 6.135, Papeete, noted with news in French, music, around 0015; fair level in Calif. (Winch)

Taiwan—Radio Free China, BED3, 15.234, BED6, 11.735, Taipei, has its North American transmission in *English* 2300-2400; opens with chorus singing and call by woman announcer. (ISWC, London) The 7.135A outlet noted with fair level around 0700-0800. (Stein, Calif.) Ferguson, N. C., recently checked 11.735 and 7.135A channels around 0630-0735 but found no *English* at any time during the check period; formerly had *English* 0630, 0700, or 0730.

Tangiers—Radio International noted on 6.110 at 1515 tune-in; news in French 1530; still on the air 1600. (Pearce, England) *Radio Africa*, 7.127A, noted to 1900. (Leary, Ind.)

Thailand—HS8PD, Bangkok, broadcasts Home Service programs in Thai 0700-1000 on 11.910. (WRH Bulletin)

Trinidad—Radio Trinidad, 9.625, noted with music 1745, BBC news relay 1800; poor signal in Missouri. (Newcomb) has had QRM evenings; still signs off 2200. (Patterson, Ga.) Noted with news 0545 and identifying as "Radio Trinidad and the Radiodiffusion Golden Network." (Rosenauer, Calif.)

Trans-Jordan—Nattugglan, Sweden, reports Ramallah heard on 7.030 to 1421 sign-off with march.

Turkey—A station of the Physical Institution of Istanbul University is audible irregularly on 7.750 with Oriental and Western music. *Radio Ankara* now broadcasts in 14 languages in addition to Turkish. (Radio Sweden) TAV, 17.83, is heard with good level to Far East in *English* 0730-0815. (Ridgeway, South Africa) Noted with weak level in North Carolina. (Ferguson) TAT, 9.515, still heard at fine level in *English* to North America 1815-1900. (Van Gilder, Mass.) TAS, 7.285, heard in *English* for Western Europe 1600-1645. (Green, Ontario) TAP, 9.465, is scheduled in parallel.

Uruguay—Radio Carve, 6.157, Montevideo, noted 1930; QRM. (Stark, Texas)

USI (Indonesia)—YDQ, 9.552, Makassar, Celebes, heard at fair level 0900-1000 sign-off. (Ridgeway, South Africa) Jogjakarta, 7.098, noted with fair signal recently 0700-0830 fade-out; gave call of YDJ2. (Saylor, Va.) Djakarta, 6.045, noted around 0557 with popular American songs with *English* lyrics. (Bellington, N. Y.) The Djakarta station *Radio Andir* verified for its 7.165 outlet; transmitter is RCA, 7.5 kw., with beams on Northeast and West Java; schedule on 11.940 now is 0430-0630; verification cards will be issued from Djakarta shortly. (Cushen, N. Z.)

USSR—Short Wave News, London, says a Soviet station heard on 5.484 around 1450 is believed located at Molotov.

A new transmitter in Petrozavodsk has been heard on 4.950 with programs in Finnish and Russian. (WRH Bulletin) Khabarovsk, 9.378A, has Chinese program 2100-2200, weak level in Virginia. (Saylor) *Radio Moscow* is good signal 0800-0830 in *English* to

March, 1952

SEE LEO FIRST FOR . . .

hallicrafters

I can SAVE you money . . . Liberal Trade-ins



Leo I. Meyerson WØGFO



\$169.50

New S-76 RECEIVER

Extra selectivity with double superheterodyne circuit. One RF, two conversion and 3 IF stages. Range 550-1550 Kc, 1.7-34 Mc in four bands. 8 tubes plus voltage regulator and rectifier. Complete with tubes, less speaker.

R-46 SPEAKER \$19.95

NAME YOUR TERMS • LOW DOWN PAYMENTS • PERSONALIZED SERVICE



\$199.50

SX-71 RECEIVER

Double Conversion sharp selectivity, plus built-in NBFM at moderate cost. 11 tubes plus voltage regulator and rectifier. Low down payment.

R-46 Speaker \$19.95

HALLICRAFTERS RECEIVERS AVAILABLE FOR IMMEDIATE SHIPMENT

S-38B\$49.50	S-72 Portable\$109.95
S-40B\$99.95	SX-62\$289.50
S-81\$49.50	S-78A\$89.50
S-82\$49.50	S-76\$169.50
		R-46 Speaker\$19.95

Famous WRL RADIO REFERENCE MAP 25c



CU on 10-20 & 75 Meters

NEW LOG BOOK 25c

For mobile or fixed station. Spiral binding. Full column log listing all FCC required info. Will accommodate 1,525 stations. "Q" signals, phonetic alphabet, amateur international prefixes.

PHONE 7795

WRITE—WIRE



JUST OFF THE PRESS!

WRL 1952 CATALOG

Send for your copy today. Contains everything new in radio and television. Jam-packed with bargains. Leo I. Meyerson, WØGFO



FREE

WORLD RADIO LABORATORIES

74 West Broadway

Council Bluffs, Iowa

R-3

Please send me:

- Radio Map
- New Catalog
- Used Equipment List
- SR-75 Info
- SX-71 Info
- New Log Book

Name

Address

City

State

RADIO COURSES

- RADIO OPERATING • CODE
- RADIO SERVICING • ELECTRONICS
- F.M. TELEVISION
- PREPARATION FOR CIVILIAN, MARITIME, ARMY AND NAVY LICENSE REQUIREMENTS.

Write for Catalog T.S.

Y.M.C.A. TRADE & TECH. SCHOOL

15 W. 63 St., N. Y. 23
ENdicott 2-8117



MARK THESE VALUES!

1B3GT89c	6AG585c	5U459c	6J698c	12AT7	...\$1.05
024	..\$.64	GAC7	..\$1.16	6SK7	..\$.79	6W4	..\$.65	12BE6	..\$.84
1L4	..\$.73	6AH6	..1.48	6SN7	..\$.99	7E8	..1.43	12BH7	1.07
1R5	..\$.79	6AK5	..1.37	6SL7	..\$.99	12AU7	..\$.84	50A5	..1.09
1S5	..\$.78	6AL5	..\$.59	6T8	..\$.79	12AV6	..\$.72	50L6	..\$.67
1K2A	..\$.95	6AU6	..\$.64	6BD6	..\$1.89	6J6	..\$.98	12SO7	..\$.64
5V4G	1.09	6BA6	..\$.67	6C86	..\$.78	6N7	..\$.98	95B4	..\$.59
5Y3	..\$.46	6BC5	..\$.78	6CDB	..2.25	6S17	..\$.79	All Amer. Kit	..\$3.23
6AB4	..\$.89	6BE5	..\$.77	6CD6	..2.25	6S17	..\$.79	Prices subject to change.	

1000 Kc. CRYSTALS—Laboratory Precision
Cut. New. Uncased. Each 1.35
Write for Your Free Bargain List Now!

TOP STANDARD BRANDS ONLY—100% GUARANTEED
RCA—GE—SYLVANIA—HYTRON—PHILCO—KENRAD—NU—
TUNING—WESTINGHOUSE—WESTERN ELECTRIC

MARK electronics 1888 Randall Ave.
New York 72, N. Y.

Services 2-Way Mobile Radios Best...

Say Manufacturers*

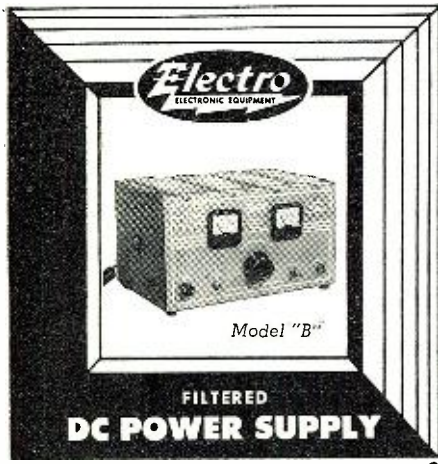

Model "B"

**FILTERED
DC POWER SUPPLY**

Leading Manufacturers Say . . . "It's the only one to withstand continuous high overloads, so we specify the Model "B" for servicing." Exclusive application of selenium rectifiers, aided by conduction cooling, doubles rectifier power rating, dissipates over 3 times the heat with lowest cost per ampere output. 1 to 20 amperes continuous duty with peak instantaneous rating of 35 amperes. Operates 2 auto radios with push-button solenoids simultaneously. Net \$49.80.

Other Uses—Phone circuits, relays, instruments, low voltage devices. Battery charging and electroplating.

* Names on request.

Model "BJ" Low-Cost Power Supply
6 Volts DC 1 to 12.5 Amperes
Net \$37.50



Model "S"

**CONVERTS BATTERY RADIOS TO
AC ALL-ELECTRIC**

Plugs into AC outlet. Hum-free reception from any 1½ volt 4-6 tube battery radio. Uses less than ¼ the power of cheapest AC radio. Fits battery space. Guaranteed 3 years.

Many Others Available



See Your Distributor!
If He Can't Supply You,
Write to Us!
FREE FOLDER!

ELECTRO PRODUCTS LABORATORIES
4501-Nb RAVENSWOOD AVE., CHICAGO 40, ILL.
In Canada: ATLAS RADIO CORP., LTD. • TORONTO

North America on 11.910, 11.960, 15.120. (Leary, Ind.) Noted in *English* 0430-0445 on 11.820, 11.630, 9.790. (Rosenhauer, Calif.) Best Moscow channels in Washington State for North American (*English*) transmission around 2000-2300 are 15.12A and 7.25A. (Oestreich)

Three Russian Home Service programs from Moscow are now on the air—First Program until 0830 on 9.720, 9.800, 11.765, 11.790, 11.880, 11.900, 11.905, 12.220, 15.170, 15.390, 15.440; from 0830 on 5.912, 5.955, 5.970, 5.980, 6.030, 7.175, 7.225, 7.260. Second Program until 0900 on 11.945; from 0915 on 7.115; from 1000 also on 6.130. Third Program until 1530 on 6.070. The news agency Tass uses these channels for its news service at dictation speed (in Russian)—5.780, 5.922, 5.940, 8.910, 9.145, 9.850, 12.020, 12.270, 15.040. (*WRH Bulletin*) Radio Tashkent, measured 6.8256, noted 2110 in foreign language. (Oskay, N. J.)

Vatican—HVJ broadcasts programs in *English* daily 1000 on 1529 kc., 9.646, 11.740, 15.120, and 1315 on 1529 kc., 5.968, 9.646, 11.740. (Radio Sweden) Has transmission for India each Tuesday 1030 over 11.740, 17.840. (ISWC, London) The 9.646 outlet noted 1345 beginning French session; in Italian 1430; heard dual on 5.97A at 1450 but at weaker level. (Bellington, N. Y.)

Venezuela—Radio Cabimas, YVMK (relaying YVML), is noted to after 2130, now on 3.410 (Stark, Texas) This one heard in Missouri at 1700 with fair signal. (Newcomb) YVKE, 4.880, Caracas, noted with news 1824-1830 when resumed in Spanish; announced *English* news for Mon.-Fri.; YVQA, 4.960, Cumana, noted 1907-1940, identification announcements by man included call of "Radio Sucre." (Machwart, Mich.) YVKT, listed 3.350, Radio Libertador, Caracas, goes past 2200 on Sundays; YVKX, 3.390, Caracas, is heard to after 2200; Radio Tropical, 3.400, Caracas, noted evenings; Radio Maracaibo, 3.440, runs to after 2130; Radio Valencia, 3.460, runs to after 2130 now. (Stark, Texas)

Yugoslavia — Belgrade, 6.100, has *English* 1145-1200 and 1400-1415; French 1415-1430, 1700-1715; appreciates reception reports and will verify if IRC is enclosed to Radio Yugoslavia, 6, Mose Pijade, Belgrade 2, Yugoslavia. (ISWC, London) Heard on this schedule. (Pearce, England)

* * *

Press Time Flashes

Radio Pakistan, 7.003A. Karachi, noted 1115 with news in native; high level; closes 1200. (Ridgeway, South Africa)

"Wir rufen den Osten! Wir rufen den Westen! . . . Sie horen den Kurzwellensender Freies Russland!" is the announcement in German of the *Free Russian Radio* said to be on the air in Russian and German daily 0730-0810 between 6.350-6.615. (Radio Sweden)

Ridgeway, South Africa, says Radio A.E.F., French Equatorial Africa, uses two transmitters in parallel in its 1230 session (9.960 and 15.596); programs

SAVE MORE!

G.E. PYRANOL, 330 V., 60 Cycles, 1.75 MU-F., \$ 1.39	
C.D. #173345 CAPACITOR (Paper), 250 MFD., 250 V.	1.19
BC-937 B VOLTAGE REGULATOR, Good, Used.	7.95
BC-451 ARC 5 CONTROL BOX, Good	8.99
BC-442 ARC 5 ANTENNA RELAY, less condenser	1.55
BC-442 ARC 5 ANTENNA RELAY WITH CONDENSER	2.75
BC-AR 408 CONTROL BOX	1.55
BC-45 231 CONTROL BOX	1.45
RE-ARRI CONTROL BOX	1.49
C-237/APQ7 CONTROL BOX	11.00
BC-375, less tubes, as is, clear	1.49
CD-307A CORDS with PL 55 and JK 26, excellent	.80
BC-375 w/Tubes and Tuning Unit, excellent condition	18.95
G.E. CIRCUIT BREAKER, 24 V., 200 amps, -PT 59,000, Brand New.	1.95
LELAND VOLTAGE REGULATOR, Type "S", volts input 1-30, load amps 5.0, Brand New	2.25
FLAT HEAD WOOD SCREWS, #12x2", Per Gro.	.95
HONING STICKS	.95
CONTROL BOX C-260A/ANO-1A	4.95
RF-9 UPT MODULATOR ADAPTER	11.90
G-1 78 R.P.W. PHONOGRAPH MOTOR AND TURNABLE, Brand New	2.95
TRIMM HEADSETS, Like New, Per Pair	1.95
HS-39 HEADSETS w/Plug and Cord, used, good	1.99
T-20-B MICROPHONES—W/JK 46A, Brand New	.75
T-20 MICROPHONES—W/PT 291, Excellent.	.20
#30 STEEL BARE WIRE, 12 to 15 lbs, per reel	.18
WL 130 C WIRE, approx. 3,000 feet per can	6.55
Per Can	15.00
HE 1153 INDICATOR with CRT Tube and Cables	5.95
RF-75 SWITCH BOX, Brand New	15.00
AS-69/APT ANTENNA ASSEMBLY, Brand New.	5.95

GRAB BAG!!

Parts taken from equipment. Consists of High Voltage Transformers, Oil Filled Capacitors, Bathtubs, Resistors, Terminal Boards, Sockets, Knobs, Relays, Controls, Coils, etc., etc.

WE LEAVE THE QUANTITY UP TO YOU!!

ONLY **17c** PER POUND THERE'S NO BETTER BUY ANYWHERE

DYNAMOTORS

	Good—Used—Tested!		
DM-18	\$ 4.50	PE-119 A	\$17.95
DM-20	5.50	PE-118 A	15.95
DM-22	2.95	PE-115 A	29.00
DM-24	3.90	D-104 Dual 12 V.	
PE-225	4.85	Input, Output 225 and 440 V., Brand New	19.95
PL-14	3.45		
PL-218 INVERTER	11.95		

50 BY-PASS CONDENSERS, TUBULARS, Popular Sizes, 400 to 600 Wkg. Volts. . . . ONLY \$2.95
HOOK-UP WIRE ASSORTMENT, Cut Lengths to 12", Stripped Ends. . . . 2 Lbs. . . .99

POTENTIOMETER KIT

15 types—Carbon and W.W. S.D. and Shaft Types. Includes ½ and 1 meg. W/switches. \$2.65

RESISTOR KITS—100 ASSORTED

Over 50 values in each kit. 5 and 10% tolerances.
½ to 3 watt \$2.95 per kit
5 and 10 watt 3.95 per kit
20 and 50 watt 5.95 per kit

TERMS—Send 25% deposit with order, balance C.O.D. Shipped F.O.B., N.Y.C. (N.Y.C. residents add 3% sales tax.)

CIRCLE SALES CORP.
113 GREEN ST., N.Y. 12, N.Y. - WOrth 4-1541-2

6 Transmitters to Check
—or 60?



The new LAMPKIN TYPE 205 FM MODULATION METER covers them all; instantly tunable to any FM transmitter, 25 to 200 Mc. It measures true peaks, as found in voice modulation, up to 25 Kc. Meets FCC specifications. Portable, weighs 14 lbs., priced at \$240.00 net.

The improved LAMPKIN TYPE 105-B MICROMETER FREQUENCY METER also covers 6 or 60 channels. Measures center frequency, AM or FM transmitters, 0.1 to 175 Mc. Accuracy 0.0025%. Meets FCC specifications. Weighs 13 lbs. Price \$220.00. Other models down to \$129.00.

WRITE, WIRE, or PHONE, NOW, for details!

LAMPKIN LABORATORIES, INC.

MFM DIVISION

BRADENTON, FLORIDA

Frequency Measuring Equipment Since 1932

are in French; also uses 9.960 and 17.845 at 0600-0805 with programs in native to 0645, then in French. (Radio Australia)

"La Voz de la Falange," Madrid, 7.380, 1 kw., is on the air 1400-1530, 1700-1930; during July and August the station will broadcast *only during the second period.* (WRH Bulletin)

* * *

Acknowledgement

Thanks, fellows, for the fine reports. Keep sending them to Kenneth R. Boord, 948 Stewartstown Road, Morgantown, West Virginia, USA. Good listening! KRB.

BOOSTER FOR FM SETS

By CHARLES ERWIN COHN

MOST present-day FM receivers, even the more elaborate ones, couple the antenna to the set with a turn of wire around the antenna coil. This does not provide a very efficient coupling and it is often beneficial to make different arrangements for handling this.

One approach to this problem is shown in Fig. 1 where a 6C4 triode is used as a grounded-grid amplifier. The circuit is quite simple, the 330 ohm resistor in the cathode circuit providing a good termination for the transmission line. If a transmission line with other than 300 ohm impedance is used, the resistor will have to be changed to conform to the line employed.

The .001 ufd. condenser is used to keep the d.c. bias, which is built up across this resistor, from being shorted out by the antenna. Although a 6C4

Fig. 1

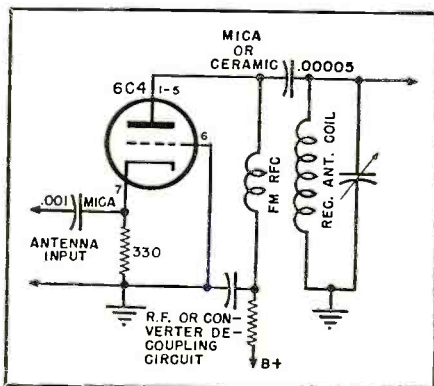

tube is shown, any good v.h.f. triode or triode-connected pentode can be used. The "B+" connection shown should be taken to the converter "B+" point or to the r.f. stage "B+" point if the receiver has one. In other words, the connection should be made at the bottom of the r.f. or i.f. coil, ahead of the decoupling resistor. This will prevent interaction with the rest of the receiver.

This circuit is capable of improving the performance of any FM set. For those receivers which already have an r.f. stage, it will improve the noise figure due to the lower noise of triodes.

For the set with no r.f. stage, the extra gain will be helpful as will the reduction in oscillator radiation. This is especially true of "Fremodyne" sets in which the performance improves rapidly with increased signal input.

-30-

ARROW "The Home of Values!"

MISCELLANEOUS SPECIALS!

	Used	New
BC 442 Less Condenser	\$1.49	\$1.95
APS 13 UHF Antenna, Pair	.98	
I-97 Bias Meter	3.95	4.95
RL 42 Antenna Gearbox Motor and Reel	4.95	6.95
Circuit Breaker 40 Amps		.59
I 82 F Five Inch 360 degree compass indicator and Selsyn receiver		7.50
A-81-2 Transmitters Selsyn for I82 indicator.		4.95
(both I82F & Trans. Selsyn for \$11.00)		
PE-101 Dynamo		2.75
Model 507, Thermal-converter Weston Type D, range .12 amp		.59
BC-1023 Marker Beacon Receiver, complete with tubes, shock mount and instruction manual.		9.95
RC43, kit of plugs, insulators, etc, for BC-1023, new		1.75
BC-924 27-38 MC. FM Transmitter, complete with tubes.	19.95	
BC-684 27-38 MC. FM Transmitter, less dynamotor.	19.95	
ARB Control Box	1.95	
BC 1206 Receiver, new	7.95	
BC-375, transmitter only	19.95	
110 volt, 60 cycle blower	7.95	
A27 Phantom antenna	1.95	
PE 206 Inverter	4.95	
Scott Hi-Fi output transformer	1.49	
PE-118 Inverter	19.95	
SCR-522, transceiver, less tubes	39.50	
BC-709, battery operated, lt. wt., inter-phone amplifier, complete with tube, shock mount and manual, brand new ea.	33.95	
BC 625 Transmitter (SCR522), less tubes, used	\$19.95	
PE 120 Vibrator Power Supply for BC 620-659, used, less vibrator	4.95	
TU6 Tuning Unit (BC375), used	2.95	
TU25 Tuning Unit (BC375), used	2.45	

MONTHLY SPECIAL!

BC 604 FM Transmitter—20-27 mc. 10 Channel crystal controlled push-button, excellent for conversion to 10 and 11 meters, small quantity on hand, in good used condition, less dynamotor, some missing side covers, etc. **\$7.95**
—otherwise complete, including tubes.

SCR 508 EQUIPMENT

BC 603 Receiver L/dyn.	\$24.95	Exc. Used
BC 604 Transmitter L/dyn.	12.95	Exc. Used
BC 605 Amplifier L/dyn.	6.95	New
FC 606 Control Box	.95	Exc. Used
FT 237 Mounting	9.95	Exc. Used
MP 48 Mast Base	2.95	Exc. Used
DM 34, Dynamotor	10.95	Exc. Used
DM 36, Dynamotor	10.95	Exc. Used
DM 37, Dynamotor	14.95	Exc. Used
TM 11-600 Tech Manual	1.95	
Crystals, Set of 80	19.95	

SCR 625 Famous Army Mine-Detector

For Prospectors, Miners, Oil Companies, Plumbers, etc.

This unit is being offered now at a considerable reduction in price. Recently advertised at \$79.50 it is now available in the same brand new wrappings in suitcase style carrying case (less batteries) at

\$59.50 WHILE THEY LAST! Used, like new, \$39.50

CJP-20 ABX Power unit, (ASB7) new with tubes	\$4.95
used with tubes	3.95

COMMAND (SCR 274 N) EQUIPMENT

	Used	New
BC-453, with tubes	\$19.95	
BC-454	9.95	
BC-455 6-9 mc receiver	7.95	\$14.95
BC-457 4-5.3 mc transmitter	6.95	
BC-458	6.95	
T-21 ARC 5, 5.3-7 mc transmitter	7.95	11.95
T-23 ARC 5, 100-156 mc xmtr.		49.50
BC-496, 2 position Rec. Control Box		1.95
MC-215 Mechanical Drive Shaft, per length		2.45
BC-450 3 Receiver Remote Control		2.95
BC-451 Transmitter Control Box	.69	1.50
BC-442 Antenna Relay, complete		3.95
3 Receiver Rack		1.95

MIKES and HEADSETS

HS 23 High Impedance Headset	new \$4.95
HS-33 Low Impedance Headset	5.95
CD-307 Ext. cord for HS 23-33	like new .95
T-32 Desk Stand microphone. Good used cond.	\$2.95
Throat Mike—T 30—New	.98c
Lip Mike—Navy Type—New	.98c
Extension Cord and Switch Assembly for lip and throat Mikes—New	.98c
CW 49505 High impedance headset complete with leather headband and rubber cushions.	Used 98c
RS-38 Microphone	new 4.95
TS 10 sound powered HAND SET	new \$9.95 ea. used \$5.95 ea.
HS-38	new \$2.29

WOBLULATOR

See page 43—December "Radio News" \$5.95 ea.

CONDENSERS. 19c each		6 for \$1.00	
1 mfd.—800 VDC	1 mfd.—400 VDC		
.1 mfd.—1200 VDC	1-2.4 mfd.—400 VDC		
1 mfd.—1200 VDC	.1-1—2000 VDC		
	39c each	3 for \$1.00	
.25 mfd.—1500 VDC	1 mfd.—1000 VDC		
2 mfd.—220VAC			

CATHODE RAY TUBES

3FP7 --- 1.95	4AP10 --- \$.95
5FP7 --- 1.95	5CP1 --- 3.95
5BP4 --- 3.95	
16JP4 --- \$19.95	
16DP4 --- 19.95	

90 DAY GUARANTEE

Tubes—304TH	\$8.95
304TL	8.95
830B	2.95
9001	1.39
9002	.98
9003	1.49

Write for complete bargain tube list.

VIBRATORS

2 Volt—7 Prong Synchronous	69c	10 for \$6.00
6 Volt—4 Prong Non-synchronous	98c	10 for 9.00

I. D. 6B/APN4

LORAN INDICATOR SCOPE less tubes, like new. **\$29.95 ONLY**

R9/APN4, complete with tubes, like new \$17.95

Shipments FOB warehouse. 20% Deposit on orders. Minimum order \$5.00. Illinois residents, add regular sales tax to remittance. Prices subject to change without notice.

ARROW SALES, Inc.

Dept. N, 1712-14 S. Michigan Ave., Chicago 16, Ill. PHONE: HARRISON 7-9374

Free NEW BIG RADIO CATALOG

Ready now. Complete with everything in radio, television and electronics. Newest parts, as well as old, standard lines. Paste coupon on penny postcard and mail today.

Lafayette Radio

DIVISION: RADIO WIRE TELEVISION, INC.

NEW YORK 13 100 Sixth Ave. NEWARK 2 24 Central Ave. BOSTON 10 110 Federal St. BRONX 58 542 E. Fordham Rd.

LAFAYETTE RADIO,

Dept. RC
100 Sixth Avenue, N. Y. 13

Please rush Free catalog to:

Name.....

Address.....

City..... State.....

PASTE ON PENNY POSTCARD

WHERE TO BUY IT...
WHOLESALE RADIO
 of Baltimore

Replace Your Old TV Aerial
 With Snyder's Amazing New
**360° MOTORLESS
 TV AERIAL**

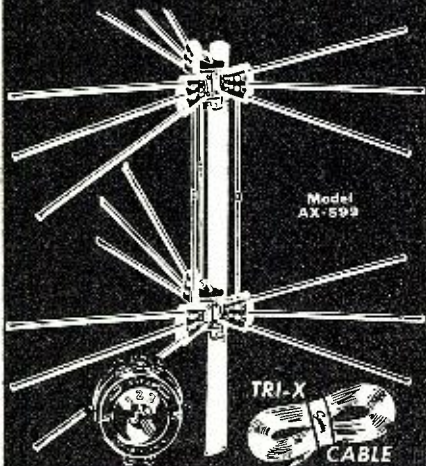

**SAME CLEAR PIX AS MOTOR
 ROTATING AERIAL SYSTEMS
 COSTING TRIPLE THIS PRICE**

only **\$16⁹⁵**

COMPLETE WITH 75
 FT. OF 3 COND.
 CABLE AND ELEC-
 TRONIC BEAM SE-
 LECTOR SWITCH

FOR ULTRA FRINGE
 Electronically beams in
 complete 360° rotation
 to give clear picture on
 all channels. You choose
 direction with Direc-
 tion Selector switch
 mounted on or near TV
 set. 18 hi-tensil 3/8"
 aluminum-alloy ele-
 ments. Has universal U
 clamp to fit masts up
 to 1 1/2".

YAGI TV ARRAYS
 For Fringe &
 Ultra Fringe



Channels
 = 2 or 3-
 = 1-HV4
 = 3-HV3
 = 6-HV6

Channels
 7-RY7
 8-RY8
 9-RY9
 10-RY10
 11-RY11
 12-RY12
 13-RY13

Highly directional and
 closely tuned to each
 channel. Cuts interfer-
 ence and noise to a
 minimum. Five ele-
 ments; one folded di-
 pole, three directors
 and one reflector. In-
 dividual array for each
 channel. Specify chan-
 nel desired.

\$7.95
 TIE RODS for stacking 2 Yagi Arrays
 Specify Hi or Lo band..... pair

\$4.95
85c

HI-FI MUSIC AMPLIFIER
GROMMES
50PG

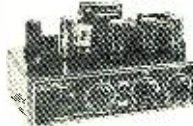

10 watt audio. Low dis-
 tortion. Freq. resp.;
 plus or minus .5 DB
 20 to 20,000 CPS. 4
 channels: radio, phono,
 xtal, magnetic. Vol.,
 bass, and treble con-
 trols. Complete with tubes and out-
 put transformer

\$49.75

3 Speed 12"
Turntable
REK-O-KUT LP743



Induction type motor, designed
 for smooth, vibration-free op-
 eration. Instantaneous speed
 changes without stopping
 turntable or re-
 moving disc.

\$54.95

Order From Dept. RN-3 or Call MUIberry 2134
 WRITE FOR FREE FYI BULLETIN

WHOLESALE
RADIO PARTS CO., Inc.
 311 W. Baltimore St.
BALTIMORE 1, MD.

Saturable Reactors

(Continued from page 69)

light bulb of the proper wattage as the load so that the control effects can be observed visually.

When all the connections have been made, with the d.c. power off, plug in the a.c. load circuit. At this point the bulb will be either completely extinguished or else very dim. Now turn on the d.c. power supply and slowly increase the current. The brightness of the bulb will increase in proportion to the current, reaching its maximum brightness at approximately 44 ma.

When the core is fully saturated at full d.c. current and the bulb is at its maximum brightness it will be found that the voltage appearing across the bulb is less than the actual line voltage (approximately 100 v.). This is due to the fact that the reactance of the coils cannot be decreased to exactly zero. As a result there will always be some drop across the reactor. In commercial applications this is corrected by providing a supply voltage which is about 5% higher than the normal operating voltage of the controlled unit.

At the other extreme it will be found that the lamp voltage does not drop to zero, since the reactor cannot be infinite in value. This of course means that the load current cannot be decreased to exactly zero. However in the case of a lamp load it will "black-out" at approximately 15% of full line voltage. When a resistive load is used the two voltages, across the reactor and across the resistive load, are 90 degrees out-of-phase. When the load is also reactive, for example a motor, the voltages will be in-phase. The net result of all this is a slight reduction in the control range.

In the next arrangement the two a.c. coils will be connected in parallel. Again following standard convention the finish of primaries #1 and #2 are

connected together and the start of these same windings are connected together. The start ends are connected to the a.c. line and the finish ends are connected to the light bulb and then to the other side of the line (coils in series with load unit). The d.c. coil connections are not changed. The actual schematic of this circuit is shown in Fig. 6B.

When using this connection it will be found that the d.c. control current needed is only one-half of that required for a series connection of the a.c. coils. It will also be found that the unit will operate much more efficiently in this arrangement. This results from the fact that the primaries were originally designed to operate on 117 volts.

If desired, a small fractional horsepower motor can be substituted for the light bulb. Its power rating must be approximately the same as the light bulb used. For this purpose, the type of motor used in erector sets or small movie projectors is the proper size, but it must be a 117 volt a.c. type.

It is necessary to observe certain precautions, because when a motor first starts it draws an excessive line current which is higher than its normal value at full speed, with the consequent danger of overloading the unit. To avoid this a shorting switch is connected across the a.c. coils so that full line voltage can be applied to the motor. Once the motor is started the switch is opened, changing the control of the motor to the saturable reactor.

In order to simplify specific arrangements and procedure the foregoing explanation has been based on the ratings of a 40 ma. power transformer. However, units have been built using 70 ma., 90 ma., and 150 ma. transformers and the system is exactly the same when any of these are used.

The gain of the unit can be calculated by the following formula:

$$gain = \frac{\text{output power (a.c.)}}{\text{input power (d.c.)}}$$

The gain of the small unit is relatively

Fig. 6. Saturable reactor with a.c. coils connected in series (A) and in parallel (B).

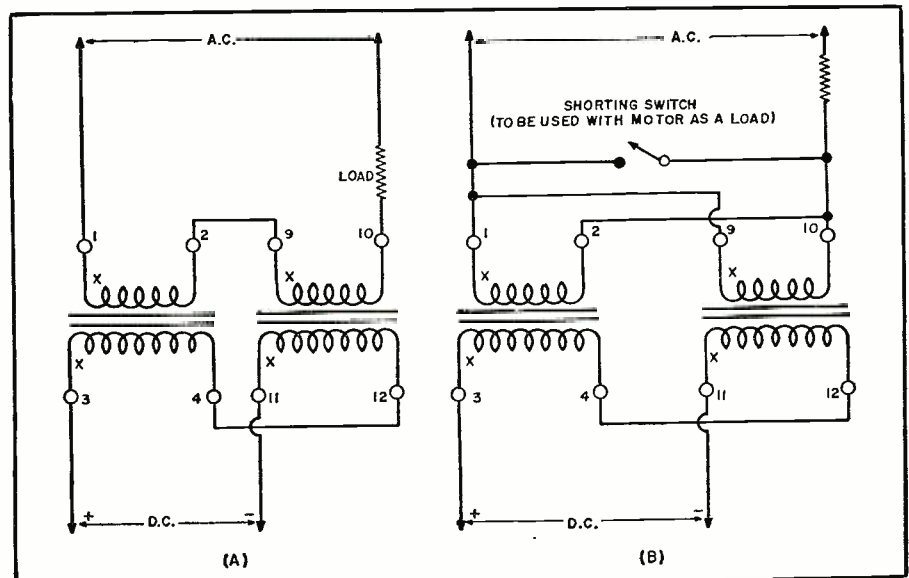

low, but as the size of the unit is increased the efficiency also increases which means that the gain is higher. The cores used are made of 4% silicon steel which operate best at high power levels.

Manual control has been used in this presentation to avoid complications. There are several very interesting ways in which these units can be controlled by means of regular electron tubes.

In the beginning of this article it was pointed out that a multiple control unit can be made by making use of the low voltage windings, making possible control based on multiple input signals. Once the unit is assembled it is merely necessary to connect the proper type of control unit to each set of windings. Since the windings are different from the high voltage windings the control conditions are entirely different. Therefore it would be necessary to experiment in order to determine the best control conditions for each of the various voltage windings.

SERVICE HINT

By H. LEEPER

In order to see clearly in some remote corner of the TV or radio chassis when soldering, additional light other than that furnished by the usual solder gun is required.

Such light is easily obtained from the gun itself, by making an extension lead as shown in the photograph below.

The base from an old flashlight bulb with two wires attached is inserted in the socket of the gun instead of the regular bulb. The bulb which was removed is placed in a socket soldered to the other ends of the wires. A portion of the rubber insulation from a test clip may be slipped around the extended socket so that it may be used any place without danger of shorting to the chassis.

Add an extension light to your solder gun.

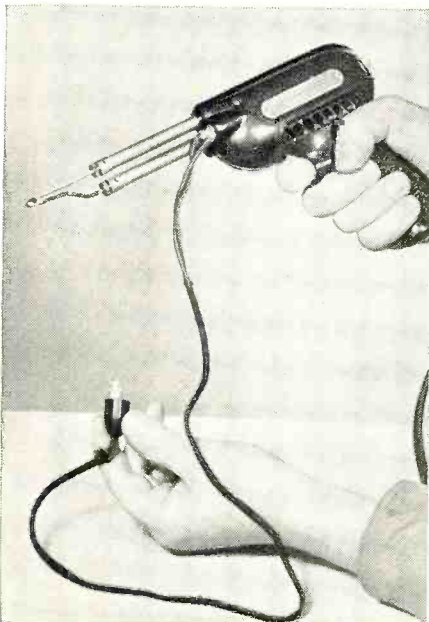

March, 1952

Be "ECONOMY- WISE" with

GREYLOCK TERRIFIC TUBE BUYS!

All tubes listed below carry 6 month Guarantee—excepting only burnouts and breakages. At these sensationally low prices, these tubes must be ordered in quantities of AT LEAST 10 ASSORTED TYPES—add 10% for orders under 10 tubes. All individually boxed in attractive Greylock Cartons.

1L4	6AT6	6J5GT	12AU6
155	6AU6	6J7GT	12A8GT
1U4	6AV6	6S4	12BA6
1U5	6BA6	6SK7GT	12F5GT
3Q4	6BE6	6V6GT	12BE6
3V4	6C4	6W4GT	25Z5
5Y3GT	6C5GT	6X4	35W4
6AL5	6C6	6X5GT	35Z5GT
6AQ5	6CB6	12AT6	117Z3

YOUR NET COST EACH **49¢**

1V2	6BC5	12AX4GT	12SQ7GT
5U4G	6SA7GT	12BA7	25Z6GT
6AB4	6SL7GT	12J5GT	35Y4
6AQ6	12AL5	12Q7GT	50B5
6AS5	12AV7	12S8GT	80

YOUR NET COST EACH **69¢**

1LA4	1X2	6BJ6	6SG7
1LN5	6BH6	6J6	7A8
1N5GT			12AT7

YOUR NET COST EACH **89¢**

0Z4M	6AR5	12AU7	35B5
1R5	6R7GT	12AV6	35C5
1T4	6SQ7GT	12AX7	50C5
3S4	6SN7GT	12SK7GT	50L6GT
5X4G	6U4GT	25L6GT	

YOUR NET COST EACH **59¢**

1LC5	6BQ6	7N7	12SN7GT
6AG5	6T8	7X7	25BQ6GT
6AK5	6Y6G	12K8GT	35L6GT
6AK6	7A7	12SA7GT	
6BA7	7E5		

YOUR NET COST EACH **79¢**

12BH7	6AC7	14C5	7C7
19TB	32L7GT	1A7GT	

YOUR NET COST EACH **99¢**

6BG6G	\$1.09	12AZ7	\$1.29
19BG6G	1.09	6AH6	1.29
183GT	1.19	6BQ7	1.49
6AG7M	1.19	6V3	1.59
6CD6G	1.29	807	1.79
6BL7GT	1.29	7JP4 CRT	16.50

SPECIAL—6AR6\$2.49



SPEAKER SPECIALS

Permanent Magnet—Alnico No. 5 Slugs	
3" PM .68 oz.	\$1.09
4" or 5" PM .68 oz.	1.29
6" PM 1.0 oz.	1.59
6x3" PM 3.16 oz.	3.49
8" PM 2.15 oz.	3.69
10" PM 6.8 oz.	5.99
12" PM 3.2 oz.	4.95

AUTO SPEAKERS

7 1/4" 4-ohm dynamic less output	\$2.19
7 1/4" PM less output	4.95



4 ELEMENT CONICAL ANTENNAS

Constructed of reinforced butt seam aluminum elements and strong steel cross bars; ruggedized insulators.

minum elements and strong steel cross bars; ruggedized insulators.

SINGLE Order #P-003..... **\$3.99**

STACKED Order #P-004..... **\$8.29**

Extra elements for conicals to make fan-flector type.

P-009—Low Band Elements, each.....49¢

P-010—High Band Elements, each.....35¢

CHIMNEY MOUNTS #E-1585.....Only 99¢

TERMS: Net C.O.D., F.O.B. New York City. 25% Deposit on all C.O.D. orders.



HIGH VOLT. FLYBACK TRANSFORMER 14K VOLTS

Used for 13", 17" round or rectangular tubes. Good for conversion and replacement use. Many set mfrs. used this flyback transformer in their sets and paid more than this for them! Order #B-2612 Each. ONLY.....\$2.99

GREYLOCK "BONDED" ELECTROLYTIC CONDENSERS

Guaranteed Fresh Stock



Mfd.	W.V.DC	Net each	Mfd.	W.V.DC	Net each
16	150	\$0.29	40 x 40	150	.45
24	150	.35	50 x 30	150	.45
30	150	.35	8	8	.29
40	150	.39	8 x 8	450	.45
20 x 20	150	.39	16	450	.39
20 x 40	150	.39	30	450	.44
30 x 30	150	.44	40	450	.49

Above prices are for minimum quantities of 10 assorted condensers. Deduct additional 10% discount in lots of 100 assorted condensers.

WHILE THEY LAST! FAMOUS MAKE TV BOOSTER list 32.50—Order #Q-001 16.95

MANY ADDITIONAL VALUES! Write for our latest supplement and complete Catalog N-3

"A Trusted Name in Radio"

GREYLOCK ELECTRONICS SUPPLY CO.
115 Liberty Street - New York 6, N. Y.

SENSATIONAL SURPLUS ELECTRONIC ASSORTMENT

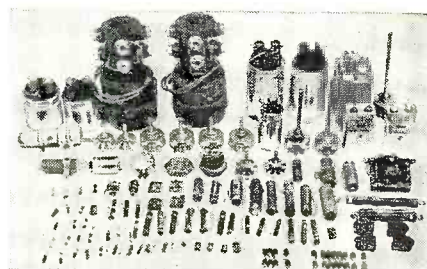

Remember—1 Coaxial Antenna Motor Alone Is Worth the Price of the Entire Assortment

COMPLETE ASSORTMENT ONLY \$19.95 A small Fraction of the original cost.
10% Off on All Orders of 5 Kits or More
Terms: 20% Deposit with order.
Balance C.O.D., F.O.B. N.Y.C.

LIMITED NUMBER! WHILE THEY LAST! EACH ASSORTMENT CONSISTS OF THE FOLLOWING—

- 2—24 Volt D.C. Coaxial Antenna Switching Motors; 2—Oil Cond. Upright Mt., .02 MFD x 8000 V. DC; 2—Oil Cond. Upright Mt., .01 MFD x 5000 V. DC; 1—Oil Cond. Upright Mt., .1 MFD x 3000 V. DC; 1—Oil Cond. Upright Mt., 5x3 MFD x 150 V. DC; 2—Oil Cond. Upright Mt., 1—1 MFD x 600 V. DC; 1—wire wound Potentiometer 2000 OHMS; 4—wire wound Potentiometer 20,000 OHMS; 2—wire wound Potentiometer 100,000 OHMS; 2—wire wound Potentiometer 250,000 OHMS; 1—Range Switch; 1—Filter Choke; 1—Mica Cond. .005—2,500 V. DC; 1—R. F. Choke; 1—Noise Filter Choke; over 20 other Oil & Mica Cond.; over 40 Resistors 3 W to 15 W; also fuses, Bulbs, Grid Caps, Hardware; numerous other items; All Parts New, individually boxed, in Mfrs. Original packing; Shipping Weight 24 lbs. Complete with list of parts.

REFONIC SALES CO., 397 Mosholu Parkway North, Bronx 67, N.Y.



Sarkes Tarzian

"Centre-Kooled"

SELENIUM RECTIFIERS

Just Off The Press—

Most complete book of its kind ever published . . . 80 pages of valuable information about Selenium Rectifiers . . . 48 pages of Radio and Television circuit diagrams . . . 20 pages on Power Rectifiers . . . 3 pages on High Voltage Rectifiers . . . a 7 page cross index replacement guide. Send 50c for your copy or see your distributor.

Sarkes Tarzian, Inc., RECTIFIER DIVISION
Dept. R-1, 415 N. College Ave.,
Bloomington, Ind.



HEY, MAC!

ONLY **\$2.95**

3-TUBE AC-DC PHONO AMPLIFIER KIT

Easy to build with our big pictorial and schematic diagrams. Plays with excellent fidelity and volume. Complete with pre-punched chassis, parts and hardware. Shipped less 125Q7, 50L6 and 35Z5 tubes and small amount of wire and solder required. Operates on 110-120 volts AC or DC. A big buy for little money!

Kit of 3 tubes for amplifier . . . \$2.46
5" Alnico PM Speaker . . . 2.15

VOCATRON PORTABLE WIRELESS INTERCOM

No special wiring or installation required. Operates on any 105-125 volt AC or DC lighting circuit over distances up to 1/2 mile! Extra units may be added for multiple station system. Neat plastic cabinets measure only 6 3/4" x 4 3/4" x 5 1/4". Complete with tubes, ready for instant use. Per pair . . . \$79.50
Extra Vocatron Intercom Unit . . . 39.75

High-Gain Conical Antenna

\$3.75 each
in lots of 10
\$4.25 singly

A-547

High-gain conical for all channels. Excellent directional response. Durable aluminum with unbreakable molded polystyrene insulators and many other exclusive features. Elements may be stacked.

300-ohm Twin Lead . \$2.50 per 100. \$19.95 per 1000
5-ft. Aluminum Mast . . . \$1.03 singly
93c each in lots of 10

STAR ELECTRONIC DISTRIBUTORS, INC.
Dept. RN-3-7736 S. Halsted, Chicago 20, Ill.



Low Cost Powerful P.A.!
COMPLETE • READY TO USE

Tops for powerful indoor-outdoor use; ideal for electioneering. Easy portability. Covers 4,000 persons indoors, up to 25,000 sq. ft. outdoors. Full 30 watts usable output; 2 high-imp. mike inputs, 1 phono input, each with separate volume control; tone control; fidelity ± 2 db from 40-20,000 cps. Complete system includes: 30 watt amplifier and tubes, Electro-Voice "Cardax" unidirectional mike with adjustable floor stand and 20' cable; 2 General Electric 12" PM speakers, each with 30' cable; portable carrying case holds all, 16 1/4" x 12 1/4" x 25". For 110-130 v., 60 cy. A.C. Shpg. wt., 75 lbs. Complete, less only phono top.

93-372. Complete 30 Watt System. Only \$119.75
93-340. 3-Speed Phono Top for above. Only \$16.95
Available on Easy Terms—write for details

FREE See the 212-Page ALLIED Catalog for other Sound Systems, ranging from 8 to 80 watts. Write for Free copy of Radio's leading Buying Guide today.

ALLIED RADIO
833 W. Jackson Blvd., Dept. 1-CA-2, Chicago 7, Ill.

Interlacing Troubles
(Continued from page 65)

uits are available which provide more accurate vertical synchronizing than does the integrator.

Vertical A.F.C.

Most current television receivers use flywheel synchronization to keep the frequency of the horizontal oscillator from being changed from one line to the next by noise. A similar system can be used to keep the frequency of the vertical oscillator from being changed from one field to the next by interference from horizontal sync or deflection signals. There is one receiver available using such a circuit, the *Radio Craftsmen RC-100* (RADIO & TELEVISION NEWS, February 1950, pages 51-53). The vertical deflection circuit of this receiver is shown in Fig. 2.

Some technicians will notice that this circuit is similar to one used by *Emerson* and others, for horizontal a.f.c. Positive and negative sync pulses are obtained from the inverter and applied to the sync discriminator, along with a signal from the vertical amplifier. The output voltage from the sync discriminator, which depends upon the phase relation between the sync pulses and the receiver deflection signal, is amplified and applied to the vertical oscillator as bias, to control its frequency. The synchronizing pulses are not applied directly to the oscillator and the control voltage is prevented from changing rapidly by C_{rs} . One novel feature of this circuit is that the deflection signal for comparison with the sync pulses is obtained from the screen of the 6AQ5 vertical output tube. This electrode has no d.c. voltage applied to it, but the vertical signal is coupled from the plate to the screen by inter-electrode capacity. The vertical oscillator plate voltage is not obtained from the damper in this receiver, so that possible source of horizontal interference is removed.

A theoretical disadvantage of a.f.c. for the vertical circuit is that it is too stable. When the video signal source is changed, at a station break or when switching channels, the picture at the receiver generally rolls through part of a frame before becoming stationary again. The reason, of course, is that the new vertical signals are not in-phase with the previous ones and the receiver phase must be changed to correspond. If the time constant of an a.f.c. system is made short so that the speed of the receiver's phase change can be very rapid, its immunity to interference will be reduced.

Vertical Separators

Several other circuits have been developed, some of which offer advantages over both the integrator and a.f.c. Apparently none of these has been used in a regular production model American television receiver, possibly because few complaints have

been received by the manufacturers about the performance of the integrator circuit and because these circuits are more expensive than the integrator, although less expensive than a.g.c.

A method of vertical sync separation which makes it possible to obtain a sharper output pulse than that of the integrator and faster action and less cost than a.f.c. uses a differentiator followed by a clipper. A simple circuit of this type was outlined by P. Mandel, *Radio-Industrie*, Paris, France, in "An Experimental Large-Screen Television Projector," *Proceedings of the I. R. E.*, December 1949, page 1464. (See Fig. 3.) A positive composite synchronizing signal is applied to a differentiator having a time constant comparable to a line interval. The output of the differentiator consists of positive pips at the beginning and negative pips at the end of each horizontal sync pulse, equalizing pulse, and section of the serrated vertical pulse. The negative output pip in each case begins at the level reached by the trailing edge of the positive pip. During the short horizontal sync and equalizing pulses the condenser cannot assume much of a charge and the output voltage across the resistor cannot fall very far. Therefore the pips which come at the end of the horizontal and equalizing pulses begin at a large positive value and do not reach a very large negative value. In the case of the much longer vertical sync pulses the condenser has a longer time to charge and the voltage across it reaches a higher value, while the voltage across the resistor falls to a lower value. Hence the pips which appear in the output at the end of each vertical pulse begin at a less positive value and extend to a more negative value than the pips following the horizontal and equalizing pulses. A clipper can, therefore, be used to pass only the pulses corresponding to the notches in the vertical synchronizing pulse. Short noise pulses will be rejected in the same manner as horizontal and equalizing pulses.

Fig. 3. Vertical sync separation by means of differentiator (A) and diode clipper (B).

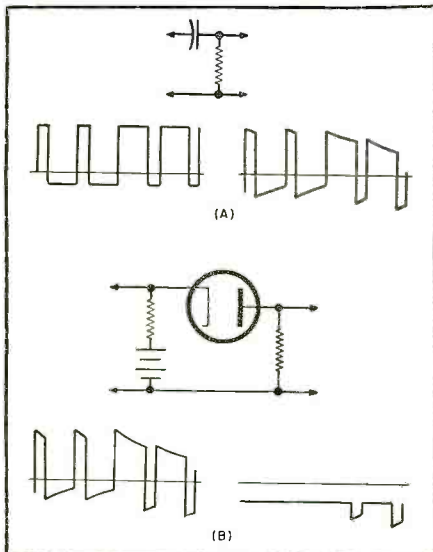

Tube Prices SMASHED!

80% to 90% off list!

Dependable performance and economical service are two outstanding features overshadowing even these sensationally low-low priced, high quality, fully guaranteed tubes. Every tube must pass rigid tests in our plant. You can compare RAD-TEL tube performance and quality with any standard tube anywhere.

Check this list for Fully Guaranteed Tubes

Type	Price	Type	Price	Type	Price	Type	Price	Type	Price
1A6	.59	5A24	.39	6BL7	.59	6T8	.56	14J7	.55
1A7GT	.47	5U4G	.40	6BN7	.79	6U5	.44	14W7	.55
1AB5	.59	5V4G	.54	6BQ6GT	.59	6U8	.59	19BG6G	.59
1B3	.49	5Y3GT	.32	6C4	.37	6V6GT	.39	19T8	.79
1B5	.59	5Y3G	.32	6C5GT	.39	6W4GT	.44	25BQ6GT	.62
1B7GT	.59	5Y4G	.35	6C86	.44	6W6GT	.44	25L6GT	.39
1C5GT	.43	5Z3	.39	6CD6G	1.11	6X4	.37	25Z5	.40
1G6	.55	6A3	.59	6E5	.48	6X5GT	.37	25Z6GT	.37
1H4	.46	6AB4	.44	6F5GT	.39	6Y6G	.48	32L7	.85
1H5GT	.40	6AC7	.59	6F6G	.39	7E6	.43	35B5	.40
1I4	.46	6AG5	.43	6F6GT	.37	7X6	.39	35C5	.39
1I6	.43	6AJ5	.90	6G6G	.52	7Z4	.37	35L6GT	.41
1I6C5	.51	6AK5	.75	6H6GT	.41	12A8GT	.46	35W4	.37
1I6C6	.48	6AL5	.38	6J5GT	.37	12AL5	.37	35Z5GT	.37
1I6C7	.51	6AQ5	.39	6J6	.52	12AT6	.37	36	.49
1N5	.46	6AQ6	.37	6J7G	.43	12AT7	.56	41	.42
1P5	.57	6AR5	.37	6J8G	.63	12AU6	.38	42	.42
1R5	.45	6AT6	.37	6K6GT	.37	12AU7	.43	43	.55
1S5	.39	6AU6	.38	6K7G	.44	12AV6	.39	45	.55
1T4	.45	6AV6	.37	6K7GT	.44	12AV7	.59	50B5	.39
1T5	.53	6B4G	.64	6L6G	.64	12AX4	.48	50C5	.59
1U4	.45	6B5	.64	6L6GA	.64	12AX7	.48	50C6	.59
1U5	.39	6BA6	.39	6S4	.38	12BA6	.38	50L6GT	.41
2A3	.59	6BC5	.44	6S8	.53	12BA7	.46	50X6	.53
3A4	.45	6BD5GT	.59	6SA7GT	.43	12BE6	.39	50Y7	.39
3E5	.46	6BE6	.39	6SD7GT	.41	12K7GT	.46	70L7GT	1.09
3Q4	.48	6BF5	.41	6SG7GT	.41	12Q7G	.39	76	.44
3Q5GT	.49	6BF6	.37	6SJ7GT	.41	12SA7GT	.44	80	.35
3S4	.46	6BG6G	.94	6SK7GT	.41	12SK7GT	.48	117L7	.89
3V4	.47	6BH6	.46	6SL7GT	.48	12SL7GT	.47	117Z3	.37
5AX4	.37	6BJ6	.39	6SN7GT	.52	12SN7GT	.52	807	.99
				6SQ7GT	.37	12SQ7	.44	1274	.99
				6SR7	.37	12SR7	.49	1276	.99



PICTURE TUBES . . .

14BP4 ... 14.50 16RP4 ... 19.50
17BP4 ... 19.50

TERMS

A 25% deposit must accompany all orders—balance C. O. D. All shipments FOB Newark warehouse. Orders under \$5—\$50 Handling Charge. Subject to prior sale.

32 BEECHER STREET
NEWARK, NEW JERSEY

\$\$ SAVING SPECIALS \$\$

- VARIAC GENERAL RADIO CO. 200C 5 to 7 1/2 AMP 115VAC in 0-135VAC out from new equip. \$16.50
 - WEETER Q-150VAC Weston or West, 2" R iron vane 5.00
 - MOTOR 4 pole shaded pole induction 1700 RPM G.I. 1/70 HP running torque 12 oz. inches list \$12.00 F/tape wire or disc recording. 3.50
 - HEADSET TELEX monoset Mod. 2570 reg. 14.00 5.95
 - MICROPHONE SMURE 707A & S343 desk stand. 6.75
 - SPEAKER 6" R 3 ohm VC 5 oz. Alnico 5 PM. 1.75
 - SPK. 4x6" 3 ohm VC 5 oz. Alnico 5 mag. PM. 1.65
 - SPK. L&S Grade 1 & 2 Navy water proof RCA. 14.95
 - Switch Radio. Phono. Water winding type. 6" MAGNETIC OVERLOAD RELAY A-B S10 20 Mil to 290 mil also 12 to 18 AMP and 15 to 43 Amp. 600 V. max. dash net. your choice. 2.95
 - CURRENT RELAYS WESTINGHOUSE type SC. 2 Amp to 1 Amp with glass cover reg. \$40.00. 3.95
 - RECTIFIERS Red. Sol. 403D2787 150 Ml 130V CIRCUIT BREAKERS Heilmann Cat. 0711 5 amp 115VAC curve D \$1.25 30 Amp. 1.65
 - POWER TRANS. Thordarson 70R2 350 550 745 mil 5V 3 Amp 6.3V 4.5 Amp from used equip. 2.95
 - OUTPUT TRANS. RCA pair 616 class AB 16 watt Sec. 4-8-15-250 ohms a rest. your choice. 1.50
 - CHOKE THORDARSON 13C30 S.H. 150 Mh. 1.25
 - CHOKE THORDARSON 4 H. 500 Mh. enclosed. 4.50
 - CHOKE CHICAGO trans. Co. 6 H 80 mil 50 ohm 1000 MFD 15 VDC Sprague C431A Condenser.95
 - 3500 X 3500 MFD 25VDC Solar DZP 4 pin can. 1.50
 - 8X8 MFD 150V 4 pin tube85
 - SCOPE TUBES 5BP1, 5BP4, 5CP1, 5FP7. 2.50
 - XTALS 2 meters 146.16 MC DC3 holder. 2.00
 - XTALS 500 KC standard GR-2B 1/2 special. 18.50
 - BC453 190 to 550 KC receiver, brand new. 24.50
 - BC696 3 to 4 meg transmitter, brand new. 5.95
 - BENDIX TA12B trans. front end 1 section. use covers 1050 KC to 7 MC uses 6SK7 tubes new.
 - AIRCRAFT EQUIPMENT MG149F AS-27A Antenna DY-11 & 12 MW-26C & LB BC1023 C-457.
 - ARC-1 1-152 Ind. BC-347 Amp. AIC-AM26 inter. phone amp. DY-22/ARC3 BC732 cont. head DM53A etc. prices on request.
- Include postage with order. Min. order \$3.00
3834 Germantown Ave. Phila., Penna. RA 5-6033

"WE'RE TEARING OUR HAIR OUT . . ."



to buy desperately needed equipment such as ART-13, BC-348, BC-224, BC-342, BC-312, ARC-1, BC-2E1, R5/ARN-7 or components. In fact, we'll buy any parts or accessories no matter how small. For speedy, efficient service and a real honest deal, phone, wire or write:
V & H RADIO & ELECTRONICS SUPPLY CO.
2033 W. Venice Blvd., Los Angeles 6, Calif.
Telephone: REpublic 3-1127

GROMMES AMPLIFIERS

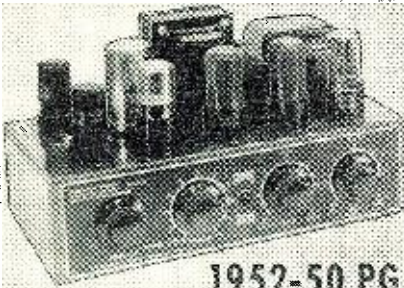

1952-50 PG

A 10 watt high fidelity single unit amplifier with unusual performance. It features extended frequency response with low distortion and plenty of reserve power. Ideal for conservative custom installations.

THE GROMMES 215BA "WILIAMSON"

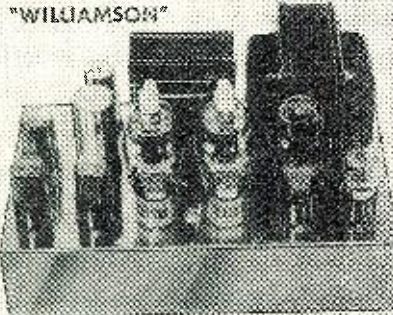

... newest addition to the famed Grommes Custom Line.

THE G SERIES



A complete line of P. A. and commercial amplifiers.

NEW TV CLARIFIER

Actually has FOUR TIMES the interference "Suck" of previous model.

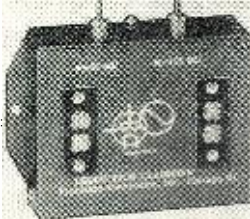

See your Jabber or WRITE FOR CATALOG

Precision Electronics, Inc.
641-643 MILWAUKEE AVE.
CHICAGO 22, ILLINOIS

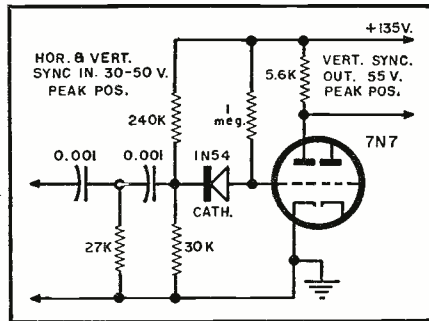

Fig. 4. Vertical sync separator and limiter.

A circuit based upon the same principle was presented by Robert C. Moses, *Sylvania Electric Products Inc.*, in "Improved Vertical Synchronizing System," *Electronics*, January 1951, pages 114-118. (See Fig. 4.) Here the output of the differentiator is applied to a crystal diode biased so as to pass only the negative pips corresponding to the vertical notches. These pulses are then amplified, inverted, and limited by the triode circuit.

This type of vertical separator circuit can be added to most existing television receivers without much trouble. The parts other than the tube would not occupy much more space than the integrator; for the extra triode one of several provisions could be made. Some receivers have unused socket holes on their chassis. In those which have a single triode vertical oscillator, a twin triode in the same socket can be used as oscillator and vertical sync clipper. In other cases, separate oscillator and amplifier tubes can be replaced by a twin triode to free one socket for the sync clipper. In almost any case, a vector socket turret could be used to add another socket.

Differentiator-Heptode Clipper Vertical Separator

An earlier circuit, in which the same principle is applied in a different and slightly more effective manner, was described by J. Hanntjes and F. Kerkhof, of *N. V. Philips' Gloeilampenfabriken*, Eindhoven, The Netherlands, in "Home Projection Television, Part III, Deflection Circuits," *Proceedings of the I. R. E.*, March 1948, pages 408-409. (See Fig. 5.) In this circuit the negative composite synchronizing signal is applied to a differentiator having a

Fig. 5. The differentiator-heptode clipper and vertical sync separator circuit.

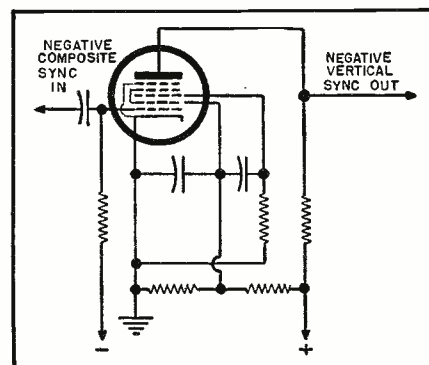

PERFORMANCE Not Size IS WHAT COUNTS



"LITTLE GIANT" LIGHTNING ARRESTER

PROTECTS

Against Lightning Hazards

No. AT 105

For ribbon-type and oval jumbo twin lead.

\$1.25 LIST

ONLY JFD Lightning Arresters offer you these exclusive patented features . . .

1. Strain-relief Retaining Lip prevents pulling or straining of lead against contact points.
2. You actually see positive contact made with lead-in wire.
3. No wire stripping or cutting.

Write for Form No. 84 showing the damage lightning can do to a Television Installation.



JFD MANUFACTURING CO., Inc.
6127th 16th AVENUE, BROOKLYN 4, N. Y.
FIRST in Television Antennas and Accessories

The **APRIL** Issue of
RADIO & TELEVISION NEWS will be on sale
April 1st



EVERY RADIOMAN

Can Use These

SERVICE HINTS!

Valuable Manual Yours—FREE!

Every page of "How to Simplify Radio Repairs" is packed with on-the-bench, practical ideas. Contains photos, charts, diagrams—no fluff—no vague theory. In plain every-day language it gives you priceless suggestions—new servicing ideas. You'll use and benefit from the experience of experts. Partial list of contents: How to Localize Trouble; How to Service Amplifiers; How to Test for Distortion; How to Test Audio Circuits; How to Test Speakers; How to Find Faults in Oscillators; How to Test Radio Parts—and it's all yours—FREE! No obligation.



SEND COUPON OR PENNY POSTCARD FOR YOUR FREE COPY TODAY!

FEILER ENGINEERING CO., Dept. 3H2
8026 N. Monticello Ave., Skokie, Ill. (Suburb of Chicago)

Please RUSH my FREE copy of "How to Simplify Radio Repairs."

Name

Address

City..... Zone..... State.....

RADIO & TELEVISION NEWS

time constant of approximately one-half line interval. In the output of the differentiator larger positive pips occur at the time of the vertical notches than after the horizontal and equalizing pulses. These pips are applied to the first grid of a heptode, which is biased so that current flows only during the vertical notches. During the first notch plate and screen current flow and both voltages fall. The screen bypass condenser has a relatively small capacity, so that the screen voltage can fall appreciably during this time. Since the third grid is connected to the screen through another condenser, the decrease in positive screen voltage makes the third grid go negative until the condenser has time to charge. The third grid is driven sufficiently negative to cut off plate current even while the bias on the first grid allows screen current to flow. The time constant in the circuit of the third grid is long enough to keep plate current cut off until the remaining notches in the vertical pulse have passed. The result is that the only signal at the plate of the tube is a short negative pulse of voltage at the time of the first notch in the vertical sync pulse.

In the original Philips circuit, the heptode vertical separator was one section of a dual-section tube, the other section being a triode used as the vertical oscillator. No available American tube is equivalent. All of our triode-heptodes have the grid of the triode section connected internally to one of the grids of the heptode. Several alternate courses are open to the American experimenter desiring to try the circuit:

First, to use a European triode-heptode. The ECH4, which has a 6.3 volt, .35 ampere, heater, is available from *North American Philips*. It has a European type base, however.

Second, to use an American triode-pentode, connecting the three grids of the pentode as the first three grids of the heptode are connected in the circuit of Fig. 5. Only one American type is usable. Most of our triode-pentodes have the third grid of the pentode connected to the cathode internally. The recently announced type 6X8 nine-pin miniature has separate connections for the plates and all of the grids of both sections, although there is a common cathode connection.

Third, to use a separate heptode for the vertical separator tube. Several pentagrid mixers and pentagrid converters are available which could be used.

Fourth, to use a separate pentode, connecting it as described under the triode-pentode. In this case, it would be preferable to use a pentode in which the suppressor is constructed to be an effective second control grid, such as the 6AS6 or 7AK7, although other sharp cut-off pentodes would probably work.

Fifth, to use a gated-beam tube, type 6BN6. The limiter grid of this tube produces an unusually sharp cut-off.

-30-

March, 1952

RIGHT!

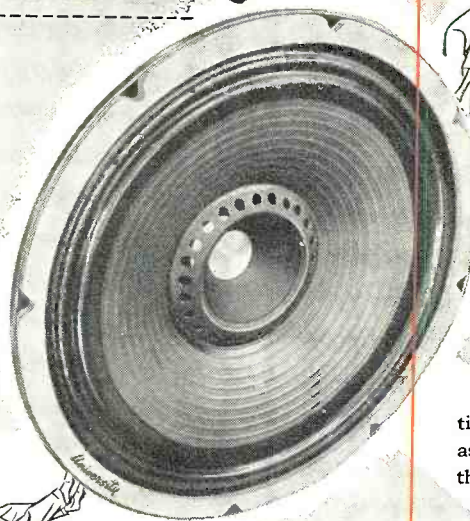

— from any angle

A challenging answer to low cost, wide-angle high fidelity reproduction. Diffusicone-12 is a newly engineered speaker with exclusive, dual concentric cone design, which diffuses the normally beam-like high frequencies. Results in exceptionally uniform response . . . assures full range reception over the entire listening area.



Write today for Bulletin 62N73
— address inquiries to Desk 38.



THE NEW

University DIFFUSICONE-12

An Engineering Achievement of UNIVERSITY LOUDSPEAKERS INC.
80 So. Kensico Ave., White Plains, New York

TOP QUALITY! LOW COST!

FISHER

HIGH QUALITY

Phonograph Preamplifier

■ Here is the top quality, reasonably priced preamplifier you have always wanted. The FISHER provides exact equalization for low-level magnetic pickups of any make, such as GE, Pickering, Audax, Clarkstan and others; also used as a microphone preamplifier.

List \$20.95



Outstanding Features:

- Uniform response, 30 to 20,000 cycles.
- Self powered. Two stages of triode amplification. Extremely low hum.
- Full low-frequency equalization. High gain. Completely enclosed chassis with bottom cover. Plugs supplied.
- Output cable can be up to 50 feet in length. size: 3¼ x 3⅝ x 3⅝ high.

WRITE FOR FULL DETAILS

FISHER RADIO CORPORATION
39 E. 47TH ST., NEW YORK

PEAK FOR VALUE!

Power Transformer Bargains

115 Volt, 60 Cy. Primary, 800 Volts CT. @ 250 MA., 6.3V @ 4A, 6.3V @ 4A, 6.3V @ 2A, 5V @ 2A, 5V @ 2A. Fully Cased. **\$7.89** ea.
BRAND NEW, Wt. 14 Lbs. Only \$3.75 ea.
 750 Volts CT @ 200 MA., 6.3V @ 10 Amps, 5VC 3A. Fully cased, removed from TV equipment. Guaranteed. **\$3.75 ea.**

SCOPE TRANSFORMER BARGAIN

2500V. @ 3 MA. 2.5V. @ 2A. 6.3VC. 6 Amp. Removed from TV equipment. Terrific value. Guaranteed. **\$1.89**

SENSITIVE RELAY

parsonal moving coil type, mounted in meter case. Adj. 700 microamps to 1 ma. Made by Triplet. **\$5.75** ea.

6 VOLT DC RELAY

Small Size. Ideal for Mobile Use, SPDT

\$0.99

PANEL METERS

NEW GOV'T SURPLUS STANDARD BRANDS
 *Special Scale

2" METERS

0-100 MA* \$2.45
 0-10 MA, AC 2.95
 0-2 AMP RF 2.95
 0-4 AMP RF 2.95
 0-50 AMP AC 3.25
 0-30 AMP DC 2.95

3" METERS

0-1 MA 4.95
 0-2 MA 4.50
 0-2.5 AMP RF 5.95
 0-500 MA 4.50
 0-100 VDC (1 MA) 5.95
 0-200 VDC (1 MA) 5.95
 0-250 VDC (1 MA) 5.95
 0-750 VDC (1 MA) 5.95
 0-150 VAC 6.95
 0-300 VAC 6.95

FILTER CHOKES

10 Hy 175 MA \$1.25
 10 Hy 250 MA 2.75
 10 Hy 350 MA 3.95
 6 Hy 500 MA 4.95
 6 Hy 400 MA (Risky) 2.95

PIGTAIL MICAS

MMF: 5, 20, 50, 60, 100, 250, 300, 400, 500, 750, 800, 1000, 2000, 3000, 4000, 5000, 6000, 10000. \$0.09 ea.

Silver Mica Capacitors

MMF: 10, 50, 60, 340, 750, 780, 1000. \$0.12 ea.

Non-Inductive Resistors

Ohms: 500, 12,500, 100 watts. \$0.75

FILAMENT TRANSFORMER

6.3 Volts at 10 Amps plus 2.5 Volts CT at 12 Amps. 3500 Volt insulation. Primary 115 Volt 60 Cy. Fully shielded. **\$2.99** ea.

BAKELITE CASED MICAS

MFD	VDC	Price	MFD	VDC	Price	MFD	VDC	Price
.001	600	\$18.	.024	1500	\$0.65	.001	5 KV	\$1.60
.002	600	.24	.033	1500	.75	.002	5 KV	1.60
.01	600	.26	.005	2500	.55	.003	5 KV	1.90
.02	600	.28	.002	2500	.45	.001	6 KV	2.50
.01	1 KV	.45	.004	2500	.55	.001	6 KV	2.50
.002	1200	.35	.00015	5KV	.70	.002	6 KV	2.90

WIRE WOUND RESISTORS

5 watt ohms: 25-50-84-200-2500 \$0.09 ea.
 10 watt ohms: 25-40-1325-2K-4K 15 ea.
 20 watt ohms: 150-300-750-1K-1.5K, 2.5K-2.7K-10K-20K 20 ea.
 30 watt ohms: 100-2500-5300-18K 22 ea.
 100 watt ohms: 100-3750-15000-2K, 10K, 15K, 20K, 100K 59 ea.

POWER SUPPLY KIT

1-UTC Power Transformer 700 VCT @ 60 ma, 5V @ 2A, 6.3V @ 1.2A.
 2-UTC 60 ma chokes. Transformer and chokes fully cased. Transf. and 2 Chokes. **SPECIAL \$3.95**

ADJUSTABLE SLIDER RESISTORS

20 Watt: 1, 5 Ohms \$0.25
 50 Watt: 500 Ohms39
 75 Watt: 100, 150, 200 Ohms 4 for .89
 100 Watt: 50, 375069

MISCELLANEOUS BARGAINS

Ceramics .0005 mfd 7 for \$0.49
 .05 600V Oil Tubular 12 for .99
 10K, 15K Pots 4 for .89
 Air Padder 50 MMF, APC5039
 .01 MFD, Moulded Paper Cond. 20 for .99

PEAK ELECTRONICS CO.

188 WASHINGTON ST., NEW YORK 7, N. Y.

Phone COrtlandt 7-6443-4

NEW TV PRODUCTS on the Market

ROTATOR ADAPTER KIT

A new rotator adapter kit, designed to permit the installation of any commercial antenna rotator on its antenna towers, has been announced by *Alprodco Inc.*, Kempton, Indiana.

The adapter, which can be installed easily and quickly without special tools, consists of four matched components. These components include an adapter mounting plate, pre-drilled to accommodate any well-known rotator, upon which the rotator is mounted. This is placed within the framework of the tower itself. A ten-foot mast pole is provided to connect the antenna to the rotator, the pole being held securely within a 24 inch bearing, the third component in the kit. Finally, a three-piece mast kit is included which affords the necessary rigid support to keep the mast pole bearing in place.

Literature on this new kit is currently available from the company.

HIGH "Q" TRAPS

A new line of high "Q" traps, designed for use between the television receiver and its associated antenna to eliminate adjacent channel and FM interference, has been introduced by *Jer-*

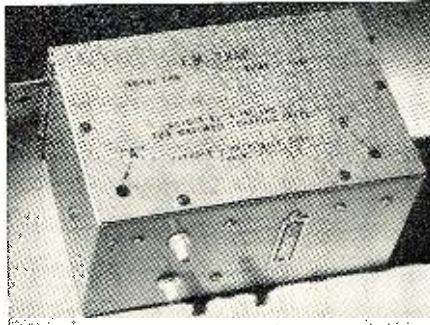

rold Electronics Corporation, 26th and Dickinson Street, Philadelphia 46, Pa.

The traps are available in four models. The TLB covers Channels 2 through 6. The Model THB is designed to trap out adjacent channel interference on Channels 7 through 13. Interference from FM stations is trapped by using Model TFM, covering the range from 88 to 108 mc. The fourth unit has been designated as the Model "T Special" and is available on special order. It can be designed so as to eliminate interfering frequencies in any bands other than v.h.f. television and FM.

Full technical details are available on request.

SWITCHING BOOSTER

Tel-A-Ray Enterprises, Inc. of Henderson, Ky. has perfected an antenna switching booster which is capable of receiving signals from four antennas

and can be switched from one to another.

Designed for fringe area reception where single-channel antennas perform better than multi-channel units, the new switching booster is equipped with four input terminals for four sep-

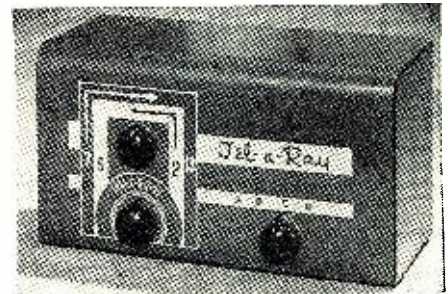

arate antennas, any one of which may be switched from the front. Four sets of terminals, supplying 6-7 volts a.c. for operation of up to four antenna-mounted preamplifiers, are mounted adjacent to the four input terminals and automatically switched as the antennas are switched.

A 6J6 preamplifier is an integral part of the switching booster and increases the strength of the signal as it arrives from the antenna. On occasions when the signal strength is naturally high, the preamplifier may be bypassed. The booster features an automatic switch which turns the booster on and off with the receiver.

ANTENNA ROTATOR

Viking Tool and Machine Corporation of Belleville, New Jersey has developed a new antenna rotator which is currently being delivered to the trade.

Powered by a simply designed impulse motor, the rotator assures full starting torque of 50 inch-pounds to give it maximum advantage in icy and adverse weather conditions.

Corrosion resistant materials are used throughout. The unit comes complete with a remote control box. An antenna direction indicator is available if desired.

CORONA INHIBITOR

The Receiving Tube Division of *Raytheon Manufacturing Company* has developed a line of picture tubes treated with the company's new "corona inhibitor."

Under certain atmospheric conditions, technicians have experienced difficulty with loss of picture brightness due to leakage, and arc-over from the second anode connector on the bulb of a television picture tube. This leakage from the second anode connection reduces the second anode volt-

age and, consequently, the brilliance of the picture. In addition, there may be audible effects from the corona. This difficulty has been experienced in varying degrees of intensity and in those cases where the leakage or corona has been slight, many valuable manhours have been lost tracking down the source of trouble.

According to the company, the new tubes treated with the "corona inhibitor" have this problem solved at the source. The company will supply additional details on these new tubes to those making their requests direct to the Receiving Tube Division at Newton, Massachusetts.

27" METAL TUBE

Rauland Corporation, 4245 North Knox Avenue, Chicago 41, Illinois is in production on a new 27" rectangular picture tube with an extremely short metal-coned envelope.

The new tube, known as the Type 27QP4, is a rectangular electrostatic focus, magnetic deflection, direct view tube. It is shorter from face to back than a standard 20" tube because of its 90 degree deflection design.

The screen of this new tube provides a picture area of approximately 390 square inches, about 40 square inches bigger than the center spread of a tabloid newspaper.

This tube can be used as a zero-voltage focus or can be focused to maximum sharpness with low voltage from the set's regular power supply. A single external magnetic field must be used in conjunction with the indicator ion trap to prevent ion spot blemish.

POWER RECTIFIER

General Electric Company, Syracuse, New York has developed a new power rectifier for television receivers, radios, and military electronic equipment.

The new rectifier has been designated the G-10 germanium rectifier. The unit operates on the junction prin-

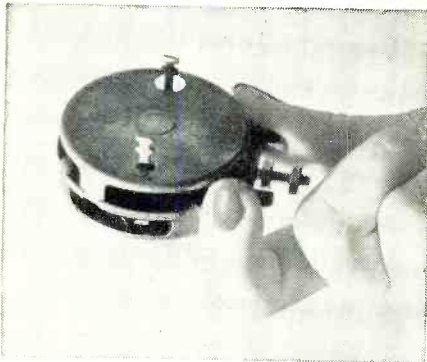

ciple and is designed to supply 350 ma. at normal television receiver plate voltages in a 55 degree centigrade ambient. It has a peak inverse voltage rating of 400 volts, with rectification efficiencies up to 98 per-cent.

The unit's small size and higher "B+" voltages are due to the extremely low internal losses. Its forward resistance at rated current is approximately 3 ohms and back resistance is about 1 megohm at -350 volts.

March, 1952



let's talk SENSE about BOOSTERS

You don't use a 5-ton truck to haul 10 light bulbs! The same basic logic applies to TV boosters, too. In many "weak station" areas, in sets forced to use only indoor antennas, in RF-boosted sets still needing more gain—experience proves a **20% average** boost in overall signal is all that's needed to give satisfactory reception.

Model TSB-1 does exactly that—and everything expected of an added stage of TV-IF—at low cost, to complete customer satisfaction, at a handsome profit for you. It's well-designed and wired up in Adaptor form for easy installation. Only one wire to connect.

- AMPLIFIES SIGNAL OVER 20% ON ALL CHANNELS
- INCREASES PICTURE BRIGHTNESS
- ELIMINATES OR MINIMIZES "SNOW"
- HAS ALL ADVANTAGES OF BROAD BAND BOOSTERS
- ELIMINATES SEPARATE TUNING FOR EACH CHANNEL
- NO SWITCHES OR EXTERNAL CONNECTIONS
- SIMPLE, PERMANENT, EASY INSTALLATION INSIDE CABINET
- EQUALS PERFORMANCE OF MANY HIGHER-PRICED BOOSTERS

Specifications: 4" high, excluding tube. Min. Diam., bottom, 7/8". Max. Diam., top, 1 3/4". Silver-plated contact pins. Draws only 0.3 amp. additional filament current from set's filament transformer. Individually boxed with complete instructions.

See the Grayburne TV-IF Booster at your favorite distributor today. Write now for complete catalog.

GRAYBURN CORPORATION, 103 Lafayette St., New York 13, N. Y.

ROUND, SQUARE, KEY and "D" OPENINGS QUICKLY MADE with Greenlee Radio Chassis Punches

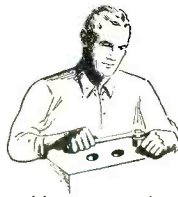
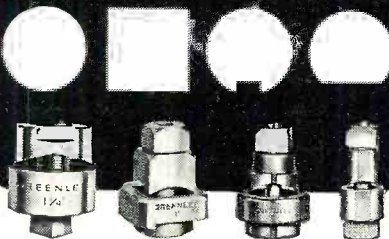

Save hours of hard, tedious work . . . cut accurate holes in chassis for sockets, plugs, controls, meters, panel lights, etc. with GREENLEE Punches. In 1-1/2 minutes or less make a smooth hole in metal, bakelite or hard rubber up to 1/16" thick. Easy to operate . . . simply turn with ordinary wrench. Wide range of sizes. Write for details. Greenlee Tool Co., 1883 Columbia Avenue, Rockford, Ill.



NOW—Get this expert SELF-TRAINING in RADIO SERVICING

by ABRAHAM MARCUS

co-author of famous "Elements of Radio" which has sold over 800,000 copies!

Here is every detail you need to know about radio repair, replacement, and re-adjustment. Easy-to-understand, step-by-step self-training handbook shows you how to locate and remedy defects quickly.

Covers: TRF Receivers; Superheterodyne Receivers; Short-Wave Receivers and Converters; Multiband Receivers; Portable Receivers; Automobile Receivers; Communication Receivers; F-M Receivers; Power Supplies operated from AC, DC, Batteries, Motor-Generators, etc.

Tells you the HOW and WHY of: Electron Tubes (Diode, Triode, Pentode, Beam Power, Thyatron, Phototube, Cathode Ray, etc.); Rectifier Circuits (Half-wave, Full-wave, Bridge, Voltage-Doubler, etc.).

Detector Circuits (Diode, Triode, Regenerative, Superregenerative, Infinite-impedance, etc.); Amplifier Circuits (Audio, Radio, I-F, Video, D-C, etc.); Oscillator Circuits (Hartley, Colpitts, Crystal, Transistor, Multiplier, Sweep-circuit, etc.); Control Circuits (Volume, AVC, DAVC, Tone, Noise-Suppression, Automatic Tuning, Automatic Frequency Control, etc.).

All in one big volume — easy to read. 16 Big Chapters. 121 Sections. 400 "Show-H ow" Diagrams. 775 pages of practical radio instruction.

Explains how to use testing instruments such as: meter, vacuum-tube voltmeters, ohmmeters, bridges, multimeters, signal generators, tube checkers, cathode-ray oscilloscopes, etc. Over 100 pages and 69 illustrations in this section alone!

Get this authoritative radio repair handbook today! Coupon below brings you "Radio Servicing" on FREE trial for 10 days. Mail it NOW.

PRENTICE-HALL, Inc., Dept. M-RN-352
70 Fifth Ave., New York 11, N. Y.

Send me, for 10 DAYS' FREE TRIAL, "Radio Servicing" by Abraham Marcus. I will return it in ten days and pay nothing—or keep it and send \$4.95 down (plus postage) and \$2 monthly for 2 months.

Name

Address

City..... State.....

() SAVE! Send \$5.95 WITH COUPON—we pay postage.

3

New
Custom-Built
Deluxe
TV Chassis

by **TECH-MASTER**

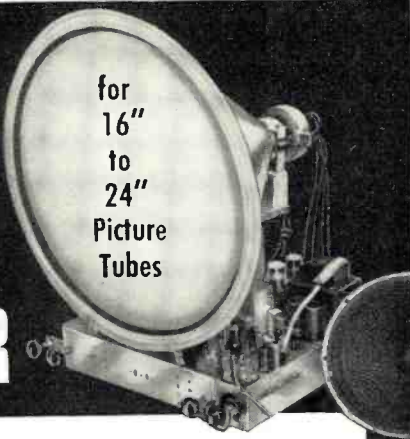

MODEL 2430—Designed specifically for all picture tubes requiring from 65 to 70 degrees horizontal deflection, (such as 24AP4, 20CP4, 19AP4, etc.) Supplied with quality PM speaker, and Universal Picture Tube Mounting Brackets & Photo Jack.\$189.50

MODEL 2431P—Similar to model 2430, but with Push-Pull Audio, True Fidelity Output and Universal Picture Tube Mounting Brackets.\$199.95

MODEL 2431C—Basically same as Model 2430 but with Continuous Tuner, Push-Pull Audio, True Fidelity Output and Universal Picture Tube Mounting Brackets. Allows complete coverage of both TV and F.M. bands.\$199.95

The new **Gold Medal Series** incorporates all the latest Tech-Master features which have made this improved 630 type chassis the standard by which custom-built TV is measured... performance and service are assured because Tech-Master design and construction are as fine as human hands and brains can produce. All chassis are supplied completely wired, aligned and tested with all tubes (less picture tube).

LOOK for your Tech-Master registration and guarantee card attached to each chassis... it is your assurance that you are buying a genuine Tech-Master receiver.

See the Gold Medal Series and other quality Tech-Master products at your favorite Radio Parts Jobber or write direct to Tech-Master Products Co. Dept. RN-3, for complete descriptive literature.



TECH-MASTER PRODUCTS CO.
443-445 Broadway • New York 13, N. Y.

Complete engineering details on the G-10 are available from the company together with information on other smaller units with lower voltage and power ratings.

U.H.F. SWEEP GENERATORS

The Tube Department of *Radio Corporation of America*, Harrison, N. J. has recently introduced two new u.h.f. sweep generators, the WR-40A and the WR-41A.

Both instruments feature continuous tuning from 470 to 890 mc. and operation is entirely on fundamental frequencies—no beat notes or harmonics

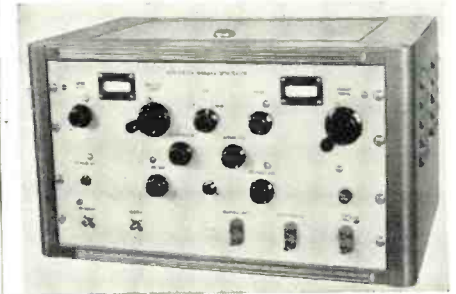

are used. They have a continuously variable sweep width from 0 to 45 mc. with an amplitude variation of .1 db per mc. or less throughout the swept range. The maximum output level of the sweep oscillator is .5 volt across a 50 ohm load. Facilities are also provided for matching to either a 72 or 300 ohm load.

The WR-40A is a laboratory-type instrument while the WR-41A is suitable for factory operations. Data sheets providing complete details on both of these units are available from the company.

TWO-SET COUPLER

A television coupler which permits the operation of two receivers from a single antenna is now being marketed by *Radio Merchandise Sales, Inc.*, 1165 Southern Blvd., New York 59, New York.

The unit has been designed to meet the requirements of two-set families or those living in apartment buildings or multi-family houses. Through this coupler, simultaneous reception on both sets is possible without interference from either set. Equal signals are provided to each set from the coupler which the company claims will reduce local oscillator radiation from the receiver and minimize incoming interference.

The coupler can be simply and quickly installed on the wall baseboard or other convenient location, at distances permitting the shortest leads to the receivers.

Literature on the coupler is available from the company on request.

FRINGE AREA ANTENNA

The latest addition to its line of fringe area TV antennas, the "Radarray" Model C, has been announced by the *Gonset Company*, 72 E. Tujunga Ave., Burbank, California.

This array is designed to give a clean

RADIO & TELEVISION NEWS

AMPERITE
Studio Microphones
at P.A. Prices

Ideal for
BROADCASTING
RECORDING
PUBLIC ADDRESS

"The ultimate in microphone quality," says Evan Rushing, sound engineer of the Hotel New Yorker.

• Shout right into the new Amperite Microphone—or stand 2 feet away—reproduction is always perfect.

• Not affected by any climatic conditions.
• Guaranteed to withstand severe "knocking around."



Models
RBLG—200 ohms
RBHG—Hi-imp.
List \$42.00



"Kontak" Mikes
Model SKH, list \$12.00
Model KKH, list \$18.00

Special Offer: Write for Special Introductory Offer, and 4-page illustrated folder.

AMPERITE Company, Inc.

561 BROADWAY • NEW YORK 12, N. Y.

Canada: Atlas Radio Corp., Ltd., 560 King St. W., Toronto

Amaze Yourself and Your Friends!
By Adding Pipe-Organ-Type Bass

to your present Amp. and Spkr. without muffling highs & middle

REVOLUTIONARY CIRCUIT INVENTION
only 4-resistors & 4-condensers

No. A25 Schematic & Data \$2.00

DULL'S ELECTRICAL TRANSLATIONS
702 N. Bancroft Wilmington, Del.

BRAND NEW TUBES

0A2	1.25	5J1	24.50	723A/B	516.50
0B3/VR90	1.10	5J15	24.50	724B	2.75
0C3/VR105	1.25	5R4CY	2.00	726A	5.95
0D3/VR150	.95	6AJ5	2.00	726B	39.50
1B22	2.95	6AN5	5.50	807	1.59
1B23	4.98	6A56	2.75	810	9.50
1B24	12.50	6E21	27.50	813	8.50
1B27	17.95			829	9.95
1B38	29.95			829B	12.50
1N21B	3.50			832A	9.95
1N22	1.25			833A	43.50
1N23	1.49			836	3.75
1N23A	2.75			838	1.49
1N23B	4.98			860	2.95
1N43	1.40			877	1.59
1N54	.89			872A	2.75
1N55	2.5	6J4	6.50	872B	.98
1N56	.89	7BP7	5.95	874	1.75
1P42	5.25	7V7	1.15	884	5.95
2C39	29.50	15E	.98	931A	.50
2C40	8.50	250R	8.95	955	.40
2C43	24.50	250TH	22.50	958A	.50
2C51	5.75	304TH	12.50	1616	.90
2E20	1.98	307A	3.95	1624	1.50
2E30	32.50	702A	2.95	1625	.45
2K39	95.50	703A	4.95	1644	.80
3B24	4.50	707B	14.95	2051	1.50
3C23	8.95	713A	.95	565A	5.95
3C33	12.50	715B	8.95	5670	3.25
3E29	13.95	715C	22.50	5694	2.10
4C35	34.50	717A	1.39	5703	4.95
4E27	16.50			5721	4.25
4X150A	35.00			5814	4.50
4X500A	85.00			5881	3.00
5B11	4.95			9001	1.75
5B14	4.50			9002	1.50
5D21	22.50			9032	1.75
5G11	4.50			9033	1.75

YOUR SURPLUS WANTED!
We pay Highest Prices!

Vacuum Capacitors
50-15 \$ 5.95
12-20 6.50
50-32 12.50

Complete Line of Transmitting & Receiving Tubes.
Send Cash With Order and Save C.O.D. Charges!

J. S. H. SALES CO.

Dept. R-10, 7552 Melrose Ave., Los Angeles 46, Calif.

directivity pattern with high front-to-back ratio, a good impedance match, and high gain on all channels. The gain and front-to-back ratio are greatest on the high channels although it is good on the low channels too.

Through the use of large diameter dipoles and an 8 foot non-resonant reflector screen, it is possible to obtain broadband characteristics greatly superior to those obtainable with conventional dipoles and resonant reflector elements.

On the high band the array functions as four half-wave dipoles in phase, spaced $\frac{3}{4}$ wave ahead of the reflector screen. On the low band, shorted stubs across the dipole elements lower the fundamental resonant frequency and at the same time provide a good impedance match on the low channel. These stubs are quarter-wave resonant on the high band and thus have negligible effect on high-band operation.

"CLOVER-V-BEAM"

Telrex, Inc. of Asbury Park, New Jersey is currently making deliveries on its new and improved "Clover-V-Beam" antenna.

The new array is compactly folded, completely preassembled, and can be speedily rigged by tightening two nuts. Performance of this new unit is attributed to the company's unique application of transposed co-linear elements in conjunction with stacked closed loop "Conical-V-Beam" dipoles. In operation the interconnecting rods load the dipoles for low frequency channels and serve as transposed half-wave transformers at the high channels. This provides the sensitivity of resonant closed loop conical dipoles at the low frequencies and long wire "V-Beam" operation at the high channels.

The "Clover-V-Beam" weighs less than 24 ounces and has a lateral dis-

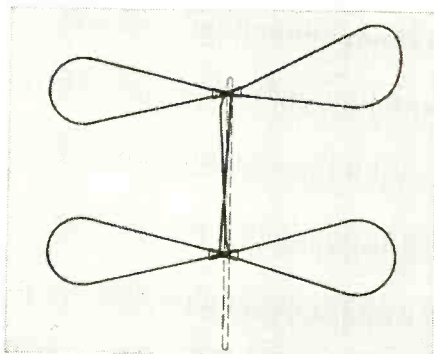

placement under 5 feet, thus offering negligible wind resistance, minimum ice loading, and small down thrust.

Application data on this antenna is available upon request to the Engineering Dept. of the company.

NEW TV COMPONENTS

Standard Transformer Corporation, 3580 Elston Avenue, Chicago, Illinois has announced the availability of two new television components—a high efficiency deflection yoke and a high voltage flyback transformer.

Deflection yoke DY-10 and horizontal output and high voltage trans-



What Do You Want to Trade In on a New Hallicrafters?

I have a complete stock of Hallicrafters receivers and transmitters. We will give you the best doggone trade-in in the world because we need used receivers badly for our trade. What do you have? Write me about it. I give you prompt delivery, 90-day FREE service and the world's lowest credit terms. Write, wire, phone, or visit either store today for the best deal. Export orders solicited.

Bob Henry
WPARA



Popular Double-IF Model SX-71

A double superheterodyne circuit receiver at modest cost. Built-in narrow band FM reception. Temperature compensated, voltage regulated. 5 position band selector for 538-1650 kc, 1600-4800 kc, 4.6-13.5 mc, 12.5-35 mc, 46-56 mc. 11 tubes plus voltage regulator and rectifier. Only \$199.50

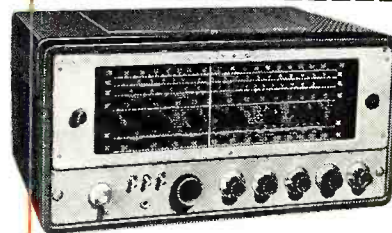

All-Wave Receiver Model SX-62

Covers 540 kc to 109 mc—including AM, FM, and SW broadcasts. Six bands: 540-1620 kc, 1620 kc-4.9mc, 4.9 mc-15 mc, 15-32 mc, 27-56 mc (AM-FM), 54-109 mc (AM-FM). Only \$289.50. Other popular Hallicrafters models: S-76, \$169.50; S-40B, \$99.95; S-72, \$109.95; S-72L, \$119.95; S-81, \$49.50; S-82, \$49.50.

Butler 2, Missouri **HENRY RADIO STORES** 11240 Olympic Blvd. LOS ANGELES 25 CALIF.
"WORLD'S LARGEST DISTRIBUTORS OF SHORT WAVE RECEIVERS"

TEVCO

SINGLE REFLECTOR CONICALS

- 1250—Single Bay $\frac{3}{8}$ " elements. 3.19
- 1256—Single Bay $\frac{1}{2}$ " elements. 3.89
- 1254—Double Bay $\frac{3}{8}$ " elements. 6.68
- 1258—Double Bay $\frac{1}{2}$ " elements. 7.89
- 1257—Four Bay $\frac{3}{8}$ " elements. 14.89
- 1253—Four Bay $\frac{1}{2}$ " elements. 17.19

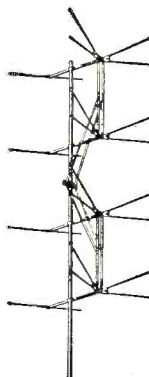

FIVE ELEMENT YAGI BEAMS

- 2002 to 2006—any to channel. 8.69
- 2007 to 2013—any hi channel. 3.19
- 1236—Single Bay Twin-V. 3.76
- 1237—Double Bay Twin-V. 7.49
- 1231—Four Bay Conical. 16.99
- 1230—Double Bay Conical. 7.89
- 1243—Swift Rig Folded Hi Folded Low. 3.89
- 1240—Single section conical—lots of 6. 1.69
- 1244—Swift Rig Folded Hi Straight Low. 3.49
- 2113—Deluxe Indoor Antenna. 1.99
- 1800—Chimney Mount. Dozen Lots 1.19
- 1805— $\frac{3}{4}$ " Mast Snap-On Standoff. Per 100 3.60
- 1873— $\frac{3}{4}$ " Mast Standoff Insulator. Per 100 5.50
- 1872— $\frac{3}{4}$ " Nail-In Insulator. Lots of 50 .02
- 1870— $\frac{3}{4}$ " Wood Screw-Eye Insulator. Lots of 50 .02
- 1229—Single Bay Conical. 3.75
- 1861—5 Ft. 1 1/4" Diam. Galv. Steel Mast. .82

Send for quantity prices and complete list

TELEVISION SUPPLY CO.

Box 13 Greenpoint Station Brooklyn, N. Y.

NEW!

MOSLEY ROOF-THRU

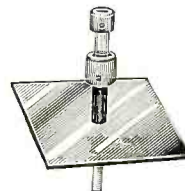

The Leak-Proof Roof Entrance for TV and FM Transmission Line and Rotator Control Cable

Here's the new ROOF-THRU, another MOSLEY product for BETTER TV PICTURES Through More Efficient Installation. ROOF-THRU provides the easiest and most practical method of bringing in lead-in for concealed-in-wall installations using MOSLEY Flush Mounted Sockets.

Why the ROOF-THRU Way Is Best:

- Permits shorter lead-in line resulting in less loss of signal energy—less interference pick-up!
- Copper flashing and plastic bushing provides perfect seal against leaks!
- Prolongs life of transmission line by keeping it out of weather!
- Eliminates unsightly wires on outside of house!
- Long lasting—weather can't hurt ROOF-THRU!
- Easy to install on new or old buildings!

Cat. No. 624 MOSLEY ROOF-THRU.

List Price.....\$5.84

See the ROOF-THRU and MOSLEY Flush Sockets at your jobber.

MOSLEY ELECTRONICS

2125 Lackland Road, Overland, Missouri

*this is it—
this is the tuner
you designed!*

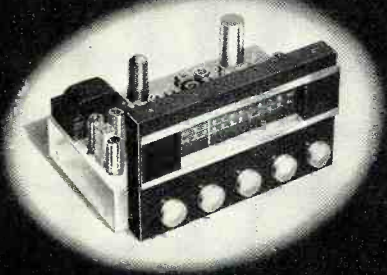

the
craftsmen 10

**High Fidelity
FM-AM Tuner**

Maybe you had a hand in designing this magnificent tuner. A lot of our friends did. Their questions and suggestions made sense because they came from people who knew what they needed. The superior flexibility and performance of the C-10 proves it. And we think it will answer your rigid requirements, too.

- Two cathode followers furnish both audio output and detector output for remote installations.
- Built-in pre-amplifier, compensated for variable reluctance pick-ups.
- Automatic Frequency Control entirely eliminates drift, simplifies tuning.
- 5 microvolts sensitivity on both FM and AM.
- 10 kc filter on AM eliminates interstation squeal.
- Bass and treble tone controls for boost, cut, or 20—20,000 cycle flat response.

Write for information—or send 50c for instructions and schematics

THE RADIO
craftsmen INC.
Dept. R-3, 4401 N. Ravenswood Ave., Chicago 40, Ill.

former A-8131 are companion units designed to be used in direct drive circuits. The two new components have extensive applications and are exact replacements in thirty-four RCA television models, thirty Emerson models, and seven Capehart models.

The DY-10 is an anti-astigmatic yoke with cosine windings and nylon

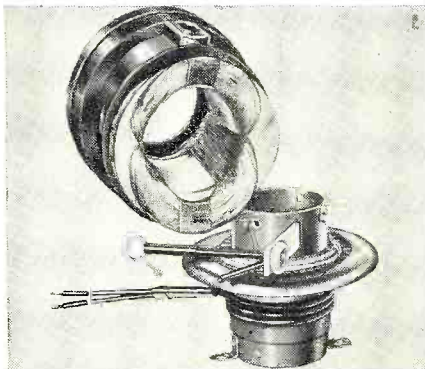

insulation, designed to provide a sharp, well-focused picture over the entire CR tube.

Specifications and a complete list of TV models for which these components are exact replacements are contained in *Stancor Bulletin 389* which is currently available.

TUBE AND TOOL CASE

Television Engineers, Inc., 1539 W. Harrison Street, Chicago is currently offering a new "Vis-U-All" tube and tool case that meets the requirement for a compact unit to hold all tubes and tools ordinarily required for home TV service work.

The new case will accommodate 45 miniature, 44 GT, and 18 large tubes—a total of 107 tubes or all tubes used in a postwar television receiver. It holds tubes snugly and protects them against breakage.

Made of strong plywood covered with durable leatherette, the new case measures 16 x 13½ x 7½ inches when closed and weighs only 7½ pounds. Fully loaded it weighs only slightly more than 20 pounds. A 15½ x 3 x 2½ inch compartment, with snap lock door, accommodates all tools ordinarily needed for home service work.

TV TOWER LINE

Tele-Ex-Pand Products Sales Corp., Berwick National Bank Bldg., Berwick, Pa., is currently marketing a new line of television towers and accessories designed for home television installations, as probe towers, as community towers, and ham antenna masts.

Deluxe, standard, and economy models are available at the present time in addition to the necessary base plates, mast mounts, and tower tops.

All of the towers are constructed of 1", electrically welded, tubular steel and have 1¼" x ½" cross bracing. All of the units have an all-weather aluminum finish.

Data sheets on these towers and the company's line of tower accessories are available on request.

SENSATIONAL VALUE!

#630 SUPER 30 TUBE CHASSIS
Mfr. Licensed under R. C. A. Patents

Complete with
21" first quality
tube
AND
Beautiful hand-
rubbed Mahog-
any Console
Cabinet.
COMPLETE PRICE
\$259.95



slightly higher
with full doors

the latest 1952 model with all the newest electronic improvements . . .

- peak sensitivity for fringe areas
- synchrolock tuning
- keyed A G C
- 15,000 volts under load
- 12-inch RCA speaker
- can be adapted to color & UHF
- high quality parts

A set—NOT A KIT

Completely wired, Factory Engineered, aligned and tested. RMA Guaranteed

1 YEAR GUARANTEE ON TUBE

A half-hour to mount; ready for operation. Saves up to \$150.

Compare this anywhere for high quality—low price!

Write Dept. F for further information. Phone and mail orders filled on receipt of money order for 25% as deposit . . . the balance C.O.D., f.o.b. N. Y.

NEW ENGLAND TELEVISION CORP.
75 CHURCH STREET NEW YORK, N. Y.

South River
★★ NEWS ★★

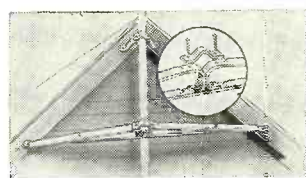

EAVE MOUNT Model EM-1

Heavy gauge steel, embossed for extra strength, rustproof, hot-dip galvanized finish. Upper bracket provides 4" clearance from eave; lower bracket, generous 48" spread. Complete with hardware.

South River Antenna Mounting Accessories are carried by every leading TV Parts Jobber from coast to coast. New catalog mailed to all Dealers and Service Men. Write, if you haven't received yours!

**SOUTH RIVER METAL
PRODUCTS CO., INC.**
SOUTH RIVER, N. J.

PIONEER AND OUTSTANDING PRODUCER
OF FINEST LINE OF ANTENNA MOUNTS

RADIO & TELEVISION NEWS

Loudness Control

(Continued from page 39)

of the holes is not critical, but should be at least $\frac{1}{16}$ inch, and preferably $\frac{3}{32}$ inch.

Remove the cover from the potentiometer and, using an ohmmeter, find the 200,000 ohm points. Make a scribe mark at these points, which are to connect to the taps. To make contact with the resistance element at these points, a scribe or fine pen point and a small amount of air drying silver paint are necessary. Apply the paint to the edge of the resistance element at each of the 200,000 ohm marks, and draw a fine line of the paint from each mark to the corresponding hole drilled in the edge of the base. The paint must be applied sparingly to the resistance element so that it will not interfere with movement of the rotor brush, and it cannot be allowed to run over the edge of the base except directly opposite the terminal hole, because a contact with the cover will ground the potentiometer and short circuit a portion of the network. Get as much of the paint as possible into each of the holes, and dip the ends of the contact wires in the paint before inserting them into the holes.

If properly done, the paint itself should hold the wires quite firmly in place. However, don't expect the paint to hold until it has completely dried. This may take several hours, but may be speeded up by baking with an infra-red heat lamp.

File notches in the edge of the cover at appropriate points to clear the ribbons of silver paint where they cross the edge of the base to the terminal wires. It is necessary that this be done because the cover must be replaced to provide the stops for the potentiometer.

All the other components of the compensating network as shown in Fig. 3 may be mounted on a small resistor board, or, if the components used are quite small, they may be mounted directly on the terminal wires as was done in the unit shown in the photograph. A shield for the complete unit may be made from a coil shield can or, for that matter, from a small empty tin.

Adjust the variable trimmer condenser only after the complete unit is installed. The effects of wiring capacitance may influence this adjustment greatly, and should be taken into account. The adjustment may be made either by measurements, or simply by listening tests. If the amplifier and speaker system to be used are capable of reasonably uniform response from 40 to 10,000 cycles or better, about 8 db of compensation at 10,000 cycles is adequate when the "Loudness Control" is set for minimum output.

However, if the amplifier or speaker does not have sufficient response below about 50 cycles, the "Loudness Control" may produce an objectionable resonance effect at low levels. In this

WORLD' FASTEST SELLING VOLT-OHM MILLIAMMETER



Model 770

is an accurate pocket-size V.O.M.
Measures only $3\frac{1}{8}'' \times 5\frac{7}{8}'' \times 2\frac{1}{4}''$.

Write Dept. RN-3 for catalog of complete line.



Manufactured and Guaranteed by
SUPERIOR INSTRUMENTS CO.
227 Fulton Street • New York 7, N. Y.

Sensitivity
1000 ohms per volt

- ★ Uses latest design 2% accurate 1 Mil. D'Arsonval type meter.
- ★ Same zero adjustment holds for both resistance ranges. It is not necessary to readjust when switching from one resistance range to another. This is an important time-saving feature never before included in a V.O.M. in this price range.
- ★ Housed in round-cornered, molded case.
- ★ Beautiful black etched panel. Depressed letters filled with permanent white, insures long-life even with constant use.

The Model 770 comes complete with self-contained batteries, test leads and all operating instructions.

\$14.90
NET

Specifications:

- 6 A.C. VOLTAGE RANGES:
0-15/30/150/300/1500/3000 Volts.
- 6 D.C. VOLTAGE RANGES:
0-7.5/15/75/150/750/1500 Volts.
- 4 D.C. CURRENT RANGES:
0-1.5/15/150 MA. 0-1.5 Amps.
- 2 RESISTANCE RANGES:
0-500 Ohms 0-1 Megohm.

AT
YOUR
RADIO
PARTS
JOBBER

115V POWER TRANSFORMERS . . . 60 cv. 700 VCT. 90ma. 6.3V, 3A, 5V, 3A, Dble half-steel	\$2.95
115V AC INDUCTION MOTOR . . . 1750 RPM. 1/2 H.P. Dble. 1/4" shaft. 2 7/8" O.D. x 1 3/4" S. B. CARBON MIKE INPUT XFMR.	1.75
138x1 3/8" DPD BAY TOGGLE (AHH) . . . GA/12	.89
V. Radio case49c; 12/ 5.49
W-110B ARMY FIELD WIRE . . . New 1/2 mile coils (60 pounds)	7.95
1 Mile on orig. steel reel (160 lbs.)	18.50
PORTABLE D.C. AMMETER (Type 515) . . . 0-15 amps. 3 1/2" mirror scale; knife ptr. 36" test leads; Hinged Lid. Metal case.	4.95

**POWERFUL
!!! ALNICO MAGNETS !!!**

#2—Polished, 1 1/2" x 1 1/4" x 3/16" . . . \$1.65
#3—Polished, 2 1/2" x 1 3/8" x 8/16" . . . 1.65
#4—Polished, 1/2" x 1 1/2" x 3/8" ea. 59c; 10/ 5.50
#5—Polished, 7/8" x 9/32" x 3/8" . . . ea. 59c; 10/ 5.50

ALNICO MAGNET KIT . . . powerful Bar, Block, "U" Rod, etc. 10 asstd. 1.98
(Write for Latest "Alnico" Supplement)

SPST PUSH-SWITCH (3A/125V) . . . all-brake/ite.	\$0.29
RADIO-TV BUILDER'S LIBRARY . . . for Ham's, Servicers, Students . . . 20 asstd. B'cast, TV, & diagrams	.98
EXPERIMENTAL TUBES . . . for Test, Research, Schools, Fil. tested. 40 asstd. revg. types.	1.98
!!ELECTROLYTICS!! . . . YOUR CHOICE. 49c; 6/ 2.49	
8mf/475V . . . 20mf/150V . . . 3x40mf/25V	
10mf/450V . . . 30mf/300V . . . 150mf/50V	
6mf/150V . . . 32mf/450V	
MIDGET PLUG & JACK (PL-391/JK-48) . . . 2 wire.	39c; 10/ 3.50
RADIO HARDWARE TREASURE . . . FULL LB. CAN OF NUTS, SCREWS, WASHERS, LUGS, ETC.	69c; 3 lbs./ 1.98
BENDIX AUTOSYNS . . . AY38D . . .	3.95
ANB-H-1 PHONE UNITS98
SOUND POWER PHONE-MIKE UNITS S1.95; 2/ 3.49	
8 1/2" . . . "Glow" in Dark . . . 100 ft. x . . . 4.50	
T-30 THROAT MIKE with neckband . . . 69c; 10/ 6.50	
SC-506 EXT. CORN. & SWITCH for T-3098
SCR-511 TECH. MANUAL . . .	1.98
TS-173 FREQ. METER TECH. MANUAL. 29c; 4/ 1.98	
BC-606 INTERPHONE CONTROL BOX . . . NEW.	.79
HIGH FIDELITY HOUSING for crystal mike. . . 1.29	
shock-mtd. 1 3/4" x 1 1/4". Less housing; rubber	
ALUMINUM HOUSING for crystal mike. . .	.98
ALL NEW . . . "JUMBO RADIO PARTS KIT"15
17 FULL LBS. of: COILS, CONDENSERS, WIRE CHASSIS, SOCKETS, CONTROLS, SWITCHES, HARDWARE, ETC. ETC.	3.95
TUBE CARTONS . . . plain white. Prices per 100	
8" Min. (1 1/2" sq. x 3/4")—\$1.20; 6" Min. (1 1/2" sq. x 3/4")—\$1.45; Med. (1 1/2" sq. x 1 1/4")—\$1.65; Large (2x2x5)—\$1.98; Extra Lge. (2 1/4" sq. x 6 1/2") . . .	3.95
ROSETTE SCREWS, 6/32x1 1/2" Bronze . . . 100/ 1.25	
25W-120 Ohm W.W. Resistor w/bracket—23c; 5/ 1.00	
50W-25 OHM "D" OHM W.W. RESISTOR . . . 29	
HI-FREQUENCY BUZZER, adjust. 4.95; 6/ .69	
Min. Order \$3.00. Only 20% deposit req. on all C.O.D.'s. Full refund with foreign orders. Please add sufficient postage—cross refunded.	

LEOTONE RADIO CORP.
67 Dey Street
New York 7, N. Y.

LEARN

Television-Radio Electricity

REFRIGERATION-ELECTRONICS

IN THE GREAT SHOPS OF **COYNE**

TRAIN QUICKLY! OLDEST, BEST EQUIPPED SCHOOL of ITS KIND in U.S. Young and Older Men . . .

Come to the Great Shops of Coyne in Chicago. Get practical training in TELEVISION-RADIO or ELECTRICITY—vital in Defense Program. Prepare now for a better job or better service rating.

START NOW—PAY LATER
You can finance most of your tuition, pay for it later in easy monthly payments. Special plan for men of Draft Age. Part time employment service available.

FREE BOOK . . . Clip coupon for Big Free Illustrated Book. Indicate below course that interests you. No salesman will call. Act NOW.

COYNE SCHOOL
B. W. Cooke, President
A TECHNICAL TRADE INSTITUTE CHARTERED NOT FOR PROFIT
Established 1899
500 S. Paulina, Chicago

**ELECTRICITY ★ TELEVISION
RADIO ★ REFRIGERATION ★ ELECTRONICS**

**B. W. COOKE, Pres.
COYNE School
500 S. Paulina St., Chicago 12, Ill. Dept. 32-85H**

Send FREE BOOK and full details on:

TELEVISION-RADIO ELECTRICITY

NAME

ADDRESS

CITY STATE

Sensational TV BARGAINS!

Rocket YAGI

5 ELEMENT TV ANTENNA

Excellent Pictures in Fringe Areas

HIGH GAIN. Clearer, sharper, steadier pictures. **PERFECT PICTURES IN FRINGE AREAS.** Minimum interference from ghosts and noise due to a directive pattern. Five elements include one folded dipole, three directors, and one reflector. Supplied less mast. **MATCHES 300 OHM IMPEDANCE.** Mailed insulator provides additional strength. Exclusive design mast clamp prevents antenna turning or canting under any conditions. **STURDY, TROUBLE-FREE CONSTRUCTION.** No return calls. No broken elements. Stands the test of severest weather. Elements of extra heavy aluminum-clamped top and bottom. **QUICK ERECTION.** Completely pre-assembled. Just swing elements into line and tighten wing nuts. Simple . . . elements . . . easy. Available for any channel, high or low band.

Channels: \$7.95 each Channels \$6.95 each
2 and 3 4, 5, and 6
Channels \$3.95 each
7 to 13

EACH CHANNEL requires a DIFFERENT Yagi. When Ordering specify exact channel number desired.
SOLD ONLY BY MAIL BY NATIONAL ELECTRONICS

Rocket DIRECTRONIC MOTORLESS TV ANTENNA

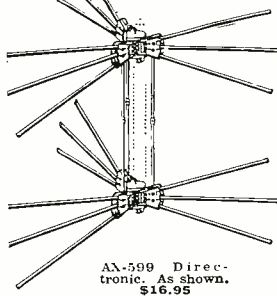

360° Electronically Switched Beam

- No Motors
- No Roof Orientation
- No Electric Power
- No Ghosts

The Directronic 18 element, 360° antenna is the finest for ultrafringe or metropolitan area reception. The HI-PAC motor is a material of extra high tensile strength not affected by weather or temperature, either mechanically or electrically. Included in the AX-599 "Servicemen's Array" are:

- 18 hi-tensile aluminum alloy elements
 - 1 set of connecting stubs (3)
 - Universal U Clamps for masts to 1 1/2"
 - Directronic Beam Selector
 - 75 feet of Tri-X Cable
 - 1 stacked array per carton
- AX-56 Directronic, 6 element Single . . . \$ 9.50
AX-56B Directronic, 12 element Stack . . . 14.25
AX-59 Directronic, 9 element Single . . . 10.35
All above antenna prices include Tri-X Cable and Switch.

SOLD ONLY BY MAIL BY NATIONAL ELECTRONICS

Rocket ALL CHANNEL CONICALS

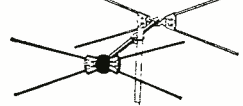

This sturdy, all-aluminum constructed TV antenna is designed for broad-band reception on all TV channels, plus FM. High Gain, 4 to 1 front to back ratio. All channels 2-13. Uni Directronic. For use with 72-150-300 ohm lines. Low inception angle. Complete with all hardware—less mast.

- Single Bay \$3.75 each
 - Stacked Array with Tie Rods \$8.20 each
- SOLD ONLY BY MAIL BY NATIONAL ELECTRONICS**

- 1 1/4" O.D. Mast Steel (Dualcoated) 5' crimped \$1.05
- Mast Steel (Dualcoated) 10' \$1.95
- Mast Steel (Zinc plated) 10' \$1.59
- Mast Connectors for 1 1/4" O.D. Mast—10" long 49c
- 3 Conductor Motor Wire 3c ft.
- 4 Conductor Motor Wire 4c ft.
- Peak Roof Saddles (Will take up to 1 1/2" O.D.) . . . \$1.49
- Twin Lead 300 Ohm—#70 Mil—Solid 2 1/2c ft.
- Twin Lead 300 Ohm—#60 Mil—7/28 Stranded 3c ft.
- Double Stacking Assembly for stacking 2-XX Arrays \$1.76 set
- Aluminum Guy Line—1/8" Stranded—300 ft. coil \$4.95
- Arrestors (TV Lightning) 69c
- Chimney Mount—Complete with Straps \$1.19
- Coax—72 Ohm 6 1/2c ft.
- Guy Wire—Galvanized—4 strand #20 1/2c ft.
- Guy Wire—Galvanized—6 strand #20 3/4c ft.
- Guy Wire—Galvanized—11 strand #20 1 1/2c ft.
- Boosters—Anchor—10-175 \$22.50
- Tec-S-503 \$26.97
- Stand-off Screw Insulators—3" for 300 Ohm \$2.75 c
- Stand-off Screw Insulators—7" for 300 Ohm \$5.50 c
- Strap Clamp Stand-off Insulators—3" \$8.50 c

PRICES SUBJECT TO CHANGE WITHOUT NOTICE
ALL PRICES F.O.B. CLEVELAND, OHIO

Do not remit more than complete purchase price. Pay shipping charges on receipt of goods. 25% Deposit on C.O.D. orders, please. Money Back guarantee

National Electronics
OF CLEVELAND
THE HOUSE OF TV VALUES
103 Delco Building • Cleveland 3, Ohio

case, additional compensation at the high frequencies can be used to advantage by producing a similar resonance effect. The combination of the two will be much more listenable than with either one alone.

Since definite rules cannot be stated which will cover all cases, it may be best to make the final adjustment of the trimmer while listening to a high quality recording at a very low level. Both the high and low frequencies should have a natural sound.

You will be very pleasantly surprised at the results obtainable with the "Loudness Control." If you are one of those people who "just don't like the highs" be prepared to change your mind. Chances are, you just haven't heard a full range system which takes into account the peculiarities of the human ear.

This "Loudness Control" has brought forth many unsolicited compliments from people who are neither electronic nor musical experts. It is no longer necessary to disturb the neighbors with over-loud music, since an appreciation of the full tonal range can now be had at any volume level.

REFERENCES

- ¹ Fletcher, H., and Munson, W. A.; "Loudness, Its Definition, Measurement, and Calculation," *Jour. Acous. Soc. Amer.*, p. 82, October, 1933.
- ² Bomberger, D. C.; "Loudness Control for Reproducing Systems," *Audio Engineering*, p. 11, May, 1948.
- ³ Winslow, J.; "Full Range Loudness Control," *Audio Engineering*, p. 24, February, 1949.
- ⁴ Turner, J. W.; "Construction Details of a Continuously Variable Loudness Control," *Audio Engineering*, p. 17, October, 1949.

-30-

RESISTOR PROTECTION

By MILTON WHITE

A COPPER alligator clip placed on the lead between a composition resistor and the soldering iron as shown in the photograph, will act as a thermal shunt, protecting the resistor against the damage often caused by the heat of the soldering operation. This protection is important where very short resistor lead lengths are required, since under this condition, the heat will not be radiated by the lead quickly enough to prevent the resistor from reaching a temperature where a permanent change in its value may occur. -30-

Method of dissipating heat and protecting resistor when soldering in close quarters.

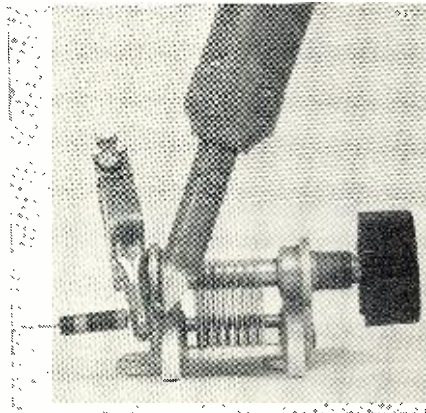

* **WANT D** WE NEED YOU. Surplus Electronic Equipment *
* **WE PAY TOP \$\$\$ FOR:** *
* Radio Receivers | An Connectors *
* Transmitters | Clamps *
* ARC-1 | Plugs *
* ARC-3 | Cords *
* ART-13 | Relays *
* Control Boxes | Telephone Materials *
* Indicators | WE BUY ANYTHING!! *
* **WRITE, WIRE TODAY!** *
* TELL US WHAT YOU HAVE *
* TALLEN COMPANY, INC. *
* Dept. RN, 159 Carlton Ave. *
* Brooklyn 5, N. Y. *

SCARCE IMMEDIATE DELIVERY RADIO AND TV TUBES

COMPLETE LINE OF

Television Picture Tubes

Radio and TV service men, experimenters, amateurs—we have many types of scarce tubes ready for immediate shipment. Don't use make-shifts or spend valuable time looking for tube sources. Try Electro FIRST . . . and get the tubes you need without delay. Get complete list and Electro's low prices. It's FREE . . . write today!

TUBES BOUGHT, SOLD and TRADED Send Your Want and Trade List!

ELECTRO-SALES 425 W. Randolph St., Chicago 6, Ill.

SCHEMATICS—CONVERSIONS FOR SURPLUS GEAR

NEW LIST! MANY ADDITIONS!

Send stamped, self addressed envelope for List B. Add 25c for chart explaining AN nomenclature.

R. E. BOX 1220
GOODHEART BEVERLY HILLS, CAL.

RADIOS TELEVISION TEST INSTRUMENTS
1, 2 & 3 band Electric and/or battery AC/DC Operation
Write for FREE Catalog
ARKAY—Radio Kits, Inc.
120 Cedar St., New York 6, N. Y.

AN/APR-4 COMPONENTS WANTED

In any condition. Also top prices for: ARC-1, ARC-3, APR-1, APR-5A, etc.; TS-34 and other "TS-" and standard Lab Test equipment, especially for the MICROWAVE REGION: ART-13, BC-348, BC-221, LAE, LAF, LAG, and other quality Surplus equipment; also quantity Spares, tubes, plugs and cable.

ENGINEERING ASSOCIATES

432 Patterson Road Dayton 9, Ohio

RADIO ENGINEERING IN 27 MONTHS

Radio engineering is a big field. There's room for you in it—if you're good. Get first-class training at Indiana Tech. Intensive specialized course, including strong basis in mathematics and electrical engineering, advanced radio theory and design (inc. TV and Electronics), Modern laboratory. Low tuition. Also 27-month courses in Aeronautical, Chemical, Civil, Electrical and Mechanical Engineering. Approved for G.I.'s. Enter March, June, September, December. You can earn part of your expenses right here in Fort Wayne while you are studying.

INDIANA TECHNICAL COLLEGE

932 E. Washington Blvd. Fort Wayne 2, Indiana
Please send me free information on B.S. Engineering Degree in 27 months as checked.

- Radio-Television
- Civil
- Mechanical
- Aeronautical
- Electrical

Name
Address

RADIO & TELEVISION NEWS

The "Codetyper"

(Continued from page 47)

output, its input grid receives a pulse from the "phantom switch network." This positive-going pulse overcomes the bias which is holding the tube to cut-off because of the large value of the cathode resistance. Plate current starts to flow through a plate resistor and the voltage at the plate drops. This negative-going pulse is coupled to a second section of the tube through a condenser and causes the second half of the tube to become biased to cut-off. When this happens, the rise in plate voltage across the load resistor initiates a positive-going pulse which is then fed to the keyer.

At the same time the square wave which appears across the cathode of the first UIG common bias resistor is taken off and differentiated. This differentiated voltage has two pips on it—a negative-going one which corresponds to the leading edge of the pulse and a positive-going one which corresponds to the trailing edge. The negative pip has no effect on UIG #2 but the positive-going pulse causes UIG #2 to trigger, thereby setting up the same conditions on UIG #2 as previously existed on UIG #1. This pulse follows at the exact moment that UIG #1 has completed its pulse to the keyer tube.

The speed of the interval or the timing thereof is governed by the size of the coupling condenser and resistor and other circuit parameters. In addition, there has to be some method of varying the pulse width depending on the code speed desired. A simple system has been devised whereby all 19 UIG's are controlled by the same potentiometer. This is accomplished by allowing the coupling condensers to discharge up to "B+" rather than down to ground as is usually the case. All grid resistors are, therefore, returned to a common "B+" point. By setting a reference voltage against this common "B+" point, the potential differences across all coupling condensers can be controlled. By varying this voltage, the timing rate of all 19 UIG's can be varied simultaneously.

As the pulse follows down through the chain each UIG is successively triggered and each triggers a keyer in sequence. If UIG #1 is triggered, 19 pulses are formed in the chain, however, the keyers are arranged in such a way that they form the various marking and spacing intervals as will be described.

Keyer Operation

All of the keyers connected to the even-numbered UIG's are, in addition to being biased to cut-off, gated off at the same time. The gating takes the form of a removal of the plate voltage from the keyers. All of the odd-numbered keyer plates are returned directly to "B+" while the even-numbered keyers have their plates re-

March, 1952

Let MILTON S. KIVER Help You Prepare For U.H.F.-TV And...

TELEVISION SERVICING

Easy to TRAIN AT HOME This Practical Way!

Men with the right training in Television Servicing are in big demand . . . pull down big pay. T.C.I. TRAINS YOU RIGHT with easy-to-follow technical training designed by servicemen, for servicemen! You learn practical, professional type Television Servicing without leaving your present job. Included are money-making extras such as set conversion, master antenna installation, U.H.F.-TV and field servicing short cuts. You can start earning Television money after the first few lessons. You learn to test, trouble shoot and repair all types of TV sets the proven, practical way!

HERE'S HOW YOU GET EXPERIENCE!

You train on your own large screen modern television receiver, furnished as part of your course. This set is yours to keep! As an optional feature you can get two weeks of actual field experience out on service jobs and on the repair bench for Chicago's largest independent servicing organization. You learn Television Servicing by actually doing Television Servicing . . . you get the practical know-how you need to qualify for BIG MONEY in this fast-growing field! Age is no barrier. Many TCI students are over 40!

ACT NOW! Fill out and mail coupon for FREE Catalog and SAMPLE LESSON. Write TODAY!

TELEVISION COMMUNICATIONS INSTITUTE
205 W Wacker Dr., Dept. 1-U Chicago 6, Ill.

We Want . . .

Radcom pays highest prices for surplus equipment, parts and tubes. We need:

- TCS-6 & up Trans Receivers
- 12 Volt TCS Power Supply
- BC-312, 342, 348 Receivers
- BC221 Frequency Meters
- Test Equipment
- SCR-508, SCR-608
- Tubes; Rectifiers RA-34

WHAT DO YOU NEED?

Radcom deals in radar, sonar, high and low power transmitters; navigational aids; all types of marine and airborne equipment.

Inquiries Invited!
Complete Export Facilities

RADCOM ENGINEERING CO.
8 Livingston Street
Newark 3, N. J.

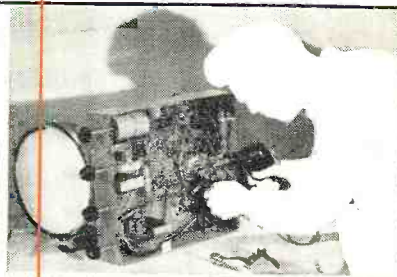

YOU GET and keep modern large screen Television receiver.

YOU DO actual testing, servicing, trouble shooting and repairing

TV BROADCASTING COURSE READY NOW!
Train at home for these big pay studio jobs! Video engineers, cameramen, microwave engineers, etc. Easy non-mathematical training covers all phases. Write!

MAIL NOW FOR FREE BOOKLET

MILTON S. KIVER, President
TELEVISION COMMUNICATIONS INSTITUTE
205 W. Wacker Dr., Dept. 1-U, Chicago 6, Ill.
Rush full facts on the course checked below. I am not obligated. Salesman will not call.

TV Servicing TV Broadcasting
Name Age
Address
City Zone State
 BEGINNERS check here for information on Pre-Tel Radio Course.

YOU CAN BUY

PICTURE TUBES

(magnetic deflection types only)

WITH A ONE YEAR GUARANTEE

for

\$ 1.30 PER INCH

Tubes smaller than 12" @ \$15.60 minimum.
Add \$1.50 per tube for all metal tubes.

Send us your dud picture tubes. We will return them completely factory rebuilt with all scratches removed, new gun, coatings and screen and guarantee them for 1 year. Broken neck tubes must have at least 2" of neck. Send them prepaid, packed securely and insured. Include full payment with order and we will ship in 48 hours. Otherwise allow 1 week C. O. D. All shipments collect.

EXAMPLE: 16" TUBE X \$1.30 = \$20.80
if metal tube add 1.50

PACKING? Send a \$2.00 deposit and we'll send you a shipping carton. Deposit will apply to order. Be sure to include tube type and size.
DEALERS: Save money—don't hang on to duds—turn them into new stock.

VACTRON

398 ASHFORD AVE., DOBBS FERRY, N. Y.

The New

Mandl's Television Servicing

● gives you detailed, illustrated trouble-shooting procedures for every flaw or failure you're likely to encounter.

A COMPLETE MASTER INDEX and separate lists of trouble symptoms for each circuit defect make it easy to locate any particular trouble and the exact procedures for correcting it. Unusual, hard-to-find flaws as well as all common trouble are dealt with.

THE LATEST CIRCUITS are explained and illustrated, including servicing techniques for UHF and VHF.

ORIGINAL PHOTOGRAPHS show actual symptoms that appear on the TV screen when defects occur. Hundreds of circuit diagrams, illustrations of station defects, scope patterns, and other illustrations aid in the identification and location of circuit faults

and these are only a few of the features that make this the most helpful, practical, and complete service manual yet to be published.

Are these outstanding radio & TV aids on your working reference shelf?

Radio and TV Mathematics

by Fischer Step-by-step solutions for hundreds of typical problems, arranged under radio and electronic headings for quick reference. Shows what formulas to use, what numerical values to substitute, how to solve each

Television for Radiomen

by Noll. Very clear, non-mathematical explanation of all principles and full instruction on installation, alignment, adjustment, and trouble-shooting.

Television & FM Antenna Guide

by Noll & Mandl A basic course on theory plus a complete handbook on all types of antennas and installation procedures.

Movies for TV

by Battison. Practical information on all equipment and experienced advice on the do's and don'ts of making newscasts, commercials, features, titles, special effects, cartoons, etc

SEE THEM ON APPROVAL

The Macmillan Co., 60 5th Ave., N. Y. 11

Please send me copies of the books checked. I will either remit in full or return the books in 10 days.

- | | |
|--|---------------|
| <input type="checkbox"/> Mandl's TV Servicing \$5. (prob.) | Signed |
| <input type="checkbox"/> Radio & TV Math. \$6.75 | |
| <input type="checkbox"/> TV for Radiomen \$7.75 | Address |
| <input type="checkbox"/> TV & FM Antenna Guide \$6.25 | |
| <input type="checkbox"/> Movies for TV \$5.00 | |

turned to one of the "sequence selectors." This means that unless a particular "sequence selector" is turned on, all of the even-numbered keyers will be unable to deliver pulses to the keying relay. Thus any pulse starting at the beginning of the chain and traveling down to the end activates the keying relay on every other pulse only, producing 10 dot marking intervals separated by 9 space intervals.

Since every other keyer is gated to cut-off a string of dots is formed. Should dashes be required in the transmission of the character it becomes necessary to activate one or more of the keyers that were gated off.

It is possible to send any number of units by entering the UIG chain at any point. Every even-numbered UIG has a cathode connection running to the "phantom switch network." This cathode connection on the even-numbered UIG is used to trigger the odd-numbered UIG immediately following. This is done by the simple expedient of putting a positive pulse across the cathode resistor of the UIG preceding the one to be triggered. For example, in sending the letter "S" which would use UIG's #19, #17, and #15 for dots and UIG's #16 and #18 for spaces, it would be necessary to start by triggering UIG #15. To do this the "phantom switch network" would have to deliver a pulse to the cathode of UIG #14 because its keyer is normally gated, which would cause the keyer connected to UIG #15 to be pulsed, operating the relay. This would provide three dots separated by two spaces. If a character consisting of more than three dots was desired, it would be necessary to go down the chain to UIG #12 or back to UIG #10, #8, #6, #4, #2, or #1 or the end of the chain. In this way it is possible to obtain any number of pulses required by a character.

In order to provide dash markers, the keyers, which are capable of supplying the spaces between the dot markers, are made conducting. Thus if a keyer which is between two dot marking intervals is made conducting, the pulses in traveling down the chain of UIG's will activate three keyers in a row instead of one keyer, then miss the next keyer because it is being held gated off, then hit the next keyer which is not gated. This condition results in three keyers, two dot markers, and the space marker being on which together form an interval three times as long on the keying relay, giving a dash interval. These dash marking intervals can be inserted anywhere along the chain by gating the appropriate keyer. The keyers that are required to make the dash marking intervals are always the space marking keyers or the even-numbered keyers.

"Sequence Selectors"

Since the even-numbered keyer plate circuits are under the control of the "sequence selectors," it might be of interest to determine how these "se-

Finest FRINGE AREA Antenna

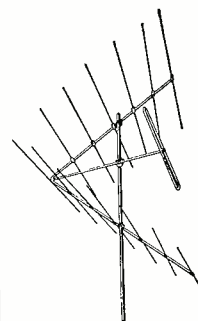

VELA

CORNER REFLECTOR

- HIGH GAIN 12 db
- BROAD BAND
- HIGH FRONT TO BACK RATIO
- RUGGED CONSTRUCTION

ORDER NOW!

Immediate delivery LIST

\$54.50

VIDEO ELECTRONICS

1220 1/2 Grand Ave.

Des Moines, Ia.

EASY MONEY!!

If you don't get our postcards telling the cash we'll pay for that surplus gear you bought when the buying was good, then YOU ARE LOSING MONEY! So send us your name and address NOW and GET ON OUR MAILING LIST!

G. L. ELECTRONICS
905 S. VERMONT AVE., LOS ANGELES 6



SOUND POWERED PHONES RCA-M1-2454

Complete with 24' of Rubber Covered Wire. NEW EXPORT PACKED Shipping weight 6 lbs.

\$9.95 per set
2 for \$19.50

EACH SET GUARANTEED
Brand New. Gov't. Cost. \$42.00
INCLUDE POSTAGE WITH ORDER

McCONNELL'S

3834 Germantown Ave.
Phila., Pa. RA 5-6033

RADIO-TV-ELECTRICAL TESTER

All-around Trouble Shooter

Will test Radio-TV tubes, ignition coils, condensers (all types), spark plugs, irons, transformers, speakers, etc., for opens, shorts, leaks, into megohms. Sensitivity compares with WVYL Tests 70-750 volts AC or DC. Tests mica, paper, oil, ceramic, air and electrolytic condensers for shorts, opens, leaks, and you can tell approximate capacity after few tests.

For all Engineers, Experts, and Beginners. NO DANGER, NO SHOCKS, NO PLUG IN and will not harm anything you test. Only \$49.50 plus 25c postage

CHECKS INDUCTION. Too.

5-day money back guarantee.

HOWARD SALES CO., Dept. RN-3
539 Atlantic Avenue Brooklyn 17, New York

T-V TUNERS

Continuous Tuning Printed Circuit Type

Rendered unserviceable by manufacturer. IDEAL FOR PARTS INCLUDING 1.5 WATTING DRIVE AND MISCELLANEOUS CONDENSERS, RESISTORS, ETC. Sold as is. No refunds. Postpaid

\$1.00 each, 3 for \$2.50, \$8.50 per dozen
Cash with order. Immediate delivery.

H & D PRODUCTS

P. O. Box 1276

Culver City, California

Advance with ELECTRICITY

You need firm grasp of fundamentals to keep pace with these complex, fast-growing fields. In thorough 2-year course learn electricity, electronics, physics, mathematics, drafting, etc. Other engineering and technical courses. Coed. Day, evening, 44th year. Write for Catalog.

FRANKLIN TECHNICAL INSTITUTE

46 Berkeley Street

Boston 16, Mass.

RADIO & TELEVISION NEWS

quence selectors" operate to provide the proper number of dashes in the proper place. The "sequence selectors" consist of shielded grid thyratrons of the 2D21 type. Nine of them are used to form the dashes and the tenth one is in the circuit to release the thyratrons that have been activated. For example, consider "sequence selector" #18. This tube is held biased to cut-off and in the standby condition the tube will not draw current. When the tube is given a positive voltage pulse, approximately 12.5 volts, from the "phantom switch network," this triggering will cause the gas to ignite, the tube starts to conduct, the voltage across the plate resistor drops, and the cathode voltage rises to the plate potential, less the drop in the tube. This plate voltage is fairly close to the "B+" supply voltage due to the small value of the plate load resistor and the small current drawn by the circuit. Thus approximately 250 volts is available across the cathode resistor. This cathode voltage is applied to keyer #18 and serves as its plate voltage. Now keyer #18 is able to close the relay when a pulse is applied to its grid. This same process applies to all the other "sequence selectors." The "phantom switch network" will activate any number of these selectors which, in turn, will operate the keyers as required.

The gaseous tubes thus ignited will remain ignited unless some means of erasing them is brought into play. When the letter is completely transmitted, the trailing edge of the pulse from the cathode of the last UIG is used to signify that the character is completed. This trailing edge causes the erase tube, which is biased to cut-off, to trigger. Plate current starts to flow and the erase relay which is in series with the plate circuit opens, breaking a set of normally-closed contacts which are used to supply plate voltage to all of the "sequence selectors" as well as to itself. Therefore, when this erase relay is pulsed, it will automatically extinguish all of the other "sequence selectors" and the erase tube itself and the circuit is now ready to form another character.

-30-

PHOTO CREDITS

Page	Credit
35, 36, 37	Vernon C. MacNabb Co.
40, 62	Radio Corporation of America
46, 47	Cadstep Laboratories
52	Collins Audio Products Co., Inc.
58	General Electric Company
72	Electronic Workshop Sales Corp.
110	Empire State Building

ERRATA

In the diagram of Fig. 3 (page 46 of the November issue) pin numbers 4 and 5 on the 6V6 tube (V₁) should be interchanged.

In the article, "A Vacuum Tube Keyed Transmitter," appearing in the January issue, the diagram of Fig. 1B has two errors in it which should be corrected. The junction point of R₁ and R₂ should be connected to the top of the key jack instead of ground as shown and the leads to the open and closed contacts of the low current relay should be reversed.

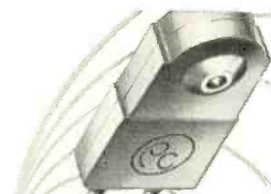

for flawless reproduction
**NO OTHER CARTRIDGE CAN
 PERFORM LIKE A PICKERING**

Pickering patented design
 provides **DYNAMIC COUPLING***
 throughout the entire audible range

* DYNAMIC COUPLING ASSURES

- constant stylus contact with the record grooves over the entire audio spectrum (20-20,000 cps)
- full frequency response
- full transient response

**NO RESONANCES
 NO MISTRACKING
 NO GRINDING OF
 GROOVE WALLS**

Pickering Cartridges transmit all of the sounds in the musical spectrum, without loss of definition, just as a fine optical lens passes all of the colors in the rainbow.

For literature address Dept. C

Well-informed engineers and technicians, schooled in the science of electro-mechanics, know that only wide-range frequency response provides full transient response; the electronic phenomena which enables the reproduction of orchestral music with all the subtle sounds that give each musical instrument its individual character.

Pickering engineers and designers have but one objective . . . to produce products that will please the music lovers' insatiable appetite for the flawless recreation of recorded music . . . for the utmost in quality insist upon Pickering Audio Components.

Pickering
 & COMPANY, INCORPORATED
 OCEANSIDE, NEW YORK



EVERYTHING you buy from KEY is fully guaranteed. If you are not satisfied you may return your purchase for credit or refund as you prefer. NO questions asked. All merchandise offered subject to prior sale. Minimum order \$2.00. All prices are FOB Baltimore, Maryland. Shipment will be made by Railway Express Collect unless otherwise specified. Include 25% with all COD orders.

AUDIO OUTPUT TRANSFORMERS

900 V. Insulation 50-60 ma primaries. Secondaries match 3.2 ohms nominal.	Price Ea.
Stock No. 987 2,000 ohms	50.49
987 2,400 ohms; with bucking winding	69
775 2,500 ohms	49
247 2,500 ohms; with bucking winding	69
178 5,000 ohms	49
656 6,000 ohms	49
578 8,000 ohms	49
868 1,100 ohms; with bucking winding	69
430	

HORIZONTAL FORMER. OUTPUT (FLYBACK) TRANSFORMER. Equivalent to RCA 21173

Price Ea.
2.69 ea.

OIL-FILLED CAPACITORS

Capacity	Voltage	Price ea.
2 mfd	1,000 V.D.C.	51.49
3.5 mfd	220 V.A.C.	69
4 mfd	3,000 V.D.C.	5.95
6 mfd	1,000 V.D.C.	3.29
7 mfd	220 V.A.C.	1.39
7 mfd	600 V.D.C.	2.69
8 mfd	1,000 V.D.C.	3.69
8 mfd	330 V.A.C.	2.75
10 mfd	1,000 V.D.C.	3.89
12 mfd	600 V.D.C.	3.50
16 mfd	330 V.A.C.	3.98

PAPER CAPACITORS, TYPE TTR

Capacity	Voltage	Price Ea.
.005 mfd.	.01 mfd.	.02 mfd
10 for \$0.49	100 for 3.85	1,000 for 29.00

BLOWERS, A. G. REDMOND TYPE L

Approx. 100 cfm 115v. 60 cy.	Price Ea.
400 V.D.C. C-D RM4100	39
400 V.D.C. C-D RM4200	49
400 V.D.C. C-D RM4400	89

POWER TRANSFORMERS, 117 V., 50/60 C. Primaries

Stock No.	Description	Price
*1159	Sec #1-650 V.C.T. @150A; Sec #2-6.3V @2.1A; Sec #3-5V @3A Jefferson	\$4.95
*1160	Sec #1-1450 V.C.T. @100A; Sec #2-6.3V @1.2A; Sec #3-5V @3A Jefferson	5.95
192	Sec #1 700 V.C.T. @090A; Sec #2-6.3 V.C.T. @4A; Sec #3-5V @3A SNC	3.89
*8398	Sec. #1-6.3V @10.0A; Sec. #2-6.3V @1.5A; Sec. #3-5V @3A.C.T.; Sec. #4-860V @.141 A.C.T. Westinghouse, Tuffnell Insulated	7.95

HIGH VOLTAGE TRANSFORMER, 117V 50/60 C Primary

Stock No.	Description	Price Ea.
*1158	P-117V, 50/60C; Sec 4000V @.025A Jefferson	8.95
*1157	Sec #1 4V @ 16.0A; Sec #2 2.5V @ 1.75A Jefferson	5.75
239	Sec #1 5V @ 3.25A; Sec #2 5V @ 3.25A can deliver 3V @ 6.5A; 10V.C.T. @ 3.25A SNC	2.50

FILTER CHOKE

Stock No.	Description	Price Ea.
647	5.6 Henries, .085A, 900V. Ins.	\$0.89
794	5.0 Henries, .090A, 900V. Ins.	.95
*8350	10.0 Henries, .225A, 500V Ins. Westinghouse, Tuffnell Insulated	4.98
*1161	Dial 30 henry, .020A Jefferson	1.00

TANK CIRCUIT, 150-200 Mc. Uses 2-826's

Description	Price Ea.
In Metal Shield Box, complete w/tubes	\$7.95 ea.
CONTROL STRIP, ANTENNA LINE, Uses 2-900G, 1-9002 Has 6VAC DPST relay, Complete w/tubes and relay	2.50 ea.

KNOB ASSORTMENT

Description	Price Ea.
SARKES TARZIAN TUNERS, Uses 1-6C4, 2-GAGB. Good condition. As is, less tubes	2.98 ea.

Panel Light socket assembly assortment

Description	Price Ea.
RECEIVER LOOP ANTENNA ASSORTMENT, 10 for	\$2.39
AC LINE CORDS, MOULDED RUBBER PLUGS ASSORTED	10 for 1.95

ATTENTION INDUSTRIAL USERS!!!!
 We have large stocks of the following items:
 Amphecol Connectors
 Allen Bradley Potentiometers
 T & B "Sta-Kon" Terminals
 Tube Sockets
 High-vacuum and Gas-filled Condensers
 Compression Type Trimmer Capacitors
 Magnet Wire
 ANP Terminals
 Bundry Hylugs
 Fiberglass Yarn
 We invite your inquiries. We will reply the same day your query is received.
 Write, wire, or phone—Phone No. Wilkens 6300.

Key Electronics Division

1801 N. LONGWOOD ST. BALTIMORE 16, MARYLAND

SELE IUM RECTIFIERS

Current (cont.)	Full Wave Bridge Types			
	18/14 Volts	36/28 Volts	54/40 Volts	130/100 Volts
2 Amps.	\$2.40	\$3.75	\$6.95	\$10.50
4 Amps.	3.85	7.00	9.00	...
6 Amps.	5.65	9.00	...	33.00
10 Amps.	6.95	10.95	...	48.00
12 Amps.	7.50	14.00	...	58.00
20 Amps.	13.25	20.50
24 Amps.	14.00	26.00
30 Amps.	19.00	30.00
36 Amps.	25.50	30.00

All our Rectifiers are new & Guaranteed one year. We manufacture special types of rectifiers and rectifier supplies to your specs... FAST DELIVERY.

Selenium Rectifier Specials

110 V, 1/2 Wave..... 65 ma.....only 59c each
110 V, 1/2 Wave..... 450 ma.....only \$1.65 each

New, Selenium Rectifier Transformers

PRI: 110V, 60 cycle in. } 4 Amps.\$ 8.75
SEC: 18, 24, and 36 } 12 Amps. 16.75
Volts } 24 Amps. 35.75
Designed for Bridge or Center-Tap use—Not Surplus.

• 110 V. PRI—36 V. @ 50 Amp. SEC..... \$39.95
• 110 V. PRI—5 V. @ 190 Amp. SEC..... 85.00

QUALITY TESTED TUBES

Large stocks available, new and guaranteed in stock now; many others not listed—complete line of receiving tubes at low prices. In ordering tubes listed below, you may also order types not listed, at about same prices. Buy in full confidence on 100% guaranteed merchandise. Submit your requirements on any types for our quotation. Call us on Westinghouse and other types of industrial and special-purpose tubes. Large stocks of Germanium Crystals. Before you buy, let us quote you.

0A2	1.00	6BE6	.70	12AT7	\$1.00
0B2	1.10	6BG6G	1.20	12AU7	.75
0Z4	.65	6BH6	.80	12AV6	.55
1A7GT	1.00	6BK7	1.40	12AY7	2.75
1B3GT	.85	6BQ6GT	.70	12BA6	.70
1A4E	1.10	6CA	.65	12BE6	.70
1N21	1.10	6CB6	.85	12BH7	1.00
1N21B	3.50	6CB6	.85	12BE6	1.00
1N23	1.45	6CD6G	1.75	12SH7	.95
1N23A	2.50	6F7	.98	12SHT	.75
1N23B	3.75	6F8G	.98	12SK7	.75
1N34	.65	6H6	.75	12SL7	.75
1N34-A	.85	6J5GT	.55	12SQ7	.75
1R5	.65	6J7	.95	25BQ6GT	.98
1U4	.65	6J7	.95	25L6GT	.65
2B7	.75	6K6GT	.79	35C5	.60
3A4	.85	6K7	.75	35Z5GT	.55
3A5	1.10	6K8	.80	50C5	.60
3D6	.50	6L7	.98	50L6GT	.60
3Q4	.55	6R8	.90	80A7	.60
3Q56T/G	1.00	6S4T	.75	304T1	9.95
3E4	.90	6S5	.85	304TH	9.95
5F7	1.95	6S7	.98	717-A	.98
5U4G	.59	6SH7	.70	807	1.65
5V4G	1.05	6SK7	.75	955	.45
5X4G	.85	6SL7GT	.75	956	.37
5Z3	.95	6SN7GT	.65	1616	.75
6AB4	.75	6S7	.75	1624	1.40
6AC7	.98	6T8	1.25	1625	.40
6AL5	1.65	6U4GT	.60	1626	.40
6AK5	.95	6V6GT	.60	1629	.30
6AK6	1.30	6V6M	1.50	5608-A	3.95
6AL5	.55	6W4GT	.60	5686	3.95
6AG5	.85	6X4	.45	5910	.75
6AH6	1.50	6X5GT	.45	9004	.44
6AN5	2.95	7A6	.65	9005	1.50
6AU6	.65	7H7	.80	9006	.44
6AV6	.95	7H7	.80	9006	.44
6BA6	1.25	12A6	.75	VR-105	1.25
6BA6	1.20	12C8	.85	VR-150	.90

• TV "Cheater" Cord—6 Ft. Complete. U.L. App'd. Reg. net 59c. Special.....\$39c

• ART-1—75 meter DeLuxe Mobile AM XMTR. Complete. Only 6"x6" with Built-in Pwr. Supply. New at\$25.00

• AR-II—Complete Radio Station in a Suitcase! Superhet RCVR. and 55 watt CW XMTR. 110 and/or 220 VAC Supply Built-in. 4 thru 16 Mcs. Ten Brand-new DeLuxe Sets in Stock. Write for Details.

• CARTER, 6 Volt Dynamotors Brand New—400 VDC @ 375 ma. List Price \$71.40. Your Cost—Special.....\$28.00

"NOTE: COLLEGES, UNIVERSITIES, INSTITUTIONS, LABS, MFRS., INDIVIDUALS... OR ANYONE HAVING NEW TUBES AND/OR EQUIPMENT IN LARGE OR SMALL QUANTITIES—SUBMIT DETAILED LIST FOR OUR CASH OFFER."

BARRY ELECTRONICS CORP.

136 Liberty Street, N. Y. 6, N. Y. R.Ecor 2-2563
Terms: 25% with order, balance C.O.D.—Send a few cents for postage—All merchandise guaranteed, F.O.B. N.Y.C.

Classified

Rate 50c per word. Minimum 10 words

RADIO ENGINEERING

COMPLETE radio, electronics theory & practice: television; broadcasting; servicing; aviation, marine, police radio. 12 or 18 months. Catalog. Valparaiso Technical Institute, Dept. N, Valparaiso, Ind.

SALE

10 WATT all triode high fidelity audio amplifiers. Built-in preamplifier, separate tone controls, seven tubes. \$67.50. Send for particulars. Electronic Wiring, Selden, L. I., N. Y.

DIAGRAMS Radio, Record Changers, Recorders, 75c; Television with Service Data, \$1.25 up. State manufacturer and model number. Kramer's Radio Service, Dept. N8, 36 Columbus Ave., New York 23, N. Y.

"SUBSTITUTE" beats tube shortage, 900 direct. Interchangeable tubes listed. Chart 50c. Alexander, 780 E. 214th St., N. Y. C.

SAVE \$7.50! Pickering D-140S Diamond LP Cartridges, \$28.50 each. More "High Fidelity" equipment bargains. Free list. Skalamera, 435 E. 74th St., New York 21.

HALLICRAFTER SX-62 with R-44 speaker. Excellent condition, \$180.00. D. Quentin Glenn, 500 Franklin St., Carlisle, Pa.

TV and FM Antennas. Yagi, Conical, Bow-Tie. Mounts, accessories. Lowest prices. Wholesale Supply Co., Dept. H, Lunenburg, Mass.

HEARING aids, used. Zeniths, less accessories, \$7. One-piece Nationals, \$10. One-piece overhauled, with accessories, \$20.00. Shelby Instrument, 321 W. 7th St., Long Beach, Calif.

TUBES, surplus, bought-sold. Free list. Betz, 73 Caroline Ave., Yonkers, N. Y.

TELETYPE machines and parts, new or used. Will buy, sell, trade. Manhattan Electronics, 219 1/2 S. Sepulveda, Manhattan Beach, Calif.

WANTED

AN/APR-4, other "APR," "ARR," "TS," "IE," ARC-1, ARC-3, ART-13, everything surplus; Tubes, Manuals, Laboratory equipment. Describe, price in first letter. Littell, Farhills Box 26, Dayton 9, Ohio.

FRENCH Importer looking for surplus SCR 510 or parts. Write Morellec, 2 rue Mademoiselle, Paris.

HELP WANTED

RADIO Officers, \$7,200-\$10,000 annual earnings, top union conditions, 6 months Radio Operating experience U.S. Merchant ships on FCC License since Jan., 1935, can get emergency FCC License to sail at once. Also experienced U.S.N. Radiomen with 2nd class Radiotelegraph license & 6 months sea Radio time. Phone, write, wire American Radio Association, CIO, 5 Beekman St., New York. CO 7-6397.

CORRESPONDENCE COURSE

USED Correspondence Courses and Books sold and rented. Money back guarantee. Catalog free. (Courses bought.) Lee Mountain, Pisgah, Ala.

RADIO Servicing Course shows latest short cut methods. Lessons easy to follow. Only \$3.00, postpaid in U.S.A. Buyers Syndicate, 30 Taylor St., Springfield, Mass.

MISCELLANEOUS

SPEAKERS repaired, wholesale prices, guaranteed workmanship. Amprite Speaker Service, 70 Vesey St., New York City 7.

WALKIE TALKIES \$4.99 Complete Set of 2
POCKET SIZE —ELECTRONIC VOICE POWERED
No tubes, batteries, adjustments, license or permit needed!
Guaranteed to work anywhere up to 1/2 mile with extra wire. Swell for garage to house, etc.: Your own private, talk-listen phone. Not war surplus. Brand new. Solid Aluminum Case. Two complete units with wire—READY TO USE! SEND ONLY \$1.00 deposit and pay postman \$3.99 C.O.D. or send \$4.99 for PP delivery. Limited supply. MIDWAY COMPANY, Dept. WRT-3, KEARNEY, NEBRASKA.



Another Outstanding Jobber
OLYMPIC ELECTRONICS SUPPLY
1440 W. OLYMPIC BLVD.
LOS ANGELES 13, CALIF.
has all 77 KITS & INSTRUMENTS in stock!
EICO
5" SCOPE KIT \$4.95
See EICO ad on Page 111



PEN-OSCIL-LITE
Extremely convenient test oscillator for all radio servicing; alignment • Small as a pen • Self powered • Range from 700 cycles audio to over 600 megacycles u.h.f. • Output from zero to 125 v. • Low in cost • Used by Signal Corps • Write for information.
GENERAL TEST EQUIPMENT
38 Argyle Buffalo 22, N. Y.

From the earliest days of Radio... to the present era of Television...
CORNISH WIRES
"Made by Engineers for Engineers"
CORNISH WIRE CO., Inc. — 50 Church St., N. Y. C. 7

Superintendent of Phone Communications
OVERSEAS AIRLINE
Free housing. Pays over \$600 per month. Must be thoroughly capable of planning and installing ground and aircraft radio equipment. Also must be well qualified radio technician capable of supervising radio repair shop. Write, SAA, Trans World Airlines, Employment Manager, Kansas City 6, Missouri.

ON-THE-SPOT BATTERY RECORDER
WALKIE-RECORDALL 8 lb. miniature BATTERY Continuous, permanent, accurate, indexed recording at only 5c per hr. Instantaneous, permanent playback. Picks up sound up to 60 ft. Records conferences, lectures, dictation, 2-way phone & sales talks; while walking, riding or flying. Records in closed briefcase with "hidden mike" Write for Detailed Literature.
MILES REPRODUCER CO., INC.
812 BROADWAY Dept 1 RN-4 NEW YORK 3, N. Y.

REPAIR PARTS FOR BC-348 (H, K, L, R only)
Also BC 224 Models F, K. Coils for ant., r.f., det., osc., i.f., c.w. osc., xtal filters, 4 gang cond., front panels, dial assemblies, vol. conds., etc. Write for complete list and free diagram.
HIGH QUALITY CRYSTAL UNITS
Western Electric-type CR-1A/AR in holders. 1/2" pin spacing. Ideal for net frequency operation. Available in quantities: 5910-6350-6370-6470-6510-6610-6870-6990-6940-7270-7350-7380-7390-7480-7580-9720. All fundamentals in KC. Good multipliers to higher frequencies. ... \$1.25 each
ELECTRONICRAFT, INC., 27 Miuburn St., Bronxville 8, N.Y.

LEARN TELEVISION
ELECTRONICS AND RADIO
Engineering Laboratory and Classroom Training. Day and Evening Classes.
Write for illustrated Catalog
ELECTRONICS INSTITUTE, Inc.
21 HENRY, DETROIT 1, MICH.

QUALITY • SERVICE • DEPENDABILITY
DUMONT PERFECTLY CENTERED
COMPLETELY MOLDED CAPACITORS
Sold and Preferred Everywhere
DUMONT Electric Corp.
308 Dyckman Street, New York 34, N. Y.



Enjoy the best!
GARRARD
Outplays the rest!
GARRARD
World's Finest 3-speed Record Changer with Automatic stop. Quiet motor. Heavy turntable. Prevents disturbing resonance, wows, rumble.
Can be used with your present set.
GARRARD SALES CORP., Dept. 3N
164 DUANE ST., N. Y. 13
Gentlemen:
I am interested in learning what to look for when purchasing a 3-speed record changer. Please send me, without obligation, your FACT SHEET.
NAME _____
ADDRESS _____
CITY _____ ZONE _____ STATE _____



MARCH
1952

INDEX OF Advertisers

While every precaution is taken to insure accuracy, we cannot guarantee against the possibility of an occasional change or omission in the preparation of this index.

NAME	PAGE
Acorn Electronics Corp.	106
Airex Radio Corp.	32
Allied Radio Corporation	27, 140, 152
Almo Radio Company	142
Aluminum Products Corp.	107
Altec Lansing Corp.	104
American Phonolic Corporation	26
American Television & Radio Co.	100
Amperite Company, Inc.	158
Amplex Electric Corporation	123
Amplifier Corporation of America	136
Argos Products Company, Inc.	142
Arkay Radio Kits, Inc.	162
Arrow Sales, Inc.	149
Ashe Radio Co., Walter	25
Atlas Tel Rad Company	168
Audel Publishers	146
Barry Electronics	166
Bell Telephone Laboratories, Inc.	12
Belmont Radio Corporation	7
Bendix Radio	143
Bionder Tongue Labs.	135
Bond Equipment Company	114
Brook Electronics, Inc.	102
Brooks Radio and Television, Inc.	144
Burstein-Appleebee Company	122
C & H Sales	140
Candler System Co.	140
Capitol Radio Engineering Institute	91
Channel Master Corp.	9
Chicago Transformer Company	111
Cisin, H. G.	126
Circle Sales Co.	148
Cleveland Institute of Radio Electronics	95
Collins Audio Products	14
Columbia Electronic Sales, Inc.	143
Comet Electronic Sales Co.	143
Communications Equipment Company	105
Cornish Wire Co.	166
Coyne Electrical School	112, 161
Davis Electronics	114
DeForest's Training, Inc.	5
Dow Radio, Inc.	98
DuKane	120
Dull's Electrical Translations	158
Dumont Electric Corp.	166
Eastern Telephone Co.	132
Editors & Engineers, Ltd.	112
Edie Electronics, Inc.	114
Electronic Exporters, Inc.	112
Electronic Instrument Co., Inc.	3rd Cover, 34, 132, 140, 166
Electronic Specialty Supply	146
Electroncraft, Inc.	166
Electronics Institute, Inc.	166
Electro Products Laboratories	148
Electro Sales	148
Electro Voice, Inc.	115
Engineering Associates	162
Esege Sales	145
Espey Manufacturing Company, Inc.	135
Fair Radio Sales	113
Feller Engineering Co.	154
Fisher Radio	155
Forest Sales	120
Franklin Technical Institute	164
G. L. Electronics	138, 164
Garrard Sales	166
General Apparatus Co.	104
General Electric Company	13, 31
General Test Equipment	166
Gonset Company	141
Goodheart, R. E.	143
Grayburne Corporation	162
Greenlee Tool Co.	157
Greenwich Sales Company	136
Greylock Electronics Supply Co.	151
H & D Products	164
Hallcrafters Company, The	22
Harvey Radio Company, Inc.	108
Heath Company	76 thru 83
Henry Radio Stores	159
Hickok Electrical Instrument Co.	24
Hollywood Technical Ins.	168
Howard Sales	164
Hytron Radio & Electronics Co.	23
Indiana Technical College	162
Instructograph Co.	90
J. F. D. Manufacturing Company	104, 154
J S H Sales Company	158
Jensen Industries, Inc.	90
Jensen Mfg. Co.	102
Jantz Mfg. Co.	116
Joseph Radio Parts Inc., Irving	129
Kaar Engineering Company	146
Ken-Way Products, Inc.	127
Key Electronics Division	165
Lafayette Radio Corporation	149
Lampkin Laboratories	148
LaPointe Placemold Corporation	16
Leotone Radio Co.	161
Littelfuse Incorporated	21
Lowell Metal Products Corp.	136
Luther, Otto	142
Macmillan Company	164
McConnell's	153, 164
McCoe Radio Company	92, 93
McGraw-Hill Book Company	144
McIntosh Laboratory, Inc.	167
Mallory & Co., P. R.	4th Cover, 17
Mark Electronics	147
Midway Company	166

(Continued on page 168)

Comparison proves—

McIntosh

WORLD'S FINEST AMPLIFIER

- Less than 1% harmonic or inter-modulation distortion even at peak power—reproducing the entire audible range from 20-20,000 cps.

Compare McIntosh 50W-2 with any amplifier—at any price. For it is only by such comparison that you can fully appreciate the truly superior qualities of this unique, patented instrument that has reached the theoretical limit of quality and efficiency! No other amplifier can give you so much power with so little distortion, at such low cost.



50W-2 Amplifier
50 Watts (Peak: 100)

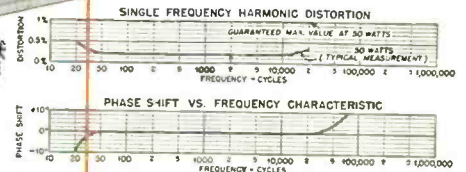

Write today for technical information and name of nearest dealer.

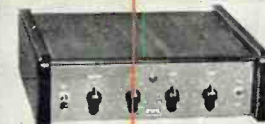

AE-2A Amplifier
Equalizer

MC INTOSH LABORATORY, INC.

322 Water St., Binghamton, N. Y.

STAY ON THE AIR WHEN POWER FAILS...with an ONAN Electric Plant



AUTOMATIC
START & STOP

Model 10EL, 10KW A.C.

When storms, floods, or fires interrupt electricity and force you off the air, you lose listeners and income. Guard against loss, assure vital public service during emergencies by installing an Onan Electric Plant. Onan Standby Electric plants serve many network and private stations. Automatic models to 35,000 watts.

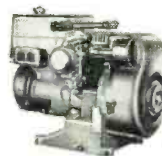

PORTABLE ELECTRIC PLANTS FOR MOBILE RADIO USES
Supply A.C. power for broadcasting at scene of events. Light in weight. Can be carried by hand or in trunk of car. A.C. models: 400 to 3,000 watts.

Write for FREE Folder



D. W. ONAN & SONS, INC.
4817 University Avenue
Minneapolis 14, Minnesota

CRONAME TV CONVERSION KIT

Be Proud of Your
Big Tube
Conversion
or Custom
Installation
3
Professional
Quality
Components

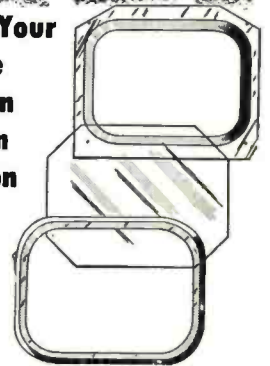

1. Metal Mask Tailored for Perfect Fit.
2. Heavy 1/4" Tempered Safety Glass.
3. Beautiful Gold Finished Metal Escutcheon.

All Popular Sizes: 14", 16", 17" and 20"
Easy Installation Instructions Included

Order CRONAME TV CONVERSION KITS;
CRONAME TUNING DIALS, KNOBS and
ACCESSORIES from Your Parts Jobber.

Send for New CRONAME Catalog.



ELECTRONICS, INC.

911 N. Larrabee St., Chicago 10, Ill.
Mfrs. of Replacement Speaker Cone Assemblies

TRIPLEX WAVE MASTER

TRIPLE DIRECTORS ¼ Wavelength Stacked
TWO BAY STACKED CONICAL
NO BOOSTER REQUIRED
MATCHES ANY OHM WIRE
75-150-300

YOUR COST
\$8.90

IMMEDIATE DELIVERY

Conical with 3-Element Dipole

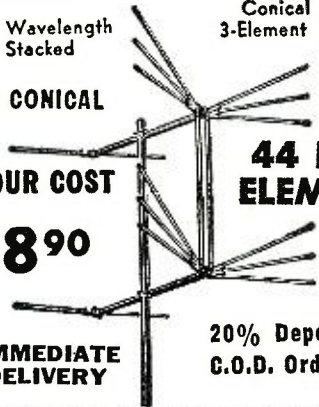

44 INCH ELEMENTS

20% Deposit
 C.O.D. Orders

GHOST FREE RECEPTION ALL CHANNELS

INSTANT ASSEMBLY

EASY INSTALLATION APPROX. WT. 7 POUNDS

Price List

\$2690

- 30% more gain than former 4X antennas.
- Reception available in fringe and formerly unsatisfactory locations, all channels.

UNDER ACTUAL TESTS... PROVED!

- Most advanced design to date.
- Easier tuning, added selectivity on any receiver.
- These tests conducted in fringe areas and locations up to 250 miles from transmitting stations—not by meter or laboratory tests, but under average home installation.

SOLD DIRECT—WRITE—WIRE—CALL—FAIRFAX 9171

RAY CO.

441 SUMMIT ST.
 TOLEDO, OHIO

SPECIAL OFFERING TO T.V. SERVICE COMPANIES & DEALERS

STANDARD BRAND TUBES

All are first quality. Many in original factory boxes. All individually boxed.

024	\$.072	6BC5	\$.095	12AUG	\$.90
1B3	\$.95	6BE6	\$.80	12AU7	\$.70
1R5	\$.85	6BG6	\$.90	12AV6	\$.70
1S5	\$.85	6BJ6	\$.85	12AV7	\$.35
174	\$.90	6BN6	\$.40	12BA6	\$.75
1U4	\$.80	6BQ8	\$.20	12BE6	\$.75
1U5	\$.80	6C4	\$.30	12BH7	\$.75
1X2	\$.05	6CB6	\$.80	12C6	\$.95
3Q4	\$.95	6CD6	\$.25	12S17	\$.75
3Q5	\$.110	6H6	\$.85	12SA7	\$.80
3V4	\$.90	6J5	\$.65	12SK7	\$.80
5U4	\$.85	6L6	\$.10	12SN7	\$.75
5V4	\$.110	6K6	\$.80	12SQ7	\$.75
5Y3	\$.50	6SA7	\$.80	25A7	\$.80
6AB4	\$.95	6SH7	\$.65	25BQ	\$.25
6AC7	\$.116	6SK7	\$.75	25L6	\$.80
6AG5	\$.106	6SN7	\$.85	32L7	\$.25
6AG7	\$.125	6T8	\$.90	35B5	\$.90
6AH6	\$.160	6T7	\$.90	35L6	\$.85
6AK5	\$.155	6T8	\$.25	35W4	\$.60
6AL5	\$.65	6V6GT	\$.80	35Z5	\$.55
6AOS	\$.65	6WA4	\$.65	4Z5	\$.65
6ARS	\$.75	6W6	\$.90	50A5	\$.00
6AT6	\$.70	6X4	\$.60	50C2	\$.90
6AUS	\$.65	6Y6G	\$.95	50C3	\$.90
6AV6	\$.70	12AT6	\$.65	50L6	\$.80

10%

from total price reduction on all orders of 50 tubes or more. Minimum order \$10.00.

TELEVISION ANTENNAE

CONICAL 8 ELEMENT—4 elements, 4 reflectors high gain, all channel for general use.

Packed 6 to a carton..... \$2.90 ea.
 Less than 6..... \$3.15 ea.

DOUBLE BAY CONICAL—with stacking rods, 4 elements, 4 reflectors per bay, two stacks with ¼ wave connecting bars. Solves fringe area problems.

Packed 6 to a carton..... \$6.40 ea.
 Less than 6..... \$6.99 ea.

FOLDED HI-LO..... \$3.99 ea.

ANTENNAE ACCESSORIES

EAVE MOUNT (12")..... \$1.50 pr.
 EAVE MOUNT (15") Heavyweight..... 2.00 pr.
 EAVE MOUNT (18") Heavyweight..... 2.25 pr.
 EAVE MOUNT (24") Heavyweight..... 3.00 pr.

SPECIAL 300 OHM TV WIRE \$15.00

1st quality 55 mil web, 22 gauge pure polyethylene and 7 Strand pure copper, 1000 ft. spools, \$17.50 per M in lots. Less than 5M ft. \$17.50 per M of 5 M ft.

TERMS: 10% deposit with order. Balance C.O.D. F.O.B. N.Y.C. Include shipping charges with paid-in-full orders.

ATLAS TEL-RAD PARTS
 153 CHAMBERS ST., DEPT. RN-3, NEW YORK 7, N.Y.
 Phone HA 40ver 2-5813

STAN-BURN

ANTENNAE SPECIALS

DOUBLE V ¾" Dowel.....	\$2.98	1-11	Or More
DOUBLE V ½" Dowel.....	2.45		
DOUBLE V ¼" Dowel.....	3.95		
10 Element Conical ¾" Dowel.....	3.55		
Folded HI Straight Low Quick Rig			
¾" elements.....	4.25	3.25	
WINDOW CONICALS.....	4.95	3.75	

MASTS

5 FOOT SWEDGED.....	.89	.69	
10 FOOT PLAIN.....	1.59	1.29	

TV WIRE

42 Mil 300 OHM.....	\$15.95 M Ft.		
55 Mil 300 OHM.....	17.95 M Ft.		
72 OHM COAXIAL.....	52.50 M Ft.		

CATHODE RAY TUBE SPECIALS

7JP4.....	\$15.00	16RP4/KP4 N.U.....	23.00
10BP4.....	14.95	16RP4A.....	26.00
10BP4 N.U.....	19.95	17BP4A.....	27.00
10BP4A N.U.....	19.95	20CP4.....	39.95
12LP4.....	19.95	20CP4 Sheldon.....	37.00
12LP4A.....	19.95	19AP4A.....	47.95
14BP4.....	19.95	19DP4A.....	47.95
16DP4A.....	26.00	24AP4A.....	73.00
16GP4.....	33.00	Single ion traps.....	.39
16AP4A.....	39.00	Double ion traps.....	.50

CHASSIS 630 K30 VIDEO OPEN FACE CABINET.....\$139.50

TRANSFORMERS

Nationally Advertised
 RCA type for 16" to 24"
 X032..... \$3.85
 G.E. type for 16" to 24"
 X045..... \$3.85
 These are very special prices while they last!

DEFLECTION YOKES

COSINE FERRITE
 TODD YOKE 70° \$4.20
 REGULAR 70°
 YOKE..... 3.85

CONDENSER SPECIALS BY PASS—ALL GUARANTEED

20x20-150 Stan Burn.....	\$0.41
50x30-150 Stan Burn.....	.49
20x150 Stan Burn.....	.32
8-450 Stan Burn.....	.41
16-450 Stan Burn.....	.49

4 Prong Vibrators each \$1.29
 Lots of 12 or more..... 1.19

Standard TV Tuners..... \$18.95
 RCA Guaranteed Tuners (with tubes) SPECIAL! While they last..... \$12.00

AUTHORIZED DISTRIBUTORS for: General Electric, Kenrad, Tung-Sol, National Union, Jewel, De Wald, Regal, Automatic and Setchel-Carlson.

We carry a complete line of popular makes of Radio and TV tubes at 50% discount. Also many other special purpose and transmitting types, and all electronic parts and equipment at lowest prices. Send us a list of your requests for quantities and prices.

TERMS: 20% with order. Balance C.O.D. All prices F.O.B. NEW YORK Warehouse. Minimum order \$5.00.
 Write for our latest price list to Dept. RN-3

STAN-BURN RADIO and ELECTRONICS CO.
 (C.B.S. THEATRE BLDG.)
 1697 BROADWAY • NEW YORK 19, N.Y.

INDEX OF ADVERTISERS

(Continued from page 167)

NAME	PAGE
Midwest Radio & Television Corp.	88
Miles Reproducer Company, Inc.	166
Milwaukee School of Engineering	134
Mosley Electronics	159
Moss Electronics	97
National Electronics	162
National Radio Institute	3
National Schools	11
Newark Surplus Materials	84
Newcomb Audio Products	133
New England Television Corp.	160
Niagara Radio Supply Corporation	101
Offenbach & Reimus Company	122
Ohmite Mfg. Company	6
Olson Radio Warehouse	86
Onan & Sons, D. W.	167
Peak Electronics Company	156
Penn Boiler & Burner Mfg. Corp.	103
Pfanzstiel Chemical Company	126
Photocon Sales	102
Pickering and Company, Inc.	165
Platt Electronics	110
Poly-Tech Company	130
Precision Development Corp.	142
Precision Electronics, Inc.	154
Premax Products	144
Premier Radio Tube Co.	117
Prentice-Hall, Inc.	157
Progressive Electronics Company	129
RCA Institutes, Inc.	85, 132
Radcom Engineering Co.	163
Radio and Television News	139
Radio Corporation of America	Second cover, 75
Radio Craftsmen, Inc., The	160
Radio Ham Shack, Inc.	121
Radio-Music Corp.	145
Radio Receptor Co., Inc.	135
Ray Mfg. Co.	153
Raytheon Manufacturing Company	168
Refonic Sales Co.	15
Regency	151
Rek-O-Kut Co., Inc.	88
Rider, Publishers, Inc., John F.	119, 147, 168
Rinehart Book Television Corp.	28, 29
Rogers-Phillips Research Labs.	124
Sams & Company, Howard W.	8, 128
Sanett, Robert	88
Sarkes-Tarzan, Inc.	152
Schott Company, Walter L.	33
Service Management	106
Simpson Electric Co.	126
Snyder Manufacturing Company	30
South River Metal Products	20
Sprague Products Co.	99
Sprayberry Academy of Radio	19
Stan Burn Radio & Electronics	168
Standard Surplus	109
Standard Transformer	141
Star Electronics Distrib. Inc.	152
Steve-EI Electronics	137
Stan Radio of Washington, D. C.	96
Superior Instruments Co.	161
Sylvania Electric Products	10
Tab	169, 170
Talbot Company	162
Tech-Master Products Co.	158
Tel-Ex-Pand Products Sales Corp.	146
Television Communications Institute	163
Television Supply Company	90
Telex, Inc.	131
Transvision, Inc.	20
Trans World Airlines, Inc.	88, 166
Triad Transformer Mfg. Co.	118
Tri Manufacturing Co.	120
Triplet Electrical Instrument Co.	144
Tri-State College	144
Ungar Electric Tool Company, Inc.	129
University Loudspeakers, Inc.	155
V & H Radio & Electronics	153
Vactron	163
Vaiparato Technical Institute	106
Video Electronics	164
Waldom Electronics, Inc.	167
Weathers Industries	136
Weller Electric Company	18
Wells Sales, Inc.	89
Wholesale Radio Parts, Inc.	150
Workshop Associates, Inc.	98
World Radio Laboratories, Inc.	147
YMCA Trade & Technical School	147

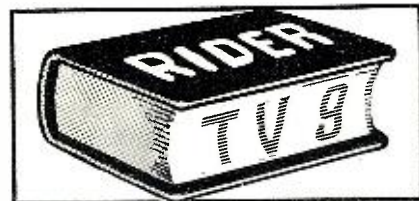

AUDIO (Sound) ENGINEERING COURSE Home Study Training

BIG PAY JOBS open in Television, Radio, Electronics, Disc Recording and Motion Pictures. Recognized and Approved Training. Write for complete details. TODAY!
HOLLYWOOD TECHNICAL INSTITUTE
 3355 Cahuenga Blvd., Dept. B. K.
 Hollywood 28, California



PRECISION RESISTORS

Over 2 1/2 Million in Stock

"TAB"-Specialists in Precision Resistors
No Mirfs Choice-We Ship Types in Stock

0.116	286	1260	3500	17500	115000
0.42	289	1350	3509	17977	116667
1.825	298	1500	3700	18000	120000
0.607	300	1400	3700	18300	130000
1.03	310	1488	3720	18380	135000
1.32	311.5	1496	3720	18400	136000
1.73	320	1500	3900	18400	140000
1.75	325	1510	4000	19000	145000
2.5	327	1520	4000	19000	145000
3.3	340	1600	4200	20000	150000
3.83	350	1640	4200	20441	155000
3.6	350	1646	4200	20500	156000
4.35	366.6	1650	4300	21000	165000
5.025	370	1670	4314	21500	166750
6.25	380	1710	4444	22500	169200
6.5	389	1712	4450	22990	175000
7.9	390	1740	4720	23000	180000
7.8	400	1770	4750	23150	180600
7.4	410	1800	4850	23225	185000
10.38	414.3	1800	4880	23250	186000
10.38	418.8	1830	4900	23500	190000
11.25	425	1850	5000	24000	198000
13.52	426.9	1850	5000	24000	198000
14.2	427	1892	5210	25000	201000
14.5	430	1894	5235	25200	205000
18.4	440	1940	5300	26000	210000
16	450	1986	5500	28333	215000
19.2	452	1987	5500	28600	220000
19.2	450	1990	5500	28600	220000
19.5	470	1999	5730	28600	229000
20	475	1990	5770	29000	230000
22.5	478	2000	5800	29000	230000
23	480	1902	6000	28000	238000
24	487	1903	6100	28430	240000
26	500	1946	6200	29000	240000
26	510	1905	6140	29000	250000
28	520	1906	6200	29500	265000
30	525	1909	6250	29500	265000
31.5	540	1908	6480	30000	270000
37	550	1909	6500	31000	275000
40	560	1910	6500	31000	275000
50	575	1911	6840	32000	300000
51.78	580	1912	6900	33000	307500
58	588	1912	6900	33000	307500
56.7	600	1914	7320	36000	314000
60	612	1915	7500	37000	316000
61	620	1916	7500	37000	316000
68	625	1917	7717	38500	330000
74	633	1918	7900	39000	335000
73	640	1919	7900	39000	335000
80	641	1922	7950	40000	353500
81.4	645	1924	8000	41400	375000
81.4	645	1924	8000	41400	375000
81.4	645	1924	8000	41400	375000
100	657	1980	8250	45000	400000
100	658	1980	8250	45000	400000
103.2	670	2045	8700	47500	420000
105	673	2080	8770	48000	422000
106.7	673	2080	8770	48000	422000
107	680	2141	9100	49000	430000
110	681	2142	9445	50000	450000
120	684	2146	9500	51000	458000
121.2	689	2150	9710	52000	470000
125	697	2160	9800	55000	472000
135	700	2187	9902	57000	500000
147.5	711	2195	10000	58333	510000
160	730	2250	10600	61430	521000
160	740	2250	10600	61430	521000
165	750	2300	10800	62000	525000
175	800	2400	11000	63000	540000
175	806	2450	10936	65000	550000
179	820	2463	11000	66600	560000
180	850	2500	11400	68000	570000
182	854	2490	11500	67500	575000
202	859	2500	11690	68000	600000
202	860	2500	11690	68000	600000
209.4	910	2600	12000	72000	650000
220	917	2625	12800	73500	654000
220	946	2635	13100	75000	660000
220	978	2700	13500	80000	660000
220	1000	2750	13580	82000	690000
230	1030	2800	14000	85000	720000
230	1056	2860	14000	85000	720000
235	1059	2870	14250	85750	761300
240	1067	2900	14500	86000	770000
245	1100	3000	14500	90000	813000
245	1110	3100	14550	91000	820000
250	1150	3163	15000	93000	840000
260	1155	3259	15000	93000	860000
270	1162	3290	16000	95000	900000
270	1200	3300	16000	95000	900000
275	1225	3333	16800	100000	930000
280	1250	3384	17000	110000	950000

Any Size Above, Each 35c; Ten for \$3.29				
CGOHMS				
1.1	1.579	2.7	6.7	10
1.1	1.65	2.7	4.23	7
1.25	1.75	2.8	4.25	7.5
1.5	1.8	2.85	4.5	8
1.3	1.9	3	5	7.74
1.39	2.1	3.3	5.1	8
1.4	2.2	3.673	6	8.5
1.57	2.25	3.75	6.5	9.05
1.7	2.4	4.2	7.5	10
Any Size Above, Each 70c; Ten for \$6.49				

Vacuum Precision HiVOLT Resistors
Megohms - 12, 25, 67, 75, 83, 99, 111, 157, 239, 3.75 1/2% Accy. Ea. \$1, 10, \$7.50

TUBE SOCKETS, ALL TYPES

- A. RCA 5-pin Giant, 803, etc. \$1.49
- B. Johnson 4-pin BAYON, 866, etc. .85
- C. 30-PL Socket, 181, etc. 1.15
- D. Johnson 7-pin Steatite, 829B, etc. .69
- E. Johnson 122-234, HK257, 813, etc. .63
- F. Small Shell BU20A, 218FL, etc. .75
- G. Med Shell DIB2PL, Cinch, etc. .89
- H. 5-pin ACORN 1-9/16" dia HAML-D, etc. .89
- I. Johnson 122-234, 8-pin Tube Lock, etc. .98
- J. 4-prong STEATITE Johnson, 866, etc. .30
- K. 5-prong STEATITE Johnson, 807, etc. .30
- L. 7-pin STEATITE Johnson, 1925, etc. .36
- M. 7-pin NATIONAL CRT, Steatite, etc. .30
- N. MINI 7-pin Mini B-HP & Shield, etc. .30
- O. MINI 7-pin Mini B-Top Mkt & Shield, etc. .23
- P. MINI 9-pin Hot Mkt Hkt Sim, etc. .33
- Q. NOVAL SHIELD 1 1/2", 12c, 1-15/16", etc. .17
- R. AMPH 8-pin 78P Pin 4.5, 6, 8, etc. .17
- S. 4-pin AMPH 8-pin 78P Pin 4.5, 6, 8, etc. .17
- T. O.C.F.A.L. 8-pin & plate Steatite, etc. .20
- U. O.C.F.A.L. 8-pin & plate Steatite, etc. .20
- V. O.C.F.A.L. 8-pin & plate Steatite, etc. .20
- W. O.C.F.A.L. 8-pin & plate Steatite, etc. .20
- X. O.C.F.A.L. 8-pin & plate Steatite, etc. .20
- Y. MAGNAL 498S-111 ceramic 500P1, etc. .69
- Z. MUKROY HV SAFETY SGT. 866A, etc. .98

VARIABLE CONDENSERS	
150mm/300V Gap HP	\$1.39
Dual 7mm ea. Sect 1000V	1.29
JOHNSON 70130 70 mm/300V Gap 1.29	
Cardwell Non-Contaminating Ceramic	1.98
CARDWELL TK-300-US 53 to 312	1.98
MMI. Can be made Split, stat. etc.	10.95
Variable Drive 10 to 50mm, etc.	5.9
Midget 3 to 15 mmf. Mtd. each.	5.9
2 1/2" Meter Butterfly Cnds 30mm/50V	98c
HP Thick Film 500V/100V/200V	98c
PLANETARY DRIVE 1/2" DIA. SHAFT	1.49
5 to 1 Cromme 27007	1.49

"TAB"

THAT'S A BUY

HIGH CURRENT MICA CNDRS.									
CYLINDRICAL					SIMILAR TYPE C				
Mfd.	Kv	Amps	Mc	Each	Mfd.	Kv	Amps	Mc	Each
.009	1.5	39	1	\$14.98	.009	1.5	39	1	\$14.98
.0023	1.5	5	3	5.98	.0023	1.5	5	3	5.98
.01	10	30	3	49.50	.0045	30	33	3	45.00
.0045	30	33	3	45.00	.0045	30	33	3	45.00
.0025	13	20	3	28.95	.0025	13	20	3	28.95
.0015	5	3.3	3	3.48	.0015	5	3.3	3	3.48
.001	30	30	3	110.00	.001	30	30	3	110.00

OIL CAPACITORS									
Mfd.	Each	Mfd.	Each	Mfd.	Each	Mfd.	Each	Mfd.	Each
4	50wvdc	2	1.69	12500	Each	2	1.69	2	1.69
4	150wvdc	10	2.98	1400wvdc	35	2.5	1.29	1.2	.39
1	1-3/5	.69	1.5	4.98	300wvdc	.5	1.39	400wvdc	.49
1	250wvdc	.25	1.29	1500wvdc	.5	1.39	1500wvdc	.49	
1	300wvdc	.5	1.39	2000wvdc	.5	1.39	2000wvdc	.49	
1	400wvdc	.5	1.39	2500wvdc	.5	1.39	2500wvdc	.49	
1	500wvdc	.5	1.39	3000wvdc	.5	1.39	3000wvdc	.49	
1	600wvdc	.5	1.39	3500wvdc	.5	1.39	3500wvdc	.49	
1	700wvdc	.5	1.39	4000wvdc	.5	1.39	4000wvdc	.49	
1	800wvdc	.5	1.39	4500wvdc	.5	1.39	4500wvdc	.49	
1	900wvdc	.5	1.39	5000wvdc	.5	1.39	5000wvdc	.49	
1	1000wvdc	.5	1.39	5500wvdc	.5	1.39	5500wvdc	.49	
1	1100wvdc	.5	1.39	6000wvdc	.5	1.39	6000wvdc	.49	
1	1200wvdc	.5	1.39	6500wvdc	.5	1.39	6500wvdc	.49	
1	1300wvdc	.5	1.39	7000wvdc	.5	1.39	7000wvdc	.49	
1	1400wvdc	.5	1.39	7500wvdc	.5	1.39	7500wvdc	.49	
1	1500wvdc	.5	1.39	8000wvdc	.5	1.39	8000wvdc	.49	
1	1600wvdc	.5	1.39	8500wvdc	.5	1.39	8500wvdc	.49	
1	1700wvdc	.5	1.39	9000wvdc	.5	1.39	9000wvdc	.49	
1	1800wvdc	.5	1.39	9500wvdc	.5	1.39	9500wvdc	.49	
1	1900wvdc	.5	1.39	10000wvdc	.5	1.39	10000wvdc	.49	
1	2000wvdc	.5	1.39	10500wvdc	.5	1.39	10500wvdc	.49	
1	2100wvdc	.5	1.39	11000wvdc	.5	1.39	11000wvdc	.49	
1	2200wvdc	.5	1.39	11500wvdc	.5	1.39	11500wvdc	.49	
1	2300wvdc	.5	1.39	12000wvdc	.5	1.39	12000wvdc	.49	
1	2400wvdc	.5	1.39	12500wvdc	.5	1.39	12500wvdc	.49	
1	2500wvdc	.5	1.39	13000wvdc	.5	1.39	13000wvdc	.49	
1	2600wvdc	.5	1.39	13500wvdc	.5	1.39	13500wvdc	.49	
1	2700wvdc	.5	1.39	14000wvdc	.5	1.39	14000wvdc	.49	
1	2800wvdc	.5	1.39	14500wvdc	.5	1.39	14500wvdc	.49	
1	2900wvdc	.5	1.39	15000wvdc	.5	1.39	15000wvdc	.49	

RHEOSTATS									
Mfd.	Each	Mfd.	Each	Mfd.	Each	Mfd.	Each	Mfd.	Each
1	50wvdc	10	2.98	12500	Each	2	1.69	2	1.69
1	150wvdc	10	2.98	1400wvdc	35	2.5	1.29	1.2	.39
1	300wvdc	.5	1.39	300wvdc	.5	1.39	300wvdc	.5	1.39
1	400wvdc	.5	1.39	400wvdc	.5	1.39	400wvdc	.5	1.39
1	500wvdc	.5	1.39	500wvdc	.5	1.39	500wvdc	.5	1.39
1	600wvdc	.5	1.39	600wvdc	.5	1.39	600wvdc	.5	1.39
1	700wvdc	.5	1.39	700wvdc	.5	1.39	700wvdc	.5	1.39
1	800wvdc	.5	1.39	800wvdc	.5	1.39	800wvdc	.5	1.39
1	900wvdc	.5	1.39	900wvdc	.5	1.39	900wvdc	.5	1.39
1	1000wvdc	.5	1.39	1000wvdc	.5	1.39	1000wvdc	.5	1.39
1	1100wvdc	.5	1.39	1100wvdc	.5	1.39	1100wvdc	.5	1.39

EICO

TEST INSTRUMENTS

guards

Majestic
HIGH STANDARDS OF
TELEVISION PRODUCTION QUALITY

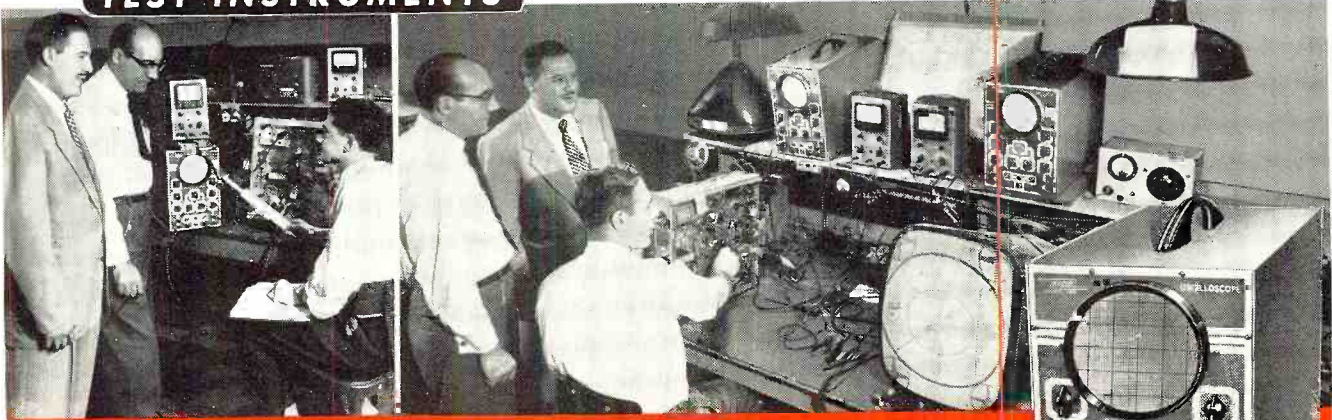

In the Majestic design laboratories, Frank J. Dieli and assistant, Paul Smith, discuss with Harry R. Ashley, some important prototype-circuit measurements just taken with the 425 Oscilloscope, #221 VTVM and #HVP-1 HV Probe.

Frank J. Dieli, Majestic's Chief Engineer, and Harry R. Ashley, President of EICO, inspecting the use of the EICO Model 425 5" Push-Pull Oscilloscope, Model 221 Vacuum Tube Voltmeter and Model HVP-1 High Voltage Probe at the important Final Test Position on the Majestic Television production lines.

KITS - Wired Instruments

For Laboratory Precision at Lowest Cost—
the Leaders Look to **EICO!**

WHY does The Majestic TV Division of The Wilcox-Gay Corp., another one of America's leading TV manufacturers, specify EICO Test Instruments on both its production lines and in its design laboratories?

BECAUSE—like Emerson, Tele-King, Tele-Tone, CBS-Columbia, and many another famous TV manufacturer coast to coast, Majestic knows that

ONLY **EICO** TEST EQUIPMENT DELIVERS ALL 10 **EICO** NOMINAL FEATURES:

1. Laboratory Precision
2. Lowest Cost
3. Lifetime Dependability
4. Speedy Operation
5. Rugged Construction
6. Quality Components
7. Latest Engineering
8. Super-Simplified Assembly and Use Instructions
9. Laboratory-Styled Appearance
10. Exclusive EICO Make-Good Guarantee

Before You buy any higher-priced equipment, be sure You look at the **EICO** line—in Wired as well as Kit form! Each **EICO** product is jam-packed with unbelievable value. YOU be the judge—compare, see **EICO** instruments today—in stock at your local jobber—and SAVE! Write NOW for FREE newest Catalog 3-R.

FOLLOW THE LEADERS... INSIST ON



NEW 555K MULTIMETER
KIT \$29.95, WIRED \$34.95
20,000 ohms/volt



NEW 950K R-C BRIDGE &
R-C-L COMP. KIT \$19.95
WIRED \$29.95



320K SIG. GEN.
KIT \$19.95, WIRED \$29.95
NEW 322K SIG. GEN.
KIT \$23.95, WIRED \$34.95



NEW 1040K BATTERY ELIM.
KIT \$25.95, WIRED \$34.95



511K VOM
KIT \$14.95
WIRED \$17.95



NEW 526K MULTIMETER
KIT \$13.90, WIRED \$16.90
1000 ohms/volt



NEW 625K
TUBE TESTER KIT \$34.95
WIRED \$49.95

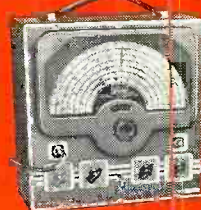

NEW 315K DELUXE SIG.
GEN. KIT \$39.95
WIRED \$59.95

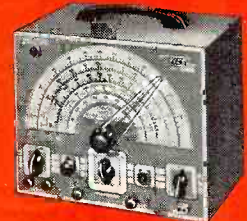

360K SWEEP GEN. KIT \$34.95
WIRED \$49.95



145K SIG.
TRACER KIT
\$19.95
WIRED
\$28.95



NEW 425K 5" PUSH-PULL
SCOPE KIT \$44.95, WIRED \$79.95



NEW 221K VTVM
KIT \$25.95, WIRED \$49.95



HIGH VOLTAGE
PROBE \$6.95

EICO

ELECTRONIC INSTRUMENT CO., Inc.
84 WITHERS STREET, BROOKLYN 11, NEW YORK

Prices 5% higher on West Coast. Due to unstable conditions, prices and specifications are subject to change without notice.

©1951

W-91-J88296-82
SOUTHERN STATE TEACHERS
COLLEGE-LIBRARY
RINGFIELD SO DAK

unlucky day?

Bad luck—in the form of dissatisfied customers—can come your way any day in the month if you buy capacitors by rating only rather than by rating *and* brand. But . . . you can make every day a lucky day if you . . .



Make Sure! Make it Mallory!

Repair work that insures satisfied customers is yours every time if you always specify Mallory capacitors, because outstanding performance is built into *all* Mallory capacitors.



Mallory FP's are the only fabricated plate capacitors available to the replacement trade. And they are accepted as *the* top notch capacitors by the makers of TV and radio sets. Mallory FP's give long-lasting service even at 185° F. (85° C.).



Mallory Plascaps* are the first completely engineered plastic tubular capacitors. Always use them and avoid leakage . . . premature shorting . . . unsoldered leads . . . off-center cartridges. Count on Mallory Plascap as you do on Mallory FP's.

In the past 25 years, Mallory research and engineering work has resulted in a series of developments that give you capacitors which are smaller . . . more uniform . . . longer-lasting . . . more resistant to heat. Look to Mallory for future capacitor improvements. Order Mallory capacitors today and be sure.

Depend on your Mallory Distributor for quality products at competitive prices.

P. R. MALLORY & CO. Inc.
MALLORY

CAPACITORS • CONTROLS • VIBRATORS • SWITCHES • RESISTORS
• RECTIFIERS • VIBRAPACK* POWER SUPPLIES • FILTERS
*Reg. U.S. Pat. Off.

APPROVED PRECISION PRODUCTS

P. R. MALLORY & CO., Inc., INDIANAPOLIS 6, INDIANA