

RADIO NEWS

ANC

FEBRUARY
1948
35¢

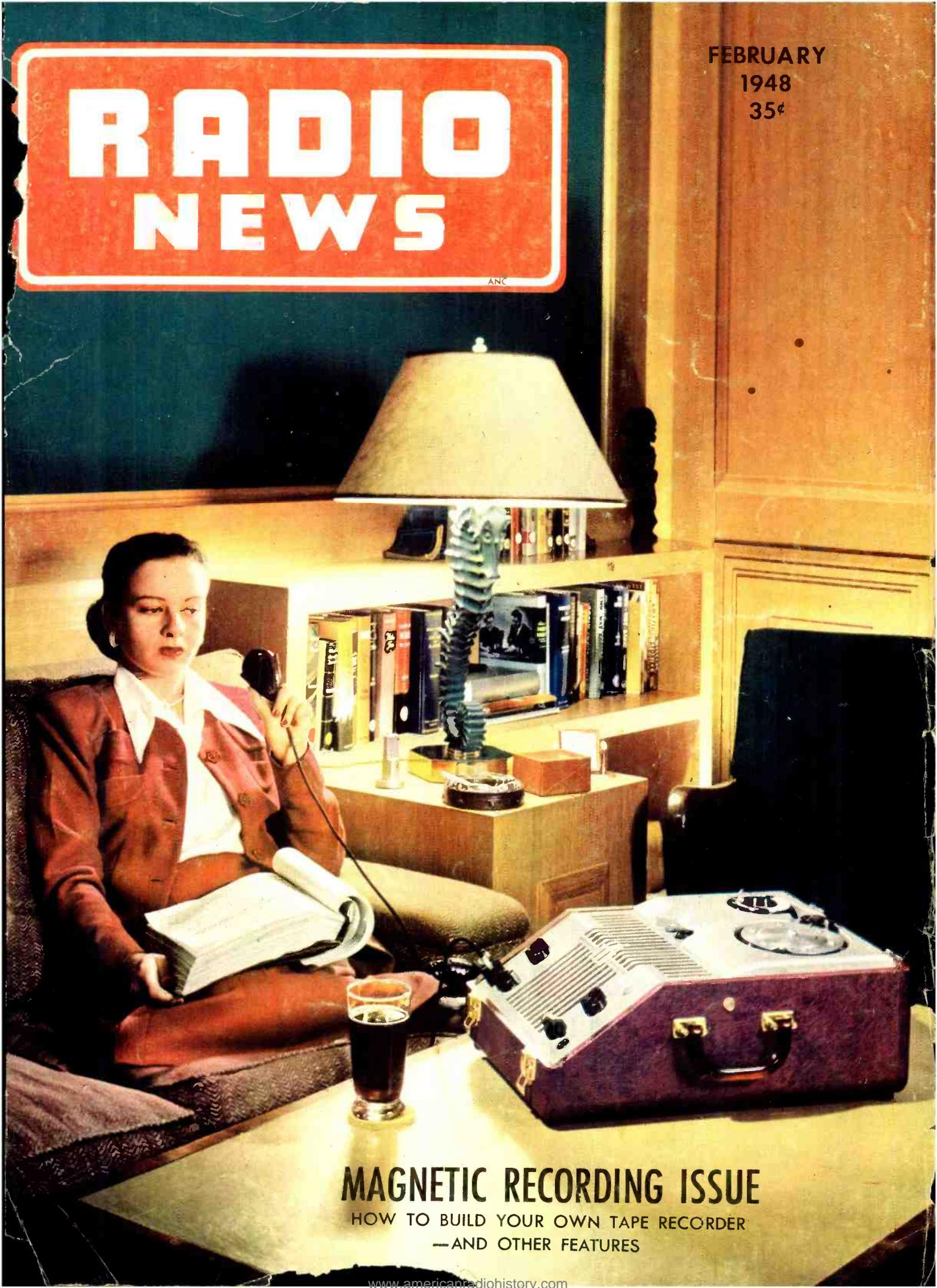

MAGNETIC RECORDING ISSUE
HOW TO BUILD YOUR OWN TAPE RECORDER
—AND OTHER FEATURES

DAVEGA

COMMUNICATIONS DIVISION

Presenting the **NEW MODEL SX-43**
hallicrafters

"The Radio Man's Radio"

...to give amateurs:

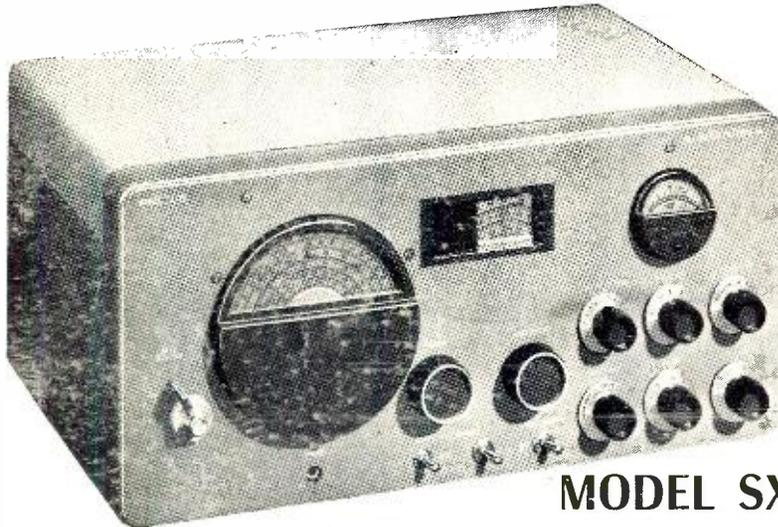

MORE VALUE
Never before all these features at this price

GREATER PERFORMANCE
AM-FM-CW ... all essential amateur frequencies from 540 kc. to 108 Mc.

LOWER PRICE
\$169⁵⁰
Sets available after August 1947

MODEL SX-43

The SX-43 offers continuous coverage from 540 Kc. to 55 Mc. and has an additional band from 88 to 108 Mc. AM reception all bands. CW on four lower bands and FM on frequencies above 44 Mc.

ONLY
\$169⁵⁰

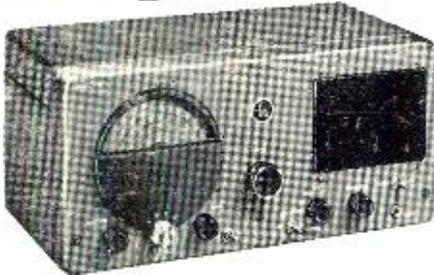

← MODEL S-51

Hallicrafters newest receiver. For land, sea, and air communications. Low price. Highly dependable. Frequency coverage from 132 Kc. to 13 Mc. in 4 bands . . . plus three fixed frequency channels which may be pre-set in the range between 200 to 300 Kc. and 2 Mc. to 3 Mc.

ONLY
\$129⁵⁰

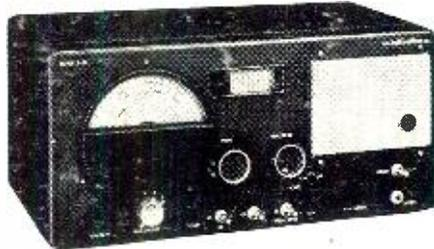

← MODEL S-40A

Overall frequency range from 540 Kc. to 43 Mc. in four bands. Nine tubes, built-in dynamic speaker.

ONLY
\$89⁵⁰

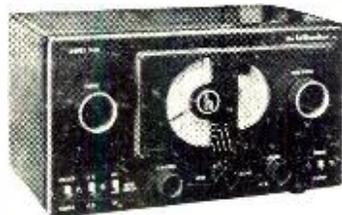

← MODEL S-38

Overall frequency range from 540 Kc. to 32 Mc. in four bands. Compact and rugged. AC-DC. Built-in speaker.

ONLY
\$47⁵⁰

NEW YORK
Downtown 63 Cortlandt Street
Downtown 200 Broadway
Hotel Commodore 111 E. 42nd Street
Times Square 152 W. 42nd Street
Madison Square Garden 825 Eighth Ave.
NEW JERSEY
Newark 60 Park Place
Jersey City 30 Journal Square
Paterson 185 Main Street
LONG ISLAND
Jamaica 163-24 Jamaica Ave.
Flushing 36-11 Main Street
Hempstead 45 Main Street
WESTCHESTER
White Plains 175 Main Street

DAVEGA

MAIL COUPON FOR DESCRIPTIVE LITERATURE

DAVEGA COMMUNICATIONS DIVISION
53 Cortlandt Street, New York 7, N. Y.
Please send full information on Communications Receivers, without obligation.

NAME

ADDRESS

CITY

RN-10

I WILL SEND YOU BOTH FREE

NEW 64 PAGE BOOK

64-page illustrated book describes many fascinating jobs Radio, Television, Electronics offer, shows big kits of Radio parts I send you, tells how I give you practical experience building real Radio circuits at home in spare time, how you make extra money fixing Radios while still learning; contains letters from many men I trained, telling what they are doing, earning. FREE. Mail Coupon below!

SAMPLE RADIO LESSON

I will also send you my Lesson, "Getting Acquainted With Receiver Servicing," FREE, to show you how practical it is to learn Radio at home in spare time. It's a valuable Lesson. Study it—keep it—use it—without obligation! Tells how "Superhet" Circuits work, gives hints on Receiver Servicing, Locating Defects, Repair of Loudspeaker, I.F. Transformer, etc. 31 illustrations. Mail Coupon below!



SEE FOR YOURSELF HOW I TRAIN YOU AT HOME TO BE A RADIO TECHNICIAN

Do you want a good-pay job in Radio—or your own money-making Radio Shop? Mail Coupon for a FREE Sample Lesson and my FREE 64-page book, "How to Be a Success in RADIO—Television, Electronics." See how N.R.I. gives you practical Radio experience at home—building, testing, repairing Radios with BIG KITS OF PARTS I send!

Many Beginners Soon Make Good Extra Money in Spare Time While Learning

The day you enroll I start sending EXTRA MONEY manuals. You LEARN Radio principles from my easy-to-grasp, illustrated lessons—PRACTICE what you learn with parts I send—USE your knowledge to make EXTRA money fixing neighbors' Radios in spare time while still learning! From here it's a short step to your own full-time Radio Shop or a good Radio job!

Future for Trained Men is Bright in Radio, Television, Electronics

It's probably easier to get started in Radio now than ever before because the Radio Repair Business is booming. Trained Radio Technicians also find profitable opportunities in Police, Aviation, Marine Radio, Broadcasting, Radio Manufacturing Public Address work. Think of even GREATER opportunities as public demand for Television, FM and Electronic devices continues to grow. Send for FREE books now!

Find Out What N.R.I. Can Do for You

Mail Coupon for Sample Lesson and my 64-page book. Read the details about my Course. Read letters from men I trained, telling what they are doing, earning. See how quickly, easily you can get started. No obligation! Just MAIL COUPON NOW in an envelope or paste it on a penny postal.

J. E. SMITH, President, Dept. 88R, National Radio Institute, Pioneer Home Study Radio School, Washington 9, D. C.

Our 34th Year of Training Men for Success in Radio

I TRAINED THESE MEN

Averages Better Than \$3,000 A Year

"I now have a shop and am doing fine. I average better than \$3,000 per year, and certainly give NRI much of the credit." —RAYMOND F. DAVIS, Ashburn, Georgia.



Made \$612 In 12 Mos. Spare Time

"Soon after I finished my experimental kits lessons I tackled my first Radio service job. I made \$612 in past 12 months in spare time." —J. W. CLARK, Wilmington, N. C.



VETERANS

You can get this training right in your own home under G. I. Bill. Mail coupon.

Build Radio Circuits Like These With Kits I Send

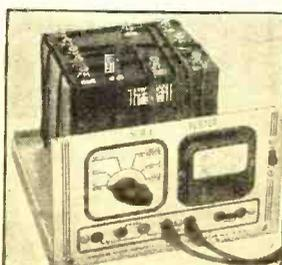
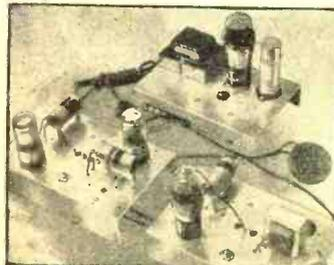

Good for Both FREE

MR. J. E. SMITH, President, Dept. 88R, National Radio Institute, Washington 9, D. C.

Mail me FREE, without obligation, Sample Lesson and 64-page book about how to win success in Radio—and Television, Electronics. (No salesman will call. Please write plainly.)

Name

Address

City State

(Please include Post Office zone number)

Approved for Training under GI Bill

RADIO NEWS

First in radio-electronics

Average Paid Circulation over 148,000

Trade Mark Registered U.S. Patent Office No. 378427

Editor
OLIVER READ, WSETI
Managing Editor
WM. A. STOCKLIN
Technical Editor
H. S. RENNE, EX-W8PTS
Associate Editors
RAY FRANK, W9JU
FRED HAMLIN
NORMAN L. CHALFIN
GAITHER LITRELL
P. B. HOEFER
C. M. SULLIVAN
Staff Photographer
ARTHUR E. HAUG
Staff Artist
R. S. KUJACK

Advertising Manager
L. L. OSTEN
Midwestern Advertising Manager
JOHN A. RONAN, JR.

Art Director
HERMAN R. BOLLIN

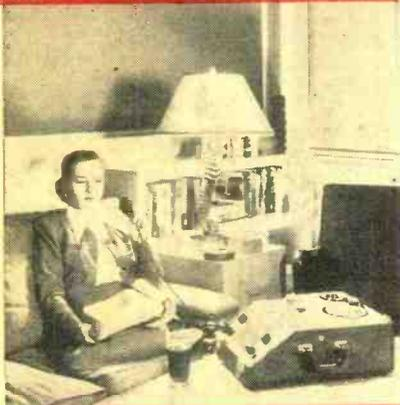

COVER PHOTO: Drama student records her part on wire—then studies her delivery and diction. These versatile units are now being used in homes, offices, and in the schoolroom. This wire recorder is manufactured by Webster-Chicago Corp. (Staff Photo by Arthur Haug)

Chairman of the Board and Publisher
WILLIAM B. ZIFF

President
B. G. DAVIS

Secretary-Treasurer
ARTHUR T. PULLEN

Vice-Presidents
GEORGE BERNER
Advertising and Sales Director

MICHAEL H. FROELICH
Editorial Director

H. J. MORGANROTH
Production Director

H. G. STRONG
Circulation Director

BRANCH OFFICES
NEW YORK (1)
Empire State Bldg., W17-0400

Manager, Eastern Division
CHARLES R. TIGHE

LOS ANGELES (14)
815 S. Hill St., TUcker 9213

Manager, Western Division
WILLIAM L. PINNEY

TORONTO
21 King Street, East
ASSOCIATED COMPANIES
Ziff Davis, Ltd., Grampians Bldg.
Western Gate, London, England
Ziff Davis-Patel, Ltd.
190 Hornby Road, Bombay, India

CONTENTS

FEBRUARY, 1948

Build Your Own Magnetic Tape Recorder.....	Lloyd B. Hust	39
Understanding the Wire Recorder.....	Ray Frank	43
Basic Amplifier for a Wire Recorder.....	L. S. Hicks	44
Magnetic Tape Systems.....	Clark E. Jackson	46
The FreModyne FM Detector.....		48
A New AM-FM Signal Generator.....	Jack Najork	49
A Quasi-Technical Discussion of Magnetic Recording....	Gene T. Clears	52
Television Installation (Part 6).....	W. W. Waye	54
The Recording and Reproduction of Sound (Part 12).....	Oliver Read	56
Converting a Brush Tape Recorder for Broadcast Use....	Merle Fleming	59
Putting Xtal Control to Work.....	McMurdo Silver	60
Practical Radio Course (Part 59).....	Alfred A. Ghirardi	64

DEPARTMENTS

For the Record.....	The Editor	8	What's New in Radio.....	80
Spot Radio News....	Fred Hamlin	18	Manufacturers' Literature.....	130
Within the Industry.....		28	New Receivers.....	142
Short-Wave.....	K. R. Boord	62	Technical Books.....	154
RN Circuit Page.....		76	Letters from Our Readers.....	160



COPYRIGHT 1948
 ZIFF-DAVIS PUBLISHING COMPANY
 185 North Wabash Ave., Chicago 1, Ill.
 VOLUME 39 NUMBER 2



RADIO NEWS is published monthly by the Ziff-Davis Publishing Company, 185 N. Wabash Ave., Chicago 1, Ill. Subscription Rates: in U. S. and Canada \$1.00 (12 issues); single copies 35 cents; in Mexico, South and Central America, and U.S. Possessions, \$4.00 (12 issues); in British Empire, \$5.00 (12 issues)—all other foreign countries \$5.00 (12 issues). Subscribers should allow at least 2 weeks for change of address. All communications about subscriptions should be addressed to: Director of Circulation, 185 N. Wabash Ave., Chicago 1, Ill. Entered as second class matter March 9, 1938, at the Post Office, Chicago, Illinois, under the Act of March 3, 1879. Entered as second class matter at the Post Office Dept., Ottawa, Canada. Contributors should retain a copy of contributions and include return postage. Contributions will be handled with reasonable care but this magazine assumes no responsibility for their safety. Accepted material is subject to whatever revisions and by-line changes that are necessary. Payment made at our current rates, covers all authors', contributors', or contestants' rights, title, and interest in and to accepted material, including photographs and drawings.

"THE hottest ham performance ever at this price . . ." That's the verdict of amateurs who have had a chance to try Hallicrafters new Model SX-43.

This new member of the Hallicrafters line offers continuous coverage from 540 kilocycles to 55 megacycles and has an additional band from 88 to 108 megacycles. AM reception is provided on all bands, except band 6, CW on the four lower bands and FM on frequencies above 44 megacycles. In the band of 44 to 55 Mc., wide band FM or narrow band AM just right for narrow band FM reception is provided.

One stage of high gain tuned RF and a type 7F8 dual triode converter assure an exceptionally good signal-to-noise ratio. Image ratio on the AM channel on band 5 (44 to 55 Mc.) is excellent as the receiver is used as a double super-heterodyne. The new Hallicrafters dual IF transformers provide a 455 kilocycle IF channel for operating frequencies below 44 megacycles and a 10.7 megacycle IF channel for the VHF bands. Two IF stages are used on the four lower bands and a third stage is added above 44 megacycles. Switching of IF frequencies is automatic. The separate electrical bandspread dial is calibrated for the amateur 3.5, 7, 14, and 28 megacycle bands.

Every important feature for excellent communications receiver performance is included.

Model SX-43

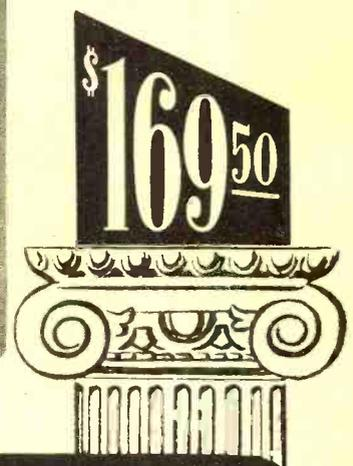

FEATURES FOUND IN NO OTHER RECEIVER AT THIS PRICE

- ALL ESSENTIAL AMATEUR FREQUENCIES FROM 540 kc to 108 MC
- AM - FM - CW RECEPTION
- IN BAND OF 44 TO 55 MC: WIDE BAND FM OR NARROW BAND AM . . . JUST RIGHT FOR NARROW BAND FM RECEPTION
- CRYSTAL FILTER AND EXPANDING IF CHANNEL PROVIDE 4 VARIATIONS OF SELECTIVITY ON LOWER BANDS
- SERIES TYPE NOISE LIMITER
- TEMPERATURE COMPENSATION FOR FREEDOM FROM DRIFT
- PERMEABILITY ADJUSTED "MICROSET" INDUCTANCES IN THE RF CIRCUITS
- SEPARATE RF AND AF GAIN CONTROLS
- EXCEPTIONALLY GOOD SIGNAL-TO-NOISE RATIO
- SEPARATE ELECTRICAL BANDSPREAD CALIBRATED FOR THE AMATEUR 3.5, 7, 14 AND 28 Mc BANDS

BUILDERS OF

Skyfone AVIATION RADIOTELEPHONE

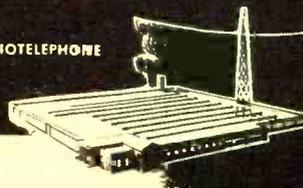

hallicrafters RADIO

THE HALLICTRAFTERS CO., MANUFACTURERS OF RADIO AND ELECTRONIC EQUIPMENT, CHICAGO 16, U. S. A.

Sole Hallicrafters Representatives in Canada:
Rogers Majestic Limited, Toronto-Montreal



Says the service expert who values his good reputation and the repeat business that goes with it—



—asserts the tone-conscious radio owner who appreciates the superior quality of Ken-Rad tubes.

KEN-RAD DOUBLE ACCEPTANCE

puts profits in the repairman's pocket

• You're glad to install Ken-Rad tubes because their reputation stands high with you, as well as with other service experts. And Ken-Rad tubes reward this enthusiasm by helping you secure a bigger repeat business—based on clients' faith in your standards of work as shown by the quality tubes and parts you use.

DOUBLY ACCEPTED . . . by you and your customers! That's why Ken-Rad tubes hold a coast-to-coast margin of popularity. Radio owners endorse their finer tone, their long-

playing life. *You* prefer to sell Ken-Rad tubes—*customers* want to buy them! It's a favorable meeting of minds, creating more sales and greater profits.

NOW is the time to impress your name and high-grade repair facilities on your neighborhood! Radio-set production is large; owners' service needs will grow. Ken-Rad tubes can help you gain wider, friendlier local recognition, with the increased business "take" that will result. Install and sell Ken-Rad *doubly-accepted* radio tubes!

• "ESSENTIAL CHARACTERISTICS" Ken-Rad's Booklet ETR-16—is a "must" for the dealer or service-man who wants a convenient, concise, and comprehensive guide to the selection of radio tube types. Your free copy will be mailed you promptly on request. Write for it today!

178-GA3-6880

KEN-RAD

Radio Tubes

PRODUCT OF GENERAL ELECTRIC COMPANY

Schenectady 5, New York

RADIO NEWS

HOW TO MAKE MONEY
in
RADIO
ELECTRONICS
TELEVISION

HOW TO READ
RADIO DIAGRAMS
AND SYMBOLS

GET THESE 2 BIG BOOKS
FREE.

IF YOU
WANT TO LEARN
RADIO!

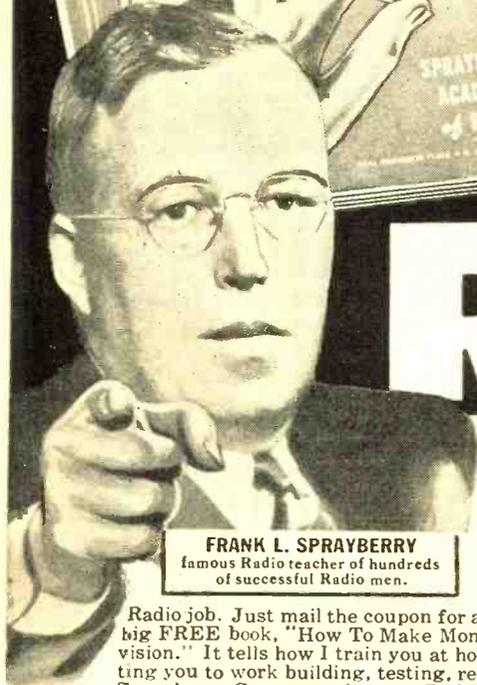

FRANK L. SPRAYBERRY
famous Radio teacher of hundreds
of successful Radio men.

I TRAIN YOU RIGHT BY SENDING YOU 8 BIG KITS OF RADIO EQUIPMENT INCLUDING A POWERFUL 6 TUBE SUPERHET RECEIVER AND 16 RANGE TEST METER!

Radio job. Just mail the coupon for a FREE Sample Lesson and my big FREE book, "How To Make Money In Radio, Electronics, Television." It tells how I train you at home during spare hours by putting you to work building, testing, repairing Radio equipment. The Sprayberry Course teaches you Radio by working with 8 big kits of Radio parts I supply. You build a powerful 6 tube superhet Radio, a 16-range test meter, perform over 175 interesting, PRACTICAL experiments. My lessons are easy and interesting — you need no previous experience in Radio. I start you at the beginning... and give you valuable "bench" experience that sticks with you.

LEARN HOW TO BUILD-TEST-REPAIR RADIOS By Working with YOUR HANDS!

Soon after you start I send you my famous BUSINESS BUILDERS that help you earn EXTRA CASH getting and doing neighborhood Radio Service jobs while learning. You couldn't pick a better time to get into Radio. The Radio Repair Business is booming! Good Radio Service and Repair Shops are needed everywhere as millions of new sets are in use. Trained men are wanted for opportunities in Police, Aviation and Marine Radio, F.M. and Standard Broadcasting and Television. Manufacturers are looking for men who know Radio as production reaches new peaks. GET THE FACTS ABOUT YOUR FUTURE IN RADIO. MAIL the COUPON TODAY for my FREE BOOKS!

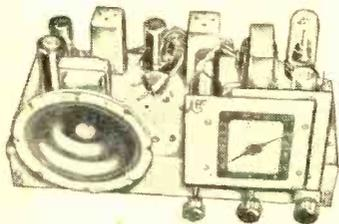

You really learn Radio the PRACTICAL way... when you build this big, powerful 6-tube Superhet Radio from parts I send you.

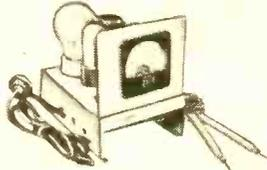

give you a fine, moving coil type Meter—with parts for a complete analyzer and Circuit Continuity Tester. "Trouble-shoot" with professional accuracy.

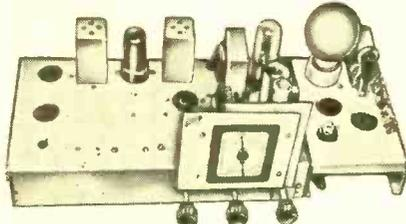

You don't have to buy expensive ready-made equipment. You get valuable experience building this Signal Generator and Multi-purpose Tester.

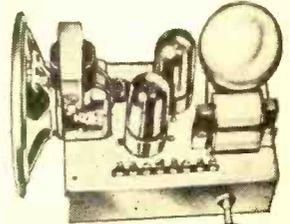

You construct this rectifier and filter, resistor and condenser tester, and really get on the Practical end of Radio.

LOW COST RADIO TRAINING STUDY AT HOME IN SPARE HOURS

Sprayberry Training costs surprisingly little! Easy monthly payments, if desired. Everything you need is furnished — nothing else to buy. With Sprayberry Training to back you up, you will be able to step into your own profitable Radio Service Business or go on to a big opportunity in Radio, Electronics or Television. The equipment I send you is yours "for keeps" — to use in your business or job. I have trained thousands of successful Radio men — and I can help you, too. Get the facts about Sprayberry Training — it's your first step to success, security and a bigger income in a field where you'll really enjoy your work. Fill out and mail coupon TODAY. I'll rush my two FREE books to you by return mail.

VETERANS: Approved for G. I. Training under Public Laws 16 and 346.

Sprayberry Academy of Radio
F. L. SPRAYBERRY, President
Room 2528, Sprayberry Bldg., Pueblo, Colorado



Trained Radio men can step into their own profitable Radio Service Shop — or —



New developments are constantly opening new big pay job opportunities in Radio.

RUSH COUPON Today!

SPRAYBERRY ACADEMY OF RADIO
F. L. SPRAYBERRY, President
Room 2528, Sprayberry Bldg., Pueblo, Colorado
Please rush my FREE copies of "How To Make Money In Radio, Electronics and Television" and "How To Make Radio Diagrams and Symbols." No salesman will call.

Name _____ Age _____

Address _____

City and Zone _____ State _____

CHECK HERE IF A VETERAN
(Mail in an Envelope or Paste on Penny Postcard)

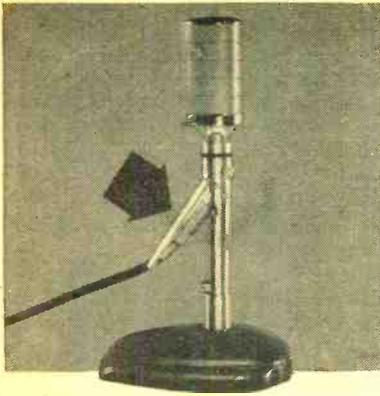

RCA STANDARDIZES ON "XL" PLUGS

... for popular microphone models such as the "Announce" (Type KN-1A) (shown above), Junior Velocity (MI-4036), Aeropressure (MI-6026, MI-6027), Program Velocity (MI-12002, MI-12003), Aerodynamic (MI-6226, MI-6228), because Cannon XL's are quality plugs, yet in the moderate price class and available everywhere.

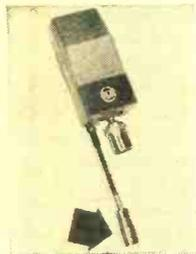

The RCA Junior Velocity Microphone, a low cost, lightweight model is equipped with XL-3-12 for speedy interchange of cable.

RCA is a big user not only in the XL but also the Cannon "P", DP, "K", and "AN" series in many types of equipment. Cannon's reputation for quality



XL-3-12 PLUG
LIST \$1.20

XL-3-11 PLUG
LIST \$1.25

and dependability is assured in RCA equipment fitted with Cannon XLs.

Write for FREE new XL-347 BULLETIN and list of 200 Cannon Electric Distributors.

SINCE 1915

CANNON ELECTRIC



Development Company

3209 HUMBOLDT ST., LOS ANGELES 31, CALIF.
IN CANADA & BRITISH EMPIRE:
CANNON ELECTRIC CO., LTD., TORONTO 13, ONT.
WORLD EXPORT (Excepting British Empire):
FRAZER & HANSEN, 301 CLAY STREET
SAN FRANCISCO 11, CALIFORNIA
REPRESENTATIVES IN PRINCIPAL CITIES

For the RECORD.

BY THE EDITOR

THE average set owner is now, more than ever, reluctant to call in a radio serviceman unless his set is completely inoperative. His hesitancy is the result of the maze of bad publicity given to members of the radio profession who have charged many an innocent set owner for unnecessary repairs and replacements instead of charging only for "services rendered" on a fair basis.

The situation in our larger cities is particularly critical. Newspaper columnists are ever quick to point an accusing finger at service technicians and to even deliberately decoy a guinea pig receiver and use it as bait to prove their case against such racketeering.

Attention was recently focused on "The Repair Racket in New York City" when a survey conducted by *WOR* and *Radio Daily* magazine put real facts before the public. Here's what happened:

An investigator was dispatched on a tour of radio service shops with a \$60.00 battery operated portable. The set was first given a thorough check by a competent engineer and was found to be in perfect condition. A short circuit was then deliberately created in the antenna system to prevent normal reception. This was done by opening the back of the portable and moving the soldering lug on one terminal approximately $\frac{1}{4}$ " in order to make contact with the other terminal. When the investigator made his tour of radio service shops the short circuit was in plain view at the rear of the chassis. It could have been repaired in less than a minute by a simple prying with a screw driver blade. The charge should have been not more than fifty cents, even though the repair was so minor that a reliable serviceman would probably make it as a courtesy service.

Not one serviceman out of two dozen picked at random in Manhattan gave an honest appraisal. The prices quoted for putting the radio in working order ranged from \$9.50 to \$15.00. One serviceman stated that the batteries were disconnected and that the oscillator was out of whack. He wanted 12 bucks to fix this imaginary ailment. Another serviceman on W. 45th St. claimed that the portable had a short in the transformer. A Broadway store wanted \$10.00 for new tubes and a realignment job—and so it went.

The set, after making the rounds, was then returned to the engineer for his examination. He removed the deliberate short he had made prior to the tour by the investigator. The radio was found to be completely out

of kilter. It just wouldn't work at all. The repair men who had quoted their fancy estimates had caused a short in the volume control, detuned the intermediate coils, and had thus knocked out the entire tuning mechanism. In addition, two microphonic tubes had been substituted, which were practically useless, and the batteries were almost completely run down.

Not one shop in the score visited would examine the radio and give an estimate of charges while the investigator waited.

We receive many similar reports from radio servicemen who object to such racketeering in their community. For example, this typical complaint arrived in the mail just the other day:

An alternate service shop was contacted when the customer's regular repairman was out of town. A representative came to the home and took the chassis and speaker back to the shop. He phoned later with an estimate of \$28.73 to put the set in order. The customer, feeling that this repair charge was way out of line, requested a few days to reach a decision. In the meantime the regular serviceman returned and was asked to accompany the customer to the shop to look over the radio.

The estimate slip showed 4 tubes, 5 condensers, complete realignment and labor totaling \$28.73. An examination of the set showed that nothing had been disturbed. The tubes had the dust of ages on them and none had even been removed for testing and— whoever heard of 5 condensers going out at once?

This set was taken home by the owner. The only repair needed to put the set back into service was the replacement of one bad condenser section. All tubes were tested and found to be in good condition. The customer stated that the reception was better than he had enjoyed in many months and the total charge was only a fraction of the estimate given by the racketeer.

This situation is not confined to New York but apparently prevails throughout the country. It's just that the metropolitan areas seem to be in the spotlight.

Many servicemen who have in the past taken a "dog eat dog" attitude are now getting together locally in order to set up a code of ethics for the conduct of their business. It is the best way we know to lay the groundwork for a campaign to win back the confidence of the public. If they don't—we can only see danger ahead for the entire industry if and when licensing is forced upon us. . . . O. R.

RADIO NEWS



ALLIED

presents 2 new
hallicrafters
Communications
Receivers

S-53 Communications Receiver

Here's *the* completely modern receiver Hams and SWL'S have been looking for—superbly engineered for top-notch performance—at a remarkable low price. The new Hallicrafters S-53 features extended frequency range, tuning 540 Kc to 54½ mc in 5 bands. Uses 2 mc IF which positively eliminates all amateur station images or repeat points within the ham bands. Features include: accurately calibrated, edge-lighted slide-rule dial; separate bandspread control and scale, with full electrical bandspread; latest series-type noise limiter circuit; voltage-stabilized oscillator; iron-core IF'S; tone control; built-in PM dynamic speaker; phone and phono jacks. Handsomely housed in rich satin-black steel cabinet with satin-chrome trim. Complete with 7 tubes and rectifier. For 105-125 volts, 50-60 cycles AC.

\$79⁵⁰

Amateur Net, only



S-51 "Sea-Farer" Marine Model

Designed and precision-built by Hallicrafters especially for marine use, weather stations, time signal reception, and similar service. Offers 4-band tuning range: 140-400 Kc, 500-1500 Kc, 1500-4400 Kc, 4.4-12 mc. Three additional pre-set frequencies are available; any one fixed frequency between 200 Kc and 300 Kc, and two fixed frequencies in the 2-3 mc band. Has BFO pitch control; automatic noise limiter; tone control; permeability tuned IF'S; universal antenna input; code-phone switch; phone jack. Built-in PM dynamic speaker is water-resistant, in shock-proof mounting. All metal parts plated to resist corrosion. In rich satin-gray steel cabinet. Operates from 105-120 volts AC or DC. (6, 12, or 32 volt power packs available at \$22.50 additional.) Complete with 9 tubes and rectifier.

\$129⁵⁰

Amateur Net, only



YOUR ALLIED CATALOG

Radio's Leading Buying Guide

Keep your latest ALLIED Catalog handy. It's the complete, preferred Buying Guide to everything in radio at lowest prices! Offers everything in radio and electronic equipment for the serviceman, sound man, engineer, ham, short-wave listener, builder and experimenter, Keeps you up-to-date on the latest equipment. Saves you money on every order. Make ALLIED your Radio Headquarters—it's the established, dependable supply source for America's radio men. Make sure your name is on our mailing list to receive the latest ALLIED Catalog—Radio's Leading Buying Guide.

Place Your Order with ALLIED Now!

ALLIED RADIO CORP.
833 W. Jackson Blvd., Dept. 1-B-8
Chicago 7, Illinois

- Place my name on your mailing list.
- Enter order for
- Enclosed \$..... Full Payment Part Payment
(Balance C.O.D.)
- Send full information on Communications Receivers and Time Payment Plan, without obligation.

Name _____

Address _____

City _____ Zone _____ State _____

A Sign of Successful Servicing



SHRYOCK HAS ALL 16 RIDER MANUALS

(and Volume XVII on order)



"The Most Dependable and Complete"

"Throughout my many years of radio service work I have seen many data services, but have always found Rider Manuals the most dependable and complete. With us they're a necessity, for we get sets of all makes and ages — sets to be found only in Rider's. We have a standing order with our jobber to automatically ship the latest volume as it comes out."

Says **"LARRY" OEBBECKE**
Shryock Radio & Tele. Co.
Philadelphia, Pa.

In towns and cities from one end of the country to the other you will find all 16 Rider Manuals over the benches of profit-making shops. This, because they earned that fingertip position of prominence. They are there, not for display, but for use — not on occasion, but for practically every job that comes to rest on the bench.

Nowhere else, nowhere else but in Rider Manuals can be

* Rider Manual data is **OFFICIAL, AUTHORIZED**, right from the service departments of the set manufacturers. They know best, the proper servicing procedures for their own products.

found the wealth of authoritative radio servicing data needed to quickly diagnose the troubles in ailing American-made receivers issued since 1920. Volume XVII to be published in March will contain material that is time-savingly-valuable to you right now.

Order it today — give your shop the Sign of Successful Servicing, a complete set of Rider Manuals.

24 HOUR DATA SERVICE

For 10c (stamps are OK) you receive photostats of schematic, voltage data, parts list (and everything else that will fit on two 8 x 11 inch sheets) on any newly issued, or old, receiver. (Additional necessary sheets same rate.) Send 20c with order; adjustment will be made. Here is a way to get whatever service data you need between Rider Manual publication dates.

Volume XVI	\$ 8.40
Volume XV	18.00
Volumes XIV to VII (ea. vol.)	15.00
Volume VI	11.00
Abridged Manuals I to V (one vol.)	17.50
Record Changers and Recorders	9.00
Master Index, covering Manuals, Vols. I to XV	1.50

NOTE: Individual Volumes VI, VII and VIII will be replaced after this year by a single Abridged Manual Vol. VI to VIII.

JOHN F. RIDER, PUBLISHER, Inc., 404 Fourth Avenue, N. Y. 16
Export Agent: Rocke International Corp., 13 E. 40th St., N.Y.C. Cable ARLAB

VOL. XVII
to be published
IN MARCH
1600 pages

This volume, taking up where Vol. XVI leaves off, will contain authorized servicing data on the products of over 100 manufacturers. In it will be found not only single band but also multi-band receivers with their Rider-exclusive "clarified-schematics." Record players and wire recorders used with receivers are covered. Also with each Vol. XVII will be the separate "How It Works" book and a cumulative index covering Volumes XVI and XVII.

Watch for publication date of separate manual on Television exclusively.

RIDER MANUALS

MEAN SUCCESSFUL SERVICING

Here's that NEW F.M.—A.M. *Sig. Gen.*

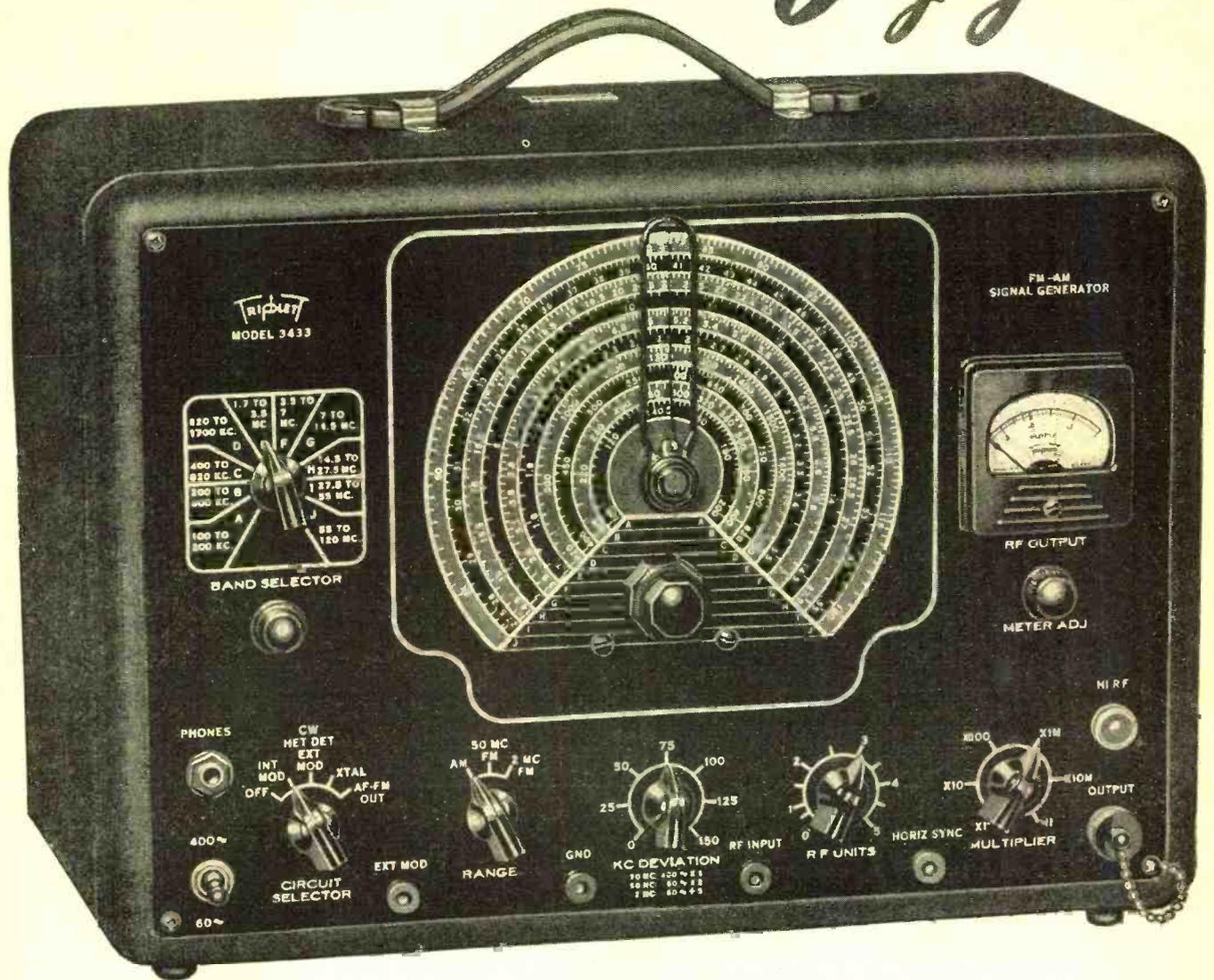

Model 3433 Signal Generator

F.M. SWEEP FROM 0 TO 300 K.C. MODULATION FREQUENCY 60 OR 400 CYCLES PER SECOND.

Stable frequency modulated signals give undistorted wave form. This permits easy and more precise alignment over all frequency ranges thus insuring maximum performance in a radio set that can in every way be comparable with original factory adjustments.

Other features include: constant deviation by using a fixed frequency reactance oscillator, 110 Volt A.C. line filter to prevent leakage thru power supply, horizontal synchronized sweep voltage available thru jack on front panel.

Be sure to see this new Triplet F.M.—A.M. Signal Generator at your Parts Distributor.

For complete technical description write Dept. N-28.

Frequency Ranges: Fundamentals—from 100 K.C. to 120 M.C. in ten bands. Added Frequency—(provided by built-in fixed 50 M.C. oscillator) from 120 M.C. to 170 M.C. Second harmonics can also be used to double the A.M. fundamental ranges.

Precision first...to Last



TRIPLET ELECTRICAL INSTRUMENT COMPANY • BLUFFTON, OHIO

Representatives in Principal U. S. and Canadian Cities.

February, 1948

Free

CONCORD RADIO CATALOG

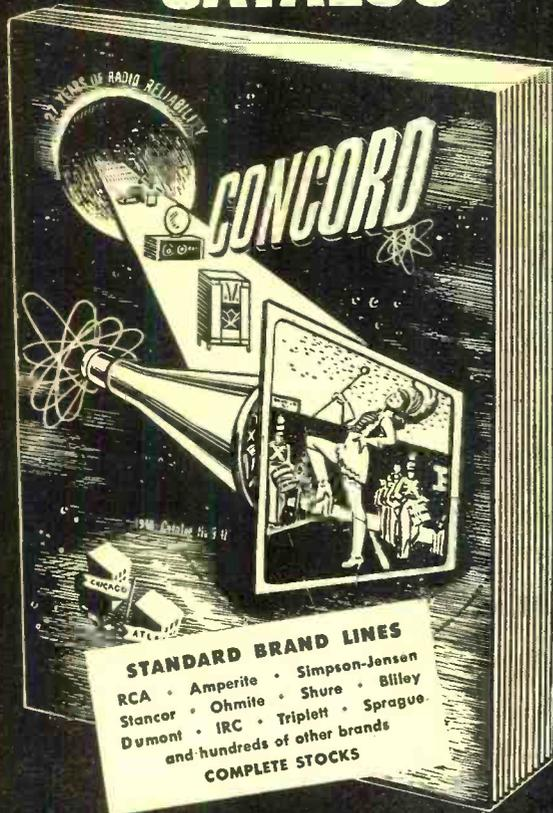

LOWEST PRICES on Everything in RADIO • TELEVISION • RADAR ELECTRONIC EQUIPMENT

- Thousands of items—parts, supplies and equipment—for every Radio and Electronic need.
- Special Bargains—hundreds of money-saving values in top quality Radio Parts.
- Immediate delivery from big complete stocks at Chicago and Atlanta.

MAIL COUPON FOR FREE COPY

CONCORD

RADIO CORPORATION

CHICAGO 7 **ATLANTA 3**
 901 W. Jackson Blvd. 265 Peachtree St.
 Downtown Chicago Branch: 229 W. Madison St.
 Lafayette Radio Corp.

A Few of the Thousands of Great Money-Saving Buys in this 160-Page Radio Catalog!

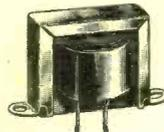

Filter Choke

30 Henry, 50 Ma.
Low Cost Per Henry

450 ohms D.C. resistance. Unshielded, strap type mounting. Ideal for replacement and experimental uses. Size: 2 1/2 x 1 1/4 x 2 1/4". Shpg. wt., 2 lbs. **59c**
 X183.....

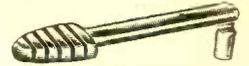

Crystal Pickup

Quality crystal pickup mounted in arm for 10" and 12" records. Mounting included. Requires 3/4" hole. Shielded lead and cartridge case. Aluminum die cast arm finished in smooth dark brown. With semi-permanent needle. **\$159**
 X143.....

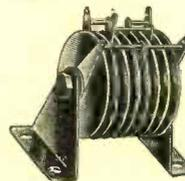

Full Wave Selenium Rectifier

BL 8-plate selenium full wave rectifier with bracket mounting. 12 VDC output with 18 VAC input, 8 VDC output with 12 VAC input both at 2 amperes drain. Measures 3" long, 1 1/4" wide, 2 1/2" high. Shpg. wt. 2 lbs. **89c**
 5B3965.....

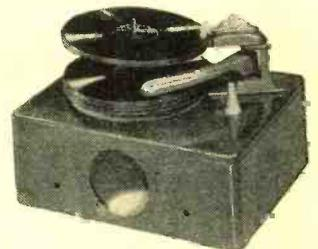

Crescent Record Changer

Single posted changer plays 10 twelve-inch records or 12 ten-inch records. Rejects any record desired. Can be operated manually. Tone arm can be moved at any time without damage. Mounted in brown metal case with ventilating louvers, and hole cut for mounting speaker. Changer is finished in two tone brown. **\$1695**
 5B9573.....



Even-Speed Phono-Motor

Model 80. Rim-drive phono motor. 9" turntable. Constant speed (78 r.p.m.) self-starting; forced draft air-cooled. For 10" and 12" records. 110 V. 60 cycles only. Wt. 4 lbs. **\$969**
 X182.....

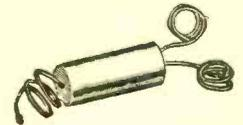

50/30 MFD. 150 WVDC Electrolytic Condenser

5B3235
See this and similar **29c** bargains on page 52 of Concord's newest catalog.

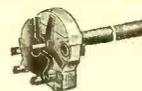

10 MMFD Double Spaced Air Padding Condenser

Same size as regular air padding condensers, but with twice the spacing between plates, and with 1/4" shaft 1 1/4" long. Mounts by means of two threaded studs. **12c**
 5B3508.....

HERE'S A REAL BARGAIN!

A Type 211 Transmitting tube for only **39c**
 5B603.....

Concord Radio Corporation, Dept. E-28,
901 W. Jackson Blvd., Chicago 7, Ill.

Yes, rush FREE COPY of the comprehensive new Concord Radio Catalog.

Name.....

Address.....

City..... State.....

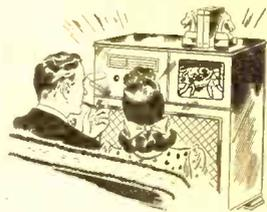

FOR *Television*

FOR *F.M.*

THE WARD *Magic Wand* AERIAL
makes any receiver work better

Scientific tests prove that quality FM or Television reception is difficult, if not impossible, without a good outdoor aerial. So, don't blame your receiver if reception isn't up to par. Do install a Ward Magic Wand Outdoor Aerial and see for yourself the almost magical improvement that results.

These new Ward outdoor FM and television aerials are available in either straight or folded dipoles (reflector kits also available) for the 88 to 106 mc FM band, and the 44 to 88 mc television band. They do away with bothersome weak spots, and your set functions at full efficiency even on distant stations.

New foolproof design adapts easily to the requirements of each installation. Universal base permits mounting at any roof or wall angle. Sturdy vertical element revolves in base to easily orient dipole for maximum gain. Dipole is of corrosion-preventive aluminum, other parts weatherproofed inside and out. Ring provides for attaching guy wires. Sixty-foot polyethylene-insulated lead-in of 300-ohm colinear transmission line included. Standoffs of exclusive design guide transmission line down mast, and to receiver, minimizing capacity to ground and eliminating line reflections. Complete, step-by-step installation instructions included with each aerial.

Get your Ward Magic Wand FM or Television Aerial today, or mail the coupon below for free catalog and name of your nearest dealer.

THE WARD PRODUCTS CORPORATION
 1524 East 45th Street, Cleveland 3, Ohio
 DIVISION OF THE GABRIEL COMPANY

IN CANADA: Atlas Radio Corp., 560 King Street, W., Toronto, Ontario, Canada
 EXPORT DEPT.: C. O. Brandes, Mgr., 4900 Euclid Avenue, Cleveland 3, Ohio
February, 1948



*As
 Advertised
 in the
 Saturday
 Evening
 POST*

ATTENTION DEALERS:
 Powerful Ward national advertising in the Saturday Evening Post, and leading newspapers, now is educating over 33 million present (and future) owners of FM and television receivers to their need for Magic Wand Aerials. Write for free details on how you can best capitalize on this advertising in your locality.

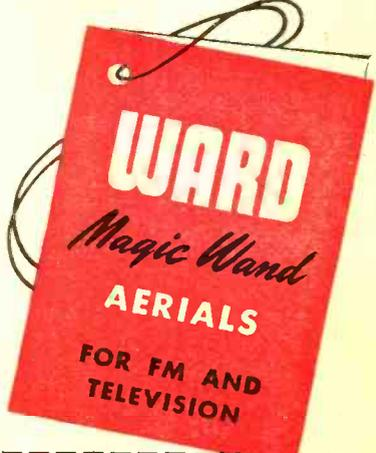

MAIL COUPON TODAY

WARD PRODUCTS CORP.
 1524 East 45th Street
 Cleveland 3, Ohio

Please send me free catalog on Ward Magic Wand Aerials for FM and Television, and name of my nearest dealer.

NAME _____

ADDRESS _____

CITY AND STATE _____

MY JOBBER IS _____

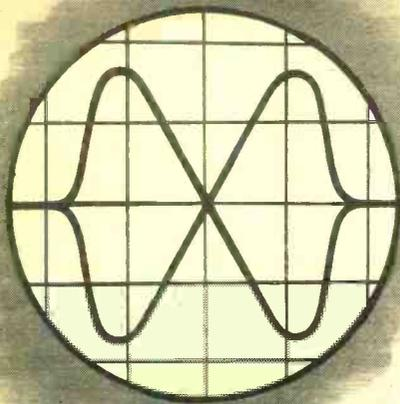

EXCLUSIVE IN PHOTOFACT Oscilloscope Wave Forms!

2 Alignment Procedures for All FM Receivers!

EXCLUSIVE! PHOTOFACT now brings you both professional methods for aligning FM receivers—the "visual" oscilloscope method, and the meter method using an AM generator and vacuum tube voltmeter. PHOTOFACT Folders now include large, clear, specially prepared diagrams of actual oscilloscope wave forms for each visual alignment described. These wave forms show you how to secure absolute maximum circuit performance in minimum time. This revolutionary development, available in no other radio data service, has been acclaimed by servicemen everywhere since its first appearance in PHOTOFACT Set No. 28, published in November 1947. Here's more powerful proof that you can't afford to be without PHOTOFACT—the complete, practical, profitable radio data service.

Howard W. Sams

World's Most Practical Radio Service Data

Bring your post-war service data library right up to January 1948! PHOTOFACT Volume 3 is ready for you—companion to Volumes 1 and 2—the most accurate and complete Radio Data ever compiled. Here is everything you need for fast, efficient, profitable servicing—bound in easy-to-use volumes. Large size schematics with the exclusive PHOTOFACT Standard Notation; photo views keyed to parts lists and alignment data; complete listings of parts values and proper replacements; alignment, stage gain, circuit voltage and re-

sistance analysis; coil resistances; dial cord stringing; disassembly instructions; record changer analysis and repair data. Send in your order today for PHOTOFACT—the only Radio Service Data that meets all of your actual needs!

- VOLUME 1. All post-war models up to Jan. 1, 1947.
- VOLUME 2. Models from Jan. 1, 1947 to July 1, 1947.
- VOLUME 3. Models from July 1, 1947 to Jan. 1, 1948.

YOUR PRICE, EACH VOLUME, IN EASY-TO-USE DELUXE BINDER... **\$18³⁹**

INDUSTRY ACCLAIMS NEW HOWARD W. SAMS MANUALS

Servicemen: "Terrific is the only word that adequately describes both books. Absolutely "musts" for servicemen."—*S. L., Chicago.*

"I think your AUTOMATIC RECORD CHANGER MANUAL and DIAL CORD books are great!"—*H. O., Maquota, Iowa.*

Manufacturers: "Your Record Changer Manual is one swell book. Should be very well received among the trade."—*Astatic.*

"The Record Changer Manual is a commendable job. Subject is well-covered."—*Jensen.*

"We have received copies of your AUTOMATIC RECORD CHANGER SERVICE MANUAL and DIAL CORD GUIDE. A great deal of hard work and thorough analysis has gone into the making of these two books. They should certainly fill an urgent need in the service industry. Extremely easy to read and should prove most helpful to our service dealer customers."—*Sylvania.*

"Your Record Changer Manual is beautifully prepared. Our compliments to you and your organization."—*Webster-Chicago.*



SPECIAL OFFER

If you haven't a complete file of all PHOTOFACT Folder Sets to date, you can trade in the individual Folder Sets you now own for complete Volumes at amazingly low cost. Write today for special offer, stating what Sets of Folders you now own (use coupon below).

BOOST YOUR EARNING POWER!

Mail This Order Form to HOWARD W. SAMS & CO., INC. 2924 E. Washington St., Indianapolis 6, Indiana.

My (check) (money order) for \$..... enclosed.

- Send PHOTOFACT Volume 3 (including Sets Nos. 21 through 30) in DeLuxe Binder, \$18.39.
- Send Volume 2. Send Volume 1 (each in DeLuxe Binder, at \$18.39 per volume).
- Send... SAMS' 1947 AUTOMATIC RECORD CHANGER MANUAL(S) at \$4.95 each.
- Send... SAMS' DIAL CORD STRINGING GUIDE(S) at \$0.75 per copy.
- Send FREE PHOTOFACT Cumulative Index.
- Send details of your Special Trade-in Offer. I own PHOTOFACT Sets Nos.

Name.....

Address.....

City..... State.....

HOWARD W. SAMS & CO., INC.
INDIANAPOLIS 6, INDIANA

Export—Ad. Auriema—89 Broad St., New York 4, N. Y.—U. S. of America
Canada—A. C. Simmonds & Sons, 301 King St., East—Toronto, Ontario

PHOTOFACT SERVICE

"The Service that pays for itself over and over again"

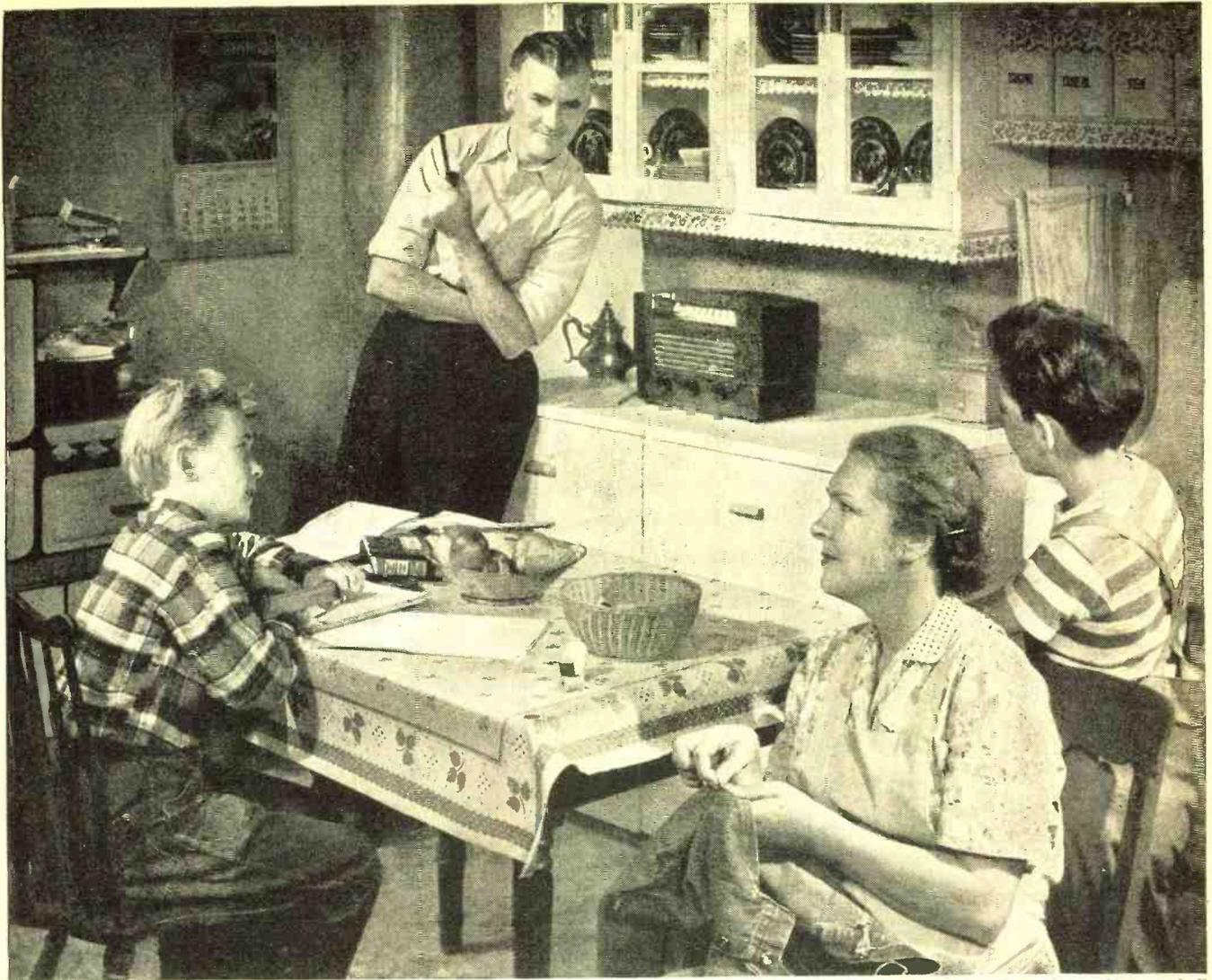

"Our American concept of radio is that it is of the people and for the people."

Freedom to LISTEN – Freedom to LOOK

As the world grows smaller, the question of international communications and world understanding grows larger. The most important phase of this problem is *Freedom to Listen* and *Freedom to Look*—for all peoples of the world.

Radio, by its very nature, is a medium of mass communication; it is a carrier of intelligence. It delivers ideas with an impact that is powerful. . . . Its essence is freedom—liberty of thought and of speech.

Radio should make a prisoner of no man and it should make no man its slave. No one should be forced to listen

and no one compelled to refrain from listening. Always and everywhere, it should be the prerogative of every listener to turn his receiver on or off, of his own free will.

The principle of *Freedom to Listen* should be established for all peoples without restriction or fear. This is as important as *Freedom of Speech* and *Freedom of the Press*.

Television is on the way and moving steadily forward. Television fires the imagination, and the day is foreseen when we shall look around the earth from city to city, and nation to nation,

as easily as we now listen to global broadcasts. Therefore, *Freedom to Look* is as important as *Freedom to Listen*, for the combination of these will be the radio of the future.

The "Voice of Peace" must speak around this planet and be heard by all people everywhere, no matter what their race, or creed, or political philosophies."

David Sarnoff

President and Chairman of the Board,
Radio Corporation of America.

* Excerpts from an address before the United States National Commission for UNESCO.



RADIO CORPORATION of AMERICA

FREEDOM IS EVERYBODY'S BUSINESS

February, 1948

McMurdo
SILVER

NEW!



FM & TELEVISION SWEEP SIGNAL GENERATOR

Here's what you and thousands of research and service technicians have demanded . . . a frequency-modulated FM and TV sweep signal generator. With this new McMurdo Silver MODEL 909 and your oscilloscope you can visually align FM and TV receivers . . . quickly and perfectly . . . for it comes with simple but complete instructions to put you at the head of the parade in FM and TV service.

Quality and completeness are as high as price is low . . . the regular "trademark" of Silver LCETI . . . Laboratory Caliber Electronic Test Instruments at prices you can afford.

CENTER-FREQUENCY RANGE 2/226 mc. — 5" vernier-driven calibrated dial. A new Silver development covers 2/77, 70/154 and 151/226 mc. in 3 bands without band-switching!

STABILITY is extraordinary. New u.h.f. tubes give stability such that FM and TV 'scope pictures once set up will "stay put" for hours on end.

SIZE AND STYLE match "VOMAX" and all Silver LCETI. Power required is 105/125V., 50/60 a.c. at 35 watts. Size 12 $\frac{1}{2}$ " x 7 $\frac{3}{8}$ " x 6" overall.

CO-AXIAL OUTPUT CABLES. 3 ft., d.c. isolated, 5/125 Ω impedance for r.f.; separate horizontal synchronizing cable. Both with clips for direct connection to receiver circuits.

SWEEP FREQUENCY is panel-knob variable 0/9 mc. . . . to set correct sweep for FM and TV i.f. and r.f. alignment. True electronic, not distorting and troublesome mechanical sweep.

SYNCHRONIZATION is either power line sine wave, or sawtooth to 'scope from 909. R.F. OUTPUT is panel-knob controllable 0/500,000 microvolts maximum. More than ample for all visual alignment with any good oscilloscope.

MODEL 909 FM & TV SWEEP SIGNAL GENERATOR makes you master, not victim, of today's most profitable service fields . . . at a price which is already the amazement of the industry!

Model 909 Only \$48.50 Net

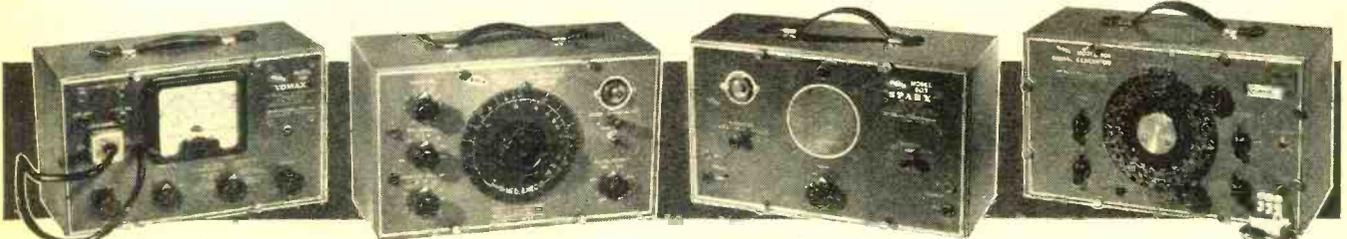

900 "VOMAX" 51 ranges; d.c., a.c., a.f., i.f., r.f., 20 Ω /500 mc. 0/3000 V. d.c.; 0/1200 V. a.c., current 0/12 A. ; resistance 0/2000 meg Ω ; db. -10/+50. The overwhelming choice of wise research and service technicians.
Only \$59.85 Net

904 CONDENSER/RESISTOR TESTER. $\frac{1}{4}$ mmfd./1000 mfd.; $\frac{1}{4}$ Ω /1000 meg Ω ; variable d.c. polarizing voltage leakage current; 0/50% power factor. Laboratory accuracy of $\pm 3\%$. Measures all condensers with 0/500 V. rated d.c. volts applied.
Only \$49.90 Net

905 "SPARX" DYNAMIC SIGNAL TRACER/TEST SPEAKER. Traces a.f., i.f., r.f. signals thru any receiver, tests pick ups, mikes, PA amplifiers. 20 Ω /200 mc. Saves time in receiver repairs as does no other single instrument
Only \$39.90 Net

906 FM/AM SIGNAL GENERATOR. 8 ranges, $\pm 1\%$ accurate, 90 kc./210 mc. 0/100% AM, 0/1000 kc. FM modulation. Less than 1 microvolt to over 1 volt metered output. The outstanding signal generator buy.
Only \$99.50 Net

SEND FOR COMPLETE CATALOG. See these and Silver communication transmitters, receivers, "Micromatch", Xtal-controlled VFO, pretuned freq. multiplier at your jobber.

OVER 36 YEARS OF RADIO ENGINEERING ACHIEVEMENT

McMurdo Silver Co., Inc.

EXECUTIVE OFFICES: 1240 MAIN ST., HARTFORD 3, CONN.
FACTORY OFFICE: 1249 MAIN ST., HARTFORD 3, CONN.

LOOKING FOR HIGH FIDELITY IN AUDIO COMPONENTS?

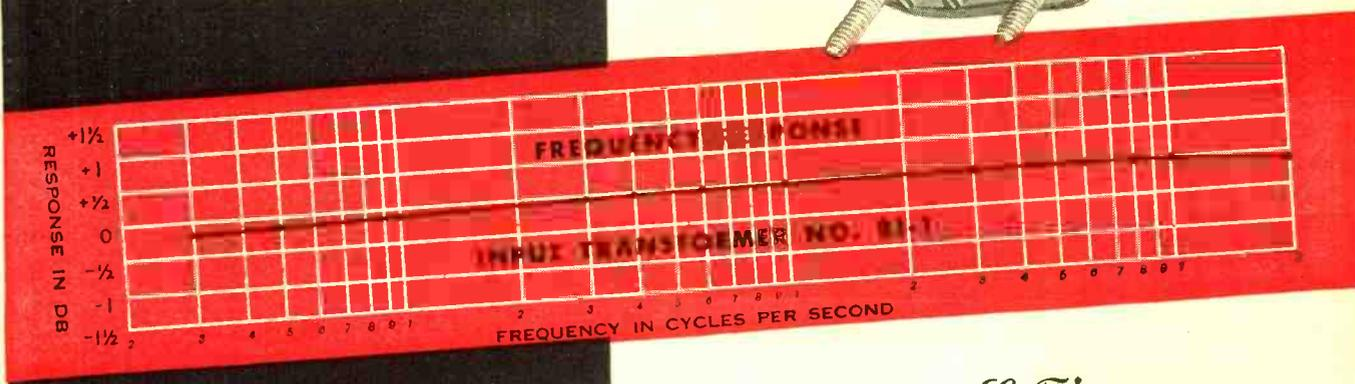

INPUT TRANSFORMERS

Catalog No.	Application	Impedance Primary—Secondary	Max. Power Level
BI-1	Line to Single or P.P. Grids	*Pri.—600/150 ohms CT *Sec.—50,000 ohms CT	+20 dbm.
BI-2	Line to Single or P.P. Grids	*Pri.—600/150 ohms CT *Sec.—50,000 ohms CT	+20 dbm.
BI-3	Line bridging to P.P. Grids	*Pri.—8,000/6,000 ohms CT *Sec.—50,000 ohms CT	+20 dbm.
BI-4	Line to line	*Pri.—600/150 ohms CT *Sec.—600/150 ohms CT	+20 dbm.
BI-5	Line to line	*Pri.—600/150 ohms CT *Sec.—600/150 ohms CT	+30 dbm.
BI-6	Interstage—P.P. Plates to Single or P.P. Grids	*Pri.—20,000 ohms CT *Sec.—50,000 ohms CT	+20 dbm.

OUTPUT TRANSFORMERS

Catalog No.	Application	Impedance Primary—Secondary	Max. Power Level
B0-1	Single Plate to Line	Pri.—15,000 ohms at 0 to 10 ma d-c. *Sec.—600/150 ohms CT	+20 dbm.
B0-2	P.P. Plates to Line	*Pri.—20,000 ohms CT *Sec.—600/150 ohms CT	+30 dbm.
B0-3	P.P. Plates to Line	*Pri.—5,000 ohms CT *Sec.—600/150 ohms CT	+40 dbm.
B0-4	P.P. Plates to Line	*Pri.—7,500 ohms CT *Sec.—600/150 ohms CT	+43 dbm.
B0-5	P.P. Plates to Line	*Pri.—10,000 ohms CT *Sec.—600/150 ohms CT; 16/8/4 ohms	+37 dbm.

†Has tertiary winding to provide 15% inverse feedback.
*Split and balanced windings.

Characteristic of C.T.'s New Full

Frequency Range Input and Output Transformers

They provide response within $\pm 1/2$ db over the full range from 30 to 15,000 cycles . . . and response within ± 1 db up to 20,000 cycles. That's tested performance . . . not just a curve.

Their percentage of distortion is exceptionally low over the full range . . . at low as well as high frequencies.

They're *Sealed in Steel* to protect the delicate, fine wire coil windings against corrosion by atmospheric moisture. The drawn steel cases are compact and streamlined . . . help achieve a clean, uncluttered appearance for any gear.

Input units have hum-bucking core construction and additional inner cases of special alloy for hum shielding of -70 dbm or better.

For 250-watt, 1-KW, and 5-KW Transmitters

Matched sets of Driver and Modulation Transformers, and Modulation Reactors. Response within ± 1 db over the Full Frequency Range of 30 to 15,000 cycles. Distortion very low . . . well within FCC limits for transmitters.

Distributorships for this new stock line are now being established. For full information, see your radio parts jobber or write direct.



CHICAGO TRANSFORMER

DIVISION OF ESSEX WIRE CORPORATION

3501 ADDISON STREET • CHICAGO 18, ILLINOIS

FOR FASTER SOLDERING
2 NEW WELLER
SOLDERING GUNS
 with

Solderlite



The new Weller Soldering Guns with Solderlite plus the fast 5 second heating help make service work more profitable for radio, television and appliance service men, electrical maintenance men, electric motor rewinding and repair shops automotive electrical service.

A useful and time-saving tool for laboratory workers, experimenters, hobbyists, telephone installation and maintenance men. S107 100 watts single heat, D207 100/135 watts dual heat.

See your radio parts distributor or write for bulletin direct.

WELLER
MANUFACTURING CO.
 810 Packer St., Easton, Pa.

Spot Radio News

★ Presenting latest information on the Radio Industry.

By **FRED HAMLIN**
 Washington Editor, RADIO NEWS

YOU DON'T have to await word from the weather man to learn that it's going to be one of the hottest Springs in Washington history from all indications—at least so far as radio is concerned. Two of the warmest controversies in recent radio history are scheduled to come up, and the results promise to become torrid. One concerns the controversy between the Federal Communications Commission and the Federal Bureau of Investigation (FCC-FBI), a row started early last fall by FCC Commissioner Clifford J. Durr. The other concerns editorializing on the air—a FCC-industry controversy.

FOR A TIME, it appeared that the FCC-FBI battle would end in peace. It began last October when Commissioner Durr, speaking in Chicago, said that the FBI was sending unsolicited security reports on individuals seeking licenses from the FCC for broadcasting stations. Although the nub of the Durr evidence indicated that the applicants in question were planning commercial stations, it is understood that FBI reports might also concern ham applicants. Commissioner Durr also questioned the legal quality of the FBI reports. Testimony reported is neither sworn nor does it list the person testifying.

FBI, IN THE person of Director J. Edgar Hoover, immediately and understandably responded to the Durr charges, and with equal promptness FCC acting chairman Paul Walker wrote Hoover, saying that Mr. Durr's statements did not voice the attitude of the Commission and would Mr. Hoover please start sending the reports again? Mr. Hoover said he would, and it looked as if the whole business was permanently buried—until just before Christmas. At this point, Congressional investigation of Mr. Durr was called for from the Hill by Senator Homer Capehart of Indiana, a member of the foreign and interstate commerce committee. The senator charged that Mr. Durr's speech was a "brazen effort to sabotage the FBI in its lawful duty to uncover Communists and other disloyal persons. There are many angles to this smelly case that remain to be cleared up if the confidence of the people in the FCC is not to be seriously im-

paired." What form the investigation will take was not known as this goes to press, but it may be significant that Commissioner Durr has not backed down on his original charges. If and/or when he is called before a Congressional committee to defend them, the resulting battle should make radio news headlines.

WHATEVER THE DATE on the FCC-FBI show, you can be sure of this: Hearings on FCC's controversial "Mayflower" doctrine banning editorializing in radio broadcasts will begin March 1. That is the final word from the Commission, which recently cancelled the opening, scheduled for Jan. 12, and announced the March date. That the sessions will be full-dress and full-throttle is assured by FCC itself, which has written nearly a hundred letters to organizations and private individuals asking them to voice their views on the subject. Assured is the intensive opposition to the Mayflower doctrine by the National Association of Broadcasters, whose president, Judge Justin Miller, has already been campaigning against the FCC stand as limiting freedom of speech.

GETTING SO you have to schedule a convention so far ahead, in order to coordinate with everyone concerned, that radio convention-attenders will know where they are going to be anywhere up to a year ahead of time. If you are going to the 1948 gathering of the National Association of Broadcasters, for instance, you will be in Los Angeles May 17-20; and if you plan to attend the Frequency Modulation Association meeting, you'll be in Chicago October 11-12. FMA picked and announced the dates after NAB set its program, in order that there would not be the conflict there was last year, which FMA believes cut down on their attendance. With October set as an FMA month, greatly increased turnout and manufacturer-participation is anticipated by Bill Bailey, executive director of FMA, who will run the Chicago show. FMA, incidentally, is as optimistic about 1948 as they were during the fall. In a recent round-up on the frequency modulation situation, the Association points out that within the year investment in FM facilities will total some

E. B. De Vry, President
DeForest's Training, Inc.

HERE'S YOUR Big Chance

Profit Through Training in RADIO-ELECTRONICS

Prepare at HOME or in our CHICAGO LABORATORY to get REAL MONEY, a BETTER JOB, or a BUSINESS OF YOUR OWN

Our business is helping men . . . and young men . . . get into a well-paying future in the highly profitable fields of RADIO-ELECTRONICS. During the past sixteen years we have trained many men who desired better jobs or businesses of their own. We can effectively provide you with this same opportunity either in our new, modern Chicago laboratories or in the privacy of your own home.

TAKE YOUR CHOICE

If you choose to come to Chicago, we shall find comfortable living quarters for you. If you train at home, we shall send you modern, practical equipment. In either of these two methods, you will have the supervision of some of the finest instructors in the country. Fill in coupon below and we shall send you, absolutely FREE, full information about our program of building men for better opportunities in RADIO-ELECTRONICS. DeForest's Training, Inc. also includes instruction in FM Radio, Television and Industrial Electronics.

If you prefer to remain at home, you receive eight (8) big kits of radio parts and assemblies from which you can work out dozens of fascinating radio circuits to gain practical experience in your own home. In addition, you receive a 16 mm. motion picture projector and 12 information-packed reels of film which help you learn faster . . . easier. You also get modern looseleaf lessons with handy fold-out diagrams.

EMPLOYMENT SERVICE

When you complete your training our effective Employment Service helps you get started toward a real future. Mail coupon below today . . . do not delay.

VETERANS

Both our (1) Chicago Laboratory and (2) Home Study training are accepted under the "G. I. Law." If you qualify, the Government will pay cost of either training you select.

MAIL THIS OPPORTUNITY COUPON NOW!

Mr. E. B. De Vry, President
DeForest's Training, Inc.
2533 N. Ashland Ave., Dept. RN-2
Chicago 14, Illinois

Please show me how I may get started toward a good job or a business of my own in Radio-Electronics.

Name.....Age.....

Address.....Apt.....

City.....Zone.....State.....

If under 16, check here for special information.

If a discharged Veteran of World War II check here.

DeForest's Training, Inc.

CHICAGO,
ILLINOIS

Associated with the DeVRY Corporation
Builders of Movie & Electronic Equipment



Merit, now entering its
24th year, has given a new
meaning to transformers
—Merit Quality.

EXPORT DEPARTMENT:

1607 Howard Street, CHICAGO 26, U. S. A.

Cable Address: MERIT

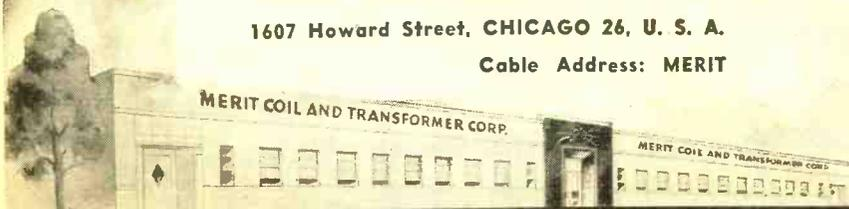

MERIT COIL & TRANSFORMER CORP.

TELEPHONE

4427 North Clark St.

Long Beach 6311

CHICAGO 40, ILL.

SPOT RADIO NEWS

\$100 million. Gross income from sets will go to an estimated \$400 million. Broadcasting, FMA reports, is beginning to show a profit and the profit curve is expected to continue upward.

TELEVISION SHOWS continued signs of rivaling all other forms of radio in progress during 1948. FCC records show 17 commercial stations already on the air at last count, 54 others authorized, 43 applications pending. Coverage reaches a total of 54 cities in 29 states. Dollars give an idea of the size of expansion—experts estimate that initial installation costs alone now total nearly \$15 million. The 43 pending applicants will spend an estimated \$6-\$8 million to get started if FCC okays them. Television networks are processing rapidly. The Atlantic seaboard hook-up now reaches from Washington, D.C., to Boston. The microwave radio relay of the *Bell System* is being used to tune in Boston, with Washington, Baltimore, Philadelphia and New York, linked by coaxial cable, also a *Bell* development. In the wake of establishing the Boston hook-up, Frank E. Mullen, *National Broadcasting Company* television chief, predicted that mid-1949 will see Chicago, New York, and intermediate cities on the network.

ELECTRONICS is still making giant strides in the aviation field, most recent development being a "brain" which points the way toward completely automatic navigation of planes. The new device also multiplies the number of lanes along which planes may fly with safety. The plane's computer, which would be set for course and destination before take-off, would receive signals from radio stations along the route and constantly inform the pilot how far he is from his destination and how close he is to being on course. The device was developed by the *Minneapolis-Honeywell Regulator Company* under Dr. Waldo H. Kliever, research director. One of the computers is now being tested by the Civil Aeronautics Administration for possible use on the airways, and *Minneapolis-Honeywell* says that many routes could be equipped within a short period if CAA and the airlines desire.

ANOTHER TOP RADIO OBSERVER sees television helping to make radio a "billion dollar" business for the first time this year. This is Stanley Glaser, manager of radio and television, the *Crosley Division, Avco Manufacturing Corporation*. Mr. Glaser predicted recently that "with television becoming a major factor in the radio industry, radio sales in 1948 may reach the one billion dollar mark for the first time." He bases his statement on the further prediction that "television receiver sales alone will contribute about \$250 million" to the total. He bases the figure on an anticipated production
(Continued on page 126)

RADIO NEWS

ALL CAPACITORS ARE NOT ALIKE!

You be the Judge! See why Centralab's
Ceramic BC "Hi-Kap" Capacitors are your best buy!

"HI-KAP" FEATURES	DESCRIPTION	ADVANTAGES
1. Impervious to moisture	Ceramic-X is non-hygroscopic. Moisture absorption is .007% or less.	No deterioration, no shorting. Longer life even under the most adverse conditions.
2. Low mass weight	Av. Wt. .029 oz.	For unit size and weight, Centralab BC "Hi-Kaps", made with Ceramic-X, are the only capacitors on the market which provide these voltage ratings.
3. Small size	Dimensions L—.540" D—.315"	
4. High capacity	Values .00005—.00025 mfd.	
	L—.830" D—.315" .0005 mfd.	
	L—1" D—.340" .000750—.005 mfd.	
	L—1.305" D—.400" .01 mfd.	
	Rating: 600 WVDC — 1000 VDC flash test.	
5. Special insulation	Wax impregnated, lacquered, dipped in special phenolic resin, cured and wax impregnated.	Prevents any possibility of shorting to adjacent leads, chassis or components.
6. Convenient side leads	Heavy #22 gauge tinned copper.	Permit rapid, close-coupled connections. No tricky bending or fitting required.
7. Low power factor	Initial — .6%. After 100 hours, 95% humidity test — 3.0%.	More efficient circuit operation, fewer failures.
8. High leakage resistance	Initial — 5000 megohms. After humidity — 500 megohms.	Long life, more efficient performance.
9. Maximum dependability	One-piece construction. Leads soldered directly to electrodes.	Will not short or become intermittent.
10. Factory tested	For your protection, all units 100% factory tested before packaging and shipping.	Your guarantee to your customers of reliable service and performance.

PART NUMBER	VALUE (MFD.)	LIST PRICE*
D6-500	.000050	\$1.25*
D6-101	.000100	1.25*
D6-151	.000150	1.25*
D6-251	.000250	1.25*
D6-501	.000500	1.25*
D6-751	.000750	1.25*
D6-102	.001000	1.25*
D6-202	.002000	1.25*
D6-502	.005000	1.50*
D6-103	.010000	1.50*

*PER ENVELOPE OF 5

Rating: 600 WVDC — 1000 V. flash tested. Individually color coded, inspected and insulated.

First in Quality — First in Performance!

YES, more and more Radio Service Dealers are turning to Centralab's ceramic by-pass and coupling capacitors for new dependability, permanence and convenient size. Compare the amazing low price at which Centralab is offering these ceramic capacitors, and you'll agree now's the time to give yourself and your service customers the newest and finest in capacitor components!

Note the wide range of Hi-Kap values available at left, and order a supply of these top quality capacitors from your Centralab Distributor today. For complete information, see your Centralab Distributor or write to Centralab, Division of Globe-Union, Milwaukee, Wis.

LOOK TO **Centralab** IN 1948!

First in component research that means lower costs for the electronic industry.

HOT RADIO VALUES at SUN RADIO!



BC-684 F.M. 35 WATT TRANSMITTER

BC-684 F.M. 35 WATT TRANSMITTER. Brand new, complete with eight tubes, crystal control, 10 channel push-button, non-linear modulation coil, less coverplate, crystal and power supply. **\$24.95**

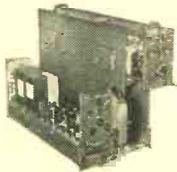

WAVEMETER

We're closing out the last few of these precision wavemeters which tune from 150-210 mc and which contain a high quality resonant cavity wavemeter, oscillator, heterodyne amplifier, electric tuning eye, complete with 19 tubes, 110 v AC power supply. The tubes alone far exceed your close out cost of **\$24.95** only.



V.H.F. TRANSMITTER

Here is one of the greatest offerings in war surplus! Hundreds sold at \$20 and now closed out at an amazingly low price. Brand new. Battery operated (67 1/2 v B and 1 1/2 v A). Frequency 80 to 105 mc. Complete with 2-1G4 tubes and full instruction manual. Ready to go on the air. Less Batteries. **\$6.95**



PORTABLE AMPLIFYING MEGAPHONE

U. S. Army Signal Corps Surplus! Complete in portable carrying case with electric megaphone and microphone, pistol grip and trigger switch. Additional hand microphone and switch. Portable tripod stand. Combination amplifier and battery case. Projects voice up to 1/4 mile. Used but guar. perfect. Complete with **\$59.95** batteries.



A.C. VOLT METER

Brand New G. E. 3" square panel meter 0-150 v. Ideal for checking primary voltage. **\$3.49**

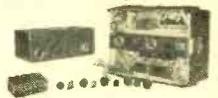

SCR-522 VHF TRANSCEIVER

The finest all purpose equipment on the surplus market. Tunes 100-156 MC. Don't confuse these with other incomplete and abused 522s. Sun Radio offers electronically perfect and guaranteed 522s. **AND COMPLETE** with tubes (one 10 tube superhet receiver with squeel circuit and one 7 tube transmitter), remote control box, 28 volt dynamotor (can be converted to 110V operation), 4 crystals and **ALL CABLE CONNECTORS** but less cables **\$24.95**

CRYSTALS!

In the greatest purchase of radio transmitting crystals ever made by one wholesaler in the history of the Radio Parts Industry, Sun Radio acquired title to over a half million dollars (\$500,000.00) of Army Surplus, precision built, exactly tolled crystals in moisture proof holders which are shock mounted. Can you visualize the immensity of this stock of ours! . . . thousands, or should we say miles of gleaming BRAND NEW CRYSTALS IN MOISTURE PROOF HOLDERS manufactured by the world's finest crystal manufacturers (RCA, Biley, Western Electric, Valpey, etc.) lying in long rows, lovely to look at but even better to own. We can't claim that we can supply every frequency, because they are offered "First come, first served," but we do claim that we can supply the early birds with the below listed frequencies AT THE LOWEST PRICES YOU HAVE EVER SEEN. . . . We say it's sensational!!! Please note that crystal shipments of 6 or less are packed in cloth containers to expedite handling. . . . No worry because all crystals are shock mounted and guaranteed delivered perfect. All crystals have Army MC harmonic ratings but Sun encloses directions for deriving the correct fundamental frequency in kilocycles. . . . And all frequencies are checked before shipment to insure your satisfaction. And remember, you may never again see the day that you can buy BRAND NEW CRYSTALS IN MOISTURE PROOF HOLDERS at the prices that we have listed here. . . .

CRYSTALS WITH A MILLION USES

Fractions Omitted									
412kc	423kc	434kc	444kc	459kc	474kc	488kc	498kc	509kc	
413	424	435	445	462	475	490	501	511	
414	425	436	446	463	477	491	502	512	
415	426	437	447	466	479	492	503	515	
416	427	438	448	468	481	493	504	516	
418	429	440	451	469	483	494	505	518	
419	430	441	453	470	484	495	506	519	
420	431	442	457	472	485	496	507	522	
422	433	443	458	473	487	497	508	523	

49c EACH

I.F. Frequency Standards	Crystal Frequency Standards	For Crystal Controlled Signal Generators
450kc	454.166kc	526.388
451.388kc	455.556kc	527.777
452.777kc	459.259kc	529.166
	465.277kc	530.555
99c EACH	3.89 EACH	99c EACH

Assorted Miscellaneous CRYSTALS					For Ham and General Use				
Fractions Omitted					Fractions Omitted				
370kc	375kc	379kc	383kc	387kc	390kc	394kc	398kc	404kc	408kc
372	376	380	384	388	391	395	401	405	409
374	377	381	386		392	396	402	406	411
					393	397	403	407	
priced at a fraction of the cost of their holders alone. 39c EACH					79c EACH				

* Payments must accompany order. Enclose 20c for postage and handling. Minimum order—\$2.00 plus postage. Crystals are shipped packed in cloth bags inasmuch as they are shock mounted. All shipments guaranteed.



MAGNETIC HEADPHONES P-20
Brand New Signal Corp 4000 ohm magnetic headphones. 8 ft. cord with standard phone plug. Headphones are adjustable to size. A \$14.50 value at only **\$2.49**



4" PM Speaker
With output transformer to match 354 tube. A \$4.95 value for **\$1.49**
In quantities of 6 **\$6.79**

★TERMS: All items F.O.B., Washington, D. C. All orders \$30.00 or less cash with order. Above \$30.00 25 per cent with order, balance C. O. D. Foreign orders cash with all orders, plus exchange rate.

SUN RADIO

OF WASHINGTON, D. C.

938 F STREET, N. W. WASH. 4. D. C.

100 WATT BENDIX TRANSMITTER TA12

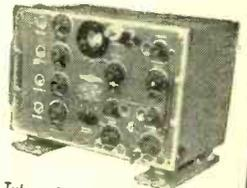

CHECK THESE VALUES: Three 807 Tubes, four 12SK7, one 2 inch 5 amp. RF meter four Separate Master oscillators. (These can be easily changed to cover 20-40-80 meters and by using crystal transmitter.)
Four separate output tanks.

One 4 position selector channel switch having seven sections which changes the ECO, IPA and output tanks simultaneously. All controls are mounted on the front panel. The housing is cast aluminum; shields and case are sheet aluminum. Dimensions 11 x 12 x 15 inches, weighing 35 1/4 lbs. Complete, simple instructions for conversion furnished. Complete with **\$49.95**



SUPERHETERODYNE RECEIVER

This crystal fixed frequency receiver comes with full conversion instruction for variable tuning of all ham bands and broadcast. A highly selective superheterodyne receiver, 110 V. A.C. power supply built in. Using the following tubes: 6K7—RF Amplifier; 6K8 Mixer and Oscillator; 6K7 I.F. Amplifier; 6F7—Detector and A.V.C.; 6C8 Output and Noise Suppressor; 80 Rectifier. Dimensions—3 1/2 x 19 x 11 1/2 inches. Comes complete, brand new, with one set of coils and two sets of tubes. **\$16.95**
Extra set of coils **\$2.95**



DC MILLIAMMETER
Brand new General Electric 2" round panel meters 0-300 **\$2.97**



MICROPHONE T-17
Brand new single button carbon hand mike by "Shure" with push to talk switch **99c**



REENTRANCE SPEAKER
8 Watt PM driver unit housed in metal weather-proof baffle, 6 1/2" diameter x 5" deep, 6 lbs. weight, voice coil 15 ohms. Ideal for communications receivers and public address work **\$6.95**

**WE BRING NATIONAL SCHOOLS
TO YOU FOR **RADIO**
HOME TRAINING IN
TELEVISION & ELECTRONICS**

RADIO SHOP AT NATIONAL

BROADCAST STUDIO AT NATIONAL

Partial View of the
Facilities that Stand
Behind Your National
Schools Home Training

TELEVISION STUDIO
AT NATIONAL

Since 1905

**For Over 42 Years
One of America's
Leading Trade Schools**

**NATIONAL SCHOOLS SHOP METHOD HOME
TRAINING WILL START YOU RIGHT**

We will train you today to get started tomorrow in one of the thousands of opportunities opening in the field of Radio, Television and Electronics. The Home Radio Service Field continues to grow. Television is here . . . Television Broadcasting facilities are being rapidly expanded, Television sales, service, installation and maintenance requirements are more and more important from day to day. Electronics is an important factor in many applications for utility, safety, accuracy and convenience. Airlines are finding new uses for Radio bringing new benefits to air transportation. Ships at sea are employing Radar together with other conventional Radio apparatus for ship-to-shore communications and safety. Frequency Modulation is modernizing Radio Broadcasting, offering static-and-interference-free reception in the home. The list of Radio applications is almost endless, and every one represents increasing opportunities in our modern world for the RADIO, TELEVISION AND ELECTRONICS TECHNICIAN WITH A SOLID TECHNICAL BACKGROUND.

YOU CAN BE A NATIONAL SCHOOLS MAN

It is not a question of opportunity but rather how to take advantage of existing opportunity. Only proper training can make these opportunities a reality. National Schools of Los Angeles, one of the oldest and largest technical trade schools in the United States, offers you Shop Method Home Training, a proved method that builds qualified technicians. Here is Home Training that BRINGS RESULTS.

Behind all training from National Schools stands a permanent faculty of experienced instructors and engineers. These men are daily teaching resident students right in our own Shops and Laboratories. From first hand experience with students here at school, our instructors understand the needs and ambitions of men like you. All of our instructors, both Home Study and Resident, have ideal facilities to make your training practical, up-to-the-minute, interesting. It takes years of experience to know how to train men, especially in the practical technical trades. Established almost 50 years ago, National Schools has a rich background of experience to help you to take full advantage of the opportunities in the Radio, Television and Electronics Industry.



VETERANS

During the war, National trained enlisted men under contract with the War Department. Both the Armed Forces Institute and Marine Corps Institute used our lesson texts on a wide scale. Now, we are training veterans, both resident and home study, through the Veterans Administration. If you are a veteran of World War II—and qualified for training under the G.I. Bill of Rights, check the coupon for special information.

GET THESE 2 BIG BOOKS FREE!

**Begin Training at Home
Later Come to Our Shops and
Laboratories in Los Angeles
—If You Prefer**

National's Master Shop Method Home Training in Radio, Electronics and Television is COMPLETE in itself. No other training is necessary; but, some men do prefer to take a short experience course here in our resident shops and laboratories, at the end of their Home Study training. They find it helpful to spend a short period of time in our modern Broadcasting Station, or our New Television Laboratories and Studios, or our Extensive Radio Servicing Shops—as well as other departments covering every specialized phase of the Radio Industry.

You are welcome to take advantage of this additional instruction if you wish. If you are interested, check the coupon below. Full details will be sent you by return mail. National Schools' OUTSTANDING FACILITIES MAKE IT POSSIBLE TO OFFER THE FINEST POSSIBLE TECHNICAL TRADE TRAINING IN RADIO, TELEVISION AND ELECTRONICS.

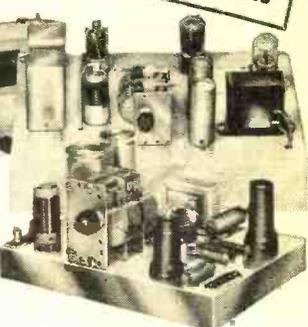

**You Get All This Radio
Experimental Equipment to
Use and Keep at Home!**

LEARN BY DOING is the basic principle of National's Shop Method Home Training. We send you standard Radio parts for an interesting series of experiments which demonstrate the fundamentals of Radio, Television and Electronics. The very essence of this training is EXPERIENCE—you get actual experience by building many different types of circuits. You build a fine, long distance MODERN SUPERHETERODYNE RECEIVER, signal generator, low-power Radio transmitter, audio oscillator, etc. This practical work develops your knowledge of Radio step by step, makes you a practical Radio Technician.

**G. I. APPROVED
NATIONAL SCHOOLS
LOS ANGELES 37, CALIFORNIA EST. 1905**

MAIL OPPORTUNITY COUPON FOR QUICK ACTION

NATIONAL SCHOOLS, Dept. RN-2
4000 South Figueroa Street, Los Angeles 37, California
Mail me FREE the two books mentioned in your ad, including a sample lesson of your course. I understand no salesman will call on me. I have checked below the plan which interests me.

NAME AGE

ADDRESS

CITY STATE

(Include your zone number)

- I am interested in home study only.
- Send information on your Combined Home-Study and Modern Resident Shop Training.
- Veteran of World War II.

WELLS' TUBE SPECIAL OF THE YEAR!

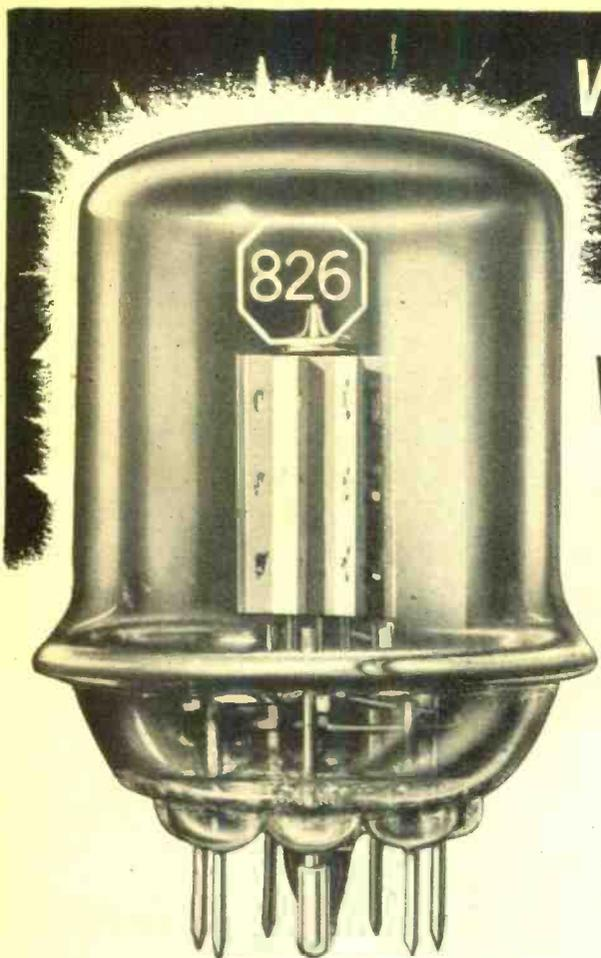

The 826—60 Watt UHF
Transmitting Tube..... **49c**
(LESS THAN THE PRICE OF A RECEIVING TUBE)

Accustomed as we are to excellent values in Government radio equipment, we were amazed at the remarkably low price at which we were able to get these 826's. The regular Amateur net price is \$9.25 and worth it! So you can see why we're calling this the TUBE SPECIAL OF THE YEAR. Build your new rig around the 826. Order plenty of spares as we doubt if you will be able to duplicate this price when our stock is gone.

UHF Operation up to 250 MC.

The 826 will perform beautifully in your 2 meter rig as well as on the lower frequency bands. Use it as a final amplifier, modulator, doubler, buffer, or oscillator. In fact, the 826 is good for practically any R.F. or audio application.

826 Specifications

These tubes are standard make, brand new, JAN inspected, and packed in their original cartons.

At our low price, 826's can be shipped only in boxes of 4 for \$1.96. Add 25c for each box of 4 tubes for prepaid shipment to any part of the continental U. S.

		<u>Power Output</u>	<u>Watts</u>
Max. Plate dissipation	60 watts		
Filament volts	7.5		
Filament amps.	4	Class C amp.	86
Max. plate voltage	1000	Class C plate mod.	53
Max. plate current	125 m.a.	Class B telephony	22
Approx. grid drive	6 watts	Grid modulated	25
Max. freq. full rating	250 mc.		

Tube Sockets for the 826

Ceramic tube sockets for 826, 829B and 832 tubes . . . only 50c each.

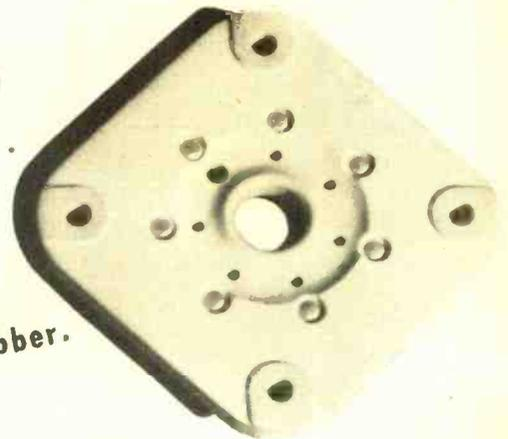

Order directly from us or through your local Parts Jobber.

WELLS
SALES, INC.

Write for Amateur Catalog H200C
Containing Hundreds of Money Saving Values

320 N. LA SALLE ST., DEPT. R-2, CHICAGO 10, ILL.

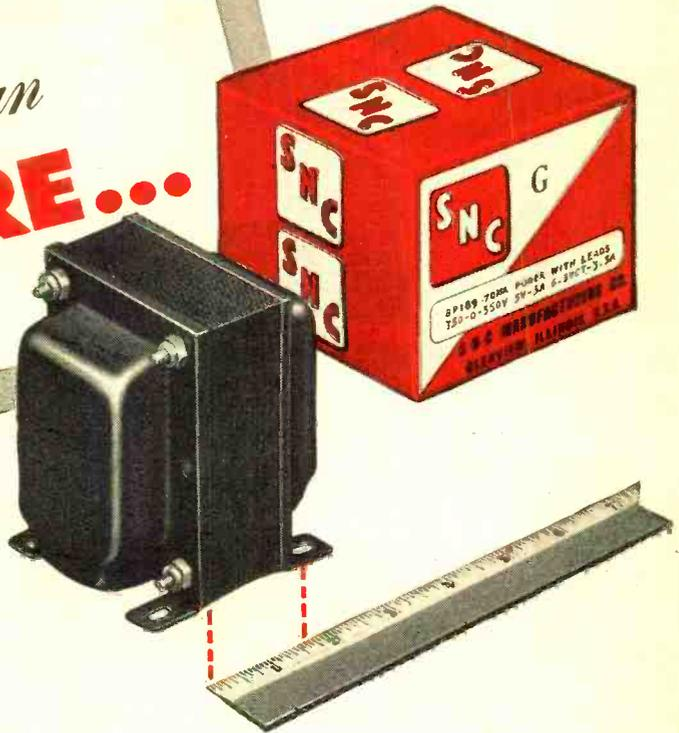

makes every
SNC TRANSFORMER *give outstanding performance*

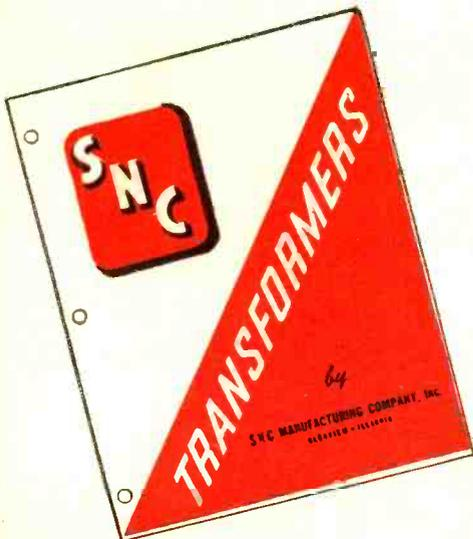

Join the increasingly large number of manufacturers, retailers, hams and other component part buyers who rely on SNC for quality, trouble-free equipment. Write for catalog today.

Place a rule against the stack of an SNC No. 8P819 transformer and the *extra* width clearly indicates the added quality built into every item in the complete SNC line.

Skillful engineering, latest production techniques and highest quality materials . . . backed by careful workmanship, exacting step-by-step inspection and rigorous final testing . . . are just a few of the reasons why SNC transformers keep rejects at a minimum and give outstanding performance.

Remember! SNC gives MORE applications with SMALLER inventories for GREATER profits!

SNC MANUFACTURING CO., INC.
Quality Transformers

WEST LAKE AVE. NEAR LEHIGH • GLENVIEW, ILLINOIS
Export Department, 308 W. Washington St., Chicago 6, Illinois, U.S.A.



Where Will You be
in **ELECTRONICS**
IN 1949?

Study NOW for a Better Job Then!

ADD TECHNICAL TRAINING TO YOUR PRACTICAL EXPERIENCE WITH ONE OF THESE CIRE HOME STUDY COURSES!

A—Master Course in Radio Communication

A complete course covering the technical fundamentals of radio-electronics, for the radioman who wants a general review. Includes preparation for Broadcast station employment.

B—Advanced Course in Radio Communication Engineering

A genuine college-level radio engineering course, completely mathematical in treatment. For the advanced radioman with considerable practical experience and training.

C—Specialized Television Engineering

An advanced college-level course for the radioman who has had formal training equivalent to A and B. Without preliminaries, every lesson is devoted to television subjects.

D—Advanced Radio Telephony for the Broadcast Engineer

An advanced, specialized course covering broadcast station engineering and operation. Without preliminary preparatory fundamentals, this course enters immediately into the heart of the subject matter. Covers the engineering knowledge and the technical duties required of the studio control operator, the master control operator, and the transmitter operator.

FREE CATALOG—Describes all Cleveland Institute home study courses—tells of CIRE unique, post-war methods of training. Use coupon below for Catalog A.

Want Your FCC "Ticket"? Get It in a Few Short Weeks with CIRE Training and Coaching!

More than ever before an FCC Commercial Operator License is a sure passport to many of the better paying jobs in this New World of Electronics.

Employers frequently give preference to the license holder, even though a license is not required for the job. Hold an FCC "ticket" and the job is yours!

Hundreds of Satisfied, Successful Students

"I have taken the first class phone license examination and received my first class ticket last Saturday, May 31. In closing I must say yours is an excellent radio course, and I really appreciate your help and the fine service you have rendered me."

Student #2876N12

"I passed the FCC examination in radiotelephone 2nd class, at Detroit on June 3rd, and I want to thank you for your ready assistance as my instructor on Section I of Nilson's Master Course."

Student #2799N12

"I have had my 1st class radiotelephone license since March of this year, and plan to continue with your course since I find it a great help in studying transmitters."

Student #2779N12

"After sending in Lesson E-9 I took the commercial operator's license examination for 2nd class radiotelephone, and passed O.K. I received the license last week."

Student #2772N1

FREE BOOKLET—Tells you the Government requirements for all classes of FCC commercial licenses. (Does not cover Amateur License examinations.) Use coupon below for Booklet B.

**How To Pass
 FCC
 LICENSE
 EXAMINATIONS**

**CLEVELAND INSTITUTE
 OF
 RADIO ELECTRONICS**
 Terminal Tower, Cleveland, Ohio

HOW TO PASS Commercial FCC LICENSE EXAMINATIONS...

CLEVELAND INSTITUTE OF RADIO ELECTRONICS
 Contractors to the Canadian Broadcasting Corporation

RN-2 TERMINAL TOWER CLEVELAND 13, OHIO

Cleveland Institute of Radio Electronics
 RN-2 Terminal Tower, Cleveland 13, Ohio

Gentlemen:

Please send me your Booklet B, "HOW TO PASS THE FCC COMMERCIAL LICENSE EXAMINATIONS," and information about License Examinations. (Does not cover Amateur License Examinations.)

Please send me your Catalog A, describing all of your home study radio-electronics courses. I desire training in course A B C. D.

Veterans check for enrollment information under G-1 Bill. NO OBLIGATION—NO SALESMEN.

NAME _____

ADDRESS _____

CITY _____ ZONE _____ STATE _____

**Don't Delay—
 Write Today!**

Approved for Training Under "G-1 Bill of Rights"



"It's the one that REALLY WORKS"
Reports Pilzer Twigg

You all remember Pilzer from way back before the war. He repairs radios at the Acme Radio Emporium. After field-testing advance samples of the new Sprague TM, Mr. Twigg reports:

"Up to now I couldn't keep a tubular in the auto radio in my Model T long enough to bother with puttin' one in. Now motoring is fun again. The radio coos like a baby. Sprague TM's are the only ones that really work!"

The first truly practical all-purpose HIGH-TEMPERATURE MOLDED paper tubulars—New type TM

- Highly heat resistant
- Moisture resistant
- Non-inflammable
- Conservatively rated
- Small in size
- Mechanically rugged
- Completely insulated

After more than four years of intensive research, plus one of the largest retooling programs in its history, Sprague announces a complete line of high-temperature molded paper tubular capacitors that offer far-reaching advantages for a long list of products ranging from home or auto radios and electrical appliances to military equipment. These new molded types will be known as "TM" units. Basically, because of its completely new method of construction, this Sprague TM unit is so far ahead of anything now available, it should

have the same effect on the paper tubular capacitor business that bakelite molded resistors had in the resistor field years ago.

The unique high-temperature molded construction of these new capacitors assures maximum dependability even under extremes of heat, humidity, and physical stress. Thus the new TM types have virtually universal application in modern equipment. **YOU CAN STOCK ONE BRAND FOR ALL REQUIREMENTS—SPRAGUE TM'S!**

Reach for a Sprague and know you're right!

CAPACITORS

SPRAGUE

*KOOLOHM RESISTORS

• T.M. Reg. U.S. Pat. Off.

SPRAGUE PRODUCTS COMPANY, North Adams, Mass.

(JOBING AND DISTRIBUTING ORGANIZATION FOR THE PRODUCTS OF THE SPRAGUE ELECTRIC COMPANY)

February, 1948

27

The Industrial
iron for
DELICATE WORK

BAFFLE PLATES
KEEP HANDLE COOL

DRAKE 400

SOLDERING IRON
For soldering in tight corners or delicate units, you can't beat the Drake 400. And this mighty mite has the long life and dependable performance necessary for industrial work. It is the only substantial industrial iron offering this combination of features.

DRAKE 400
LIST \$4.95

WEIGHS ONLY 8 OZ.
60 WATT RATING

1/4" TIP
IRON 9 INCHES LONG



**DRAKE ELECTRIC
WORKS, INC.**

3656 LINCOLN AVE. CHICAGO 14, ILL.

Within the INDUSTRY

CHARLES T. LITTLE has been appointed direct factory representative of *Acme Electric Corporation* in charge of the New York office located in the Grand Central Terminal Building.



Before joining *Acme*, Mr. Little was associated with *Delta Radionic*, manufacturers' representatives. He also served as direct factory representative for *Tobe Deutschman Corporation*.

In addition to handling the company's line of radio transformers, Mr. Little will be in charge of sales for the *Acme* fluorescent lamp ballasts, cold cathode lighting transformers and ballasts, bell ringing, chime and signaling transformers, air-cooled transformers and other products in the company's line.

JEFFERSON ELECTRIC COMPANY of Bellwood, Illinois, has purchased the *Capacitron Company, Inc.* of Chicago.

The chief products of *Capacitron* include oil-filled and electrolytic condensers, a.c. motor starting condensers, and Ballastrons, a type of condenser that provides high power factor correction for low power factor fluorescent lamp ballasts.

The *Jefferson* organization manufactures transformers, ballasts, and fuses and plans to continue the production of condensers in the present *Capacitron* plant, enlarging and providing facilities as required.

SAMUEL INSULL, JR., has been elected a vice-president of *Stewart-Warner Corporation* of Chicago by the Board of Directors of that company.



He will continue to be in charge of the company's radio division.

Prior to his appointment as assistant to the president of the company last January, Mr. Insull was vice-president of *Central Barge Company* of Chicago. He served with the U. S. Navy from August, 1943, to December, 1945, attaining the rank of commander.

GAROD ELECTRONICS CORPORATION has announced the appointment of three new district sales representatives for the *Garod* line of home receivers.

Albert Levine, with headquarters

at 1222 Arkansas Avenue, Pittsburgh 16, Pennsylvania will call on *Garod* distributors in western Pennsylvania, West Virginia, and Kentucky.

Tom Dwyer will cover the states of North and South Dakota, Minnesota, and Wisconsin. His offices are located in the Commerce Building, St. Paul, Minn.

Gamble & Mattes Co. of 322 Godchaux Building, New Orleans, La., will serve Louisiana dealers.

THE INSTITUTE OF RADIO ENGINEERS' Cincinnati Section is sponsoring its second annual Spring Technical Conference on Saturday, April 24th at the Engineering Society Headquarters Building in Cincinnati.

The conference will feature television and a number of prominent speakers are expected to present papers. The committee also plans to have demonstrations of television receivers, components, etc.

Persons interested in additional information about the conference are advised to contact William D. Montgomery at 1290 Coolidge Ave., Cincinnati 2, Ohio.

L. B. BLAYLOCK, who recently joined *Federal Telephone and Radio Corporation*, has been named to the post of Director of that company's *Radio Division*.



Mr. Blaylock, prior to his retirement from the Navy with the rank of Captain, was associated with Navy communications for 27 years. Before joining *Federal* he had been assigned to the post of Resident Inspector of Naval Material for the Camden, New Jersey, district.

He was also in charge of the Research and Design Section, Radio Division, of the Bureau of Ships in Washington, D. C. During this assignment the department under his supervision was directly responsible for the development of much of the electronic equipment presently used by the Navy.

UTAH RADIO PRODUCTS has named G. L. Koenig of *Koenig Sales*, Kansas City, Missouri, to act as representative for the company's line of replacement speakers.

This new appointment brings to fifteen the number of representatives offering country-wide coverage for *Utah*. The following men are now acting for the company: J. H. Blinn, Denver; M. C. Branum, Dallas; Art Cerf, Newark; S. S. Egert, New York

RADIO NEWS

DESIGNED FOR THE BETTER SERVICE SHOP . . .

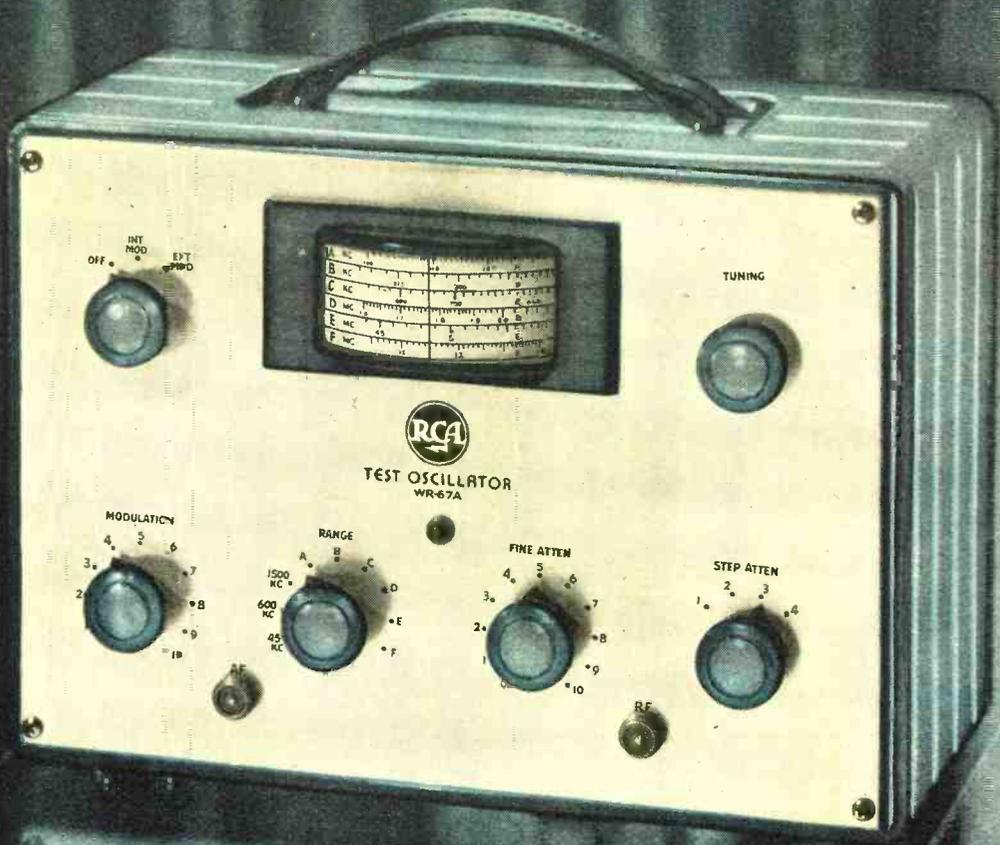

RCA's NEW TEST OSCILLATOR
 . . . second unit of a
 revolutionary new line

**Reduces testing and alignment time
 by as much as 50 per cent**

• The WR-67A is a time-saver that adds *profitable* hours to your service day . . . puts you dollars ahead.

When aligning a receiver, for example, you can switch from a pre-tuned i-f signal to pre-tuned broadcast-band signals without dialing or retuning. The range switch gives you three fixed frequencies: 1500, 600, and 455 kc. It also permits instant switching to any other frequency you select between 100 kc and 30 mc by presetting the smoothly variable tuning control.

Other outstanding features include: a signal injection probe for high-speed servicing . . . a four-step attenuator with fine control . . . double

shielding . . . miniature-type tubes throughout . . . a six-band drum dial with an easy-to-read, four-foot scale spread . . . adjustable modulation level for internal and external modulation . . . a two-stage power-line filter to minimize leakage, and a 400-cycle *audio* signal source.

Every RCA WR-67A is factory-tested with the finest precision measuring equipment—plus the WR-67A's ability to withstand rigorous "drop," "shake," and "humidity" tests—add up to real on-the-job reliability. A new bulletin is yours for the asking. *Keep in touch with your RCA Test Equipment Distributor.*

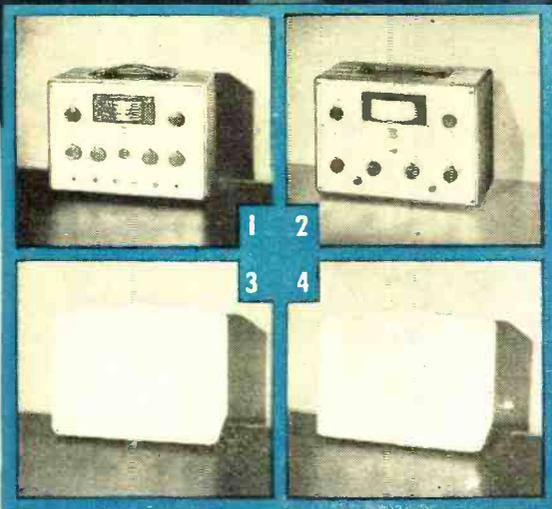

ON THE WAY—a superior line of test equipment that puts time-consuming service jobs on a profitable, production-line basis . . . that anticipates all FM and television needs. Matched styling of all instruments permits attractive, convenient grouping. Watch for announcements of the other units in this new line.



TEST AND MEASURING EQUIPMENT
RADIO CORPORATION of AMERICA
ENGINEERING PRODUCTS DEPARTMENT, CAMDEN, N. J.

In Canada: RCA VICTOR Company Limited, Montreal



**A DYNAMO
AMONG
DYNAMIC MICROPHONES**

Here is *the* microphone in its class—a high-output moving-coil dynamic that was designed to outperform... outsmart... outlast even higher priced microphones. The "Sonodyne" features a multi-impedance switch for low, medium, or high impedance—plus a high output of 52 db below 1 volt per dyne per sq. cm. It has a wide range frequency response (up to 10,000 c. p. s.) and semi-directional pickup. Mounted on swivel at rear, can be pointed 90° for non-directional pickup.

The "Sonodyne" is ideal for all general purpose use, including public address, communications, recording, and similar applications.

Shure Patents Pending



MODEL "51"

CODE: RUMON

LIST PRICE . . . \$37.50

SHURE BROTHERS, INC.

Microphones & Acoustic Devices

225 W. HURON ST., CHICAGO 10, ILL. • CABLE ADDRESS: SHUREMICRO



HIGH OUTPUT
(-52 db)



**WIDE RANGE
FREQUENCY
RESPONSE**
(up to 10,000 c. p. s.)

City; M. K. Franklin, Minneapolis; J. T. Hill, Los Angeles; Lloyd Marsh, Seattle; Robert Milsk, Detroit; C. L. Pugh, Columbus, Ohio; Salescrafters, Inc., Chicago; E. K. Seyd, Andover, Conn.; A. A. Sinai, San Francisco; M. K. Smith, Atlanta; and W. Oldenberger, Mexico City.

* * *

R. P. ALMY has resigned his post as Assistant General Sales Manager of *Sylvania Electric Products Inc.'s Radio Division* to become vice-president and assistant general manager of *Dixie Radio Supply Company* of Columbia, South Carolina.



The *Dixie Radio Supply Company*, of which Mr. Almy is part owner, distributes electronic parts and equipment in the Carolinas and maintains branches in Greenville, Greensboro, and Charlotte. Mr. Almy will have his headquarters at the main office in Columbia.

He was associated with *Sylvania* for twenty years and served in various positions in the sales department. Mr. Almy has served as chairman of the Radio Parts Manufacturers Sales Managers Club, a member of various RMA committees, a director of the Radio Trade Show Corporation and as one of the original members of the Radio Parts Industry Coordinating Committee. These activities, plus his travels throughout the United States, have made him well-known to servicemen, distributors, and the members of the parts industry.

* * *

LEE BUNTING has been named Vice-President of *Bell Television, Inc.* of New York. He was formerly sales manager for *British Industries* and *Maguire Industries* as well as serving as project and sales engineer for *Meissner Mfg. Company*.

Mr. Bunting will devote his efforts to the building of sales forces for the *Bell* organization which specializes in the rental and sale of commercial-type television receivers.

* * *

HENRY T. PAISTE has been named special television sales representative for the *Service Division* of *Philco Corporation*.



Mr. Paiste who was formerly general manager of the *Service Division*, has been associated with *Philco* for 19 years.

After a brief period in production work, he was transferred to the service division and became a service engineer. He was promoted in 1935 to the position of manager of the national service station, serving the company's distributors throughout the country.

Since April, 1947 he has concen-
(Continued on page 164)

OHMITE plate chokes

"FREQUENCY-RATED"

for easy selection and top performance

Now, for the first time, you can select a plate choke for a particular frequency and know that it will give excellent performance at this frequency. The Ohmite line of plate chokes are "frequency-rated"—their frequency characteristics have been accurately predetermined. The chart below gives the operating frequency range for each of the seven sizes.

Ohmite single-layer wound, r.f. plate chokes cover the entire frequency range of 3 to 520 megacycles. These chokes are wound on low power factor plastic or steatite cores, and are insulated and protected by a moistureproof coating. All chokes are rated 1000 ma except the Z-14 and Z-28, which are rated at 600 ma. Further information will be supplied upon request.

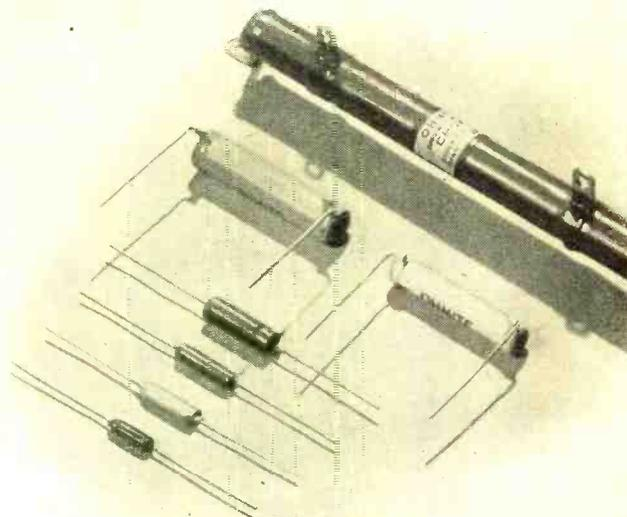

RECOMMENDED OPERATING FREQUENCY RANGES OF OHMITE R. F. PLATE CHOKES

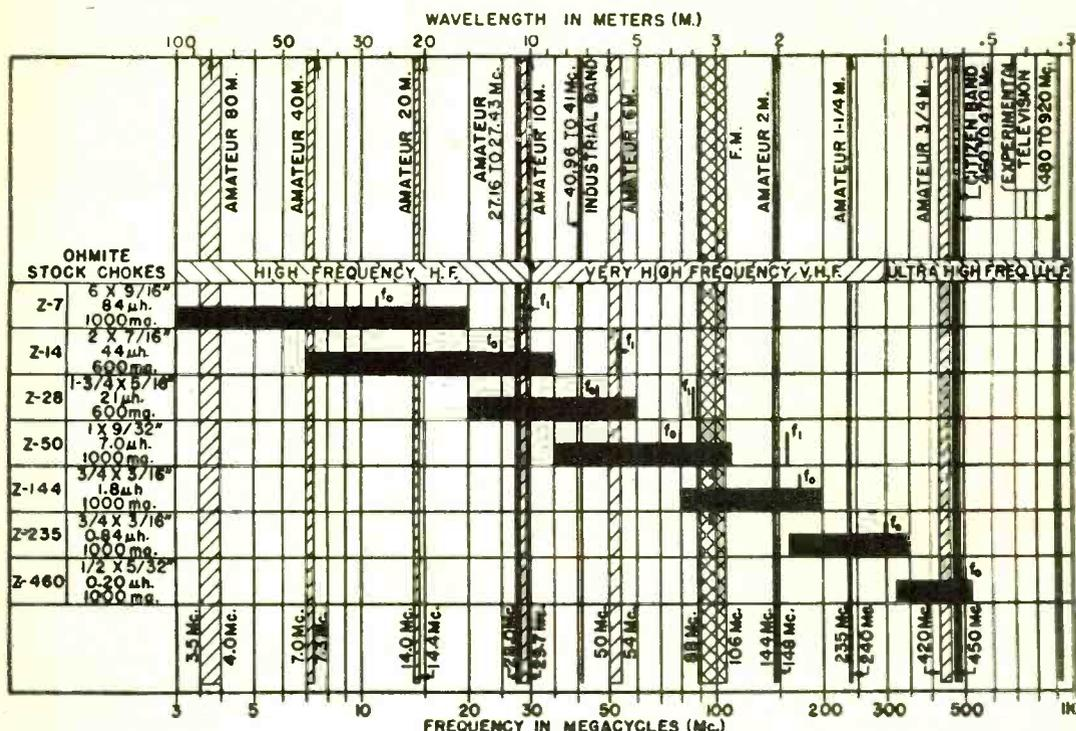

WRITE FOR
PLATE CHOKES
BULLETIN
No.
133.



**OHMITE
MANUFACTURING
COMPANY**
4883 Flournoy St.,
Chicago 44, Ill.



Be Right with...

OHMITE

RHEOSTATS • RESISTORS • TAP SWITCHES • CHOKES

I'LL HELP YOU TO EQUIPMENT EVER

ALFRED A. GHIRARDI, the man who has started thousands of students on successful careers by making Radio-Electronics easy to learn.



A FEW NIGHTS OF THIS CAN PAVE THE WAY TO A PROSPEROUS FUTURE OF THIS

Ghirardi's COMPLETE BASIC RADIO-ELECTRONIC TRAINING for beginners for only \$5 (\$5.50 foreign)

No matter what part of ELECTRONICS-RADIO-TELEVISION work you plan to enter, a knowledge of basic fundamentals is absolutely essential. Ghirardi's world-famous 972-page RADIO PHYSICS COURSE gives exactly the training you need—at a price you can afford to pay! If broken into "course" form and sent as monthly lessons, you'd regard it as a bargain at \$50 or more! Instead, you buy it for only \$5—and you progress as fast as spare reading time permits. Many have completed it in only a few weeks! Actually, this big, 4 lb. book has given more beginners their start in Radio Electronics than any other book or course!

ing of any kind. Ask any Radio-Electronic man. He'll know the book—because he probably trained from it himself! Get started now in Radio! Get started right! Our 5-DAY, MONEY-BACK GUARANTEE is your absolute protection. If you don't like RADIO PHYSICS COURSE you don't need to keep it. You cannot lose!

NO PREVIOUS TRAINING NEEDED 36 Big Courses in One

Here are a few of the things about which RADIO PHYSICS COURSE teaches you:

- | | | |
|---------------------------|----------------------------|--------------------------------|
| Sound, Speech, Music | Filters | Power Supplies |
| Electron Theory | Measuring Instruments | Loud Speakers |
| Electric Current | Radio Waves | Auto & Aircraft Radio |
| Electric Circuits | Vacuum Tubes | Aviation Radio |
| Resistance | Detector & Amplifier | Public Address Systems |
| Batteries | Tube Action | Phenoscopes, Cathode Ray Tubes |
| Electromagnetism | Radio-Frequency Amplifiers | Sound Pictures, etc., etc. |
| Electromagnetic Induction | Superheterodynes | |
| Condensers | Audio Amplifiers | |
| Alternating Currents | | |
| Transformers | | |

EASY TO UNDERSTAND

Ghirardi's RADIO PHYSICS COURSE starts you training at the very beginning—with Basic Electricity. Then it takes you step by step through the entire field of RADIO-ELECTRONICS. Nothing is omitted or condensed. Everything is explained as simply as A-B-C. You can understand every word of it without previous radio training.

RADIO PHYSICS COURSE is more widely used for home study and was more widely used for Signal Corps and Navy wartime training than any other book of its kind.

The big book that makes it easy to learn Radio at home!

SPEED UP



Repair Home and Auto Radios Faster With Ghirardi Gadgets

Ghirardi Gadgets troubleshoot radio sets with lightning speed. Just flip a card, and there before you are the "remedies" and "tests" to make for whatever "trouble" symptoms you find!

HOME RADIO GADGET—Spots 400 different troubles in Power Unit, Receiver Circuits Proper, Tubes, Loudspeaker, Antenna, Ground, Batteries, etc. Covers such symptoms as "Hum," "Weak," "Noisy," "Inoperative," "Intermittent Reception," "Fading," and many more. Tells what tests to make. Suggests the remedy for each trouble. Only 50c.

AUTO-RADIO GADGET—Spots 444 special auto-radio troubles in all possible trouble-sources for 11 common symptoms including "Hum," "Weak," "Noisy" with and without car and engine at rest, "Noisy" when car is coasting with ignition off, "No Reception," "Intermittent," "Fading," "Distortion," and "Oscillation". Only 50c.

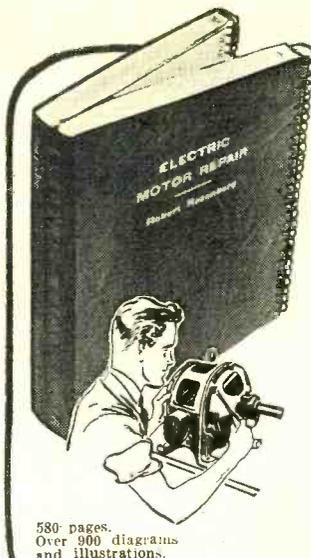

580 pages. Over 900 diagrams and illustrations.

Learn ELECTRIC MOTOR REPAIR!

Train for Big Pay in a Field That Isn't Crowded—Just the Thing for Radio Men

There's big money in motor repair work! Prices are good. The field is not crowded. The home appliance repair business is a vast one and motor service is a highly important part of it. **ELECTRIC MOTOR REPAIR** by Robert Rosenberg is the book that will train you easily and quickly—for only \$5 complete!

for actual bench use in busy shops. Every type of work is demonstrated **VISUALLY** by more than 900 easily-understood diagrams. Unique Duo-Spiral Binding arrangement divides book into two sections. **BOTH** text and related pictures can be seen **AT THE SAME TIME**. Lies open flat on the bench while you work. Contains 580 pages. Only \$5 complete.

NO OTHER HOME TRAINING BOOK LIKE IT!

ELECTRIC MOTOR REPAIR explains every detail of motor trouble diagnosing, repair and rewinding. Covers a-c and d-c motors, synchronous motors and generators and **BOTH** mechanical and electrical control systems. Quick reference guides show exactly how to handle specific jobs. Based on what can be learned from this big book alone, you can train yourself quickly for **PROFITABLE** motor repair service. Ideal for beginners. Unexcelled

TRY IT FOR 5 DAYS AT OUR RISK!

Send coupon now. Practice from **ELECTRIC MOTOR REPAIR** for 5 full days. Then, if not more than satisfied, return book to us and your money will be cheerfully refunded.

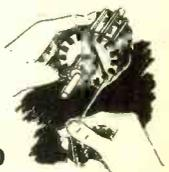

NEW • DIFFERENT • EASY TO UNDERSTAND

GHIRARDI TRAINING TO SAVE YOU LEARN EASIER, BETTER, FASTER...

REPAIR ANY RADIO-ELECTRONIC MADE . . . AND GUARANTEE TO REFUND EVERY CENT OF YOUR MONEY IN FIVE DAYS IF YOU'RE NOT SATISFIED!

THIS 4½ lb. HANDBOOK SHOWS EXACTLY HOW TO REPAIR OVER 4,800 RECEIVER MODELS

A Definite, Dependable Guide for Diagnosing, Locating and Repairing the Common Troubles in Almost Every Receiver Ever Made

Whether you repair radios for a living or work with them only occasionally, Ghirardi's RADIO TROUBLESHOOTER'S HANDBOOK will help you do the jobs better AND TWICE AS FAST. Eliminates useless testing! Saves time—helps you make more money!

TELLS YOU WHAT TO DO—EXACTLY HOW TO DO IT!

When a receiver comes in for repairs, simply turn to the 404-page Case History section. Look up the notes on that make and model. Chances are, you'll find EXACTLY the information you require. The Handbook tells what the trouble is—how to remedy it. Ideal for training and speeding up the work of new service helpers—handling tough jobs in half the usual time—repairing cheap sets rapidly.

NOT A "STUDY" BOOK

The tabulations on hundreds of additional pages give you invaluable data on Color Codes, Tubes, I-F alignment and transformer troubles, tube substitutions, etc., and the literally dozens of

charts, graphs, diagrams, data and helpful hints will save you money every day you use them!

"Thanks to Ghirardi's Handbook, I repaired my radio in one hour after it had been returned as 'unrepairable' from a local shop," writes J. L. Pizzell, Kansas City.

"WORTH 10 TIMES THE PRICE!"

"I would not take ten times the price my Handbook cost me," says C. E. Daniels of Florida.

"Started to work for me the first day I bought it. The Case Histories take you right to the trouble and save headaches and hours of testing," says Julius Siske, Jr., Curtis Bay, Maryland. Ghirardi's Big Handbook weighs 4½ lbs., contains 734 big manual-size pages. Only \$5 complete—on our 5-Day Money-Back Guarantee offer!

STOP GUESSING MISTER!
Don't guess! Don't waste time! Turn to Ghirardi's big Radio Troubleshooter's Handbook—let it tell you in a jiffy WHAT to do and HOW to do it.

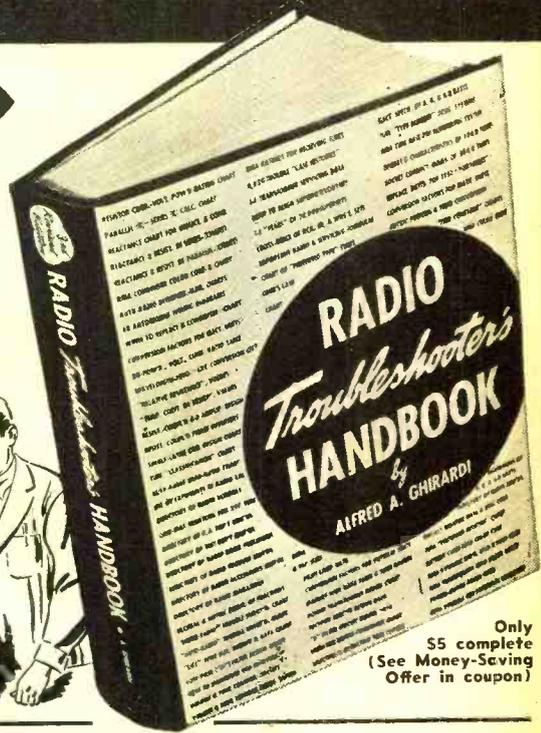

Only \$5 complete (See Money-Saving Offer in coupon)



GET A COMPLETE MODERN Professional SERVICE TRAINING . . . at Home, Without an Instructor

Now, as never before, the call is for PROFESSIONALLY TRAINED men who really KNOW Radio-Electronic repair work.



Only \$5 complete (See Money-Saving Offer in coupon)

A. A. Ghirardi's MODERN RADIO SERVICING is the finest, most complete instruction book on Radio-Electronic service work for either the novice or the professional serviceman—bar none! Actually, it gives a COMPLETE MODERN EDUCATION in truly professional service work of the kind that will be your "Open Sesame!" to the real opportunities in Radio-Electronic servicing springing up on every side.

ALL ABOUT TEST INSTRUMENTS . . . TROUBLESHOOTING . . . REPAIR

Remember! The call is now for HIGHLY TRAINED men having a broad knowledge of modern test equipment and testing techniques—NOT for "screw-driver" mechanics of limited

technical understanding! Read from the beginning, MODERN RADIO SERVICING is a complete servicing course from A to Z. Used for reference, it is an invaluable refresher course on any type of work that puzzles you. Explains test instruments used in Radio-Electronic service work—also how, when, why and where to use each one; how to make preliminary trouble checks and perform circuit analyses; how to repair or replace parts or make substitutions—and literally hundreds of additional subjects, including How to Start and Operate a Successful Service Business of Your Own. 1300 pages, 706 clear illustrations, 720 self-test review questions.

START A SERVICE BUSINESS . . . OR GET A BETTER-PAYING JOB!

There's a real future for you in servicing—and A. A. Ghirardi's MODERN RADIO SERVICING is just the book to start you on it without delay. And remember, Radio itself only represents the beginning of this big book's usefulness to you. What it teaches you about Radio Servicing, Test Instruments and Modern Scientific Technical Procedure is exactly the training you need to fit you to "grow up" with the fast-expanding Electronics profession in all of its servicing phases. The amount

of Radio and Electronic equipment that will be manufactured and sold both to industry and the public within the next few years will be tremendous. All of it must be serviced—and there'll be rich rewards for competently trained men who can fill the bill!

SEND COUPON—NOW!

MODERN RADIO SERVICING gives you real Professional service training—complete in every respect—easy to understand—and priced at only \$5 complete!

FIVE DAY UNRESTRICTED MONEY BACK GUARANTEE

DEPT. RN-28, MURRAY HILL BOOKS, INC. 232 Madison Ave., New York 16, N. Y.

- for books checked below; or send C.O.D. (in U.S.A. only) and I will pay postman this amount plus small postage charge when he delivers books to me. In either event, it is understood I may return books within 5 days if not satisfactory and you will refund my money.
- RADIO PHYSICS COURSE \$5 (\$5.50 foreign)
 - ELECTRIC MOTOR REPAIR \$5 (\$5.50 foreign)
 - GHIRARDI HOME RADIO GADGET, 50c
 - RADIO TROUBLESHOOTER'S HANDBOOK, \$5 (\$5.50 foreign)
 - MODERN RADIO SERVICING \$5 (\$5.50 foreign)
 - AUTO RADIO GADGET, 50c
 - MONEY-SAVING COMBINATION OFFER: Modern Radio Servicing and Radio Troubleshooter's Handbook—BOTH BIG BOOKS—only \$9.50 (\$10.50 foreign)

Name
Address
City & Zone State

TIME & MONEY

Mail coupon now!

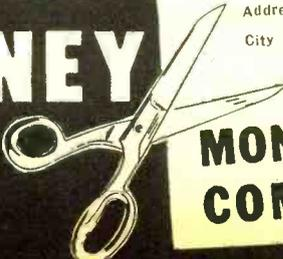

MONEY-SAVING COMBINATION

Make your service library complete! Get BOTH Ghirardi's RADIO TROUBLESHOOTER'S HANDBOOK and MODERN RADIO SERVICING at the special price of only \$9.50 for the two (\$10.50 foreign). Over 2030 pages of the finest service data money can buy! Use coupon today!

TELEVISION IS GROWING!

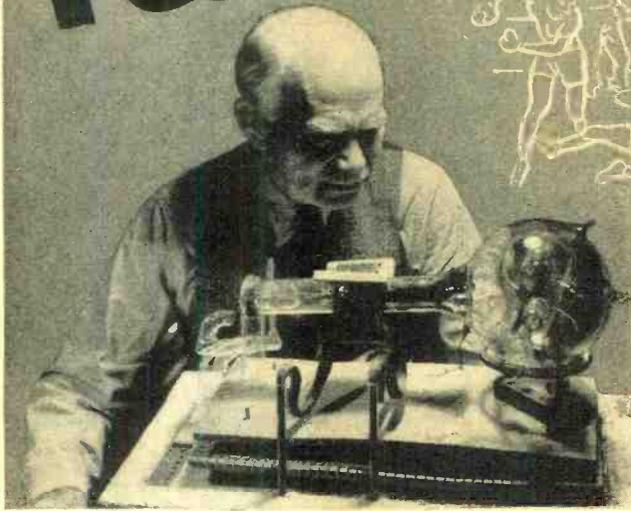

Dr. Lee de Forest

No longer is Television just a laboratory marvel. It is rapidly spreading over the nation. Practically every radio manufacturer has Television models in production. New stations are being licensed. Television is already *big business*.

Are You Ready?

Who will get those new high paying jobs? Who will step into key positions in a rapidly growing industry? Not inexperienced radio men. Not untrained electricians. But men who know Television and can be relied upon to operate and maintain expensive equipment!

American Television—A Great Training Institution!

American Television has pioneered in Television research. Its directors have made fundamental contributions to the industry. Dr. Lee de Forest, our Director of Research and Training, is known throughout the civilized world as the "Father of Radio" through his invention of the radio tube. U. A. Sanabria, President and founder of American Television, Inc. invented the Interlace Scanning System which is now the standard of all Television. Most recently, a revolutionary new circuit which corrects a common television defect known as "ghost images" has been developed by J. M. Sanabria, head of American Television's Manufacturing Division.

Most Elaborate Training Laboratories

Every modern type of equipment obtainable has been installed for instruction purposes in what we believe to be the most extensive and elaborate Television training facilities in the world. You will find complete operating studios with the new sensitive cameras and their associated equipment. A corps of highly qualified instructors will guide your study.



Start Learning TELEVISION at Home — FREE!

Prepare yourself for the endless opportunities in Television the new "American" way. Now, for the first time, you may discover in advance of entering school, just how your abilities fit into Television. If you qualify under the simple rules, you will be given a complete preliminary home study Television course absolutely free and without obligation.

Your success with the course will not only help you to decide for yourself what phase of Television you like best but will also aid us in qualifying you for residence training.

We prefer that all new resident students take this free course as it provides excellent preparation for residence study. However, there is no obligation on your part to enroll for residence training when you complete the home study course.

We urge you to take advantage of this splendid opportunity at once. Just write your name and address on a penny postcard and say: "I am interested in your free Television Course". Do it today! This offer is necessarily limited.

Approved for Veteran Training

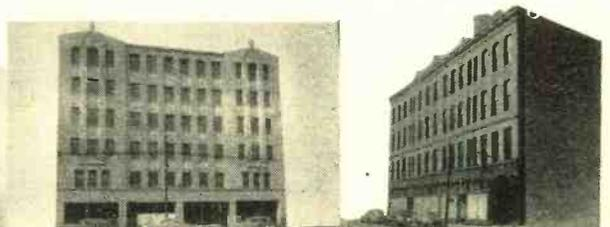

American Television, Inc.

5050 BROADWAY

CHICAGO 40, ILLINOIS

3

**DISTINGUISHED
TURNER
HAND MICROPHONES**

Designed for convenience
Engineered for **PERFORMANCE**

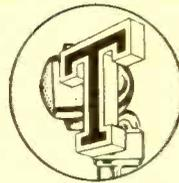

MODEL 15D, 15D-NC, or 15X—The 15D-NC, Noise Canceling Dynamic was developed for use in machine shops, factories, railroad yards, aircraft, and other installations where background noise interferes with communications. Transmits only when spoken to at close range from the front. Level: 52db below 1 volt/dyne/sq. cm. at high impedance. Response 50-5000 c.p.s. Also available as the 15D or 15X with high level wide range dynamic or crystal circuits engineered for general purpose use.

MODEL 9X or 9D—The Turner "HAN-D"—One of the handiest, all-around microphones made. Hang it, hold it, or mount on any standard microphone stand. Ideal for stage, paging, public address, amateur, police car, and traveling mike applications. 9X Crystal is equipped with high quality humidity protected crystal. Level: 52db below 1 volt/dyne/sq. cm. Response: \pm 5db from 60-7000 c.p.s. 9D Dynamic is recommended for more severe service conditions. Level: 52db below 1 volt/dyne/sq. cm. at high impedance. Response: \pm 8db from 60-7000 c.p.s. In 50, 200, 500 ohms, or high impedance.

MODEL 20X Crystal—A new, low cost unit designed to appeal to users of home recorders, economical public address, paging and call systems, and amateurs. Smooth response to voice and music. Has Metalseal crystal. Level: 54db below 1 volt/dyne/sq. cm. Response: \pm 5db from 50-7000 c.p.s.

Ask your dealer

Model 9

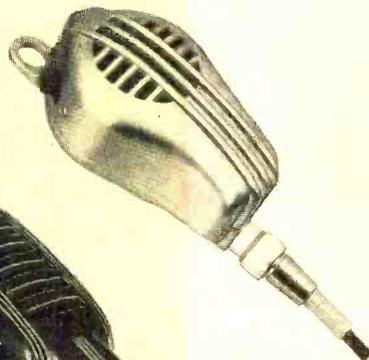

Model 20



Model 15



Licensed under U. S. patents of the American Telephone and Telegraph Company, and Western Electric Company, Incorporated. Crystals licensed under patents of the Brush Development Co.

Microphones by **TURNER**

THE TURNER COMPANY

900 17TH STREET N. E.

CEDAR RAPIDS, IOWA

NOW!

AT YOUR JOBBERS

The Radio Data Book

More Than 1000 Pages!

**HANDSOMELY BOUND
IN RED AND GOLD**

All data and basic knowledge
in radio and electronics
digested into 12 sections . . .
in a complete, quick to find,
easy to read, handbook form.

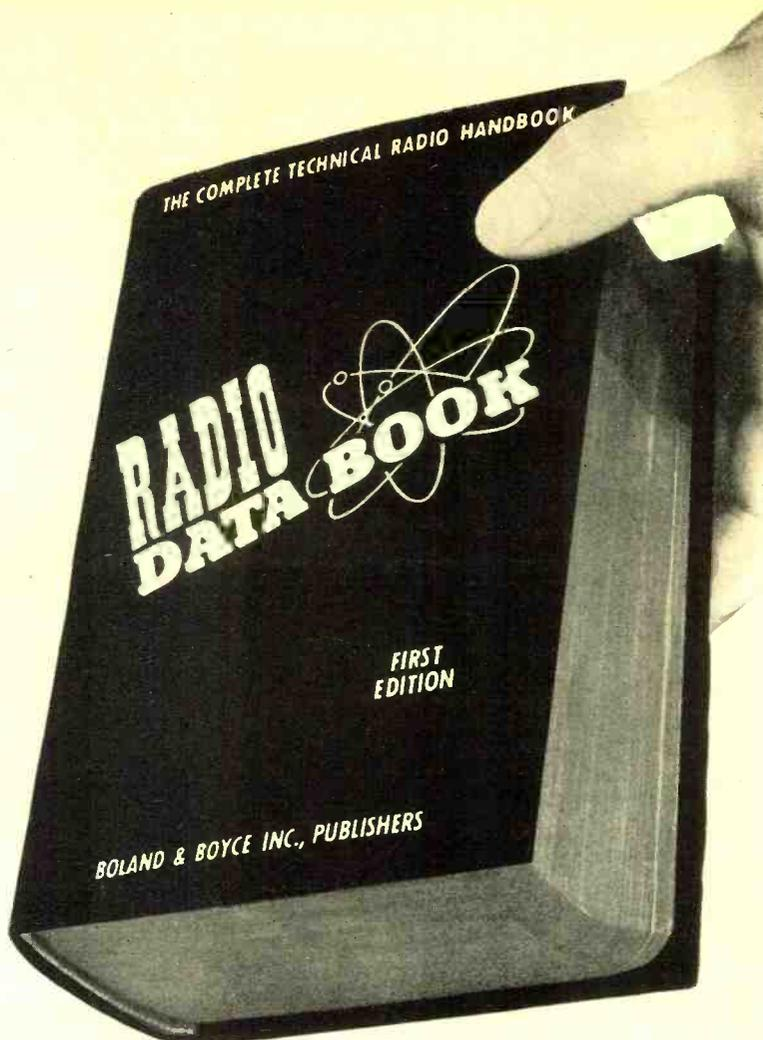

CONTENTS

Each section is a COMPLETE coverage of its subject . . . 12 sections . . . 12 books in ONE 1000 pages . . . Schematics . . . Accurate photographs . . . Specially prepared drawings . . . White on black charts . . . Diagrams . . . Isometric projections and exploded views.

Section 1. THE 150 BASIC CIRCUITS IN RADIO.

Every circuit is analyzed and explained in a Johnny-on-the-spot reference for any occasion.

Section 2. COMPLETE TEST EQUIPMENT DATA.

Know more about the test instruments you now have . . . Find the new ones you want to buy . . . They're All in here—impartially described!

Section 3. TESTING, MEASURING AND ALIGNMENT.

Simplified operation of the Oscillograph . . . See what's happening inside any radio circuit . . . Dynamic alignment—AM, FM and TELEVISION made easy with the Oscillograph . . . Scientific use of the Vacuum Tube Voltmeter, Signal Generating Equipment and other basic instruments.

Section 4. ALL ABOUT ANTENNAS.

AM-FM-Television . . . design, installation, characteristics, construction and feed.

Section 5. SOUND SYSTEMS.

Planning, installing and servicing a PA System. A complete chapter on every component . . . How to select and combine components . . . estimating costs . . . even acoustic requirements!

Section 6. ELECTRICAL AND PHYSICAL CHARACTERISTICS OF RADIO COMPONENTS.

Know the size, the power, the shape! A quick reference on the construction and design of any circuit or equipment.

Section 7. COMPLETE TUBE MANUAL: Receiving, transmitting and Commercial.

A Rick of the pages brings to you all the data and ratings of any tube made!

Section 8. CHARTS, GRAPHS AND CURVES.

Quick calculation devices . . . Plotting curves, nomographs, rules and tables for speedy solutions to radio problems.

Section 9. CODES, SYMBOLS AND STANDARDS.

Handy reference to all radio symbols and abbreviations; code symbols, phrases and characters . . . Where you want them . . . When you want them!

Section 10. 50 TESTED CIRCUITS DESIGNED FOR OPTIMUM PERFORMANCE.

Find any circuit you want with complete parts lists and specifications . . . One tube receivers to complete AM, FM and Television receiver circuits . . . Amplifiers . . . Transmitters . . . Test Equipment and Control Circuits . . . All with the latest engineering refinements.

Section 11. DICTIONARY OF RADIO AND ELECTRONIC TERMS.

Section 12. RADIO BOOK BIBLIOGRAPHY.

Plan every operation in radio and electronics with the *Radio Data Book*. This new radio bible will be your lifelong tool . . . you will use it every day, on the board, at the bench, in the field! Use it for construction, troubleshooting and testing. The RADIO DATA BOOK will be your invaluable aid in design, experiment and in layout. It will help make your production better, faster and easier. In any and every operation in radio and electronics, you will use the RADIO DATA BOOK!

The RADIO DATA BOOK is a work of complete authority, prepared by engineers with many years of practical experience. They have been assisted by the Boland & Boyce staff of editors skilled in preparing electronics manuals for the U. S. Signal Corps for many years. These men have worked for several years gathering material for this book . . . all the knowledge of radio principles and operation . . . all the statistics . . . all the newest developments in electronics . . . every possible angle and detail. Eighteen months were spent digesting this material into the most concise, the clearest, and the most readable form. The result is this invaluable manual . . . The RADIO DATA BOOK. Whether you use this book for general reference, for scientific instruction, or for education, one thing is certain—the practical help, the daily usefulness you will derive from it will prove to be worth many, many times its astonishingly low price!

Advance Sale . . . first printing. Only 10,000 available . . . To make sure to get your RADIO DATA BOOK, mail your order **NOW!**

12 complete books in one only **\$5.00!** Less than 42c per book!

Mail this Coupon to Your Jobber or Direct to:

BOLAND & BOYCE INC., Publishers
460 Bloomfield Ave., Montclair 3, N. J.

Please send me a copy of
THE RADIO DATA BOOK Enclosed is \$5.00.

NAME.....
ADDRESS.....
CITY.....ZONE.....
STATE.....

BOLAND & BOYCE INC., PUBLISHERS

**DON'T LET OTHERS PUT YOU
OUT OF THE PICTURE!**

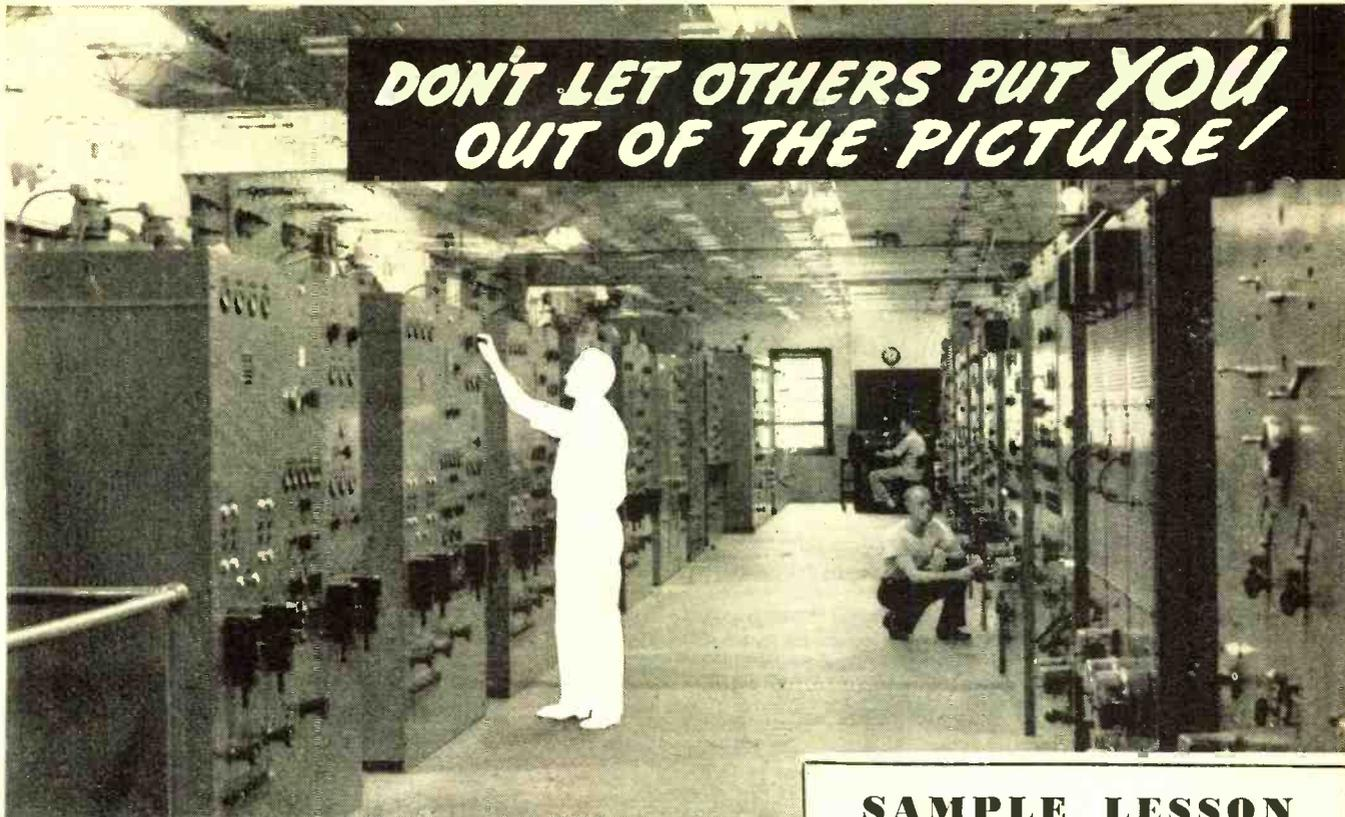

Here's How CREI Home Study Training Prepares You NOW for a BETTER Job and a SECURE Career in Radio-Electronics and Television

CREI Courses for Every Radioman Keep You Ahead of Competition—Earn You More! Never before have so many men like you had the opportunity to step ahead into better-paying jobs and enjoy lasting success. Men with up-to-date technical training are needed in every branch of radio-electronics. That's because radio's *manpower* has not kept pace with radio's *technical* developments.

What are you doing to meet this need for highly trained, expert technicians and engineers? You must improve your technical knowledge not only to qualify for the better job you want, but to *hold* the job you now occupy. CREI offers you a proved program of technical self improvement that you can study in your spare time, at home. The same type of practical, down-to-earth training for which thousands have enrolled since 1927.

Remember, too, there's a CREI course for *you*. No matter what your radio experience—CREI offers complete training in radio-electronics for *any* man who wants to improve his ability and his chances for advancement. You can "*go all the way with CREI*" from introductory basic principles to advanced training and on to specialized engineering subjects.

Read our 24-page booklet and a free sample CREI lesson . . . then judge for yourself. There is no obligation. You are already started in this field. Find out how you can rapidly prepare to advance beyond your present level. Send the coupon NOW!

VETERANS! CREI TRAINING AVAILABLE UNDER THE "G. I." BILL!

Capitol Radio Engineering Institute

An Accredited Technical Institute

DEPT. RN-2, 16TH AND PARK ROAD, N. W., WASHINGTON 10, D. C.

Branch Offices: New York (7): 170 Broadway • San Francisco (2): 760 Market St.

SAMPLE LESSON **FREE**

Now, see for yourself! Mail the coupon for free sample lesson and see how simple it is to study at home and improve your ability the CREI way.

"ELECTRON PHYSICS AND ELECTRON THEORY"—This interesting lesson from the Radio-Electronics course discusses modern theories of the composition of matter, including *atomic energy*, and their relation to present-day radio and electronics.

"PICK-UP TUBES—ICONOSCOPE AND IMAGE DISSECTOR TUBES"—An informative lesson from the Television course. These are the fundamental pick-up tubes of the television camera. It precedes the study of the Orthicon and the Image Orthicon.

MAIL COUPON FOR FREE BOOKLET & SAMPLE LESSON



CAPITOL RADIO ENGINEERING INSTITUTE

16th & Park Rd., N.W., Dept. RN-2 Washington 10, D. C.

Mail me ONE FREE sample lesson and your 24-page booklet, "CREI Training for Your Better Job in Radio Electronics". I am attaching a brief resume of my radio experience, education and present position.

Check One PRACTICAL RADIO-ELECTRONICS Course: PRACTICAL TELEVISION

NAME _____

STREET _____

CITY _____ ZONE _____ STATE _____

I am entitled to training under the "G. I." Bill.



Listen...
2 COMPLETELY NEW
Jensen Hypex*
PROJECTORS

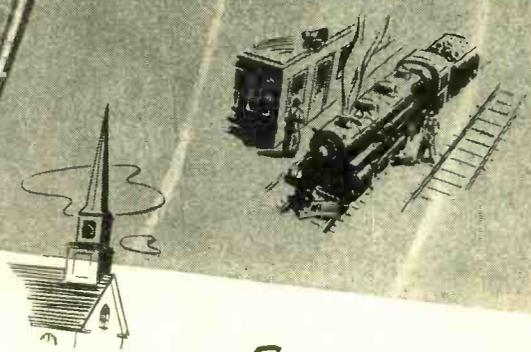
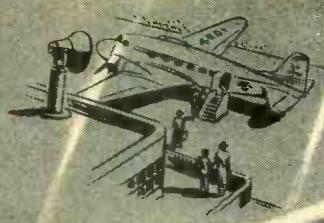

MODERN requirements for general purpose sound equipment have outmoded older designs. Replacing Models UH-20 and UH-24, these new JENSEN Hypex Projectors answer the demand for something new, better, more reliable, and at lower cost. Power handling capacity 25 watts maximum speech and music signal input. Voice coil impedance 16 ohms.

MODEL VH-20 (ST-684). For speech and music reproduction where principal requirement is for speech. Frequency range 140 to 6000 cps. Developed acoustic path length 52 inches. Coverage angle 80°. Mouth diameter 20¾ inches; length 20¼ inches. List price \$63.00.

MODEL VH-24 (ST-685). For speech and music reproduction. Superior to Model VH-20 for music because of larger size. Frequency range 110 to 6000 cps. Developed acoustic path length 58 inches. Coverage angle 75°. Mouth diameter 24¾ inches; length 22¾ inches. List price \$74.50.

JENSEN MANUFACTURING COMPANY
 6617 South Laramie Avenue, Chicago 38

In Canada: Copper Wire Products, Ltd., 11 King St., W., Toronto

*Trade Mark Registered

- Featured by*
1. Non-ferrous and stainless steel rustproof fittings.
 2. Rustproof, weatherproof terminal box.
 3. No exposed terminals. No soldering to connect.
 4. Completely new shielded and enclosed **ALNICO 5** driver unit.
 5. Entire structure an integral assembly. No taking units off and putting on. Will withstand plenty of abuse.
 6. Improved weatherproof finish on all metal parts.
 7. Non-metallic diaphragm of war-developed material.
 8. Attached adjustable bracket guaranteed to hold projector in position simply by tightening two nuts with small wrench.
 9. JENSEN patented Hypex formula for improved acoustical performance.
 10. Driver unit removable for replacement without special tools.

Jensen
 SPEAKERS WITH **ALNICO 5**



Designers and Manufacturers of Fine Acoustic Equipment

Build Your Own MAGNETIC TAPE RECORDER

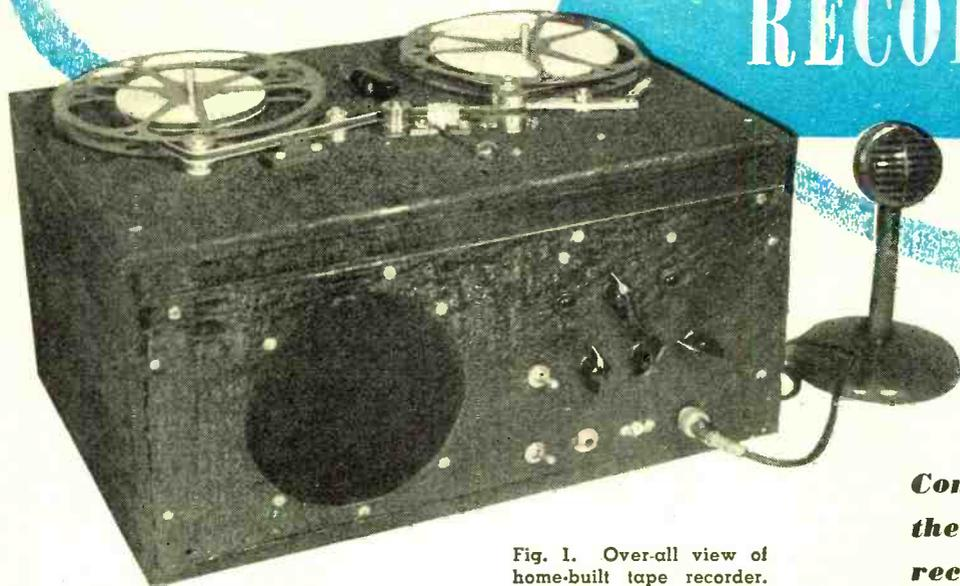

By
LLOYD B. HUST

Complete specifications for the construction of a tape recording and playback unit.

Fig. 1. Over-all view of home-built tape recorder.

MAGNETIC recording instruments are of two general types, the wire recorder and the magnetic tape recorder. The latter uses a paper tape which is coated with an extremely thin layer of magnetic material.

Of the two types, the tape recorder has several advantages, among which are, the ease of handling the tape, simplicity of splicing, the ease with which recordings can be edited, and the high fidelity capabilities of the tape.

The recorder to be described in this article utilizes 7 inch reels (regular 8 mm. 400 foot movie reels) which will hold approximately 1200 feet of tape, giving a recording time of 30 minutes at a tape speed of 8 inches per second. The audio system used has relatively high output so that an external speaker can be used in order to obtain the maximum fidelity of which the recorder is capable. A six-inch monitor speaker is included, however, in order to allow the recorder to be used as a self-contained unit.

The construction of this unit is well within the capabilities of anyone who has a working knowledge of electronic circuits and who has ordinary mechanical ability. Some of the parts must be turned on a metal-working lathe, but if the worker does not have access to such a lathe, he can have these parts custom-made at small cost.

Construction details can best be described by treating first, the mechanical components—motor, driving capstan, etc., then the electronic circuits, and, finally, the construction of the magnetic record-playback and erase heads.

The Tape Pulling Mechanism

The driving motor for the recorder is a *General Industries* RM 4 heavy-duty phonograph motor, which can be obtained at any radio supply house. The turntable of the assembly is discarded, but the motor and drive-wheel arrangement with its original mounting plate is used as is. This unit is mounted underneath the top panel by means of 8-32 bolts and $\frac{7}{8}$ " spacers cut from a length of $\frac{1}{4}$ " copper tubing. The position in which this assembly is mounted is shown in the photograph, Fig. 4.

The main drive of the recorder is

a metal capstan $\frac{3}{4}$ " in diameter. This capstan is merely a projection or hub on a flywheel which can be turned from a rough casting. The dimensions of the finished flywheel-capstan unit are given in Fig. 2, but in making a pattern for the casting, make the pattern large enough to allow for accurate machining. The casting may be made of brass or iron and will cost about \$1. If the experimenter has access to a good metal-turning lathe, he can machine this unit himself, but whether he does the work himself or hires a machinist to do it, he should be certain that the flywheel is turned

Fig. 2. Mechanical details of motor-flywheel assembly.

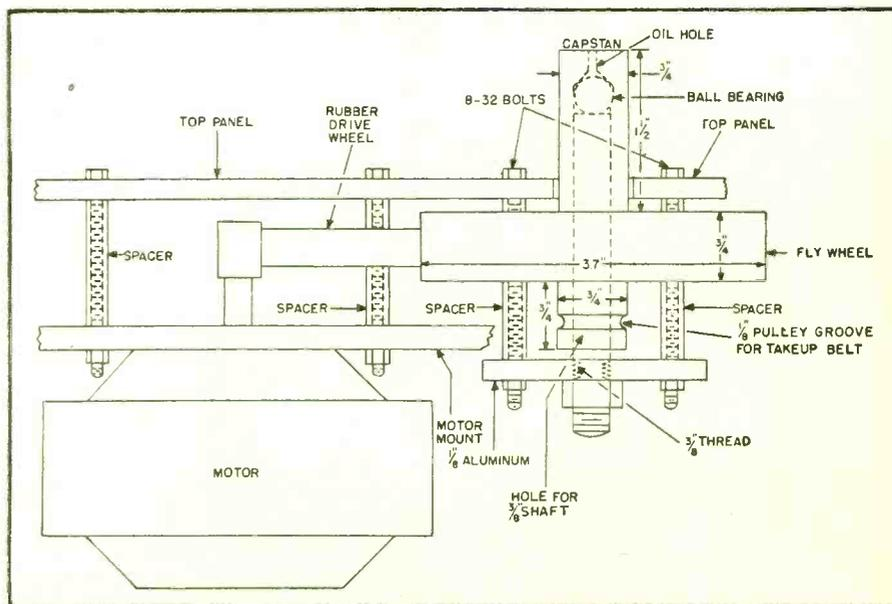

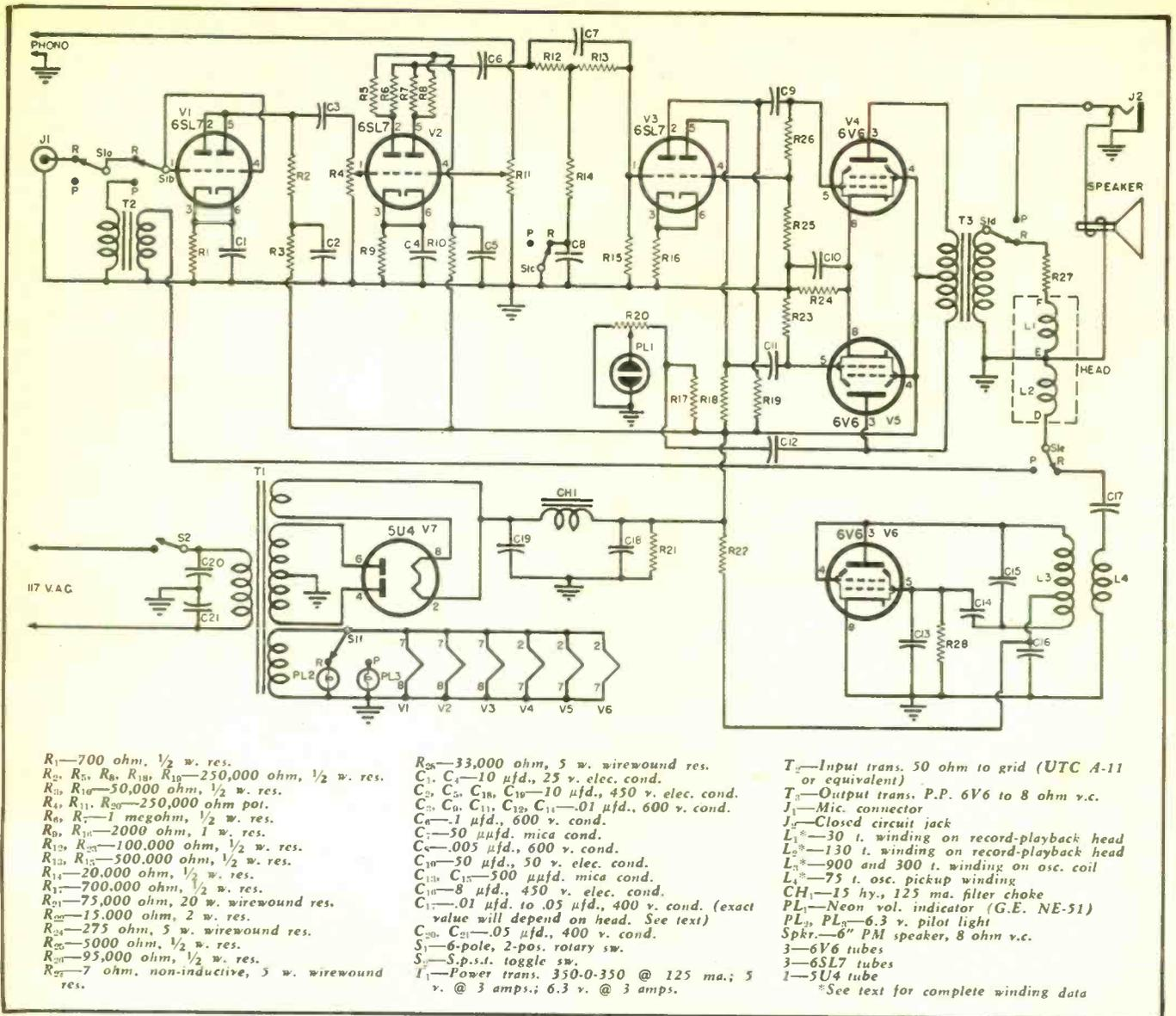

Fig. 3. Complete schematic diagram of record, playback, and erase circuits for tape recorder.

with the utmost accuracy and that the hub projection which is to be the capstan is absolutely concentric with it as well as with the shaft upon which it is to run. Failure to achieve accuracy here will result in objectionable "wow" in the recordings.

This flywheel unit runs upon a 3/8" shaft which enters from the bottom. A ball bearing at the top of the shaft, as indicated in the drawing, will insure free turning of this mechanism. The shaft hole is drilled and reamed to size and is about 2 1/2 inches in depth. A 1/8" hole is drilled from the top of the capstan to connect with the shaft bearing, allowing easy lubrication of the assembly.

The flywheel is mounted underneath the top panel as shown in Fig. 2, with the flywheel resting against the rubber drive wheel of the phonograph motor. The capstan projects through a 1 1/2" hole in the panel.

The lower hub of the flywheel is grooved to form a pulley to take a light spring belt similar to that used on the takeup pulley of motion pic-

ture projectors. (See Fig. 4.) This belt drives the takeup spindle. Such belts can be obtained from a supplier of home moving picture equipment. They cost only a few cents and can easily be cut to size.

The reel spindles should be turned on a lathe as indicated in Fig. 5. Their construction is similar to the spindles on any 8 mm. motion picture projector. The bearings for these spindles can be bearings taken from old radio volume controls. Similar bearings with 1/4" inside diameter can be purchased from any radio supply house. No specific length is indicated for the bearings, but they should be long enough so that the shafts within them do not bind when belt tension is placed upon them.

The tape guides are also shown in Fig. 5. The ones used in this unit were turned from brass, but a good plastic would serve just as well. The guides need not be made to turn as the tape passes over them, but can be fastened to the top panel with screws. Placement of these guides

is shown in the illustration Fig. 7.

The tape is held against the driving capstan by a brass pinch-wheel which is held against the capstan by a strong spring. Correct adjustment of this pinch-wheel will assure positive grip on the tape, which is essential to good recordings. The lever holding the pinch-wheel is a piece of 1/8" aluminum or brass into which is threaded a 1/4" rod which passes through a bearing in the panel.

Fig. 7 is a diagram showing the top view of the panel and the placement of the reels, guides, erase and record-playback heads, driving capstan and pinch-wheel. This diagram shows the direction of tape travel, and in this connection it should be noted that when recording, the tape passes over tape-guide "A," which brings it into contact with the erase head "B." In playing back a recording, however, the tape does not pass over guide "A," but goes directly from the reel to guide "C" so that it will not contact the erase head. Otherwise, the recording would be erased.

A two-inch pulley-drive wheel combination, constructed as shown in Fig. 6, is used as the drive for rewinding. The placement of this unit is shown in Fig. 4. The belt used is a spring belt, but it is somewhat heavier than the one used for the takeup pulley. The rewind drive is mounted in a bearing in the top panel as shown in Fig. 4. It is mounted in such a way that the wheel clears the rubber drive wheel on the motor when it is in normal position. The spring belt will hold it in this position. The wheel is free to turn on shaft "Y" (Fig. 6), and when shaft "X" is turned by means of a radio knob, which is mounted on it above the panel, the wheel is held against the rubber drive of the motor and the feed-spindle will be revolved rapidly, allowing rapid rewinding of the tape. It will be necessary to turn the reels over for rewinding, but this is very little trouble. A rewind operating without turning the reels over is possible, but it involves clutches, etc., and is too complicated for the average experimenter.

The Electronic Section

The electronic section of the recorder consists of a standard audio amplifier with a high-gain input for microphone and playback head, and a lower gain input for phonograph and radio. The arrangement of the chassis can be left to the discretion of the builder. It is necessary, however, to arrange the parts above the chassis in such a way as to allow clearance for the mechanical parts mounted above. The chassis used with this model is 10" by 14" by 1½". A 7 by 10 inch metal panel is fastened to the front; all input and output connections are brought through the chassis and panel at the bottom. The volume controls are mounted just above the chassis on the panel as is the 6-pole, 2-position switch. The arrangement of the front panel can be seen in the picture of the completed unit.

The amplifier tubes are mounted on one side of the chassis (Fig. 9), the rectifier tube, filter condensers and choke at the back and the oscillator coil and tube at the front on the extreme right (Fig. 9). This allows sufficient clearance for the motor and other mechanical parts. The power transformer is mounted at the rear on the extreme right to allow maximum isolation between it and the input transformer, which is mounted at the front on the left-hand side.

The schematic diagram (Fig. 3) of this unit shows it to be a standard amplifier except for the equalizing circuit, which follows the second tube, and the oscillator circuit, which provides the high frequency bias voltage necessary for successful magnetic recording. The equalizing circuit compensates for irregularities in the magnetization curve of the tape, and is so arranged as to give substantially a flat curve from about 100 to 5000 cycles. This curve will vary some-

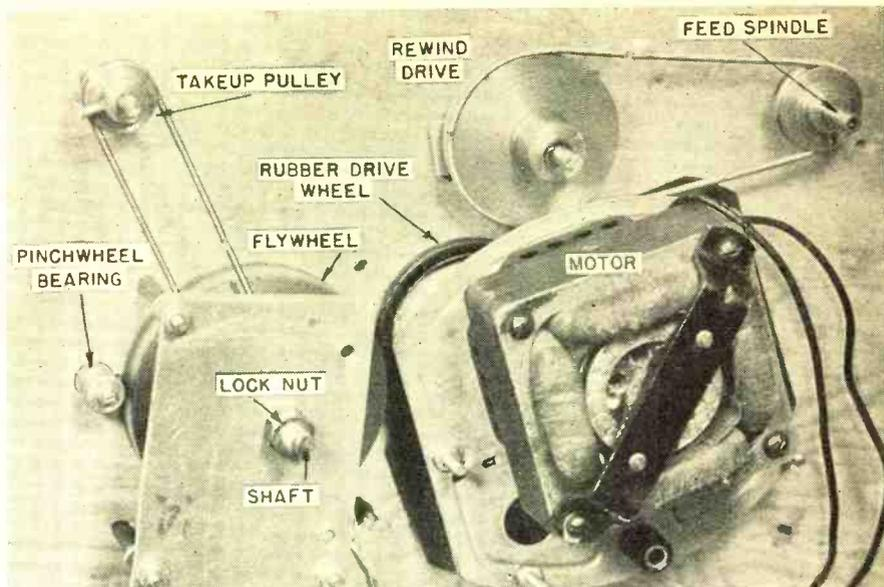

Fig. 4. Underside view of top panel, shows details of mechanical assembly.

what with various heads used, however.

No discussion of the equalizing circuit is necessary as the schematic is self-explanatory. It may, however, be necessary to make some details of the oscillator circuit clear. The oscillator coil is wound with No. 28 enameled wire, scramble wound on a form ⅝" in diameter by 1½" long. Although scramble wound, the windings should be placed in such a way as to make the finished coil as nearly cylindrical as possible.

The oscillator coil proper is wound

with 1200 turns of wire with a tap at the 900th turn. The connections are indicated in the schematic and in the parts list. The oscillator pickup coil is wound directly over the oscillator coil and consists of 75 turns of No. 22 enameled wire. The entire coil is dipped in hot wax to eliminate any moisture.

The pickup coil is connected to the bias winding of the record-playback head through a condenser of .01 to .05 μfd. The exact value of this condenser varies with individual head construction, but it can be found by

Fig. 5. Details of major components. (A) supply and takeup spindles; (B) tape guides; (C) pinch wheel; (D) erase head. See Fig. 8 for details of record head.

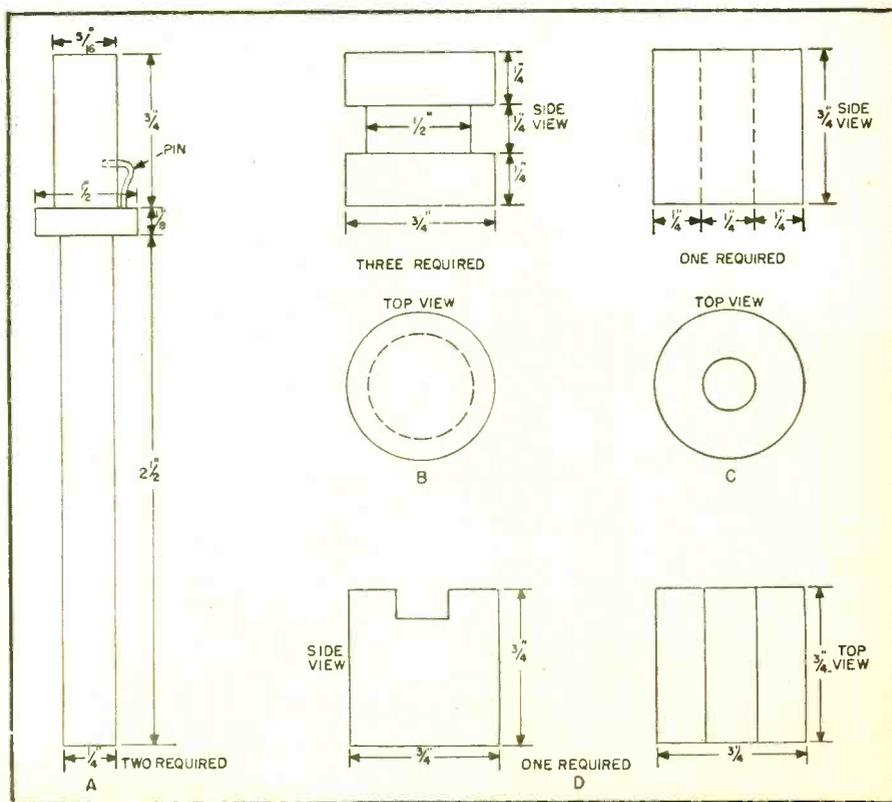

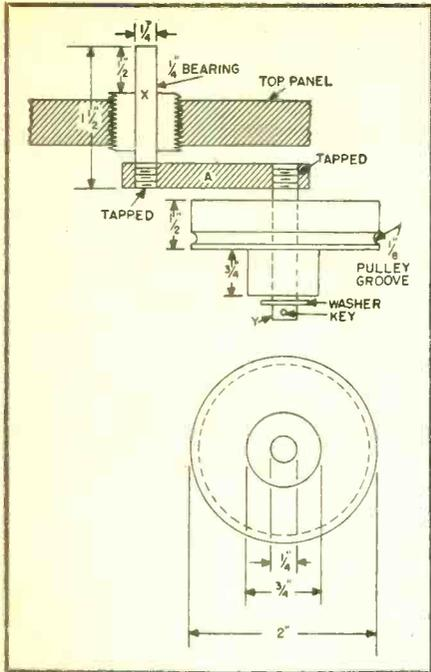

Fig. 6. Mechanical details show construction of rewind assembly. A pointer type knob fits over shaft "X" shown in diagram.

connecting a radio pilot light in series with this coil, the condenser, and the head. Various condensers should be tried. The one which resonates with the head will show the brightest glow of the lamp. The condenser used in the recorder shown is .035 μ f.

A 6-pole, 2-position switch makes all switching operations from record to playback simultaneously. This includes the switching of a.c. from one pilot light to another, indicating record or playback position. Since input and output circuits are brought close together in this switch, it is necessary to shield *all* leads to the

switch. If this is not done, hum and undesirable feedback will result.

The input transformer is used in playback position only. It is necessary because the impedance of the playback head is very low. It is very important that this transformer be well shielded and placed so as to pick up a minimum of hum. A standard input transformer with *Permalloy* shielding is best.

The volume indicator is a small neon bulb which is mounted through the top panel. It is connected as shown in the schematic, and the control R_{20} is adjusted to allow the lamp to fire at the peak of the signal when proper recording volume has been judged by trial.

Record-Playback and Erase Heads

The record-playback head is essentially an electromagnet with an entirely closed magnetic circuit except for a small gap at which point recording takes place. The core for this head must be made from thin laminations of high permeability material such as *Permalloy*. Silicon steel which is used in most transformers is definitely *not* suitable.

If the laminations were cut from sheet stock they would have to be hydrogen annealed before they would be suitable for use in a recording head. This process is far beyond the scope of anyone who does not have the specialized expensive equipment necessary for such annealing. For this reason it is necessary to secure laminations which have already been annealed, and which will require a minimum of cutting so that the molecular arrangement of the material will not be disturbed.

Such laminations are employed in the small transformers used in many

microphones, and they are used in the midget transformers often called "Ouncers." Suitable transformers are available from the *Leotone Radio Co.* The cost is 49 cents.

The laminations in these transformers are of two sizes, the small ones being the more suitable. Figs. 8A, 8B, and 8C show the steps necessary in the preparation of the individual laminations. "A" shows the lamination as it is taken from the transformer, the dotted line indicating where it should be cut. "B" shows one-half the original lamination after the cut has been made, with a dotted line indicating the second cut. "C" shows the finished lamination.

Enough of these laminations are cut to make two stacks 1/4" high. These are stacked together carefully, the back edges cleaned, after which they are carefully clamped together in a small vise and the edges tacked with solder. The solder should be placed on the back edges only. Each half of the core is then smoothed up and any irregularities removed with a small file of the type used for smoothing ignition points. It is important that the two lower ends be exactly square and smooth so that a tight fitting butt joint will be made when the two halves of the core are placed together. Care must be taken to keep from removing too much metal from the pointed parts of the laminations where the gap will be.

After each half-core is smoothed up, the coils are wound as indicated in Fig. 8. Scotch tape is used for insulation between the windings and the core. "D" represents the beginning of the winding, "E" the tap, and "F" the end of the winding. In connecting the head to the amplifier, note that in recording, the 130 turn winding is connected to the oscillator and the 30 turn winding to the output transformer through a 7 ohm non-inductive resistor. The tap "E" is grounded. In playing back, the 130 turn winding is used, while the 30 turn winding is switched out of the circuit.

After winding, the two halves of the head are butted tightly together with a .001" brass shim at the gap. The edges are fastened with solder and the faces of the head are very carefully finished with a point file so that the magnetic tape can make positive contact with the face of the head at the gap. This is most important, and the success or failure of this head will depend to a large extent upon how well these faces are finished. The construction of the entire head is a very delicate process, and the utmost care is necessary if a high fidelity head is to be the result.

The head is mounted in a small sheet-steel case which serves to shield it to some extent from the a.c. fields of the driving motor and power transformer. The exact placement of the head should be determined by experiment if the least amount of hum is to be picked up. Fig. 7 indicates ap-

(Continued on page 166)

Fig. 7. Top panel view shows direction of tape travel during record operation. Parts shown are: (A, C, and D) guides; (B) erase head; (E) record head; (G) pinch wheel; and (H) capstan.

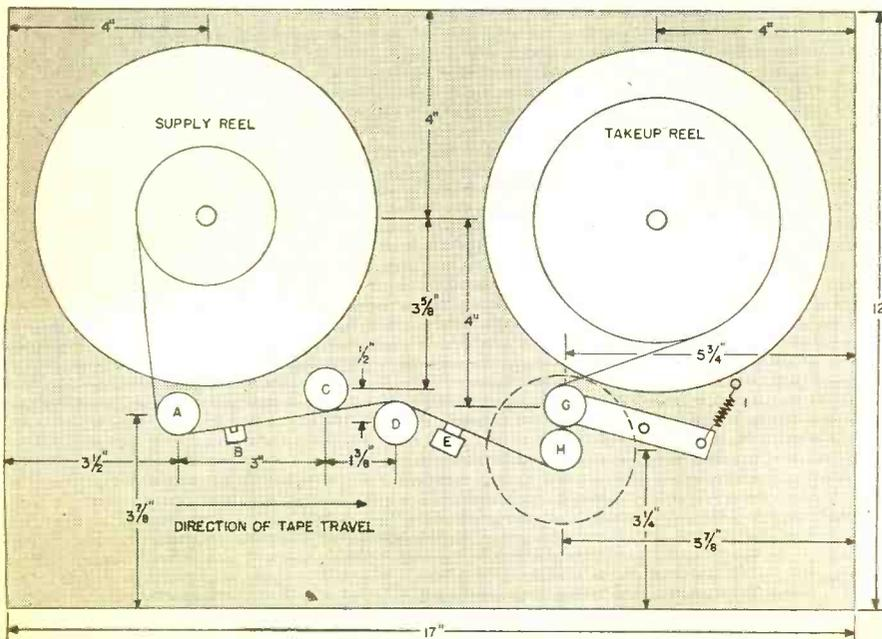

Understanding the WIRE RECORDER

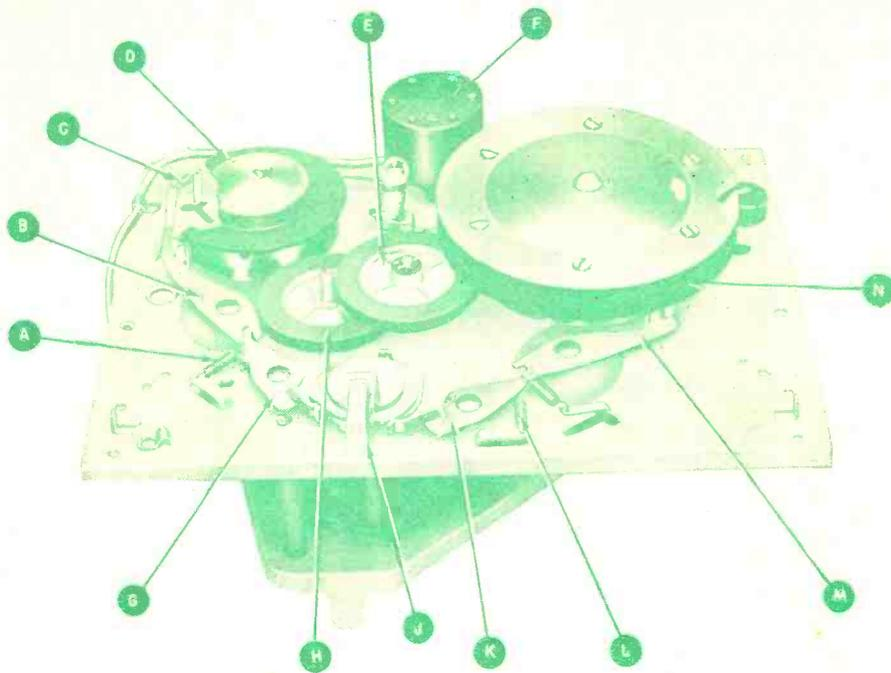

Fig. 1. Webster Model 80 wire recorder mechanism. Keyed parts are as follows: (A) "Heavy" brake spring on supply spool; (B) Brake lever; (C) "Light" brake spring on supply spool; (D) Supply spool; (E) Idler wheel; (F) Head; (G) Brake actuating lever; (H) Motor shaft and drive wheel; (I) "Operate" switch and lever; (J) "Heavy" brake spring on takeup spool; (K) Brake actuating lever; (L) "Heavy" brake spring on takeup spool; (M) Brake lever; and (N) Takeup spool.

In general, the basic principles of all wire recorders are identical. While there are many possible variations, essentially a system consists of a supply spool for the wire, a recording-bias-playback head, a take-up spool, and a mechanical means for transporting the wire from one spool to the other, the direction of wire travel depending on whether recording, playback, or rewind is desired.

Many different mechanical arrangements are used to accomplish these functions. These arrangements vary widely with different manufacturers' ideas. Some use elaborate systems employing dual motors, independent heads for recording and playback, automatic shutoffs in the event of wire breakage, electrically operated brakes, etc.

The tentative standards for wire travel have been set at two feet per second for recording. Some units use a capstan drive to insure that the wire travel is exactly this speed irrespective of the amount of wire remaining on the spools. However, it is general practice to transport the wire by driving the takeup drum at a constant speed. Due to the small variation in speed of wire travel by this method, this type of drive has been adopted by the majority of the manufacturers of popular priced units.

A typical unit of this type is the Webster Model 80 wire recorder. This unit uses a single motor for both re-

recording-playback and rewind. The motor is mounted by means of pivots, permitting it to engage either the

An explanation of details and functions of the various parts of a typical recorder.

By

RAY FRANK

Assoc. Editor, RADIO NEWS

takeup or rewind drum, simply by shifting a lever. As a result of the proper choice of idler diameters, the rewind speed is approximately seven times that of the recording speed, permitting rapid rewinding.

A combination head is used for recording, bias, and playback. Details of this head are shown in the exploded view in Fig. 2. The head is equipped with a plug-in arrangement, which permits the rapid replacement of heads for servicing. The head travels up and down during the operation of the machine, to level wind the wire on the spools.

A view of the recorder mechanism with the cover plate removed is shown in Fig. 1. With the "operate" switch *J* in neutral position, the motor, with its drive wheel, is disengaged from both
(Continued on page 152)

Fig. 2. Exploded view of combination head. Parts shown include: (A) Winding bobbins; (B) Wound bobbins; (C) Laminations; (D) Completed head assembly; (E) Contact pins and ground strap; (F) Lower half of case; (G) Lower half of case with pins; (H) Upper portion of head and shield plate; (I) Head assembly ready to install; (K) Head assembly installed in lower half of case; and (L) The completely assembled head.

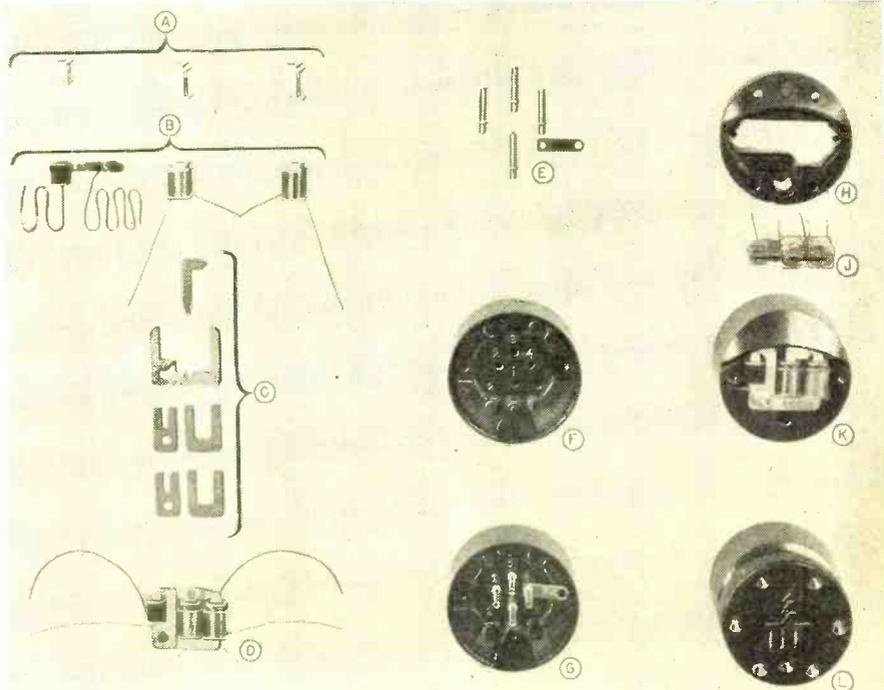

BASIC AMPLIFIER for a Wire Recorder

By
L. S. HICKS
Webster-Chicago Corp.

SINCE the advent of basic wire recorder mechanisms there have been many amplifiers built to enable such units to be used for recording and playback. Some have given excellent results, while others have been an endless source of trouble, due to the failure of constructors to observe certain necessary precautions.

To alleviate this trouble, the engineers of Webster decided to design a "foolproof" amplifier for use with their Model 79 basic unit. The amplifier to be described is the result.

The unit uses nothing but standard parts, and due to the type of circuit employed, no difficulty will be experienced with oscillation. Previous designs using a common switch for the grid and plate circuits frequently gave trouble unless the builder resorted to extensive shielding between switch sections.

The circuit is unusual in that a 6SN7 is used in cascade for the second stage. This tube is employed as an inverter which allows the recording signal to be taken off out-of-phase with the 6SJ7 grid thus eliminating any tendency toward oscillation when an unshielded common switch is used to control both grid and plate circuits.

An examination of the diagram re-

veals what appear to be two gain controls. Actually, the control R_2 in the grid circuit of the second half of the 6SN7 is a screwdriver adjusted potentiometer. Once set for the proper level, it requires no further adjustment. The proper technique for adjusting this control will be described later in the article.

To insure recording at the proper level, a meter is provided to monitor the signal fed to the recording head. By using this type of monitor indicator, the possibility of overmagnetizing the wire is reduced. While this over-

magnetizing is not serious it does introduce distortion, and if carried to the extreme, it will be impossible to erase recordings by normal means. However, the wire is not necessarily ruined, as a small piece of permanent magnet is available which will restore overmagnetized wire to its original condition.

The entire amplifier is constructed on a chassis measuring 5" x 10" x 3" equipped with a ventilated cover and handle. Plugs and cables are provided for connecting the unit to the microphone, radio, and basic recorder unit, as well as to the a.c. line. The level indicating meter is mounted in the cover of the amplifier, and is furnished with a plug and cable arrangement for connection to the amplifier.

The mechanical layout of the amplifier is clearly visible from the photographs and this layout should be closely followed if optimum, hum free performance is to be obtained. Power supply components, consisting of the power transformer, filter condensers, and rectifier tube, are mounted on the left hand side of the chassis to remove them as far as possible from the high gain input circuits, in order to avoid hum difficulties.

The 6V6GT bias oscillator tube is mounted next to the 6X5GT rectifier tube along the rear edge of the chassis.



Amplifier unit with cover removed.

Although designed for use with a specific wire recorder, this amplifier is basically the same as those used with all types of wire and tape machines.

Webster-Chicago Model 79 wire recorder with amplifier. Basic recorder unit as shown is available at most retail radio parts outlets.

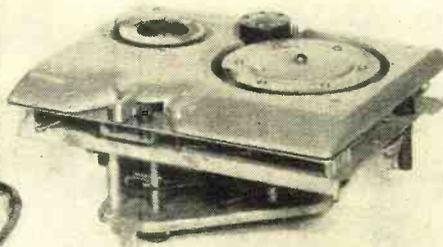
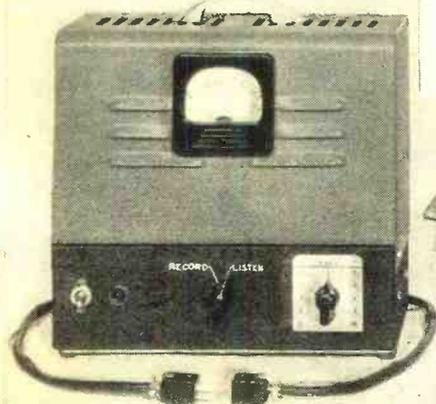

The 6SN7 is located at the right rear corner, with the 6SJ7 mounted just above the gain control. The Jones plug next to the filter condensers is used for connections to the level meter and to permit the cover of the amplifier to be removed for servicing without unsoldering leads.

The controls along the front from left to right are: "on-off" switch, pilot, record-listen switch, and gain. A bottom plate equipped with four rubber mounting feet is used for the protection of components and additional shielding.

The under view of the chassis shows the location of the various components. The filter choke is mounted on the left hand flange of the chassis, directly under the power transformer. For protection of the power transformer and other components in the event of a parts failure, an extractor type fuse post is mounted on the rear flange of the chassis. The line cord is brought through a rubber grommet between this fuse and the left edge of the chassis.

The bias oscillator coil is mounted

in the approximate center of the chassis, close to the 6V6GT oscillator tube. The transformer T_2 is located between this coil and the filter choke.

The preset level control R_6 is fastened to the chassis by means of a small bracket, at a point close to the 6SN7 tube. Placement of most of the other parts may be readily seen by an examination of the photographs.

Wiring is simple and straightforward and should present no difficulty. It is advisable to put in the heater leads first, making certain that all grounded heater leads make good contact with the chassis. Shielded wire should be used for all leads from the input up to and including the grid of the second section of the 6SN7, to avoid the possibility of hum pickup and oscillation.

For best results it is imperative that the ground terminal from the oscillator coil be carried direct to the flexible lead connecting the recording head. As the oscillator generates five watts of r.f. it is necessary that the circulating currents be confined to their respective circuits, and this re-

quires direct-leads rather than depending on the chassis for the return for this circuit. This precaution will preclude the possibility of the r.f. getting into unwanted circuits.

The primary of the output transformer is used in the plate circuit of the 6V6GT to add to the plate load of the tube and permit it to operate as a true beam power tube. With only the plate load of the oscillator coil, the inductance in the plate circuit of the tube would be inadequate to give sufficient output for the bias and erase coils in the recording head.

Only the primary of the transformer is used, and the secondary leads may be cut off or taped and tucked out of the way. Possibly, an audio choke could be used in this position, but unless several chokes of various ratings are available for comparison with the output transformer, it is suggested that the transformer specified be used.

When construction and wiring have been completed, the amplifier should be checked for proper voltages, as indicated on the diagram. A high resist-

(Continued on page 168)

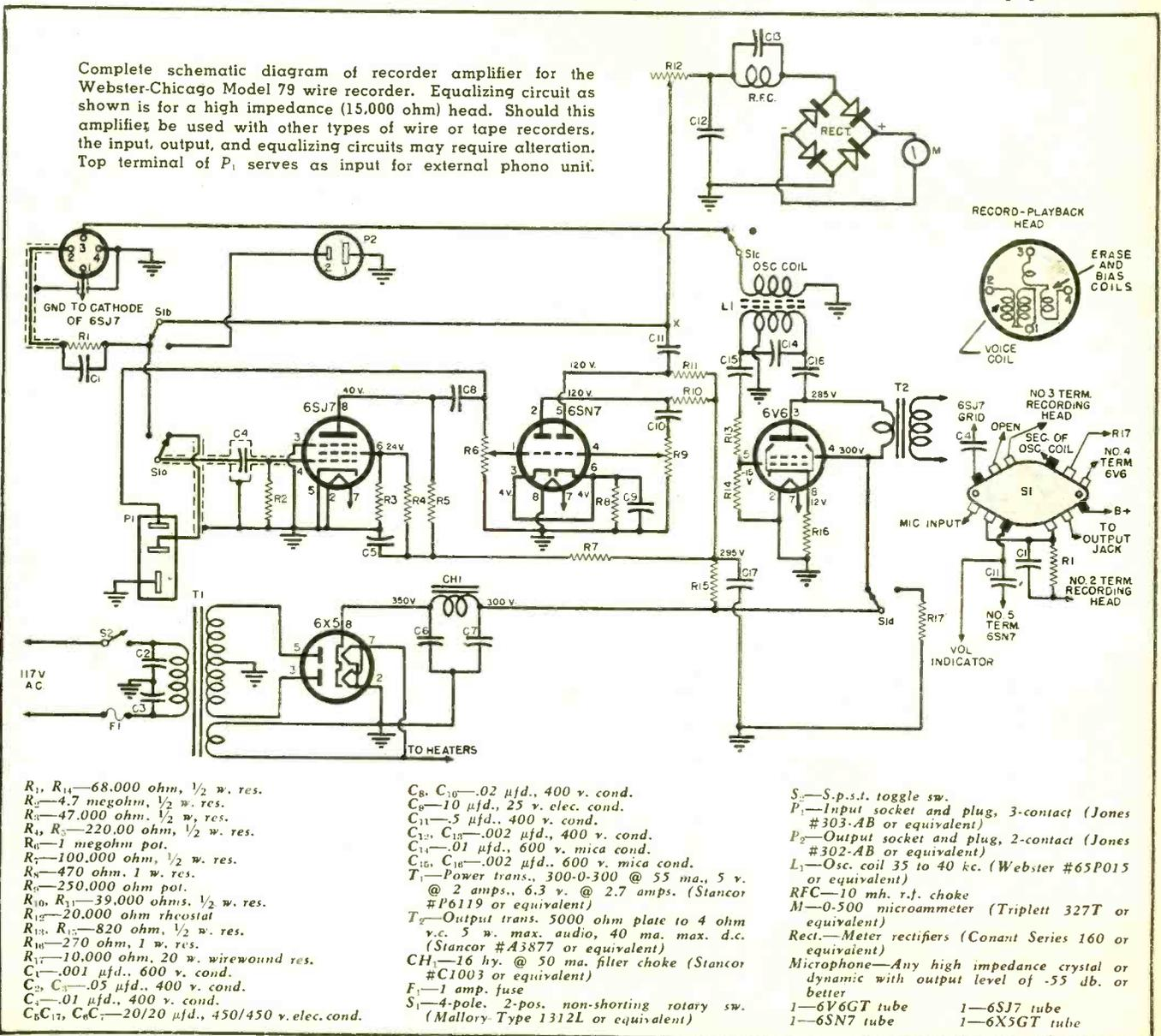

MAGNETIC TAPE SYSTEMS

By

CLARK E. JACKSON

The Brush "Soundmirror"— a tape recorder suitable for either studio or home recording.



Over-all view of the Brush "Soundmirror" BK-401 magnetic tape recording unit.

jack disconnects the radio input circuit when the microphone plug is inserted. When recording, this stage amplifies the signal from microphone or radio inputs and, when playing back, it amplifies the signal from the play head.

Where local transmitters cause interference it is possible that the high gain of the 6SJ7 stage may cause rectification of signals from nearby transmitters. If this condition should exist it may be corrected by connecting a 500 μfd . mica condenser between the grid and the cathode terminals on the 6SJ7. This connection must be made directly at the tube socket terminals. Also, another 500 μfd . mica condenser should be inserted between the cathode terminal of the tube and the chassis ground, right at the closest possible position to the tube socket terminal.

The following tube is a type 6SN7. This is the play amplifier stage. Half of the tube is used in the second stage of the amplifier and feeds the phase inverter. When recording, this stage serves as a monitor amplifier. When playing back, it amplifies the signal from the recording medium. This stage includes the play volume control and the frequency compensating circuits for playback. The remaining triode of the 6SN7 tube is the second stage amplifier which feeds Section E. This stage includes the record volume control as well as the frequency compensating circuits for use in the recording action.

The second record amplifier, Section E, is the final audio stage used during recording and employs a 6SJ7 tube. During recording it supplies the audio signal to the record-reproduce head through the audio coupling condenser. The 30 kc. bias current is introduced in this stage. It is fed to the plate circuit of the 6SJ7 through a coupling condenser and results in a current through the recording head coil which is a mixture (not a modulation) of the

(Continued on page 140)

RECORDING and playback machines designed for magnetic tape fall into two classes, one for home use—the other for broadcasters, etc. In its simplest form the magnetic tape machine is ideally suited for home use. Such a machine is the Brush "Soundmirror" BK-401, which we will use as an illustration.

Reference to the schematic diagram (Fig. 2), which has been subdivided into various blocks and the block diagram (Fig. 1) will permit the reader to understand the functions of the tape recorder. The input amplifier, Section A, utilizes a 6SJ7 tube as a high gain amplifier stage having a grid-to-plate gain in excess of 100. The microphone

Fig. 1. Block diagram shows functional operation of tape recorder.

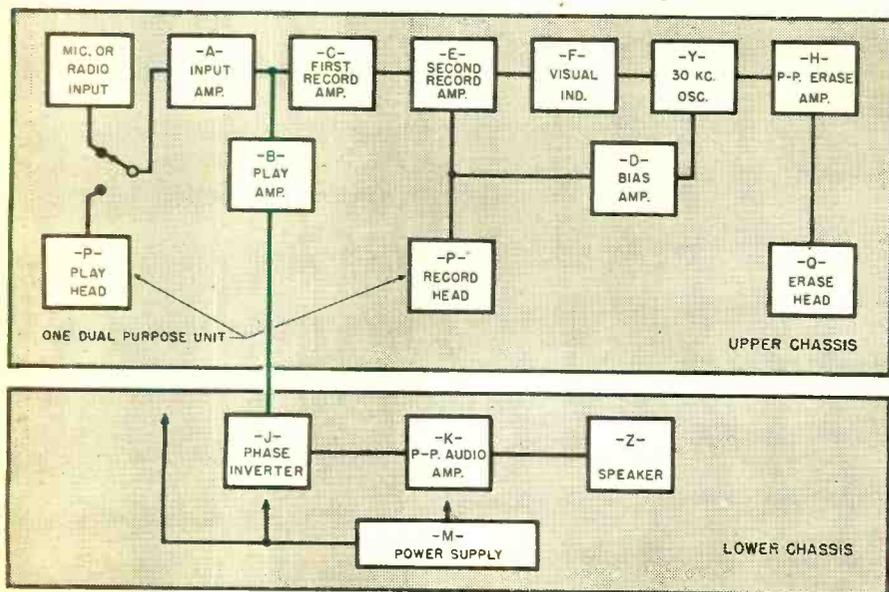

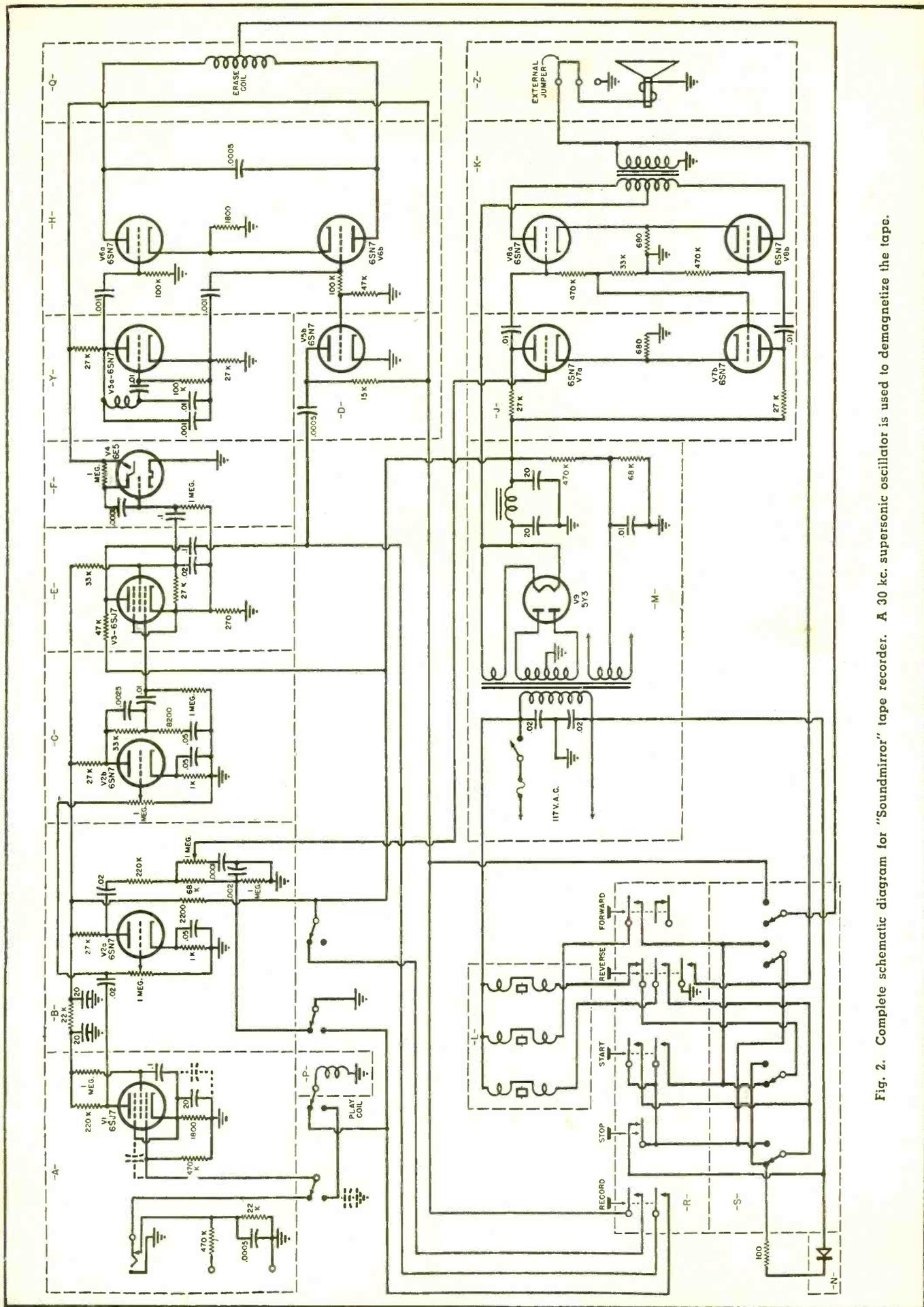

Fig. 2. Complete schematic diagram for "Soundmirror" tape recorder. A 30 kc. supersonic oscillator is used to demagnetize the tape.

The FreModyne FM Detector

New Hazeltine development permits low-cost, new band, FM receiver of relatively good performance.

THE Hazeltine "FreModyne" circuit combines superheterodyne and superregenerative principles to form a sensitive, simple, and practical FM detector. It is the result of extended theoretical and practical development work, and is intended primarily for addition to low-priced AM receivers in order to bring FM programs within the reach of all income groups.

The circuit utilizes only one dual triode to convert the relatively weak FM signals from the FM antenna into an audio signal voltage which is large enough to operate the conventional audio system of AM receivers.

In the "FreModyne" circuit one triode of the dual-triode tube serves merely as the local oscillator necessary for superheterodyne frequency conversion. The other triode performs four functions, operating as (1) a superheterodyne converter to an intermediate frequency of about 22 megacycles, (2) a superregenerative

i.f. amplifier of high gain, (3) a converter from FM to AM and (4) a detector delivering audio output. For brevity this triode is hereafter referred to as the superregenerator. The FM signal is converted to AM by side-tuning the receiver.

The use of the superheterodyne principle in the "FreModyne" circuit greatly reduces signal-frequency radiation compared to a conventional superregenerator (approximately 30-40 decibels reduction), and provides more uniform superregenerative operation. The circuit also includes a special automatic stabilizing arrangement permitting the regeneration control of the normal superregenerative receiver to be discarded. This stabilizing circuit also permits a quench wave of special shape to be obtained which gives good selectivity, good audio output, and quite linear FM detection.

Being side-tuned for FM reception, a "FreModyne" receiver has two re-

sponses for each station, both of which represent correct tuning. This compares with three responses in conventional FM receivers, only one of which represents correct tuning. The two responses obtained are quite close together on the dial, and many people, including engineers, have operated a "FreModyne" receiver for several minutes before realizing that there was more than one response.

The FM signal picked up by the antenna is applied through a signal-frequency tuned circuit to the grid of the superregenerator. Here it is mixed with the local oscillator signal, produced by a conventional Colpitts oscillator circuit. The resulting 22-megacycle signal is amplified by a Colpitts-oscillator type of superregenerative detector, and audio is recovered across a 22,000 ohm resistor in the lead from cathode to "B minus." After filtering out quench and applying de-emphasis, the audio signal is delivered, ready to be fed to a conventional audio amplifier. A resistor of 1500 ohms and a condenser of 2500 μ fd. control the quench wave shape. Another resistor of 150,000 ohms and an electrolytic condenser of 10 μ fd. permit stabilized operation with a large audio output.

A low-priced AM-FM receiver using the "FreModyne" circuit can be obtained by adding the single "FreModyne" double triode to a conventional four-tube-plus-rectifier AM receiver. The "FreModyne" circuit then merely uses the audio amplifier and power supply of the AM set. This arrangement permits very simple switching of the audio and plate-voltage supply when changing from AM to FM.

The usable FM sensitivity of the "FreModyne" receiver in its present stage of development is represented by the quieting sensitivity of the order of 74 decibels below one volt (200 μ v.) and not by the maximum sensitivity (which includes values with unusable signal-to-noise ratio). A signal weaker than 74 decibels can be heard but at a correspondingly poorer signal-to-noise ratio. For example, an 83 decibel (70 μ v.) signal gives approximately 20 decibels signal-to-noise ratio. The amount of radiation is considerably less than that of conventional superregenerative receivers and somewhat less than many conventionally designed medium-priced FM receivers.

The selectivity of the "FreModyne" (Continued on page 156)

Diagram of FreModyne superregenerative superheterodyne FM circuit.

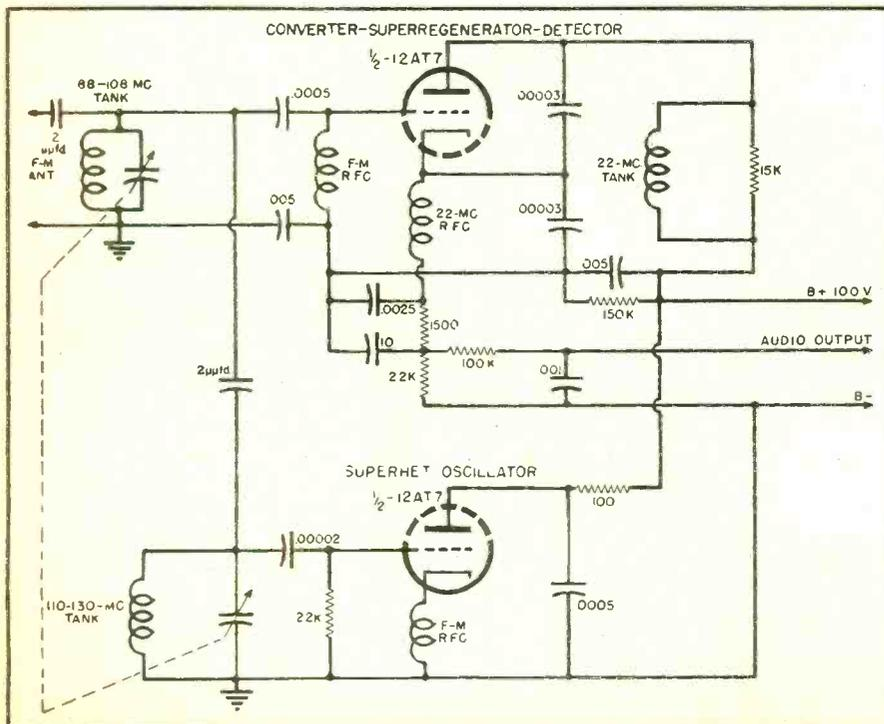

A NEW AM-FM SIGNAL GENERATOR

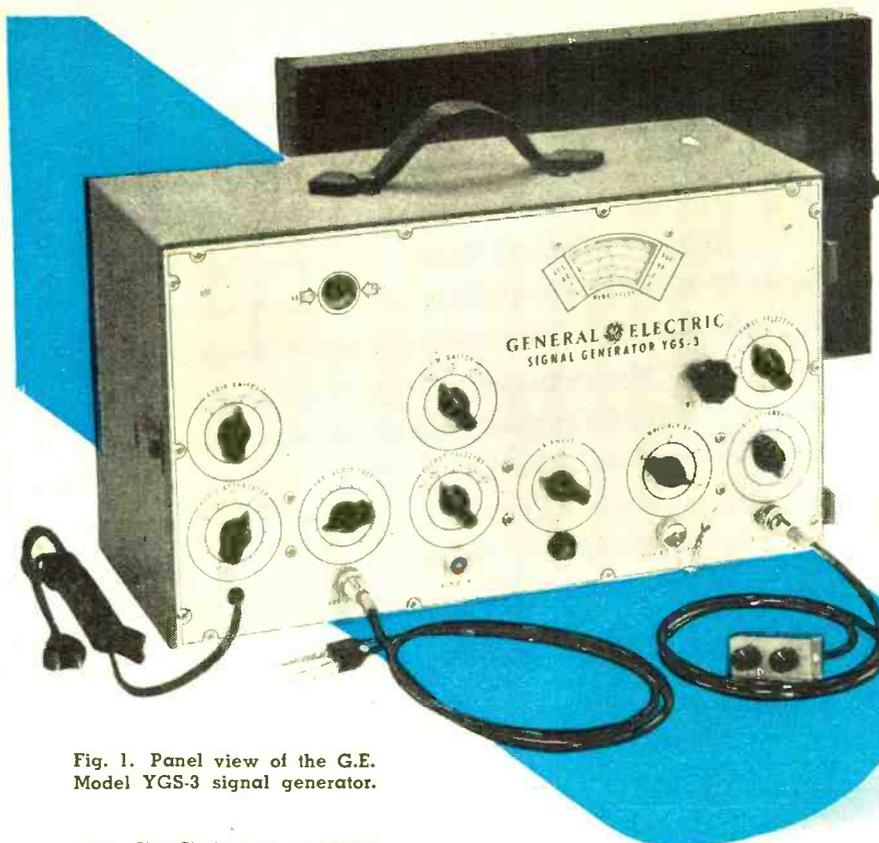

Fig. 1. Panel view of the G.E. Model YGS-3 signal generator.

By **JACK NAJORK**
General Electric Company

This instrument incorporates four separate units — r.f., FM, and audio oscillators, and a crystal calibrator. Each can be used alone or in combination.

THE accelerating popularity of FM reception has left in its wake a widespread need for a moderately priced, portable signal generator capable of supplying the audio and radio frequency voltages required for the alignment of both AM and FM receivers.

The basic requirements for an instrument of this type may be listed briefly as follows:

1. Extended r.f. coverage, continuous from 100 kc. to at least 110 mc.
2. An r.f. output of at least .1 volt throughout entire frequency range.
3. Provision for amplitude and frequency modulation.
4. Low distortion source of audio frequency voltage for modulation and audio measurement purposes.
5. Method of determining r.f. output; percentage of amplitude modulation and deviation of FM output voltages.

While not essential, the inclusion of a secondary frequency standard for internal and external calibration purposes would prove a useful adjunct and would round out the over-all versatility of the equipment.

These basic requirements can be enlarged upon to practically any degree

by the addition of various refinements, but for practical applications in the general field of radio service work, a compromise between utility, operational simplicity, and cost is indicated. The signal generator to be described was designed primarily for radio service applications; however it will also find wide utility in laboratories, production lines, test departments, etc.

Eleven tubes, seven miniature and four octal, are employed in the G.E. Model YGS-3 AM-FM signal generator which consists basically of four units:

1. An r.f. oscillator with a fundamental frequency range of 100 kc. to 150 mc. in seven bands.
2. An FM oscillator with center frequencies of 1, 20, and 50 mc. and maximum frequency deviations of ± 20 , ± 300 , and ± 750 kc. respectively.
3. A low distortion, variable frequency audio oscillator.
4. A one megacycle crystal calibrator.

These four units may, by front panel control, be employed independently or combined in any logical combination. Both AM and FM oscillators may be modulated by any audio frequency within the range of the audio oscillator or, if desired, may be modulated by an external source. The FM os-

cillator may be modulated and mixed with the r.f. oscillator to produce any desired FM output frequency within the beat frequency range of the two oscillators. Amplitude modulation and frequency deviation are continuously variable and 30% amplitude modulation or the specified frequency deviation is indicated by calibrated sections of a dual electron ray tube. The RC type audio oscillator provides good stability, low distortion, and essentially flat output throughout the designated frequency range and includes provisions for simultaneously supplying the modulating voltage for the FM oscillator and the horizontal amplifier (sweep) voltage for an external oscilloscope.

An extended, continuous radio frequency coverage of 100 kc. to 150 mc. immediately poses many problems in physical layout, bandswitching, wiring, shielding, and attenuation. Lead inductances in the 100 mc. region become an important factor and necessitate close physical proximity of radio frequency components. A compact, well-planned physical arrangement, essential from the standpoint of satisfactory high frequency operation, also contributes advantageously to shielding and attenuation by effectively confining strong radio frequency fields to a relatively small section of the equipment. These advantages are gained by deviating from the conventional, single-deck chassis layout and employing instead, individual "U" shaped brackets secured to the main chassis with the open ends of the "U" vertical. Controls are

Fig. 2. Schematic diagram for G.E. Model YGS-3 AM-FM signal generator. The instrument consists basically of four units: r.f. oscillator covering 100 kc. to 150 mc. in seven bands; FM oscillator; a variable frequency audio oscillator; and a 1 mc. crystal calibrator.

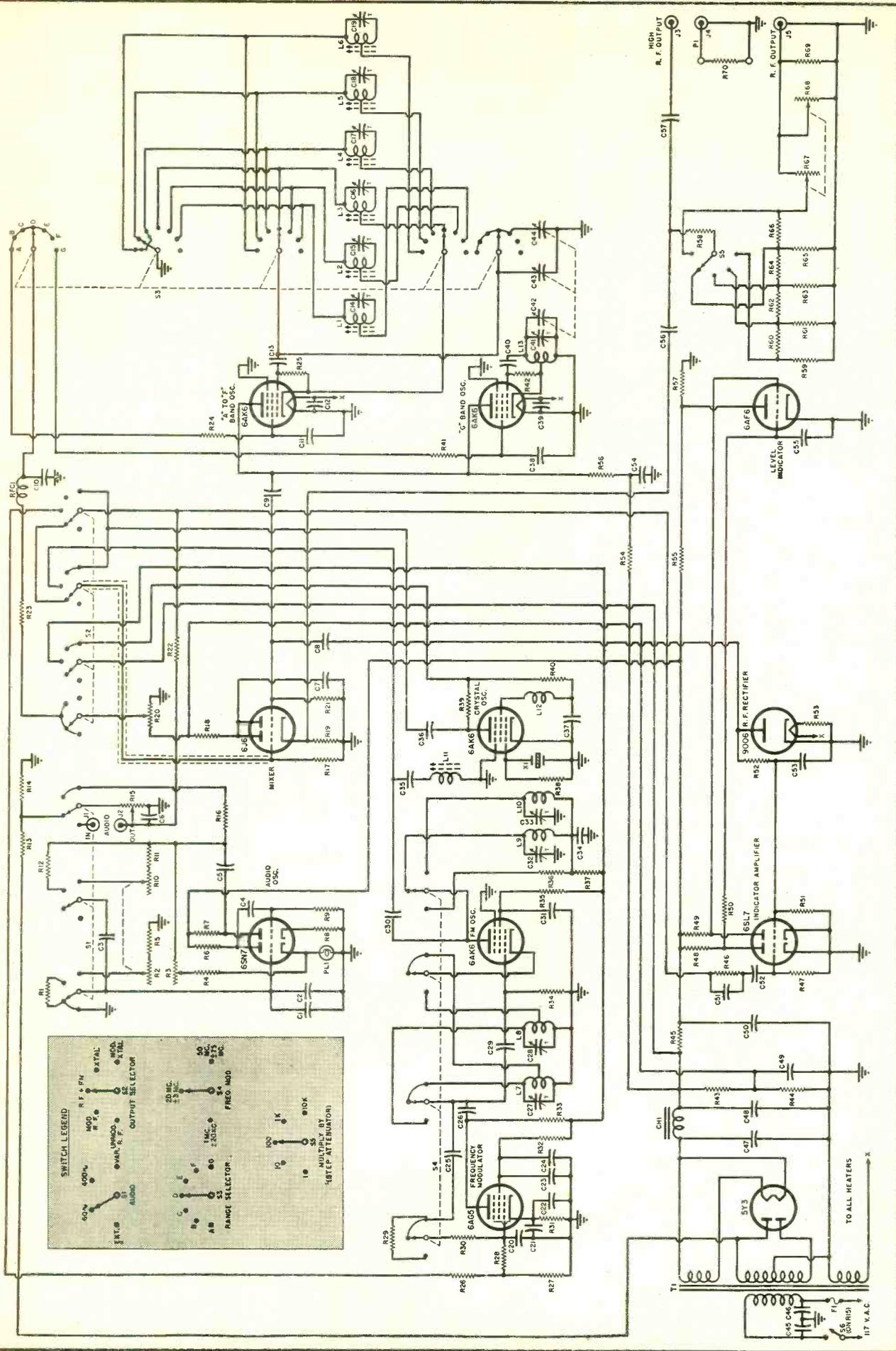

grouped on the front or panel section of the "U", and tube sockets, with tubes projecting horizontally to the rear, are fastened to the back section together with associated bypass condensers, resistors, etc. This type of construction permits short leads, compact grouping of components, and also lends itself well to subassembly manufacture. Three "U" subassemblies are used. Viewing the instrument, Fig. 6, from the top with the front panel forward, the right hand section contains the r.f. oscillator (with shield cover removed); the center section houses the FM oscillator, reactance modulator and crystal oscillator; and the third bracket contains the audio oscillator and indicator amplifier. The r.f. rectifier and mixer tubes are located on a small bracket directly underneath the r.f. oscillator.

In view of the extremely wide frequency coverage required, the use of a single section tuning condenser and band-switched coils for all ranges is impractical, since it is impossible to obtain the necessary L to C ratios required for adequate bandspreading at the higher frequencies without resorting to complicated padder-condenser switching arrangements. Bandswitching in the 100 mc. region is, in itself, a problem because of lead inductance factors and lowered circuit efficiency through losses in switch contacts and insulation. To circumvent these design difficulties, two separate, electron-coupled oscillator circuits are employed in conjunction with a special, three-gang tuning condenser. The lower frequency oscillator tunes from 100 kc. to 70 mc. and employs either one or two sections of the tuning condenser depending on the band selected. The high frequency oscil-

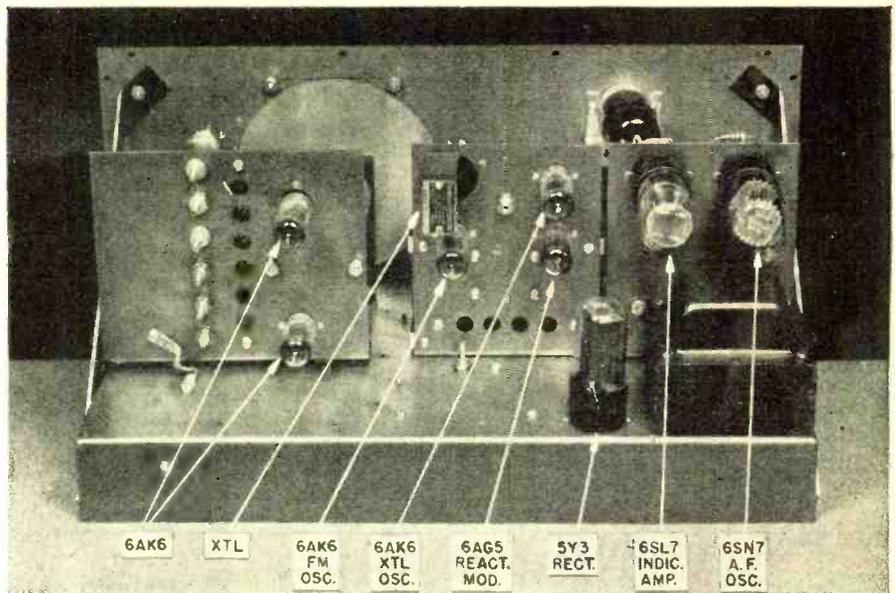

Fig. 3. Rear view of signal generator. Screws on left bracket are inductive and capacitive calibration adjustments for the variable oscillator. Four holes in the middle bracket permit access to FM oscillator trimmer condensers.

lator is designed for exclusive operation in the 70 to 150 mc. band and is tuned by a self-supporting coil permanently connected to the remaining section of the three-gang condenser. This arrangement permits the selection of constants which result in a favorable $L-C$ ratio on all bands with no compromise of efficiency or flexibility. Dial tracking difficulties, which usually increase with frequency, are simplified in the 70 to 150 mc. band since the gang section employed for this range is required to track with only one tuning curve. Hence, condenser knifing, if necessary, need not be compromised for average accuracy

on two or three bands as is usually the case.

Switching from the high to low frequency oscillator is accomplished by opening the screen lead of the oscillator tube not in use and is a function of the frequency bandswitch. The d.c. power input to either oscillator is controlled by a potentiometer (R_{20}) which varies the screen voltage of the tube in operation. The untuned plates of the oscillator tubes are paralleled and fed into one grid of the 6J6 dual triode mixer tube which functions as a cathode follower, delivering low impedance voltages to the output attenuator net-
(Continued on page 106)

Complete parts list for G.E. Model YGS-3 signal generator. Schematic diagram is shown on opposite page.

R_{17} , R_{18} —82,000 ohm, $\frac{1}{2}$ w. res. $\pm 5\%$	R_{50} —56 ohm, $\frac{1}{2}$ w. res. $\pm 5\%$	J_1 —R.f. output cable assembly (G.E. SWX-003) or audio output cable assembly (G.E. SWX-002)
R_{21} , R_{10} —Dual 500,000 ohm pot.	R_{60} , R_{62} , R_{64} , R_{66} —510 ohm, $\frac{1}{2}$ w. res. $\pm 5\%$	S_1 —3-pole, 4-pos. audio sw. (G.E. SSW-023)
R_{22} —25,000 ohm pot.	R_{61} , R_{63} , R_{65} —62 ohms, $\frac{1}{2}$ w. res. $\pm 5\%$	S_2 —4-pole, 5-pos., 2-section selector sw. (G.E. SSW-022)
R_1 —5600 ohm, $\frac{1}{2}$ w. res. $\pm 10\%$	R_{67} —50 ohms	S_3 —5-pole, 7-pos. 3-section range selector sw. (G.E. SSW-024)
R_2 —2000 ohm, $\frac{1}{2}$ w. res. $\pm 5\%$	R_{68} —Over 700 ohms	S_4 —4-pole, 3-pos., 2-section FM osc. sw. (G.E. SSW-025)
R_3 , R_{30} —100,000 ohm, 1 w. res.	R_{69} , R_{70} —100 ohm, $\frac{1}{2}$ w. res. $\pm 5\%$	S_5 —S.p., 5-pos. step attenuator sw. (G.E. SSW-026)
R_7 , R_{21} , R_{31} , R_{32} —4700 ohm, 1 w. res.	C_1 , C_2 —0.0075 μ fd. mica cond. $\pm 5\%$	S_6 —S.p.s.t. sw. (on R_{35})
R_8 , R_{36} —560 ohm, $\frac{1}{2}$ w. res. $\pm 10\%$	C_3 —0.02 μ fd. mica cond. $\pm 5\%$	L_1 —Osc. coil—Band F (G.E. SLC-013)
R_{10} , R_{17} , R_{21} , R_{30} , R_{51} —470,000 ohm, $\frac{1}{2}$ w. res.	C_4 , C_{24} , C_{31} , C_{32} —0.1 μ fd., 600 v. cond.	L_2 —Osc. coil—Band E (G.E. SLC-014)
R_{11} —1500 ohm, $\frac{1}{2}$ w. res. $\pm 5\%$	C_5 —25 μ fd., 600 v. cond.	L_3 —Osc. coil—Band D (G.E. SLC-015)
R_{13} —680,000 ohm, $\frac{1}{2}$ w. res.	C_6 —56 μ fd. mica cond. $\pm 20\%$	L_4 —Osc. coil—Band C (G.E. SLC-016)
R_{14} , R_{15} —33,000 ohm, $\frac{1}{2}$ w. res.	C_7 , C_{13} —0.1 μ fd. mica cond.	L_5 —Osc. coil—Band B (G.E. SLC-017)
R_{15} —500,000 ohm pot. (with S_6)	C_8 , C_{26} , C_{33} —33 μ fd. ceramic cond. $\pm 20\%$	L_6 —Osc. coil—Band A (G.E. SLC-018)
R_{16} —22,000 ohm, $\frac{1}{2}$ w. res.	C_9 —51 μ fd. ceramic cond. $\pm 20\%$	L_7 , L_8 —FM osc. coil—10 & 1 mc. (G.E. SLC-019)
R_{18} , R_{21} —1000 ohm, 1 w. res.	C_{10} , C_{11} , C_{12} , C_{38} , C_{39} , C_{51} , C_{57} —1500 μ fd. ceramic cond. $\pm 20\%$	L_9 , L_{10} —R.f. coil—50 & 20 mc. (G.E. SLB-003)
R_{19} —1300 ohm, $\frac{1}{2}$ w. res. $\pm 10\%$	C_{13} , C_{10} —47 μ fd. ceramic cond. $\pm 20\%$	L_{11} —R.f. coil—10 mc. trap (G.E. SLB-002)
R_{20} —50,000 ohm, 4 w. wirewound pot.	C_{14} , C_{15} , C_{16} , C_{17} , C_{18} , C_{19} , C_{27} , C_{28} , C_{32} , C_{33} —Var. trimmer strip, each section 1.6 to 18 μ fd. mica	L_{12} —R.f. coil—crystal osc. (G.E. SL1-006)
R_{22} —27,000 ohm, $\frac{1}{2}$ w. res. $\pm 10\%$	C_{20} —110 μ fd. ceramic cond. $\pm 10\%$	L_{13} —Osc. coil—Band G (No replacement part)
R_{25} , R_{34} —47,000 ohm, $\frac{1}{2}$ w. res.	C_{21} —0.2 μ fd., 600 v. cond.	X_1 —1000 kc. crystal
R_{26} —10,000 ohm, $\frac{1}{2}$ w. res. $\pm 10\%$	C_{22} —50 μ fd., 25 v. elec. cond.	RFC—R.f. choke (G.E. SL1-005)
R_{27} —56,000 ohm, $\frac{1}{2}$ w. res. $\pm 5\%$	C_{23} —4 μ fd., 450 v. elec. cond.	T_1 —Power trans. (G.E. STP-018)
R_{28} , R_{30} —100,000 ohm, $\frac{1}{2}$ w. res.	C_{24} , C_{25} —110 μ fd. mica cond. $\pm 20\%$	CH_1 —Filter choke (G.E. SLF-008)
R_{29} —330,000 ohm, $\frac{1}{2}$ w. res. $\pm 10\%$	C_{26} —27 μ fd. mica cond. $\pm 20\%$	1—6SN7 tube
R_{30} —6800 ohm, $\frac{1}{2}$ w. res. $\pm 10\%$	C_{27} —0.005 μ fd., 400 v. cond.	1—6AK6 tubes
R_{31} —2200 ohm, $\frac{1}{2}$ w. res. $\pm 10\%$	C_{28} —18 μ fd. mica cond. $\pm 20\%$	1—6AG5 tube
R_{32} —270,000 ohm, 1 w. res. $\pm 10\%$	C_{29} —1.5 to 10 μ fd. var. mica trimmer	1—6AF6G tube
R_{33} —22,000 ohm, 1 w. res.	C_{30} , C_{31} —3-sec. tuning cond. (C_{30} —64.6 μ fd.; C_{31} —129.2 μ fd.; C_{32} —335.8 μ fd.)	1—9006 tube
R_{34} —39,000 ohm, 1 w. res. $\pm 10\%$	C_{32} , C_{33} —0.1 μ fd., 130 v. a.c. cond.	1—6SL7 tube
R_{35} —10,000 ohm, 5 w. wirewound res. $\pm 5\%$	C_{34} , C_{35} —8 μ fd., 450 v. elec. cond.	1—5Y3 tube
R_{36} , R_{38} , R_{39} —1 megohm, $\frac{1}{2}$ w. res.	C_{36} —8 μ fd., 350 v. elec. cond.	* Part of a 10,000 ohm, 40 w. wirewound res. $\pm 10\%$
R_{37} —120,000 ohm, 1 w. res. $\pm 10\%$	C_{37} —10 μ fd., 450 v. elec. cond.	** Dual pot. (G.E. SRC-054)
R_{38} —2000 ohms	C_{38} —150 μ fd. mica cond. $\pm 20\%$	*** All in single unit
R_{39} —8000 ohms	C_{39} , C_{40} —0.5 μ fd., 600 v. cond.	
R_{45} —8200 ohm, 1 w. res. $\pm 10\%$	C_{41} —1000 μ fd. ceramic cond. $\pm 20\%$	
R_{46} —100,000 ohm, $\frac{1}{2}$ w. res. $\pm 10\%$	F_1 —1 amp. fuse	
R_{47} —470,000 ohm, $\frac{1}{2}$ w. res. $\pm 10\%$	PL_1 —120 v. lamp (G.E.) 3S6/5, 3 w. candlelab base	
R_{53} —5.1 ohm, $\frac{1}{2}$ w. res. $\pm 10\%$	J_1 , J_2 , J_3 , J_5 —Chassis connectors	
R_{54} —3300 ohm, 1 w. res.		
R_{55} —33,000 ohm, 1 w. res. $\pm 10\%$		
R_{57} —27,000 ohm, 1 w. res. $\pm 10\%$		
R_{58} —430 ohm, $\frac{1}{2}$ w. res. $\pm 5\%$		

A Quasi-Technical Discussion of MAGNETIC RECORDING



Fig. 1. Tape recorder recently developed by Armour Research Foundation. A dual head permits two-direction operation. One-half of tape width is used for each direction.

By
GENE T. CLEARS
Armour Research Foundation

Basic principles involved in the design and operation of present-day wire and tape recording equipment.

IT HAS been pointed out from time to time that several factors in the design and operation of magnetic recording devices have not been given adequate explanation. An attempt will be made in this discussion to explain those points that appear to have the greatest importance.

Magnetic Media

Media suitable for use in magnetic

recording may include a variety of physical shapes, but must lie within a comparatively restricted range when consideration is given to magnetic properties. Most common commercial usage is today confined to extremely small diameter (in the order of .004") wire, and thin tapes (approximately 1/4" width), which are coated with the magnetizable material which has been prepared in powder form. The tape base may be of any material that will

satisfactorily meet the requirements of flexibility and economy having, of course, a nonmagnetic characteristic. Plastic and paper-based tapes are commercially available.

Recording magnetically is made possible because of the ability of some ferromagnetic materials to retain a certain amount of the magnetic induction after the applied fields have been removed. This retained induction is termed "remanence." Another important magnetic property is the "residual induction" which is defined as the magnetic induction at which the magnetizing force is zero when the material is in a symmetrically cyclic magnetized condition. As is commonly known, a characteristic relationship between "residual induction" and the "field intensity" which produces it is not of a straight line, or linear nature. While the degree of non-linearity varies depending upon the magnetic characteristics of the medium, it is at once apparent that recording over such a characteristic would result in high distortion content. This undesirable effect may be considerably reduced through the application of a "bias" field which will be considered later.

Wartime wire recorders were designed to operate with a .004" diameter medium carbon steel wire. While it was a recognized fact that this medium had some rather undesirable limitations, the exigencies of war did not permit further research into the problem at that time. Operation of these devices in tropical climates soon proved the vulnerability of this recording medium to moisture and consequent rust. Wire breakage resulted if the level wind mechanism became out of phase and caused wire overlap. While these recorders were not de-

Fig. 2. Frequency response characteristic of a high impedance (18,500 ohms at 20 kc.) head without equalization. Output from head is approximately 13 millivolts.

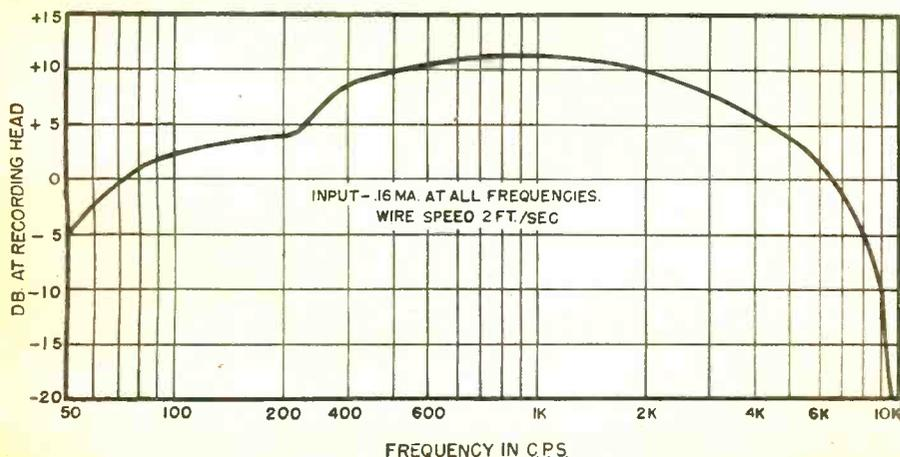

signed for fidelity reproduction, the low signal-to-noise ratio and limited frequency response were also substantially attributable to the wire characteristics. Research was accordingly directed toward stainless steel alloys. 18/8 (18% chromium and 8% nickel) stainless steel recording wire was developed as a result of this intensive research. Its qualities as a recording medium consisting of high signal-to-noise ratio and a minimum of cross-talk characteristics between adjacent strands of wire, were immediately recognized. Special processes were developed to insure optimum magnetic characteristics. Coercive forces in the order of 200-300 oersteds and B_r 's near 2000 gauss appeared to approximate this ideal, although these values, of course, represent compromises from several standpoints.

Magnetic recording tape is presently being manufactured by the *Minnesota Mining & Manufacturing Company*, the *Indiana Steel Products Company*, and the *Brush Development Company*. Inasmuch as there is a greater cross-sectional area presented to the record-playback head with this medium, the speed with which it is driven past the head can be substantially less than with wire. While commercial home entertainment wire recorders all operate at the standard wire speed of 2 feet-per-second, tape recorder speeds have not so far been standardized. Most tape devices, however, operate at either 7½" or 8" per second. At the relative wire and tape speeds in use, frequency response and dynamic range are quite similar when the two media are compared. Naturally, there are some advantages and disadvantages to both systems when specific applications are considered; however, the buyer of a home entertainment recorder must rely upon personal preference when making a choice. A tape recorder employing two-direction operation and recently developed by the *Armour Research Foundation*, is shown in Fig. 1.

High Frequency Bias

Since the days of the original wire recorder, as designed and constructed by *Valdemar Poulsen*, it became apparent that it would be necessary to operate on a linear portion of the characteristic curve in some manner. This may be accomplished through the addition of superimposed alternating or direct fields of proper magnitude. The d.c. bias results in an inherent noise on the medium when the recording is played back. The application of a superimposed field has been termed "bias," notwithstanding the fact that there exists no similarity between this usage and bias as it is commonly understood in the electronics field.

When an alternating field is used for bias, the medium is recorded symmetrically about zero magnetization. Inasmuch as it is necessary to use a field considerably beyond the highest audio frequency recorded, the terminology "supersonic bias" has been ap-

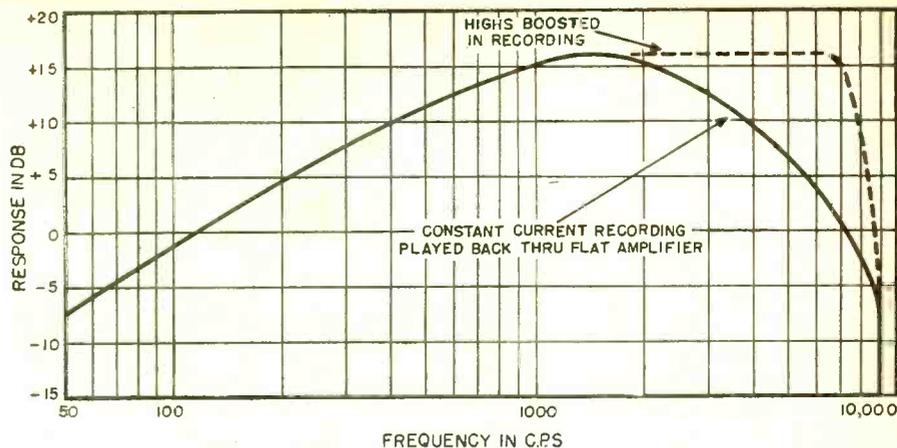

Fig. 3. Curve shows necessary high frequency pre-emphasis during recording operation. The low frequencies are boosted during playback.

plied. [See Bibliography 1, 2, 3, 7.]

This bias is normally at least 5 times the highest recordable audio frequency so that no modulation components will lie within the audio range. The magnitude of the bias field is usually adjusted to a value such that the operating point with zero audio signal will be located at the lower knee on the residual magnetization curve. In general, this can be accomplished with low bias power. However, the optimum value is dependent upon the design of the record head, and wire or tape being used.

Inasmuch as it is highly desirable to use the wire or tape over again for successive recordings, it is necessary to furnish a means to demagnetize or erase the recorded signal. While this may be accomplished by applying a d.c. field, or even a permanent magnet, both systems result in magnetically polarized areas along the medium which will greatly increase the noise level on later recordings. In very much the same way that a magnetized

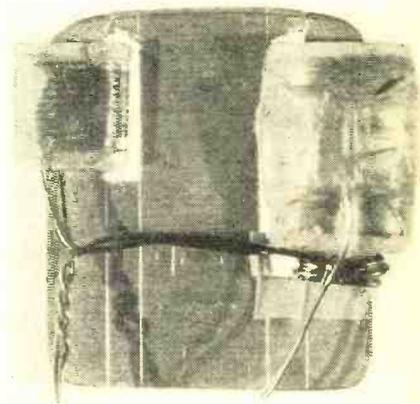
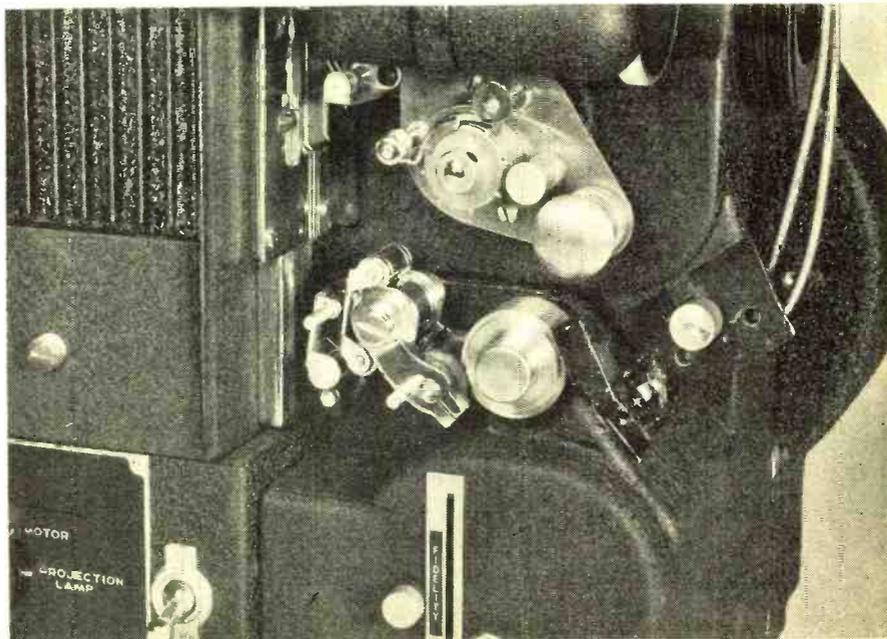

Fig. 4. One of the first heads designed for stainless steel wire recording.

watch is made magnetically neutral, the medium may be subjected to a high frequency erasing field before it approaches the record head to receive
(Continued on page 147)

Fig. 5. Closeup view shows head location on a converted 16 mm. projector. This conversion was made by the Armour Research Foundation.



Television INSTALLATION

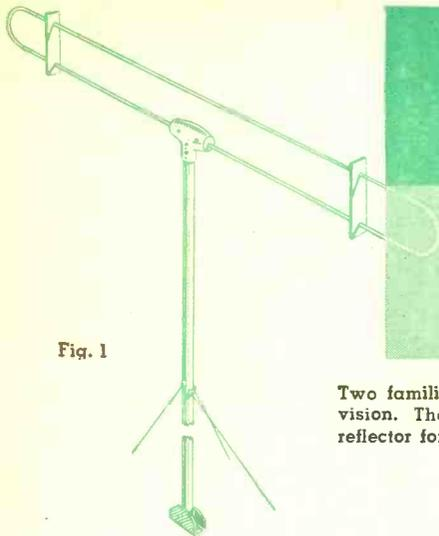

Fig. 1

Two familiar types of folded dipoles used for television. The basic dipole (Fig. 1) and a dipole with reflector for directional reception (Fig. 2) are shown.

By W. W. WAYE

Part 6. The concluding article of this series—covering a special type of antenna. The folded dipole is used effectively in many installations.

AN IMPORTANT characteristic of the highly directional antennas, previously described, is that they are also very selective. Any installation of such an antenna for the reception of more than one channel must be based on a compromise of antenna efficiency.

This can best be understood in terms of the tuning element, which is usually a dipole (of two metal rods) whose over-all length determines the television channel to which the dipole is best tuned, as shown in Table 1.

For receiving only one television channel, the proper length of dipole plus a good installation results in near-perfect, ghost-free, "noise"-free reception on that particular channel. This approaches an ideal condition because of the high degree of selectivity of such an antenna. But reception on adjacent channels usually will be fair to poor, depending upon the site and other factors.

Usually, reception of two (or perhaps three) stations is desired, and the length of the dipole is based on a mean or average value of the best length for each of the two respective channels. The complete antenna is

then oriented and adjusted to obtain the best picture signals from the two different stations; signals that are free of ghosts and "noise" interference, and are relatively equal in terms of signal strength. This means that often the signal strength of one sta-

Channel No.	Frequency	Use Over-all Dipole Length
1	44 to 50 mc.	108 in.
2	54 to 60 mc.	90 in.
3	60 to 66 mc.	81 in.
4	66 to 72 mc.	73 in.
5	76 to 82 mc.	64 in.
6	82 to 88 mc.	60 in.

To favor two or more channels, take mean average. To receive all channels, use length of 78 inches.

Table 1. Best length for any dipole to receive stations operating on channels 1-6.

tion may be sacrificed (during orientation of the antenna) to favor a weaker signal on another channel. Such a compromise is particularly noticeable when the preferred channels are well separated; as, for instance, channels 2 and 6, or, channels 2 and 5, and so forth. Thus, whenever a directional antenna is used to receive more than one television station, there inevitably is a compromise of

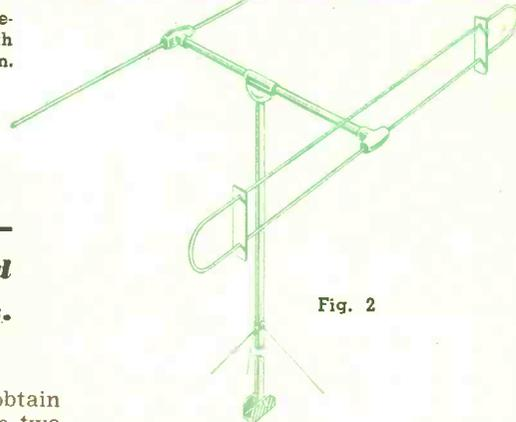

Fig. 2

either antenna or receiver efficiency. For many locations, this compromise proves to be an important installation problem.

One solution is to install a separate, highly directional antenna for each of the channels desired. This is done in some metropolitan and industrial locations, where ghost and "noise" interference are especially annoying and where considerable directivity is required for each channel of reception. Such installations, however, demand duplicate antennas, mechanical or electronic switching, and other extra equipment; the work is extremely difficult, specialized, and expensive.

A more practical solution, for all suburban locations and for most urban locations, is a special type of television antenna, known as the folded dipole, or so-called "broad-band" antenna (Fig. 1).

The Basic Antenna

The folded dipole, of which there are several variations, is primarily useful in areas where three or four

Fig. 3. Two commercial types of folded dipoles, showing rod arrangement and light-weight construction. Basic folded dipole (top), similar dipole plus reflector (bottom).

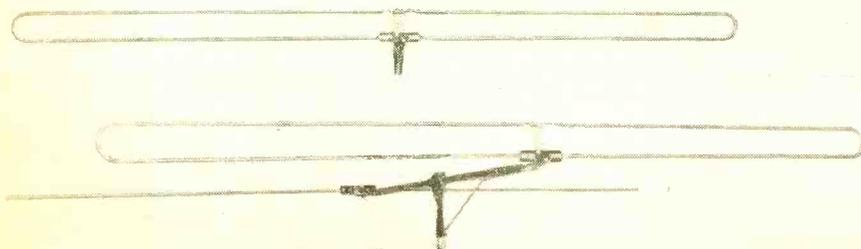
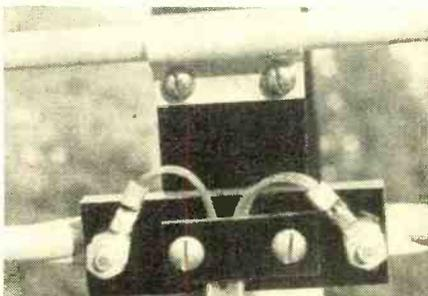

Fig. 4. Method of mounting a typical folded dipole with connections for 300-ohm lead-in.



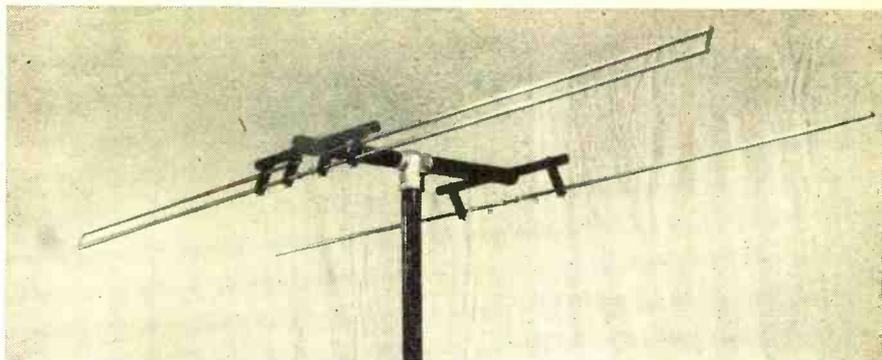

Fig. 5. (Left) Variation of basic folded dipole intended to provide broad coverage on all television channels. Use of commercial "neon suppressor" on sign plus coaxial lead-in permits "noise"-free reception. Fig. 6. (Right) This type of folded dipole provides for adjustment of all tunable factors for maximum signal strength.

strong television stations are in operation. Although similar in some respects to the ordinary (straight) dipole, it has a number of important differences, as well as individual characteristics, which should be understood before attempting any installation.

The important and characteristic ability of the folded dipole to accept picture signals on any channel (44 to 88 megacycles) is offset, to a considerable extent, by its lack of sensitivity to weak signals—sometimes called a lack of "gain." Few types of so-called "broad-band" antennas are better than a single, ordinary dipole on any one channel. Lack of "gain" is usually most pronounced when attempting to receive distant or low-power transmitters operating on channels 1 or 6. This limitation has been considerably reduced by improved design of some commercial types of folded dipole antennas. To be adequate for television reception, the folded dipole should be constructed of tubing at least one-quarter inch, with spacing between the two lengthwise elements no greater than 3 inches, or less.

Much as in the case of an ordinary dipole, the length of a folded dipole determines the television channel to which it is best tuned—with the important difference that the length of the folded dipole is far from critical, because of its generally broad response characteristic.

Most commercial types of the basic folded dipole (Fig. 3) have a standard length of about 60 or 70 inches—for "the middle of the band"—which usually proves adequate for reception of

all channels in the band (44 to 88 megacycles).

The outstanding characteristic of all antennas of this type is their impedance rating of 300 ohms. Compared to the much lower impedance (72 ohms or less) of the ordinary dipole, this is a decided advantage for television installations. The high impedance of a folded dipole permits an almost-perfect match to a typical 300-ohm "twin-lead ribbon" lead-in (Fig. 4), and since most television receivers are equipped with a balanced 300-ohm input, the same "twin-lead ribbon" lead-in can be connected to the input terminals of the receiver. Such a well-matched (300 ohm) circuit is extremely desirable in television work, because no Matching Section is necessary for insertion between the lead-in and antenna, almost all of the energy accepted by the antenna reaches the receiver with practically no loss of signal level, and any possibility of picture distortion due to "noise" pickup is minimized considerably.

One variation of the basic folded dipole, designed for uniform response on all television channels, has met with success in some installations (Fig. 5). However, the gain of the antenna is inferior to that of the basic folded dipole.

Directional Types

When properly mounted in an upright position (Fig. 3A), the basic folded dipole has about the same directivity as an ordinary dipole, and receives picture signals equally well from either front or back.

Fig. 7. The "Duoband" antenna is a modified folded dipole for complete coverage of both upper and lower TV frequency bands.

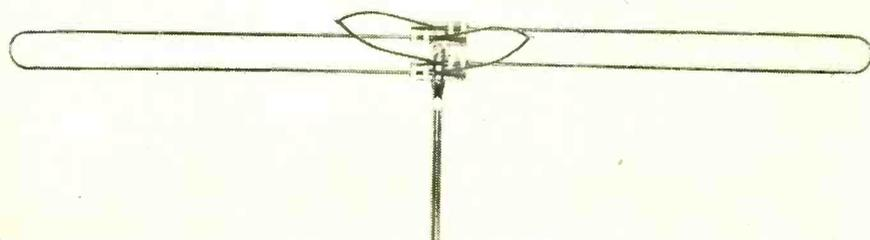

Channel No.	Frequency	Use Over-all Dipole Length
7	174 to 180 mc.	29 in.
8	180 to 186 mc.	28 in.
9	186 to 192 mc.	27 in.
10	192 to 198 mc.	26 in.
11	198 to 204 mc.	25 in.
12	204 to 210 mc.	24 in.
13	210 to 216 mc.	23 in.

To favor two or more channels, take mean average. To receive all channels, use length of 26 inches.

Table 2. Best length for any dipole to receive stations operating in upper TV band.

The folded dipole can be made *directional* in a very conventional manner, by the addition of a reflector element—usually an ordinary (straight) dipole. With such an arrangement (Fig. 3B), the antenna not only restricts reception to one direction, but it has a much higher "gain" in that direction and thus receives stronger signals.

Although popularly called a "broad response" device, the addition of a (Continued on page 170)

Fig. 8. Importance of height is demonstrated by these two installations of "Duoband" antennas. Folded dipole at left received only weak signals from one New York station, 50 miles distant. Same type of antenna at right, with increased elevation of 35 feet, received good signals from all of the New York television stations.

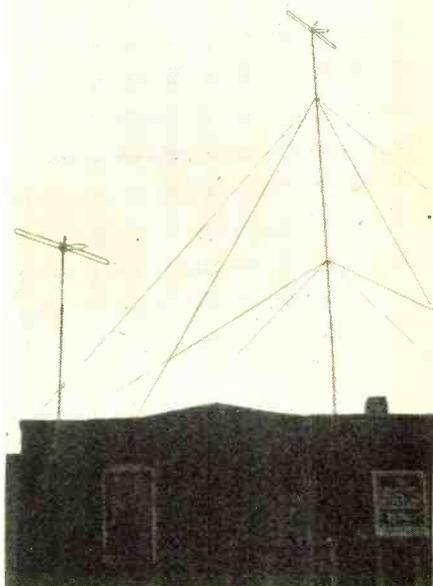

The Recording and Reproduction of SOUND

By **OLIVER READ**
Editor, RADIO NEWS



Indiana Steel Products' experimental model 5C magnetic tape recorder.

Part 12. An analysis of the mechanical and electrical requirements in the design of magnetic tape recorders.

A MAGNETIC tape recorder consists of three interdependent assemblies: 1, the mechanical unit for moving the tape; 2, the magnetic circuits of the recording and reproducing head in combination with the tape; and 3, the electronic circuits.

Mechanical Requirements

Magnetic tape sound recorders should have a constant velocity drive. This can be best achieved with a wrap-around capstan or pinch roller drive mechanism. Reel drive is undesirable because of the large change in diameter as the reel empties. A constant velocity drive makes editing possible by cutting and splicing.

Magnetic tape sound recorders, like all types of recorders, must be reasonably free from wow. The average ear is very sensitive to two common types of wow, namely, frequency wow and amplitude wow.

Frequency wow is a mechanical difficulty which is present in all types of sound recorders unless special precautions are taken to eliminate it. Frequency wow consists of periodic variation, such as is introduced by gear teeth, eccentricity of mechanical rotating parts, or irregularities in belts, and also by random variations which may result from frictional irregularities.

Amplitude wow, that is, the periodic

or random variation of loudness, is reduced to a minimum when high quality magnetic tape, such as *Hyflux*^{*}, is used, because the coating process used in depositing the magnetic powder on the tape produces a more uniform magnetic member than can be attained by other methods of manufacturing magnetic recording media, and also because the metallic nature of the magnetic powder permits a high degree of homogeneity in the manufactured product.

The solution of the problem of wow in the magnetic recorder is no more difficult than it is in any other type of sound recorder; in fact, the problem is almost identical to that encountered in talking motion pictures, because the recording medium is of similar shape and travels at a comparable speed.

It is difficult to obtain wow-free recording with systems involving gears, especially if heavy flywheels are to be avoided. It is possible to produce specially-cut gears that are wow-free, but in general this is costly and out of the range of a popularly priced unit. Flat belt drives on flat flanged pulleys have been found to be satisfactory because they are relatively free from periodic variations. Round or V-belts generally cause difficulty, because the slightest irregularity in the thickness or stiffness of the belt results in its clinging in the groove of the pulley.

Rubber-tired friction drive wheels

Fig. 1. Block diagram of self-contained portable magnetic tape recorder.

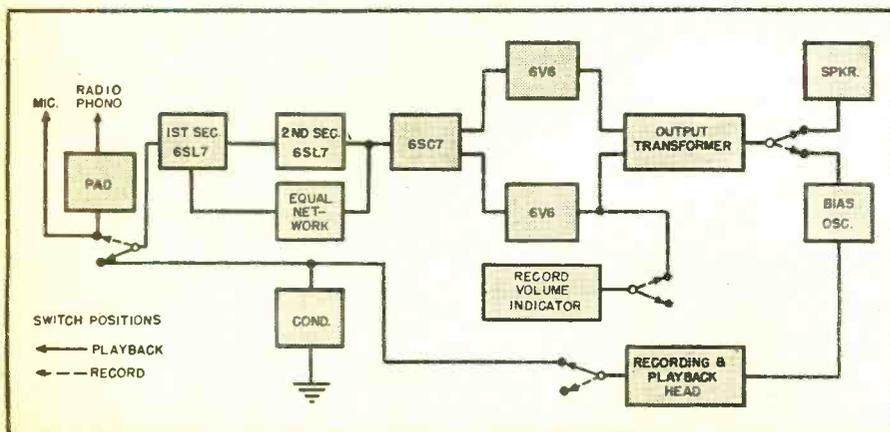

^{*}Trademark of The Indiana Steel Products Company.

have proved very satisfactory, especially for designs in which the rubber drive wheel is subject to little or no contact pressure during the idle periods.

The drive capstan or drive wheel should be directly coupled by a common shaft to a flywheel of as large rotational inertia as practical. The r.p.m. of the drive capstan should be as high as possible, so that a maximum momentum will be achieved. It is quite practical to have the drive wheel as small as three-fourths of an inch in diameter. Experience has shown that the takeup reel may be driven from the shaft common to the flywheel and drive capstan, if the flywheel has sufficient momentum to overcome the random variations of tension on the tape caused by the reeling mechanism. If it is desirable to keep the flywheel size and weight to a minimum, the takeup reel should be driven through a suitable speed reduction device direct from the motor.

The braking and drive mechanism should be so designed that the tape remains under a continuous tension when the direction of the tape is reversed. As the reel size increases, additional braking power is needed. High tensile strength of tape permits the designer a considerable degree of latitude in designing brakes and driving mechanisms. Friction and belt drives naturally provide adequate slippage under extreme loads to minimize the danger of tearing the tape.

As a protective feature, it is desirable that the rewind switch be mechanically linked to the permanent magnet eraser, so that the eraser is automatically thrown out of contact with the tape whenever the machine is rewound. In the design of a machine where the eraser is placed in advance of the recording head, there is no advantage gained by being able to erase during the rewind.

Magnetic Circuits

In the average recorder, it is desirable to use the same magnetic head for recording and playback. Fundamentally, however, the requirements for the two cases are somewhat different and circuit changes are necessary.

In recording, the magnetic member should have high permeability with as small hysteresis losses as possible at higher frequencies. Probably the most important single characteristic of the magnetic material in the recording head is that the material should have as high a magnetic saturation level as possible. A high saturation level is also very important, in order to minimize magnetic distortion and to give the recorder itself a maximum opportunity to have wide dynamic range. In a playback head, extremely high initial permeability is very desirable. The induced magnetic field in the playback head is always small, and high initial permeability will permit the best possible use of this low intensity field. For both recording and playback, the transducer assembly should

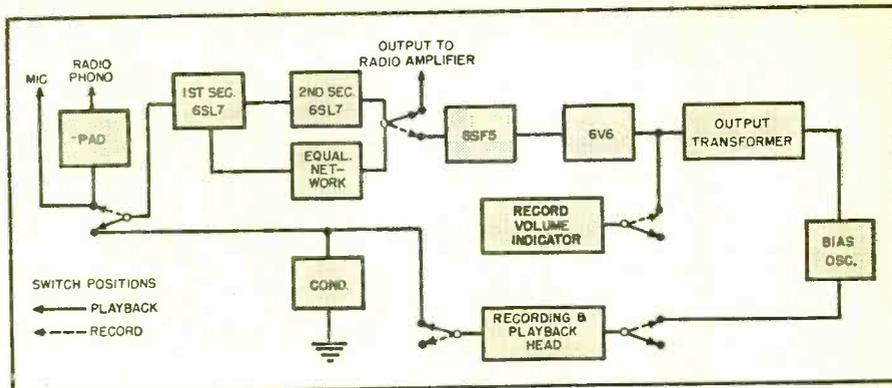

Fig. 2. Block diagram of radio adapter magnetic tape recorder.

have as nearly a closed magnetic circuit as possible, except for the recording gap. For the production of a magnetic head of a laminated structure, it is easiest to fabricate the head as an assembly of two electrically and magnetically equivalent legs with a butt joint. If this construction is used, it is imperative that the joint be fitted as closely as possible.

Experience has shown that the balance of the two legs must be very exact if extremely low pickup is desired in the presence of the comparatively strong stray magnetic field that often surrounds a shaded pole motor. With exactly reproduced layer winding, it is necessary to have the two legs wound with an accuracy of plus or minus one or two turns. If hand-wound experimental coils are used, the variations in induction due to irregular winding may be so great that the number of turns is not a suitable criterion, and the legs should then be wound to a given inductance rather than to a given number of turns.

The width of the recording gap of the head is extremely important. At low magnetic tape speeds it is desirable to have the gap as small as pos-

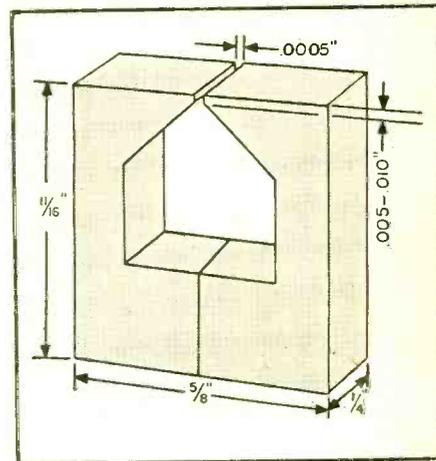
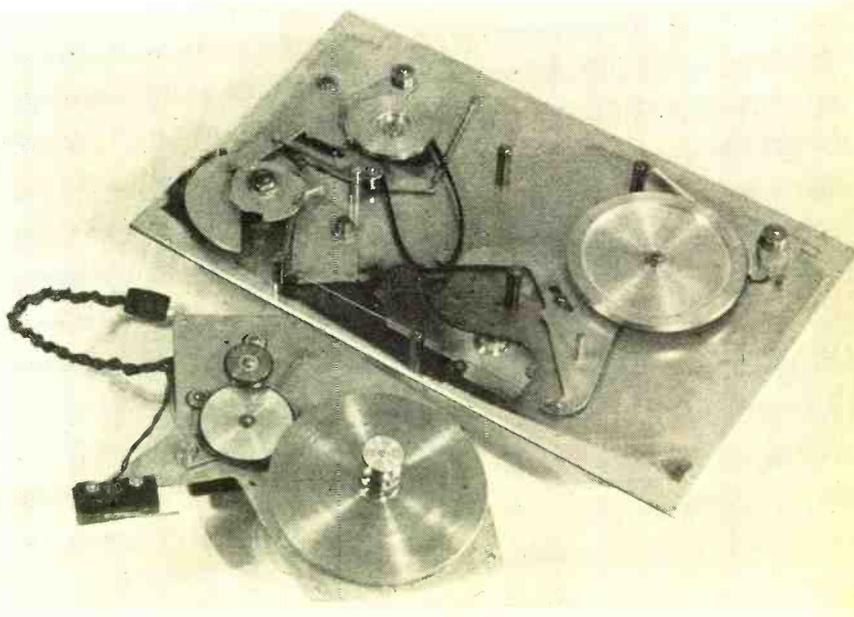

Fig. 3. Mechanical details show construction of record-playback head.

sible in order to obtain a maximum of high frequency resolution along the tape, even though longitudinal magnetization of the tape minimizes stray fields. A gap width of approximately 0.0005-0.002" has proved to be satisfactory.

It must be remembered that al-

Perspective view of under side of driving mechanism with motor flywheel subassembly removed. This is part of Indiana Steel Products' experimental model. 5C.



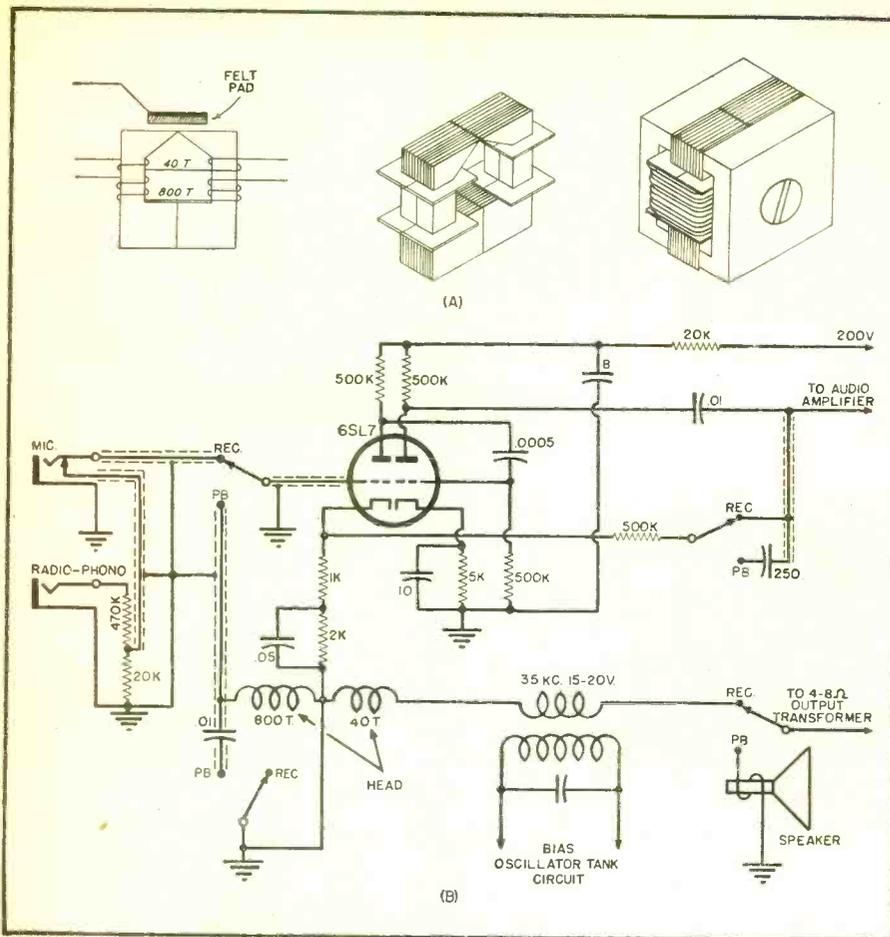

Fig. 4. (A) Construction details of head developed for use with "Hyflux" tape. (B) Basic record-reproduce circuit using high impedance head.

though it is desirable to have as narrow a gap width as possible, as far as high frequency resolution is concerned, it is at the same time desirable to have as wide a gap as possible from an energy relation standpoint. This is true because the output of the playback head is naturally dependent upon the total amount of magnetic

flux which can be placed across the magnetic gap from the recording tape.

Electronic Circuits

The electronic circuits of a magnetic tape recorder may be divided into four parts for purposes of description and discussion: (1) the input matching transformer, (2) the equal-

izer circuit, (3) the audio amplifier, and (4) the high frequency bias oscillator.

Since most practical recording and playback head designs have relatively low impedance windings, it is necessary to use a matching transformer between the head and the input of the amplifier. As the signal at this point is of rather low level, precautions must be taken to shield the transformer both electrically and magnetically. The only other real requisite for the transformer is that it have a reasonably good frequency response.

It is well-known to those versed in the art of magnetic recording that equalizing networks are necessary to compensate for the constant current recording characteristic of the particular head and recording medium used. Because of the nature of magnetic recording, the constant current frequency response characteristic rises approximately 6 db. per octave of recording medium used. Either single or multiple stage equalizers may be used; however, practice shows that single stage circuits can give very satisfactory results.

For the playback operation, the amplifier circuit will be considered in two parts. The driver and output stages, as one part, can be considered the equivalent of the average audio amplifier of a radio receiver in design and characteristics. The other part is a pre-amplifier, which is necessary to compensate for the losses in the equalizer and for the difference in signal level at the secondary of the input matching transformer and that at the output of the detector stage of a radio. This makes possible the design of an attachment which contains only the pre-amplifier and equalizer circuits. The signal from this arrangement may be fed into the audio amplifier of a radio in the same manner as for phonographs.

In an attachment as described in the preceding paragraph, it is necessary to have a low power output stage for the recording function. This allows normal radio listening while recording.

The present method of recording on magnetic tape requires a source of high frequency used in conjunction with the audio signal. A simple, non-critical Hartley oscillator circuit serves this purpose excellently. The bias signal is applied to a separate winding on the recording head. The only critical requirement with this circuit is that it be sufficiently well shielded to prevent heterodyning with an associated radio.

As in any relatively high gain audio amplifier, it is necessary to take adequate precaution with the power supply filter and with the layout of components, particularly in the pre-amplifier stages, to reduce the hum level to a minimum.

Driving Mechanism

Fig. 1 is a block diagram of the electronic components of a complete (Continued on page 131)

Perspective view of under side of driving mechanism.

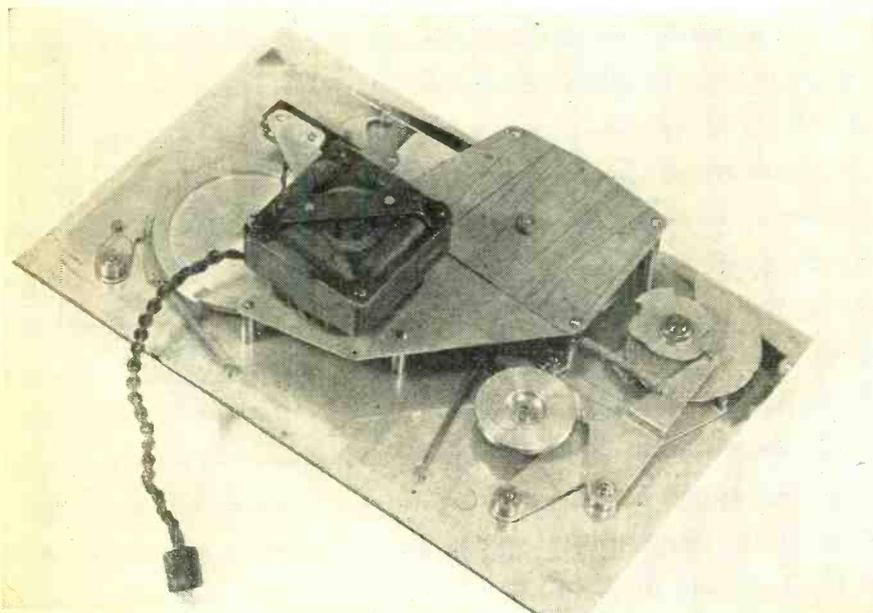

Converting a Brush Tape Recorder for Broadcast Use

By MERLE FLEMING

With minor changes, this tape recorder now meets broadcaster's requirements.

FACED with the need for a public address system and equipment to audit various transcription libraries, the staff members of a proposed broadcast station purchased a *Brush* tape recorder. While waiting for the construction permit to come through, members of the staff have been concentrating on ideas for selling time. They decided that the tape recorder would also provide a method of presenting programs to potential advertisers.

A *Brush* recorder was decided upon because it seemed to fit all these needs with comparatively few modifications necessary. As purchased, it can record, play back, be used as a public address system, and record while it is being used for public address purposes. The minor drawbacks of the recorder to the broadcaster, which will be discussed here, can be overcome with a small expenditure of time and a few odd parts that can be found in the shop of any broadcast station.

This recorder is now being used by the staff of a nearby station (out of this proposed trade area) with very good results. They find it so satisfactory that they have just bought one and feel that more expensive disc recording equipment will not be needed since the fidelity of this modified machine leaves little to be desired. They plan to make the same changes in their recorder as are described here.

As a result of the work of the chief engineer, the hum level was greatly reduced and the fidelity noticeably improved. The phono input was also changed so that the mike and the phono could be used at the same time.

The most noticeable shortcoming for station use was the hum level. The microphone and phonograph lead inside the recorder is about a foot long and is unshielded. Shielding this wire reduced the hum by about 3 db. Bypassing the cathodes of the last two audio stages to ground further reduced the hum because of an apparent unbalance in the plate circuit. In-

verse feedback consisting of 470,000 ohm resistors between the plates of the last audio stage and the phase inverter (Fig. 2) slightly decreased the hum and obviously increased the fidelity at higher volumes.

Since this recorder will be used as a public address system and a station recorder, a good 500 ohm output transformer was installed (Fig. 1). As would be expected, the hum was increased to a slight degree. However, since tape recorders lack bass, the substitution of the large transformer was worthwhile in that the bass response on a good external speaker was improved. Still not satisfied with the bass off the tape, an RC network was substituted for the plate load of the first section of the phase inverter (Fig. 2).

In order to make the phono input available when the mike was being used, the closed circuit mike jack was shorted across and the phono RC circuit removed. This RC circuit was designed (Fig. 3) as a simple mixer circuit so that the microphone and the phonograph pickup looked into higher resistance than were originally used, thus improving the over-all frequency response. The phonograph load consists of a two megohm potentiometer which is used to get a balance between mike and the phonograph. It was mounted on the phono turntable base.

The reader might think that the

gain would be reduced below a usable level with the addition of inverse feedback, bass boost and a mixing network for microphone and phono. This is not the case, for in most of the contemplated uses, only close mike work will be employed. A bridge input circuit will be designed for recording off a 500 ohm line. This will be built right into the patch board.

(Continued on page 173)

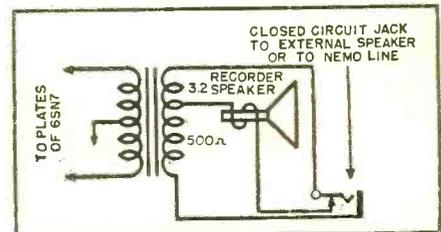

Fig. 1. Speaker modifications.

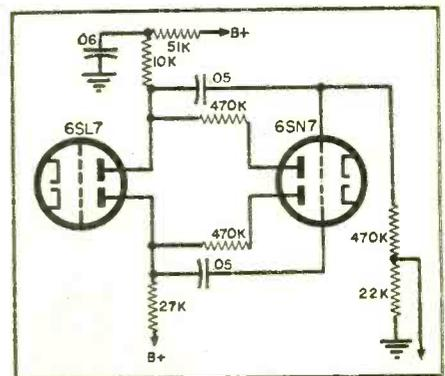
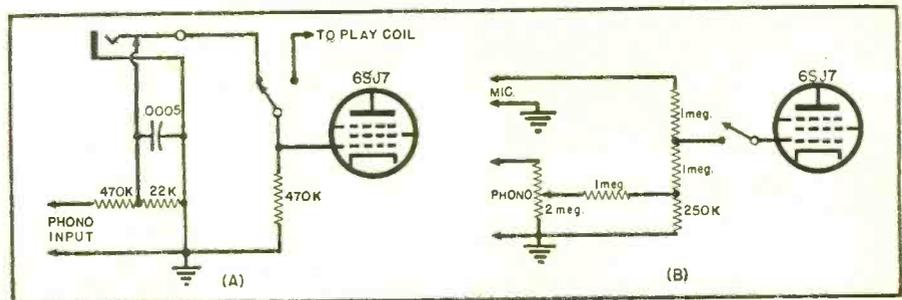

Fig. 2. Bass boost and inverse feedback circuits were added.

Fig. 3. Diagram shows necessary conversion of mixer circuit; (A) before, and (B) after.



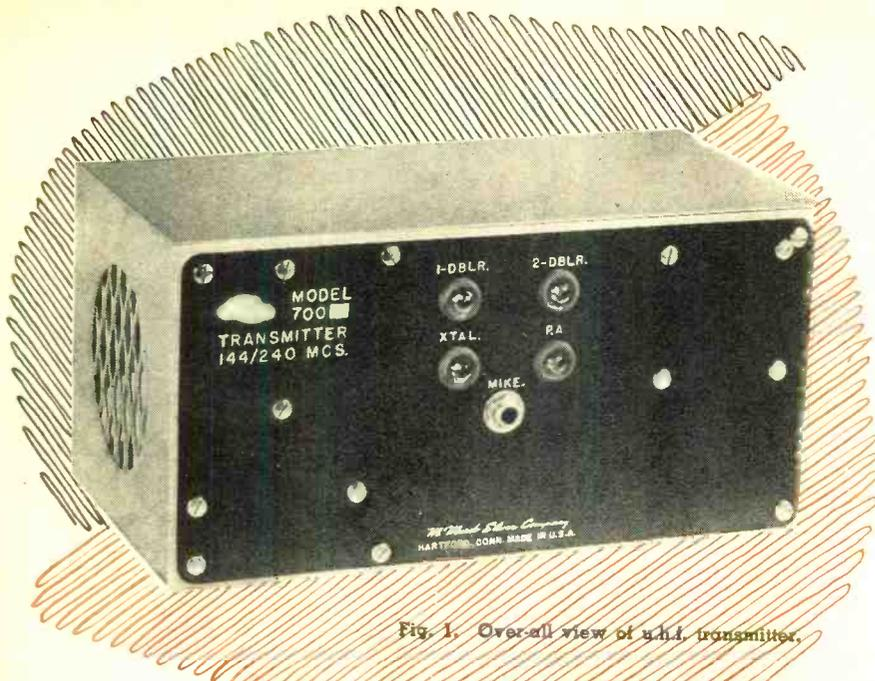

Fig. 1. Over-all view of u.h.f. transmitter.

Putting XTAL Control to Work

By McMURDO SILVER
McMurdo Silver Company

The extension of xtal control to 2½ and 1¼ meters makes for improved communication. Here's easy way to get its present-day mandatory advantages.

AS PROGRESSIVELY higher frequency bands have been opened to amateur occupancy over the years, equipment to take full advantage of their possibilities has had to be developed. In practically every case of frequency extension, each new band has at first been occupied by "modulated oscillator" transmitters and the simpler "rush-box" receivers. As equipment design possibilities and operating experience have grown through such occupancy, what we might term these "can openers" of new bands have been progressively refined or replaced by more efficient instrumentalities.

In the case of transmitters, modulated oscillators are inefficient upon two points. Inescapable and undesirable frequency modulation causes each signal to spread out so that, even in multi-megacycle-wide u.h.f. bands, there is very soon not enough space to allow all who want to operate therein to do so without excessive interference. At the same time the total power delivered by the transmitter to the antenna is spread across such a wide swath—far wider than required

for voice communication—that the effective signalling power is actually far below the generated and radiated power.

The above thoughts are far from original and are known to practically every amateur today. The question is, rather, how does one get the energy-concentrating, interference eliminating benefits of crystal control at the higher frequencies simply and effectively?

The shortest distance between two points is a straight line, as we were all taught in school. The "straight line" is to utilize known and proven techniques. This would involve a relatively low frequency oscillator followed by enough multiplier stages to drive a suitable power amplifier at the desired output frequency. One could resort to harmonic-mode operation of special crystals to obtain oscillator output at relatively high frequencies. Harmonic crystals are not too happy a solution, for total circuit cost, complexity, and the ever-present question of "how it's going to work after it's built" seem to suggest that a fundamentally-cut crystal, plus pos-

sibly one doubler or tripler stage, will bring us out at about the same point as would the harmonic-mode crystal oscillator.

Fortunately war development brought fundamental crystal cuts, up through 14 mc., within reach of every pocketbook. Using such a crystal we can get good output on its third harmonic from a single tube in the time-tested tritet circuit. From a construction and "firing-up" standpoint nothing tricky, unusual, or unfamiliar is involved. Also, fortunately, the war turned the development in the direction of more and better "miniatures"—decidedly better for u.h.f. operation because of decreased lead inductance and interelectrode capacity. Such tubes make getting up to 144 mc. just about as straightforward as getting from 80 down to 20 meters in familiar low-frequency transmitters. Coils can be wound small for u.h.f. work, while condensers that do not turn into coils as frequency is raised are readily available today.

Working along these lines, the transmitter here illustrated and described was designed and tested with most satisfying initial results at W1IJ, and has since gone into service in hundreds of u.h.f. stations. It is a straightforward and trickless design, intentionally made small enough for mobile operation as well as to occupy a minimum of priceless living space in today's often crowded "shack." Because it is crystal controlled, therefore pretuned to the frequency of the particular crystal in use, no tuning dials appear on its panel. So simple is the front panel of Fig. 1 that it would be hard to identify this compact little unit as a transmitter if it were not for the descriptive legend! All that is visible upon the etched "face-plate" are four plate-current-indicating flashlight bulbs to check tune-up and operation, and a microphone jack!

With no more than change of crystal and final amplifier plate "line," reset of the antenna coupling "hair-pin," operation can be shifted from 2½ to 1¼ meters. This simplicity of frequency shift from one band to another comes about through use of twelve times total multiplication of the frequency of a crystal lying between 12 and 12.333+ mc. for 144/148 mc. output; of eighteen time multiplication of a 13.005+ to 13.333+ mc. xtal for 235/240 mc. output. Only two out of a total of five tuned circuits need be retuned to a new and different frequency range to shift from 2½ to 1¼ meter output. This is a good start in the direction of desirable simplicity.

Figs. 1, 2 and 3 illustrate and diagram this Silver Model 700 u.h.f. transmitter. It is convenient to examine its design, tune-up and operating capabilities in terms thereof. The white-on-black etched aluminum panel shown in Fig. 1 is 5" high, 10" long, and faces a gray-enamel, hinged-cover cabinet of the same size but 5¼" deep to house the entire trans-

mitter. Mounted upon this panel are the four current indicating lamps, PL_1 , PL_2 , PL_3 , and PL_4 of Fig. 2, together with the 1-circuit jack J_1 , to receive the plug terminating the cord of a carbon microphone—which can best be the F1 transmitter unit manufactured by *Western Electric Co.*, and found in the familiar desk telephone hand set.

Fig. 2 shows the simplicity of the operating circuit. At the upper left is the xtal-controlled 6AQ5 (miniature 6V6 beam tetrode tube) triode oscillator-tripler. Panel lamp PL_1 indicates operating crystal current—allowably considerably higher for 12 to 14 mc. xtals than for lower frequency prewar xtals. Lamp PL_2 also serves as the always-desirable fuse for protection of the xtal in case of accidental overload. L_1 and C_1 comprise the triode cathode tuned circuit which is tuned approximately to xtal frequency, finally set slightly on the low-capacity side of point of maximum brilliancy of PL_1 , just as in any triode tune-up. In Fig. 3 cathode condenser C_1 is below the xtal just to the right of the lower 6AQ5 tube. In fact, the whole circuit progression from "XTAL" to C_{11} of Fig. 2 is carried out in a horizontal line in the physical assembly of Fig. 3, in the row of four rotary concentric tuning condensers and three tubes along the bottom, as it is in the diagram of Fig. 2, but reversed left-to-right. This makes for short leads between tuning condensers, coils, and tubes.

Triode oscillator plate circuit, C_2 and L_2 is designed to tune to three times xtal frequency. Tripling of frequency thus occurs in the oscillator itself, with good power output in the range of 36 to 40 mc., as determined by user choice of xtal and output frequency. One tube, one xtal and two simple low-cost tuned circuits have yielded output close enough to $2\frac{1}{2}$ and $1\frac{1}{4}$ meter band frequencies so that only two simple frequency-multiplying stages are required!

The tripled xtal frequency output of the oscillator is now doubled in frequency by the first 6C4 miniature u.h.f. triode fed from the oscillator plate circuit to develop 72 to 80 mc. output across its tuned plate circuit L_3 , C_6 . The second 6C4 has a "long-line" capacitively loaded plate circuit L_4 , C_{11} . This line is closely coupled to the grid line L_5 feeding the push-pull grids of the 832 final power amplifier, which always works "straight-through" on final output frequency. Tight coupling of L_4 to L_5 allows both circuits to be tuned simultaneously by condenser C_{11} , across the 6C4 plate line.

For 144/148 mc. output C_{11} loads the line to this frequency. For 235/240 mc. output the capacity of C_{11} is reduced to resonate to the higher frequency band. At first glance it would seem as though line lengths at L_4 and L_5 should be altered to affect this sizable frequency change with good efficiency. Actually, not changing the

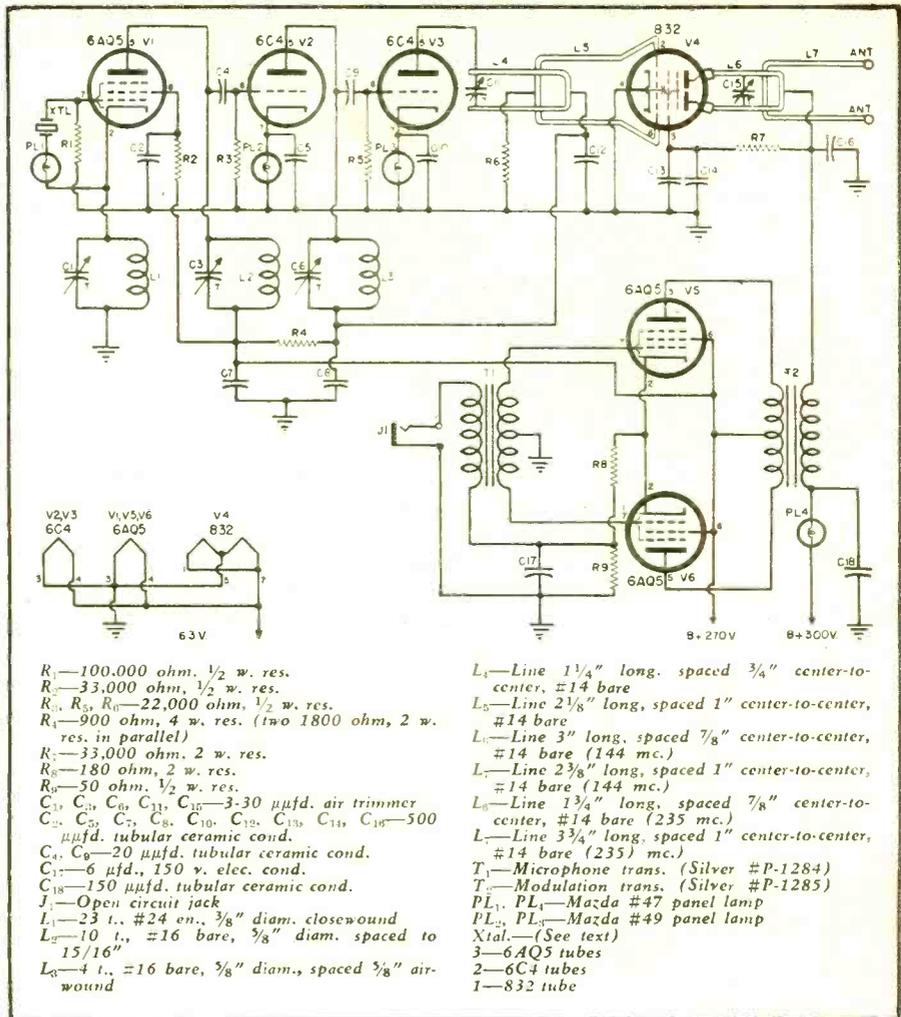

Fig. 2. Schematic diagram of crystal-controlled transmitter. Unit covers 144-148 and 235-240 mc. bands. Only one tuned circuit must be changed to switch bands.

line lengths operates to provide automatic driving power compensation. When the second 6C4 doubles to 144/148 mc. the tube output is higher than when it triples to 235/240 mc. At the same time the L_5 , C_{11} circuit efficiency is just opposite, since it performs best with minimum capacitive loading. The result of these two opposite effects is to balance drive to the

832 to maintain substantially the same drive on both bands—something obviously desirable.

Tuning condensers C_1 , C_3 , C_6 , and C_{11} are located in the same horizontal line in Fig. 3 along which the 6AQ5 tube and the two 6C4 frequency multipliers are shown. It is evident that from the close proximity of these

(Continued on page 157)

Fig. 3. Chassis layout shows proper placement of tubes and tuned circuits.

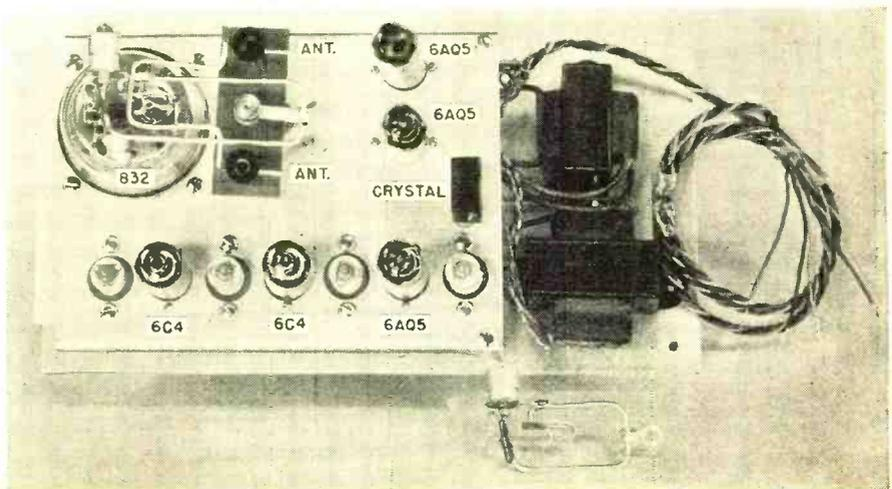



International SHORT-WAVE

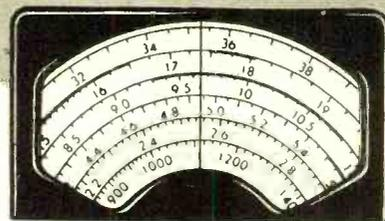

Compiled by **KENNETH R. BOORD**

THIS worldwide log covers short-wave broadcasting stations from 2 to 35 megacycles (2000-35,000 kilocycles), which are now in operation or are likely to become active in the near future, as well as a few point-to-point stations used on occasion to relay broadcast material.

Stations marked with an asterisk (*) are inactive; these include those temporarily off the air, stations formerly audible but not heard recently and therefore presumed to be off the air, and additional channels of stations currently active on other frequencies. The reader is reminded that stations change frequencies often, and that schedules are subject to change without notice.

The symbol (#) indicates stations not yet on the air, including transmitters under construction or installed as projected stations for which official frequency assign-

ments have been made but not in operation at the present.

The letter "V" indicates the frequency has been observed to fluctuate considerably over a long period of time. In most other frequency quotations, the figure given is the exact frequency upon which the station actually transmits, as measured with precision equipment by reliable sources; this often deviates from the assigned or announced frequency; for purposes of simplification, in most instances, only deviations of more than one kilocycle have been incorporated into this list.

Wherever possible, the power quoted is the actual operating power; this sometimes differs from the licensed power, since some transmitters are not operated at full capacity.

NOTE: To convert frequency (megacycles) to wavelength (meters), divide 300 by the frequency.

WORLDWIDE LOG OF SHORT-WAVE BROADCASTING STATIONS

- 2.070—Tokyo, Japan
- 2.082—YBJ2, Djokjakarta, Java, "Radio Repoebliek Indonesia"
- 2.228—CZ5B, La Malbia, Quebec, Canada.
- *2.312—HNB, Baghdad, Iraq, 5 kw.
- 2.235—YDA3, Batavia, Java, Indonesian Broadcasting Service, 250 w.
- 2.235—Jakarta III, Indonesia, "Radio Repoebliek Indonesia"
- 2.240—YDB, Batavia, Java, 00 w.
- *2.320—TGE, Guatemala City, Guatemala, "Radio Morse," 300 w.
- *3.320—TGWC, Guatemala City, Guatemala, "La Voz de Guatemala," 1 kw.
- *2.330—ZQI, Kingston, Jamaica, B.W.I., 200 w.
- 2.335—Kebumen, Java, "Radio Repoebliek Indonesia"
- *2.340—HOA, Panama City Panama, "Radio Pan-Americana," 1 kw.
- *2.370—XEIW, Chihuahua, Mexico, "Radio Emisora del Norte," 250 w.
- *2.380—Bandoeng, Java
- *2.385—Fort-de-France, Martinique, "Radio Martinique," 200 w.
- *2.390—WVL, Quarry Heights, Panama Canal Zone, AFRS, 400 w.
- *2.394—Vienna, Austria, "Radio Wien," 300 w.
- 2.400—Central Java, "Radio Repoebliek Indonesia"
- 2.410—AEXE, Tlaxcala, Mexico, 100 w.
- 2.437—HRN, Tegucigalpa, Honduras, "La Voz de Honduras," 200 w.
- 2.465—WLKS, Kure, Japan, British Commonwealth Occupation Forces Radio
- 2.500—WVW, Washington, D.C., U.S.A., Bureau of Standards, 700 w.
- 2.510—RWS1, Semarang, Java, "Radio Welvaart Semarang," 60 w.
- 2.510—JODK, Seoul, Korea, "Korean Broadcasting System," 5 kw.
- 2.600—Jakarta II, Indonesia, "Radio Repoebliek Indonesia"
- 2.600—YDD, Batavia, Java, 200 w.
- 2.625—Prishtina, Yugoslavia.
- 2.651—Malang, Java, "Radio Repoebliek Indonesia."
- *2.880—GRC, London, 100 kw.
- *2.880—Hamburg, Germany, 50 kw.
- 2.889—Purwokerto, Java, "Radio Repoebliek Indonesia"
- 2.955—SUU2, Cairo, Egypt, 10 kw.
- *2.995—Labuan, British North Borneo
- *3.010—WLXJ, Tokyo, Japan
- 3.015—YDA, Bandoeng-Chimulu, Java, "Radio Omroep Bandoeng," 5 kw.
- *3.075—JZC, Tokyo, Japan, AFRN, 10 kw.
- 3.183—Jakarta I, Indonesia; "Radio Repoebliek Indonesia"
- 3.228—HDZ, Riobamba, Ecuador, "La Voz del Chimborazo," 250 w.
- 3.240—YDI, Soerabaja, Java, "Radio Omroep Soerabaja," 250 w.
- *3.250—J09G, Niigata; J05A, Matsuyama; J06D, Fukuoka; J08F, Sapporo, Japan; all 300 w.
- 3.252—Indonesia, "Radio Repoebliek Indonesia"
- *3.305—VUC2, Calcutta, India, AIR, 10 kw.
- 3.310—YV1RO, Trujillo, Venezuela, "Radio Trujillo," 625 w.
- 3.320—Jaffa, Palestine, "Sharq-al-Adna," 2.5 kw.
- *3.335—VUD3, Delhi, AIR, 5 kw.
- *3.340—Teheran, Iran, "Radio Teheran," 2 kw.
- *3.345—J03E, Osaka; J07E, Sendai, Japan; both 300 w.
- 3.350—YBK3, Soerakarta, Java, "Radio Repoebliek Indonesia"
- *3.360—ZOH, Colombo, Ceylon, 7.5 kw.
- *3.365—VUB2, Bombay, India, AIR, 10 kw.
- 3.365—ZEA, Salisbury, Southern Rhodesia
- 3.370—YV1RT, Maracaibo, Venezuela, "La Voz de la Fe," 455 w.
- 3.371—Soerakarta, Java.
- *3.380—YV5RY, Caracas, Venezuela, "Radio Continente," 1.03 kw.
- *3.390—YV4RK, Maracay, Venezuela, 300 w.
- 3.395—Colombo, Ceylon, "Radio SEAC," 1 kw.
- 3.400—Umtali, Southern Rhodesia, 750 w.
- 3.400—YV5RW, Caracas, Venezuela, "Radio Tropical," 750 w.
- 3.410—Budapest, Hungary
- 3.410—Madioen, Java, "Radio Repoebliek Indonesia"
- *3.420—VONI, St. John's, Newfoundland, 300 w.
- 3.420—YV2RC, Merida, Venezuela, "La Voz de la Sierra," 920 w.
- 3.430—LRS2—Buenos Aires, Argentina, "Radio Splendid"
- 3.430—YV4RK, Maracay, Venezuela, "Radio Maracay," 300 w.
- *3.435—VUM2, Madras, India, AIR, 500 w.
- 3.435—Tasikmalaya, Java, "Radio Repoebliek Indonesia"
- 3.440—YV1RU, Maracaibo, Venezuela, "Radio Maracaibo," 680 w.
- 3.440—Port Stanley, Falkland Islands
- *3.450—Johannesburg, South Africa, SABC (Johannesburg III), 5 kw.
- *3.450—YV3RS, Barquisimeto, Venezuela
- 3.450—YV6RH, Barcelona, Venezuela, "Emisoras Unidas," 5 kw.
- 3.460—YV4RP, Valencia, Venezuela, "Radio Valencia," 680 w.
- 3.475—J09H, Tokyo, Japan, 300 w.
- 3.475—J04D Hiroshima, Japan, 300 w.
- 3.475—HNC, Baghdad, Iraq, 5 kw.
- 3.480—YV4RQ, Puerto Cabello, Venezuela, "Radio Puerto Cabello," 575 w.
- 3.480—ZQJ, Kingston, Jamaica, B.W.I., 200 w.
- 3.489—XZZ—Rangoon, Burma, "Radio Rangoon"
- *3.490—YV3RS, Barquisimeto, Venezuela, 650 w.
- 3.493—CR7AB, Lourenco Marques, Mozambique, "Radio Mozambique," 600 w.
- 3.495—VUD2, Delhi, AIR, 10 kw.
- 3.495—Nagoya, Japan
- 3.498—CR7IC, Beira, Mozambique, "Aero
- Clube da Beira," 100 w.
- 3.505—YV5RX, Caracas, Venezuela, "La Voz de la Patria," 1.75 kw.
- 3.515—YV6RC, Barcelona, Venezuela, "Emisoras Unidas," 6 kw.
- 3.529—HCK, Quito, Ecuador
- 3.530—YV5RS, Caracas, Venezuela, "Radio Libertador," 950 w.
- 3.532—Pekalongan, Java, "Radio Repoebliek Indonesia"
- 3.541—YV4RM, Maracay, Venezuela
- 3.558—YV2RM, San Cristobal, Venezuela
- 3.570—YV3RD, Caracas, Venezuela, "Radio Cultura," 2.5 kw.
- *3.571—HCT, Guayaquil, Ecuador, 2 kw.
- *3.580—YV3RS, Barquisimeto, Venezuela
- 3.590—YV7RB, Cumana, Venezuela, "Radio Sacre," 400 w.
- 3.590—Osaka, Japan, 500 w.
- 3.600—Indonesia, "Radio Repoebliek Indonesia"
- *3.600—VPC, Port Stanley, Falkland Islands
- *3.615—HBQ3, Geneva, Switzerland, 40 kw.
- 3.628—Magelang, Java, "Radio Repoebliek Indonesia"
- *640—Northern Rhodesia
- 3.641—Indonesia, "Radio Repoebliek Indonesia"
- *3.658—Valladolid, Spain
- 3.665—Salisbury, Southern Rhodesia.
- *3.708—HCVT, Ambato, Ecuador, "La Voz de Tunsuragua," 250 w.
- *2.710—HCQRX, Quito, Ecuador, "Radio Quito," 250 w.
- *3.748—Kediri, Java, "Radio Repoebliek Indonesia"
- *3.750—Moscow
- 3.783—Soerakarta, Java
- *3.790—JOAK, Tokyo-Kawaguchi, Japan
- 3.797—Tjilatjap, Java, "Radio Repoebliek Indonesia."
- 3.800—Bulawayo, Southern Rhodesia, 100 w.
- 3.800—Osaka, Japan, 100 w.
- 3.830—Magadan, Khabarovsk Territory, USSR
- 3.914—ZQP, Lusaka, Northern Rhodesia, 500 w.
- *3.925—Fukuoka, Japan
- 3.931—Pati, Java, "Radio Repoebliek Indonesia"
- 3.932—HC5EH, Ciudad Cuenca, Ecuador, "La Voz de Tomebamba," 500 w.
- *3.965—J06E, Kumamoto; J02J, Nagoya, Japan; both 300 w.
- 3.975—Prishtina, Yugoslavia
- 4.000—Garčet, Java, "Radio Repoebliek Indonesia"
- 4.020—HCVI, Ibarra, Ecuador, "La Voz de Inbatura," 250 w.
- 4.025—GRU, Royal Observatory (Greenwich)
- *4.044—Ponta Delgada, Azores, 1 kw.
- 4.044—Java, "Radio Repoebliek Indonesia"
- 4.050—JOAK, Tokyo, Japan, 300 w.
- *4.060—Jaffa, Palestine, "Sharq-al-Adna," 7.5 kw.
- 4.106—Java

- 4.108—HCJB. Quito, Ecuador. "La Voz de los Andes." 1 kw.
- 4.120—Pegal. Java. "Radio Repoeblk Indonesia." 1 kw.
- 4.136—Ulan-Ude, USSR (Buryat Mongol S.S.R.).
- 4.137—Salatiga, Java. "Radio Repoeblk Indonesia." 1 kw.
- 4.138—HSEH. Korea.
- 4.200—HC5EH. Ciudad Cuenca, Ecuador. 500 w.
- 4.211—Purwokerto, Java. "Radio Repoeblk Indonesia." 1 kw.
- 4.275—XMAG. Nanking, China. AFRS. 1 kw.
- 4.290—COX7. Havana, Cuba. "Radiodifusora del Ministerio de Educacion." 5 kw.
- 4.363—Djokjakarta, Java.
- 4.366—YDI2. Soerabaja, Java. "Radio Resmi Soerabaja." 300 w.
- 4.370—Tananarive, Madagascar. "Radio Tananarive." 300 w.
- 4.377—Johannesburg, South Africa, SABC (Johannesburg V). 200 w.
- 4.380—Petrovlovsk, USSR.
- 4.385—Matsuyama, Japan. 300 w.
- 4.400—JBBK, Pyongyang, Korea. 15 kw.
- *4.412—Damasus, Syria.
- *4.510—Manama, Bahrain Island.
- *4.510—Khabarovsk, U.S.S.R. (R.S.F.S.R., Siberia).
- *4.559—Moscow.
- 4.559—HC4SU (?), Ciudad Esmeralda, Ecuador.
- 4.600—Salatiga, Indonesia. "Radio Repoeblk Indonesia." 1 kw.
- 4.615—Bukit Tinggi, Sumatra. "Radio Repoeblk Indonesia." 1 kw.
- 4.630—Djember, Java. "Radio Repoeblk Indonesia." 1 kw.
- 4.650—Batavia, Java.
- 4.650—HC2AA. Guayaquil, Ecuador. "CRE, Compania Radiodifusora de Ecuador." 1 kw.
- *1.650—Leningrad, USSR.
- 4.660—SUC2, Cairo, Egypt. 10 kw.
- 4.665—HHCA. Port-au-Prince, Haiti. "Haitienne Broadcasting Co." 75 w.
- 4.677—Salatiga, Java. "Radio Repoeblk Indonesia." 1 kw.
- 4.680—Batavia, Java.
- *4.690—Batam, Georgia, U.S.S.R.
- *1.700—ZQI, Kingston, Jamaica, B.W.I.
- 4.712—HC2ET. Guayaquil, Ecuador. "Radio El Telegrafo." 1 kw.
- 4.724—Soerabaja, Java. "Radio Repoeblk Indonesia." 1 kw.
- 4.724V—Modjokerto, Java. "Radio Repoeblk Indonesia." 1 kw.
- 4.724V—YV5RY, Caracas, Venezuela. "Radio Continente." 1.03 kw.
- 4.725—HC5B. Punta, Ecuador. "Radio Libertad." 1 kw.
- 4.730—Tonkin, French Indo-China. "The Voice of Vietnam." 1 kw.
- 4.752—YV1RV, Maracaibo, Venezuela. "Ecos del Zulia." 195 w.
- 4.759V—XUSA, Chungking, China.
- *1.760—YV5RV, La Guaira, Venezuela. "Emisora Vargas." 327 w.
- 4.765—HC4FA, Portoviejo, Ecuador. "La Voz de Manabi." 100 w.
- 4.769—YV1RY, Coro, Venezuela. "Radio Coro." 215 w.
- 4.775—HJGB, Bucaramanga, Colombia. "Radio Santander." 2.5 kw.
- *1.775—HND, Baghdad, Iraq. 5 kw.
- *4.778—Singapore, Malaya. "Radio Malaya." 1 kw.
- 4.781—YV4RC, Valencia, Venezuela. "La Voz de Carabobo." 2.5 kw.
- 4.783—HJAB, Barranquilla, Colombia. "Emisora Unidas." 2.5 kw.
- 4.785—Sao Luiz, Brazil. "Radio Ribamar." 1 kw.
- 4.790—YV6RU, Ciudad Bolivar, Venezuela. "Ecos del Orinoco." 620 w.
- 4.790—Bandoeng, Java.
- 4.790—EQD, Teheran, Iran. "Radio Tehran." 2 kw.
- 4.794—HUB, San Salvador, El Salvador. "Alma Suscaiteca." 300 w.
- 4.795—HJDX, Medellin, Colombia. "Ecos de la Montana." 1 kw.
- 4.800V—YV1RX, Maracaibo, Venezuela. "Ondas del Lazo." 2 kw.
- 4.800—Lourenco Marques, Mozambique. "Radio Mozambique." 1 kw.
- 4.805—HJDU, Medellin, Colombia. "Emisora Cultural." 500 w.
- 4.805—HJDC, Quibdo, Colombia. "Direccion de Educacion." 500 w.
- 4.807—St. Denis, Reunion. "Radio St. Denis." 80 w.
- 4.810—YV1RL, Maracaibo, Venezuela. "Radio Popular." 225 w.
- *4.812—Saigon, French Indo-China. "Radio Saigon." 12 kw.
- 4.815—HJBB, Cucuta, Colombia. "La Voz de Cucuta." 1 kw.
- 4.818—HCK, Quito, Ecuador.
- *4.820—CE482, Antofagasta, Chile. "La Voz del Norte." 5 kw.
- 4.820—XEJG, Guadalajara, Mexico. 200 w.
- *4.820—Singapore, Malaya.
- 4.825—PRJ4, Paranaiba, Brazil. "Radio Educadora de Paranaiba." 500 w.
- 4.825—HJED, Cali, Colombia. "La Voz del Valle." 1 kw.
- *4.825—Stalingrad, U.S.S.R.
- 4.825—Singapore, Malaya. "Radio Malaya." 1 kw.
- 4.825—Alma-Ata (Kazakh S.S.R.), U.S.S.R.
- *4.826—Bathurst, Gambia.
- 4.829—YV2RN, San Cristobal, Venezuela. "La Voz de la Tachira." 1.3 kw.
- 4.835—VL6KG, Kalkoorlie, Western Australia. "The Voice of the Goldfields." 1 kw.
- 4.835—HJKE, Bogota, Colombia. "Radio Continental." 2.5 kw.
- 4.835—CR7BV, Lourenco Marques, Mozambique.
- 4.835—Soerabaja, Java.
- 4.840—YUC2, Calcutta, India. AIR. 10 kw.
- 4.840—YV1RZ, Valera, Venezuela. "Radio Valera." 315 w.
- 4.840—Frunze (Kirghiz S.S.R.), U.S.S.R.
- 4.840—Quito, Ecuador. "Radiodifusa. Gran Colombia." 1 kw.
- 4.845—CSX2, Ponta Delgada, Azores, "Emisora Regional Azores." 1 kw.
- 4.847V—HJGF, Bucaramanga, Colombia. "Radio Bucaramanga." 2.5 kw.
- 4.851—Central Java. "Radio Repoeblk Indonesia." 1 kw.
- 4.855—YQ7LO, Nairobi, Kenya. 1.5 kw.
- *4.855—Pietermaritzburg, South Africa, SABC. 500 w.
- 4.855—Bandoeng, Java.
- *4.855—Northern Rhodesia.
- 4.857—HJCA, Bogota, Colombia. "Radio Cristal." 1 kw.
- *4.857—YDX, Medan, Sumatra.
- *4.860—VUD3, Delhi, AIR. 5 kw.
- *4.860—YVD10, Delhi, AIR. 20 kw.
- 4.860—YVD11, Delhi, AIR. 20 kw.
- 4.860—JKE2, Yamata, Japan. AFRN. 1 kw.
- 4.860—YV3RM, Barquisimeto, Venezuela. "Radio Universal." 1 kw.
- 4.865—PRC5, Belem, Para. Brazil. "Radio Clube do Para." 2 kw.
- 4.865—YDD2, Batavia, Java. 300 w.
- 4.865—HJEX, Cali, Colombia. "Radio Pacifico." 2.5 kw.
- 4.868—Batavia, Java. "Radio Batavia." 300 w.
- 4.870—Tiflis (Georgian S.S.R.), U.S.S.R.
- *4.870—Lourenco Marques, Mozambique.
- 4.875—HJFH, Armenia, Colombia. "La Voz de Armenia." 1 kw.
- 4.878—Pietermaritzburg, South Africa, SABC. 500 w.
- 4.880—Pietermaritzburg, South Africa, SABC. 500 w.
- *1.880—ZAA, Tirana, Albania. "Radio Tirana." 3 kw.
- 4.880—VUB2, Bombay, India. AIR. 10 kw.
- 4.880—YV5RU, Caracas, Venezuela. "Ondas Populares." 1.34 kw.
- 4.885—HJDP, Medellin, Colombia. "Emisora Ciudad." 1 kw.
- 4.885—YQ7LO, Nairobi, Kenya. 1.5 kw.
- *4.893—FHE0, Dakar, Fr. West Africa. "Radio Dakar." 1 kw.
- 4.895—PRF6, Manaus, Brazil. "Radio Bare." 250 w.
- 4.895—HJCH, Bogota, Colombia. "La Voz de la Victor." 3 kw.
- 4.895—Johannesburg, South Africa, SABC (Johannesburg III). 5 kw.
- 4.895—YDZ, Elak, Dutch New Guinea. 40 w.
- 4.897—ZOH, Colombo, Ceylon. "Ceylon Broadcasting Station." 7.5 kw.
- 4.900—CR7BV, Lourenco Marques, Mozambique.
- *1.900—Lusaka, Northern Rhodesia.
- 4.903—HJAG, Barranquilla, Colombia. "Emisora Atlantico." 1 kw.
- 4.906—Bogota, Colombia. "La Voz de Bogota." 1 kw.
- 4.910—JKF2, Nasuki, Japan. "N.H.K." 5 kw.
- 4.910—YDB2, Batavia, Java. "Radio Resmi Indonesia." 300 w.
- 4.915—ZOY, Accra, Gold Coast. 5 kw.
- 4.915—YV5RN, Caracas, Venezuela. "Radio Caracas." 5 kw.
- 4.915—CR7BV, Lourenco Marques, Mozambique. "Radio Mozambique." 1 kw.
- 4.920—VUM2, Madras, India. AIR. 10 kw.
- 4.923—HJAP, Cartagena, Colombia. "Radio Colonial." 1 kw.
- *4.925—CR7BF, Lourenco Marques, Mozambique. "Radio Mozambique." 7.5 kw.
- 4.926—YBK, Soerakarta, Java. "Radio Repoeblk Indonesia." 1 kw.
- 4.930—Solo, I. Indonesia. "Radio Repoeblk Indonesia." 1 kw.
- 4.930—JKG2, Kawachi, Japan. "N.H.K." 5 kw.
- 4.940—YV3RN, Barquisimeto, Venezuela. "Radio Barquisimeto." 300 w.
- 4.945—HJCV, Bogota, Colombia. "Emisora Sur America." 1 kw.
- 4.945—SDV2, Athens, Greece.
- *1.950—YQ7LO, Nairobi, Kenya. 1.5 kw.
- 4.950—ZQI, Kingston, Jamaica, B.W.I. 200 w.
- 4.955—HJCO, Bogota, Colombia. "Radiodifusora Nacional." 1 kw.
- *1.960—VUD2, Delhi, AIR. 10 kw.
- 4.960—Batavia, Java.
- 4.960—HC5HC, Riobamba, Ecuador. "Radiodifusora Onda de Chimborazo." 1 kw.
- 4.963—HJAE, Cartagena, Colombia. "La Voz de los Laboratorios Fuentes." 1 kw.
- 4.970—YV5RM, Caracas, Venezuela. "Radiodifusora Venezuela." 4.72 kw.
- 4.975—HJAG, Barranquilla, Colombia.
- *4.990—YV3RN, Marquisimeto, Venezuela.
- 4.990—YV3RS, Barquisimeto, Venezuela. "Radiodifusora Occidental." 650 w.
- 5.000—WVV, Washington, D.C., U.S.A., Bureau of Standards. 8 kw.
- 5.005—Indonesia.
- 5.019—YVKO, Caracas, Venezuela. "Radiodifusora Nacional." 10 kw.
- *5.020—YFA10, Makassar, Celebes, N.E.I., 500 w.
- *5.030—Leningrad, U.S.S.R.
- *5.040—Tiflis (Georgian S.S.R.), U.S.S.R.
- 5.042—St. Lucia, B.W.I.
- *5.058—TPI, Reykjavik, Iceland. 7 kw.
- *5.059—Frunze (Kirghiz S.S.R.), U.S.S.R.
- *5.060—YFA10, Makassar, Celebes, N.E.I., 500 w.
- *5.080—Grozny (Chechen, A.S.S.R.), U.S.S.R.
- 5.085—Bandung, East Java. "Radio Repoeblk Indonesia." 1 kw.
- *5.090—Moscow.
- 5.090—YFA10, Makassar, Celebes, N.E.I., "Radio Makassar." 500 w.
- 5.145—PMY, Bandoeng, Java.
- *5.150—Tadzhik S.S.R., U.S.S.R.
- 5.250—LPC, Ushuaia, Tierra del Fuego, Argentina.
- *5.260—Salisbury, Southern Rhodesia.
- *5.260—Lusaka, Northern Rhodesia.
- 5.274—Pamekasan, Madoera. "Radio Repoeblk Indonesia." 1 kw.
- 5.302—DTYC, Munich, Germany. American Military Government. 100 kw.
- *5.320—Yakutsk, U.S.S.R.
- 5.360—Moscow.
- *5.390—Moscow.
- *5.440—Moscow.
- 5.450—Samarkand (Uzbek S.S.R.), U.S.S.R.
- 5.455—Batavia, Java.
- 5.480—YCN, Pontianak, Dutch Borneo. "Radio Pontianak." 40 w.
- *5.510—WLXJ, Shanghai, China.
- *5.530—OAX1B, Piura, Peru.
- 5.574—Batavia, Java.
- 5.580—HJCT, Tulcan, Ecuador. "La Voz del Carchi." 250 w.
- *5.590—OAX1B, Piura, Peru. "Radio Piura." 300 w.
- 5.620—YBJ, Djokjakarta, Java. "Radio Repoeblk Indonesia." 1 kw.
- *5.622—Rome, Italy.
- *5.637—BFN, Hamburg, Germany.
- 5.640—OAX2A, Trujillo, Peru. "Radio Trujillo." 250 w.
- *5.652—RV-19, Ashkabad, U.S.S.R.
- 5.660—HHCN, Port-au-Prince, Haiti. 100 w.
- 5.680—Indonesia.
- 5.706—OAX1B, Piura, Peru. "Radio Piura." 300 w.
- 5.720—Magadan (Khabarovsk Territory), U.S.S.R.
- 5.726V—HC1PM, Quito, Ecuador. "El Palomar." 150 w.
- *5.730—Damasus, Syria. "Radio Damasus." 1 kw.
- *5.732—SDB, Motala (Stockholm), Sweden. 12 kw.
- *5.732—Leningrad, U.S.S.R.
- *5.750—ZMB2, Apia, Western Samoa.
- *5.757—PRH5, Paramaribo, Surinam. 350 w.
- 5.758—YNIAT, Leon, Nicaragua. "La Voz del Aire." 500 w.
- *5.765—JZN, Tokyo, AFRN. 10 kw.
- 5.776—Santiago, Chile. "Radio Sociedad Nacional de Agricultura." 1 kw.
- 5.780—Batavia, Java.
- *5.785—Cairo, Egypt.
- 5.790V—Indonesia.
- 5.800—CE8AA, Santiago, Chile.
- 5.802—Batavia, Java. "Radio Noesantara." 1 kw.
- *5.810—Moscow.
- 5.810—CE8AA, Santiago, Chile.
- 5.820—WXP6, Adak, Aleutians, U.S.A.
- 5.844—PZH5, Paramaribo, Surinam. "Avros Paramaribo." 350 w.
- 5.855—CP15, La Paz, Bolivia. "Radio El Condor." 350 w.
- *5.858—Brazzaville, French Equatorial Africa.
- *5.860—CR7AA, Lourenco Marques, Mozambique. "Radio Mozambique." 300 w.
- *5.865—ZOY, Accra, Gold Coast.
- 5.866—CR4AA, Praia, Cape Verde Islands. "Radio Clube de Cabo Verde." 30 w.
- 5.870—TIGPH, San Jose, Costa Rica. "Alma Rica." 1 kw.
- 5.875—HRN, Tegucigalpa, Honduras. "La Voz de Honduras." 750 w.
- 5.878—Capetown, South Africa, SABC. 5 kw.
- 5.880—YNCS, Managua, Nicaragua.
- *5.885—HCK, Quito, Ecuador. "Radio Nacional." 300 w.
- *5.885—CE8AA, Santiago, Chile.
- 5.880V—CP15, La Paz, Bolivia.
- 5.894—OAX4Z, Lima, Peru. "Radio Nacional del Peru." 14 kw.
- 5.890—Moscow.
- *5.900—Moscow.
- *5.900—LRM, Mendoza, Argentina. 10 kw.
- 5.900—ZNB, Mafeking, Bechuanaland. 200 w.
- *5.900—CRV3, Macao, Portuguese China.
- 5.907—OAX4V, Lima, Peru. "Radio America." 500 w.
- *5.917—XGOA, Nanking, China. 10 kw.
- 5.919—Berlin, Germany.
- 5.920—Moscow.
- *5.935—PJCI, Willemstad, Curacao. "Radio Princes Juliana." 5 kw.
- 5.940—RV15, Khabarovsk, U.S.S.R. 20 kw.
- 5.943—Godthaab (?), Greenland.
- 5.945—Manama, Bahrain Island.
- 5.948—HH2S, Port-au-Prince, Haiti. "Societe Haitienne de Radiodiffusion." 300 w.
- *5.950—Moscow.
- *5.955—OAX4V, Lima, Peru. 500 w.
- 5.957—Moscow.
- *5.957—RV19, Ashkabad, U.S.S.R.
- 5.960—Ashkabad (Turkmen S.S.R.), U.S.S.R.
- *5.970—Andorra, Andorra.
- *5.970—HCQRX, Quito, Ecuador. 250 w.
- 5.970—VONH, St. John's, Newfoundland. 300 w.
- 5.971—HVJ, Vatican City, Vatican. "Radio Vaticano." 25 kw.
- 5.973—CP5, La Paz, Bolivia. "Radio Illiman." 250 w.
- 5.979—Yakutsk (Yakat A.S.S.R.), U.S.S.R.
- 5.980—YSWW, Santa Ana, El Salvador. "Radio de Pueblo." 1 kw.
- 5.980V—Andorra la Vieja, Andorra. "Radio Andorra." 20 kw.
- 5.984—OAX4P, Huancayo, Peru. "Radio Huancayo." 250 w.
- *5.985—WNRX, New York, N.Y., U.S.A.
- *5.985—VONH, St. John's, Newfoundland.
- 5.986—LR51, Buenos Aires, Argentina. "Radio Splendid." 5 kw.

(Continued on page 88)

Practical RADIO COURSE

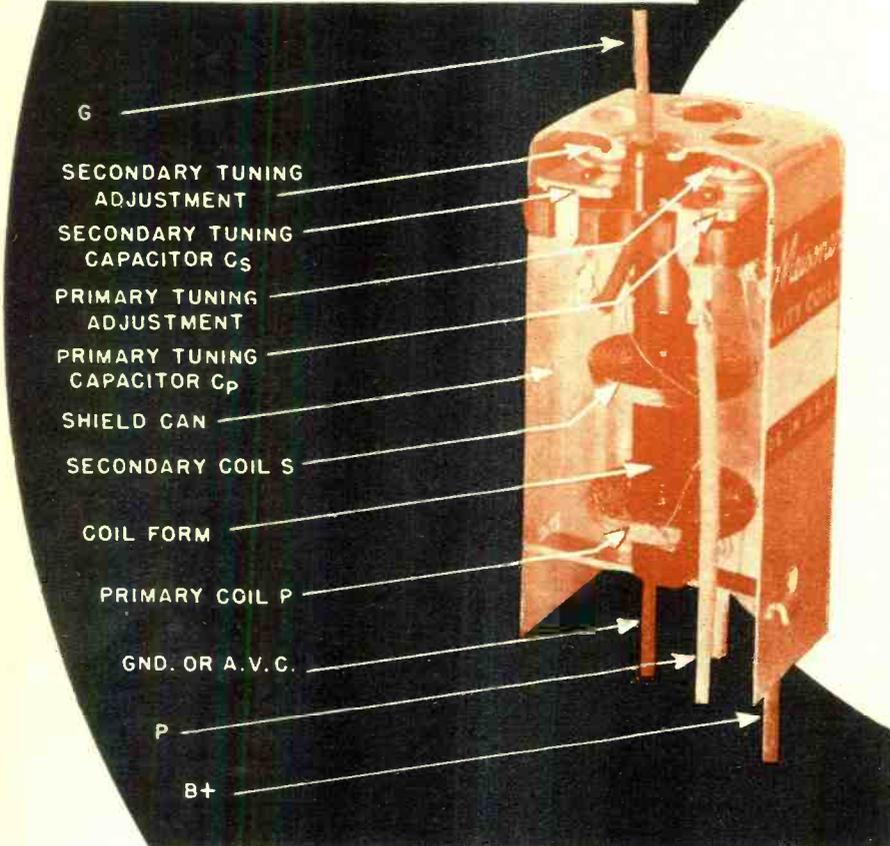

Fig. 1. Typical air-core type double-tuned i.f. transformer.

By
ALFRED A. GHIRARDI

Part 59. The i.f. transformer—covering the action of coupling circuits; action of coupled tuned circuits; effect of the degree of coupling and Q ; calculation of response and passband width; and additional methods of obtaining a bandpass characteristic.

IT WILL be recalled from the discussion in the preceding article of this series that the single-tuned type of i.f. coupling transformer does not possess the broad-band, flat-topped, steep sided type of frequency-response characteristic that is desirable in the i.f. amplifiers of most types of AM and FM sound receivers, and television receivers. An efficient band-pass type of interstage coupling arrangement is required.

Types of Bandpass Coupling Circuits

There are many types of bandpass circuit networks and, theoretically, most of them could be used in i.f. am-

plifiers. In general, when two identical tuned circuits are coupled together, either by mutual magnetic coupling or by some common reactive component in the circuit a bandpass frequency response may be obtained by employing proper circuit constants.

The two identical tuned circuits must be coupled together in order to transfer the signal energy from the input tuned circuit to the output tuned circuit. Capacitive or inductive coupling between the two tuned circuits may be used. The use of capacitive coupling is illustrated in the circuit at (A) of Fig. 2. Use of simple inductive coupling is illustrated in the circuit at (B). Another inductive

coupling arrangement, known as *link* coupling, is shown at (C). (Here a relatively small coupling inductance L_{m1} is magnetically coupled to L_1 , and similarly L_{m2} is coupled to L_2 . L_{m1} and L_{m2} are connected directly in series with each other.) Also, both capacitive and inductive coupling may be used simultaneously, as illustrated in the arrangement shown at (D). Such "combined" coupling may occur unintentionally. For example, appreciable stray capacitance existing between the two tuned circuits of (B) which have mutual inductive coupling primarily, could serve to bring about the condition of combined coupling illustrated in (D). The conditions under which this action is liable to take place in practical double-tuned i.f. transformers designed to have inductive coupling primarily, will be discussed in greater detail later.

The coupling impedance Z may be in series connection (sometimes referred to as *high-impedance* or "top-end" coupling) as illustrated at (A) of Fig. 2, or it may be in shunt connection (sometimes referred to as *low-impedance* or "bottom-end" coupling) as illustrated at (B).

The Double-Tuned Bandpass I. F. Transformer

Many types of bandpass circuit networks can be developed by elaborating on the basic types illustrated in Fig. 2. These could be used in i.f. amplifiers, but those most widely employed are the conventional, relatively inexpensive types shown in Fig. 2, that are quite simple to construct and adjust. In the i.f. amplifiers of AM and FM sound receivers, and the sound i.f. amplifiers of television receivers, the simple inductively-coupled, double-tuned circuit arrangement illustrated at (B) of Fig. 2 is most widely employed. The typical circuit arrangement for such an i.f. amplifier is illustrated in Fig. 3. In practice, the coupling unit takes the form of a transformer having similar primary and secondary windings, P and S, each being tuned to the i.f. by an adjustable postage-stamp "trimmer" type tuning condenser (C_p and C_s), arranged in the coil unit as illustrated in Fig. 1. The complete assembly of transformer and tuning trimmers is mounted in a metal shield can.

In the wide-band video i.f. amplifiers of television receivers, a somewhat more elaborate double-tuned transformer network is necessary in order to attain the extremely wide 4 mc. passband acceptance characteristic of unusual shape required, and yet provide satisfactory gain. This type will be described later.

Before proceeding further let us investigate the actions which take place in coupled tuned circuits so that we may understand why a bandpass type of response characteristic is produced under certain conditions.

Action of Coupled Tuned Circuits

When two tuned circuits resonant at the same frequency are coupled to-

gether, as at (B) in Fig. 2, the resulting behavior depends very largely upon the degree of coupling between them and the effective Q of the circuits. We shall first investigate for the condition where the circuit Q is constant but the degree of coupling is varied. The behavior may best be traced by studying the manner in which the current in the secondary circuit varies with the frequency when a constant voltage is applied to the primary circuit.

The primary and secondary coils are wound on a common coil form consisting of a cylindrical tube or dowel made of bakelite, wood, or other suitable electrical insulating material, as illustrated in Fig. 1. Each is tuned to the same resonance frequency (the i.f. of the receiver) by its trimming condenser (C_p and C_s).

Since the coils are spaced only a small distance apart, the magnetic field set up around the primary coil, P , by the i.f. signal current flowing through it cuts the secondary coil, S . The varying primary field induces a signal voltage in the secondary coil which, in turn, produces a flow of secondary current in the resonant circuit $S-C_s$. The flow of this current through the secondary sets up a magnetic field around it, which cuts the primary coil P . A counter-voltage is consequently induced in the primary coil by the secondary current, and this acts to modify the primary current.

This reaction of the secondary back to the primary leads to some extremely important effects which depend upon how closely the two windings are coupled together, i.e., upon the mutual inductance, M , between them.¹

If the magnetic coupling between P and S is made fairly loose (by having the two coils a substantial distance apart), so that little primary-to-secondary transfer of energy occurs and a small coefficient of coupling² results, the reaction of the secondary circuit back on the primary is negligible. The secondary current will be small (so the *gain* is low) and will

¹Throughout this discussion we shall assume that the only coupling existing between the circuits is that provided by the mutual inductance between P and S , i.e., that no capacitive coupling exists between the two windings. The effect of the presence of stray capacitive coupling between the primary and secondary coils of a practical i.f. transformer will be discussed later.

²The percentage of coupling between two magnetically coupled coils is usually referred to as the *coefficient of coupling*, and is designated by the letter k . It is expressed mathematically by the equation:

$$k = \frac{M}{\sqrt{L_1 \times L_2}}$$

where k = the coefficient of coupling (here expressed as a decimal)

M = the mutual inductance of the two circuits

L_1 = the self-inductance of the first coil

L_2 = the self-inductance of the second coil

If the two coils were so placed that all of the lines of force of the primary were to cut all the turns of the secondary, k would be equal to unity; the coefficient of coupling would be 1, or 100 per-cent. This is the "tightest" possible coupling and is seldom achieved in separated coupled coils having an air core. The coupling coefficient can be made extremely close to 1 if an arrangement is used in which the two coils are wound simultaneously with the wires side by side.

³For a discussion of the resonance characteristics of single-tuned i.f. transformers see Alfred A. Ghirardi, *Practical Radio Course, Part 58*, RADIO NEWS, (January, 1948).

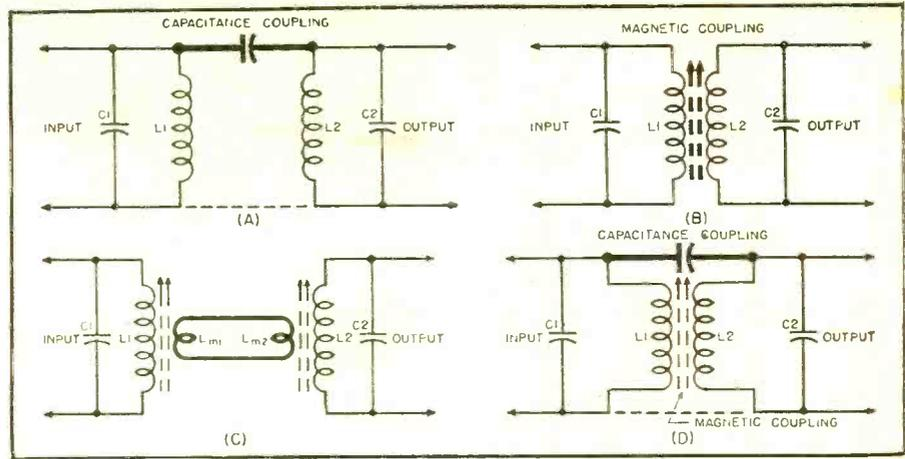

Fig. 2. Four basic bandpass tuning arrangements differing only in the method employed to couple the similar tuned input and output circuits together so that the signal energy may be transferred from one to the other. (A) Top-end capacitive coupling, (B) bottom-end mutual inductive coupling, (C) link inductive coupling, (D) combination top-end capacitive and bottom-end inductive coupling.

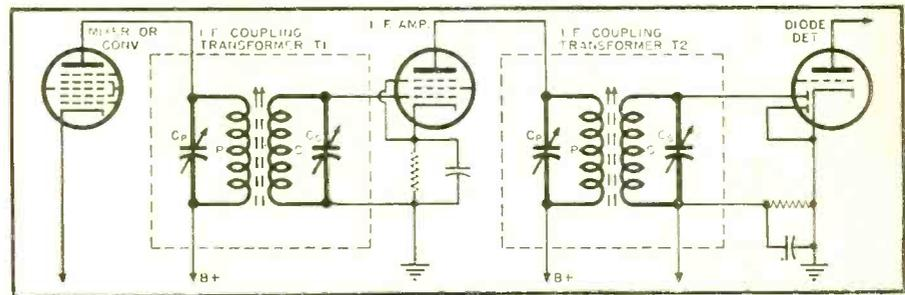

Fig. 3. Diagram shows basic circuit for single-stage i.f. amplifier. Two double-tuned bandpass i.f. coupling transformers, T_1 and T_2 , are required.

vary with frequency according to a curve having a shape approximately the *product* of the sharply peaked resonance curves of the primary and secondary circuits taken alone. Curve A in Fig. 4 illustrates the type of secondary frequency response that may be obtained under these conditions. Observe that it is of the same general sharp-peaked, wide-flanked

form as is the frequency response characteristic of a single-tuned transformer.³

If the amount of magnetic coupling between the two coils is now increased (by moving them closer together), the secondary current will increase (so the *gain* increases), and the peak of the secondary current curve will become more broad. This is illustrated

Fig. 4. Response characteristic of two coupled tuned circuits for various values of magnetic coupling between the coils. Response "E" is for the closest coupling while response "A" is for extremely loose coupling.

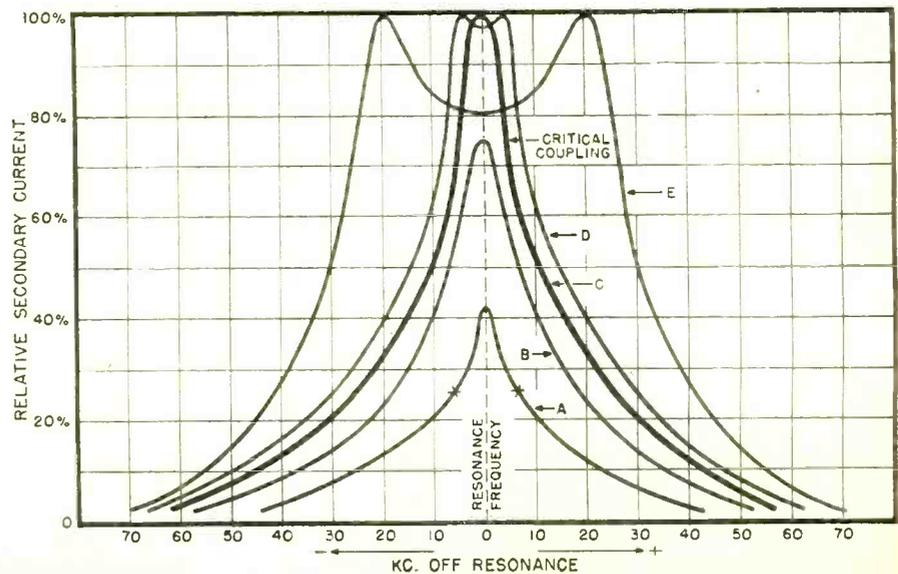

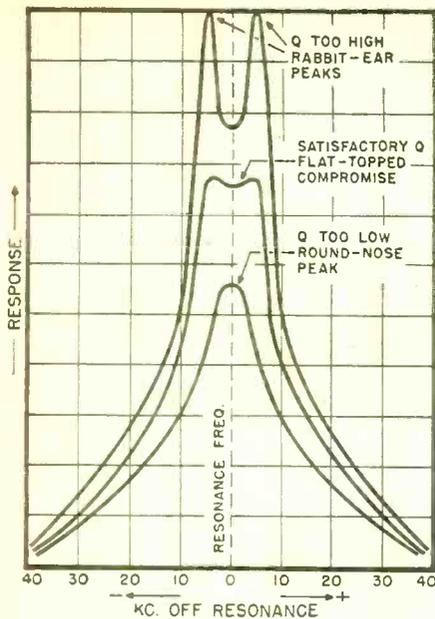
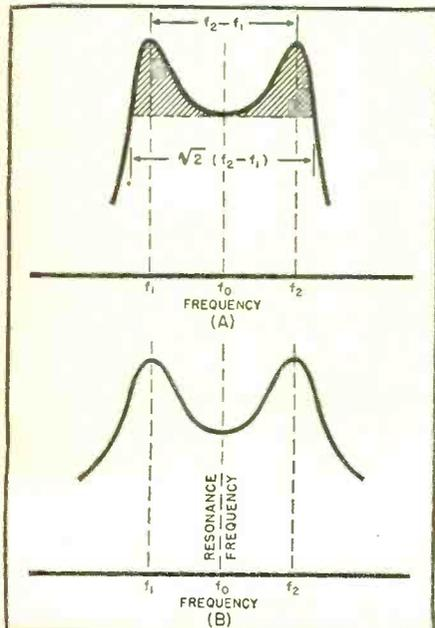

Fig. 5. Bandpass characteristics of coupled tuned circuits for various values of circuit Q with coupling held constant. Effect of Q on uniformity of response within the band being passed is also shown on graph.

by response curve B shown in Fig. 4. These trends continue until the coupling is such that the resistance that the secondary couples back into the primary at resonance is equal to the primary resistance. This coupling is called the *critical coupling*, and it causes the secondary current (and the gain) to have the maximum possible value that it can attain (see curve C in Fig. 4). At *critical coupling* the maximum energy is transferred from the primary to the sec-

Fig. 6. (A) Relationship between bandwidth, and width between centers of peaks existing when two circuits, resonant at the same frequency, are overcoupled. (B) Relationship of the resonance frequency, and frequencies at which the centers of the two peaks occur when two circuits, resonant at the same frequencies, are overcoupled.



ondary circuit. The resonance curve at critical coupling has steep sides.

As the coupling is increased beyond this "critical" value, the secondary current (and the gain) remains practically constant but the selectivity curve changes, particularly at the "nose" (top) of the curve. First there is a decided flattening of the nose of the curve, after which continued increase in coupling produces an actual decrease in secondary current around the resonance frequency, and consequently the secondary current curve begins to show a hollow and two humps (see curve D), with the hollow becoming more pronounced and the two humps spread further apart as the coefficient of coupling is further increased (see curve E). Observe that the current at these humps (which in reality are double resonance peaks) is practically the same as the peak current obtained with critical coupling.

The explanation for the decrease in secondary current at the resonance frequency for coupling greater than the "critical" value is as follows: when the coupling is made much greater than the "critical" value (overcoupling) the coupled impedance at resonance becomes larger, thus reducing the primary current. This, in turn, reduces the amount of voltage induced into the secondary, and therefore finally reduces the secondary current to a lower value.

The explanation for the appearance of double humps in the resonance curve when the coupling is greater than the "critical" value is as follows. The reactance which the secondary couples back into the primary is *inductive* for frequencies below resonance and *capacitive* for frequencies above resonance. This reactance is opposite to that of the primary circuit, and will, therefore, reduce the equivalent impedance which it offers to the applied input signal voltage. Consequently, the primary current, and therefore the voltage induced into the secondary, will *increase* for frequencies off resonance. If the coupling is sufficiently tight, this action will introduce new secondary current peaks above and below the resonance frequency to which the two coils are tuned. Observe that the current at these double peaks or humps (see

curve E in Fig. 4) is practically as large as the peak current obtained with "critical" coupling.

This rather detailed discussion of the actions taking place in a double-tuned transformer when the coupling between the primary and secondary tuned coils is varied may be summarized for convenient reference as follows:

When two circuits tuned to the same resonance frequency are coupled together by mutual inductance between the coils, the resonance curve exhibits a single fairly sharp peak at the resonance frequency when the coupling is below the "critical" value. The curve still has only a single peak when the coupling is increased to the "critical" value, but the peak is now higher and much flatter (see curves A, B and C in Fig. 4), and the resonance curve has steep sides. An increase in the coupling beyond the "critical" value produces at first a resonance curve with a top which is nearly flat (D) and later a double-humped resonance curve (E) having two prominent peaks and a marked dip at the resonance frequency.

Effect of Degree of Coupling and Q on the Resonance Characteristic

The foregoing discussion shows that it is possible to obtain a response curve of secondary current, or voltage, having a relatively flat top with steep sides by properly coupling two tuned circuits resonant at the same frequency, as is apparent by examining curve D of Fig. 4. The resulting arrangement is commonly termed a *bandpass filter*, and has characteristics that are particularly desirable for handling modulated carrier currents because the response can be made practically uniform even to those sideband frequency components that are quite removed in frequency from that of the carrier.

The *width* of the top (whether it is flat or double peaked) is determined primarily by the coefficient of coupling; close coupling produces a wide-topped response characteristic. If it contains double peaks these will be spread farther apart as the coupling is increased. The *flatness* of the top depends mainly on the circuit Q's. Use of tuned circuits having high Q's results in pronounced double peaks;

Fig. 7. Combination of a double-peaked and a single-peaked response characteristic used to provide a more flat topped response than can be obtained by either one alone.

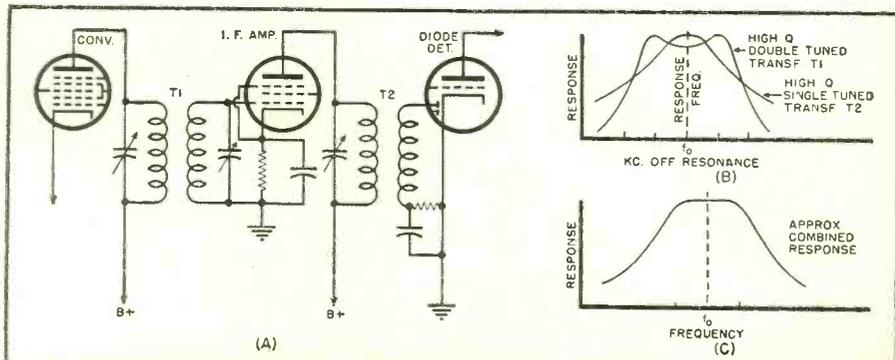

OVERWHELMING ACCEPTANCE!



- Month after month, RCA Batteries continue to smash all previous sales records.

The reasons for this unprecedented acceptance are conclusive—

RCA Batteries are designed for *radiomen* . . . to sell through *radio* outlets. And they're backed by the greatest name in radio—RCA.

RCA Batteries are your assurance of immediate customer acceptance and greater profits.

SELL RCA BATTERIES—THE COMPLETE LINE FOR THE RADIO AND ELECTRONIC TRADE



TUBE DEPARTMENT

RADIO CORPORATION of AMERICA

HARRISON, N. J.

DID YOU GET IT?

RADIO and Electronic
SETS • SUPPLIES • APPARATUS

YOU ARE DAYS AWAY FROM THE START OF SUMMER

BURSTEIN-APPLEBEE Company
1012-14 MCGEE ST.
KANSAS CITY, Mo.

1948 CATALOG NO. 481

THE BIG 'NEW B-A 1948 CATALOG #481

116 BIG Pages Packed with the Latest Developments in RADIO and ELECTRONICS, Sets Supplies and Apparatus . . . for Trade — Industry — Communications — Public Utility — Experimental and Hobby Applications.

A Bargain Section Packed With OUTSTANDING VALUES in desirable War Surplus and other Special Values.

Write for Your Copy of Catalog #481 If You Did Not Receive It.

OUTSTANDING BARGAINS!

SIX TUBE SUPERHET



Illuminated Slide-rule Dial.
Built-in Loop Antenna.
Clear Tone 5" PM Speaker.
Six Tubes AC-DC Incl. Rectifier.

Features the popular New Permeability Iron Core Tuned Mixer and Oscillator Circuits. No Ganged Condensers.

Automatic Volume Control with Full Range Volume Selector.

Tunes 540 KC to 1620 KC.

RMA Guaranteed. Licensed Under Hazeltine Patents.

Beautiful cabinet of Walnut Veneer. Highly polished to a piano finish. Built by Electronic Laboratories, old timers in quality radio components. Size 8 7/16" H. x 12 1/2" W. x 8 13/16" D. Here, Truly, is a finely engineered set.
No. 30A153. SPECIAL EACH \$17.95

MARKER BEACON RECEIVER



Can Be Adapted to Radio Controlled Devices. Was used to flash a signal lamp on pilot's instrument panel when in range of a beacon transmitter. Responds to modulated signals over a variable range of 62 to 80 MC. Tube plates and filaments operate directly from 12 to 14 volts DC. Can be

adapted for radio control of experimental apparatus, opening garage doors, etc. Comes with 4 tubes, type 6SQ7, 6U6GT, 6SC7 and 12SH7, built in adjustable 16000 ohm. SPDT relay, and a fine aluminum cabinet with shock mts. Overall size 3 1/2 x 5 3/8 x 5 3/8". Brand New in Original Factory Packing. Stk. No. 36A64, Type BC-1023A \$3.95
SPECIAL EACH

12 1/2 Ft. ANTENNA TELESCOPES DOWN TO 16 INCHES

Has tremendous pick-up — "Just it!" for mobile equipment, portable receivers and transmitters. 12 ruggedly constructed sections of solid brass — smooth telescopic

action from 16" to 12 1/2 ft. Base is 7/8" dia. with 3/8" threaded shank.
No. 38A39, Spec., Ea. \$1.95
10 Lots, Spec., Ea. \$1.65

Handy Tool Asst. BARGAIN PRICED

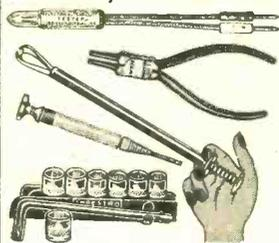

Consist of 1 AC-DC test lite, 1 pair of Kaeuter 6" round nose pliers, 1-12" fingers for getting into those hard-to-reach places, 1-4 3/8" jeweler's screwdriver with hexagon swivel head, and 1 set of good quality 9-piece vest pocket socket set. A Real Bargain, While They Last.

No. 18A938 Complete as illustrated. ONLY \$1.95

THE "TOPS" IN HEADPHONES At a Fraction of Original Cost

8000-ohm impedance, highly sensitive. Best quality Alnico magnets in molded black bakelite cases, concealed terminals. Headband fully adjustable, leather covered spring steel 12" cord with PL54 plug attached at side out of way. Jack and rubber cord supplied to extend length to 5 1/2 feet.



Extremely lightweight, only 9 oz. with removable rubber ear cushions of comfortable design. Brand New—a \$13.50 value. Stock No. 17A37, Special, Per Pair. \$1.95

10 Hy-200 Ma THORDARSON FILTER CHOKE

200 ohm DC resist., 2000 V. RMS, size 2 3/8" sq. x 4 5/8" high. Fully enclosed in black case. 12" leads at side Wt. 5 1/2 lbs. No. 13A266, Spec., Ea. \$1.88

WEATHERPROOF WIRE at GIVE AWAY PRICES



Stranded tinned conductors (3 Copper, 4 Steel) flexible, yet unusually strong to stand long runs. Conductor is rubber covered with overall weatherproof saturated braid; OD size 5/32"

Perfect for lead-ins, telephone, intercoms, etc. BRAND NEW in original factory wound coils.

No. 4A503, Three Conductor Per 550 Foot Coil, ONLY \$4.95

No. 4A502, As Above except Single Cond. Per 900 Foot Coil. \$2.95

tuned circuits having low Q's cause the top to be rounded off.

Calculation of the Response and Passband Width

In order to design a double-tuned bandpass coupling transformer of this type it is necessary to adjust the coefficient of coupling and the circuit Q's properly in order to obtain the desired width and flatness of the response characteristic so that most of the important sideband components of the particular type of modulated signal to be passed will not be severely attenuated.

The actual design of bandpass filters to give a desired performance characteristic is usually carried out quickly and without need for involved mathematical computations, by using "universal" response curves. However, there are a few simple design formulas that it is well to know.

1. The equation for finding the amount of coupling (this is the "critical" coupling) required to produce maximum transfer of energy from the primary to the secondary circuit is:

$$k_c = \frac{1}{\sqrt{Q_p Q_s}} \quad (1)$$

where: k_c = critical coupling

Q_p = Q of the primary circuit

Q_s = Q of the secondary circuit

Study of the above relation reveals that if the Q of the closely-coupled tuned primary and secondary circuits is made too low, the resulting response characteristic has a rounded peak (see Fig. 5) instead of a flat-topped peak. Also, the gain is low.

If the Q of the primary and secondary circuits is made very high, the "critical" coupling condition will exist at a comparatively low value of coupling. Consequently, when the circuit Q is too high a pronounced dip and sharp (frequently called rabbit's ears) double peaks appear even for comparatively low values of coupling because as high Q means that relatively high current will circulate in the tuned circuit of the secondary at the resonant frequency, the secondary will react upon the primary to a great extent. (The formation of a rabbit-ear peaked response is illustrated in Fig. 5.)

As a compromise between these two conflicting extremes it is common practice in the i.f. amplifiers of AM receivers to employ tuned circuits having a somewhat low Q and coupling a little tighter than "critical." This produces a fairly flat-topped response characteristic that is not too selective for acceptable "quality," while eliminating the practical tuning difficulties introduced by a rabbit-ear type of characteristic. A value of Q approximately 50 per-cent higher than that required to produce critical coupling is often used.

2. When double peaks occur, the location of the peaks in relation to the resonance frequency depends upon the actual coefficient of coupling (k), the

Our Terms: Cash with order or C.O.D. with 20% deposit please. Add Postage.

BURSTEIN-APPLEBEE CO. 1012 McGee, Kansas City 6, Mo.

ANNOUNCING

the first 13 volumes of the
**Massachusetts Institute of Technology
 RADIATION LABORATORY SERIES**
NOW AVAILABLE

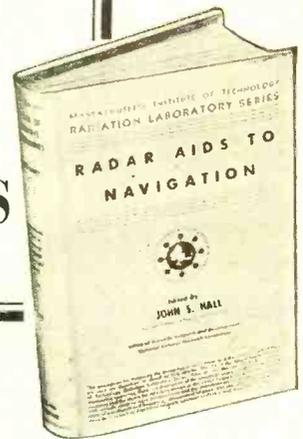
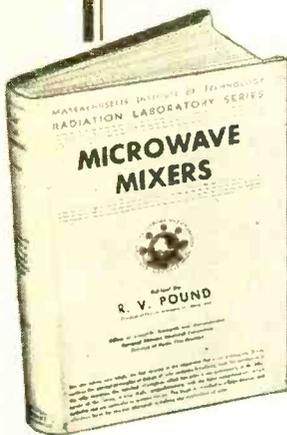

These important books are the first available of the Massachusetts Institute of Technology Radiation Laboratory Series. The Series, containing in all 27 titles and index, was written and edited principally by members of the Radiation Laboratory maintained during the war for electronic research.

RADAR SYSTEM ENGINEERING

VOL. 1. Edited by L. N. RIDENOUR, Professor of Physics, Univ. of Penn. 408 pages, over 300 illus., \$7.50

This volume outlines general principles of radar systems, and discusses basic design considerations. It describes the components of a radar set from the design engineer's standpoint and outlines the problems encountered. Moving target indication and radio transmission of data to remote indicators are carefully explained, including detailed examples of actual systems.

RADAR AIDS TO NAVIGATION

VOL. 2. Edited by JOHN S. HALL, Assoc. Professor of Astronomy and Physics, Amherst College. 389 pages, illus., \$5.00

Describes the advantages and limitations of the use of radar in navigation and pilotage. In addition to full treatment of airborne, shipborne, and landbased radar, this book contains descriptions of many other navigation devices which give a more comprehensive picture of the equipment in use. It emphasizes the practical application of modern aids for safety and accuracy in navigation.

RADAR BEACONS

VOL. 3. Edited by ARTHUR ROBERTS, Assoc. Professor of Physics, State Univ. of Iowa. 409 pages, illus., \$6.00

This comprises a survey of the design and latest developments in radar responder beacons and their use in navigation and identification. Information on practical aspects—installation, operation, and maintenance—is included. It describes various types of beacons and interrogators and shows how each is employed in communication navigation and positioning.

LORAN

VOL. 4. J. A. PIERCE, Research Fellow, Cruft Laboratory, Harvard; A. A. MCKENZIE, Assoc. Editor, Electronics; and R. H. WOODWARD, Research Fellow, Cruft Laboratory, Harvard. 468 pages, illus., \$6.00

A complete account of the design and use of the long-range pulse navigation system known as Loran, both in its original form and as sky-wave synchronized Loran. Sections are included on radio propagation at Loran frequencies and on methods for the computation and preparation of Loran navigational charts.

PULSE GENERATORS

VOL. 5. G. N. GLASCOE, Rensselaer Polytechnic Institute; and J. V. LEVACZQ, Johns Hopkins Univ. 737 pages, \$9.00

The theoretical and practical aspects of the generation of power pulses. Pulse powers in the range of 100 watts to 20 megawatts and pulse durations from .03 to 10 microseconds are considered, covering pulse formation, the effect of circuit parameters on the pulse shape, pulse power, average power, power transfer, and circuit efficiency.

KLYSTRONS AND MICROWAVE TRIODES

VOL. 7. Edited by D. R. HAMILTON, Princeton Univ.; J. K. KNIPP, Iowa State College; and J. B. H. KUPER, Brookhaven National Laboratory. 534 pages, illus. \$7.50

An authoritative discussion of low power microwave triodes, klystrons, and their performance as local oscillators, signal generators, and low-power transmitters. It explains fully the theory behind the use of klystrons and triodes as mixers, amplifiers, oscillators, and frequency multipliers. Two-cavity and reflex klystrons and planar triodes are described.

This outstanding addition to the literature of the field covers advances in radar work—makes these available to all fields concerned with the new electronics—communication, television, biological and physical sciences and the many industries in which electronics is becoming increasingly important.

TECHNIQUE OF MICROWAVE MEASUREMENT

VOL. 11. Edited by C. G. MONTGOMERY, Associate Professor of Physics, Yale University. 937 pages, illus., \$10.00

This book describes in detail the procedures for measuring the properties of microwaves and the circuits in which they are used. A full description of the measurable quantities of microwaves provides sound groundwork for the later chapters which deal with sources of power suitable for measuring purposes and the means for detecting energy at microwave frequencies. Methods for measuring wave length, impedance, frequency, and attenuation are fully described.

MICROWAVE DUPLEXERS

VOL. 14. Edited by L. D. SMULLEN and C. G. MONTGOMERY, Professor of Physics, Yale Univ. 437 pages, illus. \$6.50

An analysis of the problems of using a single antenna for receiving and transmitting pulsed signals. It discusses low-level properties of TR and ATR tubes and the methods for their design. The high-level operation is explained in detail with a description of the properties of the gases used in the tubes. Circuits used for duplexing are fully covered.

CRYSTAL RECTIFIERS

VOL. 15. Edited by H. C. TORREY and C. A. WHITMER, Rutgers Univ. 440 pages, illus., \$6.00

The characteristics and use of the silicon and germanium point-contact rectifiers used as microwave converters and for other circuit applications. Treatment of the theory of semiconductors, of the semiconductor-metal contact, of frequency conversion by rectifiers, and of noise generation by crystals is followed by engineering information on the production and use of practical crystal types. Low-level detectors, high inverse voltage crystals and crystals with negative i-f conductance are discussed in detail.

MICROWAVE MIXERS

VOL. 16. By R. V. POUND, Junior Fellow, Society of Fellows, Harvard. 381 pages, illus. \$5.50

A specialized treatment of the microwave portions of very high-frequency receivers, discussing various receiving systems and their relative merit. Design problems of practical mixers are carefully described, showing how to maintain constant absolute frequency of local oscillator and how to stabilize constant frequency difference between transmitter and local oscillator.

MICROWAVE RECEIVERS

VOL. 23. Edited by S. N. VAN VORHIS, Assoc. Professor of Physics, Univ. of Rochester. 611 pages, illus., \$8.00

This book treats together all the elements making up a wide-band receiver, describing individual circuit types—the assembly, testing, and maintenance of microwave receivers. It includes analyses of actual receivers which contain examples of important circuit combinations.

THEORY OF SERVOMECHANISMS

VOL. 25. Edited by H. M. JAMES, Purdue Univ.; N. B. NICHOLS, Taylor Instrument Co.; and R. S. PHILLIPS, Univ. of Southern Calif. 375 pages, illus. \$5.00

Outlines the standard theory of servomechanisms design, showing application of current techniques, and providing an introduction to a new technique. It covers frequency response design considerations—transfer loci, attenuation vs. log-frequency plots, and phase-angle vs. log-frequency plots—and explains the later method which depends upon minimization of rms error with which the mechanism produces a desired result in the presence of electrical noise and other disturbances.

COMPUTING MECHANISMS AND LINKAGES

VOL. 27. Edited by A. SVOBODA. 379 pages, illus., \$4.50

A discussion of computing mechanisms and a detailed study of bar linkages in computers. It includes a full account of novel methods for the design of bar linkages serving as generators of functions of one and two independent variables, and describes the design of bar linkage multipliers.

SEE
THESE
BOOKS
10 DAYS
FREE

McGRAW-HILL BOOK CO., Inc., 330 W. 42d St., NYC 18

Send me the volumes of the *Radiation Laboratory Series* indicated by the numbers I have encircled below for 10 days' examination on approval. In 10 days I will remit the price of the books I desire to keep plus a few cents postage, and return unwanted books postpaid. (Postage paid on cash orders—Same return privilege.)

11 14 15 16 23 25 27

Name.....

Address.....

City and State.....

Company.....

Position..... RN-2-48

(For Canadian price, write McGraw-Hill Co. of Canada Ltd., 12 Richmond St., E., Toronto 1.)

TELEVISION

Sensational ASSEMBLY UNIT



For the first time—a 10" Flat Surface Screen Picture unit available in assembly form. This is a sensational, complete assembly. Picture is 51 square inches.

Also available
A 12" Screen picture, 75 square inches, at a slight additional cost.

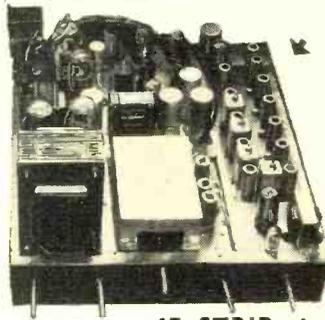

Superior performance is obtained with a new IF Video & Sound Strip (pat. pend.), aligned, wired, pre-tuned, tested. All the above circuits are contained on one chassis, ready to use when delivered. This unit designed and constructed by engineers. Licensed by Radio Corporation of America.

Easier to operate than your home radio.

10" FLAT SURFACE

C R TUBE INCLUDED

\$229.50

51 SQ. IN. PICTURE COMPLETE WITH ALL TUBES AND COMPONENTS.

PRICE F.O.B. OUR FACTORY

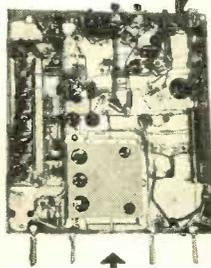

FRONT END

IF STRIP ↑

ALSO AVAILABLE
12" C R TUBE INCLUDED

\$259.50

75 SQ. IN. PICTURE COMPLETE WITH ALL TUBES AND COMPONENTS.

PRICE F.O.B. OUR FACTORY

GUARANTEED

To operate to your satisfaction when simple directions are followed.

- FRONT END will handle 13 Television Channels. It is so flexible that any number of channels from 1 to 13 can be used. We are now supplying channels 2 - 4 - 5 - 7 - 9 - 11 - 13 with this front end. Install the other channels as desired. Aligned and tested, ready to use when delivered. Merely connect B plus, filament and output I.F. leads to the television chassis. It is not necessary to make any R.F. alignments.
- 29 RCA Tubes included plus 10" flat faced CR tube or 12" CR tube
- Heavy Duty RCA 6.8 oz. slug 12" PM speaker
- Specially designed dipole antenna with 60 foot lead in.
- 4.5 mc band width for greatest picture definition.
- Approximately 10,000 volts second anode potential for better contrast and brightness.
- 5 IF picture stages
- 2 sound IF stages with Limiter and Discriminator
- High fidelity obtained with FM sound reproduction.
- Overall chassis size 17" x 19" x 3"
- Complete pictorial and schematic diagrams supplied with assembly
- IF frequency—Audio 21.6 Picture 26.1
- Only nationally advertised components used in our assembly.

TERMS: 10% WITH ORDER — BALANCE EXPRESS COLLECT

TELEVISION ASSEMBLY CO. 540 BUSHWICK AVE. BROOKLYN 6 N. Y.

coefficient for critical coupling (k_c) as given by a previous equation, and the Q ratio. The following formula gives the location of the peaks with sufficient accuracy for all ordinary design purposes:

$$f_1 = \frac{f_0}{\sqrt{1+k \left[1 - \frac{k_c^2}{2k^2} \left(\frac{Q_p}{Q_s} + \frac{Q_s}{Q_p} \right) \right]^{1/2}}} \dots (2)$$

and,

$$f_2 = \frac{f_0}{\sqrt{1-k \left[1 - \frac{k_c^2}{2k^2} \left(\frac{Q_p}{Q_s} + \frac{Q_s}{Q_p} \right) \right]^{1/2}}} \dots (3)$$

where: f_1 = the frequency at which the lower-frequency peak occurs (see Fig. 6B)

f_2 = the frequency at which the upper-frequency peak occurs (see Fig. 6B)

When the circuit Q 's are not high, or when the actual coefficient of coupling greatly exceeds the critical value, these equations reduce to the more simple expressions

$$f_1 = \frac{f_0}{\sqrt{1+k}} \dots (2a)$$

and,

$$f_2 = \frac{f_0}{\sqrt{1-k}} \dots (3a)$$

3. In practical work, one is very frequently interested in knowing the width of the frequency band over which the response in the secondary circuit of an over-coupled transformer equals or exceeds the response at resonance. This band is illustrated by the shaded portion of Fig. 6A. The width of this band can be shown to be equal to $\sqrt{2}$ times the width of the frequency band between the centers of the peaks, as shown in Fig. 6A. That is, the response beyond the peaks falls to the response at resonance when the frequency is $\sqrt{2}$ times as far from resonance as the coupling peaks.

4. When Q_p and Q_s are approximately equal, a reasonably flat-topped response characteristic can be obtained over a frequency band equal to approximately $1.2 kf_0$, where k is the actual coefficient of coupling and f_0 is the frequency at the center of the band (the resonance frequency). The circuit Q 's should then be approximately as follows:

$$Q_p = Q_s = \frac{1.75}{k} \dots (4)$$

Consideration of the type of service for which a receiver is designed will usually indicate the approximate overall i.f. amplifier passband width required for acceptable fidelity. A receiver designer will select or design the i.f. transformers to give the required over-all passband width required for the particular job at hand. For example, if the receiver is an AM broadcast type, he will want a total passband of 9 or 10 kc. so that sidebands will not be attenuated too greatly. For reception of c.w. signals

(Continued on page 172)

War Surplus Bargains Sold as Used Unless Otherwise Specified!

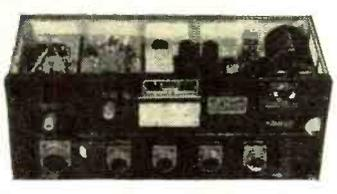

RADIO ALTIMETER APN-1

A complete 460 mc. radio receiver and transmitter which can be converted for ham or commercial use. Tubes used and included: 4-12SH7, 3-12SJ7, 2-6H6, 1-VR150, 2-955, 2-9004. Other components such as relays, 24 V dynamotor, transformers, pots, condensers, etc., make this a buy on which you can not go wrong. Complete as shown in aluminum case 18"x7"x7 1/4".

\$8⁹⁵

NAVY CRV-46151 AIRCRAFT RADIO RECEIVER

\$19⁵⁰

INCLUDING CASE



Four bands, including broadcast (195-9,050 KC). Circuit is six-tube superheterodyne with mechanical band change or remote operated electrical band change. Remote band change and tuning controls included, making this set readily adaptable to mobile ham use. Powered from self-contained 24 V DC dynamotor. The sets are complete with tubes, mounting rack and remote controls. No cables.

AIRCRAFT TRANSMITTER BC-457A OR BC-458A

Ideal to make over for master oscillator. Priced complete with tubes. Has built-in crystal for dial calibration. Used but in good condition. 5.3-7 MC or 4-5.3 MC. FREE Mounting Rack with order of two or more.



\$3⁹⁵

INTERPHONE AMPLIFIER RL-9

Convert to high fidelity phone Amp. or speech Amp. Complete with tubes and dynamotor, for 24 V DC operation. Used but in good condition.



Special Price

\$17⁵

TERMS: CASH WITH ORDER
Address Orders to Dept. B

AMERICAN SURPLUS PRODUCTS CO.
537 N. CAPITOL AVE.
INDIANAPOLIS, IND.

ARC-4 TRANSMITTER AND RECEIVER

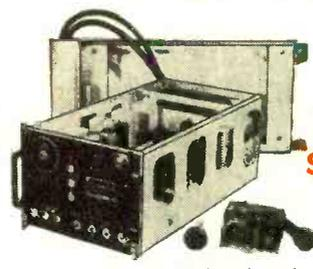

\$17⁹⁵

Including Case

Operates on any of its 4 predetermined crystal controlled frequencies in the range of 140 MC. Complete with tubes, remote control, junction box, shock mounting base and connecting plugs. This unit is ideal for amateur UHF or mobile telephone. Operates from self-contained 24 V DC dynamotor. 12 V available upon request.



BC-348 COMMUNICATIONS RECEIVER

Excellent selectivity, sensitivity and stability makes this the most outstanding of any receiver yet available from government surplus. This Receiver will give outstanding performance wherever used. Built to withstand vibration and features gear driven 100-1 ratio vernier tuning control. Six bands—500 Kc. and 1.5-18 Mc. Two stages RF, 3 stages IF, BFO, crystal filter, manual or AVC. Complete with tubes and 24 V DC dynamotor. Easily converted to 110 V AC operation. BC-348, 110 V AC power supply, including simple conversion instructions \$8.95.

\$69⁵⁰

AIRCRAFT RECEIVER R-23 ARC-5

This Receiver is very selective and sensitive; has RF stage and BFO. Offered complete with tubes 12K8, 3-12SK7, 12SR7 and 12A6, also dynamotor which snaps on Receiver Chassis. Used but good condition. 190-550 Kc. Receiver as above.



BACH \$3⁹⁵

FREE Mounting Rack with order of 3 or more.

ALL PRICES F.O.B. INDIANAPOLIS

BRAND NEW SCR-625 MINE DETECTOR

Attention, Prospectors, Miners, Oil Companies, Plumbers, Etc.
Metallic Objects Only

Used by the Army to detect buried metallic mines. Its private use suggests the location of underground or underwater pipes, cables and ore bearing rock, the location of metallic fragments in scrap materials, logs, etc., and the screening of personnel in plants for carrying of metallic objects.

New, complete in original overseas packing container. Originally sold by War Assets for \$166.00.

The U. S. Forestry Service has recommended procedure for using the SCR-625 Mine Detector to find concealed metal in tree logs and other timber products.

\$79⁵⁰

NEW WILLARD RECHARGEABLE STORAGE BATTERIES



New 6-Volt battery in spill-proof clear plastic case, housed in metal case for easy mounting. Applicable for a wide range of uses where battery power is needed. Shipped dry. Uses standard battery electrolyte available everywhere.

Price, each **\$4.00**

In lots of ten, each **3.35**
Without metal case **3.00**
In lots of ten, each **2.85**

AN/ART 13 COLLINS

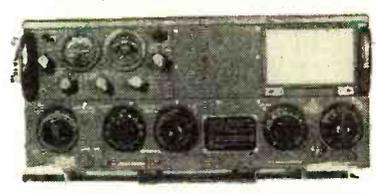

AUTO TUNE TRANSMITTER

A modern, compact, lightweight, high-powered transmitter. For frequency range 2-18 1 Mc. on any of its 11 auto tune crystal controlled or master oscillator channels. These units removed from planes, but good condition. Weight, 67 lbs. CONTROL HEAD AND DYNAMOTOR UNIT included.

\$134⁵⁰

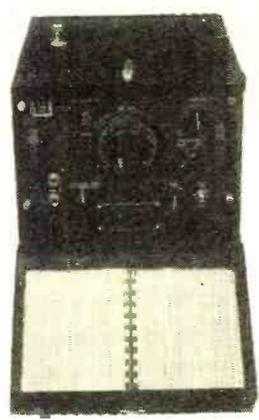

BC-221 FREQUENCY METER

Covers 125-20,000 Kc. Battery or 110 V AC vibrator operated. Beautiful equipment.

\$49⁹⁵



OXYGEN TANKS

These oxygen tanks, removed from surplus aircraft have a capacity of 500 lbs. pressure. Type D2, with complete regulator assembly. Size of tank 22"x5".

\$6⁹⁵

TERMS: CASH WITH ORDER

AMERICAN SURPLUS PRODUCTS CO.
537 N. CAPITOL AVE.
INDIANAPOLIS, IND.

DEALERS ATTENTION—TUBE TESTERS—FM/AM/SETS AMPLIFIERS

11-TUBE AM-FM SW. PHONO COMBO. \$149.50

Greatest radio receiver value in America. A powerful 11 tube AM-FM short wave receiver with FM that really works. \$40 to 1650 MC. 87.5 to 108.5 MC. 5.3 to 18.5 MC. Beautiful mahogany cabinet with slide-away changer compartment. Has Seeburg automatic record changer. This radio is the utmost in high quality workmanship. Tube complement: 6B6 R.F. Amplifier, 6BE6 AM combiner, 6CA4 FM oscillator, 6AU6 1st I.F. Amplifier (FM), 6AU6 3rd I.F. Amplifier, 6AU6 5th I.F. Amplifier, 6A15 Discriminator, 6AF6 AM Detector, AVC and AM-FM Audio Amp, 6K6 Power Amplifier Pentode, and 5Y3 Rectifier. Has built-in di-pole antenna. Cabinet size 34" high. Has built-in 10" speaker. Has piano quality finish. Complete with Model 11FM, Natural Mahogany. \$149.50 Model 11FMV, Blonde Mahogany. \$159.50

NATIONALLY KNOWN MAKE ARM-CHAIR RADIO PHONO COMBO. \$99.50

A beautiful mahogany cabinet. Size 24" x 16" x 27". Two-band, 11 tube, di-pole phono combination. Receives broadcast 540 to 1650 KC and 1 to 17.7 short wave 5.7 to 18.5 MC. Powerful 6 tube chassis with 616 output tube. Has latest silent acting automatic record changer. Plays 10-12" or 12-10" records. A \$179.00 value. Scoop price \$99.50

RADIO-ALARM CLOCK \$26.95

Our leader. The new radio alarm clock. Housed in a beautiful 12 1/2" ivory plastic cabinet with twin dials. Has Telechron electric alarm device and clock, which will turn on radio at any pre-set time. Receiver is a full fledged 5 tube AC-DC superhet with built-in loop. Receiver operates from 540 to 1650 KC. This is no doubt the most beautiful radio alarm combination that has ever been offered. A \$39.50 value. Model 5R. Net \$26.95

OUR LEADER PORTABLE RADIO RECORDER \$89.50

Our leader AC radio and Dual speed recorder. Another leading value in the electronic field. We bought them right and are passing on our buying power to you. This unit has a standard AC power transformer type, broadcast receiver and recording amplifier. Has General Industries dual speed recorder and playback mechanism, and microphone. A real hot value. Model A-4. Net \$89.50

Top quality even speed phono motor, with 9" turntable, 78 RPM for 110 volt AC 60 cycle operation. Made by a nationally known manufacturer. Net \$2.95
Crystal pick-up with regular type arm and high output cartridge (over 4 volts). High impedance, hand type with 12 feet of shielded cable covered mike cable. Net \$3.95
Latest small type Vinton loop covered mike cable. 4c per foot; 100 ft. for... \$2.95

RECORD PLAYER \$9.95

POWERFUL SINGLE RECORD PLAYER KIT Z-26. Housed in an attractive leatherette covered cabinet. Latest 78 RPM rim drive motor and light weight pick-up. Ready wired and tested 70L7 type tube amplifier. Tone and volume control, 5 PM speaker (Alnico V). This kit easily slips together. Priced complete with tubes and hook-up instructions. Kit Z-26. Net \$9.95

PORTABLE RECORD PLAYER KITS

KIT MODEL J-41. Our leader record player kit. Fine tone, low needle scratch, includes two-tone leatherette covered portable case, rim-drive photo motor, high output crystal pick-up and 6" Alnico 5 PM speaker. 70L7 ready wired and tested amplifier. No wiring to do, just mount the parts in the case. Has the tone and volume controls. Net \$14.95
KIT MODEL J-42. Has a beautiful alligator covered portable case (similar in appearance to the J-41), Alnico 5 PM speaker and ready wired and tested push-pull 117L7 amplifier. This player is powerful with good tone and low needle scratch. Separate tone and volume controls. Slips together in only a few minutes. Has single post automatic record changer; plays 10 1/2" or 12 10" records, automatically. Net \$29.95
KIT MODEL J-43. Includes two-tone leatherette case (similar in appearance to the J-41), spring-wound phono motor, 6" Alnico 5 PM speaker and ready wired and tested push-pull 6Y3 amplifier. Operates on self-contained batteries, requires no external power. Kit Model J-43. Net \$15.95



WIRE RECORDER \$89.50

McGee offers the latest in wire recorder public address systems. Housed in a convenient portable leatherette case. Has 12" PM speaker, a conventional 12 watt push-pull amplifier, with inputs for mike, phonograph or radio. A small separate 6V6 oscillator, adapts this amplifier for wire recording and erasing use. Furnished with a standard Webster \$52.92 value wire recorder mechanism. For shipping convenience this unit is shipped as separate items. Wired and tested amplifier, ready cut portable case, etc. Nothing else to buy. With 15 min. spool of wire. Net \$89.50
Broadcast superhet tuner for above wire recorder. Net \$7.95. Crystal Mike and Desk Stand \$4.95 extra.

Webster 79 Wire Recording Mechanism \$52.92

WEBSTER 79 WIRE RECORDER, PLAY BACK MECHANISM. Wiring diagram of necessary amplifier included with kit. The entire mechanism is a completely assembled unit. Weight 10 pounds. Includes one fifteen minute spool of recording wire. This is the hottest new item in the electronic field. Webster 79 recording mechanism. Net \$52.92. Extra recording wire, fifteen minutes \$2.40; thirty minutes \$3.60; one hour \$6.45

LOWEST PRICES ON RADIOS

ATLAS 3-WAY PORTABLE 6 TUBES \$22.95

Dealers Net \$22.95 Each. Three for \$66.00. Kit of Batteries, \$2.99 Extra.

Here's the hottest buy you ever run onto in a radio set. Many dealers are selling this same radio for \$49.50 less batteries, under a very popular standard brand name. We were lucky in getting the quantity. Many were sold under a very popular label for \$25.00 wholesale. You will probably know this set. It's a six tube radio with the latest AC-DC circuit and is highly sensitive, making it very good for remote locations. Cabinet is high quality mahogany period design. You will like this set. Rush your order. ATLAS 6 TUBE SET. Net \$17.95. Cash THREE FOR... \$51.00

6-TUBE AC-DC MAHOAGNY CAB. \$17.95

This one is a honey. Sold wholesale in 1947, season for \$25.00, \$39.50 list. We made a lucky purchase of a quantity of these sets. Many were sold under a very popular label for \$25.00 wholesale. You will probably know this set. It's a six tube radio with the latest AC-DC circuit and is highly sensitive, making it very good for remote locations. Cabinet is high quality mahogany period design. You will like this set. Rush your order. ATLAS 6 TUBE SET. Net \$17.95. Cash THREE FOR... \$51.00

"HOTTEST PICK ME UP RADIO IN AMERICA" NO TALLER THAN A PEN

NET EACH \$22.95

IN LOTS OF 3 \$21.95

Model 747—3 way personal radio. Receives broadcast 550 to 1650 KC. Small size only 4x5x8 inches. However, uses full size parts with 2-gang condenser and loop. Priced complete with 4 miniature tubes and disc rectifier. These sets are only slightly larger than the smallest personal radio. Volume and tone like a big set. Kit of batteries \$2.05 extra.

MECK PEE WEE SUPER \$11.95

Meck, 5 tube superhet using miniature tubes. Small plastic cabinet (7x4x5"), 2 gang condenser, loop antenna. Alnico 5 PM speaker. This is a real hot value in a small radio recorder; broadcast 550 to 1650 KC. Priced with tubes; ready to play.
Model 800B, Black plastic cabinet. \$11.95
Lots of 3 \$10.95
Model 800W, White plastic cabinet. \$12.95
Lots of 3 \$11.95
Weight 5 lbs. These are Dealer's Prices.

3-TUBE MECK FM CONVERTER \$14.85

Housed in the same cabinet as the MECK 800B shown above. Converts any table or console radio to receive FM programs (new band 88-108 m.c.). Employs super-regenerative circuit that is nonradiating, yet provides full noise reduction and frequency range of FM broadcast. Converts to audio system of AM set in exactly the same manner as you install crystal pick-up of phono player (has plug-in connector to use on sets now having phono jack). This is Dealer's Price.

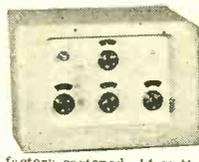

14-WATT AMP. \$29.95

THIS AMP. SHOULD SELL FOR \$50.00

Here is a high fidelity amplifier scoop we may never be able to offer again. Licensed under Western Electric patents. Brand new factory cartoned, 14 watt average output; 25 watt peak output. Matches 4-8-16 or 500 ohm line. Complete with tubes 6SL7, 6SN7, 2-12SL7, 2-6V6GT and 5Y3. Designed for 110 volt AC, 60 cycle operation. Frequency response 50 to 12,000 CPS. Hum level down 69 DB. Gain for two mikes and one phono pick-up. Eastern amplifier. Model E14A. Net \$29.95
Model E25A. Same as model E14A, except it has 2-6L6 output tubes, giving 30 watt output. NET \$44.95

MAGUIRE AUTOMATIC RECORD CHANGER \$9.95

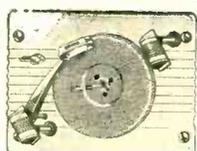

Brand new factory cartoned. This changer should sell for three times our price. Latest two-post, quick change type. Has permanent built-in needle, shuts off on the last record. Plays 12 10" or 10 12" records. Fully guaranteed. Base size 16 x 13 inches. Scoop price \$9.95. Made to fit walnut base \$2.49 extra.

Aero Changer, Base size 12 x 13 inches \$12.95. Walnut base \$2.49 extra.

Vm-800 Changer, Base size 13 x 14 inches \$14.95. Walnut base \$2.49 extra.

Oak Twin-post Changer, Base size 14 x 14 inches \$17.95. Walnut base \$2.49 extra.

General Instrument Deluxe Changer, Base size 11 x 12 inches, \$17.95. Walnut base \$2.49.

Aviola Changer, Base size 11 1/2 x 12 inches, \$14.95. Walnut base \$2.49 extra.

G.I. RECORDER MECHANISMS

Latest 1947 General Industries recording assemblies with 4 ohm magnetic cutters and crystal play back. Model R70-L-78 RPM. Net... \$24.02
Model R90-33 and 78 RPM. Net... 28.37
Model R130-L—Automatic changer with cutter. 78 RPM. Net... 39.34

\$50.00 VALUE DAYCO TUBETESTER \$32.50

Latest up to date Dayco portable tester, with illuminated roll chart, with wide angle magnifying lens. Never becomes obsolete. Sockets are provided for all bases: 4, 5, 6, 7, 8, 9, 10, 11, 12, 13, 14, 15, 16, 17, 18, 19, 20, 21, 22, 23, 24, 25, 26, 27, 28, 29, 30, 31, 32, 33, 34, 35, 36, 37, 38, 39, 40, 41, 42, 43, 44, 45, 46, 47, 48, 49, 50. Has both quality and short tests. Best tube checker value today. Portable Model 2194 Net \$32.50. Model 2193 is the same as the 2194 except it is a black model in black wrinkle finish, with sloping front panel. Counter Model 2193 Net \$29.50. These tube checkers should sell for at least \$10.00 more.

OIL-FILLED COND. SCOOP

4 MFD oil filled screw mounting 1 1/2 x 1 aluminum can super condenser. Replaces 8 mid electrolytics and won't blow at 1000 volts. Ideal for amplifiers and radio set replacement. 49c each. Ten for... \$4.50

1948 MODEL—MIKE-BROADCASTER ONLY \$7.95

Broadcasts 800 to 1500 KC from either a phonograph pick-up or a crystal or dynamic mike. Makes any radio receiver a P.A. system, record player or recording amplifier. Gives broadcast quality. Has fader control from mike to record, simulating a regular broadcast station. This is a powerful model using 2-35L6, 12SJ7 and 35Z3 tubes. Priced with tubes and connecting instructions. Wired and tested. Works on 110 volts AC-DC. Crystal mike and desk stand \$4.95 extra. Model DE-5 truly a de-luxe mike-phonos oscillator.

3-TUBE PHONO OSC. ONLY \$4.95

Model DE-4—Phonograph oscillator. Broadcasts from 800 to 1500 KC. Gain for any crystal pick up. A new powerful circuit is used to assure plenty of power. Has variable gain control for proper modulation. Priced with tubes ready to operate, two 50B5 and 34V4. Model DE-4 Net... \$4.95

SUPERHET BROADCAST TUNER FOR CONNECTION TO PHONO AMP OR P.A. SYSTEM.

Compact chassis 5x3 1/2 x 3 inches. May be mounted inside the record player cabinet. Requires only three connections to amplifier. Uses 6SA7 or 12SA7; 6SK7 or 12SK7 and crystal diode. Complete with tubes, loop antenna, dia and instructions for connecting to any amplifier. Net \$7.95. Specify if tuner is to be used with AC or AC-DC type amplifier.

McGEE RADIO COMPANY WRITE FOR CATALOG SEND 25% DEPOSIT—BALANCE C.O.D. 1225 McGEE ST., KANSAS CITY, MISSOURI

BUILD THIS 8-TUBE RADIO-AMPLIFIER • COMPLETE KIT—ONLY \$29⁹⁵

DELUXE CONSOLE CABINET

\$39⁹⁵



- SLIDE AWAY CHANGER COMP.
- RECORD ALBUM COMPARTMENT
- BEAUTIFUL, ALL WALNUT CONSTRUCTION

This is the first time we have been able to offer a beautiful floor model console. RADIO-PHONO cabinet. Finest all walnut construction; hand rubbed finish. 34" long, 33" high, 16" deep. Holds 12" speaker, large record compartment. Slide away changer compartment will accommodate change of the Webster 56 class and smaller. Receiver compartment is 15x14 1/2 x 7 1/2 inches. Will accommodate our Model PRK-10 kit; advertised here. Dealers, here is your chance to buy good cabinets at the right price. Convert those low-priced sets into radio-phonos combinations. Weight 50 lbs. Net.

\$39.95 Price with Two Post Oak Changer \$56.95 IF DESIRED, WE CAN FURNISH THIS IN BLOOD MAHOGANY AT \$10.00 EXTRA.

- A COMBINED BROADCAST SUPERHET RADIO CHASSIS AND 15 WATT P. A. SYSTEM
- HEAVY DUTY 12" P.M. SPEAKER
- CROW 8" SLIDE RULE DIAL. 2 GANG COND.
- REC. BROAD. 550 TO 1700 KC. HI-FIDELITY PUSH PULL 6V6—TWIN TONE CONTROLS
- INPUTS FOR CRYSTAL OR DYN. MIKES AND PHONO-PICKUP. WE FURNISH EVERYTHING TO BUILD THIS DELUXE CHASSIS
- WHY NOT ORDER THE CONSOLE ON THE LEFT, WITH YOUR PRK-10

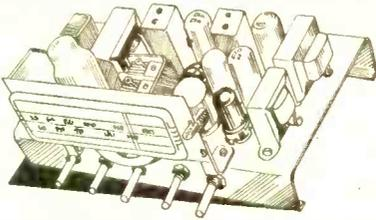

Here is something new in radio. A real 15 watt power amplifier with bass and treble controls. Has extra gain stage for crystal or dynamic mikes. And on the same chassis, a standard superhet radio receiver. We furnish all parts, knobs, escutcheon plate and tubes: 6SA7, 6SK7, 6SR7, 6SN7, 6SJ7, two 6V6 and 5Y3. No cabinet. Extra care in designing the power supply section assures low hum level, making this unit ideal for recording as well as P.A. use. We furnish everything as well as schematic diagram and photos of the completed chassis. Weight 35 lbs.

PRK-10 Radio-Amp. Kit with 12" P.M. speaker. With tubes Net

\$29⁹⁵

PRK-10X Radio-Amp. with tubes and full 165 Mill power transformer and \$30.00 value 15" Cinnnauddiograph speaker Net

\$34⁹⁵

SMALL PORTABLE KIT, \$10.95

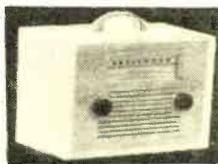

- 4-Tube Broadcast Superhet
- Priced Complete with Batteries
- Dynamic Speaker • Slide Rule Dial

PORTABLE KIT MODEL K-PX. Small size leatherette covered case 8 1/2 x 5 1/2. Easy to build. Operates on self contained B and A batteries. Rec. Broadcast 550 to 1600 K.C. Incorporates a standard superhet circuit with avc. Has 3 inch Alnico five PM speaker. Priced complete with batteries, pictorial diagram and tubes. 11S5, 1T4 and 3S4. Not AC DC, but straight battery operated. Has 2 gang cond. Everyone should have one of these personal portables. Everything furnished. Kit K-PX.....Net \$10.95

5-Tube AC-DC Broadcast Kit, \$9.95

BEAUTIFUL 10" PLASTIC CABINET
LOOP AERIAL • VERNIER DIAL
DYNAMIC SPEAKER • EASY TO BUILD



Kit Model P-85. We have finally been able to achieve our goal. Here it is. A good 5-tube broadcast AC DC superhet radio receiver for less than ten dollars. The beautiful 10 inch plastic cabinet is made of the finest material. The chassis is of the standard accepted superhet design. 456 KC ifs AVC and 5 inch Alnico 5 PM speaker. Attractive vernier dial. Two gang tuning condenser. Loop ant. We defy anyone to offer a better working AC DC receiver kit. Priced complete with diagram, photos and tubes. 12BE6, 12BA6, 12AT6, 50B5 and 35W4. Nothing else to buy. You can't go wrong on this value. Kit Model P-85.....Net \$9.95

ARM-CHAIR RADIO CABINET, \$29.95

Beautifully made walnut armchair cabinet. Outside dimensions 21" high, 16 1/2" deep, and 27" wide. Ample room for radio receiver for less than ten dollars. The beautiful 10 inch plastic cabinet is made of the finest material. The chassis is of the standard accepted superhet design. 456 KC ifs AVC and 5 inch Alnico 5 PM speaker. Attractive vernier dial. Two gang tuning condenser. Loop ant. We defy anyone to offer a better working AC DC receiver kit. Priced complete with diagram, photos and tubes. 12BE6, 12BA6, 12AT6, 50B5 and 35W4. Nothing else to buy. You can't go wrong on this value. Kit Model P-85.....Net \$9.95

SCOOP. Why not order this 9 tube radio chassis kit with the armchair cabinet? We furnish punched chassis and all the parts to build a high fidelity broadcast receiver. 12" PM speaker. Kit has 10" slide rule dial, conventional two gang superhet circuit with AVC. Incorporates two disc rectifiers as voltage doublers. Complete with tubes; 12K8, 12SK7, 12H6, 12L5, 12SL7, and 6X4. A deluxe type kit. Diagrams and photos furnished. Chassis Kit ARK-2.....Net \$19.95

SUPER MIDGET KIT, \$10.95 OUR SUPER VALUE

Build this new super Midget Broadcast Radio. Has beautifully made, highly polished walnut cabinet. Size 7 1/2 x 4 1/2 x 5 1/2. Attractive slide rule dial. Incorporates a standard superhet circuit with 456 KC ifs & AVC. Has 2 gang condenser and loop ant. Every part including Alnico 5 PM speaker and tubes. 12BE6, 12BA6, 12AT6, 50B5 & 35W4. Furnished as well as photo and easy-to-follow diagram. Weight 5 lbs. Model KP-T.

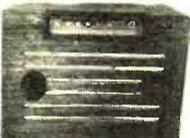

PORTABLE RADIO RECORDER KIT, \$54.95

\$90.00 value for only \$54.95. We furnish every part to build a powerful radio and dual speed recorder. The attractive leatherette case houses the sensitive superhet broadcast radio and General Industries R901, 33 1/2 and 7 1/2 RPM dual speed recorder; play back mechanism. The 9 tube receiver and amplifier is all on one chassis; 12SA7, 12SQ7, 12SK7, 12SL7, mike gain; two 35L6 push-pull output; plus disc rectifier. Has plenty of gain for crystal or dynamic mike. Has 6" heavy duty PM speaker and tone control. Kit G-31, everything complete, with tubes and diagram. \$54.95. Crystal mike and desk stand \$4.95 extra. This is without a doubt one of the best values in kits we have ever offered. Wt. 40 lbs.



20-WATT UTILITY AMP. KIT, \$17.95

Build this 20 watt utility 110 volt AC, 20 Watt power amplifier. Ready punched aluminum chassis, size 12 x 8 1/2 x 5 1/2 inches. Has two input circuits, one mike and one phono. Mike stage has 135 DB gain, for crystal or dynamic mike. Has bass and treble controls. Designed for use with PM speakers; has 8-16 ohm output transformer. All parts, controls, transformers and easy-to-follow diagram furnished, including tubes: 2-6SN7, 6J5, 2-6L6GA, 5Z3. Kit Model 20L.....Net \$17.95



12" 12 watt Alnico 5 PM speaker, \$6.95 extra. Astatic crystal mike and desk stand, \$7.95 extra.

6-110 VOLT UTILITY AMP. KIT, \$29.95
Model X-26L. Similar in appearance to the model 20 LX shown above except is designed for 6 volt DC or 110 volt AC operation. Also furnishes voltage to run phono motor. Has heavy duty 60 cycle vibrator.

3-WAY PORTABLE KIT, \$17.95

- 4 Tubes Plus Disc Rectifier
- 300 Hour Battery Pack Included
- Beautifully Built Portable Case

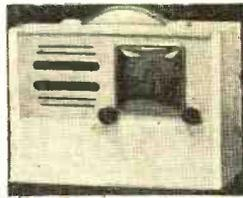

Build this powerful, 4-tube, 3-way portable kit. Operates on 110 volts AC or DC or self contained batteries. Receives broadcast 550 to 1650 K.C. Incorporates a standard superhet circuit with AVC and loop ant. Has Alnico 5 PM Speaker, 2 gang condenser. All parts and batteries are furnished including tubes, Disc Rectifier, 11S5, 1T4, 185 and 3S4. Has attractive leatherette portable cabinet size 7x9x9. Weight 14 lbs. Kit Model 3-ZA.....Net \$17.95

12-WATT AMPLIFIER KIT, \$10.95

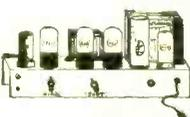

PUSH PULL 6V6 OUTPUT TUBES
GAIN FOR MIKE AND PICK-UP
EVERYTHING FURNISHED. EASY TO WIRE
FINE TONE QUALITY

KIT MODEL AC-12. 12 watt amplifier kit. Ideal for high quality record player as well as public address or recording amplifier. Matched component parts, ready punched chassis pan. One control fades from phono to microphone. Gain enough for crystal or dynamic microphone, 100 mil power transformer, for 110 volt AC 60 cycle operation. Priced complete with tubes: 2-6V6, 6SN7, 6SH7 and rectifier. Diagrams and photos furnished. Kit AC-12. Net \$10.95. 12" Alnico 5 PM speaker \$6.95 extra; crystal microphone and desk stand \$4.95 extra.

RADIO-PHONO COMB. KIT, \$19.95



Build this beautiful portable combination radio phonograph. We furnish everything. Beautiful two tone portable case, latest rim drive phono motor, Astatic crystal pick-up. All parts to build high quality 5 tube AC-DC radio. Rec. broadcast 550 to 1650 KC. Has tone control, loop antenna. 6" Alnico 5 PM speaker. Tubes 12SA7, 12SK7, 12SQ7, 50L6 and 35Z5. Simple diagram furnished. Kit Model RP-12. Wt. 20 lbs. Your Cost \$19.95

7-TUBE AC-KIT, \$19.95

KIT K-7A. Easily assembled into a fine working, attractive, transformer type AC, broadcast receiver; 550 to 1700 KC. Has push-pull audio, tone control and 6 1/2" Alnico 5 PM speaker. Beautifully made 14" walnut cabinet. Incorporates a standard superhet circuit, with AVC and loop antenna. All parts, schematic and tubes 6SA7, 6SK7, 6H6, 6SN7, 2-6V6's and 5Y3 furnished. Has full 90 mil. power trans. Weight 17 lbs. Dealers Net \$19.95



5-TUBE AC-KIT, \$14.95

Model JD5 AC. Has beautifully made 12" walnut cabinet. All parts furnished to build a powerful broadcast 5 tube AC, power transformer type, superhet. Rec. 440 to 1700 KC. Slide rule dial, 2 gang tuning cond. Loop aerial. Heavy duty Alnico 5 PM speaker. Everything furnished including photos, diagram and tubes. 6SA7, 6SD7, 6SQ7, 6K6 and rectifier. Kit JD5 AC.....Net \$14.95



JUKE BOX QUALITY AMPLIFIER KIT, \$24.95

This is the finest in audio amplifiers. Four 6V6 tubes in push-pull parallel and hooked up as cathode followers to drive any PM speaker. Gain stage for crystal or dynamic mike as well as any phono pick-up. Has variable tone control and fader control. We furnish all parts, nothing else to buy. Has a streamlined, spatter finished chassis with cover (ready punched). Complete with diagram, photos and tubes 6SH7, two 6SN7, four 6V6 and 5U4. Will give 18 watts of the sweetest audio you have ever heard. Wt. 25 lbs. Kit model JB-18.....Net \$24.95

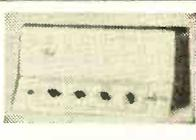

RADIO-PHONO KIT, \$19.95

Offered with walnut cabinet with hinged lid. Latest rim drive phono motor, crystal pick-up and complete kit of parts to build a conventional five-tube AC-DC superhet with loop and condenser gang. Receives broadcast 55 to 1650 KC. We furnish everything including tubes, 12BA6, 12BE6, 12AT6, 50B5, 35W4. WL3-R.....Net \$19.95



WL-3. Same as WL3-R except is record player only. No radio. Has wired and tested amplifier and speaker. Slips together in a few minutes. WL-3.....Net \$14.95

McGEE RADIO COMPANY

WRITE FOR CATALOG SEND 25% DEPOSIT — BALANCE C. O. D. 1225 McGEE ST., KANSAS CITY, MISSOURI

ARMY BC-645 I.F.F. BRAND NEW 450 M.C. TRANSMITTER RECEIVER

2 big units; all in one. A 10 tube superhet receiver for 450 Megacycle, a 5 tube 450 megacycle 2-tuned line transmitter. Both are two channel. 4-7P7, 4-7H7, 2-7E6, 2-6F6, 2-955, 1-WE 316A. The tubes that come with this unit are worth more than our sale price. This unit originally designed for identification "Friend or Foe" Army BC-645. Brand new factory cartoned, weight 25 lbs. Furnished with four page conversion instructions for a CW or MCW or phone transmitter. How to build a 110 volt AC power supply, etc. 12 volt dynamotor, \$2.95 extra. WE-316A tube \$.99, BC-645. \$9.95. 2 for \$19.00.

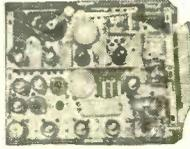

\$9.95

ARMY BC-654 80 METER XMITTER RECEIVER BC-654—Two for \$25.00

Portable voice and CW transmitter and receiver for portable, mobile, and fixed station operation. 7-tube superheterodyne receiver with 3.5 microvolt sensitivity on voice and 0.5 microvolt sensitivity on CW, and 100 milliwatts undistorted power output. 455 KC IF Uses 3-1N5GT, 1-1A7GT, 2-3Q5GT, 1-H5GT tubes, 6 tube transmitter, with antenna tuning network. Controls thermal compensated oscillator, class C final with 2-307A tubes in parallel, and crystal oscillator for checking frequency every 200 KC. 25 watts output on CW and 11.2 watts output on voice. Frequency range, transmitter and receiver, 3800 to 5800 KC. Ideal for Hams! Comes complete with cover; furnished with all tubes necessary for the operation of the trans. and rec. Less power supplies. These units are used but in good condition. Shipping weight 50 lbs. \$12.95; 2 for \$25.00. 654 Vibrator Pack 6 for 12 V.D.C. input \$4.95 extra. SCOP. BC-654 Less all tubes. Net. \$7.95

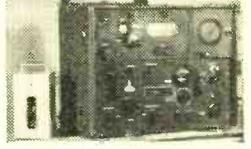

\$12.95

COMMAND REC. WITH DIAGRAMS

Order your Aircraft command receivers from McGee. We furnish you a schematic of the BC-454 (all are the same except for frequency). Also, a diagram showing how to convert receivers for 110 volt operation.

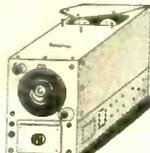

- Brand New BC-453, 200 to 500 KC with Tubes \$6.95
- Near New BC-453, 200 to 500 KC with Tubes 4.95
- Brand New BC-454, 3 to 6 MC with Tubes 4.95
- Near New BC-454, 3 to 6 MC with Tubes 3.95
- Near New BC-455, 6 to 9 MC with Tubes 3.95
- Brand New BC-946, Broadcast 550 to 1500 KC. with Tubes and Instructions. 12.95
- Triple Remot Control Head for 3 receivers. 1.95
- Triple Mounting Rack for 3 receivers. .99
- 28 volt Rec. Dynamotor. .99

15-TUBE SALVAGE SCOOP \$9.95

AM 61A Indicator Amplifier. Brand new factory cartoned. Has 28 volt DC Blower motor and fan. 2 2mf 1000 volt cond. 2 2X .5 mfd. 1000 volt cond. and many other parts. Complete with 15 tubes: 7 6SN7, 3 VR 105, 5Y3, 3 6SL7, 8016. As a salvage item this is a RED Hot Buy. The tubes are worth more than our price. Weight 30 lbs. net \$9.95



SELSYN INDICATORS \$2.95

Selsyn indicators. 5" diameter. Will operate on from 15 to 24 volts 60 cycle AC. Model I-82A can be used as either selsyn transmitter or selsyn receiver. Scoop Price, \$2.95, 2 for \$5.49



3" SELSYN INDICATOR
Works on 16 to 25v. 60 cycle
\$2.45 Two for **\$4.45**
EACH



SWITCH POT SALVAGE
99¢ 3 for **\$2.50**



HEAVY DUTY VIBRATOR—Made for 6-110 volt amplifiers. Freq. 60 CPS. Scoop Price. \$1.99
135 ma 6-110 volt conventional power transformer, with all windings; will run phono motor. \$5.95
(Use with above vibrator.)



VEEDER ROOT METER

Counts number of feet of trailing wire antennae; number turns when winding on coil; applicable for many uses; beautiful bakelite case, jewelled dial, pilot light enclosed, 3 position switch, counts up to 1000. Each .95 c



NAVY GLIDE PATH SCOOP \$3.95

Navy model ZA Glide path receiver. Has 3-6C6 tubes; several controls, transformer and handy case; size 6x7x12 inches. Ideal for salvage, near new condition. \$3.95; 2 for \$6.95



PACKARD BELL PRE-AMP. \$1.99

Housed in a handy aluminum case 5x4x5, priced complete with tubes 6SL7, 28D7, has many usable parts. Relay and control PL68 plug and patch cord.

COMMAND TRANSMITTERS \$3.95

With each command transmitter, we furnish a schematic of the BC-458 (All command Transmitters are essentially the same; except for frequency.)



- Near New BC-457, 4 to 5.3 MC with Tubes. \$2.95
- Brand New BC-457, 4 to 5.3 MC with Tubes. 5.95
- Near New BC-458, 5 to 7 MC with Tubes. 5.95
- Brand New BC-458, 5 to 7 MC with Tubes. .99
- Twin Rack for 2 Transmitters. .99
- Antenna Current Meter. 1.95
- Near New BC-456 Modulator, with 28 v dynamotor 2.95



SCR-518 ALTITUDE \$2950

Brand New

Famous SCR 518 A Altimeter. Brand new factory cartoned. Worth over \$900.00. Made by RCA. Complete as pictured. Has 29 tubes. Works in the 500 MC region. This is the complete unit. Transmitter, receiver, power supply and 3" scope indicator. Reads altitude up to 30,000 ft. Operates on 28 volts D.C. Complete with tubes: 6SN7, 2 8012, 2 6SJ7, 6C8, 6SN7, 6F8, 23D4, 6Y6, 6V6, 10 6AC7, 3 2X2, 954, 955, 956, 6J5 and 3 in. CR tube 18081. A RED hot scoop at only \$29.95 complete.



ARC-4 \$14.95

IDEAL FOR 2 METERS Priced Complete With 20 Tubes—and 12-82 Volt Dynamotor

FOUR CHANNELS CRYSTAL CONTROLLED. ARC-4 for VHF frequencies 140 to 144 megacycles. There are 7 tubes in the transmitter: 832, two 6L4, two 6V6 and two 6L6. The receiver section has 13 tubes: two 6AC7, four 6N7, three 12SJ7, two 12SQ7 and two 12A6. The unit is actually two receivers and one transmitter in one piece. One receiver is for stand-by use. Has built on dynamotor for 12 or 24 volt DC operation. Priced complete with tubes and four crystals and dynamotor. Hams convert this for two meter operation. It's a scoop at this price. Used, but guaranteed to be in good condition.

MARKER BEACON REC. \$2.95

BC 1023 A Marker beacon receiver. Designed for reception of modulated signals of the 75 MC band. Variable tuning permits coverage of 62 to 80 MC. Brand new factory cartoned. With tubes 6SQ7, 6U6, 6SC7 and 12SH7. Operates directly from 12 or 14 volts DC. Priced for quick sale only \$2.95.



SCOOP! 110 M.C. REC. \$6.95

BC-733 D Localizer Receiver
Freq. 108-110 Mc; Tube complement; 10 tubes—1-12SQ7, 2-12SR7, 1-12A6, 1-AH7GT, 2-12SG7, 3-717A. Now only \$6.95
NEAR NEW CONDITION. A RED HOT VALUE.

MODULATOR SALVAGE \$2.49

Another red hot value in salvage. All kinds of good usable parts in this unit. Con. Res. Relays, Modulation trans. and tubes VR150, 1245 and 1625. Brand new and in factory carton. Originally designed to modulate the BC-457 W.E. Transmitter. You can find many uses for this BC-456 Modulator scoop. Price \$2.49; 2 for \$4.49



NAVY ARB 4-BAND REC. 195KC to 9 M.C. \$16.95 MOST IDEAL OF ALL SURPLUS RECEIVERS

You can convert this over easily to a good ham receiver. It's one of the hottest values in surplus receivers. 28 volts DC input. Covers 4 bands, 195 kc to 9 mc. This is a deluxe type superhet receiver, note that the frequency coverage includes the standard broadcast band. Has 4 gang tuning to a 110 volt AC receiver. Priced complete with tubes: 12SF7, 12SA7, 3-12SF7 and 12A6. Has dial built on front of chassis. Electric driven or manual band change switch. Weight 28 lbs. Size 6x7x15 inches. ARB Near new condition. with tubes and dynamotor. Net \$16.95

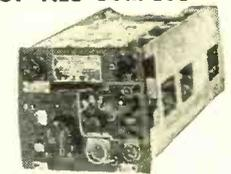

2-BAND RECEIVER

ARC-429, 201 to 400 KC and 2500 to 4700 KC, ARC-429A, 201 to 400 KC and 4150 to 7700 KC. Have plenty of either receiver used but in good condition. Priced with 6.6 volt tubes. Scoop price \$2.95

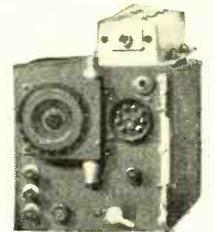

AM-26 \$1.49

AM 26 interphone amplifier. This unit is nice for parts salvage and the aluminum case is usable for receiver building etc. Size 9 1/2 x 4 1/2 x 5". Has two transformers, four tube sockets, three inter condensers, three position panel switch, toggle switch, and many small parts. All are in perfect condition. \$1.49; 2 for \$2.49



RDF RECEIVER \$19.95

MM-26-C Compass Receiver. Brand new factory cartoned. This unit covers from 150 to 1500 KC inclusive; in three bands. Complete with eleven tubes of the 6 volt type: 6SA7, 6SK7, 6Y6, etc. Has 28 volt built-in dynamotor. There is no dial built on unit and no remote cables are provided. MM-26-C receiver \$19.95. Remote control \$3.95 extra. Manually operated loop. \$6.95 extra

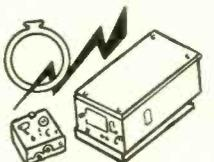

NEW BC-1206 \$4.95

Designed to receive A-N beam signals. 24-28 vdc. Tube complement: 14H7, 14A7, RF, 14H7, 14H7, 14A7, 14H7, 1F amplifier: 14H7, detector and 1st audio: 28D7, output. 195 to 420 KC. 4" high x 4" wide x 6 7/8" long. Weight 4 lbs.



R-89 \$6.95

R-89/ARN-5 Glide Path Receiver 11 tube superhet. Formerly used for blind landing. Adaptable for many uses. Receives 226 to 335 MC. Contains six relays, 11 tubes 7-6AJ5, 12ER7, 2-12SN7, 25D7. Size 13x5x6. Weight 12 lbs. A beautiful piece of equipment. Has three crystals. Priced complete with xtals and tubes. R-89/ARN-5 Near new condition. Net. \$6.95

10 TUBES FOR \$2.79
5-6V6GT and 5-6SN7GT—All are J.A.N. Guaranteed Perfect.

THE McGEE RADIO CO. PRESENTS THE GREATEST RADIO KIT OF ALL TIMES

PERSONAL PORTABLE RADIO KIT \$14.95 MAKES A \$32.50 RADIO

Size: 6 1/2" x 3 1/4" x 4 1/8"

Weights Only 3 1/2 Lbs.

- Two-Tone Ivory, Red Plastic Cab. • Loop Aerial, Built-in Lid
- 4-Tube Superhet • AVC. • Looks like and is a Commercial Radio Kit
- Two-Gang Cond., Lucite Dial • Simple Assembly and Wiring Instructions



Complete with Batteries

This kit is ready for immediate delivery. The same nationally known factory that manufactures tens of thousands of this radio, is line-producing this radio kit for us. Every part, from the cabinet down to the last resistor, is matched. The chassis is ready punched; all you do, is mount the parts and wire. This radio kit will assemble into a beautiful personal radio for you. Just the same as it does for the factory. We furnish you a diagram, photograph of the completed chassis and full assembly instructions so that those with a minimum knowledge of radio may wire this kit. The beautiful case is made of metal with plastic hinged lid and snap on back. The

lucite face of the receiver has an inlaid gold design. The circuit is the conventional two gang superhet type, with A.V.C. Receives the broadcast band, 540 to 1650 KC. Uses miniature tubes, J1K5 converter, 1R5 detector, A.V.C., J14 amplifier and 3B4 power amplifier, Alnico V PM speaker. The loop antenna is built in the lid. Radio comes on automatically when lid opens. Operates on self-contained batteries. Priced complete with tubes and 67 1/2 volt "B" battery and flash cell (Not AC-DC). Nothing else to buy. Model X-45, Price \$14.95, Shipping weight 5 lbs. SCOOP MODEL X-45 PERSONAL PORTABLE KIT WIRED AND TESTED WITH BATTERIES, NET \$19.95

RADIO SERVICEMEN! YOU CAN SAVE MONEY ON ALL RADIO PARTS AND TUBES AT McGEE

15" CINAUDAGRAPH JUKE BOX SPEAKER \$9.95

Here is without a doubt the best bargain in the whole U. S. A Jumbo 15 in. speaker made for the famous Avcon Juke box. Has standard 1 1/2 in. 16 ohm voice coil and 12000 ohm field. The field may be easily excited by hooking to your radio or amplifier as a bleeder. Packed in original cartons. Fully guaranteed. Here is your chance to get a speaker that will bring out those low notes. Our scoop price, \$9.95 each, two for only \$19.00.

"Best Bargain in America"

Popular P.M. Speakers AT LESS THAN HALF PRICE EVERY SPEAKER GUARANTEED



4 in. P.M. 1 oz. Alnico V. mag.	\$0.99
5 in. P.M. 1 oz. Alnico V. mag.	\$0.99
5 in. P.M. 1.47 oz. Alnico V. mag.	\$1.19
5 in. P.M. 2.15 oz. Alnico V. mag.	1.49
6 in. P.M. 1.47 oz. Alnico V. mag.	1.49
6 in. P.M. 2.15 oz. Alnico V. mag.	1.98
6 in. P.M. 3.16 oz. Alnico V. mag.	2.95
8 in. P.M. 2.15 oz. Alnico V. mag.	2.95
8 in. P.M. 3.16 oz. Alnico V. mag.	3.45
8 in. P.M. 20 oz. Alnico 3. mag.	3.95
10 in. P.M. 20 oz. Alnico 3. mag.	4.45
12 in. P.M. 20 oz. Alnico 3. mag.	4.95
12 in. P.M. 7 oz. Alnico V. mag.	5.95
12 in. P.M. 46 oz. Alnico 3. mag.	9.95

DEEP CUT PRICES ON FIELD COIL SPEAKERS

4 in. Dynamic. 450 ohm field.	\$1.89
5 in. Dynamic. 450 ohm field.	1.89
5 in. Dynamic. 3000 ohm field.	1.89
6 in. Dynamic. 450 ohm field.	1.96
8 in. Dynamic. 1000 ohm field.	2.95
12 in. Dynamic. 1000 ohm field.	4.95

POPULAR OVAL SPEAKERS

4x6 in. P.M. 1.47 oz. Alnico V. mag.	\$1.49
5x7 in. P.M. 2.15 oz. Alnico V. mag.	1.95
4x6 Dynamic. 450 ohm field.	1.95

15" 110 OZ. P.M. SPEAKER, \$24.95
High Fidelity 15 in. P.M. with 110 oz. Alnico 3 magnet; a \$48.00 value; made by one of the largest manufacturers of speakers. Net \$24.95

SPEAKERS WITH OUTPUT ATTACHED

5 in. P.M. 1.47 oz. Alnico V. mag. with 50L6 output.	Special \$1.49
5 in. P.M. 1.47 oz. Alnico V. mag. with Push-Pull output trans. Scoop \$1.69	
5 1/2 in. G.E. P.M. Square with 50L6 output trans. mounts in place of regular 6 in. speaker.	\$1.95
6 in. P.M. 1.47 Alnico V. magnet with 7000 ohm primary output trans. Special \$2.25	

CARBON HAND MIKE, 99c

Army carbon hand mike with push-to-talk switch, cord and plug. Brand new and factory cartoned. While they last, 99c each; two for \$1.89; ten for \$6.90.

CARTONED RADIO TUBES

"OUR OWN PRIVATE BRAND"

HYVAC . . . 39c EACH
100 ASSORTED FOR \$35.00

These tubes are boxed and branded HY VAC. All are guaranteed best quality. Full Replacement.

12SA7GT	6K7GT	6SA7GT	6SJ7	1R5
12SK7GT	6A8GT	1B4	12AT6	1S5
12SQ7GT	5Y3GT	39	12BA6	= 3Q4
35L6GT	12A6	6SD7GT	12BE6	3S4
35Z5GT	12SR7	6SK7GT	39W4	70L7GT
12K8	6Q7GT	6SQ7GT	50B5	
12SF7	6K6GT	25L6GT	35B5	
50L6GT	6V6GT	117Z3	1T4	
6SN7GT	6X5GT	117L7GT	1L4	

75% OF ALL THE TUBES YOU USE FOR 49c EACH

Guaranteed Standard	Brands	Cartoned and Uncartoned.	
5U4G	6SF5	12SG7	14R7 43 78
6C5	6SF7	12SH7	14S7 45 80
6C6	6SG7	12SJ7	25Z6GT 56
6D6	6SH7	12SL7GT	26 76
6F6GT	6SL7GT	14A7/12B7	27 25
6H6	6SR7	14B6	35Z3 77
6J5	12C8	14C7	35Z4GT
6K6GT	12H6	14H7	41
6SC7	12J5GT	14Q7	42

7A6	7H7	35A5	ILA4	ILE3
7A7	7N7	024	ILA6	ILH4
7A8	7Q7	1H5GT	ILB4	ILN5
7B4	7Y4	6A7	ILC5	
7B5	7Z4	6A8	ILC6	79c EACH
7B6	30	1N5GT	ILD5	
7B7	32	147GT		
7C6	33	30SGT		
7C5	34	50A5		
7E7	35A5	35Y4		99c EACH
7F7	35/51	10Y	6L6	
				69c EACH

SCOOP! ON NEW C.R. TUBES Brand New Fully Guaranteed

8 BP1	\$1.95	5 FP7	\$1.95
8 BP1	1.95	7 FP7	2.95
5 CP1	1.95	9 LD7	2.95
5 BP4	Has white screen; ideal for television. \$2.95		

We guarantee every condenser to be of fresh stock. Made by nationally known manufacturers. No Junk.

600 VOLT TUBULARS, MANUFACTURERS TYPE

Guaranteed all good brands. Condensers: .001, .005, .01, .02, .05, all 600 volt. Any size \$0.08 each. 100 assorted for \$6.50

POPULAR F.P. ELECTROLYTICS

in Alum. Cans. Easy Twist. Mounting all small size. All are 1x2 or 1x3 in.

40x20 150V.	.39c	18x16x450V.	.49c
40x20 150V. 10x25V.	.49c	20x450V.	.39c
40x20x10 150V.	.69c	20x350V. 20x20 25V.	.19c

TUBULAR ELECTROLYTICS In paper tubes with pig tail leads

8 Mfd. 450 Volt Tubular.	.39c each; 100 for \$32.50
18 Mfd. 450 Volt Tubular.	.59c each; 10 for \$ 5.25
8x 8 Mfd. 450 Volt Tubular.	.49c each; 10 for \$ 4.50
20x20 Mfd. 150 Volt Tubular.	.39c each; 10 for \$ 3.50
50x30 Mfd. 150 Volt Tubular.	.49c each; 10 for \$ 4.25
50x30 Mfd. 150 V. 20 Mfd.	.59c each; 10 for \$ 4.90

Automatic Record Player

Includes Maguire two post automatic record changer. Wired and tested two tube 117L7 amplifier. Tone and Volume controls. Alnico V. PM speaker. Only a few minutes required to mount changer and amp. A Real value. Model J-74. Net \$22.95

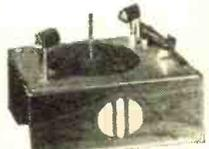

EDWARDS FM TUNER \$31.50



Converts any radio receiver or sound amplifier for FM. New and revolutionary tuning principle makes Edwards Fidelitytuner the most efficient FM converter on the market today. All the great advantages of FM reception are yours, with the compact, efficient tuner. Covers full FM band, 88 to 108 MC. Five tubes plus selenium rectifier.

4-PRONG VIBRATOR FOR AUTO SETS



\$1.29 each—10 for \$11.95

Made by the world's largest manufacturer of vibrators. Heavy duty 4 prong, 6 volt non-sync. Has 8 points. Standard base connections. Fits 70% of all car radios. \$1.29 each; 10 for \$11.95; 50 for \$55.00, 100 for \$99.95.

LAST MINUTE PARTS SPECIALS

Popular half shell power transformer. 6.3v 2 amp, 5v 2 amp, 700v center tap, at 50 MA. Not war surplus.

Net \$1.95
100 mill half shell power transformer. Flush mounting 6.3v 3.5 amp 5v 3 amp 700v center tap, at 100 MA. Not war surplus. \$2.95
150 Mill upright power transformer; fully shielded 6.3v 5 amp, 5v 3 amp 700v center tap, at 150 MA. Not war surplus. Net \$3.49
3 Section side coil auto antenna. Individually cartoned. Nationally known make. Has 30 inch shielded lead. Guaranteed best quality. Scoop price \$1.59; 10 for \$14.95

12-WATT AMPLIFIER SCOOP \$14.95

12 Watt Utility amplifier scoop. Has push-pull 7C5 output tubes. Tone control and gain for both crystal or dyn. mike and pick-up. Ideal for all around use. This amp should sell for at least \$25.00. Model MU-13. Net \$14.95
Crystal mike and desk stand \$4.95 extra.
Heavy duty 12 in 7 oz. Alnico 5 P.M. \$5.95

PULSE FORMING NETWORKS

Used in small radar modulators, available in three sizes, 67 ohm impedance, 7.5 Kilovolt rating.
H-603, one micro second, 200 pulses per second. . . . \$1.95
H-601, three micro seconds, 200 pulses per second. . . . 2.95
H-602, 16 micro seconds, 60 pulses per second. . . . 3.95
All three of above, for only. . . . 5.95

SCR 269G A.D.F. \$39.50

SCR-269G Automatic Radio Direction Finder has 17 tubes. Frequency coverage from 200 to 1750 KC, inclusive. Receivers are in perfect condition. All of the component parts are new. Consists of receiver, new RDP loop, remote control, relay, dehydrator, cables, plugs, etc. This is a terrific value at only \$39.50. Only 50 are available.

McGEE RADIO COMPANY

WRITE FOR CATALOG

SEND 25% DEPOSIT—BALANCE C. O. D.
1225 McGEE ST., KANSAS CITY, MISSOURI

get this free! radio book!

Mail coupon today for buying guide to the best values in Radio, Ham and P.A. Equipment. Send, too, for the hat-news Supplement jam-packed with bargains.

**100,000
BARGAINS
RADIO
P.A.
HAM**

LAFAYETTE SPOTLIGHT VALUES



worth \$9.00
**EMERSON
12" PM SPEAKER**
only \$4.95

This remarkable speaker has an Alnico 5 Magnet and was manufactured for Emerson by RCA. One piece cone, heavy metal frame. Excellent for replacement or new installations. Less output transformer. Shpg. wt. 9 lbs. No. KPS271.

EDWARDS FM FIDELOTUNER



connects to
any receiver
or sound
amplifier
only
\$31.50

This highly efficient tuner brings you delightful, noise-free FM with its revolutionary High Q Tuning Lines.*

Newest Features: discriminator circuit • three IF stages including limiter • permeability tuned IF and Disc "K-Trans" • slide rule dial for easy fingertip tuning • full range 88x108 Mc • 5 tubes plus selenium rectifier • VFH insulation throughout • local reception antenna included • Tubes 3-6SH7, 1-6J6, 1-6H6 • 105-130 V. 60 cycle • AC operation.

Size: 11"x6"x6 3/4". Shpg. wt. 7 1/2 lbs. No. K20360.

*Pat. Pend.

Lafayette Radio

RADIO WIRE TELEVISION, INC.

100 SIXTH AVENUE, NEW YORK 13, N. Y.
110 Federal St., Boston 10 24 Central Ave., Newark 2, N. J.

CLIP COUPON AND MAIL NOW!

LAFAYETTE RADIO, Dept. RB8,
100 Sixth Avenue, New York 13, N. Y.

- Rush Catalog #88 Supplement #88s
Enclosed is check or money order for:
 Speaker KPS271 @ \$4.95 each
 Fidelotuner K20360 @ \$31.50 each

name.....
address.....
city.....zone.....state.....



CIRCUIT PAGE

(FOR PARTS LISTS SEE PAGE 84)

RADIO NEWS, FEBRUARY, 1948

GENERAL ELECTRIC MODELS, 60, 62

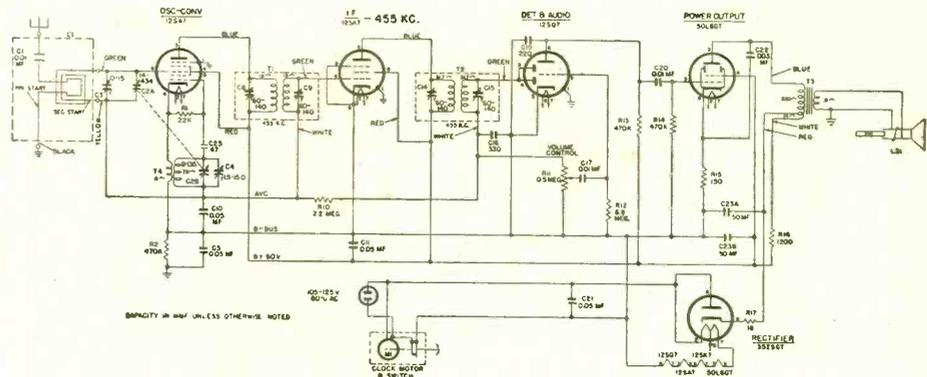

RADIO NEWS, FEBRUARY, 1948

WESTINGHOUSE MODEL H-165

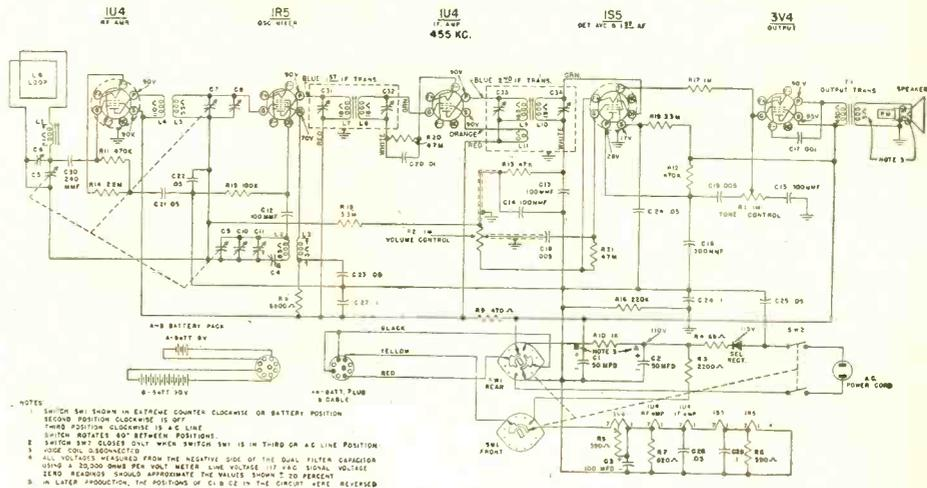

RADIO NEWS, FEBRUARY, 1948

CROSLY MODEL 58TK

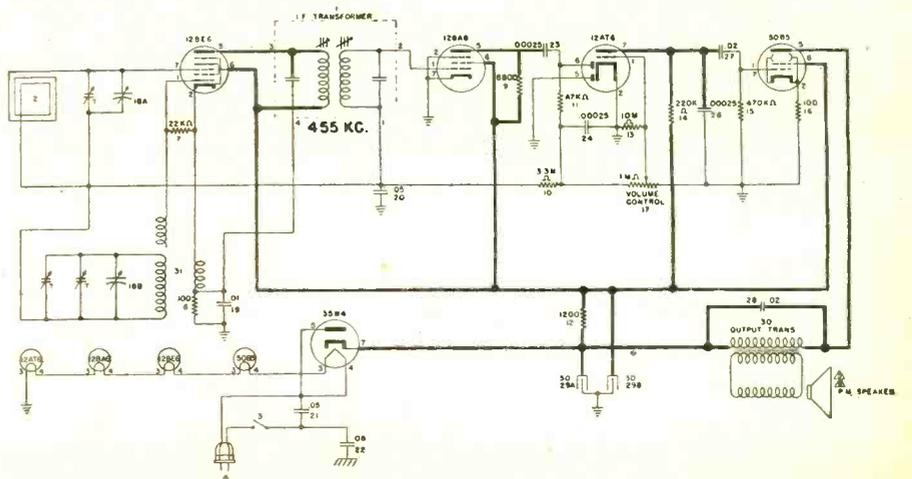

Here, and on following pages, are circuit diagrams and parts lists of many new postwar radio receivers. Radio News will bring to you other circuits as quickly as possible after we receive them from manufacturers.

RADIO NEWS, FEBRUARY, 1948

BELMONT MODEL 6D121

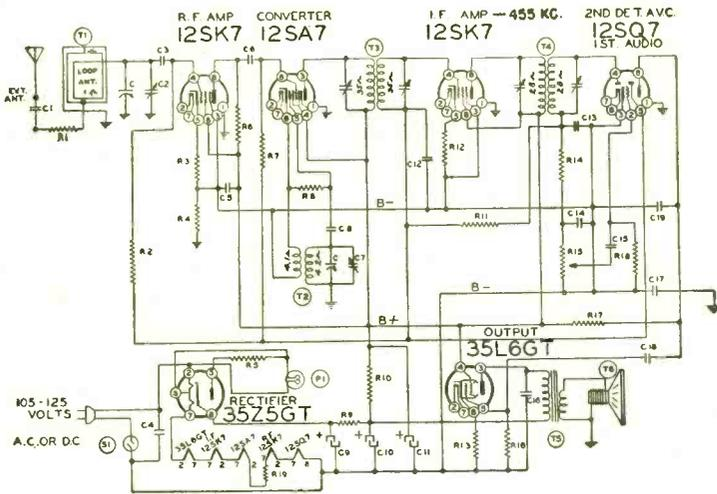

RADIO NEWS, FEBRUARY, 1948

ARVIN MODEL 182TFM

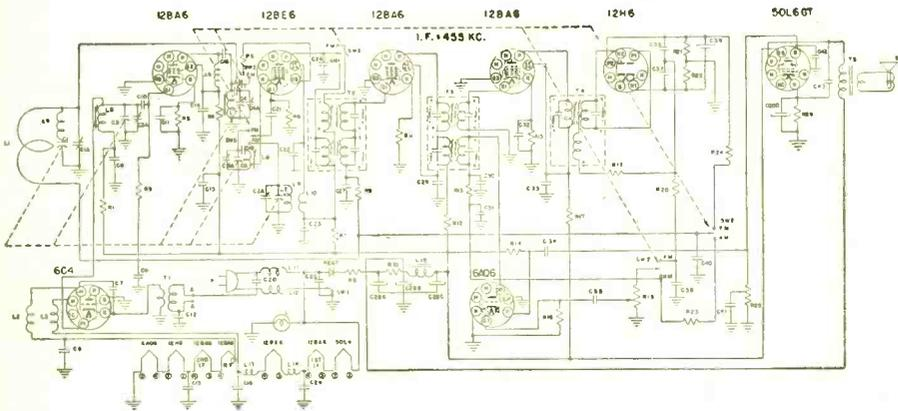

RADIO NEWS, FEBRUARY, 1948

ADMIRAL MODEL 7C64

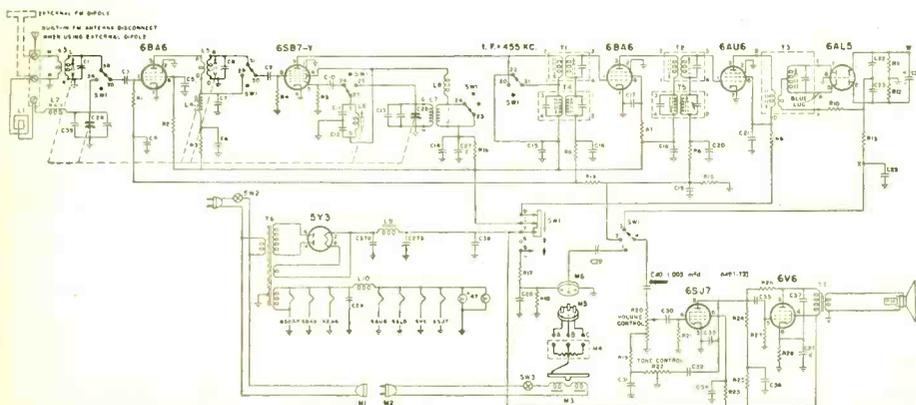

BETTER CONDENSERS

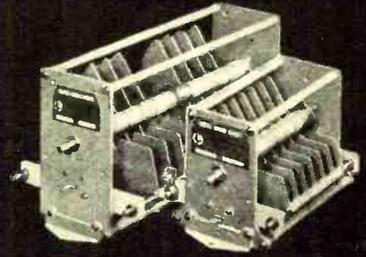

at lower cost!

Even though JOHNSON condensers offer you many outstanding advantages, they cost less than any other quality condenser.

Type C and D JOHNSON condensers are available in 52 different sizes with a wide variety of capacities and spacing.

FEATURES

TYPE C AND D—DUAL AND SINGLE

1. Sturdily constructed—heavy aluminum plates .051 thick.
2. Rounded plates for high-voltage rating.
3. Steatite insulation. Large laminated phosphor bronze rotor brushes. Center rotor contacts on all dual models.
4. Heavy tie rods for frame strength and rigidity. Brackets for top or bottom mounting.
5. Spacers that permit reassembly for different capacity or voltage ratings.
6. Occupy less panel space because of their construction.
7. Both front and rear shaft extensions permit ganging.

For Complete Details Write For Latest JOHNSON Catalog

 **JOHNSON**
a famous name in Radio
E. F. JOHNSON CO. WASECA, MINN.

HAVE ALL THE FUN . . . AND SAVE TWO-THIRDS THE COST

The NEW HEATHKIT VACUUM TUBE VOLTMETER KIT



\$24.50

The most essential tool a radio man can have, now within the reach of his pocketbook. The Heathkit VTVM is equal in quality to instruments selling for \$75.00 or more. Features 500 microamp meter, transformer power supply, 1% glass enclosed divider resistors, ceramic selector switches, 11 megohms input resistance, linear AC and DC scale, electronic AC reading RMS. Circuit uses 6SN7 in balanced bridge circuit, a 6H6 as AC rectifier and 6X5 as transformer power supply rectifier. Included is means of calibrating without standards. Average assembly time less than four pleasant hours, and you have the most useful test instrument you will ever own. Ranges 0-3, 30, 100, 300, 1000 volts AC or DC. Ohmmeter has ranges of scale times 1, 100, 1000, 10M and 1 megohm, giving range .1 ohm to 1000 megohms. Complete with detailed instructions. Add postage for 8 lbs.

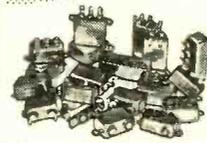

**BATHTUB
CONDENSER KIT**
.1 MFD. to 1. MFD.
up to 600 Volt.
20 FOR \$1.00

TRANSMITTER CRYSTAL KIT

4 mounted crystals between 2 MC and 3 MC.
4 FOR \$1



SOCKET KIT
20 beautiful octal, octal and miniature sockets.
20 FOR \$1

R.F. CHOKE KIT

Perfect sizes from 1/2 to 2 1/2 MH.

10 FOR \$1



POWER RHEOSTAT KIT

All knob types in 25 and 50 watt I.R.C., etc.

5 FOR \$2.95

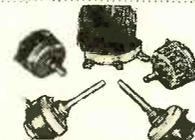

MICA CONDENSER KIT

An excellent assortment with silver mica and regular. All color coded or marked.

25 FOR \$1.00



CERAMIC CONDENSER KIT

20 beautiful condensers all marked or coded, many zero temp. coef. types.

20 FOR \$1.00



RESISTOR KIT

The best available all insulated color coded in 1/2-1.2 watt sizes.

100 FOR \$1.95



OUR BEST CONDENSER BUY

An ideal power supply filter has 2.5 MFD., 2.5 MFD., and 5 MFD., sections at 600 V. working. All oil filled, extra special. **95c**



CONDENSER SPECIAL

Brand new Cornell-Dubilier 2 MFD. 600 V. oil filled filter condensers, porcelain insulators.

3 FOR \$1.00



COMMAND SET ACCESSORIES

110V power supply kit with 24 volt filament, no wiring changes inside set, punched chassis and volume control **\$5.95**

5" PM speaker with output transformer, matching head-phone output **\$2.80**

Dual receiver rack FT2277A with connecting plugs **\$1.00**
Shock mount for above rack **\$1.00**
Single transmitter rack FT **\$1.00**

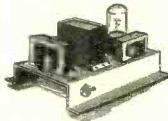

G.E. CIRCUIT BREAKER

Protect your equipment at one-fourth of cost, new G.E. 50 amp. 220 V. circuit breakers. **\$2.95**



T32 TABLE MICROPHONE

One of the Army's best. Built by Kellogg, ideal for factory call system, public address, amateur use. Brand new in original cartons, add postage for 5 lbs. **\$2.95**



2 1/2" VOLTMETER

Ideal for making pocket tester, scale 0-3 D.C. volts, made by Weston and Simpson. Tester diagram and Multiplier Resistors for 30-300V. D.C. included **\$1.95**



DC POWER SUPPLY KIT

Supplies 24 V D.C. at 100 MA from 110 V A.C. for operating 24 V electric motors - trains, etc. Complete ready to build **\$2.49**

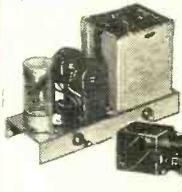

MINIATURE ELECTRIC MOTOR

only 1 1/4 "x1" x2" 6000 RPM. **\$2.95**

POWER TRANSFORMERS

MILITARY CONVERSION

Convert your military receivers without rewiring the filament. "A" type supplies 500 VCT at 50 MA, 5V at 2A and 24V at 1/2A. "B" type supplies 500 VCT at 50 MA, 5V at 2A and 12V at 1 amp. State whether A or B type desired. **\$2.95**

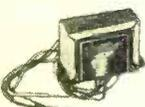

AIRCRAFT INTERPHONE AMPLIFIER

New BC 347C using 6F8 tube with tube ounce, transformers, etc. **\$2.95**



TRIMMER CONDENSER KIT

10 brand new variables 12 MMF to 50 MMF ceramic insulated. **\$1.95**



455 KC I.F.'s
Dual slug tuned square can.

3 FOR \$1

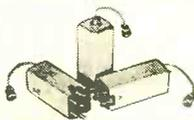

The NEW 1948 HEATHKIT 5 INCH OSCILLOSCOPE KIT

New improved model of the famous Heathkit Oscilloscope. Building an oscilloscope is the finest training for television and newer servicing technique and you save two-thirds the cost. All the features and quality of instruments selling for \$100.00 or more. Supplied complete with cabinet, two color panel, 5BP1 tube, 2 5Y3 tubes, 2 6SJ7 tubes and 8B4 sweep generator tube. Power transformer supplies 1000V negative and 350 volt positive. Sweep generator 15 cycles to 30 M. cycles. Has vertical and horizontal amplifiers. Oil filled filter condensers for long life.

Nothing else to buy, complete blueprints and instructions included.

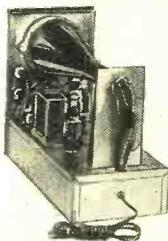

Only \$39.50

NO ORDERS UNDER \$2.00
We will ship C.O.D.
Add postage; we refund excess



The HEATH COMPANY

BENTON HARBOR, MICHIGAN

BUILD YOUR OWN QUALITY TEST EQUIPMENT



\$19.50

HEATHKIT SIGNAL GENERATOR KIT

Build your own signal generator and learn while you profit. Save two-thirds the cost and have an instrument you will be proud to place on your service bench. Supplies fundamentals from 150 KC to 30 MC on large calibrated panel. 400 cy. AF modulation can be used separately for audio testing. Has transformer power supply. Furnished complete with tubes (one 6SN7, one 6X5), transformer, coils, cabinet, punched and formed chassis, blueprints and instructions, and all small parts. Add postage for 8 lbs.

DYNAMOTORS

Consists of electric motor operating generator on same shaft. Many applications — operating radios from storage battery — using as motor.



- A Dynamotor A — Input 12 volts, output 1000 volts at 350 MA. Shipping Weight 72 pounds. **\$7.95**
- B Dynamotor B — Input 6 or 12 volts, output 500 volts, 160 MA. Shipping Weight 30 pounds. **\$5.95**
- C Dynamotor C — Input 28 volts, output 220 volts at 60 MA. Shipping Weight 6 pounds. **\$1.50**

SCR-269F AIRCRAFT RADIO COMPASS

Brand new automatic radio compasses for use on aircraft or boats. Range 200 KC to 1750 KC. Complete with loop, receiver, indicator, control box, plugs, cable and instruction manual (less inverter).



\$34.95

G.E. MODEL BC-375 TUNING UNITS

These General Electric 150 Watt transmitter tuning units are the greatest surplus buy. Over \$30.00 worth of new condensers, coils, switches, National Velvet vernier dial, etc. Supplied complete with cabinet and two reprints of conversion articles for transmitter and receiver reprinted from RADIO NEWS. Specify TU5B, TU10B or TU26B. Add postage for 20 lbs.

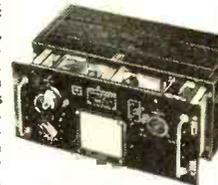

\$24.95

RG-8/U FLEXIBLE COAXIAL CABLE

Ideal for feeding any antenna up to 1 K.W. All frequencies up to 250 Mc. Brand new any length. Lowest price ever offered.



Only **4¢ PER FT.**

BRAND NEW ARMY AIR FORCE ASTROGRAPH

The case of this unit makes the finest tool and service kit ever designed. Plywood construction, 14x11x10" high, with 8 covered compartments in the bottom for repair parts, leather handle, steel reinforced covers, hinged lid. Also excellent as case for radio phonograph, movie projector, camera, shell case, fishing kit, picnic kit, etc. The astrograph itself, (which cost the government \$125.00) makes an excellent contact printer, and can be used as a foundation for enlarger, strip map holder, etc. The case alone worth twice the give-away price of **\$3.95**



SPECIALS

- PE 104A power supplies operate from 6 or 12 volt input — output 84V plate 1.4 volt filament **\$4.95**
- Ceramic Variable Condensers 50 MMF screw driver adj. Special 5 for **\$1.00**
- Lip Microphones T-45 in original sealed cartons **\$1.00**
- Thermocouples for RF Ammeters, 3 for **\$1.00**
- 10 henry 50 ma Filter Chokes 2 for **\$1.29**
- 58P1 Cathode Ray Tubes **\$2.49**
- 58P1 Socket **.79**
- Synco Motors 5SDG Brand New, per pair **\$6.95**
- Kit of Screw Driver Type Potentiometers 10 for **\$1.00**
- Kit of Metal Tubular Bypass Condensers 20 for **\$1.00**
- Kit of Relays, excellent types 5 for **\$2.50**
- Kit of Knob Type Potentiometers carbon and W.W. 10 for **\$1.95**

HEATHKIT HIGH FIDELITY AMPLIFIER KIT

Build this high fidelity amplifier and save two-thirds of the cost. Push pull output using 1619 tubes (military type 6L6's), two amplifier stages using a dual triode (6SN7), and a phase inverter give this amplifier a linear reproduction equal to amplifiers selling for ten times this price. Every part supplied: punched and former chassis, transformers (including quality output to 3-8-15 ohm voice coil), tubes, controls, and complete instructions. Add postage for 20 lbs. 12" PM speakers **\$6.95** for above



\$14.95

BC-457A TRANSMITTER

Brand new transmitters covering 4-5.3 Mc. Contains M.O. 1625, two 1625's as P.A., these make excellent VFO from conversion in May 1946 CQ. Complete in original cartons with tubes.

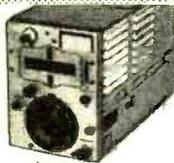

\$4.95

PUSH BUTTON TUNER



\$2.50

This beautifully constructed unit was used on an Army FM receiver. A ten push-button assembly operating four gang silver plated tuning condenser drum dial manual tuning. Brand new. Shipping Weight 10 lbs.

AN/APN-1 RADIO ALTIMETER

Brand new radio altimeters, complete with antennas, indicator, switch, plugs and instruction manual in original crate.



\$34.95

OIL FILLED CONDENSERS

CAP	VVDC	PRICE	CAP	VVDC	PRICE
5	400	\$.39	1.	1000	\$.49
4	400	.49	2.	1000	.69
5	600	.59	4	1000	.90
8	600	1.00	.25	1500	.49
2.5-2.5-5	600	1.50	1.5	1500	.79
5-5-5	600	1.95	.1	3000	1.20
8-8-8-8	600	3.95	.25	3000	1.30
.1	1000	.29	.05	7500	2.50
.25	1000	.39			

HEARING AID HEADPHONES

The Army's best — eliminate flat ears and outside noise. Complete with transformer for conversion from low to high impedance. With cord and plug complete. Add postage for 1 lb. **\$1.00**



NO ORDERS UNDER \$2.00
We will ship C.O.D.
Add postage; we refund excess

HEATHKIT TRANSMITTER KIT

A best buy in an amateur transmitter kit. Circuit uses latest post war improvements, can be assembled to cover 80-40-20-10 meters with 25 Watt output. Comes complete with 80 meter crystal, speech amplifier, 80 meter coil, four tubes, cabinet, beautiful panel and all additional parts needed less power supply. Blueprints and instructions included. Power supply kit \$10.00 additional. Shipping Weight 20 pounds; 8 pounds for power supply.



\$19.50



The HEATH COMPANY

BENTON HARBOR, MICHIGAN

What's New in Radio

TV CONVERSION KIT

Republic Television, Inc. of Dumont, New Jersey is currently marketing a conversion kit, the TC-10, which makes it possible to convert existing 5 or 7

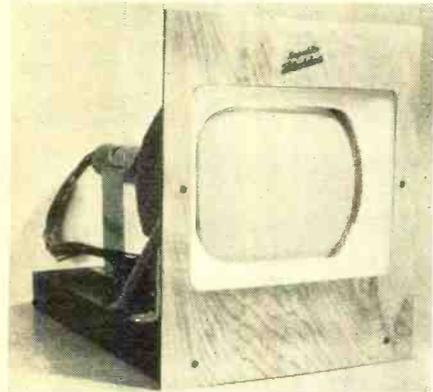

inch tube television sets to a 10 inch size.

The kit comes complete with the new Sylvania 10 inch electrostatic deflection and focus tube, power transformer, chassis, unbreakable plastic screen mask, and all other necessary components.

The manufacturer claims that such conversion can be completed in one hour.

Further details on this kit are available from Republic Television, Inc., Dumont, New Jersey.

SERVICE TEST BENCH

A new console type test bench designed particularly to meet the requirements of radio servicemen has been announced by the Radio Tube Division of Sylvania Electric Products Inc. of Emporium, Pa.

Providing ample area for benchwork, the new fixture includes sloping panel for permanent mounting of meters, test prod outlets, tube testers, and other tools. Suitably proportioned

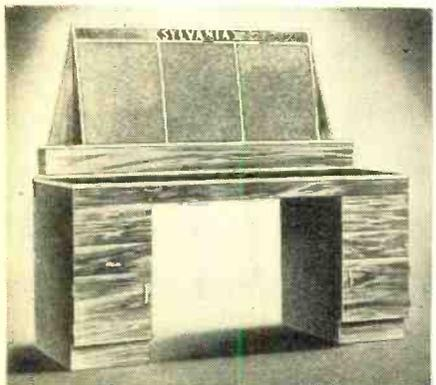

drawers for dust-proof storage of oscilloscopes, v.t.v.m.'s, and other valuable test instruments are also provided.

The seven-foot bench top is covered

with durable linoleum for improved appearance and protection of delicate equipment and components. Four shallow drawers provide out-of-sight storage of frequently used components, push-back wire, and small hand tools. Kneehole and recessed base design permit working close to the bench.

Sylvania distributors have full information of this new bench or additional details may be secured directly from Sylvania Electric Products Inc., Emporium, Pa.

RECEIVER KIT

Allied Radio Corporation has just announced a new, low-priced, a.c.-d.c. superheterodyne kit, designated the "Knight Ranger."

The receiver has been designed to tune the regular broadcast band from 535 to 1620 kc. and uses five tubes, a 12SA7GT, 12SK7GT, 12SQ7GT, 50L6GT, and a 35Z5GT.

The kit is supplied complete with all parts, hardware, solder, wire, tubes, loop antenna, walnut bakelite cabinet, and detailed instructions on the assembly of the unit.

Full details and prices on the Model

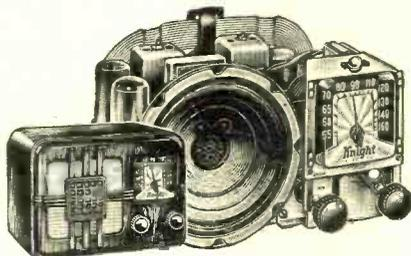

X83-275 will be supplied by Allied Radio Corporation, 833 West Jackson Boulevard, Chicago 7, Illinois upon request.

TUBE SOCKETS

Direct mounting of metal industrial tubes, similar to the 172 thyratron, to non-insulating surfaces is facilitated by the new steatite mounting bracket of compact design just introduced by American Phenolic Corporation of Chicago.

The new sockets are available with or without a feed-through steatite bushing which permits back of supporting panel wiring. Terminal screw sizes of $\frac{3}{16}$ " or $\frac{1}{4}$ " are available. Additional insulators may be used as tie points or feed-through insulators for the tube element connections, allowing design engineers to take advantage of design neatness and built-in ease of maintenance.

Surface electrical creepage distances are held at about 2" enabling use at high voltages. Exterior of stand-off is glazed and metal parts plated.

American Phenolic Corporation,

1830 South Fifty-fourth Avenue, Chicago, Illinois will supply additional details on request.

TV CONDENSERS

Cornell-Dubilier Electric Corporation of South Plainfield, New Jersey has recently added a new unit to the company's line of television condensers.

The new Type T-115 is a 3 x .1 μ fd., 3500 v. d.c. unit which measures $1\frac{1}{4}$ " x $3\frac{3}{4}$ " x 2".

The T-115 is provided with three high voltage bakelite cone insulated screw terminals with the case being common to all sections.

The condenser is impregnated and filled with Dykanol and hermetically sealed in a metal housing. Universal mounting brackets provide common connection between the condenser elements and chassis. This class of condenser is available in a wide capacity range.

Full details on this new Type T-115 will be furnished by Cornell-Dubilier Electric Corporation, South Plainfield, New Jersey upon request.

FLAT SURFACE PICTURE TUBE

Television Assembly Company of Brooklyn has announced the production of a television kit which features a flat surface picture tube.

A 10" (51 square inch picture) and a 12" (75 square inch picture) unit featuring a new front end are now available. The kit is said to be so flexible that any number of channels from 1 to 13 can be used.

The unit comes complete with a 12" speaker, specially designed dipole antenna, 29 tubes plus a 10" or 12" flat surface picture tube, complete pictorial and schematic diagrams.

Details on this construction kit may be obtained direct from Television Assembly Company, 387 Bushwick Avenue, Brooklyn 6, New York.

SPIRAL SPEAKER

The Stephens Manufacturing Corporation is now offering their newly designed "Tru-Sonic Model P-52FR Co-Spiral Speaker" for converting existing equipment to high fidelity operation.

The "Differential Diffuser" (patent pending) accomplishes high frequency dispersion with an almost 100% spherical polar pattern of over 90 degrees. The frequency range is from 40 to 14,000 cycles. As a result of tests, the company claims that the frequency characteristics attenuates record motor rumble below 70 cycles and emphasizes a band in the "power" range around 500 cycles. "Presence" is accentuated by a rise at 2300 cycles. High frequency "hash" is subdued by

MONEY BACK GUARANTEE We believe units offered for sale by mail order should be sold only on a "Money-Back-If-Not-Satisfied" basis. We carefully check the design calibration and value of all items advertised by us and unhesitatingly offer all merchandise subject to a return for credit or refund. You, the customer, are the sole judge as to value of the item or items you have purchased.

The Model 88-A COMBINATION

SIGNAL GENERATOR AND SIGNAL TRACER

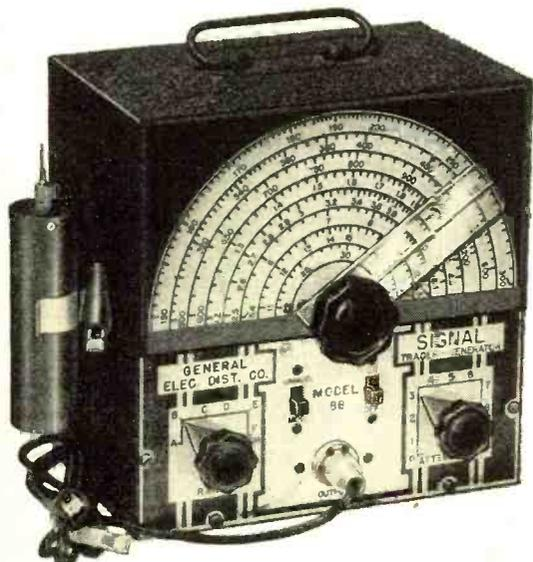

The Model 88 comes complete with all test leads and operating instructions. Only.....

\$28⁸⁵
NET

We're prepared for the demand we know will be created by this long overdue combination of the two units which have always been used together. The ultimate in signal tracing procedure is achieved by the Model 88, for the use of this model, enables you to use either the broadcast signal itself or the signal injected by the Signal Generator. This is especially useful of course when servicing "dead" or "intermittent" receivers. The Model 88 you will find is the greatest time-saver ever provided for by combining a full range Signal Generator and Signal Tracer into one unit; the set up time for interconnecting, etc., is entirely eliminated.

Signal Generator Specifications:

- Frequency Range: 150 Kilocycles to 50 Megacycles.
- The R.F. Signal Frequency is kept completely constant at all output levels. This is accomplished by use of a special grid loaded circuit which provides a constant load on the oscillatory circuit. A grounded plate oscillator is used for additional frequency stability.
- Modulation is accomplished by Grid-blocking action which has proven to be equally effective for alignment of amplitude and frequency modulation as well as for television receivers.
- Positive action attenuator provides effective output control at all times.
- R.F. is obtainable separately or modulated by the Audio Frequency.

Signal Tracer Specifications:

- Uses the new Sylvania 1N34 Germanium crystal Diode which combined with a resistance-capacity network provides a frequency range of 300 cycles to 50 Megacycles.
- Simple to operate—Clips directly on to receiver chassis, no tuning controls.
- Provision is made for insertion of phones of any impedance, a standard Volt-Ohm Milliammeter or Oscilloscope.

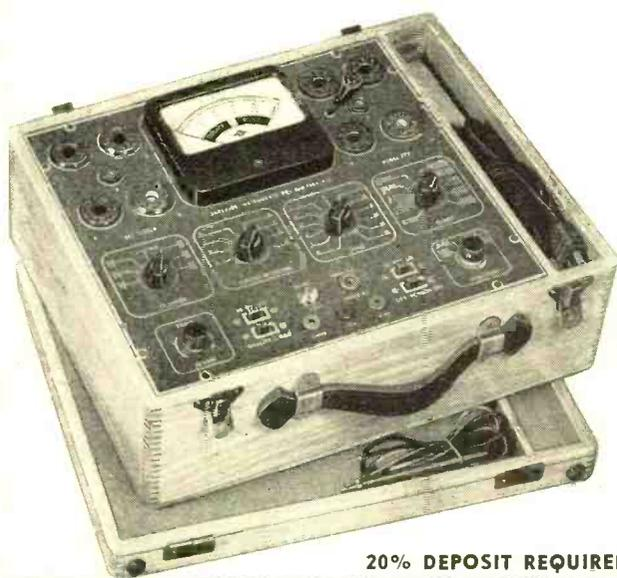

The New Model 777 20,000 OHMS PER VOLT!! SET TESTER

TUBE TESTER SPECIFICATIONS:

- Tests all tubes including 4, 5, 6, 7, 7L, Octals, Loctals, Television, Magic Eye, Thyratrons, Single Ended, Floating Filament, Mercury Vapor Rectifiers, New Miniatures, etc. Also Pilot Lights.
- Tests by the well-established emission method for tube quality, directly read on the scale of the meter.
- Tests leakages and shorts of any one element against all elements in all tubes.
- Tests both plates in rectifiers.
- Tests individual sections such as diodes, triodes, pentodes, etc., in multi-purpose tubes.
- New type line voltage adjuster.

V.O.M. SPECIFICATIONS:

- D.C. VOLTS: (At 20,000 Ohms Per Volt) 0 to 7.5/15/75/150/750/1,500 Volts
- A.C. VOLTS: (At 10,000 Ohms Per Volt) 0 to 15/30/150/300/1,500/3,000 Volts
- D.C. CURRENT: 0 to 1.5/15/150 Ma. 0 to 1.5 Amperes
- RESISTANCE: 0 to 5,000/50,000/500,000 Ohms 0 to 50 Megohms
- DECIBELS: (Based on zero decibels equals .006 Watts into a 500-ohm line.)
—10 to +18 db., +10 to +38 db., +30 to +58 db.

Model 777 operates on 90-120 Volts 60 cycles A.C. Housed in beautiful hand-rubbed cabinet. Complete with test leads, tubes, charts and detailed operating instructions. Size 13" x 12 1/2" x 6".

\$59⁹⁵
NET PRICE

20% DEPOSIT REQUIRED ON ALL C. O. D. ORDERS

GENERAL ELECTRONIC DISTRIBUTING CO.

Dept. RN-2, 98 Park Place
New York 7, N. Y.

a gradual roll-off from 8000 cycles. The unit is supplied in both 12" and 15" cone diameters.

A copy of the company's Bulletin No. 109 describing this and other

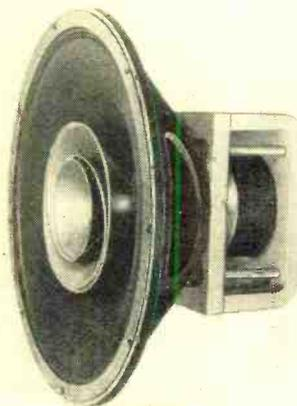

units in the line may be secured by writing *Stephens Manufacturing Corporation*, 10416 National Boulevard, Los Angeles 34, California.

TV AND FM ANTENNA

An omni-directional antenna, the TACO Type 624, has been announced by *Technical Appliance Corporation* of Sherburne, N. Y.

This "S" folded dipole meets requirements for a non-directional, horizontally polarized antenna for reception from several television or FM transmitters located at various points of the compass from the receiver.

This dipole is constructed in the form of an "S," made from 3/8" diameter, non-corrosive, aluminum tubing. A new type mounting clamp assures a rigid construction. The bakelite terminal block also mounts a strain insulator for attaching the 300 ohm ribbon type transmission line. A 5 foot mast is supplied for mounting the antenna above the roof. Screw eyes and other mounting hardware are supplied as well as a 60 foot, 300 ohm transmission line.

Technical Appliance Corporation of Sherburne, N. Y., will supply additional information on request.

D.C. RELAYS

A new multi-contact d.c. relay capable of handling as many as twelve circuits in a wide variety of contact combinations has been announced by the *Control Division* of the *General Electric Company*.

Designed for use in industrial electronic apparatus, communications, and signaling equipment, the new relay has a life expectancy of millions of operations.

Working from five basic contact arrangements, contact combinations can be stacked to satisfy intricate circuit switching requirements. Silver, palladium, or tungsten contacts can be supplied, the choice depending upon rating and life specifications.

More than 500 different coils are available for use in the relay, with ratings ranging from 1 to 250 volts and from .1 to 26,000 ohms. This

makes possible the close matching of the coil voltage and resistance with the rating of the energizing circuits.

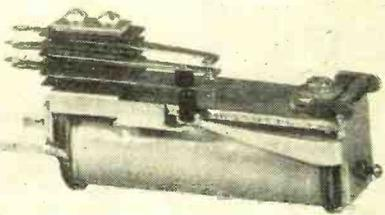

Two-section or concentric two-winding coils are also available.

Further information on these relays will be supplied by the *Control Division, General Electric Company*, Schenectady 5, New York on request.

FOLDED DIPOLE

A folded dipole designed for use as a receiving or transmitting antenna in the 85 to 150 mc. range is in production at the *Communications Equipment Division* of *Heintz and Kaufman, Ltd.*

The H-K dipole can be accurately tuned to any frequency within this range, hence is adaptable for FM reception, aviation service, the two-meter amateur band, and mobile services in the vicinity of 150 mc.

The antenna is designed for use with a 300 ohm ribbon transmission line. Due to the folded construction and use of the ribbon, correct impedance matching over a much wider frequency range is achieved. (Continued on page 116)

"ARROW" leads with Better Buys!



BIAS METER Brand New

Originally used for measuring voltages and tele-type and telephone equipment. Can be used for measuring DC voltages and bias voltages also checking polarity of DC voltages. Complete with a adaptor plug and schematic. Enclosed in metal carrying case. Requires no batteries for operation. \$4.95 ea.

NEW BC-223 AX TRANSMITTER

801 Oscillator and 801 Power Amplifiers, 2-46 modulators and 1-46 speech amplifier; 4 Xtal Frequencies and Master Oscillator on selector switch 10 to 30 watts output. Tone voice or C.W. Mod. Ideal for Ham Use. Black wrinkle case. Tubes included, packed in original cases. less \$11.95 crystals, only

Transmitter less tubes, Tuning unit and crystal 5.95

BC-348 POWER TRANSFORMER

110/120 Pr. Sec. 700V CT at 100MA; 5V at 3 amps, 12.5V at 2 amps; 12.5V at 3 amps— BRAND NEW \$2.95

ARC 4 TRANSMITTER and RECEIVER

For operation VHP frequencies in range of 140-144 mc. Four channel crystal controlled, manufactured by Western Electric—24V operation. Complete with crystal and dynamotor. Used. Good condition \$19.95

GE METER

0-10 amps., DC. each \$2.29

INTERPHONE AMPLIFIER

Comes in an aluminum cabinet 9 3/4" x 4 3/4" x 5 1/2". DC output at 60MA. less tubes. Yours for only 95c

LP-21 ADF LOOP

Low impedance loop, good for direction finder, one Selsyn motor, one Selsyn transmitter, freq. range of loop 100 Kc to 1750 Kc.; BRAND NEW \$6.95

NEW in original cartons, each \$2.95

PE-117 UNIVERSAL POWER SUPPLY

6 or 12 volt input; output 145 volts and 90 volts; less vibrator, voltage regulator and rectifier tube; ideal mobile power supply unit; excellent condition, each \$2.95

VHF Radar Transmitter

Radar unit T-85 is an amplitude modulated transmitter. Frequency range 300Mc-1500Mc. Power output 10-30 watts. Complete with two heavy duty 110 V. 60 cps. filament transformers. Tube lineup is as follows: 1-931, 2-6AC7 Video Amplifier; 1-6AG7 Video Amplifier; 1-6L6 Video Amplifier; 2-92B modulators; 1-6AG7 voltage control; 1-3C22 lighthouse oscillator, a set of lecher wires are included to measure the approximate frequency. Instruction manual included. Brand new in original carton. \$11.95

RA-10 BENDIX RECEIVER

3 band, brand new, 7 tube super heterodyne circuit, direction finder and communication receiver, freq. range 200 to 110 KC and 2 MC to 10 MC, complete with dynamotor and tubes, easily converted to operate from 110 volt \$14.95

AC-DC 1-70-D TUNING METER

Milliammeter for indicating resonance of tuned station. NEW. each 49c

SELSYN INDICATORS

For use with beam rotators for indication of direction of beam. Operate from 15-24V. 60 cycle AC supply. Small model, 3 inch diameter, only \$2.45

Large model, 5 inch diameter, only 2.95

PHANTOM ANTENNA Brand New

Used with any 80 meter transmitter as a dummy load for adjusting transmitter for maximum output before going on air. Freq. range: 2MC to 4.5MC, with instruc. manual, enclosed in metal case with cover \$1.95 ea.

TUBES

6V6	12A6	6SF7
6X5	12C8	5R4
6AG7	6SJ7	6SN7
95W4	12SL7GT	10AC Neon
12AT6	6Y6	12K8
12SR7	Amperite	10T1 36
1625	12J5	6H6
12BE6	6AT6	6GG6

49¢
Lots of 50—
10% Discount

SCOPE 3AP1 \$1.19
TUBES 5FP7 7BP7

SPRAGUE PULSE FORMING NETWORKS

Used in small radar modulators, available in 3 sizes, 67 ohms impedance, 7.5 Kilowatt rating. H-603, one micro second, 200 pulses per second \$1.95
H-601, 3 micro seconds, 200 pulses per second 2.95
H-602, 16 micro seconds, 60 pulses per second 3.95
ALL THREE ABOVE FOR ONLY... 4.95

Transmitting MICA CONDENSERS

.0008 at 5000 VDC, 24c .00005 at 3000 VDC, 19c

OIL-FILLED CONDENSERS

.25 MFD at 1500 VDC... 59c
.25 MFD at 15,000 VDC... \$4.95
1 MFD at 1000 VDC... 59c
4 MFD at 600 VDC... 29c

ARROW SALES, INC.

MAIN OFFICE

SOUTH SIDE BRANCH
8310 SOUTH HALSTED ST.

59 WEST HUBBARD ST., CHICAGO 10, ILL.
Telephone SUPERior 5575

NORTH SIDE BRANCH
1802 NORTH HUMBOLDT BLVD.

"ARROW" leads with Better Buys!

COMMAND RECEIVERS (274N Series)—Complete with Tubes

	USED	NEW
BC-946-B; 520 to 1500 KC.....		\$12.95
BC-453-A; 190-550 KC.....	\$4.95	6.95
BC-454-A; 3 to 6 MC.....	3.95	5.95
BC-455-A; 6 to 9 MC.....	3.95	5.95

COMMAND TRANSMITTERS (274N Series)—Complete with Tubes and Crystal

	USED	NEW
BC-457; 4 to 5.3 MC.....	\$3.95	\$5.95
BC-458; 5.3 to 7 MC.....	3.95	5.95
BC-459; 7 to 9.1 MC.....	3.95	5.95

BC-456 MODULATOR... BRAND NEW... \$2.95

DYNAMOTOR
DM 32A. Each 95c; 3 for... \$2.00

AN18/APT-10
Pre-amplifier Model K-1, designed to raise output level of magnetic type microphone, complete with 2 tubes 6SL7GT and 28D7 and hand switch, brand new in original cartons. Each **\$1.95** 3 for **\$5.00**

CROSS POINTER INDICATOR
Two 0-200 microampere movement, three inch case, many applications, A-1 condition. **95c**
SPECIAL, each

REMOTE CONTROL BOX
BC-450-A... \$1.95

ARB AIRCRAFT RADIO RECEIVER
The ARB is a six tube, four band, superheterodyne Aircraft Radio Receiver with built-in dynamotor, designed for the reception of MCW (tone or voice) or CW within the frequency range 195 to 1000 Kc to 9.05 megacycles. Used... **\$15.95**

AUTOMATIC FREQUENCY CONTROL UNIT
Western Electric type used for controlling frequency for teletype and telephone work, complete with 3-6SJ7 and 2-6H6 tubes. Com... **\$4.95**
plete unit, brand new in original box.

BC-604 FM 35 WATT TRANSMITTER
A-1 condition, complete with tubes, 10 channel push buttons, less crystals and power supply, each... **\$10.95**
Set of 80 crystals for above... \$14.95
BC-603 Receiver for above... 10.95

TRANSFORMER
High voltage scope transformer, 90V 60 cps, primary: 6400V secondary: 4 stand-off terminals... each... **\$2.95**

ANTENNA TRANSFER SWITCH SW-225
Triple-pole double-throw, mounted on bakelite base with nine 2" porcelain stand-off mounts. BRAND NEW... **59c**

BC-732 CONTROL BOX
With 6 position, selective switch, volume control and toggle switch... each... **59c**

COAXIAL CABLE
26 ft. of Coaxial Cable RG8, 52 ohm... 89c

OUTPUT TRANSFORMERS
6V6... 39c

FILTER CHOKES—All Fully Enclosed
3.7 H. @ 145 MA. DC, 125 ohms DC. Res. **59c**
4 MTG. Studs, each... 59c
100 ml 10H... 59c

ANTENNA MAST
7 sections, 5 ft. lengths, 2" diameter, complete with carrying bag... NEW... \$9.95

AN-PRS-1 MINE DETECTOR—BRAND NEW... \$9.50
PE-103 DYNAMOTOR... used... 5.95

BC-929-A
Contains power supply 110 V, 400 cycles, has 7 tubes such as 3CP1, brand new, complete with tubes. Each \$17.95; Used, ea... \$14.95

R-78/APS-15
Has 45 tubes, one 5" scope tube, one 2" scope tube, has 3 meters, 4 power supply units 110V 400 cycles, complete with tubes. Each... **\$39.50**

BENDIX COMPASS RECEIVER MN-26
Remote control commercial type navigational receiver. Indicates direction of any desired transmitting station. 3 bands—frequency range: 150 Kc to 1500 Kc; has 12-6 V. type tubes. Brand new, original cost \$600. **\$24.95**
Now
Accessories for Above:
Loop MN-20... \$6.95
MN-28 Control Box... 5.95
MN-52 Loop Control Unit... 1.95

T-17B HAND MIKE
BRAND NEW Perfect carbon hand mikes, light wt., 200 ohms, single button, press to talk switch, 5 ft. rubber cord, plug, dust cover. **69c**
ONLY

VHF RECEIVER BC-701
Frequency range 170-180 Mc; IP 30.5 Mc; complete with 11 tubes; self-contained power supply; brand new in beautiful wooden carrying case... **\$9.95**

NAVY GLIDE PATH RECEIVER
Bolt type, complete with 3-6CG tubes and tune from 90 to 95 Mc; operates from 12 or 24 V. Brand New... **\$2.95**

VHF TRANSMITTERS
T-26/APT-2 = 450 - 710 mc = \$ 9.95
T-27/APT-3 = 85-135 mc = 10.95

Above transmitters are amplitude modulated radar transmitters. Complete with all tubes such as 829, 832, 931, 6ACT, 6AG7, 5R4GY. Also 110 volt 400 cps. power supply. Brand new in original cartons. Manuals included.

GF12 and RU 17 NAVY RECEIVER and TRANSMITTER
Complete with receiving and transmitting coils, junction box, control boxes, plugs, power supply, instruction manual and spare parts which include tubes. Freq. Range: 200 Kc to 14 Mc. Brand new in original carton. **\$24.95**
A real buy.

GO-9
Navy type low and high frequency transmitter with power supply and tubes. Operates from 200 Kc to 18.100 Kc; requires 115V, 800 cycles. **\$29.50**
Used. Complete with tubes.

RCA AVT-112A—AIRCRAFT TRANSMITTER
For radio-telephone communication; for 6, 12 or 24 volt source freq. range from 2,500 to 6,500 Kc. Small in size and wt. (wt. 6 lbs.). Complete with 6 tubes, oscillator circuit, power amplifier modulators, dual tuning indicator and amplifier, with instruction manual, less crystal. BRAND NEW in ORIGINAL CARTONS... **\$12.95**
ONLY. Each

ALTIMETER TRANSCEIVER RT-7/APN-1
Frequency 418-162 Mc FM, with 14 tubes: 3-12SJ7; 4-12SH7; 2-12H6; 1-VR150; 2-955; 2-9094; 27 V. Dynamotor, used in working condition... **\$7.95**

RECEIVER-POWER SUPPLY UNIT
For the APN-4 indicator; complete with 16 tubes; 110 V. 400 cycles. BRAND NEW... **\$10.95**

MONTHLY SPECIALS

WAVE METERS

Freq. range: 22 to 30 meg.....	\$12.95
Freq. range: 37 to 53 meg.....	12.95
Freq. range: 155 to 230 meg.....	12.95
AC operated, complete with carrying case and magic eye for tuning indicator, veneer tuning dial.	

BC-966

VHF receiver-transmitter unit; freq. range 157-200MC, A-1 condition... **\$3.95**

KEYERS

Audio amplifier—10 watts, 110V, 60 cycle, used for code practice, complete with tubes and photo electric cell—used—A-1 condition... **\$9.95**

450-TH TRANSMITTING TUBE... \$9.95

Each... \$9.95
PORTABLE FIELD TELEPHONE EE-8
Good, used, Each... \$4.95
2 for 8.95

All shipments F.O.B. Chicago—20% Deposit Required on all orders. Minimum order accepted \$5.00.

SETCHELL CARLSON RADIO RECEIVER

Designed to receive A-N beam signals. 24-28 vdc 21.6 watts. Tube complement: 14H7 or 14A7, RF amplifier; 14H7 or 14J7, mixer; 14A7 or 14H7, IF amplifier; 14H7, detector and 1st audio amplifier, 28D7, output amplifier, 195 to 420 kc. 4" high x 4 1/2" wide x 6 1/2" long—wt. 3 lbs., 4 oz. **\$2.95**
Used, A-1 cond.

BRAND NEW in original carton... \$5.95

RADIO TRANSMITTER and RECEIVER APS-13

Light weight air-borne radar system, radio transmitter and receiver APS-13; tube complement: 5-6J6, 9-6AG5, 1-VR105, 2-D21, unit is brand new, complete with tubes, the tubes alone are worth more than this LOW PRICE! **\$10.95**
ONLY

Rack for above... \$1.95
Antenna for above... 1.95

GLIDE PATH RECEIVER R-89/ARN-5

Glide Path Receiver used in the Instrument Landing System covering the frequency range 332 to 335 mc; complete with the following tubes: 7-6AJ5, 1-12SR7, 2-12SN7, 1-28D7, and including three crystals 6497KC, 6522KC, 6457KC units **\$6.95**
are in A-1 condition for ONLY

BC-733 D LOCALIZER RECEIVER

Freq. 108-110 Mc. Tube complement: 10 tubes—1-12SA7, 2-12SR7, 1-12AG, 1-AH7GT, 2-12SG7, 3-717A... **\$6.95**
NOW ONLY

SCR-522 TRANSMITTER and RECEIVER

The standard very-high frequency airborne receiver transmitter, 100 to 156 megacycles, 4 channels selected from remote control box. Used... **\$14.95**
as is "Complete with Tubes." ONLY
Excellent condition, ONLY \$19.95

BC-625

VHF transmitter, frequency range 100-156 Mc., four channels. Part of SCR-522. Complete with tubes less crystals. Used, good condition. **\$6.95**
Each

AM-6I INDICATOR AMPLIFIER

15 tubes including two VR105; 6L7GT; 6SN7GT; with blower motor, brand new in original carton, with metal cover, each... **\$9.95**

VEEDER-ROOT METER AND CASE

Counts up to 1000... **59c**
Each

WESTON OUTPUT METER No. 687

3 scales 0-50, A-1 Condition. ONLY... \$5.95

HAND-TYPE MICROPHONE RS-38

Carbon type, with PL-68 plug, brand new... \$1.95
Used... 1.00

BC-645 TRANSMITTER-RECEIVER

BRAND NEW 15 tubes interrogator-transmitter designed for airborne use, 435 to 500MC frequency range. With some modifications the set can be used for 2-way communication, voice or code, on the following bands: ham band; 420-450mc; fixed and mobile; 450-460mc; citizens radio band; 460-470mc; television experimental; 470-500mc; complete with all tubes, including WE Doorknob tube. Size 1 1/2 x 1 1/2 x 4 1/2". Net **\$9.95**
wt. only 25 lbs. Your cost... only
DYNAMOTOR FOR ABOVE Model PE-101-C... \$2.95

RADIO PARTS

Assorted—100 mica condensers.....	\$1.19
100 Resistors 1/4 to 1 watt.....	95c
100 Tubular bypass condensers, assorted, .01 to .1, all 600 Volt.....	\$4.69
Electrolytic condensers	
50-30, 150 Volt.....	10 for \$2.89
1/2 Meg. Volume Controls	
1" shaft with switch. 10 for.....	\$3.00
1/2 Mex. Volume Controls	
1" shaft without switch. 10 for.....	1.95
Crystal Pick-up, new light wt.....	each 1.79

400 CYCLE AUTOSYN MOTOR

Ideal for indicating direction of antenna systems—BRAND NEW... each... **\$2.95**

HEADPHONES

Signal Corps, 6000 ohms or 200 ohms, each... used **79c**

ARROW SALES, INC.

MAIN OFFICE

SOUTH SIDE BRANCH

59 WEST HUBBARD ST., CHICAGO 10, ILL.

NORTH SIDE BRANCH

8310 SOUTH HALSTED ST.

Telephone SUPERior 5575

1802 NORTH HUMBOLDT BLVD.

In New Jersey...

...it's VARIETY

TELEVISION KITS

TRANSVISION STANDARD MODEL 12" KIT

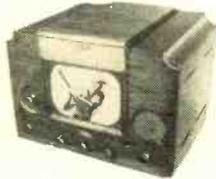

Picture size 7 1/2 square inches. 22 tubes and 12 inch picture tube. High fidelity FM sound reproduction. Advanced television circuit provides exceptionally clear pictures.

- 12" Standard Television Kit.....\$289.50*
- 12" Deluxe Television-FM Radio Kit.....359.50*
- 7" Television Kit.....160.00*
- 7" Republic Kit.....165.00*

(*Complete with tubes, less cabinet)

- Espey Basic Television Kit.....44.95*
- Complete Line of Television Components.....59.50

*Dealers' Prices on Request.

NEW! PREMIER Model 570 MICROMASTER Band Spread Dial SIGNAL GENERATOR



For testing and aligning B K O A D - C A S T, S I O R T - W A V E, F M and TELEVISION R E - C E I V E R S. Exclusive Band Spread Dial geared to the tuning condenser and main dial, giving a total scale length of approximately 60 inches. Three-color dial directly calibrated in Kilocycles and Megacycles. Range: 75 KC-50 MC. Up to 150 MC on 3rd harmonic. Size 12 1/2" x 12" x 9 1/2".

COMPLETE WITH TUBES AND \$54.75 NET CO-AXIAL CABLE.

VARIETY RADIO KITS

- 5 Tube Superhet Kit complete with tubes and cabinet.....\$14.75
- Less tubes.....11.75
- FM KIT complete with cabinet and tubes. 29.95
- 3-Way Portable Kit complete with tubes and cabinet.....18.95

- NATIONAL NC57 RECEIVER.....\$89.50

We carry a full line of National receivers and parts.

- National NC183 Receiver complete with 10" speaker.....\$269.00

ESPEY CHASSIS AND KITS

- 7B-11 Tube Superhet for AM/FM...\$140.00 List
- RM14-8 tube AC. Broadcast and two short-wave bands.....106.50 List
- 97A-Six tube AC-DC. short wave and Broadcast bands.....56.50 List

Dealers' Prices on Request.

VIBRATOR SPECIALS

- Standard 4-prong, replacing E.L. 1703, ATR 324, Mallory 294, Radiart 5300.....99c each
- 10 for.....\$8.99

- AUTO ANTENNAS, Chrome Plated, Admiralty Brass. Shielded Polyethylene Cable with Black Vinylite Cover, Side Cowl Mount, 3 Sections-36". \$1.95 each; ten for.....\$16.95

SUPREME MODEL 584 SUPER SENSITIVE MULTI-METER



D.C. VOLTS 25-5,000, 20,000 Ohms per V.
A.C. VOLTS 100-5,000, 1000 ohms per V.
Resistance Ranges 0-20 megs. D B & Output ranges.

Net \$33.77

Write Dept. RN-2. 20% Deposit with order required. Please add sufficient postage. Excess will be refunded.

Variety ELECTRIC CO., Inc.
601 Broad St., Newark 2, N. J.

Parts Lists

(FOR CIRCUIT DIAGRAMS APPEARING ON PAGES 76 AND 77)

ARVIN MODEL 182TFM

Part No.	Code and Description
C20060-102	R ₁ , R ₁₂ , R ₁₇ —1000 ohm, 1/4 w. res.
C20060-105	R ₂ , R ₂₄ —1 megohm, 1/4 w. res.
C20060-680	R ₃ , R ₁₁ , R ₁₅ —68 ohm, 1/4 w. res.
C20060-331	R ₁ , R ₇ —330 ohm, 1/4 w. res.
C20060-100	R ₇ —10 ohm, 1/4 w. res.
C20060-223	R ₆ , R ₁₈ , R ₂₀ —22,000 ohm, 1/4 w. res.
C20060-220	R ₈ —22 ohm, 1/4 w. res.
C20060-104	R ₉ —100,000 ohm, 1/4 w. res.
C20103-101	R ₁₀ —100 ohm, 1 w. res.
C20060-334	R ₁₁ —300,000 ohm, 1/4 w. res.
C20060-685	R ₁₀ —6.8 megohm, 1/4 w. res.
C20060-101	R ₁₁ —100 ohm, 1/4 w. res.
C21404-1	R ₁₀ —1 megohm vol. control
C20120-682	R ₁₁ , R ₂₅ —6800 ohm, 1/4 w. res.
C20060-225	R ₂₅ —2.2 megohm, 1/4 w. res.
C21405-1	R ₂₅ —500,000 ohm tone control & sw.
C20060-221	R ₂₀ —220 ohm, 1/4 w. res.
AC21401	C ₁ , C _{1A} , C ₂ , C _{2A} , C ₃ , C _{3A} , C ₄ , C _{4A} , C ₅ , C _{5A} —Var. cond. with trimmers.
C20204-500	C ₉ , C ₁₃ , C ₁₈ , C ₂₄ —0.0005 μfd., 500 v. cond.
C20204-101	C ₇ , C ₂₀ , C ₂₉ , C ₃₁ —0.001 μfd., 500 v. cond.
C20226-501	C ₈ , C ₁₀ —0.005 μfd., 350 v. cond.
C20226-102	C ₉ , C ₁₃ , C ₁₈ , C ₂₄ , C ₃₂ —0.01 μfd., 350 v. cond.
C20225-502	C ₁₅ , C ₂₈ , C ₂₇ , C ₂₉ , C ₃₅ —0.05 μfd., 350 v. cond.
C20204-100	C ₁₀ —0.0001 μfd., 500 v. cond.
C20206-201	C ₁₁ —0.002 μfd., 500 v. mica cond.
C20205-2	C ₁₀ —0.001 μfd., 500 v. cond.
C20204-270	C ₂₁ —0.00027 μfd., 500 v. cond.
C20068-503	C ₂₅ , C ₃₀ —0.5 μfd., 400 v. cond.
C20205-3	C ₂₈ —0.0002 μfd., 500 v. cond.
A21402	C _{28A} , C _{28B} , C _{28C} , C _{28D} —40/40/80/20 μfd., 150/150/150/25 v. elec. cond.
C20068-103	C ₃₅ —0.1 μfd., 400 v. cond.
C20205-5	C ₃₆ , C ₃₇ —0.0005 μfd., 500 v. cond.
C20203-202	C ₃₈ —0.002 μfd., 350 v. cond.
A21403	C ₃₉ —8 μfd., 50 v. elec. cond.
C20067-503	C ₁₀ —0.5 μfd., 200 v. cond.
C20067-502	C ₁₁ —0.005 μfd., 200 v. cond.
C20065-251	C ₁₂ —0.0025 μfd., 500 v. mica cond.
C20069-502	C ₁₂ —0.005 μfd., 600 v. cond.
AE21395-1	L ₁ —Antenna loop assembly
AA21445-1	L ₂ , L ₃ , L ₄ , L ₅ , L ₁₀ , L ₁₃ , L ₁₄ —High frequency choke
AC21399-1	L ₅ —First r.f. coil (FM)
AC21400-1	L ₇ —Second r.f. coil (FM)
AC21397-1	L ₈ —Osc. coil (FM)
AC21396-1	L ₉ , L ₁₀ —Osc. coil (AM)
AA21444-1	L ₁₁ , L ₁₂ —High frequency choke
AC21394-1	L ₁₆ —"B+" filter choke
AA21398-1	T ₁ —Ant. coupling trans.
AC21390-1	T ₁ —First i.f. coil
AD21391-1	T ₃ —Second i.f. coil
AD21392-1	T ₄ —Detector trans.
AC21393-1	T ₅ —Output trans.

BELMONT MODEL 6D121

Part No.	Code and Description
C-9B1-13	R ₁ —1000 ohm, 1/2 w. res.
C-9B1-31	R ₂ —1 megohm, 1/2 w. res.
C-9B1-50	R ₃ —100 ohm, 1/2 w. res.
C-9B1-26	R ₄ —150,000 ohm, 1/2 w. res.
C-9B1-42	R ₅ —22 ohm, 1/2 w. res.
C-9B1-70	R ₆ —4700 ohm, 1/2 w. res.
C-9B1-25	R ₇ —100,000 ohm, 1/2 w. res.
C-9B1-23	R ₈ , R ₉ —47,000 ohm, 1/2 w. res.
C-9B2-53	R ₉ —180 ohm, 1 w. res.
C-9B2-63	R ₁₀ —1200 ohm, 1 w. res.
C-9B1-34	R ₁₁ —3.3 megohm, 1/2 w. res.
C-9B1-52	R ₁₂ , R ₁₃ —150 ohm, 1/2 w. res.
101218 or A-10A-10626	R ₁₃ , S ₁ —1 megohm vol. control & sw.
C-9B1-29	R ₁₆ —470,000 ohm, 1/2 w. res.
C-9B1-27	R ₁₇ —220,000 ohm, 1/2 w. res.
C-9B1-35	R ₁₈ —4.7 megohm, 1/2 w. res.
C-9B2-44	R ₁₉ —33 ohm, 1 w. res.
B-8A-10211	C ₁ , C ₂ , C ₇ —2-gang var. cond.
C-8D-10778	C ₁ , C ₁₀ —0.02 μfd., 400 v. cond.
C-8F3-12	C ₂ —470 μfd. mica cond.
C-8D-10760	C ₅ —1 μfd., 400 v. cond.
C-8D-10775	C ₅ —25 μfd., 200 v. cond.
C-8F3-8	C ₆ , C ₈ , C ₁₀ —0.01 μfd. mica cond.
A-8C-10077	C ₉ , C ₁₀ , C ₁₁ —40/20/20 μfd., 150/150/150 v. elec. cond.
C-8D-10770	C ₁₂ —0.5 μfd., 200 v. mica cond.
129161	C ₁₃ , C ₁₄ —Dual .0001 μfd. mica cond.

C-8D-10774	C-8D-10953
C-8D-10778	C-212-11565
A-13D-10215	108140H or B-13A-12023
108145 or B-13B-12022	105104
114197	

C ₁₀ —0.02 μfd., 400 v. cond.
C ₁₇ —0.15 μfd., 400 v. cond.
C ₁₈ —0.004 μfd., 600 v. cond.
T ₁ —Loop ant. assembly
T ₂ —Osc. coil
T ₃ —Input i.f. coil (in can)
T ₄ —Output i.f. coil (in can)
T ₅ —Output trans. for speaker
T ₆ —5" PM speaker

GENERAL ELECTRIC MODELS 60, 62

Part No.	Code and Description
URD-081	R ₁ —22,000 ohm, 1/2 w. res.
URD-113	R ₂ , R ₁₈ , R ₁₄ —470,000 ohm, 1/2 w. res.
URD-129	R ₁₀ —2.2 megohm, 1/2 w. res.
RRC-054	R ₁₁ —0.5 megohm vol. control
URD-141	R ₁₂ —6.8 megohm, 1/2 w. res.
URD-029	R ₁₀ —150 ohm, 1/2 w. res.
URF-051	R ₁₀ —1200 ohm, 2 w. res.
RRW-008	R ₁₃ —18 ohm, 1 w. wirewound res.
UCC-630	C ₁ , C ₁₇ , C ₂₀ —0.1 μfd., 600 v. cond.
RCT-021	C _{2A} , C _{2B} —Tuning cond.
UCC-635	C ₅ , C ₁₀ , C ₁₁ , C ₂₁ —0.5 μfd., 600 v. cond.
UCU-040	C ₁₀ —330 μfd. mica cond.
UCU-036	C ₁₀ —220 μfd. mica cond.
UCC-623	C ₂₂ —0.03 μfd., 600 v. cond.
RCE-050	C _{23A} , C _{23B} —50/50 μfd., 150/150 v. elec. cond.
UCW-020	C ₂₃ —47 μfd. ceramic cond.
UOP-418	LS ₁ —4" PM speaker
RTL-050	T ₁ —First i.f. trans.
RTL-051	T ₂ —Second i.f. trans.
RTO-036	T ₃ —Output trans.
RLC-051	T ₄ —Osc. coil

WESTINGHOUSE MODEL H-165

Part No.	Code and Description
V-4796	R ₁ —1 megohm tone control
V-4797	R ₂ —1 megohm vol. control
V-4872	R ₃ —2200 ohm ballast res.
V-4807	R ₄ —68 ohm fusible res.
RC10AE391K	R ₅ , R ₆ —390 ohm, 1/4 w. res.
RC20AE821K	R ₇ —820 ohm, 1/2 w. res.
RC20AE682K	R ₈ —6800 ohm, 1/2 w. res.
RC20AE471M	R ₉ —470 ohm, 1/2 w. res.
RC30AE102M	R ₁₀ —1000 ohm, 1 w. res.
RC10AE474M	R ₁₃ , R ₁₈ —470,000 ohm, 1/4 w. res.
RC10AE473M	R ₁₃ —47,000 ohm, 1/4 w. res.
RC10AE225M	R ₁₄ —2.2 megohm, 1/4 w. res.
RC10AE104K	R ₁₅ —100,000 ohm, 1/4 w. res.
RC10AE104M	R ₁₀ —220,000 ohm, 1/4 w. res.
RC20AE105K	R ₁₇ —1 megohm, 1/2 w. res.
RC10AE335M	R ₁₈ , R ₁₉ —3.3 megohm, 1/4 w. res.
RC20AE475M	R ₂₀ , R ₂₁ —4.7 megohm, 1/2 w. res.
V-4791	C ₁ , C ₂ —Dual 50 μfd., 150 v. elec. cond.
V-3866	C ₃ —100 μfd., 25 v. elec. cond.
V-4792	C ₄ —Osc. padder cond.
V-4793	C ₅ , C ₆ , C ₇ , C ₈ , C ₉ , C ₁₀ , C ₁₁ —3-gang var. cond.
RCM20A101M	C ₁₂ —100 μfd. mica cond.
RCM20A101K	C ₁₂ , C ₁₃ —100 μfd. mica cond.
RCM20A301M	C ₁₅ , C ₁₆ —300 μfd. mica cond.
RCP10W6102A	C ₁₇ —0.01 μfd., 600 v. cond.
RCP10W6502A	C ₁₈ , C ₁₉ —0.05 μfd., 600 v. cond.
RCP10W4103A	C ₂₀ —0.1 μfd., 400 v. cond.
RCP10W4503A	C ₂₁ , C ₂₂ , C ₂₃ , C ₂₄ , C ₂₅ , C ₂₆ —0.5 μfd., 400 v. cond.
RCP10W4104A	C ₂₇ , C ₂₈ , C ₂₉ —1 μfd., 400 v. cond.
RCM20A241K	C ₃₀ —240 μfd. mica cond.
V-4811	C ₃₁ , C ₃₂ , L ₇ , L ₈ —First i.f. trans.
V-4812	C ₃₃ , C ₃₄ , L ₉ , L ₁₀ , L ₁₁ —Second i.f. trans.
V-4794	L ₁ —Ant. loading coil
V-4795	L ₂ , L ₃ —Osc. coil
V-4813	L ₄ , L ₅ —R.f. coil
V-4831	L ₆ —Loop ant.
V-4803	SW ₁ , SW ₂ —Battery-off-line sw.

CROSLLEY MODEL 58TK

Part No.	Code and Description
C-139919	1—1 f. trans.
AC-139873	2—Ant. loop and back assembly
Part of 17	3—Power sw.
C-132300-2	4—Cable and plug assembly
AD-138459	5—Speaker (less trans.)
39373-60	7—22,000 ohm, 1/2 w. res.
39373-14	8, 16—100 ohm, 1/2 w. res.
39373-161	9—6800 ohm, 1 w. res.
39373-100	10—3.3 megohm, 1/2 w. res.

Over 90%

OF NEW MOBILE TRANSMITTER DESIGNS

USE HYTRON

THE ORIGINAL INSTANT-HEATING TUBE



HY69 — the original instant-heating tube.

Because they fill a real need for conserving filament power, Hytron instant-heating tubes are in. Yes, the 2E25, 2E30, HY69, HY1269, and 5516 are in the new mobile transmitter designs of many famous friends—too many to thank in this small space. The 2E25 and 2E30 also appear on the Army-Navy Preferred List. Why so popular? With no standby current, battery drain can be cut to 4% of that with cathode types—attainable power output and range increase. Potentials of rugged filaments are centered for battery operation. Beam pentode versatility simplifies the spares problem—one type can power all stages. Join the leaders. If you build mobile equipment—for land, sea, air—put Hytron original instant-heating, easy-on-the-battery tubes on *your* preferred list.

BENDIX RADIO

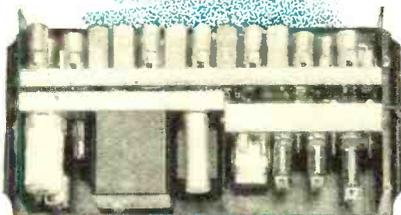

Bendix MRT-3A, 152-162 mc f-m taxicab transmitter uses 2E30's generously.



Federal's 25-watt, vhf Model FMTR-25-VC. Note emphasis on 2E30 and 5516.

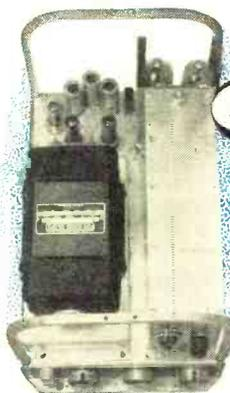

Harvey Laboratories chose 2E30's, 5516's for its Model 542 f-m transmitter.



Jefferson-Travis Model 351, 35-watt marine radio-telephone employs HY69's.

KAAR ENGINEERING CO.
PALO ALTO, CALIF.

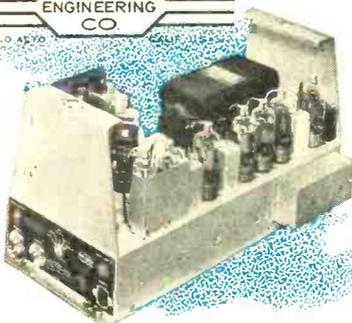

Kaar FM-50X features 2E25, HY69 throughout. Hytron instant-heating tubes since 1939.

Motorola



5516's power both driver-doubler and final of Motorola's Model FMTR-30D.

SPECIALISTS IN RADIO RECEIVING TUBES SINCE 1921

HYTRON

RADIO AND ELECTRONICS CORP.



MAIN OFFICE: SALEM, MASSACHUSETTS



WRITE FOR FREE NEW DATA SHEETS: 2E25, 2E30, HY69, HY1269, 5516.

AMPERITE MICROPHONES



Studio Velocity Models R80H, R80L List \$80.00



P. G. Dynamic Models PGH, PGL List \$32.00

Address inquiry attention Dept. R.N.

The ultimate in microphone quality, the new *Amperite Velocity* has proven in actual practice to give the highest type of reproduction in Public Address, Broadcasting and Recording.

The major disadvantage of pre-war velocities has been eliminated—namely "boominess" on close talking.

● *Shout* right into the new *Amperite Velocity*—or stand 2 feet away—the quality of reproduction is always excellent.

● Harmonic distortion is less than 1% (Note: best studio diaphragm mike is 500% higher.)

● Practically no angle discrimination . . . 120° front and back. (Best studio diaphragm microphones—discrimination 800% higher.)

● One *Amperite Velocity* Microphone will pick up an entire symphony orchestra.

There is an *Amperite* Microphone for every requirement

WRITE FOR ILLUSTRATED 4-PAGE FOLDER giving full information and prices.



Velocity Microphone for Public Address Models RBHG, RBGL List \$42.00



"Kontak" Mikes Model SKH, list \$12.00 Model KKH, list \$18.00

In Canada: Atlas Radio Corp. 560 King St. W., Toronto

AMPERITE Company
561 BROADWAY NEW YORK

- 39373-67
- 39373-144
- 39373-107
- 39373-80
- 39373-87
- B-139635
- B-137073-17
- 39001-13
- 39001-17
- 39001-19
- 39001-73
- 39001-76
- 39001-80
- B-136770
- B-137723
- AW-142640
- 11—47,000 ohm, 1/2 w. res.
- 12—1200 ohm, 1 w. res.
- 13—10 megohm, 1/2 w. res.
- 14—220,000 ohm, 1/2 w. res.
- 15—470,000 ohm, 1/2 w. res.
- 17—1 megohm vol. control & sw.
- 18A, 18B—Two section var. cond.
- 19—.01 μfd., 600 v. cond.
- 20, 21—.05 μfd., 600 v. cond.
- 22—.1 μfd., 600 v. cond.
- 23, 24, 26—250 μfd., 600 v. cond.
- 25—.003 μfd., 600 v. cond.
- 27, 28—.02 μfd., 600 v. cond.
- 29A, 29B—50/30 μfd., 150/150 v. filter cond.
- 30—Output trans.
- 31—Osc. coil assembly

ADMIRAL MODEL 7C64 CHASSIS 8B1

Part No.	Code and Description
60B 3-474	R ₁ , R ₂ , R ₁₁ , R ₂₁ , R ₂₇ —470,000 ohm, 1/4 w. res.
60B 14-273	R ₂ , R ₇ —27,000 ohm, 1 w. res.
60B 3-222	R ₃ —2200 ohm, 1/4 w. res.
60B 2-563	R ₄ —56,000 ohm, 1/4 w. res.
60B 3-223	R ₅ —22,000 ohm, 1/4 w. res.
60B 3-473	R ₈ , R ₁₀ , R ₂₅ —47,000 ohm, 1/4 w. res.
60B 21-153	R ₉ —15,000 ohm, 2 w. res.
60B 2-391	R ₁₀ —390 ohm, 1/4 w. res.
60B 1-682	R ₁₁ , R ₂₆ —6800 ohm, 1/4 w. res. ± 5%
60B 3-273	R ₁₂ —27,000 ohm, 1/4 w. res.
60B 3-224	R ₁₃ —220,000 ohm, 1/4 w. res.
60B 21-153	R ₁₄ —15,000 ohm, 2 w. res.
60B 2-124	R ₁₇ —120,000 ohm, 1/4 w. res.
60B 2-104	R ₁₈ —100,000 ohm, 1/4 w. res.
75B 2-8	R ₂₀ , SW—2 megohm vol. control (tapped at 1 megohm)
60B 3-475	R ₂₁ —47 megohm, 1/4 w. res.
75B 1-20	R ₂₂ —2 megohm tone control
60B 3-225	R ₂₃ —2.2 megohm, 1/4 w. res.
60B 3-335	R ₂₄ —3.3 megohm, 1/4 w. res.
60B 14-391	R ₂₈ —390 ohm, 1 w. res.
65B 6-31	C ₁ —30 μfd. zero temp. coefficient silver ceramic cond. ± 2%
68B 8	C _{2B} , C _{2C} —Gang cond., 440 μfd. (max.) ant. section, 160 μfd. (max.) osc. section.
65B 6-4	C ₈ , C ₉ , C ₁₀ , C ₂₅ —50 μfd. ceramic cond.
64B 1-32	C ₄ —05 μfd., 200 v. cond.
65A 10-1	C ₅ , C ₁₄ , C ₁₅ , C ₁₇ , C ₁₈ , C ₂₁ —01 μfd. ceramic disc. cond.
65B 6-30	C ₆ —22 μfd. zero temp. coefficient silver ceramic cond. ± 2%
65B 1-51	C ₇ —955 μfd. mica cond. ± 3%
64B 1-20	C ₈ , C ₃₀ —1 μfd., 400 v. cond.
65B 6-32	C ₁₁ —45 μfd. —.00015 temp. coefficient silver ceramic cond. ± 2%
65B 1-29	C ₁₂ —180 μfd. mica cond. ± 3%
65B 6-24	C ₁₃ —10 μfd. ceramic cond.
64B 1-25	C ₁₆ , C ₂₆ , C ₃₁ , C ₃₂ —01 μfd., 400 v. cond.
65B 6-3	C ₁₉ , C ₂₀ —0001 μfd. ceramic cond.
65B 6-7	C ₂₂ , C ₂₃ —0001 μfd. ceramic cond. ± 5%
67A 4-2	C ₂₄ —4 μfd., 150 v. elec. cond.
64B 1-14	C ₂₅ —002 μfd., 600 v. cond.
67C 7-10	C _{27A} , C _{27B} , C _{27C} , C _{27D} —30/30/10/20 μfd., 350/350/350/25 v. elec. cond.
64B 1-29	C ₂₈ —2 μfd., 200 v. cond.
64B 1-15	C ₂₉ —001 μfd., 600 v. cond.
64B 1-12	C ₃₀ , C ₃₅ —005 μfd., 600 v. cond.
64B 1-22	C ₃₄ , C ₃₈ —05 μfd., 400 v. cond.
64B 1-10	C ₃₇ —01 μfd., 600 v. cond.
65B 6-18	C ₂₀ —15 μfd. ceramic cond.
72B 3-7	T ₁ —First i.f. trans. (FM)
72B 3-7	T ₂ —Second i.f. trans. (FM)
72B 27	T ₃ —Discriminator trans.
72B 28-12	T ₄ —First i.f. trans. (AM)
72B 28-12	T ₅ —Second i.f. trans. (AM)
80B 5	T ₆ —Power trans.
79A 5	T ₇ —Output trans.
95A 18-2	L ₁ —Loop ant.
69A 25	L ₂ —Loop loading coil (AM)
69A 23	L ₃ —Ant. coil (FM)
A 1475	L ₄ —R.f. coil (AM)
69A 21	L ₅ —R.f. coil (FM)
69A 22	L ₆ —Osc. coil (FM)
69A 24	L ₇ —Osc. coil (AM)
73A 1	L ₈ —Osc. choke (FM)
74A 10	L ₉ —Filter choke
	L ₁₀ —R.f. choke (approximately 10 i. solid #22 hookup wound on C ₂₀)
77B 14	SW ₁ —Bandswitch
G400A 162	SW ₂ —Power sw. (Part of R ₂₀)
	SW ₃ —Phono motor sw.

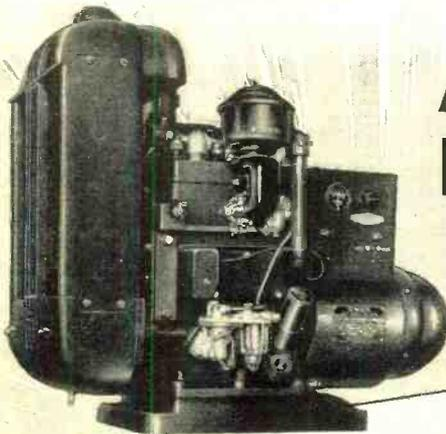

A.C. OR D.C. POWER

PORTABLE,
STANDBY OR
STATIONARY

You can simplify any power-for-electronics problem with an ONAN Electric Plant. A wide range of models and sizes makes it easy to choose the right plant for the particular application.

Lightweight one or two-cylinder air-cooled models for easy portability—A.C.—350 to 5,000 watts, D.C.—600 to 5,000 watts.

Onan two, four and six-cylinder water-cooled models are built for continuous heavy-duty operation, stationary or mobile. A.C.—3,000 to 35,000 watts, D.C.—3,500 to 10,000 watts.

ONAN Electric Plants: A.C.—350 to 35,000 watts in standard voltages and frequencies. D.C.—600 to 10,000 watts, 115 and 230 volts. Battery chargers—500 to 6,000 watts, 6 to 115 volts.

D. W. ONAN & SONS INC.
4791 Royalston Ave. Minneapolis 5, Minn.

- For—
- Radio Station Standby
 - Geophysical Survey
 - Railroad Radio
 - "Spot" Recording
 - Mobile Radio Units
 - Municipal Signal Standby
 - Amateur Radio

Write for Folder



ONAN ELECTRIC PLANTS

WAR SURPLUS WITH A MONEY BACK GUARANTEE AT R & M RADIO

**COMPLETE STOCKS
MINIMUM PRICES
IMMEDIATE
DELIVERY**

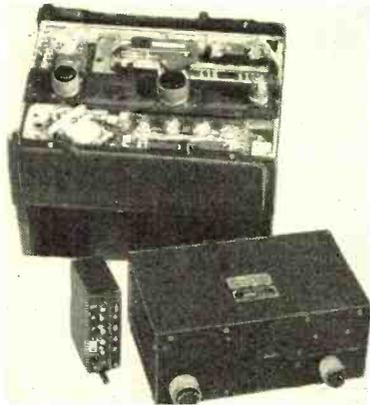

2 METER RIG AAF SCR-522

AAF SCR-522 designed to operate from 100-156 mc. makes ideal 2 meter rig (or 2-way mobile radio). Only two small changes incorporated converts to 6 meter operation. As mobile radio telephone unit the dynamotor can be converted to an engine-driven, self-excited generator or coupled to 1/4 hp. AC motor for ground station power supply.

Transmitter and Receiver complete with tubes. **\$17.50**

Trans-Rec., tubes, dynamotor, control box, plugs and conversion diagram book. **\$24.50**

PE-98 DYNAMOTOR 12-volt input for use with the SCR-522 or any 12-volt equipment. ea. **Only \$12.50**

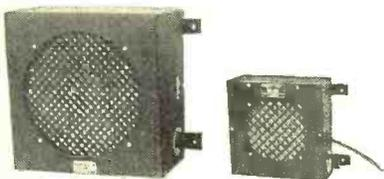

HIGH FIDELITY SPEAKERS

6-inch, 10-watt PM Speaker, ea. **\$7.95**

12-inch, 15-watt PM Speaker, ea. **\$14.50**

Brand new in Heavy Duty Steel Cabinets with beautiful black wrinkle finish.

Also has T-pad volume control and 600 ohm line to speaker transformer. Wall mounting brackets and slope front.

February, 1948

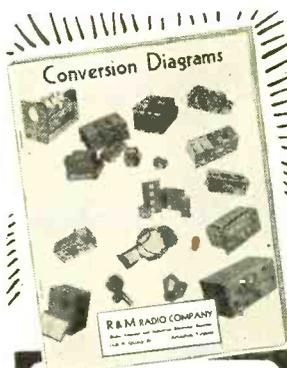

FREE CONVERSION BOOK

with each of these specials or order your copy at **\$2**

Gives data on conversion, with schematic diagrams, instructions, discussion.

Diagrams and Conversions on this War Surplus

- BC-348
- SCR-522
- BC-375
- SCR-274
- SCR-274-10 met. mobile

Also diagrams for:

- BC-221 Freq. meter
- ART-13 Collins Xmtr.
- APN-1 • SCR-718
- APN-4

Send for **FREE CATALOGUE** of radio parts and other surplus **BARGAINS**.

SAVE COD CHARGES BY REMITTING IN FULL

or send 25% deposit on all orders. Shipment is from nearest warehouse—East, Mid-West, or West Coast. All Orders Shipped Best Way, Prices FOB.



Cost Govt.
Over \$600.00

TRANSMITTERS AND RECEIVERS FOR 10 Meter Mobile Rig

WAR SURPLUS SCR-274-N COMPLETE FOR ONLY

Conversion Book gives details for low-cost, easy conversion to

- 10 METER MOBILE RIG
- 20—40—80 METER BANDS

\$19.50

This sensation of all surplus is not only an ideal 10 Meter Mobile Rig! It's a complete amateur radio station! Here are a few more ways to use the equipment included in this Command Set. The transmitter VFO driver stage gives your BC-375-E higher RF output—as high as 150 watts. Make swell standby receivers with the BC-348 on round-table "rag chews." You get all this equipment: 3 Receivers—190-550 kc, 3-6 and 6-9.1 mc; two transmitters, 4-5.3 mc, 5.3-7 mc; four dynamotors—28 volts DC input; 1 modulator with carbon mike input; two tuning control boxes; one antenna coupling box with r-f ammeter; antenna relay and 5000 volt 50 mmfd. WE vacuum condenser (antenna relay can be used with most rigs); and a complete set of tubes for each unit—29 POPULAR TUBES in all. Mechanical cables for remote tuning of receivers supplied for \$1.00 extra.

FREE CONVERSION BOOK

LOOP LP-21

Shielded Loop Antenna Rotated by Selsyn motor. Has separate selsyn transmitter for remote indicator. Has a weather proof tear drop housing over loop.

Price Only **\$8.95**



NAVY TRANSMITTER TYPE GP-7

Rated at over 125 watts, designed to cover from 350 to 9050 kc. with plug-in tuning units; one of the few transmitters

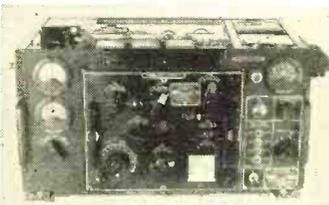

on surplus market built of standard parts, making it a very unusual buy. Limited quantities. **Only \$17.50**

Transmitter, tubes and tuning unit—

Send for **FREE Catalogue of Transmitter & Receiver Kits**

R & M RADIO COMPANY

1426 N. QUINCY STREET, DEPT. RN-28 • ARLINGTON, VIRGINIA

NEWCOMB

MANUFACTURER OF AMERICA'S TOP QUALITY AMPLIFIER

ANNOUNCES the NEW E-SERIES

A LOW-PRICED LINE OF SUPERIOR UTILITY

AMPLIFIERS

THE maker of the incomparable K and H Series of quality amplifiers has designed and produced the new E-Series with the same high quality materials and workmanship, to produce the best low-priced 10-, 17- and 25-watt amplifiers ever offered. Included in the line are phono tops and portable assemblies. The E-Series fills the need of those who want a superior, dependable amplifier, but who must confine their purchases to the lower-price range. Here are amplifiers that fill all the requirements of standard utility applications, priced within reach of all.

MODEL E-10: An outstanding value in the public address market, the E-10 delivers a full 10 watts from push-pull 6V6 tubes in a multi-stage inverse feedback circuit . . . has inputs for microphone and phonograph and a full range tone control.

49⁵⁰ RETAIL

With tubes less cover.

MODEL E-17: 17 watts of undistorted audio from push-pull 6L6 tubes. Inputs for a microphone and phonograph . . . Full range tone control . . . Multi-stage inverse feedback.

79⁵⁰ RETAIL

With tubes and cover

MODEL E-25: A really fine utility amplifier for better performance, more dependable operation. Full range tone control, 25 watts of undistorted power and inputs for 2 mikes and a phonograph make the E-25 easily applicable to most sound jobs. Inverse feedback assures lowest distortion.

99⁵⁰ RETAIL

With tubes and cover

(Prices slightly higher east of the Rockies.)

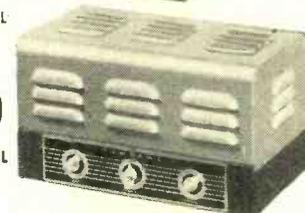

Send for Specifications

AUDIO PRODUCTS CO.

Dept. F, 6824 Lexington Avenue • Hollywood 38, California

PRE-EXAM TESTS FOR Commercial Radio Operator FCC LICENSE EXAMINATIONS



DON'T TAKE A CHANCE—AVOID FAILURE ON FCC COMMERCIAL RADIO OPERATOR LICENSE EXAMINATIONS!
USE NILSON'S COMPLETE PRE-EXAMINATION TESTS AND COACHING SERVICE Enables You To

Rehearse the FCC license examinations Practice the procedure Practice the multiple-choice examination methods used by FCC

Check your knowledge Locate your weak points Correct your weak points before taking the actual examination

Prepared by Arthur R. Nilson, Famous Co-author of Nilson and Hornung's RADIO OPERATING QUESTIONS AND ANSWERS
Cleveland Institute of Radio Electronics, RN-2 Terminal Tower, Cleveland 13, Ohio

Cleveland Institute of Radio Electronics
RN-2 Terminal Tower, Cleveland 13, Ohio
Please send information about Pre-Exam Tests.

Name.....
Address.....
City..... Zone..... State.....

International Short-Wave

(Continued from page 63)

- *5.986V—Pointe-a-Pitre, Guadeloupe, "Radio Guadeloupe," 200 w.
- *5.990—YSWW, Santa Ana, El Salvador
- *5.990—LRS1, Buenos Aires, Argentina
- 5.990—H13U, Santiago de los Caballeros, Dominican Republic, "La Voz del Comercero," 200 w.
- 5.991—HSSPD, Bangkok, Siam, "The Overseas Station," 800 w.
- 5.995—PR13, Belo Horizonte, Brazil, "Radio Inconfidencia," 1 kw.
- 6.000—ZFY, Georgetown, British Guiana, "The Voice of Guiana," 500 w.
- *6.000—20Y, Accra, Gold Coast, 5 kw.
- *6.000—XEET, Mexico City, Mexico, 500 w.
- 6.000—HHYM, Port-au-Prince, Haiti
- 6.000—Salisbury, Southern Rhodesia, 500 w.
- *6.000—Damascus, Syria
- *6.000—XGOH, Laiyang, China
- 6.000—OCX4C, Lima, Peru, "Radio Ministerio de Educacion Publica," 200 w.
- 6.000V—HCQRX, Quito, Ecuador, "Radio Quito," 250 w.
- 6.000V—Innsbruck, Austria, "Radio Vorarlberg," 250 w.
- *6.005—Moscow
- 6.005—VE9A1, Edmonton, Alberta, Canada, "The Voice of the Great Northwest," 200 w.
- 6.005—CFXC, Montreal, Quebec, Canada, 75 w.
- 6.005—HP5K, Colon, Panama, "La Voz de la Victor," 800 w.
- *6.005—JO9I, Niigata; JO2K, Nagoya; JO5B, Matsuyama; JO6F, Fukuoka; JO8G, Sapporo, Japan; all 300 w.
- 6.005—JO8C, Sapporo, Japan
- *6.006—Rabat, French Morocco
- *6.007—Johannesburg, South Africa, SABC (Johannesburg III), 5 kw.
- 6.010—Singapore, Malaya, "Radio Malaya"
- 6.010—Q2RC, Leopoldville, Belgian Congo, "Radio Congolia," 250 w.
- 6.010—CJCX, Sydney, Nova Scotia, Canada, 1 kw.
- 6.010—OLR2A, Prague, Czechoslovakia, 17 kw.
- *6.010—GRE, London, 50-100 kw.
- 6.010—VUC2, Calcutta, India, AIR, 10 kw.
- *6.010—VUD11, Delhi, AIR, 20 kw.
- 6.010—OAX4Q, Lima, Peru, 1 kw.
- 6.010—Moscow
- 6.010V—Damascus, Syria, "Radio Damascus"
- 6.012—CE601, Antofagasta, Chile, "La Voz del Norte," 250 w.
- 6.012—XE0I, Mexico City, Mexico, "Radio Mil," 2.5 kw.
- 6.015—JKD, Nazaki, Japan, AFRN, 5 kw.
- *6.015—JLR, Tokyo.
- 6.016—PRAS, Recife, Brazil, "Radio Clube Pernambuco," 5 kw.
- 6.017—XURA, Tai-Pei, Formosa, "Taiwan Broadcasting Station," 1 kw.
- 6.017—YNMM, Managua, Nicaragua, "Radio Continental," 300 w.
- 6.018V—HJCX, Bogota, Colombia, "La Voz de Colombia," 1 kw.
- 6.020—CP41, Sucre, Bolivia, "Radio Charcas," 50 w.
- 6.020—MCH, Luxembourg, Luxembourg
- 6.020—XEUW, Vera Cruz, Mexico, "El Eco de Soventeno desde Veracruz," 250 w.
- *6.020—XNCR, Yenan (T), China
- 6.020—Kiev, USSR, 40 kw.
- 6.024—Brazzaville, French Equatorial Africa, "Poste Nationale Francaise," 1.5 kw.
- 6.024—CR4A, Praia, Cape Verde Islands
- *6.025—Algiers, Algeria
- 6.025—HClIR, Ibarra, Ecuador, "Radio Commercial"
- 6.026—PGD, Huizen (Hilversum), Holland, "PCJ, Radio Nederland," 5 kw.
- 6.026—CP37, Oruro, Bolivia, "Radio Oruro," 250 w.
- 6.026—H11J, San Pedro de Macoris, Dominican Republic, 100 w.
- *6.028V—XGHT, Hantan, China
- *6.029—Rome, Italy, "Radio Italiana," 1 kw.
- 6.030—CFVP, Calgary, Alberta, Canada, "Voice of the Prairies," 100 w.
- *6.030—OLR2B, Prague, Czechoslovakia, 17 kw.
- 6.030—XEKW, Morelia, Mexico, "El Eco de Michoacan," 500 w.
- *6.030—CB7AA, Lourenco Marques, Mozambique
- 6.030—HP5B, Panama City, Panama, "Radio Miramar," 250 w.
- *6.030—Komsomolsk (Khabarovsk Territory), U.S.S.R., 50 kw.
- 6.030—Moscow
- 6.035—Rangoon, Burma, "Radio Rangoon," 1 kw.
- *6.035—GWS, London, 50-100 kw.
- 6.035—CXA30, Montevideo, Uruguay, "Radio Nacional," 1 kw.
- *6.035—XELX, Guadaluajara, Mexico, "Radio Occidental," 500 w.
- *6.035—MTCY, Chungchun, China
- 6.038—OAX6B, Arequipa, Peru, "Radio Landa," 200 w.
- 6.038—Berlin, Germany
- 6.040—WRUA, Boston, Mass., U.S.A., 50 kw.
- *6.040—YDD, Bandoeng, Java
- 6.040—XGSA, Nanking, China
- 6.040—HSSPD, Bangkok, Siam
- *6.043V—XGHT, Hantan, China
- 6.045—COBF, Havana, Cuba, "Cine Radial," 1 kw.
- 6.045—XBTW, Tampico, Mexico, "La Voz de Tampico," 100 w.

(Continued on page 92)

WAR SURPLUS BC-375-E TRANSMITTER

With thousands of usable standard radio parts

\$24.50

COMPLETE
(Gov't cost, \$1800)

Wiring & Conversion
Diagram
FREE

PARTS ALONE WORTH HUNDREDS OF DOLLARS TODAY! Use it for parts or use it as a transmitter

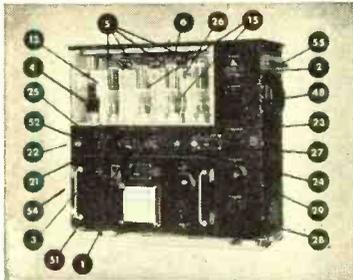

You get all this: transmitter, tubes, ant. loading unit, dynamotor, five tuning units.

COMPLETE BC-375-E TRANSMITTER

METERS

1. (1) 0-15V AC. DC., GE
2. (1) 0-8A RF with thermocouple, GE
3. (1) 0-500 MA. DC., GE

TUBES

4. (1) 10Y (VT-25)
5. (4) 211 (VT-4-C)

COILS

44. (3) RF chokes
45. (1) AF choke .5 hy 1 amp
46. (1) Parasitic Suppressor
47. (1) Tapped antenna loading coil on ceramic form

RESISTORS

6. (1) lapped Resistor 2.7 ohms, 36 watts—3.7 ohms, 26 watts
7. (1) 5 ohms 2 watt, IRC
8. (2) 5 ohms 12 watt, IRC
9. (1) 50 ohms 4 watt, IRC
10. (1) 100 ohms 12 watt, IRC
11. (1) 150 ohms 8 watt, IRC
12. (1) 200 ohms 2 watt, IRC
13. (1) 200 ohms variable, Mallory
14. (1) 2500 ohms 15 watt, IRC
15. (2) 3000 ohms variable, Mallory
16. (1) 4000 ohms 15 watt, IRC
17. (3) 11000 ohms 12 watt, IRC
18. (1) 30000 ohms 1 watt, IRC
19. (1) 200000 ohms 1 watt, IRC
20. (4) 250000 ohms 1 watt, IRC

CAPACITORS

29. (1) 22-118 mmf. variable with vernier dial
30. (1) tube thermal compensating and calibration reset capacitor
31. (2) .0001-1000 V, CD, mica
32. (1) .006-2500V, CD, mica
33. (2) .001-2500V, CD, mica
34. (1) .001-4500V, CD, mica
35. (1) .02-1000V, CD, mica
36. (1) .01-1000V, CD, mica
37. (1) .01-2500V CD, mica
38. (3) 1-300V, CD, mica
39. (1) 1-1-1 3000V GE, pyranol
40. (1) 25 mfd 25V, CD, electrolytic

COILS (continued)

48. (1) Continuously variable antenna loading coil with dial-ceramic form

SWITCHES

21. (1) Interlock
22. (1) Test
23. (1) SPDT Toggle
24. (2) DPST Toggle
25. (1) 3 pos. Mallory w/bar knob
26. (1) SPDT Toggle
27. (1) 4 pos., 3 sec. hi voltage band switch w/bar knob
28. (1) 5 pos. hi voltage, band switch w/bar knob

TRANSFORMERS

41. (1) Microphone trans. single button mic. to single grid
42. (1) Interstage transformer single plate to push-pull grids.
43. (1) Modulation transformer — class B mod. to class C plate

MISCELLANEOUS

49. (1) 8 contact antenna relay—28V D.C.
 50. (2) Ceramic insulated flexible couplings
 51. (1) 6.3V dial lamp and socket
 52. (1) mic. jack
 53. (2) .5A-1000V Fuses
 54. (3) Sockets with plugs
 55. (5) Binding posts
- Plus hardware, stand-off insulators, etc.

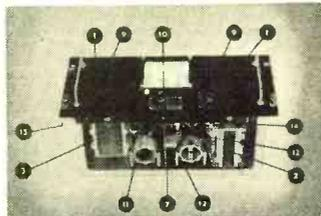

TYPICAL TUNING UNIT
TU-5-B—1500-3000 KCS

1. (2) Vernier dials
2. (1) Variable capacitor, 20-135 mmf.
3. (1) Variable capacitor, 20-156 mmf.
4. (1) Variable capacitor, 8-26 mmf.—neutralizing
5. (1) .00003-2000V capacitor, CD—mica
6. (3) .00009-3000V capacitor, CD—mica
7. (2) .0004-5000V capacitor, CD—mica
8. (3) .0001-3000V capacitor, CD—mica
9. (2) 4 position ceramic band switches
10. (2) 2 RF chokes
11. (1) Tank coil—ceramic form with tapped antenna coupling coil
12. (1) Tank coil—ceramic form
13. (1) Parasitic suppressor
14. (2) Ceramic flexible couplings
15. Plus banana jacks, stand-off insulators

PE-73 DYNAMOTOR

1. (1) Dynamotor 28V DC input—1000V DC output—GE
2. (1) Fuse, 30A 250V
3. (1) Fuse, 60A 250V
4. (1) Fuse, 1A 1000V
5. (1) Relay, 24V D. C.
6. (3) .005-5000V Capacitor, mica—CD
7. (1) .01-1000V Capacitor, mica—CD
8. (2) .01-600V Capacitor, mica—CD

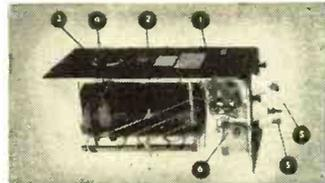

BC-306-A ANTENNA LOADING UNIT

1. (1) 3 Gang, 5 position, high voltage band switch
2. (1) Tapped inductance with variometer tuning
3. (1) Vernier dial
4. (1) Ceramic insulated flexible coupling
5. (2) Bee-hive feed-thru insulators
6. (1) Capacitor .00024-6000V SANGAMO

SAVE C. O. D. CHARGES by re-mitting in full direct—or send 25% deposit with all orders. Shipment made direct from whse. in Okla., Ariz., Ark. or Virginia.

R & M RADIO COMPANY

Dept. RN-28-1426 N. QUINCY ST., ARLINGTON, VIRGINIA

ANTENNA SWITCHES

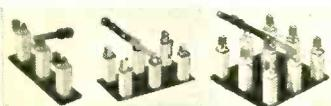

19c 29c 75c

HEADPHONE ADAPTERS MC-385

From high to low impedance, 4000 ohms to 600 ohms. Contains matching transformer.

30c each, 4 for \$1.00



Carbon Mike T-17

Used, in A-1 condition

\$1.00



Headphones 69c

HS-33 with cord and plug, 600 ohms — Used, in A-1 condition.

HEADPHONE EXTENSION CORDS 25c

Approx. 72" long, rubber covered, with JK-26 and PL-55 plugs.

R & M RADIO COMPANY, Dept. RN-28,
1426 N. Quincy St., Arlington, Va.

- Send Conversion Book. \$2 inclosed. Send C.O.D.
Send FREE catalogue on
 Xmtr. Kits. Receiver Kits. Tube Bargains.
 I am a licensed amateur. Beginner.

Name

Address

City

Zone..... State

RADIOMEN'S HEADQUARTERS * * * **WORLD WIDE MAIL ORDER SERVICE!!!**

RT-1579 consists of a three stage (cascade 6SJ7s and 6F6 output stage) high gain, high fidelity amplifier with 60 cycle, 110V power supply on the same 1 1/2 x 1 1/2 chassis, which is protected by a substantial steel cover over tubes and parts. Made by Western Electric with typical quality components such as a husky power transformer and oil condensers. This unit is obviously intended to give years of trouble-free service with no more need for repairs than a telephone. Disconnecting one wire each from the special input and output filters, will result in as high a fidelity amplifier as can be obtained. Your cost with tubes, diagram and parts list included—\$14.95.

We also offer the RT-1579 with a Raytheon Magnetic Voltage Regulator already installed beneath the cover. Imagine an amplifier complete with tubes, built to Western Electric quality standards, and immune to line voltage variations besides, making it perfectly suited for the most difficult industrial, circus, carnival, or commercial installations. Offered for a total price of only \$19.95, our price for both units. (Without explicit instructions to the contrary, the RT-1579 will be shipped for \$14.95 without regulator on orders for both units that are received after the voltage regulator supply is exhausted.)

1948 MODEL MUTUAL CONDUCTANCE TUBE TESTER \$49.95

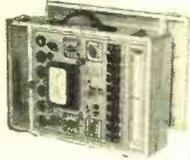

No possibility of good tubes reading "Bad" or bad tubes reading "Good" as on dynamic conductance testers or other ordinary emission testers. Attractive panel and case equal to any on the market in appearance. . . . Large 4 1/2" meter. . . . Calibrated micromho scale as well as a Bad-Good scale. . . . Front panel fuse. . . . Individual sockets for all tube base types—voltages from .75 volts to 117 volts and complete switching flexibility allow all present and future tubes to be tested regardless of location of elements on tube base. . . . Indicates gas content and detects shorts or opens on each individual section of all local, octal and miniature tubes including cold cathode, magic eye and voltage regulator tubes as well as all ballast resistors. Name of the nationally known manufacturer withheld because of special price offer.

Model "C"—Sloping front counter case. \$49.95
 Model "P"—Handsome hand-rubbed portable case. 54.95
 Built-in roll chart with either of above \$5.00 extra.

RT1463 7 tube amplifiers containing 3—7F7, 1—7Y4, 3—7N7, 4 potentiometers, numerous resistors, filter and bypass condensers, filter chokes, power and audio transformers, and six sensitive plate relays. A military development that provided amazing stepless control proportional to correction required, for ailerons, rudder and elevator, in the original application. A control amplifier of the ordinary type would deflect the rudder by some arbitrary amount when the ship was blown off the course to port or starboard. The result would either be that the correction was insufficient and the plane continued off course, or the correction would be too great, starting a series of tacking that would greatly increase fuel consumption and elapsed time in reaching the objective. This phenomenal unit, with its 3 amplifiers and six 5000 ohm relays in bridge circuits, will accurately control any 3 operations, related or unrelated, in minutely adjustable uniquely quantitative variations in either forward or reverse directions. 9"x11"x3" black crackle aluminum case. Brand new in original carton \$12.95, or used \$9.95.

AT LAST YOU CAN AFFORD A LABORATORY STANDARD MICROVOLTER

The famous Measurements Corp. Model 78B. 5 Tube Laboratory Standard Signal Generator (that sold new, FOB Boonton, N. J., for \$310.00 net), is available in perfect condition for 25 to 60 cycles, 115 V AC operation. Until now this is the sort of top-flight lab equipment that discriminating buyers have only vainly hoped would be released at a bargain price. Forth every cent the manufacturer asks, but available FOB Buffalo while our limited supply lasts for only \$79.95.

Such companies as Admiral Corp. and John Meck, Inc., have ordered from us and repeated many times on these 78 generators for use in their labs and production line testing. "REMEMBER THAT A STANDARD IS ONLY AS RELIABLE AS ITS MAKER."



Model 78-B Standard Signal Generator. Two Frequency Bands between 15 and 250 megacycles.

GENERAL ELECTRIC RT-1248 15-TUBE TRANSMITTER-RECEIVER

TERRIFIC POWER—(20 watts) on any two instantly selected, easily pre-adjusted frequencies from 435 to 500 Mc. Transmitter uses 5 tubes including a Western Electric 316 A as final. Receiver uses 10 tubes including 955's, as first detector and oscillator, and 3—7H7's as IF's, with 4 sub-tuned 40 Mc. IF transformers, plus a 7I7, 7E6's and 7F7's. In addition unit contains 8 relays designed to operate any sort of external equipment when actuated by a received signal from a similar set elsewhere. Originally designed for 12 volt operation, power supply is not included, as it is a cinch for any amateur to connect this unit for 110V AC, using any supply capable of 400V DC at 135 MA. The ideal unit for use in mobile or stationary service in the Citizen's Radio Telephone Band where no license is necessary. Instructions and diagrams supplied for running the RT-1248 transmitter on either code or voice, in AM or FM transmission or reception, for use as a mobile public address system, as on 80 to 110 Mc. FM broadcast receiver, as a Facsimile transmitter or receiver, as an amateur television transmitter or receiver, for remote control relay hookups, for Geiger-Mueller counter applications. Sells for only \$29.95 or two for \$53.90. If desired for marine or mobile use, the dynamotor which will work on either 12 or 24V DC and supply all power for the set is only \$15.00 additional.

\$9.95 TAKES ALL THREE BIG BARGAINS

- 1. AUDIO AMPLIFIER** Undreamed of value. Uses 6V6's. Has 4 microphone inputs brought to jacks at rear panel. Various output impedances available at rear panel connections. Steel case with chrome handles. 9" long x 9" high x 6" deep. Tubes included. New in original carton. Shipping weight 15 lbs. **SUPER SPECIAL—\$4.95** while supply lasts.
- 2. RADIO HEADSETS** Latest supersensitive type with rubber earpieces. Every pair guaranteed perfect. \$1.50 per pair OR 3 PAIRS FOR \$1.00.
- 3. HOME WORKSHOP AT BARGAIN PRICE** Accurate and precise 2 speed guaranteed hobby lathe, the essential machine for the home workshop. Sturdy enough for light production work or factory standby service. Supplied with 58" of beltting for connecting to any available electric motor or power take-off, such as on a jeep or tractor. Also included in this unbelievable offer are such accessories as a 1/2" drill chuck with specially hardened tool steel jaws, a 4" electric furnace high speed grinding wheel, a cotton buffing wheel with a large supply of buffing compound and a 4" steel wire scratch brush. Your cost \$6.00. Sole export agent. Distributor inquiries invited.

SCR-284 TRANSMITTER-RECEIVER—This medium power transmitter and the accompanying 7 tube very sensitive receiver are naturals for 80 or 40 meter operation (phone or CW), on either fixed stations or mobile applications. These units are brand new and come complete with 17 tubes, key, microphone, 200 KC calibrating crystal and instructions. Diagrams for use with up to 100 watts input to the final stage on 40 or 80 meters for either phone or CW, using vehicle or 110 Volt power supply. Your cost, \$39.95.

5" "SO" RADAR P.P.I. SCOPE, complete with 9 tubes including 807 tube in final power stage that provides deflecting current for magnetic yokes. Selsyn motor and self-contained 110 V. power supply designed to run on the AC supply on LST and PT boats. Various ranges from 2 to 80 miles. The most satisfactory scope available for navigational radar or panoramic television applications—\$39.95. "SO" RADAR ECHO BOXES. The perfect calibrated cavity wavemeter—\$10.00. **LORAN INDICATOR OSCILLOSCOPES**, including 26 tubes with 5" scope tube. Govt. instruction manual supplied with each of these—\$39.95.

MICROPHONES—All nationally known brands. Astatic Crystal—\$2.95; Bullett Dynamic—\$7.45; Mike Jr.—60c; Handy Mike—90c; Lapel Mike—93c; SHURE T-17 MIKES, with push to talk switch—99c. **20 ASSTD COIL FORMS**, including 11 ceramic, 3 polystyrene, and 6 fiber, all useful sizes—50c.

VARIABLE CONDENSERS: 350 MMFD, 5 gang—\$1.95; 4 gang—\$1.49; 3 gang—\$3.90; 2 gang—79c; 7.5 to 20 MMFD, 1750v spacing, extra long shaft Hammarlund—89c; miniature variables, 25 MMFD—39c; 50 MMFD—49c; 75 MMFD—59c; 100 MMFD—69c; 140 MMFD—79c.

FLUORESCENT LIGHT BALLASTS. Single 30 or 40 watt, \$1.68; Dual 40 watt High Power Factor—\$3.75.

HEADPHONES—Highest quality Signal Corps headsets with 12" cord and plug—\$1.25. 5" rubber covered patch-cords with phone plug and socket—45c.

BC-221 FREQUENCY METERS with calibrating Crystal and calibration charts. A precision frequency standard that is useful for innumerable applications for laboratory technician, service man, amateur, and experimenter at the give-away price of only \$36.95.

CLOSING OUT THE FOLLOWING DESIRABLE ITEMS AT SACRIFICE PRICES TO MAKE ROOM IN OUR WAREHOUSE FOR INCOMING STOCK.

- 917A ONE KILOWATT HIGH FREQUENCY TRANSMITTER.** This relay-controlled transmitter includes a 115V, 60 cycle power supply, protected by 8 magnetic circuit breakers, that alone is worth more than the price we are asking for the whole rig, even on today's surplus market. On the front panel are six 3 1/2" GE or Weston meters, including 250 MA, 50 MA, 1000 MA, 150 V AC and 1500 V DC at 1000 ohms per volt for screens and plate. The rack-type 21"x15"x36" unit contains six amplifier and rectifier tubes aggregating over \$200 at wholesale prices. Western Electric's price to the government was \$1500.00. Shipping weight: 500 lbs. Your cost at close-out price as is. Formerly \$69.95. Now Only. \$39.95
- BC-412 5" RADAR OSCILLOSCOPE.** Easily converted to a first class lab. scope or to an excellent home television receiver using the instructions in the August 1947 RADIO NEWS. Furnished with a brand new 5BP4 tube for the television application or a brand new 5BP1 for the scope application. Specify your choice. Sold at close-out price as is. Formerly \$59.95, now. \$29.95
- 5 INCH RECEIVER INDICATOR SCOPE.** This unit, originally sold by Western Electric for \$2,500.00 includes a 13 tube receiver with 7 IF stages; 2 tube multivibrator sweep generator; 2 tube sweep amplifier; video amplifier; pedestal impulse and sweep generator, and 115 volt, 60 cycle supply with 2x2 for high voltage. Equipped with more than 15 tubes of the 43 originally used and including a brand new scope tube in original carton. Makes a wonderful laboratory instrument and is better adapted for television than any other war surplus item. Reduced, close-out price as is. Formerly \$69.95. Now. \$39.95

SCR-274N COMMAND SET

The greatest radio equipment value in history
 A mountain of valuable equipment that includes 3 receivers covering 190 to 550 KC; 3 to 6 MC; and 6 to 9.1 MC. These receivers use plug-in coils, and consequently can be changed to any frequencies desired without conversion. Also included are two Tuning Control Boxes; 1 Antenna Coupling Box; four 28 V. Dynamotors (easily converted to 110 V. operation); two 40-Watt Transmitters including crystals, and Preamplifier and Modulator. 29 tubes supplied in all. Only a limited quantity available, so get your order in fast. Removed from unused aircraft and in guaranteed electrical condition. A super value at \$29.95, including crank type tuning knobs for receivers. Without these knobs the receivers can't be tuned, and are only useful for parts. Don't buy without knobs!

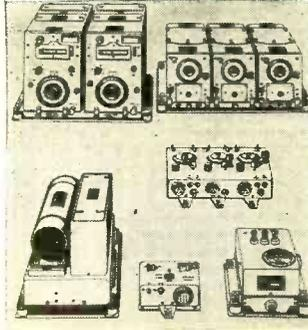

BUFFALO RADIO SUPPLY, 219-221 Genesee St., Dept. 2-N BUFFALO 3, N. Y.

RADIOMEN'S HEADQUARTERS * WORLD WIDE MAIL ORDER SERVICE!!!

AUTO RADIO DEALERS! ATTENTION!

A famous nationally advertised brand of auto radio which will fit any car and every pocketbook. Six tube superhet with three gang condenser and 6½" speaker. Dealer price \$32.20 for sample, or \$29.97 each, in lots of two or more.

INTRODUCTORY OFFERING OF OUR OWN BRAND CAR RADIO ANTENNAS

All of our car radio antennas are made of triple plated Admiralty Brass Tubing, complete with low loss shielded antenna leads and have high quality fittings.

SIDE COWL—BR-1, 3 sections extend to 66". Your price—single units—\$1.50; in lots of 12—\$1.35 ea.

SKYSCRAPER—BR-2 has 4 heavy duty sections that extend to 98". Your price—single units—\$2.45; in lots of 12—\$2.25 ea.

TILT ANGLE—BR-3, may be adjusted to all body contours. 3 sections extend to 66". Single unit price—\$1.50; 12 lot price—\$1.25 ea.

VERSATILE—BR-4, single hole fender or top cowl mounting may be adjusted to conform with all body contours. 4 sections extend to 56". Single unit price—\$2.90; 12 lot price—\$2.75 ea.

THE MONARCH—BR-5, single hole top cowl mounting, 3 sections extend to 56". Single unit price—\$1.90; 12 lot price—\$1.75 ea.

BENDIX SCR 522—Very High Frequency Voice Transmitter-Receiver—100 to 156 MC. This job was good enough for the Joint Command to make it standard equipment in everything that flew, even though each set cost the Gov't \$2500.00. Crystal Controlled and Amplitude Modulated—HIGH TRANSMITTER OUTPUT and 3 Microvolt Receiver Sensitivity gave good communication up to 180 miles of high altitudes. Receiver has ten tubes and transmitter has seven tubes, including two 832's. Furnished complete with 17 tubes, remote control unit, 4 crystals and the special wide band VHF antenna that was designed for this set. These sets have been removed from unused aircraft and are guaranteed to be in perfect condition. We include free parts and diagrams for the conversion to "continuously variable frequency coverage" in the receiver.

The SCR522 complete with 24 volt dynamotor sells for only \$37.95. The SCR 522 is also available with a brand new 12 volt dynamotor for only \$42.95.



BR1 BR2 BR3 BR4 BR5

DUE TO POPULAR DEMAND WE REPEAT THESE TERRIFIC BARGAINS

Three assorted new Microphones, including push-to-talk type.....	\$1.49
Six assorted POWER and AUDIO TRANSFORMERS, all new.....	\$1.98
Ten assorted R. F. Chokes including high frequency types.....	\$.35
Five assorted AUDIO or FILTER CHOKES.....	\$.99
One Hundred assorted RESISTORS.....	\$1.95
Ten assorted AN CABLE CONNECTORS, including many popular types.....	\$.99
Ten assorted WIRE-Wound BLEEDERS, 50 and 100 Watt, many with taps.....	\$2.49
Six assorted OIL FILLED CAN TYPE CONDENSERS, all with mounting brackets.....	\$1.49
Ten assorted METAL & BAKELITE KNOBS—(no wooden knobs).....	\$.39
Six assorted VARIABLE CONDENSERS, including butterfly types.....	\$1.49
Six assorted isolantite and bakelite R. F. Coils, shielded and unshielded.....	\$.99

The above eleven assortments, totaling over \$12.00 at the unbelievable bargain prices listed, can be purchased together as one lot at a super-special total price of \$9.95, a value so incredible that you will rub your eyes as you read this, our new year get-aquainted offer. All merchandise guaranteed to be as advertised.

Minimum order \$3.00—All prices subject to change—25% deposit with COD orders.

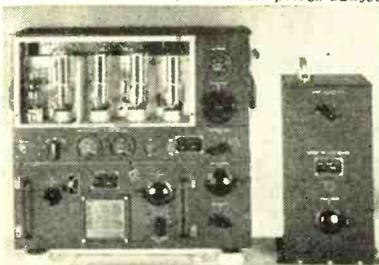

GENERAL ELECTRIC 150 WATT TRANSMITTER

Cost the Government \$1800.00
Cost to you \$44.50!!!!

This is the famous transmitter used in U.S. Army bombers and ground stations, during the war. Its design and construction have been proved in service, under all kinds of conditions, all over the world. The entire frequency range is covered by means of plug-in tuning units which are included. Each tuning unit has its own oscillator and power amplifier circuits—all designed to operate at top efficiency within its particular frequency range. Transmitter and accessories are finished in black crackle, and the milliammeter, voltmeter, and RF ammeter are mounted on the front panel. Here are the specifications: FREQUENCY RANGE: 200 to 500 KC and 1500 to 12,500 KC. (Will operate on 10 and 20 meter band with slight modification.) OSCILLATOR: Self-excited, thermo compensated, and hand calibrated. POWER AMPLIFIER: Neutralized class "C" stage, using 211 tube, and equipped with antenna coupling circuit which matches practically any length antenna. MODULATOR: Class "B"—uses two 211 tubes. POWER SUPPLY: Supplied complete with dynamotor which furnishes 1000V at 350 MA. Complete instructions are furnished to operate set from 110V AC. SIZE: 21½ x 23x9¼ inches. Total shipping weight 200 lbs., complete with all tubes, dynamotor power supply, five tuning units, antenna tuning unit and the essential plugs. These units have been removed from unused aircraft but are guaranteed to be in perfect condition.

fer coils, condensers, and antenna tuning

ARMY BC-312 COMMUNICATIONS RECEIVER

This receiver covers the frequency range of 1.5 MC to 18 MC in six direct reading bands. The dial, that is driven with split gears to prevent backlash, has 4500 logging divisions per band with approximately 600 divisions on the 20 and 40 meter ham bands and 1000 divisions on 80 meters. Two stages of RF before the converter in this set give it a very high signal to noise ratio and maximum sensitivity. Outstanding features of this receiver are: BFO with pitch control, send-receive-relay, jacks on the front panel for headphones and speaker output, and mike and key inputs. All tubes are standard 6 volt types. This receiver was designed to withstand rough usage in the field and for operation from vehicles while in motion, so it is ruggedly constructed and contains a dynamotor power supply—Your cost—\$49.95. Conversion kit to 110V AC is available for \$6.50.

PE-109 32-VOLT DIRECT CURRENT POWER PLANT

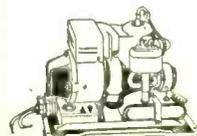

This power plant consists of a gasoline engine that is direct coupled to a 2000 watt 32 volt DC generator. This unit is ideal for use in locations that are not serviced by commercial power or to run many of the surplus items that require 24-32V DC for operation. The price of this power plant is only \$58.95. We can also supply a converter that will supply 110V AC from the above unit or from any 16-32V DC source for \$29.95.

14-Tube UHF Superhet Receiver — \$39.95

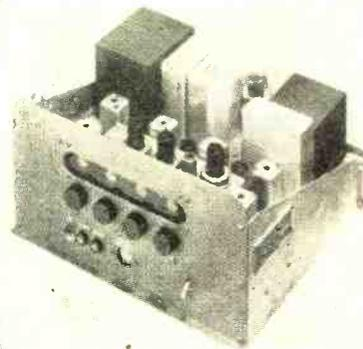

This beautifully constructed receiver was designed especially for Signal Corps communication service, and is one of the finest and most sensitive sets ever manufactured. Operating from 110V 60 cycles, this set has two tuned RF stages, tuned converter and oscillator, five I.F. stages, using iron-core IF's, a diode detector, tuning eye, and a two stage amplifier that will drive a speaker or phones. The frequency range is 158-210 Mcs. It is a simple matter to operate on other bands by making a slight alteration in the tuning coils. A complete set of tubes is included with each receiver, along with a circuit diagram and parts list. The high-voltage power supply delivers 150 milliamperes, and is well filtered by a heavy-duty choke and three 7 Mfd. oil-filled condensers. This buy of a lifetime cost the government about \$700. Amateurs and experimenters will never again be able to purchase fine equipment at such a tremendous saving!

BUFFALO RADIO SUPPLY, 219-221 Genesee St., Dept. 2N, BUFFALO 3, N. Y.
CABLE ADDRESS BUFRAD

A Better
Cone-Buy **LEOTONE**

**GET ON OUR MAILING LIST—
ALWAYS SOMETHING NEW**



ANTENNA LOOPS. High gain, spider wound. O.D. 5".....	\$0.29
1/2 MEG VOLUME CONTROLS with switch. 1/2" shaft.....	.45
RADIO HARDWARE TREASURE. An indispensable assortment of approx. 1000 screws, nuts, washers, lugs, etc.49
T-44A DYNAMIC MICROPHONE (AAF) with 5 1/2 ft. cord, PL-179, & JK-26 ext. jack. Original carton.....	.69

PORTABLE A.C. AMPLIFIER
(Lic. by W.E.)

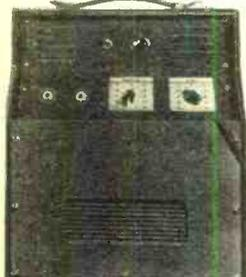

Here is a professional type High Fidelity unit at an amazingly low price. Wide freq. response for use with Musical Instruments. Speech or Phono Input, FM Tuner, etc.

FEATURES: Amplifier, FM speaker, two inputs (magnetic or crystal), vol. & tone controls. Beam Power Output. Beautiful sturdy 3 tone brown leatherette case (13 3/4" x 15 3/4" x 7 1/2").

Shpg. wt. 12 lbs. List price—\$64.50.
LEOTONE'S PRICE—While They Last. \$24.95
In lots of 3—ea. \$21.50

ALNICO MAGNETS
Powerful ALNICO MAGNETS in many sizes & shapes always in stock. Write for latest illustrated supplement. **FEB. SPECIAL—Round Bar,** plshd. O.D. 5/16"x2".....\$0.29

PE-157 POWER SUPPLY. A gold mine of relays, switches, jacks, selenium rect. chokes, etc. Portable hinged lid metal case (6 1/2"x12"). OD crackle finish. PLUS descriptive 173 p. tech. manual. Shpg. wt. 20 lbs. \$2.49

TUBES: PERFECT CONDITION, but in sealed cartons. Most types in stock at up to 80% off list. Every tube guaranteed 90 days.

#20, 26 or 27.....	\$0.29
#75, 76, 77, 78, 89, 5Y3, 6H6 or 6K7.....	.39
#35, 36, 37, 39, 84, 5Y4, 6CS, 6F5, 6J7, 6U7, 6V6, 6SA7 or 12SK7.....	.49
#1A7, 1B5, 1N5, 1H5, 6A3, 6U5, 6X5, 7A7, 7C5, 7C6, 7Y4, 50 or 50B5.....	.59
TUBE CARTONS. Plain white. Miniature (1 1/2" sq. x 2 1/4"). Per 100.....	.98
GT size (1 1/2" sq. x 3 1/4"). Per 100.....	1.25
Medium (1 1/2" sq. x 4 1/4"). Per 100.....	1.49
Large (2" sq. x 5"). Per 100.....	1.79

250 RPM DELCO MOTOR S. 27V. DC. .5 amp. Alnico PM field. 3/4" shaft. O.D. 1 3/4" x 3 3/4".\$1.95

MERCURY SWITCH. 1A @ 110V. SPST. silent action, non-inductive. O.D. 1/2" x 1 1/2".\$0.39

TRANSMITTER KNOBS, Fluted black moulded bakelite. Hvy. brass collar, setscrew.2" O.D. \$0.25
.....1" O.D. .12

FULL WAVE SELENIUM RECTIFIERS. Bridge type. 18V. AC. max. input @ 1 amp. 20 min. duty, 60ma. cont. Mfg. 3 1/2" x 9 1/2".\$1.25

NEW "JUMBO" RADIO PARTS ASSORTMENT
AMATEURS! SERVICEMEN! EXPERIMENTERS! If you want the most for your money, don't miss this outstanding buy in new & dismantled radio & electronic parts! 17 Full Pounds of Coils, Transformers, Hardware, Speaker Accessories, Resistors, Condensers, Wires, Sub-assemblies, etc., etc. All these **AND MORE** for only **\$2.95**

Prompt Service on All Speaker & Phono Repairs
Minimum Order \$2.00—20% Deposit Required on All Orders. Please Add Sufficient Postage. Write RN-2.

LEOTONE RADIO CO.



MAKERS OF CONES AND FIELD COILS
65-67 DEY STREET, NEW YORK 7, N.Y.
WORTH 2-0284-5
12,000 SQ. FT. OF RADIO PARTS.

6.015—Kuala Lumpur, Malaya. "Radio Malaya." 100 w.	6.100—Warsaw, Poland. "Polskie Radio." 10 kw.
6.045—CE604, Antofagasta, Chile. "Radio Libertad." 1 kw.	*6.100—WNRX, New York, N.Y., U.S.A., 50 kw.
6.048—Hanoi, French Indo-China. "Radio France"	*6.100—Shepparton, Australia. "Radio Australia." 100 kw.
6.048—HRA, Terucigalpa, Honduras. "La Voz de Lempira." 1.5 kw.	6.100—Belgrade, Yugoslavia. "Radio Belgrade"
6.050—GSA, London, 50-100 kw.	6.100—Leopoldville, Belgian Congo
*6.050—HP5F, Colon, Panama. "La Voz de Colon." 300 w.	6.101—TGOA, Guatemala City, Guatemala. "La Voz de las Americas"
6.050—OAX6A, Arequipa, Peru. "Radio Arequipa." 250 w.	6.102—JZH, Tokyo
6.050—Moscow	6.105—WLKS, Kure, Japan, British Commonwealth Occupation Forces Radio, 1 kw.
*6.050—Clandestine Yugoslav. "Radio Ravna-gora"	*6.105—XGSD, Nanking, China
6.050—Tiflis (Georgian S.S.R.), U.S.S.R.	*6.107—Hanoi, French Indo-China
*6.050—Tokyo	*6.108—HJFK, Pereira, Colombia
*6.051—XLRA, Hangchow, China	*6.110—CP2, La Paz, Bolivia. "Radio Nacional." 1 kw.
6.051—HJFA, Pereira, Colombia. "La Voz de Pereira." 1 kw.	6.110—XO....., China
6.055—CXA14, Colonia, Uruguay. "Radio Real de San Carlos." 1 kw.	6.110—GSL, London, 50-100 kw.
*6.055—XLRA, Hankow, China. "Hankow Broadcasting Station." 1 kw.	6.110—VUD3, Delhi, AIR, 5 kw.
*6.055—HER2, Berne, Switzerland, 25 kw.	*6.110—KZRC, Cebu, Philippines
6.057—Konsomolsk, U.S.S.R.	6.111V—HJFK, Pereira, Colombia. "La Voz Amiga." 2.5 kw.
*6.060—CP47, Cochabamba, Bolivia. "Radio Popular."	*6.111—Tokyo
*6.060—OXY, Skamlebak (Copenhagen), Denmark, 6 kw.	*6.114—QZ7LO, Nairobi, Kenya, 1.5 kw.
*6.060—VUD3, Delhi, AIR, 5 kw.	*6.115—OLR2C, Prague, Czechoslovakia, 17 kw.
6.060—VQ7LO, Nairobi, Kenya, 1.5 kw.	6.115—HIG, Ciudad Trujillo, Dominican Republic.
*6.060—KNBI, Dixon, Calif., USA, 50 kw.	*6.115—Komsomolsk, U.S.S.R., 50 kw.
*6.060—WCBN, New York, N.Y., USA, 50 kw.	*6.115—Istanbul, Turkey
6.060—Moscow	6.115V—Hamburg, Germany. "Northwest German Radio"
6.060—Berlin, Germany. "Berliner Rundfunk." 5 kw.	*6.118—Phnompenh, French Indo-China. "Radio Cambode"
6.060—Rome, Italy	*6.120—Warsaw, Poland, 10 kw.
*CKRZ, Sackville, Canada. "CBC International Service." 50 kw.	6.120—LRX1, Buenos Aires, Argentina. "Radio El Mundo." 6 kw.
*6.062—FHES, Dakar, French West Africa. "Radio Dakar." 200 w.	6.120—OIX1, Helsinki, Finland, 10 kw.
6.063—VUTMC, Akashvani, Mysore, India	*6.120—KRHO, Honolulu, Hawaii, 100 kw.
*6.036V—Berlin, Germany	*6.120—WOOO, New York, N.Y., U.S.A., 50 kw.
6.064—Tanarive, Madagascar. "Radio Tananarive"	6.120—....., U.S.A.
*6.065—LRS1, Buenos Aires, Argentina, 5 kw.	*6.120—Manila, Philippines
6.065—SBO, Mo ala (Stockholm), Sweden, 12 kw.	*6.120—Singapore, Malaya. "Radio Malaya"
*6.065—TIWS, Puntarenas, Costa Rica	*6.120—Salisbury, Southern Rhodesia
6.065—WLKS, Kure, Japan, British Commonwealth Occupation Forces Radio, 1 kw.	6.122—HP5H, Panama City, Panama. "La Voz del Pueblo." 500 w.
*6.065—Lille, France	6.125—GWA, London, 50-100 kw.
6.065V—XGHT, Hantan, China. "Hantan Broadcasting Station"	*6.125—CXA4, Montevideo, Uruguay. "Radio Electrica." 10 kw.
6.067—Tetuan, Spanish Morocco. "Radio Tetuan." 1.5 kw.	6.125—HIG, Ciudad Trujillo, Dominican Republic. "Radio La Opinion." 100 w.
6.068—CXA14, Colonia, Uruguay	6.125—Bangkok, Siam
6.070—CFRX, Toronto, Ontario, Canada. "Rogers Radio Station." 1 kw.	*6.125—MTCY, Changchun (Hsinking), China
*6.070—HOB, Panama City, Panama	6.128—OAX7A, Cuzco, Peru. "Radio Cuzco." 100 w.
*6.070—GRB, London, 50-100 kw.	*6.130—VLW, Perth, Western Australia. "A.B.C." 2 kw.
*6.070V—XGHT, Hantan, China	6.130—CHNX, Halifax, Nova Scotia, Canada, 500 w.
6.070—Petropavlovsk (Kamchatka), U.S.S.R.	6.130—COCD, Havana, Cuba. "La Voz del Aire." 1 kw.
6.072—Berlin, Germany; "Berliner Rundfunk"	*6.130—VPP2, Suva, Fiji Islands, 4 kw.
*6.072—JZH2, Tokyo	*6.130—JOGG, Kumamoto, Japan, 300 w.
6.073—HJCF, Bogota, Colombia. "La Voz de Bogota." 1 kw.	6.130—XEUZ, Mexico City, Mexico. "Cadena Radio Nacional." 500 w.
6.075—CXA3, Montevideo, Uruguay. "Radio Ariel." 2.5 kw.	*6.130—LKJ2, Fredrikstad, Norway, 7.5 kw.
6.075—Colombo, Ceylon. "Radio SEAC." 100 kw. (inactive), 7.5 kw.	*6.130—Moscow
6.078—HIX, Ciudad Trujillo, Dominican Republic. "Radio Oficial, La Voz de la Republica Dominicana"	6.132—Monte Carlo, Monaco. "Radio Monte Carlo." 300 w.
*6.080—XGSB, Nanking, China	6.135—CP30, Santa Cruz, Bolivia. "Radio Florida." 250 w.
6.080—Munich, Germany. "AFN, Frankfurt." 50 kw.	*6.135—CE613, Punta Arenas, Chile. "Radio Ejercito"
6.080—CKFX, Vancouver, British Columbia, Canada, 100 w.	*6.135—HNU, Baghdad, Iraq, 500 w.
*6.080—ZLI, Wellington, New Zealand, 10 kw	6.135—Jaffa, Palestine. "Sharq-al-Adna." 7.5 kw.
*6.080—VLWK, Cincinnati, Ohio, USA, 50 kw.	6.135—KZRC, Cebu, Philippines. "The Voice of Cebu." 250 w.
*6.080—JZH3, Tokyo	*6.136—CR7AA, Lourenco Marques, Mozambique. "Radio Mozambique." 300 w.
6.080—VP4RD, Port-of-Spain, Trinidad. "Radio Trinidad." 500 w.	*6.138—Tanarive, Madagascar. "Radio Tananarive." 1.2 kw.
6.082—Umtali, Southern Rhodesia	6.139—XEUZ, Mexico City, Mexico.
*6.083—ZIZ, Basseterre, St. Kitts, B.W.I.	*6.139—Dornbirn, Austria
*6.084—ZAA, Tirana, Albania, 3 kw.	6.140—OQ2AA, Leopoldville, Belgian Congo. "Radio Leo." 500 w.
6.084—ZBD10, Port-of-Spain, Trinidad, 3 kw	*6.140—XGOY, Chungking, China, 35 kw.
*6.085—VUM2, Madras, India, AIR, 10 kw.	6.140—OAX5C, Iquitos, Peru. "Radio Central." 300 w.
6.085—Rome, Italy. "Radio Italiana." 1 kw.	*6.140—WRUA, Boston, Mass., U.S.A., 50 kw.
*6.085—LRY1, Buenos Aires, Argentina. "Radio Belgrano." 10 kw.	6.140—Moscow
*6.087—Tabriz, Iran	6.140—CXA5, Montevideo, Uruguay, 2.5 kw.
*6.090—ZNS2, Nassau, Bahamas, 600 w.	*6.140—H1IR, San Cristobal, Dominican Republic, 200 w.
*6.090—CKOB, Sackville, Canada. "CBC International Service." 50 kw.	6.140—HC2SB, Guayaquil, Ecuador. "Radio Nacional de El Condor."
*6.090—CBFW, Montreal, Quebec, Canada. "CBC International Service." 7.5 kw.	*6.140—KZRF, Manila, Philippines
6.090—CBFW, Montreal, Quebec, Canada. "Radio Canada." 200 w.	*6.142—Tokyo
*6.090—ZBWT, Hong Kong, China, 2.5 kw.	6.145—HJDE, Medellin, Colombia. "La Voz de Antioquia." 3 kw.
*6.090—GWM, London, 50-100 kw.	*6.145—Paris. "Radiodiffusion Francaise." 100 kw.
*6.090—Beirut, Lebanon. "Radio Lebanon." 3 kw.	*6.145—Dornbirn, Austria
*6.090—Moscow	6.146—LRK1, Rosario, Argentina. "Radio Ovidio Lagos." 10 kw.
6.090—Luxembourg, Luxembourg. "Radio Luxembourg." 8 kw.	6.147—HIG, Ciudad Trujillo, Dominican Republic. "Radio La Opinion." 150 w.
*6.091—Belgrade, Yugoslavia	6.150—VLR2, Melbourne, Australia. "A.B.C." 2 kw.
*6.091—XRRA, Peiping, China. "Peiping Broadcasting Station." 1 kw.	6.150—CKRO, Winnipeg, Manitoba, Can., 2 kw.
6.091—HOB, Panama City, Panama	6.150—TIRH, San Jose, Costa Rica. "Radio El Mundo." 250 w.
*6.091—VP4RD, Port-of-Spain, Trinidad	6.150—GRW, London, 50-100 kw.
6.092—Tabriz, Iran. "Radio Tabriz"	6.150—VUB2, Bombay, India, AIR, 10 kw.
*6.095—JZH, Tokyo	*6.150—Hobry, Sweden.
6.095—Johannesburg, South Africa, SABC (Johannesburg IV), 1 kw.	6.150—Belgrade, Yugoslavia. "Radio Belgrade." 10 kw.
6.096V—Phnompenh, French Indo-China. "Radio Cambode"	6.152—CE615, Santiago, Chile. "Radio La Cooperativa Vitalicia." 5 kw.
*6.097V—HJFK, Pereira, Colombia	6.152—YSPB, San Salvador, El Salvador. "La Voz de Cuscatlan." 350 w.
6.100—VUD3, Delhi, India, AIR, 5 kw.	6.152V—Vienna, Austria. "Radio Wien." 300 w.
*6.100—VUDY, Delhi, India, AIR, 100 kw.	*6.153—TIRH, San Jose, Costa Rica.
*6.100—KZRH, Manila, Philippines. "Voice of the Philippines." 1 kw.	*6.154V—XGOY, Chungking, China. "Chinese International Broadcasting Station." 35 kw.

WE WERE SWAMPED!



Of course we expected a large response when we first announced our new Model 247 Tube Tester at the sensationally low price of \$29.90 in the November issue of this publication but we were not prepared for the very large number of orders received. Fortunately we were able to quickly expand our production facility to meet the unprecedented demand and all orders were shipped within a few days after receipt.

We take this opportunity to thank the many dealers, schools, experimenters, etc., who favored us with orders for this new model; also for their many kind letters.

THE NEW MODEL 247

TUBE TESTER



The Model 247 provides a super sensitive method of checking for shorts and leakages up to 5 Megohms between any and all of the terminals. Continuity between various sections is individually indicated. This is important, especially in the case of an element terminating at more than one pin. In such cases the element or internal connection often completes a circuit.

One of the most important improvements, we believe, is the fact that the 4-position fast-action snap switches are all numbered in exact accordance with the standard R.M.A. numbering system. Thus, if the element terminating in pin No. 7 of a tube is under test, button No. 7 is used for that test. This feature will be appreciated especially by servicemen who, when using other tube testers, have been compelled to first try various positions to locate the correct element and then have had to look up charts in order to learn which pin is used for that particular element.

Tests yesterday's tubes, today's tubes and tomorrow's tubes. The Model 247 features a newly designed element switching system designed to accommodate all future tubes as they are announced.

FEATURES:

It is impossible to insert the tube in the wrong socket when using the new Model 247. Eight separate sockets are used, one for each type of tube base made. If the tube fits in the socket it can be tested.

The Model 247 incorporates a newly designed element selector switch system which reduces the possibility of obsolescence to an absolute minimum. Any pin may be used as a filament pin and the voltage applied between that pin and any other pin, or even the "top-cap." Please note this is not a variation of the commonly used "floating-filament" arrangement but instead represents a real advance in design, inasmuch as it provides a true "free-point" system. Tubes having tapped filaments and tubes with filaments terminating in more than 1 pin are truly tested with the Model 247 as any of the pins may be placed in neutral position when necessary.

The new free-point system described above permits the Model 247 to overcome the difficulties encountered with other emission type tube testers when checking Diode, Triode and Pentode sections of multi-purpose tubes, because sections can be tested individually when using the new Model 247. The special isolating circuit allows each section to be tested as if it were in a separate envelope.

Model 247 comes complete with new speed-read chart. Comes housed in handsome hand-rubbed oak cabinet sloped for bench use. A slip-on portable hinged cover is included for outside use. Size: 10 $\frac{1}{4}$ " x 8 $\frac{3}{4}$ " x 5 $\frac{3}{4}$ ".

ONLY
\$ 29⁹⁰

20% deposit required on all C. O. D. orders.

MOSS ELECTRONIC DISTRIBUTING CO.

DEPT. RN-2, 229 FULTON STREET, NEW YORK 7, N. Y.

ANNOUNCING: THE TELE-SWEEP

(MODEL TSW-50)

A SWEEP SIGNAL GENERATOR FOR FM & TELEVISION PRICED WITHIN RANGE OF ALL SERVICEMEN, STUDENTS, EXPERIMENTERS



Here is a Sweep Generator for every need and pocket book. The TELE-SWEEP-TSW50 is ideal for alignment of FM and TV Receivers with a minimum of time and effort.

\$68.50 NET

CHECK THESE FEATURES

- SWEEP WIDTH 500 KC to 10 MC
- COMPLETE FREQ. COVERAGE in four bands 5 to 100 MC and 170 to 216 MC
- TEST PROBE for point to point checking
- OUTPUT 1 Volt. Max.

Slightly higher in the West

Precision built

TELEVISION COMPONENTS

TELEVISION COIL KIT 510:

Complete set of all coils necessary to make a 10 or 15" Receiver. Includes all RF, IF, Sound, Video Transformers, etc. IF Frequency 26 Mc. Permeability tuned with a band pass of 4.25 Mc. Price.....\$9.95

TELEVISION COIL KIT 500A:

Includes all coils necessary in the construction of a 5 or 7" Television Receiver, IF, RF, FM Discriminator Transformer, Peaking Coils, etc. IF Frequency 26 Mc, Band Pass 3.5 Mc.....\$4.95

HIGH VOLTAGE TRANSFORMER T8:

2200 volts @ 2 Ma. 2.5 volts @ 2 Amp. 6.3 volts @ 1 Amp.....\$7.95

LOW VOLTAGE TRANSFORMER T9:

350-0-350 volts @ 175 Ma. 5 Volts @ 3 Amp. 6.3 Volts @ 8 Amps.....\$8.50

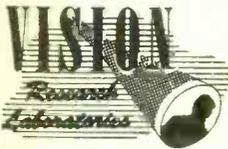

Included in this booklet is all necessary instruction data and schematics along with complete information for proper use of a Sweep Generator in visual alignment of a Receiver.....\$1.75
Included with each booklet is an 11x17" working diagram.

See the TELE-SWEEP at your jobber's now. IT'S SENSATIONAL!

AND PUBLICATIONS

CHASSIS No. 600:

Completely Punched Chassis for most any Television Receiver. Cadmium Plated 13x17x3.....\$5.50

CATHODE RAY TUBE SUPPORT & SOCKET CR-7: Adjustable Mounting Bracket & Socket for 7" CR Tube (Magnal Type) Complete with necessary hardware.....\$1.95

FRONT PANEL:

For 7" Television Receiver. Beautifully finished in walnut or mahogany.....\$3.60

DESIGN & CONSTRUCTION BOOKLET FOR 5 OR 7" TELEVISION RECEIVER TL-102:

All necessary information, Diagrams, Photographs, etc., needed for constructing a Television Receiver...\$1.75

VISION RESEARCH LABORATORIES

P. O. Box No. 52, Kew Gardens 15, N. Y.

SURPLUS SURPLUS

Complete Brand New Transmitter Receiver installation—6 or 12 VDC input SCR-284—consists of BC-654 (with tubes, xtals and spares) dynamotor PE-103, V18RA pack PE-104, cables, plugs, antenna, stand for field set up, keys, mikes, instruction books, \$69.95 complete; new, limited quantity...

Selenium Stack—4-4½" Plates—In full wave bridge arrangements—6 or 12 volt DC output, 5 amps. (100% overload with adequate ventilation.) Instructions for simple to construct auto radio demonstrator—home battery charger—to compare favorably with most expensive equipment. Included, Brand new plates.....\$4.95

Relay—115 VAC-60 cy—Solenoid—4PST—Heavy duty silver contacts. New \$2.95
Orig. Pack \$5.00
Stepper Switch—12 position—360° Rotation—will operate 12-24 VDC, \$1.50, 4 for \$5.00

Rheostat—50 watt—1.1 Ohms with toggle switch knob. 95c
Television, scope condensers—25 Mfd-2500 WVDC paper oil-cyl. can with mounting clamp, 75c.....3 for \$2.00
1-1500 VDC working—bathtub type—insulated from case, 3 for \$1.00, 100 for \$25.00

Hi-Voltage anode button H.V. Cable.....2 for \$1.00
Hi-Impedance phones—famous standard brand—less headband—cord—exceptional value.....\$1.25
Dynamotor—DM-19—input—12v—16A—output—500V—2A with cable—\$4.95
L.N.

25% deposit required on all C. O. D. orders. Prompt delivery assured. Write Dept. RNF.

GREENWICH SALES CO.

59 Cortland St. Whitehall 3-3052
NEW YORK CITY 7, N. Y.



IF YOU'RE interested in a steady year-in-year-out income—a substantial share of financial security for you and your family—you'll get in on the ground floor of this flourishing industry. You can build a lucrative business of your own NOW with TRADIO, the radio functionally-designed for coin operation in hotels, hospitals, tourist camps, motor courts, etc. Men and women like yourself all over the country are finding it a natural for big earnings and a steady income.

TRADIO ★ Tried ★ Tested ★ Proven

TRADIO has pioneered in this profitable postwar industry. Today, there are more TRADIOS installed throughout the country than any other coin radio.

Send for complete information and free illustrated brochure today. We'll put you in touch with the distributor in your territory if you'll phone Asbury Park 2-7447 or write Dept. P-2.



TRADIO, Inc. ASBURY PARK NEW JERSEY

- *6.155—XEDQ, Guadalajara, Mexico, 100 w.
- 6.155—CSWD, Lisbon, Portugal, "Radio Renascenca," 500 w.
- 6.155—CXA13, Montevideo, Uruguay, "Radio Carve," 10 kw.
- *6.155V—Vienna, Austria, "Radio Wien,"
- 6.155—XEDP, Mexico City, Mexico, "Radio Educacion," 1 kw.
- 6.155V—EQB, Teheran, Iran, "Radio Teheran," 14 kw.
- 6.158—OAX1A, Chiclayo, Peru, "Radio Delcar," 300 w.
- *6.160—CHAC, Sackville, Canada, "CBC International Service," 50 kw.
- 6.160—XURA, Tai-Pei, Formosa.
- 6.160—CBRX, Vancouver, British Columbia, Canada, 150 w.
- *6.160—ZOI, Colombo, Ceylon, "Ceylon Broadcasting Service," 7.5 kw.
- 6.160—HJCD, Bogota, Colombia, "Emisora Nueva Granada," 5 kw.
- 6.160—Moscow,
- *6.160—Paris, "Radiodiffusion Francaise," 100 kw.
- *6.160—Munich, Germany, 100 kw.
- *6.162—Noumea, New Caledonia, "Radio Noumea," 500 w.
- *6.163—Kuala Lumpur, Malaya.
- 6.164—Saigon, French Indo-China, "Radio Saigon," 12 kw.
- *6.165—TILS, San Jose, Costa Rica, "Radiodifusora Para Ti," 1 kw.
- *6.165—GWK, London, 50-100 kw.
- 6.165—HER3, Berne, Switzerland, "Swiss Broadcasting Corp.," 25 kw.
- 6.165—HECM, Port-au-Prince, Haiti, "National Broadcasting Co.," 100 w.
- *6.170—OLR2D, Prague, Czechoslovakia, 17 kw.
- 6.170—OAX5E, Chinchu, Peru, "Radio Chinchu," 300 w.
- 6.170—OAX6G, Arequipa, Peru, "Radio Central," 200 w.
- 6.170—OAX4B, Cerro de Padco, Peru.
- *6.170—Durban, South Africa, SABC, 500 w.
- *6.170—KCBS, Delano, Calif., U.S.A., 50 kw.
- *6.170—WCRB, New York, N.Y., U.S.A., 50 kw.
- 6.170—Rome, Italy, "Radio Italiana."
- 6.170—Jaffa, Palestine, "Sharq-al-Adna," 7.5 kw.
- *6.170—Munich, Germany, 80 kw.
- 6.170—YDA2, Bandung, Java, "Radio Resmi Bandoeng," 250 w.
- 6.171—CP37, Oruro, Bolivia, "Radio Oruro," 250 w.
- *6.172—KWS3, Vienna, Austria.
- *6.172—YVKB, Caracas, Venezuela.
- 6.173—CXA21, Montevideo, Uruguay, "Radio Fenix," 1 kw.
- *6.175—Kuala Lumpur, Malaya, "Radio Malaya," 1 kw.
- *6.175—XEXA, Mexico City, Mexico, "Radio Gobernacion," 100 w.
- *6.175—Paris, "Radiodiffusion Francaise," 100 kw.
- *6.175—XGNC, Kalgan, China.
- 6.175—HI9T, Puerto Plata, Dominican Republic, "Broadcasting Tropical," 100 w.
- 6.175—Batavia, Java, "Radio Resmi Indonesia," 300 w.
- *6.175—J09J, Tokyo, J04E, Hiroshima, Japan; both 300 w.
- 6.175—HOB, Panama City, Panama, "Radio Pan-Americana."
- 6.178—XEXA, Mexico City, Mexico, "Radio Gobernacion," 100 w.
- 6.179—Stuttgart, Germany, "Radio Stuttgart."
- 6.179—Ashkabad (Turkmen S.S.R.), U.S.S.R.
- 6.180—LRM, Mendoza, Argentina, "Radio Aconagua," 10 kw.
- *6.180—TRCC, San Jose, Costa Rica, "Accion Catolica," 300 w.
- 6.180—GRO, London, 50-100 kw.
- 6.185—XECC, Puebla, Mexico, "Impulsoras del Progreso," 50 w.
- 6.185—HIL, Ciudad Trujillo, Dominican Republic, "Radiofiora HIL," 50 w.
- *6.185—LLI, Fredrikstad, Norway, 8 kw.
- *6.185—JLU, Tokyo.
- 6.186—HC1TR, Ibarra, Ecuador, "Radio Equinoccial," 500 w.
- *6.187—LQ3, Formosa, Argentina, 1 kw.
- *6.188—HNE, Baghdad, Iraq, 5 kw.
- *6.188—TGX1, Guatemala City, Guatemala.
- 6.190—CP23, Tarija, Bolivia, "Radio Guadaluquivir," 250 w.
- *6.190—CE619, Santiago, Chile, 5 kw.
- *6.190—Saigon, French Indo-China, "Radio Saigon," 12 kw.
- *6.190—VUD2, Delhi, AIR, 20 kw.
- 6.190—VUD10, Delhi, AIR, 20 kw.
- 6.190—VUD7, Delhi, AIR, 100 kw.
- *6.190—VUD11, Delhi, AIR, 1.5 kw.
- *6.190—Athlone, Ireland, "Radio Eirrean," 1.5 kw.
- *6.190—WNRE, New York, N.Y., U.S.A., 50 kw.
- 6.190—HVJ, Vatican City, Vatican, "Radio Vaticano," 25 kw.
- 6.190—HIIA, Santiago, Dominican Republic, "La Voz del Yaque," 75 w.
- *6.190—J03F, Osaka: J07F, Sandai, Japan; both 300 w.
- 6.190—JLT, Tokyo.
- 6.190—TGX1, Guatemala City, Guatemala, "La Voz del Pueblo," 100 w.
- 6.190—Munich, Germany, "Radio Munchen."
- *6.190V—Vienna, Austria, 500 w.
- *6.192—Pointe-a-Pitre, Guadeloupe, "Radio Guadeloupe," 200 w.
- *6.195—GHN, London, 50-100 kw.
- *6.196—HIIA, Santiago, Dominican Republic.
- 6.197—OAX1B, Piura, Peru.
- 6.198—Amdorra, Amdorra.
- 6.199—Tangier, Tangier Zone, "Radio International," 1 kw.
- *6.200—ZYCF, Rio de Janeiro, Brazil, "Radio Tamoio," 25 kw.

RADIO NEWS

SEEING IS BELIEVING!
WE INVITE YOU TO TRY A SAMPLE ORDER: IF YOU ARE NOT SATISFIED BECAUSE OF . . . QUALITY! PRICE! SERVICE! FOR ANY REASON! RETURN THIS ORDER FOR A FULL REFUND!
WE WILL PROVE TO YOU THAT WE ARE ABLE TO FURNISH FINEST QUALITY AT LOW PRICES

25 POUNDS OF RADIO PARTS AND ASSEMBLIES

We are swamped with tons of samples and odds and ends which cannot be placed in our regular stock. We must dispose of this useful merchandise immediately to give us elbow room. Buy 25 pounds of parts and assemblies at the **\$3.00** ridiculously low price of

Paper Electrolytic Condensers GUARANTEED FRESH

20-20	400V	50c
25 Mfd	25V	15c
20-20	150V	25c
30-50	150V	46c
20-10-10	150V	40c
40-20	200V	25c
20	250V	25c
20	475V	50c

Deduct 10% from orders of 20 or more electrolytics.

ROTARY BAND SWITCHES

Furnished With Pointer Knob and Mounting Hardware.

Single pole	5 position	} 35¢
Single pole	12 position	
Double pole	6 position	
Four pole	2 position	

Any 10 for \$3.15

BAKELITE FLEXIBLE SHAFT COUPLINGS

1/4" to 1/2"-1" Outside Dia. **21c**
 10 for \$1.85

TUBES !!

MONEY-BACK GUARANTEE
 No "Off" brands, seconds or used tubes. Some in cartons.

1A5	.50	6SR7	.50	14R7	\$.75
1LH4	1.00	6V6	.50	25Z6	.60
1LN5	1.00	6X5	.60	26	.50
1N5	.60	6Y6	.60	27	.50
1R5	.60	7A8	.60	30	.50
1S5	.60	7B6	.60	31	.50
1T4	.60	7B7	.60	35A5	.60
2C26	.50	7C5	.60	35L6	.50
2C40	1.00	7C6	.60	35W4	.50
3B24	1.00	7C7	.60	35Z5	.60
5U4	.50	7E5	.50	39/44	.60
5Y3	.50	7F8	.60	50B5	.60
6A8	.60	7G7	.95	50L6	.75
6AC7	.75	7N7	.50	50X6	.75
6AG5	.75	7Y4	.60	50Y6	.50
6AL5	.50	12A6	.50	75	.50
6C4	.50	12AH7	.60	76	.50
6C5	.50	12AT6	.60	77	.50
6H6	.50	12BA6	.60	78	.50
6J5	.50	12BE6	.60	80	.50
6J7	.60	12C8	.50	84/6Z4	.50
6K6	.50	12J5	.50	117L7	1.00
6K7	.60	12SF7	.60	FM1000	1.10
6S8	.50	12SG7	.60	XXFM	.95
6SA7	.50	12SH7	.50	XXL	.60
6SD7	.50	12SK7	.50	VR105	.60
6SG7	.50	12SJ7	.50	VR150	.60
6SH7	.50	12SN7	.50	826	.60
6SJ7	.50	12SQ7	.60	954	1.00
6SK7	.50	12SR7	.50	955	.75
6SL7	.75	14A7	.75	956	.75
6SN7	.50	14B6	.75	9001	.75
6SQ7	.50	14Q7	.75	9003	.75
				9006	.75

Deduct 10% from all tube orders \$20.00 or over.

All items subject to prior sale. All prices subject to change without notice.

Low Impedance Phones

Very sensitive. Less headband. Used in perfect condition. **50c**
 10 for \$4.00

1.5V FLASHLIGHT CELLS

Guaranteed fresh—good makes. Box of 24. **\$1.20**

6V—4 PIN VIBRATOR. **\$1.00**

100" Auto Antenna Side Cowl mount 2 station. **\$2.95**

CONTROLS NO BUILD UP NECESSARY JUST LOOK AT THE PRICES. MONEY BACK GUARANTEE

1/4" dia. shaft by 3/8" long, 1/8" dia., linear taper.

5,000 Ohm	1,000,000 Ohm
10,000 Ohm	2,000,000 Ohm
75,000 Ohm	4,000,000 Ohm
500,000 Ohm	5,000,000 Ohm



Your choice **19¢**

CONTROLS WITH SWITCH

Popular Makes—O.D. 1/8"—3" shaft.

Resistance Switch	Resistance Switch	Your Choice	39¢
25,000 . . . S.P.	500,000 . . . D.P.		
250,000 . . . S.P.	1,000,000 . . . S.P.		
500,000 . . . S.P.	1,000,000 . . . D.P.		



5,000 ohm wire wound control with switch (S.P.)—3/8" long shaft.	59c
10,000 ohm wire wound control with switch (S.P.)—5/8" knurled shaft.	59c
100,000 ohm control with switch—3/8" shaft.	34c
500,000 ohm control with switch (D.P.)—3/8" shaft.	34c

Deduct 10% from all orders of 20 or more controls.

RESISTOR ASSORTMENT

100 carbon and wire wound resistors. 1/2, 1, 2, 5, 10 W. Wide range of useful sizes. All new type, standard and coded stock.

\$1.95 per kit of 100

PAPER CONDENSER ASSORTMENT

100 brand new paper by-pass condensers. Wide range of useful sizes.

\$3.85 per kit of 100

CERAMIC CONDENSERS

100 assorted **\$1.95**

MICA CONDENSERS

50 Mica Condensers for the price of 10!
 .00001 to .05 MFD. 300 to 600 V., per kit. **\$1.95**

RG 8/U Coaxial Cable | RG 22/U Coaxial Cable
 100 feet for... **\$2.85** | 100 feet for... **\$4.85**

Minimum Order \$2.00. All orders shipped F.O.B. Chicago. 25% Deposit on all C.O.D. Shipments. 10 days net to rated concerns.

IRVING JOSEPH 220 S. Halsted St., Chicago 6, Ill.

Brooks' FM Tuner

MODEL FMT-10
QUALITY—SENSITIVITY
COMPLETE

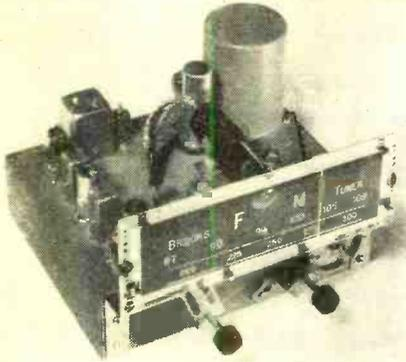

An engineered tuner for those who want the best available at reasonable prices.



Features . . .

Completely wired and calibrated
Patented Tuning Head.
Frequency coverage: 87 to 109 MC.
Sensitivity: 5 microvolts or less.
Band-width: 150 KC at 6 DB down.
High Gain Miniature Tubes.
Ten Tubes: 4-6AK5, 6BE6, 2-9001, 6AL5, 6X4, 6G5.
Input Impedance: 300 ohm line.
Linear 8-inch Slide Rule Dial.
Compact Size: 8" x 10" x 6 3/4".
Self-Contained Power Supply.
Easily assembled and adjusted.
Rigid Non-Critical Construction.
Compensated for Frequency Drift.
Quality parts used throughout.
Inductive tuning for High Q.
Selective RF Circuits.

Model FMT-10	\$59.95
Complete with Tubes	Kit Form
Model FMT-10	\$69.95
Complete with Tubes	Wired

Completely wired and aligned Tuning Head (with tubes) \$17.50
8 inch Slide Rule Dial 2.50

Brooks Electronic Laboratories
32 Kendall Park
Waltham, Massachusetts

- 6.200—HJCT. Bogota, Colombia. "Radio-difusora Nacional," 10 kw.
- *6.200—Brussels, Belgium. "Radio Nationale Belge," 5 kw.
- 6.200—Paris, "Radiodiffusion Francaise," 100 kw.
- 6.200—Baku (Azerbaijan S.S.R.), U.S.S.R.
- 6.200—Kloefla, Norway.
- 6.200—YSG, San Salvador, El Salvador. "Radio Mil."
- *6.200—HHK, Port-au-Prince, Haiti.
- *6.200—CR4AA, Praia, Cape Verde Islands.
- 6.201—HIL, Ciudad Trujillo, Dominican Republic. "Radiofisora HIL," 60 w.
- *6.203—Varazdin, Yugoslavia. "Radio Varazdin."
- *6.208—Vorarlberg, Austria.
- 6.205—YVGRD, Ciudad Bolivar, Venezuela. "La Voz de Guayana," 1 kw.
- 6.208—Noumea, New Caledonia. "Radio Noumea," 500 w.
- 6.210—HC1AC, Quito, Ecuador. "La Voz de la Democracia," 200 w.
- 6.210V—Rumania. "Radio Romania Libera."
- 6.215—Warsaw, Poland. "Radio Polskie."
- *6.218—TTPG, San Jose, Costa Rica. "La Voz de la Victoria."
- *6.219—Alma-Alta, U.S.S.R.
- 6.220—Saratov, U.S.S.R.
- 6.223—CE622, Santiago, Chile. "Radio Sociedad Nacional de Minería," 5 kw.
- 6.225—HJFB, Manizales, Colombia. "Radio Manizales," 3 kw.
- 6.225—Germany.
- *6.230—Moscow.
- 6.230—OAX4L, Lima, Peru. "Radio Miraflores."
- *6.230—XNTA, Kaifeng Area, China.
- 6.231—HCJB, Quito, Ecuador. "The Voice of the Andes."
- *6.233—CXA21, Montevideo, Uruguay. "Radio Fenix," 1 kw.
- 6.235—HRD2, La Ceiba, Honduras. "La Voz de Atlantida," 250 w.
- 6.240—HCJB, Quito, Ecuador.
- 6.240—HJCF, Bogota, Colombia. 1 kw.
- *6.240—YNSD, Managua, Nicaragua. "La Voz de Nicaragua," 500 w.
- *6.242—CP5, La Paz, Bolivia. 250 w.
- 6.244—HIN, Ciudad Trujillo, Dominican Republic. "Emisoras Unidas," 700 w.
- *6.245—Leningrad, U.S.S.R.
- 6.248—Saratov, U.S.S.R.
- 6.250—YSV, San Salvador, El Salvador.
- =6.250—CE625, Santiago, Chile. "Radio Sociedad Nacional de Agricultura," 5 kw.
- *6.250—YS UA, Cincuenta, El Salvador.
- *6.250—Vienna, Austria.
- *6.250—HHRO, Port-au-Prince, Haiti.
- 6.250—ZFO, Cat Bay, Bahamas.
- 6.255—CP33, Potosi, Bolivia. "Radio Potosi."
- 6.255—TGRA, Guatemala City, Guatemala. "La Voz de la Guardia Civil."
- 6.255—YSUA, San Salvador, El Salvador. "Radio Mil Cincuenta."
- *6.262—HC2AE, Guayaquil, Ecuador.
- 6.270V—YSR, San Salvador, El Salvador. "La Voz de El Salvador," 1 kw.
- *6.272—HIL, Ciudad Trujillo, Dominican Republic. 60 w.
- *6.273—YXNV, Managua, Nicaragua. 100 w.
- 6.275—ZPAL, Asuncion, Paraguay. "Radio Nacional de Paraguay," 3 kw.
- 6.280—Korce, Albania. "Radio Korce."
- *6.280—HCJB, Quito, Ecuador.
- *6.282—OTM1, Leopoldville, Belgian Congo.
- *6.285—HCJB, Quito, Ecuador. 1 kw.
- 6.295—Leopoldville, Belgian Congo. "Radio Congo Belge," 20 kw.
- 6.295—TGLA, Guatemala City, Guatemala. "La Voz de Centroamerica."
- 6.300—Loanda, Portuguese Guinea.
- 6.301—CP29, Tarija, Bolivia. "Radio Guadalquivir."
- 6.310—HILZ, Ciudad Trujillo, Dominican Republic. "Broadcasting Nacional," 200 w.
- *6.315—OAX4L, Lima, Peru. "Radio Miraflores."
- 6.315—OAX4M, Miraflores, Peru. "Radio Miraflores."
- *6.320V—EQB, Teheran, Iran.
- 6.322V—Baden-Baden, Germany. "Suedwestfunk," 10 kw.
- 6.328—COCW, Havana, Cuba. "Cadena Roja," 1 kw.
- 6.333—OAXGE, Arequipa, Peru. "Radio Continental," 300 w.
- 6.335—ECN1, Clandestine Spanish (Spanish Liberation Radio).
- 6.335—Gibraltar.
- *6.344—COKQ, Santiago, Cuba. "Cadena Oriental de Radio."
- 6.345—HE12, Berne, Switzerland. "Swiss Broadcasting Corp.," 25 kw.
- 6.345—Geneva, Switzerland.
- 6.350—OAX4H, Lima, Peru. "Radio Mundial," 1 kw.
- 6.350—Clandestine Italian ("Radio Venezia Giulia").
- 6.351—HRP1, San Pedro Sula, Honduras. "El Eco de Honduras," 100 w.
- 6.366—YDB3, Batavia, Java. 300 w.
- 6.370—YDAL, Batavia, Java. "Indonesian Broadcasting Service," 1 kw.
- 6.374—CS2HA, Lisbon, Portugal. "Emissora Nacional," 500 w.
- *6.380—Jaffa, Palestine.
- 6.380—Batavia, Java.
- 6.381—HILX, Ciudad Trujillo, Dominican Republic.
- 6.387—YSHQ, San Salvador, El Salvador.
- 6.388—HC1SE, Quito, Ecuador. "Radio Nariz del Diablo."
- *6.390—XPRA, Kunming, China.
- 6.393—HI9B, Santiago, Dominican Republic. "Broadcasting Hotel Mercedes," 250 w.
- 6.400—TGQA, Quezaltenango, Guatemala. "La Voz de Quezaltenango," 300 w.
- 6.404—XPRA, Kunming, China.
- *6.405—Praia, Cape Verde Islands.
- 6.410—TG3, Guatemala City, Guatemala. "Radio Morse."
- 6.415—OAX4G, Lima, Peru. "Radio Lima," 250 w.
- *6.415—Moscow.
- *6.420—OAX1A, Chiclayo, Peru. 300 w.
- *6.424—Bathurst, Gambia.
- 6.430—HILR, San Cristobal, Dominican Republic. "La Voz de Fundacion," 200 w.
- 6.440—TGWB, Guatemala City, Guatemala. "La Voz de Guatemala."
- 6.450—COHL, Santa Clara, Cuba. "RHC-Candena Azul," 5 kw.
- 6.452—YNWV, Granada, Nicaragua. "Radio Sport."
- *6.465—Praia, Cape Verde Islands.
- *6.470—XGNC, Chin Cha Chi (?), China.
- *6.480—HI2T, Ciudad Trujillo, Dominican Republic. 200 w.
- 6.480—Batavia, Java.
- 6.493—Batum (Georgian S.S.R.), U.S.S.R.
- 6.496—OBX4B, Cerro de Pasco, Peru. "Radio Azul," 100 w.
- 6.498—Prishina, Yugoslavia.
- 6.500—YSIP, San Miguel, El Salvador. "La Voz de Progreso."
- 6.511—CP40, Cochabamba, Bolivia. "Radio Central," 250 w.
- *6.520—Clandestine Yugoslav ("Slobodna Seliacka Hrvatska").
- 6.534—TGWB, Guatemala City, Guatemala. "La Voz de Guatemala," 1 kw.
- *6.537—Ljubljana, Yugoslavia.
- 6.540—YNBH, Managua, Nicaragua. "Radio Pan-Americana."
- *6.550V—Clandestine Palestine ("The Voice of Israel").
- 6.570—XGNC, North China. "Chin-Cha-Chi New China Broadcasting Station."
- *6.594—Pyongyang, Korea. 15 kw.
- *6.600—Soerakarta, Java. "Radio Noesantara."
- 6.600—Batavia, Java.
- *6.600—Moscow.
- *6.609—Vladivostok, U.S.S.R.
- 6.615—Indonesia.
- 6.621—TG2, Guatemala City, Guatemala. "Radio Morse," 300 w.
- 6.633—HIL, Ciudad Trujillo, Dominican Republic. "El HIT del Aire," 200 w.
- 6.635—HC2RL, Guayaquil, Ecuador. "Quinta Piedad," 150 w.
- *6.650—Rome, Italy.
- 6.650—YCN2, Pontianak, Dutch Borneo. "Radio Pontianak," 150 w.
- 6.660—HHCA, Port-au-Prince, Haiti. "Haitienna Broadcasting Co.," 300 w.
- *6.660—HI3C, La Romana, Dominican Republic. 30 w.
- 6.660V—Batavia, Java. "Radio Neosantara."
- 6.660V—HC2SC, Loja, Ecuador. "Coro de Santa Cecilia," 300 w.
- *6.665V—Diember, Java.
- *6.666—Bathurst, Gambia.
- *6.669—XGHT, Hantan, China. "Hantan Broadcasting Station."
- *6.672—HBQ, Geneva, Switzerland. 20 kw.
- 6.672—TGBC, Mazatenango, Guatemala. "La Voz de Mazatenango."
- 6.672—YVQ, Santa Rita, Venezuela. 20 kw.
- 6.680—SU22, Cairo, Egypt. 10 kw.
- 6.680—PYH9, Sao Paulo, Brazil. 500 w.
- 6.690—Erivan (Armenian S.S.R.), U.S.S.R.
- 6.690—Espana Independiente.
- 6.700—YCNM, Managua, Nicaragua.
- 6.700—HC2LVC, Bahia, Ecuador. "La Voz de las Caras," 150 w.
- *6.700V—Clandestine ("Voice of Slovak Republic").
- 6.700—Clandestine Greek.
- 6.701—OAX1A, Chiclayo, Peru. "Radio Delcar."
- *6.705—YVKB, Caracas, Venezuela. 1 kw.
- 6.710—Berlin, Germany.
- *6.710—Jaffa, Palestine.
- *6.715—ZLT7, Wellington, New Zealand. 1 kw.
- 6.715—CP22, Potosi, Bolivia. "Radio Internacional," 250 w.
- 6.715—YCNM, Managua, Nicaragua. "Ecos de America," 100 w.
- 6.720—Indonesia.
- 6.733—HI3C, La Romana, Dominican Republic. "La Voz de Papayayo," 30 w.
- 6.745—TG, Guatemala.
- 6.748—PMH, Bandoeng, Java. "Radio Resmi Bandoeng," 150 w.
- *6.750V—Clandestine Yugoslav ("Voice of Slovak Republic").
- *6.750—JVT, Gokyo.
- 6.758—YNVP, Managua, Nicaragua. "La Voz de Nicaragua," 800 w.
- 6.760—Batavia, Java.
- 6.760—YNSD, Managua, Nicaragua.
- 6.765—ZNR, Aden, Arabia. 5 kw.
- *6.765—Budapest, Hungary. "Budapest I.," 5 kw.
- 6.765—Clandestine Greek ("Greek Democratic Army Radio").
- *6.768—Moscow.
- 6.770—CP49, La Paz, Bolivia. "Radio Municipal," 500 w.
- 6.770—Singapore, Malaya. "British Far Eastern Broadcasting Service," 7.5 kw.
- 6.782—HNF, Baghdad, Iraq.
- 6.786—HI2A, Santiago de los Caballeros, Dominican Republic. "Broadcasting Nacional," 250 w.
- 6.790—Jaffa, Palestine. "Sharq-al-Adna," 2.5-7.5 kw.
- *6.792—Naples, Italy. "Sender Gisela."
- *6.800—ZLO, Weiouru Military Camp, New Zealand.
- 6.800—Soerabaya, Java. "Radio Resmi Soerabaya."
- 6.815—SUP2, Cairo, Egypt. 10 kw.
- 6.820—SUP2, Cairo, Egypt. 10 kw.
- 6.825—Tashkent (Uzbek S.S.R.), U.S.S.R., 15 kw.

BIG MONEY IN RADIO

SEE THESE BRAND NEW
RADIO BOOKS **FREE**

COYNE'S *New 5 Volume Set* "APPLIED PRACTICAL RADIO"

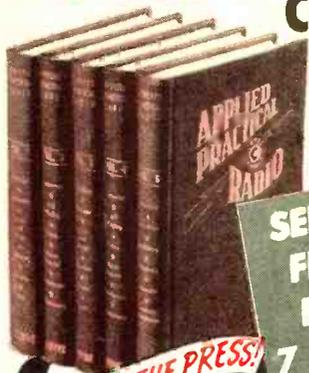

You men who want to go places in Radio, and who know how much a solid working knowledge of the field helps to get the big money—this is IT! Over 1500 pages of down-to-earth Radio, from simplest principles to newest Television! It's all there easy to understand—how and why it works . . . how to construct, install, service. PA, short-wave, auto-radio, aviation, radio-phonographs, P.M., testing instruments and trouble-shooting short-cuts, phototubes—you name it, COYNE'S got it, in "Applied Practical Radio"!

SEE IT
FREE
FOR
7 DAYS

JUST OFF THE PRESS!

PRACTICAL! CLEAR! COMPLETE!

5 big volumes—1000 illustrations and diagrams, with step-by-step photographs which "break down" the equipment for you to show what makes it "tick". Up-to-the-minute, complete, easy to follow . . . written as only COYNE books are written!

GET THIS
BOOK
FREE
for LOOKING
AT SET



Brand New!
Explains circuits
of latest sets.

VALUABLE BOOK FREE for Looking at 5-Volume Set

Send This Coupon
NOW

You must SEE these books to know how easy it is to prepare for the big jobs in radio. Here's our special offer:—we'll send the complete 5-volume set for your 7-Day FREE Examination. And with it, we'll include our valuable, new guide for all radiomen, "150 New Radio Diagrams Explained", absolutely FREE! If you keep the 5-volume Set all you pay is \$3.00 within 7 days after the books arrive and \$3.00 per month until \$16.75 is paid—or you can pay \$15.00 cash price. If you don't want the set, return it and you OWE NOTHING. But either way you keep the "150 Radio Diagrams Book" as a gift. That book is ABSOLUTELY FREE.

SEND NO MONEY REMEMBER— Coupon is not an order, just a request to see set free and get the FREE BOOK. But offer is limited, so act at once!

EDUCATIONAL BOOK PUBLISHING DIVISION
COYNE ELECTRICAL & RADIO SCHOOL
Dept. 28-T3, 500 S. Paulina St., Chicago 12, Ill.

O. K., send me postpaid, your new 5-volume set, "Applied Practical Radio" in 7 days. Free trial per your offer in Radio News. Be sure to include as a gift the book of 150 New Radio Diagrams Explained, absolutely FREE.

NAME AGE
ADDRESS
TOWN ZONE STATE

FREE BOOK

COYNE ELECTRICAL & RADIO SCHOOL (Founded 1899)
500 S. Paulina St., Dept. 28-T3, Chicago 12, Ill.

A Great Value IN RECORD CHANGERS

ALL THESE FEATURES:

- Smooth Operating
- Two Post
- Intermixes 10" and 12" records
- Plays up to 12 records
- Automatic Shutoff after last record
- Dimensions: 12 1/2" x 14 1/2" x 9" deep
- Records do not drop, are lowered to turntable



Price
\$15⁹⁵
each

Three for \$44.85

12-WATT UNIVERSAL

OUTPUT TRANSFORMERS **98c**

Standard 4-Prong Replacement Vibrators

10 for **\$8.90**

10-Watt, 4-Tube AC Amplifiers. Complete with tubes. 2—7C5, 1—7Z4, 1—7N7. Heavy-duty power transformers. Heavy-duty output transformer. **\$9⁹⁵**

TUBE VALUES:

OZ4	89 cents	10 for \$7.90
35W4	37 cents	10 for 3.39
50B5	57 cents	10 for 4.99
12AT6	47 cents	10 for 4.19

We carry complete stocks of Radio Parts and Sound Equipment. We also stock R.C.A. Tubes and R.C.A. Replacement Parts.

Send for our latest catalogue.

Dept. N

Radio Parts Company, 614 RANDOLPH ST., CHICAGO 6, ILL.

**PLEASE TEAR OUT THIS
ADV. AS REMINDER**

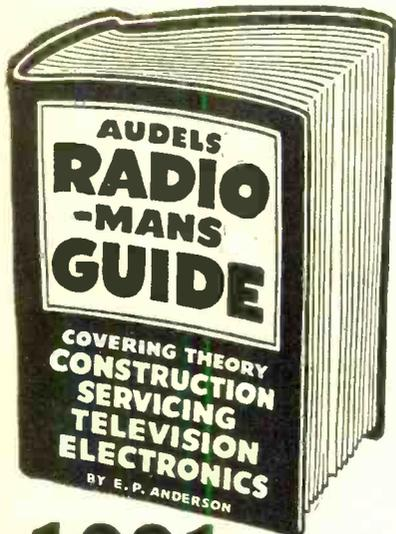

**1001 RADIO FACTS
AND FIGURES**

AUDELS RADIOMANS GUIDE—914 Pages, 633 Illustrations, Photos, Wiring Diagrams, 38 Big Chapters, covering Radio Theory, Construction, Servicing, including Important Data on Developments in Television, Electronics and Frequency Modulation, Review, Questions and Answers, Calculations & Testing. Highly Endorsed—Indispensable for Ready Reference and Home Study.

\$4 COMPLETE • PAY ONLY \$1 A MONTH
Step up your own skill with the facts and figures of your trade. Audels Mechanics Guides contain Practical Inside Trade Information in a handy form. Fully illustrated and Easy to Understand. Highly Endorsed. Check the book you want for 7 days Free Examination.

Send No Money. Nothing to pay postman.

**CUT HERE
MAIL ORDER**

AUDELS, Publishers, 49 W. 23 St., NEW YORK 10, N. Y.

Please send me postpaid for FREE EXAMINATION books marked (x) below. If I decide to keep them I agree to mail \$1 in 7 Days on each book ordered and further mail \$1 monthly on each book until I have paid price otherwise, I will return them.

- RADIOMANS GUIDE, 914 Pages \$4
- ELECTRICIANS EXAMINATIONS, 250 Pages . . . 1
- WIRING DIAGRAMS, 210 Pages . . . 1
- ELECTRIC MOTOR GUIDE, 1000 Pages . . . 4
- ELECTRICAL DICTIONARY, 9000 Terms . . . 2
- ELECTRICAL POWER CALCULATIONS, 425 Pgs. . . 2
- HANDY BOOK OF ELECTRICITY, 1440 Pages . . . 4
- ELECTRONIC DEVICES, 216 Pages . . . 2
- ELECTRIC LIBRARY, 12 vol., 7000 Pgs., \$1.50 vol. . . 1
- OIL BURNER GUIDE, 384 Pages . . . 1
- REFRIGERATION & Air Conditioning, 1280 Pgs. . . 4
- POWER PLANT ENGINEERS Guide, 1500 Pages . . . 4
- PUMPS, Hydraulics & Air Compressors, 1658 Pgs. . . 4
- WELDERS GUIDE, 400 Pages . . . 1
- BLUE PRINT READING, 416 Pages . . . 2
- SHEET METAL WORKERS Handy Book, 388 Pgs. . . 1
- SHEET METAL PATTERN LAYOUTS, 1100 Pgs. . . 4
- AIRCRAFT WORKER, 240 Pages . . . 1
- MATHEMATICS & CALCULATIONS, 700 Pgs. . . 2
- MACHINISTS Handy Book, 1600 Pages . . . 4
- MECHANICAL Dictionary, 968 Pages . . . 4
- AUTOMOBILE GUIDE, 1700 Pages . . . 4
- DIESEL ENGINE MANUAL, 400 Pages . . . 2
- MARINE ENGINEERS Handy Book, 1280 Pages . . . 4
- MECHANICAL DRAWING GUIDE, 160 Pages . . . 1
- MECHANICAL DRAWING & DESIGN, 480 Pgs. . . 2
- MILLWRIGHTS & Mechanics Guide, 1200 Pgs. . . 4
- CARPENTERS & Builders Guides (4 vols.). . . 6
- PLUMBERS & Steamfitters Guides (4 vols.). . . 6
- MASONS & Builders Guides (4 vols.). . . 6
- MASTER PAINTER & DECORATOR, 320 Pgs. . . 2
- GARDENERS & GROWERS GUIDES (4 vols.). . . 6
- ENGINEERS and Mechanics Guides
Nos. 1, 2, 3, 4, 5, 6, 7 and 8 complete . . . 12
- Answers on Practical ENGINEERING . . . 1
- ENGINEERS & FIREMANS EXAMINATIONS . . . 1

Name _____

Address _____

Occupation _____

Employed by _____ RN

- 6.840—YNOW, Managua, Nicaragua, "La Voz de la America Central," 600 w.
- 6.860—TGRB, Guatemala City, Guatemala, "La Voz de la Guardia Civil."
- *6.860—OAXIA, Chiclayo, Peru, "Radio Delcar."
- *6.870—Yakutsk, U.S.S.R.
- 6.870—HC4EB, Manta, Ecuador, "Radio Manta," 375 w.
- 6.880—Alma Ata, U.S.S.R.
- 6.885—SVD, Athens, Greece
- 6.900—TGQA, Quezaltenango, Guatemala
- 6.900—Eriwan, Armenia, U.S.S.R.
- 6.900—JWV2, Yamato, Japan, 40 kw.
- *6.910—Manama, Bahrain Island.
- 6.910—YNO, Managua, Nicaragua.
- 6.915—YVKB, Caracas, Venezuela, "Radiodifusora Nacional," 1 kw.
- 6.917—FZK6, Dakar, French West Africa, "Radio Dakar," 450 w.
- *6.920—Moscow
- *6.920—Addis Ababa, Ethiopia
- *6.940—RV90, Frunze (Kirghiz S.S.R.), U.S.S.R.
- *6.940—RVL, (Kazakh S.S.R.), U.S.S.R.
- 6.940—Moscow
- *6.940—Padang, Sumatra, "Radio Repoebliek Indonesia."
- 6.940—Batavia, Java.
- *6.945—HBQ2, Geneva, Switzerland, 20 kw.
- *6.950—YNO, Managua, Nicaragua, "La Voz de Victoria."
- *6.950—Junginster (Luxembourg), Luxembourg, 5 kw.
- *6.980—YNO, Boaco, Nicaragua, "La Voz de Boaco," 20 w.
- 6.980—FOSA, Papeete, Tahiti, "Radio Club de Tahiti," 200 w.
- 6.980—Moscow
- 6.993—Bissau, Portuguese Guinea, "Radio Bissau," 50 w.
- *6.990—XPSA, Kweiyang, China
- *6.990—XUPA, Kweiyang, China
- 7.000—HCLVT, Ambato, Ecuador, "La Voz de Tunguragua," 250 w.
- *7.000—Brazzaville, French Equatorial Africa, "Emission Nationale Française."
- 7.003—Ljubljana, Yugoslavia, "Radio Ljubljana."
- 7.005V—FET1, Valladolid, Spain, "Radio Nacional," 200 w.
- 7.007—XPSA, Kweiyang, China.
- *7.010—XPPA, Kweiyang, China, 1 kw.
- *7.011—EDV10, Madrid, Spain, "Radio SEU," 1 kw.
- 7.012V—Malaga, Spain, "Radio Nacional de Espana," 1 kw.
- *7.018—CS9MA, Ponta Delgada, Azores, "Emissora Regional Acores," 1 kw.
- 7.022—Bachmal (?), French Indo-China, "Radio Bachmal."
- 7.022—EAJ9, Malaga, Spain.
- 7.036—Valencia, Spain, "Radio Mediterraneo," 300 w.
- 7.040—YSL, San Salvador, El Salvador, "Radio Intercontinental," 100 w.
- 7.040—VP4TH, Port-of-Spain, Trinidad, B.W.I.
- 7.045—FET15, Cordoba, Spain, "Radio Cordoba."
- *7.048—XMHA, Shanghai, China.
- *7.050—XNCR, Yenan, China, 1 kw.
- *7.050—HCL3—Otavaldo, Ecuador, "Ondas de Los Lagos."
- *7.050—CS2MB, Lisbon, Portugal "Emissora Nacional," 500 w.
- *7.050—ZOY, Accra, Gold Coast.
- *7.053—OQ2AB, Elizabethville, Belgian Congo, "Radio Elizabethville," 100 w.
- 7.051—CR6RF, Benguela, Angola, "Radio Clube de Benguela."
- 7.056—HC2CM, Guayaquil, Ecuador, "Radiodifusora Iman," 50 w.
- 7.060—CP11, La Paz, Bolivia, "Radio Amautha," 600 w.
- *7.065V—EDV10, Madrid, Spain, "Radio SEU," 1 kw.
- *7.075—GRS, London, 50-100 kw.
- 7.080—EA9AA, Tangier, Tangier Zone, "Radio Africa," 1 kw.
- 7.085—Y15KG, Baghdad, Iraq.
- *7.090—XGOUS, Nanking, China.
- 7.092—, Indonesia.
- *7.095—Bissau, Portuguese Guinea.
- 7.100—XGAF, China, "K'ung Chun Broadcasting Station."
- 7.100—YDB, Bandoeng, Java, "Radio Resmi Bandoeng," 200 w.
- 7.100—Batavia, Java.
- 7.100—CR6RS, Benguela, Angola, "Radio Benguela."
- 7.100V—Cuenca, Spain, "Radio Nacional de Espana."
- 7.105—XGAF, Nanking (?), China.
- *7.107V—EDV10, Madrid, Spain, "Radio SEU," 1 kw.
- 7.120—GRM, London, 50-100 kw.
- 7.120—OAXIA, Chiclayo, Peru.
- 7.126—YQ6MI, Hargeisa, British Somaliland, "Radio Somali," 1 kw.
- 7.130V—FET22, Oviedo, Spain, "Radio Fala-ange de Oviedo."
- *7.140—CR6RE, Melanje, Angola.
- *7.143—HC4FA, Portoviejo, Ecuador, "La Voz de Manabi," 100 w.
- 7.149—OQ2AB, Elizabethville, Belgian Congo, "Radio Elizabethville," 50 w.
- *7.150—GRT, London, 50-100 kw.
- 7.150—, U.S.S.R. (?)
- 7.152—XGOY, Chungking, China, "The Voice of China," 10 kw.
- 7.155V—CR71B, Beira, Mozambique, 300 w.
- 7.155V—EDV10, Madrid, Spain, "Radio SEU," 1 kw.
- 7.160—HC1BF, Quito, Ecuador, "Radio Comercial," 500 w.
- *7.161V—Vienna, Austria, "Radio Wien," 400 w.
- 7.164—CR6RE, Malanje, Angola, "Radio Clube de Malanje," 50 w.
- *7.165—Moscow.
- 7.167—HISZ, Santiago, Dominican Republic.
- 7.170—Warsaw, Poland, "Polskie Radio."
- *7.170—Tananarive, Madagascar, "Radio Tananarive," 1.2 kw.
- 7.175V—Vienna, Austria, "Radio Wien," 250 w.
- 7.177—CR6AA, Lobito, Angola, "Radiodifusora do Lobito," 1 kw.
- 7.177—Moscow.
- *7.185—GRK, London, 50-100 kw.
- *7.185—Colombo, Ceylon, "Radio SEAC," 7.5 kw.
- *7.187—EDV10, Madrid Spain, "Radio SEU," 1 kw.
- *7.190—JCPA, Cairo, Egypt.
- 7.198—Biak, Dutch New Guinea, "Jungle Network" 1 kw.
- 7.200—Moscow.
- *7.200—XGSE, Nanking, China.
- 7.200—Medan, Sumatra, "Radio Sumatra," 120 w.
- 7.200—Boekitt Tinggi, Sumatra, "Voice of Free Indonesia."
- *7.202—YSY, San Salvador, El Salvador.
- *7.210—Horby, Sweden.
- 7.210—GWL, London, 50-100 kw.
- 7.210—VUC2, Calcutta, India, AIR, 10 kw.
- *7.210—VUD10, Delhi, AIR, 20 kw.
- 7.210—LLS, Tromsoe, Norway, 5 kw.
- 7.210—LLS, Tromsoe, Norway, 5 kw.
- *7.210—ZAA, Tirana, Albania.
- 7.210—HE13, Berne, Switzerland, 25 kw.
- *7.212—FHE7, Dakar, French West Africa, "Radio Dakar," 12 kw.
- *7.214—Rabat, French Morocco.
- *7.215—VLQ2, Brisbane, Australia, "A.B.C.," 10 kw.
- *7.220—VLG9, Melbourne, Australia, "Radio Australia," 10 kw.
- 7.220—KOP, Salzburg, Austria, U.S. Forces Station, 750 w.
- 7.220—Singapore, Malaya, "Radio Malaya," 7.5 kw.
- 7.220—Lusaka, Northern Rhodesia, 500 w.
- 7.220—Jerusalem, Palestine, British Forces Station, 7.5 kw.
- *7.222—XURA, Tai-Pei, Formosa, "Taiwan Broadcasting Station," 3 kw.
- 7.224—HISZ, Santiago, Dominican Republic.
- *7.225—Pointe-a-Pitre, Guadeloupe, "Radio Guadeloupe," 200 w.
- *7.230—KWIN, San Francisco, Calif., U.S.A.
- 7.230—GSW, London, 50-100 kw.
- *7.235—Dalat, French Indo-China, "Radio Dalat."
- 7.237—V84S, Jesselton, British North Borneo, 1 kw.
- *7.240—VLQ, Brisbane, Australia, "A.B.C.," 10 kw.
- 7.240—Paris, France, "Radiodiffusion Francaise," 25 kw.
- 7.240—Tondheim, Norway, "Norwegian Technical University," 600 w.
- 7.240—HBB2, Port-au-Prince, Haiti, 125 w.
- 7.240—VUB2, Bombay, India, AIR, 10 kw.
- 7.240—VUDS, Delhi, AIR, 7.5 kw.
- *7.240—VUD11, Delhi, AIR, 20 kw.
- *7.245—Moscow.
- 7.250—PJCI, Willemstad, Curacao, "Radio Princess Juliana," 3 kw.
- *7.250—GWI, London, 50-100 kw.
- 7.250—Rome, Italy, "RAI, Radio Italiana," 1 kw.
- *7.252—WNRX, New York, N.Y., U.S.A.
- *7.250—JCKW, Jerusalem, Palestine, British Forces Station, 7.5 kw.
- *7.252—EAJ43, Santa Cruz de Tenerife, Canary Islands, "Radio Club de Tenerife," 1 kw.
- *7.255—CR71B, Beira, Mozambique, "Do Aero Clube da Beira," 300 w.
- 7.258—JKC, Yamata, Japan, "N.H.K.," 5 kw.
- *7.258—JLW, JWV, Tokyo.
- *7.258—XGSE, Nanking, China.
- *7.260—Tonkin, French Indo-China, "The Voice of Vietnam."
- 7.260—OZQ, Skamlebak (Copenhagen), Denmark, 8 kw.
- 7.260—GSU, London, 50-100 kw.
- 7.260—VUM2, Madras, India, AIR, 10 kw.
- *7.260—Tabriz, Iran, "Radio Tabriz."
- *7.260—CS2MB, Lisbon, Portugal, "Emissora Nacional," 50 w.
- *7.265—Munich, Germany.
- *7.267—EAJ43, Santa Cruz de Tenerife, Canary Islands.
- 7.270—HC1CQ, Quito, Ecuador, "Radio Union Agencias Unidas," 150 w.
- 7.270—Dalat, French Indo-China, "Radio Dalat."
- 7.270—Rome, Italy, "RAI, Radio Italiana," 1 kw.
- 7.270—ZKG5, Pitcairn Island.
- 7.270—Moscow: 2000-2130.
- *7.270—Horby, Sweden.
- 7.275—HI2T, Ciudad Trujillo, Dominican Republic, "La Voz del Yuna," 7.5 kw.
- *7.275—VUD4, Delhi, AIR, 10 kw.
- *7.275—VUD3, Delhi, AIR, 5 kw.
- *7.275—EAJ43, Santa Cruz de Tenerife, Canary Islands, "Radio Club de Tenerife," 1 kw.
- *7.280—VLCS, Shepparton, Australia, "Radio Australia," 50 kw.
- *7.280—VLA, Shepparton, Australia, "Radio Australia," 100 kw.
- *7.280—Macao, Portuguese China.
- *7.280—Burgas, Bulgaria, "Radio Burgas."
- *7.280—GWN, London, 50-100 kw.
- 7.280—Paris, France, "Radiodiffusion Francaise," 100 kw.
- 7.285—JKA, Nazaki, Japan, "N.H.K.," 5 kw.
- *7.285—JLW, Tokyo.
- 7.285—Lusaka, Northern Rhodesia, 500 w.
- 7.290—Munich, Germany, 80 kw.
- 7.290—VUD2, Delhi, AIR, 10 kw.
- 7.290—VUD5, Delhi, AIR, 100 kw.

HAMS! EXPERIMENTERS! Look at these EXCLUSIVE "G&G" BUYS!

ARMY AIRCRAFT RECEIVER— BC-946-B

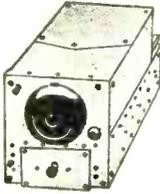

Covers 520 Kc to 1500 Kc Broadcast Band. 6 Tubes: 3—12SK7, 1—12SR7, 1—12A6, 1—12K8. Designed for dynamotor operation; can be easily converted to 110 volt or 32 volt use. Two IF Stages. Three-gang tuning cond. BRAND NEW, in sealed carton, with tubes and instruction manual, less dynamotor. **\$12.95**
Dynamotor DM-32A..... **\$1.95**

RADIO RECEIVERS All Brand New in Original Cartons

BC-453-A 190 to 550 Kc complete with tubes **\$7.95**
BC-454-A 3.1 to 6 Mc complete with tubes... **5.95**
BC-455-A 6 to 9.1 Mc complete with tubes... **6.95**
40-WATT VFO DRIVER
BC-457A 4 to 5.3 Mc..... **\$5.95**
BC-458A 5.3 to 7 Mc..... **5.95**
BC-459A 7 to 9.1 Mc..... **7.95**

BRAND NEW! ULTRA HIGH FREQ. TRANSMITTER AN/APTS



\$11.95

1500 Mc Transmitter, complete with following tubes: 2—6AC7, 1—6L6, 2—829, 1—931A, 1—6AG7, 1—522 Ultra High Frequency tube, complete with Ultra High Frequency Cavity, blower to cool the 522, Time Delay Relay, 2 filament transformer condensers, and many other component parts for Ultra High Frequency. Has Frequency Checker, complete Lecher Wires, with Slider, and Sensitive Bulb for checking wave length. Operates on 115 Volt AC for Filaments only. No plate supply included. Tubes alone worth much more than our price for transmitter—only \$11.95! Shipping weight 118 lbs. In original wooden case with instruction book.

TRANSMITTER BC-223-AX

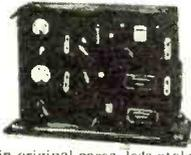

Ideal for 80-meter band! 801 osc., 801 P.A., 2—46 modulators, 1—46 speech amp., 4 xtal freq, and master osc. on selector switch. 10 to 30-watt output, tone, voice or C.W. Black wrinkle case, complete with freq. chart and tubes in original cases, less xtals. BRAND NEW, sensationally low price. **\$14.95** shpg. wt. 80 lbs.

PE-104-A VIBRATOR POWER SUPPLY



Works on 6 volt or 12 volt battery. Supplies 84 volts and 51 volts DC also 1.4 volts "C" bias. Size 7"x4"x3 3/4". Fits BC-654 (SCR-284) exactly. Can be used to operate many types of receivers now on market. ALL BRAND NEW, very low price. **\$4.95**

80 VOLT A.C. INVERTER

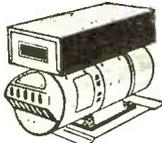

Sig. Corps PE-206A. Terrific Value! 80 Volts AC Output, 800 cy. 28 V DC Input 6000 RPM. Complete with Filter. Value \$100.00. Your Cost..... **\$6.95**

BC-645 XMTR RECEIVER 15 TUBES 435 TO 500 MC

BRAND
NEW!

\$975

2 for \$1895

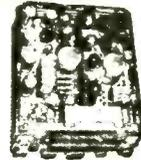

The electronic equipment that saved many lives in the war. Set can be modified to use for 2-way communication, voice or code, on following bands: ham band 420-450 mc, citizens radio 460-470 mc, fixed and mobile 450-460 mc, television experimental 470-500 mc. 15 tubes (tubes alone worth more than sale price!): 4—7F7, 4—7117, 2—7E6, 2—6F6, 2—955 and 1—WE316A. Now covers 460 to 490 mc. Brand new BC-645 with tubes, less power supply in factory carton. Shipping weight 25 lbs. PE-101C DYNAMOTOR for above BC645..... **\$2.95**

TERRIFIC VALUE!



24-VOLT STORAGE BATTERY, BRAND NEW!
Made by Delco. 12 cells, heavy duty, very rugged. Shipped dry, uses standard sulphuric acid electrolyte. **VERY SPECIAL... \$14.95**

6-VOLT STORAGE BATTERY
Navy Standard BRAND NEW. 15 ampere-hour rating..... **\$4.95**

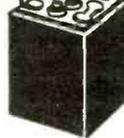

GE TUNGAR BATTERY CHARGERS

Model No. 6R-B33B2—1 to 12—6 volt batteries. 6 amp DC 115v AC. 60 cycle; complete with Tungar Bulb. Shipping weight approx. 40 lbs..... **\$29.50**

WILLARD 6-VOLT STORAGE BATTERY 27 amp. hrs.

3-cell battery, transparent plastic case, very specially priced..... **\$4.50**



WILLARD 2-VOLT BATTERY
20-amp. hrs. similar to above, but single cell..... **\$2.75**

ONE-QUART BOTTLE BATTERY ELECTROLYTE



Made by Willard, for above storage batteries. 1 quart sufficient for two 2-volt cells. Hermetically sealed. SPECIAL. per qt. bottle **95¢**

7-PRONG 2-VOLT RADIO VIBRATOR for Portable and Farm Sets Replacement for GE LB 530..... **\$1.65**

WESTERN ELECTRIC FIELD PHONE SET EE-8

Leather case, with handset, generator, ringer, etc. Requires 2 flashlight cells. Wonderful value! Good used. Each..... **\$4.95**



TWO FOR \$9.75

SETCHEL-CARLSON BEACON RADIO RECEIVER BC-1206-C



Receives A-N beam signals, operates on 24-28 V DC. 5 Tubes: 3—14H7, 14R7, 28D7. Tunes 195 to 420 Kc. Size 4"x4"x6 1/4" wide. 4 lbs. Slightly used, A-1 condition. Each..... **\$4.95**

Same as above, BRAND NEW, in original carton..... **\$7.95**

QUANTITY PRICES

Inquiries welcomed from institutions, wholesalers, dealers, large users. Phone, write, wire for quantity prices.

Please include 25% Deposit with order—Balance C.O.D. Minimum order \$3.00. All Shipments F.O.B. Our Warehouse N.Y.C.

G & G GENUINE MAJESTIC RADIO PARTS SERVICE 53 VESEY STREET - NEW YORK 7, N.Y.

SENSATIONAL Smash Value!

COMPLETE I.F.F. Equipment RC-188-A

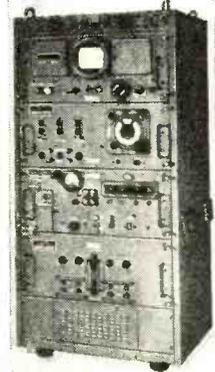

Bargain opportunity of a life-time! This I.F.F. equipment originally cost about \$20,000... now buy it for a tiny fraction of cost! Easily converted for Television. Complete assembly consists of Control unit with 5" C.R. Tube, transmitter and receiver assembly (157 to 185 Mc), Indicator unit, and Power Supply (450 watts) operating on 110 volts, 60 cycles AC. All assembled, ready to operate. 62 Tubes included: 8—6V6GT, 9—6SL7GT, 14—6SN7GT, 1—5CP1, 2—9006, 1—6Y6, 2—6E5, 1—100TH, 2—6J5, 2—2C26, 1—3E29, 1—6H6, 7—6AG5, 3—6AK5, 1—6CA, 3—2X2, 1—6X5GT, 3—5U4GT. Overall size 55" high, 28" wide, 20 1/2" deep. Shpg. weight 750 lbs. Your cost, complete, BRAND NEW, in original packing **\$195.00**

HEADPHONES—All Brand New!

Individually packed, complete with phone plug. HS-33 600 ohms, in lots of 3..... **\$1.85 each**
HS-23 2000 ohms, in lots of 3..... **1.65 each**
HS-30 headphones, with earplugs. **44¢ each**
LOTS OF 12.....

HANDSET



Cradle-type handset with butterfly switch, unbreakable black plastic, 4-ft. 3 wire cable, BRAND NEW, individually packed, each..... **\$2.75**
Same as above but slightly used, each.... **\$1.65**

140MMFD MIDGET TUNING CONDENSER

Long shaft. Lots of 3, each..... **44¢**

118 MMFD TRANSMITTING CONDENSER

Very Special Ham Value! 31 plates, Airgap .109" overall length 4 1/2", ceramic insulation, normal list price \$11.85..... each **99¢**

BEDE DC METER, new, black bakelite case, 3" round 0-1000 DC Ma. Special **\$1.95**

ALLIANCE PHONO MOTOR, special. **\$2.75**

ASTATIC CRYSTAL PICKUP, with L-26 crystal cartridge..... **\$1.79**

SPECIAL 409.5 KC CRYSTAL
Lots of six..... each **29¢**

5BP1 C.R. TUBE, Brand New. Lots of six..... each, **\$1.88**

GE-211 TUBE. Brand New..... each, **\$1.22**



FREQUENCY METER CABINET

For BC-221 Series freq. meters. BRAND NEW! 3 compartments. Massively built. 14 1/2"x10 1/2"x10". Value \$20.00. Yours for only **\$2.95**

HANDMIKE T-17

Shure model T-17 mike, 200-ohm carbon single button, with press-to-talk switch, 5-ft. rubber cord and plug. BRAND NEW, individually packed, in lots of 3, each.... **88¢**





Living Room
Concerts

More
Economical



Airport & Train
Announcements

Cannot
Tangle



Broadcast Station
Monitoring

Now Available! 8 HOURS OF CONTINUOUS PLAY ON THE MAGNETAPE* RECORDER!



Longer
Playing
Time

30 Second
Rewind

Quieter
Operation

Easy
Editing

Improved
Response
Range

Copying Valuable
Disc Records

Complete
Automatic
Erasing

Recorded
Lectures

Write today for our free illustrated technical catalog featuring our complete series of Magnetape Recorders and accessory equipment. Send 25¢ in stamps or coin for our new booklet, "Elements of Magnetic Tape Recording — and 999 Applications."
* Trademark

AMPLIFIER CORP. of AMERICA

398-2 Broadway, New York 13, N. Y.

TELEVISION RECEIVER—\$1.00

Complete instructions for building your own television receiver. 16 pages—11"x17" of pictures, pictorial diagrams, clarified schematics, 17"x22" complete schematic diagram and chassis layout. Also booklet of alignment instructions, voltage and resistance tables and trouble-shooting hints.—All for \$1.00.

CERTIFIED TELEVISION LABORATORIES
5507-13th Ave., Brooklyn 19, N. Y.

ELECTRONIC VOLT-OHMMETER

\$11.85

110 VOLTS AC 20 RANGES
0.5/10/50/100/500/1000/5000 volts
DC and AC 0-1,000,000 ohms in
six overlapping ranges. Sensitivity:
over MILLION OHMS per VOLT on 5
volt range.

Complete kit, panel, chassis, nine inch long dial scale, tubes, components. Cost is low because special slideback circuit eliminates need of expensive meter.

STERLING ELECTRONIC COMPANY
BOWLING GREEN, DEPT. 4, KENTUCKY

- *7.290—Labuan, British North Borneo.
- 7.290—VUD11, Delhi, AIR, 20 kw.
- *7.290—BFN, Hamburg, Germany.
- *7.292—HHCP, Cape Haitien, Haiti.
- *7.295—ZOY, Accra, Gold Coast, 5 kw.
- 7.295—Port Louis, Mauritius Island.
- *7.295—SVD2, Athens, Greece, "Stathmos Athinon," 7 kw.
- 7.295—Clandestine Greek.
- *7.295—XUPA (now XURA), Tai-Pei, Formosa.
- *7.398—FHE6, Dakar, Fr. West Africa, "Radio Dakar," 300 W
- *7.299—CR6RL, Luanda, Angola, "Radio Clube de Angola," 1 kw.
- *7.300—Brussels, Belgium, "Radio Nationale Belge," 5 kw.
- *7.300—Delhi, AIR, 100 kw.
- 7.300—Moscow.
- *7.308—BEG1, Ciudad Victoria, Mexico, "Radio Gobierno."
- *7.310—VIG, Port Moresby, Papua.
- *7.312—Salisbury, Southern Rhodesia.
- 7.315—YSN, San Salvador, El Salvador, "La Voz de la Democracia," 1 kw.
- 7.320—GRJ, London, 50-100 kw.
- 7.320—Sanaa, Yemen, "Yemen Broadcasting Station."
- *7.325—GRJ, London, 50-100 kw.
- 7.330—Moscow.
- *7.340—XMAG, Nanking, China.
- *7.342—Leningrad, U.S.S.R.
- 7.347.5—WFI-2, St. Thomas, Virgin Islands, "All-American Cables and Radio."
- 7.350—HC2AN, Guayaquil, Ecuador, "Radio Difusora Centil," 250 w.
- 7.355—Indonesia, "Radio Angkatan Laot."
- *7.360—HET3, Berne, Switzerland, 25 kw.
- *7.360—Moscow.
- *7.380V—XRR, Peiping, China, "Peiping Broadcasting Station," 1.5 kw.
- *7.380—HEK3, Berne, Switzerland, 25 kw.
- 7.380—HEU3, Berne, Switzerland, "Swiss Broadcasting Corp." 25 kw.
- 7.390—Berne, Switzerland, 25 kw.
- *7.400—YVKC, Caracas, Venezuela, "Radiodifusora Nacional," 1 kw.
- *7.400—XOPD, Hangechow, China.
- *7.410—PST2, Sao Paulo, Brazil, "Radio Anchieta," "A emissora do Planalto."
- 7.410—Moscow.
- 7.410—Clandestine ("Espana Independiente").
- *7.413—CE???, Santiago, Chile, "Radio Prat."
- 7.413—YNAO, Masaya, Nicaragua, "Ecos del Aire," 200 w.
- 7.418—YHP5, Soerakarta, Java, "Radio Noesantara."
- 7.420—YNFT, Granada, Nicaragua.
- 7.425—LPC, Ushuaia, Tierra del Fuego, Argentina.
- *7.430—Leningrad, U.S.S.R.
- 7.445—ZRB, Waterkloof, District Pretoria, South Africa, "South African Air Forces," 5 kw.
- 7.448—Pointe-a-Pitre, Guadeloupe, "Radio Guadeloupe," 200 w.
- 7.452—Bukit Tinggi, Sumatra, "Radio Repoeb-Ik Indonesia."
- *7.460V—LZB, Sofia, Bulgaria, "Radio Sofia."
- 7.460V—Tokyo.
- *7.461—Moscow.
- 7.462—Boekitt Tinggi, Sumatra.
- *7.480—Jaffa, Palestine, "Sharq-al-Adna," 7.5 kw.
- *7.480—Alma Ata, U.S.S.R.
- *7.489—Tiflis, U.S.S.R.
- 7.495—XNCR, North Shensi, China, "North Shensi New China Broadcasting Station," 1 kw.
- *7.500—Bathurst, Gambia.
- *7.500—Cairo, Egypt.
- 7.500V—Damascus, Syria.
- 7.500—Moscow.
- 7.502—YNFT, Granada, Nicaragua, "La Voz de la Sultana," 1 w.
- 7.510—Indonesia, "Radio Noesantara."
- *7.510—Moscow.
- *7.520—XNCR, North Shensi, China, 1 kw.
- *7.530—CRSA, Macao, Portuguese China, 200 w.
- *7.538—Dalat, French Indo-China.
- *7.540—FGAH, Pointe-a-Pitre, Guadeloupe.
- *7.545—HEF3, Berne, Switzerland, 25 kw.
- *7.545—Moscow.
- *7.558V—EAJ43, Santa Cruz de Tenerife, Canary Islands, "Radio Club de Tenerife," 1 kw.
- *7.560—Moscow.
- *7.565—HED3, Berne, Switzerland, 25 kw.
- 7.567—Soerakarta, Java.
- *7.580—XNCR, North Shensi, China, 1 kw.
- 7.580—Tokyo.
- 7.585—Santiago, Chile.
- *7.590—San Remo, Italy.
- *7.590—Ashkabad, U.S.S.R.
- 7.600—ZEA, Salisbury, Southern Rhodesia.
- 7.600V—Java.
- *7.610—Baden-Baden, Germany.
- 7.615—YNLAT, Granada, Nicaragua, "La Voz del Mombacho," 200 w.
- 7.638—CE???, Santiago, Chile, "Radio Prat."
- 7.650—Moscow.
- 7.655—Indonesia, "Radio Persatuan Indonesia."
- 7.660—YNDG, Leon, Nicaragua, "La Voz de Leon," 200 w.
- 7.671—Sofia, Bulgaria, "Radio Sofia."
- *7.675—Labuan, British North Borneo.
- 7.675—SUW2, Cairo, Egypt, 10 kw.
- *7.700—ZMR6, Apia, Western Samoa, "Apia Radio," 500 w.
- 7.715—Clandestine Greek ("Greek Democratic Army Radio").
- *7.750—CMZI, Havana, Cuba.
- *7.750—JBA, Seoul, Korea.
- *7.750—JW3U, Tientsin, China.
- 7.780—Stanlinabad (Tadzhik S.S.R.), U.S.S.R.
- *7.780—JGF, Osaka, Japan.

New... JUST OFF THE PRESS!

TELEVISION CATALOG

Send for *Your* COPY TODAY!

TELEVISION NIAGARA RADIO SUPPLY CORP
160 Greenwich St., New York 6, N. Y.

"TELEVISION IS HERE TO STAY." If you are thinking in terms of Television—whether you own a receiver or planning to build one—get Niagara's new giant Television catalog—all in one complete and comprehensive booklet on everything for Television. Kits, Components, Test Equipment, Antennas and miscellaneous—We have them all—Make us your TELEVISION HEADQUARTERS—you will save yourself considerable time and money. Clip the coupon and mail today.

NIAGARA RADIO SUPPLY CORPORATION
160 Greenwich St., New York 6, N. Y.

Please send copy of your Television Catalog to:

Name.....

Address..... Zone.....

City..... State.....

WALTER ASHE *gives you...*

Surprise TRADE-IN ALLOWANCES on your USED Equipment

It's Walter Ashe for bigger-than-ever trade-in allowances on your used Test Equipment, Receiver or Transmitter. Simply tell us what factory-built test or communication equipment you want to trade. We'll respond with an extra-liberal offer that's sure to please you. Wire, write or phone today!

Super Bargains IN SURPLUS EQUIPMENT

SUPER BARGAIN

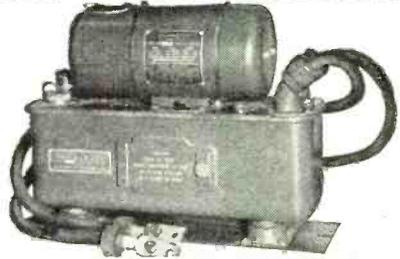

PE-103A SURPLUS DYNAMOTOR
Fortunately WALTER ASHE can still offer a fast disappearing item of SURPLUS in this Hi-Powered dynamotor unit. 6 or 12 VDC input; 500VDC at 160 MA output. Complete, Brand New in original shipping crates. Shpg. Wt. 81 lbs. **ONLY \$995**
Canon P8-CG-12S Power Plug for above; Shpg. Wt. 1/2 lb. Regular \$1.80. **ONLY 95c**



SURPLUS VFO-TRANSMITTER BRAND NEW

USES	FEATURES
*Complete Transmitter	*Range—7 to 9.1 Mc.
*VFO Exciter	*Gang Tuning
*FM Exciter	*Calibrated Dial

A versatile piece of SURPLUS equipment with many Ham uses. Ready to go, no conversion except for FM use. Utilizes 1—1626 Osc., 2—1625 (12 volt 807's) RF Amp and 1—1629 Indicator tube. Up to 100 watts input possible with appropriate power supply. Filament requirements, 12 or 24 V. AC or DC.

Supplied complete with 8000 Kc. calibrating Xtal, tubes, Schematic diagram and FM conversion instructions. **BRAND NEW** in original cartons.
Type BC-459A Aluminum finish. **ONLY \$595**
Shpg. Wt. 14 lbs. **ONLY \$595**

FILAMENT TRANSFORMER FOR ABOVE. Sec. 12 or 24 VAC. Pri. 115/230 60 cy. Shpg. Wt. 6 lbs.
BC-459A Filament transformer. **ONLY \$1.47**
Complete set of tubes for above only. **ONLY 98c**

IT'S HERE

1948
Walter Ashe
RADIO AND ELECTRONICS CATALOG

1948 Catalog
SEND FOR YOUR FREE COPY.

Amazing Bargains in Top Condition, Slightly Used Test Equipment, Receivers and Transmitters.

ARMY SURPLUS HEAD PHONES



Type HS-23—Slightly used but in perfect electrical condition. 8000 ohms impedance. Complete with leather headband and rubber cushions. Shpg. Wt. 2 lbs. **ONLY 98c**

Type HS-16A—Canvas web headband and long standard type cord. **BRAND NEW**, in original boxes. Shpg. Wt. 3 lbs. **ONLY \$1.47**

BARGAIN BASEMENT Special

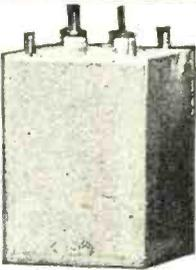

SURPLUS FILTER CHOKE
4 1/2 Hy at 150 MA. 70 ohms DC resistance. Hermetically sealed in metal case. Stand off insulator terminals.

No. 5209—Shpg. Wt. 5 lbs.
Regular Price \$1.29 . . .
Special Price, 2 or More . . . each **79c**
One Only . . . **99c**

Write for complete list of Super Bargains in Surplus Equipment.

All the Big Name Brands of New Test Equipment, Receivers and Transmitters in stock (ready for immediate delivery).

Surplus FILTER CONDENSER Bargain



3 Mfd at 400 VAC. Good for at least 1500 VDC. Metal case. Shpg. Wt. 3 lbs. **ONLY 98c**

Walter Ashe
RADIO CO.
1125 PINE ST. • ST. LOUIS 1, MO.

MAIL COUPON TODAY

TIME PAYMENTS AVAILABLE

ALL PRICES F. O. B. ST. LOUIS

WOJWD WOIYD WOULD WOPGI WOWTM W9NRF W9QDF

Remember your trade-in's worth more at the Walter Ashe store. So get Walter Ashe's offer before you make that trade.

WALTER ASHE RADIO CO.
1125 Pine St., St. Louis 1, Missouri **RN2**

Am interested in the following top condition, slightly used Test Equipment _____ (list preference)

I want to trade _____ (describe used equipment) for _____ (show make, model of new Receiver desired or other equipment)

Rush my **FREE COPY** of the big, New 1948 Walter Ashe Catalog.

NAME _____
ADDRESS _____
CITY _____ ZONE _____ STATE _____

J-36 SPEED KEY.....\$5.85



Sensitive movement, easy action, heavy crackle base. Made by Lionel on famous pattern of another well-known speed-key mfr.; money-back if not pleased;

Brand New, Original Boxes (5 lb.)\$5.85
Very slightly used, perfect **4.45**

EE-8 TELEPHONE.....\$4.95



With handset, generator, ringer, etc., in leather or heavy web case (please do not specify). Fine for garage extension, farm phones, warehouses, etc. For local or common battery lines. "Each phone tested before shipment."

Used, Fair
\$4.95.....two for \$9.50
Used, Good
\$9.95.....two for \$19.00
Used, Excellent, leather cases
\$13.95.....two for \$27.00



A. Coil Form 2" od x 3 1/4" lg. With brackets..... **\$0.19**

B. PA Coils part of Pan-Amer. No. 12GLX-2 xmtr. Plug-in ceramic form 4" od by 9 1/4" lg. These Freq: 385-525Kc..... **\$2.85**
Following have internal var. cond. and rotary link:
6.59-6.9, 7.2-7.53, 10.9-11.45, 13.5-14.37 and 21.25-22.1 MC **\$3.85**

C. Form, ribbed porc. 5 1/2" lg. x 2 3/4" d, stand-offs..... **\$0.69**

D. 20 Meter center link 100-watt plug-in B&W..... **\$1.19**

E. Final Tank for BC-610 xmtr 500w plug-in fixed link: 2-3.5, 3.5-4.5, 4.5-5.7, 5.7-8 and 11-14MC **\$1.19**

F. Form 3" od x 4 3/4" lg. lo-loss w/bracket..... **\$0.29**

**UNLESS OTHERWISE STATED
ALL MATERIAL NEW
MONEY-BACK GUARANTEE
WE'LL NOT BE UNDERSOLD**

We will meet current advertised prices on any item listed here.

REMOTE CONTROL UNIT



RM-12: good for commercial or amateur stations. Has handset, ringer, generator. Weston 301 (or equiv.) db meter. Contains EE-8 'phone. **Used** **\$10.95**

RM-13: same as above but includes 115 V 60 cps power supply, one tube amplifier: w/2 tubes **Used** **\$14.95**

TRANSFORMERS 115 V 60 CPS



A. Choke 10h 150 ma 107 ohms (GE) **\$1.65**
1 7/8 x **\$1.88**

B. 4v @ 16a, 2.5v @ 1.73 a **\$1.88**

C. 'Scope 4000vrms @ 10 ma **\$3.65**
115v 2A No. 1159 **\$2.15**
similar to "D" **\$2.65**

D. Power, 315 VDC 85 ma. 5v 3a, 6.3v 2.1a No. 1159 **\$2.15**
similar to "D" **\$2.65**

A. Push-Pull Input, pri 3000 sec 12M ohms + ct. 500-15M cps 3db **\$1.45**

B. Power, pri 115v 60 cps-sec 400vct 45ma. 6.3v .6a, 6.3v 1.5a **\$1.45**

C. Choke, 5h 225 ma 112 ohms GE **\$1.95**

D. Filament, 2.5v 10a oil-filled Lionel **\$3.88**

WRITE FOR FREE LIST
Postage extra. Minimum order \$2.00
TERMS: Net Cash, 25% deposit on C.O.D's

ELECTRONIC SUPPLIES
317-R East 2nd St. Tulsa 3, Oklahoma

7.790—Palembang, Sumatra. "Radio Repoebl-lik Indonesia."
*7.797—HBP, Geneva, Switzerland.
7.803—P.C.I. Central Java, "Radio Repoebl-lik Indonesia."
*7.820—CE???, Santiago, Chile. "Radio Prat."
*7.825—JLW, Tokyo.
7.840—Clandestine Basque ("Radio Euzkadi").
*7.850—PCJ1, Willemsted, Curacao.
7.852—ZAA, Tirana, Albania, "Radio Tirana," 3 kw.
*7.865—Moscow.
7.867—SUX, Cairo, Efypt. "Radio Cairo," 10 kw.
7.870—Biak, Dutch New Guinea.
7.876—HCICG, Quito, Ecuador. "Radio Ecuador Amazonico," 300 w.
*7.880—Balikpapan, Dutch Borneo.
*7.893—Constantine, Algeria. "Radio Algerie," 2 kw.
*7.894—YSD, San Salvador, El Salvador, "Alma Cuscatleca," 400 w.
*7.895—Jaffa, Palestine.
7.920—Pleven, Bulgaria.
7.937—PSL, Rio de Janeiro, Brazil, 12 kw.
7.944V—Alicante, Spain. "Radio Falange de Alicante," 1.2 kw.
7.950—FIA, Douala, Cameroons, 800 w.
*7.960—Biak, Dutch New Guinea. "Radio Biak."
*7.960—Balikpapan, Dutch Borneo.
*7.968—HSP6, Bangkok, Siam, 10 kw.
7.980—Biak, Dutch New Guinea. "Radio Biak," 7.990—Korea.
7.997V—PMD, Bandung, Java. "Radio Omroep Bandoeng," 527 w.
*8.000V—Tunis, Tunisia. "Radio Tunisie."
*8.000—FIA, Douala, Cameroons.
*8.000—ODE, Damascus, Syria.
8.000V—Sumatra. "R.R.I., Sumatra Salatan."
8.000V—Indonesia.
*8.007—YNMG, Jinotepe, Nicaragua. "La Voz de Jinotepe," 100 w.
8.009—YNS, Teustepe, Nicaragua. "La Voz de Teustepe."
6.020V—Beirut, Lebanon. "Radio Lebanon," 3 kw.
*8.025—LCL, Oslo, Norway. 5 kw.
*8.035—CNR, Rabat, Morocco. "Radio Maroc," 12 kw.
*8.040—WLXJ, Shanghai, China.
*8.050—Moscow.
*8.050—PSL, Rio de Janeiro, Brazil.
*8.070—Jaffa, Palestine.
8.088—YCN3, Pontianak, Dutch Borneo. "Radio Pontianak," 250 w.
8.100—Moscow.
*8.110—EFP, Teheran, Iran. "Radio Tehran," 14 kw.
*8.110—XRSA, Sichang, China.
8.125—JVP, Nazaki, 40 kw., 10 kw.
8.125—ZHV5, Freetown, Sierra Leone.
8.150—Gunchal, Madeira.
8.159V—Bissau, Portuguese Guinea. "Radio Bissau," 50 w.
*8.185—PSK, Rio de Janeiro, Brazil, 12 kw.
8.190—YNEW, Managua, Nicaragua.
8.192—YNXW, Managua, Nicaragua. "Radio America," 100 w.
*8.220—Scutari, Albania. "Radio Shkoder."
*8.280—Tokyo.
8.290—ZKG, Pitcairn Island.
8.300—CR???, Nova Lisboa (?), Angola. "Radio Angola."
8.322—HTX1, Managua, Nicaragua. "Radio Managua."
*8.326—Tananarive, Madagascar. "Radio Tananarive."
8.350—XUPB, Amoy, China. "Amoy Broadcasting Station," 400 w.
8.433—XGIO, Nanking, China.
*8.450—CRY8, Macao, Portuguese China.
*8.484—XPSA, Kweiyang, China.
*8.500—Brazzaville, French Equatorial Africa. 8.522—Khabarovsk, U.S.S.R.
*8.565—APN, Munich, Germany. 50 kw.
*8.565—HAT3, Budapest, Hungary. 5 kw.
8.635—ZKG3, Pitcairn Island.
8.640—GIC, Royal Observatory (Greenwich).
*8.660—XGNC, North China.
8.663V—COJK, Camaguey, Cuba. "La Voz de El Camagueyano," 1 kw.
*8.685—Pulau Tinggi, Sumatra. "Radio Repoebl-lik Indonesia."
8.700—COCO, Havana, Cuba. "Radio America," 5 kw.
8.743—Pematangsiantar, Sumatra.
8.760—Moscow.
8.800—IRBK, Pyonang, Korea.
*8.800—Alma-Ata (Kazakh S.S.R.), U.S.S.R.
*8.812—Menado, Celebes.
8.820—Khabarovsk, U.S.S.R.
8.825—COCOQ, Havana, Cuba. "Circuito CMQ," 5 kw.
*8.830—Moscow.
8.860—WXFG, Adak, Aleutians, U.S.A.
*8.890—XRAY, Peiping, China. U.S. Forces Station.
*8.890—Dakar, French West Africa.
8.921—Cheribon, Java. "Radio Repoebl-lik Indonesia."
8.928—Beekitt Tinggi, Sumatra. "Radio Repoebl-lik Indonesia."
8.930—KES2, Bolinas, Calif., U.S.A.
8.940—Moscow.
8.957—COGK, Santiago, Cuba. "Cadena Oriental de Radio," 1.2 kw.
*8.960—THA2, Algiers, Algeria. "Radio Algerie," 10 kw.
9.010—KEJ, San Francisco, Calif., U.S.A.
9.014—U.S.S.R.
9.026—COBZ, Havana, Cuba. "Radio Salas," 1 kw.
*9.041—XGOL, Foochow, China.
9.045—Moscow.
*9.060—TFK, Reykjavik, Iceland, 7 kw.
*9.060—Moscow.

9.080—Indonesia. "Radio Repoebl-lik Indonesia."
9.082V—CNR3, Rabat, Morocco. "Radio Maroc," 2.5 kw.
*9.100—Moscow.
*9.106—PC1, Willemstad, Curacao. 3 kw.
*9.110—HEF6, Berne, Switzerland. "Swiss Broadcasting Corp.," 25 kw.
9.110—ZRB, Waterkloof, District Pretoria, South Africa.
9.123—XOL2, Nanking, China.
*9.125—Balikpapan, Dutch Borneo. "Radio Balikpapan," 125 kw.
*9.125—HAT4, Budapest, Hungary. 5 kw.
*9.135—Moscow.
9.135—Ronne Antarctic Expedition.
9.147—YVR, Santa Rita, Venezuela, 20 kw.
9.166—CR6RE, Benguela, Angola. "Radio Clube de Benguela," 50 w.
*9.185—HEF4, Berne, Switzerland. "Swiss Broadcasting Corp.," 25 kw.
*9.190—HC2ET, Guayaquil, Ecuador. 300 w.
9.197—CE920, Puntarenas, Chile. "Radio Ejercito."
9.205—ZLN10, Wellington, New Zealand.
9.210—OQ2RC, Leopoldville, Belgian Congo. "Radio Consola."
9.213—HT2G, Ciudad Trujillo, Dominican Republic.
9.220—PR??, Rio de Janeiro, Brazil.
9.220—HI2G, Ciudad Trujillo, Dominican Republic. "Radio la Opinion," 200 w.
*9.220—Khartoum, Anglo-Egyptian Sudan. "Huna Omdurman."
*9.230—CR8AA, Macao, Portuguese China.
9.235—COBQ, Havana, Cuba. "La Voz de Cuba," 1 kw.
9.235—LOHE, Buenos Aires, Argentina.
*9.248—CR8AA, Macao, Portuguese China.
9.250—YSP, San Salvador, El Salvador. "Radio Vanguardia."
*9.250—YFA4, Makassar, Celebes.
9.252—Bucharest, Rumania. "Radio Dacia Romana," 4 kw.
9.254—CR8AA, Macao, Portuguese China. "Macao Radio Club," 200 w.
9.265—YFA4, Makassar, Celebes. "Radio Makassar," 5 kw.
9.273—COCX, Havana, Cuba. "La Emisora del Pueblo," 1 kw.
*9.274—HT3G, Ciudad Trujillo, Dominican Republic. 200 w.
*9.295—JEW, Seoul, Korea.
*9.295—WVLC, Manila, Philippines.
*9.305—PY, Manila, Philippines.
*9.310—HC2AK, Guayaquil, Ecuador. 1 kw.
*9.310—VJZ, Rabaul, New Britain.
9.320—LRS, Buenos Aires, Argentina. "Radio Splendid," 5 kw.
9.330—Andorra, Andorra. "Radio Andorra," 50 w.
9.340—OAX4J, Lima, Peru. "Radio Colonial."
9.340V—Soerabaja, Java. "Radio Omroep Soerabaja."
*9.345—HBL, Geneva, Switzerland. 20 kw.
9.350V—Pavlovo, Bulgaria. "Radio Sofia," 1 kw.
*9.352—OTM, Leopoldville, Belgian Congo. "Radio Nationale Belge," 20 kw.
*9.355—HCBS, Quito, Ecuador. "Radio Bolivar La Voz de la Libertad," 250 w.
*9.358—Sofia, Bulgaria. "Radio Rodina."
*9.358—YFA4, Makassar, Celebes. "Radio Makassar," 6 kw.
*9.360—Maccio, Brazil.
9.360—Indonesia. "Suarra Indonesia Raja."
9.360—Cetinje, Yugoslavia. "Radio Cetinje."
9.362V—COBC, Havana Cuba. "Radio Progreso," 1 kw.
9.370V—Madrid, Spain. "Radio Nacional de Espana," 40 kw.
9.380—OTM?, Leopoldville, Belgian Congo. "Radio Congo Belge," 20 kw.
9.380—OAX4W, Lima, Peru. "Radio America."
500 w.
*9.400—Makassar, Celebes.
9.407—Indonesia.
9.410—GRI, London. 50-100 kw.
9.410—Pointe-a-Pitre, Guadeloupe. "Radio Guadeloupe."
*9.415—PLV, Bandoeng, Java.
9.418—Belgrade, Yugoslavia.
*9.420—Moscow.
9.430—CP21, Sucre, Bolivia. "Radio La Plata," 270 w.
9.430—YERQ, Mexico City, Mexico. "Radio Continental."
*9.433—Moscow.
*9.437—COCH, Havana, Cuba.
*9.437—Warsaw, Poland.
9.440—Brazzaville, French Equatorial Africa. "Poste Nationale Francaise," 50 kw. and 7 kw.
*9.442—SDT, Motala (Stockholm), Sweden. 12 kw.
*9.445—Tunis, Tunisia. "Radio Tunisie," 700 w.
9.446—XPPA, Kweiyang, China. "Kwoichow Broadcasting Station," 1 kw.
*9.452—XGOA, Nanking, China. 2 kw.
9.452—COCH, Havana, Cuba. "Radio O'Shea," 1 kw.
9.455—LRY1, Buenos Aires, Argentina. "Radio Belgrano," 10 kw.
9.460—CPI, Sucre, Bolivia. "Radio Chuquisaca," 400 w.
9.465—TAP, Ankara, Turkey. "Radio Ankara," 20 kw.
*9.465V—Hanoi, French Indo-China. "Radio France."
*9.470—CR6RA, Luanda, Angola. 250 w.
9.470—Batavia, Java.
*9.470—Victoria, Hong Kong.
9.475—CR6RN, Luanda, Angola. "Radio Clube de Angola," 1 kw.
(Continued next month)

New SUPREME 1948 and F.M. Manuals

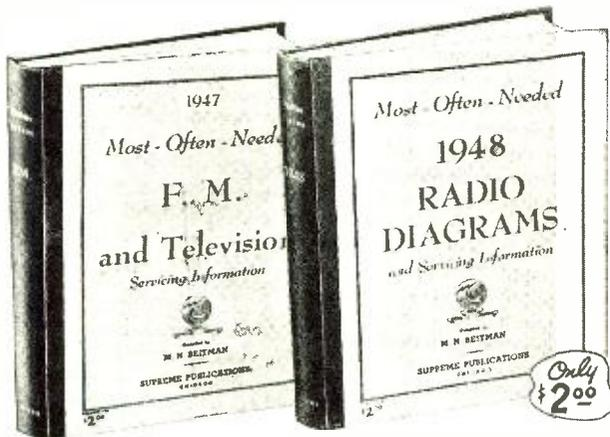

F.M. and Television

Use this giant-size manual of factory instructions for troubleshooting, repairing, and alignment of any recent F.M. and Television set. Covers every popular make, including F.M. tuners, AM-FM combinations, and all types of television receivers. Detail circuit diagrams, theory of operation, test hints, alignment data. This is the material you need to fix any modern F.M. or Television set. Don't turn this profitable work away for lack of knowledge and information. Use this newest Supreme manual to save time and money on your very next F.M. job. Data presented on 192 large-size pages, 8½ x 11 in. Sturdy, manual-style binding. Special price. **\$2.00**

New 1948 Manual

Be prepared to repair quickly all new 1948 receivers. In this big single volume you have clearly-printed, large schematics, needed alignment data, replacement parts lists, voltage values, and information on stage gain, location of trimmers, and dial stringing, for almost all recently released sets. A worthy companion to the 7 previous volumes used by over 120,000 shrewd radio servicemen. New manual covers models of 42 different manufacturers. Giant size: 8½ x 11 in. 192 pages + index.

Manual-style binding. **\$2.00**
Bargain price, only...

BIGGEST BARGAIN IN RADIO DIAGRAMS

Make these two new mammoth volumes your money-saving source for data on all recently released receivers. Learn about modern circuit developments, be ready to repair any new radio no matter how complex. You pay only \$2.00 for each of these large manuals. With these two volumes on your workbench there is nothing else to buy, nothing else to pay—a whole year of radio diagrams and service data yours for a couple of dollars total. Again Supreme Publications beats all competition and gives radio servicemen greatest bargains in service information. Read about other volumes for previous years described at the left and below. **No-risk** examination granted to servicemen.

FIND ALL RADIO FAULTS DOUBLE-QUICK

You can speed-up and simplify radio repairs with SUPREME PUBLICATIONS Manuals. Service radios faster, better, easier, save time and money, use these most-often-needed diagram manuals to get ahead, earn more per hour. For the remarkable bargain price (only \$2 for most volumes) you are assured of having in your shop and on the job, needed diagrams and other essential repair data on 4 out of 5 sets you will ever service. Every popular radio of all makes from old-timers to new 1948 sets, including F.M. and Television, is covered. Clearly printed circuits, parts lists, alignment data, and helpful service hints are the facts you need to improve your servicing ability. Save hours each day, every day, begin to earn more by making repairs in minutes instead of hours. Let these manuals furnish you with diagrams for 80% of all sets. There is no need to spend large sums for bulky, space-wasting manuals, or to buy additional drawings every few weeks; be wise, use SUPREME Manuals to get the most in diagrams and service data for the smallest cost.



SUPREME DIAGRAM MANUALS
1947 1946 1942 1941 1940 1939 1926-38
MOST-OFTEN-NEEDED RADIO DIAGRAMS
Each manual has between 192 and 208 pages of diagrams and service hints; large size, 8½ x 11". Price, each, **\$2.00**
DIAGRAMS
240 Pages
Price \$2.50

Post-War Automatic Record Changers

Service expertly a 11 new (1945-1947) record changers. Follow simplified factory instructions to make needed adjustments and repairs. Hundreds of photographs and exploded views; thousands of test hints; service instructions for all popular makes. Large size: 8½ x 11". 144 fact-filled pages. At your jobber or postpaid, only... **\$1.50**

Pre-War Record Players, Changers, & Recorders

Just what you need to repair quickly thousands of pre-war automatic record changers, manual units, pick-ups, wireless oscillators, recorders, and combinations. Hundreds of mechanical and electrical diagrams. Instructions for adjustments and repairs. Most popular units of all makes. 128 large pages, 8½ x 11 inches. Price, only... **\$1.50**

SATISFACTION GUARANTEED

Most Popular Models Made by:
R.C.A., Zenith, Philco, Sears, Fada, Emerson, Belmont, Detrola Radio, Majestic, United Motors, G.E., Westinghouse, Arvin, Stewart-Warner, Admiral, Delco, Stromberg-Carlson, Western Auto, Wards, Sparton, Motorola, Gamble, Crosley, and many others.

Select the Diagram Manuals and Record Changer Books you want to examine. See listing in left-hand column. Send the convenient no-risk trial coupon. Use the manuals in your own home or shop for 10 days at our risk. You must be completely satisfied, or return manuals and receive your money back. Write today—24-hour service.



Compiled by M. N. Beitman, radio engineer, teacher, author, & serviceman.

NO RISK TRIAL ORDER COUPON

SUPREME PUBLICATIONS, 9 S. Kedzie Ave., Chicago 12, ILL.

Ship the following manuals on trial under your guarantee of satisfaction or money-back.

- New F.M. and Television Manual @ \$2.00
- Post-War Record Changers..... @ 1.50
- Pre-War Record Players..... @ 1.50

I am enclosing \$....., send postpaid.

Send C.O.D. I am enclosing \$..... deposit.

- 1948
 - 1947
 - 1946
 - 1942
 - 1941
 - 1940
 - 1939
 - 1926-1938 @ \$2.50
- PRICED AT ONLY \$2.00 EACH**

Name:

Address:

SEND COUPON OR WRITE ORDER IN A LETTER

See Your Radio Jobber or Send Coupon →

Supreme Publications

PUBLISHERS OF RADIO BOOKS, MANUALS, AND DIAGRAMS

9 South Kedzie Ave.

Chicago 12, Illinois

February, 1948

103



ESSE Specials!

Do not fail to closely examine this list of bargains. We believe that every item listed below is a sensational value that soon can never be repeated. All equipment advertised herein is unconditionally guaranteed to the customer's satisfaction to this extent: Return any item advertised within five days after delivery for full refund except transportation charges (both ways).

Below are listed surplus radio and electronic supplies that are too numerous to picture. Every ham and operator is familiar with these items. See our previous ads for pictures and more complete descriptions.

WILLARD LEAD ACID CELLS

(Brand New)

- 2 V. (dry-chgd.).....\$1.00
 - 6 V. (dry-chgd.).....\$3.00
 - 6 V. in metal carrying case (dry-charged).....\$4.00
- (add electrolyte specific gravity 1.265 —drugstore.)

LANDING LIGHTS — AIRCRAFT

24 V. retractable, 600 watts...\$3.95

BC-348 COMMUNICATIONS REC.

The finest of all surplus receivers \$69.50
BC-348 110 V. Power supply
with complete instructions.....\$8.95

SCR-625 MINE DETECTOR

(Brand New.) The most sensitive mine detector on the surplus market. For miners, treasure hunters, plumbers, electricians, lumber mills, etc. ..\$79.50

AN/PRS-1 MINE DETECTOR

(Brand New.) A very dependable detector, Only.....\$14.95

TURBO AMPLIFIERS

Use for parts or small phono amplifier, shipped complete with the following tubes: 2—705's, 1—7Y4, 1—7F7. Our greatest bargain, (see July 1947 Radio Craft for conversion data) each.\$1.65

RECTIFIER RA-63-A

Battery charger or rectifier, or power supply units. 110 V. 60 cy. input; 12 V. 8 amp. output. Brand New....\$19.75

BC-375 GE MOPA XMTR.

The most famous of all surplus transmitters. Was used by the Army bombers and ground stations during the War. Frequency range is covered by means of plug-in tuning units as shown below. Each tuning unit has its own oscillator and power amplifier coils and condensers, and antenna tuning circuits—all designed to operate at top efficiency within its particular frequency range. Transmitter and accessories are finished in black crackle, and the milliammeter, voltmeter, and RF ammeter are mounted on the front panel. FREQUENCY RANGE: 200-500 Kc. and 1500-12,500 Kc. (Will operate on 10 and 20 meter band with slight modification). OSCILLATOR: self-excited, thermo-compensated, and hand calibrated. POWER AMPLIFIER: neutralized class "C" stage, using 211 tube, and equipped with antenna coupling circuit which matches practically any length antenna. MODULATOR: Class "B"—uses two 211 tubes. POWER SUPPLY: Dynamotor which furnishes 1000 V. at 350 Ma. Conversion instructions and diagram for 110 V. AC furnished upon request for \$1.00.

PRICES: As follows:

- Transmitter only.....\$19.50
- Tuning units TU-5B, TU-6B, TU-7B, TU-8B, TU-9B, TU-10B, TU-26B, choice....\$ 3.75
- Dynamotor PE-73C.....\$ 4.95
- Antenna tuning unit (BC-306A).....\$ 4.95

BC-357 MARKER BEACON RECEIVER

Ideal for controlling remote circuits and model aircraft, boats, etc. Operates about 75 Mc. Signal easily altered to 2-meter band. Tubes used and included: 12C8, and 12SQ7. Also sensitive relay. Circuit diagram inside case. Size, 5 $\frac{3}{8}$ x3 $\frac{3}{8}$ x5 $\frac{1}{4}$ ". For 24 V. DC operation.....\$2.95

RADIO ALTIMETER INDICATOR 1-152-AM

Includes 3DP1, 2X2, and 3 type 6AG5 tubes. Powered by 110 V. 400 cy.....\$8.75

T-39/APQ-9 RADAR TRANSMITTER

Contains many excellent parts for the VHF experimenter such as a cavity oscillator using 2—RCA 8012 tubes rated at full output to 500 Mc. Tubes are forced air-cooled by 24 V. DC motor, which is easily converted for 110 V. AC operation. Other valuable parts such as a pair of 807's, 2—6AC7's, 1—931, and 1—6AG7 tubes, ceramic switch, potentiometers, gears, revolution counter, etc.....\$12.50

APN-1 RADIO ALTIMETER

A complete 460 Mc. radio rec. and trans. which can be converted for ham or commercial use. Tubes used and included: 4—12SH7, 3—12SJ7, 2—6H6, 1—VR150, 2—955, 2—9004. Other components such as relays, 24 V. dynamotor, transformers, pots, condensers, etc. make this a buy on which you cannot go wrong. Complete in aluminum case 18x7x7 $\frac{1}{4}$ ". Price.....\$8.95

INTERPHONE AMPLIFIER

We've sold thousands of these. Every ham and experimenter could use several at our low price. Type AM-26/AIC with 28 V. DC dynamotor. Contains 2—12A6 and 2—12J7 tubes. Easily converted for phonograph or inter-communication amplifier. A steal.....\$1.75

BC-966-A IFF

Approximately 2-meter delete operation, 14 tubes, 350 V. DC dynamotor, 12 V DC input. Contains voltage regulators and many other fine parts. Worth much more than our price for parts.....\$4.75

DETROLA AIRCRAFT RECEIVER

If you want a good 28 V. DC operated 200-400 Kc. aircraft receiver—just don't pass up this bargain. A few left at.....each \$4.75

**ARB (CRV-46151) AIRCRAFT
RADIO RECEIVER**

6 tube, 4 band, superheterodyne rec. with built-in dynamotor. Designed for reception of MCW, (tone or voice) or CW within the frequency range 195 Kc. to 9.05 Mc. We bought a carload of these in order to sell them at this price.....\$19.50

BC-221 FREQUENCY METER

Covers 125-20,000 Kc. Battery or 110 V. AC, vibra-packed operated. A beautiful instrument.....\$49.95

T-17-B Carbon Microphones,
Handmade, Brand New.....\$1.00

HS-33 Headphones, 600 ohm.
(Used).....\$0.75

Headphone Ext. Cord.....\$0.50

Telegraph Keys, New.....\$0.45

PE-103 Dynamotor, New.....\$8.95

IF AMPLIFIER STRIP

19 Mc. containing 5 WE 7-17A tubes.....\$3.95

INTERVALOMETER

Electronic timing device. Was used for releasing bombs at intervals. Ideal for darkroom timer, model train controller. (Contains relays, switches, pilot light, resistors, knobs, etc.).....\$2.25

C-1 AUTOPILOT GYRO

Operates from 24 V. DC or 110 V. AC Adaptable to many interesting uses\$4.95

TELRAD 18-A FREQ. STANDARD

Checks signals in the range of 100 Kc. to 45 Mc. with a high degree of accuracy. Self-contained power supply for 110, 130, 150, 220, and 250 V. 25-60 cy. AC. Complete with tubes, dual crystal, and instruction book. One of the best buys on the surplus market today. Brand new.....\$24.95

BEAM ROTATING MOTORS

Look at other ads for more complete descriptions. Fellows, we've sold hundreds of these. Every ham shack cannot afford to be without one.

24-28 V. DC motor.....\$9.95

24-28 V. motor with beam mounting plates attached.....\$14.50

Transformer to operate beam motor on 110 V. (New).....\$4.95

Selsyn indicators for beam rotating motor (operates from 15-25 V. 60 cy. AC supply). Choice of 5" or 3" model, each.....\$2.85

BL Selenium Rectifier (New).....\$1.25

Radio Set SCR-510 (New).....\$49.75

R-89-ARN5 GLIDE PATH REC.

326-335 Mc. on any of 3 pre-determined crystal controlled frequencies. Contains 11 tubes, 6 relays, and other valuable parts. For 24 V. DC operation. Size, 13 3/4 x 5 1/4 x 6 3/8".....\$7.95

AIRCRAFT SUPPLIES

These instruments have all been tested for accuracy.

Sensitive Altimeters.....\$9.00

Gyro-horizons.....\$7.50

Magnetic Compasses.....\$6.00

MN-26 Radio Compass (Brand new).....\$69.50

SCR-269F Radio Compass (Brand new).....\$69.50

Astro Compass. These are beautiful instruments that should sell on the regular market for many, many times our price. They have various uses including those of the Yachtsman as well as the airman. If you desire, send for more complete descriptive literature....\$11.50

BC-733D LOCALIZER REC.

A part of aircraft blind landing equipment. Operates on any one of its 6 pre-determined crystal controlled frequencies in the range of 108-120 Mc. Contains 10 tubes—6 of which are W.E. 717-A's—and crystals. Ideal receiver for conversion to 144 Mc. ham band or mobile telephone bands and police and taxicabs. For 24 V. DC operation. Size, 14 1/2 x 7 x 4 5/8". Complete with dynamotor.....\$4.95
Throat Mikes, 7 for.....\$1.00

NAVY HOSPITAL TENTS

These large, brand new, fire-resistant fungus-proof, waterproof, heavy canvas tents are of the finest grade canvas with tie-down ropes, in canvas carrying bag. Wgt. 365 lbs. Size, 16' width, 50' long, 12' apex, 4' sidewall. We have but 20 of these left and must sell them immediately. Can be used to house automobiles, machinery, side-shows, or various purposes. Our sacrifice price.....\$185.00

LIFE RAFTS—Off-Season Sale

Large size rubber floats, ideal for fishing and boating. Sold in an "as is" condition—some need minor repairs and inflation valve inserted. Ea. \$12.50

C-1 AUTO PILOT AMPLIFIER

Were used to control operation of Servo-units, causing them to move the control surface of airplane in one direction or the other in response to signals received. The complete amplifier includes one rect. 7Y4, 3—7F7's for amplification and control, 3—7N7's for signal discrimination, 1 power transformer, 6 relays, 4 control pots, chokes, condensers, etc. Convert for use on radio controlled models, doors, etc. Operates from 24 V. DC. Size 9 1/4 x 6 1/4 x 7 5/8". Complete.....\$3.95

**SCR-274N COMMAND SET
COMPONENTS (ARC-5)**

Modulator with dynamotor....\$5.75
Rec. 190-550 Kc.....\$5.75
Trans. 4-5.3 Mc.....\$5.75
Trans. 3-4 Mc.....\$5.75
Trans. 5.3-7 Mc.....\$5.75

COLLINS ANI/ART-13 XMTR.

A compact, light-weight, modern, high-powered transmitter. Frequency range 2-18-1 Mc. on any of its 11 auto-tune crystal controlled or master oscillator channels. Dec. 1947 "Radio News" gives conversion data for converting 24 V. DC operation to 110 V. AC. These are in exceptionally fine condition, tested in our labs. Weight, 67 lbs. (Dynamotor included).....\$134.50

ESSE Radio Co Unless Otherwise Stated, All of This Equipment Is Sold As Used
CASH REQUIRED WITH ALL ORDERS
40-42 W. SOUTH STREET INDIANAPOLIS 4, IND. Orders Shipped F.O.B. Collect

More
MONEY
in your
POCKET

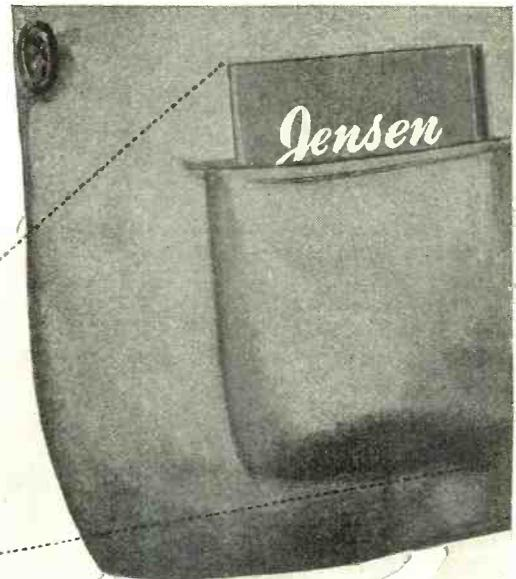

when you carry the handy Jensen Saleskit.

Radio Servicemen who take the Jensen Phonograph Needle Saleskit on service calls say they would not be without it. This handy kit, shown above, helps demonstrate fine needles, sells on sight, adds \$\$\$s to your income.

Contains 3 Jensen Concert Needles retailing at \$1 each, and 3 Jensen Genuine Sapphire Needles

at \$2.50 each. Needles are beautifully packaged. Adds profit to every call. What's more, Jensen phonograph needles augment your work, assure full, clear tone of the instruments you repair, make all records sound better.

Generous discounts to servicemen boost your income. WRITE TODAY for complete details.

JENSEN INDUSTRIES, Inc., 331 SOUTH WOOD ST. • CHICAGO 12, ILL.

New Signal Generator
(Continued from page 51)

work. The second grid of the 6J6 may be switched to the audio oscillator, the crystal calibrator, or the FM oscillator, producing respectively, amplitude modulated r.f., r.f. and crystal mixed, and r.f. and FM mixed. A master output selector switch accomplishes the second mixer grid switching and also energizes the proper auxiliary circuits.

Fixed, pre-tuned grid and plate circuits are used with the 6AK6 frequency modulated, electron-coupled oscillator to provide the three center output frequencies of 1, 20, and 50 mc. A three position switch permits selection of the desired output frequency which is modulated by a 6AG5 reactance modulator. With the output selector switch (*S₂*) in the "R.F.+FM" position, the output of the audio oscillator is automatically shifted to the grid of the reactance modulator tube, the audio attenuator thus functioning as a frequency deviation control. One megacycle output is developed with the grid circuit of the FM oscillator tuned to one megacycle and the plate circuit coupled to an untuned resistive load. For 20 and 50 mc. output, the grid circuit of the oscillator is resonated at 10 mc. and the plate circuit selects either the second or fifth harmonic. Frequency doubling and quintupling in the plate circuit of the oscillator bears the obvious advantage of multiplying the grid circuit deviation by factors of two and five respectively and is a simple solution to the prob-

Fig. 4. Connections between signal generator and external v.t.v.m. to determine relative "Q" and/or resonant frequency of tuned circuits, i.e., coil and condenser combinations.

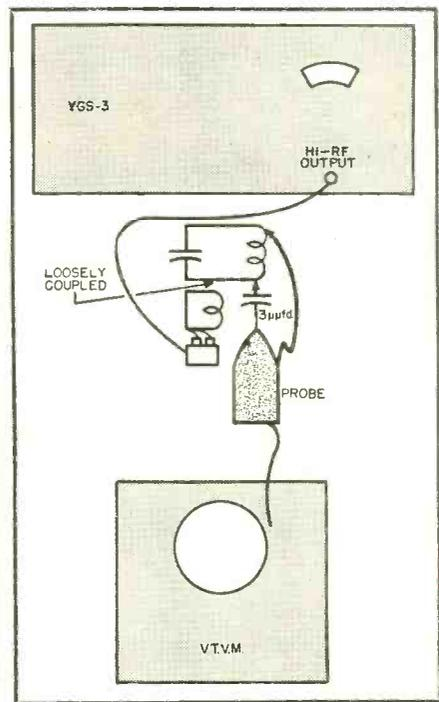

G-C Better Products for the Radio Industry

Tube Puller • Inspection Mirror
Wire Stripper • Static Chaser Injector & Powder

G-C "Speedex" WIRE STRIPPER

Strips insulation from wire sizes #8 to #30. Ideal tool for manufacturers, electricians, maintenance men, etc. Strips 750 to 1000 wires per hour.

No. 733—12 to 20 wire... List \$6.00



NEW G-C INSPECTION MIRROR

Handy, inexpensive... for radiomen, servicemen, electricians. Ideal for inspecting parts that are hard to see. Every serviceman is a prospect.

No. 5090... List 50c



NEW G-C STATIC CHASER INJECTOR AND POWDER

Tire static powder kit. Improve auto radio reception. Eliminates wheel static interference. New powder is blown into all inner tubes, easy to use. For every car owner.

No. 5604—Injector for G-C Static Powder... List \$1.50
 No. 5605—G-C Static Powder Packet for 5 tires... List 1.00
 No. 5606—Kit—Powder Packet and Injector... List 2.50



NEW TUBE PULLER

Makes it easy to remove or insert miniature tubes. Simple to use. Inserts or extracts tubes from hard-to-reach places, where fingers fail. Saves time and money. Ends tube breakage.

No. 5093—Miniature Puller. List \$1.50



Have you seen the new G-C "Speedex" Wire Strippers... write for illustrated literature.

RADIO DIVISION, DEPT. H

G-C Products are available at leading distributors. Write for your copy of our new illustrated catalog.

GENERAL CEMENT Mfg. Co., Rockford, Ill., U.S.A.
Manufacturers of over 3,000 products • Sales offices in principal cities

INDUSTRIAL & ELECTRONIC POWER SUPPLY EQUIPMENT

TRANSFORMERS

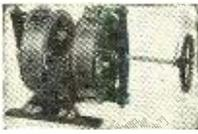

T-103—Voltage regulator Transstat, American Transformer Co. Spec. 29145, Max. KVA output 11.5, 50/60 cye. 0-115 V. 100 amps or 230 V. 50 amps. \$75.00
Net Wt. 134 lbs. Dim. 25" W x 16" D x 17 1/2" H (Encl. 8" shaft ext.)

T-101—Plate Transformer, Amertran Spec. 29108, Primary 115 V. 60 cye. 10.4 KVA. Secondary 17600 V. .520 amps. 35 KVA test. \$65.00
Net Wt. 500 lbs. Dim. 19" W x 15 1/2" D x 41" H. O. A.



T-102—Filament Transformer, American Transformer Co. Spec. 29106, Type WS .050 KVA, 50/60 cye. Single phase, 35 KVA test, 12 KV D.C. operating. Primary 115 V. secondary 5 V., 10 amps with integral standoff insulator and socket for No. 371, 872, etc. rectifier tubes. \$12.50
Net Wt. 15 1/2 lbs. Dim. 6 1/2" W x 6" D x 12" H. O. A.

T-104—Voltage Regulator Transstat, American Transformer Co. Spec. 29144, 115 V. 60 cye. Max. KVA .25 single phase, voltage range 103-126 volts; max. amps 2.17 (for filament voltage control) \$9.50
Net Wt. 15 lbs. Dim. 5" W x 11" D x 7 1/2" H. O. A.

CHOKE COIL

C-106—Amertran Disc. Type, Specification No. 29107, Line volts 15,000 V. D.C., Ripple frequency 120, 149 ohms resistance, .20 D.C. amps at 300 henrys 48% ripple, .52 amps D.C. at 25 henrys 48% ripple. \$42.00
Net Wt. 280 lbs. Dim. 17" W x 12" D x 31 1/2" H. O. A.

CAPACITORS

C-107—G.E. Capacitor Cat. No. 14F59 or Westinghouse Inerteen, 1.0 mfd. 25,000 V. D.C. \$36.00
Net Wt. 65 lbs. Dim. 14 1/2" W x 8 1/2" D x 15" H. O. A.
C-132—Aerovox, 10 mfd. 600 volt, D.C. Oil filled \$1.00

RELAY

RC-115—R.W. Cramer Co. Time Delay Relay Type TD2 120S, 1 min. interval, 115 V. 60 cye synchronous motor drive. Contact rating 10 amp. 115 V. single pole, normally open. \$4.95

METERS

M-144-5—R.W. Cramer Co. Running Time Meter—3". Type RT2H, 115 V. 60 cye. Flush mounting. \$5.95
Net Wt. 1 lb.

M-141—Weston Model 476—3", 0-130 V. A.C. volt meter, flush type, calibrated for steel panel mounting. \$4.95
Net Wt. 1 lb.

M-140AB—Weston Model 476—3" A.C. Ammeter. 3 amp. full scale, calibrated 0-120 amps, flush mounting, with 40/1 current trans. \$8.50
Net Wt. 3 lbs.

M-146—Weston Model 476—3". Filament voltage indicator, 0-130 V. movement with 115 V. mark. Flush mounting, calibrated for steel panel. \$3.95
Net Wt. 1 lb.

M-143AB—Weston Kilovoltmeter—3". Model 301, 20 KV. @ 1000 ohms per volt, flush type, calibrated for steel panel mounting, with 20 meg. 20 KV Weston resistor complete with clips and standoff insulators. \$18.00
Net Wt. 4 lbs.

M-142—Weston Model 301—3". D.C. Milliammeter. 0-800 Ma., flush type, calibrated for steel panel mounting. \$4.95

HEATERS

H-149—Chromolox strip heaters, 300 W.; 115 V. (1/2 x 1 1/2 x 12") \$1.00

MOTOR AND BLOWER

MB-156—Motor blower unit, Mfg. by Champion Blower Co. Cat. No. O-CE, direct connected, 4" inlet, 4" exhaust, 1/20 H.P., 115 V. 60 cye. 1750 R.P.M. Capacitor motor. \$21.50

POWER SUPPLY

(RA-38) 115 V., 60 cye. input, adjustable output 0-15,000 V. A.C. or D.C. @ 500 Mils. Shipping weight 1100 lbs. \$200.00



All merchandise in "as new" condition. Add approximately 20% to net weights for estimated shipping weights. Terms are 30% with order, balance C.O.D. All prices l.o.b. Los Angeles Warehouse.

Write for additional detailed information on any of the above items and for special quantity discounts.

1527 E. Seventh Street

EPCO

Los Angeles 21, California

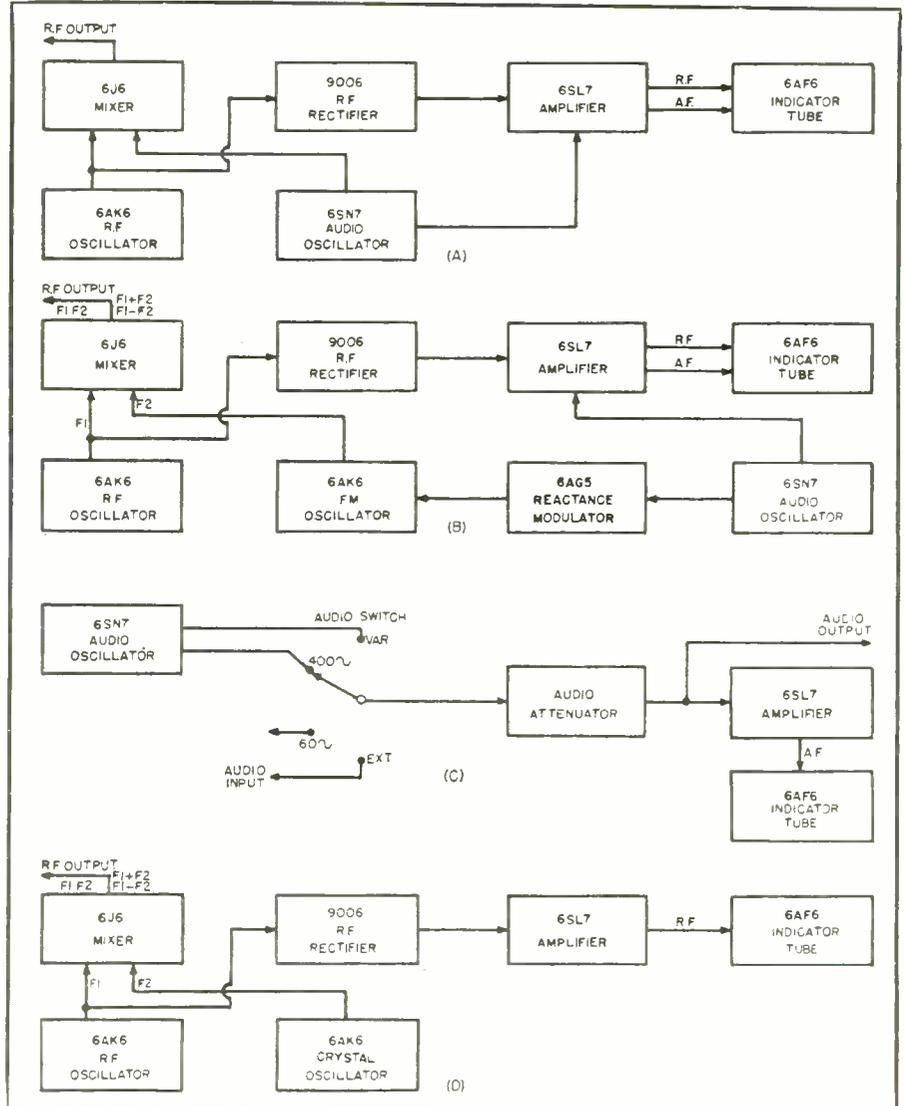
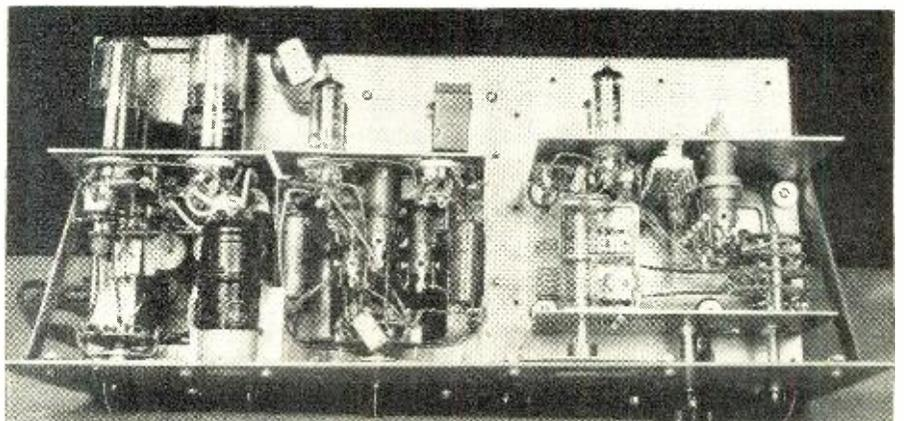

Fig. 5. Block diagrams show functional operation of the various segments that make up the signal generator. (A) Amplitude modulated output; (B) Frequency modulated output; (C) Audio system; (D) R.f. and crystal output.

lem of extending deviation on the higher frequencies. A second important advantage gained by this method of operation is the reduction of amplitude modulation which is usually brought about by attempting to obtain excessive frequency shift without re-

gard to linearity or amplitude modulation. By limiting the 10 mc. deviation to a relatively small swing, total amplitude modulation never exceeds 10% and deviation linearity is excellent. A high "Q" series-resonant trap ($C_{35} - L_{11}$) inserted in the plate cir-

Fig. 6. Top of chassis view with cover plates removed. Brackets left to right are: audio; crystal oscillator, FM oscillator and reactance modulator; and variable oscillator.



BUY from America's STOREHOUSE of QUALITY PARTS

IRC VOLUME CONTROLS



1000 ohm wire wound midsets — manufacturers close out — 1/4" shaft 3/8" long — list \$1.25 — over 90% off.

EACH
12c

IRC SEALED
Box of 252
24.95

OUTPUT TRANSFORMERS

Clean stocks — long leads — mounting feet — made to fit where you need them.

For 6F6-6K6 — to 4 ohm voice coil — size 2" x 1 3/8" x 1 3/8".
50L6-35L6-25L6 to 4 ohm voice coil 1 3/8" x 1 3/8" x 1 3/8".
Specify quantity of each type you need at...



49c

MULTI-USE WIRE

An old favorite — back again! Stranded No. 22 tinned wire — glass "ROCKBESTOS" 1000 volt insulation — fireproof aircraft wire — a wartime development — at this low price you can use the best.

100 feet... **45c** 1000 feet... **389**



MODEL 451A AC-DC Volt-Ohm — Meter

A dependable instrument of wide utility — sensitivity 1000 ohms per volt. Ranges: Volts AC, DC, and Output Ranges: 0-10/50/100/500/1000. Ohms full scale, 500,000. Ohms center scale, 7200.



1490

NET complete with batteries

MODEL 312 Volt-Ohm — Milliammeter

An economy pocket meter featuring a 2" moving vane meter. Reads: AC-DC volts, 0-25 50 125 250; Mills AC-DC, 0-50; Ohms, 100,000; mfd., .05-15. Jacks provide range selection.



675

NET Complete with cord and plug

JEWELLED PILOT LIGHT ASSEMBLIES

- Miniature bayonet socket
- Mount in 1" hole
- Lamps removable from front of panel
- Available in red, green, or amber — quantities limited — order now.

List Price \$1.30
At RSE's 85% off — you **19c** pay
Back again — by popular demand!



Pep-Up PHILCO CHANGERS

At last! All the parts you need to restore brilliant tone and volume to "sick" changers! You'll need all three items — sell your customer a 100% reconditioning job —
Selenium cell only, no holder **\$1.80**
Sapphire needle only, no mirror **\$1.20**
Special original equipment lamp **27c**
RECONDITIONING KIT — all three above items — postpaid — special at **321**

RADIO RULE

Here is a clear 6" plastic rule — a necessity for radio students, draftsmen, hams, all who desire cleaner, more precise work.

Nationally advertised at \$2.00.

Order yours today postpaid only **35c**

February, 1948

LOWEST PRICES

RADIO SUPPLY & ENGINEERING CO., Inc.

129 SELDEN AVE.

DETROIT 1, MICH.

SPRAGUE

.5 mfd — 300 Volt



That's right — genuine Sprague condensers — manufacturers close out — new fresh stock — size 3/4" x 2 1/2" — tinned leads — all guaranteed.

NET EACH **6c** 10 FOR **49c**

VOLUME CONTROLS



Our own private brand — made by a nationally known manufacturer — you have this same control on your shelf now — the same kind that net for \$1.09! Standard noise-free carbon construction — 3/8" bushing — 1/4" shaft, 2" long — complete with switch. Ideal all purpose replacement control — individually boxed in our colorful carton carrying the RSE quality seal of approval.

Full range of sizes — with attached switches!

10 M ohms **59c** each
15 M ohms
25 M ohms
50 M ohms
100 M ohms
250 M ohms
1 Meg. ohms **55.00** per 100 assorted
2 Meg. ohms

500 M ohms — less switch 39c ea. 100 for \$35.00

IRC 10 MEG. 1/2 WATT.



IRC type BTS 10 Meg. 1/2 Watt resistors — manufacturers close-out — clean stock — how can you pass them up at **1c** ea.

TRIPLETT PANEL METERS



Panel meters by Triplet! Top quality instruments — new — boxed — five popular types — priced right — your chance to get those meters you've always wanted.

Model 332 — 0-150 A.C. volts — 3" round flush mounting black brass case.

Model 231 — 0-150 A.C. volts — 2" round flush mounting bakelite case.

Model 233 — 0-150 A.C. volts — 2" round metal case — less mounting clamp.

Model 221 — 0-30 D.C. volts — 2" round flush mounting bakelite case.

Model 324 — 0-400 D.C. volts — 3" round projection mounting — bakelite case.

Model 331 — 0-30 A.C. amps. — 3" round flush mounting bakelite case.

Model 322 — 0-150 D.C. volts — 3" round flush mounting black brass case.

Supply limited — order now — list models you desire.

295
EACH

PHONO PICKUP CRYSTALS

Standard types — Set Manufacturers close-out — all Guaranteed



Shure P30 — Shure's newest and finest — osmium tipped permanent needle — 1.8 volts output — fits standard mounting holes. List Price \$7.50. You pay us **269**



SHURE P93 — W57A — pintype terminals — 3/4 oz. pressure, 1.6 volt output — 5000 cycle cutoff. List price \$5.55 — our Special... **198**



Astatic L75 — another new type — 1 1/4 oz. pressure — .75 volt output — 6000 cycle cutoff. List price \$5.55 — 64% off. **198**



ASTATIC L40 — The prewar favorite — used in millions of phonographs — solder terminals — 1 1/4 oz. pressure — .6 volt output — 4500 cycle cutoff. List price \$4.45 — your cost... **198**

RESISTANCE LINE CORDS



Standard 3 terminal 135 ohm AC-DC cords — sturdy construction, flexible — 5 1/2" long complete with plug — for sets having approximately 69-75.2 volts drop in the filaments. Regular list price 1.17

Only 33c

AEROVOX 8/8/8 — 450



Genuine Aerovox triple 8 mfd. — 450 volts — inverted screw mounting — insulated aluminum can 1 1/2" x 4" — 6" insulated leads — List price \$4.25 — one time only at **89c**

OZ4 TUBES



New, guaranteed, made by the only maker of OZ4's. Buy now! Hit that car radio business hard — \$2.20 List — 60% or more off — limited quantity.

Egg crate of 100 **79.00**

In colorful RSE box at 88c ea.

AEROVOX — SOLAR PAPER TUBULARS



Genuine name brand paper by-passes! New, fresh, full capacity standard merchandise — not surplus — all guaranteed! Check the list prices — our low nets — no need to figure the discount — buy 'em now, they've hit bottom!

Mfd.	Volts	List Price	Net Each	Per 100
.01	600	30c	10c	\$ 9.15
.02	600	30c	11c	\$ 9.95
.05	600	40c	14c	\$12.95
.1	600	45c	16c	\$14.95

Quantity Prices not assorted.

SEND FOR FREE CATALOG



DEMAND THIS SEAL OF QUALITY

ORDER INSTRUCTIONS

Include full remittance with orders of \$3.00 or less. Include 25% deposit with all C.O.D. orders of \$3.00 or more. All shipments sent express collect if postage is not included. Prices subject to change without notice. BE SURE TO INCLUDE SUFFICIENT POSTAGE. EXCESS WILL BE REFUNDED.

MAKE MONEY!

ASSEMBLING COIN RADIOS

Thousands of dollars have been made during the past year by wide awake radio amateurs who have installed coin radios in Hotels, Hospitals, Motels and Tourist Cabins. Great demand—No experience necessary.

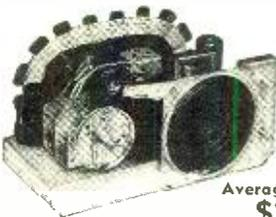
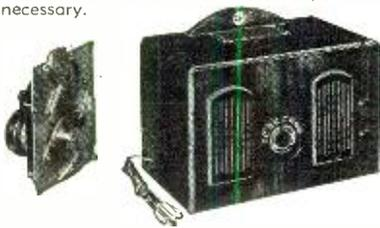

Just
3
Steps

Average Profit
\$25 Per Set

If Sold Outright

Much More If Operated on a Rental Basis!

We supply complete chassis with 6 tubes, quarter coin slot and one or two hour timer ready to place in walnut cabinet. Furnished with foolproof lock and coin box. Fill out order blank and mail to:

EICHEL ELECTRONIC CORP.
EVANSVILLE 8, INDIANA

FILL OUT... MAIL

EICHEL ELECTRONIC CORP.
EVANSVILLE 8, INDIANA

No.	PLEASE SHIP ME	Amt.
	Cabinets with lock @ \$6.75	
	6 Tube Chassis @ \$18.65	
	5 Tube Chassis (including plastic auxiliary case) @ \$16.50	
	Timers @ \$6.50	

I understand either of the above chassis with the timer and cabinet include all of the parts for your latest model coin operated radio.

Name

Street No.

City and State



GET HIGH SPEED WITHOUT NERVOUS TENSION

Amazing Book shows how "crack" operators rely on something besides practice to develop high speed and proficiency. You can learn code or improve your present efficiency in sending and receiving by the same system that has made code champions and radio telegraph experts. Send for 52-page book. It is free.

CANDLER SYSTEM CO.

P.O. Box 92B Dept. 2-B Denver, Colo.

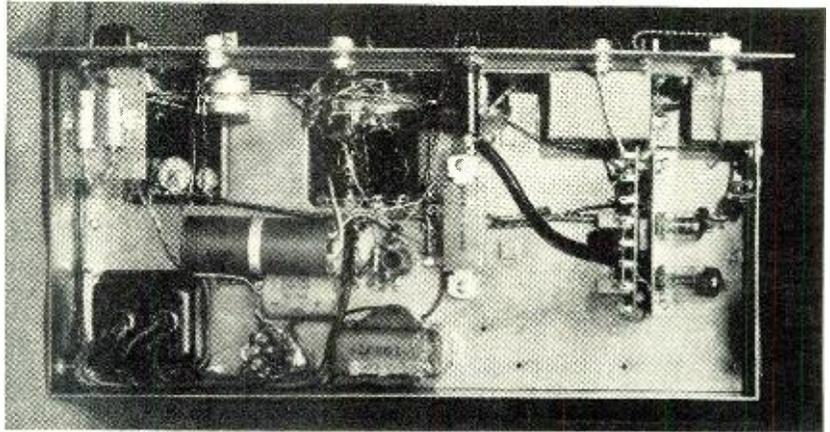

Fig. 7. Under chassis view. Bracket containing 9006 r.f. rectifier and 6J6 mixer tubes is shown to the right of chassis. Shield cover has been removed to show a.c. line bypass condensers (top left) which suppress r.f. leakage to power cord.

cuit of the FM oscillator effectively removes the 10 mc. component from the 20 and 50 mc. output signals.

A low temperature coefficient crystal with a fundamental frequency of one megacycle is employed in the 6AK6 crystal calibrator unit. The generation of a high order of harmonics is enhanced through the use of a fixed-tuned, high *L* to *C* screen circuit and an untuned resistive plate load. By placing the output selector switch in the "R.F. + XTAL" position, both crystal and variable frequency oscillators are energized, thus permitting rapid checks on the calibration of the variable frequency oscillator every 1000 kc. Amplitude modulation of the crystal oscillator is variable from zero to in excess of 100% and may be accomplished by either the internal audio oscillator or an external source.

The audio frequency generator consists of a 6SN7 dual triode functioning in a modified Wien bridge type oscillator. Excellent wave shape and linear output can be obtained from this type of oscillator, as evidenced by a total distortion figure of less than 5% and output linearity within ± 2 db. over the designed frequency range of 100 to 12,000 cycles. Rated audio output is approximately five volts across an optimum external load of 20,000 ohms. An audio switch (*S*₁) permits selection of four audio voltages: 1. 60 cycles; 2. 400 cycles fixed; 3. Variable (100 to 12,000 c.p.s.); and 4. External.

The standard 400 cycle frequency used in the majority of audio and modulated r.f. tests is included in the audio switch positions to facilitate rapid and accurate resetting to a standard reference frequency. Audio voltage is always available at the audio output jack regardless of the position of the master output selector. This feature is of importance in many visual alignment operations which require simultaneously a frequency modulated signal and an audio voltage of the same frequency as that used for modulation.

The output indicator circuits employ three tubes; a 9006, a 6SL7, and a 6AF6G, which function in the following manner: A small portion of the

r.f. voltage developed by the variable frequency r.f. oscillator is rectified by the 9006 high frequency diode. The rectified voltage is amplified by one section of the 6SL7 dual triode and then applied to one half of the 6AF6G dual indicator tube which is calibrated to reach zero shadow angle with an r.f. output of approximately 25,000 microvolts on the calibrated r.f. output jack. The second section of the 6SL7 rectifies sufficient a.f. voltage from the audio oscillator to actuate the second half of the indicator tube. The two sections of the 6AF6G are calibrated to indicate the following operating conditions: 1. 30% amplitude modulation; 2. Specified frequency deviation of the FM oscillator; 3. Audio output of 1 volt across an external load; and 4. An r.f. output of 25,000 microvolts on low jack (max. output is at least 1/4 volt on any frequency).

The r.f. output voltage is regulated by a five step decade resistance network and a constant impedance "L" pad which permits the cathode load of the 6J6 mixer to remain constant regardless of attenuator control settings. Output impedance at the termination of the r.f. cable varies between zero and fifty ohms depending upon attenuator settings. A 100 ohm resistor housed in a shielded compartment at the end of the r.f. cable (*R*₁₀) serves as part of the attenuator network and reduces cable resonance effects at high frequencies. Since losses in ordinary low capacity microphone cable increase rapidly at the higher frequencies, a polyethylene insulated coaxial cable is employed for the r.f. output lead. Two r.f. and one a.f. output jacks are located on the front panel together with an a.f. input jack for the insertion of external audio voltages.

For ease and speed of operation, all controls are calibrated directly on the front panel, thus obviating the necessity of reference to charts or tables. Especially useful are the audio attenuator calibrations in decibels (0 to -60) and the variable audio frequency calibration in kilocycles (.1 to 12).



**RADAR
AIRCRAFT**

INDICATOR BC 704 A
Indicator, Part of Radar Set SCR 521. Makes an excellent foundation unit for a high gain scope. Has following tubes: 4-6AC7, 3-6H6, and 1-5BP1 CR tube. Comes enclosed in metal shield. New, with all tubes, less power supply. With wooden carrying case. **\$17.50**

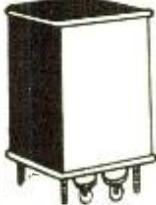

SPECIAL
Transformer to supply filaments of equipment using 12-volt tubes. Input: 117 V 60 Cy. Output: 26 V @ 2 A. **\$1.50**

POWER TRANSFORMER
Pri.: 117 v., 60 cycles. Sec. 330-0-330 v. @ 85 ma., 5 v. @ 2 amp., 6.3 v. @ 3 amp., 6.3 v. @ 7.5 amp. Size: 6x4 1/4 x3 1/8". Weight: 9 1/4 lbs. New. **\$1.95**

Power Pair—Transformer
470 V CT @ 60 ma.; 6.3 V windings @ 1.65 A and 5 V @ 2 A—Primary: 115 V 50 to 1200 Cy. PLUS a 6 Hy. 50 ma. choke. Both. **\$1.75**

**FILAMENT TRANSFORMERS
All Primaries 117V, 60 Cy.**

No. 5126: 5V @ 3 A CT, 5V @ 3 A CT, 5V @ 6 A CT **\$2.25**
No. 5100: 6.3 VCT @ 1.2 A, 5000 volt test. **1.35**
No. 5085: 6.3 V NCT @ .6 A, 6.3 V NCT @ 1.5 A. **1.40**
No. UX 6899: 5V @ 5.5 A, 5V @ 5.5 A 29,000 V test. **24.50**

CHOKES

6 Hy @ 150 Ma. **\$1.50**
6 Hy @ 300 Ma. **3.25**
1 Hy @ 800 Ma., 7.5 Ohms. **8.95**
Dual Choke 2-2 Hy @ 100 Ma. **.90**
Dual Choke 7 Hy @ 75 Ma., 11 Hy @ 60 Ma. **1.50**
8.5 Hy @ 125 Ma. **1.50**
25 Hy @ 65 Ma. **1.10**

POWER SUPPLY FOR SCR-522

Power Unit type 15. Input: 12 v.d.c. at 30 amps. Output 300 V. at 260 Ma., 150 V. at 10 Ma., 14 1/2 V. at 5 amps. Contains relay, filters, etc. Totally enclosed. Size: 13 1/2 x 8 1/2 x 5 1/4". New, complete in wooden carrying chest. **\$7.89**

MICROWAVE PLUMBING

10 CENTIMETER

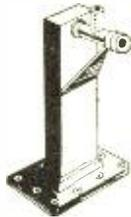

Sand Load (Dummy Antenna) wave guide section with cooling fins, app. 23" high. **\$28.00**
Rigid Coax Directional Coupler CU-30/UP 20 DB drop has short right angle, about 8". **5.50**

Waveguide to flexible coax coupler (RG 18/U), with flange. Gold plated. App. 10" high (as shown). **17.50**
Rigid coax slotted-section CU-60/AP. **5.00**

Stub-supported rigid coax, gold plated, 5' lengths. Per 5' length. **5.00**

10 Cm. McNally cavity. Silver Plated. Type SG Each. **3.00**
Crystal Mixer, "S" Band. Complete with Type "N" fitting and IN22 crystal. **3.85**
10 Cm waveguide. 5/9" choke to cover. Per section. **12.00**
Per set of 4 sections. **45.00**

3 CENTIMETER

Wave Guide Sections 2.5' long, silver plated with choke flange. **\$5.75**
Wave Guide 90 deg. bend E Plane 18" long. **4.00**
Wave Guide 90 deg. bend E plane with 20DB directional coupler. **4.75**
Wave Guide 18" long "S" curve. **2.00**
Rotary wave guide in/out choke to choke joint. **6.00**
3Cm wavemeter Maquire 1539TFX. **15.00**
3Cm stabilizer cavity, tunable transmission type. Model 1551 (TFX II GA). **20.00**
3 Cm waveguide. 1 1/8 x 3/8". 15 ft. lengths available. Per ft. **1.50**
Waveguide 2.5' long, silver plate, 180 deg. bend choke to cover. **5.95**
Duplexer Section using 1B24. **10.00**

CONNECTORS

UG 21/U, Type "N" Male. **.65**
UG 86/U, Gold Plated. **.85**

COAX CABLE

RG9U51 ohm Silver Coated. per ft. **5 .07 1/2**
RG8U 52 ohm. per ft. **.04 1/2**
COAX Connectors. Amphenol Loss type 831R, 831AP. ea. **.27**
831F. ea. **.45**

"Communications"

DON'T MISS THESE BUYS!
Cathode Ray Tubes
8BP1..... \$1.25 5BP4..... \$1.60
3FP7..... 1.20 5BP1..... 1.20
5FP7..... 1.75 5JP2..... 4.00
Rectifier Tubes
872A..... \$1.00 705A..... \$1.25

SPECIAL SPECIAL
1619 TUBES. Same characteristics as 6L6, but uses only 2.5 volts for filament. A steal at this price..... **5 for \$1.00**



DYNAMOTORS

PE 73 CM. Power supply for BC 375. Input: 28 VDC. Output: 1000 VDC @ 350 Ma. Starting relay, filter etc. New. **\$4.95**
BD 77KM. Power supply for BC 191. Input: 14 VDC. Output 1000 VDC @ 350 Ma. New, with spare fuse links, etc. **\$5.95**
PE 101C. Input: 13/26 VDC @ 12.6/6.3 A. Output: 400 VDC @ 135 Ma., 800 VDC @ 20 Ma. (9 VAC @ 20 Ma.) **\$3.49** (Mfrs. Write for quantity prices and discounts on above items.)
PE 86 Input: 28 VDC, Output: 250 VDC @ 60 Ma. Westinghouse. **1.60**
PC 77 Input: 12 VDC, Output 275 VDC @ 110 Ma. 500 VDC @ 50 Ma. **3.25**
DAG 33A: Input: 18 VDC @ 3.2 A, Output: 450 VDC @ 60 Ma. **2.45**
DM 33 A, Input: 28 VDC @ 7 A, Output: 540 VDC @ 250 Ma. Power supply for modulator for SCR 274 N. **3.95**
Dry Model 23350. Input 27 VDC @ 1.75 A. Output: 285 VDC @ 75 Ma. **1.75**
DM-21: In 14 VDC 3.3 A Out 235 VDC 90 Ma. with filter **2.59**

BC 1267 TRANSMITTER AND RECEIVER

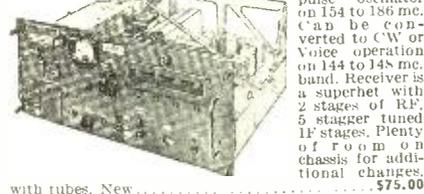

NEW 1 KW. pulse oscillator on 154 to 186 mc. Can be converted to CW or Voice operation on 144 to 148 mc. band. Receiver is a superhet with 2 stages of RF, 5 stagger tuned IF stages. Plenty of room on chassis for additional changes. **\$75.00** with tubes. New.

POWER SUPPLY RA 105 A

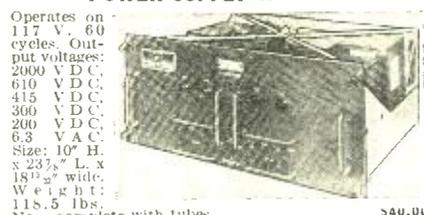

Operates on 117 V, 60 cycles. Output voltages: 2000 V D.C., 610 V D.C., 415 V D.C., 360 V D.C., 200 V D.C., 6.3 V A.C. Size: 10" H. x 23 1/2" L. x 18 1/2" wide. Weight: 118.5 lbs. New, complete with tubes. **\$40.00**

INDICATOR I-221. NEW. Remote antenna direction controller and indicator, using 2 sectym motors. 360 deg. rotation. Operates on 117 VAC, 60 cps. with tubes. New. **\$50.00**

Mounting rack (M179) for above 3 units with blower, APX size 4x2x2' Control unit BC 1073. Consists of pulse generator, and a wavemeter which measures frequencies from 150 to 210 mc. The pulse generator makes an excellent square-wave generator with variable pulse-widths. The wavemeter can be modified into a UHF oscillator. 117 VAC, 60 cps. operation **50.00**

ANTENNA, AN 128 A. NEW. 2 parallel vertical dipoles working against a square reflector. Impedance is 50 ohms. Broad band pass. Makes an ideal antenna, with high gain and directivity on 2 meters APX 5x4'. Complete Set RC 148 Xmtr and Recvr BC 1267 and power supply RA 105. Both units with tubes, used, in excellent condition. **40.00** **47.50**

COMPLETE TRANSMITTER AND RECEIVER RC 145

BC 1267 RA 105 A, Indicator I 221, may be operated as independent units, or the complete set of components combined to form a unit may be purchased at this special price—with mounting rack FM 79. **190.00** Govt. cost \$5000.

**AMATEUR
INDUSTRIAL**

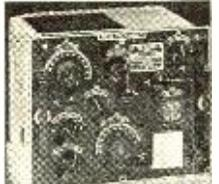

TUNING UNITS
From TCE and GP-7. Ideal basis for ECO rig. Ranges: B 800-1500 kc. C 1.5-3 mc. E 4.525-6.5 mc. F 6.2-9.05 mc. Units C or F, Each. **\$2.75**
Units B or E, Each. **2.00**

PULSE TRANSFORMERS

All Standard Name Items GE No. K2731
Repetition Rate: 635 PPS. Pri. Imp: 50 Ohms. Sec. Imp: 450 Ohms. Pulse Width: 1 Micro-sec. Pri. Input: 9.5 KV PK. Sec. Output: 28 KV PK. Peak Output: 800 KW. Binar: 2.75 Amp. **\$19.50**
Type G.E. K2450A will receive 13KV, 4 micro-second pulse on pri-secondary delivers 14-KV Peak power out 100KW GE. **15.00**
Hi Volt. Magnetron Input transformer W.E. No. D-166173 with cooling fins. **12.00**
UX 4298E Raytheon Pri. 4 KV, 1 microsecond sec. 16 KV, 16 amps. Fil. pri. 115v. 400 cycle. Raytheon **15.00**
Hi Volt input pulse Transformer W.E. No. D-169271 **9.95**
Pulse Input, line to Magnetron. G.E. K2748A. **12.00**
Utah Pulse or Blocking Oscillator Transformer Freq. limits 790-810 cy—3 windings turns ratio 1:1:1. Dimensions 1 1/2 x 1 1/2 x 1 1/2". **.75**

MICROWAVE ANTENNAS

Relay System Parabolic reflectors approx. range: 2000 to 6000 Mc. Dimensions: 4-15' x 3'. New. **\$85.00**
Dipole for above... **5.00**
TDY "Jam" Radar rotating antenna, 10cm, 30 deg. beam, 115V AC drive. New. **\$100.00**
50 Surface Search Radar rotating antenna, 10 cm. 24" dish, complete with drive and select motors. New. **75.00**
Used. **45.00**
3 CM ANTENNA WITH DISH, 14 1/4". Cutler Feed horizontal and vertical scan with 28V DC drive motor and drive mechanism. Complete. New. **65.00**
AS 125.APR Cone antenna, stub-supported, with type "N" connector. **4.50**
10 CM horn, rectangular-to-square-to circular RF assembly ending in horn, radiating circularly polarized beam. Wave-guide input, complete with flange. **35.00**
Parabolic Peel. Radiation pattern approx. 25 deg. in horizontal, 33 deg. in vertical planes. **20.00**

MICROWAVE TUBES (Magnetrons)

2J32 (10 CM.)	\$15.00	2J21	\$15.00
Magnet for 2J32	8.00	2J21A	15.00
2J38 with magnet	25.00	2J22	15.00
2J55 with magnet	25.00	2J26	15.00
3J31 (1 CM.)	17.50	2J27	15.00
Magnet for 3J31	8.00	2J31	15.00
W.E. 720BY (S band) 1000 KW.	25.00	W.E. 700A (L band)	45.00
Klystron, 2K25-723, AB.	35.00		

MICROWAVE TEST EQUIPMENT

Wave guide experimental kit. Consists of: One direct-reading wavemeter, app. 2600-3400 mc. (cavity type); One dummy load w/crystal probe. One line stretcher, full wave; two wave guide to RG 18/U coax couplers; two Y sections w/flanges. Complete. **\$250.00**
10 CM ECHO BOX, complete with micrometer adjust cavity and resonance indicator. Type TS 238/GP. With calibration chart. **105.00**
10 CM WAVEMETER, Model "SL". Micrometer adjust cavity with micro-ammeter resonance indicator. Includes 115 VAC operation converter section. In grey metal carrying case, complete with cables and spares. Made by Western Electric. **135.00**
W. E. 1138 A. Signal generator, 2700-2900 Mc. range. Lighthouse tube oscillator with attenuator and output meter, 115 VAC input, reg. power supply. With circuit diagram. **50.00**

SPECIALS

10 Cm. RF Package. Consists of: 80 Xmtr-receiver using 2J27 magnetron oscillator, 250 KW peak input, 707-B Receiver-mixer. **\$150.00**
Modulator-motor-alternator unit for above. **75.00**
Receiver rectifier power unit for above. **25.00**
Rotating antenna using dipole feed and parabolic reflector. New Less Hood. **75.00**
Used. **45.00**
RT39APG15 Transmitter-receiver. Lighthouse tube oscillator .5 KW. App. 2700 Mc. operation. With lighthouse and TR tubes. **100.00**

All merchandise guaranteed. Mail orders promptly filled. All prices, F.O.B. New York City. Send Money Order or Check. Shipping charges sent C.O.D.
COMMUNICATIONS EQUIPMENT CO.
131 N. Liberty St., New York City 7, N. Y. Digby 9-4124

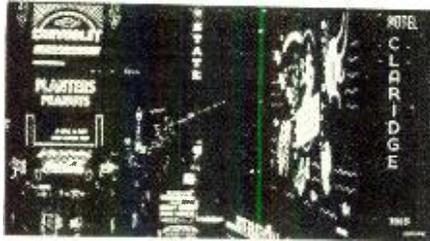

Night Scene on Broadway, New York City

We teach Neon Tube Bending, Color Gassing, Neon Glass Blowing, Cold Cathode Lighting, other important branches.

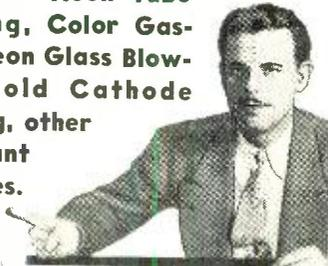

C. C. Blakely, Executive Director Acme Neon Institute, Chicago, Ill.

Today's wide open field for ambitious men who want to make good, steady money is the colorful, profitable, exciting business of Neon sign construction. I'll train you for a highly paid place in America's most fascinating industry. Learn Neon Tube Bending, Color Gassing, Neon Glass Blowing, Cold Cathode Lighting, Bombarding, other important branches of this great and growing art. Rush coupon for interesting folder, "Your Big Opportunity."

Coast-to-Coast Opportunities

We're getting calls for Acme Trained Men from coast-to-coast. Today beginners have a once-in-a-lifetime chance to master an art and learn a profession that will pay big dividends for life. Our practical, intensive 500 hour course prepares you for thousands of BIG MONEY opportunities in a fine job, or in business for yourself.



Train Under Experts

Acme Training in Neon is under the supervision of experts, masters of the trade, who teach you all the short cuts, tricks and latest methods. No experience needed. We assist out-of-town students in getting comfortable rooms at reasonable rates.

LEARN BY DOING. Photo shows instructor bending Neon Tube. Training covers Color Gassing, Cold Cathode Lighting, Bombarding, other important branches.

Acme Training Approved under the G.I. Bill of Rights.

ACME NEON INSTITUTE

1648 West Van Buren St. Chicago 12, Ill.

FREE FACTS

Acme Neon Institute
Dept. B-7, 1648 West Van Buren St.
Chicago 12, Illinois

Send at once the FREE FOLDER, "Your Big Opportunity," plus full facts on how you train me for a highly paid place in the field of Neon.

Name

Street

City State

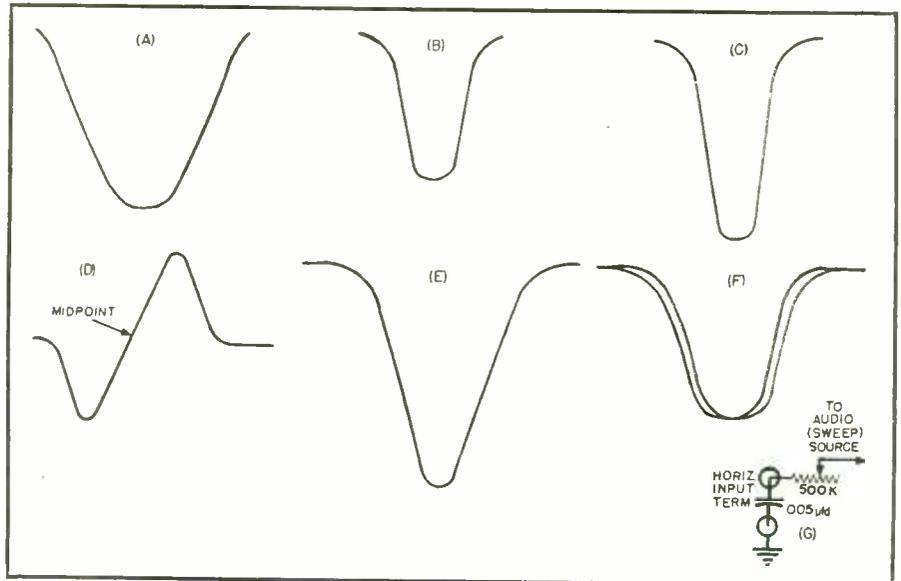
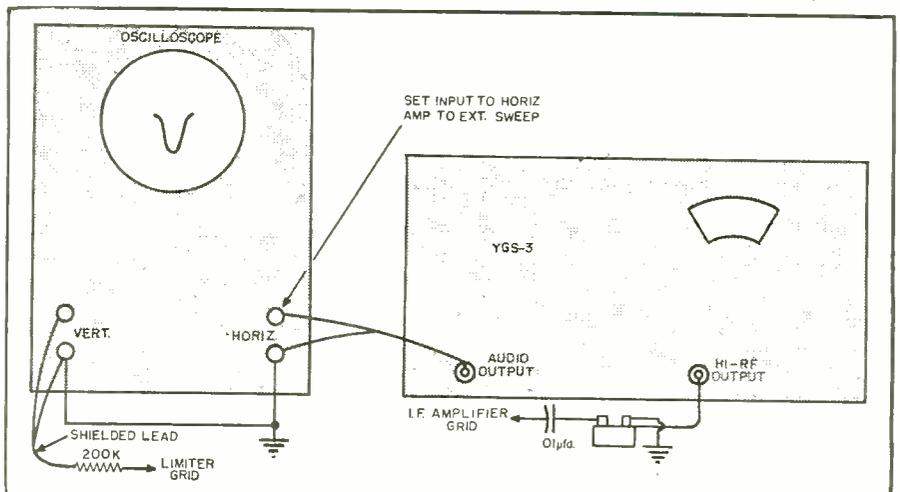

Fig. 8. Sketches of typical oscilloscope response curves obtained when signal generator is used for visual alignment. (A) For single FM i.f. stage on 10.7 mc., (B) for two i.f. FM stages on 10.7 mc., (C) for entire i.f. channel (FM, three stages) on 10.7 mc., (D) for proper alignment of discriminator and (E) for two stages of 455 kc. i.f. Phase shift in visual alignment manifests itself by a double trace (Curve F) on the oscilloscope screen. This condition can usually be corrected by the addition of a simple phase shifting network connected to the horizontal plates of the oscilloscope. Constants and connections are shown in (G). The potentiometer should be adjusted for a single trace. It is advisable to mount the network permanently on a small strip of textolite secured to the oscilloscope. If this is not done, direct hand contact with the potentiometer will result in excessive hum pickup.

Unusual operating flexibility and a wide utility in all alignment and test processes result from the incorporation of the design features described. Conventional alignment of AM receivers by the output meter and modulated signal method can be speeded up by initially advancing the generator audio control to produce an overmodulated r.f. signal capable of being "forced" through circuits greatly misaligned. After the circuits have been roughly peaked, the modulation should be reduced to the calibrated 30% level for exact adjustments. Maximum alignment speed and accuracy are achieved by visual alignment methods wherein the actual response curves of the circuits under test are traced directly on the screen of an oscilloscope. This is accomplished by employing a

frequency modulated test signal which is swept back and forth across the center frequency of the circuits to be aligned. This unit, by virtue of its low amplitude modulation and continuously variable frequency deviation, is ideally suited to all forms of visual alignment operation. The maximum deviation of ± 750 kc. permits observation of the entire response curve of a single, broad-band i.f. stage or discriminator; while the calibrated deviation feature enables the operator to quickly determine the approximate bandwidth of circuits under alignment. Typical signal generator and oscilloscope connections are shown in Figs. 8 and 9, which also illustrate the usual response curves obtained from various stages of properly aligned i.f. channels.

Fig. 9. Connections between external oscilloscope, signal generator, and external receiver for visual alignment of FM i.f. channels.



Go to WESTERN for Values...

INTRODUCTORY OFFER BC-645, NEW, COMPLETE. \$795

This is the UHF transmitter written up in Feb. '47 QST. 15 tubes, including WE doorknob. Easily modified to ham band 420-430 mc. citizens radio, etc. A real parts fest: silver-plated lecher lines, relays, etc. Furnished with schematic of original and complete conversion data, including new schematic, for fixed or mobile voice communications. AC power supply or dynamotor connections. Neat, compact, light weight: 10 1/2 x 13 1/2 x 4 3/4", net wt. 25 lbs.

DYNAMOTOR UNIT PE-101-C

Made for BC-645 described above, useful for any other mobile job. Choose 12 or 24v dc in, get outputs of 800v at 20 ma plus 400v at 135 ma plus 9v at 1.1 amp. Also brand new. Special at only. \$2.75

SIG. GEN. I-222-A

Crystal calib. Self-contained 115v, 60 cy power supply. BRAND NEW, with 6 tubes and Xtal. Schematic and instructions furnished. Combination signal generator and heterodyne type wavemeter. Calibrated 8-15 mc and 150-230 mc. Turret-selected osc. fundamentals are 8-15 and 45-77 mc. As 4th harmonics are easily used, gives almost complete coverage 8-308 mc. The 5 mc Xtal-controlled calibrating oscillator gives harmonics of 5 mc all the way up. Vernier scale above dial. Coarse and fine output attenuators adjust up to 100,000 microvolts. A steal at only. \$44.95

GASOLINE ENGINE GENERATOR

Brand new and complete. With instruction book. Output 32v DC at 550 watts. 2350 rpm, runs 5 hours at full load with one filling of any standard commercial grade gasoline. Shunt-wound, totally enclosed 4-pole generator conforms to latest AIEE standards. Armature mounted directly on crankshaft. Compact and light weight. A RARE BUY AT ONLY. \$49.50

GIBSON GIRL SCR-578

New, complete sea-rescue automatic SOS transmitter. With kite, balloon, tech. manual, parachute, etc., only. \$25.00



SEL SYN INDICATORS

Use with beam rotators. Operate from 15-24v, 60 cy.

1-82, 5" NAVIGATOR'S MODEL. \$2.95

1-81, 3" PILOT'S MODEL. \$2.45



FM Tank and Artillery mobile receiver and transmitter, complete with 24v dynamotor. Frequency range 20-27 mc. Transmitter power output is 30 watts. Complete with all tubes. Crystal controlled. APPROXIMATELY 80 CRYSTALS FURNISHED. EACH IN ITS HOLDER. READY TO USE! Any of ten channels may be selected by push-button tuning. Condition: Used, excellent. PRICE FOR BOTH UNITS IS LESS THAN FOR CRYSTALS ALONE! BOTH. ONLY. \$29.95

Bendix Manual DF

MN-26-C radio-compass receiver, includes broadcast band, range 150-1500 kc. Very late model. With schematic. BRAND NEW, complete with 12 tubes. \$19.45

Loop MN-20 for above. \$6.95

Loop Control Box MN-52 for above. \$1.95

Control Box MN-28 for receiver MN-26. \$3.95



AN/ARC-4

Receiver-transmitter, range 140-144 mc. crystal controlled 4-channel. Input 12v. Complete with 20 tubes, 4 crystals, and dynamotor. Condition good used. A real buy at only. \$17.86

RADAR TRANSMITTERS

Amplitude-modulated radar transmitters. A gold mine of parts! Brand new, with tubes and manuals. \$9.95

T-26/APT-2, 450-710 mc. \$9.95

T-27/APT-3, 83-135 mc. 10.95

BROADCAST-BAND RECEIVER

Navy ADF Receiver DZ-1, made by RCA. Continuous 15 to 1750 kc in 6 bands, gear-train tuning with vernier and coarse scales, broad or sharp band-pass, CW or MCW. All controls on front panel. No headaches of mechanical or electrical control interconnections. Beautifully built with 5-gang tuning capacitor, shielded tubes and coil. 8 tubes: 3-6D6, 2-76, 2-6C6, 1-41. Complete with tubes, less power supply. In excellent condition. Special introductory price only. \$14.95

TUBE SPECIALS

3AP1 95c 450TH \$9.95
5BP7 95c 7BP7 1.19
12A6 10 for \$2.90

Transmitter T-85/APT-5



Amplitude modulated radar unit, brand new in original carton with instruction manual. Output 10-30 watts, 300-1500 mc. Complete with 1-931, 2-6AC7, 2-6AG7, 1-6L6, 2-829B, 1-3C22 (lighthouse). Resonant cavity and tuned lines. Buy it for parts and for fun experimenting. \$11.95

ARC-5 VHF TRANSMITTER

T-23/ARC-5, brand new, 100-156 mc. As ahead of the older SCR type VHF gear as the auto is ahead of the horse and buggy! 4 Xtal-controlled channels selected by 3 motor-driven turrets. Motor can be spun by hand for manual switching. Tubes: 2-1625, 2-832A with xtals. \$12.95 Less tubes. \$8.95
With tubes. \$4.95
PUSH-PULL MODULATOR MD-7/ARC-5 for above, new, with dynamotor DY-8/ARC-5 and 2-1625, 1-VR-150, 1-12J5. \$4.95
With schematic, only.

APN-9 LORAN

R-65/APN-9 Loran Receiver, Indicator, and 115v, 400 cy power supply complete in one chassis. BRAND NEW, with 35 tubes including 6SK7's, 2X2, etc. 3BPI scope with magnifying lens in front. Only 35 lbs. Convert to test scope or salvage for scope, television, etc. Furnished with schematic. Less outer case. \$24.95

SCR-274-N COMMAND SETS

With Schematics—Tubes—Crystals

RECEIVERS

BC-453—190-550 kc. Used, \$4.95 New, \$6.95
BC-454—3-6 mc. Used, 3.95 New, 4.95

TRANSMITTERS

BC-457—4-5.3 mc. New, \$4.35
BC-458—5.3-7 mc. New, 4.35
Modulator RC-456 New, 2.95
Dynamotor DM-32-A New, 95c

R-89/ARN-5

Glide path receiver. Crystal control of local oscillator. 332-335 mc. complete with relays, 7-6AJ5, 1-12SH7, 2-12SN7, 1-28D7, and 3 crystals: 6497 kc, 6522 kc, 6457 kc. 90-cycle band-pass and 150-cycle band pass filters, excellent for making an intermodulation checker. Beautiful cabinet and chassis as foundation for many interesting experimental and construction projects. Broad pass band on 20.7 mc IF's ideal for television. SCHEMATIC FURNISHED! Condition: Used, excellent. Only. \$6.45

BC-733-D

Localizer receiver of the blind landing system. Companion to the glide path receiver. Also contains 90 and 150 cycle band-pass filters. Has the best AVC system yet developed; can use parts or use as a model for construction. 10 tubes, crystals, relays, etc. Schematic included. \$6.35
Don't pass this up! At only. \$6.35

ADF LOOP LP-21

Brand new. Low impedance loop antenna complete with Selsyn transmitter, motor and compensator. Designed for 100-1750 kc. Excellent value at. \$6.95

SEND FOR YOUR COPY OF OUR FREE CATALOG

WESTERN RADIO CO., Inc. • 3633 South Racine Avenue
Chicago 9, Illinois

NESSCO ELECTRONICS Presents

BC-733D
A 10-tube superhet receiver for lateral blind landing guidance (CAA type certificate) (TC-1045)
108-110MC **\$6.45**

ANTENNA RELAY UNIT BC-442
0-10 Weston Meter and 50MMF 5000 V. vacuum condensers change over unit, with mounting FT-229.
Ea. ONLY **\$1.95**

HANDSET—TS-13
Cradle type with butterfly switch, cord and plugs, individually boxed.
NOW **\$2.25**



SCR-269F RADIO COMPASS
A complete auto. direction finder with all components less inverter; 17-tube superhet
200-1750KC **\$34.95**

TU-10B
Tuning unit for BC-375
... a terrific parts value with a metal case..... ONLY **\$2.10**

BC-306
Antenna loading unit for BC-375. Another parts value..... **\$1.50**

RSARN/7
15-tube superhet radio compass receiver 100 to 1750KC; CW-tone-voice.
AT ONLY **\$32.50**

SHOCK MOUNTS
4 each of 3 sizes — small medium and large. **99c**
ALL FOR ONLY **99c**

CD-605
A six-foot cord with a PL-55 plug; with low to high impedance x former for your headset..... **39c**

KNOBS
For BC-312 and 342 receivers. Set of 4 with screws..... **29c**

PLUGS and Connectors
Your choice for ONLY **49¢**

For the SCR-522..... PLQ-167
For the BC-733..... PL-172
For your 269-F Radio Compass Inverter..... PLQ-254
For the SCR-274 N..... PL-152
PL-154A
PL-258
..... 49c each

YOUR CHOICE OF ANY OF THE ABOVE FOR ONLY 20% deposit required on all C.O.D. orders

division of
NATIONAL EQUIPMENT & SUPPLY CO., INC.
1500 S. Western Avenue Chicago 8, Ill. MONroe 9504

Columbia WIRE

February Specials!

Intercom and P/A Wire

22 ga. twisted pair stranded wire color coded with tinned copper shield and weather proof waxed cotton braid overall. Highest grade.
250 foot coil **\$ 9.75**
1000 foot spool..... **37.50**
Same as above, but 20 ga. conductors.
250 foot coil **\$10.95**
1000 foot spool..... **40.50**
As above, but 18 ga. conductors.
250 foot coil **\$11.75**
1000 foot spool..... **43.00**

300 OHM Twin Transmission Line

For FM and television antennas. 20 ga. conductors in polyethylene jacket.
500 foot spool..... **\$11.25**
1000 foot spool..... **21.50**

22 Ga. Shielded Wire

We are closing out a large stock of shielded wire that is not in continuous lengths. All wire is new and in perfect condition. Sold in 100 foot coils only.
Per 100 feet..... **\$1.25**

We carry in stock for immediate delivery many types of wire and cable in gauges of from 23 to 2, in addition to various types of multi-conductor cable for many uses. We also manufacture cord sets and cables to specifications. Send us your inquiries for prompt attention. See your local jobber or write direct.
OUR NEW CATALOG IS NOW AVAILABLE FOR DISTRIBUTION

Write for Your Copy Today

COLUMBIA WIRE & SUPPLY CO.
5734 ELSTON AVE.
CHICAGO 30, ILLINOIS

For added sales
(and profits!)



demonstrate

the amazing Shockproof

nylon needle*

by

DUOTONE

Actually b-o-u-n-c-e the whole tone arm on a record without effect. A spring steel shaft and nylon elbow—that is the secret! **\$2.50 LIST**

*pat. pending



The low impedance r.f. output of the Model YGS-3 makes possible measurements which ordinarily cannot be performed with high impedance output signal sources. For example, the relative "Q" (figure of merit) of inductances with resonant frequencies within the frequency range of the signal generator can be determined in conjunction with a vacuum tube voltmeter. Connections are shown in Fig. 4. The v.t.v.m. readings will vary with the "Q" of the coil and r.f. output of the signal generator, high "Q" coils exhibiting sharp meter peaks as the unit is tuned through resonance. The parallel resonant frequency of a coil and condenser combination can be found in the same manner, v.t.v.m. peaking indicating resonance.

The calibrated audio attenuator control can be used advantageously to determine the db. gain per stage of an audio amplifier. This is done by connecting a suitable output meter to the output of the amplifier under test and introducing the audio signal into the grid of the last stage of the amplifier. The audio attenuator is adjusted for a predetermined output level. The audio signal is then shifted to the grid of the preceding stage and the audio attenuator setting reduced until the same output level is obtained. The difference between the two attenuator readings is equal to the gain in db. of the second stage. This procedure may be carried out for each preceding stage to determine the over-all gain up to the grid of the final amplifier. For most accurate results the grid circuit of each stage should present the same impedance to the audio oscillator, although small variations in grid circuit impedances can be tolerated if only an approximate check is required.

Functions of the audio attenuator control and the a.f. section of the indicator tube remain unchanged with the audio switch set to select an external audio voltage. Thus, an audio voltage of unknown amplitude (exceeding 1 volt) can be inserted in the audio "in" jack, be reduced by means of the audio attenuator control to the calibrated level of one volt, and then be re-employed at the audio "out" jack. In the same manner, an external audio voltage can be fed into the audio "in" jack to amplitude or frequency modulate the internal r.f. or FM oscillators, the indicator tube indicating 30% amplitude modulation or specified frequency deviation, dependent on settings of the audio attenuator control.

Since an external audio signal can be used to frequency modulate the FM oscillator, it is possible to connect the output of a crystal phonograph pickup to the audio "in" jack to produce a musically modulated r.f. signal which can be received directly on FM receivers tuned to the proper frequency. This feature is of value to radio service dealers who are faced with the problem of demonstrating FM receivers in localities not yet served by FM transmitters.

NOW BUILD 15 RADIOS

COMPLETE KIT \$14.75



**ABSOLUTELY NO KNOWLEDGE OF RADIO NECESSARY
YOU NEED NO ADDITIONAL PARTS**

THE PROGRESSIVE RADIO KIT is the ONLY COMPLETE KIT. Operates on 110-120 volts AC/DC. Contains everything you need. Instruction Book, Metal Chassis, Tubes, Condensers, Resistors and all other necessary radio parts. The 36-page Instruction Book written by expert radio instructors and engineers teaches you to build radios in a professional manner. The first circuit built is a simple one-tube detector receiver. Each succeeding circuit incorporates new arrangements of detectors, RF and AF amplifiers. This kit is excellent for learning the principles of receiver, transmitter and amplifier design. It is used in many radio schools and colleges. All of

the commonly used detectors are used, including diode, gridleak, plate and infinite-impedance. The transmitters are designed with Hartley and Armstrong oscillators, using screen-grid and control-grid modulation. Both vacuum tube and selenium rectification are employed in these circuits. The circuits are designed to provide excellent performance. Altogether, fifteen circuits are constructed, including 11 receivers, 1 audio amplifier, and 3 transmitters. The sets start with simple circuits of 1 tube plus rectifier, gradually grow more complex, and finish with several examples of radio sets using three tubes plus rectifier.

SPECIAL FREE OFFER

Electrical and Radio Tester sent absolutely FREE with each Progressive Radio Kit. PLUS FREE membership in Progressive Radio Club. Entitles you to free expert advice and consultation service with licensed radio technicians. Write for further information or ORDER your KIT NOW!

PROGRESSIVE RADIO KIT
1 Kit \$14.75
2 Kits 28.15
3 Kits 41.50

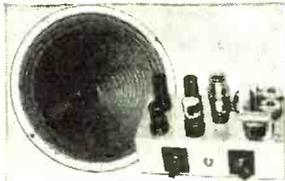

PROGRESSIVE AMPLIFIER KIT Only \$15.75

HIGH FIDELITY, HUMLESS AMPLIFIER • SEVEN TUBE PERFORMANCE

Amplifier can be readily modified to match the GE reluctance pick-up. Separate mike and phono input. Regulated power supply maintains constant voltage supply. DC heater supply, whether amplifier is used on AC or DC, provides humless operation by eliminating cathode-heater leakage hum. Contains degenerative feedback for improved frequency response, balanced phase inversion and push-pull beam power output. Every stage thoroughly decoupled to improve low-frequency response and to prevent moto-boating. Tone and volume controls completely variable. Seven-tube performance. Uses 2 selenium rectifiers, 2-beam power amplifiers,

1 high-mu pentode mike amplifier, 1 twin-triode phase inverter, and 1 voltage regulator tube.

PROGRESSIVE UNIT PRICES ON AMPLIFIER KIT (LESS TUBES)

1 Kit \$15.75
2 Kits 29.92
3 Kits 42.51

PROGRESSIVE UNIT PRICES ON TUBES for Amplifier Kit

(1-12SL7, 1-12SJ7, 1-VR75, 2-12A6's)
1 set \$3.00
2 sets 5.70
3 sets 8.10

This newest Progressive Kit will enable you to build a newly designed, high fidelity, humless amplifier. Beautiful aluminum custom-punched chassis, etched tone and volume control plates. Designed by former Western Electric engineer. Ideal amplifier for television kit or set, FM tuner, AM tuner, microphone, phonograph, wire and instantaneous recorders. Electrify your musical instruments by connecting them to the Progressive Amplifier by means of a contact mike.

RADIO PARTS SCOOP!

NO SURPLUS—ALL PARTS GUARANTEED BRAND NEW!

PHONES—Single Head Set

1000 ohms DC, Reg. Price \$1.65
Buy 1 for \$1.10 and save .55
Buy 2 for 1.90 and save 1.40
Buy 3 for 2.55 and save 2.40

CONDENSER KIT

50 Paper Tubular Condensers, Values from .002 mfd. to .1 mfd., 400 v. DC to 600 v. DC.
Regular Price \$5.00

Buy 1 Kit for \$1.95 and save \$3.05
Buy 2 Kits for 3.80 and save 6.20
Buy 3 Kits for 5.55 and save 9.45

RESISTOR KIT

100 Carbon Resistors, 1/2 watt, RMA color-coded, values from 120 ohms to 2.2 megohms.
Regular Price \$5.00

Buy 1 Kit for \$1.50 and save \$ 3.50
Buy 2 Kits for 2.80 and save 7.20
Buy 3 Kits for 3.90 and save 11.10

SELENIUM RECTIFIERS

Regular Price \$1.10
Buy 1 for \$0.79 and save \$0.31
Buy 2 for 1.54 and save .66
Buy 3 for 2.25 and save 1.05

12" ALNICO SLUG SPEAKER

Regular Price \$8.00
Buy 1 for \$ 5.60 and save \$2.40
Buy 2 for 10.80 and save 5.20
Buy 3 for 15.95 and save 8.05

6" ALNICO SLUG SPEAKER

Regular Price \$2.35
Buy 1 for \$1.69 and save \$0.66
Buy 2 for 3.18 and save 1.52
Buy 3 for 4.65 and save 2.40

ANTENNA AND RF COIL SET

(Broadcast Band)

Regular Price \$1.00
Buy 1 set for \$0.59 and save \$0.41
Buy 2 sets for 1.10 and save .90
Buy 3 sets for 1.50 and save 1.50

VARIABLE CONDENSER

(420-420 mfd.)
Regular Price \$1.80
Buy 1 for \$1.45 and save \$0.35
Buy 2 for 2.60 and save 1.00
Buy 3 for 3.60 and save 1.80

MIDGET SOLDERING IRON

35 watts 110/120 volts UL approved.
Regular Price \$1.00

Buy 1 for \$0.69 and save \$0.31
Buy 2 for 1.30 and save .70
Buy 3 for 1.80 and save 1.20

55 WATT SOLDERING IRON

Famous Make—UL approved.
Regular Price \$2.50
Buy 1 for \$1.90 and save \$0.60
Buy 2 for 3.60 and save 1.40
Buy 3 for 5.10 and save 2.40

75 WATT SOLDERING IRON

Famous Make—UL approved.
Regular Price \$3.00
Buy 1 for \$2.40 and save \$0.60
Buy 2 for 4.60 and save 1.40
Buy 3 for 6.60 and save 2.40

LONG NOSE PLIERS AND CUTTERS

Exceptional quality, Hydrazed for extra toughness. Diamond-tested cutters.
Regular Price \$1.95
Buy 1 for \$1.45 and save \$0.50
Buy 2 for 2.70 and save 1.20
Buy 3 for 3.60 and save 2.25

PROGRESSIVE RADIO TOOL KIT

A Progressive Electronics Special. Contains 75 watt 110/120 volt soldering iron, long nose pliers and cutters, screwdriver, insulated alignment tool.
Regular Price \$5.45

Buy 1 Kit for \$3.25 and save \$2.20
Buy 2 Kits for 6.10 and save 4.80
Buy 3 Kits for 8.70 and save 7.65

20-20 MFD. 150 W.V. DC

Electrolytic Condensers

Regular Price 75c.
Buy 1 for \$0.30 and save \$0.45
Buy 5 for 1.40 and save 2.35
Buy 10 for 2.60 and save 4.90

40-40 MFD. 150 W.V. DC

Electrolytic Condensers

Regular Price \$1.05
Buy 1 for \$0.45 and save \$0.60
Buy 5 for 2.10 and save 3.15
Buy 10 for 4.00 and save 6.50

10-10 MFD. 450 W.V. DC

ELECTROLYTIC CONDENSERS

Regular Price \$1.25
Buy 1 for \$0.65 and save \$0.60
Buy 2 for 1.24 and save 1.28
Buy 3 for 1.74 and save 2.01

1/2 MEG POT. WITH SWITCH

1/2" shaft.
Regular Price \$1.00
Buy 1 for \$0.35 and save \$0.65
Buy 2 for .66 and save 1.34
Buy 3 for .90 and save 2.10

25,000 OHM WIRE-WOUND POT.

1/4" shaft.
Regular Price \$1.00
Buy 1 for \$0.35 and save \$0.65
Buy 2 for .66 and save 1.34
Buy 3 for .90 and save 2.10

6 TUBE SUPERHET CHASSIS

Regular Price 79c.
Buy 1 for \$0.49 and save \$0.30
Buy 2 for .90 and save .68
Buy 3 for 1.20 and save 1.17

100 3-LUG TIE STRIPS

Regular Price \$3.60
Buy 100 for \$2.60 and save \$1.00
Buy 200 for 5.00 and save 2.20
Buy 300 for 7.20 and save 3.60

10 OCTAL BAKELITE SOCKETS

Regular Price \$1.20
Buy 10 for \$1.00 and save \$0.20
Buy 20 for 1.80 and save .60
Buy 30 for 2.40 and save 1.20

4 TUBE TRF

MIDGET RECEIVER

Regular Price \$12.75
7 1/2" x 8 1/2" x 4 1/4". Weighs only 2 3/4 lbs. Beautiful suede finish cabinet (assorted colors). Uses miniature tubes: 12BA6, 12AT6, 50B5, 35W4, 4" Alnico V Speaker.
Buy 1 for \$11.75 and save \$1.00
Buy 2 for 23.00 and save 2.50
Buy 3 for 33.75 and save 4.50

PROGRESSIVE ELECTRONICS CO. Dept. RN-6
497 UNION AVENUE • BROOKLYN 11, NEW YORK

TWO GREAT **OLSON** MONEY-SAVERS

OHM CHEST

with 100 Insulated Resistors

This handsome Chest has 20 compartments, 10 in the base and 10 in a removable tray. Walnut finish; brass hinges and fastener. Contains 100 resistors stamped with resistance values, 5 ohms to 20 megohms, 1/2 watt to 2 watts, color coded. Every size is popular!



\$4.95
COMPLETE

Send for our FREE MONTHLY BARGAIN BULLETIN



Free with each Ohm Chest ordered, you get our "Resist-O-Guide" free. Revolving wheels in color show all resistance values.

MAIL THIS COUPON RIGHT AWAY!

CAP CHEST

with 27 "Akrad" Condensers

A terrific buy! We want you to try the amazing new Olson "Akrad" Condensers, so we pack 27 "Akrads" (a \$31.45 List Value) in a beautiful walnut-finish wood chest with hinged lid and 6 compartments—and send you the whole works for only \$9.95. Wow! Order now!

QUAN.	CAP.	VOLTAGE	LIST	TOTAL
2	10	25	\$0.75	\$1.50
2	25	25	.85	1.70
5	20	150	.95	4.75
5	40	150	1.10	5.50
4	20-20	150	1.30	5.20
5	8	450	.95	4.75
4	16	450	1.35	5.40
Walnut Finished Chest			2.65	2.65
			TOTAL	\$31.45

\$9.95
COMPLETE

GUARANTEE

Use 5 Olson "Akrads." If for any reason you are not satisfied, you can return the rest with Cap Chest and get back the \$9.95 and postage.

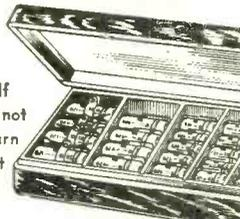

OLSON
RADIO WAREHOUSE Inc.
73 E. MILL ST.
Dept. 115
AKRON, OHIO

- Send me _____ Ohm Chests with 100 Insulated Resistors in each, at \$4.95.
- Send me _____ Cap Chests with 27 "Akrad" Condensers in each at \$9.95.
- I enclose \$_____ Send my order C.O.D. Olson pays the postage. I will pay the postage.

NAME _____ (Please Print)
ADDRESS _____ (Please Print)
CITY _____ STATE _____

DELCO BLOWERS

Dual turbo-2 part outlet with 200 cu ft/min cap 115 v 60 cyc cont duty 2750 rpm induct. motor. Sealed dust proof and quiet. Excel for cooling pp tubes, xmtng cabinets, projection and dark rooms etc. Dim. 10 3/4" L x 6" H x 6 1/4" D. Ship wt. approx 20 lbs. **BRAND NEW! \$14.90**
YOUR COST

STEPPER RELAYS

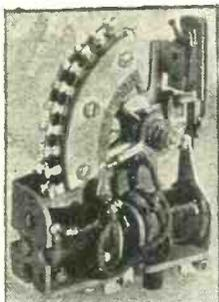

- *2 poles 10 pos
- *24-28 vdc op.
- *Normally open "holding" contact in "off" position.
- *Individ boxed, new and guaranteed.

Precision relay mg'd for telephone switching use. Stepping coil res. 160, release coil 220 ohms. Bobbins removable for rewinding to other ohm-ages if desired. Excellent for automatic-electric-mechanical designs, remote control, games, etc. . . . YOUR COST, ea. **\$7.95**

A. A. F. APS-13 RADAR 415 MEG XMITTER—RECEIVER

Designed for 415 MC operation. Will hit ham band with simple retuning. Receiver is red hot superhet with 30 MC IF. Xmtr uses pp 6J6 G'teed to operate. Supplied with 28 vdc dymtr and 17 tubes. Wt. only 16 lbs unpacked. Uses 9-6AG5, 5-6J6, 2-2D21, 1-VR105. Tubes listed at three times the low complete price of **\$11.90**

ALL MERCHANDISE FULLY GUARANTEED 20% WITH ORDER—BALANCE C. O. D.

We will ship collect only.

ATLANTIC INDUSTRIAL CO.
8672-B 80th ST., WOODHAVEN 21, N. Y.

TELEVISION CONVERSION



Television Set For 15" Cathode Ray Tubes

\$485.00

Build in two hours your own 15" or 20" Television Set from a new RCA latest Model 7" Television Receiver.

We supply you with Cabinet, new RCA 13 Channel Television Set complete with tubes, 15" or 20" Picture Tube, Focusing Coil, Focus Control and diagram of changes. Same, but with 20" Tube and Larger **\$675.00** Cabinet. . . .

TRANSMISSION KITS

7", 10" and 12" TRANSMISSION Television and F.M. KITS . . . STANDARD and DeLuxe LC Models. Ask for DEALERS prices.

- * RCA TELEVISION RECEIVERS
- * LATEST TELEVISION COMPONENTS
- * TELEVISION I-F AND VIDEO COIL KITS

Send 50 cents for catalog including diagrams for Belmont, G.E., Dumont, Andrea and Viewtone Television Receivers and Transmission Kits.

World's First Specialized House in Television
TELETRONICS SERVICE & SUPPLY CORP.
264 West 40th Street New York 18, N.Y.
Phone PENnsylvania 6-8730

What's New in Radio

(Continued from page 82)

quency range is possible with this antenna. For 85 mc. operation the dipole is extended to 65 inches, while at 148 mc. its over-all length is reduced to 37 inches. Parasitic elements for the



construction of beam antennas will be made available through jobbers.

For additional information write Communications Equipment Division, Heintz and Kaufman, Ltd., 50 Drumm Street, San Francisco, California.

2 1/2" SPEAKER

A new series of PM speakers designed for use in small radio receivers and call systems has been introduced by Perfection Electric Company of Chicago.

Known as the 25 series, these 2 1/2" speaker units are available in three types; the 25A with a magnet weight of .68 ounces, voice coil impedance of 3.2, normal wattage 1.50 with a peak

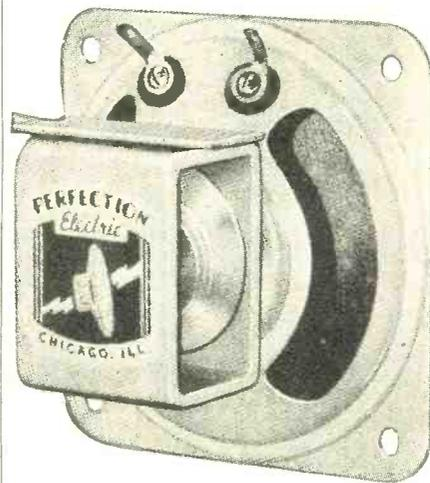

of 2.5; the 25B has a magnet weighing 1 ounce, a voice coil impedance of 3.2 and a wattage of 2 and 3, normal and peak respectively; while the 25C has a magnet weight of 1.47 ounces, a voice coil impedance of 3.2 and the same wattage ratings as the 25B.

Diaphragm resonances as low as 175 cycles are available.

Additional details on the 25 series, as well as other speakers in the company's line, may be secured by writing Perfection Electric Company, 829 South State Street, Chicago 5, Illinois.

REPLACEMENT UNIT

Radio Corporation of America is now producing a new phonograph motor and turntable which is suitable for either installation or replacement applications.

The new unit features an instant

RADIO NEWS

Now

YOU CAN HAVE IMPROVED NO-DRIFT FM
in the Sensational New 1948

MIDWEST RADIOS

NEW SERIES 16*
SUPER DELUXE AM-FM CHASSIS

14 1/2" PANASONIC SPEAKER

Here is the finest radio Midwest has ever produced in its 28 years of manufacturing—a world-ranging, 5-band radio with improved Midwest No-Drift FM . . . plus Standard Broadcast and 3 short wave bands, Television Audio Switch-over, and Color-Ray Tone Selection. The Series 16* Super De Luxe Chassis is a powerful, magnificently-toned radio that challenges comparison for performance, sensitivity, selectivity, and advanced engineering features. Supplied with satin stripe copper finish panel—ready to mount in your present cabinet. Send today for the FREE 1948 Midwest Radio Catalog. Buy your radio direct from the manufacturer on Easy Terms and 30 Days Trial and SAVE!



5 WAVE BANDS

SERIES 16 CHASSIS USES ALL THESE LATEST-TYPE TUBES

30 DAYS TRIAL **LOW FACTORY-TO-YOU PRICES** **EASY TERMS**

A COMPLETE LINE OF FINE RADIOS AND RADIO-PHONOGRAPHS . . . Available in Separate Chassis Like the Powerful Series 16* AM-FM Model above, or in beautiful Radio-Phonograph Consoles like this:

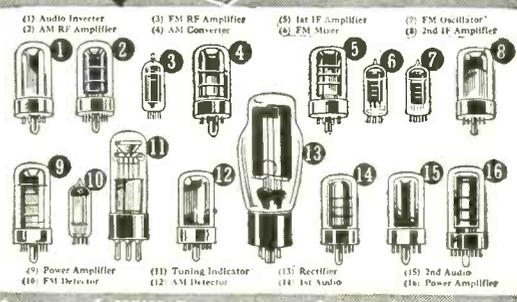

Scores of NEW Features such as the Exclusive **MIDWEST TRI-MAGNADYNE COIL SYSTEM** and **COLOR-RAY TONE SELECTION**



SYMPHONY GRAND AM-FM RADIO-PHONOGRAPH CONSOLE with NEW Intermix AUTOMATIC RECORD CHANGER

Our Finest! A superbly beautiful musical instrument . . . a masterpiece of furniture design and radio engineering that offers the sensational Midwest NO-DRIFT FM, Automatic Intermix Record-Changer, Exclusive Color-Ray Tone Selection, World-ranging 5-Band Reception, Television Audio Switch-Over, and many more new and exclusive features.

Rush for Free Catalog!
 FILL IN COUPON AND MAIL TODAY OR JUST SEND YOUR NAME AND ADDRESS ON 1c POSTCARD

MIDWEST RADIO CORP.
 Dept. 37-S, 909 Broadway
 Cincinnati 2, Ohio

Gentlemen: Please send me your new FREE catalog and details of your liberal 30 Days Trial.

Name.....
 Address.....
 City..... Zone..... State.....

MIDWEST RADIO CORP.
 Dept. 37-S • 909 BROADWAY • CINCINNATI 2, OHIO

PEAK SUPER SPECIALS

SPECIALS OF THE MONTH

FILTER CHOKE—8 henry 160 mils—140 ohm D.C. resistance \$1.39 ea.—2 for \$2.50
R.C.A. POWER TRANSFORMER—Pri. 110 v. 60 cy. Sec. 770 v. CT 100 MA 6.3 v. @ 2.5 A. 5 v. @ 2 A. Fully Shielded 4 1/2 x 4 3/8. Yours for \$2.75

FOR GRIDS 'N' PLATES

This Westinghouse 3-inch panel meter (0-2 ma scale), complete with shunts for 20 ma and 200 ma. **\$475**
 A Peak Special at.....



400 ma or 500 ma shunts for above. Each.....\$0.35
 Multiplier to make above 0-2000 v. DC.....\$1.95

G.E. 2" SCOPE

This compact unit only 4 1/2 x 2 1/2 x 6 1/4" ideal for modulation indicator, etc. has focus intensity and reticle brilliance controls—Uses 2AP1, CRT and 9006 rectifier. We supply complete instructions with each scope. Rectifier built in—need only transformer delivering 350-400 v. 6.3, 1 amp for operation. Very simple changes. Comes with 9006 but less 2AP1. **\$495** only.
 2AP1.....\$2.49



APN4, 5" SCOPE INDICATOR (25 tubes)

Makes an ideal basis for 5" scope. Also can be converted into Panadaptor with marker pips at 100KC-20KC-2KC. Has electronic switch for observing 2 frequencies simultaneously. Unit contains an accurate 100KC crystal. Tube complement: (1) 5CP1 (3) 6SL7 (14) 6SN7 (6) 6H6 (1) 6SJ7. Come with tubes and 100KC crystal. **\$2495**
 Marvelous buy at.....

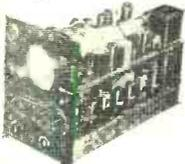

A SWELL BC 348 "S" METER

This G.E. tiny but accurate meter is only 1 1/2" sq. Basic 0-1 ma. Swell for "S" or field strength meter, etc. **\$395**
 Only.....



S.C. TEST SET (1-114)

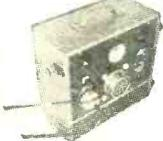

In portable wood case 6" x 6" x 10", including cover not shown, with Weston 0-150 v. AC. Meter has 2 switching ckts and comes complete with test and line cables. A Buy at only **\$395**
 Same with other make meter.....\$3.25

METERS (STANDARD BRAND)

2" 150-0-150 microamp.	3" 0-20 ma DC..... 3.95
Model 506..... \$3.49	3" 0-15 ma DC..... 3.95
3" 0-50 amps AC..... 4.95	
3" 0-2 ma DC..... 3.95	3" 0-150 v. AC..... 3.95

PEAK METER VALUES

2" GE 0-5 MA..... \$1.95	2" McClintoch 0-50 micro-amp..... \$7.50
2" GE 0-1.2 MA..... 2.49	
2" GE 0-1 amp R.F..... 3.49	3" W.E. 500-0-500 micro-amp..... 3.49
	4" GE 1-0-1 ma DC..... 3.95

ELECTROLYTIC CONDENSER BARGAINS (FAMOUS MAKES)

25 mfd 25 v.w. tubular... \$0.25	16 mfd 450 v.w. can... \$.69
50 mfd 50 v.w. tubular... .29	20x20 mfd 450 v.w. can. 1.05
4 mfd 150 v.w. tubular... .18	80 mfd 200 v.w. can... .69
8 mfd 450 v.w. tubular... .37	200 mfd 200 v.w. can... .98
12 mfd 450 v.w. tubular... .44	1000 mfd 25 v.w. can... .95
500 mfd 15 v.w. tubular... .49	Deduct 10% if you order a total of 10 or more.
10 mfd 450 v.w. can... .49	

2 KW Antenna Changeover relay DPDT isolantite insulation—110-220 v. 60 cy. input—rigid construction. Suitable for Broadcast Sta. **\$795**
 Only.....

A BIG 10 BITS

Lotsa Good parts kicking around our jern. (Quantities too small for advertising). Dunno exactly what we'll scrape up to put into your bag, but if ya send an extra \$2.50 with your order, we promise ya won't be sorry.

If not rated, 25% with order, balance C.O.D.—Discount 10% on any item ordered in lots of 10.

PEAK ELECTRONICS CO.
 188 WASHINGTON ST., DEPT. MR
 NEW YORK 7, N. Y.

starting, constant speed, two-pole motor which is fan-cooled. The nine-inch turntable, finished in brown flock, is rim-driven for quiet operation at 78 r.p.m. by the motor which operates on a 117 volt, 60-cycle power line.

Special oil-less bearing construction is featured for a permanent, rigid alignment of the turntable shaft. The entire assembly weighs less than four pounds while the motor size is 3 1/8 x 2 inches. Only 2 1/2 inch clearance below the mounting plate is required.

A new catalogue sheet illustrating and describing this unit is available

serviceman or counterman can use to write orders, make notations, or keep records. The unit is vest pocket size.

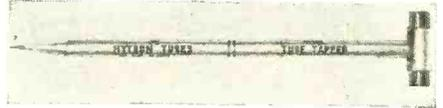

Hytron is merchandising these tube tappers to servicemen and dealers through their local jobbers or distributors.

BATTERY ELIMINATOR

A new direct current power supply unit designed to meet the needs of servicemen who handle automobile radio repairs has been introduced by the Rectifier Division, The Schauer Machine Co.

Known as the "Electrox Master Battery Eliminator," Model AR-2, it will operate practically any type or size of automobile radio, whether push-button or manually tuned. It delivers 6 volts d.c., free of hum (less than 3% ripple). Its d.c. output is adjustable, turning the rheostat adjusts the output to 6 volts with any load current between 3 and 15 amperes.

Full details on this equipment will be supplied by the Rectifier Division, The Schauer Machine Co., 2044 Reading Road, Cincinnati 2, Ohio.

FREQUENCY METER

A frequency meter especially designed for measurements in the 72-76 and 152-162 mc. band has been announced by Browning Laboratories, Inc.

Designated as the Model S-7, the new meter features an accuracy in

from RCA tube distributors. Ask for Form No. 2F455.

TUBE TAPPER

One of a line of service sales aids is the new handy tube tapper being offered by Hytron Radio and Electronics Corp. of Salem, Massachusetts.

This new tool is designed to assist the serviceman to locate intermittent "shorts" and "opens" in tubes and other components. The tube tapper is in the form of a pencil which the

Dave Thompson, W6VQB, points out to Robert D. Smith, W6AUW, president of the Stanford Radio Club, the final amplifier of the club's experimental single-sideband transmitter. With this transmitter, the radio club's station, W6YX, was first to use single-sideband transmission on amateur bands. Previously single-sideband, because of its complexity, had been used only in commercial point-to-point radio stations. The new circuit is so simple it can be easily duplicated and operated by amateurs. Single-sideband doubles the number of stations which can operate without interference, cuts power requirements by two-thirds, and makes possible simultaneous transmission and reception.

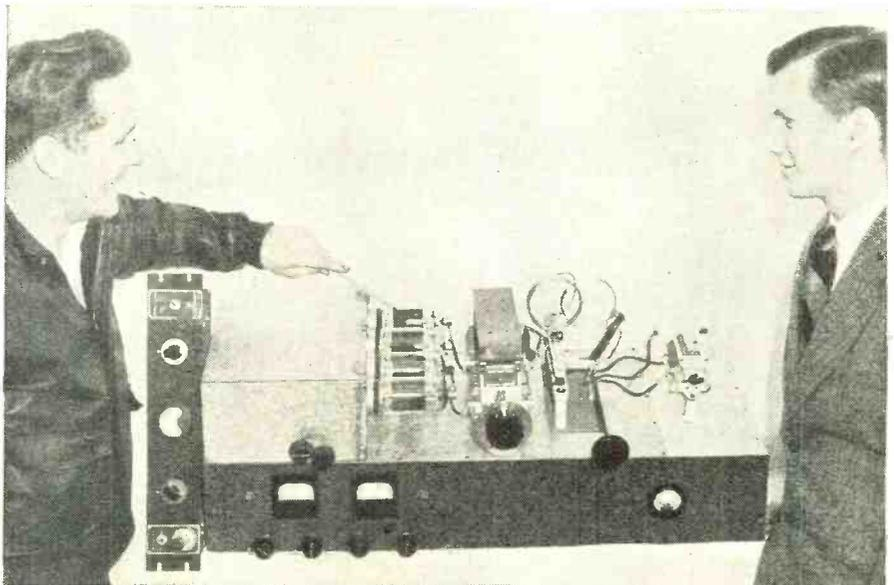

TRANSFORMERS

110v 60 cyc.
6.3v Ct @ 1 amp.....
8 volts Ct @ 1 amp

98¢
EA.



VIBRATORS

6v—4 prong.....
2v—7 prong.....

98¢
EA.

GENERAL RADIO 566A WAVEMETER
.5 mc to 150 mc

5 PLUG IN COILS, Reg. Price \$69.50.
BRAND NEW..... **\$39.50**

SELENIUM RECTIFIERS
Full Wave Bridge Type

INPUT	OUTPUT		
up to 18v A.C.	up to 12v D.C.	1 Amp.	\$1.95
up to 18v A.C.	up to 12v D.C.	5 Amp.	4.45
up to 18v A.C.	up to 12v D.C.	10 Amp.	7.45
up to 18v A.C.	up to 12v D.C.	15 Amp.	9.95
up to 18v A.C.	up to 12v D.C.	30 Amp.	14.95
up to 36v A.C.	up to 28v D.C.	1 Amp.	3.45
up to 36v A.C.	up to 28v D.C.	5 Amp.	7.45
up to 36v A.C.	up to 28v D.C.	10 Amp.	12.45
up to 36v A.C.	up to 28v D.C.	15 Amp.	18.95
up to 54v A.C.	up to 36v D.C.	25 Amp.	.98
up to 115v A.C.	up to 100v D.C.	25 Amp.	2.95
up to 115v A.C.	up to 100v D.C.	6 Amp.	6.95
up to 115v A.C.	up to 100v D.C.	5 Amp.	19.95

OIL CONDENSERS:
G. E., AEROVOX, CD., ETC.

All Ratings, D.C.

1mfd. 600v.	\$.50	2mfd. 2000v.	\$1.75
2mfd. 600v.	.35	3mfd. 2000v.	2.75
4mfd. 600v.	.60	4mfd. 2000v.	3.75
8mfd. 600v.	1.10	15mfd. 2000v.	4.95
10mfd. 600v.	1.15	1mfd. 2500v.	1.25
1mfd. 1000v.	.60	25mfd. 2500v.	1.45
2mfd. 1000v.	.70	5mfd. 2500v.	1.75
4mfd. 1000v.	.95	.05mfd. 3000v.	1.95
8mfd. 1000v.	1.95	1mfd. 3000v.	2.25
10mfd. 1000v.	2.10	25mfd. 3000v.	2.65
15mfd. 1000v.	2.25	5mfd. 3000v.	2.85
20mfd. 1000v.	2.95	1mfd. 3000v.	3.50
24mfd. 1500v.	6.95	12mfd. 3000v.	6.95
25mfd. 2000v.	1.05	2mfd. 4000v.	5.95
5mfd. 2000v.	1.15	1mfd. 5000v.	4.95
1mfd. 2000v.	.95	1mfd. 7000v.	2.95
SPECIAL! 2 mfd. 3000v.....\$4.45			

HIGH CAPACITY CONDENSERS

2x3500 mfd.—25WVDC.....	\$3.45
1000 mfd.—30WVDC.....	2.95
1000 mfd.—15WVDC.....	.99
1000 mfd.—50WVDC.....	1.95

BC-314 RECEIVER

Used but in perfect condition. Two stages RF, separate local and beat oscillators. For 12-volt DC operation but easily converted to 110-volt AC. Frequency range 150-1500 KC, continuous in 6 bands. This unit is ideal as an airport or marine low frequency receiver, also a very excellent BC receiver. Complete with tubes, specially priced at... **\$29.50**

BC-375-E TRANSMITTER

Operates from 200 kc—12.5 mc complete with all tubes, dynamotor, six tuning units and one antenna tuning unit.

LIKE NEW..... **\$39.50**

SOLA

Constant Voltage
Transformer

Pri.: 190 to 260v 60 cyc.
Sec.:115 volts @ 1.74 amps.
Rated 250 V. A.

Brand New..... **\$29.95**

PERMALLOY SHIELDS
for CATHODE RAY TUBES

3" Shield.....\$1.49
5" Shield..... 1.98

TUBES (Brand New)
Army-Navy Inspected

1N21...	\$.39	371B...	\$5.95
2AP1...	2.25	450TH...	39.95
2C40...	1.19	703A...	7.95
2D21...	.89	705A...	3.95
2V3G...	1.25	715B...	7.95
2X2...	.84	721A...	4.35
3AP1...	3.00	726/AC...	7.50
3BP1...	2.95	801...	1.49
3E29...	2.95	802...	1.98
3GP1...	3.95	803...	8.95
5BP4...	4.95	804...	9.95
5CP1...	3.95	805...	4.95
5JP1...	11.95	806...	14.95
5LP1...	8.95	807...	.95
5R4GY...	.98	808...	2.95
5Y3...	.41	809...	1.50
6AB7...	.99	810...	5.95
6AC7...	.99	811...	1.95
6AG5...	.99	812...	3.15
6AG7...	.99	813...	8.95
6AJ5...	.99	814...	4.45
6AK5...	.90	815...	3.95
6AL5...	.99	829-A-B...	3.00
6AR6...	1.29	832...	2.25
6B4G...	1.29	833A...	39.50
6C4...	.69	836...	1.75
6C5...	.49	837...	2.50
6D4...	.99	838...	3.95
6F6...	.89	861...	69.50
6F6G...	.59	866...	.75
6J4...	1.50	872A...	2.50
6J5...	.55	884...	.98
6J6...	.89	885...	.98
6L6...	1.23	954...	.75
6L7...	.98	955...	.75
6N7...	1.02	956...	.75
6SH7...	.59	957...	.75
6SL7...	.89	958...	.75
6SN7...	.69	959...	.75
6SR7...	.89	1005...	.69
7A4...	.81	1616...	2.95
7F7...	1.25	1619...	.75
7L7...	1.59	1620...	1.98
10Y...	.98	1622...	1.98
12X3...	1.50	1624...	.90
15E...	1.50	1625...	.75
HK24G...	1.75	1626...	.75
28D7...	.98	8001...	6.49
30...	.75	8003...	9.95
35T/TG...	3.50	8005...	4.95
VR90...	.75	8011...	3.75
VR105...	.75	8016...	1.65
VR150...	.75	8025A...	4.95
100TH...	7.95	1654...	1.98
100TS...	3.00	9001...	1.15
211...	1.25	9002...	.98
75T...	2.95	9003...	.98
250TH...	14.95	9004...	.98
257B...	6.49	9005...	.98
304TH...	9.95	9006...	.98

GLIDE PATH RECEIVER R-89/ARN-5

Glide Path Receiver used in the Instrument Landing System covering the frequency range 332 to 335 mc; complete with the following tubes: 7—6AJ5, 1—12SR7, 2—12SN7, 1—28D7, and including three crystals 6497KC, 6522K. **\$12.95**

TRANSFORMERS—115 V 60 CYC.
HI-VOLTAGE INSULATION

3710v @ 10 ma;	2x2½v @ 3A.....	\$9.95
2500v @ 10 ma.....		6.50
2500v @ 15 ma.....		6.50
2150v @ 15 ma.....		6.50
2100v @ 10 ma.....		6.50
1750v @ 4 ma.;	6.3v @ 3A.....	7.50
1700v @ 4 ma.;	6.3v @ 6A; 2½v @ 1.75A.....	8.50
1600v @ 4 ma.;	700v CT @ 150 ma.; 6.3v @ 9A.....	8.50
1600v @ 2 ma.;	6.3v @ 6A; 2½v @ 1.75A.....	8.50
1500v @ 7 ma.;	2½v @ 1.75A.....	7.50
550-0-550 @ 150 ma.;	5v @ 3A; 2x6.3v @ 5A C.T.....	7.95
525-0-525v @ 60 ma.;	925v @ 10 ma.; 2x5v @ 3A; 6.3v @ 3.6A; 6.3v @ 2A; 6.3v @ 1A.....	8.95
525v @ 35 ma.;	5v @ 35 ma.; 2½v @ 1.75A.....	1.98
520-0-520v @ 120 ma.;	5v @ 2A; 6.3v CT @ 5A.....	5.95
500-0-500v @ 25 ma.;	262-0-262v @ 55 ma.; 6.3v @ 1A; 2x5v @ 2A.....	4.49
500-0-500v @ 100 ma.;	5v CT @ 3A.....	4.95
442-0-442v @ 1000 ma.....		9.95
400-230-0-230-400v @ 250 ma.;	3x5v @ 3A; 6.3v @ 5A; 6.3v @ 3A; 6.3v @ 1A.....	7.95
400-0-400v @ 200 ma.;	5v @ 3A.....	4.95
400-315-0-100-315v @ 200 ma.;	2.5v @ 2A; 6.3v @ 1A; 5v @ 3A; 6.3v @ 9A.....	7.50
350-0-350v @ 150 ma.;	5v @ 3A; 6.3v @ 6A; 78v @ 1A.....	4.95
350-0-350v @ 45 ma.;	675v @ 5 ma.; 2½v @ 2A; 2x6.3v @ 1A; 6.3v @ 2A.....	4.95
350-0-350v @ 80 ma.;	6.3v @ 6A; 6.3v @ 3.75A; 2x5v @ 3A.....	3.98
350-0-350v @ 120 ma.;	5v CT @ 3A; 6.3v CT @ 4.7A.....	3.95
350-0-350v @ 70 ma.;	400v @ 10 ma.; 65v; 6.3v @ 6A; 6.3v @ 4A; 5v @ 2A.....	2.49
350-0-350v @ 150 ma.;	5v @ 3A; 6.3v @ 7.5A; 6.3v @ 3A.....	5.95
340-0-340v @ 300 ma.;	1540v @ 5 ma.....	7.50
325-0-325v @ 120 ma.;	10v @ 5A; 5v @ 7A.....	3.49
300-0-300v @ 65 ma.;	2x5v @ 2A; 6.3v @ 2½A; 6.3v @ 1A.....	3.49
250-0-250v @ 100 ma.;	2x6.3v @ 4A; 6.3v @ 5-A; 6.3v @ 1A.....	4.95
200-0-200v A 140 ma.;	6.3v @ 4A; 5v @ 2A.....	1.98
120-0-120v @ 50 ma.....		.98
24v @ 6A.....		3.50
6.3v @ 10A; 6.3v @ 1A.....		3.50
6.3v @ 1A; 2½v @ 2A.....		3.95
6.3v @ 21½A; 6.3v @ 2A; 2½v @ 2A.....		6.95
6.3v @ 25A; 6.3v @ 3A; 5v @ 12A; 6.3v CT @ 9A.....		4.95
5v CT @ 16A.....		3.49
5v CT A 60A.....		7.95
5v @ 115A.....		14.95
5v @ 190A.....		17.50
2½v @ 2A; 5v @ 3A.....		2.95
10v @ 5A.....		1.49

FILTER CHOKES

HI-VOLTAGE INSULATION

10 hy @ 400ma.....	\$4.95	4 hy @ 600ma.....	\$5.95
8 hy @ 300ma.....	3.95	10 hy @ 250 ma.....	2.49
8/30 hy @ 250ma 3.50		10 hy @ 200ma.....	1.98
25 hy @ 160ma.....	3.49	10/20 @ 85ma.....	1.59
12 hy @ 150ma.....	2.25	15 hy @ 125ma.....	1.49
12 hy @ 100ma.....	1.39	15 hy @ 100ma.....	1.39
30 hy @ 70ma.....	1.39	3 hy @ 50ma.....	.29
20 hy @ 30ma.....	1.49	30 hy Dual @ 20ma.....	1.49
120 hy Dual @ 17ma.....	1.39	200 hy @ 12ma.....	1.39
		1 hy @ 5 amps..	\$6.95

ALL PRICES SUBJECT TO CHANGE WITHOUT NOTICE

All merchandise guaranteed. Mail orders promptly filled.
All prices F.O.3. New York City. Send money order or check.
Shipping charges sent C.O.D. Minimum order \$5.00.

ATTENTION!

INDUSTRIALS—LABS—SCHOOLS—AMATEURS

Let us quote on components and equipment that you require. We have too many items to be listed on this page. Place your name on our mailing list now for new catalog.

RADIO HAM SHACK Inc.
63 DEY STREET • NEW YORK 7, N. Y.

The **ONLY** POWER SUPPLY

That gives these ratings* without overheating

Electro
ELECTRICAL AND RADIO EQUIPMENT



MODEL "A"

- *6V at 15 amps. in series
- *12V at 7½ amps. in parallel
- *6V at 7½ amps. separately

Operates auto radios with solenoid tuning and tone controls—also 12. volt marine and aircraft radios from 115v., 60 cycle supply.

Height: 7¾". Length: 11¾".
Width: 7¾". Ship. wt.: 31 lbs.

DC OUTPUT

Oversize transformers, chokes and rectifiers insure against overheating. Large capacity condensers for wide-range voltage regulation. Instantaneous power for solenoid operation. Two separately filtered DC output sources.

Compact. Sturdy. 18-gauge steel construction. Handsome blue Hammerloid finish. Comes completely equipped including 6' rubber cord and plug. Vastly superior and costs no more than batteries for equal service.

Send for complete description of this up-to-the-minute power supply.

ELECTRO PRODUCTS LABORATORIES

Pioneer Manufacturers of Battery Eliminators

549 WEST RANDOLPH STREET

CHICAGO 6, ILLINOIS

either band of .005% or .0025% where minor precautions are taken, rendering measurements of central station and satellite transmitters possible in the bands covered by the instrument. The meter is housed in a rugged

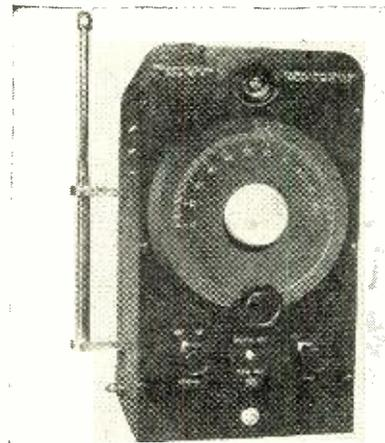

steel cabinet and has an engraved aluminum panel. A whip antenna mounted at the side of the cabinet furnishes coupling to the transmitter and may be telescoped to form a convenient carrying handle. Charts supplied with the instrument show deviation from assigned frequency.

The unit is available in single or two specified frequencies on either or both bands. Operation is from 117 volts a.c. or d.c. and the meter consumes approximately 50 watts.

Browning Laboratories, Inc., Winchester, Massachusetts will supply full details on request.

KILOVOLTER

Of particular interest to the television industry is the new Kilovolter Model 6 recently introduced by C-B Manufacturing Co. of New York.

This new unit will deliver 600 microamps at 6000 volts d.c. or 1 milliamp at 4000 volts. This is the maximum voltage requirement of any

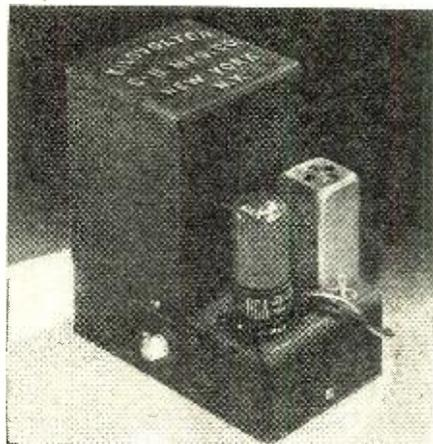

7" television picture tube (including new rating on the 7GP4). The voltage is adjustable by reducing the "B" supply voltage.

The Model 6 measures 4" x 6" x 6" and weighs 2 pounds. It is easily mounted on the receiver by means of two screws and can be connected by

RADIO NEWS

TOP VALUE OFFERS

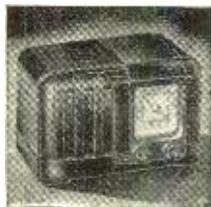

Kit Model S-5
a 1-Band Receiver
Model S-5 uses the universally accepted superheterodyne circuit containing the following tubes: 12SA7, 12SK7, 12SQ7, 50L6, 35Z5 and tunes from 550 Kc. to 1600

Kc. Price of kit, less tubes.....\$10.95

Kit Model S-6X a 2-Band Receiver

Model S-6X, a 6-tube, 2-band receiver kit . . . covers the following ranges: 550 Kc., 1600 Kc., 6-16 Mc. Complete with tubes and ready for assembly.....\$16.95

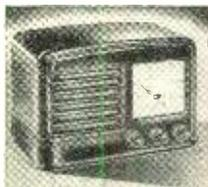

Also Available

MULTITESTER KIT MODEL M-3C

A versatile, compact multitester 4"x7"x3" using a 3½" rd. meter of 1000 ohms per volt sensitivity. Employs the following ranges: Volts AC or DC 0/5/50/150/500/1500. Milliamperes D.C. 0/5/50/150. Ohms 0/2000/20,000/200,000. Price complete.....\$10.95

All kits accompanied by a detailed illustrated instruction sheet. Many other kit models available. Write for Catalog M.

Now ready! New educational pamphlet . . . complete and simplified diagrams and instructions on all our models.....50c

RADIO KITS COMPANY

120 Cedar Street

New York 6, N. Y.

SENSATIONAL SALE!

Not Surplus Stock

(All fresh manufacture)

CONDENSER SPECIALS:

.01	
.02	
.03	
.05	400V05 ea.
.001	
.005	
.0001- 600V Tubl.09 ea.
.0005- 600V Tubl.10 ea.
.0005-1000V Tubl.15 ea.
40-20-150V45 ea.
40-20-20-150V50 ea.
40-20-20-150 & 25V50 ea.

RESISTORS: All Radioman numbers.

No dead values. 100 Ass't., ½ & 1 Watt\$1.59

50L6: Output Transformers. Regular size. Long leads, ea.35

35Z5GT Tubes in bulk cartons, ea....40

Terms: Remittance with order. 25% Deposit. Balance C.O.D. (Orders not less than \$3.00).

JENSEN'S RADIO SUPPLY & SERVICE

176 Seneca Street

Buffalo 3, N. Y.

NEVER BEFORE

NEW 4 CONDUCTOR 16 GAUGE RUBBER COVERED CABLE
\$18

Color coded. Used by United States Government as Field Telephone Cable. 1300 feet on steel reel F.O.B. Our warehouse. Shipped motor freight or express shipping charges collect.

WILLARD 2 VOLT BATTERIES

ONLY \$1.25 each



Brand new, Compact, spill proof, Built-in Hygrometer. Group several together for higher voltages. Uses Standard Electrolyte. Guaranteed. Add 35c to cover postage and handling.

ASTOGRAPH AND CARRYING CASE

Both Only

\$2.25

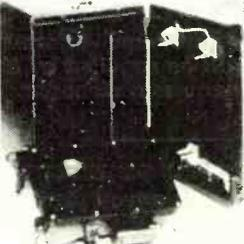

There is an unlimited number of uses for both the instrument and the carrying case. The instrument is easily adapted to navigation purposes, for both boats and aircraft. It is also an excellent item for the home craftsman wishing to make an enlarger, film viewer or other photographic instruments.

The box, which measures 13 1/2" long, 10 1/2" wide and 7 1/2" deep, is made of 3/4" plywood and is a beautiful case for cameraman, fisherman, hunter and mechanic. The carrying case alone is worth at least double our low price on the complete unit. Send check or money order today—Michigan orders add 07c for sales tax. *Shipped Express Collect*

MICHIGAN SALES ADD 3% TAX

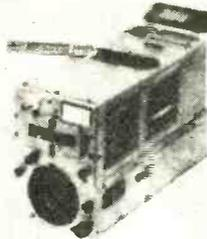

AIRCRAFT TRANSMITTERS

only \$330

BC-457-A, 4 to 5.3 MC and BC-458-A, 5.3 to 7 MC. These

transmitters are companion sets to the 453, 4, and 5 receiver series. They are used, but in excellent condition. It's really built rugged and makes an excellent 55 watt transmitter. With tubes.

Shipped Express Collect

OTHER GREAT BUYS

74" 4-conductor shielded cable with PL 108 on each end \$.15

Brand New Head Sets, 8000 ohm Resistance \$ 1.29
 (Add 25c to cover handling)

Brand New 5cPI Cathode Ray tubes \$ 1.95
 (Add 35c to cover handling)

SCR 522 Transmitter and Receiver (used good) \$13.75
 (Shipped Express Collect)

BC434F Control Box \$ 1.25
 (Add 25c to cover handling)

500' \$2.95

3 CONDUCTOR TELEPHONE WIRE

3 conductor Braided insulated copper & steel telephone wire. It is made of copper for conductivity, and steel for strength. Worth at least 3c per ft. Yet due to an exceptional buy, we can now offer it at less than 1c a ft.

Shipped Express Collect



TIME DELAY RELAY

\$1.49

only

A current relay S.P.D.T. Type B-5, Manufactured by Guardian Electric Co., Mfrs. Part No. 3446. New in original cartons. Add 1c to cover handling and postage.

LOOP ANTENNA

LP-21-A

\$5.95

ONLY



Used primarily on aircraft & Marine ADF Systems, Loop LP-21-A contains an electric motor and selsyn. These loops have been removed from salvage aircraft, but are guaranteed to be in excellent working condition.

Shipped Express Collect

PHANTOM ANTENNA

85c

A transmitting antenna, for use on approximately 450 MC. Complete with standard coax connector. A weatherproof unit.

Add 25c to cover handling and postage

MINIMUM ORDER \$2.00

NO C.O.D. ORDERS

N. SILVERSTINE CO.

6532 EAST McNICHOLS ROAD
 DETROIT 12, MICHIGAN

Surplus

Bargains

SMASH VALUES from MID-AMERICA

Look at these sensational buys in brand-new, unused, top-quality radio parts and electronic equipment. You've never seen big buys like these before! And that's only the beginning. These values are but a few of the hundreds and hundreds of items Mid-America has in stock right now. Write for free catalog. You'll save money!

New Standard Brand TUBES at World's Lowest Prices!

1A5GT.....47c	12AT6.....47c	9002.....41c
1H5GT.....47c	12C8.....49c	9003.....31c
1N5GT.....59c	12SA7GT.....47c	9006.....41c
1R5.....59c	12SG7.....49c	1E36.....19c
2A2/879.....39c	12SK7.....47c	1H20.....19c
30A.....72c	12SQ7.....49c	2C26.....49c
30S6GT.....69c	12S07GT.....47c	3BP1.....\$1.00
5Y3GT.....43c	12SR7.....69c	5CP1.....\$1.75
6AG5.....69c	28D7.....79c	3D21A.....\$1.00
6AH6.....49c	35L6GT.....47c	15E.....\$1.95
6J6.....59c	35W4.....45c	15R.....\$1.95
6SA7.....47c	50A5.....65c	RK34/2C34.....79c
6SA7GT.....47c	50B5.....47c	HY114B.....79c
6SH7.....34c	117Z3.....79c	HY615.....79c
6SK7GT.....47c	954.....39c	801A.....99c
6S07.....45c	955.....39c	803.....\$3.75
6V6GT/G.....47c	1613.....25c	807.....90c
6X5GT.....45c	1619.....13c	830B.....\$1.95
7C4.....59c	1624.....25c	1005.....49c
7E5.....59c	1625.....25c	1960.....\$1.00
7Y4.....59c	1632.....25c	V890.....79c
7Z4.....59c	1633.....25c	VR150.....79c



DACO Tube Tester

Tests performance, leakage and shorts in ALL receiving tubes, even sub-miniature and acorn, PLUS provision for tubes that may be invented. Durable construction is fully shielded; dust-proof case, high-visibility meter, illuminated chart; no books or charts to be misplaced. Simple, fast operation with positive contact slide-switches; tests EVERY tube element. 110 volt AC. 16 1/2" x 14 3/4". MA-2193 **\$2950**

PORTABLE DACO TUBE TESTER

Same construction and operating features as counter model. Enclosed in sturdy case with durable black leatherette covering. 12 1/2" x 12 3/4". MA-2194 **\$3250**



PHONO AMP and RECORD CHANGER

Inexpensive phono amplifier and record changer with "big set" features. Positive-action Crescent changer handles 10" and 12" records without jamming; finger-tip reject button. Lightweight counter-balanced pickup arm with Shure crystal and lifetime floating sapphire needle. 78 RPM constant-speed motor. 5" PM speaker and high-quality amplifier complete with tubes. Base measures 15 1/2" x 12 1/4" x 6". MA21 **\$2395**
Base with motor, turntable and record changer. MA-2192 **\$1495**



15" HIGH-FIDELITY DYNAMIC SPEAKER

Husky 25-watt dynamic speaker for use where perfect reproduction is desired. Ideal for both indoor and outdoor installations. 12,500 ohm field. 16 ohm voice coil. Regular \$40.00 **\$1895**
List. MA-2190.



FM and HAM ANTENNA

AN-104-B. 1/2-wave at 100-156 MC; formerly used with SCR-522, 274-N, ARC-5. A pair make an excellent broad-band dipole for FM reception. Coaxial connector in base. Very sturdy; use anywhere. MA-2153 **39c**

FREE CATALOG

Order now—right from this ad! Send 25% deposit—we ship C.O.D. for balance plus postage. Write, too, for Mid-America's big, complete catalog that lists hundreds and hundreds of hard-to-get items—ALL AT UNBEATABLE LOW PRICES! Mail orders and catalog requests to store address—Dept. E-28

MID-AMERICA CO. Inc.

STORE: 2412 S. MICHIGAN AVE. CHICAGO 16, ILL.
WAREHOUSE: 2307 S. ARCHER AVE. CHICAGO 16, ILL.

four wires to the low voltage supply. The high voltage terminal is connected directly to the load in the receiver.

Performance data on this Kilovolter is obtainable on request from C-B Manufacturing Co., New York 18, New York.

10-WATT AMPLIFIER

The newest addition to Newcomb Audio Products Company's line of lower priced utility amplifiers is the E-10, a 10-watt unit.

This new amplifier delivers a full 10 watts from push-pull 6V6 tubes in a multi-stage inverse feedback circuit and has inputs for microphone and phonograph in addition to full range tone control.

Full details on the E series of low



cost units is available from Newcomb Audio Products Company, 6824 Lexington Avenue, Hollywood 38, California.

SNAP-ON FERRET SET

Snap-On Tools Corporation has recently introduced a streamlined and completely redesigned 3/8" drive line

of sockets and handles known as the "Snap-On Ferret Set."

The new set features palm-grip handles built to conform to the shape

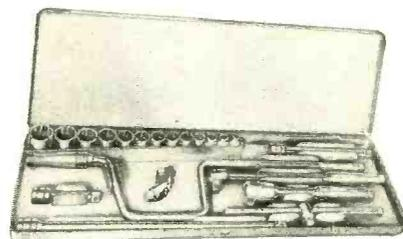

of the user's hand. Four sockets have been added which gives the set size coverage between 1/4" and 3/8". The newly designed sockets have four indentations on the inside of the socket drive hole to make the engaging of the ball found in the handle of the driving unit an easy job. Improved size markings make the new sockets easier to select.

The entire set is housed in a streamlined box which has rounded corners and extra-deep partitions. The box is finished in red.

Prices and additional information on this unit will be supplied by Snap-On Tools Corporation, Kenosha, Wisconsin.

SWEEP SIGNAL GENERATOR

A new, low cost sweep signal generator for the visual alignment of FM and television receivers has just been announced by Vision Research Laboratories of Kew Gardens, New York.

This new instrument is now available to servicemen, students, and experimenters in FM and television at

If you have never seen a pair of six hundred dollar smiles take a good look at these happy gentlemen. The occasion for all the joy was the presentation of the first prize money in the Rider Manual Contest. Albert N. Giddis (left) of Lowell, Massachusetts was named winner of the \$500.00 first prize for his letter on "Rider Manuals Mean Successful Servicing." Henri Jappe (right) partner of A. W. Mayer Co., Boston radio parts jobber who was designated by Mr. Giddis as his jobber, accepted the \$100.00 jobber prize. Mr. Giddis has headed the servicing department at Gaudmont Brothers of Lowell, Massachusetts for the past fifteen years. Oh yes, the man in the center who is looking so pleased at parting with all that cash is John Rider.

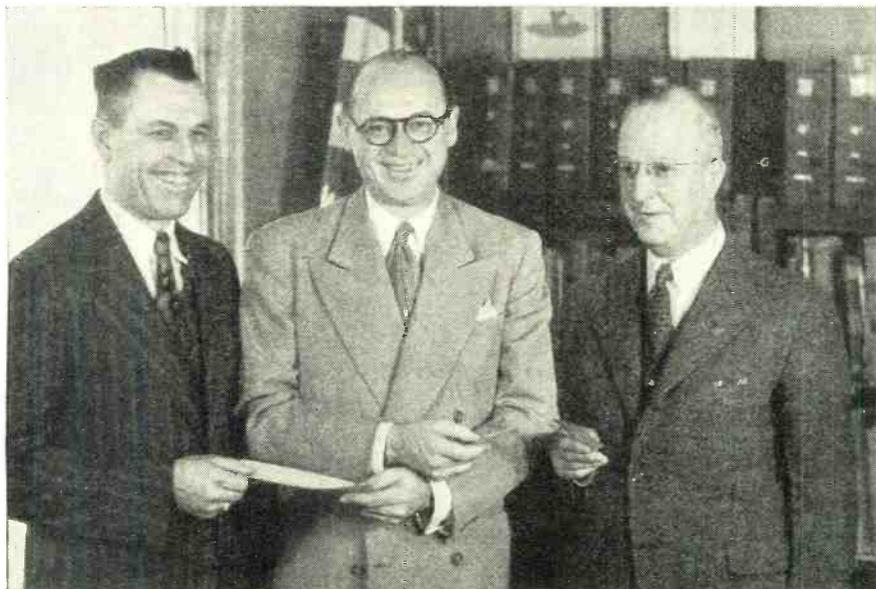

low cost. The equipment generates a broad frequency modulated test signal which, when used in conjunction with any standard oscilloscope, provides the means of visually aligning

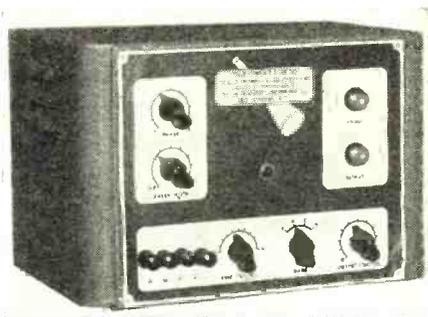

the complex circuits used in FM and television sets.

Among other features, this unit has a sweep of 50 kc. to 10 mc., an output of one volt max., and a complete frequency coverage in four bands (5 to 100 mc.-170 to 215 mc.).

A complete instruction book comes with each unit.

Further details on this sweep signal generator may be secured from *Vision Research Laboratories*, Kew Gardens, New York.

R.F. POWER AMPLIFIER

The *James Millen Manufacturing Company* has just released an extremely compact, 75-watt output r.f. power amplifier chassis in unit form.

By means of plug-in inductors, this unit can be operated on the 2, 6, 10, 15, and 20 meter amateur bands. Special inductors are also available for commercial applications of this amplifier.

The unit uses the 829B tube and is extremely compact. Provision is made for either panel or table mounting.

For further details on this unit, address your requests to *The James Millen Manufacturing Company*, Malden, Massachusetts. -30-

Al Gross, president of a Cleveland electronics firm, has recently developed a miniature two-way radio which weighs only 11 oz. The unit is 6 inches long and about 3 inches wide. It is designed to operate in the 460-470 mc. band. Production has already started and these new units are expected to be on the market some time this year.

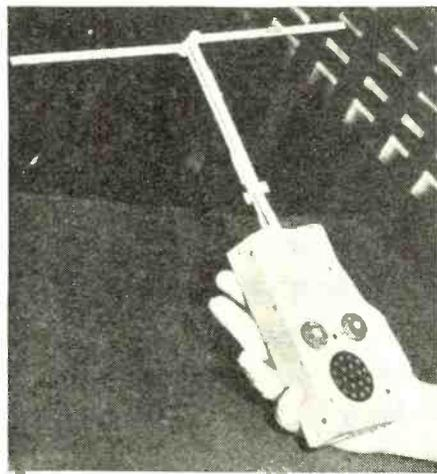

"The Kit for the Millions"

NO TECHNICAL KNOWLEDGE REQUIRED FOR ASSEMBLY!

TRANSVISION

... Tops in quality ... Tops in value!

TELEVISION KITS

SCOOP! All Transvision 12" STANDARD Kits can now be had equipped with superb FM RADIO at the extra cost of only \$7.95 (Not to be confused with De Luxe model which has continuous tuning)

12" TELEVISION KITS—

Standard and DeLuxe Models

Picture size 1½ times larger than with 10" tube . . . A big 75 square inch picture!

Sharp, steady picture achieved with advanced Transvision television circuit. Picture has remarkable brightness even in lighted room (no darkening of room is required). IDEAL FOR HOME or COMMERCIAL INSTALLATIONS.

12" TRANSVISION TELEVISION KIT . . . Standard Model . . . FEATURES: 12" picture tube . . . Picture size 1½ times larger than with 10" tube . . . RF Unit designed for 13 channels: factory wired and pre-tuned for 7 channels (no areas have been assigned more than 7 channels; however if desired, up to 6 more channels may be added at very nominal cost) . . . 4 mc bandwidth for full picture definition . . . High fidelity F.M. sound reproduction . . . picture size 75 square inches . . . 9000 volts second anode potential for brightness and contrast . . . maximum picture, sensitivity (better than 50 microvolts) . . . 22 tubes and 12" picture tube, antenna, lead-in wire, etc. (Cabinet extra, if desired). LIST \$289.00

12" TRANSVISION TELEVISION KIT . . . DeLuxe Model with Superb Built-in F.M. RADIO. Same characteristics as the Standard Model, plus the following ADDITIONAL FEATURES:—50-216 mc continuous tuning . . . Covers the entire F.M. band and all 13 television channels . . . Cut-off switch eliminates unused tubes when set is used only as F.M. receiver . . . LIST \$359.00

TRANSVISION ALL-CHANNEL R. F. UNIT

FACTORY PRE-WIRED and TUNED . . . For use in Building your own custom-made television receiver . . . for any 7", 10", 12", 15", or 20" Kit.

Transvision all-channel R.F. unit is factory pre-wired and tuned for 7 channels* (covers all channels in lower and higher bands in any single area operating presently or in the future). Average sensitivity 20 microvolts; has R.F. stage before oscillator; complete with 3 tubes; 1-6AK5, 1-6AK6, 1-6C4; input impedance—300 ohms, balanced to ground. Size—9½" deep, 4½" high, 6¾" wide. *NOTE: No single area is scheduled for more than 7 channels. However, 6 more channels can be added to this unit, if desired, at nominal factory cost. These extra 6 channels are unnecessary—and would only serve for experimental purposes. The seven channels supplied in the R.F. Unit cover any required area.

TRANSVISION ALL-CHANNEL R.F. UNIT . . . LIST \$37.95
Same R.F. Unit, plus FM Band . . . LIST \$47.95

TRANSVISION FEATHERWEIGHT SOLDERING IRON

NOTE THESE NEW, REMARKABLE FEATURES: Weighs only 3 ounces (without the cord) . . . Delivers working output of 200 watt iron at fraction of current normally consumed by heavier irons . . . Heats up in 20 seconds . . . Finger-tip button control . . . Cool grip . . . Retains heat (with switch off) up to one minute . . . Featherweight permits long periods of soldering without fatigue . . . Economical—intermittent control feature prevents tip corrosion and necessity of frequent cleaning . . . Long, thin tip permits soldering in tight corners . . . Tips are interchangeable to suit work at hand . . . For operation on 110V, AC, 60 cycles. Complete with 6 volt transformer. . . . LIST \$13.95

All prices listed above are 5% additional west of the Mississippi. All prices are fair traded.

See your local distributor or for further information write to Dept. R.N:—

➔ **TRANSVISION, INC.**
385 NORTH AVE., NEW ROCHELLE, N. Y.



12" KIT (Table Model)

ALL TRANSVISION KITS ARE COMPLETE—Nothing more to buy! . . . All Transvision Television Kits are COMPLETE with all tubes, including picture tube, wired and pre-tuned RF units and IF's, high gain folded di-pole antenna with 60 ft. lead-in cable, wire and solder.

TRANSVISION TELEVISION CABINETS—Beautiful, sturdily built cabinets with hand-some rubbed wood finish. Fully drilled.

12" Table Model Cabinet . . . LIST \$44.50
12" Console Cabinet with compartment for record changer . . . LIST \$74.50
7" Table Model Cabinet . . . LIST 32.50

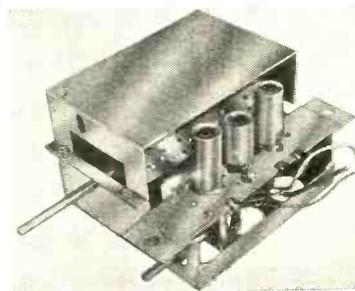

ALL-CHANNEL R-F UNIT



Featherweight Soldering Iron



**THE 90811
MILLEN RF
AMPLIFIER**



The 90811 RF Amplifier provides 75 watt output on all bands 2-6-10-15 and 20 meters. It is identical with the final amplifier used in the Millen 90810 High Frequency Transmitter. The 90811 uses an 829 B tube and can be driven with as little as 1 1/2 to 2 watts. The 90811 comes equipped with 10 meter grid and plate coils. Coils for other bands are available. This unit makes an ideal final for the ham who wants to go on 6-10 or 20 meters with 75 or 100 watts. It is also an ideal power amplifier for mobile installations. 90811 with 10 meter coils (but less tube)

- 48021 20 meter grid coil..... 1.80
 - 48121 20 meter plate coil..... 1.80
- Coils also available for 2 and 6 meters at \$3.60 per set



**GON-SET
6-15 CONVERTER**

6-10-11-15 meter bands in one converter without changing coils! 8 tubes, actually 3 separate converters in one, with selector switch, large band spread dial, output frequency 7 mc. Built-in power supply. Complete—Net Price, \$75.00

HARVEY-WELLS TBS-50

Rated 50 watts using an 807 in final amplifier. All bands from 2 meters thru 80. Has self-contained push-pull 6L6 modulator stage. Complete with tubes, built-in band switching coils and meter, in very attractive hammer-tone finish cabinet. Just the thing for mobile or low power fixed operation.

NATIONAL NC 183

IN STOCK! The new National NC183; 2 stages RF, exceptionally high image rejection; uses a stabilized voltage regulated circuit; push-pull audio output and latest type crystal filter. Frequency Range: 540 KC to 31 MC, continuous, plus 6 meter band. Complete with tubes, speaker and built-in power supply..... \$269.00

COLLINS

We are now taking orders on all Collins equipment for shipment from factory direct to you. Write us for literature and prices.

NOTE: All prices Net, F.O.B. N.Y. and subject to change without notice.

Telephone: **IO. 3-1800**

HARVEY
RADIO COMPANY INC.
103 West 43rd St., New York 18, N. Y.

BANDSWITCHING Without a Switch

By **EDWIN W. HILL, WA4HMS/1**

THERE is a simple, effective way to avoid the losses and complications of r.f. switch wiring yet still retain the advantages and convenience of band-switching. The illustrated circuit is being used successfully in the low power exciter stages of a four-band amateur transmitter which has band-switching in every stage. Capacitive coupling must be used between stages but that is no disadvantage since this is the simplest way to couple exciter stages and requires a minimum number of tuning controls.

The fundamental basis of the scheme is to use a separate tank coil and condenser for each band to be covered (Fig. 1A) and to short the unused tanks by bending one of the outside rotor plates of each tuning condenser in such a way that the rotor shorts to the stator when the condenser is tuned to its maximum capacity. Thus only the desired tank is in the circuit and no additional switches are required.

The one disadvantage of this method over conventional bandswitching is that a separate tuning condenser and knob or dial must be used with each coil. However, this is not expensive because of the small size and low cost of tuning condensers of the kind ordinarily used in exciter stages. In the case of the author's transmitter, these tuning condensers are ceramic insulated, double-spaced midgets which cost twenty cents each at surplus prices.

Several important advantages are gained, however. The stray minimum capacity of the circuit is lower than when wires are brought to contacts on a switch. There is no possibility of power being absorbed by idle adjacent coils due to accidental resonances because each coil is shorted out com-

pletely. Circulating currents in unused coils are low because the coils can be isolated or shielded from each other. It is easier to obtain more favorable LC ratios in the tuned circuits. Finally—and this is perhaps the greatest advantage—it is possible to increase the efficiency of frequency multiplier stages appreciably by leaving two of the tanks in the circuit (Fig. 1B) at one time; that is, the fundamental tank and a tank tuned to the second, fourth, or

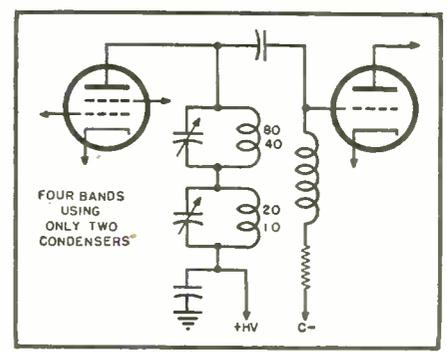

Fig. 2.

any desired harmonic. This results in a very worthwhile gain in the output of the frequency multiplier.

When most favorable LC ratios are of secondary importance to economy and space requirements it is possible to cover four amateur bands (Fig. 2.) with only two tuning condensers and coils. This is done by using a tuning condenser of sufficiently large capacity so that the coil tunes to two adjacent ham bands, one at almost maximum capacity and the other at almost minimum.

-30-

Fig. 1.

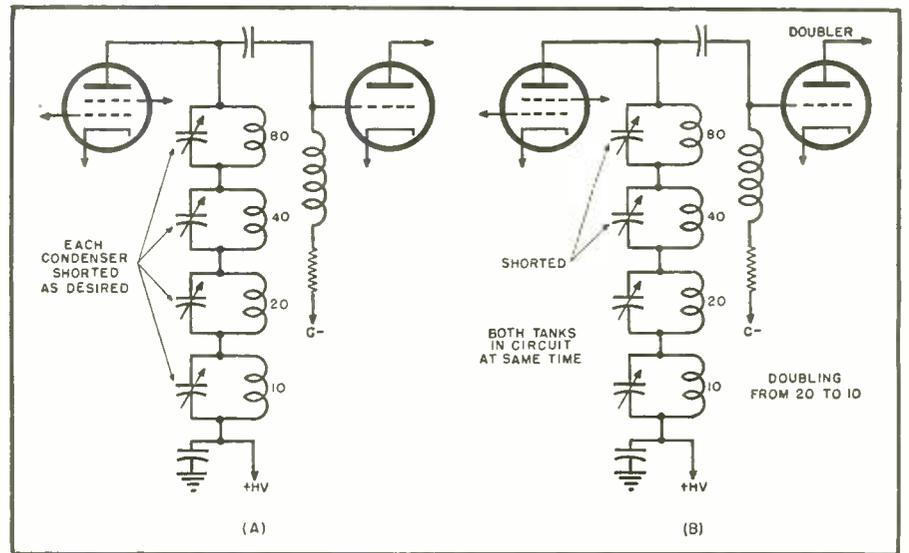

(A)

(B)

STILL UNQUESTIONABLY THE FINEST

**The COLLINS
Custom Built FM/AM Tuner
Tops For Recording, Too**



THIS tuner has received wide acclaim throughout the country as the best medium for reception of FM and AM broadcasts. Many extra, personal accessories may be ordered with the tuner to make it exactly what you want. Its 17-tube circuits employ Armstrong FM, full complement of vacuum tubes, self-contained power supply and latest circuit developments. *Write for full information about this marvelous product.*

COLLINS AUDIO PRODUCTS CO., INC.

126 Park Street Westfield, N. J.

* WE 2-4390 *

**Fixing Radios the Old
Hard Way?**

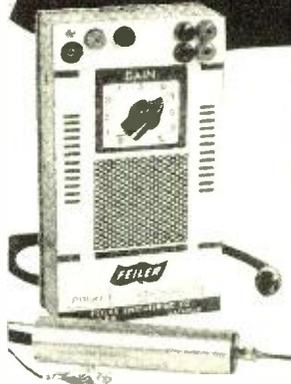

The Feiler Stethoscope does everything but make the actual repair. And the Stethoscope does it faster, better and much easier. Thousands of radio men, many with little experience, are already fixing radios and other electronic equipment this new way.

You will find that just this one low priced unit and a few basic hand tools are all you need to fix practically any radio.



The "Inside Story" of the **STETHOSCOPE**—how it works—how it instantly locates trouble in any circuit—is yours for the asking. The "Inside Story," a 24 page illustrated booklet, is full of practical tips and hints on radio servicing. To get your free copy, send your name and address on a penny post card today.

Here is the new Model TS-5 "Pocket Stethoscope" built to take out on the job. It's light, compact and rugged yet performs like the bench models. Stethoscopes are available in 4 types ranging from \$9.85 to \$34.95.



**"MAKES RADIO REPAIRS
AUTOMATIC"**

Available for Export—Choice
Territories Still Open

FEILER ENGINEERING COMPANY

945 George St. Dept. 2H8 Chicago 14, Illinois

February, 1948

**U. S. GOVERNMENT
SURPLUS BARGAINS**

**I. F. F.
RECEIVER AND
TRANSMITTER**

Complete with 14 tubes

EACH **\$5⁹⁵**

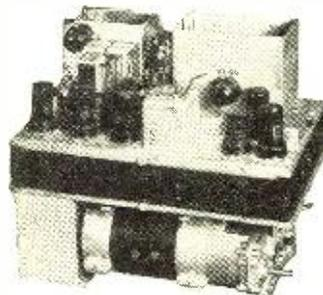

C6J

Gas-Filled RECTIFIER
Maximum Anode Amperes 6.4
Nominal D.C. Output Volts 350
Filament: Amps 18 Volts 2.5
Heating Time 40 Secs.
Peak Inverse Volts 1250
Peak Anode Current 77
Critical Grid Voltage -2
Cond. Mercury Temp. Limits 40° to 65° C.
Height 9 1/4"
Width 2 1/16"
Base: 4 Pin #412

PRICE EACH **\$3⁹⁵**

TUBES

FG17

Mercury Vapor RECTIFIER
Maximum Anode Amperes .5
Nominal D.C. Output Volts 1250
Filament: Amps 5 Volts 2.5
Heating Time 5 Secs.
Peak Inverse Volts 5000
Peak Anode Current 2
Critical Grid Voltage -5
Cond. Mercury Temp. Limits 40° to 80° C.
Height 6 3/4"
Width 2 1/16"
Base: Medium 4 Pin

PRICE EACH **\$1⁵⁰**

VIBRATOR-PAC Model 125 AX

12 or 24 volts new, complete with vibrators and tubes.
500 volts output at 160 milliamperes. New.....

\$4⁹⁵

**BC 375
TRANSMITTER**

With Tuning Unit. **\$6⁹⁵**
NEW, EACH

**4 Mfd.
CONDENSERS**

1,000 VOLTS **50c**
PRICE EACH

**BC 7330 LOCALIZER
RECEIVER**

BC-7330 Localizer Receiver Freq. 108-110 Mc., tube complement: 10 tubes—1—12SQ7, 2—12SH7, 1—12A6, 1—A1H7GT, 2—12SG7, 3—717A. **\$4⁹⁵**
NEW EACH

**INTER-PHONE
AMPLIFIERS**

Inter-Phone Amplifiers (Model AM-26-A12) 4 tube, complete with tubes and dynamotor **\$3⁹⁵**
NEW EACH

**GRAB
BOX**

Approximately 10 lbs. of miscellaneous radio parts. All usable—All new.

BOX **\$1⁰⁰**
EACH...



All Orders F.O.B. DETROIT, Shipped RAILWAY EXPRESS

No order under \$5.00—Please send check or money order. Orders shipped C.O.D. subject to 25% advance deposit.

RADIO CENTER

2530 E. DAVISON AVE. DETROIT 12, MICH.

SPECIAL SURPLUS SALE

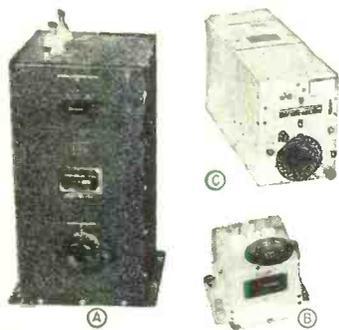

FL-8-C Radio Filter \$1.29

(A) ANTENNA TUNER

A. BC. 306-A National "Velvet Vernier" dial with 100-0 scale, 5 position heavy duty high voltage—3 section RF switch. Two high voltage standoff insulators with spring type binding posts. Low frequency variocoupler. Overall dimensions approx. 18½" high, 8" wide, 8" deep. **\$1.66**

(B) ANTENNA RELAY UNIT

B. 0-10 Meter Weston Thermo-couple unit with 50 MMF, 5000 V Vacuum cond. (illustrated as B-A). Complete. **\$2.45**

10-meter Receiver—New. 3-6 MC Receiver converts to 10. Diagram furnished.

SPECIAL 274N-SERIES.

(C) RECEIVERS (274N Series)

B.C. 454A. 3-6MC. New.....\$3.95
B.C. 455A. 6-9.1MC..... 5.95
B.C. 453A. 190-550KC..... 6.95

G.E.—SPRAGUE-AEROVOX oil filled condensers, 4000 Volts, 2MMF.....\$3.19
4000 Volts, 3MMF..... 3.95
BEACON Receiver tunes to 75 Meg., has current relay. Operates on 2 Mils.....\$1.79

TRANSMITTERS

B.C. 696. 3-4MC (VFO).....\$5.95
B.C. 457A. 4-5.3MC..... 3.95
B.C. 458A. 5-3.7MC..... 3.95
B.C. 459. 7-9.1MC (VFO) New..... 5.95

MODULATOR UNIT

B.C. 456A.....\$3.95
Conversion diagrams furnished.
DM-32 DYNAMOTOR..... 1.50
B.C. 348. Receiver Mount and Plug... 2.49
Fil. Trans. 1½-amp., 24 Volt..... 1.79
Fil. Trans. 2½-amp. 12-24 Volt..... 3.95
F. Band Pass Filter, 1000 cycle, close tolerance..... 1.98
Dual Choke—12 HY-200 MA 550HM D.C. resistance. Steel case with stand-off insulators. New..... 2.95

TUBES

6AK5..... 79c 6AJ5..... 79c
Bendix Ant. Insulators, CAA approved—4-inch.....\$1.00 doz.

Also thousands of additional special items such as condensers, tubes, capacitors, transformers, insulators, radar equipment. Inquiries solicited. Get your name on our mailing list. Terms: Cash with order.

ESEGE SALES, Ltd.

1306 Bond Street
LOS ANGELES, CALIF.
TEL. RICHMOND 71162

FOR THE "HIGHS"
in HIGH FIDELITY...

use the new

UNIVERSITY TWEETER



Quick, Easy
Installation!

It's a fact! This new tweeter gives you full range reproduction right up to 15,000 cycles when used in conjunction with any standard cone speaker. Quickly attaches to the voice coil terminals of your present cone speaker through a simple, inexpensive high pass filter. Available in handsome walnut cabinet or in single or dual unit unmounted types. Prices from \$20.00. For details write today to UNIVERSITY LOUDSPEAKERS, INC., 80 South Kensico Avenue, White Plains, New York.

University Loudspeakers

Radio Parts Distributors NEW YEAR SPECIALS

NATIONALLY KNOWN BRANDS

5" PM Alnico #5 Magnet.....\$1.09
6 for \$6.00
8" PM Alnico #5 Magnet.....\$2.89
5 for \$13.75
10" PM Alnico #5 Magnet.....\$3.25
5 for \$15.50

Popular Brand Phono. Motors with 9" Turntable.....\$2.89

Pickup Arm D-9 with L26 Cartridges.....\$2.29
Cartridges L40A.....Each \$1.79
Cartridges L75A.....Each \$1.79

FILTER CHOKES

Heavy duty Filter Chokes 5 Hy 220 Ma D.C. Size 2¼ x 3x3¼.....Each \$1.19
Filter Choke 2x2½ x 2¾ 40 Ma-20Hy... 79c
Known Brands Oil Filled Condensers 2mfd —1000 Volt.....Each \$1.19

CONDENSER SPECIALS

25 mfd	25VV	\$0.27	10 for \$2.30
8 mfd	150VV	.25	10 for 2.05
12 mfd	150 V	.32	10 for 2.60
20 mfd	150 V	.34	10 for 2.75
30 mfd	150 V	.37	10 for 2.95
4 mfd	450 V	.32	10 for 2.60
12 mfd	450 V	.41	10 for 3.30
20-20 mfd	150 V	.59	10 for 4.70
40-20	150 V	.63	10 for 5.05
8-8	450 V	.59	10 for 4.70
16-16	450 V	1.09	10 for 8.60

FREE! Write for R.P.D.'s latest bulletin for more sensational values.

TERMS: Remittance with order plus postage or 25% deposit, balance C.O.D.

RADIO PARTS DISTRIBUTORS

925 E. 55th St. Chicago 15, Ill.

Spot Radio News

(Continued from page 20)

tion of some 600,000 video receivers—a third of the estimated dollar volume on sales of standard broadcast receivers and auto sets. He believes that the year will also see public demand outstripping production. "More and better" programs will whet the appetite of television customers, Mr. Glaser thinks. Summing up the situation, he adds: "While about 75 per-cent of total television sales will be in the table model class, substantial sales of console type receivers are expected to exert a strong influence on total dollar volume, especially if the installment-buying restrictions lifted last November 1 are not restored. The expansion of the immediate future is indicated by the fact that 1948 will see television stations in at least 50 major market areas in the United States." He also sees "a marked increase in the FM output during the year," and a healthy market all along the line, inspired by the desire of the public to replace war-worn sets and to have more than one set per household.

RADIO NOISE—interference, static, you know it, you name it—seems destined to come in for an additional beating during the year. Two government agencies are working on the problem, and one has already reported progress. This is a new method of measuring radio noise interference developed by the Signal Corps at their laboratories at Monmouth, N. J. Engineers believe that work will lead to the solution of major noise measurement problems now encountered by industry and government, because it provides for accurate evaluation by comparison with an established standard and all but removes the chance of personnel error. The Signal Corps work grew out of the war, when interference hampered radio activities. Trucks, tanks, and engine-driven generators were the worst noise offenders. Noise-measuring methods were studied at the time, but commercial instruments fell short of military needs. Signal Corps fell back on listening tests with sensitive receivers, modified for use as noise meters, but even this fell short of what they wanted, because variations constantly cropped up owing to the judgment and hearing ability of the men using the instruments. This is not to say that the listening tests failed to accomplish anything, the Corps hastens to add—some 50,000 engines, 100,000 engine-driven generators, and 3,000,000 vehicles were quieted down as a result of the work.

NOW SIGNAL CORPS engineers come up with a new principle of measurement, using a stable radio noise generator as an interference reference standard. Work on models is nearing completion and it is anti-

RADIO NEWS

pated that they will measure radio interference within the frequency range of 150 kc. to 40 mc. Indeed, a test set was successfully exhibited at the 1947 meeting of the International Special Committee on Radio Interference, held in Switzerland. The set was left with the Committee for tests by other national experts. The Corps is also cooperating with other government and industrial agencies, including the American Standards Association Committee on Interference Measurement and the Society of Automotive Engineers Committee on Vehicular Radio Interference.

ANOTHER ANTI-NOISE campaign is under way at the National Bureau of Standards, where scientists are observing and analyzing radio noise generated by the sun. This is a companion project to cosmic radio noise studies already under way. The new job will seek to find the range of frequencies broadcast from the sun, received intensities, and the correlation of solar noise with other solar, interstellar, and terrestrial phenomena. Outstanding gadgets in the Bureau of Standards research will be two giant radar mirrors at the Bureau's radio propagation laboratory at Sterling, Virginia. These will intercept and record solar noise reaching the earth. The reflectors, about twenty-five feet in diameter, allow the capture of a large amount of energy from solar broadcasts. Automatically controlled, they will be directed at the sun constantly throughout the day. First studies will be made in the 480-500 mc. band.

THE BUREAU'S STUDIES have added significance these days, because it has been found that high- and ultra-high-frequency receivers, while practically eliminating internal set noises, are limited by interference from natural phenomena. Atmospheric radio noise—like that from a lightning discharge—ceases to be a major problem above 15 mc., but it is at this frequency that cosmic noise becomes noticeable as a low, steady hiss. Even FM suffers from this interference. FM itself tends to suppress the hiss within a certain range of the transmission station, but as distance increases, cosmic takes over until it completely drowns out the FM signal. Another strange thing—Standards experts have discovered that the universe has some powerful stations to compete with those on earth. Main center for broadcasting cosmic noise is the constellation Sagittarius in the Milky Way. It follows that the nearer you are to Sagittarius on the earth's surface, the worse the interference. The sun is another broadcasting center, in the ultra-high-frequency bands. It gives out with a hiss, but there is also an undulating component superimposed upon the stable noise—"puffs" or "swishes" lasting a second or less. Sometimes the swishes overlap and you get a grinding noise. This also may cause streaks to appear on a tele-

TEST CRAFT Instrument Co. Proudly presents
THE NEW MODEL TC-48

COMBINATION TEST SPEAKER



A COMBINATION TEST SPEAKER

plus resistor tester
plus condenser tester
plus resistor substituter
plus condenser substituter
plus output meter

No need to carry the speaker to your shop in servicing any radio from the small midget to the most elaborate console. Any output tube or tubes can be matched simply by rotating input switch to tube listed and rotate field switch for proper impedance and proceed with testing. External voice coil connection permits testing of set speaker to determine if output transformer is open or shorted.

SPECIFICATIONS

RESISTOR CONDENSER TESTER: 110 Volt A.C. power source for basic indications of either shorts and opens in both resistors and condensers. Leakage indication for condensers only.

CAPACITY SUBSTITUTION: 7 capacity values available, .001, .01, .02, .05, .10 at 600 volts and 30 mfd. and 50 mfd. at 150 V. Provides substitution of by-pass coupling and electrolytic condensers.

RESISTOR SUBSTITUTION: 6 resistance values available, 400, 50K, 100K, 500K, 2 meg. and 5 meg. at 1/2 w ft. Provides substitution of grid bias and other types of resistors.

OUTPUT METER: Neon type of output indicator for receiver alignment.

UNIVERSAL AND SUBSTITUTION SPEAKER: Field—500-1000-1500 and 2500 ohms at 175 ma. Speaker—Permanent magnet type. Voice Coil—2.8 ohms. Input—Single or push pull.

Available at your regular radio parts jobber. If your jobber cannot supply you, send your order directly to us.

A MUST FOR EVERY RADIO
SERVICEMAN AND ENGINEER

\$ 27⁵⁰
NET
PRICE

THIS UNIT COMES HOUSED IN A RUGGED, BATTLESHIP GRAY, CRACKLE-FINISHED, STEEL CABINET, COMPLETE WITH FULL OPERATING INSTRUCTIONS, READY TO OPERATE ON 110-125 Volts A.C., 50-60 Cycles. SIZE: 7"x11"x5".

Now Available for IMMEDIATE SHIPMENT

TEST CRAFT INSTRUMENT CO.
42 WARREN STREET Dept. RN NEW YORK 7, N. Y.



PICKERING UNIFORMITY

EVERY Pickering Cartridge which leaves our laboratory has been carefully tested for the following characteristics, the allowable limits for which are shown:

FREQUENCY RESPONSE • ± 2 db, 40-10,000 cps
WAVEFORM DISTORTION • 1 per cent maximum
OUTPUT LEVEL • 70 millivolts, ± 2 db
TRACKING PRESSURE • 15 grams max. at 40 and 10,000 cps

IN ADDITION, optical inspection of the stylus polish and shape, mechanical inspection of the moving parts, and electrical inspection of the pickup coil has been made on each unit.

REGULAR sampling tests reveal absolute stability, amazing ruggedness, and complete insensitivity to the effects of temperature and humidity.

NO OTHER PICKUP CAN QUITE MATCH THIS PERFORMANCE

Available with diamond or sapphire stylus from all principal distributors

Pickering & Company, Inc.

29 West 57th Street

New York 19, N. Y.

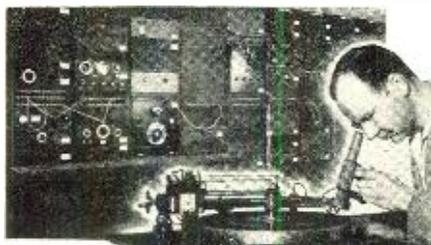

School of SOUND RECORDING and TRANSMISSION ENGINEERING

Learn sound recording and transmission engineering techniques of the professionals, as used in Motion Picture, Broadcast, F-M, Television, and Commercial Recording Studios.

A nine months practical engineering course, devoted exclusively to the technique of sound recording and transmission measurements. Well equipped studios, professional recorders and circuit laboratory containing latest model test equipment installed for student training. A portion of our laboratory is pictured above.

• New classes admitted the first School day of Jan., Apr., July, Oct.
Affiliated with the Don Martin School of Radio Arts
Approved for Veterans



H.M. Tremaine
Director

Write for Literature • Sound Department
Don Martin SCHOOL of RADIO ARTS
1655 Cherokee • Hollywood 28, California

RADIO TUBES

For immediate shipment
R.M.A. Guaranteed
Below Distributor Costs
Individually Sealed Cartons

Type	Price
6K6GT	.40
6K5GT	.46
6V6GT	.46
6SA7GT	.46
6SJ7GT	.46
6SK7GT	.46
6SQ7GT	.46
6X5GT	.40
12SA7GT	.46
12SQ7GT	.46
12SK7GT	.46
12SJ7GT	.46
35L6GT	.40
35Z5GT	.32
50L6GT	.46

RATED ACCOUNTS—2% 10 DAYS
ALL OTHERS 2% C.O.D.
10% DISCOUNT ON LOTS OF 50 OR MORE

RAVAC ELECTRONICS CORP.

432—4th Avenue
New York 16, N.Y.

vision screen, and picture jumpiness. Sometimes the solar bursts are so intense, lasting several hours, that radar pointed toward the sun becomes "blind." What the Bureau scientists are shooting for is the solution of the two chief problems in the field of cosmic noise; determining the intensity-versus-frequency function of the radiation; and a more accurate survey of intensity-versus-position at a variety of frequencies. To investigate the intensity-versus-frequency problem, a series of measurements are being made over the frequency range from 25 to 110 mc. by means of a battery of specially designed receivers, each tuned to a particular frequency. The intensity-versus-position problem requires the highest possible resolving power, which may be obtained either by going to the higher frequencies or by using larger collectors. Both lines of exploration are to be employed. When the Bureau gets data, scientists expect that it will be useful in a number of ways. For example, a radio sextant might be built to determine position from the direction of arrival of solar noise—"shooting the sun" by sound instead of sight and thereby jumping the problem of interference by cloud formations. The Bureau also believes that it may be possible, by analysis of the direction and intensity of cosmic noise, to study details of the Milky Way that cannot readily be seen through a telescope.

IT'S RARE radio news indeed to learn that FCC, undaunted by its load of work and by the economy wave that washed over it from the Congress, is one of the few government agencies that has actually cut down in the number of its employees. Believe it or not, last count showed that the Commission had a total of 1301 employees, a drop of twenty-eight from the total in June, 1947—1329. FCC didn't issue the report, either. It was put out by the joint committee on reduction of non-essential Federal expenditures, Sen. Harry F. Byrd, Virginia economy-waver, reporting. —50—

FRAYED TEST LEADS

THE insulation on test leads wears very quickly at the points where the wire enters the prod handles. Reinforce them and lengthen their life by dabbing on a few drops of "household cement" or airplane dope. Two applications are usually necessary, because the insulation is slightly absorbent and soaks up the first coating. Give the cement plenty of time to harden—about fifteen minutes—before using the cords . . . D.J.B.

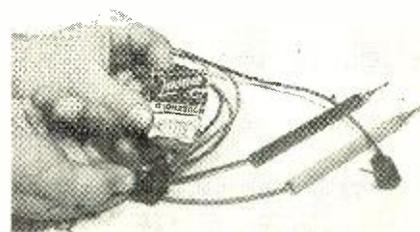

In Our 25th Year



ATTENTION !!!
ALL SCR-522 OWNERS:
 Remote Control Boxes for SCR 522's, Brand New in Original Packing. Consists of 5 push button switches, 5 Western Electric Pilot Assemblies, with Pilot Bulbs and Dimmer, and lever Switch, all finished in Black Crackle. Order yours Today for only...each **\$1.25**
 Antenna Plug 46-PS-1 for 522A.....Each 15c

I. T. & T. SELINIUM RECTIFIERS
 Full Wave Bridge Rectifier; 54 volts AC input, 39 Volts D.C. Output at 1.2 Amps. Signal Corps. Spec. 4D0238. Special at **\$1.50**
 Full Wave Bridge Rectifier; 144 Volts AC Input, 96 Volts DC Output at 1.1 Amp. Signal Corps. Spec. 9D0612B. Special at **2.50**
 These Rectifiers are All Brand New.

ARMY RADIO PHONES.

They're weather, water, and shock proof. Made to Army Specs. A complete Dynamic Hand Mike, 2 Ear phones, Headband, Cord Set, A Wonderful Buy. For Only each **\$1.95**

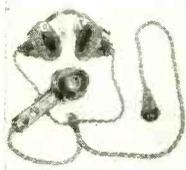

These Units are all Brand New.

ITEMS YOU MAY BE LOOKING FOR

Are-5 Banana Plugs, Silver Plated... per doz. **\$0.10**
 24 Volt G.E. Relay 200 Amp. Silver Plated Contacts..... each **.39**
 110 Volt Candelabra Base 1-inch Bull's-eye Pilot Assemblies, Clear or Amber..... each **.39**
 39" Telescoping Antenna..... each **.25**
 6 Volt Bayonet Base Pilot Assemblies with Dimmer, Red or White..... each **.19**

ANOTHER LEEDS SPECIAL

We have just received some 6.3 Volt Filament Transformers at 6 Amps. They'll go fast at each **\$1.50**

LEEDS

The Home of RADIO

OIL FILLED CONDENSERS

3x. 2 Mfd	4000 VDC	Tobe	\$0.98
2x. 1 Mfd	7500 VDC	G.E.	2.00
.02 Mfd	8000 VDC	Aero	.98
16 Mfd	400 VDC	W.E. Co.	.98
10 Mfd	600 VDC	G.E. or C.D.	.98
1 Mfd	5000 VDC	Solar	2.95
2 Mfd	600 VDC	C.D.	.49
2 Mfd	1000 VDC	Aero	.79

BEST BUY OF THE MONTH

100 Watt Wire Wound, Ferrule Type Resistors, in the following sizes: 25,000, 30,000, 40,000, 50,000 and 100,000 ohms. For Only, each **\$0.25**

Wire Wound Potentiometer

100,000 ohm, precision made G.R. type; 25 watt, 6" diameter. Brand new. **\$1.95**



METER SPECIAL

New in Original Cartons. 0-1 MA DC Gruen 2" round metal case. **\$1.95**

LEEDS SPECIAL

Westinghouse Meter, 2 inch ground bakelite case: 0-30-M.A.-D.C. Brand new—in original cartons. **\$1.95**

If not rated 25% with order, balance C.O.D. All prices F.O.B. our warehouse New York. No order under \$2.00. We ship to any part of the globe.

LEEDS RADIO CO.

Dept. RN2

75 VESEY STREET

COrtlandt 7-2612 New York City 7

Quality—Price—Dependability

RADIO TRANSMITTER & RECEIVER AFS 13

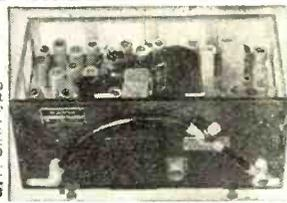

Tunes 410/420 megacycles; light weight airborne Radar; 17 tubes, including 5 6J6; 9/6AG5, 2 D21; 17W105 and 30 megacycles I.F. strip with schematic. All for **\$11.95**

5-INCH CATHODE RAY TUBES

Type 5B11 Green Screen, Brand New in Original Cartons. All Scope owners will want a few at this ridiculously new low price of...each **\$1.45**

VARIABLE AND MICA CONDENSERS

0.4 Mfd Aerovox Mica Condensers, 600 VDC eff. in low loss moulded Bakelite Case. A REAL BUY AT..... each **\$0.95**
 APC-25 Trimmers, Screw-driver Adjusted, 12 plates, 25Mmfd. Silver Plated Variables..... 15c ea.; 10 for **1.25**
 25 Mmfd Balanced Stator variables, Polished Plates, Isolantite Insulation, Swell for V.I.F. 29c ea.; 10 for **2.50**
 15 Assorted Silver Micas..... all for **.95**
 .01 Mfd 600 VDC Postage Stamp Micas..... 5c ea.; 100 for **4.75**

Ouncer Transformers, Mike to Grid, 25:1 Ratio Low to High Impedance..... 35c ea.; 10 for **\$2.95**
 Heinemann Magnetic Circuit Breakers, in 3 and 5 Amp. Sizes..... **.95**
 832 Tubes Brand New..... **2.15**
 Crystal Diodes 1N23A..... 35c ea.; 3 for **1.00**
 De Jur Wire Wound Potentiometer 12 Watts 20,000 Ohms..... **.49**

STEEL CHASSIS

10 x 17 x 3.....	\$1.38	11 x 17 x 3.....	\$1.86
5 x 10 x 3.....	.87	13 x 17 x 3.....	2.22
7 x 13 x 2.....	.96	7 x 7 x 2.....	.63
10 x 14 x 3.....	1.35	4 x 17 x 3.....	.99

STEEL CANS AND BOXES

4 x 4 x 2.....	\$0.68	12 x 7 x 6.....	\$1.68
4 x 5 x 3.....	.78	15 x 9 x 7.....	2.35
6 x 6 x 6.....	.99	11 x 12 x 8.....	2.25

1/8 INCH STEEL PANELS

3 1/4 x 19.....	\$0.66	10 1/4 x 19.....	\$1.22
5 1/4 x 19.....	.87	12 1/4 x 19.....	1.46
8 3/4 x 19.....	1.10	14 x 19.....	1.62

1/8 INCH ALUMINUM PANELS

3 1/4 x 19.....	\$1.38	8 3/4 x 19.....	\$2.25
5 1/4 x 19.....	1.74	10 1/4 x 19.....	2.87

TOM ALLEN Can't Keep It Secret!!! His Values TALK !!!

Field Telephones EE-8 & RM-29—Ideal for farm, warehouse, garage extension, or similar use. Works on 2 flashlight cells. With handset, generator, ringer, etc. In strong case. New. Only **\$14.95—\$9.95** Good used.....



T-45 Lip Microphone. It eliminates noises. You could find many uses for this mike. It's a buy at..... **49c**
 T-30 Throat Mike. New..... **39c**

BC-314F Receiver, with 2 stages of RF; separate local and beat frequency oscillator. Frequency range 150 to 1500 kc in 4 bands. 12 VDC can be easily converted to A.C. Complete with tubes. A real buy at..... **\$29.85**

RA-20 Powerpack—Converts BC-312 to AC operation; fits into dynamotor compartment. Works splendidly with BC 314-224-348-435-456-457. Primary 110 VAC 60 cycle; delivers 250 VDC @ 95 mls; 12V @ 3 amps; 12 VCT @ **\$9.95** 2 amps.

Gibson Girl Emergency Transmitter SCR 578A & B—Automatic or manual transmitting on 500 kc. No batteries required. Automatically transmits SOS signals. **\$9.95** A wonderful buy at.....



T-7B Handmike—New 200 Ohm, single button carbon mike. Ideal for home transmitter or portable rig. 5 ft. rubber cord, plug and dust cover. Special..... **\$1.29**

TS-13 Handset—200 Ohm carbon mike, 2500 Ohm earphone, 6 ft. rubber cord, 1—PL55 1—PL68 plugs attached. New **\$2.95**
 TS-15A Handset 200 Ohm, same as above in good condition..... **\$1.98**



BC-1023A — Ultra High Frequency Radio Receiver covering 62 to 80 mc range. An extremely sensitive relay works on 1/4 of mill. Contains 4 tubes—12SH7-6SQ7-6SC7-6U6TG. Brand New, Only **\$4.59**



Antenna AN-131A Half Wave 40 to 48 meg. 10 1/2 ft. long. Comes in 8 sections connected on a spring steel cable. Used on the SCR300 walkie talkie. In original sealed carton. **99c**

72 inch Whip Antenna, 37-50 meg. attached matching retractable section. Containing cylinder is 5" long 3 1/2" diameter with coaxial cable. New, Special. **\$2.45**

G.E. 50 Watt Ceramic Tube Sockets; for 211-838-250 T.H. and other type tubes. New, Each **79c**

R-15 High Impedance 8000 Ohm Headset. Has 8 ft. cord, rubber cushions and P155 plug. Brand New, Special at, set..... **\$1.79**

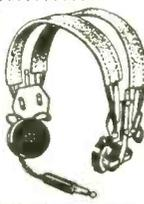

HS-30-U Hearing Aid type headset with rubber cushions 500 Ohms, low impedance. Brand New, Only **80c** each.....

Write for Quantity Discounts Prompt Delivery—Write Dept. RNF 25% Deposit Required on C.O.D. Orders Shipped F.O.B. New York. Minimum Order \$2.00

TOM ALLEN CORP.
 564 ATLANTIC AVE.
 BROOKLYN 17 NEW YORK

Radio Compass R5-ARN—Automatic Direction Finder. Complete with 15 tube superhet receiver with a frequency range from 200 to 1750 kc. All component parts less power supply. Instruction book giving complete information included. Brand New, Specially Priced **\$19.95**

Parachute 12 ft. in diameter, orange color silk, nylon cord, about 40 sq. feet of fine material can be used for underthings, wearing apparel and many other purposes. Brand New, Only **\$4.95**

Rubber Balloons—4 ft. in diameter; New, of extra heavy rubber. Used in the service for weather reports. Special..... **\$1.49**

SA-261-U Microphone Switch, 1 inch diameter. Each, Only **26c**

HI-Impedance Headphones, 6 ft. cord, with PL-54 plug; no headband; slightly used. **69c**

R-9A/APN 4 Receiver and Power Supply for APN 4. Contains 16 tubes. It's brand new, in perfect condition; works wonderfully. Look at the price, only **\$12.95**

BC 709A—Interphone Amplifier. Operates on 24 volt input, complete with dynamotor; 1—6V6 and 1—6SJ7 tube, volume control, carbon or magnetic microphone input. Complete. Brand New. **\$7.49**

FEBRUARY SPECIALS



SCOOP: The famous B-19, Mark II, 40 & 80 meter transmitter-receiver with tubes, dynamotor power supply, instruction manual, 12 ft. antenna & base, V.H.F. antenna and base, dummy antenna, mounts, 1 headset, microphone, key, junction boxes and interconnecting cables. N-1..... **\$29.95**

B-19 Mark II complete tank installation with all spares. Packed for export. Instruction manual, etc. N-1..... **44.95**

Headset & Microphone used with Mark II, N-1... **1.95**

BC348 Receivers, 200-500, 1500-18,000 KC. Complete with 28 volt dynamotor & tubes. N-2 **\$59.95**; N-3 **\$54.95**; U-1 **\$49.95**; U-2 **\$39.95**. Add **\$20.00** for conversion to 115 volts A.C.

BC224 Receivers, 200-500, 1500-18,000 KC. Complete with 14 volt dynamotor & tubes. N-1 **\$64.95**; N-2 **\$59.95**; U-1 **\$49.95**; U-2 **\$39.95**. Add **\$20.00** for conversion to 115 volts A.C. (NOTE: The BC224 is identical to the BC348 except input voltage.)

SCR522 Specials

Two meter transmitter-receiver with tubes N-1 **\$24.95**; N-2 **\$17.95**; U-1 **\$12.95**.

BC1206-C Satchell Carlson Beacon Receiver 28 volts D.C. 195-420 KC, 5 tubes, N-1..... **4.95**

BC474 with tubes, N-1 **\$37.50** with manual; N-2 **\$32.50**; U-1 **\$27.50**; U-2 **\$22.50**; U-3 **\$12.50**.

GIBSON GIRL SCR578B transmitter for sending distress signals from boats. Transmitter complete with balloon, hydrogen generator, kite and instruction manuals. N-1..... **25.00**

Famous 16 mm G.S.A.P. camera with 1 3/4" f 3.5 lens, speed 16-32-64 frames per second, 24 volts D.C. Standard 50 ft. magazines. Special N-1... **25.00**

EE-8 Telephone field sets with handset and ringer N-1 **\$15.00** ea., **\$28.00** pr.; N-2 **\$13.00** ea., **\$25.00** pr.; U-2 **\$10.00** ea., **\$18.00** pr.; U-3 **\$7.00** ea., **\$13.00** pr.

SCR284A, 3800-5800 kc.—Complete set..... **69.50**

BC654A Trans. Rec. Tubes, Xtal..... **19.95**

PE104A 6-12 volt vibrapack, **\$5.95**; (U)..... **4.95**

PE103A 6-12 volt dynamotor..... **8.95**

CD501A cable for PE103 A-BC654A..... **1.95**

GN45A Handcrank Generator and stand..... **4.95**

BC348 Mounting Base. Postpaid..... **2.50**

BC348 Outlet Plug PL-Q103. Postpaid..... **.80**

BC348 Mounting Base and outlet plug. Postpaid..... **3.00**

Sound powered handset N-1 **\$15.00** ea., pr..... **25.00**

Trim commercial 17,000 ohm headset N-1..... **4.25**

HS-23 8,000 ohm headset N-1 **\$1.29**; U-2..... **.89**

HS-33 600 ohm headset N-1..... **1.29**

Extension cords, PL55 plug incl. N-1..... **.40**

HS-30 Ear plug headset N-1 **\$0.95**; U-1..... **.50**

Matching transformer, HS-30..... **.50**

TS-13 Handsets N-1..... **3.45**

115 V.A.C. 1/4 h.p. motor with 250v 600MA amp-dyne generator N-2..... **18.75**

200FD Johnson var. cond. dual N-2..... **1.19**

182A Selsyn Compass Indicator U-1..... **1.50**

Companion Transmitter Selsyn U-1..... **1.50**

181A Selsyn Compass Indicator U-1..... **1.50**

Companion Transmitter Selsyn U-1..... **1.50**

BC733D Aircraft Glidepath Receiver N-1..... **24.95**

(Approved by C.A.A.)

SCOOP: MN26 Radio Compass Receiver 150-1500 KC U-1 **\$18.95**; U-2 28 V. D.C..... **14.95**

SCR610 FM 10 meter transmitter-receiver, 6, 12 and 24 volt power supply with tubes U-1..... **14.95**

T-17 Mike N-1..... **1.95**

Meter Rectifier, full wave midget Selenium, 10 volts, 30MA, N-1..... **.29**

APS-15 3CM Radar Transmitter complete with magnet, magnetron, Klystron and other tubes..... **14.95**

BC464D Receiver and selector for 5 channel remote control with battery container and antenna N-1..... **14.95**

CODE: N-1 New, in original boxes.
N-2 New, repacked.
N-3 New, removed from new equipment.
U-1 Used, excellent condition.
U-2 Used, minor scratches.
U-3 Used, rough handled, good working condition.

TERMS: F.O.B. Pasadena unless postpaid. No C.O.D.'s under **\$5.00**. 25% deposit on ALL orders. All C.O.D.'s shipped by Rail Express. Save freight and C.O.D. fees by sending full price with order and we will ship by fast truck. Minimum order **\$2.00**. Californians include 2 1/2% sales tax.

PHOTOCON SALES

1062 N. Allen Ave. Pasadena 7, Calif.

Manufacturers' Literature

Readers are asked to write directly to the manufacturer for the literature. By mentioning RADIO NEWS, the issue and page, and enclosing the proper amount, when indicated, delay will be prevented.

HEXACON FLYER

Hexacon Electric Company is currently offering a two-color flyer describing the company's line of electric soldering irons.

Performance characteristics and operational specifications are included in the bulletin which may be obtained upon request to *Hexacon Electric Co.*, 161 W. Clay Avenue, Roselle Park, New Jersey.

TAPE RECORDERS

A series of ten *Magnetape Recorders* and accessory equipment is described and featured in the recently released, 8-page circular issued by the *Magnephone Division of Amplifier Corp. of America*.

These units, the first of a complete line of magnetic tape recorders and playback instruments, feature extended frequency response up to 12,500 cycles, adjustable tape speed, portability, and an 8-hour continuous play model.

Accessory equipment described in the circulator includes an "E-Z-Cue" for instantly locating any section of a reel, a cabinet designed to hold the recorder and 200 reels of tape, labels and index cards for instant reference, a handy splicing and maintenance kit, and a robot timing device to automatically start and stop the recording of any one or more programs from a pretuned broadcast station.

Copies of the circular are available upon request to the *Magnephone Division, Amplifier Corp. of America*, 398-2 Broadway, New York 13, New York.

ADVERTISING SERVICE

In an effort to assist radio jobbers, the *J. F. D. Manufacturing Co., Inc.* of Brooklyn, New York has instituted a program whereby mats and electros of all *JFD* products are available for use in the preparation of ads, catalogues, and mailing pieces.

In addition, the company has prepared 4" x 6" stuffers covering the more popular service items. These stuffers are available to all jobbers for distribution, without charge. Space has been provided on these stuffers for the jobber to imprint or stamp his own name.

For further details, jobbers are requested to write direct to *J. F. D. Manufacturing Co., Inc.*, 4117 Fort Hamilton Parkway, Brooklyn 19, New York.

ANTENNA SYSTEMS

Dayton Aircraft Products, Inc., has just issued an 8-page booklet on the

reduction of precipitation static in aircraft radio.

The booklet goes into considerable detail on the causes for precipitation static and describes the methods developed by the U. S. Air Forces during the war for greatly reducing this static. The methods now used consist of metal and ceramic antenna fittings, which in conjunction with polyethylene wire, insulate the antenna system against corona discharge. These fittings are made to be used on marker beacon, compass sense, and receiving and transmitting antennas.

The booklet, complete with installation and maintenance instructions, will be forwarded free of charge on request to *Dayton Aircraft Products, Inc.*, 342 Xenia, Dayton, Ohio.

ANNIVERSARY BOOKLET

L. S. Brach Manufacturing Corporation, now in its 40th year of serving the radio and electrical industries, has issued a special anniversary booklet which should be of interest to our readers.

The booklet traces the beginnings of the company and summarizes briefly the accomplishments of the organization both in war and peace.

Copies of this publication are being distributed free of charge upon request.

Address your letters to *L. S. Brach Manufacturing Corporation*, 200 Central Avenue, Newark 4, New Jersey.

CONDENSER DATA

Illinois Condenser Co. of Chicago has just published a new supplement to their catalogue of September, 1947.

The supplement lists new additions to the "Illini" line of electrolytic condensers and contains information about types designed especially for use in voltage doubling circuits. Several new high voltage, high capacity types are also listed, for the first time.

Copies of the supplement may be secured by writing *Illinois Condenser Co.*, 1616 Throop Street, Chicago 22, Illinois.

W-L CATALOGUE

Ward-Leonard Electric Company has announced the availability of its new catalogue, D-30, which describes and illustrates a comprehensive line of stock units in resistors, rheostats, and amateur relays.

The publication covers "Vitrohm" rheostats and resistors in a wide range of types and values. Full information is given on ring type and heavy duty plate type rheostats and on fixed tubular, Adjustohm, Stripohm, plaque,

non-inductive, Discohms, line voltage reducers, and fluorescent lamp resistors.

The company's complete line of radio amateur relays for standard applications are also listed in the catalogue. Included among stock items are antenna, r.f. break-in, bandswitching, keying, overload, time delay, safety, sensitive, latch-in, and remote control relays and transmitter control panels for low, medium or high power ham rigs, in kit form or completely assembled and wired.

A copy of catalogue D-30 may be procured by writing to the Radio and Electronic Distributor Division, *Ward Leonard Electric Company*, 53 W. Jackson Boulevard, Chicago 4, Illinois.

SERVICE TEST EQUIPMENT

The *Specialty Division of General Electric Company's Electronics Department* has just published a new 18-page catalogue covering service test equipment.

The publication lists the specifications of nine instruments in the division's line of test equipment; tube checker, Type YTW-1; signal generator, Type YGS-3; oscilloscopes, Types CRO-3A and CRO-5A; capacitance-resistance bridge, Type YCW-1; unimeters, Types YMW-1A and UM-3; sine or square-wave generator, Type YGA-2; and high voltage multiplier, Type YYW-1.

A copy of this catalogue, which has been designated ESD-129, may be secured from company distributors or direct from the *Specialty Division, General Electric Company, Electronics Park, Syracuse, New York.*

-30-

Recording of Sound

(Continued from page 58)

self-contained unit with the main switching functions given to illustrate how the components of the circuit are utilized for either recording or reproducing.

The amplifier consists of two voltage stages utilizing a single 6SL7, an equalizer network, a 6SC7 as a phase inverter, and two 6V6's in push-pull in the output stage. Other components shown are record-playback head with a non-inductive resistor in series, a Hartley oscillator for the bias supply, a neon lamp volume indicator circuit, and a well-shielded input transformer.

With the selector switch in the "record" position, a signal may be fed from a microphone into the first stage, or from the detector stage of a radio, or from a phonograph into the second stage. From that point the signal may be followed through the equalizer network, the remaining stages of the amplifier, and thence to a portion of the winding on the record-playback head through a non-inductive resistor. A signal of 35-60 kc. from the bias oscillator is fed to the other portion of the winding on the head. The method of applying the high frequency bias sig-

February, 1948

MANUFACTURERS' SERVICEMEN

This Sensational Picture IF & Sound IF Strip developed by our engineering staff and enables you to build a 10"-12" 15" - 20" Direct View or Projection Type Receiver with FM Sound Supplied with a 13 Channel RF Front End Unit

PICTURE IF & SOUND IF STRIP

PATENTS PENDING

Chassis Size
4 1/2" x 13" x 5"

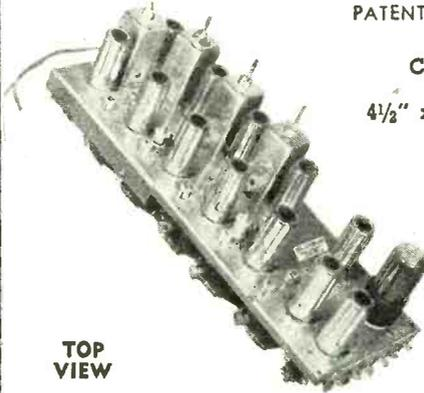

TOP VIEW

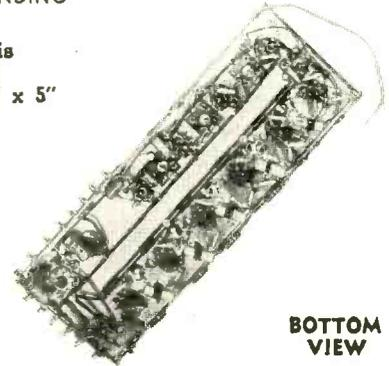

BOTTOM VIEW

1. PICTURE IF STAGES

Five picture IF stages of amplification and second detector

2. SOUND IF STAGES

Two IF stages with limiter and discriminator

3. VIDEO STAGES

Two stages of Video with a frequency response of 4.5 mc/s

4. ONE D.C. RESTORER

5. IF FREQUENCY

Audio 21.25—Picture 25.75

6. TUBES

5—6J6—Picture IF Amplifier

1—6J6—Picture IF Amplifier & Detector

1—6AU6—1st Video Amplifier

1—6K6gt—2nd Video Amplifier

1—6AU6—Limiter

1—6AL5—D.C. Restorer

1—6AL5—Discriminator

2—6BA6—Sound IF Amplifier

Picture IF Band Width 4.5 mc/s

• All the Above Circuits and tubes are contained on 1 chassis. • Front End Unit on separate chassis. • Both Picture IF & Sound IF delivered completely wired, tested, tubed, and matched ready for use.

FRONT END

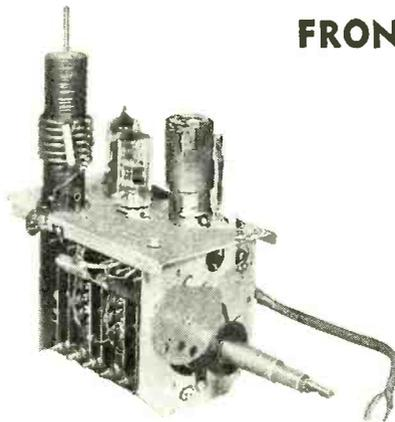

The Front End covers channels from 44 to 88 mc/s and 174 to 216 mc/s (13 channels). Matched antenna input for 300 ohm line. Tubes: 1-6J6 RF Amplifier 1-6J6 Converter 1-6J6 Oscillator

PRICE **\$119.50**
DEALERS NET

Contact Us for your Local Distributor

TELEVISION
INDUSTRIES

540 BUSHWICK AVE.
BROOKLYN 6, N. Y.

*Light
in Weight!*

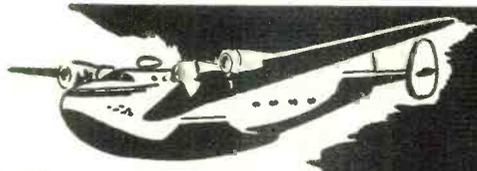

Combining minimum weight with small size, JOHNSON Type H Condensers are designed especially for aircraft transmitters. Simple and rugged in construction, JOHNSON Type H Condensers easily withstand heavy vibration. STEATITE end plates prevent any possibility of "short circuit loops" and permit panel mounting with both rotor and stator insulated from ground. Capacities and spacings are provided for low and medium power stages. Aluminum plates are .020" thick. End plates are 1½" square.

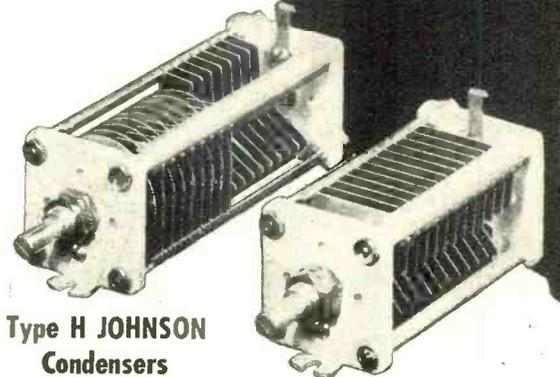

**Type H JOHNSON
Condensers**

Excellent for police equipment, airline ground equipment, amateur equipment, test equipment, VHF and others. They're small in size—great in performance!

For Further Details Write for Latest JOHNSON Catalog



JOHNSON *a famous name in Radio*

E. F. JOHNSON CO., WASECA, MINNESOTA

**RC-163 VERTICAL
3-ELEMENT ARRAY**

With Electrically Operated Rotator Continuously Tunable 20 to 39 Mc. (10-11 & 15 Meters)

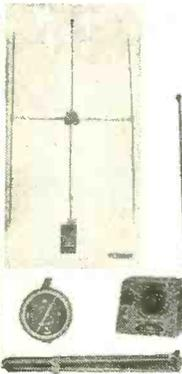

Operates under all outdoor conditions. Assembly consists of 3-element array, rotating mechanism, field strength meter, Surveyor's Compass and Tripod, and all accessories and cables.

- All Three Elements Driven
- Feeds with 72-ohm line
- Rotator strong enough to handle additional beams at same time
- Continuously Rotatable • 4 to 5 db Forward Gain; Cardioid Pattern, completely null at back
- Simplified Assembly, easy tuning, ready to go on air one-half hour after uncrating!
- Changeover

from 10-11 to 15 meters or back, in ten minutes. Operates on 12V 4½ Amps DC. Shpg. wt. 330 lbs. Your net cost, complete assembly, FOB Lynbrook, N. Y. **89.50**

HOTTEST ITEM OUT!! Make your SCR-522 Receiver operate on 144 to 148 Mc. with ONE DIAL control, in less than 1 hour! Parts and instructions 3.00
Include 8c Postage

ARC/5 2-3 Mc XMTR. \$9.00
BC-454 3-6 Mc RCVR 5.50
BC-455 6-9 Mc RCVR 5.50

XMTG TUBE BARGAINS!

807 \$1.00 8025A 500 Mc Triode. \$3.95
805 3.95 35TG 2.95
810 5.95 100TH 7.50
250TH 11.95

ALL TUBES SHIPPED EXPRESS.

MERIT RADIO SUPPLY CO.

471 Merrick Road LYNBROOK, N. Y.

TECHNICAL KO's

Power Xformer 850VCT, 750VCT @ 200 Ma.
5V @ 3A, 6.3V @ 5A \$4.14

6V6 Metal \$0.89 6L6 Metal \$0.95
12SQ7 Metal32 12K8 Metal32

.01-150V Paper (Midget)60 for 1.00
.02-1600V Paper10 for 1.00
.1-600V Paper12 for 1.00
Mica—.002, .005, .006 etc. 600V08
Cond. Kit .01-.00001 100 for 3.00
Bathtub Kit 3x.1, .5, 1 etc. 10 for .89
Resistor Kit ½ & 1w Assorted 100 for 1.49
Choke—Nationally Known 12H-80 Ma-250 ohms 1.09
Choke—Nationally Adv. 10H-100Ma-250 ohms 1.09

OIL-FILLED NATIONALLY ADV.		TRANSMITTING MICAS	
.05 MFD	1000V \$0.28	.000025	2500V \$0.11
.1	2500V .60	.00005	1600V .12
.1	7500V 1.85	.00005	2500V .14
2X.1	7000V 4.75	.00005	5000V .95
.12	15000V 5.95	.000067	2500V .20
.25	1000V .35	.00007	2500V .14
.25	4000V 2.75	.00025	2500V .25
.25	6000V 4.00	.00025	5000V .95
10X.25	600V 1.00	.0004	2500V .18
.5	600V .28	.0005	2500V .18
.5	1000V .35	.00072	5000V .95
.5	2000V .40	.0008	5000V .95
.5	3000V .60	.001	2500V .18
.75	2000V .55	.0015	5000V .95
.77	330VAC .35	.002	2500V .27
1.0	1000V .45	.002	3000V .66
2.0	1000V .60	.0025	1200V .15
4.0	600V .60	.00275	2000V .28
4.0	1000V 1.00	.003	2500V .30
6.0	1000V 1.25	.004	2500V .36
6.0	2000V 1.75	.005	3000V .66
8.0	600V .70	.006	2000V .33
8.0	1000V 1.75	.008	1200V .12
10.0	600V .85	.01	1200V .14
30.0	330VAC 2.35	.02	600V .11

\$2.00 min. order F.O.B., N.Y.C. Add postage. 50% deposit, balance C.O.D. with all orders. Manufacturers' inquiries invited.

TECHNICAL RADIO PARTS CO.

265 Greenwich St. Dept. N-8 N. Y. 7, N. Y.

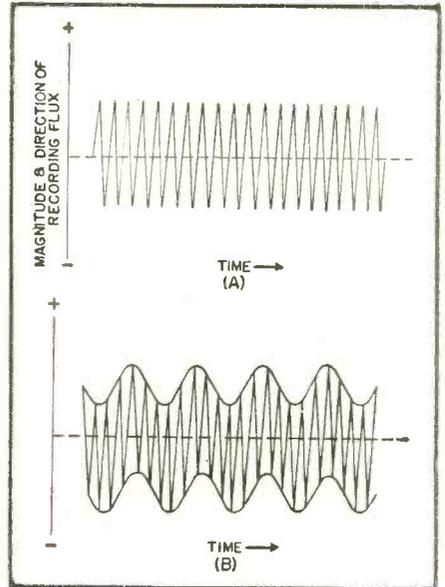

Fig. 5. Typical oscillograph patterns. (A) Bias supply and (B) with superimposed audio. It is essential that the wave shape of the bias supply be as nearly perfect as possible. Any non-uniformity will result in noise and distortion on a recorded signal.

nal and the audio signal to separate or tapped windings has been found to be more satisfactory than mixing in the amplifier.

The non-inductive resistor serves two purposes; to match the audio winding of the head (approximately 1 ohm) to a four or eight ohm winding of the output transformer, whichever may be chosen, and to increase the ratio of the signal to the inherent noise of the amplifier (i.e., hum and thermal noise present when gain control is turned down).

The method of recording used requires a magnetically saturated medium to which a high frequency bias signal is applied with the audio signal superimposed. For the type core used in the head design described from ten to fifteen ampere turns are required for the bias component, and from two to four ampere turns for the audio component of the signal.

For the playback function, the selector switch is set accordingly and the signal from the head passes through the input transformer into the first stage of the amplifier. The signal passes through the amplifier in the same manner as for recording, and then to a speaker.

Care must be taken in positioning and shielding the input transformer. Experience has shown that it is most practical to have it as near the head as possible. Shielding should be both electromagnetic and electrostatic. The voltage gain of the transformer should be from 75 to 100.

The recording volume level indicator consists of a small neon lamp biased so that the maximum desirable peak signal at the plate of one of the output tubes will cause the lamp to ignite. A potentiometer arrangement for supplying the bias voltage to the lamp facilitates proper adjustment.



AVAILABLE NOW!
WORLDS ONLY COMPLETE
1948
LINE



The only complete line of new 1948 model speakers in the world. Available now, this new complete line of speakers is designed for every need and requirement . . . 2" to 15" . . . square, round, ovals and pin-cushions.

Cinaudagraph
Speakers

DIVISION OF **Aircon** MFG. CORP.

General Office and Factory, 1401 Fairfax Trafficway, Kansas City 15, Kansas

EFFECTIVE

on both television bands
and all F-M stations

The LABORATORY ENGINEERED Antenna for Television and F-M Receivers

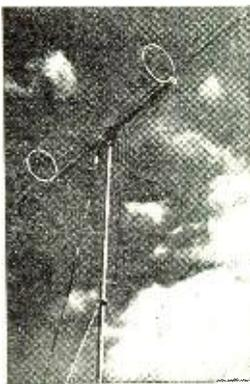

Model 300

ALLWAVE TELEVISION F-M Antenna

Effective on all stations, not just one station . . . no extra attachments to buy to reach all channels or new stations . . . full coverage . . . reduces noise . . . low standing wave ratio . . . easy to install . . . comes complete . . . striking appearance . . . all metal construction. Designed to match all sets with the standard 300-ohm input . . . **ECONOMICALLY PRICED.**

Also Available—Model M-100

"Under-carpet F-M Antenna" . . . low cost . . . ideal reception . . . complete in individual carton . . . ready to install . . . can be hung vertically, behind drapes, etc. Write for illustrated literature and prices.

AVAILABLE AT LEADING JOBBERS

Jobbers: Write for illustrated and technical literature and quantity prices.



TRICRAFT PRODUCTS COMPANY

1535 N. Ashland Ave. Chicago 22, Ill.

Dept. N

Manufacturing specialists of special antenna

CURRENT CONVERSION

WITH **ATR** QUALITY PRODUCTS



ATR "A" BATTERY ELIMINATORS

For **DEMONSTRATING**
and **TESTING AUTO RADIOS**

New Models . . . Designed for Testing D.C. Electrica Apparatus on Regular A.C. lines. Equipped with Full-Wave Dry Disc Type Rectifier Assuring Noiseless, Interference-Free Operation and Extreme Long Life and Reliability.

- Eliminates Storage Batteries and Battery Chargers.
- Operates the Equipment at Maximum Efficiency.
- Fully Automatic and Fool-Proof.
- Type 60-ELIA . . . Rated Output: 6.3 Volts at 6.5 Amperes.

Dealer Net Price \$22.80

- Type 120C-ELIO . . . Rated Output 6.3 Volts at 14 Amperes.

Dealer Net Price \$37.20



ATR AUTO RADIO VIBRATORS

Designed for Use in Standard Vibrator-Operated Auto Radio Receivers. Built with Precision Construction for Longer Lasting Life. Price are approximately 15% lower.

ATR STANDARD AND HEAVY DUTY INVERTERS



For Inverting D.C. to A.C.
Specially Designed for Operating A.C. Radios, Television Sets Amplifiers, Address Systems, and Radio Test Equipment from D.C Voltages in Vehicles, Ships, Trains, Planes and in D.C. Districts.

Write for New ATR Catalog—Today!

AMERICAN TELEVISION AND RADIO CO.

Quality Products Since 1931

SAINT PAUL 1, MINNESOTA — U. S. A.

NUMBERS 4 and 5 OF THE WALSCO Hit Parade

WALSCO STANDARD TEST RECORD

FOR IMMEDIATE . . . ACCURATE . . . AUDIBLE ADJUSTMENT OF RECORD CHANGERS AND COIN OPERATED PHONOGRAPHS . . . SOLVES THE PROBLEM OF ADJUSTING PICKUP AND TRIPPING MECHANISM THROUGH **SOUND!**



- Three Tone lead-in grooves permits immediate adjustment to proper set down position of the pick-up through audible means.
- Made to RMA and NAB standards.
- Record plays in less than 40 seconds.
- Audio tone at end of record indicates proper adjustment of tripping action.

The WALSCO Standard Test Record saves time and increases efficiency in the adjustment of record changers and coin operated phonographs. Write for full information.

WALSCO products

Help The Radio Man

WALTER L. SCHOTT CO. BEVERLY HILLS CALIF. CHICAGO 5, ILL.

WALSCO UNIBELT THE UNIVERSAL DIAL DRIVE BELT CAN BE CUT TO FIT ANY DIAL DRIVE Will not Slip or Stretch

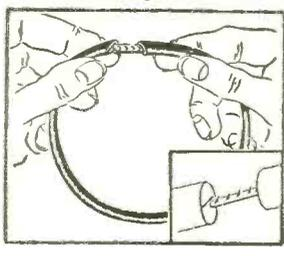

"UNIBELT" comes in 5-foot length spools and can be installed without taking dial mechanism apart. A real time and money saver. Eliminates the need for stocking numerous sizes of belts.

Free sample and literature. Write to Dept. 1A

AMAZING BLACK LIGHT

Complete with resistance line cord & ultra violet ray filter. Ready to operate from your 110v. AC line. Rigid Mount . . . \$2.95
Gooseneck Mount . . . \$3.49
Replacement Bulbs—\$.35 ea.

FILTER CHOKES

30 Henry 50 MA, 2500 volt RMS 500 ohm DC resistance. Open frame . . . \$.75
10 Henry 100 MA, 455 ohm DC resistance. Mfd. by Westinghouse. hermetically sealed . . . \$.85

WIRE WOUND RHEOSTATS

50 Watts, 8 ohm, 35 ohm and 250 ohm . . . \$.85
25 Watts, 100 ohm, 25 ohm, 35 ohm, 2500 ohm . . . \$.75

CAPACITORS

1100 MFD. 50 Volt . . . \$.90
1500 MFD. 50 Volt . . . \$ 1.10
2000 MFD. 50 Volt . . . \$ 1.25
500 MFD. 200 v. . . \$ 1.75

SWITCHES

Slide switch: Stackpole DPDT . . . \$.15
SPDT momentary, center off position, long bat handle . . . \$.29
4 pole DT 10A, 125 v. . . \$.50
SPDT center off position, 6A, 125V. . . \$.29

CONDENSERS

3 Gang Variable Condenser 50 MMFD per section Ceramic insulation . . . \$.65
4 Gang Variable Condenser 50 MMFD per section Ceramic insulation . . . \$.85
Oil filled condensers: .03 mfd. 7500 v. DC . . . \$ 1.15
 .30 mfd. 2000 v. DC . . . \$.65
 1 mfd. 2500 v. DC . . . \$ 1.25
 1 mfd. 1200 v. DC . . . \$.65
 4 mfd. 2000 v. DC . . . \$ 2.75
Variable Condenser 2.5 to 10 mmf. . . \$.45
10 Mfd 1500 v. DC . . . \$ 3.15

No sale less than \$2.00. All prices FOB New York City. Add 25c to cover postage. 20% Deposit required with all orders.

A. M. RADIO SALES COMPANY 345 CANAL ST. NEW YORK CITY 13, N. Y.

BARGAIN SPECIALS!

SURPLUS SPECIAL—Small 110 v. AC open frame motors. 1/2" shaft. 2700 R.P.M., 1/70 H.P., mfd. by BARBER COLMAN . . . \$2.00 ea. CO.

MISCELLANEOUS

- PL259A Coax Connector and Socket. *Silver Plated for RG8U and RG11U . . . \$0.50 pr.
- 3AG fuse holder, Mfd. by Littelfuse \$.20
- Flexible shafts, 4 1/2 inches long 3 for \$.25
- Grounding straps, heavy flexible wire, lugs both ends—4 inches long 4 for \$.05
- Mica trimmers: Variable 3-30 Mmfd 4 gang . . . \$.20
- Variable ceramicon 4-30 mmf. 7-45 mmf. \$.25
- Filament Transformer: 5 volts @ 4 amp, 110 volt pri. open frame, porcelain standoffs. Mfd. by G.E. \$ 1.00
- 0 to 15 DC Milliammeter. Simpson 3/2" Bakelite case . . . \$ 2.95
- Pilot Light Assy. 1" Ruby jewel complete with 110 v. AC Candelabra base bulb \$.40
- 12 v. Edwards' Buzzer complete with push button \$.40

SYNCHRONOUS MOTOR

1/2" shaft 110 v. AC 60 cy. 1 RPM, 2.2 watts Mfg. by Hayden Mfg. Co. \$ 1.25

Fig. 2 is a block diagram of the circuit components for a radio adapter unit. Much of the circuit is the same as for the self-contained unit with the exception of the final amplifier stages. It is desirable to have the recording amplifier self-contained in the adapter and to use the radio amplifier for playback only. Two circuits are required between the unit and the radio, one for recording radio programs and the other for the reproduction of recordings. The signal from the equalizer, approximately 0.5 volt, is fed into the phonograph jack or the first audio stage. Other than this the operation of this unit is the same as that of the self-contained unit.

Record—Reproduce Heads

Fig. 3 is a schematic drawing of the construction of an experimental record-playback head of low-impedance type. The core is built up in two legs of .007 inch mumetal laminations. Each leg is wound with 80 turns of 28 heavy Formvar copper wire, one leg having a tap at the first 30 turns. The tap is grounded, and for recording the audio signal is fed to the 30-turn winding and the bias signal to the 130-turn winding. During playback the signal from the 130-turn winding is fed to the primary of the input transformer. The ground surfaces of the two legs of the core are butted together with a .0005" thick non-magnetic spacer at the recording gap and tacked at several points with solder. The head may be potted in a small magnetic shield can.

Although the coils are wound on the core in a hum-bucking arrangement, it may be necessary to have additional magnetic shielding between the head and the driving motor and/or the power transformer.

High-Impedance Head

The new head developed by The Indiana Steel Products Company incorporates many improvements which add to the flexibility and fidelity of

Fig. 6. Circuit diagram shows test setup for checking wave shape of bias oscillator.

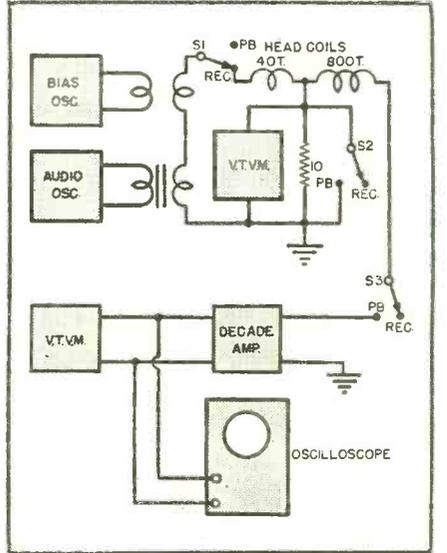

Deluxe Table Model. Can be screwed down or hooked to table with C Clamp. Complete . . . \$31.75

COIN RADIO KITS SEPARATELY OR COMPLETE UNITS

- PLASTIC CABINET AND GRILL for table model . . . \$ 5.75
- Richly grained brown or ivory marble effect. No stains—no burns—No refinishing. Exceptional acoustics only equaled by this type of cabinet.
- TIMERS (Quarter 1 and 2 hour or 5c 10 Minutes) . . . \$ 4.95
- AC RADIO Chassis RCA 5-Tube Super-Het, Completely Wired . . . \$ 15.35
- METAL HINGED BASE AND BACK with No-Cheat Coin Box and Brackets. . . . \$ 3.45
- MISCELLANEOUS ACCESSORIES 2 LOCKS, WING NUTS, NAME PLATES, Etc. . . . \$ 1.80
- CONSOLE PLASTICS BASE to complete Console Model . . . \$ 4.25
- BEAUTY PARLOR DRYER HEAD SETS AND HOLDER . . . \$ 1.80

Deluxe Console, no stand needed. Can be fastened to floor. Complete . . . \$35.00

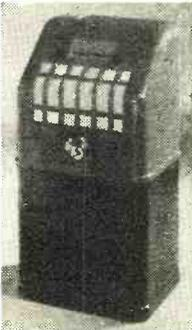

RADIO-COIN-MATIC

BOX 9465
1110 S. NORMANDIE
LOS ANGELES 6, CALIF.

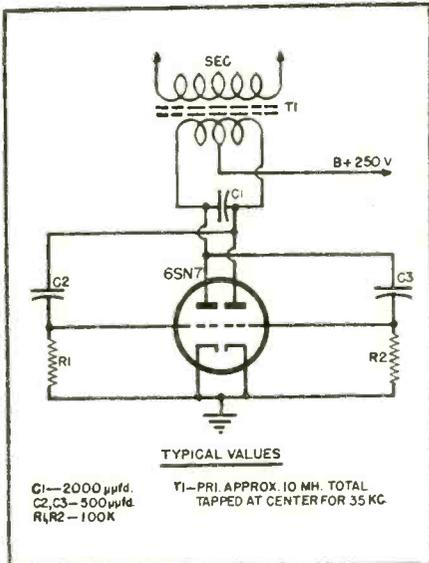

Fig. 7. Diagram of push-pull bias oscillator.

magnetic requirements. This new design incorporates a flat top so that a pressure pad can be used to assure more intimate contact of tape with the gap area. This head was designed in conjunction with *Hyflux* tape and is illustrated in Fig. 4A.

Tests have indicated that *Mumetal* is a satisfactory material for a dual purpose head. Indications are that *Permalloy* or other materials of similar composition and characteristics are also satisfactory. It should be emphasized, however, that all magnetic materials of this nature must be properly heat treated after stamping or other cold working. It is imperative that close tolerances shown for pole dimensions be closely held. The gap length should be as short as possible consistent with uniformity. The best possible mechanical joint will result in an effective magnetic gap of approximately .0005". Spacers of any thickness under .001" usually contribute to non-uniformity and it has been found more desirable to use a plain butt joint between the two polished surfaces when a very small gap is required. A basic record-reproduce circuit for use with this head is shown in Fig. 4B.

Bias and Audio Current Requirements

Both bias and audio flux above the

Fig. 8. Bias oscillator circuit as applied to magnetic tape recording.

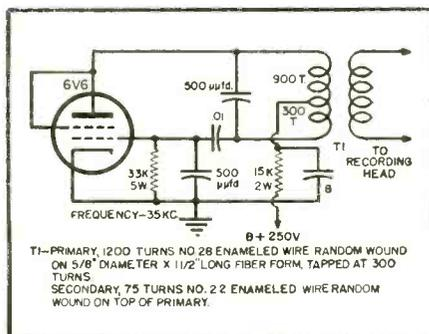

Here it is GIANT War Surplus CLEARANCE!

MODEL ATD

AIRCRAFT TRANSMITTER

Covers 540 Kc. to 9050 Kc. C.W. or fone, designed for Dynamotor Operation. Power supply requirements are 380 volts and 1000 volts DC.

Separate Ant. Tuning units covering the following frequencies

540—1500 Kc.

1500—3000 Kc.

3000—9050 Kc.

10 1/2" high, 12 1/4" deep, 2 1/2" long. Shipping weight 100 lbs. Price F.O.B. New York City.

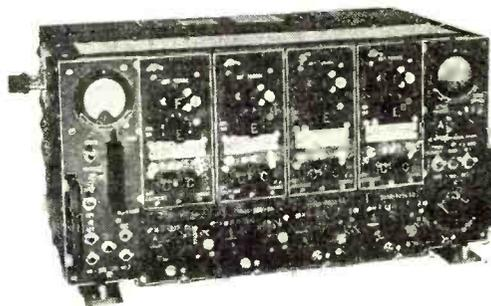

Tube line-up as follows: RF Osc. 6L6—RF Amp. 814 Audio—6SL7 Pre. Amp. into 6L6 driver and side tone amplifier with pair of 6L6 modulators, screen of oscillator tube, regulated with VR 150 Tube. All circuits are metered.

FOR FAST TURNOVER

MASTER OSCILLATOR MI-19427-B

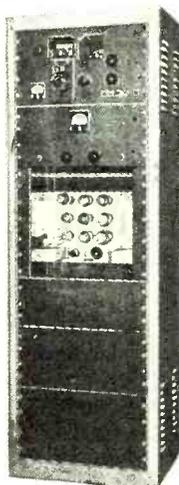

This unit was built for R.C.A. Add a final—becomes a complete transmitter with signal shifter. Voltage regulated power supply is perfect for Television sweep circuits for field or station use or wherever 300 v. must be maintained under varying load conditions—COMPLETE \$225.00 (less tubes)

TECHNICAL SUMMARY

ELECTRICAL CHARACTERISTICS
 Output Frequency . . . 2 to 20 megacycles
 Output Level, Buffer Amplifier . . . Sufficient to drive an RCA-807
 Modulation . . . Frequency . . . 650 cycles ± 150 cycles
 Frequency Deviation . . . (maximum) . . . ± 500 cycles
 Power Consumption 200 watts
 Power Supply . . . 115 230 volts, 50/60 cycles
 Oscillator Filament 6.3 volts a-c
 Current 0.05 ampere d-c
 Amplifier and Tone Generator Filament Voltage 6.3 volts a-c
TYPICAL PERFORMANCE DATA
 Line voltage change ± 10 per cent 0.0005 per cent
 Temperature change, per degree Fahrenheit 0.0007 per cent
 Relative humidity change of 1 per cent over the range of 30 to 95 at a dry bulb temperature of 110 degrees F 0.0003 per cent

MECHANICAL SPECIFICATIONS—Dimensions: Height, 66 9/16 in.; Width, 22 in.; Depth, 17 1/8 in. Weight, 275 pounds.

WRITE FOR LATEST BULLETIN 2N8

20% deposit with all orders unless Rated—All prices F.O.B. N. Y. City

Limited quantity

COMPLETE \$4950 ONLY

COMPLETE (Less Tubes) SPECIAL

\$225.00

NIAGARA RADIO SUPPLY CORP.
160 GREENWICH ST., NEW YORK 6, N. Y.

EE-8 B ARMY SIGNAL CORPS FIELD TELEPHONES

Portable field unit, fully equipped with ringer, coils, condenser, generator and crank, can be used anywhere. Various Manufacturers. Regular \$28.50 value. OUR PRICE (without carrying case) with handset \$10.50 each. UNUSED. IMMEDIATE DELIVERY.

Maspeth Telephone & Radio Corporation
427 Flatbush Ave. Extension
Brooklyn 1, N. Y.
Telephone ULster 7-0500



RADIO COURSES

Preparatory, Broadcast, Marine Operating, Servicing, Aeronautical, Television, Frequency Modulation, Radar.

Classes forming for mid-year term February 2nd. Entrance Exam. Jan. 12th.
Veteran Training. Literature.

COMMERCIAL RADIO INSTITUTE

(Founded 1920) 38 W. Biddle St. Baltimore 1, Md.

SAVE \$ ON RADIO SURPLUS

ATTENTION: Prospectors,
Explorers for Hidden Treasures!

Do you seek hidden treasures or rare metallic ores? If so, construct a U.S. Army Type 214 Metal Detector from these U.S. Army Mine Detector Amplifiers that we are offering at a ridiculously low price. Complete Amplifier (as illustrated) (less tubes and batteries) with Battery case and cables. Cables, head-phone cord and jack (no phones). Complete Army wiring diagram. U.S. Army DETECTOR SET Amplifier Type AN/PRS-1. **\$2.49** as described. Only 1 set available.

No. C.O.D.'s. Eveready 45 volt batteries = \$1.89, \$1.65 ea. 6 volt A. 73c. 2-1N5 tubes. 95c ea.
U.S. SIGNAL CORPS 5 METER SHORT WAVE XMTRS.

(72.2Mc) XMTRS and TUBE only, less mike batteries and antenna. One 1½ volt dry cell and 67½ volts of B operates it. Just attach di-pole, key or mike, connect the batteries and it's ready to use. Signal Corps spec. wired with silvered wire, mica condensers, and precision resistors. Highly stable circuit with Lo-Loss silvered inductance. Converts easily to walkie-talkie and Ham bands. Only. **\$2.95**
No C.O.D.'s.

SELENIUM RECTIFIERS

Lots of 12. 65c Single Lots 75c

BRAND NEW SENSITIVE RELAYS MICRO-AMMETERS MODEL 705

(2½-0-2½ 2 0-2 range) with A.C. Rectifier. Cost Uncle Sam \$45.00. Our price **\$10.00**



GENUINE SIGNAL CORPS FEATHER-WEIGHT HEADPHONES WITH COIL AND PLUG 2000 OHMS-8000 OHMS IMPEDANCE **\$1.00**

NATIONALLY ADVERTISED OIL FILLED FILTER CONDENSERS

1-MFD-1000 working volts. 4 for **\$1.00**

WEBSTER RECORD CUTTING HEAD

Here is your opportunity to buy a genuine WEBSTER HOME RECORDING CUTTING HEAD. These units are all Brand new and were made for a nationally advertised manufacturer to be in their quality Home Recording Radios. Size 1 3/8 x 2 3/8 ready to fit your cutting arm or bracket. SPECIAL **\$2.95**

3 BAND ALL-WAVE DIAL 6" DIAMETER 75c

GENERAL ELECTRIC 5 AMPERE 110-125 VOLT, 60 CYCLE WATT HOUR METERS, SLIGHTLY USED, PERFECT CONDITION. SAME AS USED IN YOUR HOME **\$3.50**

AMPLIFIER CHASSIS, SIZE 18" x 8" x 2 1/2". BLUE CRACKLE FINISH DRILLED FOR CONDENSERS-TRANSFORMER AND BRACKET **65c**

STROMBERG-CARLSON, 3 BAND ALL-WAVE TUNING UNIT. COMPLETE WITH SPEAKERS, EXTERNALS AND BAND SWITCH. READY TO INSTALL-DIAGRAM, etc. **\$3.75**

8-9 GANG PUSH BUTTON TUNING UNIT (PLEASE SPECIFY). COMPLETE WITH BUTTONS **25c**

24 VOLT D.C. AIRCRAFT MOTOR, APPROX. 1/8 H.P. ALMOST NEW **\$1.50**

U.S. AIR FORCE RESISTOR AND CONDENSER ASST. 1/4-1/2 WATT-100 PIECES. **95c**

U.S. AIR FORCE MICA CONDENSER ASST. 100 PIECES **\$1.25**

LOW-LOSS-SHORT WAVE

Variable Condensers
AT RIDICULOUS LOW PRICE
1/4" Shaft Type

3 Plate-12-15 MMFD.	15c
5 Plate-20 MMFD.	20c
9 Plate-36-40 MMFD.	25c
10 Plate-40 MMFD.	25c
11 Plate-45-50 MMFD.	26c
14 Plate-55-60 MMFD.	47c
27 Plate-100-110 MMFD.	45c
37 Plate-150 MMFD.	50c
38 Plate-150-155 MMFD.	55c
53 Plate-210-21 MMFD.	60c

Lock Type Air Trimmer Variable Condensers

3 Plate-12-15 MMFD.	10c
5 Plate-20 MMFD.	11c
7 Plate-28-30 MMFD.	13c
9 Plate-36-39 MMFD.	13c
10 Plate-40 MMFD.	14c
13 Plate-50 MMFD.	17c
14 Plate-56 MMFD.	20c
20 Plate-80-100 MMFD.	25c
27 Plate-100-110 MMFD.	35c

OIL FILLED By-Pass Filter Condensers (Bathub Type)

Removed from Gov't apparatus, but Electrically Perfect IC-1-Dual (2)-1-600 VOLT IC-2-5-MFD-600 VOLT EVERY ONE GUARANTEED. Each **15c**

NEWARK SURPLUS MATERIALS CO.

324 Plane Street Dept. N. Newark 1, N. J.

PRACTICAL TECHNICAL TRAINING FOR YOU

Specialize in Electronics, Radio, Electricity, Refrigeration, Heating and Air Conditioning, or Welding. Prepare in one year for position as Technician, or in two additional years secure your B.S. Degree in Electrical Engineering with major in Machinery or Electronics.

Write for booklet "Career Building"

MILWAUKEE SCHOOL OF ENGINEERING
"A Technical Institute"

RR-2-48, N. Broadway and E. State, Milwaukee, Wis.

gap must be greater than that required by magnetic recording media of lower coercive force. The exact value of current required to produce the proper flux depends on size of the head structure, number of turns in the coil, and pole and gap dimensions. For a head constructed in accordance with Fig. 4A the following bias and audio currents are typical of those giving optimum results on Hyflux coatings:

Bias frequency	35 to 60 kc.
Bias current	60 to 75 ma.
Audio	20 to 35 ma.

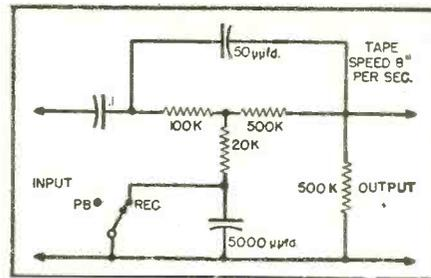

Fig. 9. Equalizer circuit for magnetic tape recording.

The bias current is chosen to give highest mid-range output with satisfactory low frequency waveform. Low bias results in low frequency distortion, generally low output, and extended high frequency response. Excessive bias shows up in reduced high frequency response. A practical value should be selected which results in satisfactory freedom from low frequency distortion. A good rule of thumb is to select the bias frequency as five times the top audio frequency desired plus 10 kc.

It is essential that the wave shape of the bias supply be as nearly perfect as possible. Any non-uniformity in the positive and negative half cycles will result in noise and distortion on a recorded signal. It should be remembered that the recording of a signal is due to the displacement of the positive and negative bias peaks by the audio signal component. For example, during a positive half cycle of the audio signal, the bias may alternate through several cycles but each bias cycle will be displaced in a positive sense by the audio signal component. The direction and magnitude of the remanence on the tape is proportional to the mean value of the displaced bias cycles which is the audio signal

recorded. Since a new portion of tape is constantly being exposed to the gap influence, it is essential that several bias cycles take place for each half wave of audio frequency being recorded. This is necessary in order that any particular portion on the tape will have its hysteresis loops stabilized before leaving the gap area, thereby assuring that the magnetic remanence is linear and at the highest possible value. A typical oscillograph pattern of the sum of the bias and audio currents is shown in Fig. 5. The oscilloscope in this case replaces the vacuum tube voltmeter connected across the 10 ohm resistor shown in Fig. 6. Bias oscillator circuits which have been found to be satisfactory are shown in Figs. 7 and 8. The push-pull arrangement of Fig. 7 is highly recommended because it provides an output of better wave shape.

Noise

There are two types of noise which must be considered in magnetic recording. While these two kinds of noise are related and result from the same cause, namely, magnetic variation, the type which rides on the signal known as "modulated noise," is the most perplexing. Naturally this type of noise is nearly absent when no sig-

Fig. 10. Response curves show the low frequency boost available from the circuit shown. Inverse feedback is used to obtain these results.

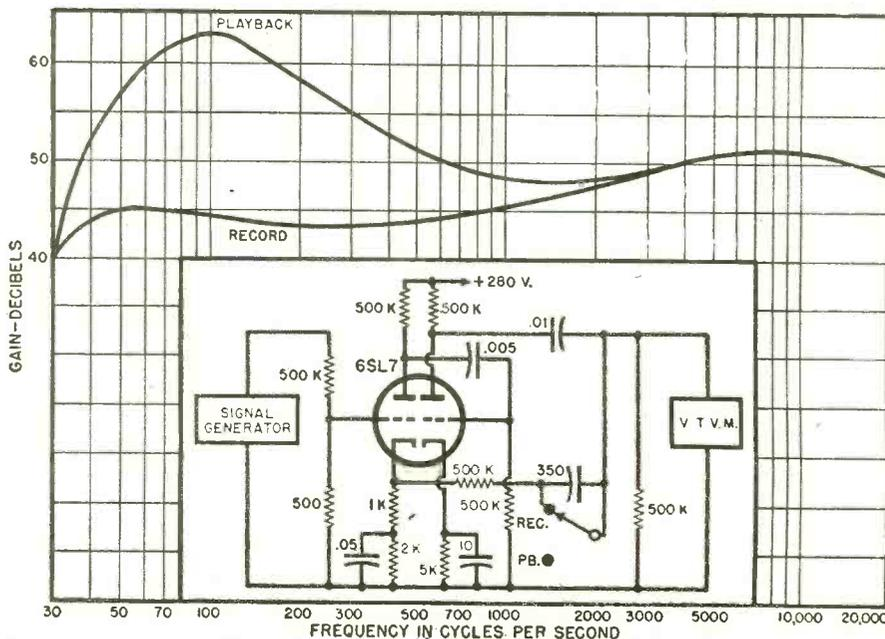

TOP QUALITY PLUS SPEEDY SERVICE

ADAPTOL AM TUNER

Here is a tuner to use in building your own sets. Self-contained power supply — can be used for adding to amplifiers, record players, recording equipment, modernizing old sets. Will supply broadcast reception for hotels, factories, stores where a paging or P.A. system is installed. Permeability-tuned drift-free IF's. Range 540-1700 kc, 110v ac-dc, 50-60 cycles. 4 1/2 x 3 1/2 x 3 3/4 complete with 3 tubes. **12.45**

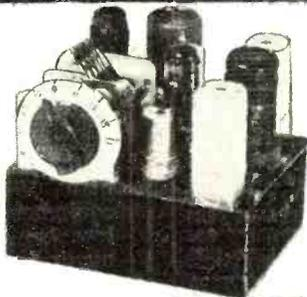

THE NEW McMURDO SILVER FM/TV SWEEP GENERATOR MODEL 909

Brand new—one of the "hottest" items in the test equipment market. A "must" for the progressive serviceman. Center-Frequency Range: 2-226 mc. 5" vernier dial. Covers 3 bands: 2-77, 70-154 and 151-226 mc. without band switching.

Sweep Frequency: Panel-knob variable 0-9 mc—to set correct sweep for FM and TV i.f., discriminator and r.f. alignment. True electronic sweep.

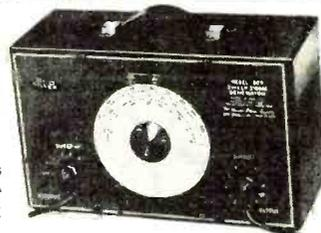

48⁵⁰ net

CONDENSER SPECIALS

Metal Can Dry Electrolytic With Leads and Screw Base

8 mfd. 450 volts—1x2 1/2" .70—10 for \$6.30
8 mfd. 600 volts—1-3/8x3/8" 1.35—10 for 12.00
16 mfd. 600 volts—1-3/8x3/8" 1.80—10 for 16.00

CARDBOARD, CLAMP-MOUNTING CAPACITOR

Easily mounted with center screw and metal clamp. .8 mfd. 450 volts—1-3/8x3" .46 — 10 for 4.10



DRILL EXTENSION

45 degree offset drilling attachment with 0-5/32 tapered Jacobs chuck—designed to fit 1/4" electric or pneumatic drill: Ideal for overhead work and getting into small places.

3.49

Radio Electric
SERVICE CO. OF PENNA., INC.

7TH AND ARCH STREETS, PHILA. 6, PENNA.
Branches: 5930 Market St. & 3145 N. Broad St., Phila.
Also in Wilmington, Del., Easton, Pa., Allentown, Pa., Camden, N.J.

SIX TUBE AUTO RADIO

Amazing tone, amazing quality, amazing price—Here is a 6-tube, 3-gang, RF Stage auto radio made by Automatic. Universal mounting, self-contained 5 inch speaker, all in one piece. A post-war radio at a pre-war price.

27⁹⁷ net

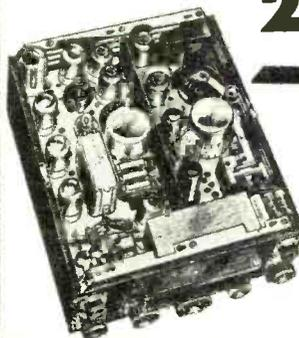
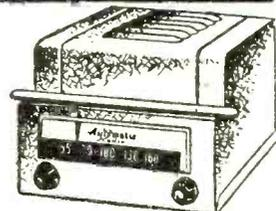

BC 645 ULTRA HI-FREQUENCY TRANSMITTER-RECEIVER

You read about it recently in QST! Originally operated in the frequency band from 450 to 500 M.C. Can be converted to 420 MC amateur band. Consists of complete transmitter and modulator system, and receiver. Instructions for conversion to AC supply.

COMPLETE WITH 15 TUBES **11⁹⁵**

Write for big Free Bulletin • Include postage with cash orders

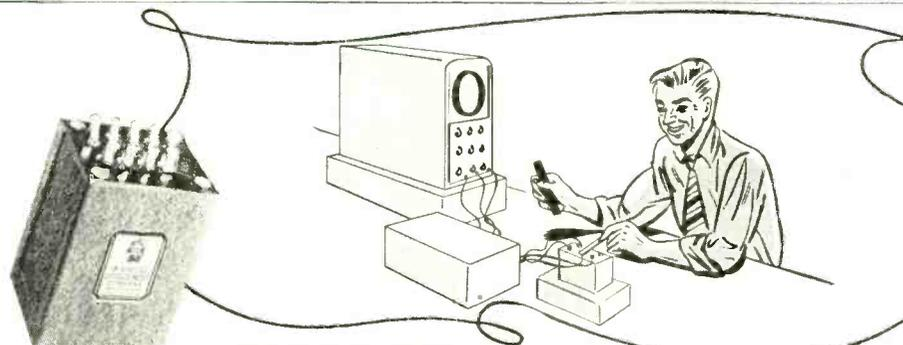

GROOMING an

ADC AUDIO TRANSFORMER for FAULTLESS PERFORMANCE

3 Complete Tests to Meet Rigid ADC Specifications.

Strict electrical tests are given each and every ADC Audio Transformer at three different stages of production. In order to give you faultless performance on the job, every transformer must come within catalog specifications on all tests. (Customer specifications on special transformers.)

1st TEST. After assembly of coil and laminations, each component must perform within ADC specifications on frequency response, impedance ratio, phasing, breakdown and balance tests. Any unit failing to meet all requirements is rejected.

2nd TEST. After impregnation, baking and casing, each transformer is re-checked for continuity breakdown and other requirements of the particular unit. This guarantees correct wiring, perfect insulation — no "shorts" or "opens."

3rd TEST. After cleaning, labeling, etc., a final continuity, breakdown and thorough visual check is made. This quality control test—plus the finest materials and workmanship available—assures you of faultless ADC performance on the job.

Consult your jobber about ADC Audio Transformers and other Components. Ask for Catalog 46-T.

Other ADC Components: JACKS • JACK PANELS • PLUGS • PATCH CORDS



Audio Development Co.

2833-13th Avenue So., Minneapolis, Minn.

Audio Develops the Finest

SELENIUM RECTIFIERS

FOR ALL APPLICATIONS

FULL WAVE BRIDGE TYPES

Input	Output	Current	Price
From 0-18 V.A.C.	From 0-14 V.D.C.	1 AMP.	\$2.49
0-18 V.A.C.	0-14 V.D.C.	3 AMP.	3.49
0-18 V.A.C.	0-14 V.D.C.	5 AMP.	4.95
0-18 V.A.C.	0-14 V.D.C.	10 AMP.	7.95
0-18 V.A.C.	0-14 V.D.C.	15 AMP.	10.95
0-18 V.A.C.	0-14 V.D.C.	20 AMP.	13.95
0-18 V.A.C.	0-14 V.D.C.	25 AMP.	16.95
0-18 V.A.C.	0-14 V.D.C.	30 AMP.	18.95

HALF WAVE TYPES*

Input	Output	Current	Price
From 0-18 V.A.C.	From 0-7 V.D.C.	3 AMP.	\$2.25
0-18 V.A.C.	0-7 V.D.C.	5 AMP.	2.95
0-18 V.A.C.	0-7 V.D.C.	10 AMP.	4.95
0-18 V.A.C.	0-7 V.D.C.	15 AMP.	6.95
0-18 V.A.C.	0-7 V.D.C.	20 AMP.	8.95
0-18 V.A.C.	0-7 V.D.C.	25 AMP.	10.95

Input	Output	Current	Price
From 0-36 V.A.C.	From 0-28 V.D.C.	2 AMP.	\$4.95
0-36 V.A.C.	0-28 V.D.C.	3 AMP.	5.95
0-36 V.A.C.	0-28 V.D.C.	5 AMP.	7.95
0-36 V.A.C.	0-28 V.D.C.	10 AMP.	13.95
0-36 V.A.C.	0-28 V.D.C.	15 AMP.	18.95
0-36 V.A.C.	0-28 V.D.C.	20 AMP.	25.95
0-36 V.A.C.	0-28 V.D.C.	2 AMP.	14.95
0-120 V.A.C.	From 0-100 V.D.C.	2 AMP.	14.95
0-120 V.A.C.	0-100 V.D.C.	5 AMP.	18.95

Input	Output	Current	Price
From 0-36 V.A.C.	From 0-14 V.D.C.	3 AMP.	\$2.95
0-36 V.A.C.	0-14 V.D.C.	5 AMP.	4.95
0-36 V.A.C.	0-14 V.D.C.	10 AMP.	7.95
0-36 V.A.C.	0-14 V.D.C.	15 AMP.	10.95
0-36 V.A.C.	0-14 V.D.C.	20 AMP.	13.95
0-36 V.A.C.	0-14 V.D.C.	25 AMP.	16.95

*Use with capacitor to obtain any voltage up to twice rated output.

FULL WAVE CENTER TAP

Input	Output	Current	Price
400-0-400 V.A.C.	0-450 V.D.C.	600 Mills	\$5.95
9-0-9 V.A.C.	0-7 V.D.C.	22 Amps.	8.95

CAPACITORS

1000 MFD., 15 V.D.C.	\$0.98
2000 MFD., 15 V.D.C.	1.69

It would be impossible to give a complete listing of all our rectifier types. Our engineering staff is at your service to help you work out the application of selenium rectifiers to your specific problems. Write us for quotations or further information on capacitors and transformers to be used in conjunction with selenium rectifiers.
25% REQUIRED ON ALL C.O.D.'s—ADD 10% FOR PARCEL POST

OPAD GREEN COMPANY • 191 Greenwich St., Dept. 3
NEW YORK 7, N. Y. • Phone: BEEKMAN 3-7385

Permoflux SPEAKERS

YOUR JOBBER CAN SUPPLY YOU!

Permoflux quality and dependability—the same as supplied to the major set manufacturers—is your assurance of complete customer satisfaction. You'll find Permoflux Speakers easy to install and readily available in both PM and Electro-dynamic types. You'll find too, that it pays to give your customers "tops in tone" with a Permoflux Replacement Speaker.

TWO COMPLETE FACTORIES TO SERVE YOU **PERMOFLUX** WRITE FOR FREE BULLETIN
PIONEER MANUFACTURERS OF PERMANENT MAGNET DYNAMIC TRANSDUCERS

PERMOFLUX CORPORATION
4900 WEST GRAND AVE., CHICAGO 39, ILLINOIS
236 SOUTH VERDUGO ROAD, GLENDALE 5, CALIFORNIA

nal is present and is proportional in magnitude to the average signal. The maximum value of this noise is known as the "saturated modulation noise." The second type of disturbance, "unmodulated noise," may exist even when no signal is present and is usually due to either d.c. magnetization of the playback head or of the tape, or both. With proper adjustment of the equipment, this noise is usually very low, being down 60 to 80 db. from a maximum signal, particularly in the case of coated media. The magnetic variations responsible for noise are due, in many cases, to irregularities in tape coating and to poor resolution between recording medium and the gap. Noise of the above type is apparently due to small magnetic discontinuities and surface irregularities in the recording media which cause extraneous flux changes. In the case of modulation noise, a recorded signal is modulated by the flux changes.

Erasing Methods

The demonstration machines built by *The Indiana Steel Products Company* have all used permanent magnet erasing and are capable of good fidelity and satisfactory frequency response. The modulation noise seems to be more dependent on the recording medium than on erasing methods when the proper bias flux is used. It is possible to erase maximum signals on *Hyflux* with current at the bias frequency when sufficient power is used in a properly designed erase head. The ability of any erase head to completely erase signals is dependent not only on the coercive force of the medium, but also on the coating thickness. Since thin coatings produce satisfactory output, this tape is relatively easy to erase with the conventional high frequency erase head without excessive heating.

Recording Circuits

With high coercive force recording media, considerable high frequency energy in the form of gap flux is required. Every possible means should be used to improve head efficiency so that the required flux can be produced without heating due to eddy currents. An improved bias and audio series mixing circuit is shown schematically in Fig. 6. It has resulted in a considerably improved performance, less bias being required to produce a given value of gap flux. The high impedance pickup winding is open circuited during the recording operation, and a relatively high voltage at the bias frequency appears across its terminals. Care must be exercised in the construction of such a head in order that a breakdown of insulation will be avoided. A bias or audio supply of high voltage from open ended sources, such as the plate of a tube, is not recommended, since it is difficult to obtain efficient transfer to the head windings. Low voltage bias and audio circuits are easier to handle and require less shielding. In using the test setup shown in Fig. 6, both the

ALL at 59¢ each

RADIO TUBES—KNOWN BRANDS—BULK

43	1LN5	1H5	6F6	6Q7	25L6	6SA7	14B6
47	14A7	6A7	6V6	6X5	35L6	6SQ7	14Q7
OZ4	35Y4	6A8	6H6	7B7	50L6	50B5	117Z3

KITS

- FM, CONDENSER & COIL, (.88 to 108Mc), incl. Instructions. \$ 4.95
- 5-TUBE SUPER-HET, complete with tubes and bakelite cabinet. 12.50
- 6-TUBE SUPER-HET, complete with tubes and bakelite cabinet. 13.95
- INTER-COMMUNICATION, complete with cabinets and 3 tubes. 12.75

3 WAY-PORTABLE RADIO (Leatherette 9"x6"x4½") AC-DC, comp. with batteries. 19.90

PHONO MOTOR, complete with turntable. 2.95

CRYSTAL PICK-UP ARM, including all hardware. 1.75

OUTPUT TRANSFORMER (50L6).39

VOLUME CONTROLS, ½ or 1 Meg. with switches.39

100-KNOBS. ASSORTED. 4.95

100-SOCKETS. ASSORTED. 4.95

100-CONDENSERS. ASSORTED.001 to .02. 3.95

100-RESISTORS. ASSORTED. 1.50

BROOKS RADIO DISTRIBUTING CORP.
80 VESEY STREET (DEPT. B) NEW YORK 7, N.Y.

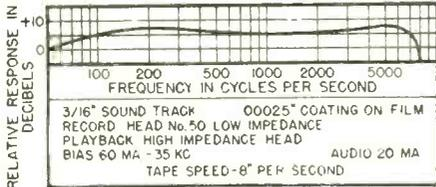

Fig. 11. Typical frequency response curve. Low and high frequency ends have been boosted to give flat frequency response.

bias and audio sources should be continuously variable in both output and frequency over the required range.

Equalization

The subject of equalizing the normal tape response is frequently brought up by engineers and experimenters. Several arrangements which are practical can be used. Fig. 9 shows one version of a popular tone control circuit which is capable of satisfactory low frequency boost, in addition to considerable high frequency variation. The inverse feedback network included in the schematic (Fig. 10) performs satisfactorily. With a properly chosen high impedance pickup head winding, a very satisfactory high frequency boost can be obtained by resonating the circuit with a condenser of proper value shunted across the winding. If the top frequency response desired is 6000 c.p.s., the condenser is chosen to resonate the head at this frequency. As high as 20 db. boost at 6000 c.p.s. can be obtained in this manner.

In order to avoid low frequency overload distortion when the bias and audio currents are chosen for best high frequency performance it may not be desirable to use constant current over the audio range. This is done by pre-equalizing the highs to obtain a rising recording characteristic.

Frequency Response

With the proper choice of heads, circuits, correct bias and audio current adjustments, the frequency response of Hyflux tape at 7½" to 8" per second is easily equalized to from 100 to above 7000 c.p.s. flat to within 3 db. A typical frequency response curve employing a resonated head for high frequency boost and a bridged T net-

Fig. 12. Constant current response using Hyflux tape at 8 inches-per-second.

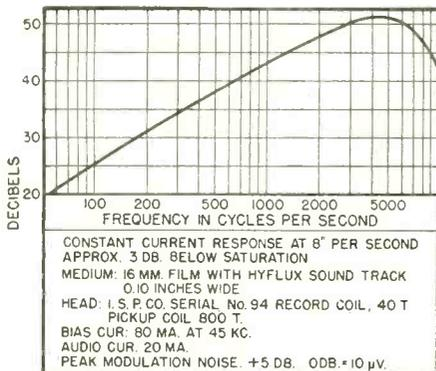

Lower Prices United Surplus Lower Prices

★ ★ ★ ★ ★ TRANSMITTER AND RECEIVER (SCR-528)

● **F.M. TRANSMITTER, BC-604C.** Temperature Crystal controlled. Freq. Range: 20 to 27.9 Mc. Uses 7—1619, 1—1624 tubes. Ten preset channels controlled by push buttons. All circuits Metered. Carbon and Dynamic Mic. Input. Size: 12" H., 9" D., 18" L. Output: 25 W. @ 100% Mod.

● **RECVR BC-603C.** Variable tuning; Freq. Range: 20-28 Mc. Uses: 1—6H6, 1—6J5, 1—6V6, 3—6AC7, 2—12SG7, 2—6SL7 tubes. Push buttons may be preset for ten channels. Calibrated dial. Built-in speaker. Squelch may be switched on or off. Size: 12" H., 7" W., 13" D.

This complete set requires small conversion for use in 28 Mc. Ham band. Shipped complete with tubes, 80 crystals, 2 dynamotors, Recvr and Xmitter schematic diagram.

All sets used but in good operating condition. 12 or 24 volts. (Kindly specify voltage desired.) Shipping wt. approx. 165 lbs. Nationally advertised brand. Specially **\$59.50** priced at just.....

★ ★ ★ ★ ★ 25 WATT HIGH GAIN AMPLIFIER

● A heavy duty P.A. System, modulator, etc. Uses: 2—6SJ7, 1—6N7, 2—6L6, 1—5U4 tubes. Two Mic. inputs and one phono input. Four controls are Mic. #1, Mic. #2, phono gain and tone control. Output impedance: 4, 8 or 15 ohms. Monitor jack on front panel. Housed in attractive black wrinkle finished cabinet 10½" High, 21½" Long, 15" Wide. Complete with tubes. Like new. Wt. approx. 60 lbs. **\$44.50**

★ ★ ★ ★ *Just Off the Press* ★ ★ ★ ★
UNITED SURPLUS New 1948 free CATALOG!
Chock-full of Spectacular Bargains. Write for your free copy today!

- QUANTITIES ARE LIMITED — ORDER NOW.
- All orders shipped f.o.b., Chicago.
- 25% deposit—Balance C.O.D.



United Surplus Materials

3313-19 W. OGDEN AVE.
CHICAGO 23, ILL.

PRACTICAL TRAINING FM-RADIO-TV



Four fully-equipped laboratories provide the PRACTICAL training necessary for successful careers in Radio Communications (FCC licenses) and in Radio-Television (Technician) Servicing. Train under supervision of technical specialists—with COMMERCIAL-type equipment. Investigate why WRCI SPECIALIZED TRAINING methods are outstanding in the West; why WRCI laboratory-trained specialists are preferred for responsible positions. Read our illustrated bulletin before enrolling in any school. Approved for veteran training—non-veterans accepted. Send for free copy of Bulletin-A today.

WESTERN RADIO COMMUNICATIONS INSTITUTE
631 West Ninth Street, Los Angeles 15, California

Get a new
ELECTRIC SOLDERING IRON
FREE
... and assemble your own
MAGI-KLIPS
RADIO & ELECTRONIC EXPERIMENTER'S KIT



This is the same MAGI-KLIPS Kit—complete with all parts—that we sell ready assembled for \$29.75.

In knocked-down form with full instructions for assembly, it is now available at the new low price—

\$19.75

... complete with a new Electric Soldering Iron—the ideal iron for wiring your unassembled MAGI-KLIPS Kit.

Remember, you build 18 different experiments with your MAGI-KLIPS Kit. You actually teach yourself radio and electronics and have a lot of fun at the same time.

RADIO RECEIVER, HOME BROADCASTER, PHOTO-ELECTRIC RELAY, CODE PRACTICE OSCILLATOR, SIGNAL TRACER, REMOTE CONTROL RELAY, Phonograph Transmitter, Intercommunication Amplifier, Code Transmitter, Radio Frequency Oscillator, Telephone Line Amplifier, Electronic Switch, Phonograph Amplifier, Temperature Control Relay, Contact Detector, Electronic Metronome, Interval Timer (one-shot), Interval Timer (repeating).



PHONO-AMPLIFIER KIT. A real bargain. Uses 35Z5 and 50L6. Complete diagram and instructions for assembling. Also good for call system.

Kit Form \$1.85
Wired and Tested. 2.45
Tubes for above. 1.65

CODE PRACTICE OSCILLATOR KIT

Learn the code! Get your ham ticket! Uses 50L6, 35Z5. 4" PM speaker. Tone and volume controls. Ideal for classroom instruction. Complete diagram and assembly instructions.

Kit Form \$2.85
Speaker and Transformer for above. 1.95
Tubes for above. 1.65
Wired and Tested, with Tubes and Speaker 6.00

Terms: 20% deposit, balance C.O.D.
Send for your copy of **FREE** booklet, "ELECTRONICS MADE EASY"

DEER & TAYLOR COMPANY
Dept. N 1342 Milvia St. Berkeley 9, Calif.

NOW AVAILABLE!
Amplifier for GE pickup



New circuits for the first time enable you to attain full benefit from the new General Electric Model DL 1RM 6C Variable Reluctance Magnetic pickup. Employs an exclusive, humless (DC on heaters) pre-equalized pre-amplifier to produce the most satisfying musical amplifier the world has ever known. If you are a perfectionist, you are the one for whom the ACA-100GE was designed. Send for technical literature.

AMPLIFIER CORP. of AMERICA

398-2 Broadway, New York 13, N. Y.

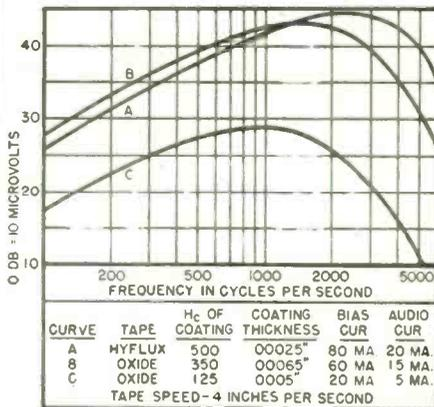

Fig. 13. Response curve similar to that shown in Fig. 12 with the exception that tape speed has been reduced from 8 to 4 inches-per-second. Curves B and C show results using oxide-coated tape.

work for low frequency adjustment is shown in Fig. 11. The low frequencies are boosted about 15 db. maximum at 100 c.p.s. Fig. 12 is typical of constant current response at 8" per second. The response at a tape speed of 4" per second is shown in Fig. 13.

(Ed. NOTE: Standards for tape and heads have not, at this date, been adopted. The above data applies, in general, to other heads and to tapes of similar characteristics.)

(To be continued)

Tape Systems
(Continued from page 46)

30 kc. bias current and the audio frequency which is being recorded. For proper functioning, the 30 kc. potential across the recording head should range from 60 to 100 volts as measured with an a.c. vacuum tube voltmeter having a minimum input impedance of 10 megohms.

A visual recording indicator is provided, see Section F, employing a type 6E5 tube. It is used as a volume indicator when recording. It receives an audio voltage from the screen of the

6SJ7 second record-amplifier tube. The screen of the tube is used as the source of this indicating voltage so that the audio voltage present will be the only actuator of the volume indicator. Since the 30 kc. bias current is available in the plate circuit, the plate could not be used as a source of audio voltage alone for the indicator.

The 30 kc. supersonic oscillator (Section Y) employs a 6SN7, the first half of which is used in the oscillator circuit. The quality of this tube is critical and only one with a very high reading on a mutual conductance type tube tester should be employed. It may be necessary to interchange this tube with others of the same type to obtain best results. The bias current originated in this oscillator stage is, after proper amplification, used for the erasure as well as the recording bias.

A push-pull erase amplifier is employed (see Section H) using the two triodes of a type 6SN7 tube. These are connected to form a push-pull amplifier which receives its driving signal from Section Y. During the recording operation the plate-to-plate potential in this stage ranges between 80 and 100 volts and results in a 30 kc. current through the erase head coil of approximately 20 ma.

A conventional phase inverter stage is utilized (Section J) which provides the signal for the final amplifier stage. Either a 6SL7 or a 6SN7 may be used in the phase inverter position. When a 6SN7 is employed the grid resistor should be 22,000 ohms. If a 6SL7 is used, the same resistor should have a value of 33,000 ohms. It may be desirable, in equipment using the 6SL7, to replace it with a 6SN7 with a proper grid resistor since this substitution may reduce possible microphonics. A "Class A" push-pull audio amplifier stage (Section K) using a type 6SN7 is self-explanatory.

The principal components are shown in Fig. 3, as well as the selector push-buttons.

Fig. 3. Top view of Brush "Soundmirror" tape recorder. Keyed parts are: (1) Supply reel; (2) Reverse limit switch; (3) Brake shoe for head; (4) Takeup reel; (5) Forward push-button; (6) Reverse push-button; (7) Start push-button; (8) Stop push-button; (9) Record push-button; (10) Forward limit switch; (11) Drive capstan; (12) Record-reproduce head; (13) Erase head; and (14) On-off toggle switch.

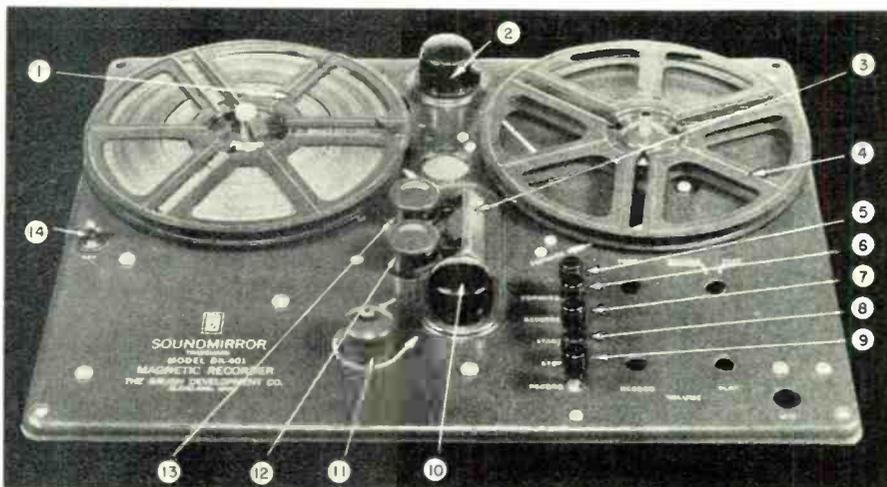

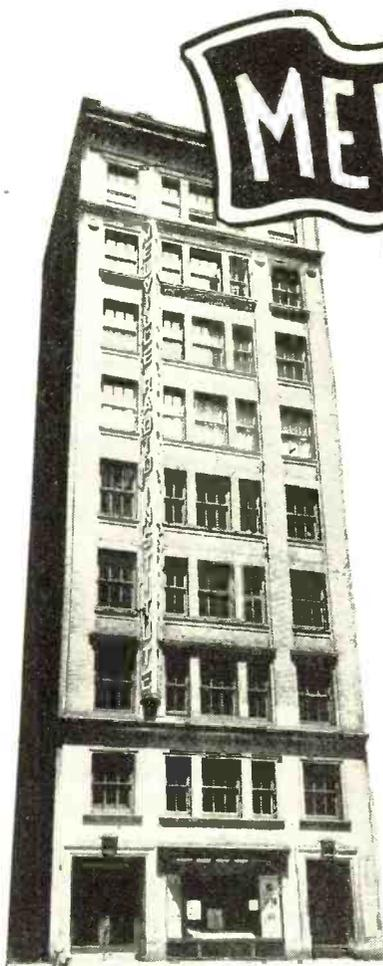

RADIO INSTITUTE

Outstanding PRE-WAR Technical Training Center for

TELEVISION & RADIO

Under the personal direction of Frank Melville, former Airlines, Merchant Marine, and Broadcast technician, you may soon qualify as:

- RADIO TECHNICIAN
- AIRLINES RADIO OFFICER
- PT. TO PT. TELEGRAPHER
- RADIO AMATEUR
- MERCHANT-MARINE RADIO OFFICER
- TELEVISION TECHNICIAN
- HOME RECEIVER REPAIRMAN
- VISUAL TELEGRAPH OPR. (SLIP TAPE)

MELVILLE RADIO INSTITUTE believes vocational training means vocational training. Thus we, like many radio schools, teach ample theory. But, unlike most schools, two-thirds of our technical students' time is spent in laboratories and shops, where, with superior equipment, they learn by *doing* — not memorizing.

FREE employment service is available to all MELVILLE graduates.

Visit the 10-story MELVILLE Building today as our guest and observe the school in operation.

Day and evening classes approved for veterans. Licensed by the State of New York.

MELVILLE RADIO INSTITUTE
Melville Building
15 West 46th St., N. Y. 19 • LO 4-0340

MAIL THIS COUPON NOW!

MELVILLE RADIO INSTITUTE R.N.
Melville Building
15 West 46th St., New York 19, N. Y.

Gentlemen: Send me Free information about your school.

Name.....

Address.....

Mine Detector, SCR 625, useful for locating metals buried in ground. Uses 1000 cycle balanced search coil. Sensitive. Contractors, plumbers, prospectors, miners all need this easy to use metal detector. Complete w/carrying case. \$49.95
500 kc transmitter, 5 watt, portable 6V input Mackay Radio. Complete. \$25.95
SCR 522 VHF Transceiver, with all tubes. Excellent condition. \$22.95
BC 375 w/tubes and 1 tuning unit. \$19.95
SCR 274N Command Set consisting of three receivers covering (190-550 MC) (3.0-6.0 MC) (6.0-9.1 MC) and two transmitters covering (4.0-5.3 MC) (5.3-7 MC) plus all equipment including control units, racks, connectors, modulator unit and four 24 VDC dyna-motors to complete an operating installation. Each transmitter output is 40 Watts. The equipment is easily converted to 110 V 60 cycle operation. \$29.95
SCOPE BC 1266, 15 tube, 110 V 60 cycle scope. Uses 5CP1 CRT, 2X2 rectifier. (Schematic) has most of the stuff necessary to make a service scope or a TV set. \$39.95
Indicator I221A. Buy above scope with this indicator in original package. Has individual small removable chassis with 110 V 60 cycle selsyn with illuminated azimuth scale and dial knob, 6ES tuning eye, 6X5 rectifier. Also on main chassis 6400 V transformer, 100 TH relays, breakers, condensers, 4-6SL7, 6Y6, 6SN7. (Schematic) this item and BC 1266 scope, both for. \$53.50
Indicator only. 24.95
Army Portable Field Telephone EE-8 with handset generator, ringer, etc. in leather or heavy web case. Shipped with 2 flashlight batteries. Ready to use. Each. \$8.75—Pair. \$15.95
Handset TS-13, 200 ohm carbon mike and 2500 ohm earphone with butterfly switch. Has 6 ft. rubber covered cord with PL 55 and PL 68 plugs. \$2.95
Handset P-18, high-Z. w/6' cord & PL 55. \$1.95
Cable 19 conductor, #18 stranded 15'16" D. 250' 600 V. Ins. RC w/connectors. \$14.95
Cable 2 conductor, #18 stranded 600 V. 250' RC w/connectors, 1 conductor #18 shielded. \$6.95
Cable 14 conductor, #15 stranded 600 V insulation. Crush proof cotton core, heavy duty RC 50' long connector one end lugs other, 1" OD. \$4.95
Cable 7 conductor, #14 stranded, 600 V insulation. Heavy duty rubber covered 65'. Connectors both ends. 7/8" OD. R. C. \$4.95
R8B/U COAX, 52 ohm, ft. 6c. Reel 1200 ft. \$59.00
Wire #8 Stranded, ins. 4 ft. lengths, 200 ft. \$1.98
Conduit, Greenfield Flexible, 10 ft. length, 1 inch. \$1.29 2 inches. \$1.89
Auto-Transformer 300 watt 0/115/140/150/160 volts 60 cycle GE #68G356. Cased. \$2.95

GOVERNMENT SURPLUS

Electricity for Stand-by Service. Gasoline Engine generating plant. PE 182. Complete modern new AC power unit. 9.4 KVA at 80% power factor. Can put out 115 V, 230 V, 440 V, single or 3-phase, 60 cycle. Completely enclosed in sturdy metal housing with elaborate control panel. Mounted on steel skid. Export packed, with spare parts and tools. Photo and full description on request. Regularly \$1800.00 OUR PRICE. \$699.00

NEW GUARANTEED TUBES

1R4\$1.29	6K7\$.79	12DP7\$8.95
1T489	6L71.25	12GP7 8.95
2AP12.49	6N779	12SG789
3Q589	6S795	12SN779
3D61.10	6J889	12K398
3B71.10	6SF579	25L679
5B14.95	6SH765	3078
5BP44.95	6SK779	3549
5CP13.95	6SL789	3889
6U598	6SN789	39/4459
6F689	6SR71.50	4665
6G61.10	6W796	7649
6AG799	1079	21199
6J780	12A659	95449

Philips—DCG3-100E, EL3N, BB2-250E, 13201E

Kenotron Vacuum Rectifier, Westinghouse type WL531. Air-cooled, inverse peak volts, 50,000 Peak Amps. 75. \$29.00
Scope & Plate X-Former. 1540 V @ 20 MA & 700 VCT @ 240 MA. Cased & impregnated. \$1k. #18. \$6.95
Power X-Former. 700 VCT @ 70 MA, 6.3 VCT @ 2.5 A., 5V @ 2 A. Upright, shielded. \$3.25
Choke—6 H @ 450 MA, 2.5 KV working. Shielded. \$1k. #24. \$4.95
Circuit Breakers. Single pole, 115 V AC. Choice of 1.5, 5, 7, 10, 12, 15, 30 or 35 amps. \$2.95
Double pole 115 V AC, choice of 1.25 or 4 A \$4.95
Double pole 230 V AC. 8 amps. \$4.95
MAY WE SEND YOU ONE OF OUR FLYERS ON RADIO AND ELECTRONIC EQUIPMENT, PHOTOGRAPHIC SUPPLIES AND EQUIPMENT.—TELL US YOUR WANTS.

THE ABELL DISTRIBUTING CO.
7 E. Biddle St., Baltimore 2, Maryland

Relay, 24 V, 60 cycle, coil, contacts 15 amp DPST normally open. \$1.95
Bulbs, 6 watt, 12 volt candelabra base, 10 for \$0.90
Canvas, waterproof OD, any size, Sq. Ft. \$0.05
Typewriters. Standard, L. C. Smith, Remington, Underwood, 10, 11, 14 and 20" carriages. Pica and elite type. Standard and Signal Corps Keyboard. Reconditioned. Excellent. Satisfaction guaranteed. \$59.50
1/4 HP Motor, Cap. Start—Standard Brand. \$21.50
BE PREPARED FOR FIRE—1 qt. Carbon Tetrachloride fire extinguisher. Reconditioned. Recharged. Guaranteed. \$4.95 NEW \$9.89
Antenna Tripod Assembly. Rotating ball-bearing head. Takes 2" shaft. Shaft can be clamped. Stands 4 feet high. Light weight. Strong. Can be set up anywhere. Good for rotating beams or anything else that rotates. 2A3490. \$6.95
Antenna Support, 5' lengths of 1 1/2" alloy tubing with 6" sleeve. Can be nested for long lengths. Good for TV antennas, ham rigs, etc. MS-44 \$1.95
Rotary Beam Mount, with 1/6 HP reversible 110 V 60 cycle drive motor. 7 slip rings, for connecting any circuit up to 5 amps, selsyn transmitter, indicating rose, all weather waterproof housing, mounting feet. A sturdy mount used to drive the TR 24 tower on IFF equipment remotely. \$49.50
Less Motor. \$29.50
Insulator assortment—standoff, strain, antenna, feedthru, etc. 50 pieces. \$1.98
Safety belt, with strap. State belt size. \$5.75
Lineman's pole climbers. \$4.50

LAST CHANCE—WHILE THEY LAST!

6V Lantern Batteries. Eveready 409 or 509 or equal. 2-5/8" x 2-3/8" x 3-7/8". Mfg. June 1945 or later. Box of 30. \$1.98
45 V BA-26, Heavy Duty "B" Batteries. 8 x 4 1/4" x 7 1/2". Mfg. May 1945 or later. Carton of 4. \$1.98
Handset cords. 8'—3 conductor tinsel w/lugs. 2 for \$0.49 12 for \$1.99
Hunting knife. 6" scabbard. \$1.95
BC-221 Frequency Meter—A heterodyne frequency meter complete with tubes, crystal, calibration chart. Fundamental ranges are 125-250 and 200-400 kc. Can be used with 110 volts AC power pack, batteries or vibrapack. Makes a fine signal generator or converts to VFO. These are slightly used but Guaranteed Al. \$37.75

MISCELLANEOUS MERCHANDISE MART

Look at these bargains we have hunted up for you!
Navy Dungarees, Blue denim, all sizes. \$2.25
Reconditioned Army Mackinaws. 3.25
Reconditioned Army Field Jackets. 2.95
Navy Regulation "T" Shirts. 30 to 42. .99
Army Socks, work, 3 pr. for. .20

NEW RECEIVERS for Winter Market

AM-FM TABLE UNIT

Stewart-Warner Corporation recently introduced a new line of receivers to the trade at regional meetings held in Chicago and New York.

One of the featured units was a

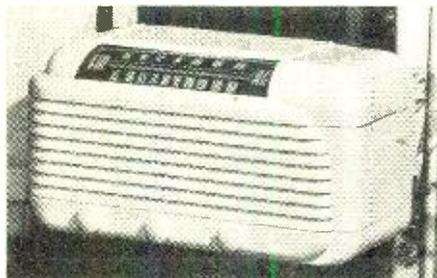

small-sized table model receiver, measuring 8" high, 14 $\frac{1}{16}$ " wide, and 6 $\frac{3}{8}$ " deep, which provides both AM and FM reception.

The receiver, which operates on either a.c. or d.c. covers the 540-1600 kc. band on standard broadcast and 88-108 mc. on FM. The set uses seven tubes plus a selenium type dry rectifier. The plastic cabinet is available in either mahogany or ivory.

Further information on this AM-FM table radio may be secured from Stewart-Warner Corporation, 1828 West Diversey, Chicago, Illinois.

CROSLY CONSOLE

The new Crosley Model 148 CP features a mahogany cabinet by Carrolton 38" high, 38" wide, and 18 $\frac{1}{2}$ " deep.

A spacious album compartment is included on each side of the speaker to provide ample storage space for records. An exclusive floating jewel

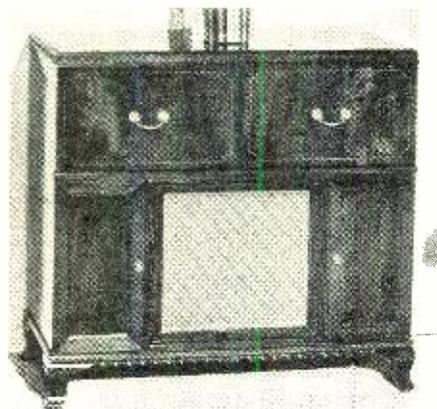

tone system and fast record changer which takes 10 and 12 inch records intermixed are special features of the phonograph section of the unit.

The radio portion covers AM, FM, and short-wave bands with a built-in

dipole being provided for FM reception. A 12" PM speaker assures high fidelity reception on both radio and phono.

The circuit uses 12 tubes, 1 tuning indicator, and 1 rectifier and operates on 117 volts a.c.

Full details on the Model 148 CP are available from the Crosley Division, Avco Manufacturing Corporation, Cincinnati, Ohio.

COIN RADIO

A new coin-operated radio designed and engineered specifically for booth operation is currently being produced by Tradio, Inc. of Asbury Park, New Jersey.

Designated the "Tradio-ette," this six tube receiver measures 7 $\frac{1}{2}$ " long by 7 $\frac{1}{2}$ " wide by 5" deep.

The unit features a 3-gang condenser with bandpass stage for high selectivity, preset maximum volume



which restricts the program to the individual booth, simple plug-in installation with no inter-unit wiring necessary, slug rejector for bad coins, variable timer at the option of the operator, pick-proof lock, and all-aluminum cabinet.

Details on this line of booth receivers may be secured from Tradio, Inc., Asbury Park, New Jersey.

WIRE RECORDER

A lightweight wire recorder which completely eliminates the complicated handling of wire by utilizing a simple "plug-in" cartridge has been developed by the RCA Victor Division of the Radio Corporation of America.

Housed in a streamlined, black plastic cabinet with disappearing carrying handle, the new wire recorder weighs less than 25 pounds with cartridge and microphone. Intended for use in offices, schools, studios, broadcast stations, and homes, the recorder

features only three simple controls and operates from any 110 volt a.c. power source. An indicator light to show correct recording volume makes possible recordings of professional quality, without regard to the skill of the user.

Outstanding feature of the new re-

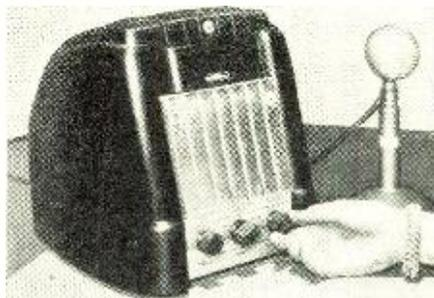

coder, the "plug-in" cartridge records up to a half-hour of speech or music on its more than half-a-mile of stainless-steel plated brass wire, and may be operated to permit playback without tedious rewinding. The "immediate playback" feature of the recorder is made possible by the unique design of the cartridge which contains two length of permanent wire wound on four spools. Untouched by human hands, the wires wind, unwind, and rewind themselves, permitting the operator to record a speech or musical selection and returning to the exact starting point on the wire for immediate playback.

The unit is now being marketed by the RCA Victor Division of Radio Corporation of America, Camden, New Jersey.

PERSONAL PORTABLE

The tiniest personal portable in the Zenith Radio Corporation's line has been released under the name "Zenette."

The new radio is smaller than most women's purses so that it can be carried anywhere. The receiver operates on a.c.-d.c. or self-contained batteries. The "Zenette" receives the extended broadcast range from 535 to 1620 kc. Battery drain is prevented and tubes protected by a switch that automatically cuts the battery out of the circuit when the plug is removed for use on a.c. or d.c. power line.

The unit comes in a molded plastic case which is available in maroon, ivory, or black. The swing-top lid carries the antenna. A tuning control separated from the combined on-off and volume knob provides easy, accurate station selectivity.

Zenith Radio Corporation, 6001 W. Dickens Avenue, Chicago 39, Illinois will supply additional details on request.

RECORD CHANGER

Garrard Sales Corporation of New York are now offering the Garrard record changer as a completely packaged unit in three different styles.

The unit may now be obtained mounted on a wood base, mounted in

a carrying case, or housed in a deluxe table model cabinet. The record changer has a governor-controlled,

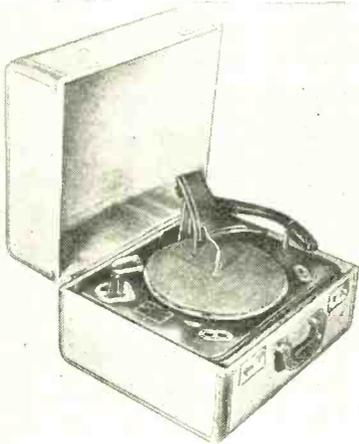

speed-regulated motor. It plays 10 and 12 inch records in any sequence without adjustment, and features an exclusive non-slip spindle.

Standard models operate on a.c. only, but a.c.-d.c. models are available at a slightly higher price.

For further information write to *Garrard Sales Corporation*, 315 Broadway, New York, 7, New York.

PERIOD CONSOLE

Housed in an authentic period cabinet of mahogany, the new *Magnavox* "Traditional" console radio provides a large storage space for records.

Equipped with a supersensitive radio of eight tubes plus rectifier, 10-watt power output, a 12 inch *Magnavox* Duosonic speaker, and fully automatic record changer, the "Traditional" will retail in the moderate priced class.

This same model is also available with genuine *Armstrong* FM, combin-

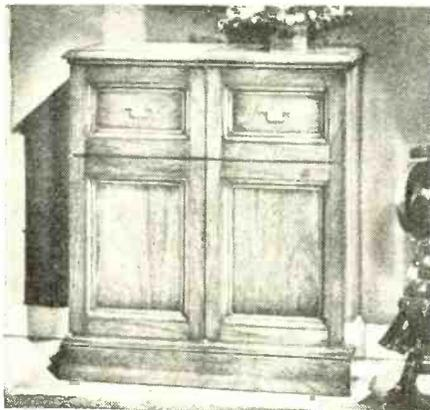

ing 14 amplifier tubes, two rectifiers, and one tuning tube at a slightly higher price.

Details on this console may be secured by writing *Magnavox Company*, Fort Wayne, Indiana.

PORTABLE UNIT

Air King Products Co., Inc. of Brooklyn, New York has just announced the production of a new portable wire recorder and phono-combination.

This recorder employs a five-tube

February, 1948

SENGO FOR SENSATIONAL SAVINGS! ON A YEAR-ROUND BASIS!

* 1625 TRANSMITTING Beam Power, Amplifier. Same as 807 except 12.6 volt filament medium 7 pin base. 14c ea.
* 955 ACORN TUBE—Detector Amplifier Oscillator Tube—Brand New. Each....19c
* 829 PUSH PULL twin-unit. Beam power amplifier tube. \$1.49 ea.

VOLUME CONTROLS

250,000 ohms tapped with switch 3" shaft
500,000 ohms tapped with switch 3" shaft
1 meg ohms tapped with switch 3" shaft
2 meg ohms tapped with switch 3" shaft

44¢ EACH

500,000 ohms with switch 2 1/4" shaft
40¢ EACH

STANDARD BRAND MOTOR AND AC CRYSTAL PICK UP



60 cycles—115 volts with turntable

\$4.35 COMPLETE

FREE

I NEEDLE CUP With motor and pick up

I F TRANSFORMERS

Midget Type 456 KC Input-Output.
Medium Size 456 KC IF Coils—Input and Output.
ONLY 19c EACH

OUTPUT TRANSFORMERS for

50L6 ea. 45c
3Q5 ea. 45c
6V6 ea. 50c

All Sturdily Constructed

HANDY KITS FOR SERVICEMEN & HAMS

Tubular By-Pass Condensers Kit of 25. Fresh Stock. Wax impregnated. 25 selected condensers are of standard capacities and working voltages. Long flexible pigtail leads on each condenser.

RESISTORS—Kit of 100 assorted insulated resistors. Popular ohmages 1/2, 1/4 and 1 watt. Assortment of 100..... \$1.79

CERAMICON KIT of 25 condensers. Fresh Stock. All condensers are color-coded and have long flexible pigtail leads.

25 for \$1.29

SENGO RADIO, Inc.

25 for 89c

96B WARREN ST., N. Y. 7, N. Y.

BEEKMAN 3-6498

25% DEPOSIT ON ALL ORDERS, BALANCE C.O.D. F.O.B. NEW YORK

WE'VE GOT PLENTY OF TUBES!

Every Tube in Carton. R.M.A. Guaranteed

Type	Ea.	Lots of 10	Type	Ea.	Lots of 10
1A5GT	59	49	7Y1	41	35
1U5	36	30	7X7	44	35
1V	45	39	7AF7	44	35
1L4	55	49	12A6	35	25
1T1	69	55	12A8GT	45	37
185	69	55	12A76	50	45
2A5	65	55	12BA6	50	45
2A6	79	69	12BE6	50	45
2X2	79	72	12E5GT	49	39
3A4	69	59	12F7GT	45	39
3A5GT	55	50	12K7GT	45	39
5U4G	50	40	12K8	65	59
5W4GT	40	36	12Q7GT	45	39
5Y3GT	40	33	12SA7GT	40	32
5Y3G	42	37	12SF7	39	34
5Y4G	40	37	12SQ7GT	40	32
5X4G	40	37	12SK7GT	45	35
6A7	50	45	12SR7	39	34
6A8GT	49	39	12SJ7GT	55	49
6A5	98	92	2A	49	39
6AC7	65	60	26	39	30
6AK5	74	69	27	42	37
6AG7	79	41	41	40	35
6AK7	89	79	42	42	38
6B7G	55	49	43	54	49
6E5GT	40	35	45	49	39
6C6	45	32	47	49	39
6C8G	37	29	56	49	39
6D6	45	37	57	45	39
6F6GT	45	39	58	45	39
6H6GT	45	39	71A	39	29
6J5GT	45	39	75	50	39
6K7GT	42	38	76	45	39
6K6GT	45	39	77	35	27
6K7GT	49	39	78	35	27
6K7G	50	41	80	40	38
6L6G	79	69	83V	99	89
6M7GT	47	39	84/6Z4	45	36
6S7	59	48	85	49	45
6T7G	35	25	25L6GT	49	39
6V6GT	45	39	25Z5	49	45
6X5GT	49	39	25Z6GT	45	39
6SA7GT	44	37	35W4	43	40
6SJ7GT	44	37	35Z3	44	35
6SK7GT	49	39	35Z5GT	43	39
6SL7GT	49	47	35L6GT	45	39
6SN7GT	49	47	50L6GT	50	45
68Q7GT	44	37	11Z3	55	45
68Q7	44	39	11Z6GT	89	76
7C6	44	35	50B5	42	32
7F7	49	44	32L7GT	59	49

OD3/VR150 VOLTAGE REGULATOR TUBE 49¢ EACH

BRAND NEW WILLARD #20-2 VOLT STORAGE BATTERY and 2 VOLT VIBRATOR



Used in General Electric model 2530 or larger A PACK portables. Suitable for all farm radio sets. Individually boxed.

BOTH FOR \$3.39

Battery alone \$2.49
Vibrator alone 99c

SPEAKERS

4" PM Speaker \$1.19
5" PM Speaker 1.15
6" PM Speaker 1.55
8" PM Speaker 2.75
12" PM Speaker 5.49
4x6 inch PM Speaker. 1.89

F. P. ELECTROLYTIC CONDENSERS

All Popular Makes—Fresh Stock. Type FP Fabricated Plate Metal Cased Dry Electrolytics. All types use the mounting ears as the negative terminal. Separate positive terminals provided for each section.
15x15 mfd at 450 v.w. 69c
20x20x20 mfd. at 150 v.w. 69c
10x10 mfd at 450 v.w. and 20 mfd at 25 v.w. 71c
20x20 mfd at 450 v.w. and 20 mfd at 25 v.w. 89c
60x60 mfd. at 150 v.w. and 25 mfd at 50 v.w. 78c
20x20 mfd at 300 v.w. and 25 mfd at 20 v.w. 82c

ELECTROLYTIC CONDENSERS

Popular Brands—Fresh Stock
40x40 mfd at 150 Volts. ea. 49c
50x30 mfd at 150 Volts. ea. 49c

ELECTRICAL TRAINING

For Men of Ambition and Limited Time—Train for Successful Careers in Electricity

BLISS

Intensive 32 weeks residence course in fundamentals of INDUSTRIAL ELECTRICAL ENGINEERING, including radio and electronics. Extensive laboratory practice in electrical measurements; testing power equipment; circuit tracing; wiring techniques; radio and industrial electronics; use of machine tools; motor construction; drafting. A basic training meeting industry's requirements for engineering aides, laboratory assistants; operating, production and maintenance technicians; customer engineers; draftsmen. Graduates hold responsible technical and executive positions.
Modern buildings, dormitories, dining hall, campus. Moderate cost. 54th year. Classes begin March 22; July 26. For catalog write 7698 Takoma Ave., Washington 12, D. C.

ELECTRICAL SCHOOL

A TECHNICAL INSTITUTE



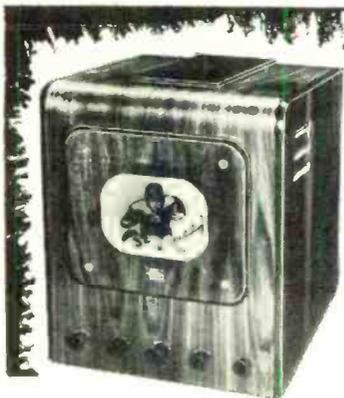

HERE'S THE NEW DYNAMIC 10" TELEVISION KIT

Model TU-10P, complete with all parts, tubes, instructions, etc. Less Cabinet.....Dealer Net

\$184.50

DeLuxe Model TU-10C shown above. Complete with cabinet in choice of walnut or mahogany.....Dealer Net

\$210.50

Place your order with your regular jobber. If your jobber does not handle our line kindly write for a list of jobbers in your state who do distribute our kits.

- CHECK THESE FEATURES:**
- 4 MC bandwidth giving beautiful picture definition.
 - 26.4 MC trap-tuned, high gain, video I.F. transformers.
 - EXCLUSIVE TRUE F.M. SOUND CIRCUIT—WE DO NOT USE SLOPE DETECTION.
 - Extremely stable hold circuits.
 - 17 Tubes—MOSTLY DUAL PURPOSE, including new, brighter 10" television cathode-ray picture tube.
 - R.F. & Oscillator sections prewired at factory.

DYNAMIC TELEVISION ASSOCIATES, INC.

Manufacturers, Television and Electronic Equipment
155 Prince Street Brooklyn, N. Y.

EASY TO LEARN CODE

It is easy to learn or increase speed with an Instructograph Code Teacher. Affords the quickest, and most practical method yet developed. For beginners or advanced students. Available tapes from beginner's alphabet to typical messages on all subjects. Speed range 5 to 40 WPM. Always ready—no QRM.



ENDORSED BY THOUSANDS!

The Instructograph Code Teacher literally takes the place of an operator-instructor and enables anyone to learn and master code without further assistance. Thousands of successful operators have "acquired the code" with the Instructograph System. Write today for convenient rental and purchase plans.

INSTRUCTOGRAPH COMPANY

4711 SHERIDAN ROAD, CHICAGO 40, ILLINOIS

RADIO SERVICE MEN!

TEST EQUIPMENT

—Sylvania, R. C. A.

Triplet, Hickock, Jackson, and Simpson.

Complete stock of all test equipment. Serving all counties in eastern New York State

Distributors of RADIO EQUIPMENT

CHIEF ELECTRONICS

104 MAIN STREET, POUGHKEEPSIE, N. Y.
The Square Deal Supply House

amplifier with radio attachment cord. The unit plays either 10 to 12-inch records and comes equipped with a permanent needle.

Housed in a sturdy luggage-type carrying case, the wooden box pro-



vides excellent baffle qualities, yet is compact and practical. The unit also includes the automatic shut-off feature whereby the motor turns off after the wire rewinds. A safety lock prevents accidental erasures and the visual tone indicator assures proper level when recording. For recording, the microphone rests on a table stand.

The new Model A-750 retails in the moderate price class and additional details on the unit may be obtained from *Air King Products Co., Inc.*, 170 53rd Street, Brooklyn 32, New York.

FM TUNER

The new model FMC-12 "Telvar" FM tuner, recently introduced by *Audar, Inc.*, is designed to bring frequency modulation programs within the range of everybody's pocketbook.



This unit, which sells in the low price class, can be attached to any ordinary radio by the serviceman. It is housed in a leatherette cabinet measuring 9½" x 7" over-all and uses the regular amplifying facilities of the AM broadcast receiver for volume. It provides the full noise reduction and frequency range of FM broadcast.

Audar, Inc., of Argos, Indiana, will supply additional information on this tuner by request.

LEAR HOME RECEIVER

One of the outstanding receivers in the *Lear* "Dynatrop" line of home receivers is the deluxe modern unit in bleached mahogany.

This combination unit includes both AM and FM coverage in addition to

SERVICEMEN—STUDENTS—HOBBYISTS

Why deprive yourself any longer?

For Only **\$19.95** YOU CAN OWN THE NEW



RCP #720 FM SIGNAL GENERATOR

A boon to servicemen and all those who require an FM Signal Generator. Compactness is achieved by using only the 4 frequencies that are actually needed in FM Servicing and Alignment—10.7 MC. for I.F. and 88 MC. for the low end—and 98 MC. for midpoint and 108 MC. for the top end of the FM Band. Each of these fixed frequencies is a fundamental and each is frequency modulated.

The accuracy and stability of this practical unit is of the same degree as the large commercial bench type units and has a continuously variable attenuator.

Model 720 case and chassis is completely isolated from the power supply, so there is no chance of shock or short circuit. Supplied complete with tubes, instruction book and output cable.

—BOTH POCKET SIZE—

Also Available The New **RCP #710 GENERATOR**

For All Standard Broadcast Application Only **\$17.95**

This unit provides four fundamental fixed frequencies, namely, 456 KC, 465 KC, 1500 KC and 550 KC. Broadcast band alignment is provided for by these

fixed frequencies for approximately 90% of all receivers in existence today. Ample harmonics available for other applications.

Designed for safe AC and DC operation. Complete with tubes, output cable and instruction book.

Adson

RADIO CO.

221 FULTON ST., N.Y. 7, N.Y.

providing a "Learecorder," single record phonograph turntable as well as an automatic record changer. The new "Leartron" pickup and "Leartronic" scratch filter have been incor-



porated in the phono circuit. The receiver is equipped with coaxial speaker, bass reflex tone chamber, microphone, a full-hour spool of wire with cue disc, and index pads.

Ample record album and spool storage space is provided in the large cabinet. A radio time clock, headphones, and additional spools of wire are available as accessories.

Lear, Incorporated, 110 Ionia Avenue, N.W., Grand Rapids, Michigan, will supply additional information on the "Dynatrop" line of receivers to those requesting it.

DUAL-SPEED RECORD PLAYER

Designed to meet the needs of the institutional market, the Victor Animatograph Corporation has announced production on a dual-speed record player unit, known as "The Sonomaster."

The player is housed in a leather-bound carrying case which weighs 40 pounds and measures 22½" x 16½" x 11".

The new unit features the new General Electric variable reluctance

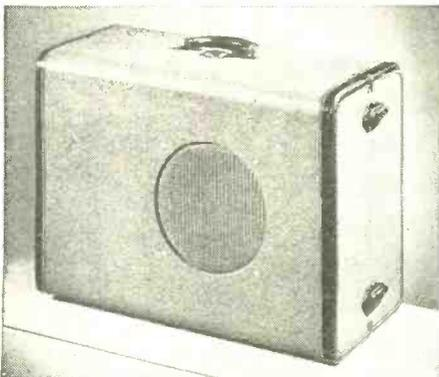

pickup which is unaffected by changes in temperature and humidity. It is equipped with a natural sapphire stylus which is soft-spring mounted and operates with only one-ounce pressure. The new instrument will reproduce records up to 16" diameter at either 33½ or 78 r.p.m.

The unit is completely self-contained and contains its own powerful amplifier and speaker. The amplifier is a four-stage, six-tube unit

EXTRA Listening Pleasure From Any Radio



FM RECEPTOR

With The
Meissner

• The thrill and incomparable beauty of FM reception is available to all with the Meissner model 8C FM receptor. A simple connection to any present AM radio . . . and the full scale fidelity of FM reception, unbelievably free from static, interference or fading, is brought to the listener as only the quality of Meissner skill can produce it. See and hear the new MEISSNER — there is nothing like it! Retail Price . . . \$57.50.

• New FM Band, 88 to 108 Mc. • Audio Fidelity, flat within plus or minus 2 db. from 50 to 15,000 CPS • Audio Output, 3 volts R. M. S. at minimum useable signal input, 30% modulation. • For greater signal inputs, output voltages as high as 15 volts R. M. S. obtained without distortion. • Power Supply, 105 to 125 volts, 50 or 60 cycle AC. Consumption, 35 watts • Tube Complement, 2 type 6AG5, 2 type 6BA6, 2 type 6C4, 1 type 6AL5 and 1 type 6X5GT/G

M **MEISSNER MANUFACTURING**
DIVISION OF MAGUIRE INDUSTRIES, INC.
MT. CARMEL, ILL., U. S. A.

SPEAKER RECONING

ALL WORK GUARANTEED

3" — \$1.15	7" — \$1.70	15" — \$5.00
4" — 1.25	8" — 1.95	4x6 — 1.60
5" — 1.35	10" — 2.50	5x7 — 1.75
6" — 1.50	12" — 2.75	6x9 — 2.00

OXFORD RECONING SERVICE
1039 Selby Ave. St. Paul, Minn.

Radio Technician and Announcers

A practical 13-month course in First Class Radiotelephone Operation and Announcing is offered by Don Martin School of Radio Arts. Most stations these days require combination men. We specialize in this type of training and maintain a placement bureau for our graduates. Serving the industry for 10 years, the School of Radio Arts can train you. Write for our catalogue outlining the courses offered. Classes can be arranged so you can do part time work on the side.

APPROVED FOR VETERANS

DON MARTIN SCHOOL OF RADIO ARTS
1655 North Cherokee St. Hollywood 28, Calif.

VERIFIED SPEAKERS

"They Glorify The Tone"

WRIGHT
Inc.

2232 University Avenue

St. Paul 4, Minnesota

OUTSTANDING EQUIPMENT AT FAIR PRICES

SCR-522 V.H.F. TRANSMITTER & RECEIVER—100 to 156 Mc. complete with tubes, Like New... **\$24⁹⁵**
 SCR-522 DYNAMOTOR Pe 98, 12 volt operation. Brand New... **\$12⁹⁵**
 24 volt operation, New... **\$7.95**

MARKER BEACON RECEIVER BC-1023



Receives 75 Mc. Modulated Signal, can be varied from 62 to 80 Mc. Operates self-contained sensitive relay that can be used to operate equipment from remote point. Needs only 12 to 14 volts DC for filament and plate voltage. Complete with four tubes, instruction book. Shock mounted. Size 5 3/4" x 5 3/4" x 3 3/4". Brand New. In original boxes. Shtg. weight: **\$3.79**
 4 lbs.

TG 10 AUTOMATIC KEYS

Amplifier 25 Watt. This well designed keyer can be used for code classes. Photo cell is actuated by inked tape recordings, can be converted easily to a 25 Watt amplifier, 110 volt 60 cycle operation. Comes with two 6L6's, two 6SN7's, two 6NT's, and one 5U4G output trans., 4, 8, and 15 ohm. Tape motor can be used as phono motor. **\$18.50**
 Used but in good condition.....

B19 MARK II, POWER SUPPLY NO. 1

12 Volt input, 275 volt 110 Ma. & 500 volt 50 Ma. output. In metal case completely filtered. Brand New **\$7.50**

B19 MARK III, POWER SUPPLY NO. 3

Same output as above. Uses two Permanent field dynamotors. High voltage supply is used only when transmitting. Completely filtered with relay. Can be used with Mark II Sets. Can also be operated at six volts, half the output voltage, same current. Brand New, original boxes... **\$9.50**

B19 MARK II TRANSMITTING AND RECEIVING SETS

15 Tube set, complete with all spare parts, ready to operate. Freq. 2 to 8 Mc., 235 Mc. & Inter-com. set. Brand New... **\$49.50**

0-500 MICROAMMETER—0 to 600 and 0 to 15 volt DC scale. Luminous Dial with multipliers. Brand, New... **\$2.50**

BC 348 AND BC 375

SHOCK MOUNTING FT 151 for BC 375... **\$1.50**
 SHOCK MOUNTING FT 154 for BC 348... **1.50**

WE CAN FURNISH ANY ITEMS FOR B19 MARK II SETS!

Shipments made F.O.B., Lima Ohio
 25% Deposit required on C.O.D. Orders

FAIR RADIO SALES
 223 S. MAIN ST. LIMA, OHIO

TELEVISION ELECTRONICS

LEARN RADIO THE NORTHWESTERN WAY

- BASIC RADIO
- RADIO SERVICE
- COMMUNICATIONS
- INDUSTRIAL ELECTRONICS
- TELEVISION

Highly Trained Instructors
 Modern Equipment
 Spacious Building and Grounds

NORTHWESTERN VOCATIONAL INST.



745 Grand Ave.
 ST. PAUL 5
 MINN.

including rectifier. Power output is 14 watts and the amplifier has separate channels for microphone and phonograph to permit the unit to be used as a public address system.

A 10-inch heavy-duty PM speaker with 25 watt capacity is built into the case. The player operates on 50 cycle, 110, 120, 130 volt a.c.

Descriptive literature on "The Sonomaster" will be forwarded by Victor Animatograph Corporation, Davenport, Iowa, upon request.

—50—

HIGHEST SET OUTPUT

THE Radio Manufacturers Association has announced that radio set production, including television sets and FM-AM receivers, broke all industry records in October, 1947.

For the first time in the industry's history more than two million radio and television receivers were manufactured by RMA member-companies in a single month. FM-AM receivers, produced in October, numbered 151,244. Television sets reached a new high of 23,693 although the September reported figure of 32,719 was higher due to the inclusion of 16,991 sets produced earlier but not reported.

The new figures make a ten month total of 14,364,218 sets of all types. Of this number FM-AM sets accounted for 830,106, while television receivers for the same period numbered 125,081.

A breakdown of the October figures show that of the FM-AM sets 49,319 were table models, 555 were converters and tuners, 656 consoles, and 100,714 radio-phonograph consoles. Of the television receivers 13,503 were table models, 10,181 were consoles and radio-phonograph combinations, and 9 were converters.

—50—

This compact radiation detector was designed at the University of Chicago for possible use by American troops. Designed in 1945 by Dr. O. G. Landsverk, who now manufactures them, the instruments were unveiled recently after being declassified by the Atomic Energy Commission. The larger type Geiger counter shown is one of several in use at the Institute for Nuclear Studies, part of the University of Chicago's \$12,000,000 program in atomic research.



IT STAYS STUCK!

WITH...

MULTI-PURPOSE AMBROID



If you want permanent results from an adhesive, you can't equal multi-purpose Ambroid liquid cement — for home workshop, household or factory. A quality leader for 37 years, ready-to-use Ambroid is waterproof, transparent, quick-drying, extra strong. Flexible, heat-and corrosion-resistant. For assembling, repairing or mending jobs, keep Ambroid handy. At your dealer's, or send 25¢ for big 2-oz. tube post-paid. Money back guarantee.

Also 50¢ 4-oz. tube. Pts., qts., gals., for industrial use.



310 Franklin St., Boston 10, Mass.

SIGNAL - TRACER - GENERATOR

- Pencil Probe
- High Gain Tracer
- Built-In Detector
- Sig. Injector Gen.
- AC-DC Operation

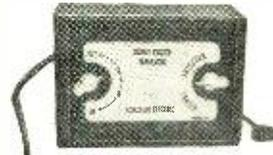

ONLY **\$16.50**

Ready to operate—Signal Tracer with loudspeaker operation—Signal Generator—Multivibrator—Puts out strong A.F., I.F., R.F. signal 1000 cycles to 25 megacycles.

PHONO-OSC-AMPLIFIERS

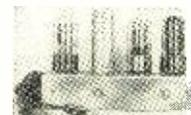

35Z5, 12SQ7, 50L6 Hi-Gain, Hi-Fi. AC DC Amp. Complete... **\$4.69**

Wireless Phono-Osc. Mike or Phono inp. Complete with tubes. Wired... **\$4.49**

YORK DISTRIBUTORS

523 Knickerbocker Ave., Bklyn. 21, N.Y.

TINY RADIO!
 FITS IN YOUR HAND! Really works, too! Unbreakable Red Plastic Cabinets. No tubes, batteries or electric "plug-ins"! Works on new Patented "Permacrystal" and Roto Tuner! Easy to use! Should last for years! **Guaranteed to Work** anywhere for you on local radio programs. or send only \$1.00 (bill, money order or check) and pay postman \$2.99 plus postage on delivery. Complete ready to play — marvelous gifts — bargain priced! Get your Tiny Radio now!

Only **\$3.99 Postpaid**
 Complete ready to play — marvelous gifts — bargain priced! Get your Tiny Radio now!
 PAKETTE PRODUCTS CO., Dept. TRN-2, Kearney, Nebr.

WALKIE-TALKIES

As used by the Armed Forces in combat. These units are guaranteed to be in perfect working operation. Complete with tubes, battery pack, and telephone-type handset, \$49.95 each. Operate on 28-38 MC and 38-52 MC (F.M. band). Extra tubes, antennas, handsets, and battery packs available.

HARRIS SUPPLY COMPANY
 1336 W. Chase Avenue Chicago 26, Illinois

Magnetic Recording

(Continued from page 53)

a new recording. This field may be supplied by the same oscillator that supplies the supersonic bias. The magnitude of the necessary erase energy is dependent upon the head design and the recording medium. It, therefore, follows that if an intensely strong audio signal has driven the medium up to its saturation point, erasing may not be complete if the erase current has been predetermined and set at too low a value.

Drive Systems

Several different methods may be used to move or drive the magnetic medium. The type of drive system adopted depends upon the purpose for which the recorder is to be used, and the degree of perfection to be expected from the over-all system.

If a recorder is to be designed as an office dictation device in which only speech recording is to be made, a fairly high degree of wire or tape speed variation may be tolerated. This is because flutter or wow, which results from a variation in the speed of the medium, is not easily discernible, and not objectionable when the spoken word is recorded and played back. This is perhaps true for three reasons; first of all, because individuals are accustomed to listening to a variation in the rate or delivery of spoken sentences; second, the average voice range consists of relatively low frequency components, consequently, rate changes are far less pronounced than with higher frequency components; and, third, staccato components of speech are not easily affected by flutter or speed variations.

Musical recording, of course, must take place with a minimum of variation in the speed of the medium. Long sustained musical notes, or instruments in which the trueness of reproduction depends upon harmonic components, are especially vulnerable to the smallest degree of flutter, or wow. Consequently, a drive system that will fulfill the most stringent requirements must be utilized for really flutter-free operation. Such a method is the so-called "capstan drive." This arrangement which was named for its analogous counterpart to the marine application of the capstan, normally requires approximately a half turn wrap of the magnetic medium around the capstan, in which a good frictional contact has been made. The capstan is normally sufficiently weighted with a flywheel so that once the proper operating speed has been attained, inertia effects will insure constant speed. Speed variations of .1 of 1% may be realized through this design.

While the capstan system approaches the ideal from the recording standpoint, it is somewhat expensive, space consuming, and difficult to manufacture on a production basis. A quite satisfactory spool drive may be accom-

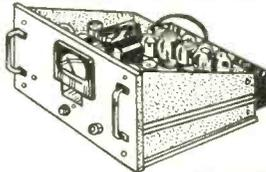
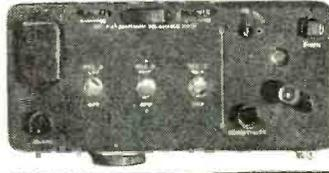

SHOOTS THE WORKS!

	<p>BUILD YOUR OWN</p> <p>6-tube super-het, 3-band receiver... slug tuning. We furnish blond, Swedish modern cabinet, slug tuner and dial plate. Also schematic with list of other parts required \$2.95</p> <p>Kit with all necessary parts to complete above..... \$6.95</p>
	<p>PHOTO-CELL AMPLIFIER</p> <p>110V, 60 Cy. panel type has 0-50 Micro Ammeter on front panel with tubes 6V6, 6J7, 45, 80, VR105 \$9.95</p>
	<p>REMOTE CONTROL TUNER</p> <p>C-38/ARC5 Tuning head... 6 volume controls less switches 39c</p> <p>3 for \$1.00</p>
	<p>PHOTO CELL RELAY CONTROL</p> <p>Amplifier De Vrey Complete with Tubes. \$9.25</p>
	<p>MASTER CONTROL FOR RADIO</p> <p>Compass... Complete with meter. \$1.30</p>
	<p>PUSH BUTTON ASSEMBLY</p> <p>Can be used on most any standard radio. Complete with condenser and resistor... 4 stations... 79c</p>
	<p>TRIMMER AND PADDER</p> <p>Condenser Assortment 20 for \$1</p>
	<p>RESISTOR ASSORTMENT</p> <p>1/2 and 1 Watt Asst. Ohmic values 100 for \$1.69 500 for \$6.95</p>
	<p>CONDENSER ASSORTMENT</p> <p>Mica, Ceramic, Paper, Tubular and Can. 100 for \$2.69</p>
	<p>New Circular Available! WRITE TODAY</p>

AMERICAN SALES COMPANY

1811 West 47th Street Chicago, Illinois

SERVICE KIT

Kit includes assortment of:

- 100 Resistors, 1/2 and 1-watt.
- 50 Condensers, paper, mica electrolytic & can.
- 10 Switches, Toggle, Gang & Rotary.
- 100 ft. Spaghetti, various sizes.
- 12 Knobs, round and bar.
- 2 lbs. Hookup wire.
- 20 Fuses.
- 6 Volume Controls.
- 10 Tube Sockets.
- 1 lb. Hardware (screws, nuts, lugs, etc.)
- 12 Wire Wound Resistors—10 & 25 Watt.
- 25 Connectors, Plugs, Ties.
- 10 Jacks (Phone) & Tip.
- 12 Padder Condensers.
- 12 Terminal Boards.
- 25 Ceramic Insulators.
- 2 Panel Lights (1 neon).
- 1 Screw Driver.
- 1 Tube Puller.
- 2 Allen Wrenches.
- 2 Panel Fuse Holders.
- 4 Binding Post Strips, and many other valuable items.

Your Cost
\$9.95
Complete

DYNAMOTOR (Slightly Used)

Input 24 V D.C. 12 Amp. 300 V. D.C. 26 Amp. Output 150 V. D.C. .01 Amp. 14.5 V. D.C. 5 Amp. with Voltage Regulator and Filter System \$2.95

MICRO AMMETER

BeeDee U-200 D.C. \$3.00

MILLI AMMETER

BeeDee O-1000 M.A. \$1.95

METER RECTIFIERS

Full Wave 95c
Half Wave 65c

PARABOLIC REFLECTORS

15" spun aluminum. Alzak fin. for 1200 Mc. Up. Pr. \$3.00

BUTTERFLY TUNERS

80 to 300 Mc. 300 to 1000 Mc. New in cartons \$1.89

KNOB ASSORTMENT

25 Knobs, all popular sizes \$1.00

SPOT SURPLUS SPECIALS

DELIVERY GUARANTEED!

Our buyers attend all U. S. Gov't. surplus sales. We buy in quantities that enable us to offer you the best electronic equipment including hard-to-get radar and communications sets, tubes and parts -- at the lowest prices.

SEND FOR BULLETIN "M" FOR COMPLETE UP-TO-THE-MINUTE STOCK AND PRICE LISTS.

PACIFIC COAST DEALERS: Write for special prices.

New...

- 826 Tubes \$1.00
- Sound powered phones \$4.95 per set
- Carbon mikes 25c each

25% CASH WITH ALL ORDERS. MINIMUM ORDER \$1.00

G. & M. EQUIPMENT CO., Inc.

4505 VAN NUYS BOULEVARD • VAN NUYS, CALIFORNIA • STATE 4-3233

HOBCO
FEBRUARY
SPECIALS

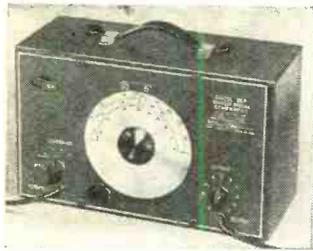

**McMurdo Silver Model 909
 FM/TV SWEEP
 SIGNAL GENERATOR**

Range 2/226 MC—a frequency modulated FM and TV SWEEP Signal generator—demanded by thousands of research and service technicians. With this new McMurdo Silver 909, Oscilloscope and AM Signal Generator, one can visually align FM and TV receivers quickly and perfectly. Complete instructions supplied.

Only Net
\$48⁵⁰



**AIR KING PORTABLE
 WIRE RECORDER**

Has console features in a portable case, including automatic shut-off after wire winds—Safety Lock that prevents accidental erasures—visual tone indicator to maintain recording level,—highly sensitive microphone with table stand—few controls for easy operation—five tube amplifier, including rectifier. Price includes these extras—2 spools of wire, cord for radio recording, microphone table stand.

List Price
\$129⁵⁰

Write for Our Radio Parts
 Bulletins—issued Monthly



HENRY O. BERMAN CO., Inc.

10-12 E. LOMBARD STREET
 Dept. R-5 BALTIMORE 2, MD.
 Electronic Equipment and Replacement Parts

S.S.S.

"Servicing by Signal Substitution"

Learn about this modern dynamic approach to radio servicing with ONLY BASIC TEST EQUIPMENT.

... Fully described in a 120 page book available from your Precision Distributor or factory at 40c.

... Schools are invited to inquire regarding quantity orders from our Educational Division.

PRECISION

APPARATUS COMPANY INC.
 ELMHURST 9, N. Y.

Manufacturers of Fine Test Equipment
 RADIO • TELEVISION • ELECTRICAL • LABORATORY

plished through the use of roller devices which have a rubber surface. When intermediate idler mechanisms of this nature are employed, it is important that the surface configuration be as truly circular as is attainable. This type of drive has been adopted by several manufacturers presently producing magnetic recording equipment. It is very satisfactory for most musical recording.

Possibly the simplest type of drive mechanism, and that employed on earlier recorders, is the belt drive. While slippage and belt tension do become a problem when this is employed, they may be minimized through the use of neoprene belts which maintain tension for a long time. Belt drive is currently being used for magnetic recording devices engineered for business dictation uses.

Heads

Magnetic heads of the combination record, playback, and erase types have received a great deal of research time. Initially, the erase coil was designed as a separate component from the head proper; however, today, all three functions are combined in one head. Research at the *Armour Research Foundation* has included both open-slot and thread-through heads for wire of various types and designs. A number of heads for tape, both of the high and low impedance types, and heads for motion picture magnetic sound including 35 mm., 16 mm. and 8 mm. equipment have been designed. [See Bibliography 1.]

The first wire heads were designed for use with medium carbon steel wire. These heads were wound on a laminated core and were of the open type

(the recording medium did not have to be threaded through the coil area). Because of the magnetic characteristics of medium carbon wire, erasing did not require a strong field. When the stainless steel medium was adopted, head redesign became necessary in order to increase erase efficiency. One of the first heads designed for the stainless steel wire is pictured in Fig. 4. This head was originally designed to erase wire having a coercive force in the vicinity of 200 oersteds. Its core was made of *Allegheny 4750*, an alloy approximately 50-50 nickel-iron, manufactured by the *Allegheny Ludlum Company* of Pittsburgh, Pennsylvania. This head included a recording coil containing 3000 turns of #44 *Formex* wire, an erase coil of 20 turns of #28 *Formex* wire and a coupling coil in series with the erase coil and located adjacent to, but above the recording coil. This latter coil consisted of 4 turns and supplied the supersonic bias component. The recording gap of .002" and the erase gap of .010" were filled with solder after they had been shaped and cut. Constructing a head for either magnetic wire or tape is a precision operation and should be done with great care.

Originally, closed type magnetic heads in which the magnetic medium is passed through the erase or record-playback coils were more highly efficient than the open type. However, recent improvements in open type head design has made possible excellent results equalling closed head performance.

Magnetic heads may be designed to use either high or low impedance windings. While the low impedance

Fig. 6. An 8 mm. projector converted for experimental magnetic sound-on-film recording.

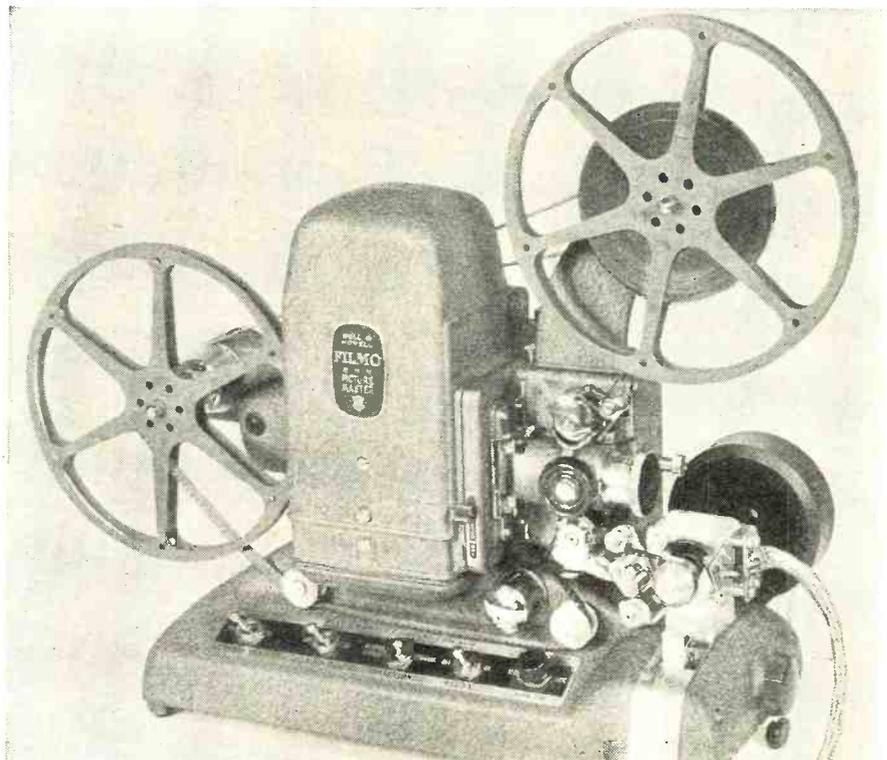

head is somewhat superior from the standpoint of response characteristics, the cost of the coupling transformer precludes its use in low cost equipment. The high impedance head shown in Fig. 4 has a d.c. resistance of 385 ohms and an impedance of 18,500 ohms at 20 kc. Unequalized response for this head is shown in Fig. 2.

Equalizers

It is apparent from Fig. 2, that in order to make recordings pleasing to the listener, it will be necessary to add some form of frequency equalization into the recording or playback amplifiers, or both.

While logic would indicate the desirability of a perfectly flat frequency response, the optimum recording-playback frequency response curve is affected by several influencing factors including the performance of associated equipment, i.e., microphones, loudspeakers, and individual preference. Another factor of importance must take into consideration whether the recording is made up of entirely music or speech components. We will have to assume, however, that it is desired to achieve a flat response over as great a range as is practicable using available media, heads and standard speeds of operation. [See Bibliography 3, 7.]

In order to approach this problem, it is necessary to know: (1) the approximate level of recording and to have an energy versus frequency curve covering the program; (2) the unequalized response characteristic of the recording medium and heads; (3) information to enable the determination of the overload level; (4) information concerning the noise level over the usable range; and (5) anticipated harmonic distortion and hum to be expected in the amplifiers.

In considering a recording equalizer, it is important to attempt to achieve a maximum signal-to-noise ratio through frequency discrimination so that there is an equal probability of overload at all frequencies. The frequency equalizer for the playback amplifier is normally designed to obtain a flat over-all response after the recording amplifier equalizer has been completed.

For several reasons it has been found expedient to pre-emphasize high frequencies during recording, and post-emphasize lows on playback. Normally, high frequency pre-emphasis is designed to boost frequencies which are above that of maximum response to the level of the frequency of maximum response. This is shown in Fig. 3. The playback amplifier, designed to boost low frequencies, must be carefully designed so as to minimize hum as far as possible. Normally, the low frequency drop off is quite linear, and a low frequency boost of 5 or 6 db. per octave will be satisfactory.

Signal-To-Noise Ratio and Dynamic Range

Determination of the effective signal-to-noise ratio of a magnetic re-

make henry your hallicrafters headquarters

COMPLETE STOCKS

Henry has everything in the ham field

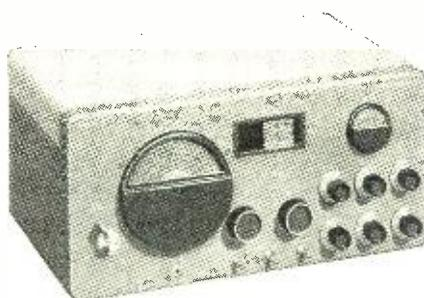
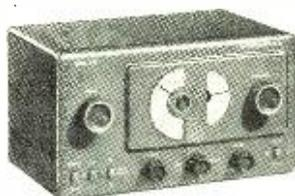

QUICK DELIVERY

Shipments 4 hours after receipt of order

S-38 Biggest little buy on the market. Frequency range: 540 kc to 32 Mc in 4 bands. Separate electrical bandspread dial. CW pitch control adjustable from front panel, automatic noise limiter. Self-contained PM dynamic speaker . . . **\$47.50**

SX-43 Hottest ham performance ever at this price. All essential ham frequencies from 540 kc to 108 Mc. In the band of 44 to 55 Mc, wide band FM or narrow band AM, just right for narrow band FM reception is provided . . . **\$169.50**

BUTLER MISSOURI **HENRY RADIO STORES** 11240 Olympic Blvd LOS ANGELES 25 CALIF.
"World's Largest Distributor of Short Wave Receivers"

MOTOR GENERATORS

Brand New War Surplus Machines built by Allis Chalmers Co. to U. S. Navy Specifications.
Input: 115 V. D.C. at 14 amps., 3600 rpm. Output: 120 V. A.C., 60 Cy, 1 ph, at 10.4 amps., 1000 Watts continuous duty. Ball bearings. Splashproof. Fully enclosed. Centrifugal starter. Frequency adjustable to load. Price \$87.50.
Same machine but for 230 V. D.C. input. Price \$125.00. Spare parts kit with extra brushes, brush-holders, field coils, bearings, etc., for either machine, \$29.50.
All prices FOB Tuckahoe, New York
ELECTRONICRAFT, INC.
5 Waverly Place, Tuckahoe 7, New York

Radio Shop Owners

Increase Your Profits Through Our Speaker Reconing Service

Quick Service—Prices on Request

S & R CONING SERVICE
169 West Eldorado Decatur, Ill.

Learn and Earn! TELEVISION RADIO F. M. COMMUNICATION

offer profitable occupation for both men and women. You learn by actual work, how to build and operate, and fit yourself for a higher pay job. Write for catalog.

Approved for Veterans

HOLLYWOOD SOUND INSTITUTE
1040-A N. Kenmore Los Angeles 27

MORE FOR YOUR MONEY....

because—

They More Than Meet
Your Needs.

LECTROHM RESISTORS

Lectrohm Resistors are built to exceed your requirements—regardless of specifications, production or experimental aim. Available in a complete range of line ratings, based on NEMA and RMA standards. Lectrohm Resistors are accurately spaced, wire wound and integrally embedded in vitreous enamel for long, dependable service. Quality alloy wire is silver soldered to solder lug in special process, assuring always-perfect electrical bond. For safety's sake—use only a resistor that you are certain will dissipate your required rating without overload. And for efficiency's sake—always specify only Lectrohm Resistors. Write for Lectrohm's new catalog of valuable resistor data—today.



5131 West 25th Street, Cicero 50, Illinois
Division of
National Lock Washer Co., Newark, N. J.



LEARN RADIO ELECTRONICS

APPROVED FOR VETERANS

TELEVISION—FM—RECEIVERS—
TRANSMITTERS—LORAN—RADAR

Become a COMMERCIAL OPERATOR

Pre-FCC exam. tests — SOUND MOTION
PICTURES — AUDIO VISUAL DEMONSTRATIONS—LABORATORY CONSTRUCTION

ELECTRONIC
TECHNICAL INSTITUTE

771 Venice Blvd. Los Angeles 15, Calif.
Phone Richmond 9573

Mr. Radio Service Dealer "Speed is our Motto"

One day service on all orders. None too small. Only Nationally Advertised Merchandise (No Surplus Handled). TUBES—Any quantity 50% off list.

Mail us your orders.
Illustrated list on request.

Bill Sutton's Wholesale Electronics
Fifth at Commerce Fort Worth, Texas

TUBES! TUBES! TUBES! THOUSANDS OF TUBES . . .

NEW, STANDARD BRAND TUBES

MINIMUM ORDER \$5.00, QUANTITY PRICES ON REQUEST

1A3 \$0.98	6AG799	6SS775	35Y4 1.10	715B 4.95	1851 1.25
1A7GT 1.10	6AK599	6U598	35W469	717A75	205090
1B24 4.50	6AL599	6V6GT99	35Z399	723A B 9.95	205190
1G498	6AQ598	6Y6G69	35Z569	801A 2.25	5514 3.95
1G698	6AT675	6X498	1.10	801A75	719349
1H4C98	6AU689	6X589	.37	.69	802 RK25.. 1.49
1L4 1.10	6B4 1.29	7AE775	.38	.89	803 8.95
1R4 1294... 1.29	6B6G99	7C4 1.50	39 44	.59	807 1.25
1T4 1.10	6B889	7C589	41	.69	808 2.95
1H599	6C464	7F7 1.25	45	.64	809 1.50
1NSGT 1.10	6C551	7L7GT 1.39	46	.65	811 1.95
1LN5T 1.92	6C675	70Y 1.50	47	.90	812 3.25
1R5 1.10	6C21 12.95	12A689	50B5	1.89	812H 6.90
1S5 1.10	6D675	12AH7 1.10	50L6GT	.75	813 8.95
2A3 1.39	6F4 1.35	12AT6 1.10	70L789	814 4.49	900598
2C2298	6G551	12BA689	71A69	826 3.00	900669
2C26A97	6F695	12BE689	7589	.89	826 1.75
2C34 1.15	6F6G80	12C889	75T 2.95	826B 3.95	HY75 1.25
2C40 2.60	6F7 1.25	12J569	7675	830B 5.25	HY615 1.25
2C44 1.75	6F8 1.10	12K8 1.25	7775	832A 2.25	OZ4 1.25
2D21 1.50	6G6 1.10	12SA7GT... .99	7875	835A 34.50	RK60 1.25
2E22 3.95	6H669	12SG789	7989	.89	836 1.15
2E30 2.25	6J4 1.50	12SH789	8053	837 2.50	T20 1.95
2J32 20.00	6J559	12SJ779	8298	838 3.75	TZ40 2.95
2J33 20.00	6J689	12SK789	8398	841 1.20	V70D 6.90
2L851 4.95	6K689	12SL7 1.10	8475	845 3.75	VR7875
2X284	6K779	12SN7GT... .79	8589	85089	VR9075
3A449	6K8 1.25	12SR779	117L7 1.89	866A75	VR15075
3B798	6L6 1.25	12X398	117Z389	872A 2.25	ZZ25 1.95
3B22 4.95	6L6G 1.20	14A7 1.10	117Z6GT... 1.10	874 1.95	902 2.95
3B24 1.95	6L791	14B7 1.10	121A 2.65	88475	2AP1 2.25
3D6 1299... .89	6N7 1.25	14H7 1.25	205B 4.50	92349	3BP1 3.45
3E29 2.95	6Q598	14J7 1.25	211 1.25	95475	3BP1 2.95
3Q4 1.10	6Q5G98	14R7 1.10	215A 3.00	95575	5BP1 3.95
3QS7 1.10	6Q789	15E 1.50	217C 7.50	95675	5BP4 5.45
3S4 1.19	6R798	23D498	250R 3.95	95775	5CP1 3.95
4C35 1.95	6SA790	23D698	250TH 14.95	958A75	5FP7 4.50
5R4CY 1.15	6SC785	24C 1.35	304TL 4.95	95975	7BP7 7.95
5T4 1.25	6SF579	25AC6GT.. .75	307A 6.25	99159	7DP4 14.95
5U498	6SG789	25L6GT75	311A 3.00	100539	7EP4 18.95
5V4C98	6SH765	25Z575	311B 3.00	100639	7GP4 19.40
5W498	6SL7GT69	25Z698	394A 4.50	101395	9AP4 50.00
5Y360	6SK775	28D775	417A 19.95	1014 1.75	108P4 34.95
5Y4C59	6SL789	3078	446A 2.60	1616 2.95	10TP4 42.90
5Z389	6SN7GT69	32L7 1.50	703A 7.50	161998	12JPA 49.40
5Z489	6SQ789	3498	705A 4.95	162498	15AP4 110.00
6AB7 1853.. .90	6SR789	35L6GT75	713A 1.65	162598	20AP4 270.00
6AC799					
6AG599					

20% DEPOSIT WITH ALL ORDERS UNLESS RATED

NIAGARA RADIO SUPPLY CORP.

160 GREENWICH ST.,
NEW YORK 6, N. Y.

order system depends on several factors. Important among these are the magnetic properties of the medium and its vulnerability to magnetic noise, the speed of the medium, cross-talk or magnetic transfer, mechanical noise resulting from mechanical imperfections in the media, amplifier noise, the effect of stray electrostatic or electromagnetic fields and consideration of the frequency distribution along with considerations relating to the amount of pre- and post-equalization employed.

Dynamic range, which is dependent upon the signal-to-noise ratio, is also a function of the various noise contributions referred to in the previous paragraph and is usually in the order of from 35 to 45 db. for the entire system. This may be raised by careful design.

Speed vs. Fidelity

The speed at which the recording medium is driven has a very marked effect on high frequency response of a magnetic recording system. The low frequency response, however, is affected only slightly. [See Bibliography 4.]

This high frequency effect is mainly caused by self-demagnetization in the wire or tape and by the relation between wavelength and gap length. Inasmuch as self-demagnetization is not important at the low frequencies, speed reduction does not have much of an effect. As the frequency is increased, self-demagnetization becomes quite evident and increases rapidly with speed reduction after a critical frequency has been reached. High frequency response is also reduced unless the gap length is much less than the audio wavelength.

Through the determination of a constant current frequency response curve at a given wire speed, it is not difficult to obtain curves showing frequency versus speed effects. This may be accomplished by playing back a fixed wavelength at varying speeds, which will render demagnetizing and gap length effects ineffective as they will remain constant. The output voltage will be directly proportional to the speed.

While most commercial home entertainment magnetic recorders will give an essentially flat response from approximately 100 to 4500 cycles, it is possible to design magnetic recording equipment into a really high fidelity recording system. *Armour* has designed a master wire recorder essentially flat in response from 40 to 14,000 c.p.s., and equipment rendering a similar response is available commercially.

Magnetic Sound for Motion Pictures

In the discussion of magnetic media, heads, etc., this latest application of magnetic sound was intentionally omitted. As a direct outgrowth of magnetic tape recording, the idea of placing a magnetic sound track on the edge of the film was a further step in the utilization of magnetic recording.

Experimental work has so far included the conversion of projectors of 35 mm., 16 mm., and 8 mm. sizes and has proven to be an exceedingly satisfactory means of motion picture recording. Frequency response, essentially flat to 5000 c.p.s., can be easily attained at 24 frame-per-second, 16 mm. sound speed. Response to 3000 c.p.s. can be obtained at conventional 8 mm. speed. [See Bibliography 5, 6.]

Magnetic heads can be either of the high or low impedance type, however, the low are to be preferred so as to minimize hum pickup and decrease head size. The sound track consists of a special iron oxide coating which is applied to the edge of the film. This track is approximately .032" wide and 1/2 mil thick, placed outside of the sprocket holes.

Some means of film speed stabilization is necessary for satisfactory projector operation with magnetic sound as with optical sound so as to minimize sprocket flutter and wow as far as possible.

Figs. 5 and 6 show head location on converted 16 mm. and 8 mm. projectors, respectively. This is not a conversion that can be accomplished easily in a home shop. Neither the material for coating nor heads are as yet available on the commercial market.

BIBLIOGRAPHY

1. Javite Alex E.: "An Appraisal of Design Trends in Magnetic Sound Recorders," *Electrical Manufacturing*, June, 1946.
2. Vaile, Dr. R. B., Jr.: "Recent Developments in Magnetic Recording of Sound," *Proceedings of the National Electronics Conference*, Vol. 2, 1946.
3. Holmes, Lynn C. and Clark, Donald L.: "Supersonic Bias for Magnetic Recording," *Electronics*, July, 1945.
4. Camras, Marvin: "Theoretical Response from a Magnetic Wire Recorder," *Proceedings of the IRE and Waves and Electrons*, Vol. 34, No. 8, August, 1946.
5. Camras, Marvin: "Magnetic Sound for Motion Pictures," *Journal of the Society of Motion Picture Engineers*, Vol. 48, No. 1, January, 1947.
6. Camras, Marvin: "Recent Developments in Magnetic Recording for Motion Picture Films," *The Journal of the Acoustical Society of America*, Vol. 19, No. 2, March, 1947.
7. Read, Oliver: "The Recording and Reproduction of Sound," (Part 6), *Radio News*, Vol. 38, No. 2, August, 1947.

-30-

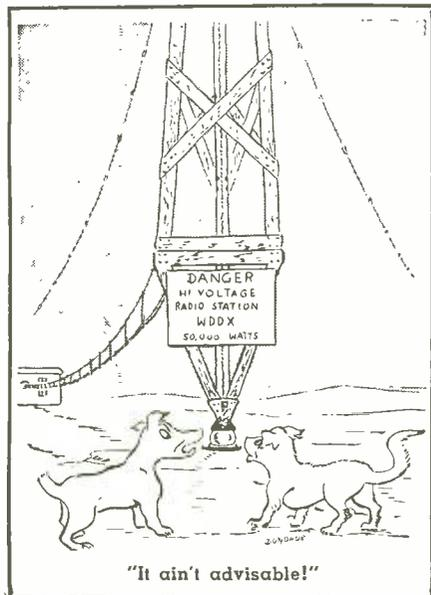

February, 1948

ESPEY

The Custom Built Chassis

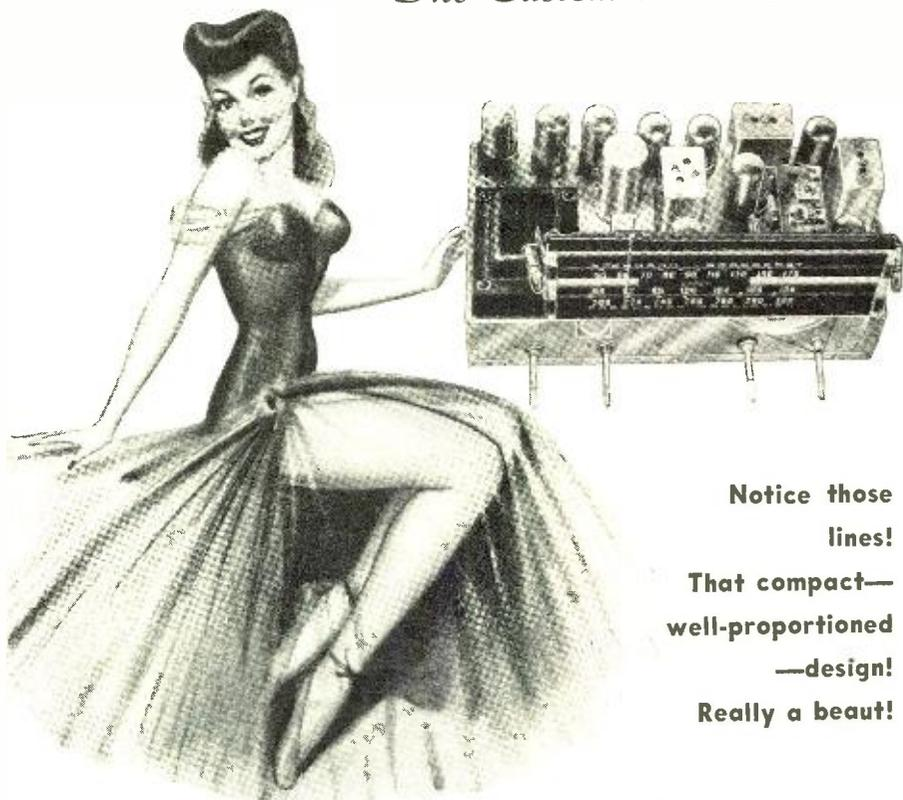

Notice those lines!
That compact—well-proportioned—design!
Really a beaut!

Yess! In producing the **ESPEY Custom-Built Chassis** we have in mind the need for full, well-rounded design, moulded to meet the needs of a discriminating market. The **Model 7-B** is only one of the quality line of custom-built receiver chassis produced by **ESPEY**. It is carefully engineered and manufactured to give absolute satisfaction in any type of installation.

The **7-B** is an AM/FM superheterodyne receiver with 11 tubes including a rectifier tube, operating on 105/125 volts AC 50/60 cycle. Wired for phono operation this superbly engineered receiver, is supplied ready to operate with 10" PM speaker with Alnico No. 5 magnet, antennas and all necessary hardware.

For further details about this—and the rest of the ESPEY line—write to Department A today.

ESPEY MANUFACTURING COMPANY, INC.
 528 EAST 72ND STREET-NEW YORK 21, N.Y.

L P 21-A (NEW)
RADIO COMPASS LOOPS
 Complete with dehydrator and couplings
\$5.50 EA.

Will operate as motor drive for antenna on 10 volts 60 cycle AC
 Antenna change over relays 24 v. DC at \$.95 ea.

NEW T-U 5B UNITS \$2.00 | **DM 33 Dynamotor 24v input 625v output**
A Box Chuck Full of Good Parts | **NEW \$1.00 EA.**

TUBES!	2C261	35c	12Z3	\$1.00	1629	18c	
'45	30c	9JPI	\$7.50	959	40c	UX6653	30c

AIRCRAFT INSTRUMENTS! ECLIPSE VOLTAGE REGULATOR 1042-6 (NEW) \$7.50
 NEW MANIFOLD PRESSURE GAUGES 0-50, 0-70 \$2.50 EA.
 AN5531-1 (NEW) G.E. TACH. GEN. \$5.00 EA.

FARWEST TRADING CO., INC.
 209-1st Ave., South | Cable Address "FARCO" | SEATTLE 4, WASH.

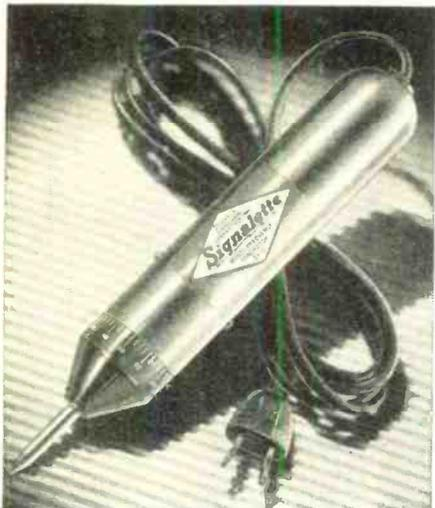

Faster Signal Tracing

Signalite

MULTI-FREQUENCY GENERATOR

Generates R.F., I.F. and AUDIO Frequencies, 2500 cycles to over 20 megacycles, using new electronic multivibrator radar principle. Completely self-contained—fits coat pocket or tool chest. Just plug into A.C. or D.C. LINE AND CHECK RECEIVER SENSITIVITY, AUDIO GAIN, R.F. and I.F. alignment, auto radio aerial peaking or shielding, breaks in wires, stage by stage signal tracing, tube testing by direct comparison, etc., etc. Sturdy construction, handsome appearance! See at your distributor or write for details. Shipping wt. 13 ozs.

Clippard Instrument Laboratory, Inc.

Dept. N

1125 Bank St., Cincinnati 14, O.

PRICE \$9.95

at distributor or F.O.B. Cincinnati

Recognized Jobbers — wire, write for details of territory open!

LOOK! New, Low Prices!

COMMAND TRANSMITTER

Bc-457-A, 4 to 5.3MC. Use as E.C.O. on 80 or 40meter. Complete with 4 tubes, and 4600 K.C. Crystal.



BRAND NEW in original cartons, each \$4.50

TRANSFORMER

Suitable to operate all Command transmitters Primary 115 v. 60 cycle.
 Sec. #1, 400-220-0-220-400 125M.A. simultaneous operation.
 Sec. #2, 5.0v. 3A.
 Sec. #3, 5.0v. 3A.
 Sec. #4, 5.0v. 3A.
 Sec. #5, 6.3v. 2A.
 Sec. #6, 6.3v. 3A.
 Sec. #7, 6.3v. 3A. each \$3.95
 With B.C. 457-A combination.... each 8.00

RADIO COMPASS CONTROL BOX



0-5D.C.M.A. meter, band switch, gears, controls, knobs, jacks, switches, etc. Give away price each \$1.25

SHOCK MOUNTS FOR APS-13

Dimensions—15 1/4" x 7 3/16" shock mounted Brand new each \$0.59

TUBES

All brand new, in cartons, J.A.N.

1619	\$0.19	1629	\$0.29
162539	10Y39
162639	6AK-569
12A619	5BP4	3.25

QUAD ELECTRICAL SUPPLY

1650 North Damen Avenue, Chicago 47, Illinois

Wire Recorder

(Continued from page 43)

drives. The motor is held in this neutral position by means of springs. When the operation control is thrown to the "run" position, the motor is shifted by means of a cam arrangement, so that the motor shaft makes contact with the idler wheel *E*. This idler wheel *E* is supported by a bracket which is free to move in a lateral direction. Because of the pressure of the motor shaft the idler wheel is forced against the drive drum of the takeup wheel *N*. Through the reduction obtained by this arrangement, the takeup drum is driven at the proper speed to pull the wire at two feet per second.

When the "operate" switch is thrown to the "rewind" position, a cam on its shaft shifts the motor so that the rubber drive wheel mounted on its shaft makes contact with the supply drum *D*. Due to the difference in size between the motor shaft and the rubber drive wheel fastened to this shaft, the rewind speed is approximately seven times the "run" speed.

An ingenious "memory" brake is used in conjunction with the "operate" switch. When this switch is thrown to the "run" position, a felt pad brake on arm *M* is removed from the takeup drum, permitting it to rotate freely, being retarded only by the friction of the idler wheel *E*. The same operation puts a light brake on the supply drum *D*. When the switch is returned to "neutral," a light brake is applied to the takeup drum and a heavy brake applied to the supply drum.

With the switch in the "rewind" position, the brake is removed from the supply drum and a light brake applied to the takeup drum. Returning the switch to neutral leaves a heavy brake on the supply drum and a light brake on the takeup drum.

This type of braking system insures that the machine will not allow slack in the wire with its attendant danger of fouling, when the switch is returned to "neutral" from either the "run" or "rewind" position. Control of the braking sequence is accomplished by means of an auxiliary cam mounted concentrically with the cam which controls the motor shifting.

The shaft which supports the takeup drum also carries a worm gear, used to raise and lower the head which in turn acts as a level wind for the wire. Details of this level wind are shown in Fig. 3. This worm *D* drives a pinion mounted on a bracket *C*, and fastened to a shaft which carries a cam. Through this cam and lever *B* the head supporting bracket *A* is alternately raised and lowered.

As the wire passes through the head in operation, the wire is wound in even layers on the spools, and the danger of pileup and tangling of the wire is thus eliminated.

An additional cam is fastened to the lower end of the shaft which carries the operate switch. This cam operates a motor switch, turning on the motor in either "run" or "rewind" position. An additional set of contacts on this switch opens the leads to the bias winding of the head in the "off" and "rewind" position, to prevent accidental erasing of the wire.

Two bakelite buttons are mounted on either side of the "operate" switch

Fig. 3. Bottom view of recorder mechanism. Parts shown are (A) Head actuating arm; (B) Head actuating lever; (C) Pinion gear bracket; (D) Worm gear and takeup drum shaft; (E) Motor; (F) Extractor type fuse post; (G) "Light" brake spring on takeup drum.

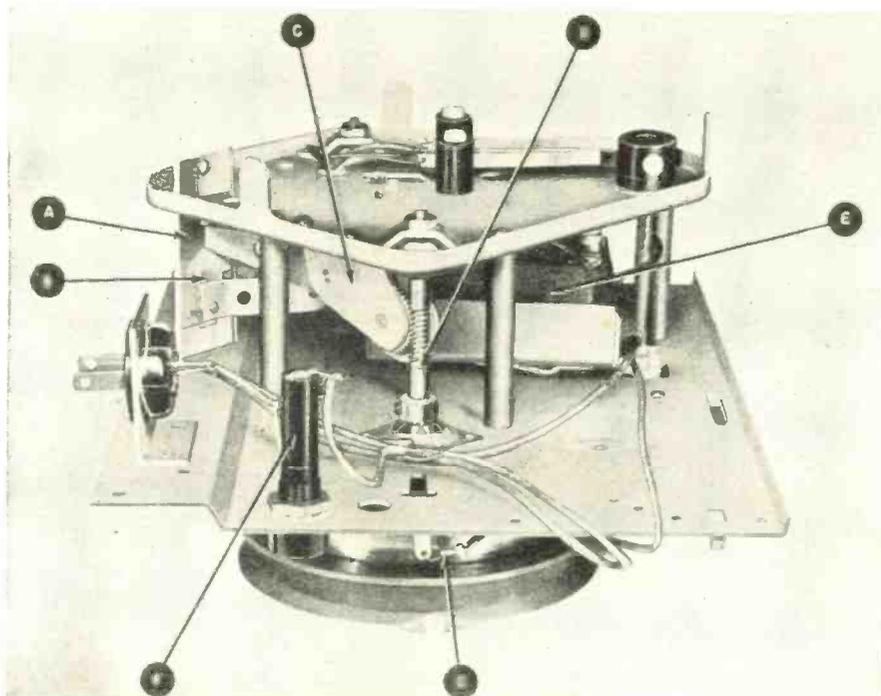

to prevent accidental overswing of the switch when it is returned to "neutral" from either the "run" or "rewind" position. These buttons must be depressed in order to permit the "operate" lever to be moved from its "neutral" position.

The exploded view of the recording head, Fig. 2, shows the various parts which go to make up the head. The laminations used are a special high permeability alloy, annealed after punching. The essential components of the head are shown in assembled form in the lower left of the photograph. The small coil on the left is the erase coil and is connected to the supersonic oscillator in the unit. As the wire travel is from left to right across the head, this coil acts to erase any previous recordings from the wire. The voice coils are wound around the center and right hand legs, and consist of many turns of extremely small wire. The two smaller coils, which are wound at the upper end of these bobbins, are the bias coils and are connected in series with the erase coil. Their purpose is to introduce a supersonic bias on the wire during the recording operation.

The top edge of the laminations have a narrow slot cut lengthwise to accommodate the wire in its travel across the head. Due to the curved nature of these laminations and the manner of feeding the wire, the entire length of the wire in the head at any one time, makes contact with the magnetizing section of the head across the entire head. This method of feed makes certain that the wire will be evenly magnetized in proportion to the audio signal present. It is essential that the wire make good contact with the head during recording and playback to prevent variations in output which might be caused by a poor contact.

A small piece of high permeability metal is mounted in the upper half of the head case to act as a shield against hum pickup. Due to the low output of the head it is necessary to use extreme care in order to minimize any chance of hum pickup.

A novel feature is used in conjunction with the wire holding clip on the takeup drum. When the wire is placed under this clip the spring action of the clip holds the wire in place. The clip may be released by depressing the button in the center of the takeup drum. When the wire is rewound it is not necessary to watch the progress of the rewinding process as a slight curl is given to the end of the wire as it leaves the drum at the conclusion of the rewinding. This slight curl, plus the momentary tug on the wire as it leaves the clip, tucks the free end of the wire under the last turn of wire on the rewind spool. There is no danger of the free end of the wire becoming loose and fouling.

A pilot light is provided to illuminate the head and allow the progress of the wire through the head to be observed.

All Mail Orders Shipped Promptly!

SAVE ON THESE MONEY-SAVING VALUES!

JUST CLIP THIS AD AND CHECK OFF THE ITEMS YOU WANT! SAVE ON QUALITY!

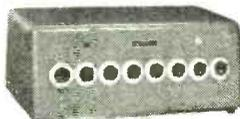

30-WATT AMPLIFIER

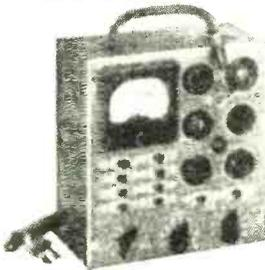

PRECISION TUBE TESTER

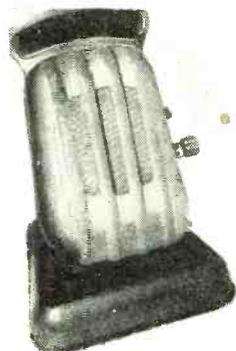

"ULTRA MIKE"

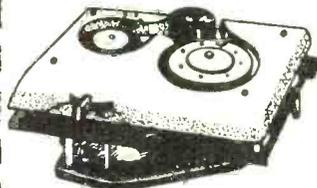

WIRE RECORDER

NEIL & PETERSEN 30-WATT AMPLIFIER
Model 8430 . . . High fidelity, custom-built, new styling. Excellent performance over frequency range from 30 to 18,000 cycles. Four tone controls. Microphone inputs, 3 high impedance, 128 db. gain . . . line input, 1 high impedance, 300M ohms, 85 db. gain . . . output impedance, 4-8-16-250-500 ohms. **\$99.38**
Attractive cabinet. Write for Literature!

MODEL TE-1 PRECISION TUBE TESTER
Separate switching for each pin of each socket so that any of the heater voltages of the plate voltage can be applied. Checks all standard receiving tubes . . . line check for line voltage variations. Tube element short test and chart listing data for the testing of 570 different type receiving tubes. Rugged, crackle finish metal cabinet, 7"x8"x3 1/2" . . . weighs 6 **\$29.95**
lbs. net.

SC-146 Output Meter . . . **\$10.49**

FREQUENCY METERS
57-63 cycles. **\$2.95**
Limited Quantity!

"ULTRA MIKE" WIRELESS MICROPHONE
This unit with your regular radio and NO extra interconnecting wires will provide superior results as a . . . calling system . . . public address . . . detectophone . . . baby or invalid watcher. The "Ultra Mike" is light, economical to operate, completely self-contained. No connections to power lines, portable. Complete with batteries, tubes, etc. Your Cost. **\$6.63**
Special . . . **\$18.00**
F.O.B. Chicago . . . Retail

CERAMIC CONDENSER KITS
Assorted . . . all marked or coded! **\$1.85**
20 for . . .

TUBE SOCKET KITS
Assorted. **98c**
25 for . . .

VITREOUS ENAMELED RESISTOR KITS
5 to 100 watts. Assorted. **\$1.49**
20 for . . .

WEBSTER WIRE RECORDER
Model 79—Foundation unit . . . Especially designed for the experimenter, amateur and engineer for building a complete magnetic recorder or adding a wire recorder to a sound system. Physical specifications: 10 1/2"x8 3/4"x5 1/2" (3 1/2" below main plate, 2" above). Net weight, 10 lbs. Net. **\$52.92**

4-TUBE AMPLIFIER KIT
For use with Model 79 Unit . . . less oscillator coil— which is furnished with foundation unit. **\$23.95**
Diagram included . . .

1% CA PRECISION RESISTORS

100 ohms	30,000	70,000
3300 ohms	50,000	75,000
5000 ohms	55,000	150,000
9000 ohms	60,000	180,000
18,000 ohms	65,000	800,000

Order by size **59c EA.**

25% Deposit with all C.O.D. Orders

Mort's Radio Shack

630 W. RANDOLPH STREET

CHICAGO 6, ILL.

BC-348

SHOCK MOUNT BASE

Dress up your "348" with a new base—fits all models—brand new in original cartons.

\$1.65

Shipped Anywhere In U.S. for 35c. Enclose \$2.00 for Each Base Wanted. Money Back Guaranteed.

ELECTRONIC SALES CO.

5559 W. Adams Blvd., Los Angeles 16, Calif.

GET ON OUR MAILING LIST



RADIO ENGINEERING TELEVISION ELECTRONICS

Thorough training in all phases of radio and electronics, open to high school and junior college graduates. Old established school specializing in Radio training exclusively. Modern laboratories and courses. Enrollments limited. Approved veteran training.

VALPARAISO TECHNICAL INSTITUTE
Dept. BD Valparaiso, Ind.

"America's Best Buy"

TUBULAR ELECTROLYTICS

Fresh Stock. Fully Guaranteed

	Each	10	100
20 mfd..... 150V	\$0.21	\$1.79	\$16.95
20-20 mfd..... 150V	.29	2.49	22.98
8 mfd..... 450V	.19	1.85	17.98

BY-PASS CONDENSERS

		\$0.06	\$0.55	\$ 4.60
.01..... 600V		.06	.55	4.75
.02..... 600V		.06	.55	4.95
.05..... 600V		.07	.65	4.49
.1..... 600V		.11	.98	8.95
.25..... 600V		.14	1.25	9.95
.005..... 1700V		.15	1.30	10.20
.01..... 1700V		.16	1.40	10.95

RESISTOR ASSORTMENT

100 assorted 1/4-1/2 watt carbon resistors.
All RMA color coded. Special \$1.29.

CRYSTALS 74c each

Your frequency plus or minus 10 KC



80	Meter, 3500-4000KC
40	Meter, 7000-7300KC for multiplying into
20	Meter, 7300-7425KC
10	Meter, 7300-7425KC
6	Meter, 6250-6750KC
2 1/2	Meter 8000-8222KC

Postage extra 20% deposit on COD.

Write for latest bargain list featuring

"America's Best Buys."

POTTER RADIO CO.

1314 McGee St., Kansas City 6, Mo.

2 OUTSTANDING SPECIALS!

XTAL HAND MIKE With 100 Ft. Cable



A crystal hand microphone with 100 feet of rubber covered shielded cable for only \$5.95. Yes sir, there's a genuine bargain you can't afford to pass up. The cable alone is worth the price of the complete unit. 2 1/4" diameter high impedance high quality crystal mike that is excellent for voice frequencies. Perfect for ham. P. A. work, etc.

\$5.95

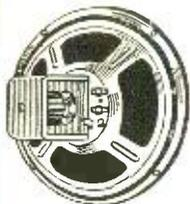

SENSATIONAL VALUE

Emerson 12" PM
Speaker Alnico
5 Magnet

A terrific speaker buy! Manufactured for Emerson by RCA. One piece cone heavy metal frame. Ideal for replacement use or new installations. Furnished less output transformer.

\$4.95

**AUDIVIEW
RADIO PARTS CO.**

325 Canal St., New York 13, N. Y.

Technical BOOKS

"1947 AUTOMATIC RECORD CHANGER SERVICE MANUAL"

compiled and published by *Howard W. Sams & Co., Inc.*, Indianapolis, Indiana. 400 pages. Price \$4.95.

This newly issued manual for servicemen covers more than forty different automatic record changers and includes wire, ribbon, tape, and paper disc recorders. Each unit is described in 8 to 12 pages of original photos, diagrams, and text.

Included with the description are top, side, bottom, and rear views of each mechanism along with exploded view diagrams. Full data is provided on change cycle, adjustments, service hints, and kinks. Components are keyed to the text and a complete replacement parts list for each unit is included. All of the units described are treated uniformly throughout the book.

The book opens flat for easy reference use on the service bench. As a practical how-to-do-it text, this book is highly recommended for the serviceman.

* * *

"PLASTICS FOR ELECTRICAL AND RADIO ENGINEERS"

by *W. J. Tucker and R. S. Roberts*. Published by *The Technical Press Ltd.*, Gloucester Road, Kingston Hill, Surrey, England. 148 pages. Price 12 shillings.

This little handbook of plastics is designed to provide the electronics engineer with essential data relating to the application of plastics in the electrical and radio industries.

Thoroughly practical, this book discusses molding and manufacturing procedure and the advantages and limitations of the various plastic materials. One section of the text is devoted to insulating and testing problems and special tables applicable to the electronic industry are included for ready reference.

The material is written in such a manner that any engineer, no matter what his training in plastic techniques, can evaluate the various properties of the different types of plastic materials and decide which type is best suited to his needs. The authors have presented complete details on the components making up the various plastic materials and listed such essential data as breakdown temperatures; physical limitations with regards to fabrication; imperviousness to cold, heat, acids, moisture, light, dryness, etc., and flow-points.

While many of the commercial products discussed in the book are of exclusively English origin, the basic formulas are, for the most part, duplicated in products available in this country.

Engineers should find this manual of great assistance in the designing of

equipment used in the electrical and radio fields.

* * *

"ELEMENTS OF RADIO SERVICING" by *William Marcus and Alex Levy*. Published by *McGraw-Hill Book Company, Inc.*, New York. 468 pages. Price \$4.50.

In this thoroughly practical handbook, the authors have provided the radio serviceman with a handy manual covering all phases of superheterodyne servicing and the proper use of the various types of test equipment employed in servicing a receiver.

Although written for the beginner, the book contains much valuable data on servicing techniques and shortcuts that the more experienced serviceman could use to his profit.

The book is divided into 24 chapters and an appendix. The authors first discuss the principles of operation of a superheterodyne receiver and then outline servicing procedures for such a unit. Multimeters and signal generators, as applied to the servicing of receivers, are covered in four interesting and clearly presented chapters. From that point the discussion deals with a.c. power supplies, loudspeakers, second or power audio amplifier stage, first audio amplifier stage, detector stage, i.f. amplifier stage, converters, variations on the converter, r.f. amplifier stage, antennas, a.c.-d.c. power supply, automobile radio installations, auto radio power supplies, push-pull output stage, alignment of a superheterodyne, a survey of the servicing procedure, and a discussion of the service bench. The appendix covers symbols and abbreviations, color code for resistors, Ohm's Law and its derivatives, color code for condensers, automobile battery ground chart, graphic symbols, and tubes and their prongs.

Each stage discussed is analyzed to provide a quick check for normal functioning of the stage, along with a typical or basic circuit schematic, the function of the stage, the function and common value for each component, normal test data for the stage, a listing of the common troubles encountered in the stage along with data on how these troubles may be located and how components may be replaced, variations from the typical stage that are frequently used and special troubleshooting procedures to be followed, and a summary of tests, including an outline of procedures to be followed in tracing various symptoms to their cause.

By following the procedure and with a little practice in using this method, servicing time can be cut for all types of home receiver repairs. The book is enthusiastically recommended for the student and is entirely suitable for home study.

* * *

"INDUSTRIAL ELECTRONICS MAINTENANCE" by *R. C. Roetger*. Published by *Prentice-Hall, Inc.*, New York. 183 pages. Price \$3.50.

The increased use of electronics in various industrial processes has

opened an entirely new field to the radio and electronics technician.

However, as any serviceman who has tried to work on industrial equipment knows, there are different techniques for handling this type of repair. This new book outlines many of the procedures to be followed both in preventative and corrective maintenance. The author has outlined the minimum test equipment and tools needed for most industrial jobs.

The book is divided into sixteen chapters and five appendices. Subjects covered include principles of maintenance, fundamental maintenance procedure, special equipment needed, industrial electronic components, rectifiers, inverters, and electronic contactors, audio frequency amplifiers, photoelectric relays and measuring circuits, motor control, welding control, regulators, servo systems, automatic machinery control, electronic heating, and miscellaneous industrial apparatus. The appendices cover symbols used in circuit diagrams, color codes, formulas, units, and installation hints.

This text is clearly written, simply presented, and entirely understandable. Servicemen who wish to take on industrial electronic maintenance as an added source of income will find this book of great assistance in preparing for this new field.

* * *

"MODERN RADIO INSTRUMENTS AND TESTING METHODS" by The Technical Staff, Coyne Electrical and Radio School. Published by *Coyne Electrical and Radio School*, Chicago. 343 pages. Price \$3.50.

The avowed intention of the compilers of this text is to provide a practical book for the radio serviceman. That this goal has been met is amply demonstrated throughout the book.

Without assuming any previous knowledge of the subject, the book deals with indicating meters, the operation and care of meters, measurements with direct current and low frequencies, measurements at high frequencies, measurements with bridges, analyzers and multimeters, electronic voltmeters, signal tracing, signal generators and test oscillators, tube testing, cathode-ray oscilloscopes and oscillographs, and oscilloscope tests and measurements.

Not content with merely explaining the operation of the test units, the compilers have spent considerable time in discussing the various uses of the equipment and servicing shortcuts which should be of great assistance to the busy serviceman.

Although this book is written for the "practicing" radio serviceman, the novice should have no difficulty in using this book as a home study text.

-30-



"I don't like this electric blanket, Ma. When it's turned up for cooking breakfast it's too hot for comfort!"

February, 1948

Get brilliant,
ghost-free reception
on all channels
of Both bands...

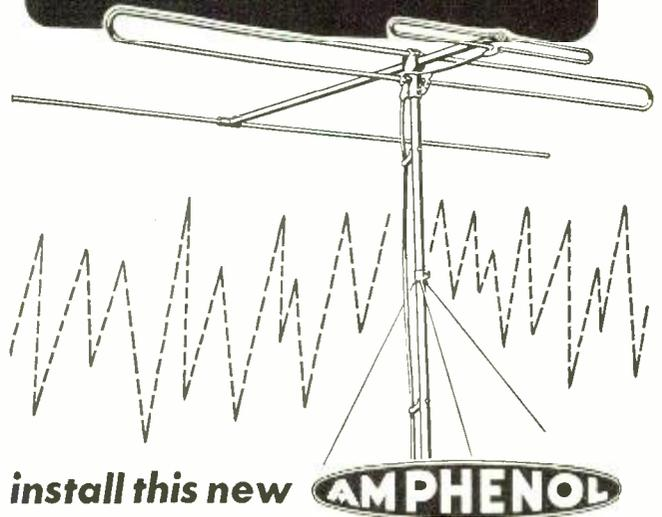

install this new **AMPHENOL**

TELEVISION *Array*

Today, in most communities, a single 54-88 mc folded dipole television antenna is all you need.

Tomorrow, with two television bands in use, an ordinary TV antenna designed for service on either the 54-88 mc, or the 174-216 mc band will not satisfactorily receive the other. So, if you want brilliant reception on *all* channels, in *both* bands, and don't want to buy two antennas, this new Amphenol Television Array is the one to buy.

This antenna array is unique. Its two broadband folded dipoles and reflectors have a common transmission line. This permits the large folded dipole to also serve as a reflector for the small folded dipole.

Amazing as it seems, this arrangement produces more gain than a dipole. This is true over the whole high frequency band, and also over most of the low. In areas of low signal strength, this array delivers brighter, clearer pictures. Also, its highly directional pattern virtually eliminates "ghosts."

Antenna elements and supports are of sandblasted aluminum tubing and aluminum alloy castings. The five foot mast is of cadmium plated steel tubing. Designed to withstand high winds and ice loading, the antenna is easily assembled with ordinary tools. No element length adjustment is required.

Swivel mounting plate and guy clamp permit installation on every type roof. Seventy-five feet of low-loss Amphenol 300 ohm Twin-Lead, which matches the input of most television receivers, is included. A good impedance match is achieved on both bands.

See your jobber, or write direct, for prices and complete technical data.

AMERICAN PHENOLIC CORPORATION

1830 SOUTH 54TH AVENUE • CHICAGO 50, ILLINOIS

COAXIAL CABLES AND CONNECTORS — INDUSTRIAL CONNECTORS, FITTINGS AND CONDUIT —
ANTENNAS — RADIO COMPONENTS — PLASTICS FOR ELECTRONICS

155

SEND FOR THESE SPECIALS

ALL NEW MERCHANDISE

CAPACITORS

203 5 mfd., 350 V. DC Electrolytics.....	\$0.29
239 1 mfd., 1500 V. DC Bathub.....	.15
314 15 mfd., 35 V. DC Electrolytics.....	.15
314X 3 mfd., 450 V. DC Electrolytics.....	.19
327 2-1 mfd., 600 V. Bathub.....	.09
343 (2) .05 mfd., 600 V. Bathub.....	.09
1521 10 mfd., 1,000 V. oil-filled.....	1.40
2181 150 mfd 50 V. Electrolytics.....	.40

RECTIFIERS

12N2 6.5 V., AC, 2.2 V. DC @ 3.0 amp. Full-wave center tap.....	\$1.20
2855 Selenium 180 V., 400 ma. G.E. Full-wave bridge.....	6.90
3048 Selenium 54 V. AC 1.6 amp., DC. Full-wave bridge, G.E.....	4.40
7176 Sulphide 3.5 V. AC, 1.8 V. DC. 1-amp. Full-wave bridge.....	.90
7374 Selenium, 36 V. AC, 2 amp. DC, half-wave.....	.75
7966 Selenium No. B7DH1CM, 154 V. AC, 6-amp. DC. Full-wave bridge.....	6.85

RESISTORS

RS20 10,000 ohm, 20 watt, wire wound.....	\$0.22
RS184 450 ohm, 5 watt, wire wound.....	.12
7404 100,000 ohm, 1 watt.....	.45
2550 50 ohm, 25 watt, wirewound with slider.....	.12
5219 Potentiometer, dual 1-meg.....	.60

TRANSFORMERS

6AN2 Double carbon button, microphone input 18 ohms to 6,000 ohms.....	\$0.70
44 80-110-220 V. 50-1,600 cy. 422 V., 15 mil. CT and 6.3 V. @ 3 amp.....	.95
82 110-24 V., 1-amp. unceased.....	1.60
Transtat No. TH-2 1/2 B, 115/230 v. 50/60 cycle input, 0-260 v. @ 2 1/2 amp. output.....	21.50

TUBES

All tubes new, boxed, and of standard manufacture.

6AQ6 Miniature duodiode Hi-Mu triode.....	\$0.70
6C4 Power triode.....	.55
931A Photo multiplier.....	1.45
955 Acorn.....	.45
2D21 Miniature thyratron.....	.70
2C40 Lighthouse triode.....	2.40
750 TL Transmitting triode.....	27.00

CONDENSERS

10 mfd. 600 v. DC Oil filled.....	\$0.95
2 mfd. 2500 v. DC Oil filled.....	2.20
.25-.25 mfd. Dual 6,000 v.-DC 12,000 v. DC Oil filled.....	3.75
MK-9 Microphone button, universal, carbon.....	.25
5007 Sockets, molded mica, 7-prong miniature.....	.12
6230 Thermo switch, Fenwall -50 +400° F. 110 V. AC, 25 amp.....	1.60

MISCELLANEOUS

Telescoping Antennae AN-75B 1'-3" to 7'-0" solid brass—clamp on..... \$1.25
Add approximately 20% to net weights for estimated shipping weights. Terms are 30% with order, balance C.O.D. All prices are f.o.b.

Write for additional detailed information on any of the above items and for special quantity discounts.

EPCO 1527 E. SEVENTH ST. LOS ANGELES 21, CALIF.

FreModyne Circuit

(Continued from page 48)

circuit is better than that of many conventionally designed receivers. It is sufficient for good rejection of local stations, particularly when the receiver is side-tuned on the appropriate side of the desired signal, that is, away from the interfering signal.

The "FreModyne" circuit discriminates against impulse noise such as that due to automobile ignition. The use of superregeneration makes the receiver periodically sensitive for short intervals, so that it completely ignores many impulses occurring between these intervals. The detector characteristic is logarithmic so that the large-amplitude noise pulses that are not ignored, are crushed or compressed.

Many manufacturers of radio re-

ceivers have started the design and production of "FreModyne" models, so that this will shortly be a standard type of FM receiver. Production in large numbers is expected.

-30-

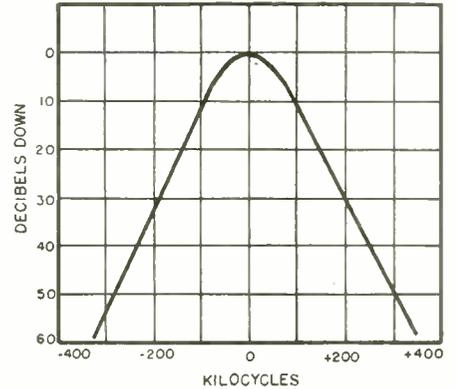

Typical selectivity curve.

Block diagram of AM-FM receiver using FreModyne FM circuit.

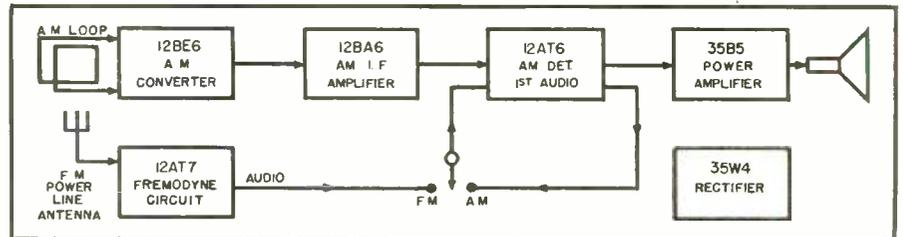

A new development in the communications field was recently demonstrated in Chicago when the Chicago Tribune used the Westinghouse infrared "talking beam" to transmit a news story from the headquarters of the Electric Club in the Civic Opera Building to the Tribune Tower. Clayton Kirkpatrick (seated), Tribune reporter, is shown transmitting his story while Carl F. Jensen, Westinghouse engineer, monitors the "beamcast." Designed primarily to provide secret communication between military units, transmissions are limited to line-of-sight objectives. Fog, darkness, and stormy weather do not interfere with the transmission clarity. Transmission is accomplished by modulating an infrared light source and transmitting this modulated light beam to the receiver where it is detected by means of a photoelectric cell.



Prepare For A Good Job Now in
RADIO
SOUND and TELEVISION
in a Few Short Weeks

LEARN QUICKLY IN
THE GREAT SHOPS OF
COYNE

Get ready for a better job, bigger pay NOW in Radio. Cash in with "All-around" knowledge of Radio—Sound—Television. Train on actual equipment not by "Home-study". You learn quickest at COYNE because it's a real SHOP course!

G. I. APPROVED..also Finance Plan for NON-VETERANS. Don't let lack of cash hold you back. Many earn while learning. FREE Employment Service to graduates. Get facts today!

SEND COUPON FOR FREE BOOK

Send at once for Big Free Book on Radio, Sound and Television, and facts about our Finance Plan.

MAIL THIS COUPON TODAY

B.W. COOKE, Pres.,
Coyne Electrical and Radio School
500 S. Paulina St., Dept. 28-1K, Chicago 12, Ill.
Please send Big FREE Book and complete details.

NAME.....
STREET.....
CITY.....STATE.....

Xtal Control

(Continued from page 61)

items in Fig. 3 the essential requirement of short leads is satisfied to a high degree. L_1 is wound upon a ceramic form mounted so close to C_1 as to result in less than $1\frac{1}{2}$ " of total lead length to C_1 . This relatively low-frequency circuit is not excessively demanding in this respect; but each succeeding tuned circuit, working at higher and higher frequencies, makes air-wound coils mounted directly upon their tuning condensers practically mandatory. The physical arrangement employed accomplishes just such mounting for high efficiency. L_2 is mounted directly upon the terminals of C_{11} , with its center-tap supported by tubular ceramic bypass condenser C_{12} . It turns the physical circuit progression at right angles—to rise behind the 832 socket in close proximity to L_6 , the ends of which are soldered directly to the 832 socket grid contacts.

The 832 dual beam tetrode final power amplifier is "sunk" through the vertical aluminum channel comprising the "chassis." This sinking of the 832 tube, coupled with a shield band around the tube base, isolates the grid and plate circuits to allow straight-through operation on final output frequency without self-oscillation or the need for tricky neutralization to eliminate same. Grid circuits are on the front side of the channel, which separates and shields them from the plate circuits on the rear thereof. Fig. 3 shows how the long line 832 plate circuit L_6 is terminated in spring-clips to slip over the 832 plate pins, and how C_{15} is mounted directly on this line. Centertap of L_6 is terminated in a low-inductance lug having a hole in its center to fasten beneath the brass thumb-nut seam at the center of the dark terminal board at the right of the 832 in Fig. 3. Two binding posts on this terminal board carry the antenna coupling "hairpin" L_7 , which may be slipped to right or left or bent to or from L_6 to establish best antenna coupling.

The only tuned circuit to be changed in order to shift from $2\frac{1}{2}$ to $1\frac{1}{4}$ meters is L_6 , C_{15} . Two tuned lines accompany each transmitter, as seen in Fig. 3, where the $2\frac{1}{2}$ meter line is shown in operating position and the $1\frac{1}{4}$ meter line and condenser can be seen leaning against the channel just below the modulation transformer T_2 .

The modulator uses two 6AQ5 tubes in push-pull, "Class A," to develop 14 to 15 watts undistorted speech output from any good carbon microphone. This is ample to 100% plate-and-screen modulate 28 to 30 watts input to the 832. Current for microphone operation is obtained, not from dry-cells, but from the voltage drop across R_0 , which with R_1 comprises the cathode bias resistor for the 6AQ5 modulators.



TELEX MONOSET— WHEREVER, WHENEVER HEADSETS ARE REQUIRED

MODERN • LIGHTWEIGHT • COMFORTABLE

Cleverly designed in tough durable Tenite, the TELEX Monoset is quickly replacing old-style, cumbersome headsets because it is made to wear under the chin instead of over the head. Precision-built magnetic receiver assures excellent fidelity.

The NEW Monosets incorporate a volume control feature that permits the wearer to control volume of sound at the point of reception. Write Department AU for information.

Specifications

IMPEDANCE

2000 ohms—Part No. 2568

500 ohms—Part No. 2569

128 ohms—Part No. 2570

SENSITIVITY

88 d.b. above .000204 dynes per square centimeter for 10 microwatt input.

HEARING AT ITS BEST



TELEX INC.

ELECTRO-ACOUSTIC DIVISION

TELEX PARK
Minneapolis, Minn.

Canadian Distributors:

SONO FILM, LTD., WINNIPEG

RADIO

Technician and Radio Service Courses
FM and TELEVISION

American Radio Institute
101 West 63rd St., New York 23, N. Y.
Approved Under GI Bill of Rights
Licensed by New York State

ROTA-BASE

NEW HANDY LAB. DIAL actually gives a "PROBE" picture of radio tube connections. INSTANTLY, ACCURATELY. No more valuable time lost thumbing pages or on lengthy readings. Filament, grid, plate, cathode, etc., to more than 300 tube types are shown. NOW ONLY \$1.95 post-paid, or sent C.O.D. plus postage. Order TODAY. money refunded if you are not delightfully pleased.

REED MFG. CO.

11350-P. Burbank Blvd., N. Hollywood, Calif.

RECORDS

LATEST & HARD-TO-GET BACK NUMBERS

Some slightly used and some brand new—Victor, Bluebird, Columbia, Okeh, Decca, Capitol, etc. Such artists as Glenn Miller, Benny Goodman, Harry James, Bing Crosby, Frank Sinatra, Gene Autry, Duke Ellington, Fats Waller, Guy Lombardo, Andrews Sisters, Kate Smith, Ink Spots, Mills Bros., etc.

BIG PROFITS Your opportunity to cash in on this new field that is sweeping the country. Specify the type of music that sells best in your territory such as Swing, Sweet Music, Cow-boy, Hill-billy, Polkas, Blues, etc. Your price \$13.50 per 100 records, f.o.b. Chicago. All shipments made within 48 hours.

CHAS. HOODWIN CO.

4419 Broadway, F15, Chicago 40, Illinois
World's Largest Dealers in Used Records

NOW—A REALLY HIGH-POWERED— Radio Engineering Library

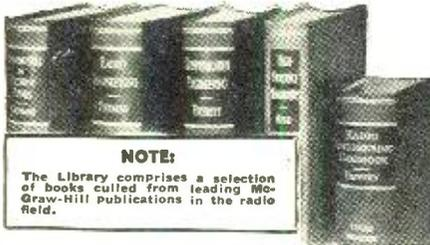

NOTE:

The Library comprises a selection of books culled from leading McGraw-Hill Publications in the radio field.

- especially selected by radio specialists of McGraw-Hill Publications.
- to give most complete, dependable coverage of facts needed by all whose fields are grounded on radio fundamentals.
- available at a special price and on easy terms.

THESE books cover circuit phenomena, tube theory, networks, measurements, and other subjects—give specialized treatments of all fields of practical design and application. They are books of recognized position in the literature—books you will refer to and be referred to often. If you are a practical designer, researcher or engineer in any field based on radio, you want these books for the help they give on hundreds of problems throughout the whole field of radio engineering.

- 5 VOLUMES, 3559 PAGES, 2558 ILLUSTRATIONS**
1. Eastman's FUNDAMENTALS OF VACUUM TUBES
 2. Terman's RADIO ENGINEERING
 3. Everitt's COMMUNICATION ENGINEERING
 4. Hund's HIGH FREQUENCY MEASUREMENTS
 5. Henney's RADIO ENGINEERING HANDBOOK

10 days' examination. Easy terms. Special price under this offer less than books bought separately. Add these standard works to your library now; pay small monthly installments, while you use the books.

10 DAYS' FREE EXAMINATION—SEND COUPON

McGRAW-HILL BOOK CO., Inc.
330 W. 42nd Street, New York 36, N. Y.
Send me Radio Engineering Library, 5 vols., for 10 days' examination on approval. In 10 days I will send \$2.50 plus few cents postage, and \$5.00 monthly till \$27.50 is paid, or return books postpaid. (We pay postage on orders accompanied by remittance of first installment.)

Name

Address

City and State

Company

Position

RN-2-48

SCOOP!

NEW PACKAGE DEAL SAVES YOU MONEY

List Price	R. C.A.—Kenrad—G.E.	Your Cost
\$11.50	10 33Z5 Tubes.....	\$ 3.90
15.00	10 5016 Tubes.....	4.90
10.50	10 7Y3 Tubes.....	3.30
ALL TUBES IN INDIVIDUAL CARTONS		
\$20.00	10 Mallory 40-20-150V.....	\$ 4.90
7.50	50 Ass'd. by Pass Cond.....	3.50
5.00	100 Ass'd. Resistors.....	1.85
2.00	100 Ft. Ass'd. Dial Cord.....	1.00
6.00	10 OSC. Coils 455 KC.....	3.30
15.00	10 Centralab Vol. Cont. .5 Mex. W. Switch.....	4.90

PACKAGE KIT OF ALL ABOVE ITEMS, ONLY 28.50
Service men: Write for Free Illustrated Catalog: Bargains Galore!

JOYCE RADIO DISTRIBUTORS
Box 2068 Hollywood 28, California

MILES "TELEMIKE"

A midret unit (1 1/4"x1 1/4"x1 1/4") requiring no physical contact to telephone. PICKS UP BOTH SIDES OF TELEPHONE CONVERSATIONS for group loud speaker listening or for recording when used with standard amplifier or recorder. PRICE \$25.00 postpaid.

Write for details on our complete line of FILMGRAPH TELEPHONE—CONFERENCE—DICTATION—"TALKIE" RECORDERS & REPRODUCERS.

MILES REPRODUCER CO., Inc.

Dept. RN-2, 812 Broadway, New York 3, New York.

1" OSCILLOSCOPE

Anyone can build the world's smallest oscilloscope for less than \$15. ● Measures 3" x 4" x 5"
● Has focus, intensity, X and Y input axis controls ● Internal sweep ● Simple, easy to understand plans and instructions \$1.00 pp.

PLASTICS & ELECTRONICS COMPANY

272 Northland Ave. Buffalo 8, N. Y.

Power required for operation is 6.3 volts a.c. or d.c. at 3.35 amperes for tube heaters and 300 volts at 200 to 220 ma. for tube plate and screen circuits. This power may be obtained from a simple a.c. power supply built up of standard broadcast-receiver replacement parts available from any amateur supply house. For mobile operation heater current may be taken from the car storage battery, with high voltage obtained therefrom via either a military surplus dynamotor or a suitable vibrator power supply. Send-Receive control can be by means of a s.p.s.t. switch mounted as is most convenient, and operating to disconnect the tied-together red and blue power cable leads from the positive high voltage power supply terminal.

It is evident that except for frequencies involved and the choice of tubes, circuit constants, and their physical proximity, the foregoing description of this u.h.f. transmitter might also describe a conventional lower-frequency rig. That is the point of this story—to show how familiar low-frequency techniques may be applied to u.h.f. transmitters to take the mystery and uncertainty out of their "firing-up" and operation.

There is nothing tricky about tuning this transmitter up to maximum efficiency that ordinary common sense, an absorption wavemeter, and possibly a 100 ma. meter won't take care of. It does require a little more care than low frequency tune-up, but needs no skill not possessed by any amateur accustomed to conventional transmitters employing frequency multiplying stages.

As the transmitter leaves the factory, it is tuned for output on the 2 1/2 meter band. This band is so narrow, percentage-wise, that only slight readjustment of condenser C₁ should be necessary to complete the job. But let's look at tune-up in its most difficult form. First, some means of tuning condenser C₁ must be available. Its capacity is varied, 3 to 30 μfd., by turning the rotor up and down a threaded center stem by means of a hexagon nut-like head on the rotor. This hex head may be turned by slipping a piece of 1/4" inside diameter spaghetti tubing over the hex head, or by gently pushing it around with the rubber eraser found upon the end of an ordinary lead pencil.

With tubes in sockets and power connected, "B+" to blue cable wire but not to the red wire going to 832 plates, simply rotate C₁ around close-to-full-in position to obtain maximum brilliancy of "XTAL" panel lamp, then "back-off" C₁ to setting just on the low-capacity side of maximum lamp brilliance. Now adjust C₂ (between 6AQ5 and 6C5 tubes) for slight dimming of the "XTAL" lamp brilliancy and maximum glow of "1-DBLR" lamp. Watch the "1-DBLR" lamp closely because the change in its brilliancy is not very marked (due to operation of it and "2-DBLR" lamps at well below their

rated current). Dimming room illumination will help, too, in this adjustment, since it will make change in brilliancy of the "1-DBLR" lamp more easily observable. Now tune C₂, between the two 6C4 tubes, for maximum brilliancy of "2-DBLR" lamp. Just as correct tuning of C₂ took power from the oscillator, thereby dimming the "XTAL" lamp while brightening the "1-DBLR" lamp, so will tuning C₂ for maximum brilliancy of the "2-DBLR" lamp draw power from the first 6C4 frequency multiplier and so dim the glow of the "1-DBLR" lamp. If in doubt about selected harmonic frequency, hold the coil of an absorption wavemeter close to coil being tuned (as just below each coil position in Fig. 3) and tune the wavemeter for panel lamp dimming.

Adjustment of C₁₁ for maximum glow of "PA" lamp, with simultaneous dimming of brilliancy of the "2-DBLR" lamp, will tune the second 6C4 frequency multiplier plate circuit and the 832 grid circuit. Since the range of C₁₁ includes both 2 1/2 and 1 1/4 meter bands, care must be taken to pick the correct band. This is not difficult, since the C₁₁ rotor is almost entirely out of the stator cups. Glow of the "PA" lamp indicates the circuit is tuned to 235/240 mc. Conversely, with C₁₁ rotor and stator almost fully meshed the circuit tunes to 144/148 mc.

The next step is to mount the appropriate 832 plate line as in Fig. 3, apply power to the 832 plates and screen by connecting the red cable lead to "B+ 300 volts," and rotate C₁₅ for resonant plate current dip of the 832, as indicated by dimming of the "PA" lamp.

If a suitable antenna for the desired operating frequency is now connected to the antenna hairpin binding posts through appropriate coaxial, twin-lead, or open line, "PA" loading and power output may be adjusted by slight readjustment of C₁₁ and C₁₅, coupled with adjustment of spacing between hairpin and 832 plate line.

Because lamps PL₂ and PL₃ are 60 ma. panel lamps, and actual 6C4 plate currents run a little less than half this value, changes in their brilliancy with tuning adjustments are not as marked as could be desired with some particular tubes and xtals. In such a case temporary substitution of a 0-100 milliammeter successively for each lamp as the circuits are tuned will make for easier tuning. Such a meter should have the two leads from it terminated at the tip and shell of the bayonet base of a broken or burned-out panel lamp. The lamp base serves as a "plug" to connect the meter in the desired circuit by removal of that circuit's lamp from its socket and plugging in the meter in place of the lamp. The only precaution necessary is to remember that the lamp sockets are "open circuit jacks," that either lamp or meter "plug" must be in each socket if the transmitter is to operate. Removal of any one lamp, or its burnout, will disable the entire trans-

mitter until it is finally replaced.

Carrier power output, using a 300 volt plate supply, will usually be 8 to 10 watts on 2½ meters, 5 to 7 watts on 1¼ meters. This may not sound like a lot on paper, but because it is concentrated in a narrow band where none is wasted, it is, in fact, superior to much higher power obtained from a modulated oscillator where the "spread" of the signal cuts the usefulness of the transmitter-generated power way down. A few watts of frequency-concentrated output will give better communication, plus a welcome relief from QRM. Concentrated power on these bands gives a mighty respectable signal indeed—as witness first tests of this transmitter when its signals spanned the most unfavorable and hilly terrain lying in the 45-mile line-of-sight distance between Madison and Hartford, Connecticut, a span never previously bridged by higher, but not frequency-concentrated, transmitter power.

Drive to 832 push-pull final is adequate, but not excessive, 832 grid current running around 1 to 2 ma. Downward modulation will not occur unless drive to the 832 is too low. This could be due to a poor crystal (of which there seem to be quite a few nowadays), to weak tubes in oscillator and multiplier sockets, or to a weak, "war-surplus" 832. These factors obviously would make for poor performance in any transmitter; in this one these difficulties can often be offset by increasing plate voltage to oscillator and multipliers by 10% to 20%.

A.F. SIGNAL TRACER

IF you have had to lug an armful of test equipment on service calls, this servicing hint is for you!

Drill two small holes on the top of the wooden cabinet in which your multimeter is housed and mount phone jacks. On the meter panel mount a s.p.s.t. rotary switch which is then connected across the phone jacks.

The jacks should be wired in series with the regular multimeter circuit. It is immaterial to which side the meter is wired as either the plus or minus side works equally well.

In operation, the meter is used in the customary manner but when the switch is opened with the phones plugged in, an audio signal can be heard if there is any a.c. in the voltage under test.

In effect, one instrument serves both as a multimeter and an a.f. signal tracer with only a pair of phones added to the load the serviceman must carry. O.E.B. Jr.

By adding phone jacks and switch, conventional multimeter serves as an audio frequency signal tracer.

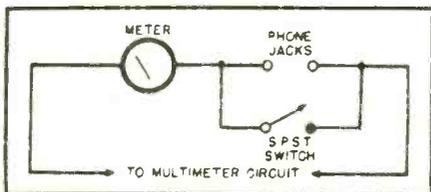

February, 1948

• It's RADIONIC for PRICE • It's RADIONIC for VALUE • It's RADIONIC for DELIVERY •

FREE
RADIONIC CATALOG



It's a must for all

- Service Dealers
- Amateurs
- Experimenters
- Industrials
- Institutions
- Government Agencies

TELEVISION "BOOSTER"

MILLEN
"R9er"

Use with any television set and improve signal strength 20 to 30 db. Enables good pictures in many "fringe areas". Small, compact and highly efficient accessory. Millen "R9er"..... \$24.75
Coils (one required for each channel; specify channel.) Each..... \$3.90



CHANCELLOR RADIO • TELEVISION KITS AND COMPONENTS • RADIOS • TEST INSTRUMENTS • PARTS AND ACCESSORIES • INTER-COMMUNICATORS • DISC AND WIRE RECORDERS • PUBLIC ADDRESS • AMATEUR EQUIPMENT • TUBES • RECORD CHANGERS • TECHNICAL BOOKS • HARDWARE

RADIONIC
EQUIPMENT COMPANY
170 NASSAU STREET, N. Y. 7

Tribune Theatre Entrance
Telephone: WOrth 2-0421
Cable "CHANSLOR"

SAVE \$200
OR MORE ON YOUR
TELEVISION SET

TRANSVISION'S
15" GIANT
TUBE KIT
(120 Sq. In.)
yours for only
\$348.75



TRANSVISION

NO EXTRAS WRITE FOR DEALER'S PRICES

• AT LOW COST you now can have one of these huge screen TRANSVISION Television Receivers, preferred by engineers. Kit is complete from tubes to antenna. 20 hours of the most fascinating kind of work you've ever tackled gives you all the big sporting events, on-the-spot news, movies; ladies will see fashion shows, musical comedy, stage shows; the kids will be wild about the circus, rodeo, animated cartoons—and there are hundreds of other stupendous entertainment features available to the whole family. Suitable for large rooms.

• ANYONE CAN BUILD IT. Step-by-step crystal-clear instructions designed to make assembly easy. Top-flight performance guaranteed by manufacturer. Soldering iron and screw driver only tools needed. Absolutely no instruments or technical knowledge required. Simply follow directions. Thousands of people have assembled these superb TRANSVISION Receivers and now enjoy highest quality performance formerly available only in costliest factory-built sets. ORDER NOW FOR IMMEDIATE DELIVERY OR WRITE FOR FURTHER DETAILS

(Terms: 10% deposit, balance C.O.D. We pay express charges if full payment is sent with order.) Fine walnut finished cabinets for above kits available at moderate cost.

12" tube kit
as above
\$289.00

SPECIAL OFFER: To see for yourself, you may order the instructions separately. Includes parts list, schematic diagrams, and parts by stage drawings, etc. Send \$1.75, credit applied to your kit when ordered.

FREE CATALOG
MAIL TODAY!

RADIONIC EQUIPMENT CO., DEPT. 52
170 NASSAU STREET, NEW YORK 7, N. Y.

- Please send me your free catalogs, supplements and bargain lists as published—listing products of leading manufacturers of radio-electronic parts and equipment.
- Please send me Transvision instructions described above. I enclose \$1.75 which is returned to me if kit is ordered.

NAME.....
P.O. BOX or STREET.....
TOWN..... STATE.....

CORRESPONDENCE COURSES IN
RADIO and ELECTRICAL ENGINEERING

ELECTRICAL ENGINEERING Get a good grasp of wide electrical field. Prepare yourself at Low Cost for secure future. Modern course. So simplified anyone can understand quickly.

RADIO ENGINEERING Extra fine course in radio, public address, photo-electric work. Trains you to be super-service man, real vacuum-tube technician. Servicemen needed badly. Diploma on completion. Many graduates earning big pay.

WRITE Send postcard for Free Copies of \$25 Either school catalog (full details, all 4 Courses about deferred payment plan, experimental kits, etc. Lincoln Engineering School, Box 931-R110, Lincoln 2, Nebr.

Now Sound Economically
FOR YOUR SILENT PROJECTOR
\$59.95

Convert your 16mm silent projector to sound (regardless of make) with Apex sound head & radiofilm adapter. Guaranteed excellent performance. Write today for free information.
APEX VIDEO • 12209 J Branford St. • Roscoe, Calif.

KEEP YOUR TOOLS AT YOUR Fingertips WITH THE DAVIS WIZARD TOOLRAK

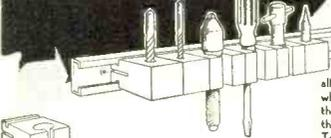

Keep your tools right where you want them—handy but out of the way—with Toolrak, save space—keep tools in order—prevent drawer damage and lost tools. With Toolrak, all your tools are out where you can use them, even when they're put away. Toolrak helps you keep your shop neat, efficient.

Clear maple holders, fine natural finish; shaped, drilled, slotted to hold great variety of tools. Holders are removable, interchangeable in aluminum back-strip—you can arrange them any way you want, rearrange them to fit your changing needs. Easy to install in 2 minutes. Screws furnished.

The Wizard Toolrak "Ten" 12" long. Holds 10 tools \$1.90 from your jobber*
*Jobbers—Write for Information

If your jobber does not yet carry Toolrak, ORDER YOURS DIRECT. Add 10c to cover packing, mailing. If you prefer, SEND NO MONEY—pay postman \$2.00 plus small C.O.D. charge.

Davis—Development Company
348-2 First National Bank Bldg.
Colorado Springs, Colorado

It's RADIONIC for PRICE • It's RADIONIC for VALUE • It's RADIONIC for DELIVERY • It's RADIONIC for PRICE • It's RADIONIC for VALUE • It's RADIONIC for DELIVERY •

HEARING IS BELIEVING!



TWO WAY SPEAKER SYSTEMS

Here's the Loudspeaker System you have been waiting for. New for 1948—compact, powerful, with brilliant reproduction of speech and music. Powerful 25 watt units, coupled to a crossover network, are used in both the high and low frequency speakers. Offered for the first time for Public Address use! Ideal for schools, skating rinks, auditoriums and amusement centers. Will reproduce high fidelity recordings with breath-taking realism. Circular upon request. Inquiries invited from jobbers, dealers and manufacturers' agents.

COLORTONE CO.
SOUTH BEND 15, INDIANA



TRAIN FOR RADIO IN MIAMI

Prepare for a radio career in one of America's most beautiful cities—busy, romantic Miami—at the crossroads of two continents.

Embry-Riddle's internationally known Government-approved School of Aviation offers a full year Radio Course, designed to qualify you for important jobs in the Radio Industry. Approved training under G.I. Bill. Immediate enrollment.

FOR FREE INFORMATION
MAIL THIS COUPON—TODAY!

Dean of Enrollments—Dept. 55-A
EMBRY-RIDDLE SCHOOL OF AVIATION
Miami 30, Florida

Name _____ Age _____

Address _____

City _____ State _____

Check One Veteran Non-Veteran

LETTERS

from our readers

IT WORKS

I AM enclosing a photograph of the electronic photo timer which I built from the description published in the July, 1947, issue of RADIO NEWS.

"Although I have been more or less in the mechanical end of radio for many years, this is the first chance I've had to build something concerning electronic circuits. I am pleased to say that the timer works very well.

"You noticed (from the photograph) that there are markings for the setting of the calibration control. In the article it said that calibrating for 55 seconds would make all the ranges accurate. Mine needs calibration for each range. I can get 100% accuracy on the two lower ranges but the high calibration is about 2 seconds off from 25 to 55 seconds. I used plus or minus 5% resistors as is suggested and with the exception of an electrolytic condenser in place of the paper one listed for the high range all parts are as listed. If you think that this change would cause the error please advise.

"Another thing that is wrong is when the time is set for a long amount of time on the high range. While the relay is released momentarily the light will stay on. I would appreciate your advice to remedy this. Despite these minor shortcomings I am well satisfied with the device and I hope that you will keep publishing these useful articles as well as the fine informative articles that have been in the magazine in the past."

Morton Meyer
Kenmore Recording Co.
Brooklyn, New York

Electrolytic condensers should never be used with a timer of this nature. The leakage current through the electrolytic is variable and highly unpredictable with the necessary accuracy. A paper or oil-filled condenser should be used. This is undoubtedly the reason for nonlinearity of calculations. We cannot understand why the light will stay on when the relay is released from the circuit. The only possibility of this happening would be for the relay contacts to arc across or to short out temporarily.

GOOD OLD DAYS

I WAS rather surprised to see W6YB assigned to a Marine Ham station at Oceanside. The last I can remember of old 6YB was when it was the call of our old home town junior college at Modesto, California.

"The part which referred to the new W6YB as serving reminded me strongly of the sponsor of the original 6YB, Professor William F. Martin, W6FWB. "Prof" Martin, as we all called him,

started many an embryo ham on his career in amateur radio. His interest in radio dated back to the first war and he helped and gave boys the opportunity of obtaining their licenses from that time on. The calls he has helped dated from W6AXI to W6QMW (the first Chinese girl to be licensed in USA) and I understand he was still turning out hams until his death just a few years ago. Many of the hams he turned out helped serve in the last war.

"The call 6YB represented his devotion and unselfish help to ham radio. It is rather a coincidence that this call be assigned to another who has dedicated 6YB to service.

"I would be interested in hearing from other former operators of old 6YB and MJC radio club."

Dr. Thomas W. Wing, W6MVK
1423 South Vermont Avenue
Los Angeles 6, California

We hope other ops will take W6MVK up on his invitation to correspond.

HELP FOR RURAL AREAS

I WONDER if the people who live in the metropolitan areas of our country realize what kind of radio reception we who live in rural areas have to contend with, and what you, as an editor of RADIO NEWS, thinks about the situation.

"It is the custom of the FCC to allow a continual increase in the number of radio stations, and at the same time to allow periodic increases of power to those already established. We now have somewhere around 800 broadcast stations in the U. S. with 95 channels available for them. This means an average of about 9 stations per channel, not counting the "clear channel stations."

"Now when reception is good, which means after dark in this locality, and especially during the evening in winter time, it is next to impossible to get decent radio reception in rural communities like this, excepting from the clear channel stations. WLW is the only one of these which we can get with any degree of consistency. The balance of the band sounds just like 160 meters did before the war.

"It seems to me that these small stations should be made to reduce their power since improvements in receiver design would still give them the same listening radius. Take KDAL, for instance. We listen to it a lot here. Recently they increased power to 5 kw. We noticed an increase of signal strength here of course, but we still cannot listen to it after dark, or late afternoons at this time of the year. Now isn't it

RADIO NEWS

logical to assume that this station causes interference with some other stations now which it did not bother before the power was increased? And if this is true of KDAL, it is true for all other stations which share frequencies.

"The sad part (for we people who live in rural communities) is that increasing the number and power of these city stations only makes things worse for us, and I can see the day when it will be useless to even own a radio unless you live within 50 or 100 miles of some city, large enough to support a 50 kw. station.

"What do you think?"

Jack Watt
Ontonagon, Mich.

Well, Readers, what do you think is the solution to this problem?

* * *

THE FOLDED DIPOLE

JUST a thank-you from a fellow ham for the dope on the folded dipole idea by Carl V. Hays, W6RTP. This is truly a go-getter and to date after just one week I'd like to advise that I have worked nine countries and practically all districts in the United States. Here is a partial list of some of the "F-B" contacts that I thought might be interesting to others that haven't been having good luck with their "skyhooks": KP4BY, KP4EE, KP4EJ, W8ZXH/KP4, W4LGP/KP4, KP4BY, D4AXT, VE7AC, W4FOJ/Marine-Mobile, Puerto Cabello, Venezuela, PY7QG Natal, Brazil, HR1MB Teguciagalpa, Honduras, KZ5AY Howard Field, C. Z., CO8JB, and ZS6FU Randfontein, South Africa.

"Using the idea you suggested for the suspension of the dipole I found it to be impossible to get the bamboo spreaders so I went to a lumber dealer and purchased a 2 x 4, 16 feet long and had it ripped to give me one 2 x 2 and two 1 x 2 pieces and by using four carriage bolts with washers and nuts I had it constructed in about an hour. I had an old speaker stand with a weighted base and about a five foot upright and extension with a big knurled nut on it so I bolted the 2 x 2 upright of the framework to it and lashed it with a piece of window cord to form a means of rotating the antenna. I have found in this particular location that the best signal reports come from the direction that the ends point to. This is contrary to my ideas of the antenna because I thought it would work best broadside, but for me I find that it works best off the ends, if there is any difference.

"In any event I did want to report that I am using your idea and to express my thanks for the suggestion. I cut my flat top for 28,500 but find that it tunes very broadly and with my e.c.o. at any frequency from 28.5 to 29.7 that the loading does not change more than about 10 mils. Everything is just as you stated with the exception that during wet weather the loading does change some but not too much for satisfactory operation. Incidentally, the past week has been

The Sensational New 275 Watt Globe King . . .

UNCONDITIONALLY GUARANTEED

10 DAY FREE TRIAL . . .

When you buy WRL equipment you are entitled to try it for ten days and if you are for any reason not entirely satisfied you may return it and your money will be gladly refunded! This new WRL-275 watt transmitter is a versatile advanced design that will give you top performance on 10, 20, 40, and 80 meters, on CW and phone. It has RF exciter section capable of 40 watts input on all bands including 6 meters; RF final speech amplifier and modulator capable of modulating inputs from 300 to 350 watts; and the dual power supply. These sections can be purchased separately if you so desire. Comes in a grey streamlined crackle finish steel cabinet. Size 28 1/2" high by 22" wide by 14 1/4" deep. For only \$20.00 we wire this kit complete ready to go and all you have to do is in most cases, hook on the antenna, plug in your mike and you are on the air. Send today for a complete detailed description.

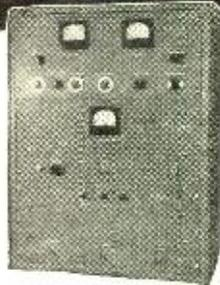

Kit Form
\$356.45
As Low As
\$70 DOWN

Wired
\$376.45
Per Month
\$25.30
12 Mo.



Final Exciter Section

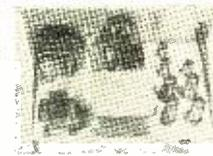

Speech Amplifier and Modulator



Dual Power Supply Section

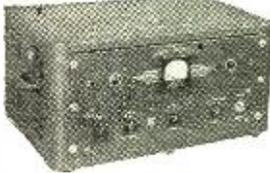

WRL Globe Trotter XMTR Kit

Amateurs the world over are praising the performance of this high quality, low cost rig. It's a 40 watt input kit including all parts, power supply, chassis panel and streamlined cabinet. Write for export price, Cat. No. 70-300 less tubes, \$69.95. Cat. No. 70-312 same as above, wired, \$79.50. 1 set of coils, meters, tubes, extra, \$17.49.



WRL Exciter Kit

From our own labs. Uses 6L6 regenerative Osc. into an R7 driver or final. Similar to unit described in A.R.R.L. Handbook. Output 35 to 40 watts. Comes mounted on standard relay rack panel 3 1/2" x 19".
Cat. No. 70-302 less accessories, \$19.95
Cat. No. 70-310 same as above, wired, \$25.95
Set of coils, meter tubes, extra, \$10.78
Power Supply wired with tubes, \$22.75

20% DOWN—MONTHLY PAYMENTS TO FIT YOUR NEEDS!
It's Easy—We Finance Our Own Paper—No Red Tape

Hams all over the world are enjoying our personal service, fast delivery, liberal trade-ins and easy payment plan. We make it easy for you to buy and easy for you to pay. Just write and tell us what you want, the make and models you now have and I will answer your inquiry the same day giving you trade in allowances. Many times it will serve as a down payment on new gear. Dollar for Dollar you will get more at WRL. We carry a large stock of all national merchandise such as Hallicrafter, National, Hammarlund, RME, Millen, Sonar, receivers, transmitters, test equipment, beams, etc. Write me for anything you want. We can fill your order quickly.

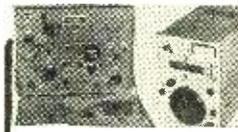

SENSATIONAL BARGAINS

Transmitting Tube, new 2.49

PE-104 Receiver back for 654 4.95
PE-103 Popular Dynamo new 9.95
6 ft. Cable and 2 plugs by fil 1.95
634 and PE 103 1.95
274 N SERIES VFO and XMTR
Complete with tubes and crystal
New BC-459 A-7 to D-1 MC \$5.95
Newly new BC-457A-4 to 5.3 MC 3.95

Brand new (Navy) CBV-52232

-2 to 3 MC 5.95

New completely shielded Transform-

ers to operate with the above

274 transmitters-1200V C

T 200 MA, NV @ 3a-Twin

6.3 V C T. fil @ 3 A ea.

Series three for 1 1/2 tubes to

operate XALTR 55.95

GET THIS 68 PAGE BARGAIN CATALOG

SAVINGS



Get Acquainted Offer

New Giant Radio Reference Map

Just right for your control room wall. Approximately 4' x 3'. Contains time zones, amateur zones, leading shortwave stations, monitoring stations, etc.

MAIL COUPON TODAY and 25c



World Radio Laboratories
LABORATORIES INCORPORATED
COUNCIL BLUFFS, IOWA

World Radio Laboratories
744 West Broadway
Council Bluffs, Iowa

Send latest free flyer with bargains

Enclosed is 25c for radio reference map

Send more data on "Globe King" Kit

Send more data on Globe Trotter Kit

Send more data on WRL Exciter Kit

Name

Address

City

Zone

State

Call letters

GREYLOCK

A Dependable Name in RADIO TUBES

GT, Glass, and Miniature Types

ALL TUBES IN INDIVIDUAL CARTONS

12SA7, 12SK7, 12SQ7, 50L6, 12AT6,
12BA6, 12BE6, 35W4, 50B5 . . .each 39c

1R5, 1R5, 1T4, 3S4, 3Q4, 6AK5, 6AC5,
6AC7, 6AQ5, 6BE6, 6BA6, 6AU6,
6BJ6, 6X4 . . .each 49c

32L7, 70L7, 117L7 . . .each 59c

All Tubes Carry RMA 90-Day Guarantee

PM SPEAKERS

4" Alnico No. 5 . . .each \$1.19

5" Alnico No. 5 . . .each 1.29

TERMS: Net C.O.D. No order accepted for less than \$5.00

Write for Bargain Catalog N-2
GREYLOCK ELECTRONIC SUPPLY CO.
30 Church Street New York 7, N. Y.

Solve Resonance Problems Quickly

Inductance, Capacity, Reactance, Frequency, Wavelength. Wide range, audio or radio frequencies to 1000 MC. The original

LIGHTNING CALCULATOR

\$1.00 POSTPAID

LIGHTNING CALCULATOR CO.

496 ATLANTIC AVE. • BROOKLYN 17, N. Y.



Quick Starting

Like the split second dash of a startled deer in the snow-capped northlands, the Radiart VIBRATOR has no equal in quick starting! This is true even under the most adverse conditions occasioned by frigid temperatures. The low battery voltage that accompanies cold weather holds no threat to Radiart VIBRATORS, they start, and start quickly even with a minimum of voltage . . . even less than 5 volts . . . yet easily withstand high voltages. This unique quality is a tribute to the special design and engineering skill behind Radiart VIBRATORS. Just another reason why Radiart leads the field . . . and is preferred by servicemen who want their customers to be supplied with the best.



The Radiart Corp.
CLEVELAND 2, OHIO

nothing but rain here and to me that makes this report all the more interesting.

"More simple ideas like this are bound to make RADIO NEWS a mighty popular magazine with the ham fraternity and while my experience probably is just a mere drop in the bucket compared to some of the other fellows, I still think it's a darn swell idea and best of all from my standpoint, I'm not keeping it a secret. So here's a big pat on the back for you fellows up there at RADIO NEWS headquarters. Give me a call some time!"

A. Lynne Brannen, W4BTI
Marietta, Georgia

Take a bow, Mr. Hays, for the nifty job you did on the dipole article.

-30-

PROJECTION TV UNIT

ONE of the television receivers receiving a lot of attention at the recent Radiolympia show in London was the "His Master's Voice" projection television Model 1852.

Providing a brilliant black and white picture 20 inches by 16 inches, the new unit can be viewed satisfactorily by an audience of as many as 100 persons. A 4" projection type tube, developed by the H.M.V. Research Organization, is used in this unit and has a life comparable to that of any ordinary direct vision type of cathode-ray tube. The optical system, based on the Schmidt principle, employs special lenses produced to the designers' specification.

The H.M.V. Model 1852 is a combined projection type television and all-wave push-button radio receiver. Special features of the television section include t.r.f. video and sound channels, automatic protection of the tube by relay in the event of time base failures, simple control arrangements, and oil-filled transformers for adequate insulation. The radio is a 5-tube, 3-band, push-button superhet with provision for supplying radio programs to an extension speaker in another room during television reception.

The price on this unit is 340 guineas. The guinea is worth approximately \$4.20 at the present rate of exchange.

-30-

British projection television unit.

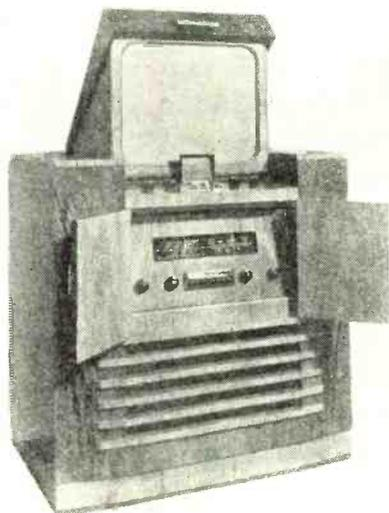

February, 1948

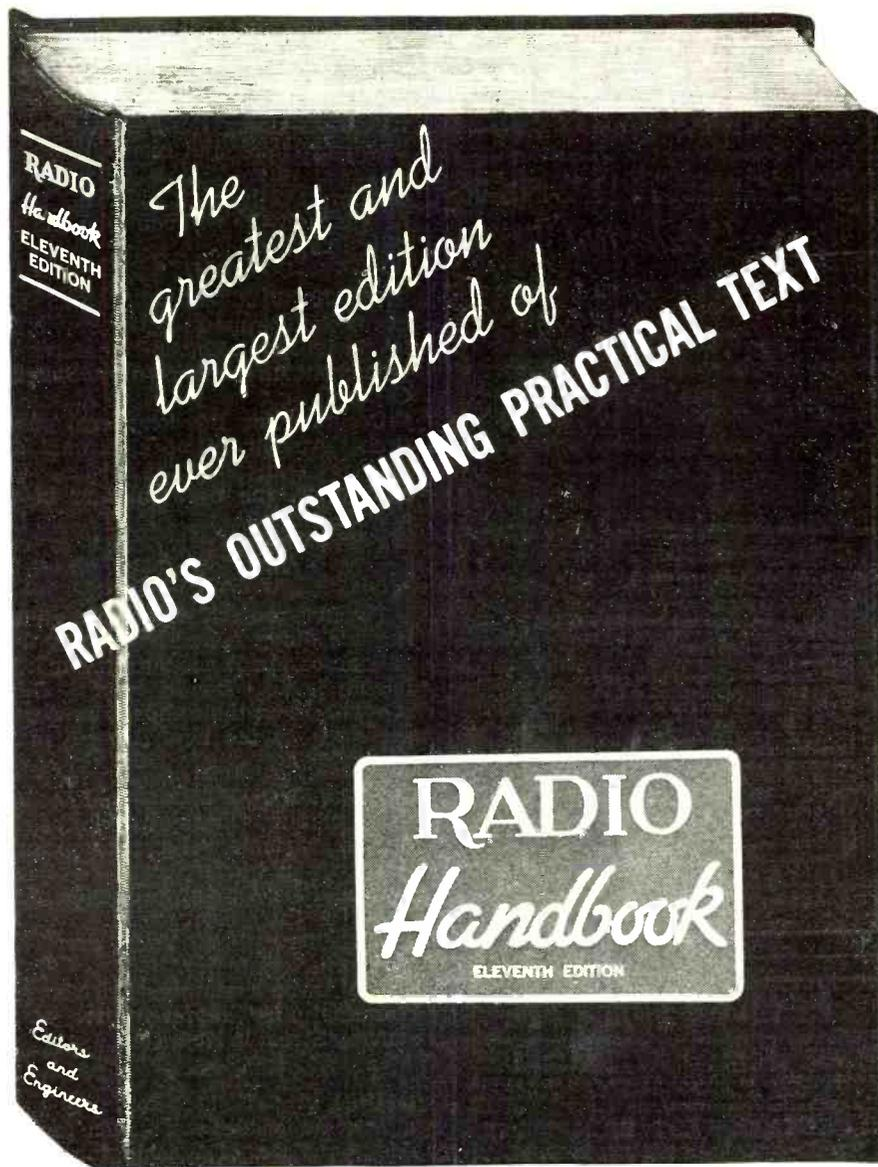

The 11th edition RADIO HANDBOOK

contains the greatest array of practical radio equipment ever shown between the covers of one book—all brand-new. As useful for engineers as for amateurs.

GET IT AT YOUR FAVORITE DEALER FOR..... **\$300**

Mail orders, \$3.25 postpaid in U.S.A.; foreign, \$3.50.

IN U. S. A.
CLOTHBOUND
GOLD STAMPED

(DEALERS: "Technical" discounts allowed on this book when purchased by the radio, book, and news trades in quantities for resale.)

Editors and Engineers 1302 KENWOOD ROAD Santa Barbara CALIFORNIA

SENSATIONAL NEWS! TWO WEEK DELIVERY!

SPEAKER REPAIR PRICE LIST

2"	\$1.30	12"	\$2.65
3"-4"	1.35	12" Jukebox.	3.30
5"	1.40	13"-14"-15" ..	3.65
6"	1.60	15" Jukebox.	4.50
7"	1.90	4"x6"	1.60
8"	2.25	5"x7"	2.10
9"-10"-11" ..	2.40	6"x9"	2.25

Above prices do not include replacement of field coil.

Write for **FREE Parts Buying Guide**

SPEAKER REPAIR SERVICE

We repair and recondition any type or kind of speaker at the lowest price. All work done by factory trained experts—all work **GUARANTEED.**

U.S.R.S.

U. S. RADIO SUPPLY

5116 HARPER AVENUE
CHICAGO 15, ILLINOIS

DEPT. NE 2

MORE FEATURES

for your money in
this miniature

SUPERHET TUNER

by "Adaptol"



Adaptol offers the outstanding buy in compact, efficient Superhet Tuners. Here are just a few of the useful applications:—

Highly suitable for use in conjunction with wire and tape recorders. Installed in record player, makes phono-radio combination. Has many experimental uses. Tuner for custom-built radios.

For modernizing obsolete radios. For conversion of military, foreign, and short wave receivers to broadcast band at the flick of a switch.

CIRCUIT FEATURES:—Self-contained power supply for 110V. D.C.-A.C. 50-60 cycles. Three tube circuit of conventional design, using the latest miniature and dual purpose tubes. Permeability tuned drift-free I.F.'s. **COMPACT:** Approximately 4 1/2" x 3 1/2" x 3 1/2".

List price \$20.00 complete with tubes. Add 5% west of Rockies. FOB Brooklyn, N. Y.

See your local distributor, or write for further information to:

**ADAPTOL CO., 120 New Lots Ave.,
Brooklyn, N. Y.**

PEN-OSCIL-LITE

Extremely convenient test oscillator for all radio servicing; alignment. Small as a pen. Self powered. Range from 700 cycles audio to over 600 megacycles u.h.f. Output from zero to 125 v. Low in cost. Used by Signal Corps. Write for information.

**GENERAL TEST EQUIPMENT
38 Argyle Buffalo 9, N. Y.**

A CAREER WITH
A FUTURE!

TELEVISION

Shop Work . Shop Techniques . Theory
FULLY EQUIPPED LABORATORIES

- RADIO SERVICE & REPAIR
- F. M. & TELEVISION
- TRANSMITTER COURSES
Preparing for F.C.C. LICENSES
- RADIO TECHNOLOGY
A Junior College Level Course preparing for positions in Radio-Electronic Engineering Field.

Morning • Afternoon • Evening Classes
MODERATE RATES • INSTALLMENTS

Available Under G. I. Bill

Come In and See Our Students at Work

**DELEHANTY SCHOOL OF
RADIO • ELECTRONICS • TELEVISION**
105 East 13 St., N. Y. 3, N. Y. • Dept. S.
LICENSED BY STATE OF NEW YORK

Within the Industry

(Continued from page 30)

trated on aiding the handling of distributors' sales and service problems in areas where Philco television receivers have been introduced. In his new capacity he will continue and amplify this work.

* * *

SYLVANIA ELECTRIC PRODUCTS INC. has broken ground for the first building in its new electronic research development to be known as *Sylvania Center*.

Designed for the long-term peacetime development of electronic and lighting equipment, television, FM, and radar, the first building in the new Center will house the physics laboratory which is expected to cost nearly a million dollars, fully equipped.

The new project, which is located at Bayside, Long Island, will cover over 28 1/2 acres of a 57 acre site facing Long Island Sound. Dr. Bennett S. Ellefson will direct the company's research activities at the new Bayside plant.

* * *

CLARKSTAN CORPORATION of Los Angeles, manufacturers of a line of ring tuners, variable reluctance pickups, transcription arms, etc., have appointed Paul D. Aaron of New York to act as their representative for the Metropolitan New York area and northern New Jersey.

Mr. Aaron maintains his offices as manufacturers' representative at 71 Murray Street in New York.

* * *

MELVIN C. SPRINKLE, formerly manager of radio sales and service for *Jordan Piano Co.* of Washington, D. C., has joined the sales engineering staff of *Altec Lansing Corporation* in their New York offices.

He has served as a factory representative for *Radiomarine Corp.*, and as a senior radio engineer for the Bureau of Ships, U. S. Navy. Mr. Sprinkle is a member of the IRE and has served on the teaching staff of *Capitol Radio Engineering Institute* as well as acting as Washington representative for *Scott Radio Laboratories*.

* * *

KAY ELECTRIC COMPANY, manufacturers of the "Mega-Sweep" Sweeping Oscillator and the "Mega-Match," have purchased two acres of property which incorporates new facilities to handle the company's increased business.

The company is now located on Maple Avenue, Pine Brook, New Jersey.

* * *

AIR KING PRODUCTS COMPANY, INC., Brooklyn manufacturers of the *Air King* line of radios, combinations, and wire recorders, have appointed three new distributors to handle the company's products.

Test-O-Lite

the MODERN TROUBLE SHOOTER

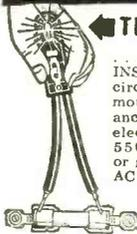

THE NEON GLOW

LOCATES TROUBLE INSTANTLY in electric circuits, fuses, cut-outs, motors, radios, appliances. Tests everything electrical from 100 to 550 volts. Indicates hot or grounded wires. Tells AC from DC. Engineers prefer it because it has patented safety features.



FUSES



MOTORS



OUTLETS

PUTS "FINGER" ON THE TROUBLE SPOT -- QUICKLY

Far superior to ordinary clumsy test bulb. Saves precious time. Indispensable in shop or home. Vest pocket size. Lifetime guarantee. (Pat. No. 1,775,883.) Purchase through regular electrical dealers.

L. S. BRACH MFG. CORP.

200 Central Ave. Newark, N. J.

Gibson RADIO RULE



FOR DESIGNING

CIRCUIT DIAGRAMS
ACCURATE — QUICK — UNIFORM

USED BY
Students
Engineers

Technicians
Radio Amateurs

75¢ EACH

Order direct or thru your local dealer.

This original GIBSON RADIO RULE after years of use at Government schools, Universities and by technicians has proved invaluable. Designed and manufactured for use in the making of accurate and uniform circuit drawings, these drawings to include all form: fuses, meters, coils, transformers, relays, jacks, ground, condensers, crystals, switches, and A.C. connectors. Made of transparent plastic, compact in size, 2x6 inches, complete with cover and directions.

GIBSON RADIO RULE
P. O. Box 307 Seattle 11, Wash.

Priced for Quick Disposal
CW-3 WILCOX

**RADIO
RECEIVERS**
\$12.75 EACH

Express Collect

While they last—Any Quantity

Superhet circuit 1900-16500 K.C.; 110 Volt 60 Cycle A.C.; one stage R.F.; B.F.O., noise and sensitivity controls; audio output limiter; rack mounting; complete with coil; complete set spare tubes; original crates.

Dept. M

AMERICAN MDSE. MART

411 Finance Bldg. Philadelphia 2, Pa.

See the many

BARGAINS

offered in the

CLASSIFIED COLUMNS

of this issue

Chief Electronics will cover the Poughkeepsie, New York area; Cumberland Wholesalers will serve dealers in Connellsville, Pennsylvania, while the David White Radio Supply Co. will provide service for customers in Little Rock, Arkansas.

EDWARD E. LEWIS has been elected president of Colonial Radio Corporation, wholly-owned subsidiary of Sylvania Electric Products Inc.



Mr. Lewis was formerly executive vice-president of Colonial, having been elected to that post on July 1, 1947.

He has been associated with Sylvania as an independent consultant since 1945.

He has been associated with General Electric Company and Radio Corporation of America prior to establishing himself as an independent industrial consultant. Mr. Lewis will maintain his offices at the company's Buffalo, New York, plant.

KENNETH E. WEITZEL has been assigned to the application engineering section of the Tube Division of General Electric Company's Electronics Department. He will maintain headquarters in the company's Chicago office in the Merchandise Mart.

Formerly employed on application engineering of miniature tubes for FM and television receivers, Mr. Weitzel will be engaged in on-the-spot engineering with Chicago area manufacturers of radio receivers.

H. H. RANIER, manager of distributor sales, Radio Tube Division of Sylvania Electric Products, Inc., is now making his headquarters at the company's New York office, 500 Fifth Avenue.



The new move will enable Mr. Ranier to work more closely with

Sylvania's general sales and advertising offices in New York. Long associated with the radio tube industry, he joined the Sylvania staff eight years ago and prior to this new move made his headquarters in Chicago.

ROBERT E. CASSATT, for the last two years Advertising and Sales Promotion Manager of the General Electric Company's Specialty Division, has been named Assistant Advertising and Sales Promotion Manager of the company's Receiver Division.

In his new position as assistant to Fred A. Parnell, he will be responsible for the exploitation of components and universal parts while continuing to direct the advertising and sales promotion activities of the Specialty Division.

-30-

February, 1948

CLEARANCE SALE!

\$351⁰⁰ VALUE

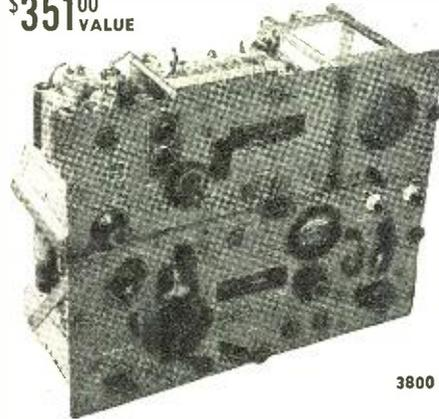

RECEIVER EXMITTER

FREE A COMPLETE SET OF 13 TRANSMITTING AND RECEIVER TUBES PLUS

FREE 1-200 KC CRYSTAL

BC-654-A is a combined transmitter and receiver designed for portable or vehicular operation. The frequency range of both transmitter and receiver is continuous from 3800 to 5800 kilocycles; all stages gang tuned by anti-back lash worm gear dial mechanisms.

25 WATTS POWER COVERS 3800 KC TO 5800 KC YOUR PRICE **\$13⁹⁵**

Frequency Meter

Directly calibrated on large Vernier Dial from 80 to 300 meg. Also included — Automatic Switching arrangement. Beautiful black metal case. Instructions included.



\$3⁴⁹

NAVY COMPARTMENT SPEAKER

Amplifier Unit with Heavy Duty Speaker (32 oz.)

Speaker alone worth \$25.00.

Works from 110 volts AC-DC. Used but in operating condition. Uses 1-35Z5 Rect. & 2-35L6 in P.P. Audio input .006 watts 600 ohms imp. 5 Channel selection input, volume control complete with tubes in gray navy case 14x14x7 1/2".



Your Price **\$9.95** Value \$100.00

A WIRE BUY

No. 18-7. Strand Black Plastic Vinylite Indoor or Outdoor Wiring on 27" reel—15,000 ft. \$270.00 Value. Lifetime Covering 100 Uses.

YOUR PRICE **\$30⁰⁰**



SEND POSTCARD FOR OUR LATEST BULLETIN

All Prices F.O.B. N. Y. C.—20% deposit, Bal. C.O.D.

MANUEL KLEIN 74 CORTLANDT STREET NEW YORK 7, N. Y.



MALLORYLINE NOISE FILTER Rating 110-220 V. (AC-DC). \$10.00 Value. Your Price..... **\$2.95**

RADIO ENGINEERING I

COMPLETE Radio Engineering Course. Bachelor of Science Degree. Courses also in Civil, Electrical, Mechanical, Chemical, Aeronautical Engineering, Business Administration, Accounting, Secretarial, Science. Graduates successful. 64th year. Enter Jan., March, June, Sept. Write for catalog.

TRI-STATE COLLEGE 1628 College Ave. ANGOLA, INDIANA

TUNING CONTROL KNOBS For Command Set Receivers 69c. ea. 3 for \$2. Postpaid in U.S.A.

BC 454, etc. series with locking sleeve. Brand new, not surplus. Makes tuning simple for fixed or mobile use.

Send for Latest Bulletin

ALVARADIO

903 S. Alvarado, Los Angeles 6, Cal

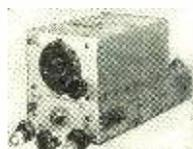

UTICA TOOLS

PLIERS FOR EVERY NEED

TOOL NO. 654-6"

Ask Your Dealer

UTICA DROP FORGE & TOOL CORP. UTICA, 4 NEW YORK



EVERY RADIOMAN NEEDS—
"RANGE MASTER" MODEL 10
The 8-in-1 Service Instrument

A precision instrument for RADIO TESTING, Appliance Repairing, Service Calls, Amateur and Experimental Work.



"RANGE-MASTER" covers these 25 ranges.

- (1) CAPACITY .001-1, .01-1, 1-10 Mfd.
 - (2) A.C. CURRENT 0-150, 0-1.5, 0-15 amps.
 - (3) A.C. VOLTAGE 1 10 100 500 1000 volts.
 - (4) D.C. VOLTAGE 10 100 500 1000 volts.
 - (5) D.C. CURRENT 1 10 100 1000 milliamps.
 - (6) RESISTANCE 0 to 10,000 100,000 1 megohm.
 - (7) Special High range ohmmeter to 2 megs and 20 megohms.
 - (8) Sensitive A.C. microammeter to 1100 microamps.
- TELEVISION SERVICEMEN**
 This is the only instrument in its class that can be used as an **OSCILLOSCOPE CALIBRATOR**. A standard bleeder will deliver 1-10-100 accurate RMS volts from A.C. line.
- Available in KIT form, or assembled.
 Complete KIT and Instruction \$17.95 net
 Bench Model (assembled) 23.50 net
 Foundation Meter with 3-color scale, schematic and operating instructions 7.85 net
 Test leads85

Ask your local distributor, or write to Dept. R.N.
BRADSHAW INSTRUMENTS CO.
 942 Kings Highway, Brooklyn 23, N. Y.

BARGAINS
FROM OUR FREE CATALOG

- TUBES:** Pop. Brand, Sealed Cartons; order any type, we have 'em all—60% to 80% off.
- 5 TUBE KIT:** 50L8, 35Z5, 12SA7, 12SK7, 12SQ7 \$2.75
 - 5 TUBE KIT:** 50B5, 35W4, 12AT6, 12BA6, 12BE6 \$2.75
 - 12SA7, 384, 6N7, 1T4, 6AK5, 12BD6, 6J6, 9001, 6AH6, 6AL5, 717A 69c ea.
 - SPECIAL:** 70L7 79c; 1LA6 \$1.19
 - ACORN TUBES:** 954, 955, 956, 957, 958A 49c
 - HEAR. AID:** CK501AX to CK509AX 49c
 - CONDENSERS:** Fresh, Pop. Brand; order any type, we have 'em all—80% off.
 - 30 @ 150—29c; 50/50 @ 150—59c; 16/16 @ 150—34c; 50 @ 150 39c
 - VOL. CONTROLS:** ALL OHMMAGES, 1/4, 1/2 and 2 meg. with switch, 3' Shaft 47c
 - 12" P.M. Speaker, Heavy Slug \$4.95
 - L-71 Pickup & Crystal Cartridge \$1.89

LOWEST PRICES ANYWHERE—
WRITE FOR FREE CATALOG
 Send 20c With Order—Bal. C.O.D.

COMMERCIAL RADIO
 36 BRATTLE ST. BOSTON 8, MASS.

ATTENTION—TELEVISION SERVICEMEN AND DEALERS

Make television measurement of high voltage easy and safe. Use the HiVolter. Converts most low range vacuum tube voltmeters, such as R C A VoltOhmyst into high voltage testers. Read 10 kilovolts full scale. Indispensable for radiomen who service television receivers. Keeps your hands away from high potentials and yet is easy to handle. Simple to connect. Just plug the probe of the V.T.V.M. into the HiVolter. Only 10 1/2 inches long. Use it like you would use any probe. Price \$3.25—deposit \$1.00 with order.

MILLER ELECTRONIC DEVELOPMENT LABS.
 Distributors Write for Quantity Prices.
 94 Holland Avenue, Elmont, New York

In Indiana IT'S
Stanton Radio Supply
 521 State St.
 HAMMOND, INDIANA

Home-Built Recorder
 (Continued from page 42)

proximately the best possible position. The erase head is simply a small Alnico V magnet of a shape similar to that shown in Fig. 5D. A magnet of this shape can be secured for a few cents from the *Leotone Radio Co.* (Such magnets are shown in their advertisement in *RADIO NEWS* from time to time.) This magnet is so placed that in recording, the tape passes over both poles before it reaches the record head. When one is playing a recording back, he should be certain that the tape bypasses this magnet.

Before the tape guides and heads are mounted, the tape pulling mechanism should be assembled and tested. All parts should run freely. The tape should be under slight tension at all times, but the friction in the bearings of the spindles and the rewind drive wheel will supply what tension is necessary. When all parts operate smoothly, the guides and heads should be mounted. If the tape does not make positive contact with the record head after all adjustments have been made, it may be necessary to make a small pressure pad of felt to hold the tape against the faces of the head. If everything is aligned properly, however, this will not be necessary.

The finished unit is housed in a plywood cabinet which measures 12 by 17 by 9 inches. The back of this cabinet is left open to assure adequate ventilation. The finish can be left to the discretion of the builder.

To make a recording the machine should be threaded with magnetic tape, the switch turned to *record* position, the volume control advanced until the volume indicator glows on the peaks of the signal, and then the motor started. Short test recordings can be rewound by hand, but for re-

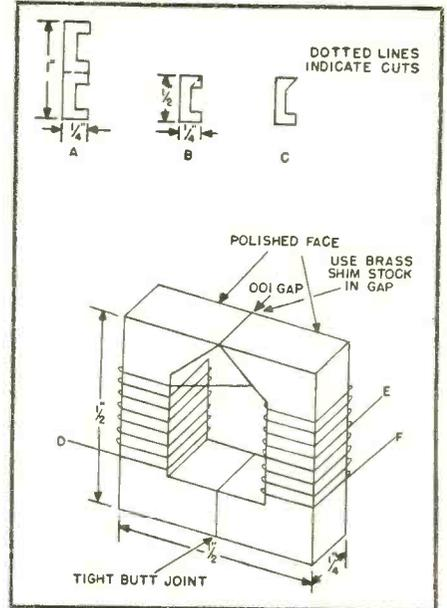
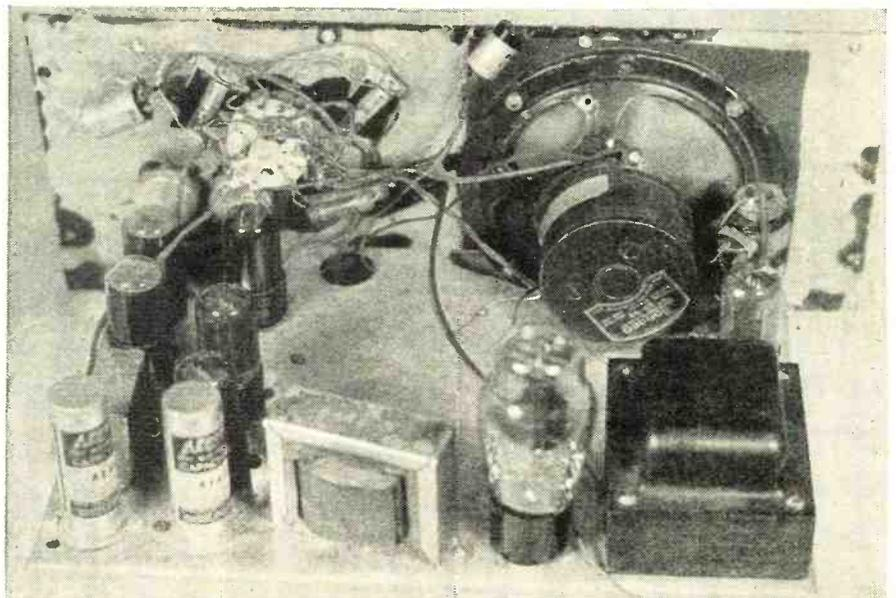

Fig. 8. Construction details for record-playback head. In the assembled head, wires D-E are the 130-turn winding, and E-F are the 30-turn winding. Number 30 cotton-covered enameled wire is used.

winding long recordings, the reels should be turned over, the takeup reel held by hand until after the rewind pulley is pulled into place by turning the knob controlling its action. A little practice will make both recording and rewinding easy.

There are several brands of recording tape on the market. Among them are: *Brush* recording tape, made by *The Brush Development Co.*, and available at most radio supply stores; *Scotch* brand magnetic recording tape, made by the *Minnesota Mining and Mfg. Co.*, St. Paul, Minn., and available from them; then *Hyflux* magnetic recording tape, made by the *Indiana Steel Products Co.*, 6 North Michigan Ave., Chicago, Illinois, and available at that address.

Fig. 9. Top-rear view of amplifier assembly shows position of major components.



- 1—General Industries RM4 heavy-duty phono motor assembly
- 1—Flywheel and capstan
- 1—Rewind drive wheel
- 2— $\frac{3}{4}$ " pulleys to fit reel spindles
- 2— $\frac{1}{4}$ " shafts for rewind assembly
- 4—Threaded brass bearings, $\frac{1}{4}$ " i.d.
- 2—Reel spindles
- 3—Tape guides
- 1—Pinch wheel and lever
- 1—Spring for pinch wheel assembly
- 2—Spring belts
- 1—3" x 6" (approx.) piece of aluminum or brass
- 1— $\frac{1}{4}$ " copper tubing for spacers (approx. 1 ft.)
- 2—7" reels (400 ft. 8 mm. movie reels)
- 1—1200 ft. roll magnetic tape
- 1— $\frac{1}{2}$ " plywood panel 17" x 12"

- Assorted 8-32 bolts and nuts
- 1—Small trans. ("Ouncer" type or type used in microphone) laminations only to be used
- 1—Small Alnico V magnet (to be used as erase head)
- 1—Small spool No. 30 en. c.c. wire
- 1—Small piece sheet steel (to be used for case and mounting of record-playback head)

Parts list for miscellaneous mechanical components required to build the tape-pulling mechanism and record, playback, and erase heads.

Of all the types of tape tried on this recorder, best results were obtained in this particular application with *Hyflux*. It requires a higher bias voltage than the other tapes, but on this recorder it gave much better high frequency response than any other.

It would be well to say, at this point, that a high background noise usually indicates insufficient bias voltage. This can be remedied by using a smaller value of resistance in the oscillator plate resistor, R_{22} . Care should be taken, however, to see that too high a bias voltage is not used, as this causes heating of the head and can damage it.

A little experimentation on the part of the builder should enable him to find out easily the correct adjustments for the recorder, and if he makes these correctly, he will have a versatile, high fidelity instrument, well worth the cost and effort expended in constructing it.

-30-



February, 1948

NEW, GUARANTEED SURPLUS!

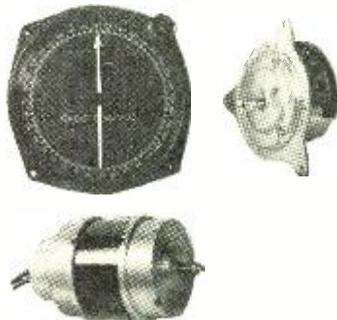

Synchro

Similar to Navy Ordnance type 5G with shaft detail per Army Ord. Dwg. C-78414. 115 V. 60 cy. Stock #SD-43. Price \$9.50 each net.

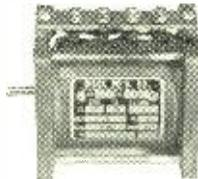

Servo Motor

Diehl Type FP-25-3. 2-phase 60 cycles. 20 volts per phase. 2.5 watts output. 2 pole. Stall torque 2.5 oz/in. 1 oz/in. at 2700 rpm. Stock #SD-33. Price \$8.50 ea. net.

Synchro-Kollsman 775-01. Designed for 26 to 47 volt 400 cycle excitation. May be used on 60 cycles at reduced voltage. Operates as transmitter or receiver. Diameter 2 $\frac{3}{8}$ ", length 2 $\frac{1}{4}$ " plus $\frac{5}{8}$ " shaft extension. Stock #SD-57. Price \$3.75. ea. net.

DC Motor—Delco Type 5069466. Alnico field. 10,000 rpm. Operates on from 6 to 27.5 volts DC. Size 1" x 1" x 1 $\frac{1}{8}$ ". Stock #SD-65. Price \$1.95 ea. net.

Microwave Antenna—AS-217A/AG-15B. 12 centimeter dipole, parabola and conic scan spinner motor housed in 16-inch weatherproof Radome. Stock #SD-95. Price \$9.50 ea. net.

Kollsman Drag Cup Motor. 776-01, 2 phase 400 cycle. Fixed phase 29 volts, var. phase 35 volts max. 0.47 oz/in. stall torque. Stock #SD-56. Price \$9.50 ea. net.

Remote Position Indicating System

5-inch indicator with 360 degree dial. Pioneer Type I-82A. 2320 transmitting Auto-syn with heavy-duty brushes. Operates on 6-12 V. 60 cy. Stock #SD-115. Price \$9.95 per system.

Servo Motor

Pioneer Type CK-2. 2 phase 400 cycle. Fixed phase 26 V., var. phase. 49 V. max. 1.05 oz/in. stall torque. Stock #SD-97. Price \$4.75 ea. net.

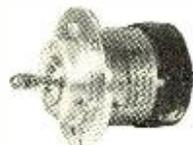

Phase Shift Capacitor—Four stator single rotor capacitor. 0 to 360 degree phase shifting with circuit supplied. Constant amplitude. See RADIO NEWS (Eng. Ed.), June, 1947. Stock #SD-114. Price \$4.75. ea. net.

Radio Compass Loop-Type LP-21LM. Used with SCR-269G and ARN-7 Radio Compass. Stock #SD-99. Price \$9.50 ea. net.

Null Type Synchro Indicator—Requires zero torque. Consists of Bendix control transformer, size 5, rectifier, magic eye tube and manual drive dial. Manually turned to null. 115 V. 60 cy. Use with S-43 transmitter. Stock #SD-119. Price \$12.50 ea. net.

Magnesyne Transmitter or Indicator. Pioneer Type CL-3 (6 power). 28 V. 400 cycles. Stock #SD-6. Price \$6.00 ea. net.

SERVO-TEK PRODUCTS CO.

Incorporated
Surplus Division

247 CROOKS AVE.

CLIFTON, N. J.

Write for complete listing or call ARmory 4-2677

Open account shipments to rated concerns; others may order C.O.D.

RCA Institutes, Inc.

Offer thorough training courses in all technical phases of Radio and Television
WEEKLY RATES DAYS—EVENINGS
VETERANS: RCA Institutes is approved under G. I. Bill of Rights
For Free Catalog write Dept. RN-48
BCA INSTITUTES, Inc.
A Service of Radio Corporation of America
75 Varick St., New York 13, N. Y.

PROJECTION TELEVISION

Adapt your present RCA, GE, Crosley, Philco television receiver for a 6x8 foot projected picture with the addition of a 30 KV-RF power supply and a STP1 projection lens assembly. Complete pictorial construction details of the 30 KV supply and projection system based on actual New York tavern installations described in booklet just published at \$2 each, postpaid.

PERFORMANCE RADIO CO.
2898 Jerome Avenue, New York 58, N. Y.

SURPLUS RADIO PARTS

SCR274N Right Angle Drive type MC211A, NEW	\$.75
SCR522 Microphone Adapter M299. For Carbon Mike Operation of the SCR522, NEW	1.35
Plug for above (sold only with adapter) NEW39
AN/APN-1 Radio Altimeter Plugs, NEW ea. No. 16 stranded aircraft wire, shielded, 4c per foot	Per M feet 22.50
T44 Mike, Cord & Plug. USED65
Jack for above (CD495). USED55
Plug, fits BC348 receiver. NEW21
BC732A Control Head. NEW	4.50

Flexible tuning shafts in stock—write for list.

Please include postage.
LONG ISLAND RADIO CO.
164-21 Northern Blvd. Flushing, N. Y.

WAR SURPLUS

BRAND NEW
COMPONENTS FROM FORMERLY SECRET
SPERRY "AUTO PILOT"



VERTICAL GYRO UNIT

Designed for
B-29 Superfort
ARMY PAID
\$2855.00

YOU PAY ONLY
\$1495

Less than 1/2¢ on the dollar!

Aluminum casing, housing one 400-cyc., 115-v., 3-ph. motor propelled Gyroscope • two 24-v. DC shunt-wound Motors • 2 Electronic Relays • Auto-Transformer • and hundreds of other parts. A masterpiece of precision. 15x14x9"; 36 lbs

AMPLIFIER RACK

WITH RELAYS
AND METERS

GOVERNMENT PAID
\$100.00

YOU PAY ONLY
\$695



Consists of magnesium cabinet that mounts

- 7 DPDT Allied Relays • 1 SPST Relay
- 1 Weston 0-125 AC Volt Meter
- 1 350 to 450-cycle Frequency Meter
- 1 115-volt, 400-cyc. Transformer
- And many other parts

This unit is of special interest to "hams"! The cabinet would be excellent for small transmitters or receivers. 12 1/2 x 14 x 10"; 23 lbs.

You pay shipping costs. Send check or money order to

SURPLEX RETAIL SALES INC.

2409 S. LaSalle St., Chicago 16, Ill.
Dept. RN-2 Phone CALumet 9130

HIGH PRECISION 100 Kc. CRYSTALS



Price \$3.95 each

(No. C. O. D.'s. Please include 25¢ for postage and handling.)

Brand New Surplus at about 1/10 Gov't. cost. An ideal Frequency Standard for Amateurs, Servicemen, Laboratories, etc.

Exceptional Frequency Stability ± 15 cycles from -50° to +80° C. (.0015) 10G Vibration Test. Calibrated at 30° C. Brand New, Mounted in Sealed Cases as Shown.

ELECTRONICRAFT, Inc.

5 Waverly Place

Tuckahoe, N. Y.

Recorder Amplifier

(Continued from page 45)

ance or vacuum tube voltmeter should be used for these readings to prevent upsetting of the voltages by the load of the meter.

If r.f. meters are available, the output of the oscillator may be easily checked. When operating properly, the oscillator should develop approximately five volts of r.f. at one ampere with the recording head connected and the switch in record position. As few experimenters will have the necessary r.f. meters available, an alternate method of checking the oscillator output is to employ the pilot light normally used to illuminate the recording head. This bulb is a 6-8 volt, 200 ma. type. It should be connected across the secondary of the oscillator coil, with the recorder in "run" position. This is to insure that the recording head is connected in the circuit, as the recorder switch opens the oscillator lead in the "off" and "rewind" position. If the oscillator is functioning properly, the pilot light should show medium brilliance.

The next step is the adjustment of the level indicating meter. An audio oscillator or some other source of 1000-cycle tone should be available for this adjustment. Code practice oscillators which may be adjusted in frequency and output may also be used if nothing better is available.

The meter circuit should be disconnected from the balance of the circuit at the point marked "X" on the diagram, or by disconnecting the plug leading to the meter circuit.

With the input from the audio oscillator applied to the terminals of the meter plug or between the arm of pot R_{12} and ground, the audio source should be adjusted to exactly 7 volts. The resistor R_{12} should then be adjusted until the meter reads two-thirds full scale, and then left in this position.

The two-thirds point should be marked on the meter scale and thus becomes the upper limiting mark for proper recording level. If desired, a new scale may be pasted over the meter face, and the "normal" and "over" sections designated by green and red water colors respectively.

When calibration of the meter has been completed, it should be reconnected in the circuit. Do not disturb the setting of the meter adjustment R_{12} at any time.

The next step is the setting of the fixed gain control R_9 . A voltage divider consisting of a 220 ohm resistor in series with a 270,000 ohm unit should be made up and connected across the output of the audio oscillator. The 220 ohm resistor should be connected to the grounded side of the audio oscillator, with the grounded side of the oscillator also connected to the grounded side of P_1 . The junction of the two resistors should then be connected to the center of P_1 . With seven volts from the audio oscillator, at 1000 cycles, applied to the voltage divider, the gain control R_9 should be turned full on. The fixed gain should then be adjusted so that the output meter reads full scale. This will be the mark at the high end of the scale and will indicate that the input to the amplifier is approximately five millivolts. This approximates the output of both the microphone and the playback head at maximum levels.

If a calibrated audio microvolter is used, an input voltage of five millivolts may be applied to the microphone input of plug P_1 , and the output at the plate of the second section of the 6SN7 set to 10 volts. The gain control R_9 should be full on when this adjustment is made, and the output voltage set by adjusting the "fixed" control R_9 .

When the adjustments described have been made the amplifier is ready for use. The output of the amplifier may be fed into the phono input of any radio equipped with a phono jack, or if desired may be coupled into the phono channel of an amplifier. Com-

Under chassis view of wire recorder amplifier.

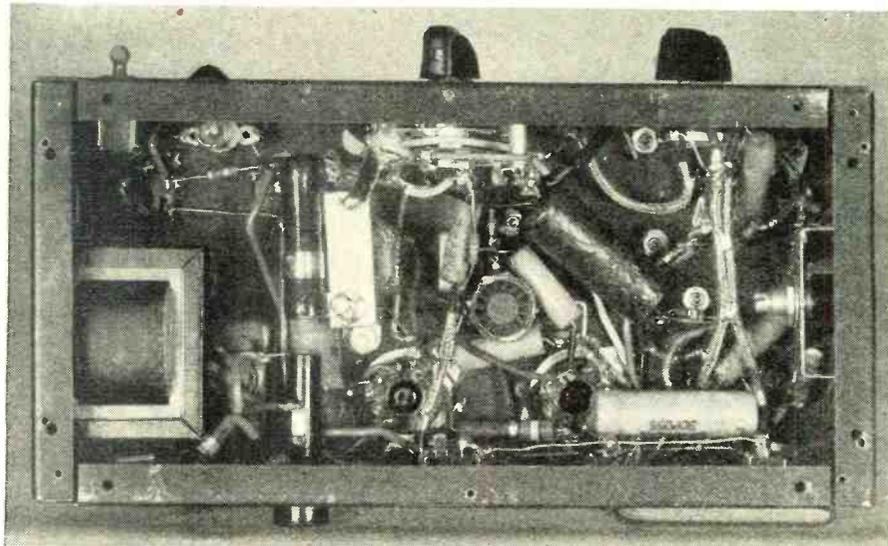

compensation for the frequency characteristics of the wire is automatic, and the fidelity will be equal to, or in excess of that obtained from commercial recordings.

The serious constructor will find this basic unit free from trouble, and a good starting point for more elaborate designs. One possibility that suggests itself is the inclusion of a beam power output stage in this basic unit. This could easily be added by arranging to switch the output of the amplifier to the grid of a 6V6 or similar tube for playback. As the load of the oscillator is disconnected from "B plus" in this position, the over-all load on the power supply would be approximately the same. The plate and screen circuits of the output stage would simply replace the dummy load offered by R₁₇.

In use, the gain control is so adjusted that peaks of speech or music just cause the output meter to hit the line dividing the "normal" and "over" ranges on the meter. This will insure the optimum recording level.

-30-

SERVICE LEGISLATION

OF interest to radio servicemen as being indicative of a possible trend is a proposed local law for the licensing of radio technicians in New York City.

Introduced by City Councilman Stanley Isaacs, the new law provides for the "licensing of all persons who construct, service, repair, install, or test any radio or television apparatus, electronic devices, public address systems, electrical sound amplification system, accessory thereto, part thereof, or attachment thereto, or who solicits, or estimates the cost of said construction, service, repair, installation or testing, but does not apply to any person engaged exclusively in the manufacture, operation, maintenance, repair, installation or testing of commercial motion picture sound equipment, commercial communication equipment, or amateur communication equipment."

Written examinations are to be given to qualified applicants on the following subjects: (A) fundamental electricity, (B) radio receiving circuits, (C) auto radio installation and servicing, (D) p.a. and sound equipment circuits and installation, (E) antennas, (F) commercial radio test equipment, and (G) service methods and use of commercial test equipment. According to the bill, persons seeking a license as a home radio technician would be required to take the test covering A, B, E, F, G; applicants for a license for auto radio technician would be examined in subjects A, B, C, E, F, and G, etc.

In addition to the written examination it is contemplated that a practical examination be given on the repair, installation or servicing of such equipment as the Board of Examiners may deem proper, to the end that the ability to repair, install, or service such equipment, and to put theoretical knowledge to practical use in a reasonable time, shall be ascertained.

The bill is currently being discussed with representatives of the radio industry and interested trade association personnel.

-30-



Servicing Simplified

FOR AM, FM & TELEVISION

A MUST FOR RADIO REPAIR SHOPS



THE MULTI-ANALYST solves your radio problems quickly—The easiest, most effective method of diagnosis—Saves time—wide frequency response—No frequency controls—Both audible and visual indications—Perfect for checking distortion or fading—This handsome, compact unit contains a complete, stable Vacuum Tube Volt-Ohmmeter—electronic on all ranges—Reads video voltages—Big 4½" meter—Exceptional value..... **\$89.50**

THE MODEL 210 VTVM is the perfect instrument for radio repair shop, laboratory, or ham shack—An accurate, stable, high impedance utility instrument with a huge 8½" no squint meter—2% overall accuracy—RF and AC measurements from 30 cycles to 300 mc—Reads to 5,000 volts DC—electronic on all ranges—Resistance measurements from .2 ohm to 1,000 megohms—Complete..... **\$69.50**

ELECTRONIC INSTRUMENT CO., Inc.



926 CLARKSON AVE. BROOKLYN, N. Y.

Write for **FREE** illustrated brochure and see your jobbers for a conclusive demonstration. Complete instruction manual with each instrument. Licensed by RCA.

TELEVISION COIL KIT

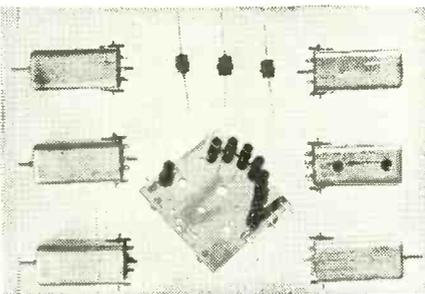

Complete **\$23⁵⁰**

LOOK AT THESE FEATURES!

- Video IF Bandwidth of 4.25 MC that can operate ANY size picture tube with maximum resolution.
- Five stages Video IF permeability tuned with sound and adjacent channel rejection traps in shielded cans
- 5 Channel RF Tuner, permeability tuned mounted on switch assembly plate.
- FM Sound Discriminator for TRUE FM.
- Can provide Video Operation for 10, 12, 15 or 20-inch picture tube upon further construction.
- Video Peaking Chokes to maintain bandwidth.
- Detailed Construction Manual & Parts List with every kit, for 20 Tube, 7 In. Television Set.
- Continued Service Bulletins.

ORDER DIRECT OR THRU LOCAL DEALER TERMS

Shipped Parcel Post prepaid on receipt of check or money order. Or P.P. Collect on receipt of 25% deposit with order, balance COD.

RAY-LECTRON CO.

706 Tenth Avenue
BELMAR, N. J.

SENSATIONAL SELLER!

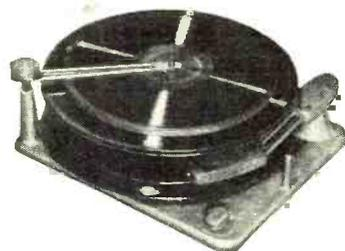

LAKE DELUXE CHANGER

Revolutionizes the Industry!
A Sensational Seller!

11 Outstanding Features:

- Positive Intermix
- Service Adjustments Eliminated
- Minimizes Record Wear
- Single Knob Control
- Plays ALL Records
- Pick-up arm may be grasped at any time and changer will not be thrown out of adjustment
- Resonance-free ball bearing tone arm
- Easily operated—any child can do it
- Completely Jam-proof
- Records Gently Lowered on Spindle—**not** dropped
- Automatic Shut-off on last record

Dimensions: 13 3/16" W x 12 1/4" D x 7 7/8" H. No. 116A..... **YOUR NET \$28.73**

FREE DEALERS and SERVICEMEN: Write for our NEW 16-page 1948 illustrated catalog on radio parts, tubes, accessories, cabinets, sets, electrical appliances, etc. Get on our mailing list today!

Lake Radio Sales Co.

615 W. Randolph Street
DEPT. A
Chicago 6, Ill.

AMATEURS! HAMS! EXPERIMENTERS!

**NOW—TRANSMITTING TUBES at
SENTATIONALLY LOW PRICES!**

- J. A. N. INSPECTED**
- ★ 1625 TRANSMITTING Beam Power. Amol⁹er. Same as 807 except 12.6 volt filament medium. 7 pin base.....ea. 1.4c
 - ★ 836 HALF-WAVE HIGH VACUUM RECTIFIER. Ratings—5000 V maximum. Heater—2.5 V at 5 amps.....ea. 39c
 - ★ 836A/3B27 HALF WAVE HIGH VACUUM RECTIFIER.....ea. 99c
 - ★ 829 PUSH-PULL TWIN-UNIT BEAM POWER AMPLIFIER TUBE.....ea. \$1.49

4E27/HK257B Beam Power Amplifier

★ with an enclosed tantalum anode. Medium metal shell. Giant 7-pin, bayonet base. Wire top terminal. Cathode 5 Volts—7.5 amps. Trans-conductance Micro-Mhos—2800. Class of Service—C-P. Maximum plate ratings—4000 volts. DC Input—250. W.



★ **ONLY \$1.95 EACH**

★ ODS/VR150—Voltage Regulator Tube ea. 49c

★ 25% deposit on all orders, balance C. O. D., F. O. B. New York

★ **SENCO RADIO, Inc.**
★ 96B Warren St., N. Y. 7, N. Y.
★ Tel. Beekman 3-6498

LEARN RADIO!

IN ONLY 10 MONTHS
PREPARE FOR A GOOD JOB!
COMMERCIAL OPERATOR (CODE)
BROADCAST ENGINEER
RADIO SERVICEMAN

Television Servicing—15 Months

Veterans get \$130.00 Equipment
SEND FOR FREE LITERATURE
BALTIMORE TECHNICAL INSTITUTE
1425 EUTAW PLACE, DEPT. R. BALT. 17, MD.

Ask for **ELECTROPARTS** Chemicals

"The Finest At The Lowest"

Write for Latest Catalog 1-47. Dept. R
GLENDALE CALIFORNIA

NEW EQUIPMENT FOR OLD

You can trade in your old test equipment, any make, any type, for credit on these new Supreme test instruments at ALMO. See the table below for the amount allowed on your old equipment towards purchase of these nationally known Supreme test instruments.

Model	Regular Cost	Your Trade-in Allowance	Net Cost To You
504 B Tube Tester	\$89.50	\$15.00	\$74.50
546 A Oscilloscope	89.75	20.00	69.75
563 Generator	62.95	12.50	50.45
589 Tube Tester	48.95	10.00	38.95
589 Port. Tube Tester	62.50	10.00	52.50

WRITE FOR MORE DETAILS

10% Cash with Orders **ALMO** Phone LO 3.9255
Covers the Globe

509 ARCH ST., PHILA, PENN.

Television Installation (Continued from page 55)

dipole has a pronounced limiting effect on the selectivity—and some commercial types have extreme difficulty in receiving channels 1 or 6. In preparing such an antenna for installation, this limiting factor should be considered when determining the best over-all length for the folded dipole to receive specific television channels. See Table 1.

One type of this directional antenna has been developed which (Fig. 6) provides adjustment of all tunable factors, such as length of folded dipole, length of reflector dipole, distance between elements, etc.

Most of the present types of commercial folded dipoles are used to receive channels 1 through 6 only, because the majority of television stations operate on these so-called "lower" channels.

Seven additional channels—between 174 and 216 megacycles—have been assigned for television services, as shown in Table 2, but only a few stations in certain areas have been allocated to these high frequencies.

Eventually, however, stations will be operating on most of these "upper" channels, and suitable television receiving antennas will be required for adequate reception under most of the conditions now existing for the "lower" channels. For the most part, this will mean reuse of established antenna designs with element sizes reduced to dimensions appropriate for the higher frequencies involved.

A few types of very short folded dipoles, with and without reflectors, have already appeared on the market, most of them with a length of about 24 inches. When reception of only the "upper" channels is required, they

Table 3. Outline of procedure for siting and orienting a folded dipole antenna.

SITING AND ORIENTING THE FOLDED DIPOLE ANTENNA

Assembled dipole, mounted on pole, is used on roof as a "probe." Lead-in consists of 300-ohm "twin-lead ribbon" connected between antenna and set. Dipole is portable.

1. Best site is determined experimentally, using two-man coordination system in communication by means of any simple, two-way, battery operated telephone system. While man on roof uses "probing" dipole to test various locations, man at set observes merit of locations in terms of signal strength and picture quality, and the absence of ghosts and "noise" interference on all channels.
2. Site is selected where picture signals are strong, and ghost and "noise" interference not too serious.
3. If desired signals are weak, or ghost images predominate, use folded dipole with a reflector element for greater directivity.
4. Erect suitable folded dipole antenna in roof mounting bracket, but leave free to rotate.
5. Using same two-man coordination system, antenna is rotated and adjusted for best ghost-free reception on desired channels, based on the best results observed by man at receiver.
6. For all "noisy" locations, replace the "twin-lead ribbon" with a well-matched coaxial cable lead-in. Suppress "noise" at source, when possible. Install antenna and lead-in permanently.

PITCO LINE FILTERS

- 5 Amp. 110-220 Volts, A.C. or D.C.
- 10 Amp. 110-220 Volts, A.C. or D.C.

Highest Quality... Dependable Performance

Exhaustive tests and actual operating performance have definitely proven the superiority of the Pitco Line Filter over other designs. The dependable unit presents a solution to the problem of serious radio interference from power lines, motors, and appliances. It provides inductance as well as capacitance, thereby assuring thorough filtering action.

The Pitco Line Filter plugs into the electrical outlet and can be connected at the receptacle of the filter with either the radio set or interfering device. Wherever installed, you'll find this sturdy, compact filter is unsurpassed for high quality and outstanding performance.

For Complete Details, See Your Distributor or Write Direct.

ASK FOR OUR NEW CATALOG ON THE PITCO ADJUSTABLE END LINK COIL.

Pittsburgh Coil Co., Carnegie, Pa.

Coils • Test Leads • Line Filters • Indoor Aerials • Phono-Switches • Circle Cutters

TUBE SPECIAL!

Standard Brands—Individual Cartons

TYPE	LIST PRICE	DEALERS COST
12AT6	\$1.50	\$.60 per tube
12BA6	1.80	.72 per tube
12BE6	1.80	.72 per tube
35W4	1.15	.46 per tube
50B5	1.80	.72 per tube

Total List Price \$8.05

A KIT OF ONE EACH OF THE ABOVE TUBES—WHILE THEY LAST

Special \$2.65 Per Kit of 5 Tubes

Write for Our Complete Tube Price List TRY INTERSTATE IN '48

INTERSTATE RADIO & PARTS CO.
6357 South Ashland Avenue
CHICAGO 36, ILLINOIS
PHONE GROVEHILL 7588

ATTENTION

RADIO SERVICE DEALERS AND HAMS
QUALITY MERCHANDISE AT
DEALER'S DISCOUNTS

Only well known standard brands (no surplus), such as G.E. KEN-RAD tubes at 50% off list, Sprague condensers, Utah speakers, etc.

**ALL ORDERS FILLED SAME DAY RECEIVED
NO ORDER TOO LARGE OR TOO SMALL
WHOLESALE ONLY**

We want satisfied customers. Get acquainted with us now. Write for our regular bulletins.

EL MONTE ELECTRONIC SUPPLY CO.
992 East Valley Blvd. El Monte, Calif.
Phone Budlong 8-4228

ELECTRIC SOLDERING IRON \$1.00

SENSATIONALLY PRICED

Not a toy—the real McCoy. Mighty Mite Electric Soldering Iron with new, amazing "Demon-Heat" element performs like soldering irons costing many times more. Handiest electric soldering iron ever offered for hobbyists, home workmen, mechanics. 35 watts 110-120 volts. GUARANTEED. No COD orders. Price \$1.00 includes mailing. Dealers write for quantity prices. OHIO FACTORY SALES. 10314 Superior Ave., Dept. RN, Cleveland, Ohio.

RADIO ENGINEERING DEGREE IN 27 MONTHS

Intensive, specialized course, including strong basis in mathematics and electrical engineering, advanced Radio Theory and Design. Modern laboratory. Low tuition. Self-help opportunities. Also 27-month courses in Aeronautical, Chemical, Civil, Electrical and Mechanical Engineering. Gov't approved for G.I.'s. Enter March, June, Sept., Dec. Catalogue.

INDIANA TECHNICAL COLLEGE
928 E. Washington Blvd., Fort Wayne 2, Ind.

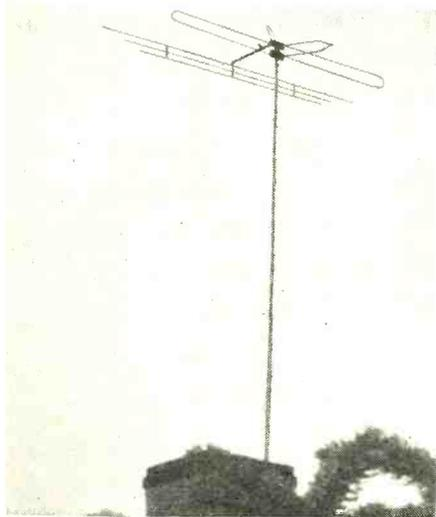

Fig. 9. This installation of a modified folded dipole plus reflector provides adequate ghost-free reception of all New York TV stations—at airline distance of 55 miles.

are installed alone. However, they are usually mounted with a conventional (long) folded dipole for reception of the "lower" channels, so that the pair provides reception of all channels 1 through 13. Such a system requires a large antenna array, as well as a mechanical or electronic switching arrangement.

Modified Types

Anticipating an eventual demand for a single-element antenna capable of receiving all television channels 1 through 13, and, at the same time, fulfilling a need for a more sensitive antenna for the "lower" channels 1 through 6,—a modified type of folded dipole known as the *Duoband* antenna (Fig. 7), is widely used for true all-channel reception. Compared to most conventional types, this modified folded dipole has the same signal acceptance for each of the thirteen television channels.

When receiving stations on any of the "lower" channels, the directivity of this antenna is about the same as that for a conventional folded dipole—receiving equally as well from either front or back. For reception of stations on any of the "upper" channels, however, the antenna has a pronounced directional effect which aids materially in reducing ghost images as well as "noise" interference. This effect is produced by the diminutive "wings" near the center of the antenna (Fig. 7). Sited and oriented like other types of antennas, this modified folded dipole should be erected as high as possible (Fig. 8).

A similar directional effect often is also required on the "lower" channels, and this is achieved with a reflector unit consisting of usually 3, but sometimes 4, parallel dipoles attached behind the *Duoband* antenna. The result (Fig. 9) is a highly directional antenna, with a truly broad response covering all thirteen television channels.

These antennas, and all folded di-

3 COMPLETE UNITS — READY TO INSTALL

FIRST in the Field With Outstanding NEW Features

AM-FM Tuner
Hi-Fidelity Amplifier
12 inch, 16 watt SPEAKER

3 of the finest quality instruments that money can buy. The ultimate in design, appearance and durability... adaptable to any type of installation.

Automatic frequency control. Most revolutionary development in FM design—entirely eliminates drift and multiple tuning responses. Polished chrome chassis—complete with cable, decals, antennae \$100 *

Uniform frequency response from 20 to 20,000 cycles; 9 watt with less than 2% distortion. Durable polished chrome chassis. Complete \$35.40 *

Wide tonal range—altogether dustproof—beautifully chrome plated. Complete \$11.10 *

All 3 units—Ready to install..... \$146.50 *

* All prices are less Federal Excise Tax. Literature upon request.

THE RADIO CRAFTSMEN, Inc. 1341 S. MICHIGAN AVE., CHICAGO 5, ILLINOIS

★ ★ ★ ★ ★ ★ ★ ★ ★ ★

"Service with a STAR"

New LOW Price . . . Same HIGH QUALITY

THE STAR TESTER

Volt—Ohm
Milliammeter

\$24²⁵

An all-around tester with high quality features at an amazingly low price. Built for versatility and handiness. Gives you easy, accurate reading, with a 4 1/2, 400 microampers meter. Case is metal, crackle finished. Comes complete with batteries, test leads, and instructions for use.

DESIGN DATA

- 5—DC Voltage Ranges—0 to 1000 volts
- 5—AC Voltage Ranges—0 to 1000 volts
- 5—Output Meter Ranges—0 to 1000 volts
- 4—DC Current Ranges—0 to 1000 ma.
- 3—Resistance Ranges—0 to 5 megohms
- Decibel Ranges— —10 to +54

You are using the best when you "Service with a STAR." Contact your dealer today, or write us direct.

Literature available on all STAR products. Write for our copies today!

STAR MEASUREMENTS CO.
442 East 166th St., Dept. N-2, New York 56, N.Y.

★ ★ ★ ★ ★ ★ ★ ★ ★ ★

IT'S NO LIE... *Federated* CUTS DOWN Prices!

WEBSTER Wire Recorder Foundation Unit
Record speech or music up to a full hour! Wire can be "erased" and recorded again and again! Complete unit consists of wire transporting mechanism, triple-purpose recording head (records, erases, plays back) oscillator coil, 15-minute spool of wire, all connectors. Model 79 \$52.92

RCA WIRE RECORDER
New model, easy to operate, records up to 30 minutes on single cartridge, and plays back. Complete unit as illustrated, compact and portable, including tubes, mike, stand, connectors, and one 30-min. cartridge. Your Cost... \$130.00

Bargain Special Filter Condenser
40/20/20 Mfd. all at 150 V.V. DC. Can be mounted any position. Paper Tubular dry electrolytic. trolitic. 10 for \$1.90

Please include 25% Deposit with order, Balance C.O.D. Minimum C.U.D. Order \$5.00. DEPARTMENT 28-E

Federated Purchaser
INCORPORATED
distributors of RADIO—ELECTRONIC and SOUND EQUIPMENT
80 PARK PLACE, N. Y. 7
Phone: Dlgby 9-3050

RISCO HAS IT

All Changers Brand New

V. M. MIXER CHANGER



\$15.50

Above Easily Attached to Any Radio or CAN BE USED WITH AMPLIFIER BELOW

SERVICEMEN'S SPECIALS

100—INSUL. RES. KIT 1/2, 1, 2w.	\$1.65
25—MICA COND.—CODED89
15—ASST. KNOBS89
15—ASST. BY-PASS COND.89
15—ASST. SOCKETS69
1000 1/2w. RES.—ANY SIZE IRC	10.00
ALLIANCE PHONO MOTORS	2.50
ASTATIC or SHURE PICKUPS	1.79

PHONO AMPLIFIER

3 TUBE AC-DC
Wired Vol. & Tone Control

\$2.75

Uses 12807, 50L6, 35Z5.

Wired & Tested—Set of 3 Tubes

Output Trans.

5" Alnico Spk.

2-Tubes—\$1.50. **\$2.75**

25% on C.O.D. orders. Orders Filled as Received. B.E. 3-8554. We Sell Retail. Free Catalog Just Out. We Specialize in Mail Orders.

RISCO ELECTRONICS

WHOLESALE DISTRIBUTORS

22 Warren St., New York 7, N. Y.

GIANT 1¢ SALE

PAY 1 PENNY MORE—GET 2

Over \$150,000 worth of merchandise set aside for this special sale. Stock up now for the entire year. **SAVE YOURSELF \$\$\$\$\$.**

ALL ITEMS GUARANTEED

For example a High Voltage Western Electric Transformer, input 115 V, 60c—output 1200 V @ 1 ma. 2 3/4" x 3 3/4" x 5 3/4" and weighing 5 lbs. sells for \$2.25. **YOU GET 2 for \$2.25.**
New Westinghouse Cross pointer meter with 2-200 microamp movements 3 1/2" No. Mx16 sells for \$3.95. **YOU GET 2 for \$3.95.**

ALSO

Filter chokes—resistors—ceramic sockets—High Voltage Transformers—Relays—Selenium rectifiers—Westinghouse meters—Connectors—Rheostats—Condensers—Tubes and hundreds of other parts.

Write for special to Sale Catalogue—for the Buys of a Lifetime! Sale extends through March 30.

Universal/general corp.

Dept. N
365 Canal St., New York 13, N. Y. WALKER 5-9642



STEADY PROFITS

YOUR OWN BUSINESS

with CORADIO

THE COIN OPERATED RADIO

Place these specially built radios that play 1 or 2 hours for 25c in the thousands of available hotel rooms, tourists courts, etc. They yield immediate profits and steady income. Install Coradio, the finest made.

Limited capital required Send for further information. Write today.

CORADIO Coin Operated Radio
Dept. J, C 108 W. 31 Street, New York 1, N. Y.

poles and special types of antennas, are installed in the conventional manner. See Table 3. They must be sited and oriented for ghost-free, interference-free, adequately strong reception of the principal stations in the area. In every case, the installation must be considered on an *individual* basis, taking into account the specific problems of the particular location.

—50—

Practical Radio Course

(Continued from page 70)

by a communications receiver, he may decide on a characteristic that provides a 6 kc. total passband width, in order to attain a high degree of adjacent-channel selectivity which makes for greater discrimination against unwanted off-channel signals, and less noise. Such a receiver can be made even more selective by employing a total passband width of only 3 kc.

Gain and Selectivity of Bandpass Circuits in Cascade

The foregoing numerical calculations pertaining to the selectivity and passband acceptance response of a bandpass coupling transformer apply for a single such transformer only, since the over-all bandwidth *decreases* with each such transformer added in cascade in the circuit. For example, if each of two such transformers has a passband width of 12 kc. an over-all measurement on two in cascade may show a passband width of only about 8 kc.

The over-all gain for n stages is equal to $(\text{gain per stage})^n$.

Additional Methods for Obtaining a Bandpass Response Characteristic

High over-all gain, fairly flat-topped over-all bandpass frequency response, and reasonably good adjacent-channel signal attenuation can be obtained by combining the high gain and *double-peaked* response characteristic produced by one coupling transformer of the high- Q double-tuned type, with the *single, sharp-peaked* response characteristic of a following transformer of the high Q single-tuned type. Such systems, see (A) of Fig. 7, have been used satisfactorily in the

single-stage i.f. amplifiers of some radio receivers (especially auto-radio types that employed a 175 kc. i.f.) and have been previously discussed.⁴ As shown at (B) and (C) in Fig. 7, the single-peaked response of the single-tuned transformer serves to compensate for the decrease in response that occurs around the resonance frequency in the high- Q double-tuned transformer. The steep-sided response characteristic of the double-tuned transformer is relied upon to supply the major portion of the adjacent-channel signal attenuation.

Bandpass response can also be obtained by tuning the coupled primary and secondary circuits of the two coupling transformers of a single-stage amplifier to slightly different frequencies. The frequency-response curves illustrated in Fig. 8 show the effect on the response characteristic as the coupling between the resonant primary and secondary circuits, each tuned to a different frequency slightly each side of the mid-frequency of the bandpass range, is increased. Observe that for loose coupling, two resonant points are distinctly present, resulting in an over-all double-peaked response with a sharply-reduced minimum response at the mid-point frequency. For very tight coupling, the reaction of the secondary circuit back upon the primary is so strong that the response is low and there are no longer two individual peaks of response. The two circuits are no longer able to act independently, so a single, combined, low, broad, fairly flat response is produced. By employing a compromise value of coupling that lies between these two extremes (or suitable selection of values of primary and secondary Q), the more desirable practically flat-topped characteristic shown at the center may be obtained.

One objection to this method of obtaining a bandpass response is that it is usually difficult to adjust the tuned circuits properly under field conditions, since a frequency adjustment made on the secondary circuit affects the resonance frequency of the primary, and vice versa, as the two circuits are necessarily coupled rather closely. Another objection lies in the fact that the gain (or response) obtained under this detuned condition is less than if the same passband is obtained with the primary and secondary resonant at the same frequency.

(To be continued)

⁴Alfred A. Ghirardi, *Practical Radio Course, Part 58, Fig. 4, RADIO NEWS, (January, 1948).*

Fig. 8. Primary and secondary circuit detuning to produce bandpass response characteristic.

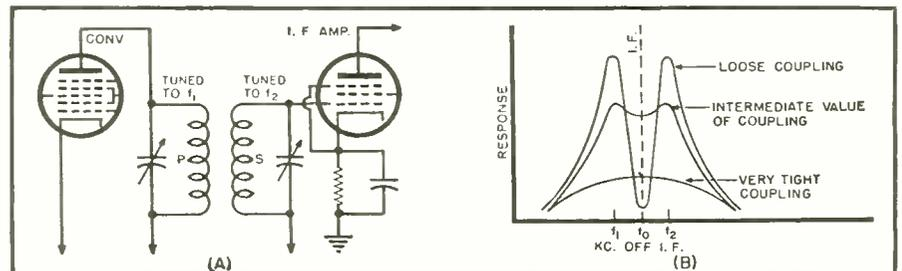

Converting Recorder

(Continued from page 59)

Since expense was a consideration, it was found that a *General Industries* motor and an *Astatic* "400" crystal pickup mounted on a plywood base made a very serviceable phonograph for auditing and preparing sample programs. It was not felt that orthoacoustic compensation was needed for transcriptions.

A better speaker in a large cabinet will be used when the unit serves as a public address system. This speaker and recorder, along with a high impedance velocity microphone, will be used later for promotion purposes in addressing local organizations.

In using the recorder for broadcasting, the control operator merely plugs the 500 ohm output from the recorder into one of the remote repeat coils and brings it in as is normally done for a remote broadcast. The 500 ohm output jack cuts off the recorder's speaker when a plug is inserted, and thereby maintains an impedance match at all times.

In using the recorder for selling time, sample fifteen-minute programs are made up for specific merchandisers. Then the salesman takes the recorder and plays the sample program to the prospective advertiser during his interview. The results obtained through the use of the recorder in this fashion have been highly satisfactory.

BATTERY ELIMINATOR USED TO CHARGE CAR BATTERY

MOST battery eliminators—used by servicemen for testing car radios—may also be used to charge the car battery.

Polarity of the eliminator leads should be observed when attaching to the battery and an ammeter connected in the circuit as shown will indicate if the eliminator is being overloaded. H.L.



February, 1948

KEEP POSTED ON ELECTRON TUBES

Use this convenient coupon for obtaining the RCA tube reference data you need.

RCA, Commercial Engineering, Section BW60, Harrison, N. J.

Send me the RCA publications checked below. I am enclosing \$..... to cover cost of the books for which there is a charge.

Name _____
Address _____
City _____ Zone _____ State _____

- Quick-Reference Chart, Miniature Tubes (Free). [A]
- HB-3 Tube Handbook (\$10.00)*. [B]
- RC-15 Receiving Tube Manual (35 cents). [C]
- Receiving Tubes for AM, FM, and Television Broadcast (10 cents). [D]
- Radiotron Designers Handbook (\$1.25). [E]
- Quick Selection Guide, Non-Receiving Types (Free). [F]
- Power and Gas Tubes for Radio and Industry (10 cents). [G]
- Phototubes, Cathode-Ray and Special Types (10 cents). [H]
- RCA Preferred Types List (Free). [I]
- Headliners for Hams (Free). [J]

*Price applies to U. S. and possessions only.



TUBE DEPARTMENT

RADIO CORPORATION OF AMERICA
HARRISON, N. J.



THE "TELETRAP"

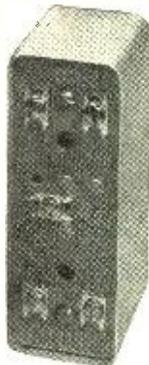

Models
1002A
1005A

INTERFERENCE ELIMINATOR FOR TELE SETS

Eliminates FM and amateur interference from tele image by absorption of interfering signal. Two adjustments provide for elimination of signals in 80-115Mc and 40-60Mc Ranges.
Model 1005A List \$10

THE SIMPLEST FM CONVERTER

Converts 40-50Mc FM Tuners and receivers to 88-108Mc operation. Simple to attach and adjust. No power required. Hundreds now in use all over U.S.

Model 1002A List \$10.00

CRYSTAL CONTROL FOR FM TV AND BC RECEIVERS

Send 25c (no stamps) for booklet describing applications of quartz crystal control for local oscillator of your home receivers.

See Your Local Parts Jobber or write for information

CRYSTAL DEVICES CO.

DEPT. N

1819 Broadway, NEW YORK 23, N. Y.

SCHUH DOES IT AGAIN!

NARROW BAND F.M.
Noise Free Reception

Only adapter for BC 348 receiver using 915KC IF. Also made in 455-465KC model. 3 3/4 x 4 1/8 x 1 1/2". Completely Chromium Plated. Easily mounted. Uses 6AK5 limiter and 6AL5 discriminator. Instructions supplied.

Price (less tubes) **\$10.95**
6AL5 tubes Each..... 90c
6AK5 tubes Each..... 90c

400V POWER SUPPLY KITS

All electrical components for 410 VDC @ .200 Amp—50 cycle 110 VAC input. 410 VDC @ .150 Amp on 25 cycle 110 input. 1% ripple. Consists of herm. sealed power transformer and choke and 2-10 Mfd oil filled condensers, rectifier tube, socket, and diagram. ONLY **\$9.50**
8" x 17" x 3" steel chassis for above..... \$1.46

800V Power Supply Kit..... includes components listed for 410V supply—plus one additional transformer, rectifier tube, socket, and diagram. Power supply will deliver 800V at 200 amp. when used on 115V, 60 cycle power line. Can be built on same chassis as above kit. **\$14.25**

RA20 Powerpack converts BC312 receiver to AC operation. Fits in dynamotor compartment. Also for external use with BC348, 314, 224, and used with BC696 and 459 as ECO. Input 110-120 VAC, 60 cycles. Output 250 VDC @ .95 MA, 12V @ .6 A, 12V CT @ 3A. Shipping weight. 12 lbs..... **\$7.95**

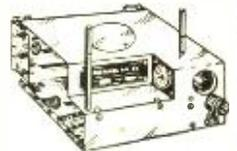

FILTER KITS

11 hy @ .600 amp herm. sealed choke and 2 condensers 2mfd @ 5000 volts. Only..... **\$15.95**
SWAP your old receiver on a new National. Good Allowance—Write Us.

Open 5 evenings and Saturday afternoons!

TERMS: 30% with order. Balance C.O.D. Shipments F.O.B. Chicago.

SCHUH'S RADIO PARTS

1253 Loyola Avenue • Chicago 26, Illinois

RADIO VALUES

A TREASURE CHEST OF RADIO PARTS
Consists of transformers, condensers, dial controls, insulators, terminal connectors, coils, practically all types of switches. Many useful items. Every assortment different.
No. R6508—7 lb. Kit for only.....**\$1.25**

PIONEER GEN-E-MOTOR DYNAMOTORS

Double Shaft Dynamotor. Input volts 18. Output volts 450. 1-1/16" shaft length. 1/4" shaft length with small gear. Size of motor 7 1/2" L. x 4 1/4" H. x 3 3/4" Dia.
No. 9626.....Each. \$5.50
Winco Dynamotor. Input volts 12 Amps. 9.9, output volts 400 Amps. 180. Temp. rise 40° C. R.P.M. 4200. Duty cont. Size 7" L. x 4" H. x 3 3/4" Dia. Four lead wires.
No. 9629.....Each. \$6.50

RADIO CONDENSERS

Sirague Auto Radio Condenser 5 MFD 1600 V. D.C. Size 2" L. x 1 1/16" Dia. with lead wire.
No. 9631—lots of 10.....10c ea.

ROTARY SNAP SWITCH

Radio Snap Switch. Split shaft 1/2". Ind. lock nuts. 1/2" Approved. Rating 15 Amps. 10. 125 V. Single solder lugs.
No. 9637.....Lots of 10. Each. 15c

PIONEER GEN-E-MOTOR DYNAMOTORS

Same as No. 9626 Input Volts 9. Output V. 450.
No. 9628.....\$5.50

BAKELITE HANDLE

Brown Marbled Bakelite Handle used for radios, luggage, etc. Size 3" L. x 2 1/2" W. with holes on each end for rings.
No. 9638.....Lots of 10. Each. 8c

PUSH BUTTON SWITCH

6 V. push button switch. 2 screw terminals. Size 1 1/2" L. x 3/4" Dia.
No. 9636.....Each. 15c

SHUNT MOTOR

Aluminum Body Shunt Motor. Type B-9-1. 7 Amps. 27 1/2 Volts. D.C. 5600 R.P.M. 1 1/2" shaft length. Plunger Type. 3/16" shaft.
No. 9639.....Each. \$2.25

SEND FOR FREE CATALOG

G. & E. EQUIPMENT SUPPLY CO.
OGDEN AT FULTON, CHICAGO 7, ILL.
We ship C.O.D. All prices F.O.B. our warehouse.

LEARN

TELEVISION ELECTRONICS RADIO

Modern Completely Equipped Laboratories
DAY AND EVENING CLASSES
G.I. Approved—Veterans Receive Subsistence

ENROLL NOW!

ELECTRONICS INSTITUTE, INC.
21 Henry, Detroit 1, Mich.

APPLIANCE SERVICEMEN

Construct your signalling Iron Tester with **PYRION'S** thermo-electric relay, which "sounds off" when proper adjustment temperature reached. Also prevents iron overheating if forgotten! Automatic. Absolutely no attention required. Price \$6.25. Other parts available anywhere for less than \$2.00. Information on request.
Pyrlon Controls, 2215 Moore Ave., Anniston, Ala.

ORDER NOW

- 300 ohm Amphenol.....per C \$ 2.91
- 150 ohm Amphenol.....per C \$ 2.62
- 75 ohm Amphenol (small).....per C \$ 2.01
- 75 ohm Amphenol (heavy duty).....per C \$ 7.20
- SCR 522 used but in good condition.....\$14.50
- SCR 522C Brand new in cartons.....\$24.50
- APS 13 (Tail Warning Radar).....\$ 9.95
- Kilowatt 75 Ohm Amphenol Twin Lead, per 100 ft.....\$ 7.20
- 3 Gang 410 Mmfd. Per Sect. Cond. Excellent quality.....\$ 2.95
- National ACN Dials.....\$ 3.00
- 24G Transmitting Tube.....\$ 1.00
- 2C40 Lighthouse Tube.....\$ 0.95
- 2" PM Speaker (Bakelite Cased) Used in Walkie Talkie.....\$ 1.95
- 1M 13 Portable frequency meter boxes in canvas case (New).....\$ 1.25
- SIREN, Commercial type hand operated, very loud noise, gov't cost \$21.00. Spec. \$ 4.95
- Transmitting condenser 2mfd. @ 2500 W.V., \$2.95 each.....Two for \$ 5.00

Send for Our Special Bulletin of Government Surplus Items

DOW RADIO

1759 E. COLORADO ST., PASADENA 4, CALIF.
Pasadena Phone—SYcamore 3-1196
Los Angeles Phone—RYan 16683

Classified

Rate 20c per word. Minimum 10 words.

RADIO ENGINEERING

RADIO Engineering Broadcasting, Aviation and Police Radio, Servicing, Marine Operating and Electronics taught thoroughly. Expenses low. Write for Catalog. Valparaiso Technical Institute. Dept. N, Valparaiso, Ind.

FOR SALE

BARGAINS in guaranteed filter condensers. Send for free sample and price list. William H. DePeau, 1435 North 15th St., Harrisburg, Pa.

MULTICOLORE Maps. U. S. or World 50"x38", either type 75c. Both \$1.25 or on approval. Powell, 68 Lyall Road, Clifton, N. J.

CAPACITORS. 200 Surplus 50 MFD CD oil filled KGT 3500 330 VAC 1000 VDC. Old list \$28.00 now \$3.00 each. 4 for \$11.00 or \$2.50 each for 50 or more. Prices FOB Dayton, Ohio. Shipping charges COD. Send Money Order or check to Capacitors, 1652 Russett Ave., Dayton 10, Ohio.

NEW cartoned tubes 39c each. 100 assorted for \$35.00. 1R5, 1S5, 1T4, 3S4, 1L4, 5Y3gt, 6SA7gt, 6SD7gt, 6SK7gt, 6SN7gt, 6H6, 6X5gt, 7Y4, 6A8gt, 12A6gt, 12AT6, 12BA6, 12BE6, 12J5gt, 12K8, 12SA7gt, 12SQ7gt, 12SN7gt, 12SL7gt, 31, 35B5, 35W4, 3Z5, 50B5, 50L6, 70L7gt, 80, 89, 117L7gt, 117Z3. Write for bargain flyer. Henshaw Radio Supply, 3313 Delavan, Kansas City 2, Kansas.

MY collection of early issues of several different Radio magazines. Box 1081, Clovis, N. M.

SCOTT Communication Receiver Type S L R-M. Finest communication receivers made for worldwide reception. Four wave bands including broadcast. Used three months. \$200.00. Dr. E. F. Miller, Lambrecht Bldg., Idaho Falls, Idaho.

EXPERIMENTERS, Technicians, Engineers! Build a laboratory tube tester. Emission, Transconductance, Power Output tests. More economical and flexible than best commercial models. Illustrated pamphlet, \$2.00. Poly-Tech Laboratories, Wall Street, Boulder, Colorado.

6 ASSORTED Crystals, Catwhiskers, instructions, "Radiobuilder," catalog, all 25c. Laboratories, Eye-h, San Carlos, California.

RUBBER stamps etc. For sale. Cookson, Box O-RN, Puxico, Missouri.

LUMINOUS paint (shines in the dark). Many uses. Sample bottle \$1.00 (refundable). Price list. Willis Products, N-61 Hayes, Wilkes Barre, Pa.

RADIO Tubes, new, \$45.00 per 100 assorted, standard brands, cartoned, 10% deposit, Bal. C.O.D. Best Radio Shop, 3349 Fulton, Cleveland 9, Ohio.

NEW and used Hallicrafters, National, Hammarlund, Collins, RME, Millen, Meissner, other receivers, transmitters, etc. Lowest prices. World's best terms. Shipped on approval. Guns, cameras, etc. traded for. Write. Henry Radio, Butler, Missouri.

YOU can accurately align superheterodyne receivers without signal generator. Complete instructions \$1. Moneyback Guarantee! Chas. Gates, Pecos 1, Texas.

NEW Wire-Recording Magazine. 10,000 feet stainless steel wire, switches, brakes, recording, reproducing, erasing head, etc. with complete instructions for building 8000 cycle recorder, \$35.00. Christopher Carey, Fair Haven, Vermont.

NEW Electronic Tubes, 802, \$1.00. G.E. Kenotron GL 8020, \$2.50; VR90, 884, 45, 81, \$5.00; 250R, \$3.75. Rectigon 6 Amp Battery Charger Bulb, \$1.50. Potentiometers, \$1.75 doz. Matched Tone Headphones, \$7.5. Magnetic contactors 3 pole 100 H.P., \$8.00. 3/8" bore wire, copper, nickel, aluminum, tin, monel, choice \$5.00 lb., "Allen" Soldering paste, \$.25 lb. D. Smith, 235 Vermont Ave., Oak Ridge, Tenn.

6V DYNAMOTOR from 12V surplus. No rewinding. Full original output. Instructions. 50c. Paul Hawkins, 1306 E. 27th, Kansas City, Mo.

ERECO Beam Rotator. 110 VAC, heavy duty, variable speed, selsyn indicator, weather-proofed. Complete indicator and rotator ready to plug in, \$69.95. Satisfied users all over the country. Buy from your dealer or direct. Free literature. Dick Rose, Erec, 2912 Hewitt, Everett, Washington.

RHEOSTAT-POWER Control, large 4x7, metal and asbestos with bronze set contacts, for motors, machinery, etc. Price \$2.00. Radioco, 1110 Marshall Bldg., Cleveland, O.

VEEDER Electric Counter. For counting electric impulses in connection with electric eye, etc. Value, \$15.00. Price, \$2.50. Radioco, 1110 Marshall Bldg., Cleveland, O.

BC-457B EASILY converted to hot 10 meter receiver, fixed or mobile. Instructions, Schematics, \$1.00. Brown, 3327 Geronimo, Tucson, Arizona.

TELEVISION High Voltage R.F. Power Supply Coil. 10 K.V. at 750 microamps. Excellent quality. Guaranteed. Circuit included. \$6.50. Coast Electronics Co., P.O. Box 891, Red Bank, New Jersey.

RADIO Tubes—Dealers, order your needs—be surprised at prices. Address Radio Tubes. Box 108, Elizabeth City, N. C.

FREE wholesale bulletin. Tubes, parts. Bargain prices. Henshaw Radio Supply, 3313 Delavan, Kansas City, Kansas.

WRITE Dept. RN18 for our free wholesale list of Radio parts & accessories. R. C. Radio Parts & Distributing Co., 731 Central Ave., Kansas City 6, Kansas.

LOWEST Prices. Radio Tubes, parts. Bargain lists 3c. Potter, 1314 McGee, Kansas City 6, Mo.

SELENIUM Rectifiers, full wave, 1/2 ampere, \$1.85; 1 ampere, \$2.50. Half wave 5 ampers, \$4.50; 2.2 ampers, \$2.25; 1.5 ampere, \$1.85. Bulletin Bursma Radio, Route 5, Grand Rapids, Mich.

CHOKES, swinging, rated 2-12 henries, 100-1000 MA. 5 1/4"x7"x10 1/2", heavy duty with porcelain insulators, \$7.50; Filament transformers, 2.5 volts, 11 amps, cased, porcelain insulators, \$2.50; with pair 866, \$4.00. SKL Laboratory, Box 188, Lexington 73, Mass.

CAMERA suppliers to the Radio profession special prices on Argus, Revere, Keystone, Briskin cameras, etc. We buy and trade. Just write: Charles Wolfe, 167 Canal Street, New York 13, N. Y.

HEARING Aids. Zeniths, others. All used but working. Make miniature transmitters or receivers. Complete with cords, ear piece. \$20.00 ea. Shelby Instrument, 321 W. 7th, Long Beach, Calif.

IDEAL Chargers for 2-volt batteries, list \$4.95, in quantities 98c, sample \$1.75. Modelectric Products, Asbury Park, N. J.

WANTED

AN/TRC-1 Equipments T-14 Transmitters R19 Receivers TS32 Oscillators, complete or parts, any quantity. Box 458, % Radio News, 185 N. Wabash Ave., Chicago 1, Illinois.

TELETYPEWRITERS used or new, parts, accessories. Box 447, % Radio News, 185 N. Wabash Ave., Chicago 1, Illinois.

TRC7 RADIO Equipments. RT-53 Receiver-Transmitters, AS-12 Antennas. Box 448, % Radio News, 185 N. Wabash Ave., Chicago 1, Ill.

WESTERN Electric Carrier Telephone or Telegraph Filters, equalizers, repeating coils, etc. Also CF1 and CF2 carrier equipment and parts. Box 450, % Radio News, 185 N. Wabash Ave., Chicago 1, Illinois.

W E OR Kuthe Type 394A Grid Controlled Rectifiers. Box 451, % Radio News, 185 N. Wabash Ave., Chicago 1, Illinois.

HELP WANTED

INSTRUCTORS in Radio-Electronics and Television. Prefer former Navy Radio Technician Instructors with Teacher Training. Must be willing to locate in Detroit, Mich. Write to Box 452, % Radio News, 185 N. Wabash Ave., Chicago 1, Ill.

RAILWAY Telegraphy needs men. Complete training. Instruments furnished. Positions waiting. Bell Telegraph Railway Institute, 10 Parker Ave., San Francisco 18, Calif.

SITUATIONS WANTED

TELEVISION Engineer, first class operators license, Radar and Video Research experience. Box 457, % Radio News, 185 N. Wabash, Chicago 1, Illinois.

PATENT ATTORNEYS

LANCASTER, Alwine & Rommel. Registered Patent Attorneys. Patent Practice before U. S. Patent Office. Validity and Infringement Investigations and Opinions. Booklet and form "Evidence of Concealment" forwarded upon request. Suite 414, 815 15th St., N. W., Washington 5, D. C.

CORRESPONDENCE COURSES

USED Correspondence Courses and Educational Books sold or rented. Inexpensive. Money-back guarantee. Write for Free Catalog listing 4000 bargains. — (Courses Bought.) — Lee Mountain, Pisgah, Ala.

AMATEUR radio licenses. Complete code and theory preparation for passing amateur radio examinations. Home study courses. American Radio Institute, 101 West 63rd Street, New York City 23.

MISCELLANEOUS

PHONOGRAPH records 20c. Catalogue sent free. Paramount, NG-313 East Market, Wilkes-Barre, Penna.

CONE torn? Save your time and money. Use "Cone Patch," the new magic musical cement. No working, passes all Vibrations. Seam is almost invisible. Voicoid, solution stops hum in cores permanently. Postcard brings literature and sample. Radio Research Products, 6417 Harper Ave., Chicago 37, Illinois.

MAKE more money, easily. Become independent. We show you how. Eye-opening information free. Radiomen and beginners, write: Merit, 216-32d 132nd Avenue, Springfield Gardens 13, N. Y.

26 YEARS experience radio repairing at your fingertips. I've repaired 45000 radios. Have perfected simple system you can follow step by step. No calculations or formulas. Total price \$2.00 postpaid or C.O.D. Money back guarantee. Ross Radio, 14615-C Grandriver, Detroit 27, Mich.

ELECTRIC meter laboratory. Electrical instruments, tube checkers, and analysers repaired, checked and calibrated. Prompt and reliable service guaranteed. Hazelton Instrument Co., 140 Liberty St., New York 6, N. Y. Tel. Barclay 7-4239.

TESTING Equipment. All types and models. Expertly repaired and calibrated. Free estimates. Metro-politan Electronics, 42 Warren St., N. Y. 7, N. Y.

SQUELCH EFFECT IN RECEIVERS

By JOHN T. FRYE

OCCASIONALLY a receiver will be encountered which acts as though it were equipped with an automatic squelch circuit when such is not the case. Strong stations will come through clearly when they are tuned in precisely, but weak stations cannot be heard at all; there is no between-station background noise; slight detuning from even a strong station results in distorted, choked reception.

This condition is caused by a gassy tube somewhere along the a.v.c. circuit. It may be the second-detector or any of the tubes supplied with a.v.c. Quite often the tube will test perfectly good on an average tube-checker; but the substitution of a non-gassy tube will clear up the condition.

-30-

ERRATA

In the diagram appearing on page 50 of the December 1947 issue of RADIO NEWS, the plate of the 6SF7 i.f. stage is shown as returning to ground through a 2200 ohm resistor. This resistor should be connected to the "B" plus line, instead of ground.

Since publication of the article, "Dynamic Noise Suppression Circuits," which appeared in the January 1948 issue of RADIO NEWS, the author has advised us of an improvement in the circuit. The 6SQ7, Fig. 4, page 48, is replaced by a 6B8G tube. The screen resistor should be 470,000 ohms bypassed with a .2 μ d. condenser. The cathode resistor should be 680 ohms bypassed with a 25 μ d. or more condenser. The plate circuit will remain the same as that indicated for the 6SQ7 tube. No other change in the circuit is necessary.

Photo Credits

Pages	Credit
43 (Top), 46, 140, 152	Howard W. Sams & Co.
43 (Bottom)	Art Haug
44, 198	Webster-Chicago
49, 51, 108, 110	General Electric Co.
52, 73	Armour Research Foundation
54 (Bottom left)	Ward Products Co.
54 (Bottom right)	TACO
55 (Top right)	Shur-Antenna Mount
55 (Bottom left)	Dielectric Products Co.
56, 57, 98	Indiana Steel Products Co.
60, 61	McMurdo Silver Co.
64	Meisner Mfg. Division
118	Stanford University
122	John Rider
123 (Bottom), 146, 150	Ame
148	Bell & Howell

Chicago

INSTRUMENTS

Quality at Low Cost!



POCKET VOLT-OHM-MILLIAMMETERS FOR ONLY \$5.25

Anyone can now own a good volt-ohm-milliammeter. There is a Chicago V.O.M.A. priced at only \$5.25. Chicago "Featherweights" that slip easily into the pocket are the original miniature radio test instruments. They are popular throughout the world.

For years, Chicago Instruments have given radio men accurate, dependable service. And because of simplicity of design and freedom from "gadgets" we have been able to hold down prices to a fraction of what you would normally pay for instruments of similar quality.

Chicago Instruments are available in a variety of ranges and sensitivities. You may see them at your Suppliers or get the complete details by writing for Bulletin No. 10.

CHICAGO INDUSTRIAL INSTRUMENT CO., 536 W. ELM ST., CHICAGO 10, ILL.

CUT ACCURATE HOLES IN RADIO CHASSIS

"DYNOPTIMUM" TUBE TESTER

MODEL 322



WITH A GREENLEE RADIO CHASSIS PUNCH

● Make smooth, true holes quickly this easy way. Just turn GREENLEE punch with an ordinary wrench and have an accurately-sized opening for plugs, sockets, and other receptacles. No reaming or filing. A GREENLEE Punch for each of these sizes: 1/8", 3/16", 1/4", 3/8", 1/2", 5/8", 3/4", 7/8", 1", 1 1/8", 1 1/4", 1 1/2", 1 3/4", 1 7/8", 1 3/4", 2 1/4". Also GREENLEE Knockout Punches and Cutters for conduit and meter holes up to 3 1/2". Get facts now. Write Greenlee Tool Co., 1882 Columbia Avenue, Rockford, Illinois.



Gives you more test features, at lower cost, than any other tube tester on the market

NOW ONLY \$37.95

Compare this value-packed instrument . . . feature for feature, performance against performance. You'll see instantly why you can be many dollars ahead with this unexcelled tube tester. Order today from your local jobber. Write direct for catalog on the complete R. C. P. line of instruments.

- Accurate tests due to famous exclusive Dynoptimum circuit
- Easier to operate than other testers—only three selector switches
- Provides for quality—short—leakage and noise tests
- Up to date including miniatures and sub-miniatures tubes
- Operating instructions and tube chart gives approximately 800 tube testings

R. C. P. INSTRUMENTS—Best for Every Test

RADIO CITY PRODUCTS CO., INC.

152 West 25th Street, New York 1, N. Y.



FEBRUARY SPECIAL

Two Gang super-het tuning condensers.....\$0.75
3 for.....2.00

OPERATES FROM A BEAM OF LIGHT

Photo-electric relay kit complete with all parts including tubes, relay, sensitivity control and simple assembly instructions. Build your own magic eye alarm system—use light beam control. Only \$4.95.

LABS — SCHOOLS — INDUSTRIALS — GET ON OUR MAILING LIST—SEND US YOUR REQUIREMENTS.
Allied relay-24v. d.c., d.p.d.t. 10 amp. contacts. 75c; 10 for.....\$5.00

G. E. Solenoid operated contactor
#CR2820—controls 6 circuits—operates
on 115V. 60CY., 4 3/4 x 9 3/4. 15 amps
contacts double break each circuit. G. E.
Catalog price \$25.00. YOUR PRICE. \$5.95

4 mfd. @ 600V oil filled with mtg. clamp. \$ 5.00
59c; 10 for.....\$ 5.00
Leach 6V dc relay, 3 pole n.o., \$1.25; 10 for 10.00
UTC "S-6" input Xmtr.—line or mike to
grid; dealer's price, \$3.10. Your cost,
\$1.25; 10 for.....10.00

Weston #476—3 1/2" Bakelite: 0.8V AC. \$3.95
Weston #507 R.F., amps. 0-1.5 2% 3.95
accuracy to 65mc; bakelite case.....
Filter Chokes, 10HV., @ 160MA. 1500
ohms res. \$1.25; 10 for.....10.00
Westinghouse Filter chokes—4 by @ 90
mils. 300 ohms res. hermetically
sealed 2" can 69c; 5 for.....3.00

25% deposit with order; balance COD; save COD
charges; send full amount. Minimum Order, \$2.00.

RADIO DEVELOPMENT & SALES CO.

382 State Street Brooklyn 2, N. Y.

ORDER BY MAIL! POSTPAID*



(A) STATION CONTROL BOX.....\$2.00

Contains 2 4P2T anti-cap switches, 3 jacks, 1
ST Jones strip, 2 HD Jones Plugs, 1 full wave
meter rectifier, 6 cond., 3 resistors, P.B. for
VFO & Trans. control, key jack & tone jack.
Brand new.

(B) ARR-1 CONVERTERS.....\$4.95

Complete with four 934 Acorn tubes and shock
mounting. Covers 234-258 mc. Easily con-
verted to 2, 6, 10 meters. Complete with sche-
matic diagram. Brand new.

(C) ALTITUDE LIMIT SWITCH.....\$1.00

Contains 14 2500 ohm, 2w resistors, 2 gaud,
1 pole, 11 pos. switch. Removable glass dial
face and dial, attenuator type case. Fine for
making decade boxes and attenuators. Brand
New.

(D) TELEPHONE HANDSET HANGER..\$1.00

Fits most types on market. Made of Navy in-
spected castings. Fine for desk, mobile or ma-
rine use. Brand new.
*All Items Shipped Postpaid upon Receipt of
Cash with Order.

ALL ABOVE ITEMS BRAND NEW!
Send for Latest Bulletin!

ALVARADIO

903 S. Alvarado, Los Angeles 6, Calif.

NO INFLATION AT BROOKS!

• Your Dollar buys 2 1/2 lbs. of these
useful radio parts . . .

- Brackets
- Spacers
- Collars
- Springs
- Shafts
- Clamps
- Holddowns
- Standoffs
- Washers
- Rivets
- Etc.

Mostly Aluminum

Send your name and ad-
dress on a post card and
pay the postman only... **\$1.00**
for
2 1/2
lbs.

Plus Postage

GEORGE BROOKS and ASSOCIATES
777 W. Adams St. Chicago 6, Ill.

Wire, Tape, & Disc RECORDERS

Write for Our Free Catalog
of Recorders and Accessories

ACME ELECTRONICS CO.

6523 Euclid Ave. Cleveland 3, Ohio

INDEX OF

Advertisers

FEB.
1948

While every precaution is taken to assure accuracy, we cannot guarantee against the possibility of an occasional change or omission in the preparation of this index.

ADVERTISER	PAGE NO.	ADVERTISER	PAGE NO.
A. M. Radio Sales Co.	134	Electronic Products Laboratories	120
Abell Distributing Company	141	Electroncraft Inc.	149, 168
Acme Electronics	176	Electronic Instrument Company	169
Acme Neon Institute	112	Electronic Sales Company	153
Adaptol Co.	164	Electronic Technical Institute	150
Adson Radio Co.	144	Electronics Institute, Inc.	174
Allen Corporation	129	Embry-Riddle School of Aviation	160
Allied Radio Corp.	9	Esege Sales Co.	126
Almo Radio Company	170	Espey Manufacturing Company, Inc.	151
Alvaradio	165, 176	Esse Radio Company	104, 105
Ambroid Company	146		
American Merchandise Mart, Inc.	164	Fair Radio Sales	146
American Phenolic Corp.	155	Farwest Trading Company	151
American Radio Institute	157	Federated Purchaser, Inc.	171
American Sales Co.	147	Feiler Engineering Co.	125
American Surplus Products Co.	71		
American Television, Inc.	34	G & E Equipment Supply Co.	174
American Television and Radio Co.	133	G & G Radio Parts Service	99
Amperite Co.	86	G & M Sales	147
Amplifier Corp. of America	100, 140, 177	General Cement Mfg. Co.	106
Apex Video	159	General Electronics Distributing Co.	81
Arrow Sales, Inc.	82, 83	General Test Equipment	164
Ashe Radio Co., Walter	101	Gibson Radio Rule	164
Atlantic Industrial Co.	116	Greenlee Tool Co.	175
Audel, Publishers	98	Greenwich Sales Co.	94
Audio Development Co.	137	Greylock Electronic Supply Co.	161
Audiview Radio Parts Co.	154		
		Hallcrafters Radio	5
Baltimore Technical Institute	170	Harris Supply Company	146
Bell Telephone Laboratories	178	Harvey Radio Co., Inc.	124
Berman Company, Inc., Henry O.	148	Heath Company	78, 79
Bliss Electrical School	143	Henry Radio Stores	149
Boland & Boyce Inc., Publishers	36	Hollywood Sound Institute	149
Brach Manufacturing Co.	164	Hoodwin Company, Charles	157
Bradshaw Instruments Co.	166	Hytron Radio	85
Brooks Electronic Laboratories	96		
Brooks Radio Distributing Corp.	138	Indiana Technical College	170
Brooks and Associates, George	176	Interstate Radio and Parts Co.	170
Buffalo Radio Supply	90, 91	Instructograph Company	159
Burstein-Applebee Co.	68		
		James Vibrapower Co.	177
Candler System Co.	110	Jensen Industries	110
Cannon Electric Development Co.	8	Jensen Mfg. Co.	38
Capitol Radio Engineering Institute	37	Jensens Radio Supply and Service	120
Centralab, Division of Globe-Union, Inc.	21	Johnson Company, E. F.	77, 132
Certified Television Lab.	100	Joseph, Irving	95
Chicago Industrial Instrument Co.	176	Joyce Radio Company	158
Chicago Transformer Co., Division of Essex Wire	17		
Chief Electronics	144	Ken-Rad, Division of General Electric	6
Cinaudagraph Speakers	133	Klein, Manuel	165
Cleveland Institute of Radio Electronics	26, 88		
Clippard Instrument	152	Lake Radio Sales Co.	169
Collins Audio Products Co.	125	Lectrohm, Inc.	150
Colortone Company	160	Leeds Radio	129
Columbia Wire and Supply Co.	114	Leotone Radio Co.	92
Commercial Radio	166	Lightning Calculator Co.	161
Commercial Radio Institute	135	Lincoln Engineering School	159
Communications Equipment Co.	111	Long Island Radio Co.	167
Concord Radio Corp.	12		
Coradio	172	Mallory and Co., Inc., P. R.	Third Cover
Coyne Electrical School	156	Martin, Don, School of Radio Arts	128, 145
Coyne Electrical and Radio School	97	Maspeth Telephone and Radio Corp.	135
Crystal Devices Company	173	Meissner Manufacturing, Div. of Maguire, Inc.	145
		Melville Radio Institute	141
Davega Stores	Second Cover	Merit Coil and Transformer Corp.	20
Davis Development Co.	159	Merit Radio Supply Company	132
Deer and Taylor Co.	140	Mid-America Co., Inc.	122
DeForest's Training, Inc.	19	Miles Reproducer Co., Inc.	158
DeLahanty School of Television	164	Miller Electronic Development	166
Dow Radio	174	Milwaukee School of Engineering	136
Drake Electric Works, Inc.	28	Morts Radio Shack	153
Duotone Company	114	Moss Electronic Distributing Co.	93
Dynamic Television Association, Inc.	144	Murray Hill Books, Inc.	32, 33
		McGee Radio Company	72, 73, 74, 75
EPCO	108, 156	McGraw-Hill Book Company	69, 158
Editors and Engineers	163	McMurdo Silver Company, Inc.	16
Eichel Electronics Corp.	110		
El-Monte Electronic Supply	170	National Equipment Supply Co., Inc.	114
Electro-Parts Company	170	National Radio Institute	3
		National Schools	23

ADVERTISER	PAGE NO.
Newark Surplus Materials Co.	136
Newcomb Audio Products Co.	88
Niagara Radio Supply Corp.	100, 135, 150
Northwestern Vocational Institute	146
Ohio Factory Sales	170
Ohmite Manufacturing Company	31
Olson Radio Warehouse, Inc.	116
Onan and Sons, D. W.	86
Opad & Green	138
Oxford Reconing Service	145
Pakette Radio	146
Peak Electronics Co.	118
Performance Radio	167
Pernoflux Corporation	138
Photocon Sales	130
Pickering Company, Inc.	128
Pittsburgh Coil Company	170
Plastics and Electronics Company	158
Potter Radio Company	154
Precision Apparatus	148
Progressive Electronics Co.	115
Pyron Controls	174
Quad Electrical Supply	152
RCA Institutes, Inc.	167
R & M Radio Company	87, 89
Radiart Corp., The	162
Radio Center	125
Radio City Products	175
Radio Coin-Matic	134
Radio Corporation of America	15, 29, 67, 173
Radio Craftsman, Inc.	171
Radio Development and Sales Co.	176
Radio Electric Service Co.	137
Radio Ham Shack Inc.	119
Radio Kits Company	120
Radio Parts Company	97
Radio Parts Distributors	126
Radio Supply and Engineering Co., Inc.	109
Radio Wire Television, Inc.	76
Radionic Equipment Co.	159
Radolek Company	177
Ravac Electronics Corp.	128
Ray-lectron Company	169
Reed Mfg. Co.	157
Rider Publisher, Inc., John F.	10
Risco Sales Electronics Wholesale Distributors	172
SNC Manufacturing Co., Inc.	25
S & R Coning Service	149
Sams Company, Howard W.	14
Schott Co., Walter	134
Schuh's Radio Parts	173
Senco Radio, Inc.	143, 170
Servo-Tek Products Co.	167
Shure Brothers, Inc.	30
Silverstine, N. Co.	121
Sprague Products Company	27
Sprayberry Academy of Radio	7
Stanton Radio Supply	166
Star Measurement Co.	171
Sterling Electronic Company	100
Sun Radio of Washington, D. C.	22
Supreme Publications	103
Surplex Retail Sales Inc.	168
Sutton's Wholesale Electronics, Bill	150
Sylvania Electric Products, Inc.	Fourth Cover
TAB	107
Technical Radio Parts	132
Teleonics Service & Supply	116
Television Assembly Co.	70
Television Industries	131
Telex, Inc.	157
Test-Craft Instruments	127
Tradio, Inc.	94
Transvision, Inc.	123
Tricraft Products Company	133
Triplett Electrical Instrument Company	11
Tri-State College	165
Turner Company, The	35
U. S. Radio Supply	163
United Surplus Materials	139
Universal General Co.	172
University Loudspeakers, Inc.	126
Utica Drop Forge and Tool Corporation	165
Valparaiso Technical Institute	153
Variety Electric Co., Inc.	84
Vision Research	94
Ward Products Corp.	13
Weller Manufacturing Co.	18
Wells Sales, Inc.	24
Western Radio Co.	113
Western Radio Communications Institute	139
World Radio Laboratories, Inc.	161
Wright, Inc.	145
York Distributors	146

Insist on Genuine JAMES VIBRATORS

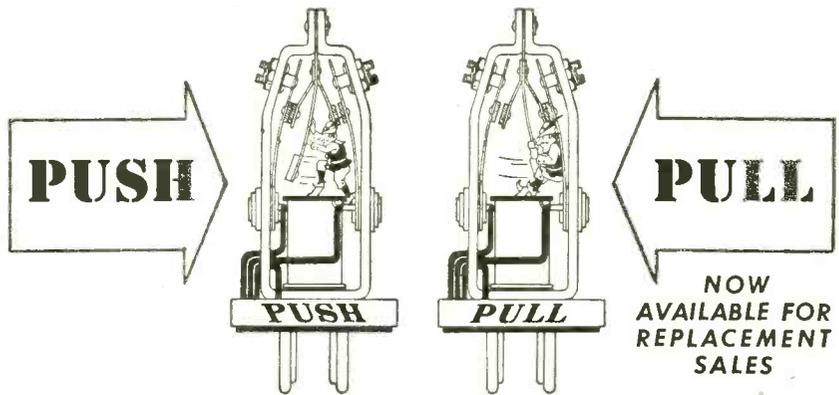

SYNCHRONOUS AND NON-SYNCHRONOUS TYPES

Over the years the James Vibrator has become famous for long life and extreme dependability. Note these outstanding features: (1) Patented Push-Pull Action (2) Frame-Mounted cooler-operating reeds (3) Adjustable contacts.

The war years and various shortages have kept the James Vibrator in short supply. New production facilities now permit prompt shipments on replacement vibrators of all types.

Ask your Radio Parts Distributor. Write for Interchangeability Chart, price list and catalog.

JAMES VIBRAPOWER Co.

3224 W. Armitage Ave.

Chicago 47, Illinois

Technicians Everywhere
agree that when
BETTER AMPLIFIERS
are made,
it's A. C. Shaney
who's "a-goin' to make them"

A. C. Shaney, long known as the outstanding designer of high-quality amplifiers, and his associates at the Amplifier Corp. of America, are getting ready to announce the completion of the finest line of public address and political amplifier equipment ever produced. New standards of quality and workmanship, new circuits, new materials, and new manufacturing processes have been combined to make this soon-to-be-announced amplifier line the answer to all requirements. Specifications and performance ratings of these popular-priced models will equal or surpass those formerly found only in high-cost, custom-built equipment. And Amplifier Corp. of America will guarantee every amplifier for 5 full years—an expression of confidence that only the country's leading and most thorough manufacturer of the most modern amplifier designs would dare make.

You can't afford to buy any amplifier until you have investigated the new concept in amplifier design and construction offered by A. C. Shaney and the Amplifier Corp. of America.

Join the many thousands who are "watching and waiting" for the latest in amplifiers from

AMPLIFIER CORP. of AMERICA

398-2 Broadway, New York 13, N. Y.

A postal card will put you on our mailing list to be among the first to know.



Up-to-the-Minute
Buying
Information

- Radio Repair Parts
- Sound Systems • Tools
- Kits • Phono Equipment
- Tubes • Test Instruments
- Experimenters' Supplies

**REGULAR SUPPLEMENTS
KEEP YOU POSTED**

Catalog sent immediately upon request. Price and Data Supplements, issued regularly, assure you of up-to-the-minute information—give exact and current data you need for profitable buying. Send the coupon today for this helpful buying service.

**BIG VALUES, LARGE STOCKS,
FAST, DEPENDABLE SERVICE.**

FREE... SEND TODAY

RADOLEK CO., Dept. B-028
601 W. Randolph St., Chicago 6, Ill.
Please send your Free Profit Guide Catalog and regular Supplements.

Name
Address
City Zone State

SAVE AT RADOLEK

Television stations get programs by telephone lines, too

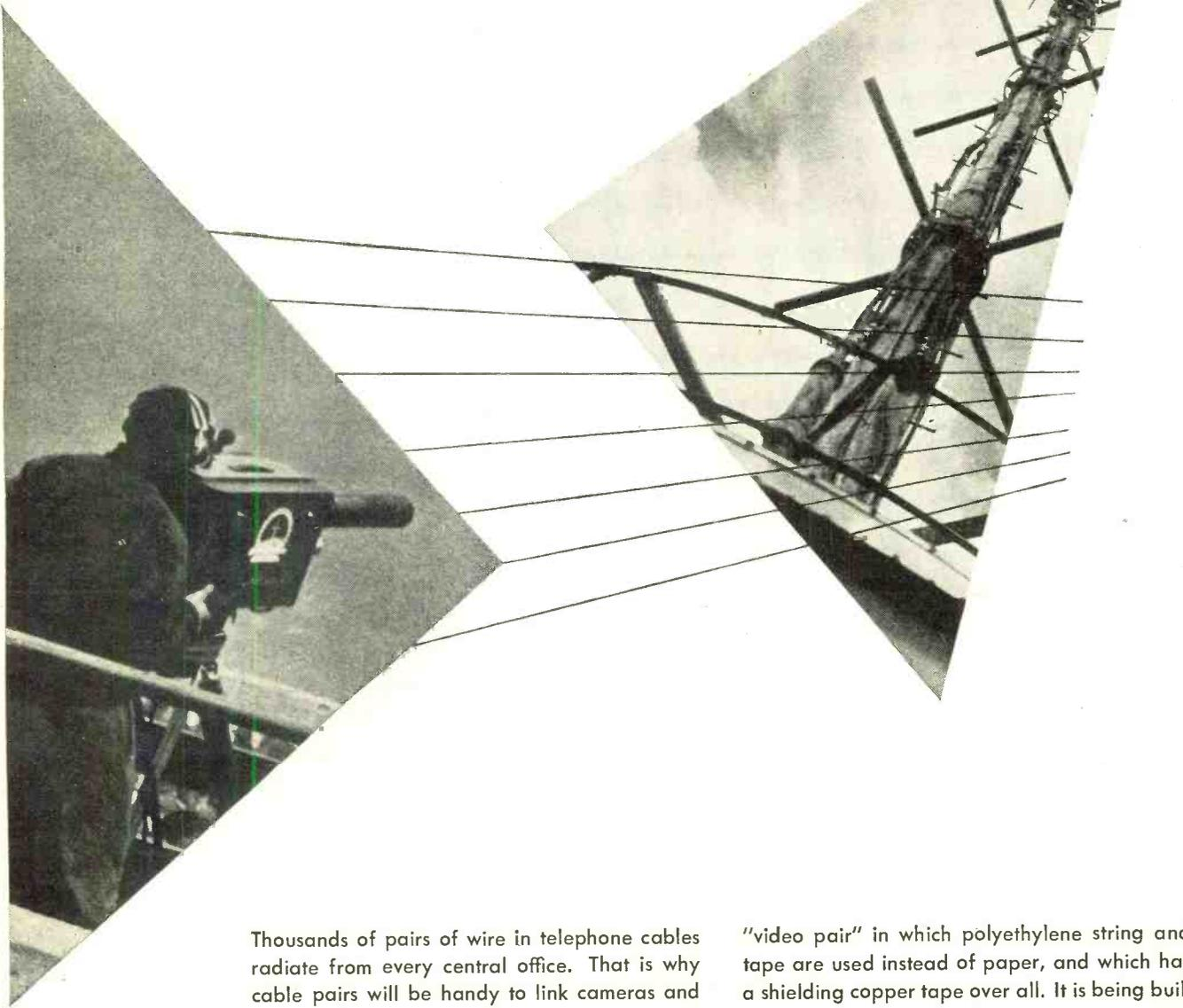

Thousands of pairs of wire in telephone cables radiate from every central office. That is why cable pairs will be handy to link cameras and transmitters wherever a television program may originate.

Since cable pairs are designed first for voice transmission—top frequency, about 3200 cycles per second—the loss at picture frequencies up to 4,000,000 cycles is high, so an amplifier is inserted about every mile. Equalizing networks are also needed to bring the losses at all frequencies to the same value.

Recently, the Laboratories have developed a

"video pair" in which polyethylene string and tape are used instead of paper, and which has a shielding copper tape over all. It is being built into new telephone cables which go to points where television programs are certain to originate. Losses are so much less that amplifiers can be four miles apart.

Inside an all-weather sheath, "video" travels safely and reliably alongside your telephone call, a sound program, telegraph signals, pictures for tomorrow's papers. This service of the telephone cable was ready when television needed it because of Bell Laboratories activity.



BELL TELEPHONE LABORATORIES EXPLORING AND INVENTING.

DEVISING AND PERFECTING, FOR CONTINUED IMPROVEMENTS AND ECONOMIES IN TELEPHONE SERVICE
PRINTED IN USA.

RADIO NEWS

Sustained CAPACITY

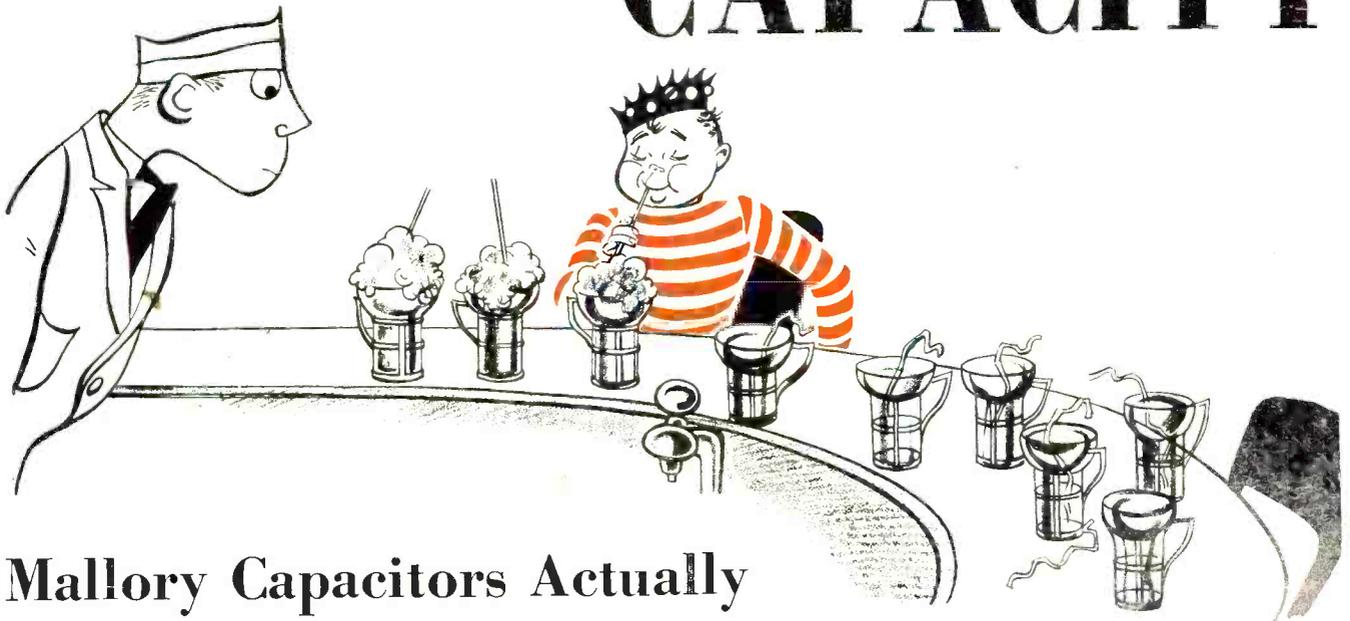

Mallory Capacitors Actually Increase in Capacity After 2,000* Hours

Install Mallory FP Capacitors with the knowledge that they will last in a "hot set" with temperatures up around 185° F.—they will last on the shelf or in an inactive set without needing reaging—and they will last without loss of capacity.

Their RF impedance—their ability to withstand ripple current, are other plus values that make Mallory capacitors popular with radio service men, as well as with manufacturers of radio equipment.

THE MALLORY "GOOD SERVICE FOR GOOD BUSINESS" PLAN

will increase business and profits in your shop.

A unique follow-up file makes it easy to keep customers.

You tie in with Mallory acceptance to develop new business—ask your distributor about it.

Mallory is never satisfied to produce parts that just get by. In all Mallory Parts you will find a generous margin in *your* favor. Mallory capacitors will operate at 185° F. —that's 35° hotter than R. M. A. requirements.

*2,000 HOURS OF OPERATION

An actual test of Mallory capacitors operated in an oven at 185°F. and 450 volts DC. plus 10 volts of 120 cycle ripple, showed them still going strong and with increased capacity at the end of 2,000 hours. Typical results:

At Start of Test		After 2,000 Hours	
Capacity	Resistance	Capacity	Resistance
20.9 mmf	6.16 ohms	23.5 mmf	6.5 ohms
20.1 mmf	6.5 ohms	23.4 mmf	6.55 ohms

BUY MALLORY ASSURED QUALITY AT REGULAR PRICE LEVELS

P. R. MALLORY & CO., Inc.
MALLORY

CAPACITORS . . . CONTROLS . . . VIBRATORS . . .
SWITCHES . . . RESISTORS . . . RECTIFIERS . . .
VIBRAPACK* POWER SUPPLIES . . . FILTERS

*Reg. U. S. Pat. Off.

APPROVED PRECISION PRODUCTS

P. R. MALLORY & CO., Inc., INDIANAPOLIS 6, INDIANA



Link FM — With Sylvania Lock-Ins — Covers New Jersey For Its State Police Radio System

Automotive equipment of the New Jersey State Police includes vehicles always on the alert to deal with every emergency. Fleet is spearheaded by 180 patrol cars of the department in addition to 42 patrol cars of the State Motor Vehicle Department which is served by the State Police. These vehicles are constantly in touch with fixed FM stations located at 26 strategic points throughout the state. In addition, emergency trucks carry complete radio equipment equivalent to that of a fixed station!

Link Radio Corporation, manufacturer of the communications equipment, makes extensive use of Sylvania Lock-In tubes to assure unfailing efficiency of this statewide network. Lock-In tubes stay put through vibration and jarring. They have few welded joints... no soldered ones. Elements cannot warp or weave... connections are short and direct. Top location of getter reduces losses... separation of getter material from leads cuts down leakage.

See Sylvania Distributors—or write Radio Tube Division, Emporium, Pa.

SYLVANIA ELECTRIC

MAKERS OF RADIO TUBES; CATHODE RAY TUBES; ELECTRONIC DEVICES; FLUORESCENT LAMPS, FIXTURES, WIRING DEVICES; ELECTRIC LIGHT BULBS



↑ Drivers of both emergency trucks and patrol cars can maintain two-way communication with fixed stations.

Radio equipment in emergency trucks duplicates the set-up used in fixed transmitting stations.



The superior mechanical and electrical features of Sylvania Electric's famous Lock-In tube make it the ideal choice for equipment on the road, in the air, on the rails, marine radar, FM and television.

