

RADIO NEWS

AUGUST
1947
35c



HOME RECEIVER PRODUCTION HITS ALL-TIME HIGH



*Now in a New
and Up-to-Date
Catalog Line*

CHICAGO TRANSFORMERS and REACTORS

Sealed in Steel

For years, Chicago Transformer has met with outstanding success the varying requirements of the electronics industry for top-quality, custom-built transformers and reactors. Today, C.T. is augmenting this service to the industry with a new catalog line of units, to be manufactured on a standard design basis.

Now, small-quantity purchasers of transformers in the various fields of electronics—broadcast, communications, experimental, amateur, public address, and industrial control—can acquire for their equipment the advantages of progressive, practical C.T. engineering.

Now, large-scale manufacturers of electronic equipment who are in a position to utilize standard components can find in C.T.'s new catalog the transformer ratings and constructions that will fit their latest designs.

Characteristics of this new line are as up-to-date as tomorrow's laboratory project. Ratings have been skillfully selected, by men who know the trends in circuit design, to achieve maximum flexibility of application, close matching with today's preferred types of tubes, and conformance with RMA and FCC standards.

Modern, too, is the type of mounting used. Drawn steel cases and three variations of Chicago Transformer's famous Sealed in Steel construction will offer the combined advantages of "steel wall" protection against moisture and corrosion, efficient magnetic shielding, vibration-proof mechanical strength, compactness, and a streamlined appearance that spells "eye appeal" in finished equipment.

For further details, write for catalog

THE POWER LINE

Plate and Filament Supply Transformers with high voltage secondaries for both capacitor-input and reactor-input systems, and with corresponding filament supplies.

Plate Transformers for use in low to medium high power transmitters.

Filter Reactors accurately matched with the Plate and Filament Supply and Plate Transformers above.

Filament Transformers for supplying the filaments of today's most widely used tubes.

Bias Transformers—combination plate and filament supply.

Step-Down Transformers for operating radios and appliances on 220 volts, 50/60 cycles, in the export trade.

THE AUDIO LINE

Full-Frequency Range, 30 to 15,000 Cycles, provides uniform response over this entire band with $\pm 1/2$ db up to 10 watts of audio power, within ± 1 db over 10 watts. Standard RMA impedances. Included are Input, Output, Driver, and Modulation Transformers; Modulation Reactors.

Public Address Range, 50 to 10,000 Cycles, frequency response within $\pm 1/2$ db up to 10 watts of power, within ± 1 db over 10 watts, throughout this range. Secondary impedances match 600 and 150-ohm lines, 16, 8, and 4-ohm reproducing systems. Listed are Driver and Output Transformers.

Commercial Range, 200 to 3,500 Cycles, affords response with variations not exceeding ± 1 db over the range of voice frequencies. For use with 600 or 150-ohm lines. Input, Output, Driver, and Modulation Transformers offered.



CHICAGO TRANSFORMER

DIVISION OF ESSEX WIRE CORPORATION

3501 ADDISON STREET • CHICAGO 18, ILLINOIS



I Will Show You How to Learn RADIO by Practicing in Spare Time

I Send You Big Kits of Radio Parts

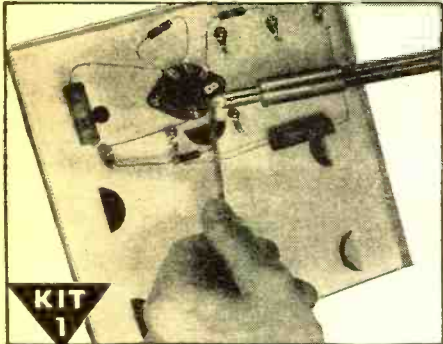

KIT 1

I send you Soldering Equipment and Radio parts; show you how to do Radio soldering; how to mount and connect Radio parts; give you practical experience.

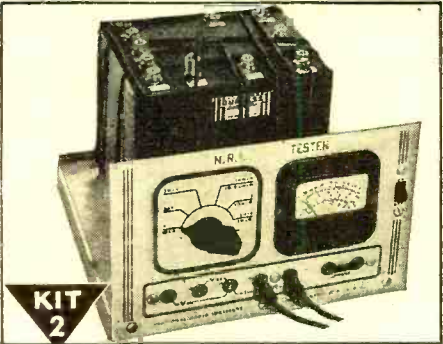

KIT 2

Early in my course I show you how to build this N. R. I. Tester with parts I send. It soon helps you fix neighborhood Radios and earn EXTRA money in spare time.

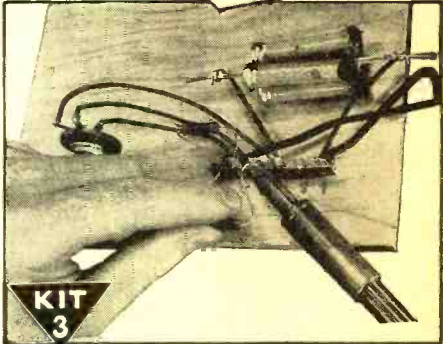

KIT 3

You get parts to build Radio Circuits; then test them; see how they work, learn how to design special circuits; how to locate and repair circuit defects.

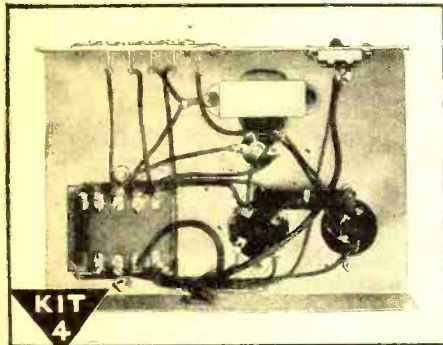

KIT 4

You get parts to build this Vacuum Tube Power Pack; make changes which give you experience with packs of many kinds; learn to correct power pack troubles.

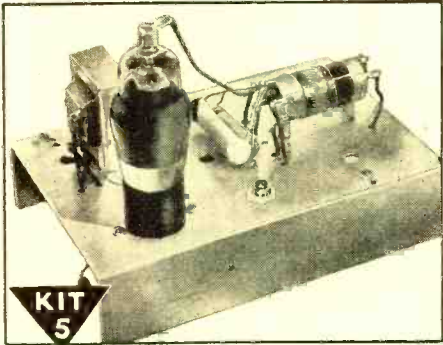

KIT 5

Building this A. M. Signal Generator gives you more valuable experience. It provides amplitude-modulated signals for many tests and experiments.



KIT 6

You build this Superheterodyne Receiver which brings in local and distant stations—and gives you more experience to help you win success in Radio.

I Will Train You at Home - SAMPLE LESSON FREE

Do you want a good-pay job in Radio—or your own money-making Radio Shop? Mail Coupon for a FREE Sample Lesson and my FREE 64-page book, "How to Be a Success in RADIO—Television, Electronics." See how N. R. I. gives you practical Radio experience at home—building, testing, repairing Radios with BIG KITS OF PARTS I send!

Future for Trained Men Is Bright in Radio, Television, Electronics
It's probably easier to get started in Radio now than ever before because the Radio Repair business is booming. Trained Radio Technicians also find profitable opportunities in Police, Aviation, Marine Radio, Broadcasting, Radio Manufacturing, Public Address work. Think of even greater opportunities as Television and Electronics become available to the public! Send for free books now!

Find Out What N. R. I. Can Do for You
Mail Coupon for Sample Lesson and my 64-page book. Read the details about my Course. Read letters from men I trained, telling what they are doing, earning. See how quickly, easily, you can get started. No obligation! Just MAIL COUPON NOW in an envelope or paste it on a penny postal. J. E. SMITH, President, Dept. 7HR, National Radio Institute, Pioneer Home Study Radio School, Washington 9, D. C.

Our 33rd Year of Training Men for Success in Radio

Many Beginners Soon Make Good Extra Money in Spare Time While Learning

The day you enroll I start sending EXTRA MONEY manuals. You LEARN Radio principles from my easy-to-grasp, illustrated lessons—PRACTICE what you learn with parts I send—USE your knowledge to make EXTRA money fixing neighbors' Radios in spare time while still learning! From here it's a short step to your own full-time Radio Shop or a good Radio job!

My training includes TELEVISION • ELECTRONICS • F M

Good for Both - FREE

Mr. J. E. SMITH, President, Dept. 7HR, National Radio Institute, Washington 9, D. C.
Mail me FREE, without obligation, Sample Lesson and 64-page book about how to win success in Radio—Television, Electronics. (No salesman will call. Please write plainly.)

Name.....
Address.....
City..... State.....
(Please include Post Office zone number)



VETERANS
You can get this training right in your own home under G. I. Bill.
Mail coupon for full details.

APPROVED FOR TRAINING UNDER GI BILL

Editor
OLIVER READ, W9ETI
Managing Editor
WM. A. STOCKLIN
Technical Editor
H. S. RENNE, EX-W8PTS
Associate Editors
RAY FRANK, W9JU
PAUL WENDEL
FRED HAMLIN
GAITHER LITTRELL
P. B. HOEFER
C. M. SULLIVAN
Staff Photographers
ARTHUR E. HAUG
WALTER STEINHARD
Staff Artist
R. S. KUPJACK

Advertising Manager
L. L. OSTEN
Midwestern Advertising Manager
JOHN A. RONAN, JR.

Art Director
HERMAN R. BOLLIN

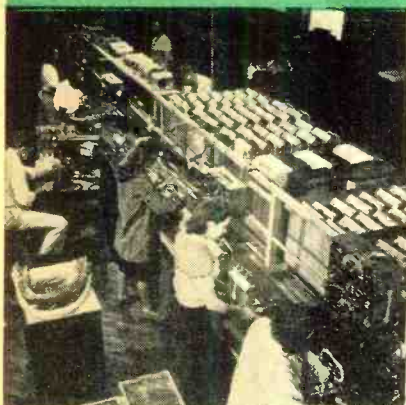

THE COVER: This Templetone Radio Mfg. Corporation assembly line is typical of the activity in radio plants throughout the country. Home receiver production has now reached an all-time high for the industry. Photo by Walter Steinhard.

Chairman of the Board and Publisher
WILLIAM B. ZIFF

President
B. G. DAVIS

Secretary-Treasurer
ARTHUR T. PULLEN

Vice-Presidents
GEORGE BERNER
Advertising and Sales Director

MICHAEL H. FROELICH
Editorial Director

H. J. MORGANROTH
Production Director

H. G. STRONG
Circulation Director

BRANCH OFFICES

NEW YORK (1)
 Empire State Bldg., W1 7-0400

Manager, Eastern Division
CHARLES R. TIGHE

LOS ANGELES (14)
 815 S. Hill St., TUCKER 9213

Manager, Western Division
WILLIAM L. PINNEY

WASHINGTON (4)
 International Bldg., EXecutive 2502

TORONTO
 21 King Street, East

ASSOCIATED COMPANIES
 Ziff Davis, Ltd., Grampians Bldg.
 Western Gate, London W. 6, England
 Ziff-Davis-Patel, Ltd.
 190 Hornby Road, Bombay, India

RADIO NEWS

First in radio-electronics

Average Paid Circulation over 135,000

Reg. U. S. Pat. Off.

AUGUST, 1947

FOR THE SERVICEMAN-DEALER

A Capacitance Test Bridge.....	John M. Heinrich	42
Every Home a Bonanza!.....	Dr. Louis Bader	49
Appliance Financing by Commercial Banks.....	Louis J. Asterita	50
You Pay Before You Play.....	A. E. Yohalem	56
Practical Transformer Design and Construction (Part 3).....	C. Roeschke	60
Visual Alignment of Television Receivers.....	M. H. Kronenberg	64

FOR THE AMATEUR

Antenna Loading Problems and Solutions.....	J. T. Goode	44
New 6-10-11 Meter Converter.....	Frank Lester, W2AMJ	51
An Inexpensive 18-db. Preselector.....	T. J. Dodge	61
A 3-Element Rotary Beam.....	H. E. Schwartz, Jr., W2NUD	62

OF GENERAL INTEREST

Robot Telephone.....	Leon Laden	39
Build Your Own Television Receiver.....	Leon S. Wecker and Tom Gootée	45
A Two-Tube Intercom.....	E. Bruce Pray	54
The Recording and Reproduction of Sound (Part 6).....	Oliver Read	57

DEPARTMENTS

For the Record.....	The Editor	8	RN Circuit Page.....	72
Spot Radio News.....	Fred Hamlin	16	What's New in Radio.....	74
Within the Industry.....		28	For the Experimenter.....	78
Short-Wave.....	K. R. Boord	66	Technical Books	106
Manufacturers' Literature			154	



COPYRIGHT 1947
 ZIFF-DAVIS PUBLISHING COMPANY
 185 North Wabash Ave., Chicago 1, Ill.
 VOLUME 38 • NUMBER 2



RADIO NEWS is published monthly by the Ziff-Davis Publishing Company, 185 N. Wabash Ave., Chicago 1, Ill. Subscription Rates: in U. S. and Canada \$4.00 (12 issues), single copies 35 cents; in Mexico, South and Central America, and U.S. Possessions, \$4.00 (12 issues); in British Empire, \$5.00 (12 issues)—all other foreign countries \$5.00 (12 issues). Subscribers should allow at least 2 weeks for change of address. All communications about subscriptions should be addressed to: Director of Circulation, 185 N. Wabash Ave., Chicago 1, Ill. Entered as second class matter March 9, 1938, at the Post Office, Chicago, Illinois, under the Act of March 3, 1879. Entered as second class matter at the Post Office Dept., Ottawa, Canada. Contributors should retain a copy of contributions and include return postage. Contributions will be handled with reasonable care but this magazine assumes no responsibility for their safety. Accepted material is subject to whatever revisions and by-line changes that are necessary. Payment made at our current rates, covers all authors', contributors', or contestants' rights, title, and interest in and to accepted material, including photos and drawings.

RADIO NEWS

Presenting the **NEW MODEL SX-43**

...to give amateurs:

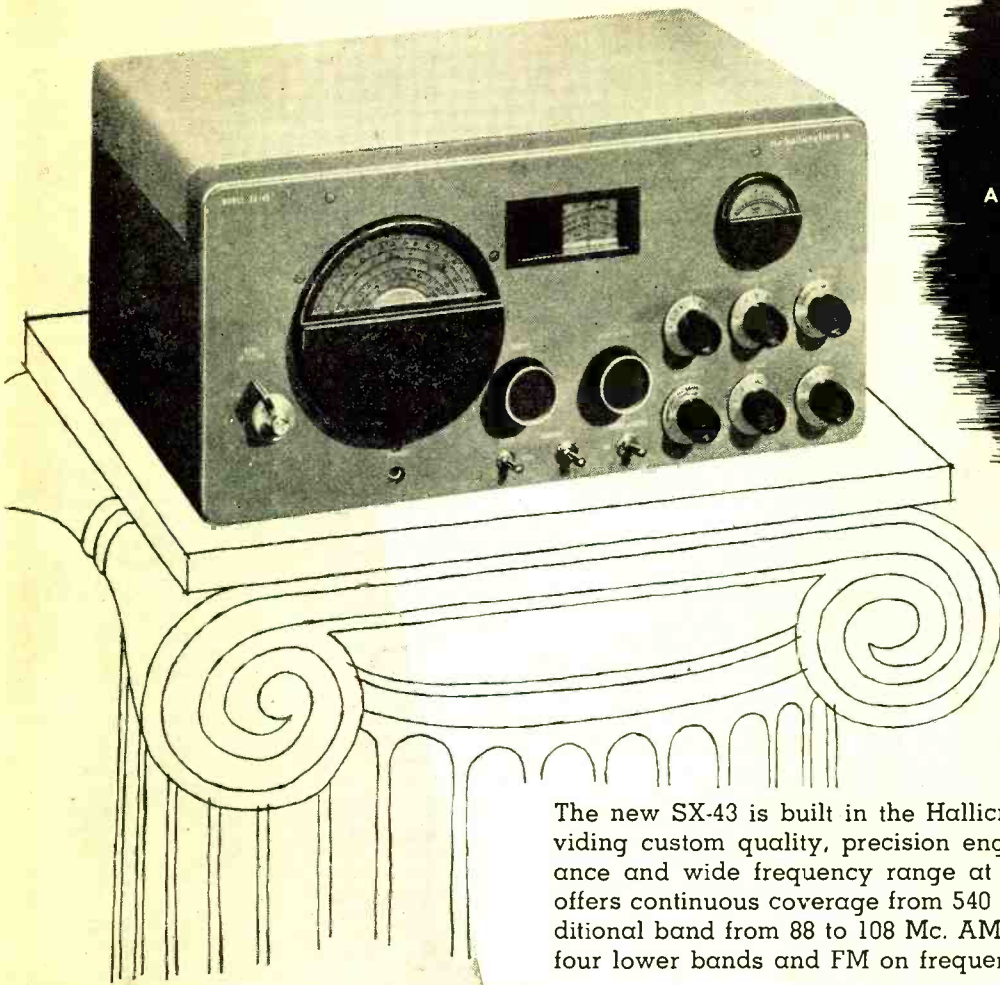

**MORE
VALUE**

Never before all these features at this price

**GREATER
PERFORMANCE**

AM-FM-CW . . . all essential amateur frequencies from 540 kc. to 108 Mc.

LOWER PRICE

\$169⁵⁰

Sets available after August 1947

**Built in the
Hallicrafters
Classic
Tradition**

The new SX-43 is built in the Hallicrafters classic tradition: providing custom quality, precision engineering, excellent performance and wide frequency range at a medium price. The SX-43 offers continuous coverage from 540 kc. to 55 Mc. and has an additional band from 88 to 108 Mc. AM reception all bands. CW on four lower bands and FM on frequencies above 44 Mc.

New **LOW PRICE** Transmitter



\$69⁵⁰

**MODEL
HT-17**

- Ham bands from 3.5 to 30 Mc.
- 15 watts power output on low frequency bands.

Here's real Hallicrafters transmitter performance with maximum convenience and economy. A pi-section matching network, as well as a link, provides coupling to any type of antenna or permits the HT-17 to be used as an exciter for a high power final amplifier. Coil sets extra.

Added technical details on all these models in Hallicrafters New Catalog, No. 38. Ask your local distributor for a copy.

NEW BETTER QUALITY AM WITH NARROW BAND FM

Exclusively designed - **VARIABLE
MASTER OSCILLATOR \$110.00**
(amateur net)

Here is the hottest transmitter item available today. Packed with outstanding features never before available in one low-priced unit. Add to the HT-18 one or two amplifier stages and you have a complete, high quality transmitter permitting operation on phone or CW up to 1 KW.

MODEL HT-18



Narrow band FM . . . direct frequency calibration . . . finger-tip control of entire station . . . full frequency deviation on all ham bands to 29.7 Mc. . . only 1/10 the distortion of comparable units . . . excellent stability . . . clean keying . . .

BUILDERS OF *Skyphone* AVIATION RADIOTELEPHONE

hallicrafters RADIO

THE HALLICTRAFTERS CO., MANUFACTURERS OF RADIO AND ELECTRONIC EQUIPMENT, CHICAGO 16, U. S. A.

Sole Hallicrafters Representatives in Canada:
Rogers Majestic Limited, Toronto-Montreal

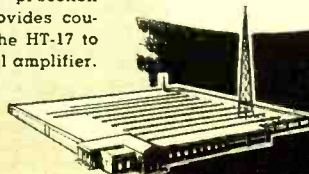

**"I find by comparison
there is no comparison—**

**PHOTOFACT^{*} is
by far superior
in all ways"**

—E. S. Worthington, Jr.
Maplewood, Missouri
(In Radio Servicing Since 1929)

Hundreds of OLD TIME Radio Service Men have made the same comparison, and like Mr. Worthington they've found helpful, time saving, profit making, exclusive advantages in PHOTOFACT that no other service can provide.

It's like trying to compare an encyclopedia with a dictionary.
Make the test for yourself.

**You'll find these EXCLUSIVE
PHOTOFACT ADVANTAGES**

● **MOST ACCURATE**

Based on study of the actual equipment in our own laboratories.

● **MOST COMPLETE**

Gives you all the data you need.

● **MOST UNIFORM**

Data is always in the same place—easiest for fast reference.

● **DIAL CORD DRAWINGS**

For EVERY receiver.

● **PRODUCTION CHANGES**

The only service that is always up-to-date.

● **CODED SCHEMATICS**

For every receiver, keyed to complete parts lists and photographs.

● **PHOTOGRAPHS**

Top—bottom and other views of EVERY instrument—LARGE—CLEAR with each part coded.

*Reg. U. S. Pat. Off.



Ask to see PHOTOFACT VOLUMES I and II. Notice these points. The same complete data always in the same easy-to-find location! BIG, CLEAR, ACCURATE PICTURES—each with its simple coding system—keyed for instant reference to complete parts lists. Full alignment and circuit data! DISASSEMBLY INSTRUCTIONS! DIAL CORD DRAW-

INGS! And even RECORD CHANGERS are completely diagrammed.

Put any other service beside PHOTOFACT and compare. Use PHOTOFACTS once—you'll use them forever.

Individual Set #21—available July 15 at the same low cost of \$1.50. Order Volumes I and II and the current set from your nearest distributor, or mail directly to us.

**COMPARE . . . and You'll Buy PHOTOFACT
HOWARD W. SAMS & CO., INC.**

INDIANAPOLIS 6, INDIANA

Export—Ad. Auriema—89 Broad St., New York 4, N. Y.—U. S. of America
Canada—A. C. Simmonds & Sons, 301 King St. East—Toronto, Ontario

PHOTOFACT SERVICE

"The Service that pays for itself over and over again"

HOWARD W. SAMS & CO., INC.

Indianapolis 6, Indiana

My (check) (money order) is enclosed.

Send _____

Name _____

Address _____

City _____ State _____

PHOTOFACTS are based on OUR actual study of the equipment covered. We ORIGINATE information—WE DO NOT COPY IT. Every fact is quadruple checked for accuracy. NO OTHER SERVICE COMPARES WITH PHOTOFACT.

PHOTOFACT VOLUMES I and II—the first 20 sets of PHOTOFACT Folders—are now available. Think of it! Almost 3800 pages, covering approximately 1800 NEW 1946 and 1947 models and chassis designations—yours for only \$18.39 for each volume. If you prefer drawer filing, order any or all of the 20 individual sets of folders at \$1.50 per set. Less than two cents a model brings you this complete, up-to-the-minute service.



RADIO NEWS



NOW! An Amazing Opportunity to LEARN RADIO AT HOME

I SEND YOU 8 BIG KITS OF RADIO PARTS

Including a **COMPLETE 6 TUBE SUPER-METERODYNE RECEIVER**

I TRAIN YOU RIGHT by PUTTING YOU TO WORK with REAL PROFESSIONAL EQUIPMENT!

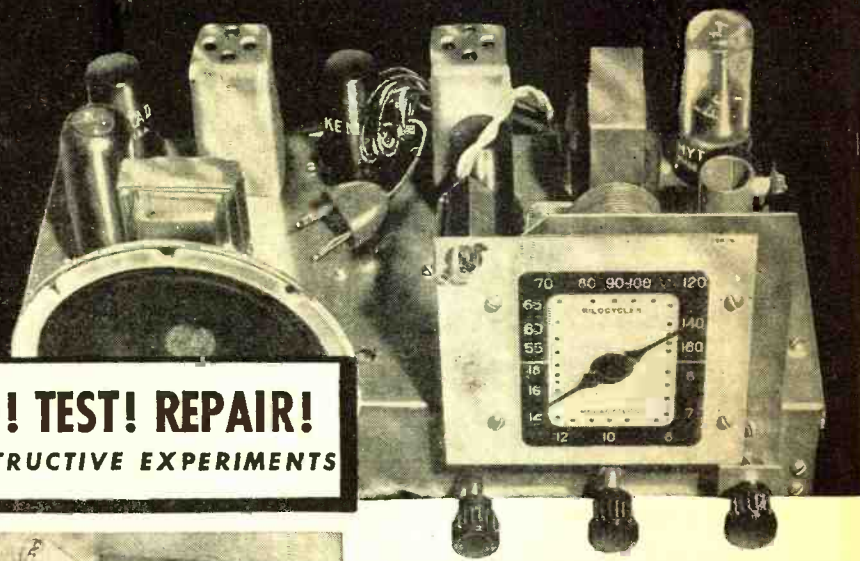

LEARN HOW TO BUILD CIRCUITS! TEST! REPAIR!
YOU DO OVER 175 INSTRUCTIVE EXPERIMENTS



YOU BUILD THIS USEFUL TEST EQUIPMENT!



I give you a fine, moving-coil type Meter Instrument on Jewel Bearings — with parts for a complete Analyzer Circuit Continuity Tester. You learn how to check and correct Receiver defects with professional accuracy and speed.

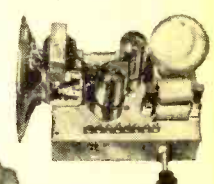

Soldering, wiring, connecting Radio parts . . . Building circuits — you can't beat this method of learning. When you construct this Rectifier and Filter, Resistor and Condenser Tester, etc., you get a really practical slant on Radio.

HERE'S THE EASIEST, MOST PRACTICAL WAY OF ALL TO PREPARE FOR GOOD PAY in RADIO ELECTRONICS and TELEVISION!

I train your mind by putting you to work with your hands on a big 6-Tube Superheterodyne Receiver. And, believe me, when you get busy with real Radio Parts — 8 big Kits of them — you really LEARN Radio and learn it RIGHT! You get the practical stuff you need to be useful in Radio, and that's what it takes to make money. You don't have to worry about what to do with these 8 Kits of Parts. Step by step, I show you how to build circuits, test, experiment, trouble-shoot. And you don't need any previous experience. The Sprayberry Course starts right at the beginning of Radio! You can't get lost! Simplified lessons, coupled with real "Shop" practice, makes every subject plain and easy to understand and remember. Soon after you begin Sprayberry Training, I'll send you my sensational BUSINESS BUILDERS.

A BUSINESS OF YOUR OWN . . . OR A GOOD RADIO JOB
You'll find out how to get and do neighborhood Radio repair jobs for nice profits and rich experience while learning. This sort of work can easily pave the way for a Radio Service business of your own. But with Sprayberry Training, you're not limited. You can swing into any one of the swiftly expanding branches of Radio-Electronics INCLUDING Radio, Television, FM, Radar, Industrial Electronics. Be wise! Decide now to become a fully qualified RADIO - ELECTRONICIAN. Get full details about my Training at once! Mail coupon below for my 2 big FREE Books.

GET THESE VALUABLE FREE BOOKS

"How to Read Radio Diagrams and Symbols"

Here's a valuable and wonderfully complete new book which explains in simple English how to read and understand any Radio Set Diagram. Includes translation of all Radio symbols. Send for this volume at once. It's free! Along with it, I will send you another Big Free book describing in detail my Radio-Electronic Training.



You'll get valuable experience and practice building this Signal Generator and multi-purpose Tester. Makes a breeze out of fixing Radios and you don't have to spend money on outside, ready-made equipment.

RUSH COUPON!

SPRAYBERRY ACADEMY OF RADIO
F. L. Sprayberry, President, Room 2587, Pueblo, Colorado
Please rush my FREE copies of "How to MAKE MONEY in RADIO, ELECTRONICS and TELEVISION," and "HOW to READ RADIO DIAGRAMS and SYMBOLS."

Name Age

Address

City State

(Mail in envelope or paste on penny postcard)

TRANSVISION

TELEVISION KIT BASIC COMPONENTS

Transvision now offers the following basic components for use in building your own high quality television receiver:

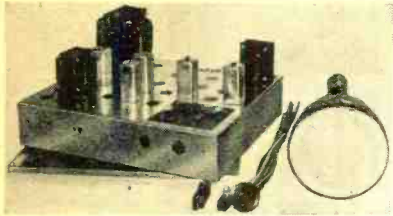

(1) **Transvision Television Chassis.** Heavy duty, cadmium plated, completely punched for 17 tubes, and all other parts. Size 17" long x 15" deep x 3½" high. With bottom plate and safety interlock switch. Schematic diagram included. Net. \$7.95

(2) **Transvision R.F. Unit.** Completely wired and factory tuned for 3 channels, with provision for extra channels. Net \$22.90



(3) **Transvision Coil Kit—I.F. Transformers and Peaking Coils (FM Sound).** Includes 4 video I.F. transformers; 1 sound I.F. detector; 1—250 mh peaking coil; 2—125 mh peaking coils and 1—35 mh peaking coil. Picture resolution 3.5 mc (bandwidth). Will operate any size picture tube from 7 inches to 20 inches with maximum definition. Fixed tuned, with channel and sound traps included, as well as coupling and loading net works all in shielded coil cans. Designed for use with 3—6AC7 picture I.F. stages and 6H6 detector. Picture I.F. frequency 26.4 mc; sound I.F. carrier 21.9 mc. Complete Kit, 9 coils. Net \$10.75

(4) **Transvision Low Voltage Transformer** with four secondary windings. Net \$9.95

(5) **Transvision High Voltage Transformer.** Primary 117V-60 cycles, secondary No. 1 1700V at 4MA. Secondary No. 2 2.5V at 2 AMPS, 5000 volt insulation. Especially designed to provide 270C volts DC at second anode of Cathode Ray Tube when using Transvision circuit. Net \$6.30

(6) **Transvision Filter Choke.** 20 henrys, 30 MA, 2000 volt insulation. Net \$1.40

(7) **Transvision Filter Choke.** 10 henrys, 175 MA, 2000 volt insulation. Net \$3.50

(8) **Transvision Front Panel** for 7" Cathode Ray Tube. Rubbed wood finish. Drilled for Transvision chassis. Size 17¼" wide x 17½" high. Net \$2.95

(9) **Transvision Cabinet.** Rubbed wood furniture finish. With mounting blocks for 7" tube. Completely drilled. Control decals are included. Individually boxed, ready for shipment. Net \$29.95

(10) **Lectrovision Type 7EP4—7" Cathode Ray Tube.** Electrostatic focus and deflection, black and white color, operates up to 3000 volts on second anode. Net \$23.00

(11) **Transvision Complete Manual of Instructions.** Anyone can easily follow these instructions for building the Transvision Television Kit. Included are schematic diagram, layout diagram, full set of photographs and bill of materials. No technical knowledge whatsoever required. Net \$1.25

See your local distributor, or for further information write to:

TRANSVISION, INC. Dept. R.N.
385 North Ave., New Rochelle, N.Y.

For the RECORD.

BY THE EDITOR

AS WE write this we are on our way back from a circle tour to the West Coast covering, to date, a total of 5000 miles. This trip had a twofold purpose; to contact the members of the radio industry in the various fields, and to conduct tests to determine the effectiveness of narrow-band FM for amateur mobile operation.

Prior to leaving Chicago, the car was equipped with a 28 mc. FM transmitter constructed in the RADIO NEWS lab. In order to make the signal easily readable on the average communications receiver, the total deviation was kept to a maximum of 1200 cycles either side of the center frequency. This corresponds to a deviation ratio of 0.4.

Normal practice in narrow-band FM work is to use a deviation ratio considerably greater than this, usually something over 1. While there are some advantages to a larger deviation ratio, most communications receivers are not capable of accepting a total deviation of more than 4 kc.

The power input to the transmitter was 31 watts, supplied by a surplus dynamotor, mounted in the trunk. Measured output was 22.5 watts, fed to a quarter-wave antenna.

The regular auto radio was used for reception, in conjunction with a converter. Little time was available to work on the car noise, but a series type noise limiter was added to the receiver, and a tuned filter placed in the generator lead.

Time did not permit extensive tests before leaving Chicago, and only a few locals were contacted. It was fully realized that conditions during the summer months were very poor for 28 mc. operation, however, in the West Coast cities, there is a great deal of mobile operation, and this activity is rapidly spreading to other parts of the country.

The home station was equipped with a 100 watt transmitter and the latest in receivers. A three elements fixed beam was mounted on the roof and oriented so the maximum signal was to the west.

Schedules were worked out on the basis of the predictions prepared monthly by the Bureau of Standards. The predictions did not offer much encouragement for contact with the home station, but as the 28 mc. band is not too consistent it was hoped that occasional sporadic openings would permit contact from time to time.

At the time of writing, no contacts have been made with the home station. This in itself is of no impor-

tance as no form of transmission, FM or AM, can work when conditions are not right.

Local contacts have been more than satisfactory when the operator on the receiving end tuned his receiver properly. It is surprising how many amateurs do not know how to properly tune an FM station on an AM receiver.

In the process of tuning many narrow-band FM stations, it was found that the best results were obtained by turning off the a.v.c. of the receiver and tuning slightly to the side of the carrier. If the a.v.c. is left on, the gain of the receiver tends to increase as the receiver is detuned from resonance, with the result that the signal is often lost in the resultant noise.

The best answer, of course, is the use of receivers specifically designed for narrow-band FM reception. None of the receivers currently available to the amateur make provision for narrow-band FM reception, although it is our understanding that at least one manufacturer has seen this need and is planning production of a receiver with this provision.

While the results so far have been inconclusive, we feel that narrow-band FM will eventually replace AM for all mobile work. The audio power required is negligible with the result that the power input may be much greater for the same battery drain. The tubes will have greater life as the modulation peaks are missing, with the possibility of running the tubes at their c.w. ratings.

Another great advantage to FM is the improvement in signal-to-noise ratio, permitting the reception of FM signals that would be unreadable on AM. Reduction in interference will also result if the deviation ratio is kept less than 1. The amount of space occupied by a signal modulated by any given audio frequency, is in direct proportion to the deviation, and if this ratio is kept to low values, it is possible for an FM signal to take up considerably less space in the spectrum than the equivalent AM station. Needless to say, this will permit the operation of many more stations in the same band.

If a receiver is used that is specifically designed for FM reception, interference from AM signals is reduced or eliminated. This feature is of particular value in mobile work where the noise level is exceedingly high. This noise, being of the amplitude type, is absent in a good FM receiver. O. R.



With a Modern Communications Receiver!

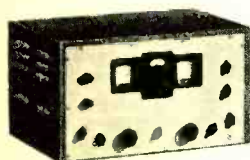

HAMMARLUND HQ-129X
NET, with speaker, \$173.25



HALLICRAFTERS SX-42
NET, less speaker, \$275.00



NATIONAL NC-2-40D
NET, less speaker, \$225.00



NATIONAL NC-173
NET, with speaker, \$189.50



RME-45
NET, with speaker, \$198.70

ALLIED has them all-- AVAILABLE FOR IMMEDIATE DELIVERY

World's Finest Communications Receivers

National NC-46 & Speaker.....	\$107.40
National HRO, less speaker.....	274.35
Hallicrafters S-38.....	47.50
Hallicrafters S-40A.....	89.50
Hammarlund SPC-400X & Speaker.	347.25
Collins 75A-1 Receiver.....	375.00
RME-84.....	98.70
RME VHF-152 Converter.....	86.60
RME DB-22 Preselector.....	60.00

Net F.O.B. Chicago. Prices subject to possible change

Radio reception that "reaches out" to the far places of the earth is no accident. It's the result of the skill of the ham or short wave listener—and the *quality of the equipment he uses*. ALLIED offers you the world's largest stocks of fine receivers and associated equipment, available for immediate delivery at the lowest prevailing prices. Everything you need in Radio is listed in ALLIED'S catalog—the largest and most complete in the field. And ALLIED specialists in every field of Radio and Electronics are prepared to serve you personally, to help you satisfy your needs better, faster and more economically.

Time Payments • Trade-Ins Accepted

ALLIED RADIO
Everything in Radio and Electronics

SEND FOR ALLIED'S 164-PAGE CATALOG
RADIO'S LEADING BUYING GUIDE

FREE



ALLIED RADIO CORP.
833 W. Jackson Blvd., Dept. 1-HH-7
Chicago 7, Illinois

Send FREE 1947 ALLIED CATALOG

Enter order for.....

Enclosed \$..... Full Payment
 Part Payment (Balance C.O.D.)

Send full information on Communications Receivers and Time Payment Plan, without obligation.

Name.....*

Address.....

City..... Zone..... State.....

ENGINEERING...



SERVICING...

is easier with SNC quality transformers

Here's Why!

Comprehensive research done by SNC in the field of transformer requirements has produced a line outstanding for its sturdy quality, superior design, simplicity and wide range of usefulness.

Both engineers and servicemen, particularly those in the radio field, find their work made easier due to the absence of duplication or overlap in SNC transformer specifications. And balanced design, skilled workmanship, and finest materials practically eliminate the problem of rejects.

It will pay you to investigate SNC! Write for free catalog, today.

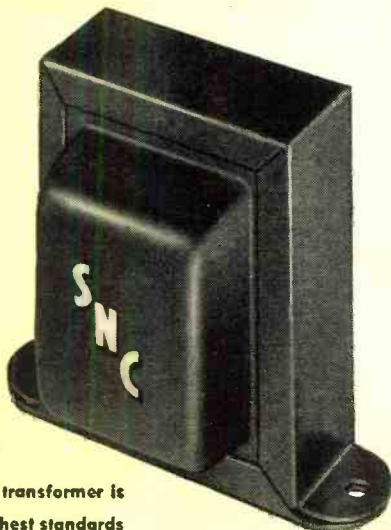

Every SNC transformer is built to highest standards for finest performance.

Remember! SNC gives MORE applications with SMALLER inventories for GREATER profits!

SNC MANUFACTURING CO., INC.
Quality Transformers
WEST LAKE AVE. NEAR LEHIGH • GLENVIEW, ILLINOIS

Snap-on Basic ELECTRONIC CONTROL SERVICE TOOL KIT

▶ . . . cuts "down-time" to a minimum
▶ . . . speeds maintenance . . . because
▶ you always have the right tool
▶ at the right time



▶ A made-to-order, "tested-on-the-job" kit to service
▶ Electronic Controls, Panels, Relays . . . Heat Control
▶ Panels . . . Spot Welding Timers . . . Small
▶ Hoist Controls . . . and Welding Machine Starters.

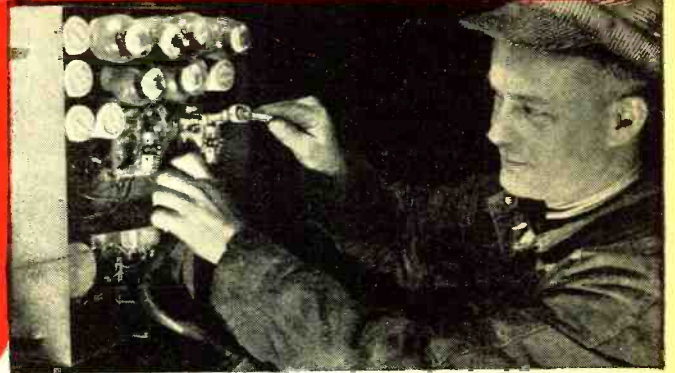

This complete 51-pc. kit
with Handy Hold-all Box
for only

\$48.47

Actually tested in the shops where "down-time" must be held at an absolute minimum, this kit has proved its value over and over again. It contains all the basic tools you will need . . . and they're Snap-on tools, built and sized to precision tolerances with the *feel* and *balance* that gives you fast nut-turning efficiency. Check the complete list at the right . . . tear out coupon and mail today.

SNAP-ON TOOLS CORPORATION
8120-H 28th AVENUE • KENOSHA, WISCONSIN
International Division: Kenosha, Wisconsin, U. S. A.

- 1 Midget Set 1/4" drive
- Including . . . Ratchet, Sliding Tee
- Nut Spinner, Flextation
- Plastic Grip Handle
- Universal Joint
- 2" and 6" extension
- 8 Hex. Sockets 3/16" to 7/16"
- 8 Deep Hex. Sockets 3/16" to 7/16"
- 3 Square Sockets, 1/4", 5/16", 3/8"
- 4 Dwarf Boxsockets 7/16" to 3/4"
- 8 Ignition Wrenches 7/32" to 3/8"
- 1 9 1/4" Screw Starter
- Tungsten Ignition File
- 6" Mill Bastard File
- 5" Gripper Pliers

- 6" Diag. Cutter Pliers
- 6" Needle Nose Pliers
- 3 Screw Drivers
- 4" Offset, 1 1/2" and
- 2 1/2" Stubby,
- plus a 3" and 4" blade.
- 1 Red Hold-all Box

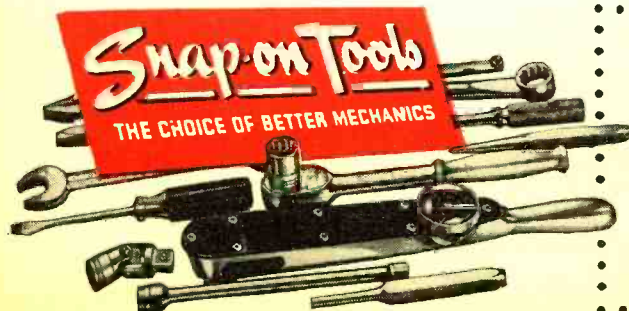
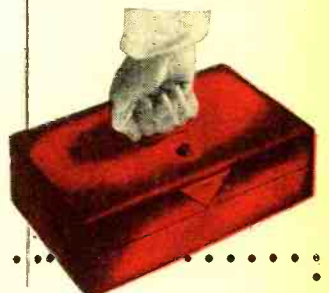

Please send me the \$48.47 Electronic Control Service Kit, No. TM-151.
I am enclosing . . .

Check Money Order Company Purchase Order

Name.....

Company.....

Address.....

City..... (Zone) State.....

DAVEGA COMMUNICATIONS DIVISION

For your hallicrafters "the radio man's radio"

**REMEMBERED BY THE VETERAN
PREFERRED BY THE RADIO AMATEUR**



Radio amateurs, those exacting pioneers of the air waves, short wave listeners and radio hobbyists will find endless possibilities in the far-reaching performance of Hallicrafters Communications equipment. Simplicity of design and easy operation make them appealing to all others. The basic qualities and precise engineering that go into Hallicrafters circuits result in a much superior performance on regular broadcast reception and FM as well as short waves. Come in for a demonstration and see how simple it is to operate.



MODEL SX-42 A truly post war radio. Greatest continuous frequency coverage of any communication receiver—from 540 Kc to 110 Mc, in six bands. FM-AM-CW. 15 tubes... \$275



MODEL S-40A Overall frequency range from 540 Kc to 43 Mc in four bands. Nine tubes, built-in dynamic speaker... \$89.50



MODEL S-38 Overall frequency range from 540 Kc to 32 Mc in four bands. Compact and rugged. AC-DC. Built-in speaker... \$47.50



3 GREAT RECEIVERS AVAILABLE NOW!

DAVEGA

MAIL COUPON FOR DESCRIPTION LITERATURE

NEW YORK
Downtown.....63 Cortlandt Street
Hotel Commodore...111 East 42nd St.
Times Square.....152 W. 42nd Street

NEW JERSEY
Newark.....60 Park Place
Jersey City.....30 Journal Sq.
Paterson.....185 Main Street

LONG ISLAND
Jamaica.....163-24 Jamaica Ave.
Flushing.....39-11 Main Street
Hempstead.....45 Main Street

WESTCHESTER
White Plains.....175 Main Street

DAVEGA COMMUNICATIONS DIVISION
63 Cortlandt Street, New York 7, N. Y.

Please send full information on Communication Receivers, without obligation.

NAME

ADDRESS

CITY

RN-4

Here's Why Your Antenna Installations Will Give

LONGER-LASTING PERFORMANCE

with Federal's



H-F Transmission Lines

1. Their unusually low attenuation losses assure the most efficient transfer of energy between antenna and receiver or transmitter.
2. Their uniformity and permanence of characteristics permit peak receiver performance, without annoying distortion from locally-induced interference.
3. Their flexibility and outstanding resistance to weathering, moisture and abrasion contribute to years of trouble-free service.

IN THE FIVE ITEMS listed here, there's a high-frequency cable for practically every antenna application. The K-1128 75-ohm line, for transmitter use—the K-1079 and K-1046 lines for general FM and Television service. The smooth oval cross-section of these 75, 100, and 300-ohm lines prevents the accumulation of foreign matter, thereby maintaining stable capacity characteristics. The K-32 and KT-51 coaxial cables offer peak performance for applications where locally-induced interference is severe.

For complete information and prices on these cables, see your local distributor. For other high-frequency cables—write to Federal, Dept. D-159.

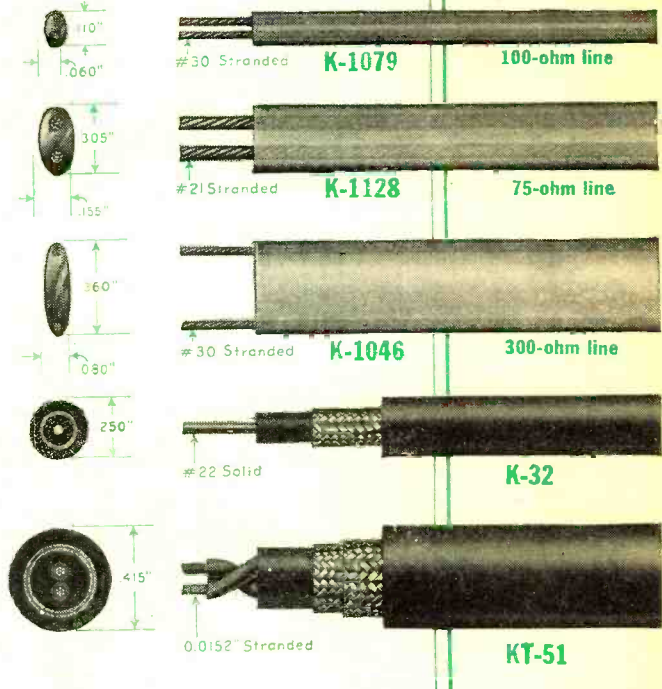

DATA FOR FEDERAL H-F CABLES								
Type Number	Characteristic Impedance Ohms	Velocity of Propagation (in percent)	Capacitance Per Ft. mmf	Attenuation, Db per 100 Ft. Frequency in Megacycles				
				1.0	1.7	30	100	300
K-1079	100	71	15.5	.6	.75	2.8	5.2	8.8
K-1128	75	71	19.5	.3	.4	2.0	4.0	7.3
K-1046	300	300	4.0	.38	.57	.85	2.0	—
K-32	73	66	22	—	—	2.0	3.8	7.0
KT-51	95	56	16	—	—	1.8	3.8	7.5

*Reg. U. S. Pat. Off.



Federal Telephone and Radio Corporation

SELENIUM and INTELIN DIVISION, 1000 Passaic Ave., East Newark, New Jersey

In Canada: — Federal Electric Manufacturing Company, Ltd., Montreal.
Export Distributors: — International Standard Electric Corp., 67 Broad St., N. Y. C.

KEEPING FEDERAL YEARS AHEAD... is IT&T's world wide research and engineering organization, of which the Federal Telecommunication Laboratories, Nutley, N. J., is a unit.

YOU BE THE JUDGE!

➔ See for yourself why BC "Hi-Kap" Capacitors, feature for feature . . . are your best buy for **QUALITY!**

➔ See for yourself why BC "Hi-Kap" Capacitors, feature for feature . . . are your best buy for **PRICE!**



◀ SEE
**THIS DISPLAY
AT YOUR
CENTRALAB
DISTRIBUTOR**

SEE THESE
**"HI-KAP" VALUES
AND PRICES** ➔

PART NUMBER	VALUE (MFD.)	LIST PRICE*
D6-500	.000050	\$1.25*
D6-101	.000100	1.25*
D6-151	.000150	1.25*
D6-251	.000250	1.25*
D6-501	.000500	1.25*
D6-751	.000750	1.25*
D6-102	.001000	1.25*
D6-202	.002000	1.25*
D6-502	.005000	1.50*
D6-103	.010000	1.50*

*PER ENVELOPE OF 5
Rating: 600 WVDC — 1000 V. flash tested. Individually color coded, inspected and insulated.

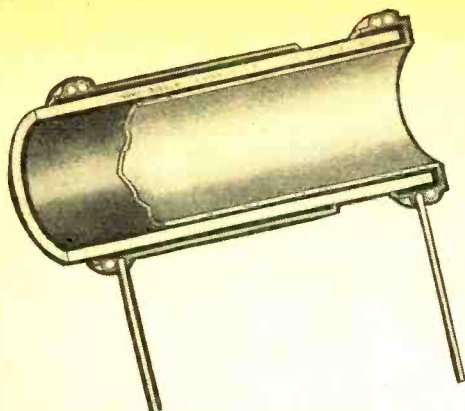

➔ *Never before has the dependability, permanence and convenience of ceramic by-pass and coupling capacitors been offered to Radio Service Dealers at a favorable price!*

"HI-KAP" FEATURES	DESCRIPTION			ADVANTAGES
1. Impervious to moisture	Ceramic-X is non-hygroscopic. Moisture absorption is .007% or less.			No deterioration, no shorting. Longer life even under the most adverse conditions.
2. Low mass weight	Av. Wt.	Dimensions	Values	For unit size and weight, Centralab BC "Hi-Kaps", made with Ceramic-X, are the only capacitors on the market which provide these voltage ratings.
3. Small size	.029 oz.	D—.315" L—.540"	.00005— .00025 mfd.	
4. High capacity	.044 oz.	D—.315" L—.830"	.0005 mfd.	
5. Special insulation	.050 oz.	D—.340" L—1"	.000750— .005 mfd.	
6. Convenient side leads	.082 oz. D—.400" L—1.305" Rating: 600 WVDC — 1000 VDC flash test.			Prevents any possibility of shorting to adjacent leads, chassis or components.
7. Low power factor	Wax impregnated, lacquered, dipped in special phenolic resin, cured and wax impregnated.			Permit rapid, close-coupled connections. No tricky bending or fitting required.
8. High leakage resistance	Heavy #22 gauge tinned copper.			More efficient circuit operation, fewer failures.
9. Maximum dependability	Initial — .6%. After 100 hours, 95% humidity test — 3.0%.			Long life, more efficient performance.
10. Factory tested	Initial — 5000 megohms. After humidity — 500 megohms.			Will not short or become intermittent.
	One-piece construction. Leads soldered directly to electrodes.			Your guarantee to your customers of reliable service and performance.
	For your protection, all units 100% factory tested before packaging and shipping.			

➔ *See your Centralab Distributor for complete information on this new line of ceramic by-pass and coupling capacitors, or write direct to*

Centralab

DIVISION OF GLOBE-UNION INC., MILWAUKEE, WIS.

The **LITTLE** differences

make the

BIG

DIFFERENCE

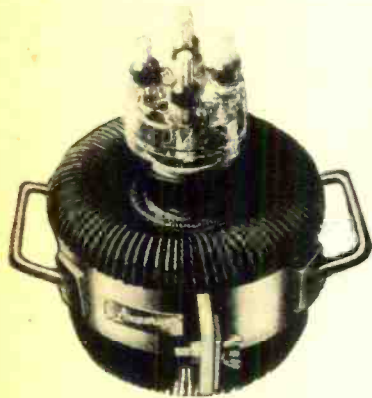
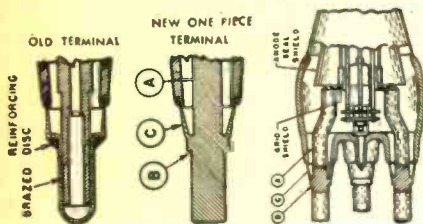

Though all transmitting tubes may look alike, the little "extras" are the things that distinguish Amperex tubes. For example, one of these "differences" is the one-piece contact pin and grid and filament support used in the Amperex 889R-A. Made of pure, oxygen-free, non-magnetic copper, this support is a complete unit by itself.

This new Amperex structure is stronger... **much stronger!** Where the old pins could be distorted by side pressure, the new ones resist that pressure up to the breaking point of the glass.

In addition, the one-piece design has enabled us to relocate and redesign the anode and grid shields, thus reducing glass heating and resultant punctures. It will pay you well to...

Re-tube With Amperex

AMPEREX ELECTRONIC CORP.

25 WASHINGTON STREET, BROOKLYN 1, N. Y.

In Canada and Newfoundland: Rogers Majestic Limited
11-19 Brentcliffe Road, Leaside, Toronto, Ontario, Canada

Spot Radio News

★ Presenting latest information on the Radio Industry.

WITH THE RECENT Radio Manufacturers Association convention in Chicago now history, next big national appearance for which the entire industry is now pointing is National Radio Week, October 26-November 1. RMA will coordinate its activities with the National Association of Broadcasters, the Frequency Modulation Association, the Television Broadcasters Association and all other interested groups to make the week outstanding in radio annals. Emphasis will be given to the rapid growth in broadcasting facilities since the end of the war, especially in the FM field. Another point that will be emphasized: You can get a million dollars in radio entertainment for the price of a receiver. RMA is already busy preparing material for radio dealers and stations, with suggestions for cooperative local promotion programs. W. B. McGill of Westinghouse Radio Stations, Inc., Philadelphia, is chairman of RMA's committee on Radio Week. John M. Cutler, station WSB, Atlanta, is heading up the parallel committee with NAB.

THE RMA CHICAGO MEETING. incidentally, made history on a number of scores. The twenty-third, it was also the largest, brought out some thousands of the industry's leaders. Consensus was that more was accomplished at the intensive business sessions than ever before. And it was generally agreed that the banquet, addressed by Brig. Gen. David Sarnoff, president of the *Radio Corporation of America*, hit an all-time high... Credit for the success of the convention is shared by retiring RMA president R. C. Cosgrove and convention committee chairman Leslie F. Muter.

MAX F. BALCOM, Vice-President and Treasurer of *Sylvania Electric Products Inc.* was named President of the Radio Manufacturers Association for the coming year at the Chicago business session of the organization. He succeeds Ray C. Cosgrove of *Crosley* who completed his third term as RMA president.

Serving with Mr. Balcom will be R. E. Carlson, Vice-President, *Tung-Sol Lamp Works, Inc.* and W. J. Barkley, Executive Vice-President, *Collins Radio Company* as the newly elected Vice-Presidents. Paul V. Galvin, President, *Motorola, Inc.*; J. J. Kahn, Presi-

dent, *Standard Transformer Corp.*; and Allen Shoup, President, *Sound, Inc.* were reelected as RMA Vice-Presidents. Leslie F. Muter, President, *The Muter Company* was reelected Treasurer for his thirteenth year.

Four new RMA Directors and two new Division chairmen were elected by the respective RMA divisions. The new Directors are: H. L. Hoffman, President, *Hoffman Radio Corporation*, and Harry C. Sparks, President of the *Sparks-Withington Company*, representing the Set Division; E. N. Wendell, Executive Vice-President, *Federal Telephone & Radio Corporation*, and W. A. McDonald, President, *Hazeltine Electronics Corporation*, representing the Transmitter Division. The new Division Chairmen are E. E. Carlson for the Tube Division and F. D. Wilson, General Sales Manager, *Operadio Manufacturing Corporation*, for the Amplifier Division.

Directors reelected for three year terms include: Set Division, E. Alschuler, President, *Sentinel Radio Corporation*; G. M. Gardner, President, *Wells-Gardner*; Joseph Gerl, President, *Sonora Radio & Television Corporation*; Ray H. Manson, President, *Stromberg-Carlson Company*; and Harold C. Mattes, Executive Vice-President, *Belmont Radio Corporation*. Tube Division, E. E. Carlson, Vice-President, *Tung-Sol Lamp Works, Inc.*; Transmitter Division, H. J. Hoffman, Vice-President, *Machlett Laboratories, Inc.*; Ray F. Sparrow, Vice-President, *P. R. Mallory & Co., Inc.*; R. C. Sprague, President, *Sprague Electric Company*; and Allen Shoup, President, *Sound, Inc.*

Bond Geddes was renamed Executive Vice-President and Secretary of RMA and John W. Van Allen of Buffalo, New York was reappointed General Counsel.

GETTING BACK to Radio Week, the industry will not be alone in celebrating. Retailers, department stores, music and furniture stores will be among the many who will participate. Among those who have offered fullest cooperation are William A. Mills, executive secretary of the National Association of Music Merchants; James P. Oliver, of the National Retail Furniture Association, and Howard P. Abrahams, of the National Retail Dry Goods Association. All three associations are now working on plans to

RADIO NEWS

RADIO and ELECTRONICS offers YOU...

REAL MONEY, REAL JOB, AND REAL INDEPENDENCE

... FOLLOW THE ADVICE OF THE MASTERS

PREPARE *today* **SUCCEED** *tomorrow*

Make good money ... get a real job ... be independent by owning your own business ... follow the advice of the masters ... "PREPARE TODAY TO SUCCEED TOMORROW."

Whether you are an ex-G.I., a teen-age youth or an older man, few other fields offer you such a vast variety of opportunities for real money and a brighter future as the colorful, fascinating field of RADIO and ELECTRONICS.

Get Late Facts

Use the coupon below! Get the late facts about the exciting news in F.M. Radio, Broadcast Radio, Television, Electronics, Radar, 2-Way Train Radio, Sound Motion Picture Equipment, Sound Recording — and other fast-moving branches of this field.

15 Years Experience In Training Men

Also see how readily YOU can prepare to enter the field of Radio and Electronics by means of the remarkably effective courses and Employment Help of DeForest's Training, Inc. that have been getting results for over 15 years.

DeForest's Training, Inc. is the first school of its kind ever to receive the CERTIFICATE OF MERIT of the New York Museum of Science and Industry. It won this award for the efficiency and thoroughness of its courses.

Prepare now for a job in Radio, Electronics and Communications, by attending RESIDENT LABORATORY courses in Chicago, or in your spare time at home. DeForest's Training, Inc. offers you these 4 BIG HOME TRAINING ADVANTAGES:

- (1) We supply you with a 16 Mm. motion picture machine with 12 reels of fact-packed information;
- (2) Illustrated loose-leaf lessons with handy fold-out diagrams;
- (3) 8 big commercial-type Radio Electronic Kits of assemblies and parts, from which you may work out more than 133 modern experiments including 7 different types of radio receivers at home; and
- (4) After you complete your training, you get the benefit of our effective employment service.

YOU NEED NO PREVIOUS ELECTRICAL OR RADIO EXPERIENCE

If you prefer, you can get ALL of your Training in our—

NEW CHICAGO LABORATORIES

... offering you some of the finest Radio-Electronic Training Facilities in the nation. Enjoy many post-war training advantages in a modern, new building, housing a wealth of "LEARN-BY-DOING" Equipment. Visitors invited.



VETERANS!!

Both the Home Study and Chicago laboratory courses of DeForest's Training, Inc. are accepted for your training. If you qualify under the "G. I. Law," you can obtain this training without cost.

DeFOREST'S TRAINING, INC.

2533-41 N. ASHLAND AVE. CHICAGO, ILLINOIS

Affiliated with DeVry Corporation, Chicago

DeFOREST'S TRAINING, INC.
2533-41 N. Ashland Ave., Dept. R.N.—D 8
Chicago 14, Illinois, U.S.A.

Send me your big book "VICTORY FOR YOU", showing how I may make my start in Radio-Electronics with your modern home training plan. No obligation.

Name Age

Address Apt.

City Zone State

If under 16, check here If a discharged veteran of World War II, check here.



SPOT RADIO NEWS

furnish their members with promotion kits, posters, streamers and other material prepared by RMA and NAB.

WATCH FOR RADIO to go back to school in a big way when the fall semester begins. Straw-in-the-wind—and also history-making—is a report now being rushed for early fall publication giving basic standards for school sound recording and playback equipment. The report is the result of work by an RMA committee and the U.S. Office of Education. It will be published by RMA and will supplement the "School Sound Systems" brochure by RMA published last fall and widely distributed by the Office of Education. Previews of the report indicate that scores of devices developed during the war will be enlisted for educational purposes under expert guidance. Recording by engraved discs will be only one of the available methods. Magnetic wire and tape, and embossed tape and discs, not to mention photographic processes, will be covered in detail in the report, together with advice on operation and application to the educational field. The report will also summarize present thinking of foremost radio manufacturers and educators specializing in audio education. Expected to be the masterpiece in its field, credit for the report's creation goes to scores of experts in both the industry and in education. Among these are Lee McCanne of RMA and vice president of the *Stromberg-Carlson Co.*, Rochester, N. Y. Dr. R. R. Lowdermilk, radio education specialist of the Office of Education, and C. F. Gill, of RMA and the *General Electric Co.*, Syracuse, N. Y.

IN A STATEMENT made in Washington recently by Paul Mowrey, head of American Broadcasting Company's television activities, he told students at American University that job possibilities in television are "sensational." Best reason he gave was mathematical: It takes 77 persons to handle a television show which four or less could handle for radio. But don't plan to go to work tomorrow—Mowrey added that the television employment market would not boom in a big way for perhaps another eighteen months.

TELEVISION and a number of other radio services are suffering from acute growing pains concerning which much will be heard at the Federal Communications Commission for some time to come, if recent informal meetings at FCC are any indication. Current television troubles are three—the high cost of piping programs from one center to another, interference from local radio services in the same channels, and need for more channels.

HIGH INTERCITY TRANSMISSION costs were revealed publicly for the first time before FCC by the



INDEPENDENCE from transformer worries is also celebrated by users of Merit Transformers. Get the "Constitution" of Merit Transformers. The flag is Merit Quality.

EXPORT DEPARTMENT:

1607 Howard Street, CHICAGO 26, U. S. A.
Cable Address: MERIT

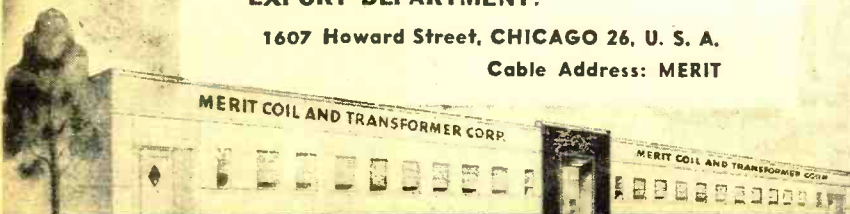

MERIT COIL & TRANSFORMER CORP.

TELEPHONE

4427 North Clark St. Long Beach 6311 CHICAGO 40, ILL.

**W.J. COUCH & CO.
RADIO**

A SIGN OF SUCCESSFUL SERVICING

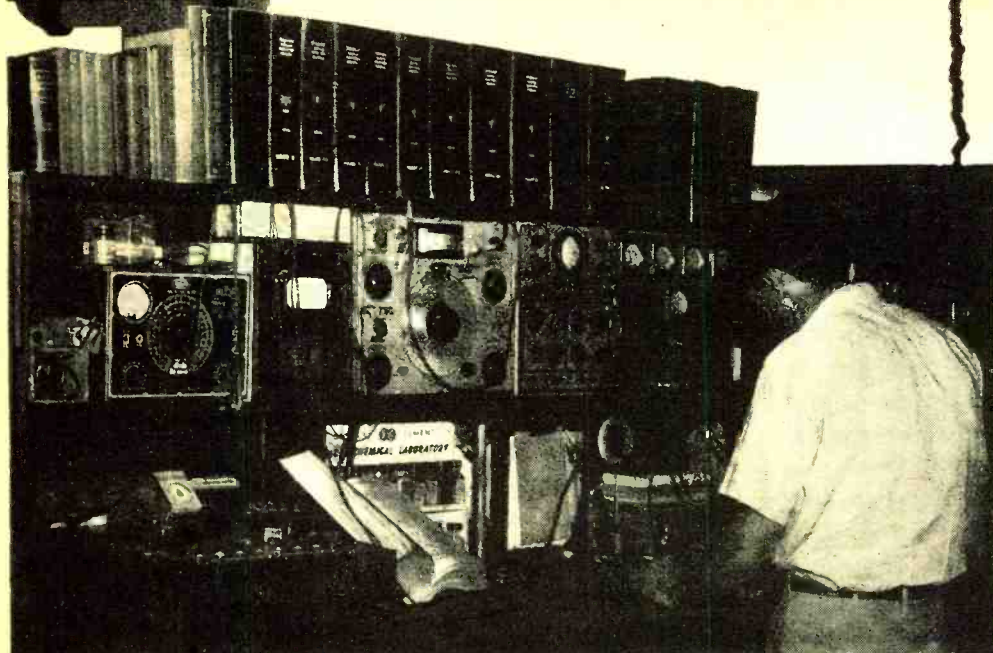

Couch has all fifteen RIDER MANUALS

W. J. Couch & Company of Tullahoma, Tenn., was recently featured in a national radio publication because of the completeness of its servicing equipment. In the Couch shop, as in thousands of other successful servicing establishments, you'll find all fifteen Rider Manuals in daily use. From no other single source is such data available.

Comprehensive servicing information is essential to shops called upon to service all makes and all types of radio receivers—of all ages. That's why the first fourteen volumes of Rider Manual are so time-savingly valuable to the average shop. These volumes alone cover the years when 82% of the sets now in American homes were issued. (From 1920 to April 1942 inclusive.)

And, the information on these receivers is the OFFICIAL, AUTHORIZED servicing data direct from the service departments of the manufac-

turers who made the sets. No one knows better than the manufacturer what procedures are best for his product. That is the foundation on which Rider Manuals are built.

Volume XV, covering sets issued during 1946, plus some unpublished pre-war models, is the result of "Seventeen Years of Continuing Service to the Radio Servicing Industry". It is full of exclusive features. For example, the 520 "clarified-schematics", which break down composite diagrams of complicated multiband receivers into individual schematics of each circuit as it exists with each turn of wave band or equipment switch.

With each Volume XV is the 200-page "How It Works" book, a guide to the theory of operation of new technical features in latest receivers. Volume XV also has all popular "Ham" communication receivers, Scott receivers, Magnavox RA combinations and record player combinations. These you find only in Rider Publications.

Rider Manuals are an investment which keeps pouring out profits for you. Those who bought Volume I, 17 years ago, are still benefiting from it. Be sure your shop has the Sign of Successful Servicing—all fifteen Rider Manuals.



**VOL. XV
JUST OUT!**

2000 pages, plus
200 page "How
It Works" Book.
\$18.00 complete

Volumes XIV to VII (each volume)..... \$15.00
Volume VI 11.00
Abridged Manuals I to V (one volume)..... 17.50
Record Changers and Recorders 9.00

RIDER MANUALS

MEAN SUCCESSFUL SERVICING

SEND IN YOUR ENTRY
NOW!

There are
224
Opportunities
to WIN

RIDER MANUAL CONTEST

\$4,325.00
WORTH OF

CASH PRIZES

AND
SERVICING
EQUIPMENT

JUST TELL WHY
(in 100 Words or Less)

**"RIDER MANUALS
MEAN
SUCCESSFUL SERVICING"**

That's all you need do. Nothing to buy. Nothing difficult. No need for fancy writing. Write your entry on official blank, obtainable from your parts jobber, in plain everyday English. The first thing you write may win you one of the 224 valuable prizes. Call your jobber.

**GET THE OFFICIAL
ENTRY BLANK
FROM YOUR JOBBER
TODAY!**

**JOHN F. RIDER
Publisher, Inc.**

404-4th AVE., N. Y. 17, N. Y.

Export Division,
Rocke International Corp.,
13 E. 40th St., New York City
Cable ARLAB

"HIRE" the BEST MAN IN THE BUSINESS!

TO HELP IN YOUR SHOP

For Only \$5... For Keeps!



Let him show you how to ELIMINATE TEDIOUS TESTING

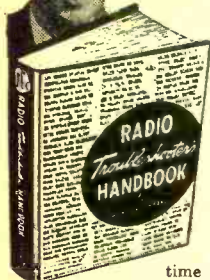

It took one of the best men in the business—A. Ghirardi—years of time and thousands of dollars to prepare the data you get in his **RADIO TROUBLESHOOTER'S HANDBOOK** for only \$5. That's why this big 744-page book is **AS GOOD AS ANOTHER MAN IN YOUR SHOP**—and an outstanding expert at that! It eliminates tedious testing on 4 jobs out of 5! Cuts service time in half! Enables you to repair cheap sets profitably. Ideal for training new helpers!

Cuts service time in half on 4 jobs out of 5!

Just look up the make and model of the radio you want to fix. Nine times out of ten the **HANDBOOK** gives all the detailed data you need—in 2 minutes or less. Clear instructions tell just what the trouble is likely to be—exactly how to repair it. Weighs 4½ lbs. Covers specific data for practically every radio in use. Also, it gives you hundreds of helpful charts; tuning alignment data; transformer hints; tube data; color codes, etc. to help you repair any radio ever made—easier, better and faster. Only \$5 complete. **5-DAY MONEY-BACK GUARANTEE.**

LET HIM GIVE YOU A COMPLETE GUIDE TO PROFESSIONAL SERVICING

Know how to make preliminary trouble checks on complicated jobs? Know how to analyze ANY circuit and its components quickly and scientifically? Know just where, when and how to use all types of test instruments—how to interpret their readings to track down the trouble?

Nowhere else can you get this kind of training faster, easier, and at less cost than in Ghirardi's **MODERN RADIO SERVICING**. This 1300-page book, refreshes you on any puzzling type of work—prepares you for the **RICH OPPORTUNITIES** that only servicemen with the true "Know How" of their profession can grasp. 706 illustrations. 720 self-test review questions to make study easy. Weighs over 3½ lbs. Only \$5 complete. **5-DAY MONEY-BACK GUARANTEE!**



MONEY-SAVING OFFER
Let the Handbook save time on common jobs. Let Modern Radio Servicing train you for **PROFESSIONAL** work. Get both big books, only \$9.50 for the two. Use coupon!

5-DAY MONEY-BACK GUARANTEE

Dept. RN-87, Murray Hill Books, Inc., 232 Madison Avenue, New York 16, N. Y.

- Enclosed find \$_____ for books checked, or
- send C.O.D. (in U.S.A. only) for this amount plus postage. If not fully satisfied, I may return books within five days for complete refund of my money.
- RADIO TROUBLESHOOTER'S HANDBOOK**, \$5 (\$5.50 foreign).
- MODERN RADIO SERVICING**, \$5 (\$5.50 foreign).
- MONEY SAVING COMBINATION**: Both big books over 2040 pages—only \$9.50 for the two (\$10.50 foreign).

Name _____
Address _____
City & Zone _____ State _____

American Telephone & Telegraph Company, operators of the only available video cables—virtually a monopoly. Monthly rates were quoted at \$40 per circuit mile for eight consecutive hours daily, plus \$2 for each additional consecutive hour. Figure mileage on a coast-to-coast hook-up basis, and you're spending folding money, to put it mildly. *AT&T* said rates should come down appreciably with more use of the circuits and established that cost of putting in the circuits was extremely high. Short of a lot of customers, however, they did not see how they could reduce charges. A hinted alternative at the informal FCC meeting was that an independent competitive network be set up and many television broadcasters seemed interested. But to do that would take time, and all are eager to get going on hook-ups as soon as possible. *AT&T* is equally eager to extend its circuits nationwide.

TELEVISION INTERFERENCE is coming mostly from mobile and special service units and often plays hob with telecasts. Exhibited at the FCC meeting was a telecast over *WDTT*, Washington, from somewhere in the northeast of the city, which faded repeatedly owing to interference. Mobile and special service unit folks are just as unhappy about the situation as the television people—they complain of interference from telecasts. Solutions are difficult to find. Some of the experts recommended that television and the competing services should all "move upstairs," as should FM, to make more room for everybody. Whether FCC will take action toward such moves seems doubtful, at least for the present. The moves would not only result in loud bleats from one and all, but might throw a sizable monkey wrench into the work now progressing toward establishing channels in the international field.

TELEVISION has a familiar solution for its problems—as who hasn't—more channels. At the moment, best estimate of the television experts is that ten new channels, giving them a total of 23, would do them nicely. That's the opinion of Thomas Goldsmith, Jr., of the *DuMont Laboratories*, Passaic, N. J., owner of the world's most powerful television station, *WABD*. Reporting that *DuMont* has already made and sold some 8000 receivers, Mr. Goldsmith feels that a minimum of three television stations should be available in any area with a potential receiver population of 50,000 persons or more. The ten new channels he requests fall between 108 and 174 mc.—now occupied by aviation, some amateurs, some mobile units. He points out that these channels were originally proposed when the present thirteen channels were assigned. If assigned, it would mean that television could use the spectrum between 44 mc. and 216 mc. except for small regions retained for

FM, amateurs, and miscellaneous services. Speaking for aviation interests, E. K. Morse of *Aeronautical Radio, Inc.*, pointed out that changing frequencies at this time or in the future would strike a severe blow to aircraft operations, especially in the transport field, where units costing around \$10,000 are being installed in each plane.

WHAT ALL THIS will add up to is trouble any way you figure it. Radio is expanding so rapidly in all departments that it is going to be difficult in the extreme to give every service enough to meet minimum needs, much less maximum wants. It's going to be tough for the various services and it's going to be tough, indeed, for FCC. As everybody agreed at the close of the informal summer meetings of the Commission, there are going to have to be a lot more meetings, more expert testimony—and lots of compromises.

ONE THING that came out of the FCC summer hearing—however expensive, the *Bell System's* intercity television network is already a reality and is expanding by leaps and bounds. "Manufacturing capacity and output of coaxial cable and associated equipment have been stepped up," says George Gillman, *AT&T* engineer, "construction forces have been expanded, and the program has taken definite shape. As of October 1, 1946, about 2700 route miles of coaxial cable were in the ground. Today this figure has increased to about 4000 miles and the going rate of installation is nearly 3000 sheath miles of cable per year." Plans call for continuing at this rate for the next few years. By the end of 1949, some 11,000 miles of cable will be in, according to the plans. What this means in intercity television service is that the New York-Boston link will be ready for testing by fall. New York-Chicago link is scheduled to go into operation some time during 1949. New York-Washington has already been operating more than a year experimentally. Philadelphia and Baltimore will be added to this hook-up in the near future, with Richmond, Va., being added by next summer. Similarly, intermediate cities will be hooked up with the New York-Chicago cable when completed. A Los Angeles-San Francisco hook-up is expected by early 1949, a complete national network by 1950-51.

RADAR WENT SAILING down the Potomac the other day under the auspices of Capt. W. R. Griswold of the *Sperry Gyroscope Company's* ship "Wanderer" with results wonderful to behold. Capt. Griswold, a veteran of the wartime merchant marine, could tell where he was, where he was going and what was in his way—all by electronic means. He does his navigating by reading a 12-inch viewing scope which picks out landmarks, buoys, (Continued on page 104)

MAKE MORE MONEY

IN Radio TELEVISION & ELECTRONICS

Now!

GET THESE 2 BIG BOOKS

FREE!

You men already in Radio know how great the demand is for trained, experienced servicemen, operators and technicians. You know how fast the field is growing and how important it is to keep up with developments — F.M. Receivers, Electronics and Television. You know, too, a fellow cannot learn too much about any industry for **REAL SUCCESS**. Whether you have experience or are merely **INTERESTED** in radio as an amateur, you must recognize the **WONDERFUL OPPORTUNITY** right within your grasp to cash in on your natural abilities. Make them pay dividends. Get into the **EXPERT RADIO SERVICE FIELD**. Be an F.M. and **TELEVISION** specialist—**OWN A BUSINESS OF YOUR OWN**, if you prefer. Fill out and mail the coupon below for all the details of our plan.

Get the Latest Inside Information—Short Cuts—Trade Secrets by

Here's Just a Few of the Interesting Facts you Learn with the **FREE MANUAL**.

1. Routine for Diagnosing Radio Troubles.
2. Preliminary Inspection of Receivers.
3. How to Check Power Supply.
4. How to Identify Various Stages of Receiver.
5. How to Trace the Circuit and Prepare Skeleton Diagram.
6. How to Test and Measure Voltages.
7. How to Test Speaker in Audio Stages.
8. How to Test Detector, I. F., R.F., and Mixer Stages.
9. Complete Reference Table for Quickly Locating Receiver Troubles.

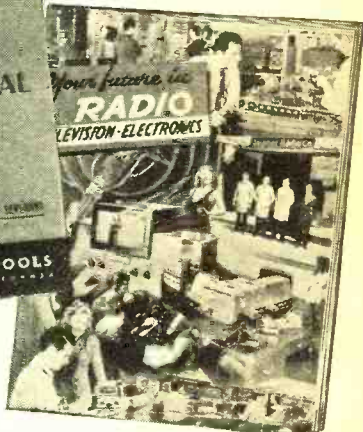
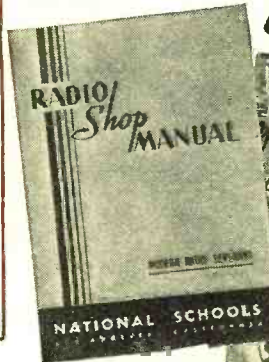

SHOP METHOD HOME TRAINING

FROM A REAL ESTABLISHED RESIDENT SCHOOL
Now the famous National Schools brings its exclusive Shop-Method of training right into your own home. You can learn the most up-to-date, approved projects, systems and circuits step by step in your spare time. This is the sound practical training you want and need—the development of experienced instructors working with thousands of students right in shops, **NEW F.M.** broadcast studios and experimental laboratories of **NATIONAL SCHOOLS**—one of the most advanced trade educational centers in the world.



LEARN BY DOING

Work with Real Experimental Equipment Furnished without Extra Cost as Part of Your National Training

Experience is the best teacher. You learn by experience with the exclusive National Shop-Method of Home Training. In the course of your study you actually build various types of receivers—a powerful superheterodyne, a signal generator, an audio oscillator and others—You make tests and conduct experiments that show you the *why and how of things*. You understand what makes the various elements of electronics operate because you actually see them work for you. Not only do you gain marvelous experience by this method of learning but you receive valuable equipment you will use on the job in the practice of your profession as an electronics expert. *Mail the coupon* and learn what this means to you.

Send the Coupon and prove to yourself what YOU can do in RADIO!

VETERANS

If you qualify for training under G. I. Bill, check the coupon for a Special Bulletin.



Be sure of Your Success And Security

Don't let your postwar ambitions lag. Don't let YOUR future depend on others. **Build a career for yourself.** Never in all history have there been such great futures before you. You can prepare to step into an essential, well paid position or, if you wish, **GET INTO BUSINESS FOR YOURSELF.** Start NOW. Radio men are vitally needed. Fill out and mail the coupon immediately and examine the **NATIONAL SHOP TRAINING METHOD COURSE** carefully, without obligation.

FREE LESSON INCLUDED

Examine the exclusive National Shop Method of Home Training. See for yourself how sound and practical it is. Be convinced that you can learn Radio, Electronics, Television—quickly and easily in your spare time. You can't tell until you try. This trial is **ABSOLUTELY FREE**. Fill out the coupon immediately while you are thinking about it and drop it in the mail at once.

Mail the coupon here for the books that tell you the complete story of the marvelous new system of training in Radio, Electronics and Television. Learn the facts of this exclusive shop-method of home training. See for yourself! **DECIDE FOR YOURSELF!**

This is the **MODERN SYSTEM OF TRAINING**: it matches the rapid progress constantly being made in Radio, Television and Electronics. It is **TIME TESTED**, too. National Schools has been training men for more than a third of a century. It is the very same training that has helped thousands to more pay and greater opportunity.

You owe it to yourself—your future—to read the book "Your Future in Radio, Electronics and Television"—**FREE** to you when you send in the coupon.

NATIONAL SCHOOLS

LOS ANGELES 37, CALIFORNIA EST. 1905



MAIL OPPORTUNITY COUPON FOR QUICK ACTION

National Schools, Dept. 8-RN

(Mail in envelope or paste on penny post card)

4000 South Figueroa Street, Los Angeles 37, California

Mail me **FREE** the two books mentioned in your ad, including a sample lesson of your course. I understand no salesman will call on me.

NAME

ADDRESS

CITY..... ZONE..... STATE.....

Check here if Veteran of World War II

August, 1947

21

ONCE IN A LIFETIME VALUE!! PRICES CUT BELOW PREWAR LEVEL

A TERRIFIC OPPORTUNITY FOR SERVICEMEN TO BUY A COMPLETE SERVICE LABORATORY...TWO BASIC INSTRUMENTS FOR ALMOST THE PRICE OF ONE

Act Now — Limited Time Only — 1 Year Guarantee

5,000 OHMS PER VOLT
VOLT-OHM MILLIAMMETER



Hand-rubbed oak portable cabinet complete with cover, self-contained battery, test leads and instructions. Measures 4"x6½"x7".
4 D.C. VOLTAGE RANGES: 0 to 15/75/300/1,500 VOLTS
4 A.C. VOLTAGE RANGES: 0 to 15/75/300/1,500 VOLTS
4 OUTPUT METER RANGES: 0 to 15/75/300/1,500 VOLTS
4 D.C. CURRENT RANGES: 0 to 150 Microamperes — 0 to 15/75/150 Ma.
4 RESISTANCE RANGES: — 0 to 2,000/20,000/200,000 Ohms — 0 to 2 Megohms
4 DECIBEL RANGES: — 10 to +18 D.B. +4 to +32 D.B. +16 to +44 D.B. +30 to +58 D.B.

Services F.M., A.M. and Television Receivers. Generates R. F. Frequencies from 150 Kilocycles to 50 Megacycles. (150 Kc to 12.5 Mc on fundamentals and from 11 Mc. to 50 Mc. on harmonics.) R.F. signal constant at all output levels. Direct reading—all calibrations are etched on the front panel.

Processed dual-tone front panel. Cabinet of heavy gauge crystalline steel. Complete with shielded test lead, self-contained batteries and instructions.

ABOVE ↑

RIGHT →

REGULAR TOTAL PRICE

\$67¹⁵

**NOW
BOTH FOR
\$49⁵⁰**

BATTERY OPERATED
SIGNAL GENERATOR

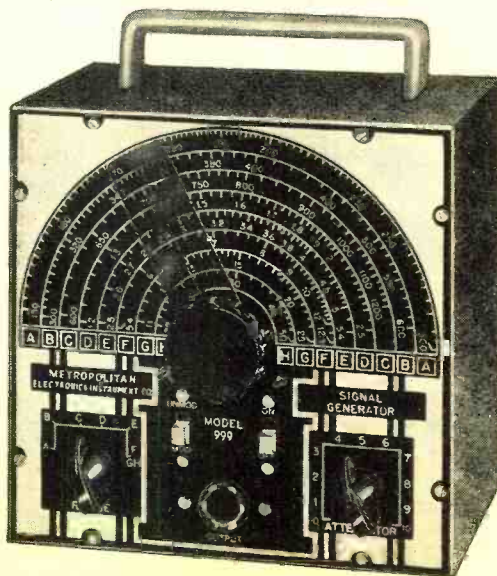

NATIONALLY ADVERTISED TEST EQUIPMENT—IMMEDIATE DELIVERY

TERMS

25% DEPOSIT, BALANCE C. O. D.
OR FULL PAYMENT WITH ORDER

WRITE FOR FREE CATALOG

22

LOW-COST
TELEVISION
IS HERE!

Certified

TELEVISION RECEIVER KIT
ready for Easy, Rapid Assembly
THE GREATEST BUY IN TELEVISION!

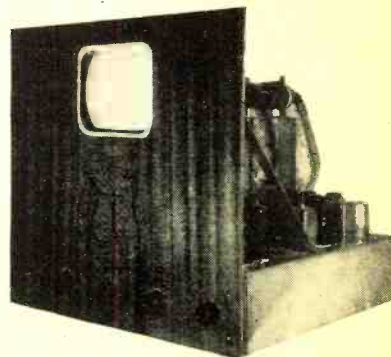

A complete television kit using a seven-inch tube which gives a 26-square-inch picture. This kit has everything, all power transformers, chokes, I.F.'s—R.F.'s, condensers, resistors, mounting brackets, nuts, front panel and a complete punched chassis, plus simple Jo understand schematic diagrams. This receiver is a well engineered piece of equipment having three stages of video I.F. amplification which are slug tuned for maximum gain and efficiency. Only five controls are on the front panel giving simplicity of operation. The instructions are written in an easy step-by-step system enabling accurate construction. Alignment procedure without the use of expensive test equipment is given in detail.

A specially constructed glass between the scope tube and panel along with grill cloth is included. Besides all of the above, a beautifully finished front panel comes to you in choice of Walnut, Blonde Maple or Mahogany.

YOUR PRICE **\$89⁹⁵**
(LESS TUBES)

COMPLETE WITH ALL TUBES . . . \$129.95

Sorry . . .

In our June 1947 ad we used a "Transvision" cut on a television kit that was not a "Transvision" item. Transvision Television Kits are \$159.50 complete with tubes.

Metropolitan ELECTRONIC & INSTRUMENT CO.

Dept. R, 42 WARREN STREET, New York 7, N. Y., U. S. A.

Phone: BARclay 7-5556

RADIO NEWS

when you order a
STANCOR product
 you order the
FINEST

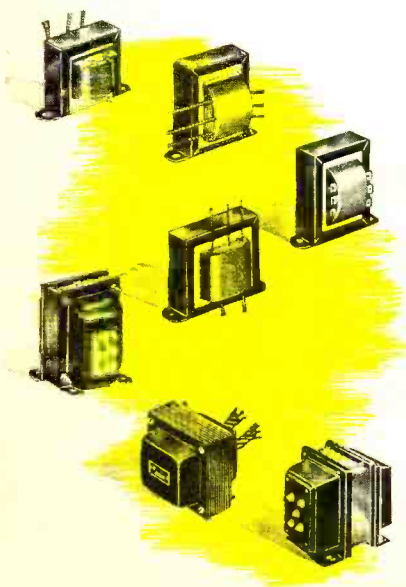
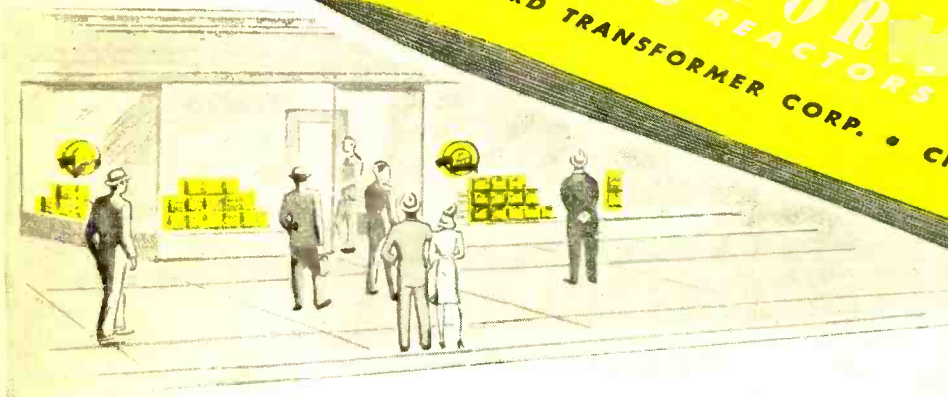

The big black-and-yellow STANCOR catalog is the logical place for the radio serviceman to turn for a transformer to meet any standard need. . . . For there you will find the most complete selection of Replacement and General Purpose Transformers. . . . And there you'll find the FINEST. . . . For the most exacting quality is built into every STANCOR product. . . . Quality plus advanced design and universal application. . . . Yes, reach for the well-thumbed STANCOR catalog . . . for behind it are STANCOR's new streamlined plant facilities to give you better products and better service . . . to help you give your customers complete and lasting satisfaction.

standardize on **STANCOR**  **TRANSFORMERS**

STANDARD TRANSFORMER CORPORATION • ELSTON, KEDZIE AND ADDISON, CHICAGO, ILL.

August, 1947

23

TELEVISION-

America's Next Giant Industry?



Billboard Announcing Telecasts of Ball Games in Chicago

Today, RIGHT NOW, clear and bright pictures of great sports events, as well as other equally interesting programs, are being telecast for the enjoyment of thousands. Television stations in New York, Chicago, Philadelphia, Washington, Detroit, St. Louis and Los Angeles are already operating on regular schedules. Construction has started in several other centers and it is believed that practically every major city in the country will have this wonderful service before the end of 1948.

Who will build, maintain, and operate the new telecast stations? Who will design, produce, install and service the receivers?

Men Must Be Trained for These New Professions

Alert young men with an ambition to grow with television are training now in the greatly enlarged instruction laboratories of American Television, Inc. A wide choice of courses available. Advanced methods and latest obtainable equipment used.

One of Our New Buildings.
Air Conditioned the Year Round.



U. A. Sanabria

Dr. Lee deForest

The Men Who Direct American Television

The instructional quality of training is under the constant personal supervision of two internationally known engineers, Mr. U. A. Sanabria, President and Founder of American Television, Inc. and Dr. Lee deForest, the famed inventor of the radio tube.



FREE PRE-ENTRANCE COURSE

A Short Home Study Television Course is available to qualified war veterans who are considering residence training. This course is free of any charge or obligation. Your success with it will help you to learn your own abilities in television. It will also aid us greatly in qualifying you for residence training. Your acceptance of the Home Study course in no way obligates you to enter our residence school. So we urge you to take advantage at once of the very unusual opportunity it offers.



Approved for Veteran Training Under G. I. Bill of Rights

American Television, Inc.

5050 BROADWAY

CHICAGO 40, ILLINOIS

REQUEST FOR FREE INFORMATION

American Television, Inc., Dept. of Information
5050 Broadway, Chicago 40, Illinois

Please send details of your Television Training.

NAME _____

ADDRESS _____

CITY _____

ZONE _____

STATE _____

I am a veteran

A Masterpiece of the Cabinetmaker's Art

The New
DELCO RADIO
Combination

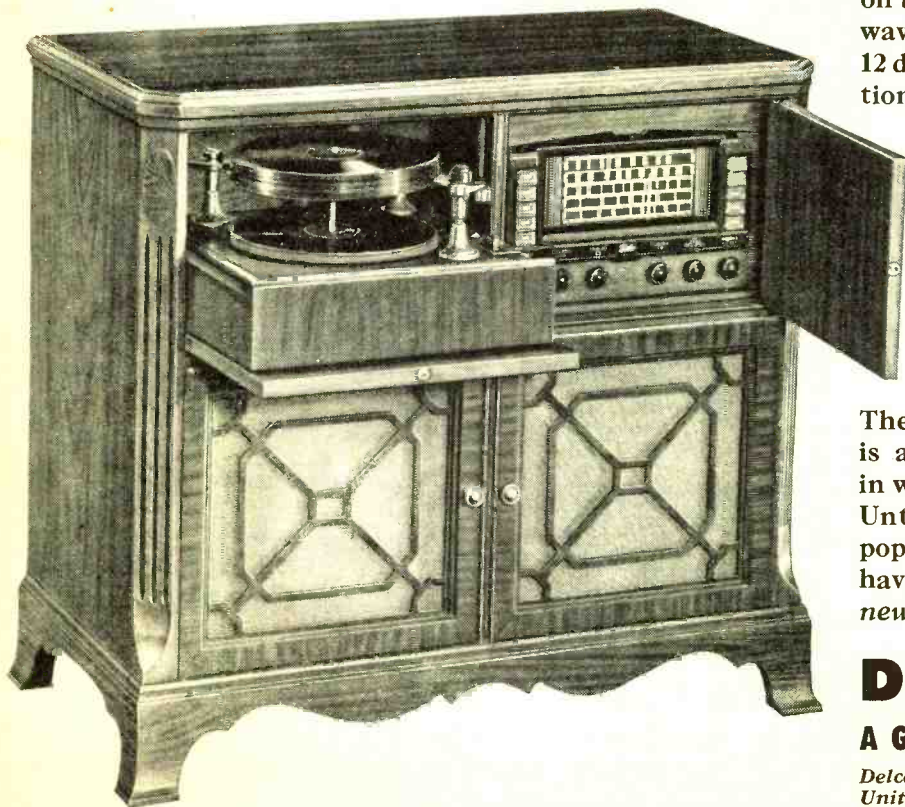

LOOK at it as a piece of furniture and you'll see that the new Delco Radio Combination is outstanding in the field. The grace and distinction of its 18th-Century design . . . the superlative materials and workmanship . . . make it a handsome addition to the finest home.

Listen to it as a musical instrument and you'll find that the new Delco Radio Combination lives up to all the promise of its appearance. It brings a new richness and clarity of tone to both recordings and radio broadcasts.

This new Combination has 14 tubes plus rectifier . . . automatic tuning on *both* AM and FM . . . three short-wave bands . . . a 15-inch speaker . . . 12 different bass and treble combinations . . . and advanced engineering throughout. The record player handles fourteen 10-inch or ten 12-inch records, and shuts off automatically after the last record plays. A special lightweight tone arm with *jeweled-point* pick-up makes recordings sound better and last longer.

The new Delco Radio Combination is available in two models: R-1251 in walnut, and R-1252 in mahogany. Until you've seen them and the other popular Delco radio models, you haven't seen *the best of all that's new in radio!*

DELCO RADIO
A GENERAL MOTORS PRODUCT

Delco radios are distributed nationally by United Motors Service. See your United Motors distributor about the Delco radio line.



Radio Books

on radio
from these leading
radio parts dealers

WHO REGULARLY STOCK MOST OF THESE BOOKS, AND CAN OBTAIN QUICKLY NEARLY ALL OTHERS CURRENTLY IN PRINT

ALABAMA: Birmingham, Forbes Distributing, Reid Distributing.
ALASKA: Anchorage, Robble's Radio Supply, Fairbanks, Fairbanks Radio Supply, Juneau, Alaska Electronics.
ARIZONA: Phoenix, Radio Parts, Radio Specialties.
ARKANSAS: Little Rock, Tanner Radio & Electronics.
CALIFORNIA: Fresno, Jack C. Ar buckle, Martin Distributing, Long Beach, Fred S. Dean Radio Electric Co., Scott Radio Supply, Los Angeles, Henry Radio Shop, Hollywood Radio Supply Co., Kierulff & Co., Pacific Radio Exchange, Inc., Radio Equipment Distributors, Radio Specialties, Oakland, Electric Supply, Pasadena, Dow Radio Supply Co., Sacramento, E. M. Kemp Co., San Diego, Western Radio & Television Supply Co., San Francisco, Offenbach-Reimus, Zack Radio, San Jose, Frank Quement, Santa Ana, Radio & Television Equipment, Santa Barbara, Channel Radio Supply.
COLORADO: Colorado Springs, Murray Radio Co., Denver, Radio Products Sales, Western Electronic Lab. Co.
CONNECTICUT: Hartford, Hatry & Young, Inc., R. G. Scoll & Co., Snow Haven, Congress Radio.
D. C. Washington: Capitol Radio Wholesalers, Kenyon Radio Supply, Sun Radio Service.
FLORIDA: Miami, Electronic Supply, Walder Radio, Pensacola, Grice Radio, Gulf Radio, Pensacola Appliances, Petersburg, Cooper Radio, Welch Radio Supply.
GEORGIA: Atlanta, Concord Radio, Southeastern Radio Parts, Yancey Co., Inc., Columbus, Radio Sales & Service Co.
IDAHO: Boise, Craddock's Radio Supply.
ILLINOIS: Chicago, Allied Radio, Concord Radio, Newark Electric, Peoria, Klaus Radio & Electric, Rock Island, Tri-City Radio Supply.
INDIANA: Indianapolis, Radio Distributing Co., South Bend, Radio Distributing Co.
IOWA: Des Moines, G. W. Onthank Co.
KANSAS: Topeka, Overton Electric Co.
KENTUCKY: Lexington, Radio Equipment, Owensboro, Central Electronic.
MARYLAND: Baltimore, Kann-Ellert Electronics, Wholesale Radio Parts.
MASSACHUSETTS: Boston, DeMambo Radio Supply, Radio Shack, Worcester, Radio Maintenance Supply Co.
MICHIGAN: Detroit, M. N. Duffy & Co., Radio Electronic Supply, Radio Supply & Engineering Co., Inc., Grand Rapids, Wholesale Radio Co., Lansing, Budd's Music House, Muskegon, Industrial Electric Supply, Pontiac, Electronic Supply.
MINNESOTA: Duluth, Lew Bonn Co., Minneapolis, Lew Bonn Co., Northwest Radio Electric Supply.
MISSISSIPPI: Greenville, Goyer Supply Co., Jackson, Cabell Electric, Ellington Radio, Inc.
MISSOURI: Joplin, 4-State Radio & Supply, Springfield, Harry Reid Radio Supply, St. Louis, Radionics.
NEBRASKA: Omaha, Omaha Appliance, Radio Equipment Co.
NEW JERSEY: Trenton, Allen & Hurley.
NEW YORK: Albany, Fort Orange Radio Distributing, E. E. Taylor, Co., Buffalo, Bars Radio & Electronic Parts Co., Buffalo Radio Supply Co., Genesee Radio & Parts, Radio Equipment, Jamaica, Norman Radio Distributors, Middletown, L. S. Radio Sales, New York City, Fordham Supply Co., Newark Electric Co., Terminal Radio Corp., Niagara Falls, Niagara Radio Supply, Poughkeepsie, Chief Electronics, Rochester, Masline Radio & Electronic Equipment, Rochester Radio Supply, Syracuse, Broome Distributing, Stewart W. Smith, Troy, Trojan Radio, Utica, Yeath Electric Co., White Plains, Westchester Electronic Supply Co.
NORTH CAROLINA: Fayetteville, Dugan's Radio Supply Co., Eastern Radio Supply, Winston-Salem, Lambeth Electric Supply.
OHIO: Akron, Brighton Sporting Goods, Olson Radio Warehouse, Radio & Electronic Supply, Cincinnati, Holub & Hogg, Steinberg's, Cleveland, Pioneer Radio Supply, Progress Radio Supply, Radio & Electronic Parts, Columbus, Engle-Peters, Inc., Thompson Radio Supplies, Dayton, Standard Radio & Electronic Products, Lima, Warren Radio, Toledo, Toledo Radio Specialties, Warren Radio, Warren, Radio Specialties.
OKLAHOMA: Enid, Radio-Electronics, Oklahoma City, Radio Supply Co.
OREGON: Portland, Bargelt Supply, Harper-Meggee, Lou Johnson Co., United Radio Supply.
PENNSYLVANIA: Altoona, Kennedy's Radio Supply, Erie, Warren Radio, Philadelphia, Almo Radio, M. & E. Sporting Goods, Radio Electric Service, Sanders Electronics, Eugene G. Wile, Pittsburgh, Radio Parts Co., Tydings Co., Reading, George D. Barbey Co., Scranton, Scranton Radio and Television Supply, Wilkes-Barre, General Radio, York, C. R. Minnick.
RHODE ISLAND: Providence, DeMambo Radio Supply.
SOUTH CAROLINA: Anderson, Electronic Supply, Columbia, Dixie Radio Supply Co.
TENNESSEE: Memphis, Bluff City Distributing.
TEXAS: Beaumont, Montague Radio Dist. Co., Corpus Christi, Wicks-De Vilbiss Dallas, Wilkinson Brothers, El Paso, Midland Specialty, Houston, R. C. Fall, Lubbock, R & R Parts & Supply Co., San Antonio, Modern Radio Supply, Olsen Radio Supply.
UTAH: Salt Lake City, Radio Supply Co., Standard Supply.
VIRGINIA: Norfolk, Radio Parts Distributing, Radio Supply.
WASHINGTON: Everett, Pringle Radio Wholesale Co., Seattle, General Radio, Inc., Harper-Meggee, Radio Produce Sales, Seattle Radio, Spokane, Harper-Meggee, Northwest Electronics.
WEST VIRGINIA: Charleston, Hicks Radio Supply, Wheeling, General Distributors, Wheeling Radio Supply.
WISCONSIN: Madison, Satterfield Radio Supply.

CANADA

BRITISH COLUMBIA: Vancouver, Hygrade Radio, Ltd., Western Agencies, Victoria, Elision Quebec Radio Supply.

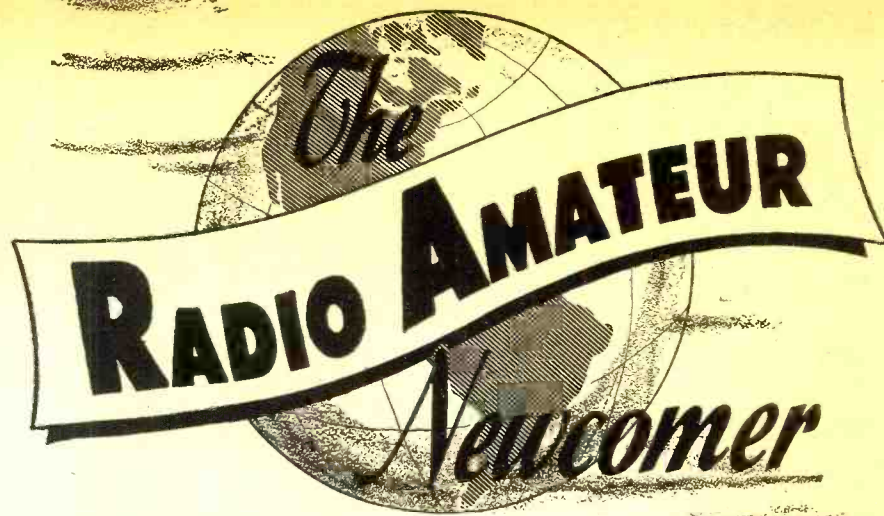

Just Out!

Ideal for those getting started in amateur radio, or interested in it. Complete. You need no other books to get your license and get on the air. How-to-build simple equipment for a complete station on all newcomer bands. Operating instructions. Simple theory. Complete section of study questions, including those needed to pass the license exams. U. S. A. Amateur radio regulations. Written by those masters of making-it-plain, the editors of the "Radio Handbook" and the prewar "Radio."

Book No. NH. \$1.00 at your dealer, or \$1.10 postpaid from us.

These Are New:

ELECTRONICS for INDUSTRY by Bendz

The principles and practical aspects of industrial, non-communications electronics. Numerous diagrams instead of mathematics clarify the discussions. Many control applications; 1- to 5-element control tubes; high-frequency induction heating; many others. The author is a leading practical engineer.

BOOK NO. BE20 501 PAGES \$5.00*

THEORY and APPL. of RADIO-FREQ. HEATING—Brown

A comprehensive text on this subject by 3 RCA Lab. engineers. Eminently practical but with adequate theoretical foundation throughout; many practical applications.

BOOK NO. BH30 425 PAGES \$6.50*

The WORLD'S RADIO TUBES

U. S., British, French, Czech, German, Italian, Russian, etc., etc.

240 pages of complete characteristics with explanations—up to date—1946 edition

ELECTRONICS says: "Here at last is the radio tube handbook radio engineers have dreamed of... in seven carefully prepared tables and charts... 'Probably the most complete and authoritative set of tube-data in existence,'" says RADIO CRAFT.

BUY IT AT YOUR FAVORITE RADIO PARTS DEALER or direct by mail from us.

\$2.50 per copy; add 15c postage outside U.S.A.

* Add 3% (minimum, 10c) for postage and packing; foreign, 10%. Prices are subject to change without notice.

If you don't live near or deal regularly with one of our dealers, you may order direct from

Editors and Engineers 1302 KENWOOD ROAD Santa Barbara CALIFORNIA

HIGH-FREQUENCY INDUCTION HEATING—Curtis

Excellent, less-comprehensive book on the same subject with particular emphasis on heating of metals.

BOOK NO. CH10 235 PAGES \$3.00*

RADAR ENGINEERING—Fink

The most comprehensive book yet published on this subject; by a former M.I.T. Staff member. Practice and theory of the entire radar system.

BOOK NO. FR10 644 PAGES \$7.00*

THE OUTSTANDING PRACTICAL HANDBOOK



ENLARGED TENTH EDITION

Radio's outstanding practical text. How-to-build-it descriptions of dozens of tested-and-tried types of transmitting, receiving and test equipment. Supplemented by basic electrical and radio theory in the simplest possible language for those without mathematical or technical training.

Illustrated with hundreds of diagrams and large photographs showing details of construction. Has the most complete tube tables to be found in any book. New edition contains expanded U.H.F. sections, more test equipment which can be home-built, enlarged and modernized receiving- and transmitting tube tables, grounded-grid amplifier data, speech clipping, splatter suppressor, cathode follower data, pulse-time modulation, transformerless power supplies, wave guides, cavity resonators, butterfly circuit, klystron, U.H.F. crystal diode, radar and highly-efficient mobile antennas.

The ideal text for the practical radioman. Over 700 pages, durably clothbound, gold-stamped Book RH. \$2.50 at your dealers. Postpaid, \$2.75 in USA.; elsewhere, \$3.00.

MEISSNER KITS

**FOR THOSE WHO
WANT TO BUILD
THEIR OWN**

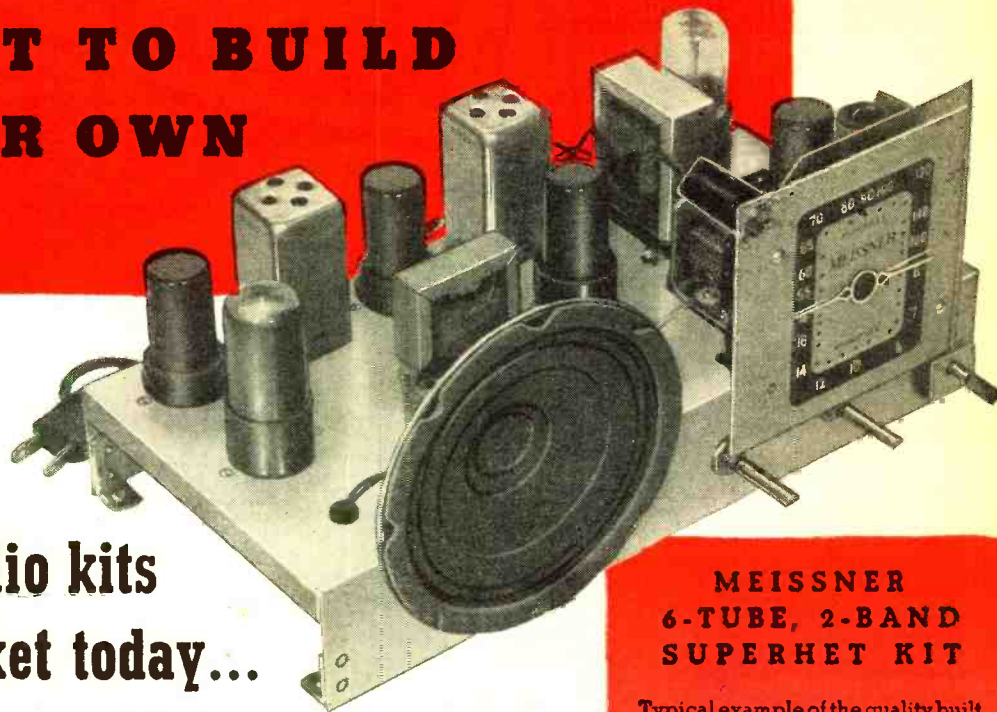

**There are
no finer radio kits
on the market today...
than these new Meissners**

The finest quality components, careful circuit designs for sure, efficient operation, plus unusual ease of assembly, all make these new Meissner Kits the outstanding buy for those interested in constructing their own sets.

Kits include all parts, tubes and speaker . . . everything except cabinet. A screwdriver, pliers and soldering iron are all that is required to assemble any Meissner Kit into a complete radio. See this complete line today or write for new free catalog to the address below.

Meissner

ELECTRONIC DISTRIBUTOR AND
INDUSTRIAL SALES DEPARTMENT

MAGUIRE INDUSTRIES, INCORPORATED

936 NORTH MICHIGAN AVENUE, CHICAGO 11, ILLINOIS

EXPORT ADDRESS — SCHEEL INTERNATIONAL, INCORPORATED
4237-39 N. LINCOLN AVENUE, CHICAGO 18, ILL. CABLE — HARSHEEL

MEISSNER 6-TUBE, 2-BAND SUPERHET KIT

Typical example of the quality built into every Meissner Kit is this new 6-tube broadcast and shortwave receiver covering the frequencies between 500 and 1600 kilocycles and 6-18 megacycles. The short-wave band includes foreign stations, government, commercial and amateur services. Equipped with filter choke to provide hum-free output without power loss and an I-F wave-trap to eliminate troublesome image interference. Large 6-inch speaker provides extended audio response without distortion. Tubes employed are 12SK7 R-F Amplifier, 12SA7 oscillator mixer, 12SK7 I-F Amplifier, 12SQ7 detector, AVC and audio amplifier, 35L6GT beam power output and 35Z5GT rectifier Pilot light for dial illumination. 110 volt, DC or 50-60 cycle AC operation.

HARVEY

for xmitters es rcvrs



PANADAPTOR . . . enables you to check your signal, locate holes in the band, quickly pick answers to your CQ. Fits any communications receiver\$99.50

HANDY-TALKIE

The HT-144 is tops for a hand set in the 2 meter band. Antenna telescopes, batteries self-contained, one hand control. 45-75 hours battery life



.....\$34.50
tubes extra \$2.49
batteries extra....\$2.25

SONAR . . . 6 or 10 and 11 meter portable transmitter, 22.5 watts into antenna with 2E26 in final. NB FM. 40 meter xtal. Complete with tubes and coil for either band, less xtal and power supply. \$72.45

SUPREME AF-100 XMITTR . . . 100 watts output on CW or phone, 10 to 80 meters. VFO and 2 xtal positions.\$450.00

In stock for immediate delivery

Collins 75A.....	\$ 530.00
Hallicrafters S38 complete.....	47.50
Hallicrafters S40A.....	89.50
Hallicrafters SX42.....	275.00
Hammarlund HQ129X and speaker.....	173.25
Hammarlund SP-400X and speaker.....	347.25
National NC-173 complete....	189.50
National NC-2-40D (complete with speaker).....	241.45
National HRO-5TA1 complete.....	306.71
National NC-46 complete.....	107.40
National 1-10A with tubes and coils.....	67.50
RME-45 complete.....	198.70
Hallicrafters panadaptor.....	99.50
Meck 60T transmitter.....	150.00
Millen 90700 ECO.....	42.50
Millen 90800 exciter.....	42.50
Millen 90281 power supply....	84.50
Millen 90902 scope.....	42.50
Meissner signal shifter.....	120.00
Collins 30 K-1 transmitter.....	1825.00
Collins 32V transmitter.....	590.00
Collins 70-8 PTO.....	45.00
Bud VFO-21.....	52.50
Sonar XE10 FM exciter.....	39.45
Sonar VFX 680 FM exciter.....	87.45

NOTE: All prices quoted are NET, FOB New York and subject to change without notice.

Telephone:  Longacre 3-1800

HARVEY

RADIO COMPANY INC.

103 West 43rd St., New York 18, N. Y.

Within the INDUSTRY

HAROLD L. MANN is the new chief industrial engineer for the *Farnsworth Television & Radio Corporation*.

While Mr. Mann will make his headquarters at the company's Fort Wayne plant, he will also have charge of the industrial engineering programs at *Farnsworth's* plants in Marion, Huntington and Bluffton, Indiana.



He was formerly associated with *RCA* as a production control supervisor and later as machine shop superintendent at the Indianapolis plant of the same company. He also served as director of the standards division for the *Crosley Corporation* at Cincinnati.

ADMIRAL CORPORATION of Chicago recently opened a new plant in Harvard, Illinois, for the assembly of small radios.

The plant was built by the company to handle much of the production of its smaller sets. Harvard which is 80 miles northwest of Chicago is also the home of two other of the company's main plants and their cabinet factory. *Admiral* recently acquired another cabinet plant in Shelbyville, Indiana.

E. F. JOHNSON COMPANY of Waseca, Minnesota, has purchased the "Speedx" line from the *Les Logan Company* of San Francisco.

The line includes the "Speedx" bakelite and metal hand keys, high speed semi-automatic keys, and practice sets and buzzers for amateur and commercial work.

The purchase covers inventory, tools and rights to the "Speedx" name. The line will be manufactured in Waseca.

WILLIAM J. KELLY, who for nine years served as Eastern District Manager for the *McGraw Electric Company*, has joined the *Stromberg-Carlson* radio sales division as District Merchandiser covering the New York metropolitan area and the Eastern seaboard as far south as Virginia.



Mr. Kelly has been associated with the electrical appliance industry for the past 16 years, having served as retail radio and appliance salesman for the *New York State Electric and Gas Company* before becoming a factory

representative for the *Edison General Electric Appliance (Hotpoint) Company*.

JAY GOULD, Executive Vice-President of the *Frankfort Distillers Corporation*, has been elected to the Board of Directors of *Majestic Radio & Television Corporation* to fill the vacancy caused by the death of James J. Walker.

Mr. Gould has been a sales executive with a number of prominent corporations and prior to his association with *Frankfort Distillers* was President of *Best Foods, Inc.*

SOLA ELECTRIC COMPANY, manufacturers of transformers, have recently moved into their new plant at 4633 West 16th Street, Chicago 50, Illinois.

The new building has been designed to provide greater engineering, research and production facilities than were previously available as well as ideal working conditions for the employees.

TERRY P. CUNNINGHAM has been appointed Advertising Manager of the Radio Tube, Electronics, and International Divisions of *Sylvania Electric Products Inc.*



Mr. Cunningham served as Advertising Manager for *Sylvania's* Radio Tube Division for two years before becoming Sales Manager for the Home Radio Division of *Colonial Radio Corporation*, a *Sylvania* subsidiary, in 1944.

He has specialized in radio advertising and merchandising campaigns while on the staff of Chicago and Milwaukee advertising agencies. His experience in the promotion of radio merchandise covers a period of twenty-one years.

GENERAL ELECTRIC COMPANY has announced the completion of a one-way microwave radio relay circuit for commercial television operation between New York City and Schenectady, New York. Present plans call for the extension of this circuit to Syracuse, New York, if approved by the FCC.

Station *WRGB*, *General Electric's* television outlet in Schenectady, has an application pending before the Commission seeking to use this circuit commercially for relaying to the Troy-Albany-Schenectady area television programs available in New York City.

The new relay operates in the 2000 mc. region and is extremely direc-



RADIOTELEPHONE SYSTEMS BUILT *specifically*
TO MEET RAILROAD SERVICE REQUIREMENTS

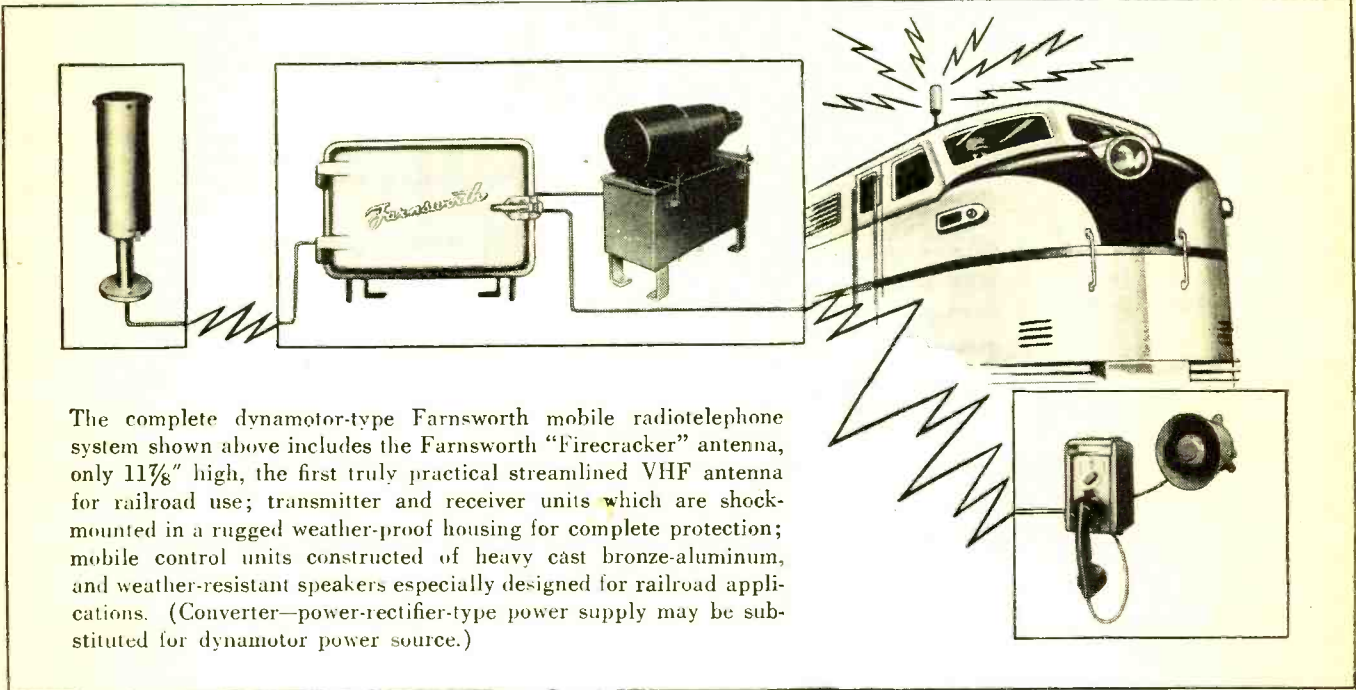

The complete dynamotor-type Farnsworth mobile radiotelephone system shown above includes the Farnsworth "Firecracker" antenna, only 11 $\frac{7}{8}$ " high, the first truly practical streamlined VHF antenna for railroad use; transmitter and receiver units which are shock-mounted in a rugged weather-proof housing for complete protection; mobile control units constructed of heavy cast bronze-aluminum, and weather-resistant speakers especially designed for railroad applications. (Converter—power-rectifier-type power supply may be substituted for dynamotor power source.)

RADIO has already demonstrated its usefulness in railway operations. The design of proper specialized equipment for the practical application of this dependable communications tool in railway service is, however, dependent upon a thorough knowledge of the unique and exacting requirements of railway operation.

Because Farnsworth engineers have secured this knowledge through their pioneering accomplishments in adapting radio to railroad operations, Farnsworth is today producing VHF communications systems that have been *specifically designed and precisely developed for railway service.*

Standardized design and unitized construction are only two of many important engineering results of Farnsworth's pioneering, long-term development and field-testing program in railway radio communications.

They give Farnsworth equipment these practical features:

- The same receiver, transmitter, and in some cases, power supply and remote control unit, is usable for mobile, wayside or relay installations, thus providing complete interchangeability of basic equipment.
- Because all connections are made by a single, break-away plug, transmitters, receivers and power converters can be instantly disassociated for purposes of maintenance or relocation without manually disconnecting a single wire.
- Personnel unlicensed by the FCC and without technical training can replace all units of Farnsworth systems.

Only Farnsworth radiotelephone systems offer all these vital service and maintenance advantages. For complete information write Farnsworth Television & Radio Corporation, Dept. RN-8, Fort Wayne 1, Indiana.

Farnsworth
Television · Radio · Phonograph-Radio

Farnsworth Radio and Television Receivers and Transmitters • Aircraft Radio Equipment • Farnsworth Television Tubes • Mobile Communications and Traffic Control Systems for Rail and Highway • The Farnsworth Phonograph-Radio • The Capehart • The Panamuse by Capehart

the Crescent C-250 Record Changer

does these
3 jobs
better



FLOATING OPERATION



REJECT CONTROL



CHILDPROOF



THE CRESCENT Speakers

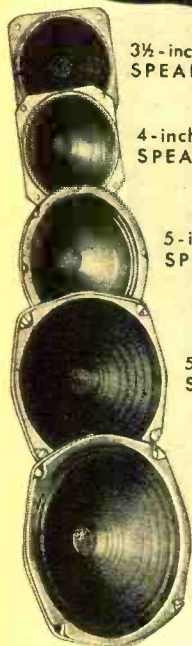

3½ - inch
SPEAKER

4 - inch
SPEAKER

5 - inch
SPEAKER

5¼ - inch
SPEAKER

6 - inch
SPEAKER

Crescent Speakers, designed and engineered to the most exacting standards, deliver the finest in tonal performance.

performs • endures • attracts

The most attractive and well designed changer in the popular priced field. Equipped with dependable cushion mounted motor — "Barry" mounts to eliminate vibrations and fool-proof in operation. Hammertone finished with smart plastic trim. Has both reject button and control knob for convenient on-off-manual and automatic operation. Plays 10" or 12" records automatically.

CONTACT YOUR CLOSEST CRESCENT SALES REPRESENTATIVE

W.M. RUTT, c/o CRESCENT ELECTRONICS CO.
401 Broadway, New York 13, N. Y.

MILLER-JOYCE CO.
609 S. Vermont Ave., Los Angeles 5, Calif.

LES LOGAN CO.
530 Gough St., San Francisco, Calif.

HARRISON-REYNOLDS CO.
419 Commonwealth Ave., Boston 15, Mass.



CRESCENT INDUSTRIES INC.
4132-54 W. BELMONT AVENUE
CHICAGO 41, ILLINOIS

tional. The microwaves are beamed from a transmitter on top of the *General Electric* office building at 570 Lexington Avenue, New York, to a relay station on Beacon Mountain 55 miles from the city. Another tower at Round Top Mountain picks up the relay and transmits it to the Helderberg mountains where it is finally transmitted a distance of 14 miles to the Schenectady terminus.

* * *

RICHARD W. BELLEW has been promoted to the post of Manager of the Amateur Sales Department for *Collins Radio Corporation*.



He has been an amateur (W8DYY, now W5FWD) since 1929. In addition to his amateur ticket, Mr. Bellew holds his radio telephone first class and radio telegraph second class commercial licenses.

During the war, from 1942 until 1945, Mr. Bellew was connected with the Standards Laboratory of *Raytheon Manufacturing Company*. He joined the *Collins* organization in the Amateur Sales Department in September of 1946.

* * *

SAM WILEY of Chicago has been appointed field representative for the Midwest territory of the *Snyder Manufacturing Company*, manufacturers of antennas and automotive radio accessories.

Mr. Wiley, who has been active in the sales field throughout the Midwest for several years, will coordinate field activities for the *Snyder* firm in that territory.

* * *

WILLIAM M. SHIPLEY has been named Eastern Regional Manager for the *Crosley Division of Avco Manufacturing Corporation*.

Mr. Shipley returns to *Crosley* after an absence of six years, during which time he served as Vice-President of *Thomas W. Berger, Inc.*, national sales and merchandising organization.

He served as Manager of major accounts at *Crosley* from 1937 until 1940.

* * *

SAMUEL C. MILBOURNE, formerly Chief Engineer for *Eastern Amplifier Corporation*, has joined the staff of *Streuber & LaChicotte* as Manager of the company's new engineering consulting and buying service, specializing in the electric, electronic, and motion picture fields.

Mr. Milbourne will function in connection with the company's new export buying service.

* * *

E. J. HENDRICKSON has been appointed Manager of the *Farnsworth Sales Division*.
(Continued on page 153)

RADIO NEWS

Don't Muff Your Chances in RADIO ELECTRONICS



**NEW DEVELOPMENTS
SPELL**

New Opportunities!

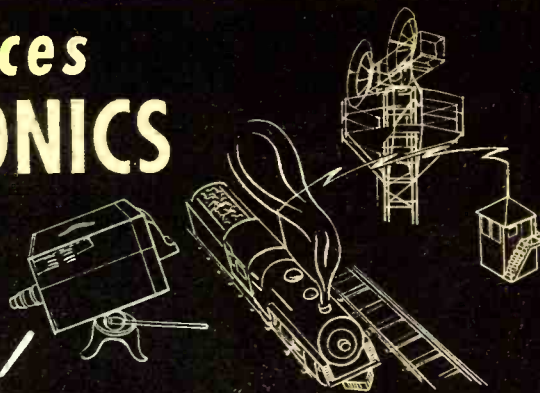

YOU MUST ADD TECHNICAL TRAINING TO YOUR PRACTICAL EXPERIENCE!

Old jobs as well as new ones in radio require new knowledge. To forge ahead you must "Know the WHY as well as the HOW." FM, Television, Micro-Wave Relay Systems, Mobile Communication Systems for trains, buses, automobiles, trucks—all these new techniques and many more mean new, better jobs for you who are qualified. Start your training NOW for one of those better, more exciting jobs in this New World of Electronics!

CLEVELAND INSTITUTE COURSES OFFER COMPLETE TECHNICAL TRAINING RANGING FROM LOW-LEVEL TO COLLEGE-LEVEL.

- A. Master Course in Radio Communication.** Covers complete preparation for broadcast station employment including preparation for FCC License Examinations.
- B. Advanced Course in Radio Communication Engineering.** A college-level Radio Engineering Course.
- C. Specialized Television Engineering.** Including post-war Television Techniques.

All Courses Include

The Remarkable Workbooks of Instructional Aids, prepared by the instructing staff of Cleveland Institute. Choose the course best suited to your needs—Start with the section you are qualified to enter—Use the economical CIRE "Pay-As-You-Go-Plan."

LET CLEVELAND INSTITUTE TAKE OVER YOUR PERSONAL UP-GRADING PROBLEM!

Qualified, competent instructors, ample, personalized instructional aids, orderly, progressively arranged study assignments in recognized, approved technical texts—these are only a few of the many superior advantages of CIRE's plan of personalized spare-time home study training for professional self-improvement.

ENROLL FOR INDIVIDUAL SECTIONS OF COURSES, IF YOU PREFER

If you need only highly specialized training, you can study one or more of the following sections instead of a complete course.

1. Mathematics of Radio.
2. Fundamentals of DC and AC Theory.
3. Essentials of Radio Communication.
4. Communication Networks.
5. Advanced Radio Telephony for the Broadcast Operator.
6. Audio and Radio Components and Systems (Design of Receiver and Transmitter Equipment).

CLEVELAND INSTITUTE OF RADIO ELECTRONICS

Contractors to the Canadian Broadcasting Corporation

RN-8 Terminal Tower
CLEVELAND 13, OHIO

Approved for Training under "G-I Bill of Rights"

(MAIL THIS COUPON)

Cleveland Institute of Radio Electronics, RN-8, Terminal Tower, Cleveland 13, Ohio.

Gentlemen: Please send information about your home courses in Radio Electronics.

NAME

ADDRESS

CITY

ZONE STATE

I desire training in A B C

I have had experience in broadcasting servicing

operating mfg. CAA Army-Navy

amateur other I am a

High School Grad. College Degree

Check here for Veteran Enrollment Information.

How To Pass
FCC
LICENSE
EXAMINATIONS

CLEVELAND INSTITUTE
OF
RADIO ELECTRONICS
Terminal Tower - Cleveland, Ohio

Don't Delay—
Write Today!

Approved for Veteran
Training under
"G-I Bill of Rights"

CLEVELAND INSTITUTE OF RADIO ELECTRONICS

Contractors to the Canadian Broadcasting Corporation

RN-8 Terminal Tower
CLEVELAND 13, OHIO

Get your FCC Commercial Radio Operators' LICENSE NOW!

IT'S EASY IF YOU FOLLOW OUR PLAN!

Thousands of new jobs are opening up—FM, TELEVISION, MOBILE COMMUNICATIONS SYSTEMS, are only a few of the radio fields which require licensed operators.

TIME IS IMPORTANT TO YOU!

You can get your License quickly with NILSON'S MASTER COURSE in RADIO COMMUNICATION and exclusive CIRE Workbooks of Instructional Aids. Saves you many hours or random, undirected study.

Assures a MINIMUM of time in getting your ticket.

FREE BOOKLET tells you the Government Requirements for all classes of commercial licenses—Sent immediately upon receipt of coupon.

MAIL THIS COUPON

CLEVELAND INSTITUTE OF RADIO ELECTRONICS
RN-8 Terminal Tower, Cleveland 13, Ohio

Gentlemen: Please send information about your Home Study Course for preparation for FCC Commercial License Examinations.

Name

Address

City Zone State

If a Veteran check here

NOW *One* INSTRUMENT FOR ELECTRONIC MEASUREMENTS

WESTON ELECTRONIC ANALYZER

Incorporating:

1. A conventional Volt-Ohm-Milliammeter with self-contained power source.
2. A high impedance electronic Volt-Ohmmeter using 115 volt, 60 cycle power.
3. A stable, probe-type, Vacuum Tube Voltmeter, for use to 300 megacycles.



Model 769

Accurate a-c measurements .25 volt to 120 volts, 50 cycles to 300 megacycles.

Extremely small R.F. Probe (3½" x ¾" dia.). Probe constants, 5 megohms paralleled by 5 mmfd., approx.

New unity gain d-c amplifier provides absolute stability with line voltage variations from 105 to 130 volts.

D-C Electronic amplifier ranges 3 to 1200 volts at 15 megohms, resistance ranges 3000 ohms to 3000 megohms.

Conventional 10,000 ohm per volt d-c ranges 3 to 1200 volts, 1000 ohm per volt a-c rectifier ranges 3 to 1200 volts.

Resistance ranges 3000 to 300,000 ohms where a-c power is not available.

Entire Model 769 protected from external RF influences.

Uses standard commercial types of tubes replaceable without recalibration.

Size only 10" x 13" x 6½".

Full details from your jobber or local WESTON representative. Literature available... Weston Electrical Instrument Corporation, 658 Frelinghuysen Avenue, Newark 5, New Jersey.

WESTON
Instruments

ALBANY • ATLANTA • BOSTON • BUFFALO • CHARLOTTE • CHICAGO • CINCINNATI • CLEVELAND
DALLAS • DENVER • DETROIT • JACKSONVILLE • KNOXVILLE • LITTLE ROCK • LOS ANGELES
MERIDEN • MINNEAPOLIS • NEWARK • NEW ORLEANS • NEW YORK • PHILADELPHIA
PHOENIX • PITTSBURGH • ROCHESTER • SAN FRANCISCO • SEATTLE • ST. LOUIS
SYRACUSE • IN CANADA, NORTHERN ELECTRIC CO., LTD., POWERLITE DEVICES, LTD.

Why Mallory-Made Vibrators make the Best Replacements:



MORE MALLORY-MADE VIBRATORS ARE IN USE TODAY THAN ALL OTHER MAKES COMBINED

There are excellent mechanical and engineering reasons why more Mallory-made vibrators are used in original equipment than all other makes combined.

TWELVE MALLORY VIBRATORS ANSWER 90% OF YOUR REPLACEMENT NEEDS

Make replacements easily and quickly. Thanks to the Mallory program of standardization, the number of vibrators you need to meet most of your requirements is materially reduced—only twelve in all.

MALLORY HAS A COMPLETE VIBRATOR LINE

In addition to the 12 basic units, Mallory also makes 39 other replacement vibrators so that even when you meet a rare or unusual service problem, your Mallory distributor can supply the answer. The Mallory line leaves nothing out—it's a complete line that rounds out your business.

See Your
Mallory Distributor
for a free copy of
the 1947 Replacement
Vibrator Guide.

P. R. MALLORY & CO., Inc.
MALLORY

VIBRATORS . . . VIBRAPACKS* . . . CAPACITORS . . . VOLUME CONTROLS . . . SWITCHES . . . RESISTORS . . . FILTERS . . . RECTIFIERS . . . POWER SUPPLIES.

*Reg. U. S. Pat. Off.

APPROVED PRECISION PRODUCTS

P. R. MALLORY & CO., Inc., INDIANAPOLIS 6, INDIANA

A BILLION ORDERS A DAY

In a large modern telephone office 2,000,000 switch contacts await the orders of your dial to clear a path for your voice. They open and close a billion times a day.

At first, contacts were of platinum—highly resistant to heat and corrosion but costly. Years ago, Bell Laboratories scientists began looking elsewhere, explored the contact properties of other precious metals—gold, silver, palladium and their alloys—and with the Western Electric Company, manufacturing unit of the Bell System, restudied shape, size and method of attachment.

Outcome of this long research is a bar-shaped contact welded to the switch and positioned at right angles to its mate. For most applications, an inexpensive base is capped with precious metal.

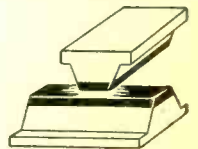

Savings from these contacts help keep down the cost of telephone service. This is but one example of how Bell Laboratories serve the public through your Bell Telephone Company.

An engineer examines contacts in a crossbar office. Horizontal bars seen in the crossbar switches select contacts which are then operated by vertical bars to establish talking paths between subscribers.

BELL TELEPHONE LABORATORIES



EXPLORING AND INVENTING, DEVISING AND PERFECTING, FOR CONTINUED IMPROVEMENTS AND ECONOMIES IN TELEPHONE SERVICE

RADIO NEWS

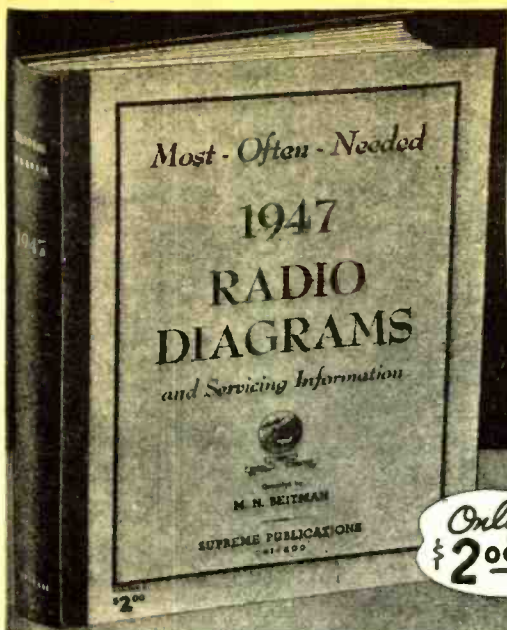

Supreme Diagram Manuals Cut Service Time in 1/2



Amazing Bargain Offer in Diagram Manuals

Repair double-quick any radio with the help of *Supreme Manuals*. In the newest 1947 volume you have large schematics, replacement parts lists, needed alignment data, voltage values, and information on stage gain, location of trimmers, and dial stringing, for almost all sets released between June 1, 1946, and March, 1947. A worthy companion to the six previous volumes used by over 100,000 shrewd radio servicemen. There is no need to spend large sums for bulky, space-wasting manuals or to buy additional drawings every few weeks — get these low-priced SUPREME PUBLICATIONS manuals and you have all the service information you will ever need. The 1947 volume covers 327 models of 52 different manufacturers. Large size: 8½ x 11 in., 192 pages + index. Manual style binding. Price, only \$2, post-paid. Send coupon for this and other manuals, or get SUPREME books at your radio parts jobber.

Use Supreme *Most-Often-Needed* Diagram Manuals, to service radios faster, better, easier, save money and time. At unbelievable low cost (only \$2 for most volumes) you are assured of having in your shop ready to help you with every job, diagrams and other essential repair data on 4 out of 5 radio sets you will ever service. Every popular radio of every make, from old-timers to new 1947 sets, is included. Old style T.R.F., midgerts, new portables, superhets, AM-FM, television, every type of radio made since 1926 to date is covered. Clearly printed circuits, parts lists, alignment data, and helpful service hints are the facts you need to speed up your servicing. Save hours each day, every day, let these seven volumes furnish diagrams for 80% of all sets. See pictures of these attractive manuals above. Each volume has between 192 and 240 pages, giant size 8½x11 inches. Manual style binding. No greater bargain ever offered. Send coupon today. Complete satisfaction guaranteed.

Post-War Automatic Record Changers

Service expertly all new (1945-1947) record changers. Follow simplified factory instructions to make needed adjustments and repairs. Hundreds of photographs and exploded views; thousands of test hints; service instructions for all popular makes. Large size: 8½ x 11". 144 fact-filled pages. At your jobber or postpaid, only **\$1.50**

Pre-War Record Players Changers, & Recorders

Just what you need to repair quickly thousands of pre-war automatic record changers, pick-ups, recorders, wireless oscillators, manual units, and combinations. Many hundreds of mechanical and electrical diagrams. Instructions for adjustments and repairs. Most popular units of all makes. 128 large pages 8½ x 11 inches. Price, only **\$1.50**

Circuits of Every Make

R.C.A., Zenith, G.E., Philco, Sears, Pada, Detrola Radio, United Motors, Majestic, Arvin, Westinghouse, Stewart-Warner, Delco Admiral, Western Auto, Wards, Emerson Radio, Gamble, Motorola, Belmont, Crosley, Sparton, and many other makes.

See Your Radio Jobber or Write →

Supreme Publications

PUBLISHERS OF RADIO BOOKS, MANUALS, AND DIAGRAMS

9 South Kedzie Avenue • Chicago 12, Illinois

August, 1947

NO RISK TRIAL ORDER COUPON

SUPREME PUBLICATIONS, 9 S. Kedzie Ave., Chicago 12, ILL.

Ship the following manuals: (Money back guaranteed)

1947 1946 1942 1941 1940 1939 1926-1938

Price each volume only \$2.00, postpaid \$2.50

Post-War Automatic Record Changers, \$1.50.

Pre-War Record Players, Changers, & Recorders, \$1.50.

I am enclosing \$..... send postpaid.

Send C.O.D. I am enclosing \$..... deposit.

Name:

Address:

CAPITOL RADIO ENGINEERING INSTITUTE
 - Where Professional Radiomen Study

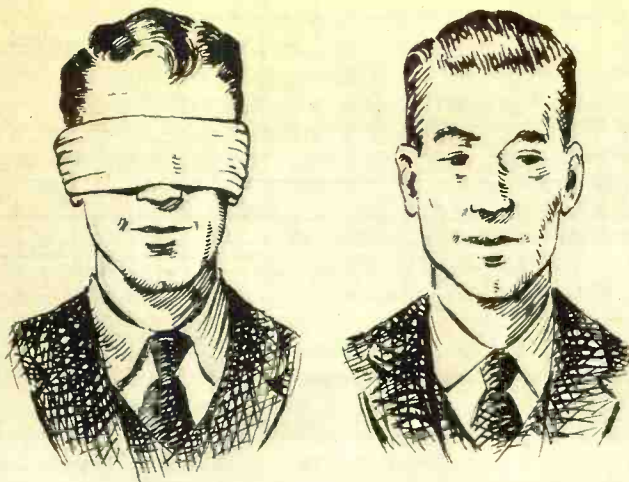

Which Will Get the Better Job?

The Radioman Who Looks Ahead Will Get Ahead

Don't play blind man's bluff with your future! Are you, like many other professional radiomen, so wrapped up in your present routine work that you are losing sight of where you will be tomorrow?

Look at the successful radioman. You'll find that he's the fellow who looked and *planned* ahead. Today, as a member of the great radio-electronic industry, you have opportunities that few men ever enjoyed in the past. Your future success can be assured by the plans *you* make *today*.

The radio industry is expanding so fast, that it is doubtful any radioman can truthfully say he has kept pace with all the major developments. Thousands of new men have joined the ranks of the radio industry creating new competition for you. New developments create demands for more advanced technical ability. You can't afford to be

a "pre-war model". You must "re-tool" your technical knowledge in order to keep pace.

If you are wise, you will look ahead and start now to increase your technical ability with the thorough, practical technical training for which thousands of professional radiomen have enrolled with CREI since 1927. In our proved method of instruction, you learn not only "how", but "why". This is real, honest-to-goodness practical engineering training that leads to better jobs and security in the knowledge that you are capable of coping with tough problems of communications and industrial electronic equipment.

It costs you nothing to read the interesting facts. Please write today.

VETERANS! CREI TRAINING AVAILABLE UNDER THE "G.I." BILL!

MAIL COUPON FOR FREE BOOKLET

If you have had professional or amateur radio experience and want to make more money, let us prove to you we have the training you need to qualify for a radio job. To help us intelligently answer your inquiry—PLEASE STATE BRIEFLY YOUR BACKGROUND OF EXPERIENCE, EDUCATION AND PRESENT POSITION.



CAPITOL RADIO ENGINEERING INSTITUTE
 16th & Park Rd., N.W., Dept. RN-8, Washington 10, D.C.

Gentlemen: Please send me your free booklet, "CREI Training for Your Better Job in RADIO-ELECTRONICS", together with full details of your home study training. I am attaching a brief resume of my experience, education and present position.

Check PRACTICAL RADIO ENGINEERING
 Course PRACTICAL TELEVISION ENGINEERING

NAME.....

STREET.....

CITY..... ZONE..... STATE.....

I am entitled to training under the G.I. Bill.

Capitol Radio Engineering Institute

An Accredited Technical Institute

DEPT. RN-8 16TH AND PARK ROAD, N. W., WASHINGTON 10, D. C.

Branch Offices: New York (7): 170 Broadway • San Francisco (2): 760 Market St.



FREE

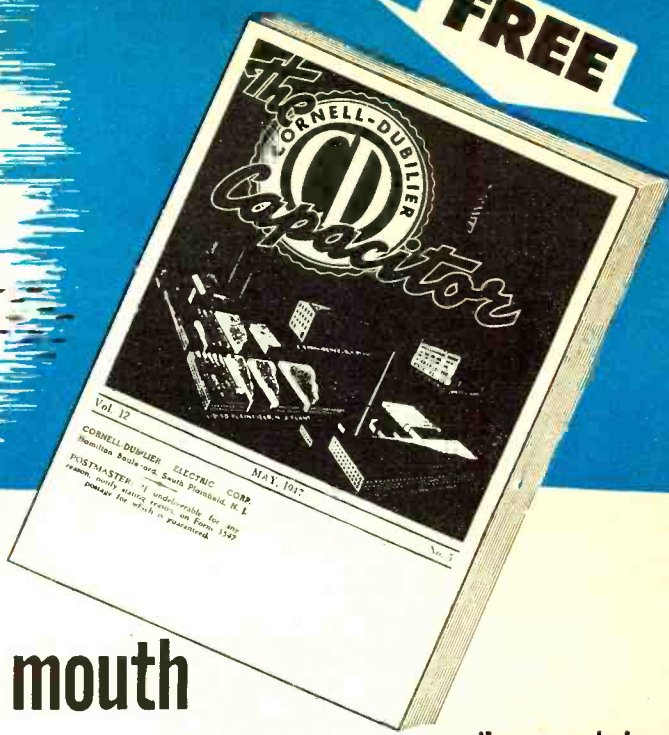

tips right out of the horse's mouth

The editor of "The Capacitor" probably won't like being referred to as a "horse's mouth." However, that's only our way of "plugging" the scores of hot ideas for servicemen that he includes in every issue of "The Capacitor."

mail coupon below
for your free
subscription to the
C-D capacitor

Here's a magazine that's published for servicemen only. Every month it is loaded with ideas for speeding up service procedures — for increasing store traffic — for adding new dollars to your income. Its convenient, pocket-size pages contain valuable technical data — information on the new type tubes — notes on trouble shooting. Yes, and also dozens of helpful hints that will help you to repair any radio ever made, easier, better and twice as fast.

Accept "The Capacitor" with C-D's compliments. Put it to work in your shop speeding up repair jobs — building bigger profits. *Don't wait! Mail coupon below NOW, so your FREE subscription will start at once!* Cornell-Dubilier Electric Corp., Dept. RN-8, South Plainfield, New Jersey.

TITLES OF ARTICLES IN RECENT ISSUES — These articles are typical of the ones you'll find in "The Capacitor" every month: *How to Use Audio Oscillator and Signal Generator to Simplify Tests* — *New Requirements of FM and Television Servicing* — *Hum Elimination* — *Aligning Superhets*. Think how such articles will help you — mail coupon NOW.

FINDS "THE CAPACITOR" OF GREAT INTEREST — Washington, D. C. service shop owner writes, "I wish to thank you for mailing me 'The Capacitor.' The special items are of particular interest because of their easy reading and their simplification of complex circuits."

FREE ADS FOR SERVICEMEN — Yes, that's right — your ad will be run absolutely free in The Trading Post which appears in all issues of "The Capacitor." Use this service to buy that new tester you've been wanting — to sell that spare 'scope — or to work out a swap with other servicemen.

- MICA
- DYKANOL
- PAPER
- ELECTROLYTIC

1910  1947

CORNELL-DUBILIER
WORLD'S LARGEST MANUFACTURER OF
CAPACITORS

CLIP THIS COUPON — MAIL AT ONCE

Cornell-Dubilier Electric Corporation Dept. RN-8
South Plainfield, New Jersey

Please start my FREE subscription to "The Capacitor" at once.

Name.....

Address.....

City..... Zone..... State.....

YOUR REPORT

RST=5-9-9X



with the

FOUR-20

T R A N S M I T T E R

● You can be on the air with the Four-20

Transmitter five minutes after it is unpacked. All you need is a crystal and a key and you are all set to go with a full 20 watts output at the antenna terminals.

Stability is assured by an improved oscillator circuit that allows less than five milliamperes of R.F. current to pass through the crystal. A special resistor network keeps the load on the transmitter constant with the key up or down.

And in the Four-20 the matching problem is solved by the special output coil which will match any transmission line from 50 to 600 ohms.

You will be amazed when those reports come in—**RST=599X**.



Write for Descriptive Booklet

For phone operation use the *FOUR-11*
Modulator, companion unit to the *FOUR-20*



HAMMARLUND

THE HAMMARLUND MFG. CO., INC., 460 W. 34TH ST., NEW YORK 1, N. Y.
MANUFACTURERS OF PRECISION COMMUNICATIONS EQUIPMENT

ROBOT TELEPHONE

By **LEON LADEN**
London, England

Swiss-invented automaton known as the Ipsophon extends customary telephone communications facilities to include remarkable new electronic features.

AT AN all-inclusive rental fee of about 40 dollars a month, Americans will share before long with the Swiss and the rest of the world a robot telephone which electronically answers, remembers, and reveals messages recorded automatically during one's presence in, or absence from, home, office or store.

This extraordinary device, called the *Ipsophon*, is connected with the public telephone system in the same way as the ordinary telephone apparatus but, in addition to providing the customary communications facilities, acts as a dependable, critical two-way brain to everything coming through the line when the receiver is not picked up after the bell has rung four times in succession.

The equipment described was invented, developed, and perfected for everyday use by a team of engineers and physicists at the Research Division of the Oerlikon Machine-Tool Works of *Bührle & Company*, near Zürich, Switzerland, and is currently being produced in serial manufacture for installation throughout the network of the Swiss Telephone Service.

Principles of Operation

The basic concept of the *Ipsophon* is neither new nor spectacular. Projects to extend and amplify the communications facilities of the ordinary telephone in respect to time and space have been discussed frequently in the past and are as familiar to American telecommunications engineers as to their European contemporaries. In fact, the earliest recorded experiments on telephonographs, as these devices were originally named, date back to the end of the last century.

August, 1947

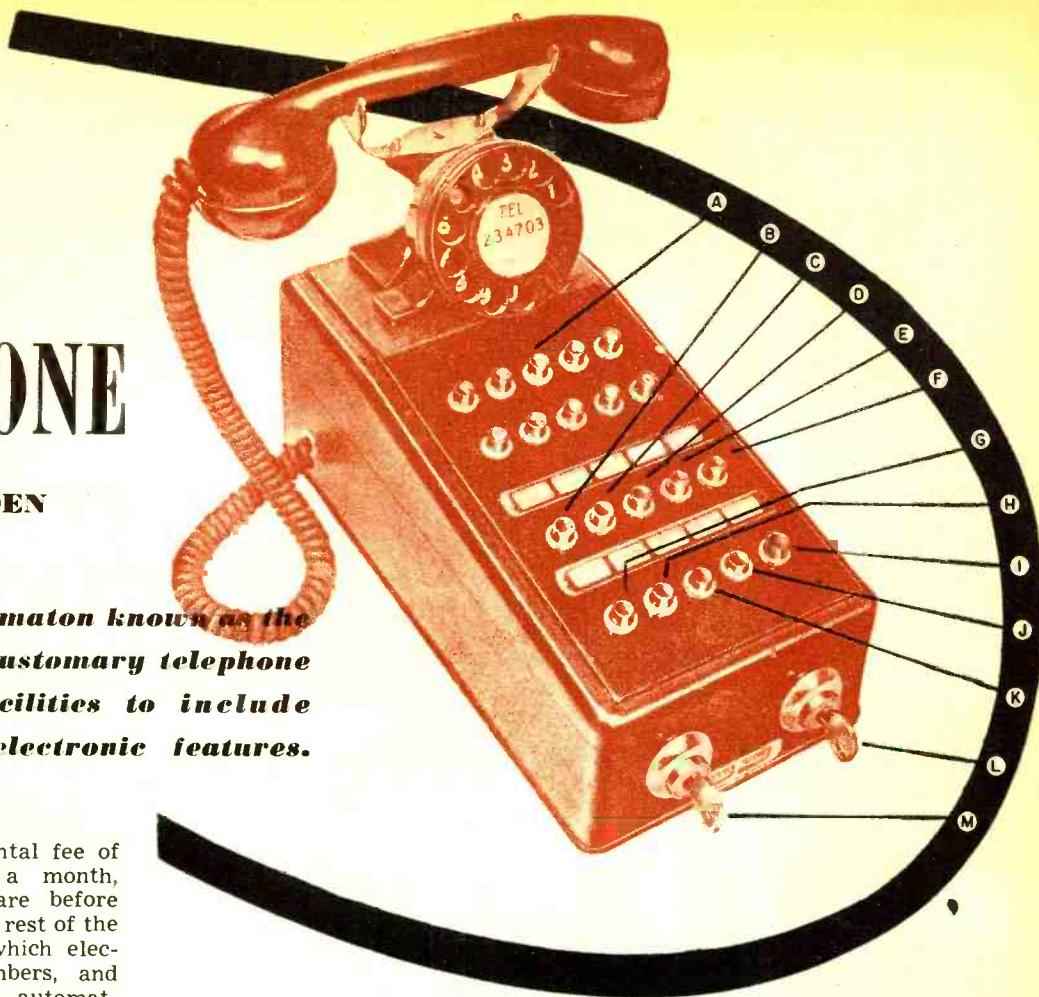

Push-button type keyboard is used with the Ipsophon. The various tele-control operations are: (A) buttons 1 through 0 for fixing code key, (B) button for external line, (C) button for internal line, (D) press-to-link telephone lines with Ipsophon, (E) press-to-record conversations on ordinary telephone line, (F) press-to-listen to conversations being recorded, (G) press-to-record messages or dictation, (H) press-to-listen to messages recorded by Ipsophon, (I) call button for internal installations, (J) push-to-erase recordings on Ipsophon, (K) press-to-repeat at will, (L) key for fixing internal line buttons, (M) secret code key.

But progressive efforts to design a workable telephonograph which could automatically accept incoming calls during one's absence, or whenever for one reason or other it was inconvenient to answer personally, presented formidable technical obstacles in practical application as long as no really efficient medium was available for recording, reproducing, and cancelling the spoken word.

Recent progress in the recording of sound for news services, broadcasting, and films, however, has led to the development of the magnetic metal tape or wire recording process—a durable as well as practically noise-free sound carrier system—ideally suited for the purpose.

As is well known, the physical principle of this process is based on the fact that longitudinal or transverse magnetization of a steel tape or wire takes place as it is drawn at constant speed past the poles of electromagnets. Adapted to the recording of messages in the *Ipsophon*, the magnetic sound system transforms the voice frequency variations into current variations

which are fed to the coils of a small electromagnet. A thin moving wire of specially treated steel is drawn past this electromagnet and is magnetized according to the current intensity in the coil. The wire remains magnetized as long as desired for reproducing the spoken word. When needed, these voice frequencies are passed on to the receiver for audible reproduction in the earphones. The magnetism in the wire may be subsequently wiped out by magnetic cancellation.

Thus, there is no wear of either the wire or the reproducer even when the recorded messages require innumerable reproductions because cancellations proceed without mechanical alteration of the wire. In practical application, this means that a recorded message can be reproduced almost indefinitely and a wire reused for any number of recordings after prior cancellation.

Nevertheless, a telephonograph whose automatically recorded messages could only be heard by the subscriber through the device itself would, undeniably, make listening-in ex-

tremely tiresome and necessitate physical presence or the aid of servicing personnel.

To eliminate this contingency, and ensure that local and long-distance calls are communicated direct to the subscriber over the ordinary telephone at all times without delay or unauthorized "tapping," an ingeniously uncanny device is used, known as the acoustic code key.

This device operates not unlike the combination lock on a safe door.

For locking purposes, it merely requires the pressing down of selective buttons on a self-locking, ten-number keyboard which may be arranged to form any one of 1023 different possible cipher combinations.

On the other hand, to make the *Ipsophon* reveal on call from an outside telephone the message entrusted to it, the caller must give the previously selected cipher combination when ringing up his own number. This is done by him acoustically by emitting two vocal impulses at given intervals of time, which set in motion electronical-

ly-controlled cams linked with the sound carrier of the call system, thereby activating corresponding relay and contact switches to open or close the appropriate reproduction, recording, or cancellation circuits.

Practical Application

To illustrate the actual operation of the *Ipsophon*, let us assume that a Mr. Brown is expecting an important confidential call from his friend and business associate, Mr. Black.

Before leaving his home, therefore, he sets the acoustic code combination key on the *Ipsophon* to form, say, the cipher 520.

Some time later, Mr. Black, on dialing his friend's telephone number, receives no reply.

Undismayed, Mr. Black holds the line until the bell at the other end has rung four times in succession and the instrument emits, of its own accord, the words:

"Hello, hello. This is the residence of Mr. Brown (address follows). This is Mr. Brown's *Ipsophon* speaking.

Your call will be recorded automatically. Ready? Please start speaking now!"

From that moment onwards, the instrument acts as Mr. Brown's proxy and faithfully listens to everything Mr. Black is saying, recording it word for word, sentence after sentence.

As soon as Mr. Black has finished speaking and has replaced the receiver, the line is clear for other callers.

Mr. Brown, who at about that time may be anywhere in or out of the country but still wants to know whether his friend and/or anyone else has rung up during his absence, picks up a telephone and dials his own number.

When the connection has been made, he hears the electronic voice emit the already familiar reply:

"Hello, hello. This is the residence of Mr. Brown (address follows). This is Mr. Brown's *Ipsophon* speaking. Your call will be recorded automatically. Ready?"

Immediately after hearing the word "Ready?", and before the instrument can proceed with the last sentence, Mr. Brown says twice, very distinctly, the words "Hello, hello."

Instead of continuing the announcement with the phrase "Please start speaking now!", the *Ipsophon* this time emits, at intervals of about two seconds duration, the range of numbers . . . 1 . . . 2 . . . 3 . . . 4 . . . 5 . . . 6 . . . 7 . . . 8 . . . 9 . . . 0.

Remembering that the cipher combination he arranged on the acoustic code keyboard before leaving his home was 520, Mr. Brown passes this secret number on to the electronic robot acoustically by repeating the words "Hello, hello" immediately after hearing each one of the relative numbers —5, 2 and 0—coming from the *Ipsophon*.

On completion of this code number, the instrument starts repeating without further ado all messages recorded during Mr. Brown's absence, reproducing separate calls in consecutive order of call at intervals of from 2 to 4 seconds and announcing the end of reproductions by a high-pitched note.

Special Features

When reproduction of all recordings has terminated, the instrument again emits a buzz. If the caller, immediately after hearing it, emits two vocal impulses by saying "Hello, hello," he can then dictate his answers to the messages just received.

This tele-answering facility is, of course, particularly valuable whenever the instrument is shared by two or more business partners living miles apart in different localities.

Equally, the tele-cancellation of all recorded messages can be carried out with the utmost simplicity by merely uttering the word "Cancel" into the microphone at the end of reproductions.

Another notable feature of the unit is the use of two separate sound carrier communication units; the first of these provides a recording capacity of

Fig. 1. Schematic diagram shows operation of main functions (recording, reproducing, and erasing) performed by *Ipsophon*.

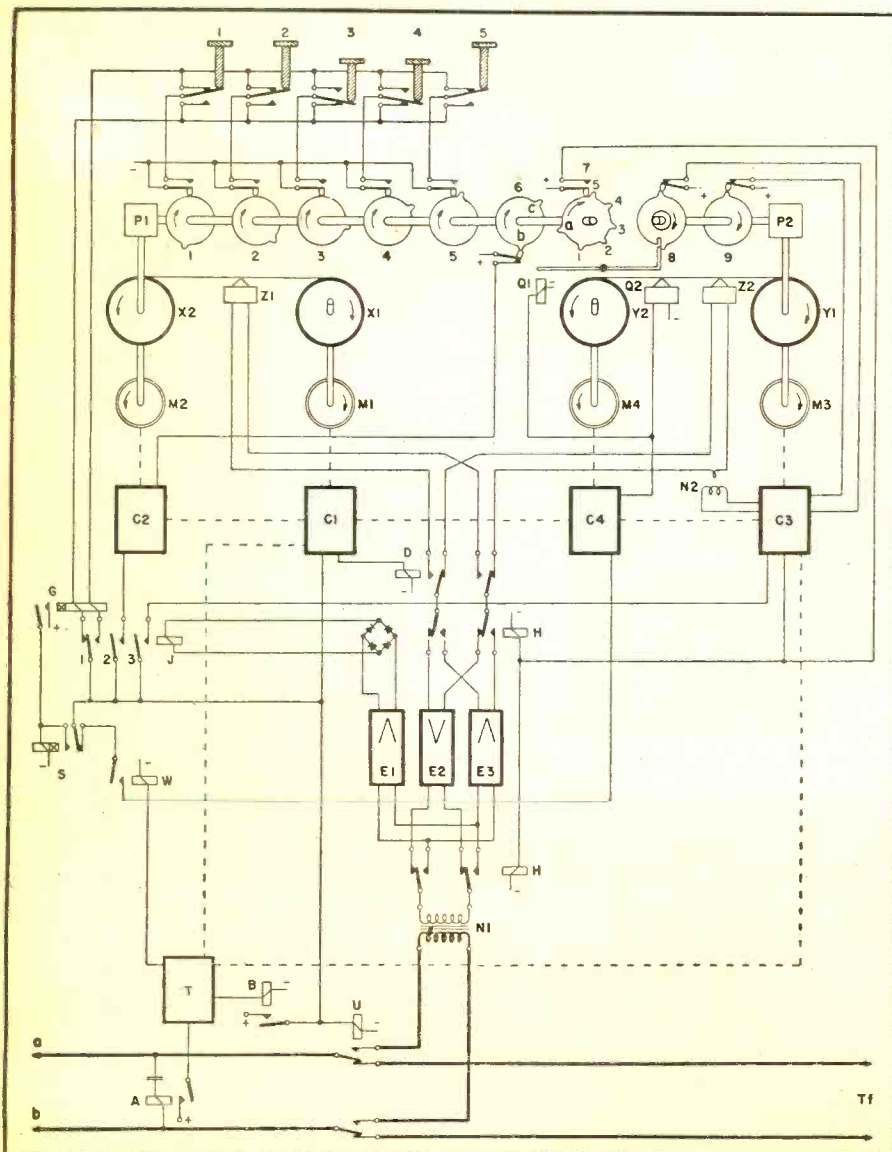

five minutes and the second one of twenty-five minutes. This means that the total recording capacity of the instrument—a half hour—is almost always available, since as soon as the capacity of the first recorder has been exhausted, the second unit automatically takes its place. Moreover, while one recording unit is occupied by reproduction, the other one is simultaneously rewound at quintuple speed, so that even when the recording capacity is being utilized to the full, it is never necessary to wait more than a minute for commencement of reproduction.

The diagram (Fig. 1) illustrates the control layout of the main functions performed by the *Ipsophon*. Since the automatic section alone comprises 74 relays, a complete blueprint of the entire instrument would involve a wealth of detail inimical to clarity. This diagram, therefore, is confined strictly to the connections necessary for carrying out the actual process of recording, reproducing, and cancelling the spoken word by vocal impulses from a distance.

This is done as follows:

The *Ipsophon* is connected to the telephone circuit at the two terminals *a* and *b* (Fig. 1). The relay *A*, wired in parallel with the calling bell of the telephone receiver *T*, is excited at each call, transmitting to the timing device, *T*, direct current impulses coinciding with the ring tones. This timing device, *T*, checks whether four ringing tones mature, which happens unless the receiver is lifted by the subscriber. The timing device engages the relay *B*, setting the mechanism of the *Ipsophon* in motion. The closing of the contacts of relay *B* switches the service line through to the repeater *N*, through the relay *U*. The motor control mechanism *C* is then engaged. *C*₁ excites relay *D*, which shunts the sound head *Z*₁ onto the terminals of the output amplifier *E*₂. *C*₁ starts up motor *M*₁, controlling the feed of the spool *X*₁, which carries the sound recording element. The spool *X*₂ is set in motion by the sound recording wire, as a result of which the reduction gear *P*₁ begins to drive the cam-shaft with the cam-discs 1 to 7. Immediately after being set in motion, cam No. 6 opens its contact, thus setting in operation (in motor control mechanism *C*) the timing device, in agreement with the impulses sent out by the relay *J*. The feed of the sound recording wire releases (through the sound head *Z*₁, the amplifier *E*₂, the repeater and the service line) the announcement, whose wording is fixed once and for all, made to the inquirer in the following terms:

"Hello, hello. This is the residence of Mr. Brown (address follows). This is Mr. Brown's *Ipsophon* speaking. Your call will be recorded automatically. Ready?"

After the word "Ready?", cam 7₂ switches the amplifiers *E*₁ and *E*₂ over, through relays *H*, for a period of 3 seconds, to their recording position. If the inquirer remains silent, the bal-

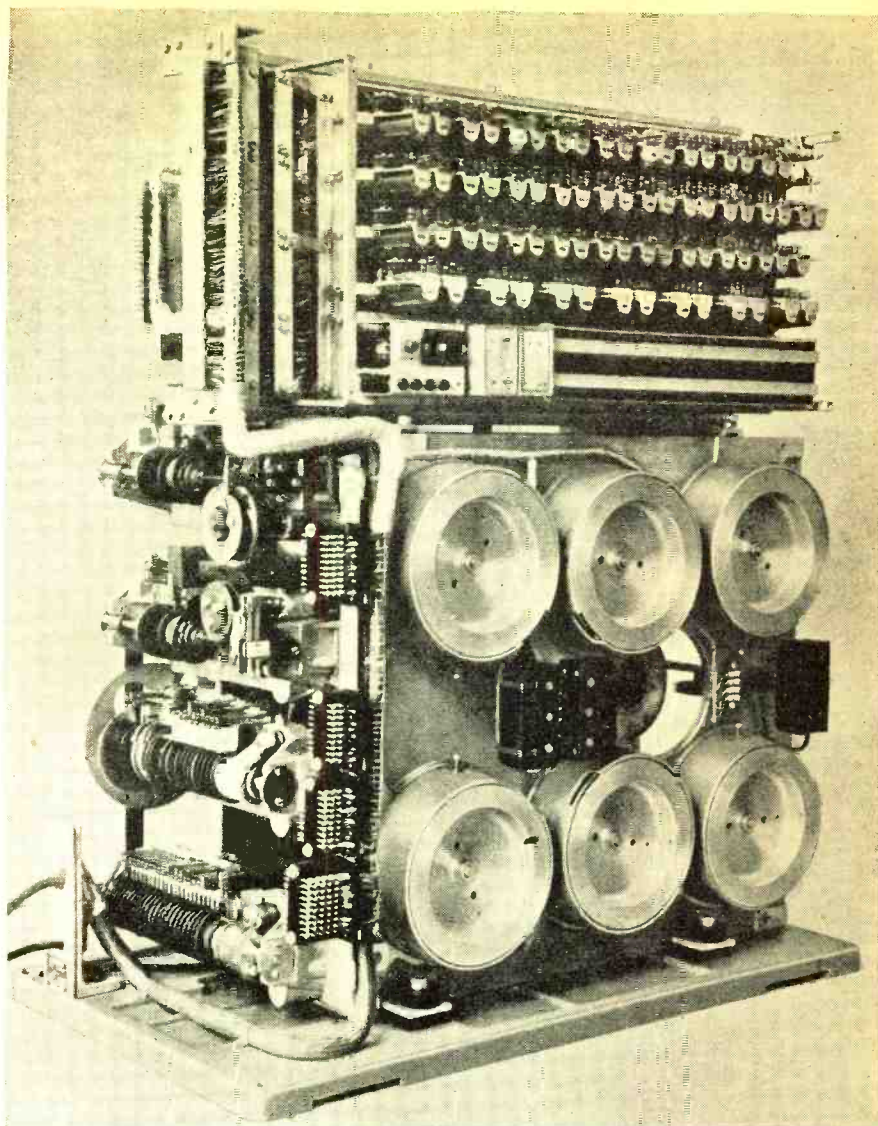

Recording apparatus with sound carrier and sound heads. When set in motion, the various relays and contact switches open or close circuits electronically.

ance of the announcement, after amplifier *E*₂ has been switched on again, is communicated to the inquirer in the following terms:

"Please start speaking now!"

After this sentence has been pronounced, cam 6 again closes its contacts, thus stopping motor *M*₁, through *C*₂ and *C*₁, and simultaneously switching on motor *M*₂, which controls the reverse motion of the sound recording wire. This movement is interrupted by cam 6₂. At the same time, *C*₂ engages motor control mechanism *C*₃, which controls the feed of the recording unit.

*C*₃, through relays *E*, switches over amplifiers *E*₁ and *E*₂ to recording, and *M*₂ takes care of the feed of spool *Y*₁, which carries the sound recording wire. The cam-disc 9, driven through the reduction gear *P*₂, opens its contact immediately after being started up, while cam-disc 8, mounted on a friction clutch, is held in its initial position by the pawl. The sound recording wire drawn along by *Y*₁ is magnetized by the sound head *Z*₂ (which is connected to *E*₁) in accordance with the vocal frequency applied. The im-

pulse relay *J*, connected to amplifier *E*₁ through a current rectifier, supervises the arrival of the speech impulses. *C*₃ remains in engagement as long as the caller continues to speak. At the end of the call, the caller rings off. Since the relay *J* receives no further impulses, the timing device *T*, through *C*₂, measures off an interval of 12 seconds. If during this period, relay *J* is not again excited, the device *T* drops again, thus switching *C*₃ out of circuit and bringing about, as a result of the dropping of relay *U*, the switching back of the service line to the ordinary telephone receiver. The entire instrument is then back in its position of rest.

The same operations are repeated for each fresh recording, cam-disc 9 performing each time a rotary movement within the limits of an angle corresponding to the duration of the recording.

When the subscriber rings up his own number for the purpose of hearing calls recorded during his absence, he hears the usual announcement

(Continued on page 102)

A CAPACITANCE TEST BRIDGE

Front panel view of home-built test instrument. The main control is R_{12} . To the left is S_1 , and to the right, from top to bottom, are R_1 , S_2 , and S_3 .

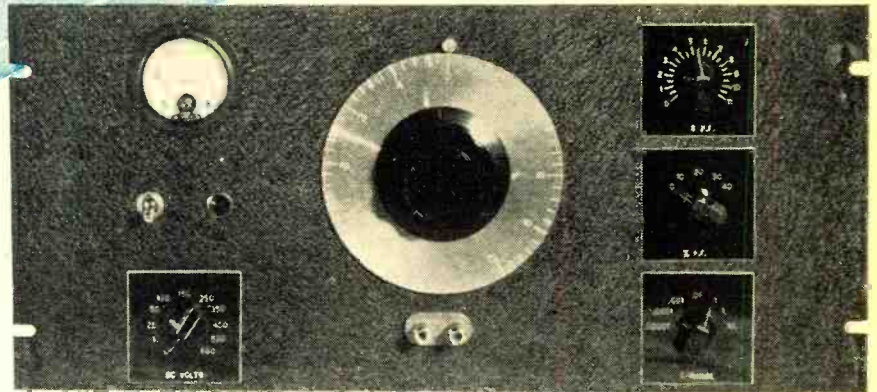

By

JOHN M. HEINRICH

A direct reading test instrument. Condensers ranging from 1 $\mu\text{fd.}$ to 100 $\mu\text{fd.}$ can be analyzed accurately under simulated operating conditions.

MOST servicemen have occasion to use a capacitance test bridge and one which can be built easily and inexpensively becomes a doubly welcome addition to the test bench equipment in a service shop.

The heart of this instrument is a modified general purpose bridge. Its advantages over the Wien bridge are that a single standard can be used for extremely wide ranges of measurement, each range varies in decade steps, and a polarizing voltage can easily be applied across the unknown without affecting the bridge or accuracy. As with any precision equipment, the factors of accuracy and re-

liability depend solely upon reliably stable and accurate bridge elements, and painstaking care in calibration. The fact that resistive elements are used to change the range simplifies both design and calibration in that it is usually much easier to determine the value of resistive elements as compared to that of reactive elements. The circuit is neither critical nor complex, but extreme care must be used in wiring for optimum results. Strong and solid construction is also a necessity that should not be casually overlooked.

In the original instrument the standard condenser (C_1) is a high quality

mica with a rated capacity of .01 $\mu\text{fd.}$ and a working voltage of 2500 volts. The actual measured capacity is .011 $\mu\text{fd.}$ The variable resistance (R_{12}) is a General Radio, type #314 potentiometer rated at 10,000 ohms, and a measured value of 9165 ohms. In any duplications of this instrument, it is suggested that the constructor try to match the resistance to the standard condenser instead of the reverse. Both time and expense can be reduced to a minimum in a search for the correct value of the standard.

This ratio of resistance to capacitive reactance, approximately 1 to 25 on the high end of the capacity dial and 1 to 250 on the low end, was experimentally found to give optimum results for both capacity and power factor measurements. A higher ratio will tend to slightly, but unnecessarily, increase the null point sensitivity for capacity measurements, but it will also, at the same time, decrease the power factor sensitivity. A smaller ratio will tend to generally decrease the over-all bridge sensitivity and drag the null point over a considerable portion of the dial. This combination begins showing the approaching null point three divisions removed either side of balance, and between 1 and 10 of the capacitance dial introducing 10% power factor causes the meter indication to decrease 80%. These features add considerably to the over-all accuracy of measurements. However, between 0 and 1 of the capacitance dial, the capacity null point is extremely sharp and the power factor determinations are almost as insensitive. Neither type of measurement is recommended in this portion of the dial.

The power factor control is a 25,000 potentiometer (R_1) and the decade resistors (R_2 , R_3 , R_4 , R_5) are 24,000

Over-all performance data for the test bridge.

Capacitance Range: 1 $\mu\text{fd.}$ to 100 $\mu\text{fd.}$ in seven decade ranges. Values are read directly from a linearly calibrated dial and multiplier switch.

Capacitance Accuracy: Within 2% over the main decade (1-10) of the dial for all ranges. On the lowest range, if the zero capacity of the bridge is taken into consideration (1 $\mu\text{fd.}$), the same accuracy can be maintained if the unknown is connected directly to the terminal posts. On this range this method is recommended.

Power Factor Range: 0-50% in five decade ranges. Values are read directly from a linear potentiometer scale and a decade selector switch. Total power factor equals the sum of the two readings. The variable element covers 10% power factor and the selector switch introduces four 10% increments. In this way an extremely high degree of accuracy can be main-

tained as compared to conventional methods.

Power Factor Accuracy: Dependent upon the accuracy of the standard condenser and the tolerance of the resistances. With care an accuracy to within 2% can very easily be secured.

Voltage Applied to Unknown: Varies continuously with the setting of the bridge. For small capacities it is approximately 30 volts and decreases with range so that at 100 $\mu\text{fd.}$ it is approximately 1 volt r.m.s.

Polarizing Voltage: A built-in power supply provides up to 600 volts d.c. in ten steps.

Controls: Capacitance dial, capacitance multiplier switch, power factor control, power factor decade switch, polarizing voltage selector switch and power switch.

ohms, 1 w. units. In any duplication of this instrument, the correct total value, for the series fixed resistors and the potentiometer, for 50% power factor measurement will be equal to $\frac{1}{2}$ the reactance of the standard condenser at the bridge frequency.

The seven range resistors are all 2 watt units padded out to the correct value. With this setup it is possible to keep the error as low as .6% for all ranges.

The terminal insulators are low-loss *General Radio*, type 274-Z, and the terminal posts are also *General Radio*, type 138-VD.

The bridge supply transformer is a government surplus driver transformer for 2A3's to 100TH's. The full primary winding is connected across the a.c. line, but only the outer half of the split secondary is used to supply the bridge outfit. The series condenser (C_6), 3 μ fd., 1000 v., is to limit the voltage across the unknown condenser for the highest ranges; to protect the transformer in case the terminal posts are shorted, especially on the last three highest ranges; and to prevent the polarizing voltage from being shorted out by the transformer winding. The voltage rating of this condenser must be greater than the polarizing voltage to be applied since

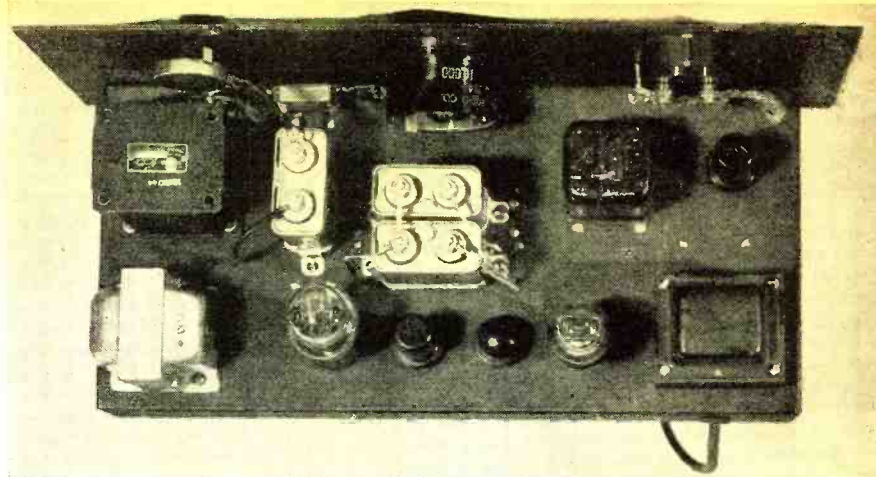

Top view of completed test instrument. The relative placement of component parts is important and should be followed as closely as possible.

this voltage appears across the condenser. The value is not critical and can be increased (capacity and working voltage) to increase the null sensitivity of the bridge on the last range. The resistance side of the bridge should be grounded to prevent body capacity from affecting measurements, as well as to stabilize the lower ranges. This grounded side will produce the least

stray capacity across the terminal posts and this feature should be duplicated for that reason. The resulting stray capacity, after calibration of the instrument, measured only 1 μ fd., whereas without a ground it increased to approximately 12 μ fd.

The choke, CH_1 , is also a government surplus item. Its value is neither
(Continued on page 148)

Schematic diagram of a.c. operated capacitance test bridge. Parts are easily obtainable or are to be found in most junk boxes.

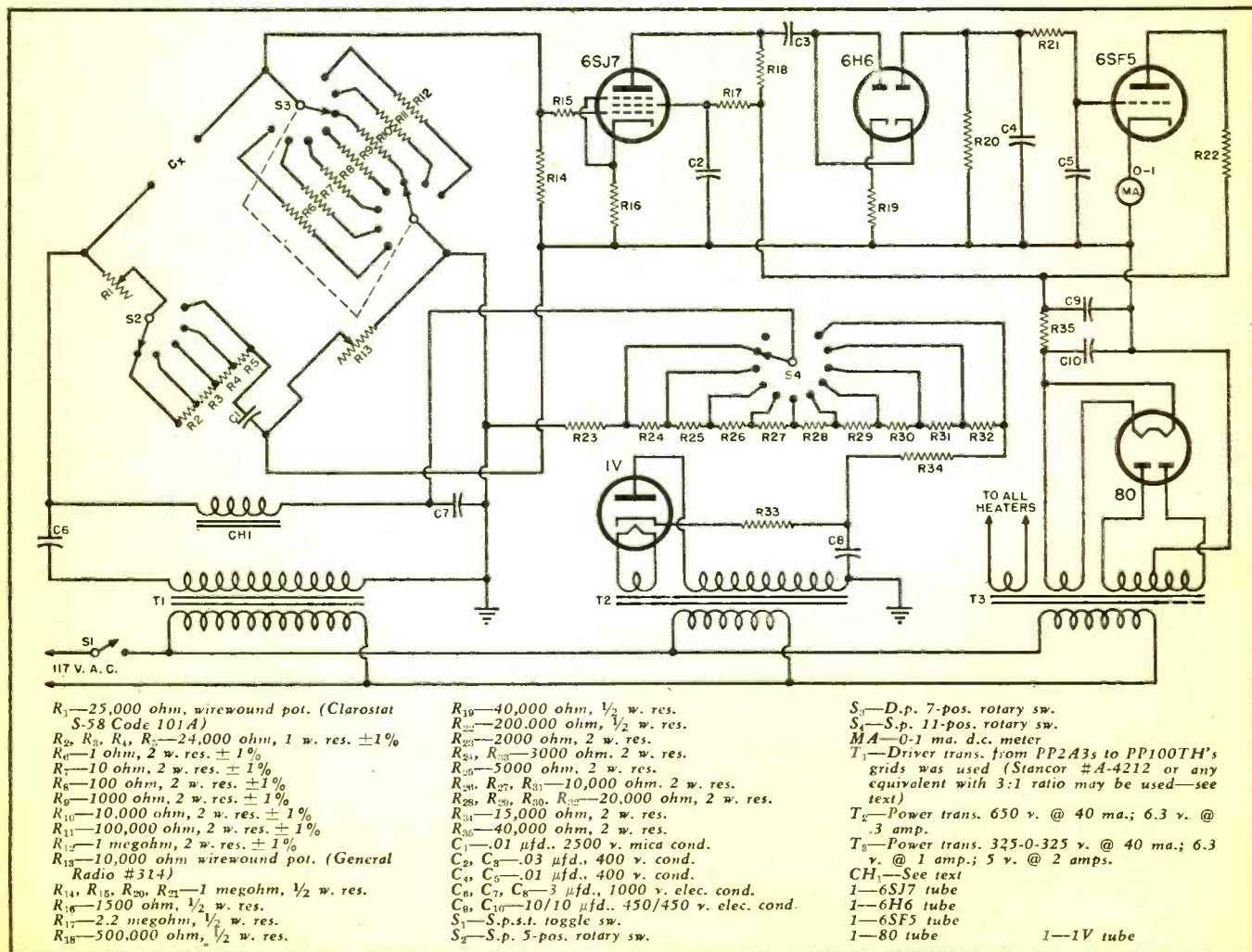

Antenna Loading Problems and Solutions

By J. T. GOODE

Asst. Chief Eng., Packard-Bell Co.

Standard panel light bulbs are the only pieces of equipment required to properly match antenna to transmitter.

ANYONE who loads a transmitting antenna for the first time soon finds out there is considerably more to the problem than what appears on the surface. The necessity of a proper match for transferring electrical power is a well established fact. Ways and means of accomplishing this result are numerous. To the engineer holding a college degree, the problem is purely mathematical. To the newcomer in radio, the problem is normally solved by an infinite number of experiments which result in a questionable answer. This same type of answer may be experienced by the en-

gineer if he relies wholly on mathematics to create the proper match.

When a transmitter is correctly matched to an antenna, the mathematical solution is achieved. Mathematical solutions to such problems deal with all circuits in a perfect state, which is seldom possible. Such being the case, the engineer must be in a position to decide where a compromise can be made in the effort to obtain perfection. The purpose of this article is to show short cuts with various r.f. loading problems.

Many different types of low impedance transmission lines are now avail-

able. The first thing to keep in mind is that the proper impedance transmission line is required for different types of antennas. For instance, a folded dipole type antenna requires a 300-ohm transmission line for proper termination. The proper transmission line for a doublet antenna is 72 ohms.

Assuming that the proper impedance transmission line has been selected for a particular antenna, the next step would be proper termination at the transmitter end. Commercially constructed pickup coils are now available with a known impedance. If such a coil is not used, the correct number of turns can be established by experimentation.

Assuming the antenna is erected and the transmission line terminated on both ends to the best of your ability, the next move will be to make final adjustments and to determine that the adjustments are giving a maximum transfer of power from the transmitter to the antenna.

Proper termination on the antenna end of the transmission line can only be obtained when the antenna length is a half wavelength at that particular frequency. When the transmitter frequency is shifted above or below this center point, a noticeable decrease in transmitter load will result. Antennas naturally take a maximum load at one frequency, so as the frequency is changed two things cause the antenna loading properties to decrease—mismatch of the transmission line and incorrect antenna length for the particular frequency.

Although there are many methods of making final adjustments on an antenna, the author selects the following for reasons that can be readily understood, namely, economy and accuracy with a minimum amount of time and effort.

The use of two sensitive r.f. microammeters is perfectly satisfactory for the following adjustments, but the

(Continued on page 108)

Fig. 1. Pilot lights used to match doublet antenna (A) and off-center Hertz antenna (B).

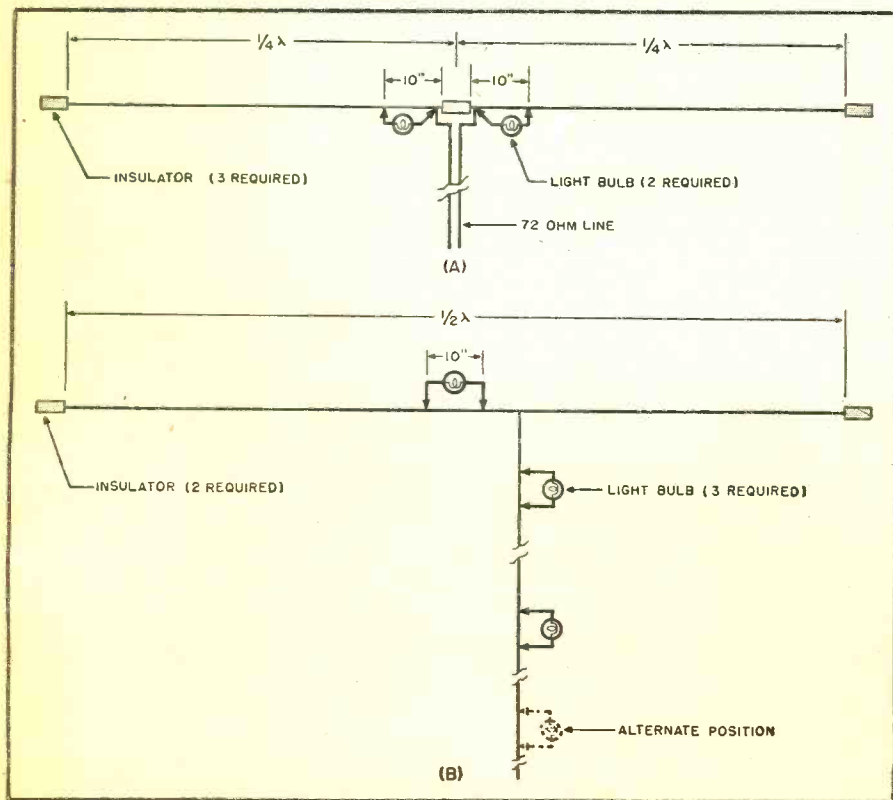

Build Your Own TELEVISION RECEIVER

**Complete construction details
for a TV receiver that covers
all channels from 44-88 mc.**

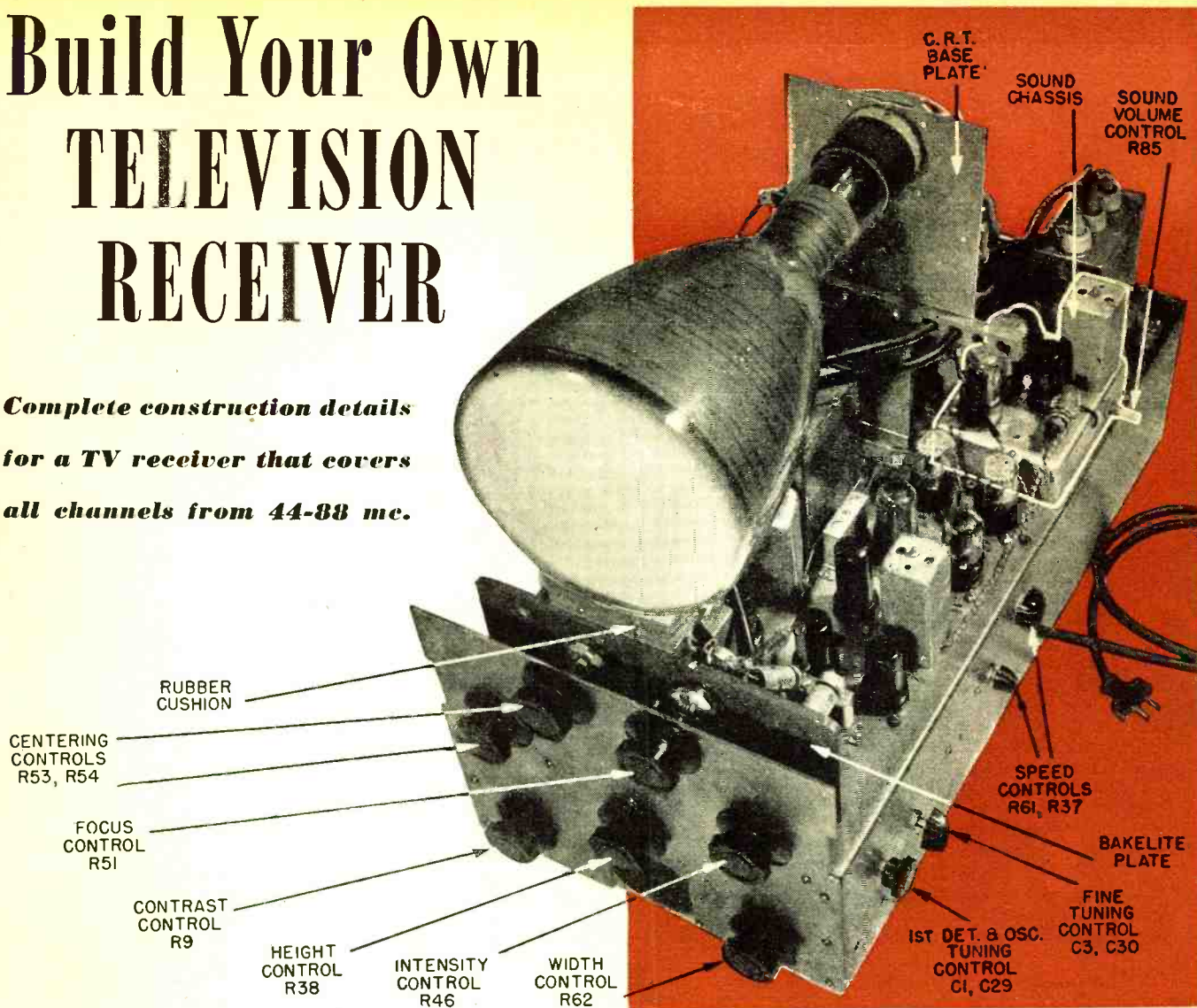

Fig. 1. Top-front view of completed television receiver with video tube shown in place. This unit has been converted from a war surplus type BC-412 oscilloscope. Many of the original components used in the oscilloscope are utilized in this set.

By

LEON S. WECKER and TOM GOOTÉE

AN EXCELLENT home television receiver can be constructed from the principal parts, tubes, and chassis of a low-cost, war-surplus oscilloscope; the type BC-412.

The completed television set has a 5-inch picture tube, self-contained high-voltage and low-voltage power supplies, and a video and sound circuit that is efficient and modern in every respect. Following the first detector stage are four sound stages feeding a PM speaker and five video stages feeding the grid of the cathode-ray tube. Necessary horizontal and vertical sync and control voltages for the picture tube are supplied by conventional circuits.

Using the easily obtained BC-412 war-surplus oscilloscope as the basis for this television receiver, actual cost of conversion is remarkably low, because the normally expensive components—used in the power supplies—are included in the complete oscilloscope unit.

The required scope is an Army Signal Corps type—numbered either BC-412-A or BC-412-B—easily recognizable by its large steel cover and by its excessive weight. It was originally used with the first mass-produced Army radar set (the SCR-268), but is now available at a very nominal price through most radio firms dealing in surplus war equipment.

However, the BC-412 scope selected for conversion *must* be equipped with a type 5BP4 cathode-ray tube. Some of the available surplus scopes have a tube with a greenish-tinted screen

which is *not* satisfactory for video reproduction.

This television receiver, designed by Leon S. Wecker, W2FZR, may also be constructed, in the same manner described, using standard parts and components purchased individually. Circuit arrangement and wiring should be relatively the same as shown in accompanying illustrations. The process may be tedious, however. The simplest method of construction is to buy a surplus BC-412 scope and perform the conversion according to these instructions.

In performing any work, adjustment, or repair of television sets and circuits, *always take proper safety precautions!*

Operating voltages often are as high as several thousand volts. Use tools that are well insulated. Avoid direct contact with any part of a television circuit! Even when the set is turned off, exercise extreme care, since the circuits contain high-voltage condensers that may still be charged.

EDITOR'S NOTE: The techniques used in constructing and servicing television receivers are far removed from those used for AM receivers. Because television receivers are comprised of various intricate circuits it should be borne in mind that in order to successfully construct the unit described in this article one should have had some previous practical experience in the construction of radio equipment.

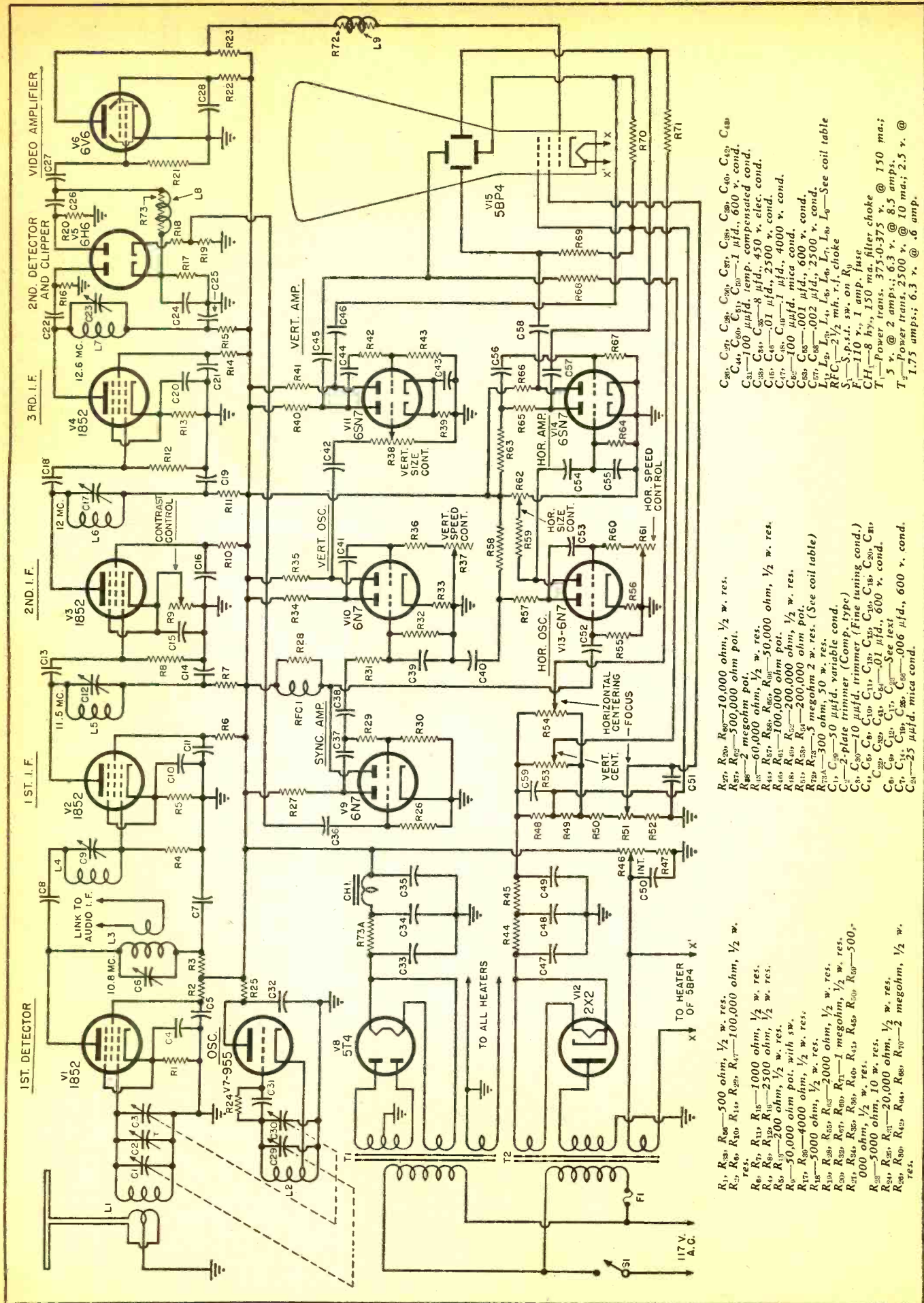

1ST I.F.
 V1 1852
 V2 1852
2ND I.F.
 V3 1852
3RD I.F.
 V4 1852
2ND DETECTOR AND CLIPPER
 V5 6H6
VIDEO AMPLIFIER
 V6 6V6
SYNC AMP
 V8 5T4
VERT. OSC.
 V10 6N7
VERT. SIZE CONT.
 V11 6SN7
VERT. SPEED CONT.
 V12 2X2
HOR. OSC.
 V13 6N7
HOR. SIZE CONT.
 V14 6SN7
VIDEO OUT.
 V15 5BP4

R1, R2, R3, R4, R5, R6, R7, R8, R9, R10, R11, R12, R13, R14, R15, R16, R17, R18, R19, R20, R21, R22, R23, R24, R25, R26, R27, R28, R29, R30, R31, R32, R33, R34, R35, R36, R37, R38, R39, R40, R41, R42, R43, R44, R45, R46, R47, R48, R49, R50, R51, R52, R53, R54, R55, R56, R57, R58, R59, R60, R61, R62, R63, R64, R65, R66, R67, R68, R69, R70, R71, R72, R73, R74, R75, R76, R77, R78, R79, R80, R81, R82, R83, R84, R85, R86, R87, R88, R89, R90, R91, R92, R93, R94, R95, R96, R97, R98, R99, R100
 C1, C2, C3, C4, C5, C6, C7, C8, C9, C10, C11, C12, C13, C14, C15, C16, C17, C18, C19, C20, C21, C22, C23, C24, C25, C26, C27, C28, C29, C30, C31, C32, C33, C34, C35, C36, C37, C38, C39, C40, C41, C42, C43, C44, C45, C46, C47, C48, C49, C50, C51, C52, C53, C54, C55, C56, C57, C58, C59
 L1, L2, L3, L4, L5, L6, L7, L8, L9
 T1, T2
 SI
 F1
 X1, X2, X3, X4, X5, X6, X7, X8, X9, X10, X11, X12, X13, X14, X15, X16, X17, X18, X19, X20, X21, X22, X23, X24, X25, X26, X27, X28, X29, X30, X31, X32, X33, X34, X35, X36, X37, X38, X39, X40, X41, X42, X43, X44, X45, X46, X47, X48, X49, X50, X51, X52, X53, X54, X55, X56, X57, X58, X59, X60, X61, X62, X63, X64, X65, X66, X67, X68, X69, X70, X71, X72, X73, X74, X75, X76, X77, X78, X79, X80, X81, X82, X83, X84, X85, X86, X87, X88, X89, X90, X91, X92, X93, X94, X95, X96, X97, X98, X99, X100

R57, R58, R59, R60—10,000 ohm, 1/2 w. res.
 R61, R62, R63, R64, R65, R66, R67, R68, R69, R70, R71—500,000 ohm pot.
 R72—2 megohm pot.
 R73—60,000 ohm, 1/2 w. res.
 R74, R75, R76, R77, R78, R79, R80, R81, R82—50,000 ohm, 1/2 w. res.
 R83, R84, R85, R86, R87, R88, R89, R90—100,000 ohm pot.
 R91, R92, R93, R94, R95, R96, R97, R98, R99, R100—200,000 ohm, 1/2 w. res.
 R101, R102, R103, R104, R105, R106, R107, R108, R109, R110—200,000 ohm pot.
 R111, R112, R113, R114, R115, R116, R117, R118, R119, R120—5 megohm 2 w. res. (See coil table)
 C1, C2—50 µfd. variable cond.
 C3—2-plate trimmer (Comp. type)
 C4, C5, C6, C7, C8, C9, C10, C11, C12, C13, C14, C15, C16, C17, C18, C19, C20, C21, C22, C23, C24, C25, C26, C27, C28, C29, C30, C31, C32, C33, C34, C35, C36, C37, C38, C39, C40, C41, C42, C43, C44, C45, C46, C47, C48, C49, C50, C51, C52, C53, C54, C55, C56, C57, C58, C59—See text
 C60, C61, C62, C63, C64, C65—See text
 C66, C67, C68, C69, C70—006 µfd., 600 v. cond.
 C71, C72, C73, C74, C75, C76, C77, C78, C79, C80—25 µfd. mica cond.

Whether the set is off or on, don't take chances with high voltage! Death hides in small wires and innocent looking components!

Preparing the Chassis

First step in converting the BC-412 scope is to remove the heavy steel case or cover. Then unscrew and remove the four handle brackets on the chassis.

Examine the main components above and below the chassis, and become familiar with their location and appearance, especially parts associated with the power supplies. A circuit diagram of the scope is glued to the shield surrounding the cathode ray tube, and this diagram can be used to identify parts and components.

Remove all tubes from their sockets, taking care in handling the type 5BP4 cathode-ray tube and its round metal shield.

Next strip and remove all wiring above and below the chassis—with the exception of wiring associated with the low-voltage and high-voltage power supplies and the filament connections. Use a soldering iron; don't cut wires! Some of them may be used later in re-wiring the chassis.

The top portion of the steel front panel is sawed off on a horizontal line that will just clear the tops of the two highest controls when the knobs are in position.

At the bottom center of the steel front panel cut an opening suitable to accommodate a 5-inch PM speaker, and drill mounting holes.

A bakelite or wooden support bracket for the cathode-ray tube should be attached to the top of the large bakelite plate (just behind the steel front panel). Heavy felt or other cushioning material should be used on the top surface of this bracket, so that the tube rests securely.

The chassis is now ready to be re-wired, according to the circuit diagram of Fig. 2.

Use wire having adequate insulation for voltages likely to be encountered. If in doubt, use heavier insulation! For all high-voltage leads use ignition cable.

Always allow adequate spacing between adjacent wires, particularly in crowded parts of the receiver. All high-voltage circuits are wired in above the chassis.

Use a good grade of solder with rosin core for connections, avoiding cold-soldered joints. Most likely sources of later trouble and defective operation are; badly soldered and loose connections, insufficiently insulated wiring, and improperly shielded and bonded wiring.

C-R-T Control Circuits

First to be mounted and wired are the four variable controls used with

Fig. 2. Complete schematic diagram of the video section of the home-built television receiver. The diagram covering the audio channel for this receiver is shown in Fig. 5.

August, 1947

the high-voltage circuit of the cathode-ray tube. These are the potentiometers controlling; *HORIZONTAL CENTERING*, *VERTICAL CENTERING*, *FOCUS*, and *INTENSITY*.

Mounting holes for seven controls are already positioned in the steel front panel, and the upper four are now used to accommodate the proper potentiometers.

They are mounted behind the large bakelite plate, so that their shafts extend out and pass through the mounting holes in the front panel. These four high-voltage controls must be properly insulated from their shafts by means of insulated couplings (Figs. 1 and 3). Original knobs can then be replaced on the four protruding shafts.

Since the high-voltage circuits are wired in above the chassis, the height of these four potentiometers makes their position ideal for all wiring. Select the proper values of associated resistors, and connect the high-voltage control circuits according to the circuit diagram.

Use ignition cable for all wiring. Make certain the proper size potentiometers are used for the four panel controls. Note that the resistance value of the *INTENSITY* control is 100,000 ohms.

Nomenclature of the original four controls (printed on the face of the steel front panel) should now correspond to the function of the new television controls.

C-R-T Amplifier Stages

Next to be connected are the *horizontal amplifier* and *vertical amplifier* stages which control the operation of the picture tube.

The two amplifiers are somewhat similar in design, each using a type 6SN7 tube in a stage of phase-inverting amplification and each performing a similar, though independent, function. Saw-tooth waves previously generated by the *horizontal oscillator* stage are amplified by the *horizontal amplifier* and then applied to the horizontal deflecting plates of the picture tube, causing the electron beam to

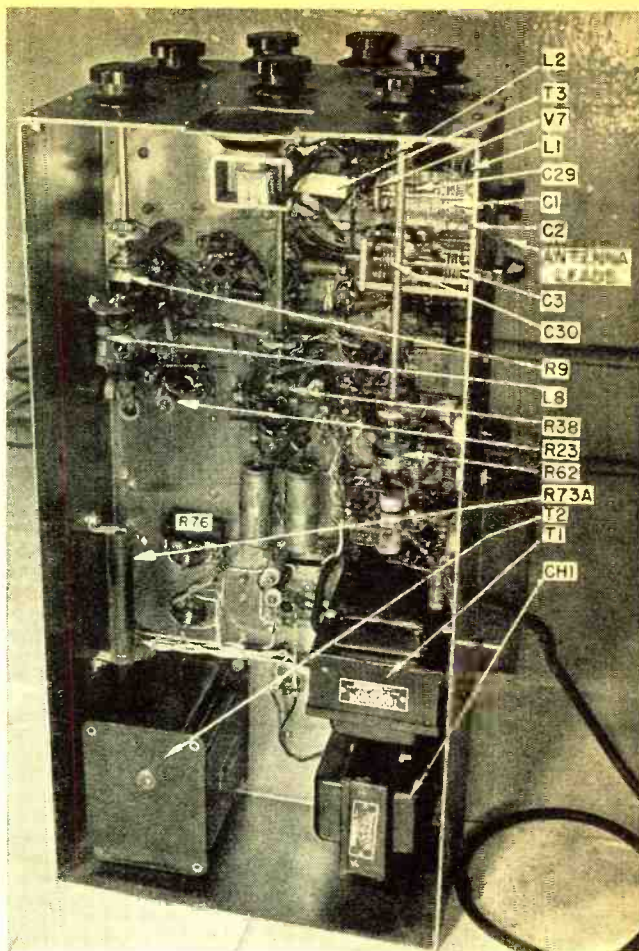

Fig. 3. Under-chassis view of completed receiver. Note that all components are grouped closely to form their respective stages. Sound trap, L (not visible in the photo), is mounted directly under the tuning condensers, C₁, C₃₀.

sweep horizontally across the face of the tube at a high frequency. Saw-tooth waves previously generated by the *vertical oscillator* stage pass through the *vertical amplifier* and are then applied to the vertical deflecting plates of the picture tube, causing the electron beam to sweep vertically at a lower frequency.

Mount the tubes for the *horizontal amplifier* and *vertical amplifier* close to the cathode-ray tube (Fig. 4). Then wire the two stages according to the circuit diagram.

Bias for the *horizontal amplifier* tube is obtained from the rectified grid current.

Couple the output of each amplifier through the 2500 w.v. condensers (mounted behind the cathode-ray tube base plate and socket), and then connect to appropriate deflecting plates of the picture tube.

C-R-T Oscillator Stages

The *horizontal oscillator* and *vertical oscillator* stages operate similarly but independently, each using a type 6N7 tube in a modified multivibrator arrangement to generate a saw-tooth voltage waveform. The *horizontal oscillator* provides a high-frequency wave which is coupled to the *horizontal amplifier* stage. The *vertical oscil-*

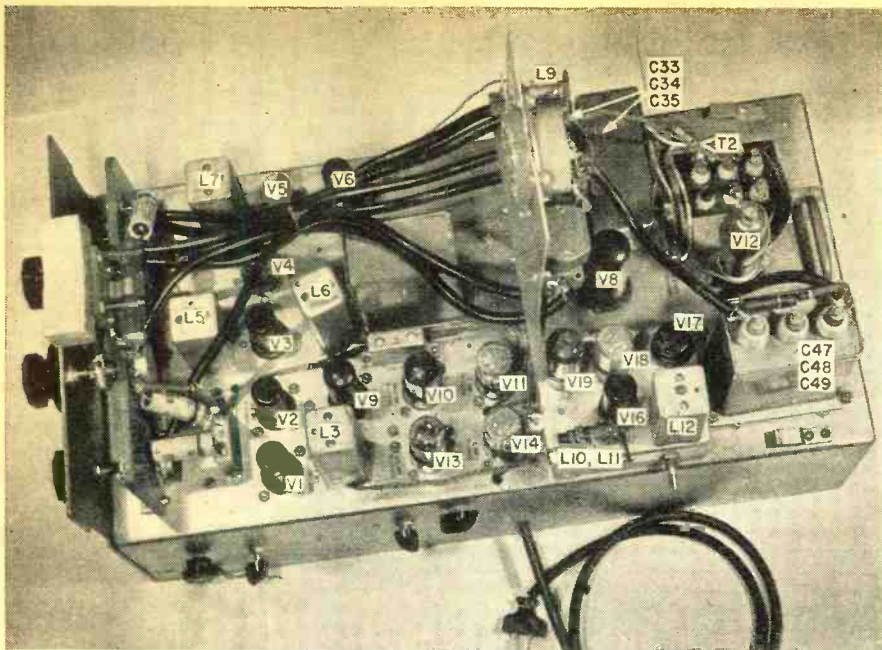

Fig. 4. Top view of completed television receiver, with cathode-ray tube removed. Note cushioned bracket for picture tube. High voltage units are toward rear of the chassis near the actual tube connections. The large, unidentified can, mounted in the center of the chassis, contains a bank of .1 μ d., 600 v. condensers.

lator provides a saw-tooth wave of lower frequency which is coupled to the vertical amplifier stage.

When free-running, each oscillator functions at a frequency determined by the resistance-capacitance balance in the grid and plate circuit. However, when sync pulses from a television transmitter are amplified (by the sync amplifier stage) and applied to the grid circuit of each oscillator, the multivibrator "locks" with the frequency of the incoming sync pulses.

In this manner the horizontal oscillator and vertical oscillator stages produce saw-tooth waves in ratio to each other and in frequency according to the incoming sync pulses from the sync amplifier stage.

Referring to the parts arrangement shown in Fig. 4, the vertical oscillator tube is placed in front of the vertical amplifier tube, and the horizontal os-

illator tube is placed in front of the horizontal amplifier tube.

Wire the two oscillator circuits according to the circuit diagram, after proper controls have been mounted.

The free-running frequency of either oscillator stage is controlled by varying the resistance in the grid circuit. The horizontal oscillator uses a 100,000 ohm variable resistor known as the HORIZONTAL SPEED control. And the vertical oscillator uses a 500,000 ohm variable resistor known as the VERTICAL SPEED control. Mount both controls on the side of the chassis near their respective oscillator tubes so that the grid leads are as short as possible.

Amount of output voltage from the horizontal oscillator is controlled by means of a 500,000 ohm potentiometer known as the HORIZONTAL SIZE control, or the WIDTH control.

Amount of output voltage from the vertical oscillator can be varied by means of a 2 megohm potentiometer known as the VERTICAL SIZE control, or the HEIGHT control. These two controls determine the width and height of the television image on the screen of the cathode-ray tube.

The HEIGHT and WIDTH controls are mounted underneath the chassis, each on a bracket that is part of the steel chassis. Extension shafts with insulated couplings protrude through openings in the lower part of the steel front panel (Fig. 3). Original knobs can be placed on the two protruding shafts, and their panel designations changed to HEIGHT and WIDTH respectively.

Preliminary Test

At this point; a preliminary check of the assembled equipment can be made to test the operation of the scope control circuits.

First, turn all controls on the front panel to the "OFF" position (full counter-clockwise) and apply 110-120 volts a.c. to the power stages.

Turn up the INTENSITY control slowly—until a faint spot appears on the screen of the picture tube.

Then vary the position of the FOCUS control to obtain the smallest and sharpest pin-point of light. However, don't make the spot too bright, since this may seriously damage the screen of the tube.

Next, check the operation of the two centering controls. Any adjustment of the HORIZONTAL CENTERING control should cause a horizontal movement of the spot on the screen. Adjustment of the VERTICAL CENTERING control should cause a vertical movement of the spot. Action of the two centering controls must be independent of each other.

If the spot fails to react to one or more of the four front panel controls, turn off the equipment and recheck all wiring relative to these circuits.

If the spot reacts favorably, advance the HORIZONTAL SIZE or WIDTH (Continued on page 134)

Fig. 5. Schematic diagram of the audio section of the television receiver. This channel is link-coupled to the video section.

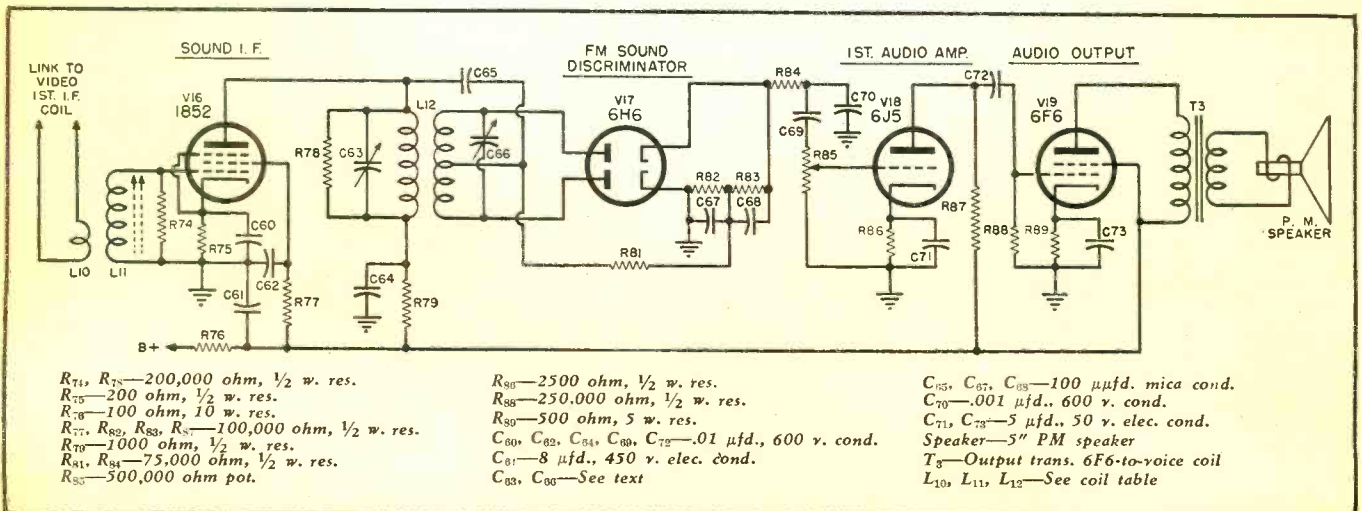

Practical TRANSFORMER DESIGN and CONSTRUCTION

By C. ROESCHKE

Part 3. Concluding article covering the design and construction of iron core transformers and reactors.

IN THIS final article on transformer design we will discuss the design and construction of a plate modulation transformer, and an audio output transformer. Several valuable hints on the practical construction of transformers are also included for the assistance of the builder.

A modulation transformer, like any audio power transformer, is designed to match the output impedance of one piece of equipment to an input impedance of a second piece of equipment. This matching is done to insure maximum power transfer and satisfactory frequency response.

When a load is connected to the secondary winding of an audio transformer, there is reflected into the primary circuit an impedance which is determined by the turns ratio of the transformer. This is the ratio of the number of turns in one winding to the number of turns in the other winding.

Mathematically, the turns ratio is equal to the square root of the ratio of the two impedances, or *turns ratio* = $\sqrt{Z_1/Z_2}$.

For example, consider a transformer which is to work out of a 5000 ohm circuit into a load of 50 ohms. Then

$$\text{Turns ratio} = \sqrt{\frac{\text{Primary Impedance}}{\text{Secondary Impedance}}}$$

$$= \sqrt{\frac{5000}{50}} = \sqrt{100} = 10$$

This means that the primary winding must have ten times as many turns as the secondary to match the 5000 ohm primary circuit to the 50 ohm secondary load.

For the purpose of design demonstration, assume that a plate modulation transformer is required for the following conditions of operation.

1. Modulator output is push-pull pentodes requiring load impedance of 10,000 ohms and that each tube draws 60 ma. plate current.
2. Audio output power to be 7.5 watts.
3. The Class C r.f. amplifier to be plate modulated draws plate current of 70 ma. at 420 volts.
4. Voice frequencies are to be used.

The secondary load resistance is equal to the r.f. amplifier d.c. plate voltage divided by the r.f. amplifier plate current. In this case then: $R = 420/.07 = 6000$ ohms

To calculate turns ratio:

$$\text{Turns ratio} = \sqrt{\frac{10,000}{6000}} = 1.29$$

Therefore, the primary must have 1.29 times the number of turns used in the secondary.

When a transformer is employed in

the plate circuit of a vacuum tube, it is necessary that it be designed to reflect the proper load impedance for the tube. In addition, the primary inductance will determine the low frequency response of that audio stage. For this reason, Fig. 16 is included to indicate proper primary inductance for good low frequency response at 50 cycles or 150 cycles. Fig. 9** can be used to calculate the primary inductance. Since our modulator tubes are pentodes and we are interested only in voice frequencies, we see in Fig. 16 that the primary inductance should be about 10 henrys.

Fig. 5* shows that the primary could be wound with No. 34 wire to carry 60 ma. and the secondary can be wound with No. 33 wire for 70 ma.

For convenience we shall use No. 33 for both windings.

This transformer is to handle 7.5 watts so, according to Fig. 17, we can try to design it with 1" laminations and a stack of 1".

Let us tabulate the data we have so far:

- Primary impedance = 10,000 ohms
- Primary d.c. = 60 ma.
- Primary inductance = 10 hy.
- Primary wire size = No. 33
- Secondary impedance = 6000 ohms
- Secondary d.c. = 70 ma.
- Secondary wire size = No. 33
- Core size = 1" stack of 1" laminations

Turns ratio = 1.29

First let us try 2700 turns, center tapped, for the primary winding. Then the secondary must have $2700/1.29 = 2090$ turns. Next we calculate the coil size as explained previously and find that the build is 81 per-cent which means that the coil will fit into the core.

The primary is for push-pull tubes and therefore must be center tapped at 1350 turns. Since "B+" is connected to the center tap, the direct current flows in opposite directions in each half of the winding which means that the core saturation effect is cancelled out as far as the primary is concerned. But the secondary has 70 ma. d.c. flowing through its entire length in one direction and this must be considered in the calculation of inductance.

Then for the secondary, $NI = 2090 \times .07 = 146$. But we are interested in the primary inductance so let us convert this effect into the primary. Thus:

$$\text{Since } NI = 146$$

$$\text{Then } 2700 \times I = 146$$

$$\text{And } I = 146/2700 = .054 \text{ amp.}$$

This means that 54 ma. flowing in the 2700 turns primary would give the same core saturation effect that 70 ma. flowing in the secondary would give. For this reason we shall use the figure 54 ma. in our primary inductance calculation.

(Continued on page 123)

Fig. 16. Primary inductance required for good response at low frequencies.

FOR TRIODE TUBE			FOR PENTODE TUBE		
D.C. Plate Resistance Ohms	Inductance		Load Impedance * Ohms	Inductance	
	for 50 cycles	Inductance for 150 Cycles		for 50 Cycles	Inductance for 150 Cycles
800	3.5 hy.	1.0 hy.	2500	8.5 hy.	3.0 hy.
1000	4.5 hy.	1.5 hy.	4000	13.0 hy.	4.0 hy.
1500	6.5 hy.	2.0 hy.	5000	16.5 hy.	5.0 hy.
2000	8.5 hy.	3.0 hy.	6000	20.0 hy.	6.0 hy.
3000	13.0 hy.	4.5 hy.	7000	25.0 hy.	7.0 hy.
5000	20.0 hy.	5.5 hy.	8000	27.0 hy.	8.0 hy.
10,000	40.0 hy.	15.0 hy.	10,000	33.0 hy.	10.0 hy.
			15,000	50.0 hy.	15.0 hy.

* This is plate-to-plate impedance for push-pull tubes.

* Figs. so designated appear in Part 1 of this article published in the June issue of Radio News.
** Figs. so designated in Part 2 of this article published in the July issue of Radio News.

and is ready to receive a signal from the recording head. The application of a supersonic signal to the recording head provides a bias, as mentioned previously, and helps to overcome the nonlinearity of the normal magnetization curve of the magnetic material.

Magnetic Materials

We will avoid the term wire recorder wherever possible inasmuch as magnetic recording techniques apply equally to other materials such as paper tape and paper discs to which has been added a coating of magnetic material. In addition, certain alloys have been found which give excellent results in magnetic recording.

Recording Bias

Either d.c. or a.c. bias will improve the linearity of the magnetic material magnetization curve, as previously mentioned. The following will explore the advantages and disadvantages of each.

Referring to Fig. 8 we see the magnetization characteristics of a typical magnetic material. Beginning at point A, with the material demagnetized, the magnetizing force (H) is increased to point B and then reduced to zero. The material, however, has become permanently magnetized and the flux density (B) does not return to zero but instead only drops to a value of C.

If the magnetizing force had been increased to point D and then reduced to zero, the residual flux density would now correspond to E. Note that (B), the residual flux density is not proportional to (H), the field intensity. This is a source of nonlinearity better illustrated in Fig. 9 where the residual flux density is plotted against original magnetizing force. From the origin to point X the characteristic is very nonlinear. Between points X and Y the linearity is excellent while after Y it again becomes nonlinear. Obviously, for good reproduction some biasing is necessary to enable operation on the linear section between X and Y. Two systems—one using d.c. and the other a supersonic bias, have been developed and are widely used.

The d.c. bias employs a saturation erase. The material in passing the erasing head is magnetized to point D (Fig. 8) and therefore will return to a residual flux density of E. (D-E-M-N is the hysteresis loop of the material.)

In order to operate on the linear portion of the loop to the left of E a fixed negative field, F, is applied to the material by the recording head. When the material leaves the recording head, the flux density decreases along a nearly straight line to G. Suppose a signal superimposed upon the fixed negative bias varied the field intensity between H and J. If the material leaves the influence of the recording head pole-pieces, when the field intensity is J, the flux density would proceed along the practically straight line to K. From H it would have gone to I. Within a limited range in the neighborhood of F the lines H-I, F-G, and J-K will be almost straight and paral-

August, 1947

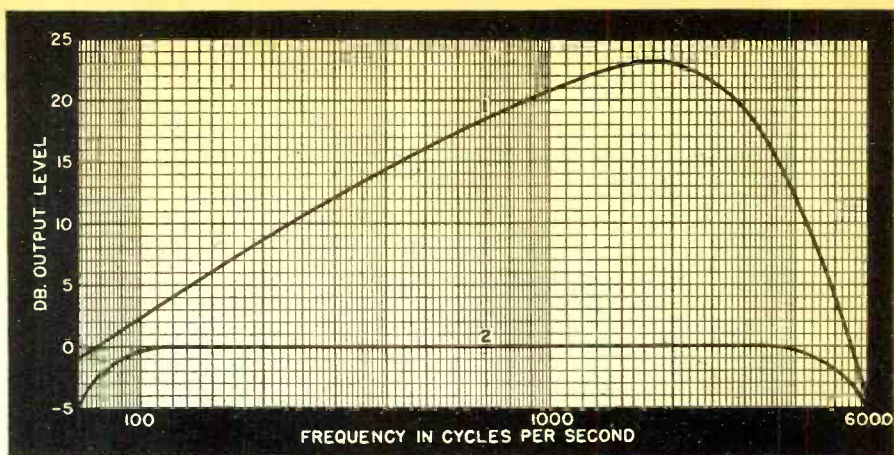

Fig. 5. Frequency response curves for wire recorder. Curve 1 shows output level minus corrective network. Curve 2 shows output with corrective network.

lel. This means that the induced reproducing voltages will be linearly related to the recording fields.

Of great importance is the magnitude of the fixed negative bias employed. If this bias is too small, the signal will be distorted by the non-linear section near E. Too large a bias will cause signal distortion by carrying over into the section near M. There is a limit to the magnitude of the recording audio field, for the curve is linear only in a limited region around F. In addition, too large a field will produce distortion. We have ignored the self-demagnetization effects of thin sections of material such as are used in magnetic recording. Demagnetization will tend to further reduce the amplitude of linear recording when d.c. bias is employed.

Supersonic Biasing

To overcome the nonlinearity of the magnetization curve, supersonic biasing was developed. It possesses several advantages over d.c. bias. Supersonic biasing, as its name implies makes use of a supersonic signal (30 kc. is commonly used) as a bias upon which the audio signal is superimposed. Normally the supersonic oscillator is also used for the erasing head,

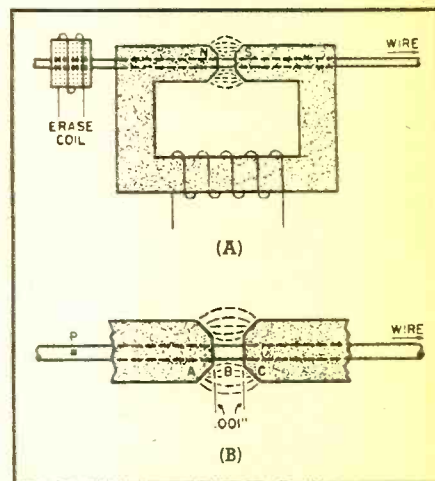
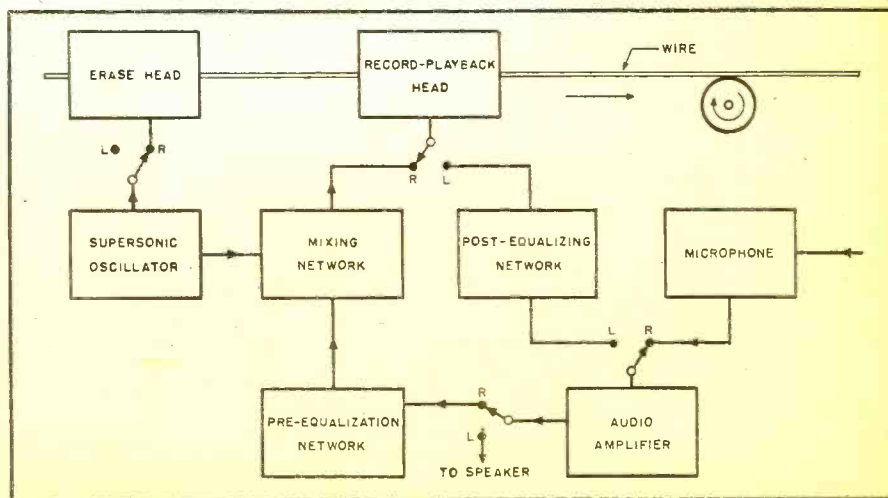

Fig. 6. (A) Cross sectional view of magnetic wire recording head. (B) Drawing illustrates details of the recorder pole pieces.

so that the magnetic material enters the recording head completely demagnetized.

Fig. 10 illustrates the action of supersonic biasing. Here a field which is a mixture of the supersonic bias and an audio signal is shown applied to the residual flux density curve. Let us
(Continued on page 142)

Fig. 7. Simplified block diagram of a typical wire recorder.



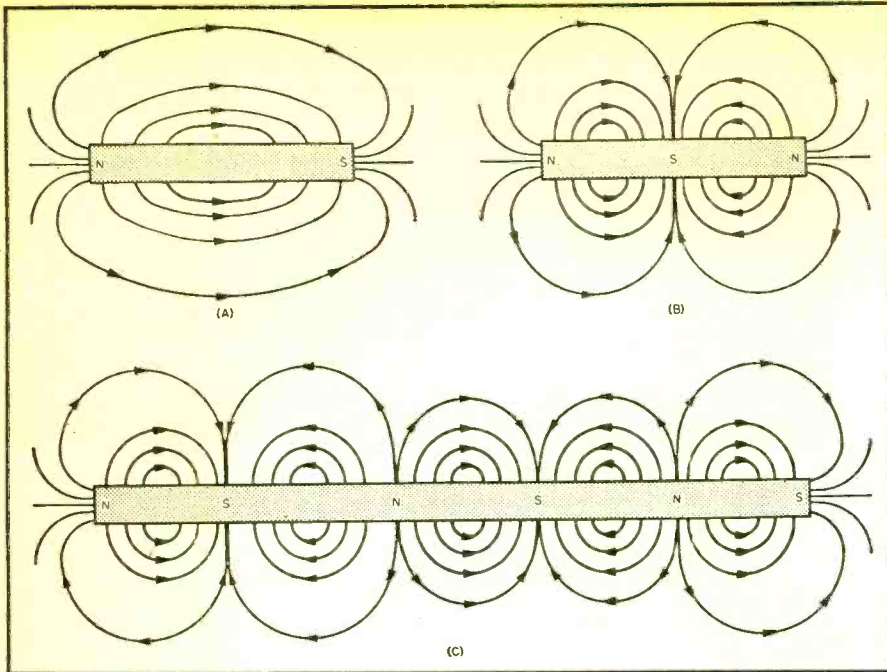

Fig. 1. Methods of magnetizing steel bars. (A) Dipole magnetized; (B) tripole magnetized; and (C) multipole magnetized steel bar.

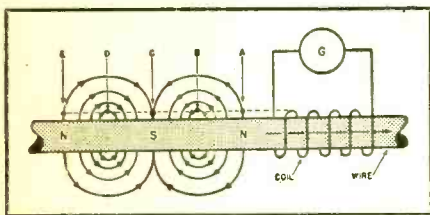

Fig. 2. How variations of magnetic field intensity are converted to an a.c. voltage.

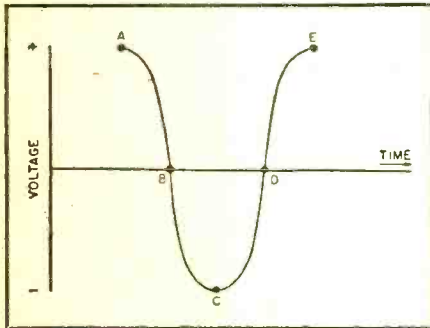
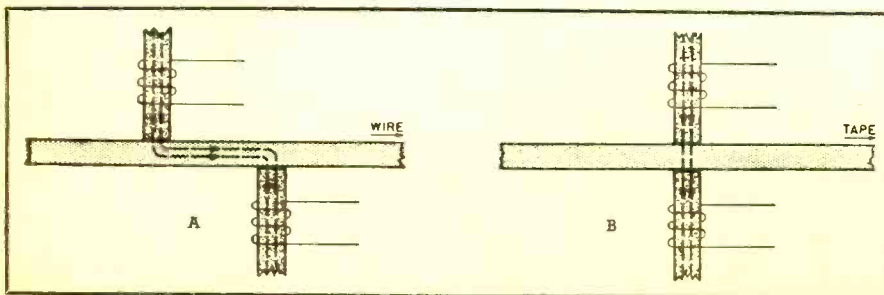

Fig. 3. Waveform (output voltage) on recording head when wire is magnetized as in Fig. 2. Peak voltage occurs when coil is at points A, C, and E. At B and D where there is no flux change, voltage is zero.

Fig. 4. (A) Longitudinal magnetization of wire using two pole pieces. (B) Perpendicular magnetization of tape using two pole pieces.



V is the velocity of wire travel.

W is the width of the air gap.

λ is the recorded wavelength.

The frequency response curve calculated from this formula is plotted as curve No. 1 in Fig. 5. Fixed values of $B_m V$, and W , have been chosen in this case. It will be noted that at frequencies low enough so that $\sin \pi W/\lambda$ is practically the same as $\pi W/\lambda$, the output voltage decreases at the same rate as the frequency. This limits the low frequency response.

High frequency response is limited by length of the recording gap, and also by the demagnetizing effect of adjacent magnetic poles at short wavelengths. The frequency characteristic can be made fairly flat by the use of a corrective network, as shown in curve No. 2 in Fig 5.¹

Generally speaking, magnetic recording machines are not particularly complicated. A magnetic material, such as wire or tape, is drawn past a recording head. As it passes through the head, the material becomes and remains magnetized. The amount of magnetization remaining in the material at each instant is governed by the impressed signal upon the recording head. In playing back, the magnetized material is drawn past a playback head. The varying magnetization which remains in the material induces corresponding voltages in the coil of the playback head. In modern practice the recording and playback heads are incorporated into a single unit.

The erasing of a signal from a magnetic material is accomplished by means of an erase head. This head impresses a field upon the material, which, erasing the old signal, makes the material ready to receive another signal or to be re-recorded. Basic components of magnetic recorders include the magnetic material, the record-reproduce head, and the erase head. In addition are the other component parts such as the drive mechanism, the spools or containers for the wire or tape, a compensated record and playback amplifier, conventional microphone, speaker, and special filter systems to overcome the nonlinearity of the magnetization curve of the recorded material.

It was discovered, following initial experiments with wire recording, that the application of a supersonic signal to the recording head was necessary to provide a bias to overcome the nonlinearity of the normal magnetization curve of a magnetic material.

Fig. 7 is a block diagram of a typical magnetic recorder. It will be noted that in the "record" position, the supersonic oscillator serves double duty by providing high frequency for both the demagnetizing head and the recording head. First the magnetic material passes through the erase head. The material is demagnetized

C. The ratio of the magnetizing force in the gap to that in the poles, may be estimated from the equation:

$$H = \frac{\mu}{B}$$

where:

H is the magnetizing force.

B is the flux density.

μ is the permeability.

Assuming that the flux density B is constant throughout the magnetic circuit, then the magnetizing force varies inversely as the permeability. Since the permeability of the pole-pieces is about 1000 times as great as that of the gap, the magnetizing force inside is only $1/1000$ that of the gap.

The magnet illustrated in Fig. 6A is used also for pickup of the recording from a magnetized wire. Analysis shows that the voltage picked up from the wire can be given by the expression:

$$E = B_m V \sin \frac{\pi W}{\lambda}$$

where:

E is the relative induced voltage.

B_m is the maximum flux density in the wire.

¹ Camras, Marvin, Armour Research Foundation. "A New Magnetic Wire Recorder" Radio-Electronic Engineering Edition of Radio News, November, 1943.

The RECORDING and REPRODUCTION of SOUND



Wire recorder becomes modern dictating machine

By **OLIVER READ**

Editor, Radio News

PRESENT methods of sound recording by magnetic means are the result of discoveries of Valdemar Poulsen, a Danish scientist, who, in 1898, experimented with magnetic recording on wire.

It is well known that hard steel can be magnetized to form a bar magnet as in Fig. 1A. It is not as well known, however, that the same bar can also be magnetized as in Fig. 1B, with a north pole at each end, and a south pole at the center. This idea is carried still further in Fig. 1C, which illustrates magnetic poles unequally spaced, and of different strength. It can be shown that within limitations, to be described later, it is possible to form a magnetic pattern corresponding to any desired wave shape.

Suppose that a magnetized bar, such as shown in Fig. 2, were to be pulled at uniform speed through a rather closely fitting coil, in accordance with Faraday's Law of Electromagnetic Induction, there would be an e.m.f. across the coil which is:

$$E = N d\phi/dt \text{ abvolts}$$

where:

E is the induced e.m.f.

N is the no. of turns in the coil.

$d\phi/dt$ is the time rate of change of flux.

The output voltage wave is illustrated in Fig. 3. It will be noted that the peak voltage occurs when the coil is at point A, C, and E where the flux

Part 6. Covering the theory and practice of various methods employed in magnetic recording on wire, tape, and non-metallic, magnetically coated materials.

change is most rapid. At points B and D, where the flux change is nil, the voltage is zero.

The principles just outlined were first used by Valdemar Poulsen about forty-five years ago. To magnetize a steel wire longitudinally, he used a pair of electromagnets arranged as in Fig. 4A. While this system worked fairly well, the magnets affected a rather long section of the wire, and necessitated a high wire speed. This may be clarified by the following practical example:

Suppose that it were desired to record a 5000 cycle wave ($f = 5000$) on the wire, and the pole pieces were spaced $\frac{1}{16}$ inch ($\lambda = \frac{1}{16}$). Then the speed corresponding to wavelength of this size would be:

$$V = f\lambda = 5000 \times \frac{1}{16} = 312 \text{ in. per sec.}$$

For good waveform the speed might have to be several times this figure.

Obviously, the mechanical problems of handling wire at such high speed were serious. Poulsen's device was bulky and noisy. The wire broke frequently, and pole-pieces wore so rapidly that they had to be renewed like phonograph needles.

Later experiments tried various methods of decreasing the pole-piece

spacing. When the pole-pieces are opposite one another, the limit of decreasing pole-piece spacing is reached, as shown in Fig. 4B. This system is unsuited for use with round wire, because the wire might rotate about its axis between the time a record was made and the time it was played, thus causing objectionable variations in amplitude.

In an attempt to correct the difficulties previously encountered in magnetic recording, experiments at the *Armour Research Foundation* were directed toward a new type of recording head illustrated in Fig. 6. With this new unit, the recording was done in a small air gap, instead of by the use of sharpened pole-pieces. This air gap was made as short as 0.001 inch, so that only a very small portion of the wire was affected at one time.

Point P on the wire is moving in the direction indicated in Fig. 6B. When this point is at A, in the interior of the pole-piece, the magnetizing force acting on it is practically zero. As soon as it passes into the air gap B, it is magnetized by a concentrated field set up by the coil. As the wire continues moving, point P passes into the field-free interior of the second pole-piece

YOU PAY BEFORE YOU PLAY

By A. E. YOHALEM

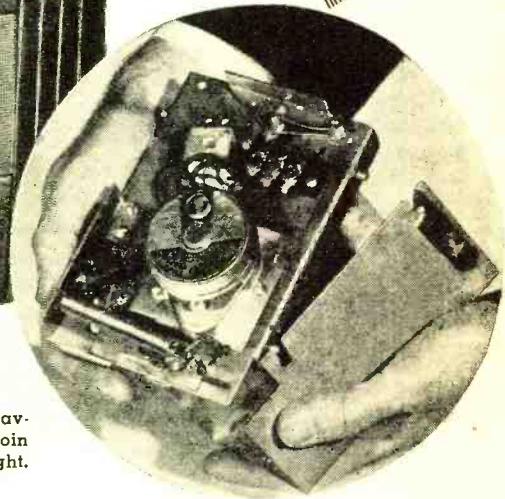
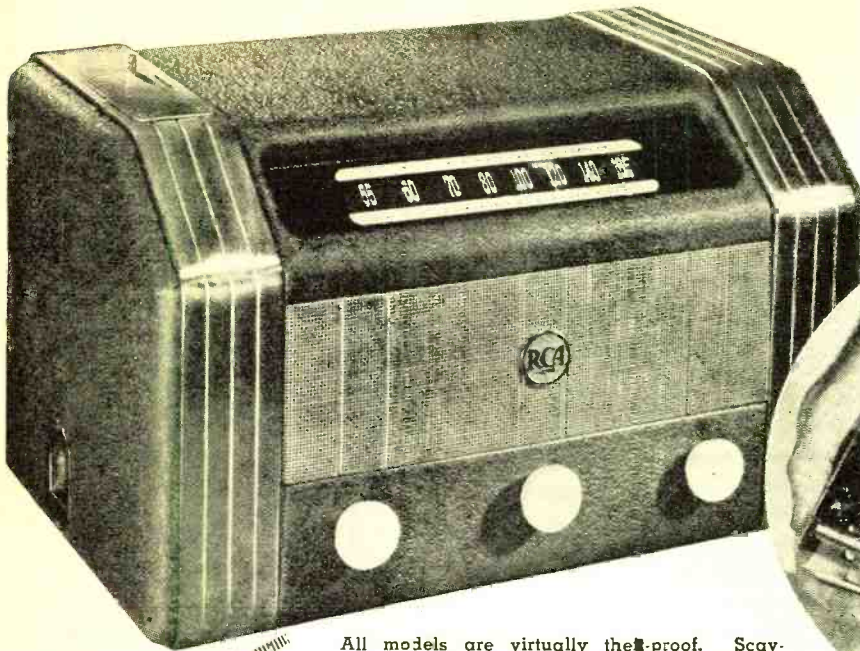

All models are virtually theft-proof. Scavenger button clears mechanism of slugs. Coin and timer mechanism is shown at the right.

There is a fast-growing market for coin operated receivers. 60,000 units are now in use.

BACK in the 1920's when some unknown gadgeteer first hit on the idea of coupling a coin-operated timing device and a radio set, the scheme was regarded as a momentary fad capitalizing on the novelty of broadcasting. Today, a flood of these coin models is beginning to pour off assembly lines into hotel rooms, tourist cabins, and hospital wards all over the country, and the pay-before-you-play sets are taking their place as a brand new market for radio production.

The clink of dimes and quarters

dropping into the slots of some 60,000 sets scattered around the country is playing a pleasant tune for the radio industry. Seeking a new outlet for their booming postwar production, manufacturers expect to sell at least \$75,000,000 worth of these slot models within the next two years.

The recent addition of *RCA Victor* to the growing ranks of coin radio manufacturers served notice that the slot set had "arrived" after a twenty year uphill battle. When the first coin radios made their debut in 1927, they followed in the footsteps of a proces-

sion of nickel-in-the-slot music boxes, player pianos, and phonographs that had been used in public locations as crowd entertainers. After successful trials in a variety of Chicago locations, ranging from restaurants to barber shops, thousands of coin-operated radios were marketed and placed in similar sites in other large cities. At the same time, several manufacturers turned out timing devices which could be used by location owners to adapt their own radios for coin play.

Initial public interest in these slot sets depended on the newly discovered wonders of broadcasting. One advertisement of the period noted that the coin radios "appeal to that inborn desire of everyone to work the controls," while sets were placarded: "It's New! Tune-in Yourself! Hear the colorful tone of radio!"

The development of the coin set paralleled the evolution of radio. Once sets emerged from their early unsightly stage and were electrified, given speakers and single-dial tuning, radio was hailed as an ideal entertainment medium. By 1929, the leading coin-phonograph manufacturers regarded broadcasting as a serious rival, and began to produce combination juke-box and radio units, which either played a record or operated the radio for five minutes when a nickel was dropped into the slot.

These devices sold for as high as \$1000, but were crude by modern standards. They oscillated, whistled and howled, and their strong point was the reception of static. Under the unskilled handling of a patron, sets

(Continued on page 112)

Housed in a sturdy steel cabinet, this rugged unit is designed to withstand the rigors of coin operation. The cash box holds up to 25 dollars in quarters.



Run wire from the new speaker to the remote speaker already in service. Connect the voice coils of these speakers in series. If the voice coils are 4 ohms each, we now have a total input impedance of 8 ohms feeding T_1 , which makes it necessary to change the tap on T_1 to match. This does not complete our changeover, however, as our master speaker is matched for 4 ohms impedance, and during talk-back operations, the 4 ohms of SP_2 would be feeding into the 8 ohms of T_1 . To finish matching, merely add a 4 ohm resistor in series with the voice coil of SP_2 and change the connections on T_2 to match 8 ohms. The switching arrangement for talk-back is not complicated in any way, being simply a double-pole, double-throw switch of the spring-back lever type, which is connected in such a way that the voice coils of the speaker are interchanged.

A Federal anti-capacity switch will work as well in this application, as will a conventional toggle switch.

Connecting the input circuit to the grid of the first tube is a little tricky, inasmuch as any attempt to couple the transformer directly to the grid of the 12SQ7 will result in a considerable decrease in gain. From 25% to 50% loss of voltage gain will be experienced, depending on the type of transformer used. As will be noted in Fig. 2, the input transformer T_1 has a 500,000 ohm potentiometer connected across its secondary, while the movable contact of the pot is connected to the grid of the 12SQ7 through the coupling capacitor C_2 . The grid circuit is completed by the use of a 5 megohm resistor which tends to keep the grid circuit at a high impedance. The 12SQ7 was chosen because of its high gain characteristics as well as the fact that its filament current rating was identical with that of the 50L6, enabling the two filaments to be connected in series. The resistance-capacitance coupling is conventional and needs no explanation. The 50L6 is a beam power tube capable of delivering up to 2 watts of power output. The bias of -6 volts is developed across R_5 and the bypass capacitor C_3 , which is used to smooth out the audio pulses caused by the plate current flowing through R_5 . The output transformer T_2 is identical with T_1 and all connections are the same.

Figs. 1 and 3 show the general layout. On top of the chassis are located two tubes, the speaker (SP_2), the two transformers (T_1 and T_2), and the filter choke (CH_1), while below the chassis are the remaining parts. The selenium rectifier is shown mounted under the chassis at the left rear. At first glance it might appear that the rectifier has been mounted too close to the filament dropping resistor R_6 , but careful inspection will show that connections to R_6 are made to the adjustable center terminal and the end terminal farthest from the rectifier. This places the rectifier approximately 2 inches away from the heat of R_6 .

In testing and adjusting the unit for final performance, no special instru-

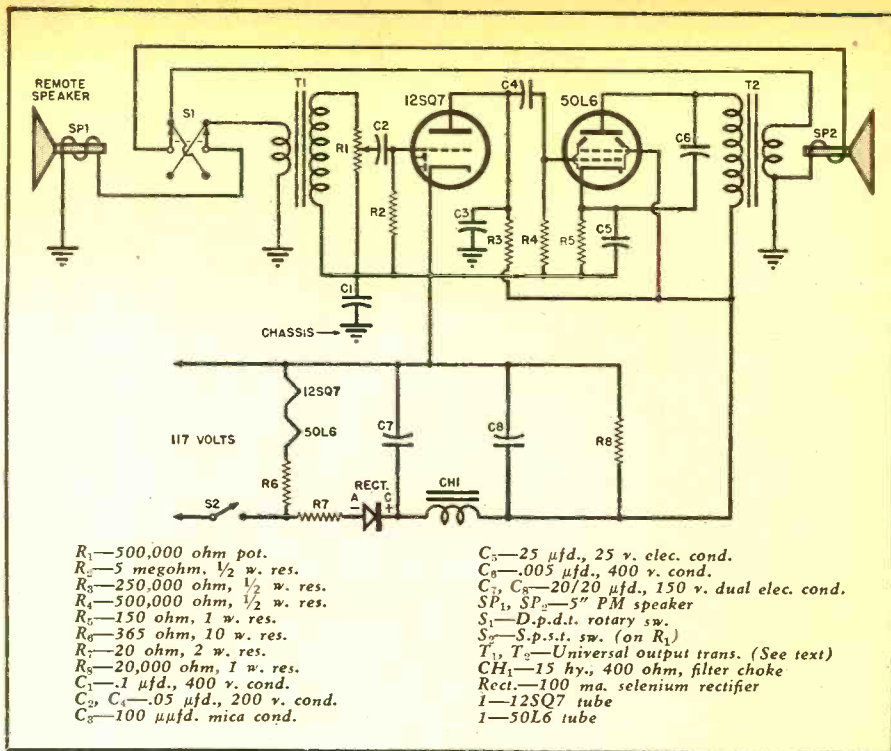

Fig. 2. Schematic diagram of intercom. Diode plates of the 12SQ7 are not used.

ments are necessary. However, those wishing to check operation critically will employ the following apparatus:

1. A high impedance vacuum tube voltmeter capable of measuring a.c. voltages up to 100 volts r.m.s.
2. An audio oscillator (the 400 cycle fixed type will do).
3. An oscilloscope. Not absolutely necessary, but will help in locating distortion.
4. A d.c. voltmeter of the high resistance type, at least 20,000 ohms-per-volt.

The first step is to ascertain whether or not the tubes are receiving proper d.c. voltages. Connect the negative terminal of the d.c. voltmeter to the negative return (not to the chassis), and the positive terminal to the plate of the 50L6. This should give 85 volts d.c. Next, shift the positive lead to the

screen grid where the voltage should be 105 d.c. volts; then to the plate of the 12SQ7 where the voltage should be 60 volts d.c.; and last, to the cathode of the 50L6 where the d.c. voltage should be 6. This cathode voltage has the same value as the negative d.c. on the 50L6 control grid.

The voltages listed above were taken by the author with the line voltage set at 115 volts. Slight variations in d.c. voltages should be expected at different line voltages. Different voltage readings will also occur if the voltmeter has a sensitivity of less than the 20,000 ohms-per-volt value.

Now that the d.c. voltages have been checked, proceed to measure the voltage gain. Connect the audio oscillator across R_1 , set its output at .01 volt by means of the v.t.v.m. or by means of

(Continued on page 100)

Fig. 3. Underchassis view. All parts are standard and are readily available.

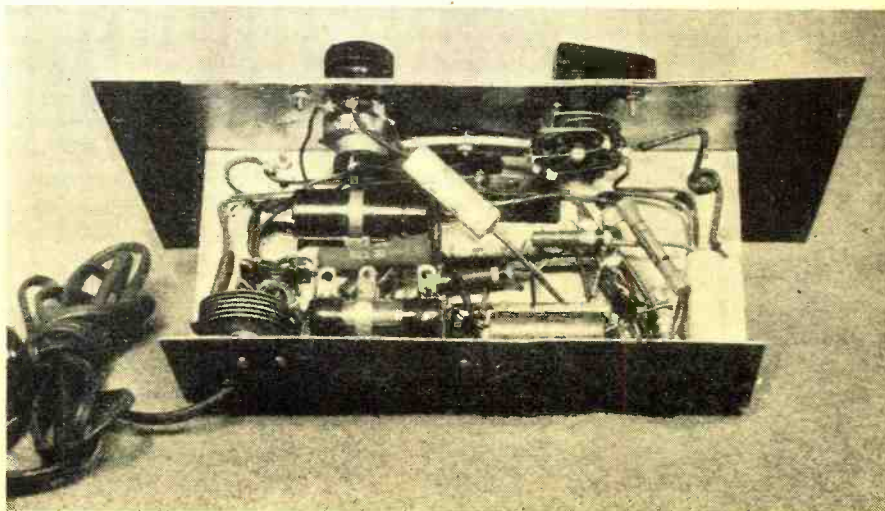

A Two-Tube INTERCOM

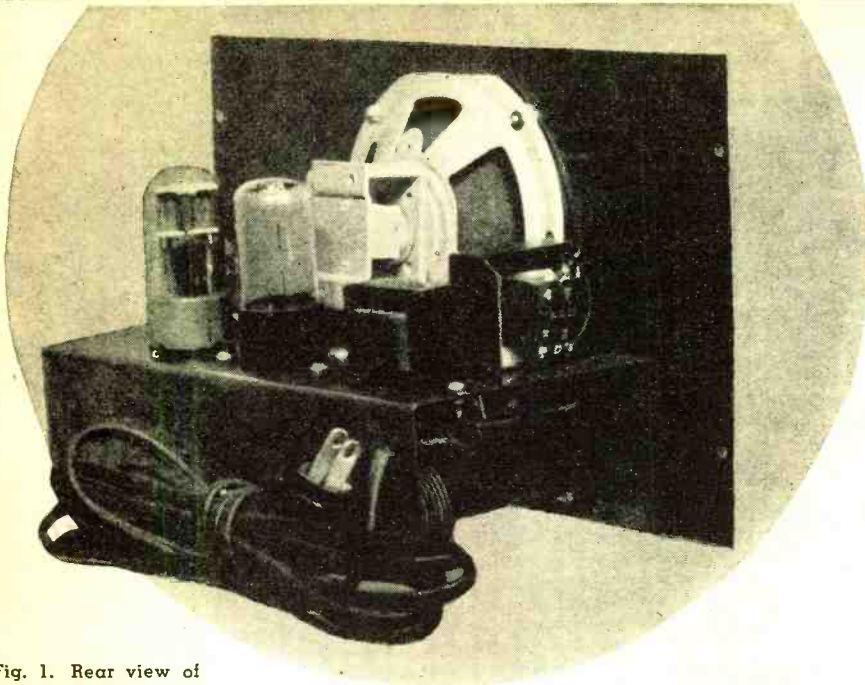

Fig. 1. Rear view of home-built intercom.

Construction details for a low-cost, two-tube, a.c.-d.c. powered audio amplifier that has been especially designed to be used as an intercom.

HOW often have you wished you had an inexpensive, small, audio amplifier unit? A unit of this type can be hooked up to operate between house and workshop to carry conversations, signals, telephone bell, etc.

A unit for this application should be lightweight for ease of handling; it must be small in size; it must have sufficient gain to insure maximum coverage; it should be equipped with a suitable talk-back arrangement; it should be relatively free of 60 cycle hum; it must also be inexpensive and easy to build.

The "intercom" being presented in this article was built from material which may be found in the "junk" box. It is small sized (5"x7"x12"), weighs only 5 lbs., and has approximately 1.5 watts output. It has sufficient over-all voltage gain to make the drop of a pencil audible. Two tubes make up the total tube complement; a 12SQ7 and a 50L6. The power supply in this case is the new type NC5 selenium rectifier recently placed on the market by *Sylvania Electric Products Inc.* Although this power supply is a half-wave job, there is practically no hum noticeable in the output.

Since the selenium rectifier is rela-

tively a newcomer to the field of rectifiers, a short review of its characteristics is in order.

The selenium rectifier is a compact, rugged, lightweight, heaterless, metallic type of rectifier, measuring only $1\frac{3}{16}$ " thick by $1\frac{3}{8}$ " in diameter. It was developed for a wide variety of rectifier applications, especially for small power supplies for home radio receivers. This unit incorporates between two metallic control surfaces, a chemically and electrically treated selenium layer which permits current flow in one direction but blocks it in the other, thus rectifying the applied a.c. In many instances the selenium rectifier has been used to replace a vacuum tube, with an increase in d.c. output resulting from the low voltage drop encountered across the selenium unit.

These units may be used in voltage doubler circuits to great advantage, and a socket for mounting is not required, which, together with the absence of a power transformer, greatly reduces the cost of constructing experimental equipment. It should be noted at this time that there are several precautions that must be observed when using this type of rectifier, namely:

1. Selenium rectifiers are limited to

By
E. BRUCE PRAY
Eng., Electronics Division
Sylvania Electric Products Inc.

operation at temperatures lower than 75°C (167°F). This means that one should take care not to mount the unit too close to power tubes or high wattage resistors.

2. It must be remembered that this unit (except for the mounting eyelet) is alive (115 volts to ground), therefore take care to keep it away from the chassis and other parts to avoid short-circuits.

3. A series peak limiting resistor must be used with these rectifiers to limit the peak current which could damage the units. A minimum of 20 ohms, 2 watts is recommended, although slightly higher values may be used with a corresponding decrease in d.c. output.

4. Never apply more than 130 volts r.m.s. as the unit is not rated for higher voltages.

The selenium rectifier is connected with a peak limiting resistor in series with the rectifier anode and the a.c. line. The cathode end of the rectifier, which is the output terminal, is connected to a conventional pi-type filter, consisting of two 20 microfarad electrolytic capacitors and a 15 henry, 400 ohm choke. A 20,000 ohm, 1 watt bleeder completes the power supply which delivers 120 volts at 100 milliamperes. The tube filaments are connected in series and then to the 115 volt line through a 365 ohm, 10 watt resistor (R_c).

Because of the danger of shock to the operator and of blowing fuses, it is very unwise to connect either side of the line directly to the chassis. Instead, connect all the negative returns to a common point and ground this single point to the chassis through a capacitor (C_1). In place of a microphone, a 5 inch PM type speaker with a 4 ohm voice coil is used, feeding into a universal output transformer connected backwards. If the transformer primary is tapped, disregard the tap and use the entire winding for maximum impedance. On the voice coil side, choose the two terminals which will match the 4 ohm voice coil of the speaker. A universal transformer is very useful if you want to match two remote stations instead of one. For example, let us say that after building the unit with one remote station we decide to add another remote station. This can be accomplished in the following manner.

design since the circuit employed is well known for its frequency stability and sure-fire performance. The use of the parallel and series pads, consisting of zero coefficient silver mica condensers with compression type mica trimmers, where specified, results in a high *C* circuit. The use of the fixed condensers, in addition to the trimmer condensers, provides easier adjustment of the bandspread due to the more or less limited tuning range of the trimmer. In addition to this, freedom from drift is assured. It is usually desirable to operate the oscillator on the high frequency side of the incoming signal as less trouble from images and harmonics will result. Needless to say the oscillator may be operated on the low frequency side with equal performance. By tuning the oscillator on the low frequency side of the incoming signal a slightly higher *C* circuit results and therefore presents less likelihood of oscillator drift. Very little oscillator drift, if any, will be experienced, especially after the oscillator coil has had a chance to age and provided that a reasonable amount of care is taken when the oscillator coils are made up.

Each of the r.f. grid coils on both 6 and 10 or 11 meters has a 3 to 30 compression type trimmer connected across it. This condenser is employed to track the grid and the plate circuit of the r.f. stage regardless of whether the antenna employed provides inductive or capacitive reaction.

Oscillator frequency drift is completely eliminated except during the initial warm up period. This is accomplished by leaving the oscillator running with "B+" on it, during standby periods. Tests indicate only 25 kc. drift during warm up.

Construction Details

From the illustrations of the converter it will be noticed that the layout is a bit unconventional since practically all of the components are mounted below the chassis. The rear apron of the chassis supports the selenium rectifier, filament transformer, and the filter choke as well as the electrolytic filter condenser. Supported from the front apron of the chassis by means of tapped standoff insulators are the two variable condenser assemblies. Insulated shaft couplings are employed since the entire inner chassis is kept completely insulated from the cabinet in order to avoid ground potential difficulties and possible shock. It is suggested that anyone who builds this converter use similar precautions as the slight additional trouble more than compensates for the increased safety achieved. The small standoff cone insulators supplied with the *National* type XB-16 coil base are removed from the base and used between the chassis and panel. All leads should be kept as short and direct as possible with grid and plate leads, as well as coupling condensers, etc., kept a reasonable distance from the chassis. Each tube has one side of its heater grounded to the chassis, while the

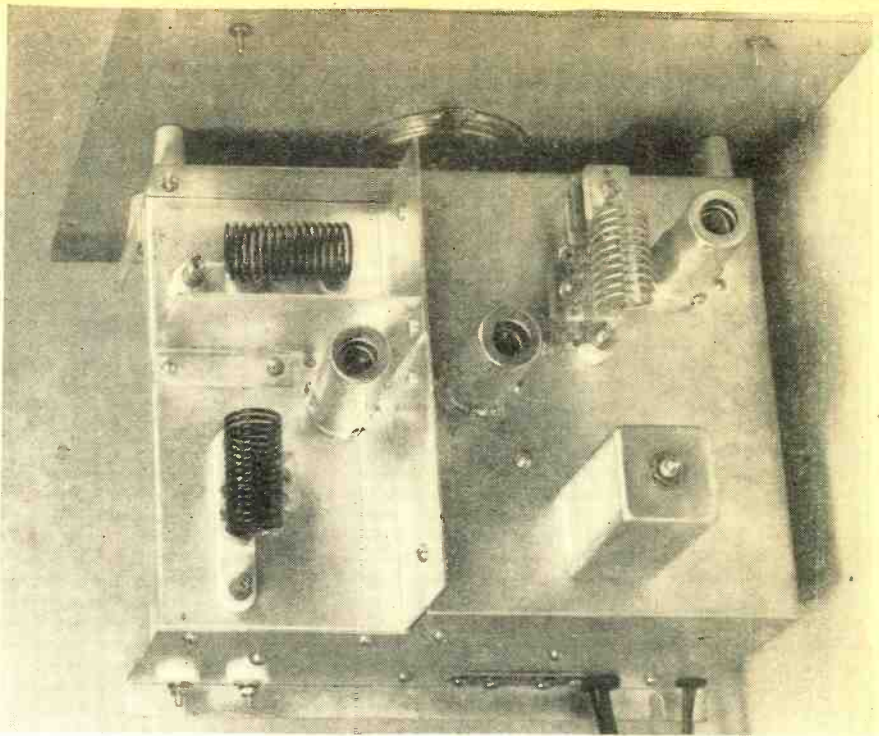

Top view of converter unit. Coils are of the plug-in type. Coil L_1 , L_2 is shown at lower left, coil L_3 may be seen at the upper left, while L_4 is shown at right.

other side is bypassed. Silver mica button type bypass condensers are employed and these are grouped conveniently around the tube socket in order to provide short direct leads. As a matter of fact, the small lugs that are part of the silver mica button condensers are of sufficient length to connect directly to the particular tube prong being bypassed thus eliminating

the need for any wire whatsoever.

The illustrations of the converter along with the schematic diagram and coil information should be self-explanatory. It will be noticed that the r.f. section of the chassis is a removable unit facilitating ease of assembly and wiring in addition to providing excellent shielding and mechanical

(Continued on page 101)

Under chassis view shows placement of various component parts.

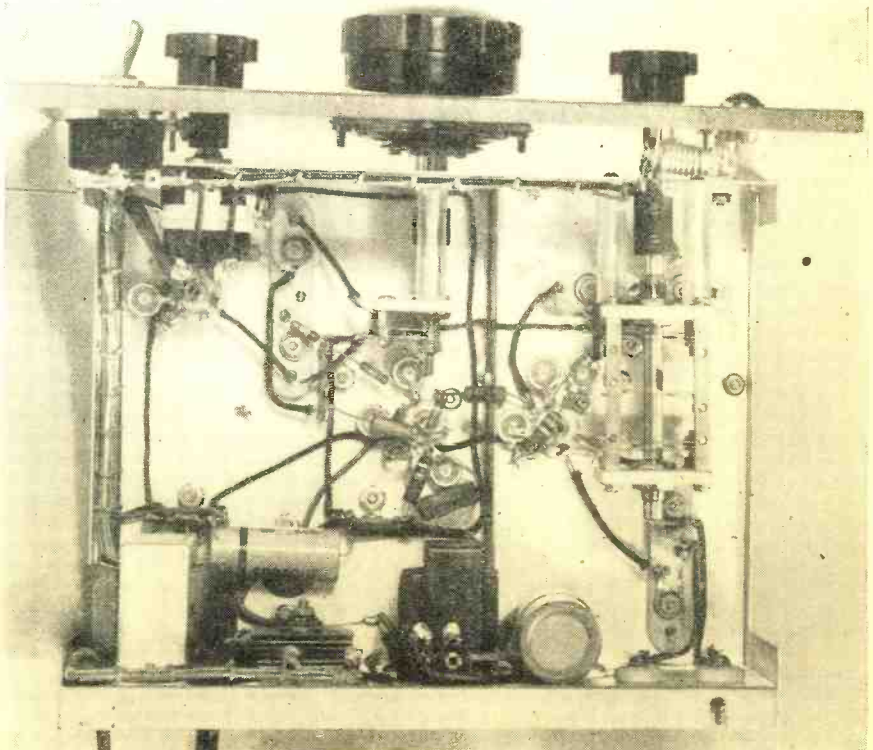

	11 METERS— $\frac{5}{8}$ " i.d.	10 METERS— $\frac{5}{8}$ " i.d.	6 METERS— $\frac{1}{2}$ " i.d.
L ₁	4 t., #20 pushback, closewound $\frac{3}{8}$ " i.d., pushed in ground end of L ₂	Same as for 11 meter coil	Same as for 11 meter coil except $\frac{5}{16}$ " i.d.
L ₂	13 $\frac{1}{4}$ t. #18 en. @ 12 t. per inch tracked with C ₂	Same as for 11 meter coil	8 t., #18 en. @ 7 t. per inch tracked with C ₂
L ₃	13 $\frac{1}{4}$ t., #18 en. @ 12 t. per inch	Same as for 11 meter coil	8 t., #18 en. @ 7 t. per inch
L ₄	10 t. #18 tinned en. @ 9 t. per inch. Tap at 6th t. from grid end	Same as for 11 meter coil. Adjust C ₁₆	5 t., #18 tinned en. @ 7 t. per inch. Tap at 2nd t. from grid end
C ₁₅	40 μ fd. silver mica, $\pm 5\%$	40 μ fd. silver mica, $\pm 5\%$	20 μ fd. silver mica, $\pm 5\%$
C ₁₆	Adjust bandset	Adjust bandset	Adjust bandset
C ₁₈	Adjust bandsread	Adjust bandsread	Adjust bandsread
C ₁₉	40 μ fd. silver mica, $\pm 5\%$	40 μ fd. silver mica, $\pm 5\%$	10 μ fd. silver mica, $\pm 5\%$

Mechanical details for constructing various coils needed in unit.

and 11 meter operation. One oscillator coil is employed for 6 meters while another oscillator coil may be used for both 10 and 11 meter operation with a little sacrifice in bandsread. If desired a separate oscillator coil can be made up for 11 meter operation and any desired degree of bandsread obtained on this band or the 10 meter band. Complete coil specifications have been included in the coil table shown above.

The Mixer

Several tubes were tried as mixers, including the 6AK5, 6BA6 and the

6BE6 which was finally adopted. All of these tubes, when properly adjusted, provided practically the same performance. It was found however that in order to obtain equal performance when using the 6AK5 or the 6BA6 as a mixer with grid injection, the injection voltage became extremely critical for optimum conversion efficiency. This is not the case with the 6BE6 where the injection voltage may vary over wide limits with no noticeable effect on the conversion efficiency. Since all of these tubes are exceptionally high gain mixers, in view of their high transconductance, it was found that all had

Complete schematic diagram for 3-tube, a.c. operated converter.

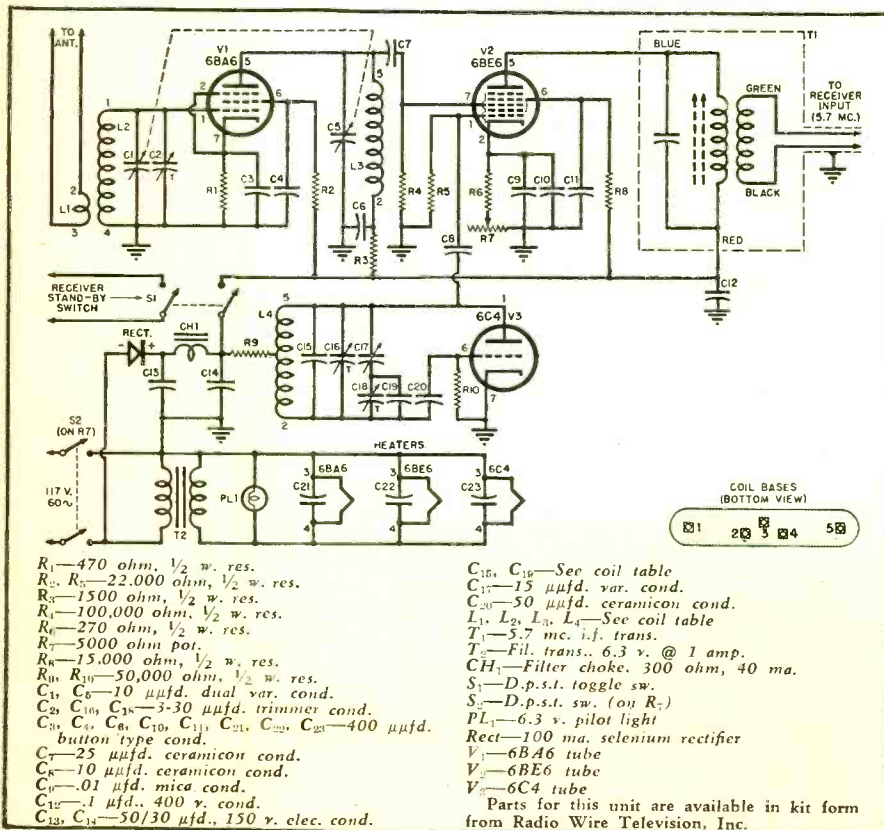

a tendency to be regenerative and that this was primarily a function of grid loading. It is for this reason that the 100,000 ohm grid resistor and the two cathode bypass condensers are employed in the control grid circuit of the 6BE6 mixer. Apparently the silver mica button type condenser provides better r.f. bypassing for the input signal frequency while the larger mica bypass condenser is advisable for the i.f. frequency bypassing. Actually the silver mica button condenser could be eliminated. However for ease in duplicating performance and results, it is suggested that dual bypassing be employed.

It was considered advisable to provide a means of adjusting the gain of the converter in order to make it as versatile as possible. This is the reason that a variable cathode bias resistor was used in the mixer cathode. Proper adjustment of this control will reduce the background noise to near inaudibility. Of course the combination is not working at maximum sensitivity under these circumstances, but there are times when it is desirable to operate in this fashion especially when working locals and possibly when employing break-in operation. In addition, if you are unfortunate enough to have several powerful locals nearby and you are having some cross modulation difficulty this can usually be reduced to a minimum, if not eliminated entirely, by increasing the bias on the mixer. The control also makes it possible to reduce gain where it will reduce background noise most effectively. It can be readily appreciated that any small amount of noise ahead of a sensitive communication receiver is greatly amplified by that receiver. The ability to more or less control the noise at the source is therefore a decided advantage. The bias control also incorporates a double-pole, single-throw switch that is used to turn the power on and off. An extra safety factor is provided by the use of the d.p.s.t. switch although a single-pole, single-throw switch is normally employed as the power or a.c. switch. Because a selenium rectifier is used one side of the a.c. line is at chassis potential and even though the chassis is completely floated, the use of the double-throw switch completely eliminates ground potential or possible shock by disconnecting the converter from both sides of the power line.

A separate double-pole, single-throw toggle switch is used as the "Receive-Transmit" or "Standby" switch, one circuit being used to open the "B plus" circuit. The other circuit of this switch is brought out to two terminals on the rear apron of the chassis, from which point it is connected to the communications receiver standby switch terminals. This one switch, therefore, makes it possible to turn on or off both the converter and receiver during transmit-receive cycles.

The Oscillator

This was the only portion of the converter where it was deemed unnecessary to experiment with circuit

**Old communications receivers
can be improved by adding
this well-designed converter.**

By

FRANK LESTER, W2AMJ

Radio Wire Television, Inc.

THE advisability of using a converter ahead of a good communications receiver is something that requires little discussion since by this time it can be assumed that the advantages of such a combination are now, more than ever, a well known fact. A good converter will usually bring an old communications receiver back to life by either extending the frequency range or very greatly improving the performance of the receiver on the high frequency end.

The converter about to be described was designed with the thought in mind that it should be as inexpensive as possible and at the same time capable of excellent performance. The instrument is low in cost in spite of the fact that only quality components were used.

For ease of construction and from past experience with converters it was found to be a definite advantage to eliminate the tracking problem by going to what may be termed two dial control. In other words, the oscillator tuning was separate from the r.f. tuning. It is possible, using this method, to make the bandspread adjustable to any desired degree. In addition many other advantages are gained which by far exceed the apparent disadvantage of a two control system. Actually, in use, the converter is essentially a single dial control unit except when one is looking for very weak signals when, of course, the r.f. end must be kept in tune in order to get the last db. gain that is possible.

Very often it will also be found quite advantageous to be able to detune the front end of the converter when local QRM is heavy.

It will be noticed that the usual power transformer is not employed and consequently a saving in cost is made possible. The use of the new selenium rectifier in conjunction with a filament transformer provides a very excellent power supply that is comparable costwise to the usual a.c.-d.c. set-up and at the same time eliminates the majority of a.c.-d.c. vices. By using the selenium rectifier and the condenser input filter arrangement shown in the schematic diagram it is possible to obtain as high as 150 volts output with a 120 volt a.c. line voltage. The output is usually in excess of 125 volts except where the line voltage is exceptionally low. The use of the new

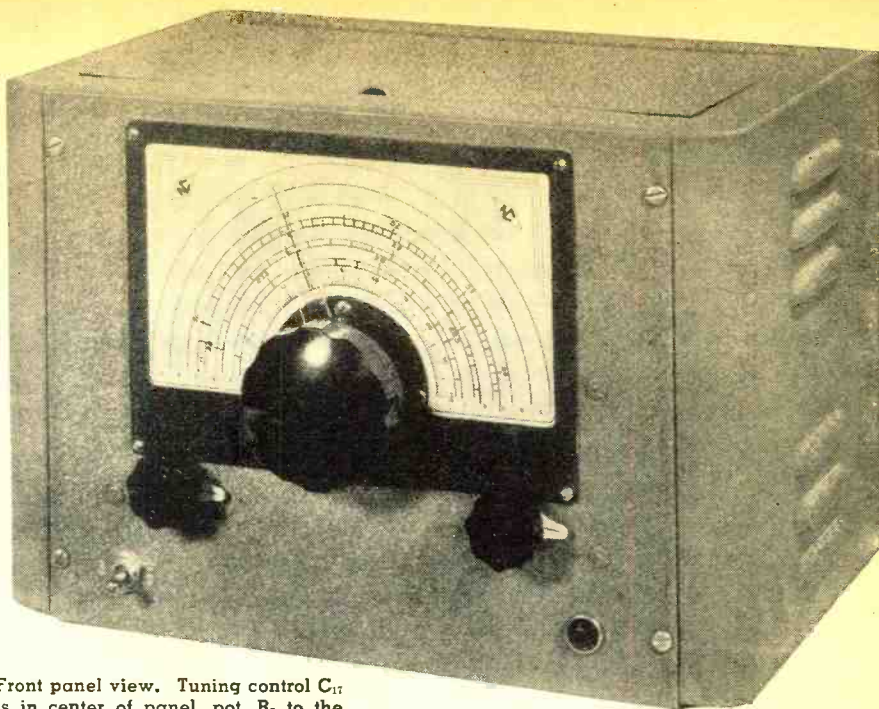

Front panel view. Tuning control C_{17} is in center of panel, pot. R. to the left, condenser C_1 , C_2 to the right and standby switch S_1 , lower left.

NEW 6-10-11 METER CONVERTER

miniature tubes makes the usual power transformer unnecessary since the tubes will supply plenty of gain with as low as 100 volts on the plates and screens. Using the selenium rectifier, therefore, will result in a saving in cost and can be said to have practically no effect whatsoever on the performance of the converter, when compared to a transformer type power supply.

The R.F. Stage

In the early design stages of the converter, since it was very desirable to obtain the highest possible signal-to-noise ratio and at the same time realize good gain from the r.f. stage, several tubes and circuits were tested in an effort to get the best possible combination. As a result of these experiments, the 6BA6 was adopted because it provided the most satisfactory performance in this application.

The value of bias resistance chosen results in the r.f. stage being very stable on 6 meters without any antenna loading whatsoever. On 10 meters, however, due to the additional gain, the r.f. stage may oscillate with-

out an antenna cut for this band loading the stage down. Increasing the bias value results in stabilizing the r.f. stage on 10 meters. However, this procedure resulted in a slight loss insofar as 6 meter performance is concerned. It was therefore decided to keep the r.f. stage hot on 10 meters and eliminate the slight instability by proper antenna loading.

If any instability is experienced on 10 or 11 meters this will be due to insufficient loading. To eliminate this condition, should it exist, an 8200 ohm, $\frac{1}{2}$ watt resistor may be connected across the r.f. grid coil. Since this will be installed on the coil itself it will have no effect on the 6 meter performance as it will be removed when the coils are changed. In all probability the resistor will not be necessary but its use is being mentioned to take care of possible trouble. This system provides excellent gain on 6 and 10 meters without any tendency for the stage to oscillate regardless of antenna loading.

One set of coils is used to cover the entire 6 meter band in the r.f. stage while another set is employed for 10

The problem of extending credit to your customers can be solved by your banker. Consult him now.

By
LOUIS J. ASTERITA
Sec'y, Consumer Credit Comm.
American Bankers Association

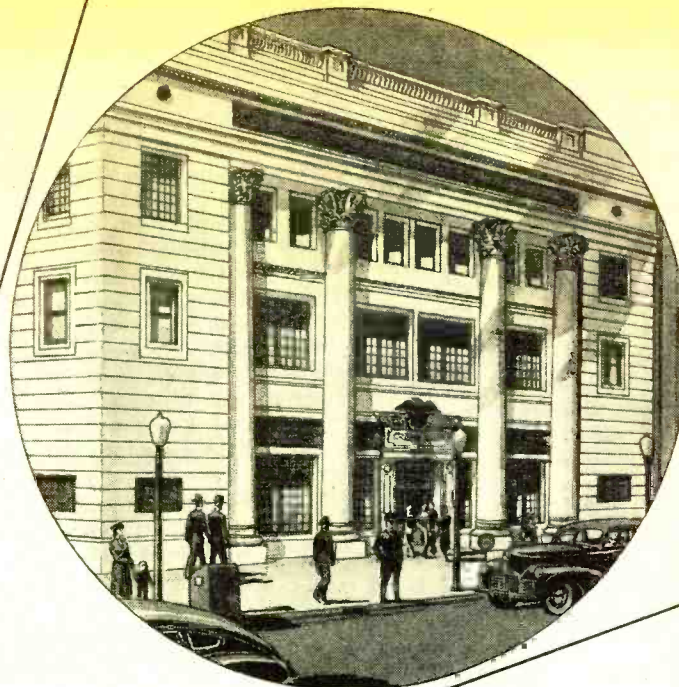

Appliance Financing by Commercial Banks



THAT the commercial banks will be prepared to offer satisfactory financing to approved appliance dealers is clearly demonstrated by the results of surveys conducted by the Consumer Credit Committee of the American Bankers Association. These surveys show that more than 7000 banks have formulated plans to finance appliance dealers when merchandise and installment paper is again available.

In order to implement this program, the American Bankers Association conducted a comprehensive study of home appliance financing with the result that a manual of operations was issued in an endeavor to acquaint banks with the techniques and methods of operation in connection with this type of financing. To date, almost 10,000 banks of the country have requested copies of this manual and approximately 5000 copies have been sent to others interested in consumer durable goods and services: This is an

indication of the tremendous interest in this field.

The Committee on Consumer Credit of the American Bankers Association, in keeping abreast of the rapid growth and development of installment sales finance business, is constantly on the alert to assist and implement the lending program of the banks. A project was recently completed which will aid considerably in the development of installment paper business in banks. The first part of the project indicates as rapidly as possible which banks in the country are doing an installment loan business, and the second part is the organization of a nationwide collection system for these banks.

A questionnaire was sent to member banks requesting them to inform the American Bankers Association whether or not they would be interested in participating with other banks in a collection arrangement on a reciprocal basis. The results of this survey have been tabulated in a directory with symbols used to indicate the extent to which each bank is engaged in the various phases of consumer lending and to what extent they will cooperate in this nationwide collection system. This gives to the banking system a collection service for handling "skip" and other specially treated paper that is far superior to anything yet developed in the credit field.

This publication lists the names of

almost 10,000 banks located in virtually every section of the United States which extends installment credit to the public buying necessary durable goods and financing through dealers. More than 7000 of these banks have indicated their willingness to cooperate with each other on a reciprocal basis in a nationwide collection service on "skip" or delinquent consumer installment accounts. In addition, this directory should be of great assistance to manufacturers of consumer durable goods and services as a source of information on the location of banks engaged in installment financing and for the type of credit services offered. With this thought in mind directories were mailed to almost 500 manufacturers throughout the country with the compliments of the banking fraternity. A specific manufacturer can look in the directory and find in any town, village, or city in the country, the installment loan services the banks in that area extend. This should, in our opinion, help the banks of the nation to obtain a reasonable share of this business.

Obviously, before the program of the banks can become effective, much will depend on the production of consumer durable goods in sufficient quantity to place the program at the disposal of the dealers. The pent-up demand that has been frequently estimated discloses some interesting fig-

(Continued on page 155)

EVERY HOME A *Bonanza!*

By **DR. LOUIS BADER**

Assoc. Prof. of Marketing
School of Commerce, N. Y. U.

Tap a rich source of revenue in your trading area by making every home owner "electrical living" minded.

THE "E" home is one which is occupied by an electrically-minded family. The members of the family have been educated by general reading, advertising, and, more particularly, by the dealer, to an appreciation of the part that electrical devices can play in making the home easier to operate, more comfortable and healthy to live in, and a source of envy and admiration to friends and neighbors.

All this, and more, applies to the "E" farm. These families have been sold the joy of living in the electrical home or on the electrified farm. To a dealer such a place may be made to become the "Acres of Diamonds" on which the Rev. Russell H. Conwell so often gave lectures, the proceeds from which helped to build Temple University of Philadelphia. Dr. Conwell said, in effect, work your own fields to discover the riches in them. Let's see, Mr. Dealer, how you can apply this formula in building your store to a point where it provides you with a worthwhile living.

Your "E" family can be taught that they ought to have nearly all of the devices listed in Table 1. But you, Mr. Dealer, will have to do most of the persuading—and all of the selling. What an opportunity! Work it properly and you will have your own "Acre of Diamonds."

If your capital permits you can open an *Appliance Department Store* where merchandise can be arranged in related groups, or if space permits you may even lay out rooms with the merchandise displayed in natural settings. If it is possible to stock complete lines you can then devote your energies to the selling and upgrading of customers.

The biggest opportunity with a complete line is in canvassing your trading area, visiting in the homes, surveying the lack of equipment in the homes and then planning how to reach each and every family on their electrical appliance needs. The job means

going out after business,—not puttering around your store waiting for it to come in. The job also demands that you be a friendly salesman, not an indifferent human icicle.

Lack of capital may prevent your carrying the full line of radios and appliances indicated in Table 1. If this is the case, the thing to do is to study your trading area with relation to the principal items people are likely to buy. If your study reveals that kitchen equipment will find a ready market in your trading area then stock kitchen equipment and build your reputation as a specialist in this field. If it is some other item do likewise in that field. Become the community expert in the sale and servicing of your special line. Then, as you grow, add line after line until you have an "appliance department store."

The main items listed in the table usually are not bought—they must be sold. To sell them you must frequently seek out the prospective customer and do her the service of selling her, oftentimes in her home. This means you must, for one thing, plan to do regular, consistent, thoughtful, friendly canvassing of your trade area.

Each day you and your salesmen must plan and make a certain number of calls. You should cover the territory consistently, beginning at some predetermined point, cover it completely, and then begin over again. The point to begin is where your market survey indicates a good possibility of making sales. This gives encouragement and, by example, opens the way for more sales among the neighbors and friends of those
(Cont. on page 151)

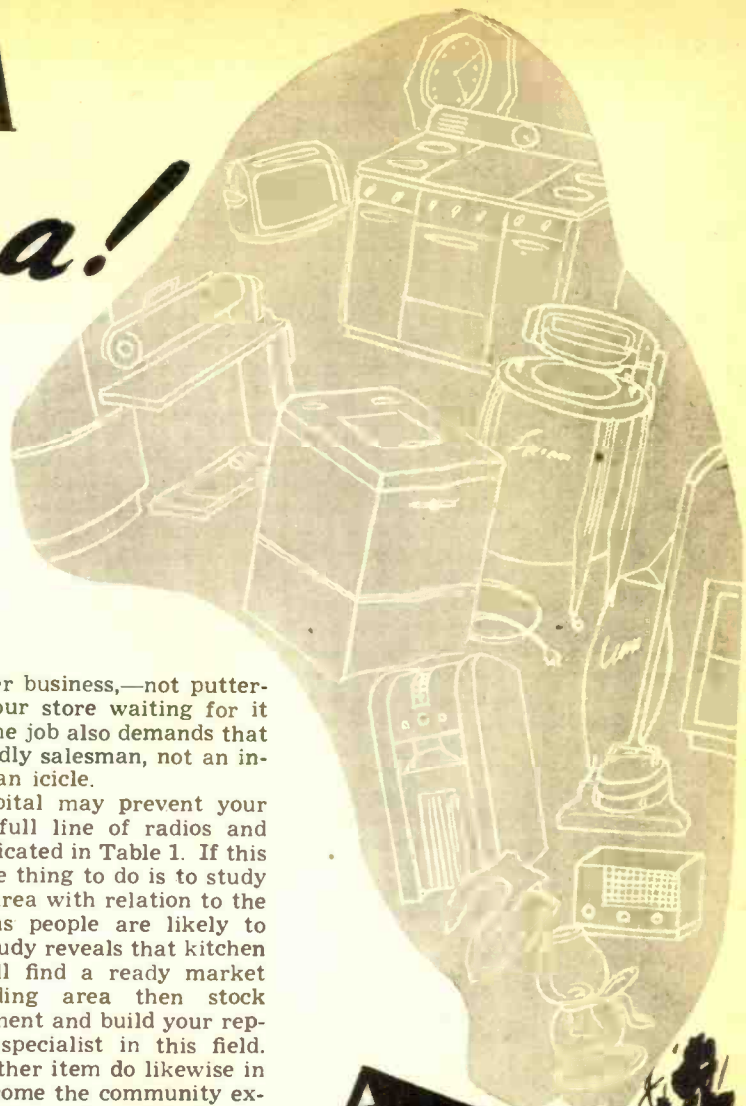

An Inexpensive 18-db. PRESELECTOR

By T. J. DODGE

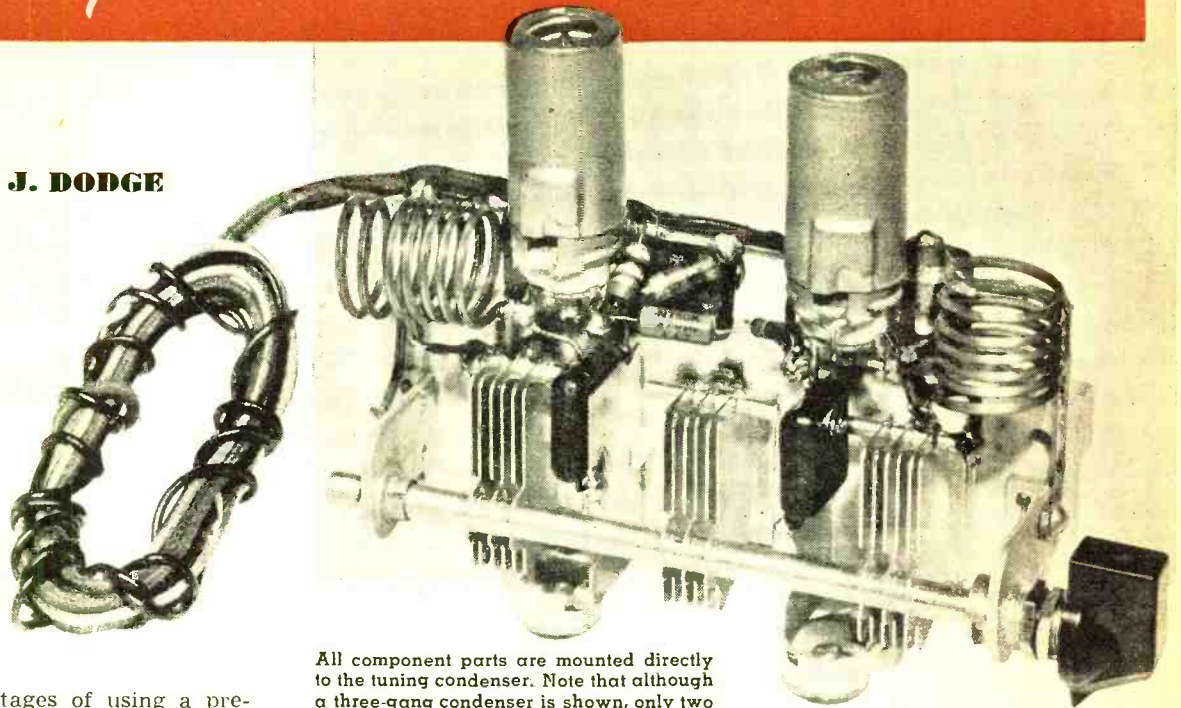

All component parts are mounted directly to the tuning condenser. Note that although a three-gang condenser is shown, only two sections are actually used. The middle section acts as a shield between the stages.

THE advantages of using a preselector at high frequencies is a well established fact. The preselector increases the sensitivity as well as the image ratio.

While many amateurs use preselectors, others do not due to the expense involved when a manufactured preselector is purchased. The preselector described in this article can be constructed in approximately two hours and requires no chassis or cabinet and a bare minimum of parts costing a total of less than \$10.

The high-frequency sensitivity of some of the older type communication receivers was considerably down at 28 megacycles in comparison to the lower frequency ranges of the receiver. This accounts for operators using such a receiver experiencing poor "DX" reception on 10 meters. When the 18 db. preselector is added to such a receiver, marked improvement will result.

The use of the preselector ahead of a modern communication receiver will result in better signal-to-noise ratio, since the i.f. gain of the receiver can be reduced by the manual control.

Considerable interference is created by image response and the preselector will improve this condition radically.

The actual noise created in a receiver normally results from high-gain stages (low frequency i.f. amplifiers and mixers). The noise created by a high-frequency r.f. amplifier is extremely low and can usually be discounted. This being the case, additional gain ahead of the mixer allows the reduction of gain behind the mixer, resulting in an over-all improvement in signal-to-noise ratio.

Improve your 10 meter DX reception with this easy-to-build, low-cost preselector.

A signal-to-noise ratio of 1:1 is insufficient for practical reception regardless of the gain capabilities of the receiver. Adding the preselector to such a receiver and reducing the i.f. gain of the receiver to a point where the over-all sensitivity is the same will result in a greatly improved signal-to-noise ratio. Although a 1-microvolt

signal could be received under both conditions, under one condition the signal would be unintelligible and the other perfectly readable.

When a communication receiver is designed, the engineer must compromise between high sensitivity and signal-to-noise ratio, and the retail price
(Continued on page 140)

Schematic diagram of home-built, two-tube preselector.

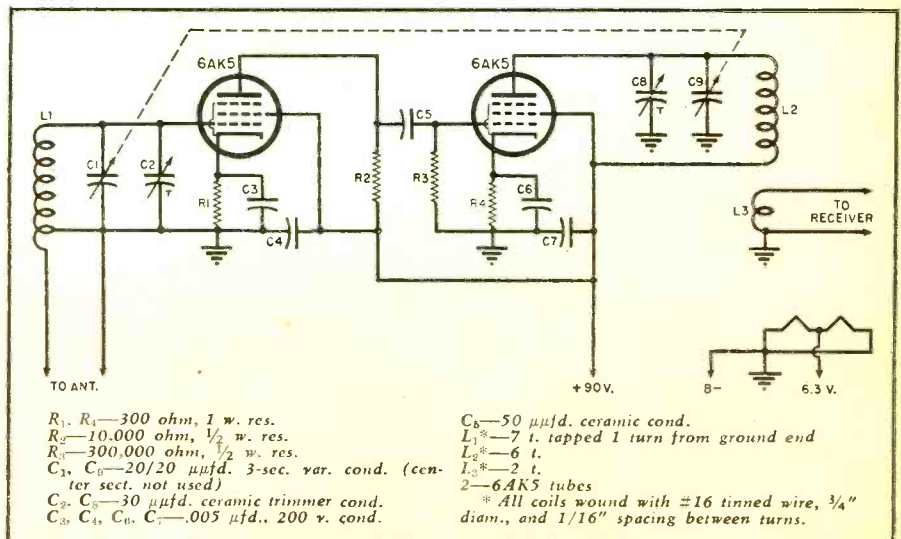

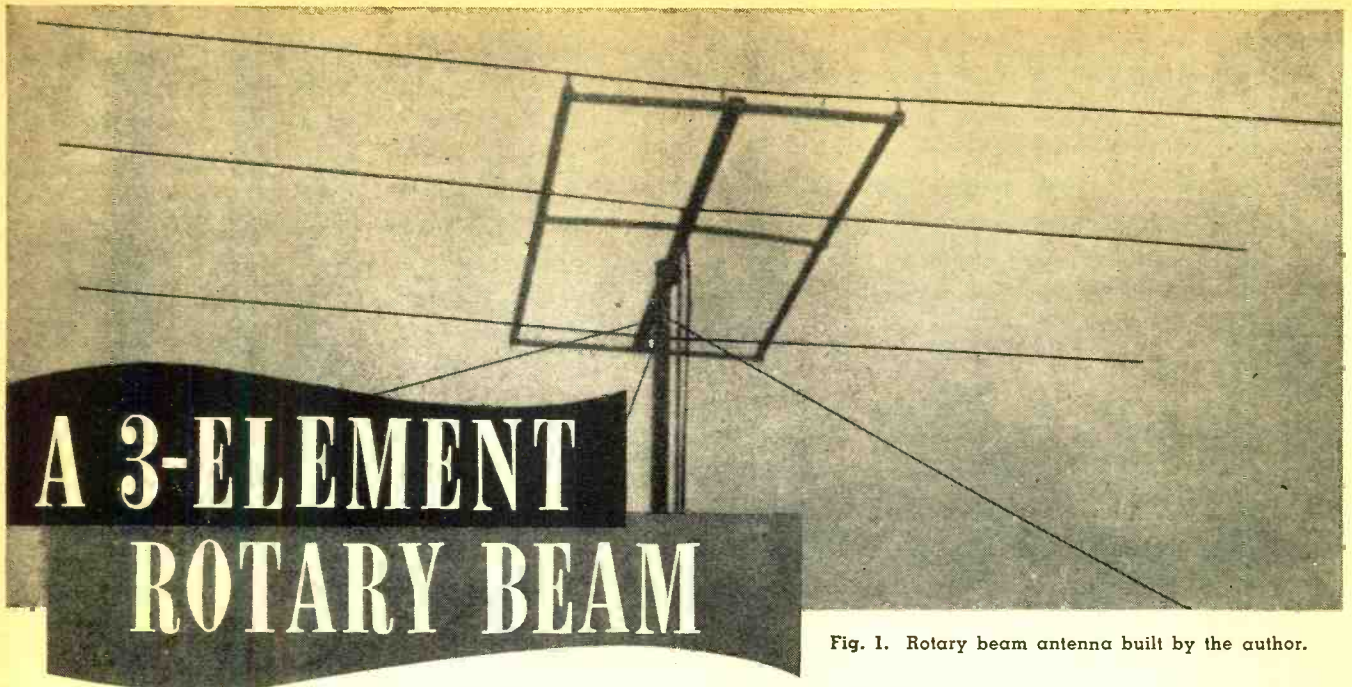

Fig. 1. Rotary beam antenna built by the author.

By H. E. SCHWARTZ, JR., W2NUD

Complete details for constructing your own rotary beam antenna. All parts are readily available.

THE need has been expressed by many hams for more complete information on the construction of an inexpensive rotatable array. The array to be described involves no machine work, and requires only ordinary hand tools and a few hours time. This antenna in no way compromises on efficiency, gain, appearance, or ease of

Fig. 2. Details of pulley assembly.

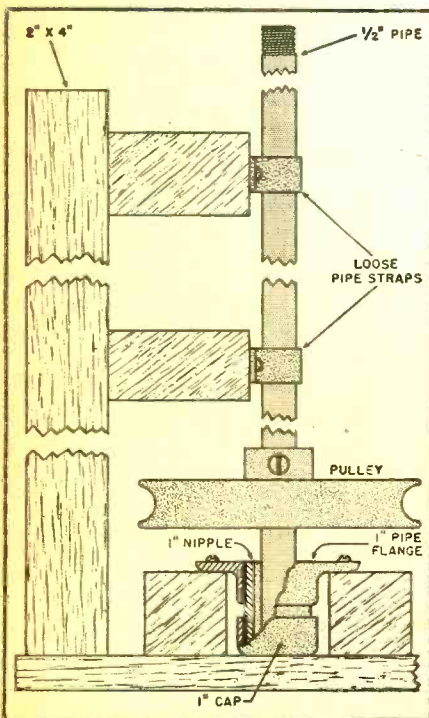

rotation, and is comparable to manufactured arrays costing several times as much.

Before the beam itself is described, it may be of interest to hear some of the reasons that led up to its construction. In the haste to get on ten meters after the band was reopened, the simplest possible antenna, a dipole, was erected high enough to be in the clear. The transmitter at W2NUD runs 120 watts input to the final on any frequency from 28.1 to 29.7 megacycles through the use of an e.c.o. and should therefore have been able to "get out." As it did not, and all other factors had been absolved of responsibility, it was evident that the antenna was at fault. A lot of breath was wasted calling DX stations, only to hear them come back to other local stations. Almost invariably the operator of the local station who had succeeded in working the DX would be heard to say those seemingly magic words: "The antenna here is a three element rotary beam old man" and so the decision was reached to construct a beam. Although the location did not seem suitable for a rotating array, as the ham shack is on the fifth floor of a six story apartment house in Manhattan, the whole scheme worked out far better than was expected.

Some thought was given regarding the relative merits of two and three element arrays, with anything larger ruled out as too bulky. The two element seemed hardly worthwhile as it is a relatively simple matter to add the third element, once the rotatable framework is constructed, and since the gain of a three element array is

greater, it was decided to build that.

The beam was constructed for a total cost of ten dollars exclusive of transmission line, which can be anything you have on hand or prefer to use. For the matching section to be described, it should be either 72 ohm coaxial cable or twisted pair of approximately 72 ohms characteristic impedance. If you are using single wire feed, or have no antenna system at all, then the cost will be increased by the price of the feeders, but will still be quite reasonable, fifteen to twenty dollars for an array which gives very nearly the ultimate in performance. The three elements cost the author only \$4.68, and the wood and pipe required made up the other five dollars.

To start construction, four lengths of $\frac{1}{2}$ " o.d., .035" wall aluminum or dural tubing should be purchased. These come in standard lengths of twelve feet and should be cut according to Fig. 5A, which shows how to obtain the basic elements from the stock lengths. Then the radiator must be extended slightly by means of scrap tubing from the junk box—these pieces were about $2\frac{1}{2}$ " long and overlap sufficiently so that $1\frac{1}{2}$ " is added at each end. They can be any metal tubing that will force fit into or over the $\frac{1}{2}$ " tubing. The total length of the radiator is given by the formula:

$L = 468/f$ where L is the length in feet and f the frequency in megacycles. This gives 16'3" for a frequency of 28.8 mc., which is the center of the ten meter phone band for which this beam was designed. The basic formulas are given throughout so that an array may be built for any frequency (greater than 14 mc. to be practical) that you desire.

The director and reflector each have a joint made from a piece of brass tubing which fits snugly inside the elements, which are split by a hacksaw

cut for about 1", so that they can be compressed tightly by means of a small strap type clamp (the type commonly used to mount 1/2" diameter tubular capacitors) on each piece. The director must be cut down to a length 4% shorter than the radiator; given by the formula:

$L = 450/f$ which becomes $15'7\frac{3}{8}"$ for 28.8 mc. The reflector must be added to with short pieces of scrap tubing, as described for the radiator, in order to make it 5% longer than the radiator, or a length given by the formula:

$L = 492/f$ or $17'1"$ for the center of the ten meter band.

Next a wooden frame must be constructed as shown in Fig. 4. The 1/2" pipe flange is mounted to the 1x4 with four #10 wood screws and the 1x2's are drilled and bolted together and to the 1x4 with two #10 by 2" machine screws and nuts at each joint. Small ceramic standoff insulators are held to the frame by #8 wood screws and have small "U" clamps, normally used to mount 1/2" diameter tubular capacitors, bolted on them. These hold the tubing quite nicely. In order to keep it from slipping out a 1/32" diameter hole is drilled through the element and a piece of wire is passed through the hole and wrapped around the element and clamp.

A thirteen foot long piece of 2x4 lumber must be purchased to serve as a mast, and is guyed by three lengths of clothesline to points on the roof approximately 120° apart. A fourteen foot piece of 1/2" galvanized iron pipe is mounted by loosely fitting pipe straps to small blocks, which in turn are nailed to the mast as shown in Fig. 2. The pipe must be off-set sufficiently so that the pulley will clear the mast. A suitable pulley, which will fit 1/2" pipe, has a set screw to fasten it and is about six inches in diameter can usually be found in a junk yard. The original set screw was removed from the pulley and a bolt of the same size and about three inches long was substituted. This bolt hits a small block of wood which is nailed to the mast, limiting rotation to approximately 350° so as not to foul up the feeders, which hang loosely to permit turning the beam. The bottom end of the pipe turns in a bearing constructed of standard plumbing parts as shown in Fig. 2. The length of the pipe can be increased to obtain greater height if desired.

The beam is turned quite easily, efficiently, and cheaply by means of a dollar's worth of ordinary clothesline. The line is wrapped around the pulley twice to give sufficient friction to turn it and passes over two clothesline pulleys, which are fastened together and suspended at a 45° angle. At the bottom end the line passes through a single pulley and the two ends are tied together to make one continuous length; this pulley has a tension spring, of the type used on screen doors, between it and the window sill, so that the line is kept under a few pounds tension at all times. It is lo-

cated at the side of the window in the ham shack, and can be easily reached. In some locations it should be possible to pass the control lines through holes in a board, which would be placed above or below the window, so that control from inside could be obtained.

An indicator can easily be rigged up, if desired, to show which way the beam is pointing, for example, a pointer of sheet metal on one line with a piece of cardboard fastened to the side of the window frame close to it, calibrated with the points of the compass and covered with transparent, adhesive, cellulose tape. However, this was not deemed necessary at this QTH as all that's needed is to look out the window and up, and the direction of the beam can be determined at a glance. Even this simple expedient is not normally required, though, for the operating procedure here is to point the beam in what seems to be the correct direction and then turn it for a maximum reading on the receiver "S" meter on a received signal. This is also automatically the correct position for transmitting.

Setting the antenna in a particular direction by means of points of the compass is only correct if a great circle path is plotted. This involved procedure seems to be the hard way to do it when the method with a received signal is so simple and accurate.

In designing the mechanical system for turning an array of this sort, a compromise must be reached in the amount of friction at the bearings in which the supporting pipe turns. The

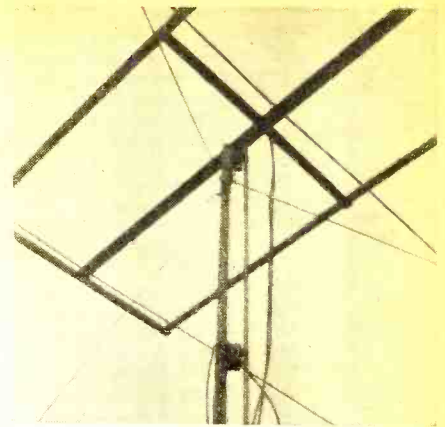

Fig. 3. Close-up view of frame assembly.

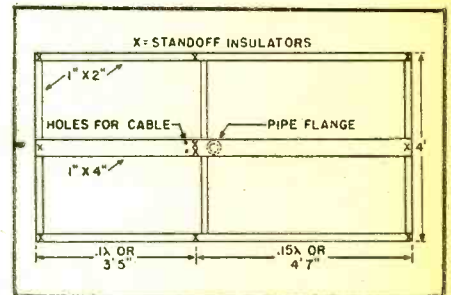
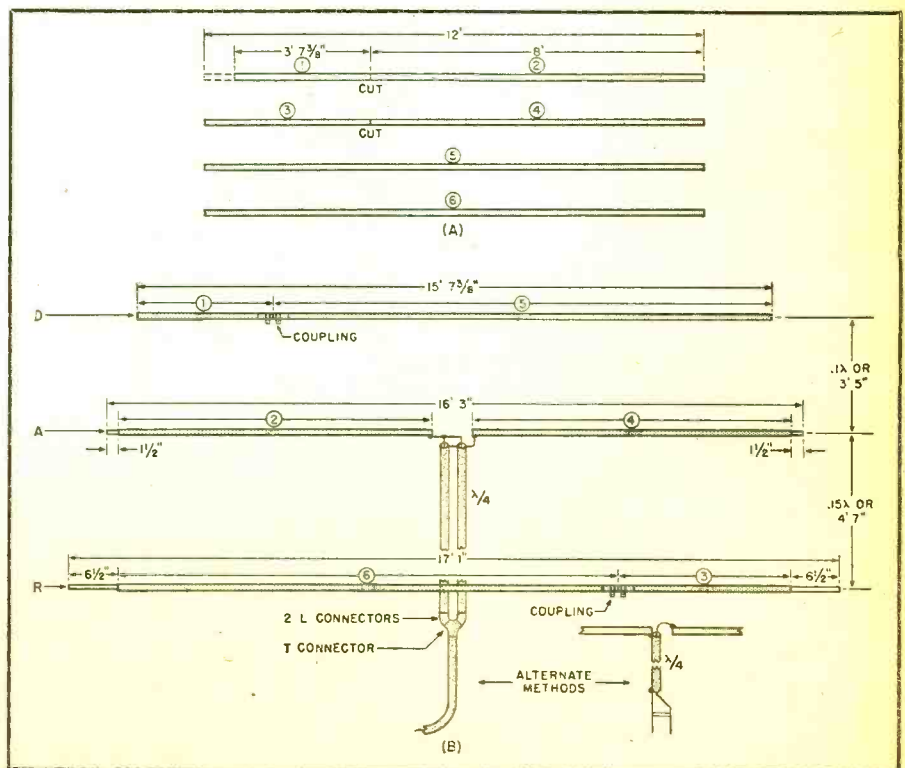

Fig. 4. Details of frame construction.

friction involved in the straps is quite small, as they serve merely as radial bearings, however the bottom bearing is also a thrust bearing, and has the

(Continued on page 110)

Fig. 5. Mechanical details of antenna elements and feed system. As shown in (A), the four 12-foot aluminum tubes are used to make up the antenna. Two of these sections numbered 5 and 6, are used as is. The other two tubes are cut to make up sections 1 through 4. The complete antenna which is shown in (B) is made up of these six sections. Placement of the various components can be readily identified by their numbers.



VISUAL ALIGNMENT of TELEVISION RECEIVERS



Consumer acceptance of television will depend, to a large extent, on the proper alignment of the receiver. Servicemen must become familiar with alignment procedures in order to give satisfactory service. The receiver shown is a popular RCA TV unit.

By
M. H. KRONENBERG

Vision Research Laboratories

The use of a sweep signal generator and oscilloscope for aligning television receivers is recommended by the service departments of many TV manufacturers.

THE present state of the art of television transmission and reception requires that adjustments on such equipment be carried out with great care and understanding of the circuits involved, if optimum performance is to be achieved. The importance of visual alignment in the production, servicing, and development of television receivers is realized by all those familiar with or working in this new field. Technique of aligning a television receiver with the aid of a sweep signal generator differs somewhat from methods used on ordinary broadcast or communications receivers, but with proper equipment the procedure is quite simple and perhaps a lot more exacting.

To align the receiver by visual means, the service bench or laboratory must contain a sweep signal generator, oscilloscope, and the usual conventional test equipment. There are several sweep generators commercially available and they are quite similar in operation but differ somewhat in circuit design. The sweep signal generator is basically a frequency-modulated signal source with means provided for variation of the sweep width, the average operating frequency, and as in the ordinary signal generator, the output signal amplitude. Before discussing the details of visual alignment, it would be well to review some facts about present day television re-

ceiver practice. There are two important i.f. frequency bands in use at the present time, one 8-13 mc. which was adopted before the war, and the other 21.25-26.5 mc. The latter is now accepted as standard for television broadcast receivers and will probably supersede the old i.f. band entirely. The few television broadcast stations presently in operation utilize channel allocations below 88 mc. (44-88 mc.), however, in the near future, as these channels become filled, it will be necessary to provide test equipment for use on the higher frequency bands.

Bandwidth requirements for the i.f. amplifier vary with the type of receiver in use, particularly with the size of the picture tube. In some smaller picture tubes, 5" or 7", picture definition may be limited by the size of the scanning "spot" and thus a bandwidth of 2.5 to 3.5 mc. will suffice. However, the larger tubes, particularly those of later design, produce an exceedingly fine luminous spot. Here the maximum definition of the system may be realized and i.f. stages are adjusted for 3.75 to 4.25 mc. widths. The "front end" circuits of the conventional receiver require that the whole channel be amplified instead of just the video signal as in the picture i.f. amplifier. Since the picture and sound carriers are situated on opposite ends of the channel, 4.5 mc. apart, then the r.f. and mixer circuits must be tuned to

operate over a range of about 5 mc.

Location of the video and picture carriers with respect to the receiver selectivity curve is another very important adjustment. This is another way of saying that the response curve of the receiver must not only be of proper bandwidth to accept the television signal, but must also be shaped accurately. The reason for this, illustrated in Fig. 1, is that transmission of the television signal is accomplished by the vestigial sideband system. In order to reproduce the lower frequencies (those sidebands near the carrier frequency) faithfully, the characteristic of the receiver must be such that it allows these components to add up to a value that is equal in amplitude to the single sideband frequencies situated further away from the carrier (high frequency components). This is accomplished by designing the i.f. circuits so that with proper alignment, a sloping amplitude vs. frequency curve exists at the edge of the high frequency side of the i.f. band-pass, whereby the picture carrier frequency (reduced to i.f.) is situated where the response falls to about 50% of the mid-band value. At the same time the picture i.f. amplifier must reject the sound carrier, and traps provided for this purpose must be tuned exactly 4.5 mc. lower than the picture carrier frequency.

From this the importance of visual alignment may be realized and equipment requirements be evaluated. The sweep generator for use in television receiver alignment must be capable of producing a calibrated frequency modulated signal capable of operation

in the frequency bands mentioned and also capable of generating sweep widths considerably greater than actual amplifier requirements. The oscilloscope used in conjunction with the sweep generator may be of the 3" variety. However, more satisfactory operation is obtained by using a 5" cathode-ray tube. Since the sweep generator generally supplies both horizontal and vertical deflection voltages, it is only necessary to provide a cathode-ray tube with suitable power supply in order to obtain the visual alignment trace.

The Sweep Generator

The several sweep generators currently on the market for use in television work are capable of generating widths of from 100 kc. to 20 mc. and to operate at frequencies within the video, i.f. and r.f. bands. The sweep generator contains a wobbled or FM signal source, amplifier, and output attenuator. Some units also contain calibrated wavetraps for frequency marking of the visual trace. The cathode-ray tube that produces the alignment trace is usually incorporated in an oscilloscope as a separate piece of equipment. Present day sweep generators differ mainly in their method of frequency modulation. Narrow-band FM signal generators utilize the reactance tube and thus are purely electronic in operation, however, in wide-band sweep generators where sweep widths of 10 or 20 mc. are required, mechanical modulating systems are sometimes used. Some pre-war sweep generators used a motor-driven rotating capacitor as the frequency modulating element. Present day sweep generators use either a reactance tube modulated oscillator or a vibrating slug actuated by a magnetic drive similar to that used in loudspeakers. Since the signal generator must operate over such a broad frequency range, and also because of the broad sweep width requirements, it has been found desirable to incorporate a heterodyne oscillator system, whereby the output of two high frequency oscillators is mixed and their difference frequency selected to produce the desired lower frequency output. A block diagram showing a typical method for obtaining the sweep signal is given in Fig. 2. One of the oscillators is frequency modulated either electronically or mechanically and its mean or average frequency kept constant. The other oscillator is not modulated but is manually tuned so that the desired difference frequency appears in the mixer load circuit. The resultant or difference frequency thus obtained contains the desired sweep width and can be adjusted to sweep through the required frequency range by varying the sweep mechanism amplitude.

The sweep generator output is applied to the amplifier or receiver under test and the output of this amplifier is rectified and fed to the vertical deflection plates of an oscilloscope. At the same time the sweep generator

must supply a horizontal deflection voltage in order to produce a composite trace on the cathode-ray tube screen. This horizontal voltage is usually derived from the same source as that used to actuate the sweep mechanism. Therefore, the trace as it appears on the screen consists of a voltage fluctuating in accordance with the amplifier's response over a wide band of frequencies, plotted against a horizontal time base. The horizontal scale indicates frequency and the vertical scale, amplitude response within the band of frequencies under investigation. The most important relationship between horizontal and vertical deflection voltages is that they be exactly in phase and of the same frequency or in some definite harmonic relation. The way in which the composite trace is formed is shown in Fig. 3A, which indicates the result of a sweep generator whose output voltage, frequency modulated sinusoidally, is fed through a broad-band amplifier, and plotted against a sinusoidal time base of equal frequency.

In order to obtain a substantially linear frequency scale on the visual trace, it is necessary to use like waveforms in the sweep mechanism and horizontal sweep. This condition is satisfied in Fig. 3A although some variation in intensity of the trace will result due to the fact that the cathode-ray tube spot velocity varies from "slow" at the edges to "fast" at the center, and the edges of the trace will appear quite bright. While the sinusoidal sweep is perhaps the most convenient method of generating a visual alignment trace, other waveforms have been successfully used such as the saw-tooth and pyramid or tri-

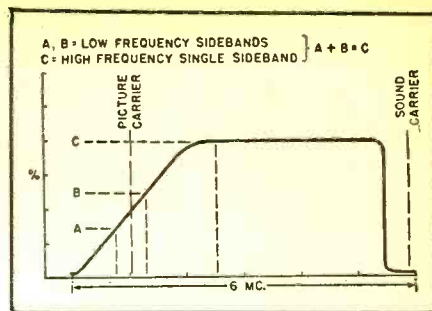

Fig. 1. Idealized video i.f. response curve showing operation of standard method of vestigial sideband television transmission.

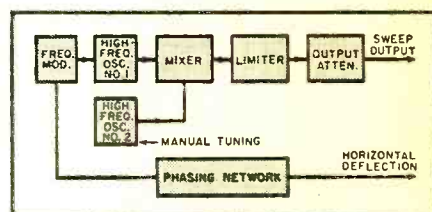

Fig. 2. Block diagram shows typical method used for obtaining the sweep signal.

angular sweeps. Generators utilizing triangular or saw-tooth waveforms are useful mainly in electronic type sweep mechanisms. In mechanical systems it is more convenient to use a sinusoidal sweep.

Behavior of Over-coupled Circuits

The conventional television receiver contains 3 or 4 stages of i.f. amplification and usually a stage of r.f. ahead of the mixer. This means that adjustments must be made on at least 5 or 6 separate broad-band coupled cir-

(Continued on page 118)

Fig. 3. Visual alignment wave shapes formed by sinusoidal sweep (A), saw-tooth sweep (B), and triangular sweep (C).

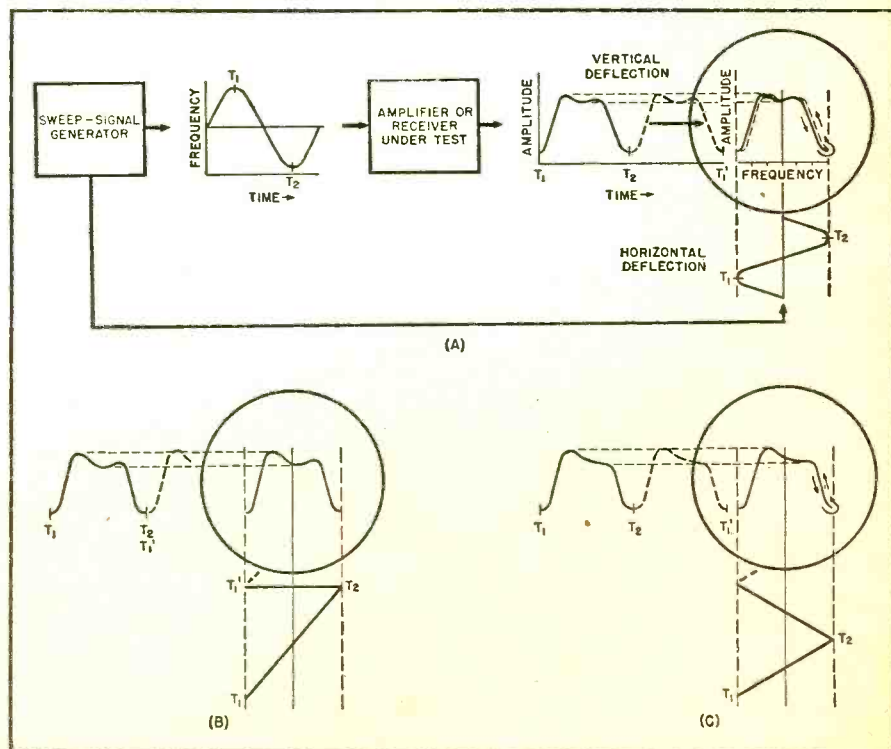



International SHORT-WAVE

Compiled by **KENNETH R. BOORD**

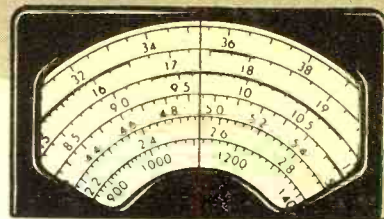

IT IS with pleasure that this month's issue of *ISW* is dedicated to *Radio Luxembourg*, Europe's most powerful commercial radio station (on long-wave) and which operates on 6.090 short-wave. Thanks go to P. Bouillon of the station, and to Guy Bolam, New York, American representative of the owners, for this data.

Luxembourg, last independent Grand Duchy to survive two World Wars, lies hidden away in a corner southeast of Belgium. The preservation of its independence throughout its thousand years of history is really remarkable, and its native language common to all Luxembourgers is an outward sign of this independence. It distinguishes the inhabitants of the Grand Duchy from its neighbors and gives them the consciousness of being a distinct community.

Nowadays, Luxembourg is very small, and has a population of under 300,000 inhabitants. Although it is one of the smallest of European countries, it is certainly one of the most beautiful. In no other country can one find—within an area of 999 square miles—such a succession of changes of scenery—highlands and valleys, forests and plains, gorges and rivers, every imaginable kind of landscape, except high mountains and the sea coast. The Grand Duchy has large

mineral deposits, iron ore being its greatest source of wealth; before the war, despite its size, Luxembourg was numbered among the first eight iron-steel exporting countries of the world.

If Luxembourg is rich in natural resources, it is even richer in historical monuments. Nowhere is the ancient and the modern mixed more closely than it is here. All over the country, medieval buildings of rough-hewn stone are to be found adjoining modern steel and concrete structures, and each, through careful architectural control, enhances the effect of the other.

Until 1933, Luxembourg was mainly known to stamp collectors and scarcely at all to the European traveler, but in that year, the modern science of *radio* was introduced to the ancient capital city of Luxembourg. Little by little, the *Radio Luxembourg* wavelength became a favorite rendezvous for listeners of all European countries. The number and variety of the programs and the international scope of the transmitter rapidly increased, until by 1939 no less than 18 different languages figured in the regular broadcasts of what had, by this time, become one of the most famous international transmitters in the world.

The station was actively sponsored by manufacturers from nearly all the European countries, and especially by

those of Great Britain. These programs quickly became so popular with listeners in the United Kingdom that in an independent survey made during the winter of 1938-39, no one was surprised when Prof. Arnold Plant of the London School of Economics found that during certain hours of the day more people in Great Britain were listening to *Radio Luxembourg* than to all the fourteen stations of the BBC added together. Officials of *Radio Luxembourg* point out that the reason for this preference on the part of the listeners was not hard to find. The programs were designed to appeal to "the Man on the Street," and the manufacturers realizing that the best advertisement for their product was the best artists in the best possible entertainment which production, ingenuity, and experience could provide, adopted this format.

In September, 1938, came Munich—and thereafter, *Radio Luxembourg* worked continuously in the closest possible touch with the British Government in the preparation and the transmission of broadcasts to Germany. In September, 1939, when war was finally declared, all broadcasting from Luxembourg was suspended in order to preserve the country's total neutrality. Nevertheless, in May, 1940, the Germans invaded the territory of the smallest Ally, and occupied the broadcasting station.

Thanks to the careful planning of *SHAEF* and above all, thanks to the patriotism and resourcefulness of the chief engineers of peacetime *Radio Luxembourg* and some of the prewar staff, Luxembourg's liberation on September 10, 1944, meant much more to the United Nations than the gain of a comparatively small piece of territory. The total destruction of the radio installation was avoided, and only twelve days later, those people of Europe, still under German domination, were stirred by the news:

"*Radio Luxembourg* returns to the air with programs of the United Nations!"

The first announcement was repeated again and again in every Continental language. It was the first time in the history of warfare that an army command had at its disposal a broadcasting station of complete Continental range, capable of firing the strangest ammunition used in the war—the truth!

Radio Luxembourg's transmitter and antenna located at the village of Junglinster.

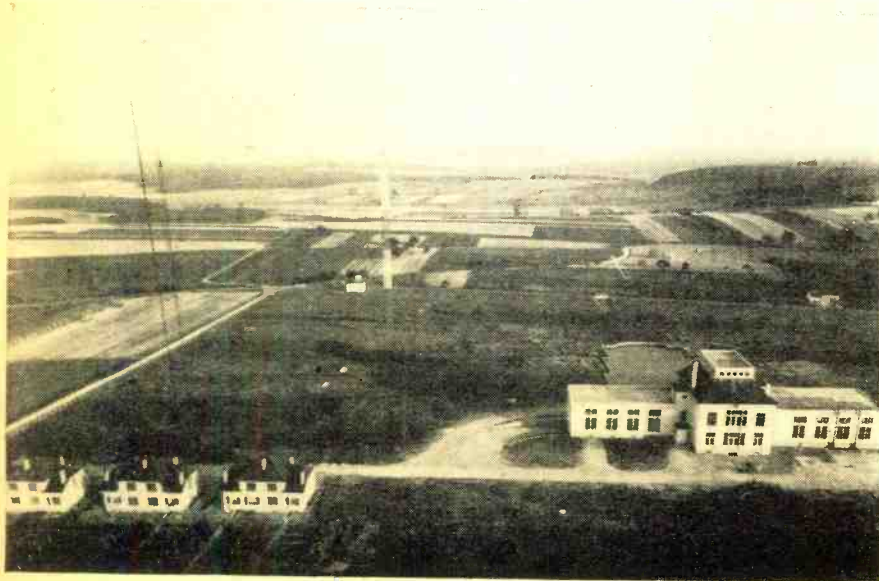



THE NATIONAL COMPANY
Proudly Presents
THE NEW HRO-7



- 11 tube (plus voltage regulator) superheterodyne.
- Frequency Range of 50 to 430 and 480 to 30,000 KC.
- AM phone and code reception.
- Accessory Connector Socket makes possible use of wide variety of accessories, such as narrow band FM discriminator, crystal calibrator, etc.
- New double action noise limiter effectively reduces interference caused by external noise pulses.
- A 6 position switch for crystal filter operation.
- Maximum bandspreading of the Amateur bands.
- Streamlined cabinet with attractive grey finish.

Known and used by hams the world over for 13 years, the old HRO now has a new successor — the HRO-7 — incorporating every one of its strong points and adding a number of modern refinements.

To begin with, the HRO-7 is housed in a streamlined grey cabinet that will enable you to meet the XYL's former objections to bringing your rig into the main part of the house. The whole family can listen when you pick up a French OP talking about the latest UN news.

Two new miniature tubes have been added to further stabilize the receiver. This will enable you to turn the rig off and on again with an absolute minimum of retuning.

As you turn the RF gain control, there'll be no appreciable change in the pitch of code signals and the HRO-7 remains unaffected by normal fluctuations in the voltage sent in by the power company.

We could go on endlessly like this — but why not go down to your nearest National dealer today and ask to see and hear the new National HRO-7 for yourself.

National
Company, Inc.
 Dept. No. 15
 Malden, Mass.

MAKERS OF LIFETIME RADIO EQUIPMENT

new

CONCORD Radio Catalog



Radio Parts Radio Sets Ham Gear Amplifiers

free

Radio Hams • Servicemen • Engineers
Sound Men • Maintenance Men
Schools • Institutions • Manufacturers
THIS CATALOG IS FOR YOU!
Mail COUPON TODAY!

Industrial Electronic and Test Equipment

It's here—ready for you now—the new, comprehensive, 1947 Concord Catalog displaying a vast, complete selection of everything in Radio and Electronics. Send for your copy now. Select your needs from value-packed pages showing thousands of items available for IMMEDIATE SHIPMENT—hundreds of them now available for the first time—featuring new, latest 1947 prices. See the new LOWER prices on finest-quality RADIO SETS, PHONO-RADIOS, RECORD CHANGERS, RECORD PLAYERS, PORTABLES, AMPLIFIERS, COMPLETE SOUND SYSTEMS, TESTERS. See complete latest listings of all the well-known, standard, dependable lines of radio parts and equipment—tubes, condensers, transformers, relays, resistors, switches, speakers—all available for IMMEDIATE SHIPMENT from huge stocks in CHICAGO and ATLANTA. Whatever your needs in Radio and Electronic Parts, Supplies and Equipment—before you buy—SEE THIS GREAT NEW CONCORD CATALOG. Mail coupon for your FREE copy now.



TIME-PAYMENT PLAN
Buy your Radio and Electronic Equipment from Concord on EASY PAYMENTS—Communications Receivers, Transmitters, Radios, Radio-Phonos, Sound Equipment, Test Equipment. Write us your needs.

WANTED TRADE-INS ON COMMUNICATIONS EQUIPMENT
Depend on Concord too, for highest trade-in values on communications receivers and transmitters. Write, phone or call to tell us what you have—or send it in for free appraisal.

CONCORD

RADIO CORPORATION
CHICAGO 7 ★ ATLANTA 3
901 W. JACKSON BLVD. 265 PEACHTREE ST.
LAFAYETTE RADIO

Concord Radio Corporation, Dept. E-87
901 W. Jackson Blvd., Chicago 7, Ill.
Yes, rush FREE COPY of the comprehensive new Concord Radio Catalog.

Name

Address

City State

American, Belgian, Czechoslovak, Dutch, English, French, Luxembourg, Polish, Russian, and even Italian and German broadcasts were heard day and night. Their messages inspired hope and the will to resist among millions of foreign slave-workers still held by the Germans.

In mid-December, *Radio Luxembourg* went off the air for three days when von Runstedt's tanks came within three miles of the transmitter—the last despairing effort by an already defeated enemy. Things soon began to move quickly. The Allied armies crossed the Rhine and eighty thousand Germans were isolated in western Holland. Over *Radio Luxembourg*, General Kirchheim asked Marshal Keitel to give up the lost struggle. Vienna, Nuremberg, Bologna, Berlin fell! Hardly anyone in *Radio Luxembourg* went to bed. They were spreading the news to the world, the best and newest news ever heard over any radio.

Surrender to Montgomery in North Germany followed surrender in Italy. Finally, twelve men of different nationalities pronounced in twelve languages the sentence the world had waited so long to hear:

"Germany has surrendered unconditionally!"

Broadcasting a few minutes before midnight on November 11, 1945, Colonel Clifford Powell, Acting Chief of the American Information Control Division, said: "*Radio Luxembourg* has contributed largely towards the breaking of the morale of German soldiers and civilians and it has helped to organize the repatriation of millions of slave-workers. It has fulfilled its military mission and can now be returned to its original owners."

Radio Luxembourg resumed its independent civilian programs immediately, under the same company and the identical management as in the days before the war. Much damage had been done by the departing Germans in September of 1944, and during the period of Allied Military Control, only temporary repairs had been effected. The central control room had been blown up and entirely destroyed. A great deal of the equipment had been stolen by the Germans or rendered useless. The transmitter and the transmitting antennas at Junglinster (10 miles from the Luxembourg capital) needed complete overhauling and many essential pieces of apparatus had to be replaced. These tasks were rendered more difficult by the shortage of technical equipment available. But gradually, the powerful broadcasting station got under way once more, and the great family of "Men of Good Will" of all the European countries began once again to look to their old friend—*Radio Luxembourg*—for their entertainment.

Regular broadcasts in French (premier Continental language) were, naturally, the first to be resumed. In January, 1946, dial-exploring listeners in Great Britain rediscovered the well-

Look to WARD

for Greater FM Values!

Ward, world's largest producer of aerials, now offers you leading values in FM with antennas completely adaptable to the varying requirements of each installation. They provide maximum electrical efficiency needed for finest FM reception. The ease with which they may be securely installed, plus strong weather-proof construction assures trouble-free operation—and extra profits for YOU!

The Straight and Folded Di-Poles shown at the right operate in a range of 88 to 106 mc. The Folded Di-Pole model provides broader antenna tuning and matched impedance to the 300 ohm transmission line for maximum response and energy transfer.

The Ward Reflector Kit can be combined with either of the two Di-Poles as illustrated above.

NOTE ALL THESE OUTSTANDING FEATURES:

- Universal base mounts on any roof or wall angle.
- Sturdy vertical element revolves or tilts in base allowing complete flexibility in orienting Di-Pole for maximum gain.
- Di-Pole element constructed of corrosion-preventive aluminum. All other parts completely weather-proofed inside and out.
- Ring provided for attachment of guy wires assuring secure installation.
- Sixty feet of dielectric 300 ohm colinear transmission line is insulated with polyethylene.
- Stand-off insulators guiding transmission line to receiver are of exclusive design minimizing capacity to ground and eliminating reflections on the line.

WARD TELEVISION ANTENNAS ALSO AVAILABLE
WRITE FOR FREE CATALOG

THE WARD PRODUCTS CORPORATION
1525 EAST 45TH STREET • CLEVELAND 3, OHIO

IN CANADA: Atlas Radio Corp., 560 King St., W., Toronto, Ontario, Canada
EXPORT DEPT.: C. O. Brandes, Mgr., 4900 Euclid Ave., Cleveland 3, Ohio

WARD

Aerials

REFLECTOR KIT MODEL FMR-63 LIST \$5.25

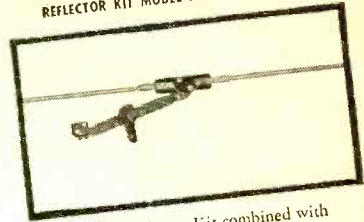

Ward's Reflector Kit combined with either the Straight or Folded Di-Poles as shown at left, provides maximum directional gain of the desired signal and eliminates undesirable and interfering reflections. Di-Pole elements can be rotated to any direction and tilted for any angle to facilitate orienting.

Folded Di-Pole with Reflector Kit

Straight Di-Pole with Reflector Kit

Folded Di-Pole Model FM-55 List \$10.25

Straight Di-Pole Model FM-60 List \$9.00

The KXP-30 Phonograph or Monitoring Amplifier



for Broadcast Station, Recording Studio, Wired Music Reproduction and for Deluxe Home Phonographs

A phonograph amplifier with remarkable performance and flexibility of application . . . the KXP-30 offers full retention of both

bass and treble tones at even the lowest volume levels, a quality not found in ordinary amplifiers. . . Wiring in one input channel provides for use of a plug-in input or bridging transformer, to convert to a 5000-ohm balanced line bridging or 50, 200 or 500 ohms balanced line input as desired. The other channel is equalized for use with a crystal pickup. The KXP-30 features extremely low distortion at all frequencies and volume levels; freedom from hum; uniform power output; dual acting individual tone controls; extended flat frequency response from 20 to 20,000 cycles.

SPECIFICATIONS

POWER OUTPUT: 30 watts at less than 5% distortion with wide flat power output versus frequency curve and low distortion at any volume level. **FREQUENCY RESPONSE:** 20 to 20,000 cycles within 1 d.b. **INPUTS:** (2) One with crystal pickup network, impedance 1/2 meg-ohm. Other without phono equalizer but wired for use with TR-91 or TR-92 plug-in input transformer, impedance without transformer 1/2 meg, with transformer, 50, 200 or 500 ohms, depending on transformer used. **OUTPUT IMPEDANCES:** (6) 3, 4, 6, 8, 16 and 500 ohms to terminal strip and two bakelite molded sockets. **GAIN:** 85 d.b. either input, high impedance. 79.5 d.b. with TR-92. 73.5 d.b. with TR-91. **TONE COMPENSATION:** Bass range from -17 to +24 d.b. Treble range from -24 to +24 d.b. **CONTROLS:** (5) Two channel input, one bass, one treble, one power switch. **CONTROL PANEL:** Etched metal, fully illuminated. **POWER CONSUMPTION:** 144 watts. **TUBES:** (7) One 617, three 6J5, two 6L6G, one 5U4G. **DIMENSIONS:** 7" x 8 1/2" x 15". **SHIPPING WEIGHT:** 26 lbs.

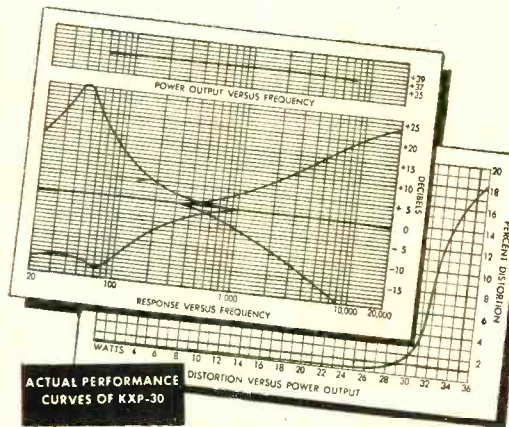

Another contribution by Newcomb toward better record enjoyment, Model LP-1 Filter and Equalizer greatly reduces surface noise and distortion. Designed for installation in either commercial or home phonographs the LP-1 is easily connected between crystal pickup and amplifier, providing an effective control of needle scratch.

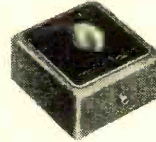

A phonograph system built around the KXP-30 and the LP-1 offers a remarkable quality of reproduction. You have not heard the best until you hear Newcomb.



AUDIO PRODUCTS CO.

Dept. F, 6824 Lexington Ave., Hollywood 38, California.

"NOT MERELY AS GOOD AS THE OTHERS . . . BUT BETTER THAN ALL OTHERS."

LEARN TELEVISION ELECTRONICS RADIO

Modern Completely Equipped Laboratories

DAY AND EVENING CLASSES
G.I. Approved—Veterans Receive Subsistence

ENROLL NOW!
ELECTRONICS INSTITUTE, INC.
21 Henry, Detroit 1, Mich.

RADIO MEN

Write for Giant
BARGAIN CATALOG
BUYERS SYNDICATE

786 Carew St., Springfield 4, Mass.

LCETI

known "gong" and the call-up, "This is Radio Luxembourg," which they had always regarded as the "trade-mark" of good broadcast entertainment before the war.

Letters of appreciation and of "welcome back" began to pour in from all countries and have continued to do so, with the result that more and more emphasis is now being laid on the exchange of programs between the countries.

In the days before the war, *Radio Luxembourg*, in the main, addressed adult audiences and the interchange of art and commerce was designed to appeal almost exclusively to the "grown-ups." Since its postwar return to the air, however, an important innovation has been introduced. In cooperation with the headquarters of the Boy Scouts Association, *Radio Luxembourg* has now also become the "Voice of International Scouting," thus adding its far-reaching power to the cause of peace between the nations by encouraging the exchange of ideas and ideals between the citizens of tomorrow.

"Now, more than ever before," say station officials, "*Radio Luxembourg*, a Free Station in a Free Country, is determined to maintain its independence and its impartiality. Furthermore, the station's enormous power and tremendous potentialities in the international field have been pledged by the Direction to the cause and the service of the United Nations."

Full-scale commercial operations were inaugurated this year.

Radio Luxembourg is owned and operated independently by the private "Compagnie Luxembourgeoise de Radiodiffusion."

The long-wave transmitter, 150 kw., operates on 232 kcs. (1293 m.), and is currently scheduled Sundays, 0030-1700; Mondays, Tuesdays, Wednesdays, Fridays, 0045-1700; and Thursdays and Saturdays, 0015-1700.*

The short-wave transmitter, 5 kw., operates on 6.090 (49.26 m.), and runs daily, 1400-1700.

On Sundays, announcements are in French and *English*; German is added on other days.

Technical Details

The technical installation consists of a studio block and administration building in Luxembourg City, with the transmitting station in the village of Junglinster, 10 miles away. The two are connected by both underground and overhead cables consisting of two radio channels and two service circuits. In the overhead system, the same facilities exist (for emergency purposes) as in the underground lines.

The broadcasting headquarters—completed in 1939—are situated in the center of the municipal park of Luxembourg and contain, besides the ad-

(Continued on page 90)

* Unless otherwise indicated, time herein is American EST; add 5 hours for GCT. News refers to newscasts in the English language. All times listed are based on the 24-hour clock.

RADIO NEWS

Words Fail Us!

We Wells people have never liked sensational advertising but when we find a piece of equipment like this G. E. Tuning Unit offered for a tiny fraction of its real value, it's hard to be modest about it. Naturally, these units tune to frequencies outside of the ham bands. But we have yet to see a real Radio Amateur who can't cut a few coil turns to build a useful piece of equipment.

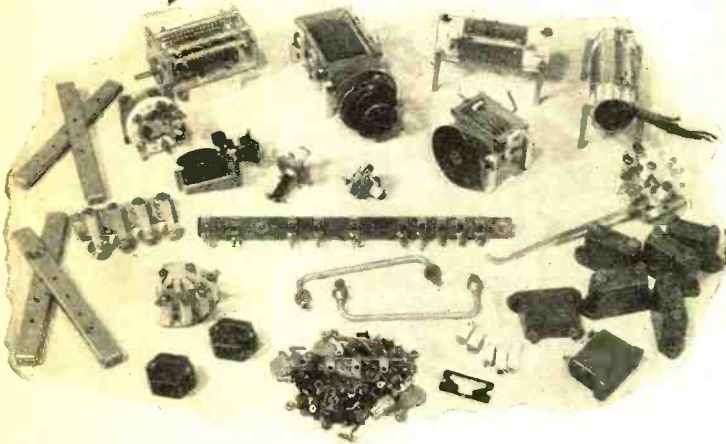
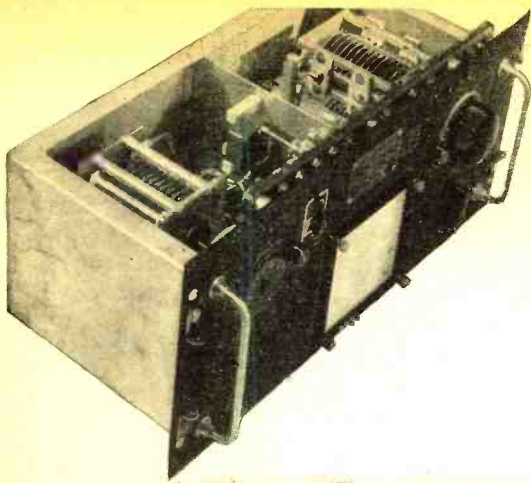

Brand New G. E. Tuning Units \$2⁵⁰ each

Easily Converted to:
MASTER OSCILLATOR TUNER
C. W. TRANSMITTER
RESONANT LINE TUNER

PARTS ALONE WORTH 20 TIMES OUR PRICE

Practically every part in the unit fits right into Amateur requirements. So we suggest that you order extras to be dismantled for spare parts.

Look At These Parts — All For \$2⁵⁰

- 1—Aluminum Panel 16 $\frac{3}{4}$ " x 7 $\frac{3}{4}$ "
- 1—Micrometer Drive unit for $\frac{1}{4}$ " shaft
- 1—GE Planetary Drive unit for $\frac{1}{4}$ " shaft
- 1—150 MMFD Trans. Plate Tuning Cond. 31 plate, ceramic insulated
- 1—125 MMFD Trans. Plate Tuning Cond. 25 plate, ceramic insulated
- 1—35 MMFD Transmitting Plate Tuning Cond. 7 Plate
- 1—Single pole 6 Pos. Heavy duty Ceramic band switch with knob
- 2—2 Pole Double Throw Heavy duty Ceramic band switch with knob
- 3—100 MMFD Transmitting mica cond. 3000 WVDC
- 1—60 MMFD Transmitting mica cond. 2000 WVDC
- 3—90 MMFD Transmitting mica cond. 3000 WVDC

- 2—40 MMFD Transmitting mica cond. 2500 WVDC
- 2—Ceramic coil forms 5" long, 2" dia. wound with No. 14 wire
- 1—Micalox strip 12" x $\frac{3}{4}$ " x $\frac{1}{4}$ " with Banana Plug jacks
- 1—Gang of 4 transmitting neutralizer condensers
- 2—Aluminum handles 5" long, 1 $\frac{1}{4}$ " dia.
- 2—Ceramic flexible shaft couplings
- 15—Ceramic standoff insulators. Tapped ends
- 8—Aluminum standoffs tapped ends
- Brackets, screws, lugs, misc. wire and ventilated case, lock washers, etc.
- 1—5 millihenry 300 MA choke RF
- 1—6 millihenry 300 MA choke RF
- 1—15000 ohm 5 watt resistor

Two Models Available:

TU 5B 1.5 to 3 Mc — \$2.50 each

TU 10B 10 to 12.5 Mc — \$2.50 each

Black crackle dustproof cabinet for above — 50c each

These tuning units may be ordered directly from us or through your local Jobber.

We Think We Have Enough for Everybody

WELLS

SALES, INC.

August, 1947

CO-AX CONNECTORS

We carry large stocks of all "83" series connectors in stock. Write for listing 100A or order from your Jobber.



Write for Amateur Radio Catalog H200-A

320 N. LA SALLE ST., DEPT. R-8, CHICAGO 10, ILL.

LEOTONE AUGUST SPECIALS

MINIATURE ALNICO V MAGNETIC PHONE UNITS (HS-30 headset replacement). 75 ohm imped. Wide freq. response & sufficient volume for use as: Pill or Pillow Speaker, either Dynamic or Contact Mike (using "Ouncer" Input below) or Hearing Aid unit. $\frac{3}{4}$ " O.D. $\frac{1}{2}$ " deep. each \$0.39



UTC "OUNCER" INPUT TRANSFORMER ($\frac{7}{8}$ "x1 3/16"). Dynamic mike or low impedance pick-up to grid. 45c ea.; 12 for... \$5.00

DPDT Relay (Allied). 18-28V. DC 230 ohm coil. $\frac{1}{4}$ " silver contacts, rated 10A@115V. AC. 1"x1 1/2"x2" \$0.59
 Line Transformer (Intercom. P.A. phone, etc.). Impedance: Pri. 250 ohms; Sec. 8 ohms with 5 equal taps, -16 to 0 db. 2" O.D. 2 1/2" high.69
 Scotch Tape. Standard 1296" roll, $\frac{1}{8}$ " wide. Printed with numeral or letter (our choice). Per roll, 23c; 10 for 2.49

SPECIAL!!—Giant "Grab-Bag" Radio Parts Kit
 A real buy for the Serviceman, Amateur or Experimenter. 15 FULL POINTS of resistors, condensers, transformers, wire, speaker, pair parts, hardware, etc., etc. An amazing value at \$1.95
4 TUBE AMPLIFIER (2-7C5, 7F7, 7Y4). Used as electronic supercharger control. 110V, 400 cycle. Black crackle finish case & slide-in chassis. Contains: Power trans. 7 mic. & oil cond., resistors, 4 local sockets plus other components worth several times the price. 8 3/4"x4 1/2"x3 3/4". Less tubes. 1.49

ALNICO MAGNETS

- | | | |
|-----|---|--------|
| #1 | Bar, 8 1/2"x5/16"x1/4" | \$0.59 |
| #2 | Face, 1 1/4"x1 3/4"x3/8" high | .98 |
| #3 | Heavy duty bar, 2 1/2"x1 3/8"x5/16" | .98 |
| #4 | Face, 3/4"x3/8"x3/8" high | .39 |
| #5 | Polished, 7/8"x9/16"x3/8" high | .35 |
| #6 | Polished bar, 9/16"x1/2"x1/4", 20 for 1.00 | 1.00 |
| #8 | ALNICO V, h'shoe, poles 3/8" sq.; 1 1/2" high | .75 |
| #10 | ALNICO V, h'shoe, poles 1"x1 1/2"; 2 3/4" high (shp. wt. 4 lbs) | 5.95 |
| #12 | (Similar to #3) | .35 |
| #15 | Polished Block, 3"x2 3/4"x1 1/2"; magnetized, wide or narrow sides. | 2.49 |
| #17 | Cylindrical, 1-1/16" O.D. 3/8" I.D. 5/16" deep | .49 |
| #19 | Round bar, 3/8" O.D., 7/16" high | .12 |
| #21 | Round bar, pol. 1/2" O.D., 4" long | .35 |
| #23 | Round bar, pol. 3/8" O.D., 2 1/2" long | .59 |
| #25 | Round bar, pol. 3/8" O.D., 5 3/4" long | 1.49 |

EXPERIMENTAL TUBES. 20 asstd. receiving types for testing, research, etc. Fil. heated. \$1.00
RADIO HARDWARE TREASURE. An indispensable assortment of approx. 1000 screws, nuts, washers, lugs, etc.49
 Variable Condensers. 2 gang, 365mmid. 3/8" shaft, 3/4" long. 2 1/2"x2 1/2"x1 1/2"75
TUBES: Perfect condition, but not in sealed cartons. Every tube guaranteed 90 days.
 #20, 26, 27, 46 or 5629
 #42, 43, 75, 77, 78, 80, 5Y3, 6H6 or 6K739
 #35, 37, 39, 84, 5Y4, 6A8, 6C5, 6F5, 6SA7 or 12SA749
 #1A7, 6A3, 6X2, 7Y4, 7C5 or 5059
TUBE CARTONS: Plain white. GT size (1 1/4" sq. 3 1/4" L.). Per 1001.25
 Medium size (1 1/2" sq. 4 3/8" L.). Per 1001.49

SERVICEMEN'S KITS

- | | | |
|-----|---|--------|
| #1 | R-F, Antenna & Osc. coils, 10 asstd. | \$0.98 |
| #2 | Speaker cones, 12 asstd. 4" to 12" moulded & free-edge (magnetic incl.). Less voice coils. | 2.00 |
| #3 | MOULDED BAKELITE CONDENSERS. 50 asstd. .0001 to 2 mfd., 200-600 WV. Clearly marked. | 2.95 |
| #4 | TUBULAR BY-PASS CONDENSERS. 50 asstd. .001 to 2 mfd., 200-600 WV. Standard brands. | 2.49 |
| #6 | Dial Scales, 25 asstd. airplane & slide-rule (acetate & glass). | 2.98 |
| #7 | Escutcheon plates, 25 asstd. airplane, slide-rule & full-vision types. | 2.95 |
| #8 | Knobs, 25 asstd. wood & bakelite, incl. setscrew & spring types. | 1.00 |
| #9 | Wafer Sockets, 12 asstd. 4 to 7 prongs. | .25 |
| #11 | Shield Cans, 15 asstd. for coils, tubes, transformers, etc. | 1.00 |
| #14 | Volume & Tone Controls, 10 asstd. wire-wound & carbon. | 1.49 |
| #15 | Wire-wound Resistors, 15 asstd. ohmage, 5 to 20 watts. | .98 |
| #16 | I-F Coils, 6 asstd. including shielded & slug-tuned. Peaks unmarked. | 1.25 |
| #17 | Dial Windows, 12 asstd. flat & moulded acetate and convex glass. | 1.29 |
| #20 | SPEAKER REPAIR KIT. A real money & time saver. Contains: 25 asstd. paper rings, 10 spiders, 25 asstd. voice coil forms, 3 yds. felt strips, 20 chamois leather segments, kit of 16 shims & tube of speaker cement | 2.49 |
| #22 | Resistor Assortment, 20 asstd. carbon & wire-wound, 1/2 to 3 watts. | .49 |
| #23 | RADIO CEMENT & SOLVENT. 3 oz. each of all-purpose cements & thinner. With brush. | .69 |
| #24 | Shaft Extenders, Reducers, Couplings, 10 asstd. most popular types used in servicing. | 1.29 |
| #25 | SPRING ASSORTMENT. 60 asstd. compression & expansion for dials, push-buttons, relays, etc. | .98 |

Prompt Service on Speaker & Phono Pick-up Repairs. Minimum Order \$2.00—20% Deposit Required on All Orders. Please Add Sufficient Postage. Write RN-8

LEOTONE RADIO CO.
 MAKERS OF CONES AND FIELD COILS
 65-67 DEY STREET, NEW YORK 7, N.Y.
 WORTH 2-0284-5
 12,000 SQ. FT. OF RADIO PARTS



CIRCUIT PAGE

(FOR PARTS LISTS SEE PAGE 86)

RADIO NEWS, AUGUST, 1947

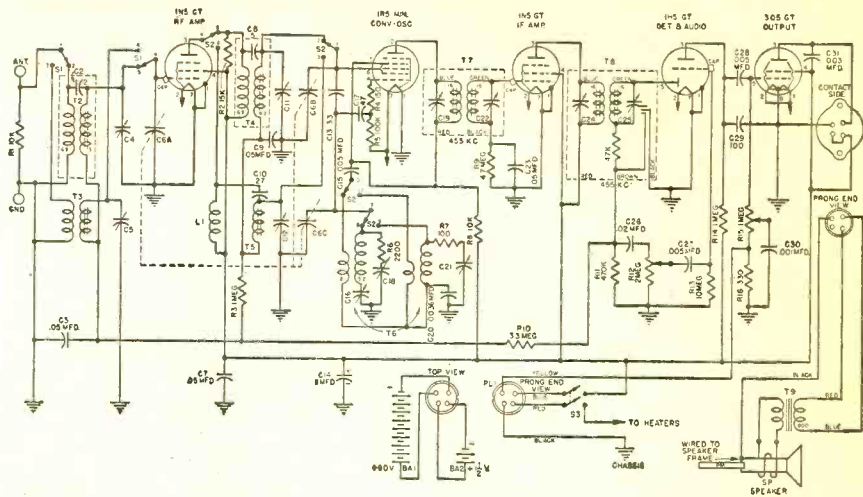

GENERAL ELECTRIC MODEL 280

RADIO NEWS, AUGUST, 1947

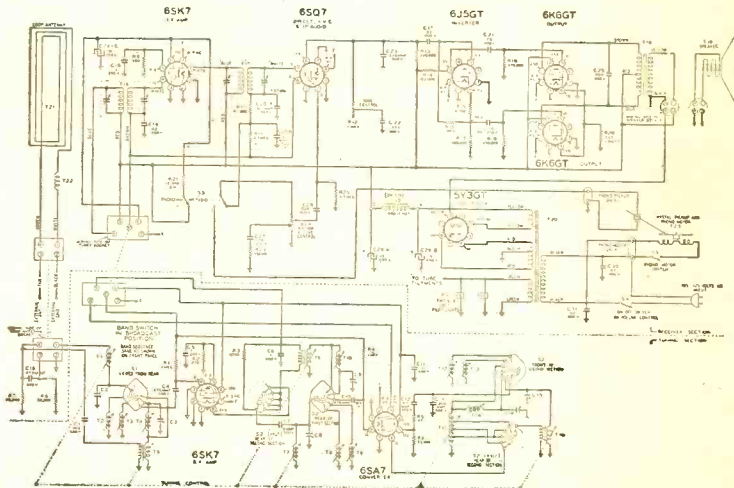

TRUETONE MODELS D1747, D1748

RADIO NEWS, AUGUST, 1947

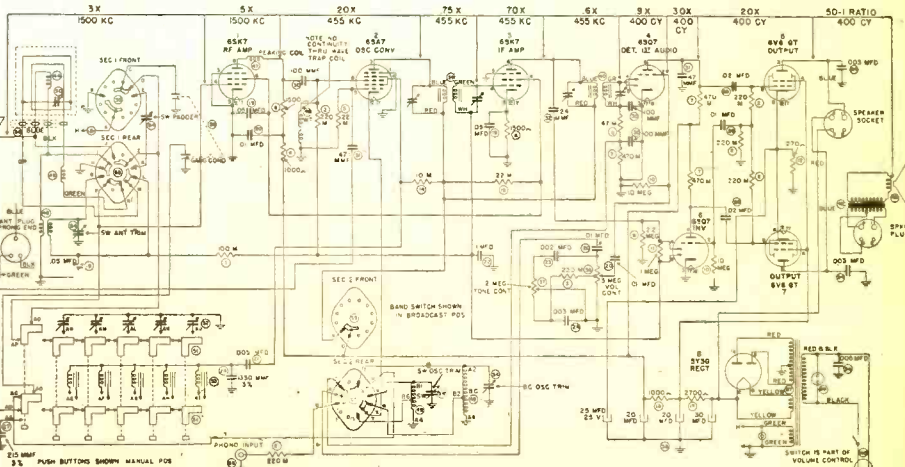

FARNSWORTH MODELS EK-081, EK-082, EK-083, EK-681

Here, and on following pages, are circuit diagrams and parts lists of many new postwar radio receivers. Radio News will bring to you other circuits as quickly as possible after we receive them from manufacturers.

RADIO NEWS, AUGUST, 1947

WARDS MODEL 74BR-1055A

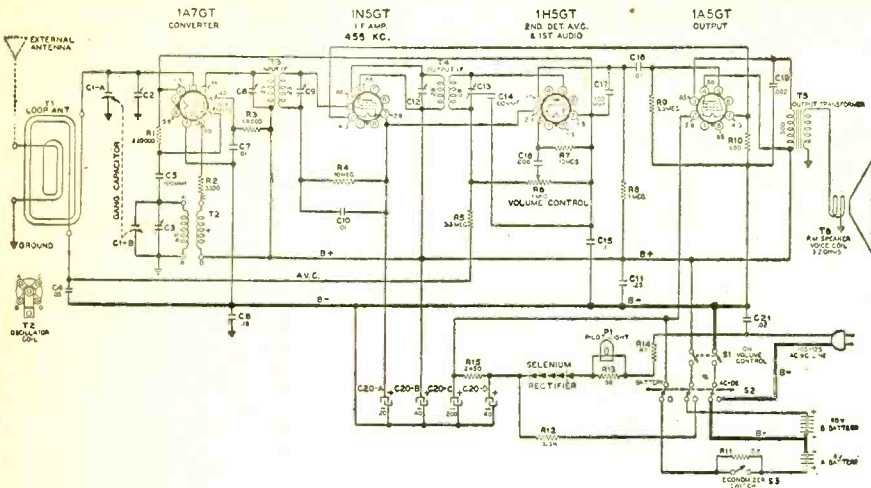

RADIO NEWS, AUGUST, 1947

ZENITH MODELS 5R080, 5R086

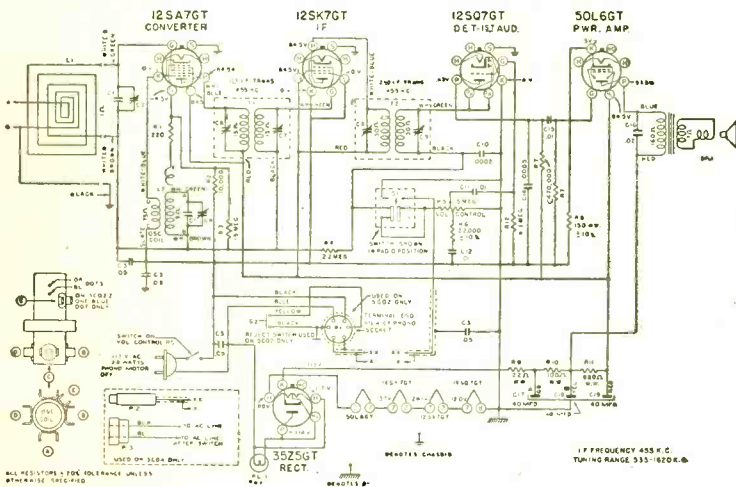

RADIO NEWS, AUGUST, 1947

HOFFMAN MODEL A301

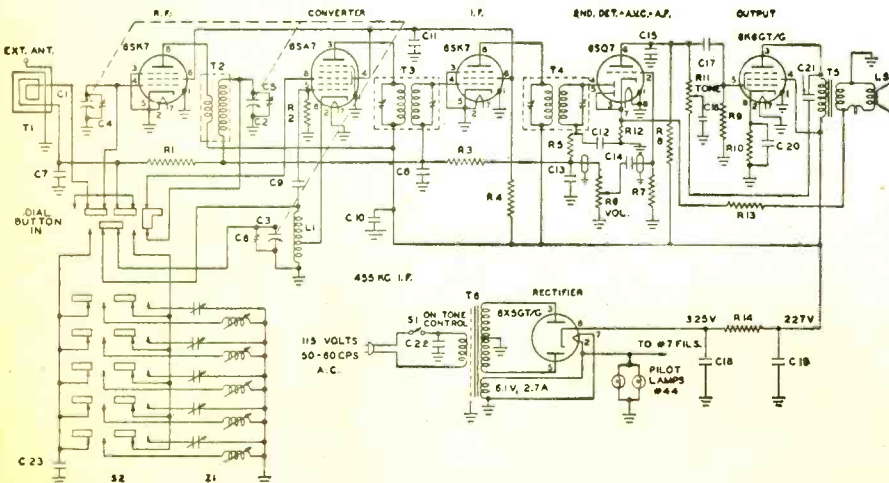

LEARN ELECTRIC MOTOR REPAIR

NO WONDER IT'S A GOOD BUSINESS!

According to no less an authority than the General Electric Co., there are **ELEVEN MOTOR-OPERATED DEVICES** in the average moderate-income American home! Many large homes have twice this many motors—in washers, refrigerators, oil burners, cleaners, fans, clocks, shavers, mixers, etc. Be the man who can repair them! It's a logical addition to any radio business!

This big book shows you how—every step of the way

ONLY \$5 complete

It Pays to Specialize in SOMETHING DIFFERENT!



ELECTRIC MOTOR REPAIR—the big new book by the publishers of famous Ghirardi Radio-Electronic books—teaches you motor repair work at home, in spare time, in a short while. Written by a leading vocational school instructor, it explains every detail of motor trouble diagnosing. Tells exactly how to handle all types of work from minor repairs and adjustments to complete rewinding. Covers a-c and d-c motors, synchronous motors and generators and mechanical and electrical control systems.

Based on what you can learn from this 580-page book alone, you can train for prompt, profitable service on practically any type of electric motor in common use.

Everything is easy to understand. All problems explained step by step in BOTH text and over 900 special illustrations. Quick reference guides show exactly how to handle specific jobs. Ideal, either for beginners or for daily bench use in busy shops.

Train now for big money in an uncrowded, wide-open field!



BORROW IT FOR 5 FULL DAYS!

Practice from **ELECTRIC MOTOR REPAIR** for 5 days repairing your own home motors or those of friends. If not more than satisfied, return book and every cent will be cheerfully refunded. Send coupon now!

NO RISK COUPON mail today

Dept. RN-87, Murray Hill Books, Inc., 232 Madison Ave., New York 16, N. Y.

Enclosed is \$5 (\$5.50 outside U.S.A.) for a copy of **ELECTRIC MOTOR REPAIR** book; or send C.O.D. for \$5 plus postage (no foreign C.O.D.'s). In either event, if not satisfied, it is understood I may return book in 5 days for complete refund of my money.

Name

Address

City & Zone State

"SPECIALS"

ANTENNA RELAY UNIT BC-442
With antenna current meter, antenna transfer relay with 3 stand-off lead-in terminals. A-1 condition. Only **95c**

TRANSFORMER

High voltage scope transformer, 90V 60 cps. primary; 6400 V secondary; 4 stand-off terminals. each **\$2.95**

ANTENNA TRANSFER SWITCH SW-225

Triple-pole, double-throw, mounted on bakelite base with nine 2" porcelain stand-off mounts. BRAND NEW. **89c**

BC 732 CONTROL BOX

With 6 position, selective switch, volume control and toggle switch. each **79c**

COAXIAL CABLE

26 ft. of Coaxial Cable RGU8, 52 ohm. **89c**

OUTPUT TRANSFORMERS

50L6. 39c 6V6. 39c

FILTER CHOKES All Fully Enclosed

Dual, 15H. @ 100 MA., 400 ohms DC. Each section, 500 VDC insulation test. 3½"x3"x6" High; 4 MTG. Studs and 4 terminals. Each **79c**
59H. Min. @ 100 MA.; 10 V RMS 60 cycles, 850 ohms DC. Res.; 4 MTG. Studs, size 4½"x3½"x3½", each. **79c**
3.7 H. @ 145 MA. DC., 125 ohms DC. Res. 4 MTG. Studs, each. **59c**

BC-310

Radio compass receiver, complete with 11 tubes, 14 V dynamotor, local or remote control, frequency range 150 to 1500 kc, with 3 bands, easily converted to 110 V, 60 cps. operation. **\$24.95**

I-70-D TUNING METER

Milliammeter for indicating resonance of tuned station, NEW. **49c ea.**

INSULATOR

2 Ceramic bowls, 3¼" dia. **29c ea.**

400 CYCLE AUTOSYN MOTOR

Ideal for indicating direction of antenna systems—BRAND NEW. **95c ea.**

FLEXIBLE CABLE

From 92" to 250" with connectors and spline knobs. **\$1.95**

HEADPHONES

Signal Corps, 8000 ohms and 200 ohms, each **\$2.49**
2000 ohms, Trimm, each. **1.79**
EARPHONES, less headband, HS18 high impedance. **79c**

INTERPHONE AMPLIFIER

Comes in an aluminum cabinet 9¼"x4¼"x5½" with two 12J5GT and two 12A6 tubes; also Electric Dynamotor 28DC Volt input and 250 V DC output at 60 MA.
Complete with 4 tubes. Yours for only **\$4.95**

Wholesalers, dealers, institutions and other quantity purchasers, write, wire, phone for quantity prices. All shipments F.O.B. Chicago. 20% deposit required on all orders. Minimum order accepted \$5.00.

WRITE FOR CATALOG
Dept. C

ARROW SALES, INC.

59 WEST HUBBARD STREET
CHICAGO 10, ILLINOIS
Telephone: SUPERIOR 5575

What's New in Radio

NEW FILTER

Burnell & Co. of Yonkers, New York, has recently added a new scratch filter to its line of filters and equalizers.

Designed to give a flat response within the passband and to provide sharp attenuation above the cut-off frequencies, this unit is adaptable to all types of recordings by means of three different cut-off frequencies which have been provided. They may be utilized by moving a single connection. This circuit feature facilitates the use of an ordinary single circuit switch for rapid changeover.

Additional details will be furnished by *Burnell & Co.*, 45 Warburton Avenue, Yonkers 2, New York.

tightly. The special hatchet design permits soldering of hard-to-reach spots on the radio chassis.

The special hexagonal barrel allows this unit to be clamped in a vise for

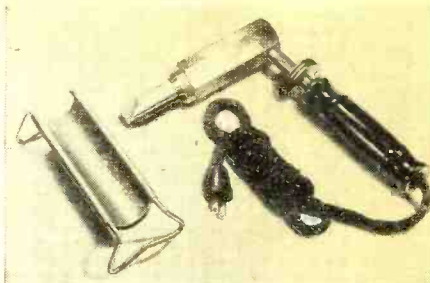

NEW RCA SCOPE

The Test and Measuring Equipment Section of *Radio Corporation of America* has recently introduced a versatile new cathode-ray oscilloscope which

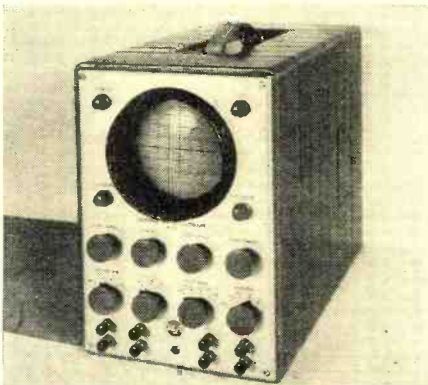

will permit the use of three different types of cathode-ray tubes.

This new oscilloscope, the Type WO-60C, is a general purpose instrument which has been designed especially for industrial applications. The unit will handle input voltages as high as 850 volts peak-to-peak. The low frequency response permits the observation of waveforms of .5 to 300,000 cycles.

Although furnished with a medium persistence cathode-ray tube, for the lowest frequencies a long-persistence flickerless screen may be used. A third tube having a short-persistence, highly actinic screen is available for photographic recording.

Full details on the new oscilloscope may be secured from the Test and Measuring Equipment Section, *Radio Corporation of America*, Camden, N.J.

HATCHET IRON

Especially designed to eliminate operator fatigue, the *Hexacon Electric Company* has announced the newest addition to its line of soldering equipment, the hatchet type soldering iron, Number 300 H.

The balanced unit rests easily in the operator's hand without the necessity for gripping or clutching the iron

easy tip removal without danger of injuring the heating element.

A request to *Hexacon Electric Company*, 119 West Clay Avenue, Roselle Park, New Jersey will bring full details on this iron.

PORTABLE PHONOGRAPH

Sarvi Electronics Mfg. Co. of Brooklyn has recently released the first of its line of phonographs to the trade.

The Model PH-52 is a portable unit which operates on a.c. and weighs ten pounds complete. The unit is housed in a three-toned leatherette covered case and contains an amplifier with three miniature tubes, a 5" Alnico PM speaker, tone and volume controls, pilot light, and a featherweight crystal pickup.

Additional information about this unit can be obtained by writing to the *Sarvi Electronics Mfg. Co.*, 297 Broadway, Brooklyn 11, New York.

PHONO-AMPLIFIER

A new phono-amplifier, specifically designed for record reproduction has been announced by *Allied Radio Corp.*

This new unit has an inverse feed-

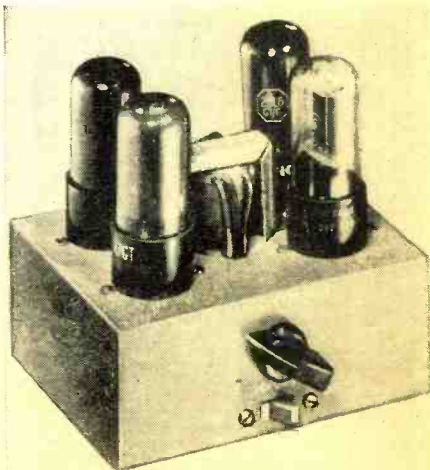

back circuit for wide frequency response and 4 watts of output which provides sufficient drive for an 8 or 10 inch speaker. The amplifier will op-

"ARROW" Leads Again with LOW PRICES!

BC-612

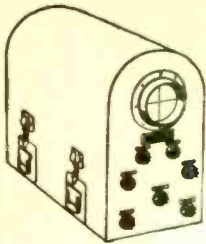

Modified BC-412, 5" Radar Oscilloscope; ideal for first class laboratory instruments; 110V 60 cycles, complete with tubes and power supply brand new in original cartons.

Each... \$49.95

ARMY AIRCRAFT RECEIVER Model BC-946-B

Broadcast band from 520 to 1500 kc. Tube complement: 3—12SK7, 1—12SR7, 1—12A6, 1—12K8. Designed for dynamotor operation, but is easily converted to 110

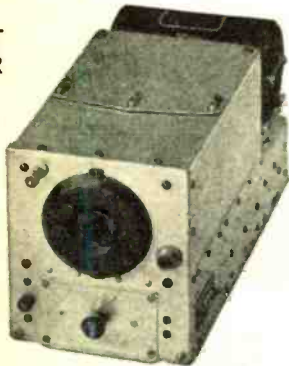

or 32 volt operation. Has two I.F. stages and three gang condenser. Comes packed in sealed carton complete with tubes and instruction manual, but less dynamotor.

RADIO RECEIVERS

- BC-454-A; 3-6 mc complete with tubes... \$3.95
- BC-453-A; 190-550 kc complete with tubes \$4.95
- BC-455-A; 6-9 mc complete with tubes... \$3.95
Used, in A-1 condition.

ARA NAVY RECEIVER

1.5 to 3 Meg. Used, in A-1 condition. Complete with 6 tubes. \$6.95

DYNAMOTOR

DM 32A. Each 95c, 3 for \$2.00

MODULATOR UNIT

BC-456-A \$2.95

REMOTE CONTROL BOX

BC-450-A \$1.95

ARB AIRCRAFT RADIO RECEIVER

The ARB is a six tube, four band, superheterodyne Aircraft Radio Receiver with built-in dynamotor, designed for the reception of MCW (tone or voice) or CW within the frequency range 195 Kc to 9.05 megacycles. Used... \$19.95

AN18/APT-10

Pre-amplifier model K-1, designed to raise output level of magnetic type microphone, complete with 2 tubes 6SL7GT and 28D7 and hand switch, brand new in original cartons. Each \$1.95, 3 for \$5.00

ART-13 TRANSMITTER

Used, in good condition, complete with tubes and calibrating crystal, freq. range 2.000 Kc to 18 mc; A-1, A-2, A-3 type transmission; power output 100 watts. Each \$75.00

RAX-1 3-RECEIVER COMBINATION

No. 1—4 bands, tunes from 200-1500 kc. ea. \$15.00
No. 2—4 bands, tunes from 1500 kc to 900 mc. ea. 15.00
No. 3—5 bands, tunes from 7 to 27 mc. ea. 19.95
Each receiver complete with tubes and 24 V Dynamotor. Used, A-1 condition. 3 Receiver combination... complete \$34.95

BC-929-A

Contains power supply 110 V. 400 cycles, has 7 tubes such as 3CP1, brand new, complete with tubes. Each... \$17.95
Used, ea. 14.95



APS-15

Has 45 tubes, one 5" scope tube, one 2" scope tube, has 3 meters, 4 power supply units 110V 400 cycles, complete with tubes. Each... \$39.50

BC-348 RECEIVER

Brand New in original cartons... \$49.95
Used \$39.95

VHF RECEIVER BC-701

Frequency range 170-180 Mc; IF 30.5 Mc; complete with 11 tubes; self-contained power supply, brand new in beautiful wooden carrying case... \$9.95

BC-404-C VHF RECEIVER

Frequency range 102-110 Mc; complete with 12 tubes, 110V 60cps, power supply included. Brand new in original cases... \$19.95
Used \$10.95

NAVY GLIDE PATH RECEIVER

Bolt type, complete with 3 6C6 tubes and tunes from 90 to 95 Mc, operates from 12 or 24V. Brand new \$3.95

RANGER MODEL 114-C AIRCRAFT RECEIVER

Combination Interphone, Amplifier and 6-Tube Superheterodyne Receiver designed to operate directly from a 24V aircraft battery. Tuning range 200 kc to 550 kc, complete with mounting rack, jackbox and cords. This unit is used as range receiver and interphone amplifier. Brand new... \$14.95

GF12 and RU 17 NAVY RECEIVER and TRANSMITTER

Complete with receiving and transmitting coils, junction box, control boxes, plugs, power supply, instruction manual and spare parts which include tubes. Brand new in original carton. A real buy... \$24.95

GO-9

Navy type low and high frequency transmitter with power supply and tubes. Operates from 200 Kc to 18,100 Kc; requires 115V, 800 cycles, Used, complete with tubes... \$49.50

HAND-TYPE MICROPHONE RS-38

Carbon type, with PL-68 plug, brand new... \$1.95
Used... 1.00

MICROPHONE AND RECEIVER P-60

Dynamic type, 50-ohm impedance; mike and phones interminate in 5-wire male plugs, 3-ft. cord... \$1.49

OXYGEN MASK MICROPHONE T44C

Used with SCR-522, magnetic type complete with JK-26 and PL-179. NEW... Ea. \$1.29

Wholesalers, dealers, institutions and other quantity purchasers... Write, Wire, Phone for Quantity Prices. All Shipments F.O.B. Chicago—20% Deposit Required on all orders. Minimum order accepted \$5.00. Write for our complete catalog.

APN-9

Self-contained power supply, complete with 29 tubes and 3 inch scope tube, 110 V. 400 cycles, used but in excellent condition. Each... \$24.95

Power supply for the APN-4 complete with 16 tubes 110 V. 400 cycles. Each... \$14.95

SETCHELL CARLSON RADIO RECEIVER

BC-1206-C

Designed to receive A-N beam signals. 24-28 vdc 21.6 watts. Tube complement: 14H7 or 14A7, RF amplifier; 14H7 or 14J7, mixer; 14A7 or 14H7, IF amplifier; 14R7, detector and 1st audio amplifier; 28D7, output amplifier. 195 to 420 kc. 4" high x 4" wide x 6 1/2" long—wt. 3 lbs., 4 oz. Used A-1 cond. \$4.95



BRAND NEW in original carton 7.95

RADIO TRANSMITTER and RECEIVER APS-13

Light weight air-borne radar system, radio transmitter and receiver APS-13; tube complement: 5—6J6, 9—6AG5, 1—VR105, 2—D21; unit is brand new, complete with tubes, the tubes alone are worth more than this LOW PRICE OF ONLY... \$15.00

GLIDE PATH RECEIVER R-89/ARN-5

Glide Path Receiver used in the Instrument Landing System covering the frequency range 332 to 335 mc; complete with the following tubes: 7—6AJ5, 1—12SR7, 2—12SN7, 1—28D7, and including three crystals 6497KC, 6522KC, 6547KC... units are in A-1 condition for ONLY... \$9.95

SCR-522 TRANSMITTER and RECEIVER

The standard very-high frequency airborne receiver transmitter. 100 to 156 megacycles. 4 channels selected from remote control box. Used, in good condition—"Complete with Tubes" ONLY... \$19.95

BC-625

VHF transmitter, frequency range 100-156 Mc; four channels. Part of the SCR-522. Complete with tubes less crystals. Used, good condition... ea. \$12.95

BC-624

VHF Companion receiver for above transmitter. Complete with tubes less crystals. Used, good condition. Diagram with either unit included... ea. \$9.95

VEEDER-ROOT METER AND CASE

Counts up to 1000. Each... 95c

WESTON OUTPUT METER No. 687

3 scales 0-50. A-1 Condition... ONLY \$8.95

ARROW SALES, INC.

59 WEST HUBBARD STREET • CHICAGO 10, ILLINOIS

Telephone: SUPERIOR 5575

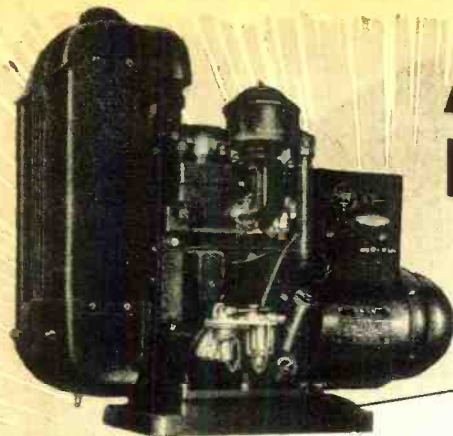

A.C. OR D.C. POWER

PORTABLE,
STANDBY OR
STATIONARY

You can simplify any power-for-electronics problem with an ONAN Electric Plant. A wide range of models and sizes makes it easy to choose the right plant for the particular application.
Lightweight one or two-cylinder air-cooled models for easy portability—A.C.—350 to 5,000 watts, D.C.—600 to 5,000 watts.
Onan two, four and six-cylinder water-cooled models are built for continuous heavy-duty operation, stationary or mobile. A.C.—3,000 to 35,000 watts, D.C.—3,500 to 10,000 watts.
ONAN Electric Plants: A.C.—350 to 35,000 watts in standard voltages and frequencies. D.C.—600 to 10,000 watts, 115 and 230 volts. Battery chargers—500 to 6,000 watts, 6 to 115 volts.

- For—
- Radio Station Standby
 - Geophysical Survey
 - Railroad Radio
 - "Spot" Recording
 - Mobile Radio Units
 - Municipal Signal Standby
 - Amateur Radio

Write for Folder

D. W. ONAN & SONS INC.
4786 Royalston Ave. Minneapolis 5, Minn.



ONAN ELECTRIC PLANTS



**Alignment Kit
Ruf-Koat
Spray Kit • Wire Stripper**
G-C NO. 5024
PROFESSIONAL ALIGNMENT KIT

Complete kit in leatherette case; contains 30 different tools, services any set. Handy to carry in roll type case.
List \$19.95.



G-C RUF-KOAT
Only wrinkle finish that will air dry. Baking not required. Easy to use, gives professional wrinkle finish.
No. 60-2—1/4 pt. List 45c

G-C SPEEDX WIRE STRIPPER

Strips insulation from 750 to 1000 wires per hour, sizes No. 8 to No. 30 Ideal for radio men, mechanics, etc.
No. 733—12 to 20 wire.
List \$6.00—other types available.



G-C FELT-KOAT FLOCK FINISH SPRAY KITS

Now it's easy to supply flock for refinishing turntables, cabinets, grilles, etc. Kit contains specially designed spray gun, 2 colors flock, undercoats, thinner, brush, instructions, etc.
No. 180-2. List \$10.75
G-C PRODUCTS ARE AVAILABLE AT LEADING DISTRIBUTORS.
Write for the new G-C 147 and Hardware Catalog of over 4000 items.

GENERAL CEMENT Mfg. Co., Rockford, Ill., U.S.A.
Manufacturers of over 3,000 products
Sales offices in principal cities



UTICA TOOLS

PLIERS FOR EVERY NEED

Ask Your Dealer

UTICA DROP FORGE & TOOL CORP.
UTICA 4, NEW YORK

Special To **SERVICE DEALERS**

4 JOB CARDS

with **COLOR OVERLAY**

also
4-10-1
BUSINESS CARDS
STATEMENTS
NOTE HEADS
ENVELOPES
IN MATCHING
ELECTRONIC DESIGN

SAMPLES ON REQUEST

RADIO PRESS MORGANTOWN WEST VIRGINIA

erate with any high-impedance crystal pickup and 110 volt phono motor.

The amplifier is only 4" wide, 5 1/4" long and 4 3/4" high with tubes inserted and can thus be combined with a speaker and turntable in a small cabinet.

Complete information will be supplied by *Allied Radio Corporation*, 833 West Jackson Boulevard, Chicago 7, Illinois.

LOW-PRICED INTERCOM

Lyman Electronic Corporation of Springfield, Massachusetts is offering a new 6 station intercom, the "Callmaster," which provides many features generally found only in higher priced units.

Among the features of this unit are



a high gain circuit capable of picking up the normal voice at 50 feet, full sized 4" speaker, pilot light, privacy of communications, and six-station call when desired.

Housed in a mahogany plastic cabinet, this unit takes only 7x5 1/2 x 3 1/2 inches of desk space.

Lyman Electronic Corporation, 12 Cass Street, Springfield, Massachusetts will supply complete details on request.

PORTABLE RECORDER

Audar, Inc. has announced the availability of a new portable disc recorder which incorporates many characteristics of a studio type unit.

This Model RE-8 includes a high output amplifier, neon recording level



indicators, 6 1/2" heavy duty PM dynamic speaker, and a hand microphone with seven feet of cable.

All switching from recording to playback is governed by a single control which automatically makes the

(Continued on page 98)

\$175 AND 25 MONOSETS GIVEN

To Winners of This EASY CONTEST!

RADIO AMATEURS

Just write 50 words or less telling us why you like the TELEX MONOSET better than old style earphones.



WIN:

\$100

and a MonoSet

\$50

and a MonoSet

\$25

and a MonoSet

PLUS

TELEX MONOSETS

to 22 Runner-ups!

HERE'S ALL YOU DO:

1. Go to your parts jobber and ask him to let you try out the revolutionary under-the-chin TELEX MONOSET.
2. In 5 minutes you'll get at least half a dozen good, WINNING ideas. Be sure to get *all* the facts and an OFFICIAL ENTRY BLANK.
3. Then write 50 words or less telling us "Why the TELEX MONOSET is

Better than Old-Style Earphones." Clearness and sincerity will count most.

4. Print or type your answer on the OFFICIAL ENTRY BLANK your jobber will give you.

Mail direct to: TELEX, INC., Telex Park, Minneapolis 1, Minnesota, before Midnight October 15, 1947.

FIRST PRIZE: \$100.00 cash and a TELEX MONOSET
 SECOND PRIZE: \$ 50.00 cash and a TELEX MONOSET
 THIRD PRIZE: \$ 25.00 cash and a TELEX MONOSET

TELEX MONOSETS to the 22 next best opinions. In case of a tie, duplicate prizes will be awarded.

Employees of Telex, Inc. and their advertising agency not eligible to enter this contest.

NO BOX TOPS!
 NO JINGLES!
 Get Entry Blank
 From Your Parts
 Jobber

CONTEST CLOSES MIDNIGHT OCTOBER 15, 1947!

TIPS TO GET STARTED WITH:

1. TELEX MONOSET is quickly replacing old-style, cumbersome headsets because you wear it under-the-chin instead of over-the-head.
2. Featherweight: Only 1.2 oz. No ear fatigue.
3. Excellent fidelity. Clear, natural reception of sound.
4. Reliable performance assured by TELEX precision engineering.
5. Exclusive, TELEX designed, volume control—permits individual adjustment of volume.

.....
 Decision of impartial judges will be final. All entries become property of Telex, Inc. Winners will be notified by mail approximately November 1, 1947. Contest subject to all state and federal regulations.

Remember, wherever a headset is used—
 TELEX MONOSET will do the job better.



-In New Jersey...

...it's **VARIETY-**

Sensationally New

TRANSVISION

TELEVISION KIT



Ready for easy rapid assembly. No knowledge of television required. Complete easy-to-follow instruction sheet gives you all the knowledge you need.

Reception is clear and sharp... comparable to a moving picture.

All necessary components are included. Nothing is required except a screw driver, cutting pliers and a soldering iron. Only the highest quality standard parts are used—the list price value of these parts alone is more than \$300. 110 volts, 60 cycles A.C. **\$159.50**

BALLENTINE PHONO MOTOR

with Turntable **\$4.29**

ASTATIC PHONO PICK-UPS

with L70A Crystal and Hardware **\$1.98**

APPROVED 6 FT. RUBBER LINE CORD

with Gilbert Plug, 12 for **\$1.98**

APPROVED 6 FT. RUBBER LINE CORD

with Molded Rubber Plug, 12 for **\$2.50**

WEBSTER RECORD CHANGER

Model 50 **\$21.17**

FEDERAL BATTERY CHARGER

rated 6-3 amps, 6 volts, 3 cells. **\$16.96**

GUARANTEED VOLUME CONTROLS

Less Switch... 48c 10 for \$4.45
With Switch... 59c 10 for 5.45
500,000, 100,000, 25,000 ohms; ¼ meg. 1 meg. 2 megs.

FEDERAL SELENIUM RECTIFIER

6 or more... **.99** ea.
Less than 6... **\$1.09** ea.
Also available 150 Mill and 200 Mill.

Bargain! Guaranteed!

100 Assorted Bypass Condensers 600V
Value \$11.00. **\$6.95**
SPECIAL

SUPERIOR Model 670

Super-Meter

A Combination Volt - Ohm Milliammeter plus Capacity Reactance Inductance and Decibel Measurements.

Complete with test leads and instructions. **\$28.40**



Full line of Weston-R.C.P.-Supreme-Superior-E.M.C.-Test Equipment

Write Dept. N-7. 20% Deposit with order required. Please add sufficient postage. Excess will be refunded.

Variety ELECTRIC CO., Inc.
601 Broad St., Newark 2, N. J.

For the EXPERIMENTER



PHONO AMPLIFIER AND POWER SUPPLY

Frequently the experimenter has need of a small amplifier of reasonable power output to use with a record player. Many simple designs are possible but they usually have the disadvantage of high distortion plus insufficient output, especially when records having wide dynamic range are played.

The simplest manner of obtaining greater output is the use of a push-pull output stage. If an a.c.-d.c. type amplifier is used, the maximum output that may be expected is in the vicinity of four watts. This is adequate for some applications, but for maximum usefulness the output should be from six to eight watts. This ordinarily requires the use of a transformer type power supply. With the advent of the new selenium rectifiers, a tubeless voltage doubling circuit may be used, and due to the increased voltage available considerably greater output may be obtained.

The amplifier shown in the photographs uses a 12SL7 as a combination voltage amplifier and phase inverter to drive a pair of 50L6's as push-pull amplifiers. An output of over eight

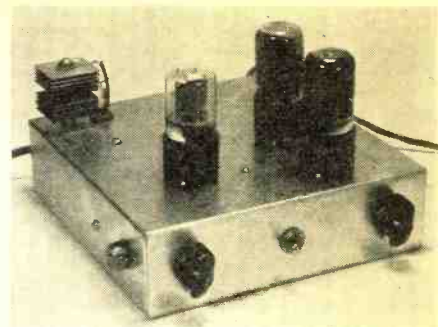

Top view of low-cost amplifier.

watts is thus easily obtained with low distortion. Sufficient gain is provided for almost any pickup, as only one quarter volt is needed to drive the amplifier to full output.

A tone control circuit, consisting of R_6 and C_5 , is included. This control is useful in reducing needle scratch and gives the effect of boosting the bass response of the amplifier.

The power supply may be used to power other equipment by opening the links shown in the diagram. A voltage of 190 volts is available at a current drain of 100 milliamperes.

Schematic diagram. Power supply is connected through terminal strip to audio stages. It can be disconnected easily and used to operate other equipment.

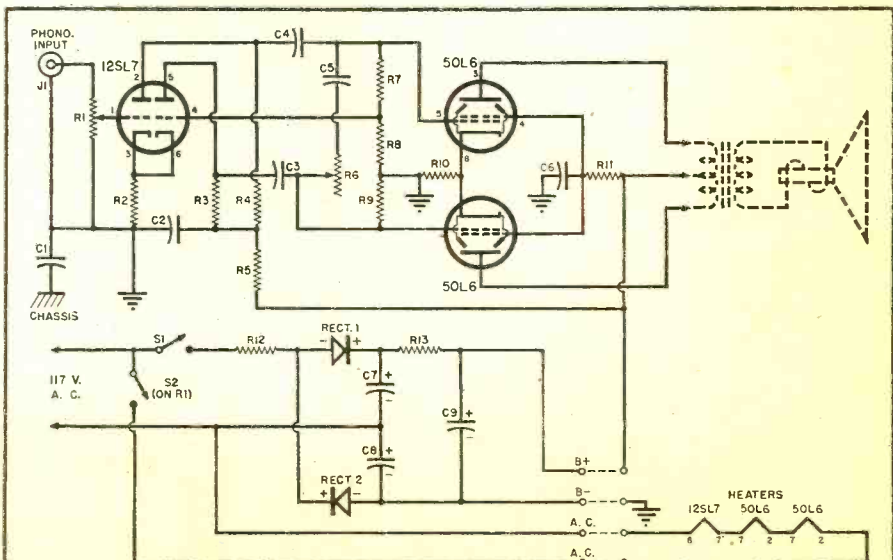

R_1, R_6 —250,000 ohm pot.
 R_2 —10,000 ohm, ½ w. res.
 R_3, R_4 —250,000 ohm, ½ w. res.
 R_5 —27,000 ohm, ½ w. res.
 R_7, R_8 —470,000 ohm, ½ w. res.
 R_9 —12,700 ohm, ½ w. res. (See text)
 R_{10} —140 ohm, 2 w. res. (100 ohms and 40 ohms in series)
 R_{11} —10,000 ohm, 1 w. res.
 R_{12} —20 ohm, 2 w. res.
 R_{13} —500 ohm, 10 w. wirewound res.

C_1 —0.05 μ fd., 400 v. cond.
 C_2 —10 μ fd., 200 v. elec. cond.
 C_3, C_4 —0.1 μ fd., 400 v. cond.
 C_5 —0.02 μ fd. mica cond.
 C_6 —8 μ fd., 150 v. elec. cond.
 C_7, C_8 —50 μ fd., 150 v. elec. cond.
 C_9 —16 μ fd., 250 v. elec. cond.
 J_1 —Microphone connector
 $Rect_1, Rect_2$ —100 ma. selenium rectifier
 S_1 —S.p.s.t. toggle sw.
 S_2 —S.p.s.t. sw. (on R_1)

FIVE NEW

OHMITE Products

for the Radio and Electronic Industry

1. NEW 2-WATT MOLDED COMPOSITION POTENTIOMETER

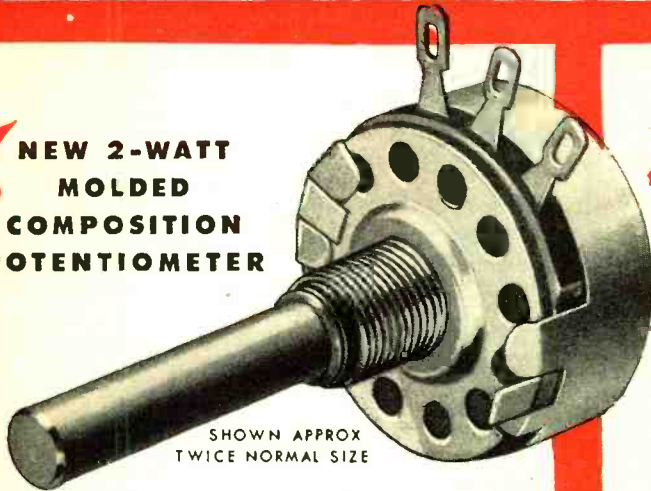

SHOWN APPROX
TWICE NORMAL SIZE

Now—a 2-watt unit with a good margin of safety, for industrial use. The resistance element is a thick, solid-molded ring, heat treated under pressure—not a film. It is unaffected by heat, cold, moisture, or length of service. Sold only through Ohmite jobbers.

2. NEW $\pm 5\%$ TOLERANCE LITTLE DEVIL COMPOSITION RESISTORS

These popular resistors are now available in $\frac{1}{2}$ and 1-watt sizes in tolerances of $\pm 5\%$, in addition to the standard $\pm 10\%$. The resistance and wattage are clearly marked on every unit. Sold only through Ohmite jobbers.



3. NEW 5-WATT BROWN DEVIL WIRE-WOUND RESISTORS

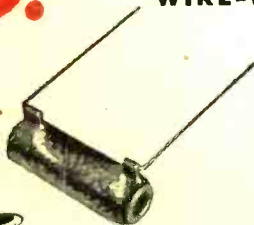

A rugged, new Ohmite wire-wound, vitreous-enameled resistor of unusual compactness. Easily mounted by its $\frac{1}{2}$ -inch tinned copper-wire leads. Tolerance $\pm 10\%$.

4. NEW RB-2 DIRECTION INDICATOR POTENTIOMETER



A compact, low-cost unit used in a simple potentiometer circuit as a transmitting element to indicate, remotely, the position of a rotary beam antenna, wind vane, or other rotating device. Used with a six-volt battery and a simple 0-1 milliammeter.

5. NEW R. F. PLATE CHOKES



These tiny, high-frequency chokes are single-layer wound on low power factor bakelite cores, covered with a moisture-proof coating. Four stock sizes for all frequencies from 50 mc. to 460 mc. Rated 1000 ma. or more.

Here are five new Ohmite products—all made to the same high standards that characterize other Ohmite products—built to stand up under severe service conditions. When you need rheostats, resistors, tap switches or chokes, play safe and specify Ohmite.

WRITE FOR
INFORMATION

OHMITE MFG. CO.

4883 Flournoy Street

Chicago, Ill.



Be Right with

OHMITE

RHEOSTATS • RESISTORS • TAP SWITCHES • CHOKES • ATTENUATORS

*Built so You
Can Read it!*

MULTIPLEX
VOLT - OHM - MILLIAMMETER

This is your instrument for all day, every day use. The Multiplex Model 458 is a rugged, accurate, portable, bench-type V.O.M. built to high industrial standards by one of America's pioneer makers of test equipment.

Multiplex Features:

Big 5½" d'Arsonval movement meter. 1000 ohms per volt. Multipliers accurate within 1%. Rotary range selector. Copper oxide rectifier for A.C. range accuracy. Priced remarkably low for \$26.00—NET an instrument of this quality—only.

See Your Jobber or Write for Bulletin 458

CHICAGO INDUSTRIAL INSTRUMENT CO.
536 West Elm Street - Chicago 10, Illinois

CUT HOLES 5/8 to 3 1/2"
IN RADIO CHASSIS

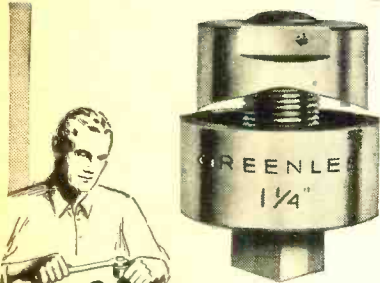

WITH A GREENLEE
RADIO CHASSIS PUNCH

● Save hours of work... no reaming or tedious filing. Punch cuts through chassis quickly... makes accurate, clean holes for sockets, plugs, and other receptacles. Just turn with an ordinary wrench. There's a GREENLEE Punch in each of these sizes: 5/8"; 3/4"; 7/8"; 1"; 1 1/8"; 1 1/4"; 1 3/8"; 1 1/2"; 1 3/4"; 1 7/8"; 2". Write for complete facts. Also get information on Knockout Punches and Cutters for conduit and meter holes up to 3 1/2". Greenlee Tool Co., 1888 Columbia Avenue, Rockford, Illinois.



All Popular Ranges

Volts D. C. 0-5/10/50/100/500/2000
Volts A. C. 0-12.5/25/125/250/1250
Milliamperes D. C. 0-1/10/100
Milliamperes A. C. 0-2.5/25/250
Ohms Full Scale 1000/200,000/2,000,000
Ohms Center Scale 50/2250/22,500
Output -5 to +55 Decibels

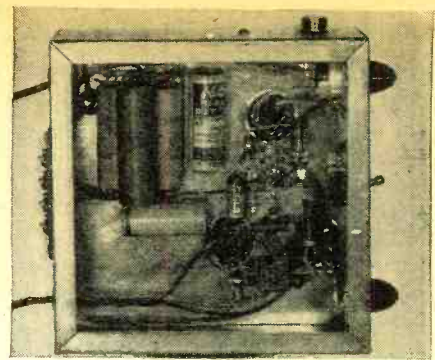

Under chassis view. A permanent magnet speaker, connected externally to the amplifier, is required. A dynamic speaker with a 450 ohm field may be used by substituting the field in place of filter resistor, R₁₃.

Due to the resistance-capacity filter used, the output voltage will vary depending on the load, increasing to about 230 volts at low current drains. The s.p.s.t. switch S₁ serves to turn off the heaters of the audio amplifier when the power supply is being used for other equipment.

Protection for the rectifiers in the event of overload is provided by means of the 20 ohm resistor, R₁₂. The use of this resistor is not absolutely necessary but its inclusion is recommended.

The components for the audio section are mounted along the front half of the chassis with power supply section at the rear. The two rectifiers are fastened together by means of a bolt and mounted above the chassis to provide proper ventilation.

The input to the amplifier is through a microphone connector, insulated from the chassis by means of fiber washers. All ground returns are made to a common bus, bypassed to the chassis by means of a .05 µfd. condenser, C₁.

The precaution of not having the chassis connected to one side of the line must be observed if the chassis is to be safe to the touch.

Shielded wire is used for the lead from the input connector to the gain control.

No output transformer was included with the amplifier, as many speakers come equipped with transformers. In the event an output transformer must be provided, the one selected should be designed for a plate-to-plate load of 4000 ohms. Use of any other load will result in either low output or distortion.

In any event, the speaker must be capable of handling at least eight watts if the maximum benefit from the amplifier is to be realized. This requires the use of a heavy duty speaker of at least the eight inch size.

R₈ consists of a 10,000-ohm and a 2700-ohm resistor in series. This particular value was selected to give equal drive to the grids of the two 50L6's. If an oscilloscope or vacuum tube voltmeter is available, the value of this resistor may be adjusted to

**Columbia's
August Specials!**

TINNED PAIR INTER-COM WIRE

22 Ga. solid copper with plastic insulation for alarm systems, inter-com work, and many other uses... take advantage of this exceptionally low price to stock up NOW.
Per 250 ft. coil \$1.73
Per 1000 ft. spool 6.05

SHIELDED WIRE

20 Ga. stranded tinned copper conductor with plastic insulation, lacquered braid with closely woven tinned copper shield overall. SPECIAL for this month only:
Per 100 ft. \$ 1.25
Per 1000 ft. 11.00

SHIELDED WIRE COTTON BRAID

Same as above, but cotton braid over shielding, can be used for microphone cable and many other applications.
Per 100 ft. \$1.75
Per 500 ft. 7.80

We carry in stock for immediate delivery many types of wire and cable in gauges of from 23 to 2, in addition to various types of multi conductor cable for many uses. We also manufacture cord sets and cables to specifications. Send us your inquiries for prompt attention.

Our NEW catalog is now available for distribution. Write for your copy today.

COLUMBIA WIRE & SUPPLY CO.
5740 NO. ELSTON AVE.
CHICAGO 30, ILLINOIS

Start Your Own RADIO SERVICE SHOP

Choose one of these
3 GREAT NEW DEALS

Includes TEST EQUIPMENT, TUBES, PARTS, TOOLS

3 complete going-in-business packages. (If necessary they can be changed to suit your needs.)

There never was a better opportunity than now to start a profitable business of your own. No fuss, no worry. Here's everything you need. Details upon request. Write, wire or phone!

\$99⁵⁰

\$179⁵⁰

\$350⁰⁰

Featherweight Miniature TEST INSTRUMENTS

Compact — Accurate — Priced Right!

- Jeweled Meter • Range Selector Switch
- All multipliers bridge tested for 1% accuracy
- Zero adjustment—built in batteries
- Molded bakelite case only 3-15/16" x 2-7/8" x 2"

MODEL 451A AC-DC Volt—Ohm—Milliammeter



A dependable instrument of wide utility—sensitivity 1000 ohms per volt. Ranges: Volts AC, DC, and Output Ranges, 0-10/50/100/500/1000; Ohms full scale, 500,000. Ohms center scale, 7200.

NET complete with batteries **14⁹⁰**

MODEL 312 Volt—Ohm—Milliammeter



An economy pocket meter featuring a 2" moving vane meter. Reads: AC-DC volts, 0-25/50/125/250; Mill's AC-DC, 0-50; Ohms, 100,000; mfd., .05-15. Jacks provide range selection.

NET Complete with cord and plug. **6⁷⁵**

FAMOUS "LITTLE TRIPLETT'S"

The Little Testers with the big 3" Meters Bakelite cases 3 1/4" x 5 3/8" x 2 1/4". Range selection switch—long, easy to read scales. We made a good buy—here they are at rock-bottom prices—the greatest buy ever offered in precision testing equipment.

Model 650SC - OUTPUT METER

A 4000 ohm constant impedance AC volt meter with ranges of 0-1.5-6-15-60-150 volts. Conversion chart for reading DB level from -10DB to +35 DB. 100 microampere meter. Excellent for receiver alignment, level indicators in recording equipment, general use on electronic apparatus. Regular net 24.50. A "one time only" Special buy at..... **10⁴⁹**



Model 606B-VOLTAGE TESTER

Checks voltage and polarity. Range: 0-440 AC-DC volts—definite indications for 115, 220, and 440 volt lines. Separate polarized vane for AC or DC indication. Built in test leads. Excellent for checking wiring, fuses, general factory installation and maintenance. Every plant — every electrician needs several at this low price. Regular net 16.67 Special at..... **8⁹⁵**



RADIART AERIALS

The Quality leader • Recognized by everyone • Admiralty brass rods • Triple plated • Permanently rattle proof • Static muffler ball • Polyethylene insulated HI Q lead with protective vinylite covering • Supplied with single pin (Motorola) connector and adaptor for bayonet style (Delco and Philco) fittings.



TYPE CF3-63

A two insulator side cowl mount—3 section 63" rod—supplied with 3 insulators and wedge adaptor to fit 95% of all car bodies—complete with 48" lead. **1⁹⁹**
List price \$4.95—our price.....

TYPE CFA3-63

All angle cowl or fender mount—A modern Radiart development—fits all body contours, straight or curved, cowl or fender. 3 section 63" rod easily adjusted to vertical without tools—complete with 40" lead. **1⁹⁹**
List price \$5.45 we sell for.....



GENERATOR CONDENSERS



PHILCO part No. 61-0177—.5 mfd.—5/8" x 1 1/8"—4" lead-slotted mounting strap for easy installation—Standard Merchandise—not war surplus—Present list price \$1.00. **Our special—over 85% off 14c**

200 WATT SOLDERING IRON

FAMOUS HEXACON ELECTRIC'S MODEL 201



FEATURES: Full 200 watt replaceable element. 5/8" tinned Copper tip, replaceable. One piece drawn case-gun metal finish. 6' heavy duty cord—stand included. Comfortable, well balanced handle. Operates on 110 volts—AC or DC. **List Price \$8.00**
Speed up your heavy work—**3⁶⁹**
Save time—save money at.....

OUTPUT TRANSFORMERS

Clean stocks — long leads — mounting feet — made to fit where you need them. For 6F6-6K6—to 4 ohm voice coil—size 2" x 1 1/8" x 1 3/8". 50L6-35L6-25L6 to 4 ohm voice coil 1 3/4" x 1 1/8" x 1 3/8". Specify quantity of each type you need at..... **4^{9c}**



Order from the Ad
Write - Wire - Phone

PHONO PICKUP CRYSTALS

Standard types—Set Manufacturers close-out—all Guaranteed



Webster F2—Replaces L26-L40-L70 etc.—pin type terminals—1 oz. pressure—1 volt output—5000 cycle cutoff. List price \$5.00—you pay us..... **1⁴⁹**



SHURE P93—W57A—pin type terminals—3/4 oz. pressure—1.6 volt output—6000 cycle cut off. List price \$4.45—our Special..... **1⁹⁸**



Astatic L-70—new postwar design—solder terminals—1 1/4 oz. pressure—1 volt output—4000 cycle cutoff. List price \$5.55—we quote you..... **1⁹⁸**

PHILCO BEAM OF LIGHT

Selenium cell only, no holder, postpaid. (Puts new life into Philco Changers) Sapphire needle only, no mirror, postpaid **1⁸⁰**
1²⁰

ALL RUBBER LAMP CORD



Underwriters Approved brown rubber covered insulated parallel Cord—"zips" apart easily—non fraying—deluxe—way above average quality. **500' Roll..... 9⁸⁹**

MULTI-USE WIRE

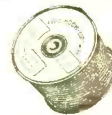

Stranded No. 22 tinned wire—glass "ROCKBESTOS" 1000 volt insulation—fireproof aircraft wire—a wartime development—at this low price you can use the best—

100 feet..... **45c** 1000 feet..... **3⁸⁹**

JEWELLED PILOT LIGHT ASSEMBLIES



• Candelabra screw base for 110 volt lamp.
• Mount in 1" hole.
• Lamps removable from front of panel.
• Available marked 1-2-3 or 4 on back of white lens. **1^{9c}**

YOUR CHOICE net **1^{9c}**

Include full remittance with orders of \$3.00 or less. Include 25% deposit with all C.O.D. orders of \$3.00 or more. Prices subject to change without notice.

SEND FOR FREE CATALOG

RADIO SUPPLY & ENGINEERING CO., Inc.

129 SELDEN AVE.

DETROIT 1, MICH.

26,000* SERVICEMEN READ

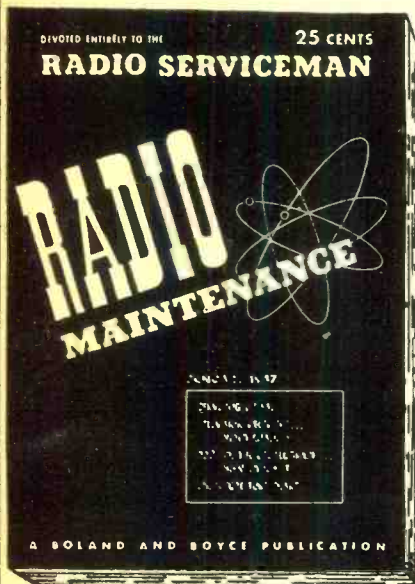

EVERY MONTH

*Paid circulation, March 1947 issue

RADIO MAINTENANCE today fills a breach that has existed in the radio field for a long time. Already 26,000 servicemen read RADIO MAINTENANCE every month because it is devoted entirely to the radio serviceman.

The RADIO MAINTENANCE staff specializes in the preparation of articles on every phase of Radio Maintenance in series form which may be filed and used for reference. The leading articles cover everything for the radio serviceman on Television, FM and AM; Test Equipment; Electronic Appliances; Tools; Antennas; Alignment; Troubleshooting; Repair; Construction; Pick-Ups and Sound Amplification and Reproduction Equipment. Also, in RADIO MAINTENANCE each month there are departments on hints and kinks, the latest news of the trade, review of trade literature, radiomen's opinions, new products and news from the organizations. All articles are presented in a step-by-step precision style, clearly illustrated, with schematics, accurate photographs, specially prepared drawings, white on black charts, color diagrams, isometric projections and exploded views.

Tear off coupon below and mail today. Your first issue will be mailed immediately on receipt of this coupon. One issue FREE if payment is enclosed.

Same
day
Service

RADIO MAINTENANCE
MAGAZINE
460 Bloomfield Avenue,
Montclair 3, N. J.

Please send me RADIO MAINTENANCE every month for

- 1 year at \$2.50 Payment enclosed
 2 years at \$4.00 Bill me later

Name _____
Address _____
City—State _____
* Occupation _____
Title _____
Employed by _____

* Independent Serviceman—Dealer Serviceman—Service Manager—Dealer—Distributor—Jobber.

give exactly the same drive to both grids. However, this is not necessary, as the values given will provide satisfactory operation.

VOLTAGE AMPLIFIER GAIN

The simple resistance-coupled audio voltage amplifier is a very widely used and highly useful electronic circuit. Many times it is helpful to be able to calculate the voltage gain of such an amplifier, that is, the ratio of the output voltage to the input voltage.

For this discussion, we will consider only the gain at mid-frequency, say in the region of 1000 cycles, as the gain at the high and low audio frequencies is complicated by various factors such as stray capacity, coupling and bypass condensers, and will be discussed in a later article.

The gain of a stage is determined primarily by the amplification factor of the tube used. Therefore, it is perhaps advisable to explain briefly what is meant by this particular tube characteristic. Amplification factor is a measure of the amount of control that the grid voltage has over the plate current. It is possible to change the plate current either by changing the grid voltage or by changing the plate voltage, and the amplification factor is defined as the ratio of the plate voltage change to the grid voltage change required to produce a given change in plate current. For example, suppose that for a given tube, a plate voltage change of 10 v. is required to change the plate current 1 ma., and a grid voltage change of only 1 volt will produce the same plate current change of 1 ma. The amplification factor then is 10/1 = 10. The symbol for amplification factor is the Greek letter mu, written μ .

A simplified circuit of a triode stage amplifier is shown in Fig. 1. The over-all gain of such a stage is equal to the voltage available at the grid of the next stage divided by the input voltage to the grid of the stage under consideration. Thus, in Fig. 1, the gain A of the stage is given by e_{g2}/e_{g1} .

The output voltage of the tube shown in Fig. 1 may be considered as equal to the input voltage times the amplification factor in series with the tube's plate resistance, r_p , as shown in the equivalent circuit of Fig. 2. At mid-frequencies, the coupling condenser C_c will have a reactance which

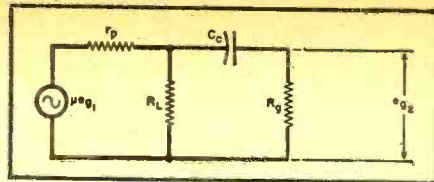

Fig. 2. Equivalent circuit.

is small compared with the values of R_L and R_g , so for our purposes may be considered as shorted. The output voltage e_{g2} then will be the voltage appearing across the parallel combination of R_L and R_g . This parallel combination is called the equivalent resistance, R_{eq} , and is given by the following equation:

$$R_{eq} = \frac{R_L R_g}{R_L + R_g}$$

The voltage μe_{g1} appears across the series combination of r_p and R_{eq} . The fraction of this voltage (e_{g2}) which appears across R_{eq} then is given by:

$$e_{g2} = \mu e_{g1} \frac{R_{eq}}{r_p + R_{eq}}$$

Since the gain has already been defined as the ratio of e_{g2}/e_{g1} , the gain is given by:

$$A = \frac{e_{g2}}{e_{g1}} = \mu \frac{R_{eq}}{r_p + R_{eq}}$$

Let us follow through an example to show how this equation was used. Assume a typical amplifier using a type 6C5 triode tube, a load resistance (R_L) of 50,000 ohms, and a grid resistance in the following stage of 1 megohm (R_g). From the tube manual, we find that the 6C5 has an amplification factor of 20 and a plate resistance of 10,000 ohms. R_{eq} (R_L and R_g in parallel) is then

$$\frac{50,000 \times 1,000,000}{50,000 + 1,000,000} = 47,600 \text{ ohms.}$$

The gain is now given by:

$$A = 20 \times \frac{47,600}{47,600 + 10,000} = 16.5$$

The gain of pentode stages can be computed in much the same way, although many times it is more convenient to use a tube characteristic called transconductance, written g_m . This is equal to the tube's amplification factor divided by its plate resistance. The gain is then equal to the transconductance times the parallel resistance of R_L and R_g , or $A = g_m R_{eq}$.

It can be seen from the above that the gain can never be greater than the amplification factor with this type of amplifier, and in general, the higher the load resistance R_L , the higher will be the gain. However, this load resistance cannot be made too high, as the d.c. voltage drop across it will be excessive, requiring an excessively high d.c. voltage supply. A compromise is usually reached in triodes wherein the load resistance R_L is from 3 to 5 times the plate resistance r_p . In pentodes, the load resistance is made as high as practicable.

Fig. 1. A Simple triode stage.

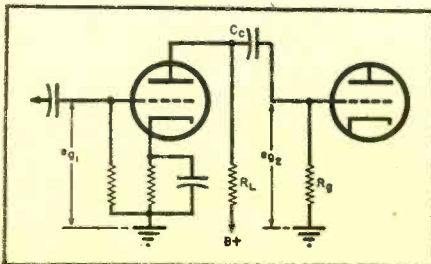

PERSONAL PORTABLE KIT, \$10.95

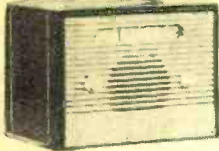

PERSONAL PORTABLE KIT MODEL K-PX. Small size leatherette covered case 8x6x7. Easy to build. Operates on self contained B and A batteries. Rec. Broadcast 550 to 1600 K.C. Incorporates a standard superhet circuit with AVC. Has 3 inch Alnico 5 PM speaker. Priced for the portable market.

complete with batteries, pictorial diagram and tubes IR5, 1S5, 1T4 and 3S4. Not AC DC, but straight battery operated. Has 2 gang cond. Everyone should have one of these personal portables. Everything furnished. Kit K-PX.....Net \$10.95

3-WAY PORTABLE KIT, \$17.95

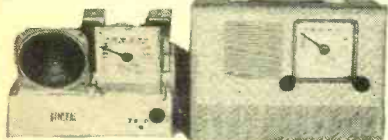

Build this powerful, 4-tube, 3-way portable kit. Operates on 110 volts AC or DC or self contained batteries. Receives broadcast 550 to 1650 K.C. Incorporates a standard superhet circuit with AVC and loop Ant. Has Alnico 5 PM Speaker, 2 gang condenser. All parts and batteries are furnished including tubes Disc Rectifier, IR5, 1T4, 1S5 and 3S4. Has attractive leatherette portable cabinet size 7x9x9. Weight 14 lbs. Kit model 3-ZA.....Net \$17.95

BEAUTIFUL PLASTIC KIT \$9.95

Kit Model P-85. We have finally been able to achieve our goal. Here it is. A good 5-tube broadcast AC DC superhet radio receiver for less than ten dollars. The beautiful 10 inch plastic cabinet is made of the finest material. The chassis is of the standard accepted superhet design. 456 KC IFS AVC and 5 inch Alnico 5 PM speaker. Attractive vernier dial. Two gang tuning condenser. Loop Ant. We defy anyone to offer a better working AC DC receiver kit. Priced complete with diagram, photos and tubes 12SK7, 12SK7, 12SQ7, 50L6 and 35Z5. Nothing else to buy. You can't go wrong on this value. Kit Model P-85.....Net \$9.95
SUPERHET. 4-Tube. 1 1/2-90 Volt FARM RADIO KIT complete, less 1000-hour battery; similar cab. to Model P-85. Model PB-48.....Net \$9.95



NEW SUPER MIDGET KIT, \$12.95

OUR SUPER VALUE

Build this new super Midget Broadcast Radio. Has beautifuly made, highly polished walnut cabinet. Size 7 1/2 x 4 1/2 x 6 1/2. Attractive slide rule dial. Incorporates a standard superhet circuit with 456 KC IFS & AVC. Has 2 gang condenser and loop ant. Every part including Alnico V. P.M. speaker and tubes. 12BB6, 12BA6, 12AT7, 50B5 & 35W4. Furnished as well as photo and easy to follow diagram. Weight 5 lbs.



KIT K-7A. Easily assembled into a fine working, attractive, transformer type AC, broadcast receiver; 550 to 1700 KC. Has push-pull audio, tone control and 6 1/2" Alnico 5 PM speaker. Beautifully made 14" walnut cabinet. Incorporates a standard superhet circuit, with AVC and loop antenna tubes 6SA7, 6SK7, 6H6, 6SN7, 2-6BE's and 5Y3 furnished. Nothing else to buy. Wt. 17 lbs. Dealers Net \$19.95



DELUXE AC-DC KIT J-D5

Beautiful walnut cabinet and all the parts to build a broadcast 5 tube AC-DC radio. Superhet with slide rule dial, 2 gang tuning condenser and loop aerial. Everything furnished; includes speaker and tubes 12SA7, 12SK7, 12SQ7, 35Z5 and 50L6 and diagram. Kit J-D5. Wt. 10 lbs.....Net \$14.95
Kit K-D5. Similar cabinet to above J-D5 except it is AC Trans. type and has 6 volt tubes.....Net \$16.95

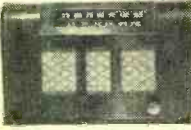

20-WATT UTILITY AMP. KIT, \$17.95

Build this 20 watt utility 110 volt AC, 20 Watt power amplifier. Ready punched aluminum chassis, size 12 x 6 x 2 1/2 inches. Has two input circuits, one mike and one phono. Mike stage has 135 DB gain, for crystal or dynamic mike. Has bass and treble controls. Designed for use with PM speakers; has 8-16 ohm output transformer. All parts, controls, transformers and easy-to-follow diagram furnished, including tubes: 2-6SN7, 6J5, 2-6L6GA, 5Z3. Kit Model 20-LX. Net.....\$17.95
12" 12 watt Alnico 5 PM speaker, \$6.95 extra. Astatic crystal mike and desk stand, \$7.95 extra.



CATHODE RAY TUBE SCOOP



All New—Factory Cartoned

- 3BP1....Net \$2.95
- 5CP1....Net 3.95
- 5BP1....Net 3.95
- 5FP7....Net 3.95
- 7BP7....Net 4.95
- 9LP7....Net 4.95

RADIO TUBE SCOOP!

ALL—NAME BRANDS OR JAN SOME ARE CARTONED EVERY TUBE GUARANTEED

12A6	35Y4	12SL7	1L4
12H6	50A5	6F8	3A4
12SH7	6V6ST	26	11S5
1631	6SN7ST	27	12AT6
1632	30	6116	12BA6
9001	76	6SN17	12BB6
12SA7	5Y3	30	50B5
12SQ7	5Y4	80	
12SK7	5Y4	6J5	
35Z5	1633	9003	
50L6	1644	185	
14A7	12SN7	1T4	
14Q7	6SD7	3S4	

49c

6C5	6V6gt	12SK7	OY4
6F6gt	6K7	35L6	12SJ7
6SA7	41	50L6	12SR7
6SK7	42	35Z5	6C6
12SA7	9A8gt	6K6	6D6
12SQ7	12J5	7T7	6B6

59c

6SC7	7Q7	7B7	35A5
6SL7	7A8	7C5	117Z6
7A7	7B8	7C8	
7A4	7Y4	7E5	
7B4	7Z4	7F7	
7A6		7N7	
7B6			

79c

1 1/2 Volt Local Tubes..... 99c
1L4, 1L5, 1L6, 1L4A, 1L4B, 1L4C, 1L4E, 6L6.

SCOOP

1000 JAN. OZ4 Each 69c

AIRCRAFT RECEIVERS

The Army Aircraft Receiver BC-454 covers 3 to 6 MC. Has 3 gang tuning condenser and two stages of 1415 KC. intermediate frequency. By removing plates from the gang and re-winding the Ant., R.F. and osc. coils you can have a red hot 10 meter receiver. We have plenty of these in the original factory carton. Priced less the 28 volt dynamotor. Has 3-12SK7, 12SR7, 12K8, and 12A6.
Near new BC-454-B 3 to 6 MC receiver with all six tubes.....Net \$3.95
Near new BC-455-B 6 to 6 MC receiver with all six tubes.....Net \$3.95
Brand new factory carton BC-454-B 3 to 6 MC with all tubes.....\$5.95
Brand new factory carton BC-455-B 6 to 9 MC with all tubes.....\$5.95
Receiver dynamotors 28 volts.....Net \$0.95

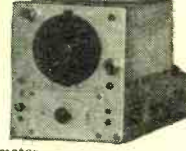

Triple remote control head for SCR-274 (BC-453-B, BC-454-B, BC-455-B) \$1.95
Flexible cable for tuning SCR-274.....\$0.75
Mounting Rack for three receivers.....\$1.95

AIRCRAFT TRANSMITTERS

This really fits the ham's dream. Ideal for a 55 watt transmitter with 575 volts at 250 MA plate supply, or VFO to drive a high power rig. It's a companion unit to the 454-455-453 series aircraft receivers. Made by Western Electric and really rugged. The oscillator will hold the frequency, even under rough operating conditions. Has 1215 M. O. and 1-1625 (807) in parallel as final P. A.; or buffer to feed into a high power rig. Built-in crystal dial calibration checker. Antenna loading inductance.
Near new BC-457-A Transmitter 4 to 5.5 MC. Complete with 4600 KC crystal and tubes.....Your Cost \$3.95
Near new BC-458-A Transmitter 5.3 to 7 MC. Complete with 6200 KC crystal and tubes.....Your Cost \$5.95

BOTTOM VIEW

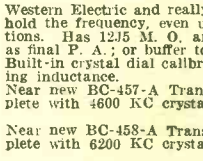

Scr-274 (AN/ARC-5) SCOOP!
Brand new, factory carton transmitter BC-457-A 4 to 5.3 MC with tubes and crystal.....\$9.95
Brand new, factory carton transmitter BC-458-A 5.3 to 7 MC with tubes and crystal.....\$9.95
Brand new, factory carton transmitter BC-459-A 7 to 9 MC with tubes and crystal.....\$9.95

EVERY KIT COMPLETE 8-TUBE RADIO AMP. KIT \$29.95

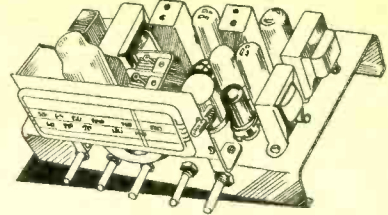

Build this High-Fi Radio Amplifier
• Beautiful 8" Slide Rule Dial.
• Standard Superhet Circuit covering Broadcast 550 to 1700 KC.
• 2-Gang Tuning Condenser.
• Offered with 12 or 15 in. PM Speakers. Push-pull 6V6 Output stage giving 15 watts of full range audio.
• Dual Tone Controls (Bass and Treble).
• Inputs for both Mike and Phono pick-up.
Here is something new in radio. A real 15 watt power amplifier with bass and treble controls. Has extra gain stage for crystal or dynamic mikes. And on the same chassis, a standard superhet radio receiver. We furnish all parts, knobs, esoutchene plate and tubes: 6SA7, 6SK7, 6SR7, 6SN7, 6SJ7, two 6V6 and 5Y3. No cabinet. Extra care in designing the power supply section assures low hum level, making this unit ideal for recording as well as P.A. use. We furnish everything as well as schematic diagram and photos of the completed chassis. Weight 35 lbs. PRK-10 Radio Amp. Kit with 12 P.M. Speaker.....Net \$29.95
PRK-10X Radio Amp. Kit with 15 in. \$30.00 value Cinnaudraph P.M. speaker.....Net \$42.95
If you desire a more powerful audio section in the above kit we offer either the PRK-10 or PRK-10X with a full 200 mill power transformer and push pull 6L6 tubes in the final giving 25 watts of full range audio for \$10.00 extra on either kit.

DELUXE REC. CHASSIS \$22.95
Deluxe broadcast receiver chassis kit model AB-4 this kit is offered for those who want a good receiver to install in their cabinet. The design is of the accepted type; standard superhet. Has power transformer push-pull 6V6's output tubes; tone control; 2 gang condenser and 8 inch deluxe slide rule dial; similar in appearance to our PRK-10 kit shown above; except it has no provision for mike. Offered with a 12" 15 watt Alnico 5 PM speaker. Priced complete with diagrams, photos and tubes 6SA7, 6SK7, 6SQ7, 6SN7, 2 6V6 and 5Y3. Kit model AB-4.....Net \$22.95

PORTABLE RADIO RECORDER KIT \$49.95
RADIO RECORDER KIT MODEL G-30. Here is the last word in kits. We furnish you everything to make this an attractive, good working radio and recorder. Has a beautiful alligator covered portable case. General Industries 12445 78 RPM recording play back mechanism. The 6 tube superhet receiver and power amplifier is all on one chassis. It is directly for your popular radio station or from any crystal or dynamic mike. Push pull output tubes assures good recordings and the best in tone quality. Furnished complete with easy to follow diagram, photos and tubes 12SA7, 12SK7, 12SQ7, 12SL7 and two 35L6. Dry disc recifier. Heavy duty 6 in. Alnico 5 PM speaker. Priced complete nothing else to buy. Kit model G-30.....Net \$49.95
Crystal mike with stand.....\$6.95 extra
G-30 With Dual Speed Cutter.....\$4.45 extra



G.I. RECORDER MECHANISMS
Latest 1947 General Industries recording assemblies with 4 ohm magnetic cutters and crystal play back
Model 12445-78 RPM. Net.....\$24.50
Model 13700-33 and 78 RPM. Net.....28.95
Model 13810-Automatic changer with output.....40.10
78 RPM. Net.....

2-TUBE PHONO-OSCILLATOR 800
Complete, wired and tested. 800 to 1500 KC. Model B. Has audio gain stage for proper power output. Complete with tubes ready to operate.....\$3.69



MIKE-OSCILLATOR 800 to 1500 KC.
Mike Oscillator model C-4. Not only does the unit work as a phono-osc., but has added gain stage for a crystal mike. Priced complete, wired and tested with 3 tubes and fader control. Net \$4.95. Crystal Mike.....\$4.90 extra



DELUXE MIKE OSCILLATOR 800 to 1500 KC Phono-Mike Oscillator. Makes any receiver a P.A. system. Record your or Recording amplifier 3 stage high output unit with power transformer for AC operation only. High gain input stage for crystal or dynamic mike. Control on panel for fading recording to DL-5. Complete with 3 tubes, wired and tested. Net \$7.95. Crystal Mike.....\$4.90 extra

BROADCAST REC., \$12.95
Army Aircraft Receiver BC-946-B broadcast band from 52 to 1500 KC with tubes: 3-12SK7, 12SR7, 12K8 and 12A6. Designed for dynamotor operation, but is easily converted to 110 volt operation. Has two I.F. stages and 3 gang condenser. Complete with tubes and instructions; less dynamotor. Net \$12.95. Good condition. Dynamotor for above receiver DM-32A \$0.95 each.



McGEE RADIO COMPANY WRITE FOR CATALOG SEND 20% DEPOSIT—BALANCE C.O.D. 1225 McGEE ST., KANSAS CITY, MISSOURI

NAVY ARB RECEIVER, \$19.95

You can convert this over, easily to a good ham receiver. It's one of the hottest values in surplus receivers. 28 volts DC input. Covers 4 bands. 195 kc to 9 mc. This is a deluxe type superhet receiver, note that the frequency coverage includes the standard broadcast band. Has 4 gang tuning condenser; can be converted to a 110 volt AC receiver. Priced complete with tubes: 12SF7, 12SA7, 3-12SF7 and 12A6. Has dial built on front of chassis. Electric driven or manual band change switch. Weight 28 lbs. Size 6x7x15 inches.

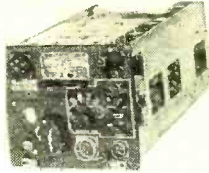

ARB Near new condition, with tubes and dynamotor.....Net \$19.95
ARB Brand new, factory cartoned, with schematic.....Net 39.95
New remote control for ARB. \$12.00 extra.

GLIDE PATH RECEIVER, \$9.95



R-89/ARN-5 Glide Path Receiver 11 tube superhet. Formerly used for blind landing. Adaptable for many uses. Receives 326 to 335 MC. Contains six relays. 11 tubes 7-6AJ5, 12SR7, 2-12SN7, 25D7. Size 13x5x6. Weight 12 lbs. A beautiful piece of equipment. Has three crystals. Priced complete with xtals and tubes.

R-89/ARN-5 Near new condition.....Net \$ 9.95
R-89/ARN-5 Brand new, factory cartoned.....Net 14.95

APS-15 RADAR SCOPE, \$39.95

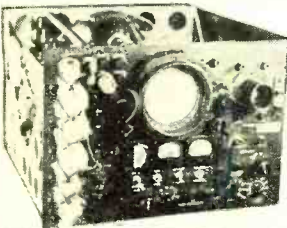

APS-15 RADAR—Aircraft Radar Range Scope. This unit is so dynamic in its operation that it is impossible to describe it in an ad. Originally used to receive radar signals and indicate range. Has a 5 in. scope tube, a 2 in. scope tube and 43 other tubes such as 7-6L6, 6SN7, VR, etc. Vert. amplifier, video amplifier. Blower motor. Rotary sweep, electro magnetic deflection yoke. Marker pip osc. sweep generator, etc. Originally cost the government thousands of dollars. Size 24x15x28. Weight 65 lbs. Scoop Price with all tubes.....\$39.95

SCR-522 TRANS. REC., \$19.95

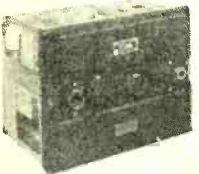

SCR-522 You are all familiar with this 100 to 156 MC Transmitter, receiver. These 522's that we have are in rough looking cases and some of the outside connectors have been damaged. However, we guarantee that if you separate the transmitter and receiver and remove the case, you will have usable merchandise. There are not many more of these units available; we have just 100 to sell.

PACKARD BELL PRE-AMP., \$1.99

Housed in a handy aluminum case 5x4x3, priced complete with tubes 6SL7, 28D7, has many usable parts. Relay and control PL68 plug and patch cord.



VEEDER-ROOT METER AND CASE

Counts number of feet of trailing wire antennae; number turns when winding on coil; applicable for many uses; beautiful bakelite case, jeweled dialite, pilot light enclosed, 3 position switch, counts up to 1000.

Each.....95c



KEYS—49c

Brand new keys. Factory cartoned. While they last, \$0.49 each 10 for \$3.95

BC-1366 Jack Box 11 bank banana plug jack and socket with 5 position single deck switch and control. 2 phone jacks. Scoop price .59 2 for \$1.00



SCOOP \$1.99

Heavy Duty Vibrator is made for replacement in 6/110 volt amplifiers. The frequency is 60 cycles. Will run stand. Phono motor.

NAVY GLIDE PATH, \$3.95

Navy model ZA Glide path receiver. Has 3-6C6 tubes; several controls, transformer and handy case; size 6x7x12 inches. Ideal for salvage, near new condition \$3.95. 2 for.....\$6.95



SYNC. VIBRATOR UNIT, 99c

MALLORY SYNC. VIB. UNIT. This is a standard type 6 volt vib. unit. Has long leads. Easily installed in the old case. A red hot item if we ever had one.

ARMY PARTS SALVAGE SCOOP!—\$2.49 EACH

TWO FOR \$4.49

Another red hot value in salvage. All kinds of good useable parts in this unit. Con. Res. Relays, Modulation trans. and tubes VR150, 12J5 and 1625. Brand new and in factory carton. Originally designed to modulate the BC 457 W E. Transmitter. You can find many uses for this. BC-456 Modulator scoop, price.....\$2.49

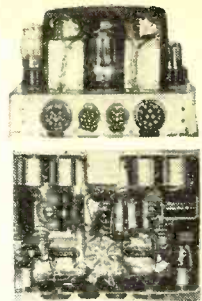

BOTTOM VIEW

G.E. SERVO-AMP. SALVAGE

\$1.95 EACH

Two for \$3.50

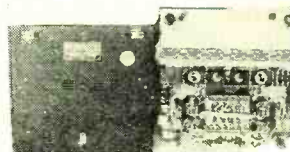

G.E. Servo amp Salvage Scoop. This item is ideal to tear up for the pieces. General Electric Servo amplifier, has 14 octal tube sockets, 5 small neon lamps. Lots of condensers, resistors and controls. Salvage value more than the purchase price of this unit. Weight 15 lbs. Brand new. Priced less tubes \$1.95 2 for.....\$3.50

SWITCH-POT. SALVAGE, 99c

A real salvage scoop. Has 3 toggle switches, 1 band switch, 6 standard size carbon controls, knobs, etc. Scoop price .99. 3 for.....\$2.50



BC929 RADAR, \$14.95

BC-929 A Radar Indicator Scoop. This unit could be rebuilt into a fine test scope. It is an ideal size. 8x9x14 priced with tubes 2-6SN7, 2-6H6, 6G5, 6X5 and 2X2. This is a red hot buy. However you will have to change the power trans. for 60 cycle use. Guaranteed to be in good condition.

Scoop Price.....\$14.95
Weight 20 lbs. Has 3 in. Cr Tube.



BC-654 TRANSMITTER RECEIVER \$12.95

GUARANTEED TO BE IN GOOD CONDITION

7-Tube Superhet Receiver and 6-Tube Trans. with 25 Watts Power.



Order Now at this Scoop Price. Covers 3800 Kc. to 5800 Kc.

Portable voice and CW transmitter and receiver for portable, mobile, and fixed station operation. 7-tube superheterodyne receiver with 3.5 microvolt sensitivity on voice and 0.5 microvolt sensitivity on CW, and 100 milliwatts undistorted power output. 455 KC IF. Uses 3-1N5GT, 1-1A7GT, 2-305GT, 1-1H5GT tubes. 6-tube transmitter, with antenna tuning network, Colpitts thermal compensated oscillator, class C final with 2-307A tubes in parallel, and crystal oscillator for checking frequency every 200 KC. 25 watts output on CW and 11.2 watts output on voice. Frequency range, transmitter and receiver, 3800 to 5800 KC. Ideal for Ham! Comes complete with cover; set of tubes installed. 5 spare tubes and 3 spare pilot lights. Less power supplies. These units are used but in good condition. Shipping weight 50 lbs. Net price with all tubes and spares \$12.95; 2 for.....\$25.00 Send your order to our Kansas City store. This unit will be shipped from our Chicago warehouse. Immediate delivery. You can hardly tell they are used. BC-654 Less all tubes and crystal.....\$7.95

BC-645, \$14.95 Each Two for \$29.00

Made by General Electric. Factory printed Conversion Diagram. New, factory cartoned. 15 tubes. Covers 450 mc.



ARMY BC-645 I.F.F. UNIT. Early in the war when radar picked up a plane, there was no way of knowing whether it was friendly or not. That was before BC-645 was invented. BC-645 sent out a signal that identified the plane as American. It probably saved more lives than any other piece of electronic equipment made. With some modifications the set can be used for 2-way communication, voice or code, on the following bands: ham hand 420-450 mc., citizens radio 460-470 mc., fixed and mobile 450-460 mc., television experimental 470-500 mc. Equipment capable of doing the jobs of the modified set sells for hundreds and hundreds of dollars. The 15 tubes alone are worth more than the sale price. 4-7F7, 4-7H7, 4-7E6, 2-6F6, 2-955 and 1-WE316A. It now covers 460 to 490 mc. Each BC-645 is shipped with a Belmont factory printed conversion diagram, showing how to make AC power supply modulator and how to make Transmitter and Receiver changes. Most Hams and experimenters already have the few parts necessary. New BC-645 with tubes less power supply. Shipping weight 25 lbs. Extra WE316A Tubes \$1.29 each. 12 Volt Dynamotor.....\$4.95

McGEE RADIO COMPANY

WRITE FOR CATALOG

SEND 20% DEPOSIT—BALANCE C.O.D. 1225 McGEE ST., KANSAS CITY, MISSOURI

Jensen

Bass Reflex CABINETS



Three types—six models to accommodate 6", 8", 12" and 15" speakers



TYPE B Bass Reflex Cabinets are manufactured in sizes for 8", 12" and 15" speakers. A superior new wood composition in outer walls and panels assures distinguished appearance at a modest price. Finish is an attractive, baked-on hammerloid, trim is of chromium and aluminum.

BASS REFLEX PRINCIPLE: Through exact acoustical proportioning of the completely enclosed cabinet, and the use of an auxiliary port, the port is made an auxiliary radiator at low frequencies. This controlled use of what otherwise would be waste energy increases efficiency.

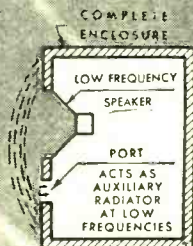

*TYPE J PERI-DYNAMIC (Model J-61) CABINET is a wall-mounting style which takes any standard six inch speaker. Handsomely styled of a textured composition material. It is complete with mounting bracket. A five-tug terminal board facilitates installation.

Meeting the high engineering and appearance standards which for years have been a Jensen hallmark, these new Bass Reflex cabinets provide acoustically correct enclosures for Jensen speakers. They are particularly suitable for Jensen Coaxials.

All of them (except the J-61) employ the widely heralded Jensen Bass Reflex principle. This, together with special acoustical treatment, assures maximum extension of low frequency response, and freedom from objectionable "boom" or resonance.

See these new cabinets today at your dealers—or write for full information and prices.

ABOVE RIGHT: New Type D Deluxe Bass Reflex Cabinets are available for either 12" or 15" speakers. Exterior styling is by a noted designer; construction by one of the nation's foremost furniture manufacturers. All hard woods are of selected striped walnut. Finish is natural walnut rubbed to a satiny smoothness.

JENSEN MANUFACTURING COMPANY

6617 SOUTH LARAMIE AVENUE • CHICAGO 38, ILLINOIS

In Canada: Copper Wire Products, Ltd.,
137 Oxford St., Guelph, Ontario



Designers and Manufacturers of Fine Acoustic Equipment



Fills a Long-Felt Need

New Improved JFD REMOTE-O-CABLE REPLACER

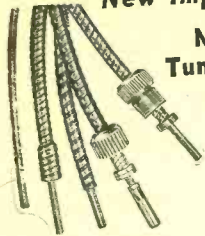

Control Shafting & Casing

Available in coils, or cut to length. Exact duplicate cables for Philco, Arvin, Delco, Motorola. Also, standard shaft and casing assemblies.

Most Efficient Auto Radio Tuning Cable-Servicing Machine in Use Today!

1. SWEDGES SHAFTING TO PREVENT UNRAVELLING.
2. CUTS SHAFTING TO EXACT LENGTH.
3. REPLACES OLD FITTINGS ON SHAFTING.
4. CASING GROOVE MAKES CUTTING EASY.

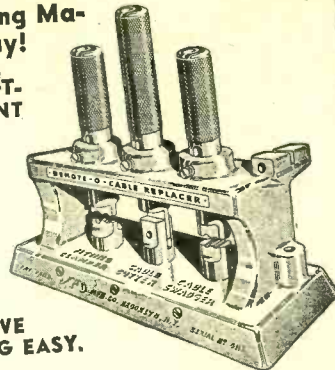

SERVICEMEN'S COMPLETE COMBINATION KIT OF CABLE, HOUSING and FITTINGS

30 different types of fittings — 120 assorted pieces. 50 ft. of cable, 50 ft. of housing. A single compact kit that fills all servicemen's needs for cable, housing, and fittings. Used in Philco, Motorola, RCA, United Motors, Bosch, Crosley, Sparton, Atwater-Kent, Stewart-Warner, Arvin, Zenith, Emerson, and other auto radio sets. All compactly packed in a FREE durable steel box. Model CK200.

EVERY SERVICEMAN MUST OWN ONE!



WRITE FOR LITERATURE

J.F.D. MANUFACTURING CO.

4109-4123 FORT HAMILTON PARKWAY, BROOKLYN 19, N. Y.

FM NOW!

This High Quality FM Kit at Remarkable Low Price



Model FM-7 is a splendid, low priced, self contained table model Frequency Modulated Radio Receiver Kit complete with tubes, speaker and beautiful Bakelite cabinet.

The FM-7 has a frequency response of 86-110MC, can also be used as a TUNER with a high quality amplifier. A phonojack is provided in the rear of the chassis with double pole, double throw switch control for feeding signal to either the radio speaker or to the phonojack. An additional jack for connecting extra loud speaker is included. The R.F. section of the kit is pre-tuned at the factory. This kit uses 2 I.F. Stages, 1 limiter stage and 1 discriminator. Miniature tubes used throughout.

Price of Model FM-7 complete as described \$29.95

Other High Quality Kits Available

- 5 tube superheterodyne, 1 band.
- 6 tube superheterodyne, 2 band.
- 5 tube AC/DC Battery kit.

For complete information, write for catalog K.

RADIO KITS COMPANY

120 Cedar Street New York 6, N. Y.

D. C. POWER SUPPLIES

Designed to replace batteries and deliver proper voltage and current to your equipment. Don't rip apart your surplus equipment. Use it as it was intended to be used. Operate it from a D.C. Power supply. All units listed. Plug into standard 110-117 volt 60 cycle AC line.

All units are housed in attractive metal cabinets finished in black wrinkle enamel, and come equipped with circuit breaker, fuse, toggle switch, and pilot light. A selenium rectifier results in long and dependable life.

Model I-12-12 delivers 12 volts at 12 amps. Filtered DC suitable for

BC-19 transceiver, etc. Net **\$32.50**

Model I-24-10 delivers 24 volts at 10 amps. Filtered DC. Net **\$45.75**

Model I-24-24 delivers 24-28 volts at 24 amps. Filtered DC. This unit is suitable for powering the ART-13 or BC-375E transmitters and dynamotors. Net **\$87.50**

Net

Other voltages and currents available, custom-built to your order. Write for information on these and on 400 cycle-115 volt output, power supplies.

Terms: Cash with order or 20% deposit; balance C.O.D.—F.O.B. Brooklyn.

ELECTRONIC CONTROLS CO.,

3124 Avenue I

Brooklyn 10

New York

25214	35—20/20/30 μ d., 25/25/450 v. elec. cond.
78057	36—Vol. control
78072	37—Tone control
26194	38—Gang capacitor
38485	39—First i.f. trans.
38486	40—Second i.f. trans.
94195	42—Output trans.

ZENITH MODELS 5R080, 5R086

Part No.	Code and Description
63-579	R ₁ —220 ohm, 1/4 w. res.
63-589	R ₂ —10,000 ohm, 1/4 w. res.
63-976	R ₃ —15 megohm, 1/4 w. res.
63-600	R ₄ —2.2 megohm, 1/4 w. res.
63-1348	R ₅ —5 megohm vol. control
63-644	R ₆ —22,000 ohm, 1/4 w. res.
63-597	R ₇ —470,000 ohm, 1/4 w. res.
63-686	R ₈ —150 ohm, 1/2 w. wirewound res.
63-1219	R ₉ —22 ohm, 1/2 w. wirewound res.
63-1220	R ₁₀ —100 ohm, 1 w. wirewound res.
63-1221	R ₁₁ —680 ohm, 1 w. wirewound res.
63-602	R ₁₃ —4.7 megohm, 1/4 w. res.
22-1419 or 22-1356	C ₁ —2-gang variable cond.
	C ₂ —Broadcast ant. trimmer (on C ₁)
22-829	C ₃ —.05 μ d., 200 v. cond.
	C ₄ —Broadcast osc. trimmer (on C ₁)
22-1017	C ₅ —.05 μ d., 200 v. cond.
	C ₆ —First i.f. trans. pri. trimmer (on T ₁)
	C ₇ —First i.f. trans. sec. trimmer (on T ₁)
	C ₈ —Second i.f. trans. pri. trimmer (on T ₂)
	C ₉ —Second i.f. trans. sec. trimmer (on T ₂)
22-953	C ₁₀ —.0002 μ d., 600 v. cond.
22-669	C ₁₁ —.01 μ d., 600 v. cond.
22-826	C ₁₂ —.01 μ d., 200 v. cond.
	C ₁₃ —Omitted
22-854	C ₁₄ —.0005 μ d., 600 v. cond.
22-196	C ₁₅ —.01 μ d., 600 v. cond.
22-1379	C ₁₆ —.02 μ d., 400 v. cond.
22-1381 or 22-1552	C ₁₇ , C ₁₈ , C ₁₉ —40/40/40 μ d., 150/150/150 v. elec. cond.
95-919	T ₁ —First i.f. trans.
95-906	T ₂ —Second i.f. trans.

HOFFMAN MODEL A301

Part No.	Code and Description
4500	R ₁ , R ₂ —22 megohm, 1/2 w. res.
4501	R ₃ —22,000 ohm, 1/2 w. res.
4502	R ₄ —2.2 megohm, 1/2 w. res.
4503	R ₅ —10,000 ohm, 2 w. res.
4504	R ₆ —47,000 ohm, 1/2 w. res.
4804	R ₇ —5 megohm vol. control
4505	R ₈ —10 megohm, 1/2 w. res.
4506	R ₉ —47 megohm, 1/2 w. res.
4507	R ₁₀ —360 ohm, 1/2 w. res.
4805	R ₁₁ —25 megohm tone control & sw.
4508	R ₁₂ —47 ohm, 1/2 w. res.
4509	R ₁₃ —330 ohm, 1/2 w. res.
4701	R ₁₄ —1500 ohm, 10 w. wirewound res.
4400	C ₁ , C ₂ , C ₃ —338/338/180 μ d. 3-section var. cond.
	C ₄ , C ₅ , C ₆ —Trimmers (Part of C ₁ , C ₂ , C ₃)
4100	C ₇ , C ₈ —.05 μ d., 200 v. cond.
4000	C ₉ , C ₁₀ , C ₁₁ , C ₁₂ —100 μ d. mica cond.
4101	C ₁₃ , C ₁₄ —.05 μ d., 400 v. cond.
4102	C ₁₅ —.005 μ d., 600 v. cond.
4103	C ₁₇ —.01 μ d., 600 v. cond.
4200	C ₁₈ , C ₁₉ —20/20/20 μ d., 450/450/450 v. elec. cond.
4104	C ₂₁ —.001 μ d., 600 v. cond.
4105	C ₂₂ —.01 μ d., 600 v. cond. (metal can)
4004	C ₂₃ —500 μ d. mica cond.
5200	L ₁ —Osc. coil
5201	T ₁ —Antenna loop
5202	T ₂ —R.f. coil (shielded)
5203	T ₃ —Input i.f. trans.
5204	T ₄ —Output i.f. trans.
5100	T ₅ —Audio output trans.
5000	T ₆ —Power trans.

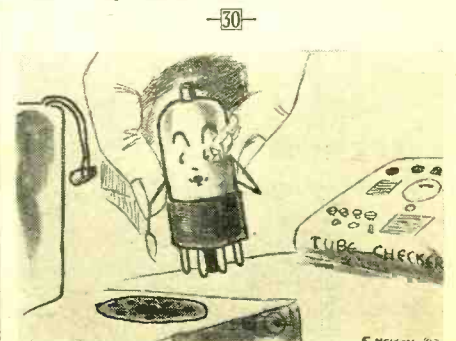

"Whew! Beat that ol' Lie Detector again!"

BENDIX 100 WATT TRANSMITTER

ONLY THIS SWITCH USED TO
CHANGE 10-20-40-80 METER BANDS

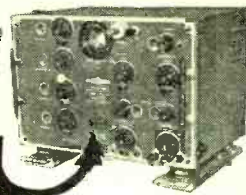

FOUR SEPARATE ELECTRONIC COUPLED OSCILLATORS: These can be easily converted to 20-40-80 meters. Crystal required for 10 meters. Each electronic coupled oscillator dial has 3000 divisions enabling quick precision shifting. This transmitter was constructed of the highest quality of precision parts, with laboratory precision. Four separate output tanks; one 4 position selector channel switch having seven sections which changes the ECO, IPA and output tanks simultaneously. All the controls are mounted on the front panel. The housing is cast aluminum; shields and case are sheet aluminum. Dimensions 11 x 12 x 15 inches, weighing 35½ lbs. Complete, simple instructions for conversion furnished. Uses three 807, four 12SK7 tubes; one 2 inch 5 amp. R.F. meter.

A complete coverage transmitter, for the new or experienced amateur. **\$49.95**
A TRUE HAM VALUE—BRAND NEW, complete with tubes.....

Sun Radio FOR THE HOTTEST VALUES IN Surplus Parts



110 VOLT AC SUPERHETERODYNE RECEIVER

This crystal fixed frequency receiver comes with full conversion instructions for variable tuning of all ham bands and broadcast. A highly selective superheterodyne receiver, 110 V. A.C. power supply built in. Uses the following tubes: 6K7 RF Amplifier; 6K8 Mixer and Oscillator; 6K7 I.F. Amplifier; 6F7 Detector and A.V.C.; 6CB Output and Noise Suppressor; 80 Rectifier. Dimensions: 3½ x 19 x 11½ inches. Comes complete, Brand New, with one set of coils and two sets of tubes..... **\$16.95**

Extra set of coils **\$2.95**



Low Frequency Receiver BC-344

Just a very few left... New, operates on 110v AC complete with 19 tubes... tunes 150-1500 kc... Your last chance to get one of these "hot" low frequency receivers at this spectacularly low price..... **\$69.95**

Speaker..... **\$7.50**

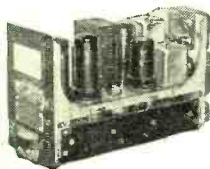

SPERRY AMPLIFIER

Brand new servo amplifier containing two beam power output tubes (1632 and 1634) similar to 6SC7, two twin triodes (1633 and 1634) similar to 6SC7, two mica condensers, dozens of color coded half watt resistors, two dual and four section bathtub condensers, three transformers, two water switches, one volume control, four octal sockets. Easily convertible..... **\$3.95**

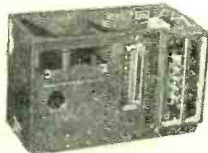

BC-684 F.M.

35 WATT TRANSMITTER

Brand new, complete with eight tubes, crystal control, 10 channel pushbutton, 27-38.9 mc, non-linear modulation coil... less coverplate, crystal, and power supply **\$17.95**

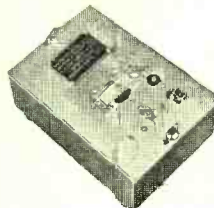

V. H. F. TRANSMITTER

Here is one of the greatest offerings in war surplus! Hundreds sold at \$20.00 and now closed out at an amazingly low price. Brand new. Battery operated (67½v B and 1½v A). Frequency 80 to 105 mc. Complete with 2-1G4 tubes and full instruction manual. Ready to go on the air. Less batteries..... **\$6.95**



R.F. TUNING UNITS

Still the best buy on surplus... Beautiful black crackled aluminum cabinet with two variable transmitting condensers and two vernier dials, one heavy duty ceramic four position water switch, mica condensers, 2,500 working volts and coils wound on porcelain ribbed forms. Available TU5B (1500-3000 kc), TU7B (4500-6200) TU8B (6200-7700 kc) and TU10B (10000-12,500 kc). Please specify model..... **\$3.89**



NEW NAVY SPEAKERS

(A) Navy type waterproof speakers Stromberg-Carlson and RCA 4½ ft. re-entrance trumpet with 25 Watt PM drive unit and line matching transformer. \$125 value for..... **\$32.50**
(B) 25 Watt PM driver unit with line-matching transformer and waterproof projector mounted in a heavy duty round metal baffle. At the lowest price ever offered! **\$14.95**

MICROPHONE



Brand New single button carbon hand microphone.

Please enclose 30 cents in stamps or money order to cover mailing and landing

\$1.79



D. C. Milliammeter

Brand new General Electric 2" round panel meters. 0-300..... **\$2.97**

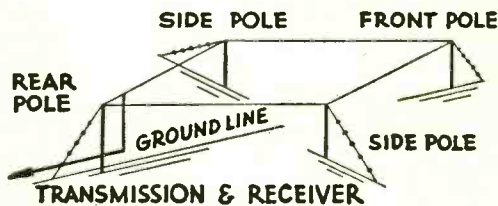

RHOMBIC ANTENNA KIT

CONSISTING OF:

- 2200 ft. wire, No. 14, AWG. Copperweld
- 12 wire rope clips
- 9 spacer insulators
- 10 strain insulators
- 1 lightning arrester protector (Viso Glow)
- 50 ft. 2 wire cable, 200 ohm transmission line
- 3 sheave pulleys
- 24 ft. flexible wire, tiller rope
- 50 ft. wire, 5/16" messenger, G.S.

Plus—Many other items, including steel thimbles, ground rod wire, guy clamps, thimble nuts, curved washers, anchors, anchor rods, bent eye bolt, stoples, machine bolts, round washers, line support turn block, porcelain tube, line support insulator, galvanized iron shield, lag screws, screw eye insulator. The present market cost of this aerial exceeds \$150.00. Our price complete less poles..... **\$24.95**



ANTENNAS

(A) Small four-section telescopic aerial ideal for portable receivers, transceivers or test equipment.

99c

(B) 22' tapered high frequency aerial covering 150 to 200 mc. Complete with coax cable connector.

\$1.69



GHM METER WESTON No. 689

A beautiful instrument for accurate work. Scale 0-10 ohm and 0-1000 ohm scaled to read 1/20 or an ohm with ease. This 2¼" round meter is housed in a black bakelite case 1¼" x 2¼" x 5". Complete with heavy duty felt lined leather case and lock. Special **\$14.95**

All items F.O.B. Washington, D.C. Orders \$30.00 or less, cash with order. Above \$30.00, 25 percent with order, balance C.O.D.

SUN RADIO OF WASHINGTON, D. C.

938 F STREET, N. W. WASH. 4. D. C.

International Short-Wave

(Continued from page 70)

ministrative services of the company, the studios and technical installations for program control.

The broadcasting of programs is assured by two transmitters housed in a modern and superbly equipped building situated in the highlands of Junglinster, 1000 feet above sea level. The long-wave transmitter is capable of radiating with 200 kw., making it one of the most powerful stations in the world. The antenna system, supported on five steel pylons of cantilever construction, each 600 feet in height, is of the umbrella or spider web type. This assures the widest possible range of transmission coverage.

The second transmitter, now operating on 6.090 with an antenna power of 5 kw., in the near future will be increased to a maximum of 25 kw. so as to ensure radio communication with the entire world. Station officials announce: "We shall, in the near future, broadcast in the 31-, 25-, and 19-meter bands on frequencies of 9.527.5, 11.782.5, and 15.350.

Facts About Luxembourg

As a Grand Duchy, Luxembourg is governed under the Constitution of 1868, as modified in 1910. Legislative power rests with a Chamber of Depu-

ties which is elected by universal suffrage. Executive power is held by a Minister of State and a Cabinet comprised of four or five ministers. The country is ruled by Grand Duchess Charlotte, who succeeded on the abdication of her sister, Marie Adelaide, January 9, 1919, was married on November 6, 1919, to Prince Felix of Bourbon-Parma. Heir is Prince Jean, born January 5, 1921; other children include four daughters and another son.

Luxembourg is a country of small landowners; 430,000 of the 500,000 acres devoted to agriculture are farmed by resident owners.

As we take our leave of *Radio Luxembourg*, we quote this statement from the station's management:

"Today, the whole world has begun to associate itself with the European listeners to *Radio Luxembourg* programs . . . Once again, from the highlands of Luxembourg on the central plateau of Junglinster, the 600-foot aerial masts of *Radio Luxembourg* have become a potent factor in support of the cultural, political, and economic well-being of the world at large."

Swedish List

Arne Skoog, Swedish DX-er, has compiled a list of short-wave stations for the official Swedish program-weekly, "*Roster i Radio*," which is available to DX-ers abroad.

Manne Ginsburg, editor, has promised to send a copy of the issue containing the list (published in June) to anyone sending in a request accompanied by an IRC. Should the demand be too great, requests will be filed until the list is published again (presumably in November or December of this year).

Mr. Skoog's list contains full information concerning frequencies, wavelengths, call-signs, locations, output, times, slogans, and owners "of all actual short-wave stations of the world," he says. It is assumed the list will be in Swedish but should be easy to translate, as have been other lists prepared by Mr. Skoog in the past.

Verification Data

Short Wave News, London, founder of the International Short Wave League, is starting a campaign for better reporting. In its lead editorial recently, the publication pointed out:

"Letters received by us from broadcasting stations indicate that far too many SWL reports fall well below the standard required to be of any practical value. Too many listeners send reports of utter uselessness and too many think that 'veries' are the only things worth considering in short wave listening." After quoting examples of some of the "worthless" reports received by *Radio Australia*, the editorial continues: "Nauseated? So are

The New KT-30 CHANNEL ANALYZER!

THE ULTIMATE IN SIGNAL TRACING INCLUDES . . .

METER — For direct reading of signal intensity.

SPEAKER — For listening to the signal.

PHONE — For checking distortion and listening to the signal in low-gain channels.

Intermittents, distortion and other time-consuming trouble causes can now be quickly and efficiently located and corrected with the aid of this new time-saving instrument. The use of low current consuming miniature battery tubes enabled us to provide super-performance and yet keep the size and weight of the complete instrument to its desirable compactness.

The Model KT-30 Channel-Analyzer is battery operated, therefore, it is always ready for instant use. A flip of the front panel switch and you are ready to follow the signal from antenna to speaker through all stages with the aid of the sensitive detector Probe. A high-pass filter contained in the Probe 'cuts off' at 300 Cycles thus allowing a signal with a super-imposed 60 or 120 Cycle hum to be heard.

Comparative signal intensities are indicated directly on the meter as the Probe follows the signal. A special 4 1/2" P.M. speaker with oversize Alnico V magnet is used for quality checks. One of the shortcomings of many previously designed Signal Tracers has been their inability to measure and check low signal intensities. This disadvantage has now been overcome for the Model KT-30 Channel-Analyzer incorporates a special circuit which permits the meter to be put across the output of the Signal Tracer. To accomplish this it is necessary only to flip a front panel switch. This results in additional gain and sensitivity permitting measurement of low signal intensities. An earphone provided with the unit permits listening to the signal in low-gain channels. Incidentally, insertion of the phone automatically cuts out the speaker.

The Model KT-30 Channel-Analyzer comes complete with detector probe, test leads, self-contained batteries and earphone. Comes housed in heavy-gauge crystalline cabinet.

NET PRICE

\$29.95

Available for Immediate Shipment—20% Deposit required on C. O. D. orders.

GENERAL ELECTRONIC DISTRIBUTING CO.

98 PARK PLACE, Dept. R.N.-8
NEW YORK 7, NEW YORK

OUR POLICY We do not advertise any unit which is not available for immediate shipment from stock • Less flowery adjectives, more detailed specifications. • All units are sold subject to one year guarantee except when components are damaged

through misuse. • We do not solicit orders for any unit that does not meet our requirements for accuracy and honest value. Any item purchased from us is sold with the understanding that it may be returned for full refund after a 10 day trial.

20% DEPOSIT REQUIRED ON ALL C.O.D. ORDERS

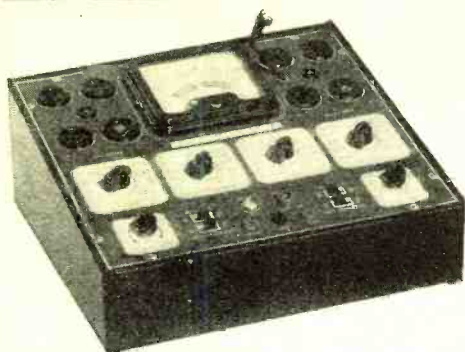

The New Model 60-T TUBE and SET TESTER

A COMPLETE TUBE TESTER

Tests all tubes including the new post-war miniature locals such as the 12AT6, 12AU6, 35W4, 50B5, 117Z3, etc. • Tests by the well-established emission method for tube quality, directly read on the scale of the meter • Tests shorts and leakages up to 3 Megohms in all tubes • Tests leakages and shorts of any one element against all elements in all tubes • Tests both plates in rectifiers • Tests individual sections such as diodes, triodes, pentodes, etc., in multi-purpose tubes.

\$49⁸⁵
NET PRICE

Model 60-T operates on 90-120 Volts 60 Cycles A.C. Housed in sloping leatherette covered cabinet. Comes complete with test leads, tube charts and detailed operating instructions.

A COMPLETE MULTI-METER

- 6 D.C. Voltage Ranges: 0 to 7.5/15/75/150/750/1,500 Volts
- 6* A.C. Voltage Ranges: 0 to 15/30/150/300/1,500/3,000 Volts
- 4 D.C. Current Ranges: 0 to 1.5/15/150 Ma. 0 to 1.5 Amps.
- Low Resistance Ranges: 0 to 2,000 Ohms (1st division is 1/10th of an ohm.)
- 2 Medium Resistance Ranges: 0 to 20,000/200,000 Ohms
- High Resistance Range: 0 to 20 Megohms
- 3 Decibel Ranges: -10 to +38, +10 to +38, +30 to +58 DB.

EXTRA: WE CAN NOW SUPPLY THE MODEL 60 HOUSED IN A BEAUTIFUL HAND-RUBBED OAK CABINET. COMPLETE WITH PORTABLE COVER MAKING IT SUITABLE FOR EITHER BENCH OR OUTSIDE USE. ONLY \$2.75 ADDITIONAL. SPECIFY MODEL 60-C

The New Model B-45 SIGNAL GENERATOR

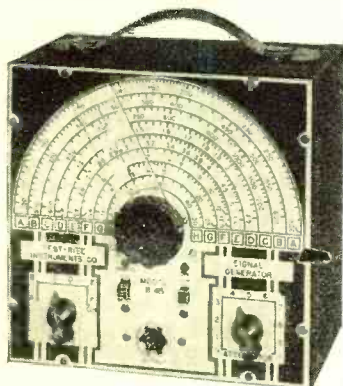

Self-modulated — provides a highly stable signal. RF frequencies from 150 Kc. to 12.5 Mc. on Fundamentals and from 11 Mc. to 50 Mc. on Harmonics. Modulation is accomplished by grid-blocking action — equally effective for alignment of amplitude and frequency modulation as well as for television receivers. Self-contained batteries. All calibrations are etched on the front panel, permitting DIRECT READING.

Model B-45 uses a beautifully processed dualtone front panel. Comes housed in a heavy-

gauge crystalline steel cabinet complete with shielded test lead, self-contained batteries and instructions. **COMPLETE, READY TO OPERATE**

\$27⁷⁵

The New Model 670 SUPER METER

A Combination VOLT-OHM-MILLIAMMETER plus CAPACITY REACTANCE, INDUCTANCE and DECIBEL MEASUREMENTS

D.C. VOLTS: 0 to 7.5/15/75/150/750/1500/7500. A.C. VOLTS: 0 to 15/30/150/300/1500/3000 Volts. OUTPUT VOLTS: 0 to 15/30/150/300/1500/3000. D.C. CURRENT: 0 to 1.5/15/150 Ma.; 0 to 1.5 Amps. RESISTANCE: 0 to 500/100,000 ohms, 0 to 10 Megohms. CAPACITY: .001 to .2 Mfd., .1 to 4 Mfd. (Quality test for electrolytics). REACTANCE: 700 to 27,000 Ohms; 13,000 Ohms to 3 Megohms.

INDUCTANCE: 1.75 to 70 Henries; 35 to 8,000 Henries. DECIBELS: -10 to +18, +10 to +38, -30 to +58.

THE MODEL 670 COMES HOUSED IN A RUGGED, CRACKLE-FINISHED STEEL CABINET COMPLETE WITH TEST LEADS AND OPERATING INSTRUCTIONS. SIZE 5 1/2" x 7 1/2" x 3".

\$28⁴⁰



The New Model CA-11 SIGNAL TRACER



SIMPLE TO OPERATE . . . BECAUSE SIGNAL INTENSITY READINGS ARE INDICATED DIRECTLY ON THE METER!

- ★ SIMPLE TO OPERATE — only 1 connecting cable—NO TUNING CONTROLS.
- ★ HIGHLY SENSITIVE — uses an improved Vacuum Tube Voltmeter circuit.
- ★ Tube and resistor-capacity network are built into the Detector Probe.
- ★ COMPLETELY PORTABLE — weighs 5 lbs. and measures 5" x 6" x 7".
- ★ Comparative Signal Intensity readings are indicated

directly on the meter as the Detector Probe is moved to follow the Signal from Antenna to Speaker.

★ Provision is made for insertion of phones.

THE MODEL CA-11 COMES HOUSED IN A BEAUTIFUL HAND-RUBBED WOODEN CABINET. COMPLETE WITH PROBE, TEST LEADS AND INSTRUCTIONS.

\$18⁷⁵

The New Model 450 TUBE TESTER

Speedy operation—assured by the newly designed rotary selector switch which replaces the usual snap, toggle, or lever action switches.

SPECIFICATIONS

- Tests all tubes up to 117 volts.
- Tests shorts and leakages up to 3 Megohms in all tubes.
- Tests both plates in rectifiers.
- New type line voltage adjuster.
- Tests individual sections such as diodes, triodes, pentodes, etc., in multi-purpose tubes
- Noise Test detects microphonic tubes or noise due to faulty elements and loose internal connections.
- Uses a 4 1/2" square rugged meter.
- Works on 90 to 125 volts 60 cycles A.C.

EXTRA SERVICE—May be used as an extremely sensitive condenser Leakage Checker. A relaxation type oscillator incorporated in this model will detect leakages even when the frequency is one per minute.

\$39⁵⁰



GENERAL ELECTRONIC DISTRIBUTING CO. Dept. RN-8, 98 Park Place NEW YORK 7, N. Y.

LEEDS

Still Leads—

New Amertran Transformers in Stock

K-291—HEAVY DUTY OUTPUT—for PP 616, PP 2A5, 6F6, 42, PP 46, 59, AB-2; 6000 ohm primary 4/8/15/250/500 ohm secondary, 30 watts.....	\$ 6.41
K-602—POWER TRANSFORMER 117v, 60 cycle primary; 580v C.T. 50 Ma DC; 5v at 3A; 6.3v at 2A.....	3.47
K-241—UNIVERSAL OUTPUT; primary 4000 to 14000 ohm C.T. secondary 1-30 ohm; 8 watts.....	1.59
K-604—POWER TRANSFORMER; pri 117v, 60 cy; sec 700v C.T. at 70 Ma DC. 5v at 3A; 6.3v at 2.5A.....	4.00
K-292—HEAVY DUTY OUTPUT—for PP6L6-ABI; pri 6600 ohm; sec 4/8/15/250/500 ohm; 30 watts.....	6.41

APS/13 Receiver & Transmitter

17 tubes—5-6J6; 9-6AG5; 1-VR-105; 2-D21; 400-600 Mc range. 30Mc I.F. complete with tubes & Dynamotor. Priced at less than the worth of the tubes.....

\$11.95

Oil-Filled Condensers

1 MFD 600 V. DC.....	\$0.39
2 MFD 600 V. DC.....	.49
4 MFD 600 V. DC.....	.69
10 MFD 600 V. DC.....	.98
16 MFD 400 V. DC.....	.98
0.1 MFD 7500 V. DC.....	1.50
0.02 MFD 3000 V. DC.....	.98
2 MFD 1000 V. DC.....	1.79
2 MFD 2000 V. DC.....	1.15
7 MFD 330 V. DC.....	1.25

LOUDSPEAKER—LS-6-C consisting of microphone P.M. speaker and trumpet with triggered gun grip handle. Brand New. Special.....

\$3.95

POTENTIOMETER—100,000 ohm wire wound, precision made to General Radio specs. 25 watt, 6" diameter. Brand New.....

\$1.95

BC-645-A TRANSCEIVER—420-450Mc; complete with W. E. Co. 310A doorknob. 15 tubes and conversion diagram. Brand New; original packing.....

\$14.95

Meters

0-1 MA DC 3" G. E.....	\$3.50
0-1 amp RF 2" G. E.....	2.45
0-30 volt AC 3" Westinghouse.....	2.45
500-0-500 microamps 4" W. E.....	3.75
5" Bakelite case, 50 millivolts basic movement, can be used for any range required by use of shunts or resistors. All Brand New in boxes. Special.....	1.95

RELAYS—SIGMA SENSITIVE, plug-in type, 5 prong, 2000 ohm, coil set at 431a DC hermetically sealed.....

\$0.95

RELAYS—G. E. HIGH CURRENT, 24v. coil; contacts will handle 200 amps. Special.....

\$0.39

BC406 RECEIVER—15 tubes, tunes 195-207Mc; 110v 60 cy AC operated, suitable for conversion to 2 meters of television; for only.....

\$15.95

SELSYNS, type 5 Synchro-transmitter, used in pairs as transmitter and follower; 110v 60 cy AC. Per pair.....

\$5.00

SELSYNS, type 11-1; indicator type in armored case 110v. 60 cy per pair.....

\$9.00

CRYSTAL PICKUPS—well known make, only 1 1/2 oz. pressure; Brand New.....

\$1.95

CRYSTAL MICROPHONES—well known make, with stand and 7 ft. cable. Brand New.....

\$5.50

HEINEMANN CIRCUIT BREAKERS magnetic type, in 5-20-35-65 amp sizes.....

\$0.95

IN CRYSTAL DIODES for use in field strength meters; as meter rectifiers, or even for crystal sets! at .35 each or 3 for.....

\$1.00

ANTENNA SECTIONS—screw in type—37" long; made of light weight steel tubing; special per section.....

\$0.15

TELESCOPING ANTENNA—very light weight, 30" long.....

\$0.25

DM-43A DYNAMOTOR, Mfd. by G.E. New input 24v at 23 amps, 7500 RPM; output 615/1000/2/3 v. at 215/260 milliamps; filtered. Special.....

\$7.50

SCHWEIN Free and rate Gyros operated from 24v. DC in metal case, ready for use; now only.....

\$5.00

Remote control box for 522A transceiver—consists of 5 push button switches, 5 V.E. pilot lite assemblies, lever switch, all mounted in one box.....

\$1.25

OUNCER TRANSFORMER—make to grid; low to high impedance; 25 to 1 ratio. 35c each 10 for.....

\$2.95

If not rated 25% with order, balance C.O.D. All prices F.O.B. our warehouse New York. No order under \$2.00

We ship to any part of the globe

LEEDS RADIO CO.

75 Vesey St., Dept. RNA

COrtland 7-2612

New York City 7

we. What value is such drive to any station—except to fill the waste paper baskets. One would gather from the attitude of these 'experimental listening stations' that the sole object a station has in going on the air is to enable it to distribute QSL cards to all and sundry. Most stations know they are getting out, but a large number of SWL's seem to think it a miracle of science that they hear such stations on their '3 valve communications receivers.' Many of the powerful stations have been good friends of the SWL in the past but frankly this attitude is on the wane. This undisputed fact must be faced squarely: *If reports generally do not undergo a pronounced improvement then the day is in sight when QSL cards for the listener will be discontinued.* In other words, a selfish section of the fraternity is jeopardizing the SWL's hobby, and it is up to every one of you to make sure your reports are up to the mark, otherwise.....

"Far from opposing reporting, regular readers know us as energetic champions of the SWL's, but we are greatly distressed by the increasing evidence of mass-reporting—the cause of scrappy information—in our midst. Some readers may say that they only send brief reports but get back a fair number of cards. That may be so, as most BC stations either verify or they don't. The fact remains that such reports are still useless. Many stations have now ceased to verify due to the reports received not justifying the expense of providing cards. How many other stations will follow suit? That matter rests entirely with the SWL's."

The editorial suggests that one should "always send a sufficiently detailed extract of program to enable station log to be accurately checked. If you *must* send a SWL card, then send a *real* report as well. *The information contained on a SWL card is totally inadequate.*"

Paul Kary, Pennsylvania, supplies the following QRA's which will be helpful to those wishing to verify commercial stations operated by these companies:

Transradio Internacional (LSX), San Martin 329, Buenos Aires, Argentina; Regie T.T. (ORP), Radio Electrisch-Centrum, Ruiselede-Post Bernem, Belgium; Cable & Wireless (West Indies), Ltd. (VPO-8, VPO-10), B.M.L.A. Buildings, Beckwith Place, Bridgetown, Barbados, B.W.I.; Institute National Belge de Radiodiffusion (RNB), 18 Place Eugene Flagey, Brussels, Belgium; Chinese Govt. Radio Administration (XGT-2), Sassoon House, Tien-Chih Road, Shanghai, China; Marconi Radio Telegraph Co. of Egypt S.A.E. (SUV, SUX, SUP), Box 795, Cairo, Egypt; Postes Telegraphes et Telephones, Rue Freiuevaux, Paris, 14eme, France; West Indies Telephone Co. (HHT), P. O. Box A-53, Port-au-Prince, Haiti; Press Wireless (MCD-3), 8, Rue Edouard-VII, Paris 9eme, France; Banco Nacional de Mexico, S.A. (XBHX), Isa-

bel la Catolica 44, Apartado 14 Bis, Mexico, D. F., Mexico; Companhia Portuguesa Radio Marconi, Rua de S. Juliao, 131, Lisbon, Portugal; RCA Frequency Bureau, RCA Building, 30 Rockefeller Plaza, New York 20, New York (for RCA stations in U. S. or Hawaii); Cable and Wireless of South Africa, Ltd. (ZSS, ZSS-3), Box 962, Capetown, South Africa; Philippine Press Wireless, Inc., 2nd Floor, Soriano Building; Plaza Cervantes, Manila, Philippines; Cable and Wireless, Ltd. (SVM), Leoforos Vassilissis Sofias 2, Athens, Greece.

Elwood Deibert, Pennsylvania, reports verification from NTMU, of the U.S.S. *Philippine Sea* (Byrd Antarctic Expedition) on 17,840, signed by E. Schiller, LCDR, U.S.N.R., Communications Officer, U.S.S. *Philippine Sea* (CV-47), Fleet Post Office, New York, New York, U. S. A.

From the Director, Direction de la Radiodiffusion D'Etat, Sofia, Bulgaria (Bulgarie), comes this data: "The research work about the reception of our transmissions abroad is carried on by our Liaison Department which sends out questionnaires to our listeners regularly. The information obtained from the replies is being systematized and handed over to our Technical Department. The verifications are sent to all persons who send us the report of reception; and International Reply Coupons are welcome."

Short Wave News, London, suggests QRA of *H.M.S. Vanguard* as probably The Admiralty, London, or direct to the Chief Radio Officer, H.M.S. Vanguard, % port of call in Britain (presumably Plymouth).

Some weeks ago, in Moscow's North American beam, the woman announcer greeted several listeners who had written to *Radio Moscow*, including the SW editor of a prominent radio club, said editor being promised a verification. However, we have no report that verification has been forthcoming. Some listeners have reported writing Moscow in the Russian language with nil results. (We are tempted to offer a prize for the first verie received from the Soviet Union!)

QRA for Lusaka is The Broadcasting Officer, Information and Public Relations Office, P. O. Box 209, Lusaka, Northern Rhodesia. (Harrison)

Hamburg's new 50-kw. station on 6.115, answered by letter from Nord-westdeutscher Rundfunk, Sender Hamburg-Elmshorn, Rothenbaumchausee 132-134, Hamburg 13, Germany (British Zone). (Bergstrom)

* * *

Annals Available

Due to so many requests for a SWL's guidebook, I have contacted the Amalgamated Short Wave Press, Ltd., 57, Maida Vale, Paddington, London, W.9, England, with regards to the availability of *The Short Wave Listeners' Annual*. W. Norman Stevens, official of the organization, replies that "the stock we now have on hand is

(Continued on page 96)

SPRAGUE TRADING POST

SWAP—BUY OR SELL!

FOR SALE—QST, March 1946: 10-meter rig modulator and power supply complete; 2 meter hand talkie; Shure 707A mike; 2 meter mobile transmitter; 2 meter transmitter-receiver complete; used 274N 6-0.1 m.a. xmitter; 10 meter two element beam; Re603 tank f-m. tech hook; A1 Postwell W2QNB, 370 Convent Ave., New York 31, N. Y.

SELL OR TRADE—Motorola #109—K-1, 10-tube home receiver, with automatic tuning. Tuning range .55 to 18 mc in 3 bands. Need any kind of ham equipment. Harry P. Keeley, Jr., W9CRV, 1206 West Acre Road, Joliet, Ill.

WANTED—500 ma. swinging choke. Will sell 2000v c.t. transformer U.T.C. 8-46, \$10. Dynamotor PE73-C, 1000v., 400 ma., \$15; assorted quality transmitting mica and variable condensers. D. Victorson, 255 E. Parkway, Brooklyn, N. Y.

FOR SALE—Code oscillator with speaker, place for phones and key. Used only 1 month \$8.50. John S. Hall, 6011 Peardice Road, Huntington 2, W. Va.

SELL OR TRADE—Back numbers several radio magazines, 1922-1930. Felix Januss, 511 E. 6th Street, Los Angeles 21, Calif.

SELL OR TRADE—New signal corps recorder BC-1016. Records code on tape at speeds up to 300 W.P.M. contains 7 tubes. A handy addition to any shack. Sell or swap for communications receiver in excellent condition. James W. Craig, Jr., 239 Preston Ave., Lexington 27, Ky.

FOR SALE—Bateman Pro 12" overhead recording mechanism with Ansatic x-29A crystal cuterhead. Very good condition \$15. Jack Hartley, 88 Diamond Bridge, Hawthorne, N. J.

WANTED—Ideas developed by hams in converting surplus BC-375-E transmitter to amateur use. Will exchange information I receive other than QST article. George J. Murray, 133 Riverbank Ave., Wyandotte, Mich.

FOR SALE—Hallcrafters 15-tube receiver, SX-28, 550 KC—42 MC including matching Hallcrafters—Jensen bass-reflex cabinet with 12" speaker. Excellent electrical and mechanical condition. \$220. F.O.B. Otto Pollet, Jr., 2122 Edgeland Ave., Louisville, Ky.

WANTED—Panoramic adapter, 10-meter transmitter. Have sound powered phones, EC-8 phone sets, Sky Buddy, laboratory decade bridge, LM-15 with cal. book, 38.5KC handy-talkies, many new tubes, galvanometers, microammeters. G. H. Amber, W8TLL, 15889 Princeton, Detroit 21, Mich.

WANTED—Receiver and Modulator diagrams for the army SCR-274-N. Will buy or buy. Urgently needed. A. L. Oliveira W1PWJ, 94 Potomaska Street, New Bedford, Mass.

WHAT'S THIS ABOUT MIDGET TUBULARS?

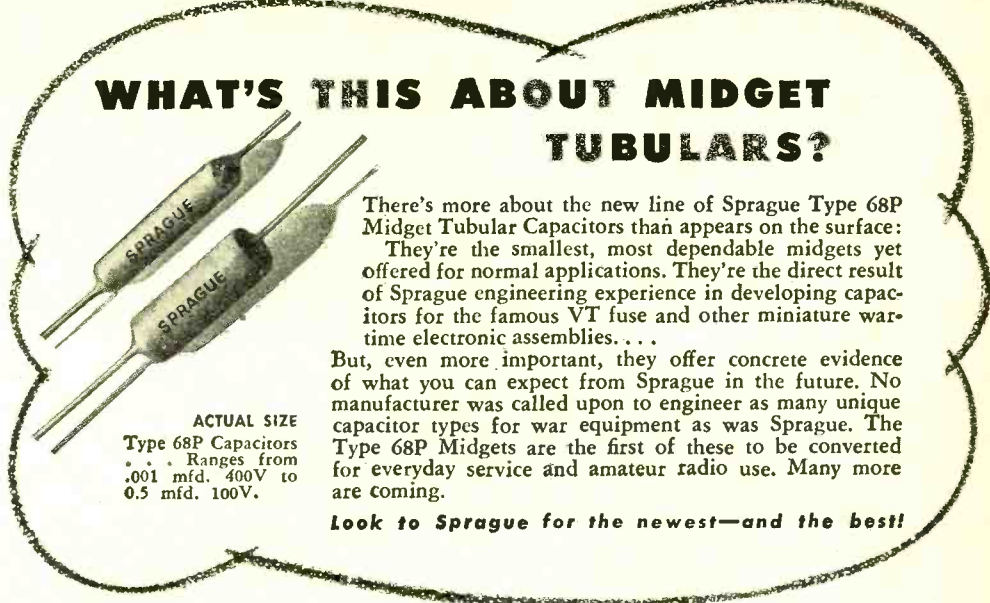

ACTUAL SIZE
Type 68P Capacitors
... Ranges from
.001 mfd. 400V to
0.5 mfd. 100V.

There's more about the new line of Sprague Type 68P Midget Tubular Capacitors than appears on the surface:

They're the smallest, most dependable midgets yet offered for normal applications. They're the direct result of Sprague engineering experience in developing capacitors for the famous VT fuse and other miniature wartime electronic assemblies...

But, even more important, they offer concrete evidence of what you can expect from Sprague in the future. No manufacturer was called upon to engineer as many unique capacitor types for war equipment as was Sprague. The Type 68P Midgets are the first of these to be converted for everyday service and amateur radio use. Many more are coming.

Look to Sprague for the newest—and the best!

FOR SALE—Hallcrafters SX-16 less speaker with new tubes. Perfect condition. Leon D. Held, W1KLD, 3047 Brighton, 14th Street, Brooklyn 24, N. Y.

WANTED—BC610 or HT9 transmitter or any similar type. Describe fully. Edward M. Muska, P. O. Box 425, Iselin, N. J.

WANTED—Medium Power transmitter either Meissner 150B, HT-O or any others. Carl J. Ruh, Amsterdam Road, R #2, Ludlow, Ky.

SELL OR TRADE—Portable radio, \$15; 12" dynamic, \$5; 8" dynamic, \$3. Used about 3 months. 1A7—1N5, 60c; 1D8, \$1; 117L7, \$1.25; 2 transformers \$1.50 ea. 6.3v. 700 plate. Norman Crawford, 2054 Franklin #2, Toledo, Ohio.

WANTED—Ham gear: various meters, transformers, etc. Also beam rotator and indicator. What have you? Eddie Howell, 501 W. Harden Street, Graham, N. C.

SELL OR TRADE—Pair 807's, National HHO dial and gear assembly, six tube 1.4v superher (Lucy) 2-12 mc. Want plate transformer 1000 to 1400v d-e @ 200 mills, filament transformer 10v @ 4 amps. R. A. Williams, W6UYF, 1616 Ohio St., Redlands, Calif.

SELL OR SWAP—450-watt C.W. rig ECO, 807, PP-40's, 3 power supplies, coils up to ten meters. Need ham receiver, camera, or what have you? Fred Hinson, 118 West Broadway, Elk City, Okla.

FOR SALE—RC-348-Q receiver converted to 115v a-c with speaker and 10 meter converter in matching black wrinkle cabinets, complete with tubes. \$75. C. L. Nelson, W7FPM, 1207 Lincoln Drive, Grand Forks, North Dakota.

WANTED—Xmitter, CW/tone, semi-portable with or without power supply. Must cover 80, 40, and 20 meters. State price. Cash. RDO VQ2AR, care D. R. Walker, 204 Elm Road, Inwood, Long Island, N. Y.

FOR SALE—Model SA-3, Type T-200 panorama scope. Excellent condition. \$70. Also 2-meter coaxial line HY-75 oscillator. \$15. G. R. Bachand, 32 Fremont St., Bloomfield, N. J.

SELL OR TRADE—Hallcrafters S-20-R. Fine condition, all new tubes, \$50 or will trade with cash for HQ 120-129 or similar receiver. J. Dubinsky, W2LVR—3404 Astoria Blvd., Jackson Heights, Queens, N. Y. C.

FOR SALE—New RC-610E, complete with speaker amplifiers. Modified for 10 meters, \$720. W7IVH, Box 383, Kirkland, Wash.

WANTED—Stancor model 110C, 60N, or 69 transmitter in kit form or wired, cash. Have for sale instructor graph, Jr. with built-in osc. Morse tapes, \$25. Will swap Weston 3" 0-5 amp. R.F. meter for 3" 0-250 d-c meter or what have you? John C. Bouse, W2PGE, 13 Ardley St., Kingston, N. Y.

FOR SALE OR TRADE—12 each following tubes: 12SR7, 12SR7, 12K8, 1629, 12AB, 1YR-150-30. Need several 6SK7, 6XQ7 or what have you? A. L. Oliveira, W1PWJ, 94 Potomaska St., New Bedford, Mass.

FOR SALE—3 home-built Hi-Fi amplifiers, 14-watts output, 2 amplifiers assembled only. Also many new tubes, transformers, chokes, 3 Jensen speakers, sound cabinet, 1 AM tuner and 1 FM Motorola tuner, old band. Asking fraction of cost; giving up hobby. Paul Stieglitz, 4155 Broadway, New York 33, N. Y.

WANTED—HT-9 Hallcrafters transmitter in good condition. State price. Paul F. Graves, W1JIF-WDIR—65 Adam Street, Hartford, Conn.

WILL TRADE—Abbott 2 meter TR-4 transmitter-receiver complete with tubes. Need 2 6" trumpets or what have you in equipment? Julius H. Pilger, 22-11 120th St., College Point, Long Island, New York, N. Y.

FOR SALE—Hallcrafters S-20R Sky Champion communication receiver, one of last sold. Perfect condition. Bill Lamp, Box 171, Jackson, Tenn.

WANTED—Used S-20R or other good communications receiver. Will pay cash. Russell Thompson, 8 E. Morgan Street, Shawnee, Okla.

WILL TRADE—New Kodak bantam, anastigmat special f/4.5 lens stops down to f/16. Focuses 2 1/2 ft. to inf., shutter speeds 1/25, 1/50, 1/100, 1/200 sec., time and bulb exposures. Bud C/O Code practice osc. Want commercial built ECO, George Alich, 339 1/2 E. Winifred, St. Paul, Minn.

FOR SALE—New Navy RAK-7 low-frequency receiver, power supply, tubes in original case—\$37. RCP multimeter, model 414, perfect condition, \$30 prepaid. Wm. D. Beal, Jr., W1PNR, 37 Circuit Road, Chesnut Hill, Mass.

SWAP—Nearly new Oahu electric Hawaiian guitar, case etc. less amplifier for RME69 or Bietlink 12 RCUR, Arthur Filkins W2ISX, Box 13 Fy Creek, N. Y.

WANTED—Xmitter 25 to 100 watts. Must be compact, phone /CW and complete for all band operation. S/SGT Donald B. Rogers, 60th A.A.C.S. Group, APO 863, c/o Postmaster New York, N. Y.

FOR SALE—Meek T60 Transmitter in perfect condition, \$100. Used four weeks. Shelly Meyerson, W2SIQ, 3831 Cannon Place, Bronx 63, N. Y.

FOR SALE—QST's, 1932 to 1946 inclusive in binders, \$4 per year. Proceedings of IRE 1939-1946 inclusive \$6 per year. Sell in series only. C. A. Draper, W8KLF, 1273 Andrews Ave., Lakewood, Ohio.

WANTED—Wire recorder unit with playback, coils and motor. Bob Creason, Ehfanna, Okla.

FOR SALE—2-meter Avradio transmitter-receiver. 20-watts, 6-volt vibrator power supply. Ideal for amateur mobile use, \$55. W0JVI, G. Petersen, 610 Brown Street, Pueblo, Colo.

FOR SALE—Transmitter, Meissner 150-B, 150-watts on fone and CW. Used 3 hours, excellent condition, complete with tubes, coils ECO, key mike and manual. \$225. W2RLM, Don Reiser, 2709 Edgenere Ave., Far Rockaway, N. Y.

SELL OR TRADE—Master teleplex with extra tapes. Want sky buddy, 50R or similar small receiver or what have you? W5KUG, 2504 Music Street, New Orleans 17, La.

WANTED—Recording lathe for 16" turntable; power transformer 400 m.a. at 2,500v and a 60-cycle, 1000-watt, R.V. generator. Fred Olinger, 46 Gahl Terrace, Cincinnati 15, Ohio.

FOR SALE—Millen ether foundation unit chassis, \$10. M. Bardfield, 4 Brinsley St., Dorchester, Mass.

SELL—Speed-x chrome bus, \$8.00; Weston 0-100 Thermo-galvanometer, \$10. Advance type 400, 110v a-c relay, \$4, SW3—4 sets coils, phones, \$12. W9KHF, 912 W. 151st St., East Chicago, Ind.

YOUR OWN AD RUN HERE FREE

The Sprague Trading Post is a free advertising service for the benefit of our radio friends. Providing only that it fits in with the spirit of this service, we'll gladly run your own ad in the first available issue of one of the six radio magazines in which this feature appears. Write CAREFULLY or print. Hold it to 40 words or less. Confine it to

radio subjects. Make sure your meaning is clear. No commercial advertising or the offering of merchandise to the highest bidder is acceptable. Sprague, of course, assumes no responsibility in connection with merchandise bought or sold through these columns or for the resulting transactions.

Send your ad to Dept. RN-87

SPRAGUE PRODUCTS COMPANY
NORTH ADAMS, MASS.

(Jobbing distributing organization for products of the Sprague Electric Co.)

ASK FOR SPRAGUE CAPACITORS and *KOOLOHM RESISTORS by name!

* Trademark Reg. U.S. Pat. Off.

RADIOMEN'S HEADQUARTERS * * * WORLD WIDE MAIL ORDER SERVICE !!!

BC-947A ONE KILOWATT HIGH FREQUENCY TRANSMITTER

This relay-controlled transmitter includes a 115V, 60 cycle power supply, protected by 3 magnetic circuit breakers, that alone is worth more than the price we are asking for the whole rig, even on today's surplus market. On the front panel are six 3 1/2" GE or Weston meters, including 250 MA, 50 MA, 1000 MA, 150V AC, and 1500V DC at 1000 ohms per volt for screens and plate. The rack-type 21"x15"x36" unit contains six amplifier and rectifier tubes aggregating over \$60.00 at WAA current wholesale prices. Western Electric's price to the government was \$1500.00. Shipping weight 500 lbs. Your cost, as is, only \$69.95.

ARMY BC 312 COMMUNICATIONS RECEIVER

This receiver covers the frequency range of 1.5 MC to 18 MC in six direct reading bands. The dial, that is driven with split gears to prevent backlash, has 4500 logging divisions per band with approximately 600 divisions on the 20 and 40 meter ham bands and 1000 divisions on 80 meters. Two stages of RF before the converter in this set give it a very high signal to noise ratio and maximum sensitivity. Outstanding features of this receiver are: BFO with pitch control, send-receiver relay, jacks on the front panel for headphones and speaker output and mike and key input, all tubes are standard 6 volt types. This receiver was designed to withstand rough usage in the field and for operation from vehicles while in motion, so it is ruggedly constructed and contains a dynamotor power supply.—Your cost \$49.95. Conversion kit to 110 VAC is available for \$6.50.

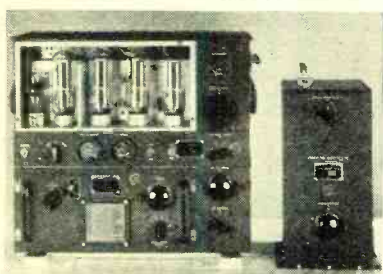

GENERAL ELECTRIC 150-WATT TRANSMITTER

Cost the Government \$1800.00
Cost to you \$44.50!!!

This is the famous transmitter used in U. S. Army bombers and ground stations, during the war. Its design and construction have been proved in service, under all kinds of conditions, all over the world. The entire frequency range is covered by means of plug-in tuning units which are included. Each tuning unit has its own oscillator and power amplifier coils and condensers, and antenna tuning circuits—all designed to operate at top efficiency within its particular frequency range.

Transmitter and accessories are finished in black crackle, and the milliammeter, voltmeter, and RF ammeter are mounted on the front panel. Here are the specifications: **FREQUENCY RANGE:** 200 to 500 Kc and 1500 to 12,500 KC. (Will operate on 10 and 20 meter band with slight modification.) **OSCILLATOR:** Self-excited, thermo compensated, and hand calibrated. **POWER AMPLIFIER:** Neutralized class "C" stage, using 211 tube, and equipped with antenna coupling circuit which matches practically any length antenna. **MODULATOR:** Class "B"—uses two 211 tubes. **POWER SUPPLY:** Supplied complete with dynamotor which furnishes 1000V at 350 MA. Complete instructions are furnished to operate set from 110V AC. **SIZE:** 21 1/2" x 23 x 9 1/4" inches. Total shipping weight 200 lbs., complete with all tubes, dynamotor power supply, five tuning units, antenna tuning unit and the essential plugs. These units have been removed from unused aircraft and are guaranteed to be in perfect condition.

GENERAL ELECTRIC RT-1248 15-TUBE TRANSMITTER-RECEIVER

TERRIFIC POWER—(20 watts) on any two instantly selected, easily pre-adjusted frequencies from 435 to 500 Mc. Transmitter uses 5 tubes including a Western Electric 316 A as final. Receiver uses 10 tubes including 955's, as first detector and oscillator, and 3 7HT's as IF's, with 4 slug-tuned 40 Mc. IF transformers, plus a 7HT, 7E6's and 7F7's. In addition unit contains 8 relays designed to operate any sort of external equipment when actuated by a received signal from a similar set elsewhere. Originally designed for 12 volt operation, power supply is not included, as it is a cinch for any amateur to connect this unit for 110V AC, using any supply capable of 400V DC at 135 MA. The ideal unit for use in mobile or stationary service in the Citizen's Radio Telephone Band where no license is necessary. Instructions and diagrams supplied for running the RT-1248 transmitter on either code or voice, in AM or FM transmission or reception, for use as a mobile public address system, as an 80 to 110 Mc. FM broadcast receiver, as a Facsimile transmitter or receiver, as an amateur television transmitter or receiver, for remote control relay hook-ups, for Geiger-Mueller counter applications. It sells for only \$29.95 or two for \$53.90. If desired for marine or mobile use, the dynamotor which will work on either 12 or 24V DC and supply all power for the set, is only \$15.00 additional.

6-BAND COMMUNICATIONS RECEIVER BC-348

Featuring coverage from 200 to 500 Kc. and 1500 to 18000 Kc. on a direct reading dial with the finest vernier drive to be found on any radio at any price—high sensitivity with a high degree of stability—crystal filter—BFO with pitch control—standard 6 volt tubes. Contains a plate supply dynamotor in compartment within the handsome black crackle finish cabinet, the removal of which leaves plenty of room for installation of a 110V, 25 or 60 cycle power supply. These receivers, which make any civilian communications receiver priced under \$200.00 look cheap and shabby by comparison, are only \$44.50. Power supply kit for conversion to 110V, 25 or 60 cycle, is only \$8.50 additional.

AIRCRAFT AMPLIFIER C1—This unit is housed in an aluminum case that is 9x8x7 inches and contains 1-7Y4, 3-7N7, 3-7F7 and six 5000 ohm sensitive relays. This unit is brand new and in its original packing—\$9.95.

BC-654 TRANSMITTER-RECEIVER—Brand NEW with 17 tubes, key, microphone and calibrating crystal—\$39.95.

C-144 Transmitter, 2 type 826 tubes as oscillator in lecher line tuning circuit that resonates between 150 and 200 megacycles contains 3 DC power supplies that operate from 110v 60 cycles. This unit is easily converted to the 2 meter ham band, may be neutralized and operated as a high power final amplifier. Your cost—\$49.95.

Minimum order \$3.00—All prices subject to change.—25% deposit with C.O.D. orders

SERVICEMEN

Check This Column for Lowest Prices on Quality Parts

TUBES: all types in stock, 60% off on all tubes if ordered in lots of 10 or more.

POWER TRANSFORMERS—Half-shell type, 110V 60 cy. Centertapped HV winding. Specify either 2.5 or 6.8 filament when ordering.

For 4-5 tube sets—850V, 40MA, 5V & 2.5 or 6.3V.....\$1.49
For 5-6 tube sets—850V, 45MA, 5V & 2.5 or 6.3V..... 1.75
For 6-7 tube sets—875V, 50MA, 5V & 2.5 or 6.3V..... 1.90
For 7-8 tube sets—700V, 70MA, 5V & 6.3 or two 2.5... 2.35
For 8-9 tube sets—700V-90MA: 5V-3A; 2.5V-3.5A; 2.5-10.5A..... 2.85

For 11 tube sets—100V, 100MA, 5V & 6.3 or 6.3V-4A... 2.85
For 9-15 tube sets: 600V, 150MA, 5V & 6.3V..... 2.95

TRANSFORMERS—All types in stock. **AUTO-TRANSFORMERS;** Steps up 110v to 220v, or steps down 220v to 110v—\$1.95. **FIL. TRANS.:** 6.3v, 8 Amps.—\$1.98; 5v, 10 Amps.—\$1.98; Universal Output Trans. 8 Watt—89c; 18 Watt—\$1.29; 30 Watt—\$1.69. **AUDIO TRANSFORMERS:** S. Plate to S. Grid 3-1—79c; S. Plate to P.P. Grids—79c; Heavy Duty Class AB or B. P.P. inputs—\$1.49; Midget Output for AC-DC sets—69c; **MIKE TRANSFORM** for T-17 Shure microphone, similar to UTC oncer type—\$2.00.

CONDENSERS—**PAPER TUBULAR** 600 WV—001; .002; .005—8c; .01; .05—9c; 1—10c; .25—23c; .5—36c; **ELECTROLYTICS:** 8mfd 200v—20c; 10mfd 35v—20c; 30mfd 150v—23c; 20/20mfd 150—35c; 30/20 150v—46c; 50mfd 150v—43c; 8mfd 475v—34c; 16mfd 350v—65c. **OIL CONDENSERS:** 4mfd 600v—49c; **BATH TUB TYPE CONDENSERS:** 3X 1mfd—20c. **RESISTORS:** All types in stock at the lowest prices; Resistor Kits—100 2 watt resistors—\$1.95.

FILTER CHOKES: 200, 300, 400, 500 ohm light duty—59c; 200 or 300 ohm heavy duty—99c; 250 ma 35 ohm, made for U.S. Navy, fully shielded—\$1.95; 75 ohm 125 ma—25c or 25 for \$4.25; "Meissner type" tapped filter chokes—25c; 8 amp. iron core A filter—25c; Choke-condenser combi. for ideal to replace any size speaker field when installing PM speakers—79c.

110 V. CIRCUIT BREAKERS of Magnetic type: Following Current Ratings in Stock: 1, 2.5, 3, 4, 8 Amps. Please Specify. \$1.95 each.

Seven Assorted I.F. Transformers—\$1.98; Five Ass'd. Oscillator Coils—69c.

SPEAKERS-PM dynamic type-4"—\$1.55; **5"**—\$1.55; **6"**—\$1.95; **8"**—\$3.95; **10"**—\$5.95; **12"**—\$7.50.

HEADPHONES—Highest quality Signal Corps headsets with 12" cord and plug \$1.25. 5' rubber covered patchcords with phone plug & socket—45c.

SELENIUM RECTIFIERS—Dry disc type 1 1/4" by 1". 1.2 Amp. maximum, suitable for converting DC relays to AC. For supplying filament source in portable radios, converting DC meters to AC applications, and also may be used in low current chargers—90c.

METER RECTIFIERS—Full wave, may be used for replacement, or in construction of all types of test equipment—\$1.25. Half Wave—90c.

LINE FILTERS—110V—each unit contains two 2 mfd. oil filled condensers and a 15 amp. iron core choke. This filter has innumerable uses such as oil burner line filter, etc. A ten dollar value for 98c.

WILLARD rechargeable 2v storage batteries for portable radios or any other purpose—\$2.95.

PUBLIC ADDRESS AMPLIFIERS—25 watts peak output. This unit has separate input circuits for microphone and phono. The gain of the microphone circuit is 122 db. The phono circuit has a gain of 82 db. The frequency response is flat from 50 to 12000 cycles. A \$65 value for only \$32.

Miniature pliers set contains one of each of the following: Needle nose, flat nose, parrot nose, standard nose. All contained in a leatherette case. Your cost—\$1.98.

ATR battery eliminator. Handy for servicing car radios or any other purpose requiring 6 or 12v at 14 amps. Net price—\$36.00.

SOCKET WRENCH SET consisting of 5 sockets ranging in size from 3/16 to 3/4" and a handle—79c.

AUTOMATIC WIRE STRIPPERS will strip up to 1000 wires per hour, a handy tool for any service job—\$3.52.

Six Foot Asbestos Insulated Flat Iron Cords, one end has a male plug, the other end has a standard flat iron socket. Your price—70c each or 10 for \$5.

SPECIAL! THIS MONTH ONLY. A FREE CRYSTAL PICK-UP WITH THE PURCHASE OF EACH PHONO MOTOR AT \$4.95.



MICROPHONES—All nationally known brands. Bullet—\$5.45; Bullet Dynamic—\$7.45; Mike Jr.—\$6c; Handy Mike—\$9c; Large Mike—\$9c; SHURE T-17 MIKES, with push to talk switch—99c.

50 ASSTD COIL FORMS, including 11 ceramic, 3 polystyrene, and 8 fiber, all useful sizes—50c.

VARIABLE CONDENSERS: 350 MMFD, 5 Rang—\$1.95; 4 Rang—\$1.49; 3 Rang—83c; 2 Rang—79c; 7.5 to 20 MMFD, 1750v spacing; extra long shaft Hammarlund—65c; miniature variables—25 MMFD—39c; 50 MMFD—46c; 75 MMFD—49c; 100 MMFD—69c; 140 MMFD—79c.

TRANSMITTING RF CHOKES, 4 PIE, 350 Ma.—25c or 5 for \$1.00.

INTERRUPTION FREQUENCY COILS for super-regenerative receivers or the tremendously popular FM adapters for standard broadcast sets. Iron core with a resonant frequency of 50 KC—39c; Air Core, 100 KC—29c.

30 MC IF TRANSFORMERS, double slug tuned—25c.

VIDEO AMPLIFIER PLATE COILS—Slug Tuned—25c.

REMOTE CONTROL UNIT: Aluminum case 4x3x2" containing 2 potentiometers, triple pole switch, 4 knobs. Rear mechanism, counter and phone jacks—59c.

MODULATION TRANSFORMERS: 10 watt, metal case—98c; 30 watt, open type—\$1.95; 40 watt, cast aluminum case—\$2.95; Class "B" input transformers, cast aluminum case—\$1.95; Transceiver audio transformers—65c; Transceiver modulation transformers—65c.

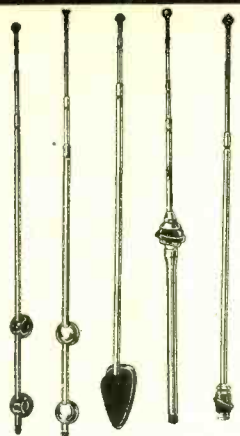

BR1 BR2 BR3 BR4 BR5

**INTRODUCTORY OFFERING OF OUR OWN BRAND
CAR RADIO ANTENNAS**

All of our car radio antennas are made of triple plated Admiralty Brass Tubing, complete with low loss shielded antenna leads and have high quality fittings.

SIDE COWL—BR-1, 3 sections extend to 66". Your price—single units—\$1.50; in lots of 12—\$1.35 ea.

SKYSCRAPER—BR-2 has 4 heavy duty sections that extend to 98". Your price—single units—\$2.45; in lots of 12—\$2.25 ea.

TILT ANGLE—BR-3, may be adjusted to all body contours. 3 sections extend to 66". Single unit price—\$1.50; 12 lot price—\$1.35 ea.

VERSATILE—BR-4, single hole fender or top cowl mounting may be adjusted to conform with all body contours. 4 sections extend to 56". Single unit price—\$2.90; 12 lot price—\$2.75 ea.

THE MONARCH—BR-5, single hole top cowl mounting, 3 sections extend to 56". Single unit price—\$1.90; 12 lot price—\$1.75 ea.

PE-109 32-VOLT DIRECT CURRENT POWER PLANT

This power plant consists of a gasoline engine that is direct coupled to a 2000 watt 32 volt DC generator. This unit is ideal for use in locations that are not serviced by commercial power or to run many of the surplus items that require 28-32 V. D.C. for operation. The price of this power plant is only \$100. We can also supply a converter that will supply 110v AC from the above unit or from any 28-32v DC source for \$29.95.

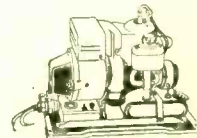

**AT LAST YOU CAN AFFORD A LABORATORY STANDARD
SIGNAL GENERATOR**

The famous Measurements Corp. Model 78B, 5 Tube Laboratory Standard Signal Generator (currently selling new, FOB Boonton, N. J., for \$310.00 net), is available in perfect condition for 25 to 60 cycle, 115 V AC operation. Until now this is the sort of top-flight lab equipment that discriminating buyers have only vainly hoped would be released at a bargain price. Worth every cent the manufacturer asks, but available FOB Buffalo while our limited supply lasts, for only \$99.95.



Model 78-B Standard Signal Generator. Two Frequency Bands between 15 and 250 megacycles.

"REMEMBER THAT A STANDARD IS ONLY AS RELIABLE AS ITS MAKER."

LORAN INDICATOR OSCILLOSCOPE, complete with 26 tubes and a 5" cathode ray tube—\$39.95.
5" SO RADAR PPI OSCILLOSCOPE, complete with 9 tubes. This unit contains magnetic deflection yokes and a Selsyn motor—\$39.95. **SO RADAR ECHO BOXES, THE PERFECT CALIBRATED CAVITY WAVEMETER**—\$10.00.
RADAR RANGE UNIT contains a three stage high gain, high fidelity, amplifier and a Helmholtz coil for manually introducing phase shift from 0° to 360°. Contains four tubes and a 110v. 60 cps. power supply. Your cost, \$19.95.
MC 363A RANGE CONVERTER containing 20 tubes, servo motor, oscillator, motor field amplifier, isolating amplifier with three stages, 3 stage summing amplifier, 2 stage preamplifier, control amplifier including band shaping motor supply network to improve servo motor operation, and high current, regulated power supply, similar in construction to the well-known RA57A power unit. Govt. cost \$2000—only—\$39.95.
SCR 610 VOICE TRANSMITTER-RECEIVER ready to operate 10 meter mobile with the addition of a crystal of the proper frequency—only \$49.95.

BENDIX SCR 522—Very High Frequency Voice Transmitter-Receiver—100 to 156 MC. This job was good enough for the Joint Command to make it standard equipment in everything that flew, even though each set cost the Gov't. \$2500.00. Crystal Controlled and Amplitude Modulated—**HIGH TRANSMITTER OUTPUT** and 3 Microvolt Receiver Sensitivity gave good communication up to 180 miles at high altitudes. Receiver has ten tubes and transmitter has seven tubes, including two 832's. Furnished complete with 17 tubes, remote control unit, dynamotor and Ant.—\$37.95. Furnished complete with 17 tubes, remote control unit, 4 crystals, 24 volt dynamotor and the special, wide band VHF antenna that was designed for this set. These sets have been removed from unused aircraft and are guaranteed to be in perfect condition. We include free parts and diagrams for the conversion to continuously variable frequency coverage in the receiver. The cost of this unit is only \$37.95. A brand new 12V. 522 dynamotor is available for \$3.00 additional, with the purchase of a 522, or separately for \$15.00.

SCR-274N COMMAND SET

The greatest radio equipment value in history.

A mountain of valuable equipment that includes 3 receivers covering 190 to 550 KC; 3 to 6 MC; and 6 to 9.1 MC. These receivers use plug-in coils, and consequently can be changed to any frequencies desired without conversion. Also included are two Tuning Control Boxes; 1 Antenna Coupling Box; four 28 V. Dynamotors (easily converted to 110 V. operation); two 40-Watt Transmitters including crystals covering 3 to 4 MC and 4 to 5.3 MC; and Preamplifier and Modulator. 29 tubes supplied in all. Only a limited quantity available, so get your order in fast. Removed from unused aircraft and in guaranteed electrical condition. A super value at \$29.95, including crank type tuning knobs for receivers.

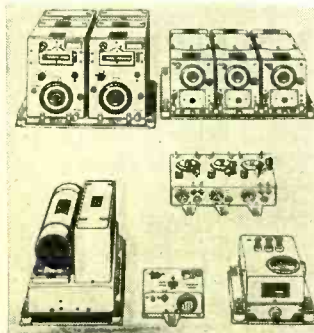

Minimum order \$3.00 - - - All prices subject to change - - - 25% deposit with C.O.D. orders

BUFFALO RADIO SUPPLY, 219-221 Genesee St., Dept. 8N, BUFFALO 3, N. Y.
CABLE ADDRESS BUFRAD

**HAMS! HERE'S THE
BEST CONVERTER BUY
ON THE MARKET...**

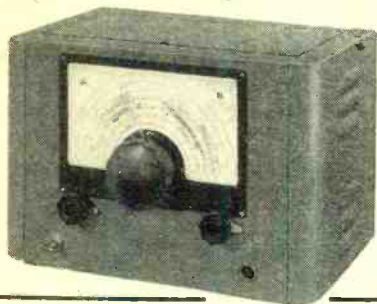

Kit or Completely Assembled

Lafayette CONVERTER

For 6, 10 and 11 meters

Frank Lester, famed W2AMJ, back in charge of ham radio at Lafayette comes through with a great ham innovation that you'll want right now!

Designed to operate directly from 105-125 volt 60-cycle A-C source, this converter uses the new selenium rectifier and three new-type miniature tubes. One 6BA6 as tuned R-F stage—one 6BE6 as mixer—one 6C4 as H-F oscillator. Single-dial tuning for controlling H-F oscillator—separate control for R-F stage. This feature eliminates tracking error. Mixer gain may be varied by separate bias control, thus permitting optimum signal-to-noise ratio regardless of receiver used. Stand-by switch controls both converter and receiver. Plug-in coils employed for all bands, one set to cover 50 to 54 mc range and another to cover from 27.180 to 29.7 mc. Output transformer adjustable from 4.7 to 6.5 mc. Kit comes complete with punched chassis, panel and cabinet as well as all parts for one band and complete instructions, less tubes. Gray crinkle cabinet 8" x 12" x 8". Shpg. wt. 15 lbs.

- K10454—Converter kit, less tubes—Your Cost only\$34.50
- K21000—Tubes for converter—Your Cost only 3.00
- K10456—Converter completely assembled, wired and tested with coils for 6, 10, 11 meter operation, including all required tubes—Your cost only 49.50

**WIRED CONVERTER SOLD ON
10 DAY MONEY BACK GUARANTEE!**

Write today for our big, new 144-page catalog—it's chock full of everything you want in radio and electronics. Ask, too, for flyer C-39 with its up-to-the-minute news on ham bargains.

Lafayette Radio

(RADIO WIRE TELEVISION, INC.)

100 Sixth Ave. 110 Federal St. 24 Central Ave.
New York 13, N. Y. Boston 10 Newark 2, N. J.

the 1947 Edition (revised); price is 61 cents (American) each; if anyone cares to send one dollar (either by International Money Order or a one-dollar bill), we will send him a copy of the Annual; a year's enrollment in the ISWL; and a sample copy of *Short Wave News*."

* * *

Club Notes

Finland—HESA is the name of a new radio club in Helsinki; officers are Wolf von Harpe, president; Martti Lindberg, secretary; Tor-Bjorn Falck, treasurer. The group is composed chiefly of students "who now have more time for DX-ing during vacation," Mr. von Harpe writes.

Germany—Borst Miers, Berlin, informs us that there are now two radio clubs in Germany—WBRC in the American Zone; and the Arbeiter Radio-Bund in the British Zone. Another club, HRC, is to be founded shortly in the American Zone, while another group, NRAC, is to begin functioning soon in the British Zone. "There are no amateur clubs in Berlin," Mr. Miers writes. "Unfortunately, all unpolitical societies are prohibited here."

* * *

This Month's Schedules

Albania—ZAA, 7.852, Tirana, 1300-1630, except Wednesday when carries additional French period to 1645. (Pearce)

Algiers—Relay of "The Voice of America in North Africa" ceased operations on June 1. (Shore) THA, 12.116, operates 0045-0545. (BSWL) French outlet on 11.835 has news in French at 0130. (URDXC) Heard signing on in French at 0129 with fine level. (Harrison)

Anglo-Egyptian Sudan—Radio-Omdurman is inaudible in New York now daytime; heard yet is the 2310-2345 transmission on 9.65 and 13.32, latter with bad QRM. (Beck) The *English* period on these frequencies is now Fridays, 1230-1300. (Pearce-Gillett)

Angola—A letter received by Mervyn Laubscher, South Africa, from Radio Clube de Malanje, Caixa Postal 83, Melanje, Angola, lists call of CR6RE, 7.14 (41 m.), power of 50 watts; scheduled weekdays, 0700-0745, 1430-1530, Sundays, 0200-0300, 0730-0830. "Our transmitter was constructed by amateurs and operates from 100 volt a.c. supply. A shortage of material does not permit us to improve our radiation and modulation conditions, while lately we have been trying to overcome certain faults due to a shortage of 8- and 12-microfarad condensers which we are unable to obtain on the market. Also, we do not have a good pick-up and we have noted a distortion of the bass notes." Laubscher says frequency has drifted to about 7.165. If anyone is lucky enough to pick up CR6RE, an IRC should be sent with report.

Laubscher reports that some time ago at 1400, during a break in the amateur QRM in the 41-m. band, he heard an announcement in Portu-

guese, mentioning "CR6AA." CR6AA is listed as Robito, Angola, on a frequency of 7.177; has been reported "inactive" for some time, but may be back on schedule.

Australia—Radio Australia's "evening" beam to Eastern North American is now carried 1900-2015 over VLC, 15.200, while VLA10, 17.84, is used in dual but beamed to South America. News at 1930. The 15.200 channel has a nice signal in West Virginia while VLA10 (100 kw.) is buried beneath Moscow which recently sat down on about (unannounced) 17.839.

Austria—Latest list of short-wave transmitters operating in Austria is: Wien I, 300 w., 6.155; Wien II, 250 w., 7.175; Wien III, 250 w., 9.665; Wien IV, 11.785, all in Vienna. Sendergruppe West (French Zone), Dornbirn-Innsbruck, 200 w., 6.145 (a later report says back on 6.005). Sendergruppe Rot-Weiss-Rot (American Zone), 1 kw., 9.563. (Kary) The 9.563 one is scheduled 1015-1800 except Sundays when schedule is 0100-1800. (Radio Australia) Radio Wien lists this station as Salzburg-Linz-Vienna and on a frequency of 9.575. (Pearce)

KOFA, 7.22, Salzburg, heard with news at 0030 and 0500. (Harrison) Very strong signal in Britain at 0000. (Pearce)

Belgian Congo—Leopoldville's 17.77 appears scheduled 0500-0700 and to British Isles, 1530-1645, news at start. Radio Australia reports the 9.745 channel used 1030-2300. This one does beam to North America, 2100-2300, news at start and around 2245.

News has been heard on 17.77 at 1630-1643. (Sutton) May be on 1355-1645 in European beam. A late flash from Carl Beck, New York, says that recently 9.745 has been used again in (*English*) transmission beginning at 1530; may be back here again from around 1300 on.

Borneo—Pontianek, 6.650, reported 0800-0845. (URDXC)

Burma—Radio Australia gives Rangoon schedules for *English* periods as 2015-2045, 0115-0200, 9.543; 0840-1015, 6.035; news at 2030, 0130, 0845, 1010; on Mondays only *English* period is 0840-1015. (NOTE: It is possible these schedules have been set forward one hour for summer.)

Canada—Canada's International Service has been heard afternoons on 21.710. (Sutton) Call is listed as CHLA. Latest schedules at hand are: To Great Britain and Europe—CKNC, 17.82, 0900-1800 daily; CKCX, 15.19, 0900-1100 daily; CKCS, 15.32, 1105-1800 daily. To Caribbean and Latin America—CKNC, 17.82, 1820-1935 daily, 1820-2105 on Sunday; CKRA, 11.76, 1820-1935 daily, including Sunday.

Canary Islands—Radio Club Tenerife, 7.558, Santa Cruz de Tenerife, is heard well 1700-1801. (Sutton via NNRC)

Cape Verde Islands—Direct from the Director of Radio Club de Cabo-Verde, Praia, comes this data: "In (Continued on page 129)

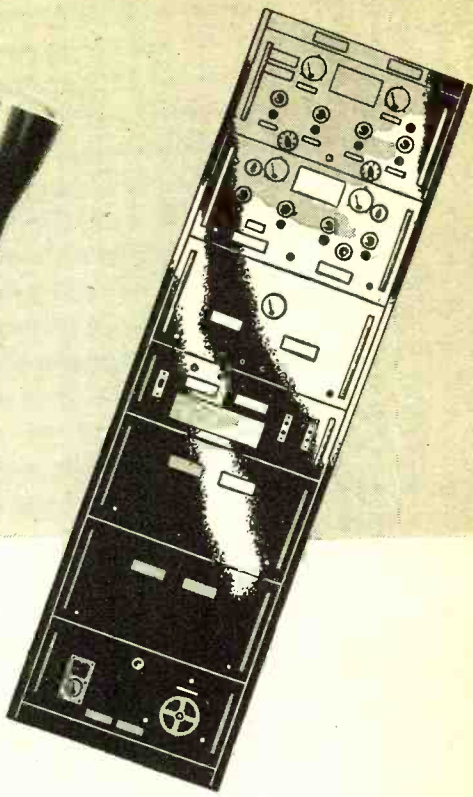
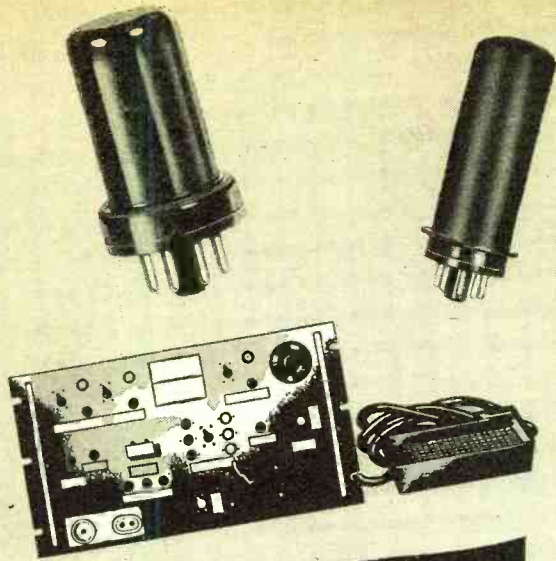

**SURPLUS
ELECTRONIC
EQUIPMENT**

**MANUFACTURERS
JOBBERS
WHOLESALEERS**

The War Assets Administration, through its network of Approved Distributors, is offering electronic tubes, devices and equipment which were declared surplus by the Armed Forces. Take advantage of this great opportunity to fill your present and future needs at fraction-of-cost prices. Most inventories still permit wide selection.

Purchasing of this equipment has been simplified to a high degree. The WAA Approved Distributors listed at right were appointed on a basis of their ability to serve you intelligently and efficiently. Write, phone or visit your nearest Approved Distributor for information concerning inventories, prices and delivery arrangements. You'll find you can "Save with Surplus."

OFFICE OF AIRCRAFT AND ELECTRONICS DISPOSAL

WAR ASSETS ADMINISTRATION



Offices located at: Atlanta • Birmingham • Boston • Charlotte • Chicago • Cincinnati • Cleveland • Dallas • Denver • Detroit • Fort Worth • Helena • Houston • Jacksonville • Kansas City, Mo. • Little Rock • Los Angeles • Louisville • Minneapolis • Nashville • New Orleans • New York • Omaha • Philadelphia • Portland, Ore. • Richmond • St. Louis • Salt Lake City • San Antonio • San Francisco • Seattle • Spokane • Tulsa

1282

- BOSTON, MASS.**
Automatic Radio Mfg. Co., Inc.
122 Brookline Ave.
Technical Apparatus Co.
165 Washington St.
- BUCHANAN, MICH.**
Electro-Voice, Inc.
Carroll & Cecil Sts.
- CANTON, MASS.**
Tobe Deutschmann Corp.
863 Washington St.
- CHICAGO, ILL.**
American Condenser Co.
4410 N. Ravenswood Ave.
Belmont Radio Corp.
3633 S. Racine Ave.
- EMPORIUM, PENNA.**
Sylvania Electric Products, Inc.
- FORT WAYNE, IND.**
Essex Wire Corp.
1601 Wall St.
- HOUSTON, TEXAS**
Navigation Instrument Co., Inc.
P.O. Box 7001,
Heights Station
- LOS ANGELES, CALIF.**
Cole Instrument Co.
1320 S. Grand Ave.
Hoffman Radio Corp.
3761 S. Hill St.
- NEWARK, N. J.**
National Union Radio Corp.
57 State St.
Standard Arcturus Corp.
99 Sussex Ave.
Tung-Sol Lamp Works, Inc.
95—8th Ave.
- NEW ORLEANS, LA.**
Southern Electronic Co.
512 St. Charles St.
- NEW YORK, N. Y.**
Carr Industries, Inc.
1269 Atlantic Ave.,
B'klyn.
Electronic Corp. of America
353 W. 48th St.
Emerson Radio & Phonograph Corp.
76—9th Ave.
General Electronics, Inc.
1819 Broadway
Hammarlund Mfg. Co., Inc.
460 W. 34th St.
Johanns & Keegan Co., Inc.
62 Pearl St.
Newark Electric Co., Inc.
242 W. 55th St.
Smith-Meeker Engineering Co.
125 Barclay St.
- NORFOLK, VA.**
Radio Parts Distributing Co.
128 W. Olney Road
- ROCHESTER, N. Y.**
W. & H. Aviation Corp.
Municipal Airport
- SALEM, MASS.**
Hytron Radio & Electronics Corp.
76 LaFayette St.
- SCHENECTADY, N. Y.**
General Electric Co.
Bldg. 267, 1 River Road
- WASECA, MINN.**
E. F. Johnson Co.
206—2nd Ave., S. W.

NEW BUD V.F.O.

COST TO
RADIO AMATEUR

\$52.50

Built to BUD
High Standards of Quality



1. Compact and entirely self-contained.
2. Stability comparable to crystal.
3. Plug-in coils for highest efficiency.
4. A dual purpose unit having V.F.O. operation, with provision for switching to crystal operation.

SEE IT AT YOUR
LOCAL DISTRIBUTORS!

BUD CAN SUPPLY ALL YOUR NEEDS!

... with the latest types of equipment including: condensers—chokes—coils—Insulators — plugs — jacks — switches —dials—test leads—jewel lights and a complete line of ultra-modern cabinets and chassis.



BUD RADIO, INC.

CLEVELAND 9, OHIO

What's New in Radio

(Continued from page 76)

proper tone compensation adjustments. The entire unit is housed in a two-tone leatherette carrying case which measures 15 $\frac{1}{8}$ "x17 $\frac{1}{8}$ "x9 $\frac{3}{4}$ ".

Additional information on this recorder may be secured from *Audar, Inc.*, Argos, Indiana.

NEW MONOSET

The new *Telex* "Monoset" unit recently announced by the *Electro-Acoustic Division of Telex, Inc.* features the addition of a volume control unit which will permit the user to control the tone level as desired.

The "Monoset," incorporates an under-chin type of construction which re-



sembles a doctor's stethoscope. It is lightweight and may be used wherever individual receivers are required. Removable, clear plastic eartips which can be easily cleaned make it practical for use in public installations such as hospitals, theaters, churches, and music stores.

The unit is also being used with electronic dictating machines which permits the stenographer to wear the headset without ear pressure or head fatigue.

Additional details of this new unit will be provided by the *Electro-Acoustic Division of Telex, Inc.*, Minneapolis, Minnesota.

BEAM ROTATOR

The *Rex L. Munger Company* of Chicago has recently announced the availability of a new "Electro-Beam Rotator" for amateur applications.

This remote-controlled, electric drive rotary beam, complete with direction indicator, has been designed to operate efficiently in any weather. The unit operates on 115 volt, 60 cycle current and uses heavy, cadmium plated steel gears and Oilite bearings. All of the steel parts are cadmium plated while the aluminum parts are anodized. Torque is adequate to turn ten meter beams. The indicator is calibrated in both degrees and direction and incorporates a fuse post, pilot light, "on-off" switch and a clockwise-counter clockwise switch with "off" position.

Full details and price will be furnished upon request to *Rex L. Munger Company*, 4701 Sheridan Road, Chicago 40, Illinois.

SOLDERING IRON STAND

A new soldering iron heat control stand, known as the "Tip-Saver," has been introduced to the radio service field by *Beyer Manufacturing Co.* of Omaha.

This unit adapts itself to fit all sizes and makes of irons by tilting slightly when the barrel of the iron is placed on the fins of the stand. The fins of the control stand absorb and radiate the excessive heat of the iron, maintaining a lower temperature at the tip when it is not in use and lying on the stand.

Beyer Manufacturing Co., 2866 Farnam Street, Omaha 2, Nebraska will supply additional details on the "Tip-Saver" upon request.

"FLASH-O-TEST"

Sterling Electronic Company of Pasadena, California has recently announced a new combined tester and flashlight, known as the "Flash-O-Test."

Designed to serve a double purpose, the new model enables the user to make simple and rapid continuity checks and when not used for this purpose the unit may be employed as a flashlight in test work.

Sterling Electronic Company, 166 N. Sierra Bonita Avenue, Pasadena 4, California will furnish additional details on this new product on request.

"THE COUPLATE"

Centralab, Division of Globe Union, has announced the first commercial application of the Printed Electronic Circuit—a new interstage coupling plate known as the "Couplate."

The "Couplate" is an integral assembly of two capacitors and two

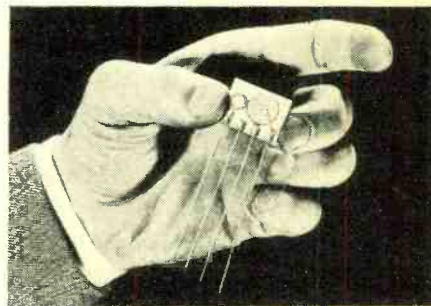

resistors closely bound to a steatite ceramic plate and mutually connected by means of metallic silver paths.

According to the manufacturer, the "Couplate" requires only four soldered connections instead of the usual eight or nine required to complete the coupling of two audio stages with standard components. This unit consists of a .01 μ fd. coupling condenser, a 250 μ fd. plate r.f. bypass condenser, a 250,000 ohm, 1/5 watt grid resistor, in a single assembly.

These component values were selected because they are suitable for

RADIO NEWS

Ready for you . . .

SURPRISE

TRADE-IN ALLOWANCES BY Walter Ashe



Your trade-in's worth more at the Walter Ashe Store. Yes, you'll be amazed at Walter Ashe's liberal allowances on your used Test

Equipment or Receiver. All the big-name brands in stock ready for your selection. Phone, wire or write today.

BRAND NEW ARMY SURPLUS KEY
Large Coin Silver Contacts. Bargain at **\$0.98**

SELSYN MOTORS
115 VAC 60 CY. Matched pairs, one transmitter, one repeater. Heavy brass case, exceptionally heavy duty type. No. 806, per pair. **\$12.50**

GOING, GOING FAST!
Just a few left, dynamotor power supply, type PE 103 500 VDC at 160 MA. 6 or 12 VDC input, BRAND NEW in original overseas shipping box **\$9.95**

BRAND NEW!
Throat mikes, 200 ohm carbon. In original box **\$0.35**

BRAND NEW!
T-17 hand mikes single button carbon. Push to talk. In original boxes. **\$1.49**

ICA 2 and 3 GANG VARIABLE CONDENSERS
No. 531. 2 gang 350 MMFD, per sec. **\$2.59**
No. 531. 3 gang 350 MMFD, per sec. **3.79**

ARMY SURPLUS HEADPHONES
BRAND NEW Army surplus phones. Type HS-23, 8000 ohm imp. Complete with leather headband and rubber cushions, in original factory boxes. **\$1.29**

MILLEN R9'er
Less tube with 10 Mtr Coil. **\$24.75**
8 or 20 Mtr. coil, E. **\$3.15**
6 AK5 tube for above. **\$0.90**

SOLAR POWER LINE FILTER
Rated 20 Amps 115 volts. **\$1.79**
As always, typical Walter Ashe Service and that means shipment the same day your order is received. Write today for your free copy of the Walter Ashe Bargain Flyer.

HI POWER FOTO FLASH KIT

THOROUGHLY PROVED AND TESTED

1. Uses AMGLOW 5414X 200 watt second flash tube.
2. Uses parallel bank condensers. 25% safety factor. No costly replacements.
3. Synchronizer adjustment control.
4. Light Weight. Heavy Duty. Army Surplus. High Voltage Transformer.
5. Unit can be fired every 3 seconds if necessary.
6. Neon bulb charge indicator.
7. 1/10,000 Second exposure.
8. Triggered by hand switch or synchronizer.
9. Sockets for connecting all cables.

Complete Kit including AMGLOW tube, carrying case, etc. with simple assembly and operating instructions. Price subject to change without notice. **\$77.50**

Write for detailed description and parts list.

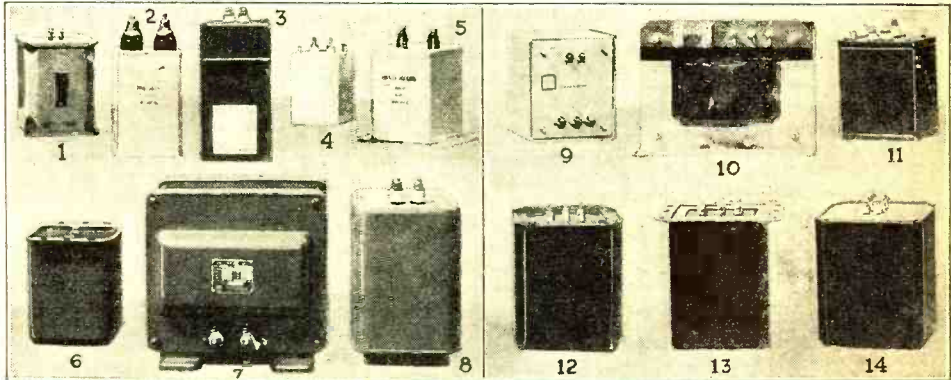

(1) FILTER CHOKE
12 Hy @ 200 MA. 200 ohms DC Res. Steel Case. **\$3.50**

(2) TRANSMITTING FILTER CONDENSER
2 Mfd. 5000 VDC, Dykanol, regular net price \$29.63. Our low down bargain price. **\$7.51**

(3) DUAL CHOKE
12 Hy @ 200 MA per section. 55 Ohms DC res. Steel case with stand-off insulators. No. 2785 **\$4.95**

(4) FILTER CHOKE
4 1/2 Hy. 150 MA. 70 ohms Res. DC. Hermetically sealed in case. Stand-off insulators No. 5209. **\$1.29**

(5) TRANSMITTING FILTER CONDENSER
2 Mfd. 4000 VDC. oil filled. Regular net price \$25.44. Our give away bargain price. **\$4.50**

(6) FILTER CHOKE
4 Hy. 300 MA. 40 ohms DC resistance. Hermetically sealed in case. screw terminals. No. 6317. **\$4.95**

(7) HIGH VOLTAGE FILTER CHOKE
6 Hy. at 1.2 Amps. 27 ohms. DC resistance. 12500 volt breakdown insulation. Shielded case and standoffs. No. 6813. A super buy at **\$17.95**

(8) FILTER CHOKE
8 Hy. at 500 MA. 55 Ohms DC res. Very high quality. Hermetically sealed. No. 8056. Net. **\$11.85**

(9) PLATE TRANSFORMER
2500 VCT, 150 MA. Pri. 115 VAC. 60 CY. Steel case with standoff insulators, No. 161919. **\$9.95**

(10) RCA 1 KW MODULATION TRANSFORMER
Primary will match class "B" tubes up to 10000 ohms plate to plate. Secondary No. 1, 450 MA for beam tube plate. Secondary No. 2, 80 MA for screen grid. **\$14.95**

(11) SCOPE TELEVISION TRANSFORMER
2100 volts at 10 MA. Pri 115 VAC, 60 Cy. Steel case with standoff insulator. No. ST. 1. **\$4.25**

(12) PLATE TRANSFORMER
2010 VCT 200 MA. Pri. 105-125 VAC 60 Cy. Steel case screw terminals. No. 8275. **\$9.95**

(13) PLATE TRANSFORMER
1400/1200 VCT at 200 MA. Pri. 115 VAC 60 Cy. Steel Case, screw terminals. No. 4891-N. **\$7.45**

(14) PLATE TRANSFORMER
1400/1200 VCT at 260 MA. Pri. 115 VAC 60 Cy. Hermetically shielded steel case, screw terminals. No. 8931. **\$7.95**

W0JWD W0WTM W0PGY W0ULH W9NRF W0QDF W0YID

Walter Ashe RADIO CO.
1125 PINE ST. • ST. LOUIS, MO.

TERMINAL has TELEKITS!

TELEKITS were designed by TELEVISION TRAINING INSTITUTE — America's foremost television specialists. Instructions furnished with each kit are complete in every detail—schematics, pictorial wiring diagrams, photographs and step-by-step instructions made easy by top-flight television experts!



**IN STOCK NOW!
SAME DAY SHIPMENT!**

You get the same detailed instructions followed successfully by thousands of students in the leading television schools who include these kits in their regular television training courses! It's fun learning television by building your own—and you save **PLENTY** at Terminal!

7" Electro-Tech TELEKIT

Advanced circuit uses only five control knobs for perfect picture and high fidelity F.M. sound. Complete with highest quality parts, pre-tuned I.F. coils, punched chassis, wire, hardware and simple instructions. Three fixed-tuned bands. Follow the clear, easy instructions—we guarantee performance!

#7 TELEKIT, less tubes & cabinet... **7750**

Complete kit of 17 matched tubes, including RCA 7GP4 7" picture tube **3995**

Cabinet for above, walnut finish..... **2250**

Front Panel only (not required if cabinet is ordered) **1000**

10" Electro-Tech TELEKIT

Incorporates the new TTI interlock circuit for flawless video reproduction. Features include 5 fixed-tuned bands, pre-tuned I.F. coils, 9500 volts power supply for 10" tube, two separate low voltage power supplies, high fidelity F.M. sound. Only five control knobs used. Complete with all parts, punched chassis, picture tube platform, wire, hardware and detailed instructions.

#10 TELEKIT, less tubes & cabinet **12450**

Complete kit of 19 matched tubes, including RCA 10BP4 10" Bright Picture tube **6535**

Cabinet for above kit, walnut finish..... **2950**

WE GUARANTEE PERFECT PERFORMANCE providing instructions are followed correctly! Telekit Service Labs in most principal cities.

If unable to visit our store, send us your mail orders with 25% deposit. Prices are F.O.B., New York.

TERMINAL RADIO CORP.

85 CORTLANDT STREET • NEW YORK 7, N. Y.

RADIO TUBES

For immediate shipment
R.M.A. Guaranteed
Below Distributor Costs
Individually Sealed Cartons

Type	Price
6K6GT	.40
6K5GT	.46
6V6GT	.46
6SA7GT	.46
6SJ7GT	.46
6SK7GT	.46
6SQ7GT	.46
6X5GT	.40
12SA7GT	.58
12SQ7GT	.46
12SK7GT	.46
12SJ7GT	.46
35L6GT	.40
35Z5GT	.32
50L6GT	.46

MANY OTHER TYPES AVAILABLE
RATED ACCOUNTS—2% 10 DAYS
ALL OTHERS 2% C.O.D.

10% DISCOUNT ON LOTS OF 50 OR MORE

RAVAC ELECTRONICS CORP.

432—4th Avenue
New York 16, N.Y.

SURPLUS SPECIALS

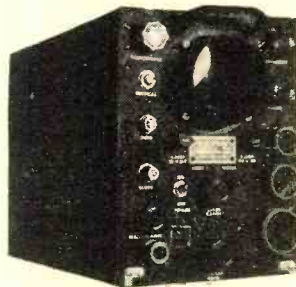

Cathode Ray Scope, 3" radar indicator ID-93/APG-13A, 115 volts 400 cps, 10 tubes plus 3" cathode ray tube. Power supply and sweep circuit need modification to make fine scope. New, made by G.E. **\$25.00**

METERS

- 0-1 Milliammeter, 3 1/2" round, Westinghouse, white scale reads 0-350 volts, new **\$ 3.50**
- 0-3 Milliammeter, 3" square, Triplett, white scale reads 0-3 ma., new **3.50**
- 1-0-1 Milliammeter, 3 1/2" round, Marion sealed meter, white scale reads 100-0-100, new **3.50**
- 0-200 Microammeter, 2 1/2" round Marion sealed meter, white scale reads 0-100, new **5.00**
- 0-1 Milliammeter, 3" square, white scale reads 0-1, 0-2.5, 0-5 ma., 0-500 volts, and 0-2.75 megohms, new **4.00**
- Dual 0-200 Microammeter, Westinghouse landing indicator, blank scale **3.50**
- 0-10 amps, 3" square meter, Triplett, white scale reads 0-10 amps, new **3.50**

OIL FILLED CAPACITORS

- 4 mfd 600 WVDC **60c**
- 1 mfd 2500 WVDC **\$1.50** G. E. Pyranol
- 2 mfd 4000 WVDC **5.00** G. E. Pyranol
- .15 mfd 4000 WVDC **1.50** G. E. Pyranol
- .05 mfd 2500 WVDC **.75** G. E. Pyranol
- .25 mfd 4000 WVDC **1.00** Sprague
- 1.1 mfd 600 WVDC.10 for 2.50
- .5, .5 mfd 600 WVDC.10 for 2.50
- 2 mfd 600 WVDC.10 for 2.50

MICAS

- .005 mfd 2500 WVDC **35c**
- Western Electric dry disc rectifier, 150 volts 50 ma **50c**

ELECTRO IMPULSE LABS.

P. O. Box 250 Red Bank, New Jersey

over 90 per-cent of the radio sets now in use and in present production.

Bulletin No. 943 which describes the features of the element is available upon request to *Centralab, Division of Globe Union, Milwaukee, Wisconsin.*

FREQUENCY STANDARD

Rogers Industries, Inc. are currently releasing their own new RFS-2 frequency standard which incorporates a crystal oscillator employing a precision, low-frequency drift 100 kc. crystal, an r.f. amplifier pentode, and a means of adjusting the frequency to exactly 100 kc. by zero-beating with Station WWV.

The unit is furnished complete and ready for installation in the receiver. Color-coded leads provide easy connection to the receiver's power supply.

Full details, including specifications and price, will be furnished by *Rogers Industries, Inc., Communications Division, 49 Bleecker Street, New York 12, New York.*

A Two-Tube Intercom

(Continued from page 55)

the scope. The v.t.v.m. should measure .38 volt r.m.s. when connected across R_1 and should read 15 volts when connected across C_6 , representing a total gain of 1500 for the amplifier. Readers owning oscilloscopes and desiring to check the amplifier for distortion, may proceed as follows:

With the X axis connected internally, connect the input of the Y axis amplifier across the grid resistor R_2 to which is connected the audio signal generator output. Adjust the output of the generator to .01 volt and increase the Y axis gain. A perfect sine wave should be seen on the screen—if not, distortion in the generator is present. Bear in mind that a Class "A" amplifier should reproduce faithfully the wave applied to the input.

Assuming a pure sine wave, connect the scope across R_1 . A wave of the same shape as the input wave should be seen, but its amplitude should be 38 times greater, showing gain in the first stage. The input to the Y axis should be transferred to the plate of the 50L6 in order to view the output of the 50L6. The amplitude of the sine wave now seen on the scope should be 39 times greater than when viewed across R_1 .

Amplitude distortion is the major problem in this type of unit, so we will

Fig. 4. Over-all view of intercom.

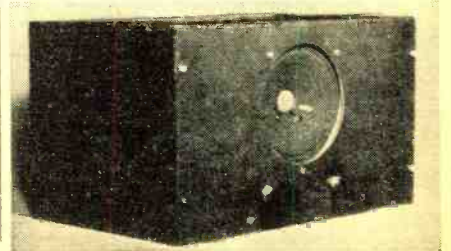

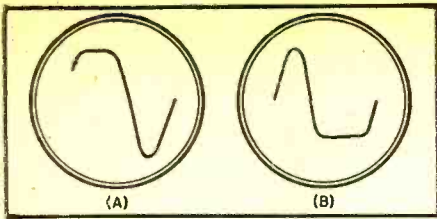

Fig. 5. (A) Should this wave shape be obtained, it would indicate that the grid of the tube under test is being driven positive and drawing current. (B) If the pattern appears as shown in this illustration, it would indicate too much grid bias on tube.

concern ourselves only with this type of distortion. If the pattern on the scope looks like Fig. 5A, the grid of the tube under test is being driven positive and drawing current. To remedy this condition, add more bias by increasing the resistance of the cathode resistor, R_c . If, on the other hand, the pattern looks like Fig. 5B, there is too much bias on the grid and it should be reduced.

-30-

6-10-11 Meter Converter

(Continued from page 53)

rigidity. The *National* type ACN dial makes it possible for anyone to mark in calibration points for any of the bands the unit will cover.

In adjusting the bandsread of the oscillator dial both the series and the parallel pads have to be very carefully adjusted. If too much bandsread is experienced, where known frequencies are too far apart, tightening or increasing the capacity of the series pads will be required and if too little bandsread is experienced the series pad or trimmer will have to be loosened or decreased in capacity. Naturally each adjustment of a series pad will require a very minor adjustment of the parallel pad to compensate. Unfortunately when the converter is installed in the cabinet and the top cover of the cabinet is raised or lowered this causes a shift in oscillator frequency of approximately 25 kc. The oscillator should, therefore, be adjusted (with the top open) approximately 25 kc. higher in frequency on the dial to compensate for this condition. For those who desire to avoid this procedure, the usual paper scale supplied with the ACN dial may be employed instead of a specially calibrated scale and the additional markings and calibrations added where needed.

Prewar 5 meter men will readily recognize that this unit is merely a modernization of the old converter that was described in the 1939 issue of "QST." Only minor changes in values, the new type power supply and tubes, as well as improved mechanical layout are responsible for the smaller size of the new version. To say that this converter is the result of many hours of effort would be putting it mildly. However, it is felt that the results compensated for the time expended. Performance checks indicate excellent

August, 1947

Now Available High Q TOROIDAL COILS

The solution of filter network problems, has been greatly simplified through the use of toroidal coils wound on molybdenum permalloy cores. Design engineers have learned to depend upon them since discovering that only these toroids possess all the necessary qualities of a good high "Q" coil.

The three principal types now being supplied are:

TYPE	RANGE
TC-1	1K.C.—20K.C.
TC-2	100cy.—5K.C.
TC-3	10K.C.—100K.C.

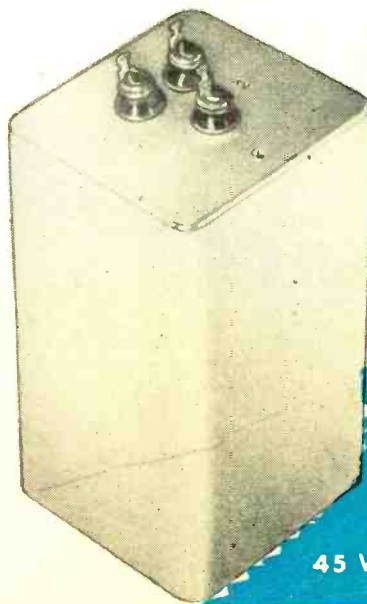
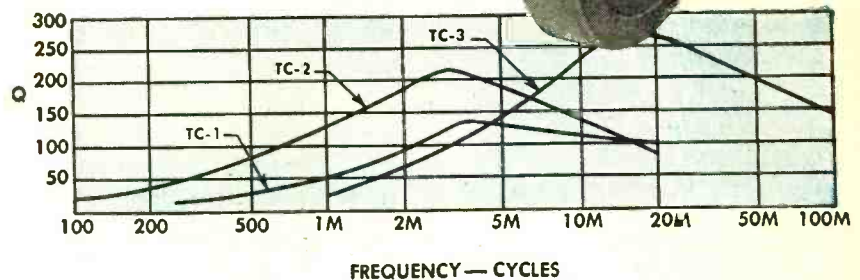

FILTERS

We are producing toroidal coil filters which consistently demonstrate the value of toroidal coils. These filters cannot be matched in stability, accuracy and sharpness by filters made with the usual laminated type of coil.

Orders for samples or production quantities are equally respected. All inquiries will be promptly handled.

Burnell & Co.

DESIGNERS AND MANUFACTURERS
OF ELECTRONIC PRODUCTS

45 WARBURTON AVE. • YONKERS 2, N. Y.

SURPLUS SAVERS MEAN MONEY SAVERS

NAVY CONTROL BOX. Black crackle; brand new. Matching plugs. 2 rotary switches, panel lamp assembly with lamp; weight 1.7 lbs.; size 6 1/2 x 3 1/2 x 2 1/4. Complete **\$1.00**

The plug that fits on the front of the BC-312; with 5 ft. of battery cable and lugs; 2 for **\$1.00**

.002 Mfd. Mica, 5000v test; 2500v DC.; 3 for **\$1.00**

CONDENSERS 4 Mfd.—2000v DC with mounting bracket; oil filled, overseas packed; 2 for **\$5.00**

MIDGET CONDENSERS—5-140 Mmfd. variable, .028 spacing, 1/4" shaft; 2 for **\$1.00**

New—SPRAGUE dry electrolytic cylindrical can, 25 mfd. 200v DC working with mtg. clamp; 4 for **\$1.00**

POWER TRANSFORMER—115v-60 cycle T10—430-0-430 at 510 mils; 5v @ 6 amps; rating marked on case. New **\$6.75**

FILAMENT TRANSFORMER—230v-60 cycle primary. 2.5v C.T. Hi-current, Hi-insulation. Sec. Black case. Federal #NL-28283; 8x8x9 1/2; 3" porcelain terminals on secondary. New **\$7.50**

Hi-Volt TRANSFORMER—115/230v, 60 cycle primary. 4500-0-4500—35 mils. Federal #NL28872; 8x8x9 1/2. 3" porcelain standoff on secondary. Cased. New **\$7.50**

NAVY SPEAKER AMPLIFIER UNIT—115v AC or DC operation. 35Z5 rectifier & Pr. of 35L6 PP output; heavy duty speaker weatherproofed for outdoor mtg. 5-channel input, vol. control; not new but guaranteed operating cond. Case 12x13 1/2-x8 with tubes & schematic **\$11.50**

BC654 TRANSCEIVER complete with tubes, 200 KC crystal; some with spares; never used; an 80-meter phone receiver and xmtr for **\$14.95**

Small CERAMIC COIL FORM grooved for prim & sec. winding. Tapped hole for screw mtg. 1 1/2" Hx3/8D. Dozen for **\$1.00**

5BP1—5BP4, sealed cartons, new. **\$4.00**

G.E. Model DJ1—Position Indicator Meter. Panel mount. 2 1/2" Indicate beam position in your rig. Instructions included. NEW **\$3.00**

25% deposit required on all C. O. D. orders. Prompt delivery assured. Write Dept. RNA.

GREENWICH SALES CO.

59 Cortland St. Whitehall 3-3052
NEW YORK CITY 7, N. Y.

sensitivity, too low to be measured by the average signal generator when the converter is employed ahead of any half-way decent communications receiver. The receivers used in the tests conducted on this unit were the *Hallcrafters* SX-25 and SX-17, *Hammarlund* HQ 129x and "Super Pro." Image ratio measurements and response to spurious frequency are of very high order and it is felt that due to the many variables there is no particular sense in quoting any set of figures as they would not be worth very much under the circumstances.

The output frequency of the converter is adjustable over approximately 4 megacycles with the mid-frequency and suggested i.f. frequency being 5.7 megacycles. When connecting the converter ahead of a receiver, it is suggested that with the converter turned off and the receiver tuned to approximately 5.7 megacycles, the r.f. gain of the receiver be reduced, if necessary, to provide practically no noise level. When the converter is then turned on, it will be found that very little noise level will be added and plenty of sensitivity will be obtained.

The output cable from the converter consists of two wires shielded, with an over-all insulation to provide isolation of the shield of the cable from the converter chassis. The shield is cut short and insulated from the converter chassis. The opposite end which connects to the antenna terminals of the receiver has the shield grounded. This

will usually prevent the receiver from picking up all but very strong signals at the i.f. frequency in addition to eliminating noise pickup.

The writer wishes to thank the gang on 6 and 10 meters for the many swell compliments on the old converter previously mentioned and is sure that this new version with its many advantages will be found just as popular. —30—

Robot Telephone

(Continued from page 41)

after the fourth ringing tone just as if he were going to make a recording. On hearing the word "Ready?", however, he pronounces twice the word "Hello." (For the sake of simplicity, the checking of the double signal, "Hello, hello," is not shown in the simplified diagram; nor, for that matter, is the complete code key of ten buttons shown since it would needlessly complicate it). If, then, after the operation of cam 7, already described, a speech impulse acts on relay *J* through the amplifier *E*, contact *J*₂ will close, thus preventing, in motor control device *C*, the switching of the latter out of circuit by cam 6, which would otherwise immediately follow. In this case *C*, remains in circuit and the text of the announcement is modified. This means that instead of emitting the invitation "Please start speaking now!", the sound recording wire successively enumerates the digits of a

METERING MULTI-STAGE TRANSMITTERS

WHEN using one meter to perform several duties in a multi-stage transmitter it is customary to use a two-deck rotary switch. To eliminate possible operational errors, a double-pole, single-throw switch for each stage should be substituted, as shown in the diagram. Non-locking types should be used to eliminate the possibility of having more than one switch in operation at one time. The switches should be connected across low value resistors which act as meter shunts. These resistors should be of such a value as to

give the correct range for easiest reading of the meter.

Since the switches do not break into the circuit across points of high potential difference, high insulation between points is not necessary. Good insulation to ground is necessary, however.

This system takes up less room than the rather bulky rotary switch and provides individual stages with conveniently placed switches. Among the switches that can be used are the Utah jack switch Type 44 or 344 or the Mallory Type 2004 non-locking unit...R.L.P.

Diagram shows method of wiring resistors and switches.

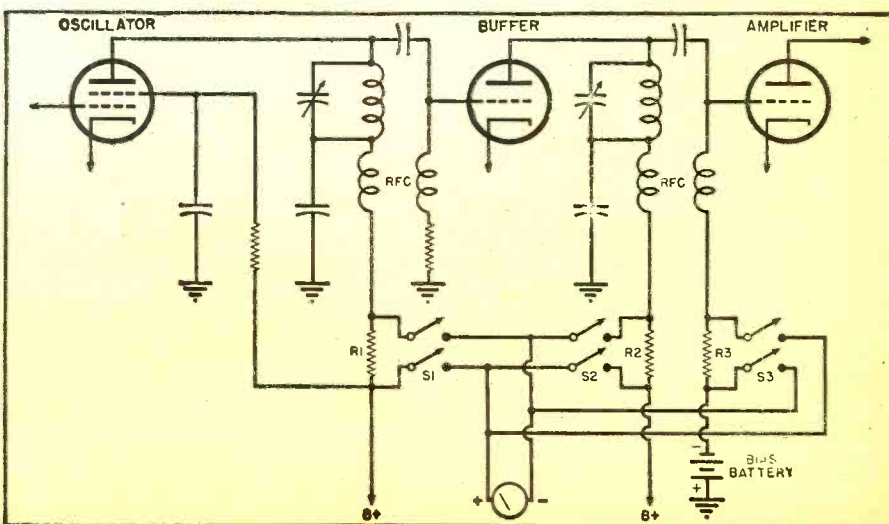

series from 1 to 5. (in the *Ipsophon* itself, from 1 to 10; the principle is the same, however, irrespective of the number of buttons used). After each digit, the relays *H* are excited as a result of the closure of the contacts 7, to 7_s, and the amplifiers are switched over to their recording position. The cams of discs 1 to 5 are closed, one after the other, simultaneously with the cams on disc 7. Thus, for instance, the closure of cam 1 results in the negative pole of the battery being shunted on the first winding of relay *G*, through the intermediary of the cam contact and the non-operating contact of button 1. In the absence of speech impulses, however, relay *G* cannot be lifted, as contact *J*₁ has not effected the transfer. Should the caller emit a speech impulse after the announcement of digit 1, which is not included in the selected code, relay *G* is excited, operating locking relay *S* and thus preventing reproduction. On the other hand, in regard to the button originally pressed by the subscriber to the *Ipsophon*, the closure of cam 3 results in the following circuit being established; negative pole of battery, cam contact, operating contact of button 3, second winding of relay *G*, contact *J*₁, positive pole of battery, through the closed contact of relay *B*. In this case, in the absence of speech impulses, relay *G* would also be operated and, through the locking relay *S*, prevent reproduction. If, however, the caller speaks, this will switch relay *G* out of circuit, and locking relay *S* will not be excited. This function is made possible by the time delay feature of the two relays, *G* and *S*.

The caller must, therefore, pronounce the word "Hello" twice, each time a digit originally chosen as a code number is announced, and remain silent when the other figures are announced. If this is done correctly, the emitted impulses set in operation the controls corresponding to the series of figures from 1 to 5, the reclosure of the circuit of cam 6, starts up motor control mechanism *C*₂ which, in turn, sets motor *M*₂ (that which controls the text of the announcement) in motion in reverse, and also simultaneously, sets in motion motor control mechanism *C*₁, which governs the reverse motion of the recording mechanism. Motor *M*₁ drives spool *Y*₂, which carries the sound recording wire. This reversal of the movement of the sound recording wire drives spool *Y*₁, thus bringing about (through the reduction gear *P*₂) the release of the reverse movement of cams 8 and 9. This reverse movement continues until the cam of disc 9 has closed its contacts and, through motor control unit *C*₃, switched motor *M*₁ out of circuit and engaged the forward movement of motor *M*₂. Cam-disc 8 has been driven by friction in this reverse rotary movement, not having been locked by the pawl. Through the forward feed of the sound recording wire, following immediately, the recordings reach the repeater *N*₁ through the sound head

August, 1947



CUTS RECORDS UP TO 10" DIAMETER

PLAYS RECORDS UP TO 12"

**MODEL GI-R90
DUAL-SPEED HOME
RECORDING AND
PHONOGRAPH ASSEMBLY**

**ONE BUTTON CONTROLS SPEED
78 or 33 1/3 R.P.M.**

JUST LOWER CUTTING ARM TO START RECORDING

Smooth RECORDING... Smooth PLAYBACK WITH GI DUAL-SPEED HOME RECORDING ASSEMBLY

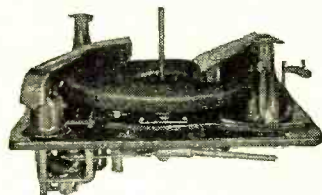

GI-RC130 Combination Record-Changer Recorder



LX Rim Drive, Constant-Speed Phonograph Motor



GI-RM4 Rim Drive, Heavy-Duty Recording Motor

You'll get quick response when you offer your customers this simple, dependable, Dual-Speed Home Recording Assembly.

It's simple as ABC to operate, with high-quality recording and fine reproduction. The sturdy, *Smooth Power* mechanism will stand up faithfully under hard home use—and it's remarkably low-priced to help you build volume sales.

Send for details. Ask us for complete information on the GI-R90 Home Recording and Phonograph Assembly—and on our complete line of Phonomotors, Recorders and Combination Record-Changer Recorders.

NOTE TO INDIVIDUAL USERS—*Smooth Power* units are sold only through established trade channels.



THE GENERAL INDUSTRIES CO.

DEPT. MR • **ELYRIA, OHIO**

I'll Train You Quickly—in at Home—in Your Spare Time—to Make More Money in the Fastest Growing Industry in the World!



WHO SAID IT COSTS A LOT OF MONEY TO LEARN RADIO ELECTRONICS?



Ghirardi's Famous RADIO PHYSICS COURSE costs you only \$5 complete... and it is complete! 36 BIG COURSES IN ONE!

FOR BEGINNERS

No Previous Experience Needed

Send coupon today! Examine Ghirardi's big, 972-page RADIO PHYSICS COURSE for five full days. See how this one giant book at ONLY \$5 can give you complete, basic training to pave the way for a brilliant future in Television, Radio, Frequency Modulation, Facsimile, Broadcasting, Communication, Servicing, Industrial Electronics, etc. Prove to yourself that training doesn't need to be expensive to be really good!

9 OUT OF 10 RADIO MEN CAN'T BE WRONG!

Actually, this famous book has given more people their start in Radio-Electronics than any other book or course ever published. On an actual survey among 817 men already in radio, 724 of them—9 OUT OF 10—answered that Ghirardi's RADIO PHYSICS COURSE is their choice as the finest, easiest to understand training on the market—and far better than any other book or course they have ever seen!



LEARN FAST! LEARN RIGHT! as fast as you can read!

You'll be pleasantly surprised how RADIO PHYSICS COURSE helps you master subjects that other courses make seem very complicated. Starting with Basic Electricity—over 300 pages—it takes you through the entire Radio-Electronics field. Everything is made crystal clear. Nothing is omitted or condensed. You buy it for only \$5 complete—ON OUR MONEY-BACK GUARANTEE. You progress as fast as spare reading time permits. Many students have completed it in a few weeks. 972 pages, 508 illustrations and 850 self-test review questions make study doubly easy. Rush coupon. You cannot lose!

MAIL ORDER—Rush Coupon

Dept. RN-87 Murray Hill Books, Inc., 232 Madison Ave., New York 16, N. Y.

Enclosed find \$5 (\$5.50 foreign) for Ghirardi's 972-page RADIO PHYSICS COURSE book; or send in C.O.D. for \$5 plus postage (no foreign C.O.D.'s). In either event, if not satisfied, it is understood I may return book in 5 days for complete refund of my money.

Name.....

Address.....

City & Zone..... State.....

MONEY-BACK GUARANTEE

Z_2 and the amplifier E_2 . The caller then hears, over the service line, all the messages recorded by the *Ipsophon*.

At the end of the reproduction, cam 8 closes its contact, thus switching motor M_3 out of circuit, through the motor control unit C_3 . At this moment a short, shrill sound is emitted by unit C_1 through the coupling transformer N_2 . This shrill sound notifies the listener that all the recordings on the *Ipsophon* have been reproduced. At the end of this shrill tone, the relays H are switched over—by the same unit C_3 —to recording. If, at that moment, two speech impulses are emitted, exciting the impulse relay J through amplifier E_1 , the relays H will remain held and motor control unit C_3 will again engage motor M_3 on "feed." Thus, the caller can record messages to the instrument immediately after the end of reproduction.

If, on the other hand, the caller does not avail himself of this facility, a second shrill sound is emitted after three seconds through the repeater N_2 , this period of time being measured by the timing device T . If two speech impulses are then emitted, impulse relay J engages the motor control unit C_3 , setting motor M_1 in motion in reverse and at the same time exciting the electromagnet Q_1 of the pawl and the cancelling electromagnet Q_2 . The result is that cam-disc 8 is held in its initial position (cam contact closed) and cam-disc 9 is driven in reverse until it reaches its position of rest. The electromagnet, Q_2 , magnetically cancels the recording from the instrument, and the entire *Ipsophon*, being returned to its initial position, is once more ready for action. If, however, after the second of the shrill tones, advantage is not taken of the opportunity to cancel the recordings, a third shrill tone is heard after an interval of two seconds, informing the caller that the recordings have not yet been erased. After this third shrill tone, the timing device T switches the *Ipsophon* out of circuit again.

A paramount requirement in a device of this type is, of course, the necessity of making it operate as reliably as the ordinary telephone.

Accordingly, no parts needing periodical attention or replacement were incorporated in the *Ipsophon*.

Breakdown through faulty manipulation is precluded by the use of automatic switching arrangements and all electro-acoustic commands are performed by coils controlled by relays and contacts similar to those in common use in telephone exchanges all over the world.

Furthermore, manipulation of the *Ipsophon* is simplified to a considerable extent by making the instrument in two separate units, the main operating apparatus and the recording device, as well as the provision for straightforward dialing arrangements, easy-to-read controls, and luminous signal indicators.

Easy to manipulate, foolproof in

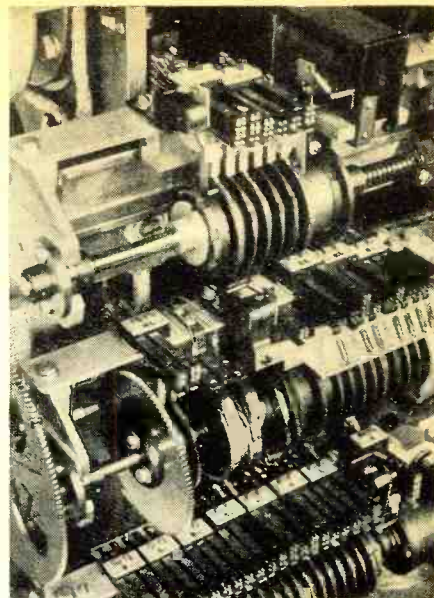

Cam mechanism for the 1st and 2nd pair of registering coils. All electro-acoustic commands are performed automatically by them.

operation, and absolutely dependable in engineering performance, the *Ipsophon* robot telephone will undoubtedly become, when popularized, a vital link in tomorrow's world-wide system of national and international telephone communications networks. —30—

Spot Radio News

(Continued from page 20)

ships and floating objects. He then calls out course changes to a man at the wheel. The image on the *Sperry* radar equipment can be translated into a range to any object, both in yards and fractions of miles of distance and in degrees of bearing. Developed for commercial use since the war, it recently was commended by 92 delegates from 31 nations at the international meeting on marine radio aids to navigation. Also demonstrated was Loran—for locating your position at sea in from three to five minutes—and the *Sperry* Gyro-Compass... Sea-going radar is already in practical use on the "Elizabeth" and the "America," as well as a number of Grace liners. Alaskan fishing boats are also using it and the captain reports that it has been installed on a couple of yachts. It costs plenty—\$12,000—but the captain estimates that it will save millions in ship losses and an inestimable number of lives when generally used.

ONE FORM OF INTERFERENCE

that's easy to fix—if you don't know it already is that coming from fluorescent lights. They have a habit of humming in the middle of your favorite program. Cause; a feed-back of radiation through the wires and tubes of the radio. Cure; move the radio and light farther apart. If this doesn't work, install a filter specially designed for fluorescent lights. —30—

4" ALNICO "5" P M SPEAKER 79¢

← SPECIALS OF THE MONTH →

G.E.—Rotary Switch, 2 deck—each deck SP3P Mycalex wafers. Can be used in Hi-frequencies up to 250 Mcs. Perfect for band switching in an exciter or final. Heavy silver plated spring contacts. Positive action by spring controlled roller bearing. **\$1.29**

TRANSFORMERS—115v 60 cyc

Hi-Voltage Insulation

1600v @ 4ma; 700VCT @ 150ma; 6.3v @ 8a.	\$8.50
2500v @ 10ma.	6.50
3710v @ 10ma; 2.5v @ 3 amp; 2.5v @ 3 amp.	9.95
3950v @ 4ma; tap at 1250v @ 1ma.	7.50
550-0-550v @ 150ma; 5v @ 3a; 2X-6.3v @ 5a	9.95
6300v @ 4ma	9.95
500-0-500v @ 100ma; 5vct @ 3a	4.95
442-0-442v @ 1000ma.	9.95
425-0-425v @ 150ma; 6.3v @ 7.5a; 6.3v @ 3a; 5v @ 3a.	5.95
400-0-400v @ 200ma; 5v @ 3a.	4.95
350-0-350v @ 150ma; 6.3v @ 6a; 5v @ 3a; 78v @ 1a.	4.95
350-0-350v @ 35ma—XLNT for Volt Doubler	1.49
300-0-300v @ 65ma; 2X-5v @ 2a; 6.3v @ 2½a; 6.3v @ 1a.	3.49
120-0-120v @ 50ma.	2.49
2.5v @ 3a, 15KV test	3.95
2.5v @ 10a, 10KV test	3.25
5v @ 115a	14.95
5v @ 190a	17.50
6.3v @ 6.6a	3.25
6.3v @ 3.1a	1.95
6.3v @ 21.5a; 6.3v @ 2a; 2.5v @ 2a	6.95

FILTER CHOKES—HI-VOLTAGE INSULATION

4 Hy @ 250ma.	\$1.98	12 Hy @ 300ms.	\$3.95
10 Hy @ 250ma.	2.49	15 Hy @ 100ma.	2.95
10 Hy @ 400ma.	4.95	15 Hy @ 125ma.	3.25
12 Hy @ 100ma.	2.95	30 Hy @ 70ma.	1.95
4 Hy @ 600ma.	5.95	1 Hy—5 amps.	6.95

SCR-522 100-156 MC. RECEIVER AND TRANSMITTER

Licensed for Railway and Taxicab Use

The ideal all-purpose transmitter-receiver for work in the 100-156 mc. spectrum. Four channel push-button operation, crystal-controlled, AM, phone, mobile or fixed station service. Ideal for amateur, aircraft, marine, railroad, taxicabs, police and experimental. Amplitude modulated—High transmitter output. Receiver has 10 tubes and transmitter has 7 tubes including two 832's. Easily converted to full 110 volt 60 cycle operation. Complete conversion instructions and schematic furnished with each unit.

Tube complement 2—832; 3—12A6; 1—6G6; 2—6557; 1—12J5GT; 1—12C8; 1—9002; 3—9003; 1—12AH7GT and 3—12SG7.

Complete with tubes **\$14.95**

BC-348 RECEIVER

Built for continuous duty, this band switching, six band receiver with a freq. range of 200 to 500 kc. and complete 1500 kc. to 18,000 kc. Has automatic noise compensator—constant sensitivity on all bands—output at 300 or 4000 ohms—xtal filter AVC-MVC-BFO; Smooth vernier tuning; 90 turns of tuning for each band. Complete with built-in dynamotor for 28 v DC. 8 tubes. Conversion instructions and schematics. **\$49.50**
Wonderful buy at

Conversion kit for 110v-60 cyc. operation, complete \$7.50

'SILVER BALL' ANTENNA SWITCH
100 Amp. 2500 V. Navy Rating
Terrific Buy **\$1.79**

BLOWER

Hi-air blast, designed for transmitting tube service. Motor operates on 100-125v 60 cycle at 7000 RPM. Noise free with self contained chokes and filters. Enclosed in satin finish, aluminum cabinet. Measures 4" high x 2½" x 3¼". Many uses.
Super buy at **\$5.95**

PERMALLOY SHIELDS for CATHODE RAY TUBES

3" Shield	\$1.49
5" Shield	1.98

TUBES (Brand New)

Army-Navy Inspected

1B24	\$13.95	311	\$ 5.95
2AP1	2.25	371B	5.95
2C40	2.79	450TH	44.50
2D21	1.49	703A	1.50
2V3G	1.25	705A	4.95
2X2	.84	715B	4.95
3AP1	3.00	721A	4.95
3BP1	2.95	726/AC	7.50
3E29	2.95	801	1.75
5BP1	3.95	802	1.75
5BP4	4.95	803	8.95
5CP1	3.95	804	9.95
5JP1	9.95	805	3.75
5LP1	9.95	806	14.95
5R4GY	.98	807	.95
5Y3	.59	808	2.95
6AB7	.99	809	1.50
6AC7	.99	810	3.50
6AG5	.99	811	1.95
6AG7	.99	812	3.95
6AJ5	1.89	812H	6.95
6AK5	.90	813	5.95
6AL5	.99	814	4.45
6AR6	1.29	815	3.95
6B4G	1.29	826	2.25
6C4	.69	829-A-B	3.00
6C5	.49	832	2.25
6F6	.89	833A	49.50
6F6G	.59	834	2.95
6J4	1.50	835	2.95
6J5	.59	836	1.75
6J6	.89	837	2.50
6L6	1.25	838	3.75
6L7	.98	841	1.20
6N7	1.39	861	89.95
6SH7	.59	866	.99
6SL7	.89	872A	2.50
6SN7	.69	884	1.10
6SR7	.89	885	1.10
7A4	.95	902	2.25
7F7	1.25	913	3.00
7L7	1.59	954	.75
9JP1	14.95	955	.75
10Y	1.50	956	.75
12X3	1.50	957	.75
15E	1.50	958	.75
24G	1.75	959	.75
28D7	.75	1005	1.98
30	.75	1616	2.95
35T/TG	3.50	1619	.75
VR90	.75	1624	.90
VR105	.75	1625	.75
VR150	.75	1626	.75
100TH	7.95	8001	8.95
100TS	3.00	8003	9.95
211	1.25	8005	4.95
250TH	14.95	8011	3.75
257B	14.95	8016	1.65
304TH	9.95	8025A	3.95
		F128A	75.00

SELENIUM RECTIFIERS Full Wave Bridge Types

INPUT	OUTPUT	
up to 18v A.C. up to 12v D.C.	5 amp.	\$4.45
up to 18v A.C. up to 12v D.C.	10 amp.	7.45
up to 18v A.C. up to 12v D.C.	15 amp.	9.95
up to 18v A.C. up to 12v D.C.	30 amp.	14.95
up to 36v A.C. up to 28v D.C.	1 amp.	3.45
up to 36v A.C. up to 28v D.C.	5 amp.	7.45
up to 36v A.C. up to 28v D.C.	10 amp.	12.95
up to 36v A.C. up to 28v D.C.	15 amp.	18.95
up to 115v A.C. up to 100v D.C.	25 amp.	2.95
up to 115v A.C. up to 100v D.C.	6 amp.	6.95
up to 115v A.C. up to 100v D.C.	5 amp.	19.95

HIGH CAPACITY CONDENSERS

4000 mfd.—18WVDC	\$1.95
4000 mfd.—30WVDC	2.95
1000 mfd.—15WVDC	1.99
2000 mfd.—50WVDC	1.95

OIL CONDENSERS:

G.E., AEROVOX, CD., ETC.

1mfd. 600v.	\$0.35	2mfd. 2000v.	\$1.75
2mfd. 600v.	.35	3mfd. 2000v.	2.75
4mfd. 600v.	.60	4mfd. 2000v.	3.75
8mfd. 600v.	1.10	15mfd. 2000v.	4.95
10mfd. 600v.	1.15	1mfd. 2500v.	1.25
1mfd. 1000v.	.60	25mfd. 2500v.	1.45
2mfd. 1000v.	.70	5mfd. 2500v.	1.75
4mfd. 1000v.	.95	.05mfd. 3000v.	1.95
8mfd. 1000v.	1.95	1mfd. 3000v.	2.25
10mfd. 1000v.	2.10	25mfd. 3000v.	2.65
15mfd. 1000v.	2.25	5mfd. 3000v.	2.85
20mfd. 1000v.	2.95	1mfd. 3000v.	3.50
24mfd. 1500v.	6.95	12mfd. 3000v.	6.95
.25mfd. 2000v.	1.05	2mfd. 4000v.	5.95
.5mfd. 2000v.	1.15	1mfd. 5000v.	4.95
1mfd. 2000v.	.95	1mfd. 7000v.	2.95

HI VOLTAGE MICAS

.01 mfd. 15000v—	\$12.95	.02 mfd. 12000v—	\$9.95
.02 mfd. 20000v—	10.95	.0005 mfd. 20000v—	9.95

CARBON PILE REGULATOR

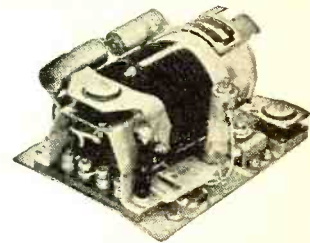

115V. 60 Cycles, 500 Watt LOAD, 750 W. AIR BLAST

Uniform voltage to all equipment at any load to 500 watts. Regulates voltages to test bench and sets under test. Line voltage regulator for output of gas driven generators. Regulates line voltage from outlets in the average home. Used in rural areas where line voltage surges.
Excellent Buy at **\$14.95**

All merchandise guaranteed. Mail orders promptly filled.
All prices F.O.B. New York City. Send money order or check.
Shipping charges sent C.O.D. Minimum order \$5.00.

ATTENTION!

INDUSTRIALS—LABS—SCHOOLS—AMATEURS

Let us quote on components and equipment that you require. We have too many items to be listed on this page. Place your name on our mailing list now for new catalog.

RADIO HAM SHACK Inc.
63 DEY STREET • NEW YORK 7, N. Y.

NOW! END WORRY... MESS... UNCERTAINTY OF STORAGE BATTERIES!

Enjoy **PERFECT** Radio Reception When Servicing
Car, Marine and Aircraft Radios!

NEW Electro
ELECTRICAL AND RADIO EQUIPMENT

Model "A"
**POWER
SUPPLY**

DC Output

Operates latest type auto
radios with solenoid tuning
and tone controls . . . also 12 volt marine and aircraft radios.

Height, 7 $\frac{3}{4}$ "
Width, 7 $\frac{3}{4}$ "

Length, 11 $\frac{3}{4}$ "
Ship. Wt. 31 lbs.

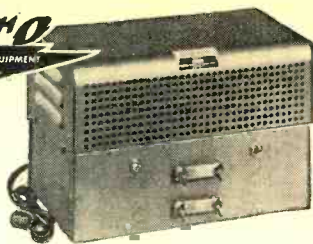

Always dependable! Reserve power a-plenty! Big, heavy duty transformers and chokes — large capacity condensers, for exceptional voltage regulation — instantaneous power for solenoid operation. Two separately filtered DC output sources: in parallel supply 6V at 15 amps. series, 12V. at 7 $\frac{1}{2}$ amps. Separately 6V at 7 $\frac{1}{2}$ amps.

Compact. Sturdy. 18-gauge steel construction. Handsome blue Hammerloid finish. Comes completely equipped including 6' rubber cord and plug. Vastly superior and costs no more than batteries for equal service.

Send for complete description of this up-to-the-minute power supply.

ELECTRO PRODUCTS LABORATORIES

Pioneer Manufacturers of Battery Eliminators

549 West Randolph Street

Chicago 6, Illinois

SENSATIONAL SELLER!



LAKE DELUXE CHANGER

Revolutionizes the Industry!
A Sensational Seller!

11 Outstanding Features:

- Positive Intermit
- Service Adjustments Eliminated
- Minimizes Record Wear
- Single Knob Control
- Plays ALL Records
- Pick-up arm may be grasped at any time and changer will not be thrown out of adjustment
- Resonance-free ball bearing tone arm
- Easily operated—any child can do it
- Completely Jam-proof
- Records Gently Lowered on Spindle —not dropped
- Automatic Shut-off on last record

Dimensions: 13 $\frac{3}{8}$ " W x 12 $\frac{1}{4}$ " D x 7 $\frac{3}{8}$ " H.
No. 116A.....YOUR NET **\$28.73**

Write for our new, illustrated, 16-page catalog NR-116. It's free. Get on our mailing list!
Write for our Special Catalog on Microphones, Amplifiers and Sound Equipment!

Lake Radio Sales Co.

615 W. Randolph Street

DEPT. A

Chicago 6, Ill.

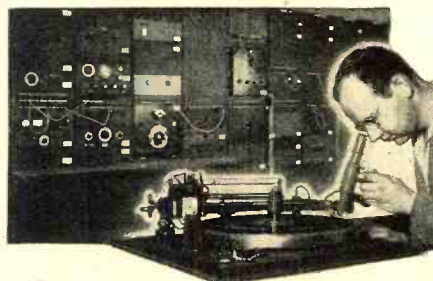

School of SOUND RECORDING and TRANSMISSION ENGINEERING

Learn sound recording and transmission engineering techniques of the professionals, as used in Motion Picture, Broadcast, F-M, Television, and Commercial Recording Studios.

A nine months practical engineering course, devoted exclusively to the technique of sound recording and transmission measurements. Well equipped studios, professional recorders and circuit laboratory containing latest model test equipment installed for student training. A portion of our laboratory is pictured above.

• New classes admitted the first School day of Jan., Apr., July, Oct.
Affiliated with the Don Martin School of Radio Arts
Approved for Veterans



H.M. Thomaine
Director

Write for literature • Sound Department
Don Martin SCHOOL of RADIO ARTS
1655 Cherokee • Hollywood 28, California

Technical BOOKS

"MUSICAL ACOUSTICS" by Chas. A. Culver. Published by *The Blakiston Company*, Philadelphia. Second Edition, 215 pages. Price \$3.00.

While this second edition of Dr. Culver's book is, like the first edition, designed to assist musicians and music school students understand the problems in acoustics confronting them in their professional careers, much of the material in this text will be of interest to that group of radio technicians and servicemen who are dealing with p.a. work and the recording and reproduction of music.

The entire text is written in language the layman can understand. While a knowledge of music might be desirable for a full appreciation of the book, the non-musical technician will profit by a careful reading of the text.

The author has devoted chapters to a discussion of the nature and transmission of sound, interference, hearing, resonance, vibrating air columns, acoustics of rooms, electronic musical instruments, and the recording and reproduction of music, to mention a few of the topics of interest to the radio technician.

This book is a must for the careful and thorough serviceman whose work is concerned with the direct transmission of sound.

* * *

"ELEMENTARY RADIO SERVICING" by William R. Wellman. Published by *D. Van Nostrand Company, Inc.*, New York. 251 pages. Price \$3.00.

This book is characterized by a clarity of style which will prove of particular value to the student or novice serviceman.

The author, formerly Service Manager for *Philco*, has broken the servicing operation down into several well defined techniques. Each of these operations is clearly and fully described and there is no valid reason why anyone capable of reading printed instructions and following them should experience any difficulty in the actual servicing of standard types of radio receivers.

No mathematics are to be encountered in this book and, in addition, complete operational procedures for using various test instruments are supplied. To cover this phase of servicing, the author has set up "Job Sheets," the purpose of which is to teach the use of the voltmeter, ohmmeter, signal generator, how to make a voltage analysis of a.c. and a.c.-d.c. receivers, how to read block diagrams, and how to do signal tracing on a superheterodyne, etc.

Separate chapters dealing with the r.f. amplifier, mixer-oscillator, i.f. amplifier, detector and a.v.c. circuits, audio amplifier, power supply, loudspeaker, alignment, miscellaneous troubles, automobile radios, battery-a.c.-d.c. portables, a.f.c., and FM, cover

RADIO NEWS

NEW!
Presto's
Dual-Motor,
Direct Drive!

▶ The new Presto 64-A transcription unit combines a number of radical improvements which are of first importance to broadcast stations, recording studios, and industrial and wired music operators.

▶ The turntable is directly gear-driven at both 33 $\frac{1}{3}$ and 78.26 rpm and two separate motors are employed — one for each speed. Speed may be changed instantly at any time by turning a mercury switch, without damage to the mechanism. *No frictional, planetary, or belt operated elements are used in this new drive mechanism.*

▶ The following points are of interest: *Motors*—Two 1800 rpm synchronous. *Speed*—Total speed error is zero. *Noise*—At least 50 db below program. *Starting*—Table on speed in less than one-eighth revolution at 33 $\frac{1}{3}$ rpm. *Adjustment*—Construction is very rugged and no attention whatsoever is required—except lubrication.

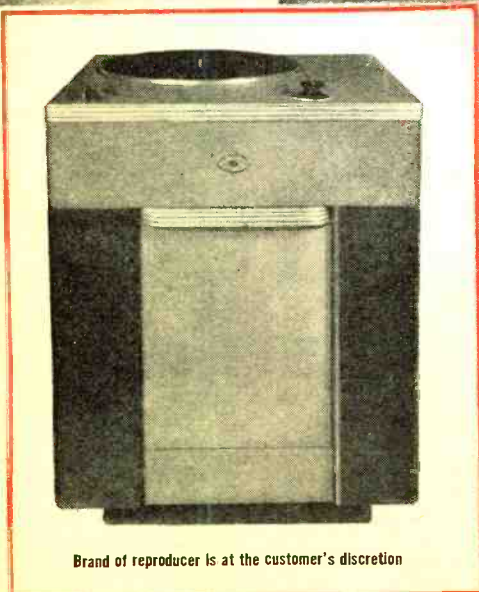
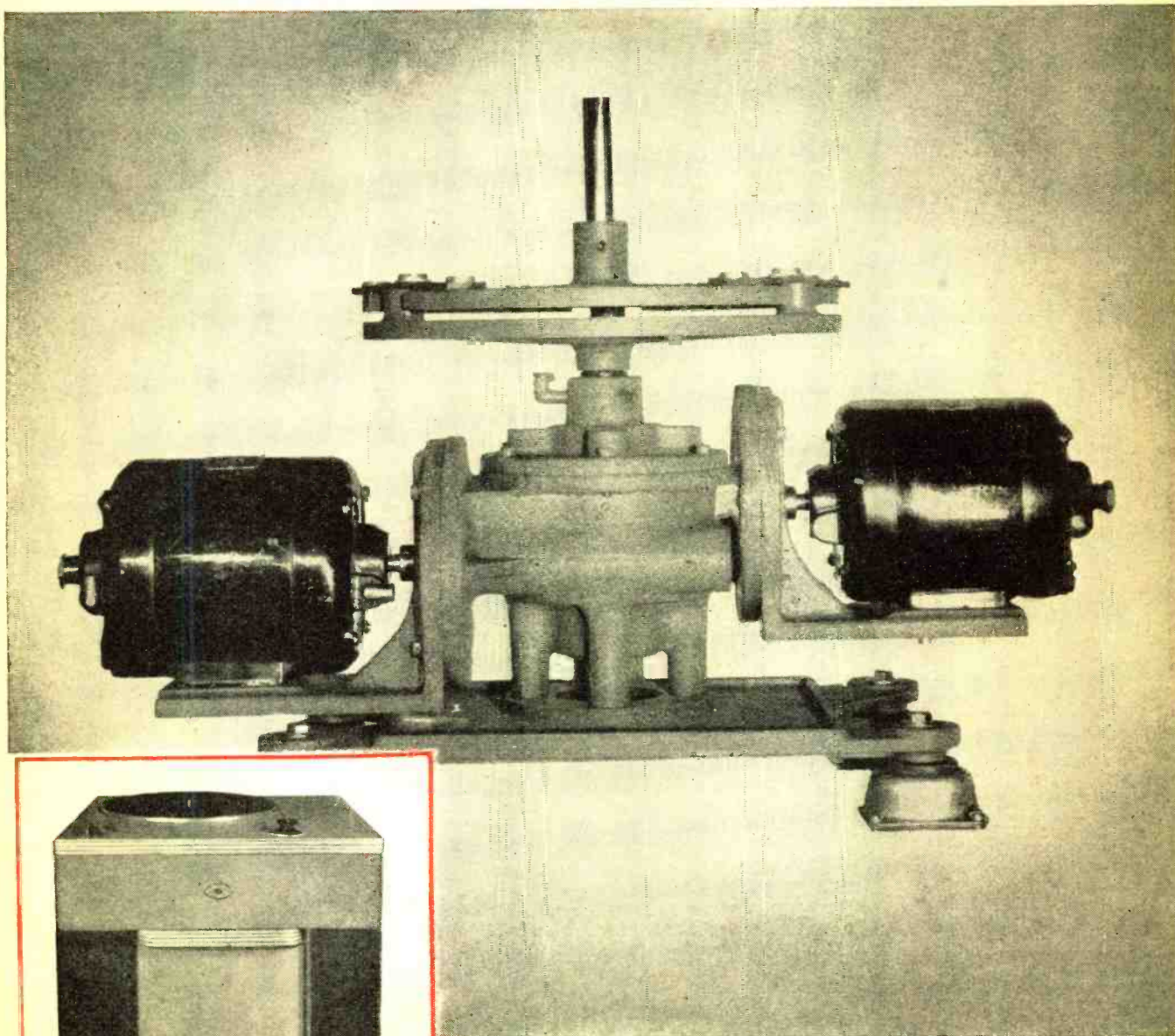

Brand of reproducer is at the customer's discretion

 **PRESTO** RECORDING CORPORATION

242 West 55th Street, New York 19, N. Y. • Walter P. Downs, Ltd., in Canada

WORLD'S LARGEST MANUFACTURER OF INSTANTANEOUS SOUND RECORDING EQUIPMENT & DISCS
August, 1947

KELNOR

REG. U. S. PAT. OFF. • PATENTS GRANTED, APP. FOR

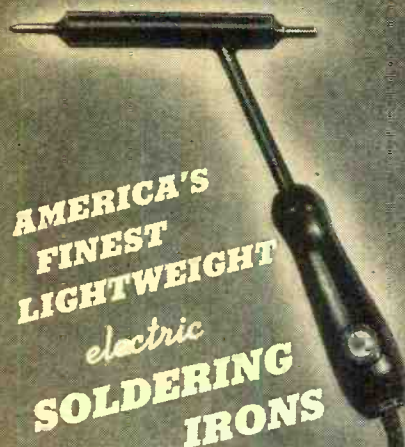

AMERICA'S
FINEST
LIGHTWEIGHT
electric
SOLDERING
IRONS

If you do
**MANUFACTURING
or REPAIRING**

in the fields of

Radio • Electronics
Radionics • Telephone
Aircraft • Transformers
Vending Machines
Instruments

you will be especially
interested in Kelnor Irons

KELNOR FEATURES:

1. Weighs Only 9 Ounces complete with 6 feet of cord and plug.
2. Solders in Hard-to-Reach Places without burning insulation on adjacent wires.
3. Kelnor Adjustable Tip. Longer for less heat, shorter for more heat.
4. Scientifically Balanced Angle Head means less operator fatigue, more soldering operations per hour.
5. Special Patented Kelnor Heating Unit. Reaches soldering temperature amazingly fast. Outperforms irons of higher wattages.
6. Reduces Cord Maintenance. Kelnor irons are held in a "natural" position which prevents cord from twisting.
7. All-Ceramic Sealed Insulation. Heating element, lead wires hermetically sealed in ceramic.
8. Rugged One-Piece Construction. Tube is welded to barrel.

GUARANTEED FOR ONE YEAR

Order from Your Retailer or Jobber
or write for information to

KELNOR MANUFACTURING CORPORATION
San Francisco, California
Sales Offices (Domestic)
Clay Estes Co., 1355 Market Street
Export:
Frazar & Hansen, 301 Clay Street

KELNOR MANUFACTURING CORPORATION

General Offices:

215 KEARNY STREET • SAN FRANCISCO 9, CALIFORNIA

each stage or circuit thoroughly and suggest various causes of common set failures.

This book is highly recommended as a practical "How-To-Do-It" book for the the student and as a home-study text on radio servicing.

-30-

Antenna Loading Problems

(Continued from page 44)

meters require identical calibration. These meters are expensive and may be easily damaged with overloads. There is another r.f. indicator which, for this particular application, is equally as accurate as r.f. microammeters and costs 5c per indicator. The common panel light bulb meets this requirement. In case of an overload the expense of the damage will be the price of a light bulb:

Installation of R.F. Indicators

For example, let us assume that we are working with a transmitter with an input of 100 watts, and a frequency of 10 meters.

Two wires are soldered to the connections of the light bulb base. These wires should be approximately six inches long. Two such light bulb assemblies are required. Refer to Fig. 1A for proper connection of light bulb assemblies to the antenna.

Tuning Procedure

Load the transmitter antenna by adjusting the pickup coil to the tank circuit of the final. Note brilliancy of light bulbs. Adjust antenna length for maximum brilliancy in each light. When this adjustment is correct, both light bulbs will be equal and at maximum brilliancy, indicating a maximum transfer of power from the transmitter to the antenna. If the impedance of the transmitter pickup coil is unknown, vary the number of turns so that maximum brilliancy of the light bulbs results.

An antenna tuned by this procedure provides a maximum transfer of power from the transmitter to the antenna, which means that the best possible match for the particular application has been achieved. Under such conditions, the standing wave ratio on the transmission line is at a minimum. If such a condition does exist, the addition or subtraction of transmission line to the particular circuit will not affect the amount of power being transferred to the antenna other than the actual loss in the transmission line. Another method of indicating standing waves on a transmission line is to apply water to the transmission line and observe any change in the transmitter loading. A 72-ohm *Amphenol* flat transmission line is relatively unaffected during a rainy season if the line is free of standing waves.

Placing r.f. ammeters in series with the transmission line will not give an accurate indication of maximum transfer of power to the antenna. A stand-

ing wave on the transmission line can cause excessive current to flow which would be indicated by the ammeter with a very small percentage of this power actually going into the antenna. If such a condition does exist, the loading of the transmitter can vary radically during a rainy season.

It is possible to have a standing wave on a transmission line and still load the antenna with a fair degree of success. Such a condition exists when an untuned transmission line is cut to length resulting in optimum operating conditions.

The number of amateurs that cut transmission line to obtain the proper transmitter load is surprising.

If the light bulbs exceed their normal brilliancy during the tuning operation the length of wire to each bulb should be reduced equally. The light bulbs will then shunt a smaller portion of the antenna, resulting in less voltage being developed which reduces the brilliancy.

For tuning applications, using low-powered transmitters, it may become necessary to use low current drain panel lights and shunt as much as 18" of the antenna. A 1-kilowatt transmitter will require approximately 4" of lead length for normal brilliancy.

The light bulb method of tuning antennas can be adapted to practically any antenna. To prune an off-centered Hertz antenna, the following procedure should be used:

Three lights bulbs are required, one at the center of the antenna, and two light bulbs shunting portions of the feeder. These two light bulbs on the feeder should be spaced approximately 10' apart. Refer to Fig. 1B.

The antenna is connected to the transmitter and the transmitter turned on. The antenna length is then adjusted so that the light bulb in the center is at maximum brilliancy. The next adjustment is to slide the antenna feeder to different positions on the antenna so that both light bulbs on the feeder have the same brilliancy. If the light bulb on the antenna is at maximum brilliancy and the two light bulbs on the feeder are equal, the feeder is a non-resonant transmission line and the antenna is cut to the proper length.

A final check is made by moving one of the feeder light bulbs approximately 4'. After this adjustment has been made, the two feeder light bulbs should remain equal in brilliancy. If there is a difference in brilliancy, the feeder will require additional adjustment at the antenna.

Although the light bulbs make fine power output indicators as well as modulation indicators, it is recommended that they be removed after all adjustments have been made. If the neighbor's radio jumps off the table and these light bulbs light up at the same time, the neighbors undoubtedly will conclude that your transmitter had something to do with their particular problems.

-30-

HERSHEL'S SPECIAL SUMMER VALUES!

MINE DETECTOR

- SCR 625 used Brand new \$49⁹⁵ 69.00**
- As't mica condensers, Cat. No. C-12—per 100.....\$ 1.95
 - Wafer Sockets, 4-5-6-7 and 8 prong, Cat. No. WF-4—Per 100.....\$ 2.95
 - 12" Utah P. M. Speaker, Alnico No. 5 with 6F6 output transformer. Cat. No. ST-100 \$ 6.95
 - As't knobs push on wood and plastic. Cat. No. KP-100—per 100.....\$ 1.95
 - Johnson sockets No. 210-25W. Cat. No. JS-210..... 49c
 - Sockets for acorn tubes. Cat. No. AT-10..... 19c
 - Jacks PL 55, PL 68..... 15c
 - Powdered iron slug with Isolantite coil form to match, ideal for broad tuning E. C. O..... 25c
 - Powdered 3/8 slug..... 10c
 - 1 Meg. Shallcross Acra—Ohm wire wound resistors ± 1W..... 89c

FILAMENT TRANSFORMER

- 110-V, 60 cy. Pri. sec.—5V—3A. Shelled Case.....\$ 1.49
- 110-V, 60 cy. Sec.: 2.5V at 5.25 amps. Shelled Case.....\$ 2.45
- 110-V, 60 cy.; Sec.: 1, 5V at 10 amps.; Sec.: 2, 5V at 10 amps.; Connected in series will give 10V at 10 amps. Shelled Case.....\$ 3.95

BC 654 TRANSMITTER & RECEIVER

Frequencies range 3800-5800 KC.—calibration every 10 KC.—with crystal oscillator checked every 200 KC. Power output 17 watts, voice or CW, with tubes and 200 KC. X-tal.

\$14⁹⁵



BUTTERFLY Condensers

Oscillator butterfly assembly condenser 76 to 300 megacycles with acorn tube socket. Mounted on Condenser. Catalog No. BC 3

\$1⁹⁵

Type B — frequency range 300 to 1000 megacycles to be used with 368 AS doorknob tube. Cat. No. BC2.

95^c

POWER TRANSFORMER

Pri. 115-V, 60 cy.; Sec. 1, 255/255 80ma.; Sec. 2, 63V 3.8A.; Sec. 3, 5V 4A.; Cat. No. H.P. 15.....\$ 1.29

SCOPE SUPPLY TRANSFORMER

Pri. 110-V AC 60 cy.; Sec. 4000-V VAC 10MA; Weight 8 3/4 lbs. \$3⁹⁵

NEW BC 223 AX TRANSMITTER

801 Oscillator and 801 Power Amplifiers, 2-46 Modulators and 1-46 Speech Amplifier 4 Xtal Frequencies and Master Oscillator on selector switch. 10 to 30 watts output. Tone Voice or C.W. Mod. Ideal for 80 meter band. Comes with 3 coils TU 17A 2000-3000 Kc. TU 18 3000-4500 Kc. TU 25 3500-5250 Kc. Black wrinkle case. Includes 2 separate cases to store extra coils. Frequencies chart and tubes included, packed in original cases, less crystals at this low price. **\$29⁹⁵**
Shipping weight 125 lbs.

BRAND NEW SCR-269-F AUTOMATIC DIRECTION FINDER RADIO COMPASS

COMPLETE WITH COMPONENT PARTS **\$75⁰⁰**

The radio compass SCR-269-F was designed to be the primary radio navigation compass for the United States Army and Navy Air Forces. Constant reception is possible day or night so that fixes can always be made to establish the plane's or ship's location.

Plotting fixes is accomplished by selecting two or more stations and plotting these on the navigation map. The point of intersection of these lines, indicates the location of the craft.

This equipment comes complete with 17 tubes superheterodyne receiver which is tunable from 200-1750 KC in three bands less inverter. A complete instruction book for operation and maintenance accompanies this equipment.

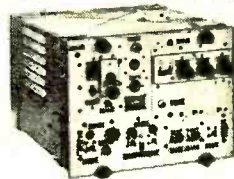

Transmitter & Receiver

The famous boat anchor, widely used on the 144 MC band. Complete power supply 110V—AC. Less power transformer and tubes. **\$14⁹⁵**
Shipping weight 100 lbs.

MODULATION TRANSFORMER 1KW \$14⁹⁵

Shipping weight 52 lbs.

RCA modulation transformer is conservatively rated at 550 Watt audio to modulate that new KW rig. Really rugged construction with protective flashover gaps, which are adjustable. Terminals and gaps are mounted on a "Mycalox" terminal board. The laminations that make up this transformer are of high audio quality and are extremely thin, making it impossible for the core to "chatter or talk".
Audio Watts—550 Sec. #1-450 Mills Sec. #2-80 Mills Turns Ratio—Pri. Sec. #1-1:1 Pri. Sec. #2-5:1 Pri. Sec. #2 Tap-25:1. Impedance Ratio—Pri. #1-1:1 Sec. #2-25:1 Pri. Sec. #2 Tap-625:1. DC Resistance—Pri. 135 ohms Sec. #1, 112 ohms; Sec. #2, 95 ohms. Transformers insulation tested: Pri. 8000V.; Sec. #2-2000V. to the rest of the coils and core. Primary center tapped for Class "B" modulators. Secondary #2 will carry 80 Mills to modulate screens of beam power screen grid tubes. Primary will match any Class "B" tubes up to 10,000 ohms plate to plate, such as 810's, 75T's, 8005's, 2B120's, 203's, H5Y12's, 211's, 813's, 82B's, 805's, 2037's. Size 9 1/2" wide, 7 1/2" deep, 7 1/4" high. Heavy channel iron mounting brackets. Weight approx. 40 lbs.

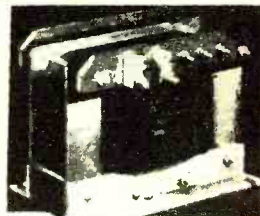

CONDENSERS

- | Cat. No. | Cap. MFD. | Working Volts | Your Cost |
|--|-----------|---------------|-----------|
| C110..... | 1..... | 5000 Oil..... | \$ 3.95 |
| C111..... | 3..... | 4000 Oil..... | \$ 4.95 |
| C112..... | 1..... | 1000 Oil..... | 44c |
| C114..... | 8..... | 600 Oil..... | 95c |
| C115..... | 2..... | 600 Oil..... | 49c |
| Westinghouse 1 MFD 6000 volts WVDC | | | \$7.95 |
| Westinghouse 1 MFD 10,000 volts WVDC | | | \$12.95 |
| General Electric 25 MFD photo flash pyranol capacitor. 2000 VDC—INT. | | | 14.95 |
| IRC type HE resistor 200 wt. tapped at 3000, 7500, 23, 750 ohms. Brand new | | | 49c |
| 144 MC Radar Osc. uses 15E or with variable coupling. Complete less tube | | | \$ 3.95 |
| Thordarson 300MA Power Transformer 110 or 220 V 60 cy. Input. Secondary: 550/ct/550 tapped at 450/450 Extra bias winding 200/ct/100 at 50ma. 18 lbs..... | | | \$ 4.95 |
| BC 191E less tubes and tuning units..... | | | \$14.95 |
| 5V Filament Transformer 60 amps. 22 lbs..... | | | \$ 5.95 |
| Ear Phones. 2000 ohms, used—in good condition..... | | | 95c |
| Ass't resistors 1/2 watt fully insulated, in popular ohmage. Cat. No. R-5 per 100 \$ | | | 1.49 |
| 1 MFD 7000 WVDC Sprague..... | | | \$1.95 |
| Plate transformer. Shelled Case. 110-V 60 cy. Pri. 800 VAC—200 MA. Sec. not tapped..... | | | \$ 3.95 |

Receiver & Transmitter SCR522, 100-156 MC. Used, in good condition. with 18 tubes and crystals. \$29⁹⁵

GENERAL ELECTRIC METERS

Type D041, 0-10MA, on 0-500 MA. 3 1/2" Round case. **\$3⁹⁵ each**

THORDARSON T48003

2H-7H 550 MA swing choke. Size 4 1/2 x 5 1/2 x 5 1/2. Square block crackle case. Cat. No. FC-205. **\$5⁹⁵**



PHOTO FLASH TUBE

High speed photo flash tube, 12,000,000 lumens light output. Stops all action. Ignition coil included on back of bulb. 10,000 flashes. Diagrams furnished on request. Your cost **\$8⁹⁵** only.....



MICA CAPACITOR .002 MFD 3000 VDC. Cat. No. RT-101..... 49c

30 MC IF Transformer in square aluminum can, silver slug tuned 29c

CORONA BALLS

Grid and plate connections for VT 127—250 TH etc. Round ball type heat dissipating silver plated. **\$1⁰⁰ each**

10^c each \$1⁰⁰ doz.

TUBES • TUBES • TUBES

- | | | | | | |
|------------|--------|-----------|------|------------|------|
| 813..... | \$5.45 | 955..... | .65 | 5BP1..... | 3.95 |
| RK60..... | 1.25 | 9004..... | .65 | 5CP1..... | 3.45 |
| VT127..... | 2.95 | 6J4..... | 1.50 | 5FP7..... | 3.45 |
| VR150..... | .69 | 6J6..... | .95 | 7BP7..... | 4.45 |
| 829..... | 2.45 | 3AP1..... | 2.45 | 9LP7..... | 5.45 |
| 872..... | 1.95 | 3BP1..... | 2.45 | 304TH..... | 6.95 |

1T4 - 1S5 - 3S4 - 1R5 59^c each
3Q4-6SN7-6SL7-6SA7

VARIABLE CONDENSERS

5 gang. app. 50MMFD per section. Air padders with worm drive 18 to 1 ratio. Flexible coupling. Condenser 6" long—1 1/2" wide—2 1/2" high. Ideal for FM and Television and R.F. section. **\$1⁹⁵**

VARIACK—1 amp—\$3.95 5 amp—\$7.95

ASS'T H. F. CHOKES.....50c doz.

- WRITE FOR FREE BULLETIN
- MICH. SALES ADD 3% SALES TAX
- MINIMUM ORDER \$2.00 FOB DETROIT

HERSHEL RADIO CO.

5249 GRAND RIVER

DETROIT 8, MICHIGAN

20% DEPOSIT REQUIRED ON ALL C.O.D. ORDERS

MORE, BETTER JOBS PER DOLLAR.

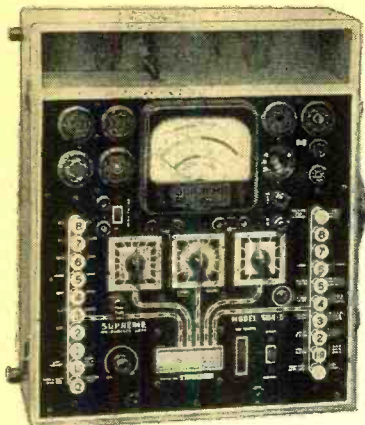

SUPREME 504-B TUBE AND SET TESTER—

the portable lab that gives you everything.

ASK YOUR SUPREME
JOBBER FOR A FREE
DEMONSTRATION



WRITE
TODAY FOR
New
CATALOG

EXPORT DEPT.: The American Steel Export Co., Inc.
347 Madison Ave., New York 17, N. Y., U. S. A.



SUPREME INSTRUMENTS CORP., Greenwood, Miss., U. S. A.

HERE'S WHY AND HOW

- **METER**—large 4-inch square-face meter, 500 microampere.
- **SPEED**—push-button operated.
- **FLEXIBLE**—simple, yet Universal Floating Filaments feature insures against obsolescence.
- **SIMPLICITY**—roll chart carries full data for tube setting. No roaming test leads when using multi-meter—only push a button.

SPECIFICATIONS

DC VOLTS—1000 Ohms per volt: 0.5-25
100-250-500-1000-2500.
AC VOLTS—0.5-10-50-250-1000.
OUTPUT VOLTS—0.5-10-50-250-1000.
OHMMETER—0-200-2000-20,000 Ohms.
0-2-20 Megohms.

Condenser Check:

Electrolytics checked on English reading scale at rated voltages of 25-50-100-200-250-300-450 volts.

Battery Test:

Check dry portable "A" and "B" batteries under load.

A 3-Element Rotary Beam

(Continued from page 63)

total weight of the array, framework, and pipe on it causing considerable friction. If this friction is too small the antenna will be found to be rotating on "its own" due to the wind; consequently there should be enough friction so that a pull on the control line is the only thing that will turn the antenna. Should there be too much friction, making it difficult to turn, then some grease can be added to the bottom bearing, although this was not found necessary.

A system using purely mechanical control such as this, with no reduction gearing, is not only cheaper, but is also more efficient than one involving gears. Any system which uses a motor to turn the beam must be geared down tremendously due to the high inherent speed of motors. When worm gears are used, and their use becomes almost obligatory due to the number of spurs that would be needed, then the efficiency is even lower and a quite large motor is needed to take care of the increased losses. Therefore a direct mechanical control as heretofore described is certainly the best control system for its cost. If your location does not seem to be as adaptable to control lines as this one, then merely add more pulleys of the "five and ten" clothesline variety and change direction or pass over or around obstacles as necessary.

The elements are spaced $10\lambda = 98.4/$ or $3'5"$ from director to radiator and slightly less than $.15\lambda$ from radiator to reflector or $4'7"$ in this case. This was shortened slightly because the lumber for the frame was available in eight foot lengths, and the gain is not noticeably affected by so doing.

So much for the mechanical details. Electrically the only new feature is the method of matching the transmission line to the antenna. This is a departure from conventional practice although it is in accordance with the general theory of matching transmission line impedance. Since the impedance of the center of a three element close-spaced array of this type is in the order of 8 ohms, and is normally within the limits of 4 and 16 ohms, and

**Step Out with
HANDY TALKY
HT-144**



You can "go places" and keep posted at the same time, with this new Handy Talky! Has press-to-talk single hand control. Telescope antenna throws on-off switch. B Battery lasts 75 hrs. reception, 45 hrs. trans. A battery 10 hrs.; easily replaced. Uses 6C4, 1S4 tubes. Size $10\frac{3}{4} \times 2\frac{3}{4} \times 2\frac{3}{4}$ ". Wt. 4 lbs. with batts.

Model HT-144 less tubes and batts. **\$34.50**

Tubes and batteries for above, READY TO OPERATE, \$3.95

New! WESTON

Proportional Mutual Conductance
Tube Checker & Circuit Analyzer



Weston's newest and most efficient instrument! All tests on all tubes. AC-DC volt-ohm-milli-ampere ranges. Durable aluminum case; Model 798-3. **\$169.50**
Mail Orders: 25% Deposit, Balance C.O.D. Minimum Order \$5.00.

Federated Purchaser
INCORPORATED
distributors of RADIO - ELECTRONIC
and SOUND EQUIPMENT
80-RR PARK PLACE, N. Y. 7
Phone: WH 4-2080

**LOW-PRICED
LARGE-IMAGE
TELEVISION
IS HERE!**

TRANSVISION'S NEW 12" TUBE KIT

At only **\$289.50*** Complete
*Note: Price subject to change downward. \$289.50 is maximum price.

**GIVES YOU LARGER IMAGE
THAN SETS SELLING AT \$500**

Here is a television receiver with a $7\frac{1}{2} \times 10"$ screen—easy to assemble in about 20 working hours. Designed and constructed by Transvision engineers with the same technical skill which goes into their 7" kit.

Just tally some of these features:

1. 12" magnetic type picture tube.
2. Receives all television channels on the air with provision for factory to add new channels as they open at NO EXTRA COST!
3. 4 mc band width for full picture definition.
4. 9,000 volts second anode potential for brightness and contrast.
5. Ratio detector for sound gives highest quality FM reproduction.
6. 22 tubes and picture tube.
7. Complete with antenna, tubes, pre-assembled and tuned R.F. Unit.

Kit comes with simple step-by-step assembly instructions. Factory guarantees clear, sharp reproduction comparable to sets selling at twice the price.

Here's a value you can't beat! Order now and be one of the first to have one of these beautiful, new Transvision sets. A \$25 deposit will assure you early delivery. Beautifully turned walnut cabinet available at slight additional cost.

7" tube Transvision kit still available at \$159.50.

Beacon Television, Inc.

Distributors for Transvision Television Kits
143 East 49th Street, New York 17, N. Y.

DEALERS: We invite your inquiry regarding an attractive money-making deal we are prepared to make with live-wire radio men!

Fig. 6. Field intensity indicator.

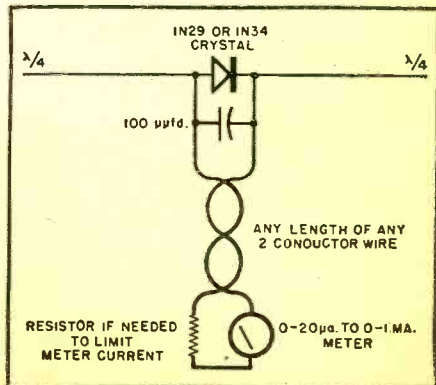

since the 72 ohm, RG-11U, coaxial cable which had been used to feed the dipole was available, it therefore became necessary to devise a matching section which would correctly match these impedances.

The formula for a quarter wave matching section is: $Z_m = \sqrt{Z_o \times Z_a}$ where Z_m is the impedance of the matching section, Z_o is the characteristic impedance of the transmission line, and Z_a is the center impedance of the radiator. Substituting the values of Z_o , 72 ohms, and Z_a , 8 ohms, yields the result of 24 ohms for Z_m , which, luckily turns out to be a value which can be obtained quite easily. It is only necessary to parallel two pieces of 50 ohm coax, RG-8U, cut to a length of: $.66\lambda/4 = 162/f$ or $15'7\frac{1}{4}"$ for the center of the ten meter band. The factor .66 is the velocity of propagation constant in the polyethylene dielectric of the coax, by which the velocity of propagation in free space must be multiplied when this cable is used, as propagation in a cable with a dielectric is slower than in air.

This section will give a perfect match for a center impedance of the radiator of 8 ohms, and values between the aforementioned limits of 4 and 16 ohms will result in a standing wave ratio on the 72 ohm line of less than two to one, which is acceptable. Incidentally the standing wave ratio on the matching section is quite high and only cable having low loss insulation, such as polyethylene, should be used. A

- 4 lengths (12 ft.) of 1/2 in. o.d., .035" wall aluminum tubing
- 1 pc. 2 x 4—13 ft. long
- 1 pc. 1 x 4—8 ft. long
- 3 pcs. 1 x 2—4 ft. long
- 2 pcs. 1 x 2—8 ft. long
- 1 baseboard about 12 in. x 12 in. x 1 in.
- 3 blocks about 2 in. x 4 in. x 4 in.
- 2 blocks to fit bottom bearing about 2 in. x 2 in. x 2 in.
- 1 1/2 in. pipe flange
- 1 in. pipe flange
- 1 in. nipple (short)
- 1 in. pipe cap
- 100 ft. of clothesline
- 14 ft. of 1/2 in. galvanized iron pipe, threaded at one end
- 3 in. pipe straps
- 1 screen door spring
- 8 #10 x 3/4 in. wood screws
- 20 #8 x 3/4 in. wood screws
- 18 #10 x 2 in. mach. screws
- 18 #10 hex. nuts
- 3 clothesline pulleys
- 1 3 in. long bolt to fit in place of pulley set screw
- 10 small ceramic standoff insulators
- 6 strap type 1/2 in. diameter condenser clamps
- 10 "U" type 1/2 in. diameter condenser clamps
- Feeder system if needed
- Matching section to suit feed system
- 1 pulley, about 6 in. diameter, hole to fit 1/2 in. pipe, with set screw
- 2 pcs. 2 1/2 in. long metal tubing to force fit into or over 1/2 in. tubing
- 2 pcs. 7 1/2 in. long metal tubing to force fit into or over 1/2 in. tubing
- 2 pcs. 4 in. long metal tubing to fit snugly into 1/2 in. tubing
- Several feet of bare wire, about #20

Parts required to build beam antenna.

standard *Amphenol* tee connector is used to connect the 72 ohm feeder to the two pieces of 50 ohm coax. At the top the two inner conductors and the two outer braids are paralleled and soldered to lugs on each half of the radiator; these lugs are fastened

with 6-32 machine screws to clamps on the elements of the type previously described for coupling the elements.

No antenna tuner is necessary with this feed system as the transmission line can be fed directly from a low impedance link of perhaps two turns, whose coupling to the final tank coil can be varied, in order to change the loading. Incidentally, the popular belief that an untuned line should not detune the final tank circuit as coupling is increased, is not true as the link itself reflects reactance back into the main winding despite the fact that its load is pure resistance, and necessitates, therefore, a change in the tuning of the final condenser in order to restore resonance. Therefore do not be misled into thinking standing waves are present by the fact that the tank condenser has to be retuned slightly as you load the final up. It should not, however, have to be adjusted too much to regain a resonant condition.

Tests have been made of the front-to-back ratio, and on a receiver several miles away the "S" meter read 50 db. above S9, when the antenna was beamed toward the receiver and S1, when the beam was pointed 180° away. This shows that the antenna is doing the job for which it was designed, as does the fact that W2NUD gets out now, whenever the band is open. If you want to squeeze every possible bit of gain out of the antenna, the element lengths can be adjusted with the use of a field strength indicator, for

Fahnestock Clips

RADIO'S GREATEST CONVENIENCE

FAHNESTOCK SPRING BINDING POST GRIPS THE WIRE BY THE ACTION OF A SPRING

No tools required to make the connection. Grips the wire with just the right pressure for good electrical contact. Simply press down, insert the wire and let go. Does not injure wire, hence connection can be made or opened as often as desired. Available in large variety of types and sizes to fit any radio purpose and any requirement as to position, space or method of attachment. You will find them in the better sets.

Positive contact; cannot jar loose. Brass or bronze—nonrusting.

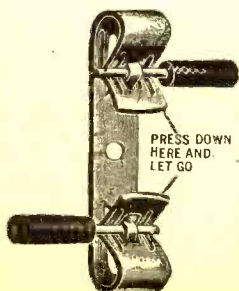
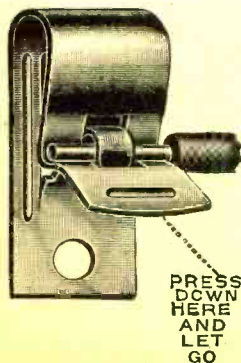

FAHNESTOCK ELECTRIC COMPANY, Inc.

46-44 ELEVENTH STREET
LONG ISLAND CITY 1, N. Y.

Dept. 12

Please send us at once, Descriptive Literature, Prices and Delivery Schedule on

FAHNESTOCK CLIPS

For

Name

Address

City..... State.....

PRE-INVENTORY SALE TRANSFORMERS

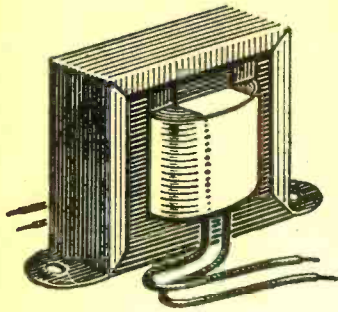

50L6 to V.C.
BRAND NEW — FIRST QUALITY
29c ea.

12 or more 25c ea.

PUSH-PULL OUTPUT

6L6 or 6F6 to V.C.
30 watts

50c ea.

12 or more 45c ea.

DRIVER TRANSFORMER

Single plate to P.P. Grids
Split Secondary

25c ea.

12 or more 20c ea.

LOW IMPEDANCE LINE TO GRID—SHIELDED

PRI 0/6/30-50 OHMS
SEC 0/100,000 OHMS

75c ea.

12 or more 70c ea.

IDEAL FOR PA WORK

100 MMFD Ceramicons
500 MMFD Ceramicons
2000 MMFD Ceramicons

2c ea.

PAPER CONDENSERS

.005—400V 3c ea.

.01 —300V 4c ea.

.1 —200V 5c ea.

10 MFD—25 volt 10c ea.

10 MFD—35 volt 12c ea.

AUTO ANTENNAS

96 in. Side Cowl \$5.95 list

Net \$2.75

50 in. Fender Mount \$7.45 list

Net \$3.65

50 in. Front Cowl \$6.45 list

Net \$2.90

Complete line of Tubes, Parts and Test
Equipment for Servicemen, Hams and
Experimenters.

**STANDARD ELECTRONICS
DISTRIBUTING CO., INC.**
1497 — 1501 MAIN ST.
BUFFALO 8, NEW YORK

25% Deposit on all Orders—
Mdse. F.O.B. our Warehouse

Write Dept. N-7

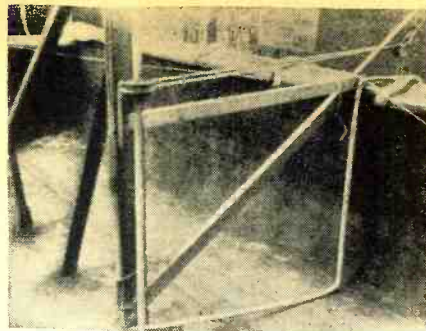

Fig. 7. Mechanical assembly of mast base.

either maximum gain in the forward direction, to put the most signal out, or for maximum front-to-back ratio, if you are interested more in rejecting unwanted received signals from the rear.

Fig. 6 outlines a simple and inexpensive field strength meter which will work nicely, if you want to experiment with element lengths by cut and try methods. However the theoretical values worked out extremely well for the author, and he is therefore content to leave the array as is for the time being at least. Perhaps when more time is available, the lengths will be set for optimum performance by means of field strength measurements.

This antenna system can be adapted for other frequencies very easily by means of the formulas given, and the method of feed can be changed to suit whatever feeders you have available. Another good combination is the familiar 600 ohm line, and a single quarter wavelength section of 75 ohm coax for matching. The new *Amphenol* twin-lead or any 300 ohm line can also be used, in which case the matching section should be a single quarter wavelength piece of 50 ohm coax. The lengths of these matching sections would also be calculated by the formula previously given as long as coaxial cable with polyethylene insulation is used; if the dielectric is some other material, then the correct velocity, which is obtainable from the manufacturer, for that material, must be used in calculating the length of the matching section. The twin-lead makes a cheaper set up if you are starting from scratch, and buying everything new; although it is only fair to warn you that some hams have experienced trouble with twin-lead when wet. The connections for 300 or 600 ohm lines are shown in Fig. 5B under alternate methods.

Many variations of the ideas presented herein are possible, utilizing the many standard feed and matching methods, if you prefer, but it is hoped that this article, containing ideas which have not previously been presented, will serve as a means of simplifying the antenna problem for other hams; and especially for those who, like the author have limited finances and lack the machine tools so often required to build the beams that have been described in the past,

You Pay Before You Play

(Continued from page 56)

often short circuited and blew out the location's lighting system! Frequently a customer's nickel's worth of time ran out in the middle of an exciting program, while the increasing use of commercial announcements blighted radio as a practical source of entertainment.

Coin sets, along with the rest of the radio industry, were hard hit by the tight squeeze of the depression. By 1932 midget models were being marketed, and, retailing for as low as ten dollars, made radio available to every American home. Coin radios lost their novelty appeal and faded from locations before the onslaught of the jukebox. Radio had created a craze for popular tunes, but only the coin-phonograph permitted patrons to select songs they wanted to hear *when* they wanted to hear them.

Meanwhile, during the late 1920's, competition between hotels took the form of providing increased comforts for the public, and one of these services was radio. Slot sets were generally ignored during this development, for first-rate hostelry believed that coin-in-the-slot devices would lower the tone of an establishment.

In the early days, a number of schemes were tried out to provide broadcasts for guests. Several hotels kept a stock of so-called "portable" battery sets on hand, which rented for a nominal fee. However, because of the need for battery renewals and elaborate loop antennas, plus the damages caused by guests' careless manipulation of the receivers, this renting plan proved unsatisfactory. Besides, when loud-speakers operated late at night they annoyed guests in neighboring rooms!

The result was the development of a centrally operated receiver and amplifier system wired to volume-controlled speaker outlets in each room. Operating along the lines of an intercommunication system, this "master-control" movement seems to have taken its impetus from installations of this type made by the Statler hotel chain in 1928. Rival hotel owners discovered that radio-equipped rooms offered a magnetic selling point to prospective guests, and soon hotel advertising all over the country began to feature the slogan "A Radio In Every Room." A few hotels charged guests fees ranging from twenty-five cents to a dollar a day for this service, but for the most part it was offered free. Such systems were expensive, however, and after the wave of bankruptcies, reorganizations, and foreclosures that hit the hotel field in the early 1930's, new radio installations became rare.

But just as the depression had killed off the coin radio and ruined the hotel business, so it was to foster the growth of the tourist cabin and revive

SAVE MONEY! SAVE TIME!

Free! on these choice pieces of equipment.
CONVERSION DIAGRAMS & SCHEMATICS WITH EACH ONE



ARMY AIR FORCE SCR-522 TRANSMITTER-RECEIVER

Gives a coverage of 100-156 MC. Ideal for aircraft communication, airport control and field operations.

When used as mobile unit or ground station, the dynamotor (supplied with set), has complete instructions for conversion to auto engine driven self-excited generator. Also uses 115 volt AC, 60 cycle motor drive. Can be converted to FM receiving and transmitting. Ideal 2 meter rig.

Priced . . . \$39.50



COMPANION OR STANDBY SET FOR BC-348 RCVR AND BC-375-E XMT

Here are a couple of things you can do with equipment included in the SCR-274-N Command Set. The transmitter VFO driver stage gives the BC-375-E higher output—as high as 150 watts. Make swell standby receivers with the BC-348 on round table "rag chews". Includes all this equipment: 3 Receivers—190-550 kc, 3-6 and 6-9.1 mc; two transmitters; four dynamotors—28 volts DC input; one modulator with carbon mike input; two tuning control boxes; one antenna coupling box with r-f ammeter; antenna relay and 5000 volt 50 mmfd. WE vacuum condenser (antenna relay can be used with most rigs); and a complete set of tubes for each unit—29 tubes in all. Complete diagrams and instructions on other conversions and uses furnished with set.

Priced . . . \$39.00

BC-221 FREQUENCY METER

Here's something to add to your equipment. A heterodyne frequency meter complete with tubes and guaranteed accuracy of 0.01% or 500 cycles whichever is greater. Dial readable one part in 50,000 MC. Better than two dial division per kc.

Fundamental ranges are 125-250 and 200-400 kc. Uses 110 volts AC, batteries, or vibrator. Makes a fine signal generator—or converts to VFO.

Used . . . \$39.50

Brand New \$59.50

With Modulation . . . \$74.50

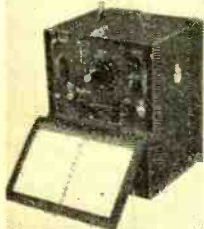

ARMY AIR FORCE BC-375-E TRANSMITTER

Has five tubes, 5 tuning units, covering 200 kc to 12 mc (less BC band). Equipped with antenna tuning unit—BC-306A—variometer and tap switch. Dynamotor (PE-73-C) complete with relay, fuses and filter. Diagram and instructions for its many uses supplied with each set. Weight approx. 275 lbs.

Priced . . . \$29.50

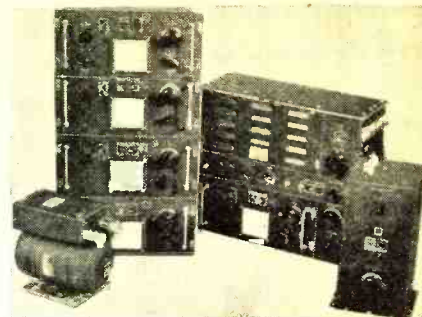

VFO DRIVER 40 WATTS OUTPUT

Four different transmitters are listed below covering the spectrum from 3 to 9 mc.

BC-696-A 3-4 ms. . . . \$12.50

BC-457-A 4-5.3 mc. . . . \$8.75

BC-458-A 5.3-7 mc. . . . \$11.50

BC-459-A 7-9.1 mc. . . . \$11.50

The above mentioned transmitter makes an ideal VFO driver with at least 40 watts output. Excellent small transmitter for mobile and ground stations. Master oscillator, power amplifier, gang-tuned, dial directly calibrated. Easily adapted to any power requirement. Built in antenna tuner. COMPLETE DIAGRAMS FURNISHED FOR MAKING CONVERSIONS.

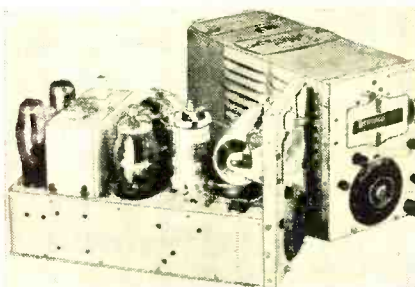

BEAUTIFUL SUPER-HET RECEIVERS

Ideal companion or standby receiver for your shack. The following receivers are available:

BC-454 3-6 mc. }
BC-453 190-550 kc. } \$9.50 each
BC-455 6-9.1 mc. }

Receivers are furnished complete with tubes and dynamotor.

The above mentioned receivers require as is 24-28 volts DC to operate but are easily converted to 110, 60 cycles, VAC, with small selenium rectifier power pack. This beautiful super-het receiver is one of the outstanding buys in the surplus market. Don't take a chance in not being able to be a proud owner of one of these fine sets, order today. CONVERSION DIAGRAMS FURNISHED.

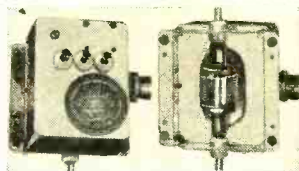
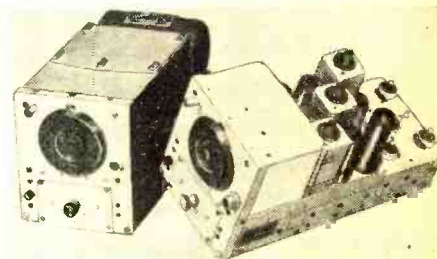

ANTENNA RELAY

BC-442-A. SWITCHING RELAY, ANTENNA CURRENT INDICATOR with 19.5 millivolt movement, current transformer and thermocouple, 50 MMFD vacuum condenser, fixed, 5000 volt rating. (CAN BE USED WITH ANY RIG). ONLY

\$2.45

ANTENNA TUNING UNIT BC-306-A

The ideal RF antenna loading unit, designed to operate from 150 to 800 kc. Has an excellent rectangular aluminum case, 16"x8"x8",

contains one ceramic, high power antenna switch, large variometer, top has two bee-hive feed through insulators, one ground binding post. Face has one standard ball knob and one velvet vernier drive dial. It makes an excellent amplifier or portable transmitter case. Weight 10 lbs.

\$7.75 each



Save C.O.D. Charges by Remitting in Full Direct . . . TO R & M Radio CO. . . .
or Send 25% Deposit on All Orders.

We save you time and money by shipping direct to you from our nearest warehouse . . .
located in the East, Mid-West and West Coast.

R & M RADIO COMPANY

1426 N. QUINCY STREET • ARLINGTON, VIRGINIA

A TELEVUE FIRST

New type layout with packaged parts and instructions make wiring and assembly simple even for beginners.

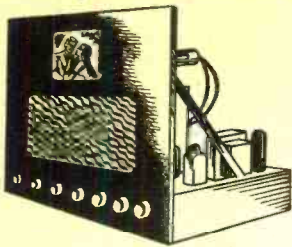

A TRULY MODERN TELEVISION KIT

Compare These "TELEVUE" FEATURES:

- ➔ R.F. Amplifier Stage
- ➔ Detail Master 7" Screen
- ➔ Lock-in-Sync Circuit
- ➔ High contrast, bright picture—daylight viewing
- ➔ Safe R.F. 4000 V. Power Supply
- ➔ 3.5 MC Band Width
- ➔ Latest Type Sound Circuit

Kit complete with all parts, including picture tube, wire, 20 tubes, stamped chassis, wired R. F., Mixer and Oscillator stages, wired R.F. High Voltage Supply; Finished Front Panel—Pre-set I.F. coils—Dipole antenna and 50' low loss lead-in wire. Price **\$152.50**

Selected hand rubbed wood cabinet engineered and custom built for the "TELEVUE" SET **\$25.00**

Also Available

We will completely wire and align set—ready to plug in. Complete with lead-in and Dipole antenna, and 50' of lead-in wire.

Terrific value..... **\$225.00**

OPERATES ON 110 V. 50-60 CYCLES-AC



FOR STEADY
LOCK-IN SYNC
PICTURES

EXPERIMENTERS

4000 V. safe R.F. power supply available as a separate unit, completely wired, shielded, with tubes and ready to mount on your chassis. Dimensions: 3 3/4" x 7" x 3 3/4" **\$19.95**

20% deposit with order, balance C.O.D.
**ORDER YOUR "TELEVUE" SET
TODAY FOR IMMEDIATE DELIVERY
UNCONDITIONALLY GUARANTEED**

Address orders and inquiries to

**TELEVISION DEVELOPMENT
LABORATORIES, INC.**

252 W. 64th St., New York 23

the slot sets. Tourist courts had grown along with the auto, and by 1930 they began to flourish along transcontinental highways and on the outskirts of towns. As hard times arrived, tourists headed for these economy priced cabins, and a large portion of the hotel trade siphoned off to the "motels."

Soon the auto court was booming into a big business, and by 1935 "motels" began to compete and rival each other for trade with inner-spring mattresses, showers, etc. According to one trade legend, radios were introduced in this competition when one alert tourist court owner noticed that his guests would drive their cars alongside their cabins to listen to a favorite program on the automobile radio going full blast!

Sensing a new potential market for the forgotten coin radio, a California manufacturer dusted off the coin-in-the-slot idea and produced a model which would play for two hours when a quarter was inserted. Lacking the red-plush background of the hotels, the informal tourist courts saw nothing wrong with installing the dividend-paying coin devices, especially when guests welcomed the idea. By 1940, several thousand sets were in use, primarily in West Coast motor courts.

Over this period of time coin-radio construction had undergone many modifications, and models were no longer merely adapted for slot operation but were engineered for it. For one thing, sets had to be given durability, for it is a maxim of auto court operation that the average "motel" room takes more punishment in the way of cigarette burns and liquor stains in the course of a year than the normal home receives in a lifetime. Then the slot mechanisms on sets had to be improved, as a bent quarter would clog a coin chute and render the radio inoperative. Slug detecting devices and pick-proof locks had to be incorporated in the sets, for guests were not above that ever-present human weakness to get something for nothing and "beat the machine." Next, a system had to be devised for either bracketing the cabinets to walls, or building sets into pieces of furniture, as there were occasional instances where a guest became so "attached" to the coin radio that he took it along when he departed. This led one manufacturer to advertise in 1940 that his sets were big enough *not* to fit in a suitcase!

With the end of the war and reconversion, coin radio production got under way again with a bang, and today more than twenty manufacturers are in the field. Benefitting from war-born improvements in technology, modern slot sets are specifically tailored for trouble-free reception to minimize service calls. The average coin radio is a 5 or 6 tube superheterodyne, housed in a sturdy steel cabinet to resist lighted cigarettes and alcohol. Its coin chute rejects slugs and bent coins, and accepts several quarters at a time

to enable a patron to "bank" his quarters in order to keep the radio from shutting off at the expiration of time paid for by one coin. Sets are equipped with built-in aerials, although the steel framework of some hotels requires the use of an additional baseboard antenna. An a.c.-d.c. inverter is also necessary in large city hotels where only 110 volt d.c. power is generated.

One problem that plagues all coin-operated devices is tampering, and several slot sets are now protected by use of a heavy die-stock back plate, reinforced by a steel band riveted around the edge, and secured by a pick-proof lock. A steel dial plate is also used on the front of the cabinet to prevent access to the set through the dial opening. As an additional precaution, the coin-box, formed of hardened steel, is welded to the interior of the cabinet and fitted with a separate lock.

All these safeguards have lowered insurance rates on coin radios, and the sets are now insured against fire, theft and malicious mischief for less than a dollar a year. To illustrate the invulnerability of modern models, the story is told of one larcenous guest who made off with a slot set, its brackets, and part of the hotel room wall. After a day of vainly trying to get into the cabinet, he disgustedly dumped the set back at the hotel with a complaining note: "I can't open this thing, and I have to drop in a quarter when I want to play the radio."

Because of servicing problems, most locations have remained out of the operating end of the coin radio business, turning it over to concerns specializing in the coin field in return for a percentage of the sets' earnings. This means that the location has no capital investment tied up in receivers, no depreciation worries, no obsolescence problem when new models appear, and no insurance headaches. Under such an arrangement, the location's only obligation is to furnish the electricity that runs the radios.

Slot sets operate at varying rates in different sections of the country, ranging from a half hour for a dime to three hours for twenty-five cents. A few models employ dual coin chutes and will accept both quarters and dimes. The most widespread plan of operation calls for locations to normally receive 25% of the receipts derived by these sets under a three year agreement, plus a renewal option for an additional three year period raising the location's commission to 35%. A coin radio is expected to gross a minimum of \$52 a year, and the operator installing the slot sets is privileged to remove his equipment in the event they do not average a dollar per week per unit over any three month period.

Having met public acceptance as a goodwill builder for the tourist court, the rival hotel field has lost little time in recognizing the slot set as an asset, and a means towards deriving extra day-to-day revenue from rooms. In



ESSE Specials!

BEAM ROTATING MOTOR

SHOWN ON LEFT

By simple conversion these motors cannot be excelled for rotating your beam antenna. Operates from 20-35 V. AC or DC. Motor: 1/3 H. P. reversible with 7,000:1 gear reduction ratio. Speed approximately 1 revolution per minute. Has heavy thrust bearing, permitting heavy weights to be borne directly. Motors are removed from electric propellers of surplus aircraft.

Price, each, including conversion data _____ **\$14.95**

BEAM ROTATING MOTOR - CONVERTED

Motor Shown on Right Converted and Ready for Use

Price _____ **\$37.50**

TRANSFORMER, specially built for operation of the above mentioned motors: 110-120 V. 60-cycle input, 28-32 V. output.

Price _____ **\$4.95**

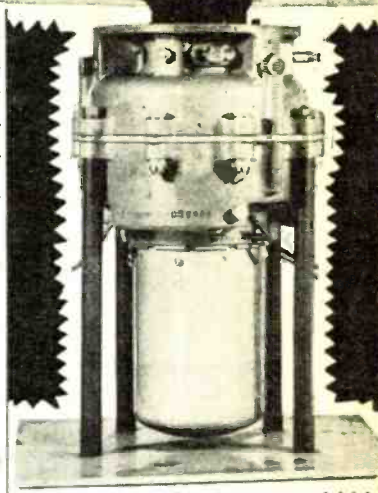
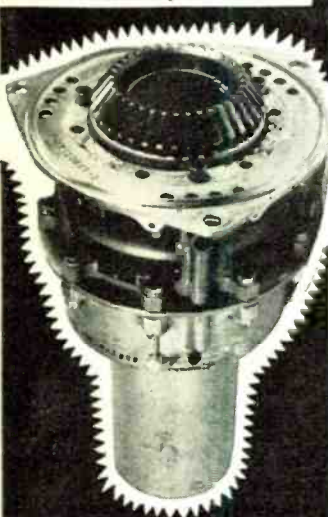

BC 348 RECEIVERS

Used but reconditioned and guaranteed.

Price _____ **\$47.95**

ARC 4 TRANSMITTER AND RECEIVER

For operation VHF frequencies in range of 140-152 mc. Four channel crystal controlled, manufactured by Western Electric - 12 or 24 V. operation.

Price _____ **\$29.75**

SCR 522

Complete with dynamotor and remote control.

Price _____ **\$27.50**

BC-654 A

Complete with tubes, less power supply.

Price _____ **\$12.50**

ART-13 COLLINS AUTO-TUNE TRANSMITTER

Price _____ **\$88.50**

BC-733 D LOCALIZER RECEIVER

Price _____ **\$8.50**

R-89/ABN-5A GLIDE PATH RECEIVER

Price _____ **\$8.50**

BC-433 ADF RECEIVER

Less dynamotor, loop, etc. _____ **\$31.50**

ARB AIRCRAFT RADIO RECEIVER

Complete with dynamotor and remote controls.

Price _____ **\$29.75**

SELSYN INDICATORS

Selsyn Indicators

For use with beam rotators for indication of direction of beam. Operate from 15-24 V. 60-cycle AC supply. Complete with Selsyn Transmitter and wiring instructions.

Price, large model

\$11.50
5-INCH DIAMETER

Price, small model

\$9.50
3-INCH DIAMETER

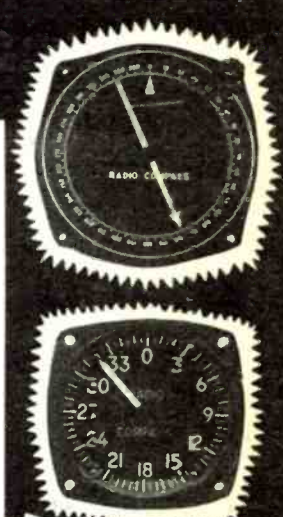

TERMS:
CASH
WITH
ORDER



Radio Company

130 W. New York St. Indianapolis 4, Ind.

For Faster Soldering

5-SECOND HEATING

Ready to solder in 5 seconds.

LESS TIP RETINNING

Heats only when needed.

FAST COOLING

Ideal for service calls.

WELLER

SOLDERING GUN

110 Watts
115 Volts
60 Cycles

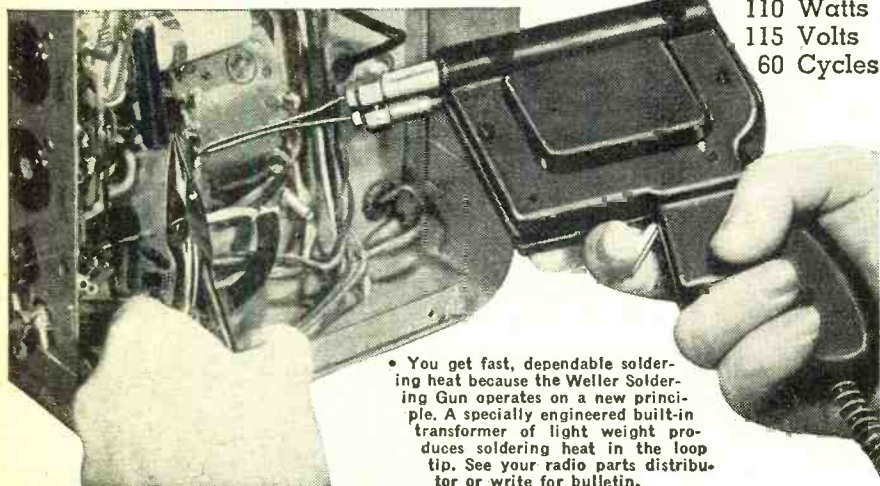

You get fast, dependable soldering heat because the Weller Soldering Gun operates on a new principle. A specially engineered built-in transformer of light weight produces soldering heat in the loop tip. See your radio parts distributor or write for bulletin.

WELLER MFG. CO. 810 Packer St., Easton, Pa.

In Canada: Atlas Radio Corp., Ltd., 560 King St., N. W., Toronto, Ont.
Export Dept.: 25 Warren St., New York 7, N. Y.

AVAILABLE NOW FROM STOCK

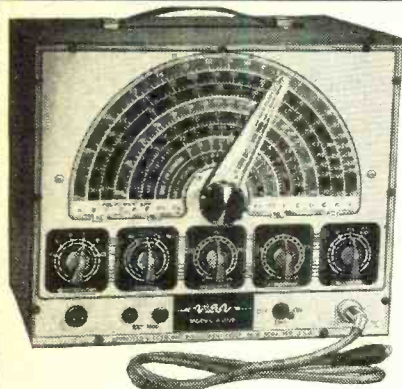

SIGNAL GENERATOR

Range from 100 kc. to 75 mc. Multicolor dial has eight scales in color for easy reading. Large plastic pointer assures fine frequency tuning. Handsome gray crackle finish metal case is ruggedly built for absolute stability.

B2880—While they last... \$39.50

Write for New Free Price Bulletin



731 West Washington Boulevard
DEPT. N CHICAGO 6, ILLINOIS

GOV'T SURPLUS

TUBES

55 MMF FEED Through.....	20 for	\$1.00
.02—1600V Paper.....	10 for	1.00
.1—600V Paper.....	10 for	1.00
100K Pot.....		.15
6V6—Metal.....		.89
5Y3 GT.....		.45
No. 80.....		.45
Resistor Kit—½ & 1 W 100 assorted..		2.00
Condenser Kit—.01—.00001—100...		3.00
Bathtubs—3 x .1, .5, .1 etc. 400V & 600V.....	10 for	.89

OIL-FILLED CONDENSERS		TRANSMITTING MICRA CONDENSERS		
—G.E., C.D., ETC.				
10	600 V	\$.80	.02 600 V	\$.19
8	600 V	.70	.002 600 V	.08
8	1000 V	1.75	.002 2500 V	.27
6	2000 V	2.95	.003 2500 V	.33
4	600 V	.50	.001 2500 V	.18
4	1000 V	1.00	.004 2500 V	.36
2	1000 V	.60	.00005 2500 V	.11
.05	1000 V	.30	.005 600 V	.08
.1	2500 V	.95	.0005 2500 V	.15
.1	7500 V	3.25	.002 3000 V	.66
.5	1000 V	.20	.00005 5000 V	.95
.5	2000 V	.40	.0025 5000 V	.95
1.	600 V	.20	.00072 5000 V	.95
1.	1000 V	.75	.0008 5000 V	.95
2.	600 V	.35	.0015 5000 V	.95
2.	4000 V	4.45	KIT of 12	3.98
3 x 2	4000 V	3.95		
3 x 10	90 V AC	.40	.12 15000 V	6.95
10 x 25	600 V	.20	.25 4000 V	2.75
.75	2000 V	.55	.25 6000 V	4.00

\$2.00 min. order F.O.B., N. Y. C. Add postage.
50% deposit, balance C.O.D. with all orders
Manufacturers inquiries invited.

TECHNICAL RADIO PARTS CO.

265 Greenwich St. Dept. N-2 N. Y. 7, N. Y.

catering to the hotel trade, cabinets have been smartly designed in several colors to blend with any room's decorative scheme. Another feature of the coin radio is acoustically modulated variable volume which is preset when a set is installed to insure that neighboring rooms will not be bothered by the nighthawk who likes to play his set at 3 a.m. A carefully planned servicing system calls for regularly scheduled coin collections, cleanings, and check-ups.

The best sites for slot sets appear to be locations with a high transiency rate, for experience with guests has indicated "the shorter they stay, the more they play." Hostelrys catering to a rapid turnover of guests, such as tourist courts and commercial hotels, are regarded as the most consistent coin-catching locations, in contrast to seasonal resorts, open only for a few months of the year, and residential hotels, where permanent guests are apt to own their receivers.

General hospitals, servicing a large number of patients who stay for short periods, are potential profit-making sites for coin sets, for radio has proven the ideal antidote to boredom in bed. Hospital models feature a jack which automatically cuts out the radio speaker when in use, and permits utilization of an under-the-pillow type speaker. Developed for use in Veterans' Hospitals to replace the old style awkward headphones, the pillow-speaker enables the occupant of one bed to listen to his set while his neighbors sleep.

Latest gadget to be incorporated in the coin radio is an electric alarm clock, which can be regulated by guests. This device is designed to attract attention to the presence of the coin radio, which, in turn, provides a constant invitation to drop a quarter in its slot. Several coin radio manufacturers have FM models in the blueprint stage, while one firm has announced plans to produce a coin-operated television set, although its potentialities are at present hampered by the relatively few areas receiving video transmissions and by the limited program schedules available even there.

As the wartime flood of hotel and "motel" patronage has begun to level off, rival managements once again are vying for patronage by adding up-to-date refinements. If a guest is to make a choice between two hostelrys which are otherwise equally attractive, he will tend to favor the location providing the additional comfort of a radio in his room. Thus, the pay-before-you-play radio seems destined to become a standard fixture in the traveler's home-away-from-home.

In seeking new markets for its output, the American radio industry is setting its sight on the coin-operated set. Conservative estimates forecast the sale of a million coin models for hotel, tourist camp, hospital, club and restaurant locations, besides creating a brand new radio servicing business potential. In addition, Canada and

RADIO NEWS

An Answer to Your Needs!

RADIO TEST INSTRUMENTS

by Rufus P. Turner

Consulting Engineer, RADIO NEWS

TELLS HOW TO CONSTRUCT, CALIBRATE, AND USE ELECTRONIC AND RADIO TEST EQUIPMENT

This well illustrated and practical manual will be an asset to any radio man's service library. It shows how to build, how to properly calibrate, how to use dozens of different types of radio and electronic testing devices. It covers briefly the theoretical explanation of radio, but only to make sure the reader first understands electrical and radio theory. The major portion of the book is devoted to technical data, which is presented in clear, understandable language. An ideal text for the practical radio man and a *must* for the radio serviceman.

Graphically Illustrated

Included are 182 informative illustrations—diagrams, charts, tables, and photographs—carefully chosen by the author to illustrate his sixteen chapters. RADIO TEST INSTRUMENTS is a unique presentation of a culmination of the author's own practices and applications. He has constructed and calibrated, tested and built, each piece of equipment described. And he shows how you can build and use these test instruments.

Covers Fully All These Test Instruments

- Multipliers
- Resistors
- Multi-Range Voltmeters
- Multi-Range Ammeters
- Ohmmeters
- Ultra-High-Resistance Meg-ohmmeters
- Volt-Ohm-Milliammeters
- Wattmeters
- Vacuum-Tube Voltmeters
- Decibel Meters
- Bridge-Type Impedance Meters
- Direct-Reading Impedance Meters
- Simple Capacitor Checkers
- Compact Capacitor Checkers
- Simple Coil Checkers
- Substitution-Type Capacitance Checkers
- Resonant Inductometers
- Precision Resistance Bridge
- High-Gain Null Detectors
- Oscilloscopes
- R.F. Test Oscillators
- and many others

Price \$4.50. Use convenient coupon with full return privilege

ZIFF-DAVIS PUBLISHING COMPANY
185 North Wabash Avenue, Chicago 1, Ill.

August, 1947

REVISED EDITION
NOW AVAILABLE!

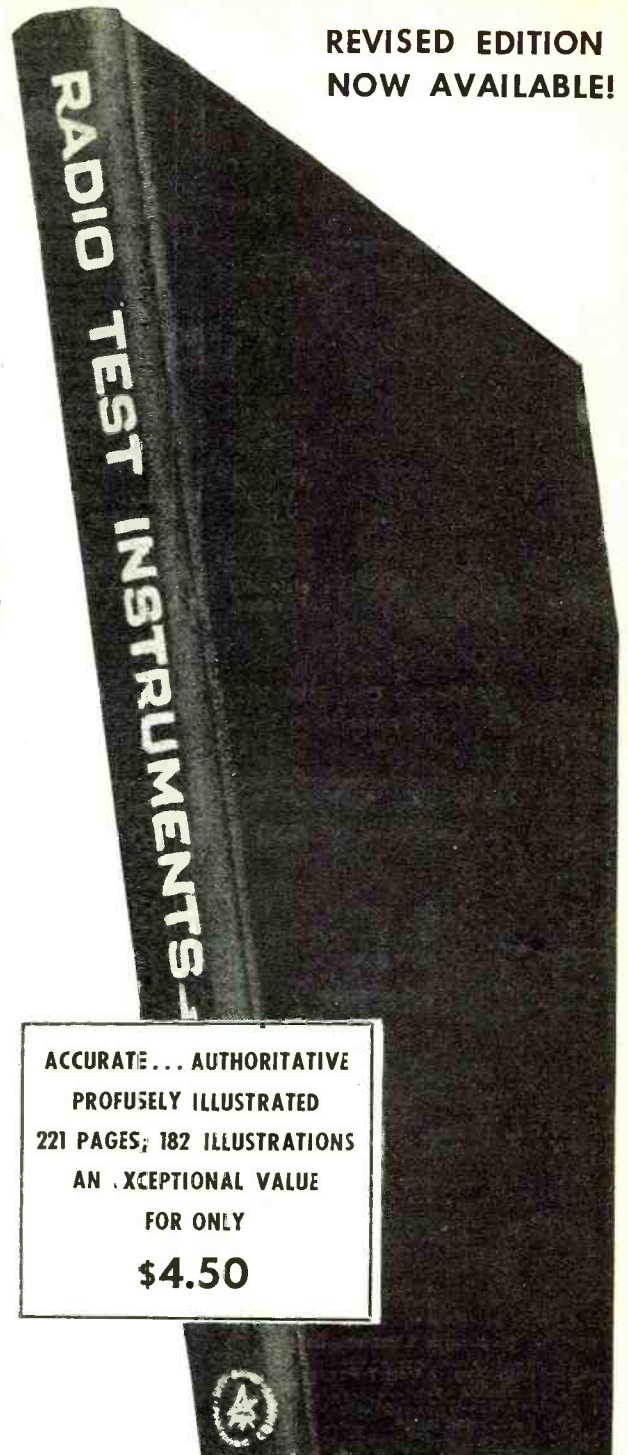

ACCURATE... AUTHORITATIVE
PROFUSELY ILLUSTRATED
221 PAGES; 182 ILLUSTRATIONS
AN EXCEPTIONAL VALUE
FOR ONLY
\$4.50

MAIL THIS COUPON TODAY

Ziff-Davis Publishing Company, Dept. RN-8
185 North Wabash Ave., Chicago 1, Ill.

I am enclosing \$4.50 (check or money order) for which please send me one copy of RADIO TEST INSTRUMENTS. I understand that I may return book within five days for full refund if I am not entirely pleased.

Name

Address

City State

Amsco PRESENTS...

Allwave Television and FM antenna complete with mounting pole, guy wires and 300 Ohm line lead-in, from 55 to 195 Meg.

\$11.85

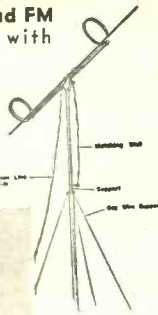

Transmitter and Receiver

(Slightly Used)
V.H.F.
Approximately 450 M.C. Complete with 17 Tubes.

\$19.95



Klystron Osc. Tube 2K25/723AB operates on 3 cm. . .

\$5.75

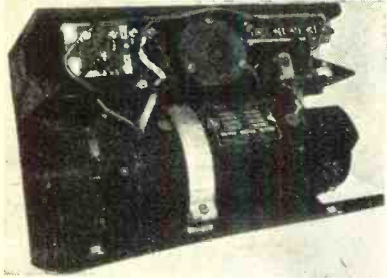

DYNAMOTOR (SLIGHTLY USED)

Input 24 V D.C. 12 Amp. Output
300 V D.C. .26 Amp.
150 V D.C. .01 Amp.
14.5 V D.C. 5 Amp.
With Voltage Regulator and Filter System. . .

\$5.95



MICRO AMMETER — Beede 0-200 D.C. \$3.29
MILLIAMPER METER — Beede 0-1000 D.C. \$3.95
METER RECTIFIERS
Full Wave . . . \$0.95
Half Wave65

- PHONO. OSC. with Selenium Rectifier \$5.29
- VIBRATOR—Syn. 2 Volt 7 Prong for G.E. Portables, etc. 1.59
- MICROPHONE—T-24 carbon with push switch and cable. .98
- MIKE BUTTONS—1" carbon contact type T-30. 3 for .79
- AIR TRIMMERS—12 assorted. 1.19
- RESISTORS—1/2 and 1 Watt, 500 assorted 7.95
- MICA CONDENSERS—25 assorted. .95
- CAPACITOR Dry Electro. 40-40-150 Volt. 6 for 1.95
- WIRE SPLICING TOOL. .49
- 5CPI TUBE 2.95
- PARABOLIC REFLECTORS — 15" spun alum. Alzak fin. for 1200 Mc. up. Pr. 3.95
- 5CPI TUBE 2.95
- 5CPI TUBE SHIELD. .79
- PHASE SHIFT CONDENSERS — 2 sections, split stator 4-15 mmfd. silver plated. .69
- FM ANTENNA (under rug installation) 88-108 Meg. 2.96
- HEADPHONES H530. .59

Write for circular featuring radio components at bargain prices.

AMERICAN SALES COMPANY

1811 West 47th Street
Chicago, Illinois

Latin America offer a fertile export field.

The automobile radio materialized from nowhere in 1935 to tap a new production outlet that now accounts for 10% of America's sixty million radio sets. Today, the coin operated radio appears to be ready to play similar sweet music for the radio manufacturers of 1947. —50—

Alignment of TV Receivers

(Continued from page 65)

Before proceeding, it is important not only to know the end result required, but also something of the behavior of the circuits involved.

One of the most common and effective methods of obtaining broad amplifier selectivity in r.f. and i.f. circuits is to employ the conventional double tuned over-coupled transformer. The coupling coefficient commonly used in video, r.f. and i.f. transformers is adjusted so that the amplitude vs. frequency characteristic just begins to show a double peaked response. Since the television receiver consists of many such transformers, each stage must be adjusted in such a way that the over-all response characteristic, which is a product of all individual stage responses, approximates as closely as possible the ideal curve. Standard practice requires that the video carrier frequency be down 6 db. or 50% of mid-band amplification and that video response to the accompanying sound carrier be in the order of minus 40 db. (voltage) or more. In practice, peaks and troughs in the selectivity curve will result. It is usually considered satisfactory to adjust the over-all response curve so that the troughs, or minimum response points within the bandpass are never less than about 70% of peak values.

Extreme peaks may be caused by regeneration or undesired oscillations in the receiver under test, however, in commercial units or completed designs, they are most likely due to improper alignment. To illustrate how improper tuning may cause an improper selectivity curve, let us observe some fundamental facts about over-coupled, double-tuned coupling. Fig. 4 shows how the conventional double-tuned r.f. transformer is affected by various conditions of coupling and tuning. Curves 1, 2, 3 of Fig. 4 indicate the effect of varying coefficient of coupling between the coils. As the coupling is increased beyond a critical point, the well known double peaked curve appears, and, assuming that L_p , C_p and L_s , C_s are tuned to the same frequency, the peaks will be almost equal in amplitude and quite symmetrical. In the usual designs, television circuit couplings are adjusted so that they exhibit the double peaked characteristic to varying degrees. Unfortunately, in the over-coupled circuit, particularly where heavy damping is used, it is difficult to obtain the correct response characteristic so important

in the television receiver, unless tuning is done carefully and with a knowledge of the behavior of the circuits being aligned. Fig. 4B shows effects of improper tuning of the transformer. In this case, where the secondary is heavily loaded, the stronger peaks will follow the tuning of the primary, or in other words, if the resonant frequency of $L_p C_p$ is lower than $L_s C_s$, then the stronger peak will be the lower frequency peak. Conversely, if $L_p C_p$ is tuned higher in frequency than $L_s C_s$, the stronger peak will be on the high frequency end of the bandpass. The effect of mistuning will be determined by the type of loading, and the usual methods of damping may be either damping both primary and secondary equally or loading down the secondary coil alone. The latter method is most commonly used. Where both primary and secondary are loaded equally, (equal Q's) the effect of asymmetry due to mistuning will not be as pronounced. Note that the effect of mistuning is similar to increasing the coefficient of coupling between the coils.

Improper tuning may result in non-symmetrical peaks of unusually wide separation. If an amplifier, designed for reasonably flat response over a given bandwidth exhibits widely separated peaks with a deep trough in the center, one may suspect that the transformers are badly mistuned. The effect of mistuning is that the effective coefficient of coupling is increased in proportion to the degree of mistuning. The family of curves in Fig. 4B shows the effect on the frequency vs. amplitude response curve of a double-tuned transformer as the primary and secondary circuits are tuned correctly (curve 1) then tuning the primary to a higher frequency, (curves 2, 3), etc. In this case, the damping resistor or load is mainly on the secondary coil. Note how the asymmetry and width of the curve increases as the mistuning is increased. The effect shown in Fig. 4B is very useful in providing information as to the degree of mistuning in the particular circuit under test. The experimenter can tell by observing the selectivity curve, just in what direction adjustments shall be made.

Alignment of a Typical Television Receiver

The most important section of the television receiver as far as determination of its selectivity or bandpass characteristic is the i.f. amplifier. The quickest and most accurate way of aligning its many tuned circuits is by visual means. The procedure, although in many ways similar to methods used in aligning a broadcast or communication receiver, requires, if the job is to be done properly, an oscilloscope, a wide-band FM or sweep generator, and a calibrated wavemeter or an ordinary signal generator. The latter equipment is used as a frequency marker, which will be found necessary if quantitative measurements are to be made directly on the cathode-ray tube screen. This so-called marker may be

provided as part of the sweep generator or may have to be supplied as auxiliary equipment. Its function is to superimpose on the visual alignment trace a small "pip" or notch which indicates the frequency at any point on the curve. The visual alignment curve is merely an electronically drawn graph, with a marker to indicate the frequency at any point along its horizontal axis. Amplitude or gain measurements on the graph may be made directly.

The setup for alignment of the television receiver is indicated in Fig. 5. The sweep generator is first connected to the last i.f. grid and its output and frequency adjusted so that the uneven trace appears on the scope. Observation of the first trace will indicate the necessary adjustments to be made. A thorough understanding of the behavior of the circuits involved is useful here but not completely necessary as a few adjustments while observing the visual trace will indicate the effect of tuning. If errors are made in early adjustments, they may be compensated for later by an over-all "touch-up."

The usual procedure in i.f. alignment is to tune and check each stage starting from the output i.f. amplifier and working "backwards" toward the front end of the receiver. The important points to check on the resultant over-all curve are the video carrier, i.f. frequencies, sound i.f. frequency and any irregularities that may appear. The picture i.f. carrier frequency should correspond to the 50% response point on the high frequency side of the bandpass and the sound traps incorporated in the video amplifier should be tuned so that the trace shows a marked dip at the sound i.f. carrier frequency. The relation between the peaks and troughs within the bandpass should be such that the amplification is never less than about 70% of maximum. Excessive peak amplitudes are usually due to improper tuning, however, as mentioned previously, any tendency toward regeneration may cause excessive amplification at one particular frequency and introduce a very strong peak. Sometimes improper connection of the sweep generator output lead may cause regeneration or oscillation that ordinarily is not present and may lead to erroneous results. It is always desirable to connect the "hot" output lead directly to the circuit with as short a lead as possible and to connect the ground side of the output cable to a point close to the ground return of that stage.

After a trial alignment test has been carried out on the i.f. amplifier, it is well to check the over-all response curve as indicated on the scope thoroughly as to amplitude vs. frequency measurements. Always adjust the horizontal sweep width and the sweep generator output so that the visual trace is centered and covers a good portion of the screen. To measure frequencies along the trace, the frequency marker generator is put into use. The

August, 1947



The one word "greatest" best describes new MODEL 906 Signal Generator . . . greatest frequency range of 90 kc. through 170 mc. AM; 90 kc. through 210 mc. FM . . . greatest calibration accuracy of 1% . . . greatest output range — metered and continuously variable from less than 1 microvolt to over 1 volt . . . greatest freedom from strays . . . greatest "buy" in history at only \$89.90 net.

Exactly as the unequalled excellence designed and built into "VOMAX" makes it outstanding the preferred, truly universal v.t.v.m., so SILVER engineering brings you in MODEL 906 a signal generator utterly without equal.

"VOMAX"

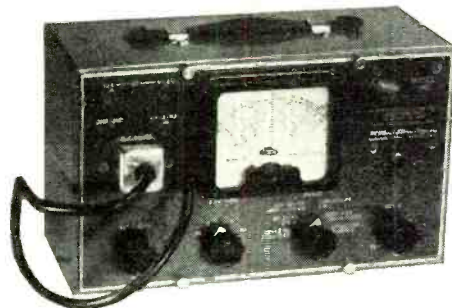

NEW FLEXIBLE PENCIL R. F. PROBE

For two years "VOMAX" has stood head and shoulders above all other meters for a.c., a.f., i.f., r.f. and d.c. voltage range . . . unequalled current and resistance ranges . . . laboratory accuracy . . . high meter input resistance . . . for real value.

Now "VOMAX" is equipped with a new, pencil-thin r.f. probe extension 5" long plus companion grounding clip and lead. With it you can reach any point in the "tightest" midget receiver chassis . . . you can bend the probe around corners if you have to! This exclusive new SILVER

development maintains "VOMAX" as the finest, most complete meter you can buy . . . still for only \$59.85 net. Present "VOMAX" users can get the new flexible pencil probe kit for 35c from their jobber.

NEW 16-PAGE CATALOG. Mail a penny post-card for complete data on these and other new SILVER products . . . famous "SPARX" visual and aural signal tracer, laboratory condenser/resistor tester, new amateur xtal-controlled all-band exciter, 80 thru 6 meter 40-watt pre-tuned frequency multiplier, transmitters, receivers, etc.

OVER 36 YEARS OF RADIO ENGINEERING ACHIEVEMENT

McMurdo Silver Co., Inc.

1240 MAIN ST., HARTFORD 3, CONNECTICUT

READ FOR PROFIT!

Just Out!

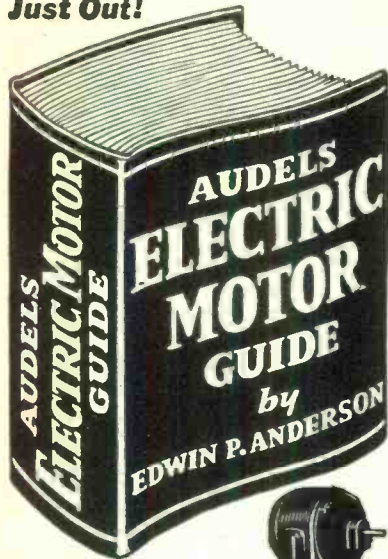

1000 PAGES OF PRACTICAL MOTOR INFORMATION

AUDELS ELECTRIC MOTOR GUIDE covering the construction, hook-ups, control, maintenance and trouble shooting of all types of motors including armature winding. Explains entire subject in every detail. 31 Chapters, 617 Illustrations & Diagrams.

A Handy Guide, Fully Indexed

for Electricians and all Electrical Workers.

\$4 COMPLETE • PAY ONLY \$1 A MONTH

Step up your own skill with the facts and figures of your trade. Audels Mechanics Guides contain Practical Inside Trade Information in a handy form. Fully illustrated and Easy to Understand. Highly Endorsed. Check the book you want for 7 days Free Examination.

Send No Money. Nothing to pay postman.

CUT HERE
MAIL ORDER

AUDELS, Publishers, 49 W. 23 St., NEW YORK 10, N. Y.

Please send me postpaid for FREE EXAMINATION books marked (X) below. If I decide to keep them I agree to mail \$1 in 7 Days on each book ordered and further mail \$1 monthly on each book until I have paid price. Otherwise, I will return them.

- ELECTRIC MOTOR GUIDE, 1000 Pages . . . \$4.
- ELECTRICIANS EXAMINATIONS, 250 Pages . . . 1.
- WIRING DIAGRAMS, 210 Pages . . . 1.
- ELECTRICAL DICTIONARY, 9000 Terms . . . 2.
- ELECTRICAL POWER CALCULATIONS, 425 Pgs. . . 2.
- ELECTRONIC DEVICES, 216 Pages . . . 2.
- RADIOMANS GUIDE, 914 Pages . . . 4.
- HANDY BOOK OF ELECTRICITY, 1340 Pages . . . 4.
- ELECTRIC LIBRARY, 12 vol., 7000 Pgs., \$1.50 vol. . . 1.
- OIL BURNER GUIDE, 384 Pages . . . 1.
- REFRIGERATION & Air Conditioning, 1280 Pgs. . . 4.
- POWER PLANT ENGINEERS Guide, 1500 Pages. . . 4.
- PUMPS, Hydraulics & Air Compressors, 1658 Pgs. . . 4.
- AUTOMOBILE GUIDE, 1540 Pages . . . 4.
- DIESEL ENGINE MANUAL, 400 Pages . . . 2.
- WELDERS GUIDE, 400 Pages . . . 1.
- BLUE PRINT READING, 416 Pages . . . 2.
- SHEET METAL WORKERS Handy Book, 388 Pgs. . . 1.
- SHEET METAL PATTERN LAYOUTS, 1100 Pgs. . . 4.
- AIRCRAFT WORKER, 240 Pages . . . 1.
- MATHEMATICS & CALCULATIONS, 700 Pgs. . . 2.
- MACHINISTS Handy Book, 1600 Pages . . . 4.
- MECHANICAL Dictionary, 968 Pages . . . 4.
- MARINE ENGINEERS Handy Book, 1280 Pages . . . 4.
- MECHANICAL DRAWING GUIDE, 160 Pages . . . 1.
- MECHANICAL DRAWING & DESIGN, 480 Pgs. . . 2.
- MILLWRIGHTS & Mechanics Guides, 1200 Pgs. . . 4.
- CARPENTERS & Builders Guides (4 vols.) . . . 6.
- PLUMBERS & Steamfitters Guides (4 vols.) . . . 6.
- MASONS & Builders Guides (4 vols.) . . . 6.
- MASTER PAINTER & DECORATOR, 320 Pgs. . . 2.
- GARDENERS & GROWERS GUIDES (4 vols.) . . . 6.
- ENGINEERS and Mechanics Guides . . . 12.
- Nos. 1, 2, 3, 4, 5, 6, 7 and 8 complete . . . 1.
- Answers on Practical ENGINEERING . . . 1.
- ENGINEERS & FIREMANS EXAMINATIONS . . . 1.

Name _____
 Address _____
 Occupation _____
 Employed by _____

marker generator is tuned to desired points of measurement within the bandpass of the trace and set so that a small "pip" appears. This "pip" will travel along the curve as the marker generator frequency is changed. Sometimes a calibrated absorption type of wave trap coupled to the sweep oscillator of the sweep generator is used as a marker. This type of marker will produce a small notch in the visual curve at whatever frequency it is tuned to, provided that it is within the bandpass of the amplifier under test.

At certain points, particularly at video carrier frequency, sound frequency, etc. on the curve, amplifier gain measurements should be made. To do this the deflection sensitivity of the scope in volts/in. should be known, and a scale used directly on the cathode-ray tube face.

The gain of the amplifier will be proportional to the height of the curve provided, of course, that the amplifiers of the scope and/or receiver are not being overloaded. Amplitude measurements are made from the top of the curve to bottom, however, it will be noticed that the axis or location of the curve in a vertical direction will change as the shape of the curve changes due to tuning adjustment. This is because the axis of the trace is actually an imaginary line extending through what might be considered the average amplitude of the vertical deflection voltage. For example, when a sinusoidal waveform is observed on the oscilloscope, its axis is considered to be a line right at the center of the curve. When the curve is not symmetrical, the curve may move up or down with respect to its axis, depending upon its shape. The effect as far as the visual alignment curve is concerned is that the curve will change its vertical position as its shape is changed but this effect should be considered apart from that due to the actual amplifier characteristic, and amplitude measurements made on the actual height of the curve regardless of position.

In Fig. 5, it is shown that the receiver output is always taken from the 2nd. detector load resistor and then applied to the scope deflection terminals. This is important since the fluctuating voltage which provides vertical deflection of the visual trace is actually a d.c. component varying in proportion to the gain of the amplifier and not the input r.f. voltage that is

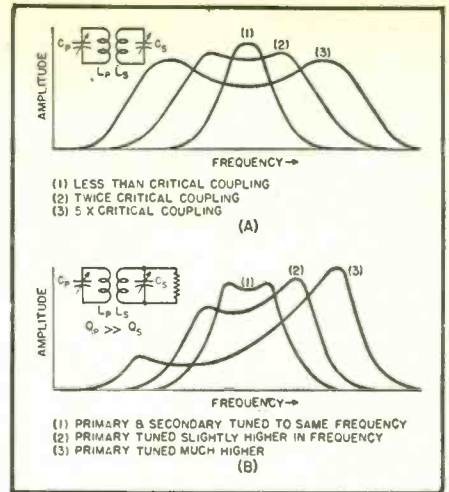

Fig. 4. Wave forms obtained by varying the coefficient of coupling (A) and the effects of mistuning on bandpass circuit (B).

applied to the amplifier. It is interesting to note that if this connection were made directly to deflection plates of the scope without any intervening amplifiers, the d.c. level of the vertical signal voltage would remain constant and the axis of the trace would remain steady regardless of tuning adjustments. This is a desirable property in a visual alignment setup but not entirely necessary.

After the i.f. amplifier has been correctly adjusted, tuning of the circuits ahead of the r.f. and mixer stages is in order. The procedure is quite similar although perhaps not as exacting. Usually the front end circuits are designed to pass a band of about 5 or 6 mc. in width so that the picture and sound carriers are situated within the front end response curve. Front end circuits should be tuned so that they do not materially change the shape of the over-all i.f. curve but merely increase the gain of the receiver as a whole.

Final Adjustment

After alignment has been completed the best check is to tune in on a local broadcaster, preferably when the standard test pattern is being transmitted. Observation of the standard test pattern will usually show up any effects of improper alignment, assuming of course that the other sections of the receiver are performing properly. If the set has been properly

Fig. 5. Visual alignment of a typical television receiver.

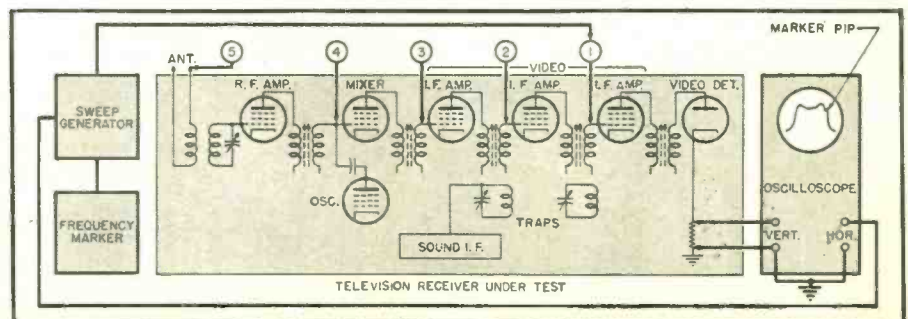

RED HOT SPECIAL!

Limited quantity for immediate shipment . . . while they last

8,000 OHM DUAL HEADSET H16/U

- Most sensitive phones built
- Hi-impedance
- Noise proof
- May be used as a sound powered intercom



BEST BUY

Light, durable, and efficient phones featuring a permanent magnet with an 8000 ohm transformer built into each unit. Molded soft neoprene earcup shaped to snugly and comfortably envelop the entire ear. Steel headband with new type adjustable sliding brackets allow earcups to be extended or retracted. Cover plates constructed of lightweight magnesium. No removable parts to become loose or lost. Especially suited to hams and commercial operators, recording engineers, aircraft pilots and similar exacting applications. Hi-impedance, extremely sensitive. May be used as sound powered interphones without use of a battery. Can even be used with simple xtal to make a complete radio receiver.

ORIGINAL COST
\$25.00

Priced at **\$2.49**

BC-728-A PORTABLE RECEIVER

Police—Shortwave—Marine—Telephone
75 Meter Ham Band—Fire Department

- Seven-Tube Superhet
- Tunes from 2-6 mc
- Operates on Wet or Dry Cell Batteries
- Designed for 2-volt input from Self-Contained Wet Cell Battery which can be recharged from 6 v. Battery
- Portable
- Can be easily padded for Broadcast Band with 300 MMFD Condensers
- Four Push Buttons
- 4" Speaker with Heavy Slug

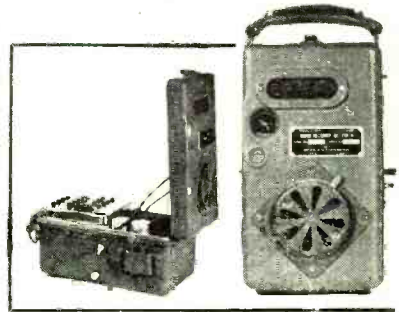

Perfect Receiver for Field Day Use or for Emergency Receiving Equipment. Pick it up and carry it anywhere. Has one stage R.F. converter, one stage I.F. detector and A.V.C. pushbutton channel selector and two stages A.F. Uses all miniature low drain tubes. This Receiver is built to rigid Army specifications, and originally designed as emergency equipment to be carried in jeeps. It is rugged . . . dependable . . . durable . . . Limited quantity.

2-Volt Storage Battery to fit Compact Space Available . . . \$3.49

Priced at . . . Complete with Tubes, Power Supply (less battery) and battery charger.

\$12.95

All prices F. O. B. N.Y.C.
WRITE FOR LATEST BULLETIN 8RN

NIAGARA RADIO SUPPLY

160 GREENWICH ST., NEW YORK 6, N. Y.
BOWling Green 9-7993

20% deposit on all orders unless rated. We prepay freight on \$100 orders in U.S.A.

MODEL 208



Engineered by specialists in the development of broadcast receivers, built in our own modern laboratory. Four times the power of pre-war radio sets. Handsomer in appearance and more efficient in operation. Visual slide rule tuning dial with built-in Regalooop, and super Alnico No. 5 permanent magnetic speaker, with automatic volume control.

FEATURES

- Six Tubes—including Rectifier
- Single Band Super-Heterodyne
- Broadcast Band 550 to 1650 K.C.
- Automatic Volume Control
- Wave Trap Rejector
- Super Sensitive Iron Core Transformers
- 5" Alnico Wonder Speaker
- Illuminated Slide Rule Dial
- Built in Regalooop

\$23.95 LIST PRICE

MODEL 1049

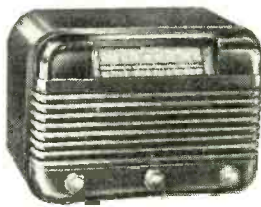

Engineered by specialists in the development of broadcast and short wave receivers, built in our own modern laboratory. Four times the power of pre-war radio sets. Handsomer in appearance and more efficient in operation. Visual slide rule tuning dial with built-in Regalooop, and super Alnico No. 5 permanent magnetic speaker with automatic volume control in the handsomest modern plastic cabinet.

FEATURES

- Six Tubes—including Rectifier
- Two Band Super-Heterodyne
- Broadcast Band 550 to 1650 K.C.
- Short Wave 16 to 49 Meters
- Automatic Volume Control
- Wave Trap Rejector
- Super Sensitive Iron Core Transformers
- 5" Alnico Wonder Speaker
- Illuminated Slide Rule Dial
- Built in Regalooop

\$23.95 LIST PRICE

MODEL 205



Engineered by specialists in the development of broadcast receivers, built in our own modern laboratory. Four times the power of pre-war radio sets. Handsomer in appearance and more efficient in operation. Visual slide rule tuning dial with built-in Regalooop, and super Alnico No. 5 permanent magnetic speaker, with automatic volume control.

FEATURES

- Five Tubes—including Rectifier
- Single Band Super-Heterodyne
- Broadcast Band 540 to 1650 K.C.
- Automatic Volume Control
- Super Sensitive Iron Core Transformers
- 5" Alnico Wonder Speaker
- Illuminated Slide Rule Dial
- Built in Regalooop

\$19.95 LIST PRICE

• ALSO AVAILABLE IN IVORY



Size:
4" wide
5" high
8" long

MODEL 747

The REGAL Super-Mite! AC, DC or BATTERY. Small enough to be packed in a suitcase, yet uses standard full size components! Parts interchangeable anywhere! The only set of its size with 5 "A" batteries and 1 "B" battery. Average life—100 hours!

FEATURES

- 4 1/2" Alnico No. 5 speaker with a heavy duty slug weighing 1.47 oz.
- Selenium rectifier (no rectifier tube necessary)
- Super-Heterodyne
- Available in six different colors
- Full size 2-gang variable condenser

\$29.50 LESS BATTERIES

WARREN DISTRIBUTORS

3145 Washington St., Jamaica Plain 30, Mass.

WRITE FOR DEALER DISCOUNT SCHEDULE

Condensers for BROADCAST-COMMUNICATION ELECTRONIC AND AMATEUR EQUIPMENT

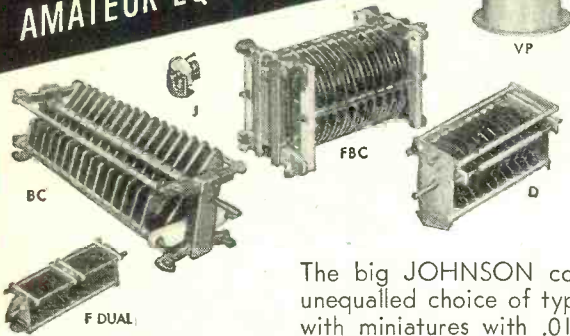

New Catalog No. 969
(ZH) Free on Request.
Specific Data furnished separately on
larger types.

The big JOHNSON condenser line offers an unequalled choice of types and sizes beginning with miniatures with .015" plate spacing, and extending through the pressurized types which offer RMS voltage ratings to 30,000 V. and capacities to 10,000 mmf. Each type is carefully designed by electronic engineers for maximum circuit efficiency. Many exclusive JOHNSON developments such as the heavy, beaded edge plates on commercial types not only increase electrical efficiency, but reduce mounting space, and through the savings in material, lower your costs.

JOHNSON Products include

Transmitting Condensers—Inductors—
Tube Sockets—R.F. Chokes— ϕ Antennas—
Insulators—Connectors—Plugs and Jacks—
Hardware—Pilot and Dial Lights—
Broadcast Components—
Directional Antenna Equipment.



FM!

FM Tuners . . .
FM/AM Tuners . . .
FM Receiver chassis . . .
High fidelity Amplifiers!

The very latest!

Custom built to precision standards. Meticulously wired by expert, trained technicians.

In the manufacture of these quality FM units, COLLINS AUDIO PRODUCTS employs only the finest in component parts, craftsmanship and the newest features in design.

See for yourself

Inspect them and you will agree there is nothing finer on the market today.

Write, call or phone.

Your inquiry will be promptly attended to

**COLLINS AUDIO PRODUCTS
COMPANY**

126 Park Street, Westfield, N. J.
Westfield 2-4390

"America's Best Buy"

TUBULAR ELECTROLYTICS
Fresh Stock. Fully Guaranteed

	Each	10	100
20 mfd. 150V	\$0.21	\$1.79	\$16.95
20-20 mfd. 150V	.29	2.49	22.98
8 mfd. 450V	.19	1.85	17.98

BY-PASS CONDENSERS

		\$0.06	\$0.55	\$ 4.60
.01 600V	.06	.55	4.75	
.02 600V	.06	.55	4.95	
.05 600V	.07	.65	5.49	
.1 600V	.11	.98	8.95	
.25 600V	.14	1.25	9.95	
.005 1700V	.15	1.30	10.20	
.01 1700V	.16	1.40	10.95	

RESISTOR ASSORTMENT

100 assorted 1/4-1/2-1 watt carbon resistors.
All RMA color coded. Special \$1.29.

CRYSTALS 74c each

Your frequency plus or minus 10 KC

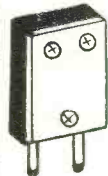

- 80 Meter, 4000-7300KC
- 40 Meter, 7000-7300KC for multiplying into
- 20 Meter, 7300-7425KC
- 10 Meter, 7300-7425KC
- 6 Meter, 6250-6750KC
- 2 1/2 Meter, 8000-8222KC

Postage extra. 20% deposit on COD.
Write for latest bargain list featuring

"America's Best Buys."

POTTER RADIO CO.

1314 McGee St., Kansas City 6, Mo.

aligned a clear and stable pattern will result. Picture definition may be determined by observing the vertical "wedge" lines particularly where they converge and meet the "bulls-eye" in the center of the pattern. In high quality receivers it should be possible to resolve the individual lines until they almost meet the pattern center circle. This indicates that the receiver is capable of reproducing a video band of at least 4 mc. in width. The pattern should also be observed for its signal-to-noise ratio, and contrast. Poor contrast or "flat" pictures accompanied by "snow" (noise) may indicate poor sensitivity due to improper r.f. alignment or improper shaping of the i.f. curve. For example, if the receiver amplitude response is much less than 50% at the video carrier frequency, the effect will be the same as if reception is attempted on a very weak station. Receiver noise will become comparable with the signal and a weak video signal will be applied to the picture tube. On the other hand, situating the picture carrier too far "up" the selectivity curve will result in excessive contrast and poor picture definition.

Usually an improvement in picture quality may be made by a final adjustment on the receiver local oscillator. After the set has been aligned and placed into operation, and tuned to a test pattern of a local station, the fine tuning control should be tuned carefully for optimum picture quality. As stated before, this condition will be obtained when the picture carrier is situated around the "50% point" of the receiver response curve. The actual best location for the video carrier may vary somewhat and is therefore best determined by tuning the local oscillator until the pattern appears at its best. After this operation is carried out, it may be found that the accompanying sound is slightly off tune. This is remedied by retuning the discriminator and sound i.f. circuits. It will be found that as experience is gained in i.f. front end alignment and adjustment of the local oscillator made more accurately, final "touch-up" adjustments will rarely be necessary. —30—

HUDSON DIVISION CONVENTION

The Hudson Division ARRL Convention will be held in Asbury Park, New Jersey on September 26, 27, and 28. This gathering is being sponsored by the Jersey Shore Amateur Radio Association and the Monmouth County Amateur Radio Association.

An elaborate program including technical talks, social activities, and trips has been planned for the hams in attendance while special features have been included on the schedule for the XYL's and YL's at the convention.

Tickets are \$3.50 each for the three-day convention and \$4.00 for the banquet. Banquet reservations are limited to the first 500 applications for tickets received. Tickets and further information about this convention may be obtained from M. Krause, Jr., W2HKY, 135 Bridge Street, Red Bank, New Jersey.

—30—

Transformer Design

(Continued from page 60)

$$\text{Then } \frac{NI}{l} = \frac{2700 \times .054}{6} = \frac{146}{6} = 24.3$$

And from Fig. 9** if $\frac{NI}{l} = 24.3$

$$\text{then } \frac{LI^2}{V} = 0.5 \times 10^{-2} = .005$$

By transposition if $\frac{LI^2}{V} = .005$ then

$$L = \frac{.005 V}{I^2} \quad (V = 6 \text{ cu. in.}), \text{ or}$$

$$L = \frac{.005 \times 6}{.054^2} = 10.3 \text{ henrys (primary inductance).}$$

Therefore this design is satisfactory.

In Fig. 12** we see that when $NI/l = 24.3$ the paper gap in the core should be about .0015" thick.

Audio Output Transformer

Here let us assume that our audio amplifier employs the same output tubes as used in the modulator described before, which means that the following conditions exist:

Output tubes—P.P. pentodes (10,000 ohm load)

Plate Current—60 ma. for each tube

Output Watts—7.5

Lowest Frequency—150 cycles (voice frequencies)

Required Primary Inductance—10 hy.

Here we have the same primary circuit requirements which existed when we designed the previous modulation transformer. Therefore, we can use the same core size and primary winding.

Assume that at times this amplifier will feed into a 500 ohm line and that at other times it will drive a loud-

ASBESTOS PAD IN SERVICE KIT

An asbestos pad of the type shown takes but little space in the tool kit or on the work bench and will be found very useful when soldering.

The iron may be placed directly on the pad or the pad may be used between the iron barrel and the radio cabinet when soldering with the chassis in place, to prevent damage to the cabinet. H. L.



August, 1947

**AN OUTSTANDING
CANNON ELECTRIC
DEVELOPMENT**

**AT A
LOW PRICE!
\$1.25 LIST**

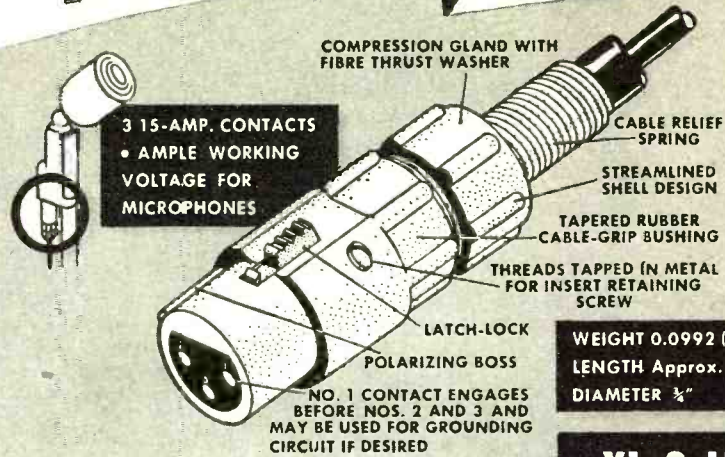

**WEIGHT 0.0992 (lbs.)
LENGTH Approx. 2 1/4"
DIAMETER 3/8"**

**XL-3-II
PLUG**

NO OTHER SMALL ELECTRIC CONNECTOR HAS ALL THESE DESIGN FEATURES

All the features noted above on the Type "XL" with one exception (the grounding contact position) are found in other leading Cannon Connectors—the result of years of development and experience. Yet no one other Cannon fitting has all these features in a shell of so small a size. This is an outstanding value in the connector field.

INTEGRAL CLAMP TYPES IN STEEL—Two integral clamp plugs (pin or socket insert assemblies) are available with rugged steel shells and, although slightly smaller in length, mate with the zinc receptacles shown at the left. Like the zinc shell types, they have a minimum flashover voltage rating of 1500 Volts (250 working voltage).

SPECIAL XL DISTRIBUTORSHIPS AVAILABLE

If you are a radio parts jobber and wish to cash in on the growing popularity of this line of connectors, write the factory or contact a Cannon Electric representative located in the following cities: Atlanta, Baltimore, Boston, Charlotte, N. C., Chicago, Cleveland, Dallas, Denver, Indianapolis, Kansas City, Milwaukee, Minneapolis, New Orleans, New York City, Salt Lake City, San Francisco, Seattle, Detroit, Pittsburgh, Ft. Smith, Ark., Buffalo.

Write for Special Type "XL-246" Bulletin, Address Dept. H-228.



**XL-3-13 \$1.25 List
RECEPTACLE**



**XL-3-14N \$1.15 List
RECEPTACLE**

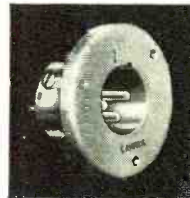

**XL-3-14 \$1.00 List
RECEPTACLE**

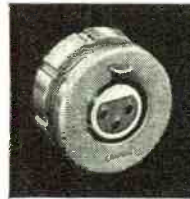

**XL-3-13N \$1.25 List
RECEPTACLE**



**CANNON ELECTRIC
DEVELOPMENT COMPANY**

3209 Humboldt Street, Los Angeles 31, California

Canada & British Empire — Cannon Electric Co., Ltd., Toronto, Ontario • World Export Agents (excepting British Empire) Frazar & Hansen, 301 Clay St., San Francisco 11, Calif.

Government Surplus

We have on hand a large selection of Radio and Electronic Equipment purchased from the United States Government, and solicit your inquiry on practically any equipment or component parts used by the Army or Navy. Listed below are only a few of the many items we now have in stock.

Indicator I-221A. Uses Selsyn with indicating rose, 100TH power tube, assorted breakers, high voltage condensers, etc. Good for antenna and transmitter control and remote modulator basic kit. 110 V 60 cycle.	527.50
Scope, 5" 110 V 60 cycle input. Control unit BC-1266. 15 Tubes including 5CP1. Has all power supplies built in except for 300 Volt amp. B voltage.	40.00
SAVE EIGHT DOLLARS! Purchase both of the preceding items, packed in original shipping case and crate. Shipping wt. 400 lbs.	59.50
Jeweled lamp assembly, 1" panel mount. Drake type 75.	.29
Message Holder, excellent for station logs, regular letter size 8 1/2 x 11" with extra clip for holding spare sheets, also protective cover. Reg. Signal Corps type.	.95
Spark Plug suppressors—6 for.	.35
Box of 50.	2.25
Electrolytics, 10x10x10 @ 400 V Mallory FP—can.	.89
Dynamotors for BC 191, BC 375 Transmitters, 14 V DC input to 1000 V DC output @ 350 MA. GE-BD-77.	9.75
Neon Bulbs, GE 1/4 W 115 V Bayonet base. 50.15 each.	1.15
Neon Bulbs, GE 1/4 W 115 V Candelabra base. 50.17 each.	1.25
Test clip, Frankel. Insulation piercing type. 12 for.	.59
RG8/U Coax. 52 Ohm. Per foot. 50' and over—Per Foot.	.07
Fiberglas tape, 1"x.015" Excellent insulation. 36 yd. roll.	.35
Empire cloth, .015" thick, Westinghouse Turf-nell, sq. yd.	.65
Kit of 100 1/2 Watt Resistors, Assorted.	2.49
Relay, 24 Volt, 60 Cycle Coll. Contact 15 Amp DPST. Normally Open. Ward Leonard.	1.95
Relay, 2.5 V or 5 V Coil, 60 Cycle, Contacts 150 Watt. Guardian Elec.	1.25
2 Amp. 3 AG. Littelfuse. 10 for.	.25
Whip Antenna, 3 removable sections to make 9 ft. Whip W/insulated Mast Base Type MP-22-A Constructed to swivel when hit by obstruction. Excellent for Mobile Antenna.	5.50
Linesman's pole climbers.	4.50
Safety belt with strap. State belt size wanted.	5.75
Terminal strips. Molded bakelite 16 screw terminals. 8 circuits. 5 1/4" long x 2" wide. Barriers between terminals. Mfg. GE. ea.	.19
Lots of 20.	.12
45 V Heavy Duty "B" Batteries 8x4 1/4 x 7 1/2". Date of Mfg. May 1945. Carton of 4.	1.98
Lots of 100.	.35
6 V Lantern Battery, 2 1/2 x 2 1/2 x 3 3/4". Date of Mfg. June 1945. Box of 5.	.98
Lots of 100.	.15
Choke 3.8 H @ 105 MA DC. Unceased but tropicalized.	.39
Heater Strip 230 V 200 Watt Chromalox type PT 702. Screw terminals. 7" strip.	.60
Cartridge heater 115 V 25 Watt. Immersion type 10" long x 1/2" round case. With asbestos covered 10" leads. Chromalox type C-304.	.50
IF Amplifier. 4 Stage. 36 Mc. 1.4 mc. wide. 7 Tubes—4—6AC7; 1—6SJ7; and 2—9002. Shipped with tubes and complete set of spare parts, including extra set of tubes. Shipping wt. 40 lbs.	19.50
BC-375 100 Watt Transmitter for A1, A2, and A3 emission covering 200-500 KC and 1.5-12.5 MC by means of seven plug-in tuning units. The power amplifier is a neutralized class "C" stage using 211 tubes and is equipped with an antenna coupling circuit. Supplied complete with all components, including 25 VDC Dynamotor necessary for an operating installation.	44.50
SCR-274-N Command Set consisting of three receivers covering (190-550 KC) (9.0-6.0 MC) (6.0-9.1 MC) and two (5.3-7 MC) unit and 24 VDC Dynamotors to complete an operating installation. Easily converted to 110 volt 60 cycle operation.	39.95

ABOVE PRICES F. O. B. BALTIMORE
MINIMUM ORDER \$2.00

THE ABELL DISTRIBUTING COMPANY
5 E. BIDDLE ST., BALTIMORE 2, MD.

SEND FOR OUR FLYERS
NAME ITEMS INTERESTED IN

speaker having an 8 ohm voice coil. Then two secondary windings will be needed; one for a 500 ohm load and one for an 8 ohm load.

$$\text{Turns ratio} = \sqrt{\frac{10,000}{500}} = \sqrt{20} =$$

4.47 for 500 ohm winding, and

$$\text{Turns ratio} = \sqrt{\frac{10,000}{8}} = \sqrt{1250} =$$

35.3 for 8 ohm winding.

With 2700 turns in the primary we find that the 500 ohm winding must have 2700/4.47 = 604 turns. Similarly, the 8 ohm winding must have 2700/35.3 = 76.5 turns (use 77 turns).

Now, we want to be able to put the full 7.5 watt output either into the 500 ohm load or into the 8 ohm load. Then, the wire used in each of these secondary windings must be heavy enough to carry such current. At 7.5 watts, the current in the 500 ohm winding is:

$$W = I^2 Z$$

$$\text{Then: } I^2 = \frac{W}{Z}$$

$$\text{And } I = \sqrt{\frac{W}{Z}}$$

$$I = \sqrt{\frac{7.5}{500}} = \sqrt{.015} = 0.122 \text{ amp.}$$

or 122 ma. and the current in the 8 ohm winding is:

$$I = \sqrt{\frac{W}{Z}} = \sqrt{\frac{7.5}{8}} = \sqrt{.937} = 0.968$$

amp.

Fig. 5* indicates that the 500 ohm winding must be wound with No. 30 wire to carry 0.122 amp. and the 8 ohm winding must have at least a No. 22 wire to carry 0.968 amp.

The coil size calculation shows a build of 83 per-cent which is satisfactory.

Since the only direct current is in the primary winding where it flows in opposite direction in each half of the coil, the core does not have to have a gap. The laminations can be interleaved as in a power transformer core.

Thus our design is as follows:

Core 1" iron 1" stack—laminations interleaved

Primary—2700 turns No. 33 wire, center tapped

500 ohm winding—604 turns No. 30 wire

8 ohm secondary—77 turns No. 22 wire

Only one secondary is to be used at one time.

Practical Hints

When the approximate specifications of a transformer are known, it is a simple matter to determine its construction in more accurate detail.

COMBINATION VOLTMETER AND SAFETY BLEEDER FOR TRANSMITTER POWER SUPPLY

By GUY E. DEXTER

HIGH-VOLTAGE transmitter power supplies should be metered. They must have bleeder resistors. The latter is an imperative safety requirement; the first a distinct advantage to efficient operating. The meter keeps the operator constantly aware of the actual value of d. c. voltage delivered to the transmitter and warns quickly of breakdowns, while the bleeder removes dangerous charges from the filter capacitors when the power unit has been switched off.

Both devices can be combined into a single unit, without the usual expense of a kilovoltmeter, as shown in the accompanying schematic. Here, a d. c. milliammeter is converted into a kilovoltmeter simply by connecting it in series with the bleeder resistor which then acts as the meter multiplier. It is necessary only to select the proper combination of resistance and milliammeter range to give the desired kilovolt deflection.

A good universal combination is a 100,000-ohm, 200 to 30C-watt wirewound resistor and a 0-50 d. c. milliammeter. If the resistor is selected carefully (or closely adjusted by means of its slider) for an exact resistance of 100,000 ohms, this combination provides an accurate 0-5000 d. c. voltmeter. The meter practically is direct-reading—simply add two ciphers mentally to the meter indications. Most milliammeters have 50 scale divisions, each of these corresponding to 100 volts. The smallest accurately readable deflection (1/2 scale division) would be 50 volts.

The values shown in the diagram for this voltmeter-bleeder combination are

suitable for all power supplies in the 1500 to 5000 volt range. The same meter and bleeder may, of course, be used all the way down to 100 volts, however all voltages lower than 2500 will fall proportionately in the lower half of the meter scale. A more satisfactory combination for voltages of 1500 and less is a 0-20 d. c. milliammeter and 100,000-ohm resistor. This will provide a 0-2000-volt scale.

A higher-resistance bleeder would, unquestionably, permit a lower range milliammeter to be used and would reduce the amount of extra current which must be delivered to the measuring-bleeding circuit. But larger resistances slow down the filter capacitor discharge so markedly as to introduce a hazard to the operator. For this reason, a 1000-ohms-per-volt combination, for example, is out of the question.

—30—

Wiring diagram of combination safety bleeder and high-voltage voltmeter. Bleeder should have a rating of approximately 300 watts.

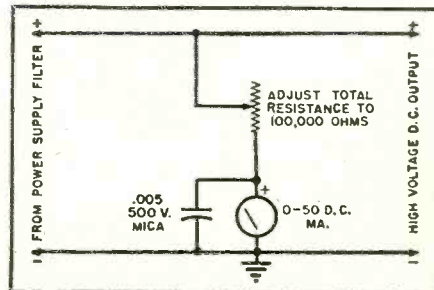

After this has been done, it is then possible to know how that unit may be used for different applications or how, by slight modification, it can be made to perform an entirely different function.

Suppose that a combination plate and filament power transformer is at hand which has 2.5 volt filament windings. It is a relatively simple job to remove the coil from the core and to remove the 2.5 volt filament windings. In a power transformer of this type, the filament windings are always on the outside of the coil. They are wound after all of the other windings have been completed and they consist of only a few turns. Assume that the 2.5 volt windings consisted of 5 turns of wire and that one wishes to replace them with 6.3 volt windings to operate modern tubes. Then 5 turns/2.5 volts = 2 turns per volt. Then the new 6.3 volt windings would have $2 \times 6.3 = 12.6$ turns (use 13 turns). In this way, by thus determining the "turns per volt" in a transformer, one can replace any windings with new ones for different voltage output. It is not necessary to wind extra turns here for higher open circuit voltage to compensate for regulation because that was done when the transformer was originally designed for 2.5 volts. Now, if one of the old 2.5 volt windings had been wound with No. 19 wire, one could see in Fig. 5* that it had been designed to supply 2.5 volts at 2 amperes (No. 19 wire will carry 2 amperes). Then $2.5 \text{ volts} \times 2 \text{ amps} = 5.0 \text{ v.a.}$ This means that the new 6.3 volt winding which is to replace the old winding could also deliver 5.0 v.a. or 6.3 volts at 0.795 amp. ($6.3 \times 0.795 = 5.0 \text{ v.a.}$ For the current of 0.795 ampere No. 23 wire could be used.

Many times it is not desirable to remove any winding in a power transformer to determine the "turns per volt." Frequently, this information can be obtained without even removing the coil from the core. The procedure is as follows:

Wind 10 or 15 turns of light insulated wire around the center leg of the core at one end of the coil. These few turns will fit into the space between the end of the coil and the core. Now, apply the proper a.c. voltage to the primary and measure the open circuit voltage developed across the temporary winding. Then, "turns per volt" is equal to:

Number of turns in temporary winding
Voltage across temporary winding

Assume that a plate transformer is available which can supply plate voltage at 500 v.a. Also assume that one intends to draw only 480 v.a. of plate power from it and that it does not have any filament winding secondaries. It would then not be necessary to use a separate filament transformer to operate some of the tubes in the equipment. One could add a filament winding to this plate transformer because it is able to supply 20 v.a. more power. Thus, a 6.3 volt winding might

BA Bargain Scoops!

52 OHM COAX CABLE
BRAND NEW 60 Foot COILS
COMPLETE WITH CONNECTORS..... \$1.25
 It's genuine Amphenol RG-5/U—use it in place of RG-8/U. Has smaller diameter (.332), less capacity between center conductor and shield, less weight, easier to handle than RG-8/U. Rated at 1100 watts at 30 Mc. Supplied complete with standard Amphenol 83-1SP-(PL 259) connectors attached at each end.
No. 4A496—60 ft. coil
with connectors..... \$1.25
 Any number coils connect together with 83-1J connectors (below)

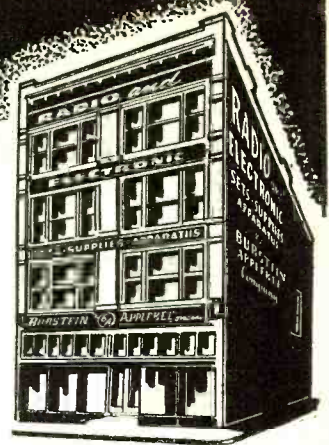

Extra Connectors
 For use with above
 Choice Each..... **35c**
 83-1SP 83-1R 83-1AP 83-1J

10 Hy. - 200 Ma.
Thordarson
Filter Choke
 200 ohm D.C. resistance,
 2000 V. RMS. Size $3\frac{3}{8}$ " sq.
 $\times 4\frac{3}{4}$ " high. Wt. $5\frac{1}{2}$ lbs.
 Has 12" leads at side.
No. 13A266
Special Each... \$1.88

80, 75 and 40 Meter
CRYSTALS, 10 for \$3.95
 In FT 243 holders, cut from highest quality quartz, accurately ground and acid etched. Frequency marked on each within 2 KC. Sorry we must sell them in ass'ts. our pick of frequencies—but you can't go wrong! There are plenty of choice frequencies for 80, 75 and 40 meters or for doubling to 20 and 10 meters in each ass't. Every one guaranteed to be an active oscillator.
 Stock No. 21T3991
Ass't. of 10 only..... \$3.95

OIL FILLED
CONDENSERS

10 mfd. 1000 volts C.D.
 Dykanal TJU List \$12.00
No. 17A268 \$1.95
 Spec. Ea.....

8 mfd. 1000 volts-Sprague
 List \$10.80
No. 18A367 \$1.45
 Spec. Ea.....

5 mfd. 600 volts Sprague List \$7.00
No. 18A366 65c
 Special Each.....

JOHNSON VARIABLE

Dual section,
 200 mmfd.
 per section,
 2000
 V. break-
 down. Spac-
 ing .045".
 Type 200FD20.
 List \$10.
No. 18A510 Special Ea..... \$2.95

Johnson variable, dual section, 304 mmfd
 per section. Spacing .045".
 Type 300ED20. List \$9.95.
Stk. No. 18A509, Special Each. \$3.45

Our terms: Cash with order or COD with 20% deposit please. Add Postage

HANDSET TS13
 Combines a 200 ohm carbon mike and 2500 ohm ear phone with butterfly switch for "listen" and "talk". Has 6 ft. flexible rubber cord with 1 each PL55 and PL68 plugs attached. Attractive bakelite case, light weight.
 Ideal for interphone outfits for home or industry, mobile and many other applications. Made to rigid Signal Corps spec.
 A Truly Outstanding Surplus Bargain. Every One BRAND NEW.
No. 17A407, Special Each..... \$3.95

\$250 Value For **99c**
CURVED
NEEDLE NOSE
 No. 16A376.
 6" Crescent Tool Co. Drop forged "Crestoloy" steel, cadmium plated. Very handy for close quarters. At this price, every tool kit and bench should have one.

Compact Rechargeable
STORAGE BATTERY

Willard 2 Volt in Spill-Proof Clear Plastic case. Only $2\frac{3}{8}$ " square and 6" high—(about the size of the ordinary #6 dry cell) make it applicable for a wide range of uses where battery power is needed. Rated at 24 AH. Gangs nicely for other voltages in multiples of 2 volts. Shipped dry. Uses standard battery electrolyte available everywhere. Every One Brand New. While They Last,
No. 5A133, Special Each..... \$1.95

The "Tops" in Headphones
 At a Fraction of Original Cost
 8000-ohm impedance, highly sensitive. Best quality Alnico magnets in molded black bakelite cases, concealed terminals. Headband fully adjustable, leather covered spring steel. 12" cord with PL54 plug attached at side out of way. Jack and rubber cord supplied to extend length to 5½ ft. Extremely lightweight, only 9 oz., with removable rubber ear cushions of comfortable design. Made to Air and Signal Corps specs. Brand New—a 13.50 Value.
Stk. No. 17A37, Special Per Pair \$2.49

BURSTEIN-APPLEBEE Company
 1012-14 MCGEE STREET,
 KANSAS CITY 6, MISSOURI

Did You Get It?
 The New
 B-A Catalog
 No. 471

**UNIVERSAL
LEADS AGAIN**

**TELEVISION
KITS
IN STOCK!**

EASY TO ASSEMBLE AND WIRE
THOROUGH STEP BY STEP INSTRUCTIONS COVERING ASSEMBLY, ALIGNMENT AND OPERATION ARE PACKED WITH EACH KIT.

7" TELEVISION KIT (less tubes) **\$77.50**
TUBE KIT FOR ABOVE \$42.77

FEATURES

- Uses simplest, most advanced television receiving circuits.
- Pretuned I.F. coils. (Only slight adjustment needed for best picture detail).
- All holes in steel chassis are drilled.
- Sound reception is high fidelity F.M.
- Performance guaranteed.
- 17-tube television receiver.



CABINET FOR EITHER KIT.....\$29.50
WALNUT FRONT PANEL, ONLY.....\$10.00

10" TELEVISION KIT (less tubes) **\$124.50**
TUBE KIT FOR ABOVE \$72.34

FEATURES

- First to use the new TTI interlock circuit for horizontal and vertical sync control—holds the picture stationary even at low signal strength and in noisy locations.
- Electro Magnetic scanning and focusing.
- Pretuned I.F. coils. (Only slight adjustment needed for best picture detail).
- 10,000 volt Electronic power supply for 10" tube.
- Two separate low voltage power supplies used to prevent interaction between circuits.
- Sound reception is high fidelity F.M.
- Performance guaranteed.
- 19-tube Television receiver.

SEND YOUR ORDER TODAY!

**UNIVERSAL
RADIO SUPPLY CO.**
1404-06 VENICE BOULEVARD
LOS ANGELES 6, CALIF.

LAMINATION SIZE	AUDIO POWER (in watts)
1/2"	1.0
3/4"	3.0
1"	5.0
1 1/8"	10.0
1 1/4"	20.0
1 1/2"	30.0
1 3/4"	60.0
2"	100.0
2 1/2"	250.0
3"	500.0

Fig. 17. Approximate lamination size for audio transformers to handle various amounts of audio power.

be added to deliver 3.17 amps. (6.3 volts x 3.17 amps. = 20 v.a.).

The wire would not have to be removed from the coil to add the new winding. It is only necessary to find the "turns per volt" by the method shown above. Then, the new filament winding could be wound in the space at the end of the coil. For 3.17 amps. No. 17 wire could be used. Instead of using enameled wire for this winding, use insulated wire of the type used for lead wire (silk or cotton covered). Use enough turns to give $1.08 \times 6.3 = 6.8$ volts open circuit to provide 6.3 volts under load. A good amount of extra insulation should be employed to insulate this winding from the coil and core. Insulate for twice the highest voltage in the transformer, plus 1000 volts.

The procedure described above to find the "turns per volt" in a power transformer can be applied to find the number of turns in the windings of an audio transformer as well. When checking an audio transformer, it is well to use as many turns as possible in the temporary winding. Apply about 2 volts a.c. to the temporary winding and measure the voltages developed across the various windings in the transformer. Then, since the "turns per volt" in the temporary winding is known, the number of turns in the other windings may be calculated. After the number of turns in each winding is known, one can then find the impedance ratio and primary inductance.

For example, assume that an output transformer of unknown characteristics is to be analyzed. Also, assume that a temporary winding has been inserted which has 20 turns. Suppose that, when 2 volts a.c. was applied to this winding, voltages across the two transformer windings were 6 volts and 200 volts. Because 2 volts was applied across 20 turns in the temporary winding, "turns per volt" = $20/2 = 10$. Now, this means that there are ten turns for each volt in the other two windings. Therefore, the first winding has $10 \times 6 = 60$ turns and the second winding has $10 \times 200 = 2000$ turns. (The above voltage measurements should be made with a relatively high resistance voltmeter). Since the transformer has a winding of 2000 turns and one of 60 turns, the turns ratio = $2000/60 = 33.3$. The impedance matching ratio is equal to the turns ratio squared. Therefore, for this trans-

former, the impedance ratio is 33.3^2 or 1115, approximately. Because the impedance ratio is 1115, the impedance reflected into the primary will be 1115 times the load connected to the 60 turn secondary. Thus, if 2 ohms is connected across the secondary, the reflected primary impedance will be $1115 \times 2 = 2230$ ohms.

Suppose a load of 6 ohms were used. Then the primary impedance is $1115 \times 6 = 6690$ ohms. Here the question arises, "What impedances are correct for this unit?" To solve this problem it is necessary to make some primary inductance calculations. First, we might find out if it could be used to match a tube such as a 2A3 tube to a speaker voice coil. The 2A3 tube draws about 60 ma. plate current and requires a load of about 2500 ohms. This transformer with an impedance ratio of 1115 would reflect 2230 ohms from a 2 ohm speaker and about 2700 ohms from a 2.5 ohm speaker. Either of these values would be satisfactory for a 2A3 tube if the primary inductance is proper for that tube.

Fig. 16 shows that at 50 cycles a triode with 2500 ohms load requires primary inductance of about 10 henrys. Now, with all factors at hand, the primary inductance may be calculated and if it is found to be 10 henrys or more it can be used with a 2A3 tube. Of course, the primary wire size must be able to carry 60 ma.

When the number of turns of wire in each winding has been determined it is then possible to find out what the wire sizes are. There are two ways to do this. One method is to remove the outer wrapper of the coil and measure the diameter of the wire near where it is soldered to the leads. The other method is based on the fact that sometimes the leads coming out of the coil are merely the ends of the wire of the winding. This is only true if the wire size is about No. 27 or larger because smaller wire is not strong enough mechanically to be used for leads. Frequently, an output transformer is constructed with about No. 25 or larger wire for the secondary and the ends serve as leads. In this case, if there are only two windings in the coil, you could measure the secondary wire size and calculate the size of primary wire. Now, if it were found that the coil had 2000 turns in the primary with 60 turns in the secondary and measurement showed the secondary to be No. 24 wire, a wire size could be assumed for the primary and calculate the size of the coil. The calculation showing the largest coil size that would fit into that core would indicate the correct primary wire size. Obviously, it is necessary to know the primary wire size in an output transformer to be certain that it will carry the tube plate current. (Wire sizes are measured with a micrometer caliper.)

When the number of turns in a filter choke have been found by the method described, using a temporary winding, its inductance may be calculated with various assumed values of

"TAB"

• **NEW GUARANTEED**

That's A Buy

ELECTRONIC PARTS •



PRECISION RESISTORS
IRC, SHALLCROSS
MEPCO, INST. RES. CO
OHMITE, WE, for
METERS, BRIDGES, AMPS

ACCURACIES	*1/2%	*5% REST 1%	5
95000	25	50	75
100	131	1260	300
84000**	500	4300**	1500
2142	4000	29400**	10000
7955*	800	20000	30000**
15000	17000	7500	147000
80000	85000	150	4300*
Above sizes ass'd. TEN for \$2.50			
20000*	50000	100000	130000
150000**	314000	201000	229000
294000			
Above sizes ass'd. 39c ea. TEN for 3.00			
330000	402000	500000	600000
Above sizes ass'd. 60c ea. TEN for 5.00			
ONE Microhm WW 1% accy. THREE for 2.00			
each 90c. SIX for 3.00			
2micr. 4.5micr. 5micr. 10micr.			
WRITE FOR OTHER SIZES FROM STOCK.			

ANTENNA PARABOLIC RADAR AS-
SEMBLY 24" Dia Drive & Selsyn motors
CO-AX fittings \$16.95
GYRO SERVO BENDIX 12800-TB 9.95
RAYTHEON VOLTAGE REGULATOR 198
to 242V in. OUTPUT VOLTS 220V/500
WATTS/50-60cy/95%PF 49.95
VAC CONDENS 50MMF/7500V. \$3.95;
100MMF/7500V 4.95
RCVR USED NAVY RBC 4 to 27 MCS 95.00
RCVR USED BC342 COMPLETE 34.95

RAYTHEON VOLTAGE REGULATOR

CASED NEW S.C. TROPICALIZED
Adj-Voltage Inpt 95-130V/60cy, outpt 115V
58AMPS, ONE HALF/1%
REGULATION, WT.
20lbs 6 1/2 H8/4
L5 1/2" W-OVER-
LOAD PRO-
TECTED.
RUGGED
DSGN.



"TAB"
SPECIAL \$10.95

WRITE FOR NEW CATALOGUE

\$2 Min. order FOB N.Y.C. Add Postage all orders
and 25% deposit. Worth 2-7236. Send for catalog
300. Specialists in International Export, School, Col-
lege & Industrial trade. Money Back Guarantee.

**COLLINS
ART/13
SPEECH
AMPLIFIER
COMPLETE
INPT
DYNAMIC OR
CARBON**

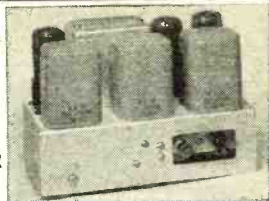

MICROPHONE OR LINE INPUT:

Output PP class "B" GRIDS. Noise level down-
55DB. INCLUDES INPT TRANSF. 1st AUDIO
to PPGrids Modulator Tubes. 6V6 Sidetone adj.
audio osc Amp & 1ldphone monitoring jack. WT 3
LBS. DIM 7 1/2 L3 1/2 W5" H, minus tubes \$4.95
& pwr supply. "TAB" SPECIAL
WITH Two 6V6 & 6SJ7 \$7.49

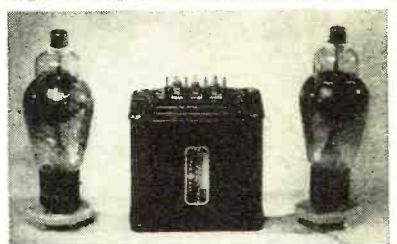

CONSISTS OF TWO JAN NEW 866A TUBES,
TRANSFORMER GARDNER FLEC CASED 2.5V
10 AMP, 115V/60cy inpt. H.V. insltd 9000V wlg
similar to illustrated unit; "TAB" Tested 16000
VAC Test: Same mtg as KENYON T389—SOCKETS
CERAMIC JOHNSON 224.
SPECIAL \$5.95



**DYNAMOTOR
NEW**

TAB TESTED GTD
6V inpt/3Amp, out-
pt 240V/100ma or
125ma inpt duty.

HI EFF P'MAGNET ALNICC 12/24V Rated 500
V/50ma at
12 or 24V inpt. \$3.49

Dynamotor 12 or 24V inpt. 275V/110ma
& 12V/3A \$1.95

Guaranteed used S.C. & NAVY EQUIP CRYSTAL
CALIB SIG GENERATOR 8-15mcs & 45 to 77mcs;
2nd, 3rd & 4th Harmonics usable coverage to 230mcs.
Consists of 6J5Xtalosc, 9006DET, 2/6SJ7 AMP,
9002VAR Two range osc, 5Y3G FW Rect; Attnr
10000microvolts, 115V/60cy op; \$45.00
RUGGED DSGN. SPECIAL
RC 342 RCVR 1.5 to 18mcs, 115V/60c. 34.95
VACUUM CONDENSER 50MMF/20000V. 6.95

"TAB"

• Dept. 8RN, Six Church Street, New York 6, N. Y., U.S.A. •

"TAB"

THAT'S A BUY

CORNER CHURCH & LIBERTY STS., ROOM 200

THAT'S A BUY



The New Home of
MELVILLE RADIO INSTITUTE

The Melville Building is ready with
facilities for over 2,000 students of

TELEVISION & RADIO

Melville Radio Institute, a well-established,
prewar school, is one of New York's out-
standing vocational training centers.

Technical know-how, ample equipment and
expert faculty have resulted in a satisfied stu-
dent body that is among New York's largest.

Visit us today without obligation and watch
the School in operation. A free brochure may
be obtained by mailing the attached coupon.

Licensed by the State of New York.
Approved for Veterans.

MAIL THIS COUPON NOW!

MELVILLE RADIO INSTITUTE
Melville Building

15 West 46th St., New York 19, N. Y.

GENTLEMEN: Send me FREE In-
formation about your school. RN

Name

Address

THE SIX MELVILLE COURSES

- RADIO TECHNICIAN
- TELEVISION TECHNICIAN
- RADIO COMMUNICATIONS
- RADIO & TELEVISION SERVICING
- FUNDAMENTAL RADIO MATH
- SLIP-TAPE TRANSCRIPTION

"The Radio School administered by
Radio Men."

MELVILLE RADIO INSTITUTE

Melville Building

15 WEST 46th St., N. Y. 19 • BR 9-5080

15 W. 46th ST., N.Y. 19

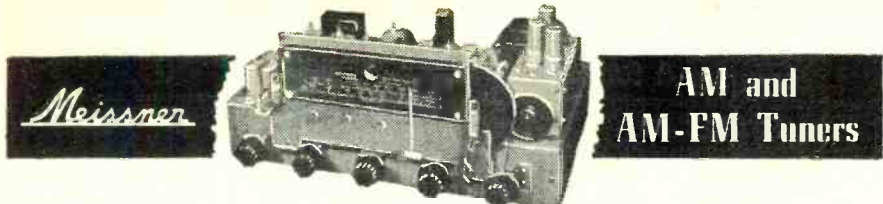

Here are the sensational post-war Meissner AM and AM-FM Tuners. They're used wherever exceptionally high fidelity reception is desired. Both units cover the broadcast band from 527 to 1620 kc. and the AM-FM Tuner also covers the FM band from 88 to 108 mc. Frequency response of the Tuners is flat within ± 2 db from 30 to 15,000 cycles! Sensitivity is less than 10 microvolts.

9-1091. AM-FM Tuner, \$144.06
with tubes, dial, escutcheon.
Tubes: 9003 R.F. amplifier; 6BE6 oscillator-converter; 2-9003 I.F. amplifiers (456 kc); 6AL5 detector for the AM section. For the FM section: 6AG5 R.F. amplifier; 6C4 oscillator; 6AG5 converter; 3-6AG5 I.F. amplifiers (10.7 mc); 2-9001 limiters; and 6AL5 detector. Two 6C4's are used for audio amplifiers, 6U5/6G5 for tuning indicator and 5Y3GT/G for rectifier. Size: 16 1/2" x 10 1/4" (requires 1 1/4" additional between chassis and panel). Wt. 19 1/2 lbs. Dial: Slide Rule, 2" x 7 1/2" opening. Calibration: AM in kc. FM in channel numbers (200 to 300).
11-8265. Cabinet, black \$8.82
wrinkle only
Size: 18 1/4" x 11 3/4" x 9". Wt. 12 lbs.

9-1092. AM Tuner, with \$91.14
tubes, dial, escutcheon.
Tubes: 6BA6; 6BE6; 2-6BA6; 6AL5; 2-6C4; 5Y3GT/G; and 6U5/6G5. Size and specs. same as Cat. 9-1091. Wt. 16 3/4 lbs.
11-8266. Cabinet panel, black \$2.35
wrinkle only
Size: 18" x 8 3/4". Wt. 2 1/2 lbs.
11-8267. Rack panel kit, \$11.47
black, with braces and hardware
11-8268. Rack panel kit, \$11.47
gray, same as above.
Size: 19" x 8 3/4". Wt. 6 1/2 lbs. (incl. braces).
AM Tuner, available in kit form. \$62.92

All prices F.O.B. Jamaica, N. Y. Please include postage. Write Dept. RN2.

Peerless RADIO DISTRIBUTORS, INC.
92-32 Merrick Road, Jamaica 3, N. Y.
Branch: 71 Murray Street, New York 7, N. Y.

For those tricky.
Resistance Problems

USE

LECTROHM ADJUSTABLE RESISTORS

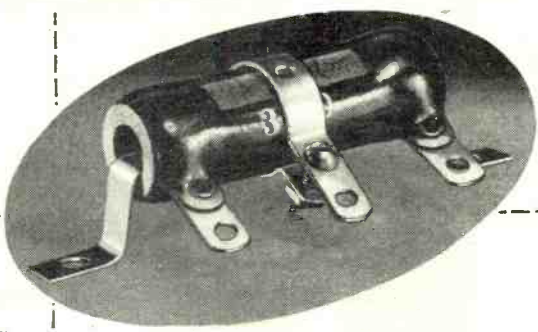

Ask your jobber or dealer for Lectrohm Adjustable Resistors—have a range of sizes on hand always for your experiments of doubtful resistances, or for those applications of varying resistances that require occasional adjustment. They are excellent too, for voltage dividers. You can get them in ratings from 10 watt to 200 watt and with one or more adjustable bands. Look for the name "Lectrohm" on all your Resistors—fixed, adjustable, ribbon-on-edge, etc.

LECTROHM INCORPORATED
5131 W. 25th STREET, CICERO 50, ILL.
Division of The National Lock Washer Co.
Newark, N. J.

IT'S NEW
NON-DIRECTIONAL
"You wouldn't buy a radio without a dial and only one push-button, so why limit your FM reception with an ordinary antenna. The HI-PAR non-directional gets them all."
Immediate Delivery Patent Pending
THE HI-PAR Non-Directional FM Antenna
HI-PAR PRODUCTS CO. FITCHBURG MASSACHUSETTS

direct current. However, one must determine the wire size used in the choke to know what maximum direct current can be allowed to flow in it. To do this, assume a wire size and calculate the coil size for a maximum of 85 per-cent build.

The following notes will help in analyzing an unknown audio transformer:

1. If there is a gap in the core, the unit must have been designed to have d.c. in one or more of the windings. This means that it is to work from a single output tube if the primary is not center tapped, or that it might be an output transformer for push-pull Class "B" tubes, or that it is a modulation transformer.

2. If the core is "interleaved," it was designed to have no d.c. saturation. This means that it might be a line-to-line transformer or a line-to-grid transformer, or a line-to-voice coil transformer, or be for push-pull class "A" or "A" tubes.

3. The number of turns in the windings can be taken as a rough indication of the impedance each winding was intended to match.

NO. OF TURNS IN WINDING	IMPEDANCE
10-100	1 to 16 ohms, approx.
200-800	100 to 600 ohms, approx.
1000-4000	1000 to 20,000 ohms, approx.

4. An "output" tube-to-voice coil transformer" can be easily changed to match a different voice coil impedance. The secondary winding is usually wound over the primary and consists of only a few turns which can be removed and replaced with the desired number of turns.

The design data given throughout this entire discussion is quite conservative and is intentionally so. This was done to provide information for designing and constructing transformers of good quality.

-50-

TESTING VOICE COIL CENTERING

CENTERING of the speaker voice coil may be checked by pressing in on the cone with the finger tips—then releasing the pressure but still keeping the fingers in contact with the cone.

Ordinarily a scraping sound will be heard if the voice coil is striking the pole pieces and in many cases such scraping will be felt by the fingers. H. L.



International Short-Wave

(Continued from page 96)

view of the insignificant power of our transmitter, short-wave radiations of Radio Clube de Cabo-Verde are especially to Portuguese listeners in Cape Verde Islands and Portuguese Guinea, so are only in the Portuguese language." With call of CR4AA, 6.024 (49.8 m.), this station is scheduled 1530-1700; QRA, Radio Clube de Cabo-Verde, Praia, Cape Verde Islands. "We shall send verifications of our transmissions to all listeners who will give us their reports—by letter in Portuguese, French, or English language."

Celebes—Call of Makassar on 9.357.5 (listed) is YFA4; on 5.060 call is YFA10. (NNRC) Signal of 9.357.5 (actually 9.365) is improving on West Coast. (Dilg) English period runs 0800-0900. (Gray) This is probably on Mon., Wed., Fri. only.

China—Detailed program schedules of XGOY and XGOA have been received via airmail by Paul Kary. XGOA, Nanking, operates on 15.35 and 9.73 for its "morning service" (beamed to North America), 2000-2300, with news at 2110, 2230, news commentary at 2140. The "evening service" on 11.835 runs 0400-1000, news at 0520, 0900, news commentary at 0600, and talks at 0410, 0840; 9.730 is scheduled to parallel at 0800 and 0915 (probably is used most of the transmitting period.)

XGOY beams to Australia, New Zealand, and East Asia on 11.913, 0355-0530; no English listed except has "The Baltimore Gospel Hour" at 0430-0530 on Sundays and "Back to the Bible" at 0500-0530 Saturdays. To East Asia and South Seas, 9.658 and 7.153, news at 0600, 0630; has "Sermons in Song" on Wednesdays at 0635. To North America and Europe on 15.170 (appears as high as 15.175) and 7.153, 0745-1050, news at 0800, 0900 (Foreign Ministry messages on Sundays), 1000; presents religious program, "Bringing Christ to the Nations" at 0830-0900 Sundays.

XGOY's 15.175 channel is heard here in West Virginia only on Sundays, around 0745-0900, when is buried by Guatemala; on weekdays, Guatemala's powerful signal on 15.17 precludes hearing XGOY. A good signal is usually heard on the 11.913 frequency around 0500-0530 sign-off; at close, asks for reports and gives Chungking (summertime) as 6:30 p.m.

The English newscast carried by Chinese stations at 0800 appears now to originate in Nanking rather than with XGOY as formerly. (Dilg)

XGNC, 6.025 (formerly 6.045), heard mornings on West Coast; apparently is call of former Kalgan station. (Baxter)

XMAG, Nanking, informs Paul Dilg is operating only on 4.275. Other frequencies on which it is heard appear to be a harmonic.

August, 1947

SELECTED SURPLUS—"THE CREAM OF THE CROP" NEW CONDITION . . . NONE FINER AVAILABLE ANYWHERE

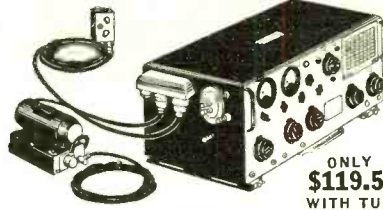

COLLINS ART-13 TRANSMITTER

We offer a small lot of Collins ART-13 Transmitters at the lowest price at which this excellent equipment has ever been sold. The frequency range is 2,000-18,100 KC. in ten channels, voice, CW or MCW. Included with each set are the following: 1 28-volt dynamotor, 1 Pilot's Control Unit and the necessary connectors, as illustrated. Output power is 100 watts normal at 50% modulation. This equipment is in PERFECT condition, having been removed from naval aircraft, and much of it has had "test service" only. Appearance is like new. Here is the buy of a lifetime.

ONLY
\$119.50
WITH TUBES

Send Your Order by Telegraph or Air-Mail

SCR-274-N COMMAND SET. 2 TRANSMITTERS & 3 RECEIVERS



ALSO INCLUDES MODULATOR

• 6 Units, as illustrated, 4-5.3mc BC-457A and 5.3-7mc BC-458A transmitters, 1 each, 3-6mc BC-454A, 130-550kc BC-453A, 6-9.1mc BC-455A Receivers, 1 each. Also BC-456A Modulator Unit. Our price of \$34.95 includes all of the tubes required, as well as four dynamotors, control box and Antenna Tuning Unit with 0-10 Meter and 50uuf. vacuum condenser.

dynamotors, control box and Antenna Tuning Unit with 0-10 Meter and 50uuf. vacuum condenser.

**ORIGINAL COST OVER \$600.00. TUBES ALONE WORTH OVER \$40.00
OUR PRICE FOR THE COMPLETE COMBINATION ONLY \$34.95**

Units also sold individually, as follows:
BC-453B Revr. 130-550kc, with tubes, \$8.95. BC-454 Revr. 3-6 Mc. with tubes, \$5.95. BC-455 Revr. 6-9 Mc. with tubes, \$5.95.
BC-457A Xmtr. 4-5.5 Mc, with 4600 Kc Xt1 & Tubes \$9.95.
BC-458A Xmtr. 5.7-7 Mc, with 6200 Kc Xt1 & Tubes \$9.95.
HOT11 Xmts and shock mounting rack \$18.95. Dynamotors, 28v for Revr. only \$1.95 ea. Current Meter 0-10 (2") \$1.95.

HEAVY-DUTY ALL-PURPOSE 6L6 PUSH-PULL AMPLIFIER

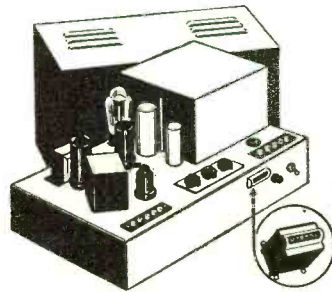

SUITABLE FOR—Wired Music, Coin Phonographs, Home Phonographs, Amusement Parks, Carnivals, Sound Trucks, Schools & Churches, Public Address, Etc.

LICENSED BY WESTERN ELECTRIC FOR USE IN P. A. SYSTEMS AND PHONOGRAPHS

• These brand new Amplifiers in factory-sealed cartons are a Manufacturer's over-run. JUST COMPLETED! Parts alone cost more than full price of the amplifier. Standard RCA tubes (2-6L6, 1-6SL7, 1-6C5, 1-5Y4G). Input for crystal or magnetic pickup, 600-ohm telephone line, and microphone. Separate Bass and Treble controls. Volume control. Output for standard 8-ohm speakers. Relay operated COUNTER (10,000 count) for coin-machine plays. Heavy duty power supply. Gray crackled case with lid. 10"x17"x9". A ONLY
\$49.50 NET
List \$147.50

SMALL PRECISION LATHE

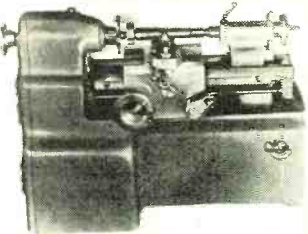

110-V. A.C.
WITH
MOTOR

\$58.50 List
• NOT SUR-
PLUS—but a
brand new
post-war
product. A
small lathe
for radio
shops, jewel-
ers, model
makers, ma-
chine shops,
hobbycrafters,
schools, etc. Automatic Feed. Work capacity 3" between centers. Swing over bed 2". Constructed of steel and cast iron. Accurately machined and finished. Fan-Cooled Motor mounted inside the base. Complete with 1 1/4" face plate, 2 lathe centers, tool post and rocker, 4-jaw chuck available at \$11.50 additional. Drill chuck \$5.50 additional. Orders filed in rotation. Deliveries now.

schools, etc. Automatic Feed. Work capacity 3" between centers. Swing over bed 2". Constructed of steel and cast iron. Accurately machined and finished. Fan-Cooled Motor mounted inside the base. Complete with 1 1/4" face plate, 2 lathe centers, tool post and rocker, 4-jaw chuck available at \$11.50 additional. Drill chuck \$5.50 additional. Orders filed in rotation. Deliveries now.

QUANTITY DISCOUNTS TO DEALERS

SCR-522 VHF XMTR-RCVR.

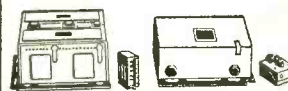

\$34.50

• 100-156Mc Transmitter-Receiver for Amateur, Civilian, Commercial and Airborne or Mobile Service. One of the most versatile surplus items—can be operated by anyone. 4 crystal-controlled channels, push-button operation. Transmitting tubes include 1-6G6G, 1-6SQ7, 3-12A6, 2-823. The 4-channel superheterodyne receiver uses 10 tubes, as follows: 1-9002, 1-6X03, 3-12SG7, 1-12X8, 1-12A7G. The dynamotor power supply is included in the purchase price. Control box and other accessories also supplied. Operation is from 28v DC, but can be converted for AC operation, simply and easily. Get one of these SCR-522 sets NOW, while stock lasts. A GREAT BUY!!

World's Lowest Price! Brand New Surplus TELEGRAPH KEYS

Mounted on Black Bakelite Base. One of Best Keys Made for U. S. Army Signal Corps. (In sealed cartons.)

4 FOR ONLY \$1.00

(Include Postage for 5 Pounds)

These Keys list for \$2.75 each. You get \$13.75 worth of equipment FOR ONLY ONE DOLLAR!

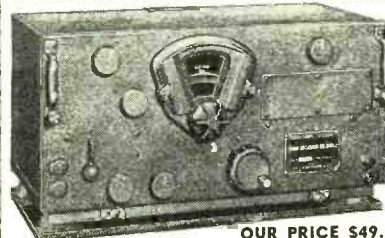

SENSATIONAL BC-348 RECEIVER

200-500kc and 1.5 to 18mc in six bands! Crystal I.F. Filter. 2 Stages RF. Combined RF and AF Gain Control. High-ratio Vernier Tuning Dial. Built-in 24v dc Dynamotor which is easily removable for AC pack installation. Two 'phone jacks on front panel, one for loud-speaker operation. Has 2 stages transformer-coupled audio. BFO Manual or automatic volume control. This is the most wanted surplus item. Limited stock. First come, first served.

OUR PRICE \$49.50. Complete With 8 Tubes

• We Can Also Supply This Same Receiver With Built-In 110 v. AC 60 Cycle Power Pack—Ready For Operation . . . \$69.50
BRAND NEW BC-348 IN ORIGINAL FACTORY CARTONS, GUARANTEED UN-USED, WITH TUBES AND DYNAMOTOR \$79.50
BRAND NEW 110 V. A.C. MODEL \$9.50

ONLY A FEW LEFT

BC-645 \$16.85

This 15-tube set will operate on frequencies for Citizens' Radio, Amateur, etc. Tubes alone worth \$26.00 net. Too well known to require description. Be safe. Order yours TODAY! Our Price ONLY \$16.85
Two for Only 30.90

12/24V. DYNAMOTOR-PE-101C. SUPPLIES ALL POWER FOR BC-645. 400V. 135MA. DC. ALSO 9V., 1.2a, AC. ONLY \$9.95 NET

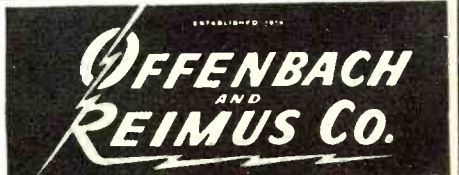

372 Ellis St., San Francisco 2, Calif.
TELEPHONE: ORdway 855
We ship C.O.D. anywhere. Send 20% Deposit.



TRANSCEIVER RT-7/APN-1

Freq. 418 to 462 Mc FM; with 14 tubes: 3-12SJ7, 4-12SH7, 2-12H6, 1-VR150, 2-955, 2-9004 & 27 dynmtr. W/book & diagram. 25 lb. pkd. As shown, NEW. BARGAIN PRICE... \$9.88



EE-8 FIELD TELEPHONE

loc. batt. & com. batt.; contains handset, induction coils, generator, ringer in leather or heavy web case (please do not specify). Make fine farm or ranch phones, intercom, etc. N E W - \$15.95, 2 for \$31. Good used - \$12.95, 2 for \$25. FOB Oakland, Cal. Write for quantity discount.

TRANSFORMERS AND CHOKES

Pr. 115v 60 cps. * Indicates hermetically sealed. POWER: #1230vct 260ma, 18v 1 amp Thord. 36.88 #250vdc 150ma, 5v 3a, 6.3v 3a Jeff. 1198. 3.78 #312vdc 85ma, 5v 3a, 6.3v 2.1a Jeff. 1159. 2.65 #330vdc 85ma, 5v 2a, 6.3v 2a, 6.3v 7.5a. 3.88 FILAMENT: 48v 2a Stator 302P. 2.88 #4v 16a, 2.5v 1.75a Jeff. 1157. 2.88 #4.5v 1 amp, 2.6v 2a W.E. #D161917. 1.48 SCOPE: 4000v rms 10ma using 2X3, 2 1158. 5.88 CHOKES: *dual 9.5 by 85ma Jeff. 1317, 2 for 2.15 12 by 200ma 105 ohm Thord. T15C45 equiv. 2.65 20 by 160ma 300 ohm Hammarlund. 4.88 5 by 225ma 112 ohm G.E., a beauty. 2.88 3.75 by 450ma 50 ohm General 344.5. 4.88 TUBES: New, indiv. cart., guaranteed. Quant. disc. WE WILL MEET PRICES OF THESE TUBES IN ANY AD THIS ISSUE RADIO NEWS: 1E5GP, 1J6G, 1L6A, 1L6B, 1L6C, 5F1, 5F2, 5Y6G, 5Y6, 5Z4, 6AB6, 6C5GT, G, 6D6, 6F8G, 6H6, 6K6GT, 6BE, 6K7G, GT, GLT, 6S7G, 6SA7, 6SC7, 6SR7G1, 6SS7, 6T6G, 6T7G, 6V6GT, 7AA, 7E5, 10X, 12CA5, 12AU6, 12BF6, 12SF6GT, 25Z5, 37, 39/44, 45, 56, 77, 78, 83V, VR150, WE215A, GL218, 250R, WE315A, 816, 832, 852, 878, 884, 901, 1635, 2051, 8016, 9002 & 9130.

FM TRANSCEIVER

BC - 659H, 2 W, 2.7 to 38.9 Mc. xtal controlled, portable battery operated 6 or 12 volt input. Used, as shown with handset, tubes and power supply, some with crystals.



\$18.95
Without handset, condition fair.
\$11.95
FOB Oakland, Cal.

ODDS 'N' ENDS

SIG. GENERATOR I-198A: 7-15 Mc. fine for VFO; with calibration chart, 1 1/2" dia., \$14.85 10 cm-radar copper co-ax, 1 1/2" dia., 52.5 ohms impedance; "L" 31"x8 1/2"; fine for 2-meter co-ax antenna. 4.85 COUPLING for above, bronze, 4 1/4" long. 2.15 WIRE, #18 stranded tinned, 1000 volt vinyl-insul. 10 colors; 1000 ft. one color. 6.88 CONDENSER, 50mmf 20,000v Eimac vacuum. 3.88 7 mid 600v oil-filled 4 1/2"x3 1/2"x1 1/4". 1.15 3 mid 4000v Sprague oil 6 1/2"x4 1/2"x3 1/2". 5.85 CABINET for Super-Pro. 19" W x 10 1/2" H erkie. 5.85 RHEOSTAT, 300 watt 700 ohm Ohmite "N". 4.85 TRIMMER, half-silvered ceramic, 3-13 or 5-20 mmf. Choice, 5 of each or ten of one. 1.88 TIP JACK screw type w/nut, insul., red. dz. 1.08 SOLENOID, 6 volt, pos. action, cased, 4 lb. 1.15



A: COILS, BC-610 final tank; Freqs.: 2-2.4, 2-4-5, 4.5-5.7 (var. or fixed link); 5.7-8.0, 8.8-11 (var. link); 11-14 & 14-18 Mc (var. link). FIXED LINK \$1.65; VAR. \$ 2.58
B: TIME-DELAY RELAY, ad. in 30-sec. intervals from 3 to 36 sec.; 10-amp cont. n.o.; 115vAC; Price Bros. #92; case 3"x3 1/2"x 5". 16.85
C: MOTOR DRIVEN SWITCH, 115vAC, makes each of 5 contacts 80 times per minute. 4.88
Postage extra. Minimum order \$2.00. FREE LIST. TERMS: Net cash, 25% deposit on C.O.D.'s.

ELECTRONIC SUPPLIES

317 E. 2nd St. Tulsa 3, Okla.

XMTA, 12.215, is "The Voice of the Chinese Air Force" in Nanking; is not affiliated with the Central Broadcasting Administration; established not long ago. (Kary)

XOPD, after much wandering, has settled down on old frequency of 9.555. (Baxter) Good signals on West Coast; location is Hangchow. (Dilg)

XRRA, Peiping, is back on 10.260, mornings, after a brief stay on 15.130; signs off at 1000. (Baxter) Does not carry 0800 Nanking news. (Dilg)

VGOUS, 9.123, Nanking, announced as XOL2; "has several harmonics on various frequencies." (Baxter, Dilg)
Czechoslovakia - Prague's OLR5A, 15.230, is being heard to North America (in English, Czech, Slovak), daily 1800-1900; news at 1835. (Sutton)

English periods to Europe are one hour earlier during summer—at 1245 on 9.55; at 1445 on 6.010. Later announcements said news would be given also at 1645. (Pearce)

Denmark—Radio Danmark, 15.320, Copenhagen, is heard in Britain on Sundays from 0700. (Pearce)

Ecuador—On June 26, HCJB, Quito, presented a special program for the International Short Wave Club, London, and other listeners, on 15.115, 12.455, 9.958, 6.240; reports are being verified from Casilla 691, Quito, Ecuador, South America.

Egypt—SUX, 7.860, Cairo, scheduled 1400-1920. (ISWC)

Falkland Islands—Stanley, 3.440, 30 watts, scheduled Sundays at 1500; educational programs, Monday through Friday, 1300-1400; hopes to have new equipment soon.

France—New Paris schedules to North America are 1700-1715 (news and commentary at start) on 17.85, 15.35, 15.24; and 1915-2015 (news at start) on 15.35, 11.845, 9.55. The former 2100-2245 transmission is now off; also the 2300-2345 period on 15.24, 11.845. (Balbi)

French Indo-China—Radio Saigon's 11.78 is still heard at 0500 in East with news. (Ferguson) Letterbox is at 0550 on Friday. The 6.190 frequency is heard well in New Zealand. (Gray)

The station on 7.530 has been definitely identified as Radio Dalat; schedule varies, usually is around 0715-0845 close down. Hanoi's 9.645, heard to 0700 sign-off with "La Marseillaise." (Baxter) Frequency varies, 9.460-9.468. (Dilg)

Germany—Miers, Berlin, lists present German s.w. stations as Berlin, 6.030; Berlin, 6.070; Baden-Baden, 6.327 (Sudwestfunk); Leipzig, 9.730; and Hamburg, 6.003 (the Hamburg station, however, is reported by other sources as on 6.115).

In verifying, Baden-Baden stated they used 1 kw. power. (Gray)

Leipzig's 9.73 now signs on at 2200. (Beck)

AFN, 6.080, Frankfurt, now signs off at 1900; announces, "This is AFN, serving the armed forces in the European Theater"; announces long- and medium-wave transmitters in Frankfurt, Bremen, Bremerhaven, Berlin,

Munich-Stuttgart; gives a 20-hour schedule of 1100-1900; last feature is musical program called "Midnight in Frankfurt," 1700-1900. (Beach)

Gold Coast—Accra, 7.299, is heard in South Africa at 1230; news at 1245; signs off at 1300; announces 4.915 in parallel, but this one is not heard due to Lourenco Marques on same channel. (Laubscher)

Greece—Paul Kary, Pennsylvania, received this information on the Greek transmitters from Cable and Wireless, Ltd., operators: "Actually, we use the same transmitter or type of transmitter (same as SVM, 9.935) for the SVD-2 broadcasts on 7.295, but whereas SVM has a six-element broad-side array antenna, SVD-2 is using a temporary folded dipole, as our third 200-ft. mast has not yet been erected. (All three 200-ft. masts were destroyed by the Germans when they left.) The three transmitters are Marconi SWB-10's, using two water-cooled CAT-9 valves in the final stage; the power into the antenna can be 27 kw. on telegraphy, or 7 kw. on telephony. The 7.295 transmission by the Greek Government has now ceased owing to QRM on that allocation, and they are now awaiting an allocation on the 30-m. band."

According to NNRC, SVR, 14.420, Athens, is heard on this new frequency calling U.S.; also said they had SVT on 15.010 but could not use that day.

Guatemala—TG2, 6.620, Guatemala City, has been heard in Britain at 1910 with news items interspersed with few bars of "Stars and Stripes Forever"; gave call as "Radio Morse." (Short Wave News)

"La Voz de Quezaltenango" signs off at 2215 on new frequency of 6.900. (NNRC)

Holland—"News of the Netherlands" (in English) is scheduled except Sundays, 2300 on 11.73, 9.59, 6.02 to North America; at 0430 on 17.17, 15.22, 6.02 to the Pacific Area; at 1300 on 11.73, 9.59, 6.02 to Europe and South Africa; and 1730 on 11.73, 9.59, 6.02 to South America.

India—Delhi's 21.510 has been heard in Ohio signing on at 0900; also heard with weak signal at 2330. (Sutton) Have heard this one in West Virginia carrying the 0730 news.

Ireland—The Irish Radio Service is establishing a new short-wave station; purpose announced to bring to the peoples of the world "an everyday story of the new Ireland speaking with its own voice"; programs to consist of music, talks, and news. (Gillett, Australia) Watch for this one!

Radio Eirrean's 9.595 is being heard again around 1610-1630, news at about 1620; announce this as their third transmission and ask for reports from North America to Radio Eirrean, Chrysler Bldg., New York 17; station has fair signal but heavy QRM in Maine; in New York signal is poor; certainly is not the 100-kw. job promised! (Beach, Beck)

Japan—WLKS, 2.465, Kure, British Occupation Forces Station, runs to

0900 Saturdays. (URDXC) Normal schedule is 0300-0730; on 6.105, schedule is 1630-1800, 2100-0500. (Harrison)

JO8C, 6.005, Sapporo, runs 1530-2000, 2030-0900. (URDXC)

Java—"Voice of Free Indonesia," 11.001, has been heard in New York with *English* at 1100-1130; call given as YHM (some sources list it as YHN); good signal. (Casey)

Radio Batavia beams a program in *English* to the U. S. daily on 11.440, 0930-1000. (Stark) Paralleling in this transmission is 15.140 (possibly as high as 15.145) to Australia and Malaya. (Dilg, Balbi, Baxter) The 15.145 channel has been heard earlier than 0930. (Dilg) The 11.440 one replaced 9.415, used in first tests. (Baxter)

"The Official Radio Station of Batavia" is using about 9.688 from before 0645 to after 1015 fade-out; mostly music; *English* heard some days at 0730-0800. (Stark) Has good signal here in West Virginia some mornings. Balbi lists this station on 9.685, 0400-1030, with news in *English* at 0530, says is Home Service; fair to good level.

Kenya—VQ7LO, 4.885, Nairobi, is scheduled Monday and Friday, 0500-0600, 1000-1400; Tuesday and Thursday, 0500-0600, 0730-0830, 1000-1400; Wednesday, 0500-0600, 1000-1500; Saturday, 0500-0615, 1000-1500; Sunday, 1000-1400. On medium-wave, 810 kcs. is in dual. (Radio Australia)

Has *English* at 0500-0540, 1100-1310; on Saturdays carries BBC news at 0600; on Sundays has Forces' Program at 0200-1000; on 6.060 (paralleling medium-wave 714 kcs.) has *daily* Indian and vernacular programs, 1200-1300; a demonstration program is listed for Tuesdays and Thursdays at 0730-0830 on 6.060 and 810 kcs. (Ferguson) (NOTE: If anyone this side of Atlantic picks up VQ7LO, please notify your ISW editor. Thanks.)

Lebanon—Short Wave News, London, says that Beirut, 8.028, is heard in Britain closing at 1145 with "This is Radio Levant, Joan Edwards saying goodnight to you." Goes off the air with "Pack Up Your Troubles In Your Old Kitbag." Signals were R7-Q4 with some CWQRM. Has ceased to use call letters FXE. Scheduled to carry news at 1100.

Macao—Radio Macao, 9.254, is now on summertime, with program one hour earlier, than during the winter month; heard signing off at 0825; news is probably around 0650. (Dilg) Letter verification to Ronald Gray, New Zealand, listed schedule of 1230-1730; stated they are using 200 watts to a center-fed Hertz antenna; use pair of Osram MT9F tubes as Class B linear amplifiers. Call is definitely Radio Macao, CR8AA.

Madagascar—Radio Tananarive has been heard signing off later again than when previously reported; this time sign-off was at 1345 on both 9.69 and 6.065; at Easter signals from this station were heard on 10.615 at 1030. (Gillett) FIQA, 9.695, is heard in

August, 1947

TRANSVISION

4 GOOD DOLLARS-AND-SENSE REASONS WHY
The TRANSVISION TELEVISION KIT
IS THE CHOICE OF DISTRIBUTORS, DEALERS
AND THOUSANDS OF USERS!

BIGGEST VALUE
LEADING "BUY" IN THE FIELD

TOP QUALITY
IN EVERY PART

NEW SYNC. CIRCUIT
GIVES STABLE PICTURE

BACKED BY EXTENSIVE
NATIONAL
ADVERTISING

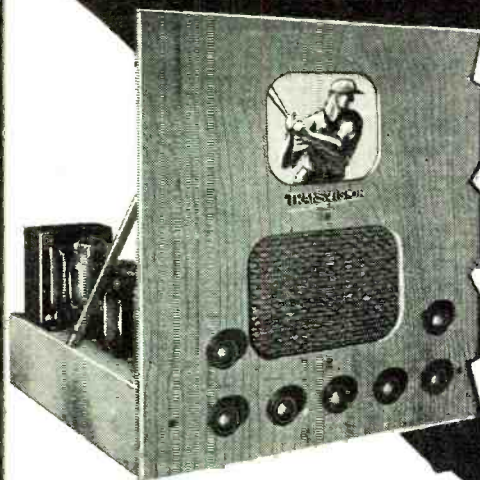

BEAUTIFUL CABINET: Transvision offers a beautifully-styled cabinet *exclusively designed for their kit*. Made of selected grain wood with attractive hand-rubbed walnut finish. An accessory kit is included for use in mounting the assembled Transvision set into the cabinet. Overall size 17 1/4" deep; 19 1/4" wide; 15 3/4" high. . . . NET \$29.95

NATIONAL ADVERTISING in leading publications, plus dealer displays, plus local service agencies back up the Transvision policy—to offer the *tops in television from every angle*: quality, value, service, dependability, and enjoyable reception.



IMMEDIATE DELIVERY: The extensive engineering and manufacturing facilities of Transvision facilitate prompt shipment of all orders.

See your local distributor, or for further information write to:

TRANSVISION Inc., Dept. R. N., 385 North Ave., New Rochelle, N.Y.

• **BIGGEST VALUE:** When assembled the Transvision Kit becomes a television receiver *worth more than twice its cost*. The quality of performance has been acclaimed superior to other available sets by over 10,000 satisfied users.

The kit is **COMPLETE** with *sight and high fidelity sound reproduction*. Nothing more to buy. No technical knowledge required for assembly. Our complete easy-to-follow instruction sheet gives you all the knowledge you need. No test equipment needed. All difficult assemblies such as the R.F. Unit, I.F. Transformers, are factory wired and pre-tuned. . . . **NET \$159.50** (fair traded).

• **TOP QUALITY PARTS:** You get a brilliant 7-inch Lectrovision Picture Tube, all other 17 tubes; pre-tuned R.F. Unit, tuned I.F. Transformers, 6" speaker, and all other necessary parts including a finished front panel, solder, hook-up wire, a **NEW SPECIALLY DESIGNED FOLDED DI-POLE ANTENNA** with 60 feet of low-loss lead in cable. The total value of all these parts would come to over \$300.00 list.

• **The pre-tuned R.F. UNIT** mentioned above is the heart of the television set. It is completely wired, pre-tuned, and tested by Transvision. Includes 6C4 oscillator and 6AC7 converter tubes. Designed for high conversion gain and 6mc bandwidth. Nothing for you to do but install.



• **NEW SYNC. CIRCUIT** achieves stable picture, sharp focus. Engineered by Transvision, it gives a maximum of picture stability even in areas of low signal strength or high noise levels. Clear enjoyable reception assured.



TELEVISION KIT

\$159⁵⁰ \$174⁵⁰

Including leatherette cabinet

with solid mahogany, walnut or birch cabinet

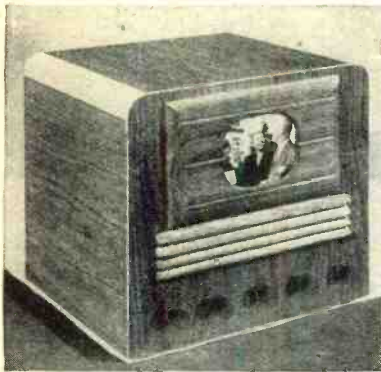

Has the following features:

- New and brighter DuMont 7" Cathode Ray Tube
- New advanced TRUE FM sound included
- Non-flicker pictures
- Latest electronic holding circuits
- Simple wiring from large, clear, schematics
- All parts individually wrapped and packaged
- High frequency I.F.'s conforming to latest I.R.E. standards

Production now at an all-time high
Sold ONLY through reputable distributors

DYNAMIC TELEVISION ASSOCIATES, INC.

Manufacturers, Television and Electronic Equipment
155 Prince Street Brooklyn, N. Y.

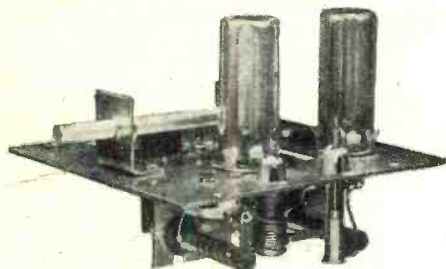

fm
fm
fm

INTRODUCING MODEL FMF-2 TUNER

Tuning range 87.5 to 108.5 megacycles. Positive mechanical drive—no backlash. 180 degree dial rotation. Image ratio is 120-1 minimum. Input matches 300 ohm line. There is no perceptible frequency drift from a cold start (8 kc). Tracking error is 3 DB or less.

Intermediate frequency to be

used 10.7 megacycles. Tube complement: 6AK5 mixer, 6C4 local oscillator. Units are completely aligned at factory. Chassis size: 4 1/2" x 4 1/2" (Mounting hole dimension 3 7/8" x 3 7/8"). Voltage requirements: 6.3 volts at .45 amp, 100 volts. See your jobber or write for catalogue.

RADIO TUNING DEVICES

392 State Street

Stamford, Connecticut

WRCI ELECTRONICS

Graduates now employed as Airline Flight Radio Officers, Broadcast Operators, Merchant Marine Radio Officers, Radio Technicians, radio shop owners. The technical staff and laboratory facilities of WRCI provide superior practical training with modern laboratory equipment. No time wasted on non-essentials. Small classes—uncrowded facilities. Specialized training in RADIO-TELEVISION SERVICING and in RADIO OPERATING. Beginners' classes start monthly. Quota for non-veterans. Approved for veterans. Member L. A. Chamber of Commerce. Free copy of "Lifetime Careers in Radio-Electronics" upon request.

WESTERN RADIO COMMUNICATIONS INSTITUTE, 631 W. 9th St., Los Angeles 15, Calif.

RADIO SERVICE MEN!

• RCA RADIOTRON
• TUNGSOIL
• SYLVANIA
TUBES, PARTS AND EQUIPMENT
Serving Eastern New York State
Distributors of RADIO EQUIPMENT

CHIEF ELECTRONICS

104 MAIN STREET, POUGHKEEPSIE, N. Y.
The Square Deal Supply House

PEN-OSCIL-LITE

Extremely convenient test oscillator for all radio servicing: alignment • Small as a pen • Self powered • Range from 700 cycles audio to over 600 megacycles u.h.f. • Output from zero to 125 v. • Low in cost • Used by Signal Corps • Write for information.

GENERAL TEST EQUIPMENT
38 Argyle Buffalo 9, N. Y.

Britain at 1155 with recorded dance music, followed by local French news, gives call of "Ici Radio Tananarive." (Short Wave News) Heard signing off, at 1345.

Malaya—Tan Bin Hussain, Malayan correspondent to *Short Wave News*, London, reports that *Radio Malaya* is to have three new 5-kw. short-wave transmitters—two in Singapore (for Blue and Red Networks, respectively), one near Kuala Lumpur to provide the link with Singapore, replacing the present rather inefficient telephone line circuit. *Radio Malaya*, however, will concentrate primarily on medium-wave broadcasting, so that radio will be within the reach of the masses, it has been announced by J. S. Dumeresque, the Director of Broadcasting. The medium-wave scheme will center on three 10-kw. transmitters—at Singapore, Kuala Lumpur, Penang; respectively. With all the projects in view, Mr. Hussain writes, it is believed that Malaya "will have one of the finest radio systems in the Empire."

Kuala Lumpur, now on 6.045, opens at 0530; Saturday sign-off is 1130, other days at 1030. (Gillett) Good on West Coast; news at 0900. (Baxter) *Radio Australia* says increased signal level indicates this is a new, higher-powered transmitter, probably 5- or 7-kw.; formerly was 1 kw.

Radio Malaya, 4.820, Singapore, is heard in Mexico around 0715. (Butcher)

Malta—VPT2, 15.015, heard several times afternoons testing with GBC on 13.390. (Harrison)

Mozambique—CR7BJ, 9.650, is heard in Texas at 0000-0100; no *English* noted. (Stark) Is only Mozambique transmission now heard in New York. (Beck)

A. Goncalves, manager, Radio Clube de Mocambique, Lourenco Marques, address of Box 594, sends us this data: "We are broadcasting *two separate* programs—one in Portuguese and the other in *English* and Afrikaan." Schedules are: Portuguese—Weekdays, 0000-0100, 0400-0630, CR7BK, 740 kcs., CR7BJ, 9.645; 1100-1500, CR7BK, 740 kcs., CR7AA, 6.137, CR7BJ, 9.645; Sundays, 0400-0700, CR7BK, 740 kcs., CR7BJ, 9.645, and 1100-1500, CR7BK, 740 kcs., CR7AA, 6.137. *English* and Afrikaan—Weekdays, 1100-1700, CR7BV, 4.900, CR7AB, 3.490; Sundays, 0200-0700, CR7BE, 9.580; 1000-1700, CR7BV, 4.900, CR7AB, 3.490. The *English*-Afrikaan program is entirely musical, therefore has no newscast. Interval signal is four chimes—*doh-mi-doh-sol*—and text, "*Radio Mocambique, Lourenco Marques, for happy listening in the 60- and 85-meter bands.*" Verifications are sent to listeners sending in complete reports.

New Guinea—Jungle Network, 7.198, Biak, reported 0400-0530; may run later. (URDXC)

Northern Rhodesia—Lusaka's 9.705 (announced) is being heard on West Coast; *English* has been heard some days (Tuesdays); woman announcer

RADIO NEWS

said operating in 31-, 41-, and 76-meter bands. Opens at 1030. (Dilg) Signs on with drums and says, "Good evening." (Baxter) Letter of verification states this new frequency is intended to service Nyasaland, Northern and Southern Rhodesia, a radius of about 500 miles; transmitter is a Marconi SWB8 with power of 2.5 kw. (Laubscher). Has been heard in Australia at 1530-1630 sign-off. Lusaka also uses 7.285 and 3.914. (Radio Australia)

Norway—Oslo's LKQ, 11.735, LKJ, 9.54, are heard signing on at 0300 with what may be Norwegian National Anthem; 26 time pips begin program period. (Gillett) LLS, 7.210, Tromsøe, in verifying by card (airmail), gave power as 10 kw. (Pearce)

Palestine—JCKW, 7.218, Jerusalem, comes on with English programs at 1130 after Indian session; leaves the air at 1600 with Ted Lewis' "Goodnight Melody." (Laubscher) Heard in Britain at 0030 with announcement of time as "half-past seven"; good level. (Short Wave News)

Philippines—KZRH, 9.64, Manila, is heard in North Carolina around 0600-0645; musical numbers stronger than voice announcements. (Ferguson)

Siam—Bangkok appears to be experimenting to find a proper frequency; is heard some days on 6.125, others on usual 5.995 (listed 6.040); former best in Australia. First transmission ends at 0630, news at 0615; last transmission (native) concludes at 0915; (Gillett) Heard on West Coast. (Dilg)

Southern Rhodesia—ZEA, 3.658, ZEB, 3.700, Salisbury, are scheduled early afternoons; low-powered. (Harrison)

Spanish Morocco—Radio Tetuan, 6.067, is heard 1330-1500 on weekdays, to 1600 Sundays; 1.5 kw. power, (Swahn) Heard in Britain from 1630 announcing as "Habla Radio Tetuan." (BSWL)

Surinam—PZR, Paramaribo, listed on 11.332, is heard in Charleston, West Virginia, on actual frequency (measured) of 11.323 with S9 level at 1700; sign-off varies, usually is around 2035. Uses some American recording and has had relay of PCJ (Dutch) news at 1900-1915; the 5.843 channel seems to parallel. (Arthur)

Signal Generator

designed for

RADIO SERVICEMEN

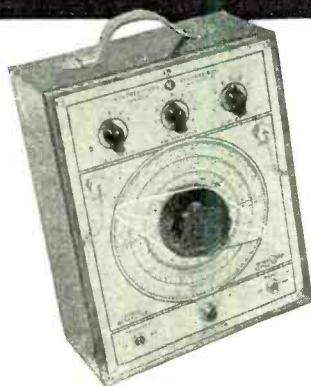

Send for bulletin

Model 700 Signal Generator is a general purpose radio and audio frequency oscillator. Rugged construction in steel cabinet, with leather carrying handle.

DEALERS: Be prepared to demonstrate this excellent piece of equipment. **WRITE TODAY** for **SPECIAL DEMONSTRATOR OFFER** to...

DEPARTMENT SG-2

NORTHEASTERN ENGINEERING, INC.
MANCHESTER, N. H.

August, 1947

36 TYPES OF...



No. 146-108

... INDUSTRIAL ELECTRON TUBE SOCKETS

by

AMPHENOL

To insure top performance and long uninterrupted tube life, leading manufacturers of electron tubes cooperated with Amphenol engineers in designing these new Industrial Sockets. With 36 types currently available, and more to come, Amphenol Sockets today are available for practically all electron tubes now in use.

Amphenol Industrial Electron Tube Sockets combine the best of design in terminals, contacts and insulation. Quick-connect screw type terminals simplify testing in original equipment and the replacement of sockets in older equipment. Cloverleaf contacts, an exclusive Amphenol feature, provide four full lines of contact to the tube pins and assure against loss of conductivity under the heavy current loads of industrial applications. Insulation materials have been chosen to provide maximum physical strength, high arc-resistance and reduced carbon tracking. Barriers provide extra safety factors.

These Amphenol Features Spell Top Efficiency

- ★ First to comply with N.E.M.A. and Underwriters' specifications for industrial equipment.
- ★ Reversible binding screw terminals simplify wiring and maintenance.
- ★ Rugged insulating barriers prevent flashover and arcing in humid and dusty industrial applications.
- ★ Cloverleaf contacts... four full length lines of contact with each tube pin.

See your parts jobber, or write today, for full technical and cost data on Amphenol Industrial Electron Tube Sockets.

AMERICAN PHENOLIC CORPORATION

1830 South 54th Avenue, Chicago 50, Illinois

COAXIAL CABLES AND CONNECTORS • INDUSTRIAL CONNECTORS, FITTINGS AND CONDUIT • ANTENNAS • RADIO COMPONENTS • PLASTICS FOR ELECTRONICS

133

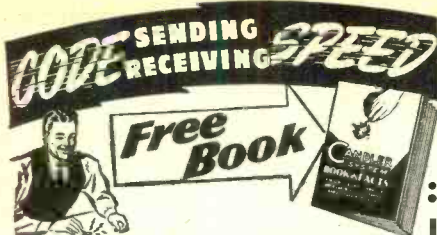

GET HIGH SPEED WITHOUT NERVOUS TENSION

Amazing Book shows how "crack" operators rely on something besides practice to develop high speed and proficiency. You can learn code or improve your present efficiency in sending and receiving by the same system that has made code champions and radio telegraph experts. Send for 52-page book. It is free.

CANDLER SYSTEM CO.
P.O. Box 928 Dept. 2-J Denver, Colo.

"TELEVISION SPECIALISTS"

Design Data & Parts

• **NEW TELEVISION COIL KIT 510**—Build a 10" or 15" television receiver. • Complete kit of permeability tuned video IF, RF, and Sound Coils for high quality television receiver designs. Contains all necessary coils for 3 stages inc. wide video, 2 stages sound, discriminator, peaking, oscillator, and RF. Complete instructions included. Priced at Only.....**\$9.95**

TELEVISION COIL KIT 500A—including 10 matched coils for low cost 7" television receiver design described in booklet. Only.....**\$4.95**

"Design and Construction of a Modern 5 or 7" Television Receiver"
New 2nd Edition

More Pages, Greater Detail, Drawings, Photographs. Designed for Good Performance, Simplicity, Economy. For Experimenters, Servicemen... any technicians that prefer to build their own.

"Design and Construction of a Visual Alignment Sweep Signal Generator"

Build a Television Sweep Generator, inexpensive, simple... yet professional in performance. A "must" for servicemen... for alignment of Television Receivers.

Included with each booklet is an 11 x 17" working diagram.

We Carry a Complete Line of Television Parts for the Experimenter!

R.F. & I.F. Coils C.R. Tubes
H.V. & L.V. Transformers Punched Chassis
Complete line of Resistors, Condensers, Special CR Tube Sockets, etc.

SEND FOR OUR LATEST PARTS LIST



P. O. Box No. 52, Kew Gardens 15, N. Y.

Enclosed is \$_____ (check or money order).

Quantity

- Television Receiver Bklet.....\$1.75-ea.
- Sweep Signal Generator Bklet...\$1.75 ea.
- Television Receiver Coil Kit 500A.\$4.95 ea.
- Permeability Tuned Coil Kit 510...\$9.95 ea.

Name _____

Address _____

City _____

Zone _____

State _____

Order Direct or Through Your Dealer

Sweden—SDB-2, 10.78, Stockholm, has improved signals in the daily 2000-2100 beam; comes on with usual chimes; news shortly after start. Parallel frequency of 9.535 is seldom audible in America. (Officials of the station say would substitute 15.155 for 9.353, but are afraid if leave 9.535 will lose "sole channel" in 31-m. band.)

Current frequencies used by Stockholm include 15.155, 11.705, 10.780, 9.535, 6.065. A new Broadcasting House was begun during 1946, is intended that it will be completely up-to-date in every way possible, with 15 major studios including 3 concert halls seating audiences up to 1000; it is expected this new building will be completed in 1949. (BSWL)

Switzerland—"The United Nations Radio" in Geneva has been heard testing around 1900-1925 on 9.515, strong signal; verification was by letter, stating that tests were being conducted on 9.515, 9.545, 9.595, 9.655, 11.715, 17.770. QRA is United Nations Radio, Information Centre, Section Radio, Palais des Nations, Geneva, Switzerland. (Shore) Heard signing off at 1930 on 9.515. (Beck)

Berne is using 11.865 and 11.815, 0215-0330 on Monday, Tuesday, Thursday, Friday to Australia. (Balbi)

Tangiers—A letter to Bergstrom, Sweden, from "Radio International" states that this "is a comparatively new station. We began broadcasting on September 18, 1946. We now broadcast eight hours a day, one to four in the afternoon and seven to midnight in the evening; we use four languages—French, Spanish, English, and Arabic." Slogan is "Aqui Tanger, Radio International" (Spanish); "Ici Tanger, Radio Internationale" (French) or "This is Tangier, Radio International" (English). Frequency was given as 6.200 (48.39 m.) and QRA is 34 Goya street, Tangiers. Hours of operation would probably be 0700-1000, 1300-1800 EST.

Trinidad—VP4RD, Port-of-Spain, has has testing daily at 0600-0620 or later 9.635 (announced); at sign-off says moving to 6.085 where has been inaudible, probably due to proximity of Toronto's powerful CFRX, 6.070. (Ferguson) Fair signal here in West Virginia in earlier period. Fair signals with light QRM in New York. (Beck)

On 9.635, has been heard testing around 1900-2017 sign-off; good carrier but poor readability. (Arthur, McLaughlin) Bad spot due to London on either side (9.625 and 9.64).

I have received a letter from A. Cross, Chief Engineer, Trinidad Broadcasting Co., Ltd., Broadcasting House, Port-of-Spain, Trinidad, B.W.I., thanking me for my report on the 9.635 frequency and asking for further reports. In part, he writes: "We hope to go on the air with a proper program schedule on or about August 1. At present we are using a pair of vertically stacked dipoles which are designed to give maximum radiation

vertically and so provide a good local service. There is some lateral radiation, otherwise you would not have heard us, but we shall shortly try an experiment of using single dipole radiators, and I shall be glad to know when we do this if you receive us better. I will notify you when the change in antenna is made."

Turkey—During the summer, TAP, 9.465, Ankara, has news daily at 1145 instead of 1245 as in winter. English periods to Britain are at 1530 on Monday and Thursday, and the Postbag period is Sunday at that hour. (Pearce)

U.S.S.R.—Albert E. Langer, Philadelphia, reports Moscow on 17 megacycles (probably 17.765) 0830-1730; broadcasts alternate in French, English, and German, with language change every half hour; notes played on half-hour for about 30 seconds; also says the evening North American (English) beam can be heard 1820-1950 on 11.63, 11.89, 15.16, 15.41, 15.44, and 1930-1950 on 11.88 and 15.23.

The morning North American beam (English) is scheduled 0745-0815 on 11.75, 15.11, 15.17, 15.23, 17.74, and 21.35.

Uruguay—CXA3, 6.075, Montevideo, is heard with good signal in New Zealand, opening at 0500 with "Good Morning" song. (Gray)

Acknowledgements

Thanks for the splendid reports being received this summer. Reports should be mailed to reach your ISW editor by the 5th of any month. QRA is Kenneth R. Boord, 948 Stewartstown Road, Morgantown, West Virginia, U.S.A. Good listening!..K.R.B.

Build a TV Receiver

(Continued from page 48)

control until a thin horizontal line is visible on the screen. As this control is adjusted, the horizontal line should vary in width.

If a horizontal line fails to appear or if the sweep is erratic, turn off the equipment and recheck all wiring in the vicinity of the horizontal oscillator and horizontal amplifier stages.

Test the VERTICAL SIZE or HEIGHT control by first closing the WIDTH control and then slowly opening the HEIGHT control. Result should be a thin vertical line, varying in height as the HEIGHT control is adjusted.

If a vertical line fails to appear or if the sweep is erratic, turn off the equipment and recheck all wiring in the vicinity of the vertical oscillator and vertical amplifier stages.

Finally: Open the WIDTH control to a point where the horizontal line on the screen is of optimum width (just within the confines of the edge of the picture tube), and open the HEIGHT control so that the image on the screen is of approximately correct height. Then, if the control circuits

have been wired properly, the result on the screen of the picture tube should be an almost-square raster.

Next stage to be wired is the *syncronizing amplifier*, using a type 6N7 tube. Function of this stage is the amplification of sync pulses received from the *second detector* stage of the video circuit.

Mount the *sync amplifier* tube in front of the *vertical oscillator* tube (Fig. 4) so that the output of the *sync amplifier* can be coupled conveniently to both oscillator stages.

Two kinds of pulses are required, horizontal sync pulses at a high frequency and vertical sync pulses at a lower rate of repetition. Both kinds are obtained from the single output of the *sync amplifier* by use of suitable R-C network filters to provide separation. Method of separation is evident by referring to the circuit diagram.

Horizontal sync pulses must be of higher frequency than the vertical sync pulses. Thus, an R-C network (high-pass filter) is used between the *sync amplifier* and the input to the *horizontal oscillator* stage, and another R-C network (low-pass filter) is used between the *sync amplifier* and the input of the *vertical oscillator* stage.

In this way the two oscillator stages are synchronized with their respective high- and low-frequencies pulses, and the resultant beam sweep within the picture tube is synchronized with the sync transmissions of any television station to which the *first detector* of the receiver is tuned.

First Detector

The input of the receiver consists of a *first detector* stage using a type 1852 tube, with a *local oscillator* using a type 955 acorn tube. The r.f. oscillator is tuned *above* the frequency of the incoming television signal, and mixing of the two signals produces a strong intermediate beat frequency.

Particularly critical of construction and adjustment is the *first detector* stage and its associated *local oscillator*.

Each of these stages is tuned by a variable 50 μ fd. condenser. They may be tuned individually, or the two condensers may be ganged together.

To accommodate two *separate* tuning condensers, drill two holes in the side of the chassis so that the condensers can be mounted close to each other and as close as possible to their *respective grids*. If a two-gang condenser is used, drill only one hole in the side of the chassis so that the condensers can be mounted close to their *respective grids*.

The *first detector* tube is placed forward (Fig. 4) above the chassis, but the *local oscillator* tube is mounted underneath the chassis just behind the oscillator tuning condenser, so that all leads of the oscillator circuit are as short as possible.

Drill two holes in the chassis above and just behind the oscillator tuning condenser and mount the acorn socket

"BUILD YOUR OWN"

KITS

and SAVE!

AT LONG LAST!

F.M.

KITS!

A Real Live Low Priced F.M. Kit

Kit includes 8 tubes, power transformer, speaker and all necessary parts to complete this unit. Nothing else to buy.

\$29⁷⁵

Per Kit
Less Cabinet

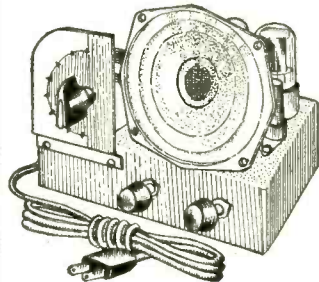

BROADCAST BAND T.R.F. KIT

Most amazing 2 tube circuit on the market! Provides 4 tube operation. Has nearly as much SOCK as ordinary 6 tube superhet! Ideal for the beginner, student or hobbyist. Nothing else required except soldering iron and side-cutter.

COMPLETE with Speaker, Tubes, etc.

\$6⁹⁵

THE FOLLOWING KITS ARE COMPLETE WITH TUBES, DIAGRAM, ETC.

Less speaker unless specified below.

- 4 TUBE A.C. SIGNAL GENERATOR 200 KC to 30 MC Freq. range. Ready wound coils. COMPLETE..... \$15
- SIGNAL TRACER AND V.O.M. Build this unit for price of V.O.M. parts alone! With 0-1 MA meter, tubes, cabinet, etc. \$20
- "WALKIE-TALKIE" 10, 5, 2 1/2 meters. 90 VDC @ 12 MA; 1.5 @ .41 amps. \$10
- Set of two "WALKIE-TALKIES"..... \$18.50
- 2-30 MC SHORT WAVE RECEIVER \$4
- 2-30 MC TRANSMITTER \$4
- CODE OSCILLATOR (Audio) \$4
- PHONO OSCILLATOR (Wireless) \$4
- A.C.-D.C. AMPLIFIER 3 tubes, 1 1/2 watt. \$5
- A.C. POWER SUPPLY 250 V @ 60 MA; 6.3 @ 2 amps. \$6

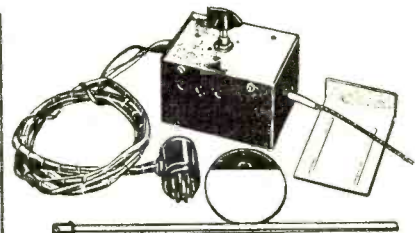

SPECIAL PURCHASE! F.M. CONVERTER

From old 42-50mc band to new 108-88mc F.M. band

Complete Unit Ready to Plug In. A Regular \$15 Value. Our Price.....

\$5

TERMS: Cash with order F.O.B. Chicago. Please remit postage charges.

IRVING JOSEPH

All items subject to prior sale. MANUFACTURERS: Write your requirements.

220 SOUTH HALSTED STREET • CHICAGO 6, ILLINOIS

BE SECURE in a Well Paid Profession. Classes Starting in September. Investigate Our Courses Now.

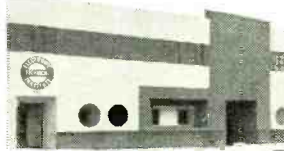

Learn RADIO-ELECTRONICS

APPROVED FOR TRAINING UNDER GI BILL

Big opportunity now available for well trained men. Learn the magic of Television, Frequency Modulation, Transmitter and Receiver Theory. Instruction with Sound Motion Pictures. Start a spare time business while learning.

WITHOUT OBLIGATION SEND FOR FREE 1947-1948 YEAR BOOK

Name..... Address.....
City..... State.....

ELECTRONIC TECHNICAL INSTITUTE
771 Venice Blvd., RN-8, Los Angeles 15, Calif., RICHMOND 9573

- I am interested in:
- AMATEUR RADIO COMMUNICATIONS
 - Television
 - Radio Servicing & General Electronics
 - Home Training
 - Amateur Radio Correspondence Course



ALL CLASS ROOMS HAVE NEW and LATEST TEST AND LABORATORY EQUIPMENT AVAILABLE FOR STUDENTS' USE.

SELENIUM RECTIFIERS FOR ALL APPLICATIONS

HALF WAVE TYPES

Input	Output	Current	Price
From 0-18 V.A.C.	From 0-14 V.D.C.	3 AMP.	\$2.25
0-18 V.A.C.	0-14 V.D.C.	5 AMP.	2.95
0-18 V.A.C.	0-14 V.D.C.	10 AMP.	4.95
0-18 V.A.C.	0-14 V.D.C.	15 AMP.	6.95
0-18 V.A.C.	0-14 V.D.C.	20 AMP.	8.95
0-18 V.A.C.	0-14 V.D.C.	25 AMP.	10.95

Input	Output	Current	Price
From 0-36 V.A.C.	From 0-28 V.D.C.	3 AMP.	\$2.95
0-36 V.A.C.	0-28 V.D.C.	5 AMP.	4.95
0-36 V.A.C.	0-28 V.D.C.	10 AMP.	7.95
0-36 V.A.C.	0-28 V.D.C.	15 AMP.	10.95
0-36 V.A.C.	0-28 V.D.C.	20 AMP.	13.95
0-36 V.A.C.	0-28 V.D.C.	25 AMP.	16.95

FULL WAVE BRIDGE TYPES

Input	Output	Current	Price
From 0-18 V.A.C.	From 0-14 V.D.C.	5 AMP.	\$4.95
0-18 V.A.C.	0-14 V.D.C.	10 AMP.	7.95
0-18 V.A.C.	0-14 V.D.C.	15 AMP.	10.95
0-18 V.A.C.	0-14 V.D.C.	20 AMP.	13.95
0-18 V.A.C.	0-14 V.D.C.	25 AMP.	16.95
0-18 V.A.C.	0-14 V.D.C.	30 AMP.	19.95

Input	Output	Current	Price
From 0-36 V.A.C.	From 0-28 V.D.C.	5 AMP.	\$7.95
0-36 V.A.C.	0-28 V.D.C.	10 AMP.	13.95
0-36 V.A.C.	0-28 V.D.C.	15 AMP.	19.95
0-36 V.A.C.	0-28 V.D.C.	20 AMP.	25.95

It would be impossible to give a complete listing of all our rectifier types. Our engineering staff is at your service to help you work out the application of selenium rectifiers to your specific problems. Write us for quotations or further information.

Send check or money order

25% Deposit required on all C.O.D.s.

OPAD GREEN COMPANY
191 GREENWICH STREET
NEW YORK 7, N.Y.

Mr. Radio Service Dealer
"Speed is our Motto"

One day service on all orders. None too small. Only Nationally Advertised Merchandise (No Surplus Handled). TUBES—Any quantity 50% off list.

Mail us your orders.

Illustrated list on request.

Bill Sutton's Wholesale Electronics
Fifth at Commerce Fort Worth, Texas

LCETI

on two 6/32 stand-off bolts. Height of the socket may be adjusted by running two nuts *under the socket* up to the desired position.

The 100 μ fd. condenser (C_{31}) used in the oscillator grid circuit should be temperature compensated to minimize any frequency shift due to changes in temperature.

The r.f. coils for the *first detector* and the *local oscillator* stages are made from No. 14 wire. They are air wound with a diameter of about $\frac{3}{4}$ inch. The exact number of turns cannot be given as the coils will vary in size for each individual case, due to differences in the placement of parts, types of sockets, length of circuit leads, and other common factors. However, in most cases between 3 and 4 turns of wire should be about right.

The cathode of the 955 tube is connected to a point on the oscillator coil L_2 about one turn in from the grounded side of the coil.

Solder the completed r.f. coils to their respective tuning condensers.

The *local oscillator* functions at a frequency higher than the television signal frequency by an amount that represents the desired intermediate frequency of the video signal; 12.75 megacycles.

Close proximity of the oscillator coil and the first detector coil is sufficient for adequate mixing, and additional coupling is not required to produce a strong beat frequency.

If desired, additional 10 μ fd. fine-tuning condensers (C_3 , C_{30}) can be placed in parallel with the oscillator and first detector main tuning condensers as shown in the circuit diagram. The two fine-tuning condensers should be ganged.

Video Stages

Following the *first detector* stage of the receiver, the video signal is applied to three *video i.f. amplifiers*, each stage using a type 1852.

Since the video signal is composed of a very wide band of frequencies, all components of the *i.f. amplifier* stages must be capable of passing a wide band of frequencies or the definition of the final television picture will be considerably impaired. The chief difficulty in maintaining a broad-band frequency response lies in the construction and adjustment of the i.f. tuning coils.

It may be possible to purchase broad-band i.f. coils at 12.75 megacycles, which would be adequate for use in this receiver.

However, if such coils are not available, they may be constructed without too much trouble.

The best source of parts are old or defective 465 kc. i.f. transformers used in broadcast receivers. These units provide most of the essential units. Unwind the old coils, but keep the coil forms for the new video i.f. coils. Also retain the old assembly bracket, bolts, and shield can.

Intermediate frequency of the video signal is 12.75 mc. To construct a coil for this frequency, wind about 17 turns

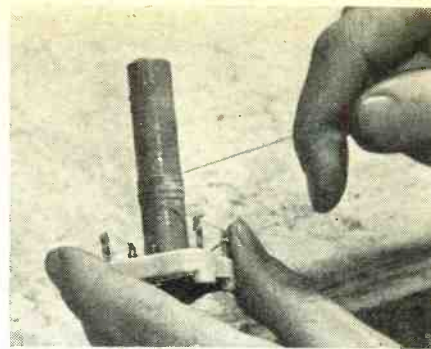

Fig. 6. Photograph shows method of winding i.f.'s on old coil forms. For complete coil specifications see Table 1.

of No. 28 wire on a $\frac{3}{4}$ inch coil form.

The same trimmer condensers used on the old i.f. transformers can be used across the newly wound coil. Since the *video i.f. amplifiers* pass a wide band of frequencies and are critical, peaked tuning is not necessary.

Mount the rewound coil and trimmer on the assembly bracket. The 1000 ohm filter resistor and the .006 bypass condenser (associated with each *video i.f. amplifier* stage) are also mounted on the assembly bracket inside the shield can, to conserve wiring space underneath the chassis.

Attach proper leads and then place each video i.f. coil assembly can close to its respective stage, as indicated in Fig. 4.

To prevent sound signals from interfering with the video signals, a wave trap—or "sound" trap—is used between the first detector i.f. coil and the grid of the first video i.f. amplifier tube. The "sound" trap consists of a coil L_4 and condenser C_9 in parallel, and tuned to 8.6 megacycles (the sound i.f. signal). Construct the coil of No. 28 wire wound on a $\frac{3}{4}$ inch form. It is tuned to reject the 8.6 mc. frequency by means of a small trimmer condenser. Connect directly in series with grid of 1st i.f. tube.

All wiring of the first detector and i.f. amplifier stages is now to be completed. But to minimize any tendencies toward oscillation, *make all leads as short as possible*.

The *CONTRAST* control—associated with the second *i.f. amplifier* stage—is mounted on a bracket below the chassis, and an insulated extension shaft protrudes through a mounting hole in the steel front plate of the receiver (Fig. 3).

After suitable amplification, the

Table 1. Coil specifications.

L_1 —Pri. 2 t. #28 wire c.t.
Sec. 3 to 4 t. #14 wire, $\frac{3}{4}$ " diam. (See text)
L_2 —Osc. coil 3 to 4 t. #14 wire, $\frac{3}{4}$ " diam. (See text)
L_3 —I.f. trans. Pri. 17 t. #28 wire on $\frac{3}{4}$ " diam. form. Sec. 2 t. #28 wire link
L_4 —Sound trap 25 t. #28 wire on $\frac{3}{4}$ " diam. form
L_5 , L_6 , L_7 —I.f. trans. 17 t. #28 wire on $\frac{3}{4}$ " diam. form
L_8 , L_9 —Peaking coils 50 t. #32 wire wound on 2 w. 500,000 ohm resistor
L_{10} , L_{11} —Sound i.f. Pri. 2 t. #28 wire link
Sec. 25 t. #28 wire on $\frac{3}{4}$ " diam. form
L_{12} —Discriminator trans. Pri. 25 t. #28 wire on $\frac{3}{4}$ " diam. form; Sec. 25 t. #28 wire c.t.

video i.f. signal is applied to a *second detector and clipper* stage using a type 6H6 double diode. Output of this stage is R-C coupled to the final stage: a *video amplifier* using a type 6V6 beam power tube.

Connect the *second detector and clipper* stage and the *video stage* according to the circuit diagram, but do not complete wiring of the plate circuit of the final, output stage.

Peaking coils L_2 and L_3 may be used, as indicated in the diagram, to bring up the higher frequencies for better picture definition. They are simply 2 watt, 500,000 ohm resistors, R_{12} and R_{13} , with 50 turns of No. 32 wire wound on them.

The video circuit of the television receiver is now ready to be aligned and tested.

Video Alignment

Using a signal generator with an output meter or loudspeaker, the *video i.f. amplifiers* are aligned in conventional manner.

The i.f. stages are stagger tuned, that is, the first coil is tuned to 10.8 mc. for maximum output, the second coil is tuned to 11.5 mc., the third coil is tuned to 12.0 mc., and the fourth i.f. coil is tuned to 12.6 mc.

Connect the output or loudspeaker across the output of the final *video amplifier*. Short out the tuning condenser of the *local oscillator*, and turn the *CONTRAST* control up (clockwise).

Then attach the leads from the signal generator between the grid of the *first detector* and ground, and adjust the signal generator for maximum output.

Tune each i.f. coil assembly for maximum output from each stage. Changes in some or all of the i.f. coil windings may be found necessary. Alignment procedure should be repeated several times.

If no signal is indicated in the output of the video circuit, turn off the set and carefully recheck the wiring and construction of all video stages. Start with the final amplifier and work back, step-by-step, to the first detector—until the trouble is found.

After the i.f. coil assemblies of the video circuit have been properly aligned, disconnect the signal generator and output indicator and remove the short across the oscillator tuning condenser. Then connect the output of the *video amplifier* to the grid of the cathode-ray tube, according to the circuit diagram.

The video circuit is now ready to receive a television picture.

First, make certain that a local television transmitter is on the air, preferably a station operating on one of the higher frequency channels. Then tune the receiver to the station. Adjust the trimmer across the tuning condenser of the *first detector* for maximum picture brilliance. Controls on the front panel are used to bring the picture into sharp focus and desired intensity.

If no picture is visible on the cath-



OLSON RADIO WAREHOUSE, INC. AKRON 8, O.

Free Gifts

for Olson customers

MARLIN RIFLE
 .22 Caliber



EASTMAN KODAKS



BULOVA
 Wrist Watch



REMINGTON
 Electric Shaver



Why not buy your Radio Parts where you get a **FREE BONUS?** Here's just a few of the big selection of nationally known articles you can get free. Olson sends you a free "Pointer" for every dollar's worth of Parts you order, and you get your gifts by saving up Olson Pointers. No catch to it... no limit to the number of free gifts you can get. Start saving these Olson Pointers **NOW!**



Paste the coupon on a Postcard-

GET THIS FREE BARGAIN BOOK

This is our big new book of Olson Bargains, containing 60 pages of real money-saving values in Radio Parts, Sound and Testing Equipment. It also has a section of **GIFT PREMIUMS** you can get by saving Olson Pointers. Mail the coupon **TODAY** for this valuable Free Book!

OLSON RADIO WAREHOUSE, INC.

73 E. MILL ST., DEPT. 89, AKRON, OHIO

I want to get Olson's Free Gifts. Send me your new **FREE** Premium Book and Price Guide right away.

NAME _____

COMPANY _____

ADDRESS _____

CITY _____ STATE _____

Permoflux

SPEAKERS



AN OLD NAME IN SPEAKERS

FOR YEARS A MAJOR SUPPLIER TO THE INDUSTRY

A NEW HIGH IN PERFORMANCE*

Announces... a COMPLETE JOBBER LINE of standard replacement and hi-fidelity de luxe loud speakers with both permanent and electro-magnet fields. These quality speakers, together with matching output transformers, embody the same skillfully engineered features as used in the units that PERMOFLUX now supplies to the radio set manufacturers.

*A two-to-one preference for use by radio set manufacturers. Sound room laboratory tests show greater uniformity and frequency response than other comparable makes.

TWO COMPLETE FACTORIES TO SERVE YOU

PERMOFLUX

WRITE FOR FREE BULLETIN

PIONEER MANUFACTURERS OF PERMANENT MAGNET DYNAMIC TRANSDUCERS

PERMOFLUX CORPORATION

4900 WEST GRAND AVE., CHICAGO 39, ILLINOIS

236 SOUTH VERDUGO ROAD, GLENDALE 5, CALIFORNIA

HAMS

Use the ROGERS R.F.S.-2

FREQUENCY STANDARD

- The ROGERS RFS-2 Frequency Standard, when built into your receiver, provides an accurate, low-cost means of checking your transmitter, calibrating your receiver, etc.
- The rugged, precision-built, 100 kc crystal generates marker signals every 100 kc over the entire range of your receiver.
- Adjust the frequency of the unit to zero beat with WWV and your set becomes a frequency meter comparable in accuracy to an expensive standard.
- Furnished complete with tube, crystal and instructions for installing.

ONLY \$1450

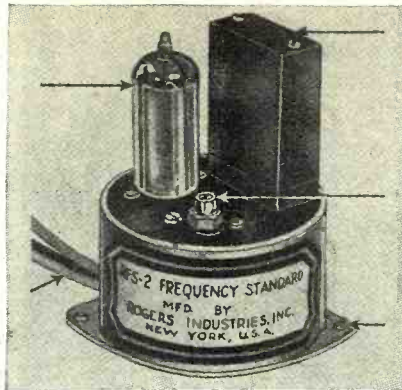

SPECIFICATIONS:

TUBE
Filament supply: 6.3 VAC
Filament current: .3 Amp.
Plate Supply: 200-250 VDC
Plate current: approx. 2 Milliampères

CRYSTAL
100 kc. low-drift silver-plated, sealed against contamination and moisture.

PHYSICAL
Housing 2 3/8" dia. 1 1/2" high
Over all hght. 3 3/8"
Mounting holes 2 3/4"

SEE YOUR NEAREST DEALER, OR WRITE:

ROGERS INDUSTRIES, Inc.

43-49 Bleecker Street,
New York 12, N. Y.

New! Munger ELECTRO-BEAM ROTATOR

Now You Can Have the Best Type of Directional Antenna at Low Cost!



PRICED AT ONLY

\$69.50 COMPLETE

F.O.B. Chicago, Illinois

ORDER ONE NOW!

- Price Includes Reversible Electro-Beam Rotator and Direction Indicator.
- Foolproof Potentiometer and Meter Circuit. Calibrations in Both Degrees and Directions.

A SENSATIONAL VALUE



When you see the many fine features of my new Electro-Beam Rotator, you'll be as pleased as I am. And you'll feel good too, because it's such an honest value—priced low because we kept you in mind constantly through all the stages of design, engineering and testing. Now that it's ready for delivery, you can take my word that it's a real honey. About the specs: 1 R.P.M.—115 volts, 60 cycle operation. Powerful reversible motor drives main shaft through heavy steel gears. Lifetime Oilite bearings. Mechanism is completely weatherproofed—housed in sturdy non-rusting duraluminum case. All parts accessible for easy inspection. Rotator mechanism weighing only 10 1/2 lbs. makes it easy to mount. Top mounting plate 10" x 12".

10 Day Free Trial Offer—No Risk

Send your check for \$69.50 for one Electro-Beam Rotator complete with Direction Indicator. You pay small express charge upon arrival. Try it at my risk for 10 days. If you are not completely satisfied in every way, return the units undamaged in their original carton and your money will be immediately refunded in full. You take no chances. Order your Munger Electro-Beam Rotator today!

Illustrated Bulletin on Request

MANUFACTURED AND SOLD EXCLUSIVELY BY



W9UP

Rex L. Munger Company
4701 Sheridan Road Chicago 40, Illinois

VERIFIED SPEAKERS

"They speak for themselves"

WRIGHT Inc.

2232 University Avenue

St. Paul 4, Minnesota

10" x 15" BLUEPRINTER

COMPLETE WITH SUPPLIES ONLY \$38.95

PRINT COPIES OF SKETCHES, ALL DIAGRAMS, AND PLATE DATA AS ORIGINAL. EASY TO MAKE PRINTS DIRECT FROM WRITTEN, PRINTED, TYPED TRACINGS OR NEGATIVES. IDEAL FOR SHOP ORDERS, RECEIPTS, LETTERHEADS, STATEMENTS, ETC.

BLUE LINE FEATURE INCLUDED. COPIES COST 2¢ PER COPY. RUSH ORDER NOW \$4.95. FOR ITSELF. FOR ITSELF.

BEST VIBRATOR CO.
BOX 5802, CLEVELAND, 1, OHIO

RADIO

Technician and Radio Service Courses
FM and TELEVISION

American Radio Institute
101 West 63rd St., New York 23, N. Y.
Approved Under GI Bill of Rights
Licensed by New York State

ode-ray tube, insert a pair of phones and a small condenser in series across the output of the *video amplifier*. If a signal is audible, the r.f. coil of the *local oscillator* may have to be pared to bring the receiver into the television band. Absence of any signal indicates either (1) the transmitting station is off the air, or (2) there are undiscovered defects in the wiring, adjustment, or alignment of the video circuit.

Sound Stages

The four-tube sound circuit consists of a *sound i.f. amplifier* stage using a type 1852 tube, followed by an *FM discriminator* stage using a type 6H6 double diode. Audio signals from the *discriminator* pass through a 6J5 *voltage amplifier* and are then applied to an *output amplifier* stage using a type 6F6 tube to feed a 5-inch PM speaker.

The complete sound circuit is constructed on a small, separate chassis (Figs. 1 and 5), which is supplied by the builder. Dimensions are not critical, but the chassis must be small enough to fit snugly in place on top of the main chassis and yet be large enough to accommodate the four sound tubes, two i.f. coil assemblies, and other parts.

As previously mentioned in the discussion of the video stages, the i.f. coil, L_{10} and L_{11} , and the discriminator coil, L_{12} , assemblies can be easily constructed from old or defective 465 kc. i.f. transformers used in broadcast receivers. Note that the top view photograph shows L_{10} , L_{11} as an iron core slug assembly. Should a coil of this type be easily obtainable, it may be used in lieu of a home-constructed coil. It is possible, however, to build your own shielded i.f. coil and use it in place of the iron slug type unit. In doing so, strip all wiring and unwind the old coil. Keep the coil forms, assembly bracket, bolts and shield cans.

The intermediate frequency of the sound signal is 8.6 megacycles.

To construct a coil for this frequency, wind about 25 turns of No. 28 wire on a 3/4 inch coil form (Fig. 6).

The first i.f. coil assembly also has a 2-turn loop primary winding. This winding is link coupled—via two well insulated leads—to the first i.f. coil of the *video* circuit, and thus supplies an input signal for the sound circuit.

Make a 2-turn loop on the coil form of the first *video* i.f. coil, bring the two leads to the sound chassis, and then connect them to the 2-turn loop on the coil form of the first *sound* i.f. coil assembly. Each 2-turn loop should be in close proximity to the main coil winding, but the degree of coupling is not critical. However, all windings on any single coil form must be in the same direction. Mount coil assembly directly on chassis.

The second i.f. coil assembly of the sound circuit (used with the *discriminator* stage) has both a primary winding and a separate secondary winding. The secondary winding is center-tapped, as shown in the circuit dia-

gram. Again, both windings must be in the same direction.

The trimmer condensers retrieved from the old broadcast band i.f. transformers can also be used across the newly wound sound i.f. and discriminator coils, since critical peaking is not necessary. Further, both sound coils are deliberately broadened by placing 200,000 ohm resistors across the windings.

Mount discriminator coil with trimmer and resistor on its assembly bracket, attach leads, and cover the coil assembly with a shield can. Then place coil assembly close to its respective stage (Fig. 1).

Install the 5 inch PM speaker behind the lower opening in the steel front panel.

Mount tube sockets and tubes, and complete all wiring of the four stages of the sound circuit, according to the circuit diagram. Leads associated with the *sound i.f. amplifier* and the *discriminator* stages should be as short and direct as possible.

Power for the sound circuit is obtained from the video power supply.

After assembly, the sound chassis is attached to the main receiver chassis, and the sound circuit is aligned in the conventional manner.

Operation may often be improved, however, by further *realigning* of the sound circuit when the television receiver is actually tuned to a transmitting station.

Sight and sound must be synchronized. When they are not, it's a good

indication that the video or sound i.f. amplifier stages are improperly aligned.

When the television receiver is functioning normally, the set is ready for installation and connection to an antenna.

Installation

Twin-parallel 300-ohm feeder line is used to connect the receiver to its antenna, and this transmission line may be of any reasonable length. At the receiver, this line terminates in a 2-turn loop inductively coupled to the *first detector* r.f. coil assembly. The 2-turn loop must be center-tapped to ground, and must be wound in the same direction as the r.f. coil. The two windings may be loosely coupled.

It's important that the antenna of any television set be given considerable consideration with regard to type of design, construction, and installation, because the effectiveness of the antenna greatly influences the operation of the receiver.

The designer of this set, Leon S. Wecker, recommends use of a folded dipole, constructed from a section of 300-ohm twin-parallel feeder line.

Cut off a 7-foot section of the transmission line. Close and solder the pair of wires at each end. At the exact center of the 7-foot section, nip one of the pair of wires and pull out the ends from the plastic dielectric. At this point connect the feeder line (which leads to the input of the receiver). Since the plastic shield material melts

easily when heated, use a red-hot nail or piece of metal to join the two pieces of plastic in a strong physical bond.

With the wires extended taut and supported by insulators or other *non-metallic* means, mount the folded-dipole antenna in a horizontal position and as high as possible. Position of the antenna in *azimuth* is adjusted for reception of the clearest and brightest picture images from a desired television transmitter, indicating maximum signal reception. Usually this position will be broadside to the transmitter. But in cities and towns, signals *reflected* by tall buildings may be used to better advantage.

However, if multiple images appear on the picture tube, they may be due to either poor antenna design, poor antenna location, or both.

At times better reception is possible when using a directional antenna. The folded dipole may be converted into a directional antenna simply by placing an 8-foot length of taut, heavy wire 3½ feet behind and parallel to the folded dipole. Both antenna and reflector can be mounted on a wooden framework so they can be rotated together until the point of best and clearest reception is reached.

Further improvements in the physical appearance of the completed television receiver may be made. At a nominal cost, the set can be enclosed in a plywood cabinet or other covering. Such finishing touches can be accomplished at the convenience of the builder.

-30-

HAMS! EXPERIMENTERS! Look at these EXCLUSIVE "G&G" BUYS!

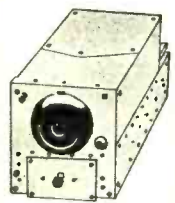

ARMY AIRCRAFT RECEIVER—BC-946-B

Covers 520 Kc to 1500 Kc Broadcast Band. Tubes: 3—12SK7, 1—12SR7, 1—12AG, 1—12K8. Designed for dynamotor operation; can be easily converted to 110 volt or 32 volt use. Two IF Stages. Three-zang tuning cond. BRAND NEW, in sealed carton, with tubes and instruction manual, less dynamotor. **\$12.95**

DYNAMOTOR DM-32A **\$1.95**

Astatic R-3 Crystal Handmike, with 6-ft. R.C. mike cable. **\$4.50**

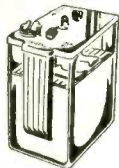

WILLARD 2-VOLT STORAGE BATTERY 20 Ampere-Hours

Exact replacement for GE portables—brand new. **\$2.75**

Willard 2 volt (3-cell) storage battery, brand new. **\$7.95**

Magnetic Pickup **\$2.20**

Shure Magnetic Cutting Head Special **\$1.95**

TELEGRAPH KEY Sig. Corps J-38 **59c**

7-PRONG 2-VOLT RADIO VIBRATOR for Portable and Farm Sets Replacement for GE LB 530 **\$1.65**

KIT OF 100 ASSORTED CARBON RESISTORS RMA color coded, ½ watt **\$1.44**

HEADPHONES

Sig. Corps HS-33 phones **\$2.49**

DC METER SPECIALI

BEEDE METER, new, black bakelite case, 3" round 0-1000 DC Ma. Special **\$1.95**

MAGNAVOX "FP" FILTER CONDENSERS

8 mfd 500 volts **45c**
16 mfd 500 volts **65c**
8-8 mfd 500 volts **70c**
40-20-20 mfd 150/150/25 V **40c**



RADAR OSCILLOSCOPE APN-4, 27 TUBES!

Very special value! Easily converted to service scope. Contains 27 tubes: 7—6H6, 1—6S7, 18—6SN7, 1—5CP1 C.R. Tube. Complete with cover. ALL BRAND NEW, in original sealed crate! Shpg. wt. 106 lbs. All yours for **\$39.50**

RECEIVER AND POWER SUPPLY FOR APN-4. Another Smash Value! Contains 16 Tubes: 1—6SN7, 1—6SL7, 1—6H6, 4—6SK7, 1—VR105-30, 1—6S7, 2—2X2, 1—5U4G, 3—6H4G, 1—6SA7. ALL BRAND NEW and in perfect working order. In original sealed crate. Shpg. wt. 80 lbs. Only **\$29.50**

BC-412 OSCILLOSCOPE (Modified to BC-612)

With very little effort you can convert this 5" C.R. Oscilloscope to first class laboratory instrument! ALL BRAND NEW, in original sealed crate. Contains 13 tubes: 6AC7, 6—6L6's, 2—6S47's, 879, 5T4, 6A6, 5B4 C.R. Tube. 110 V 60 cycle. Shpg. wt. 200 lbs. Only **\$59.50**

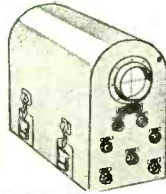

C.R. OSCILLOSCOPE TUBES EACH

12DP7.....12" Scope Tube.....	\$6.95
9L7.....9" Scope Tube.....	5.95
7BP7.....7" Scope Tube.....	4.95
5BP7.....5" Scope Tube.....	3.95
5BP1.....5" Scope Tube.....	3.95
5CP1.....5" Scope Tube.....	3.95
3AP1.....3" Scope Tube.....	2.95
3BP1.....3" Scope Tube.....	2.95

PLEASE INCLUDE 25% deposit with order—Balance C.O.D.

G&G GENUINE MAJESTIC
RADIO PARTS SERVICE
53 VESEY STREET · NEW YORK 7, N.Y.

"More than 10,000 Satisfied Dealers and Servicemen since 1940!"

SCR-522 VHF XMTR-RCVR 100-156 Mc

Ten Tube Crystal-controlled superhet rcvr. has extreme sensitivity; 7 tube Xmtr, temperature stabilized, delivers 15 watts. Used on AAF and RAF planes—now yours at a tiny fraction of original cost! Complete rig powered by 28 VDC Dynamotor. Easily converted to 110 v 60 cycle operation. Complete with all tubes. **\$14.25**



BC-403-E OSCILLOSCOPE

Sensational Buy! Must be seen to be appreciated! Contains 14 tubes: 6—6L6, 6S7, 6AC7, 2—879, 6H6, 2—5T4, 5B14 C.R. Tube. Has self-powered air blower with 1-hp Motor 110 v 60 cycle. Size 27" x 35" x 12". Shpg. wt. 385 lbs. ALL BRAND NEW in original crate. Yours for only **\$85.00**

SETCHELL CARLSON RADIO RECEIVER BC-1206-C

Designed to receive A-N Beam signals, operates on 24-28 V DC. Tubes: 3—14H7, 14R7, 28D7. Tunes 195 to 420 Kc. Size: 4" x 4" x 6" wide. 4 lbs. Complete with tubes. BRAND NEW **\$7.95** in original carton.

Brand New Navy Standard STORAGE BATTERY

Mfrd. by Gould Storage Battery Corp. 6 Volts. 15 Ampere-hours. Perfect for amateurs, experimenters, radio servicemen. Shipped dry with complete charging instructions. Size: 4½" x 4½" x 6½" high. Shpg. wt. 12 lbs. ONLY A FEW LEFT! **\$4.95**



The BEST in SURPLUS

Dynamotor DM-36 24V Input	ea. \$1.50
Miniature Headphones, with H'Band, Cord	ea. 1.00
Tubes 6SN7, 6HG, 6SA7, 6V6 New Bulk	ea. .49
455 KC I.F. Transformers Special	39c or 3 1.00
BC-746 Tuning Unit contains plug-in rec., ant., coil tuning condenser, trans. tank coil, one 3755 crystal, one 4180 crystal complete	ea. 1.00
4 Gang variable condenser 12-147 MFD	ea. 1.00
Cased output transformer 7000 ohm to V.C.	4 for 1.00
Transmitter RF Chokes 2.5 MH 500 M. A.	2 for 1.00
Power Rheostats 25 and 50 W.	2 for 1.00
Microswitches, blade or plunger type	3 for 1.00
Amphenol Connector Kit, 10 male and female for	1.00
Weston 0-8 Milliampere (0-60 scale) 2 1/2"	ea. 2.95
Weston Voltmeter Switch one pole nine pos. with knob	ea. .99
Bakelite sheet fabric base size 40"x50" comes in 3/8" or 1/2" or 3/4" thicknesses	lb. .59
Circuit Breakers Heinman one amp., 110V	ea. 1.00
Cutler Hammer, toggles spdt	39c or 3 for 1.00
Resistor Kit 1/2-1-2 Watt excellent sizes	100 for 1.95
Potentiometer Kit all long shafts	10 for 1.95

No Orders Under \$2.00
We Will Ship C.O.D.

THE HEATH COMPANY
BENTON HARBOR, MICHIGAN

ELECTRONIC VOLT-OHM-METER

\$11.85

110 VOLTS AC 20 RANGES

0.5/10/50/100/500/1000/5000 volts DC and AC 0-1,000,000 ohms in six overlapping ranges. Sensitivity: over MILLION OHMS per VOLT on 5 volt range.

POSTPAID

Complete kit includes all component parts, tubes, punched and drilled chassis and beautifully enameled panel. Easily assembled and wired. Special slideback circuit developed during war by scientist at the California Institute of Technology gives amazing sensitivity and flexibility while completely eliminating necessity of batteries and expensive meter. Each instrument is individually calibrated. Dial scale over nine inches long!

In addition to performing the usual volt-ohm functions, this instrument really measures these voltages: SUPERHET OSCILLATOR, AVC, AFC, TRUE GRID BIAS AT THE GRID, BIAS CELLS without affecting the circuit. Measures the exact leakage resistance of INSULATION, TUBES, CONDENSERS. It can be used with a signal generator for SIGNAL TRACING.

STERLING ELECTRONIC COMPANY

Dept. 3

166 N. Sierra Bonita AVE., Pasadena 4, California

LEARN RADIO!

IN ONLY 10 MONTHS
PREPARE FOR A GOOD JOB!
BROADCAST ENGINEER
COMMERCIAL OPERATOR (CODE)
RADIO SERVICEMAN

Television Servicing—15 Months

VETERANS GET FREE
EQUIPMENT

SEND FOR FREE LITERATURE
BALTIMORE TECHNICAL INSTITUTE
1425 EUTAW PLACE, BALT. 17, MD.

FREE CATALOG

BIG G. & E. CATALOG OF RADIO, REFRIGERATION and ELECTRICAL PARTS, at today's lowest prices. Hundreds of newest items in stock, immediate shipment. Send for your copy today.

G. & E. EQUIPMENT SUPPLY CO.
400 N. Sangamon Street
CHICAGO 22, ILLINOIS

18-db. Preselector

(Continued from page 61)

of the equipment. High-gain, all-band r.f. amplifier stages add materially to the cost of the equipment.

The actual advantages of additional r.f. stages increases with frequency. One r.f. amplifier stage can be adequate at 14 megacycles yet be totally insufficient at 28 megacycles.

Commercially built preselectors normally cover all bands, and adequate shielding is required to prevent oscillation. The equipment is normally housed in an attractive cabinet with an elaborate dial.

The preselector described was designed around the following specifications; low cost, minimum size, and the elimination of all shielding, the frequency requirement being 28 megacycles. The unit was to consist of two amplifier stages and three tuned circuits. Experience proved the use of three tuned circuits would require shielding. Rather than complicate the mechanical design by the addition of shielding, one tuned circuit was removed.

6AK5 type tubes were selected because of high gain and minimum space requirements.

The circuit of the 18-db. preselector is unique in its simplicity. The r.f. is fed into the antenna pickup coil. The input and output tank condensers are ganged together, each section being shunted by a 30 μ fd. trimmer. The plate circuit of the first stage and the grid circuit of the second stage are resistance coupled. The plate circuit of the second stage is tracked with the input grid circuit. The output of the preselector consists of a pickup coil which feeds the antenna circuit of the receiver.

Power for the preselector is supplied by the receiver. The power required for the filaments of the 6AK5's should not seriously overload the power transformer in the receiver, since the current drain is low. The plate voltage supplied to the preselector should be approximately 90 volts. If such a voltage is not available from the screen circuit in the receiver, a suitable dropping resistor should be employed to reduce the voltage to approximately 90 volts. This voltage is in no way critical. The use of higher plate voltage will not materially affect the gain, but may cause regeneration or actual oscillation.

Mechanical Design

A piece of #14 bus bar is formed around and connected to the rotor on both ends of the variable condenser. The shield plates between the sections of the variable are connected to the bus bar with both ends soldered.

The tube sockets are soldered to the bus bar. The tube sockets are placed to require minimum grid and plate leads. The cathode bypass condensers connect directly to the cathodes and

bus bar ground. These leads are kept at an absolute minimum. Individual screen bypass condensers connect directly from the screen to the metal shield plates on the variable. The "B+" end of the plate coil connects directly to the screen connection of the tube socket.

Although the two screens are connected directly, individual bypass condensers are used to reduce the r.f. path to ground to a minimum. The coupling condenser between the plate of the first stage and the grid of the second stage is a 50 μ fd. ceramic. The two trimmer condensers are soldered directly to the condenser stators and the condenser shield plates. 30 μ fd. ceramic trimmers were used. The use of a ceramic trimmer is desirable due to the limited amount of space required and the excellent "Q" factor.

The input coil consists of seven turns of #16 tinned wire with the inside diameter of 3/4" and spacing between turns 1/16". The coil is secured by connecting one end to the variable condenser stator and soldering the sixth turn to the bus bar which supports the tube sockets. Antenna connections are made from this supporting bus bar and the end of the coil.

The output tank circuit consists of six turns of #16 tinned wire with an inside diameter of 3/4", spacing 1/16". One end of the coil is connected to the variable condenser stator, and the other is connected to the screen prong of the tube socket. The output coil consists of two turns of #16 tinned wire, inside diameter 3/4", spacing 1/16". One end of this output coil is soldered directly to the bus bar which supports the tube sockets and is secured so the output coil is properly coupled to the plate tank coil.

The filaments of the two 6AK5's are parallel, with one side going to ground. Three leads are required to connect the preselector to the receiver: ground, filament, and "B+". An additional cable will be required to connect the output coil to the antenna circuit of the receiver. If transmission line is used for this purpose and the antenna circuit of the receiver is grounded, make sure that the ground of the receiver and the ground of the preselector are connected properly. In such a case, the "B—" lead between the preselector and the receiver may be eliminated. Connect an antenna and ground to the input coil of the preselector. If a transmission line is used for this connection, the connections are the same.

Both input and output pickup coils need not be connected to ground. The addition of a terminal block will supply an insulated mounting. If a balanced transmission line is used to feed the preselector, ungrounding one side of the pickup coil may be desirable.

Tuning Procedure

Tune the receiver to the low-frequency end of the 10-meter band. Rotate the variable of the preselector to maximum capacity (20 μ fd.). Ad-

just the two ceramic trimmer condensers located on the side of the variable for maximum signal output.

The actual location of the variable will be determined by the adjustment of the trimmers.

The spacing of the coils should be varied so that the same amount of trimmer capacity is required for both input and output coils. If this is accomplished, the preselector will track over its entire range. This condition can be indicated by observing the position of the ceramic trimmer rotors. When the two rotors are in the same position, the capacity will be approximately the same.

Actual gain measurements indicated a consistent gain of 18 db.

A calibrated dial for a one-band preselector is not absolutely necessary, since the condenser is tuned for maximum output. The operation of this condenser is the same as the antenna trimmer control which is used on most communications type receivers.

The preselector can be designed to cover both 10 and 20 meters with the same coils if the coils are properly designed. For such operation the coil inductance should be increased so the 20-meter band is covered when the variable condenser is nearly closed. The 10-meter band will tune with the variable condenser near the minimum capacity position.

Such operation will result in extremely sharp tuning. The addition of a vernier to the tuning control will improve this condition.

If more bandspread is desired, plates may be removed from the main tuning condenser and additional capacity will be required in the trimmer adjustment.

The preselector may be mounted in any convenient location. Some receivers may have sufficient space for actual mounting in the cabinet. If the preselector is to be mounted in the same cabinet as the receiver, a certain amount of caution should be observed in establishing the actual location. If placed too near the r.f. stage of the receiver, regeneration or oscillation might result.

This preselector may be constructed for all-band coverage by adding the necessary switch and coils. A shield between the two stages may be required.

Although only two sections of the 3-gang variable condenser are used, the space created by the use of the 3-gang condenser is desirable. The use of a 2-gang condenser will change the mechanical layout slightly. If the mechanical layout is changed, the position of the coils should be such that inductive coupling between the coils is reduced to a minimum.

NOTE: This preselector, after being observed by a 10-meter Los Angeles organization known as "The Rabbit Twisters," was labeled the "Stinkometer." "The Rabbit Twisters" network consists of W6FHN, W6MYS, W6MYN, W6WTS, W6NXW, W6WHH, W6EAT and yours truly, W6LVT.

NEWARK-HEADQUARTERS FOR VALUE

Amazing New 7" TELEVISION KIT

Again Newark shows the way! This fine 7" Telekit, at an amazing price, is easy to assemble from complete kit of parts, simple instructions. Guaranteed Performance! 17 tubes including 7" picture tube. Sound reception is high fidelity FM. Less tubes and cabinet.

\$77.50

Only \$15.50 Down—\$5.48 Monthly

Walnut Cabinet for above.....\$29.50
Front Panel Only.....\$10.00



20% DOWN
1 YEAR TO PAY

New — RCA WIRE RECORDER

Complete Recorder—Reproducer. Portable, Efficient! Simple, anyone can operate. 1/2 hr. recording on one cartridge. Use and re-use same wire. Excellent reproduction. Complete, with tubes, mike, 7' cable & plug, Mike Stand, 3-1/2 hr. cartridges. 25 lbs.

\$139.50

Only \$27.90 Down—\$9.86 Monthly

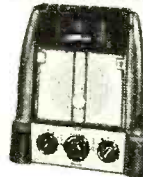

T-17B HAND MIKE

BRAND NEW — Perfect Carbon Hand Mikes. Light wgt., 200 ohms. Single button, press to talk switch. 5 ft. rubber cord, plug, dust cover. Terrific at.....

99c



O-150 DC MICROAMMETER

Precision-made by leading mfrs. 2 1/2" Bakelite Case. All Brand New—Perfect DC meters. A Great Buy! No. S-437. Only.....

\$3.45

HS-30 HEADPHONES

NEW Signal Corps Phones, 250 ohm impd. with matching transformer to 8000 ohms. PL-540 Plug, 8' Cord. Soft rubber earplugs. Light, adj. headband. Amazing Bargain.....

\$1.95

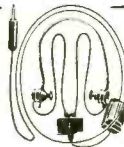

BUY OVER \$75 WORTH OF EQUIPMENT

Take ONE YEAR TO PAY
20% Down—Pay Monthly

ORDER FROM
New York or Chicago
Shipments FOB N.Y. or Chicago
20% Deposit Required
with C.O.D. Orders
Send Full Amount of
Order—Save C.O.D. Chgs
Prices Subj. to Change

NEW YORK
Offices & Warehouse
242 W. 55th St., N.Y. 19

NEWARK CHICAGO
ELECTRIC COMPANY, INC. 323 W. Madison St.
Chicago 6, Ill.

New York City Stores: 115-17 W. 45th St. & 212 Fulton St.

Smashing Reductions! TRANSMITTING AND SPECIAL PURPOSE TUBES

Hams, Experimenters! Save NOW on these Great Surplus Tube Buys! All JAN Approved — All NEW and GUARANTEED. Many thousands in stock! Order NOW!

Hy69	\$1.65	809	1.50
Hy615	1.13	811	1.95
2AP1	2.25	813	6.75
2AP1A	5.25	814	4.50
2C26A	.75	826	1.50
2C40	2.63	832A/832	2.25
2C44	1.50	836	1.13
2K25/723AB	12.00	837	2.25
2X2/879	.90	838	3.75
3AP1	3.00	845W	3.75
3BP1	3.00	865	1.50
3C24/24G	1.20	872A/872	2.25
3CP1	6.00	874	1.95
3DP1	4.50	884	.75
3EP1	3.00	931A	1.88
3E29	3.00	954	.75
3FP7	3.00	955	.75
3GP1	3.75	956	.75
5AP1	4.50	957	.75
5BP1	3.75	958A	.75
5BP4	3.75	959	.75
5CP1	3.75	1616	3.00
5LP1	9.00	1619	.75
6AC7W	.68	1624	.90
6AK5	.90	1625	.53
9JP1	6.00	1626	.60
9GP7/9MP7	12.00	1629	.27
10y	.75	1851	.95
12DP7	6.00	2051	.53
75T	2.25	7193	.45
OC3/UR105	.75	8005	3.15
OD3/VR150	.75	9001	1.05
304TL	3.75	9002	.90
316A	.75	9003	1.05
801A/801	1.13	9004	.90
807	.95	9006	.68

RIM DRIVE PHONO MOTOR

Price Slashed! Made by leading mfg. Sturdy, quiet motor. 9" Turntable. For 110 volt AC only. 78RPM. Complete with turntable. No. S-376.....

\$2.49



CRYSTAL PICKUP

Brand New, High Fidelity Crystal Pickup with tangent head. 7" mtg. center. Famous make. No. S-240. While they last.....

\$1.88



440 mmfd. Condenser

87 Plates, .070 Gap. Ceramic front and end. 2500 V. Insul. Silver Contacts. 2 x 2 x 7". 1/4" shaft.

69c



U.S.R.S. MONTHLY SPECIAL

SERVICEMEN'S HANDY KITS CAPACITORS

PAPER TUBULARS
Assortment of 35 paper tubular condensers. Unconditional 1-year guarantee. Each unit plainly marked with capacity and voltage. Wax impregnated and filled at both ends. Kit consists of 5 each: .001, .002, .005, .01, .02, .05 and .1 mfd., 600 Volts.



1-000 Kit Complete—Net.....

\$2.20

Write for Free Illustrated Flyer

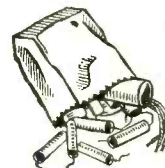

ELECTROLYTICS

Assortment of 18 electrolytic condensers. Unconditional 1-year guarantee. Each unit plainly marked with capacity and voltage. Made of highest quality materials for low leakage and high surges. Kit consists of 2 each: 8, 16, 20, 30, 40, 16x16, 20x20, 30x20, and 30x30 mfd. 150 Volts.

1-005 Kit Complete—Net.....

\$4.85

U.S.R.S.

U. S. RADIO SUPPLY
5116 HARPER AVENUE
CHICAGO 15, ILLINOIS
DEPT. NE 8

ANNOUNCING—

The first volume in the long-awaited Massachusetts Institute of Technology Radiation Laboratory Series, bringing you—

the engineering data you need to design RADAR SYSTEMS



Here is an important book which presents the general principles of the design of various radar systems. From the standpoint of the designer the book discusses the basic considerations which underlie systems design.

Just Out

RADAR SYSTEM ENGINEERING

Edited by Louis N. Ridenour, Editor-in-Chief, Radiation Laboratory Series; Professor of Physics, University of Pennsylvania. Over 900 pages, 6 x 9, \$7.50.

AFTER a general approach to problems encountered, this authoritative book takes up the leading design considerations for the important components that make up a radar set. Detailed examples of actual systems are included. Two new and important auxiliary techniques—moving target indication and the transmission of radar displays to a remote indicator by radio means—are fully treated. Anyone interested in the varied applications of radar will find this new volume of immense value as a basic, useful reference.

10 DAYS' FREE EXAMINATION—MAIL COUPON

McGraw-Hill Book Co., 330 W. 42nd St., N. Y. 18, N. Y. Send me M.I.T. Radiation Lab. Series, #4, Ridenour RADAR SYSTEM ENGINEERING for 10 days' examination on approval. In 10 days I will send you \$7.50 plus few cents postage or return book postpaid. (We pay postage cash orders; same return privilege.)

Name
 Address
 City and State
 Company
 Position RN-8-47

LEARN

ELECTRICITY OR RADIO

... in the
GREAT SHOPS OF COYNE
Train in a Few Short Weeks

Here at Coyne in a few short weeks you can train for your big opportunity in Electricity or Radio. You train on actual full-size Electrical or Radio equipment. 48 years training experience. For Veterans and non-veterans.

NOT A "HOME-STUDY" COURSE

All Coyne training is given here in our big Chicago shops. Not a Correspondence course. VETERANS! Coyne is authorized to train Veterans under the G.I. Bill. Coupon brings details.

FREE BOOK—rush coupon for free illustrated book on whichever course you prefer—no obligation. Tells how Coyne helps you get better jobs.

B. W. COOKE, Dir.,
 COYNE ELECTRICAL
 SCHOOL, Dept. C7-81H
 500 S. Paulina St., Chicago 12, Ill.

Your Choice of
2 Great Fields

Send FREE BOOK and full details on course checked:

ELECTRICITY RADIO

NAME

ADDRESS

CITY STATE

Sound Recording

(Continued from page 59)

first consider the magnetizing action of a typical wire record-reproduce head as illustrated in Fig. 11A. The demagnetized wire entering the head from the left will be shielded from the magnetic field until it enters the re-recording gap between the two pole pieces.

During the time in which it travels from the first pole to the shielding of the second pole, the element of wire will be subjected to the varying magnetic fields existing in the gap. In this time interval the audio signal intensity will have changed only a small increment. However, the supersonic bias will have gone through 1½ or 2 cycles. The residual flux density that is left in an element of wire will depend upon the field intensity existing in the gap at the instant that the element left the gap and entered the second pole. Referring again to Fig. 10, this means that if one element of wire had a residual flux density corresponding to a field of point E, the residual flux of the following segment would correspond to point F.

But what effect does this have upon reproduction? We find that the gap is long enough to contain several negative and positive peaks of the supersonic bias. The total flux in the gap will then depend upon the sum of the gap fluxes. In Fig. 10 the projection of the positive peaks on the residual flux curve produces curve A. The projection of the negative peaks forms curve B. The addition of A and B results in a curve that represents the effective flux that the wire will reproduce in the gap. Although some distortion is present in the resultant curve, it is a great improvement over reproduction without bias. As in d.c. biasing, the linearity of the response using supersonic

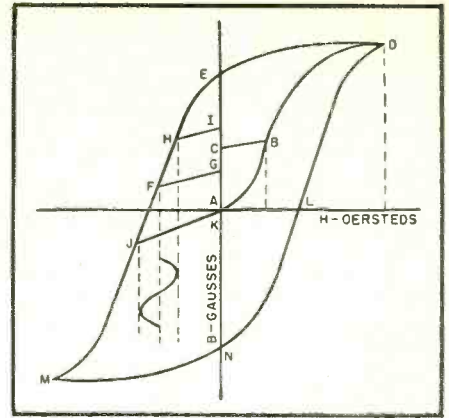

Fig. 8. Typical magnetic material magnetization characteristics.

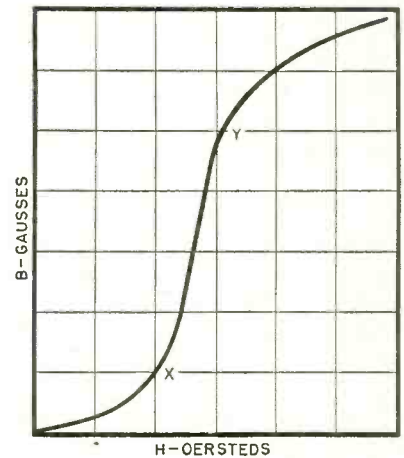

Fig. 9. Residual flux density curve.

biasing is dependent upon the amount of bias used. The response shown in Fig. 10 probably could be improved upon with a more careful choice of bias.

Distortion

Regular intermodulation measurements can be made to check distortion

Fig. 10. Supersonic biasing effect. Combined audio and supersonic magnetizing field is applied to residual flux density curve to plot the flux signal that the wire will produce in the gap.

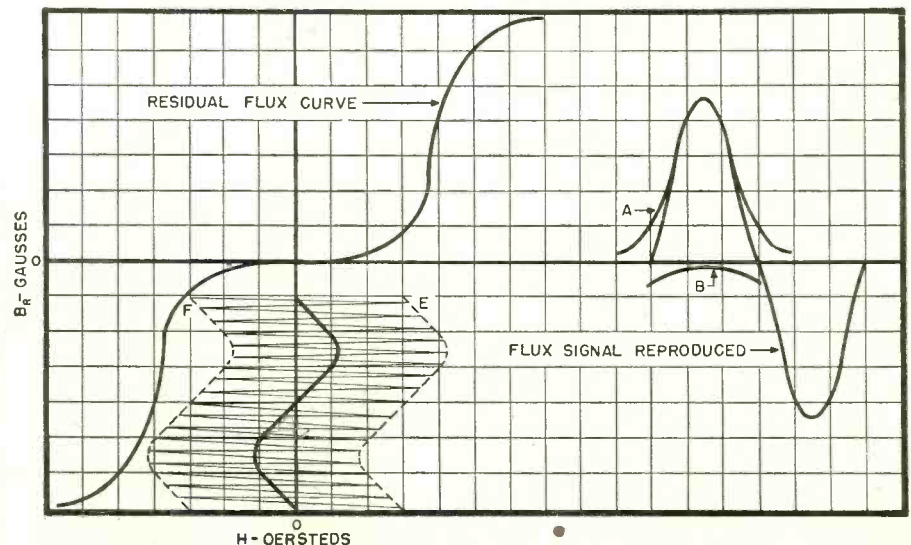

and, accordingly, to check the bias for best results. A low frequency sine wave of fairly large amplitude is simultaneously recorded on the magnetic material with a high frequency sine wave of low amplitude. If the system were perfectly linear, the output of the reproducing head would show no modulation of the high frequency signal by the lower. As the system is not perfectly linear, some modulation will occur. The bias can be adjusted to make this a minimum.

Two advantages can be attributed to supersonic biasing as compared to d.c. biasing. These are, less noise and a greater linear amplitude range allowing higher level recording. Experimenters have been led to the conclusion that noise in magnetic recording is largely caused by the passage between pole pieces of many randomly distributed magnetic irregularities which are less than .0015 inch in diameter. Magnetically saturated material was found to be ten to twenty decibels noisier than demagnetized material. This means that d.c. biasing, with its saturation erase and fixed magnetic bias, will be noisier than supersonic biasing which uses a demagnetizing erase.

Magnetic Head Design

Fig. 12 illustrates in simplified form, various types of recording-producing heads now being commonly used. Practical experience has shown the desirability of combining the recording and reproducing functions into a single head. At the same time, while the overall response characteristics are influenced to some extent by the recording head design, they are much more dependent upon the design of the playback head. Therefore, the playback requirements usually govern the design of the head.

The open type head, commonly employed where a magnetic material is in the form of wire, is shown in Fig. 11B. Note that the wire hole of Fig. 11A has been replaced by a tapered slot. This is done for ease in placing the wire in the head while the taper will allow a splice or knot to be made in the wire and yet permit the wire to ride up out of the slot and prevent a jam. Fig. 12C shows a closed type head which is similar to the open type except that the coil surrounds both the wire and the pole pieces. The closed type reduces the effect of stray fields and produces a response curve that is a little more regular than that of the open type.

The heads illustrated in Figs. 12C and 11B may be made of several laminations if a high impedance head is desired, or of a single lamination if a low impedance head is preferred. In either case, the lamination should be kept as thin as practical to reduce eddy current losses and to improve the high frequency response.

Heads for record-playback should be made of a material that offers high permeability at low flux density. Mu metal or molybdenum *Permalloy* are commonly used. Magnetic coupling

Another MASCO

PRIZE WINNING PACKAGE OF PROFIT

Dual Speed PORTABLE DISC RECORDER With Single Play-Back

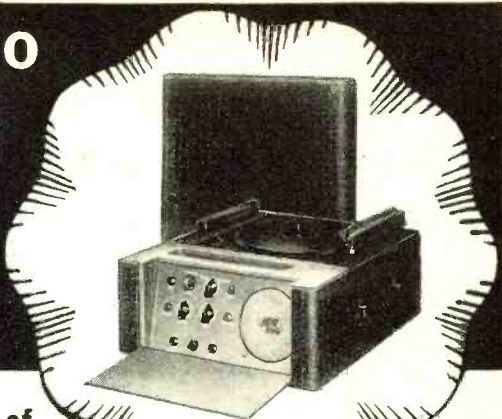

NEW! With Every Facility of the Professional Type Recorder

Sensation of the Chicago Show... because distributors and dealers recognized the big market for this disc recorder and play back... broadcast stations, talent agents, schools, churches, lecture halls, night clubs and people who entertain at home.

It has 3 separate input jacks, providing for 1. direct recording from microphone, 2. direct recording electronically from a phonograph (dubbing), 3. direct recording from radio to record. Selector switch on panel allows for simple change of function.

Volume level indicator eye assures accurate recording level. Separate volume and tone controls allow for any desired volume or tone setting.

Complete with heavy duty 6 in. P.M. Alnico V Speaker and kit of 5 matched tubes

List Price \$135.00

Add 5% West of Rockies

Contact your local Masco distributor for immediate delivery. For descriptive literature or other information write directly to factory, Dept. N.

COMPLETE SELF-CONTAINED DUAL SPEED DISC RECORDER...

...AND PLAY-BACK WITH BUILT-IN AMPLIFIER AND SPEAKER

FEATURES

- Combined recorder and P.A. system.
- Recording and play-back both 78 and 33 1/3 RPM.
- Electronic volume level indicator.
- Heavy duty 6 in. Alnico V Speaker.
- Separate volume and tone controls.
- Five tubes including rectifier.
- Separate jack for external speaker.
- Adjustable cutting head.
- Separate motor switch.
- Fused circuit.

MASCO

MARK SIMPSON MANUFACTURING CO., Inc.
32-28 49th Street, Long Island City 3, N.Y.

SOUND SYSTEMS and Accessories

RAvenswood 8-5810-1-2-3-4

F.M. KIT (88 to 108 MC)

Consists of Variable Condenser, Set of Matched Coils, Schematic and Instructions for building a Tuner \$4.95

ELECTRIC PHONO MOTOR, complete with turntable	\$ 2.95
CRYSTAL PICK-UP ARM	1.75
CRYSTAL CARTRIDGE	1.25
LOOP ANTENNA, assorted sizes, oval shape	.39
RESISTANCE CORDS, 160 to 290 ohms	.49
OSCILLATOR COIL, 456KC	.19
I.F. COIL, 456 KC	.59
SELENIUM RECTIFIER, 150 MA	.95
BROOKS INVERTER, 50 Watts—110 V (Also available in 220 V)	8.95
VOLUME CONTROL, any size with switch	.39
VOLUME CONTROL, any size less switch	.19
ELECTROLYTIC CONDENSER, P-B, 20/20—150 V	.26
ELECTROLYTIC CONDENSER, C-D, 40/40/20—150 V 25 V	.44
1000—ASSORTED TUBULAR CONDENSERS, .002 to .1	39.50
1000—ASSORTED RESISTORS, 1/2 Watt	15.00

BROOKS RADIO DISTRIBUTING CORP.

80 Vesey Street (Dept. B) New York 7, N. Y. CO 7-2312

RECEIVER EXMITTER

\$351⁰⁰ VALUE



YOUR PRICE **\$14⁵⁰**

FREE

A COMPLETE SET OF TRANSMITTING AND RECEIVER TUBES WORTH \$35.00

FREE 1-200 KC CRYSTAL

BC-654-A is a combined transmitter and receiver designed for portable or vehicular operation. The frequency range of both transmitter and receiver is continuous from 3700 to 5800 kilocycles; all stages are tuned by anti-back lash worm gear dial mechanisms.

YOUR GUARANTEE

We will ship you at once the above receiver and transmitter and include FREE a complete set of 13 transmitter and receiver tubes.

— RUSH YOUR ORDER —

\$5.00 Deposit—Balance Express Collect

MANUEL KLEIN

74R Cortlandt St., New York 7, N. Y.

Complete

TELEVISION COIL KIT

With these Coils, Construction of Your Television Set is Simplified

Instruction Manual for 20 Tube, 7 inch Picture Tube Set, included with each Kit.

Build a Quality Set with our 6 Channel Tuner; 5 stages, 4.25 MC Video bandwidth, IF Coils; and FM Sound-Discriminator, at Low Cost. Video Bandwidth satisfactory for ANY size Picture Tube.

OUR **\$23⁵⁰** OFFER

INCLUDES THE FOLLOWING

1 Oscillator Tank Coil, 1 Antenna Coil, 6 RF Tuning Coils, all mounted on Switch Assembly Plate; 5 Video IF Coils, Shielded, Permeability Tuned; 1 Shielded Discriminator Coil; 3 Video Peaking Coils, and Instruction Manual containing Circuit Diagram for 20 Tube Seven Inch Picture Tube Set, together with detailed Assembly Instructions, and Parts list.

ORDER DIRECT OR THRU LOCAL DEALER

TERMS

Shipped Parcel Post Prepaid on receipt of check or money order. Or P. P. collect on receipt of 25% deposit with order, balance C. O. D. Manual only, \$1.00 plus 12c postage. Television Parts, Deflection Components, C. R. Tubes, in stock. Send for free listing to Dept. J.

RAY-LECTRON CO.

706 Tenth Avenue
BELMAR, N. J.

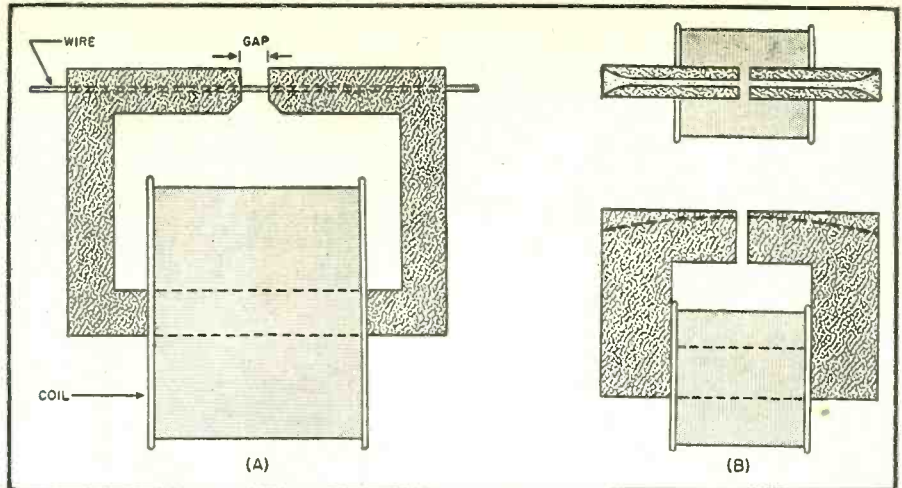

Fig. 11. (A) Typical wire record-reproduce head. (B) Open type wire record-reproduce head.

between the magnetic recording material and the head should be excellent. The gap between pole pieces is normally filled with a nonmagnetic material such as solder or soft copper but these materials wear excessively. Better results can be achieved and a more permanent head secured by employing beryllium copper.

The gap in commercial heads is usually somewhere between .001 inch and .002 inch depending upon the wire speed and the desired frequency response. Inasmuch as frequency range is largely dependent upon the length of gap, the matter of spacing becomes extremely important, as will be discussed later. The major difference between a recording-reproducing head and the erasing head is in the length of the gap. Usually an erasing head gap will be about .010 inch.

Considerations for Magnetic Tape Recording

Considerable advancement has been made in magnetic recorders which employ a magnetized material in the form of a tape. As tape will run flat and will not twist when unwinding, it can be magnetized either longitudinally or transversely. A simplified

diagram of a head for transverse recording on magnetic tape is illustrated in Fig. 12A. It will be noted that pole pieces are thin, single laminations. Increasing the thickness of the laminations will have the same limiting effect on frequency as increasing the gap on the head of Fig. 11A. Improved and increased response, combined with a sturdier construction is obtained by using thicker offset pole pieces (Fig. 12B). This head derives increased gain from the decrease in reluctance that wider pole pieces effect in the region of low permeability that exists at the end of each pole.

Frequency Response

As mentioned previously, the length of the air gap becomes a most important factor in setting the general frequency response of the system. The over-all frequency response of a magnetic recorder is also dependent upon such factors as head design, wire or tape speed, magnetic recording material, and amplifier compensation. Some of the frequency limiting factors in the recording-reproducing head have already been discussed.

If a wire containing two alternating magnetic fields, both of the same mag-

Fig. 12. (A) Record-reproduce head for transverse recording on tape. (B) Offset thick pole pieces used to improve characteristics of head shown in (A). (C) The closed type record-reproduce head used in some types of magnetic recorders.

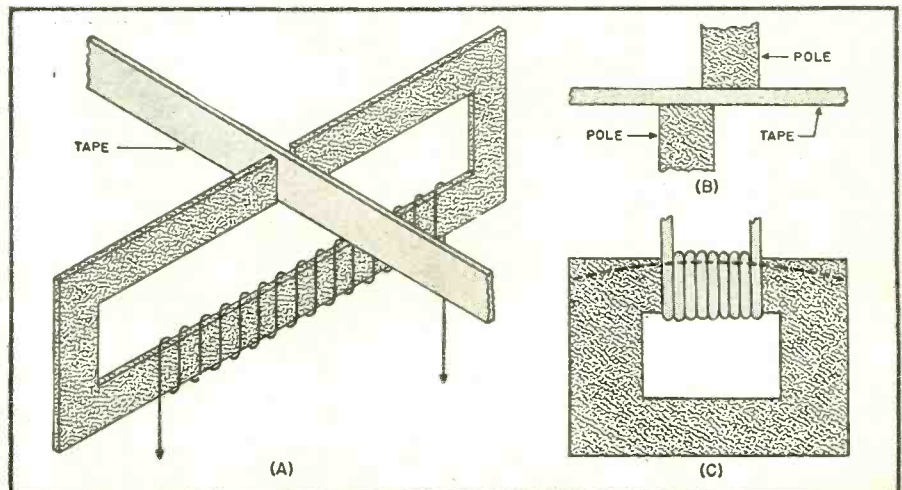

Presenting the NEW Ferret Line.

Matched, aluminum test units with all miniature tubes.
Blue-gray Hammertone finish. Uniform size—10¼ x 10¼ x 5½.



**DELUXE TEST SPEAKER
And Universal Substitutor**

Model 721

Eliminates need for removing set speaker from radios for servicing.

Provides substitution for choke, electrolytic and by-pass condensers, coupling, and a wide range of resistors.

Field substitutor—500, 1000, 1500, and 2500 Ohms.

Voice coil connection permits substitution of any output transformer.

6" P.M. dustproof speaker. **\$29 95 • Net**

**SIGNAL GENERATOR
Wide Range FM-AM Television
Model 701**

Range: 170 K.C. to 115 M.C.—all fundamentals.
Crystal calibrated, low loss permeability tuned coils. Internal 400 cycle sine wave modulation—to 100%. Follow-up shorting Turret coils with no dead spots.
Tubes: 6C4, 6AU6, 6X4.
Vernier drive—9" easy-to-read scale.
Ladder attenuator—triple shielded. **\$74 95 Net**

**AUDIO OSCILLATOR
Sine Wave—Square Wave
Model 710**

Range: 20 to 24,000 Cycles.
Oscillator: RC type.
Sine or square wave through-out range by rotating panel switch.
High impedance output.
2% accuracy over all bands.
Three color, completely enclosed 9" dial for ease in reading.
Tubes: 6X4, 6AQ5, 6AU6, A4522, 6SL7 **\$89 95 Net**



**Combination Signal Tracer
and Electronic Volt Ohm
Meter with Germanium
Crystal Probe**

Model 730

Range: AC-DC 1v to 3000v (7 bands).
Zero center scale for F.M. alignment.
Ohm Scale: 10 Ohms to 10 Megohms.
Frequency Range: Audio to 110 MC
Input: 100 Megohms AC or DC.
Tubes: 6X4, 0A2, 6AQ5, 2-12AU7, 2-A4522.

High gain Signal Tracer with enclosed speaker. No amplifications needed in receiver—no hum.
8" illuminated dial. **\$89 95 Net**



All prices slightly higher in Eastern States



COASTWISE ELECTRONICS CO., INC.

130 North Beaudry Ave.
Los Angeles 12, Calif.

Designers and Manufacturers of Electronic Equipment

New York Office & Warehouse
258 Broadway, New York 7, N. Y.

AIRMEN • HAMS • SEAMEN • EXPERIMENTERS

BARGAINS FROM ONE OF AMERICA'S
LARGEST SURPLUS INVENTORIES!

Just A Few Items From Our Tremendous Stock

- BC-348s—(M, N, O, Q Models) RECEIVERS
- ARN-5—GLIDE PATH LOCALIZERS
- ART-13—TRANSMITTERS
- TA-12—BENDIX 50W TRANSMITTERS
- TA-2J—BENDIX 25W TRANSMITTERS
- SCR-241—75MC TRANSMITTERS
- MN-26C—BENDIX RADIO COMPASS
- 2CR-269-G—BENDIX RADIO COMPASS
- APN-4—SHORAN RADAR NAVIGATION EQUIPMENT

- SCR-522s
- BC-191-Ns

- HALLICRAFTERS**
- S-36 RECEIVER
 - S-20R RECEIVER
 - SX-28 RECEIVER

TEST SETS

- I-139-A
- I-173-A

OSCILLOSCOPES

- MODEL 160-B
- 5" DUMONT
- 3" DUMONT

Send for Catalogue

AGENTS WAR ASSETS ADMINISTRATION

W & H AVIATION CORP.

MUNICIPAL AIRPORT, ROCHESTER, NEW YORK

PHONE GENESEE 7301

Phone • Wire • Write—We Ship "AT ONCE"

EXCEPTIONAL VALUES

Complete stocks! Immediate delivery! Standard, nationally known and guaranteed merchandise at LOWEST current prices. Look at these challenging values—just a few we offer you. Send your trial order—learn more about our service. Prices shown, FOB Philadelphia. Terms 25% with order, balance COD.

TRANSVISION TELEVISION

Complete Kit and Cabinet



Famous for large, bright pictures of amazing clearness, excellent sound performance and high signal sensitivity. EASY to build without previous experience. No instruments to buy. Our price INCLUDES handsome walnut finish cabinet, speaker, all tubes, plus antenna. Nothing else to buy. REQUIRES NO ALIGNMENT. Price only.....

\$188.45

ATR "A" BATTERY ELIMINATORS FOR AUTO RADIOS



Type 60 Ella. Rated output 6.5 volts at 6.5 amperes. Has an on-off switch, pilot light indicator, 10 ampere fuse, rubber mounting feet. Heavy gauge metal cabinet. Operates at top efficiency. Delivers filtered current at correct voltage. Fully automatic and foolproof. Actual \$34.95 value.

\$20.59

NATIONALLY KNOWN "UTILIPHONE" INTERCOM SETS \$2995



Famous for newest electronic design, sturdy construction and quality parts. Smartly styled. High amplification, invite, natural talking without leaning over close to speaker. Easy to install. An outstanding value. Our attractive price in c. d. e. s. As low as only \$29.95.

speaker and microphones. Ask for Dealer Price.

GET THESE HI-VALUE SPECIALS

Phonograph Amplifiers	\$3.75
Pick-Up Arm	2.10
Phonograph Motor	3.50
Top Cow! Auto Radio Antenna	2.36
80 Watt Solder Iron	1.69
100 Watt Solder Iron	2.29

A. C. RADIO SUPPLY CO.

1539 W. Passyunk Ave., Phila. 45, Pa.

WAR SURPLUS!

All merchandise is the product of nationally known manufacturers under government contract—no "off" brands.

Oscilloscope, Dumont 164E.....	\$49.50
.1 mfd. 200 vwdc. paper condenser, Micamold.....	.05
In lots of 50, each.....	.04
4 mfd. 500 vwdc. paper condenser, for replacing electrolytics and give superior service.....	.69
In lots of 50, each.....	.59
Cathode-Ray Power Xformer, Thordarson T-46543, 1250v, 880v CT, 2.5v, 2.5v, 6.3v, 6.3v, 5v.....	8.50
0-1 ma DC Meter, Weston 301, 3 1/2".....	4.25
5CPI Cathode-Ray tube.....	4.83
100TH Transmitting tube.....	7.75
807 Transmitting tube.....	.95
1/4 W Neon bulbs, candelabra screw or bayonet (Specify).....	.11
Headset, HS-30, miniature type.....	1.27
Octal Socket, steatite.....	.15
Carbon Resistors 1/2 W & 1W, any resistance value—10% Discount in lots 100 (may be asstd.).....	.02 1/2
Kit of 100 Carbon Resistors, 1/2 W & 1W, mixed values (all useful values).....	1.83

We have thousands of choice items in our warehouses too numerous to mention. Let us know your requirements. Drop us a card to receive our regular bulletins and flyers.

Price RADIO Laboratories

2816 Hemlock Ave., Baltimore 14, Md.
Minimum order \$2.00. We also ship C.O.D., 10% with order

itude, but one twice the frequency of the other, is passed through a reproducing head, the higher frequency will induce an e.m.f. that is twice that induced by the lower frequency. This is, of course, caused by the fact that induced voltage is directly proportional to both the flux density and frequency. As might be expected, a constant rise in output is had with frequency but this is true only at the lower frequencies. At higher frequencies the response begins to drop off when the wavelength of the signal, as recorded on the medium, approaches the length of the gap. Fig. 13 illustrates the effect of gap length on frequency response while Fig. 14 gives the effect of wire speed.

The speed of the magnetic material has little effect upon the low frequencies but it does have a considerable effect upon the high frequency response. Commercial recorders operate at speeds ranging from 7.8 inches per second up to 6 feet per second with 2 feet per second giving excellent results on some of the latest models, such as the machine used to dictate this article. The current through the recording head coil determines the residual flux density which will be left in the magnetic material. A recording head is largely inductive and its impedance increases with frequency. It is necessary to use an amplifier with a rising characteristic to make the recording head current independent of the frequency of the input signal or to insert a large resistance in series with the coil. Constant recording current was used for the curves of Figs. 13 and 14. Referring to Fig. 13, it may be seen at a glance that some sort of equalization is required in order to achieve an over-all flat frequency response within the desired range.

Pre-equalization, post-equalization, or a combination of both are commonly used in magnetic recording. As the linear section of the magnetic materials magnetization curve does not extend indefinitely, only a limited amount of pre-equalization can be used before overloading. This is particularly true when using pre-equalization to extend the high frequency range. On the other hand, post-equalization is not desirable for the higher frequencies, as most of the noise lies in this region. Higher frequency re-

sponse can be obtained by using pre-equalization but overloading necessitates reducing the recording level and lowering the signal-to-noise ratio as the range is extended. Inasmuch as the low frequency response is normally lower than that of the middle frequencies, some sort of equalization is required. Overloading precludes the supplying of all of the required equalization with pre-equalization alone. Therefore, a combination of pre-equalization and post-equalization will be found to be most satisfactory.

Materials for Magnetic Recording

Many varieties and shapes of magnetic materials are now being employed for magnetic recording. Noise level, frequency response, and signal amplitude will be affected by the type of magnetic material used. At the lower frequencies, with a fixed speed, the retentivity (measure of residual flux density) will determine the magnitude of output voltage from the reproducing head. However, we find that the shorter magnetic poles of the higher frequencies in the thin cross section of the magnetic material produce a strong self-demagnetizing effect which tends to reduce the induced higher frequency output voltage.

The effectiveness of this demagnetization depends upon the coercive force of the material. Coercive force is defined as the magnetizing force required to reduce the residual flux density to zero after saturation. If the residual flux were N , Fig. 8, the coercive force would be AL . Materials having a high coercive force will experience less self-demagnetization. Since high coercive force materials have a low retentivity, it means that some low frequency output voltage must be sacrificed in order to extend the upper frequency range.

High coercive force and low retentivity offer the additional advantage of reducing noise from crosstalk induced into the material by an adjacent turn of material when wound upon the spool.

Improved magnetic tape, having only part of its density occupied by the magnetic coating, does offer a certain amount of insulation and crosstalk is not encountered when turns are wound over one another on the spools.

There are two commonly used types of wire for magnetic recording. If we are satisfied to reproduce only the human voice, say to 3000 c.p.s., hard drawn carbon wire, or a chrome steel with a coercive force of about 50 oersteds is very satisfactory. Stainless steel wire possessing a coercive force of 175 oersteds will give recordings that are superior to the common shellac records found in our stores, but not quite equal to the latest vertically cut vinylite records.

When Vicalloy tape (developed by Bell Telephone Laboratories) with a coercive force of 250 oersteds is used, the quality of vertically cut vinylite can be readily equalled. An equalized response from 100 to 8000 cycles, with

Fig. 13. Frequency vs. response curves show result when gap length is changed.

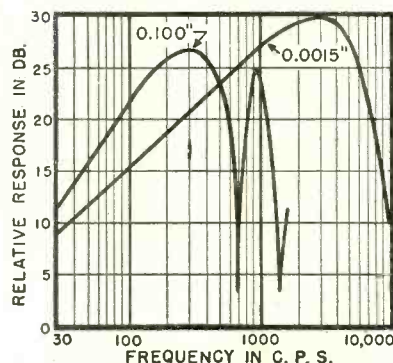

a useful volume range of more than 50 decibels, has been obtained from Vicalloy tape using the recording-reproducing head illustrated in Fig. 12B. The tape speed in this case was only 16 inches per second. Considerable research on magnetic tape recording has also been done by the *Indiana Steel Products Company*. (Metallic wire and tape are the most common magnetic material shapes used in magnetic recording.) A German machine, on the other hand, was found that records upon magnetically coated plastic tape, producing forty-five minutes of recording from one-half mile of tape. It possesses the additional feature of a special pitch restoring head that permits restoration of the original pitch when the tape is played back at other than the recording speed.

Magnetically Coated Tape and Paper Discs

Considerable research has been done in the United States by the *Brush Development Company* on magnetic recording materials. Both a magnetically coated paper tape and a magnetically coated paper disc have been used successfully. Here the recording medium is a suspension of finely divided magnetic particles in a coating applied to paper. Paper tape is very easy to handle and cheaper than most other magnetic materials. It lends itself readily to editing for a section of the paper tape may be cut out with a scissors and the ends joined with glue or adhesive.

Plated brass wire has also been found to be well suited to magnetic recording. A frequency response of 80 to 8000 c.p.s. (down 6 db. at 10,000) with a signal-to-noise ratio of 35 db., can be obtained. The wire is .0046 inch in diameter and is plated with a magnetic material. Wire speed is 24 inches per second and the minimum recording time is four hours for a unit which has been developed.

Another unit uses a 1/4 inch wide magnetic coated paper tape. The frequency response is 100 to 5000 c.p.s. with a signal-to-noise ratio of at least 40 db. The tape speed is very low, being only 7.8 inches per second.

New uses are being found for magnetic recording almost daily. Expand-

Fig. 14. Illustrating the influence of wire speed on frequency response.

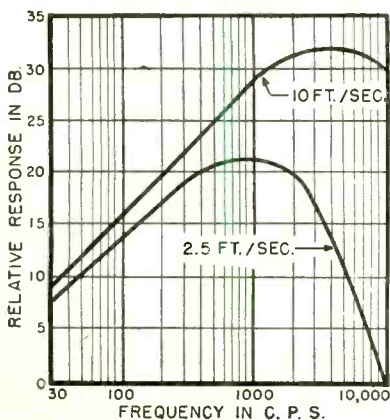

August, 1947

PARTS AND EQUIPMENT SPECIALS!



MEISSNER AM-FM TUNERS

Covers the FM band from 88 to 108 MC. At 105-125 volts, 50-60 cycles, power consumption is 50 watts. Tubes: 9003 R.F. amplifier; 6BE6 oscillator-converter; 2-9003 I.F. amplifiers (456 KC); 6AL5 detector for the AM section. For the FM Section: 6AG5 R.F. amplifier; 6C4 oscillator; 6AG5 converter; 3-6AG5 I.F. amplifiers (10.7 MC); 2-9001 limiters; and 6AL5 detector. Two 6C4's are used for audio amplifiers, a 6U5/6G5 for tuning indicator and 5Y3GT/G for rectifier.

Now Available for Immediate Delivery. Write for Prices.

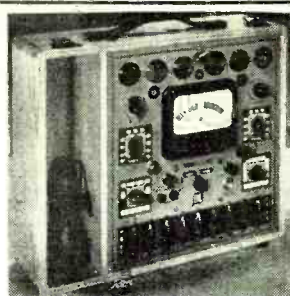

Electronic Measurements Corp. SERIES 200

MUTUAL CONDUCTANCE TUBE CHECKER

- Model 200 AC 3" meter in sloping counter case..... \$49.85
- Model 200 AP 3" Meter in hand rubbed carrying case... \$53.85
- Model 200 BC 4 1/2" Meter in sloping front counter case... \$52.85
- Model 200 BP 4 1/2" Meter in hand rubbed carrying case... \$56.85

Here for the first time is a true mutual conductance type tube tester with complete flexibility, and at a price no higher than that charged by other manufacturers for the ordinary emission type.

CHECK THESE FEATURES!

1. Checks mutual conductance on a calibrated microhm scale, as well as on a REJECT-GOOD scale.
2. Checks five element tubes as pentodes.
3. Checks tubes for gas content.
4. Detects both shorted and open elements.
5. Complete switching, flexibility allows all present and future tubes to be tested, regardless of location of elements on base.

GUARANTEED ELECTROLYTIC TUBULAR CONDENSERS

- Sprague 16 MFD 450 v..... ea. 49c
- Mallory 40x20 MFD 150 v..... ea. 49c
- Solar .01 MFD 400 v..... per 100 \$7.00
- 8 MFD 450 v..... 10 or more, ea. 25c
- 20 MFD 150 v..... 10 or more, ea. 26c

BROWNING FM-AM TUNERS

Receives both old and new FM band (87 MC to 109 MC) and standard broadcast band (530 KC to 1650 KC). 115 volt 60 cycle operation. Tubes: one 6BE6, one 6C04, one 6BA6, one 6SG7, two 7AG7, two 6SJ7, one 6H6, one 6SA7, one 6SF7, one 6E5 or 6U5 (tuning eye).
Net Price \$143.90
POWER PACK for above 15.73



The MEISSNER RADIO-PHONO-RECORDER

Portable Radio, Recorder, and Public Address System. 7 tubes. High fidelity crystal-cutting head for 10" records. Excellent crystal microphone. Dual turntable speeds, 33 1/3 and 78 r.p.m.

Now Available for Immediate Delivery. Write for Prices.

25% Deposit on All Orders



SOMETHING NEW IN TEST SPEAKERS

No need to carry the speaker to your shop in servicing any radio from the small midget to the most elaborate console. Any output tube or tubes can be matched simply by rotating input switch to tube listed on the front panel and rotate field switch for proper impedance and proceed with testing. External voice coil connection permits testing of set speaker to determine if output transformer is open or shorted. Field Impedance: 500, 1000, 1500 and 2500 Ohms.

\$19.95

OUTDOOR AERIAL KITS
Complete with 25 ft. lead-in wire, 50 ft. antenna wire, ground straps, glass insulators and nail knobs.
Each 69c

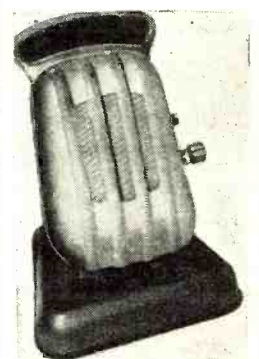

"ULTRA MIKE" WIRELESS MICROPHONE

This unit with your regular radio and NO extra interconnecting wires will provide superior results as a

- CALLING SYSTEM
- PUBLIC ADDRESS
- DETECTOPHONE
- BABY OR INVALID WATCHER

The "Ultra Mike" is light—economical to operate—completely self-contained—no connections to power lines—portable. Complete with batteries, tubes, etc.

YOUR COST..... \$6.63
Retail \$18.00

F.O.B. Chicago

The Radio Shack Inc. OF CHICAGO

630 W. RANDOLPH STREET CHICAGO 6, ILL.

5,000 DEALERS NEEDED!

to sell
this
Popular
Holder to
Amateurs



We need DEALERS to handle the demand created by national advertising for this unique Deka Xtal. Supply the amateurs in your territory. Write NOW for profitable dealer plan!

The Deka Xtal is rugged, compact, sealed against moisture and dirt. Plugs into oscillator for crystal control and signal shifting.

**SCIENTIFIC
RADIO PRODUCTS COMPANY**
738 1/2 W. Broadway, Council Bluffs, Iowa

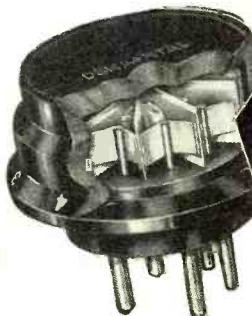

10 FREQUENCIES WITH
FINGERTIP CONTROL

**10
CRYSTALS**

- Deka Holder \$5.95
- Your choice of crystals in 40, 80 meter bands ± 1 KC. Ea. \$1.35
- 20 meter band ± 4 Kc. Ea. \$2.00

SPECIAL PRE-LOADED UNIT PRICE
Deka-Xtal and 10 crystals selected by Scientific to cover your favorite ham band..... \$14.95

Highbridge's Best Buy

BRAND NEW 7EP4

Immediate Delivery

Individually packed—in original cartons—**\$19.50**
Guaranteed.

WESTERN ELECTRIC INPUT TRANSFORMER

Video core type; impd. ratio between windings: 1-2, 3-4, 5-6, in parallel 50-900 ohms; Freq. range, 10 KC to 2 MC; made for set AN/APQ-13; Electrostatic shield between windings, oil filled; **\$1.95**
5 1/2" diameter, 5" high, wt. 5 lbs.

K8-9524—Transformer Pri. 115 V—60 cycles. Sec. #1—450 V @ 30 MA C.T. Sec. #2—6.4 V @ 1250 MA. Rectangular metal case, stud. mts. solder eyes—approx. size 3 1/4" x 2 1/4" x 3 3/8" with stand-off 1/8". **\$1.95**

No. T2G-97. Special. **\$1.95**

1.R. #7313 Filament Trans. 115 V—50-60 cycle. Sec. #1—27 KV @ 4.3 amps No. C.T.—Sec. #2—5.1 V @ 3 amp C.T.; Sec. #3—64 V @ 3 amp No. C.T.—Sec. #4 5.1 V @ 3 amp C.T.—Sec. #5—2.6 V @ 3.5 amps No. C.T.—Rectangular metal case, solder post terminals; Mtd on porcelain standoffs; stud mts. size 5/8" x 1/4" x 5/8" with standoffs 6/16". **\$4.95**

T2E-88. Special **\$4.95**

New 631 PI/SNA glass strobtron tube. **\$3.25**

100 By-Pass Condensers, 10 Varieties. Special. **\$4.95**

High voltage transformer with Glass Standoffs. Pri. 115 V. A.C.—400 cycle—Sec. 5,700 V. Rectangular; approx. size 6 1/4" x 4 1/4" x 3 3/8" with standoff 7/16"—13 Mills D.C. **\$3.95**

T3F-7. Special **\$3.95**

TUBE

12A6	.83	6SN7	.79
6SQ7	.83	6S17	.83
6AJ5	1.25	6C4	.79
1625	.70	5FB1	5.95

All Prices F.O.B. New York City, N. Y.

Highbridge Radio-Television and Appliance Co.

343 Canal CA 6-8661 New York 13

Don't forget
to refer to the

RADIONIC

Catalog!

... BECAUSE IT'S ONE
COMPLETE COMPREHENSIVE
RELIABLE VOLUME

PARTS AND ACCESSORIES • TEST INSTRUMENTS
RADIOS • TELEVISION COMPONENTS • INTER-
COMMUNICATORS • RECORDERS • PUBLIC AD-
DRESS • TUBES • HARDWARE • RECORD CHANGERS
TECHNICAL BOOKS

CHANCELLOR RADIO

RADIONIC

EQUIPMENT COMPANY

DEPT. 58 TRIBUNE THEATRE ENTRANCE
170 NASSAU ST., N. Y. 7, N. Y. WOrth
CABLE "CHANCELLOR" 2-0421

Radionic Equipment Co., Dept. 58
170 Nassau Street
New York 7, N. Y.

Please send me a FREE copy of your 1947 Catalog. I understand it has thousands of items illustrated, described and priced and will be a great help to me in my search for "hard-to-find" radio equipment, CHANCELLOR Portable and Phono Radios.

Name.....

Address.....

City.....State.....

MAIL TODAY

ing at a terrific rate and becoming more and more popular with the passing of time, magnetic recording bids fair to become universally used not only in certain dictating machines but also as a conventional entertainment media.

(To be continued)

Capacitance Test Bridge

(Continued from page 43)

critical nor will it affect the bridge circuit, but it should have as high an inductance as is possible. Its object is to prevent the bridge supply voltage from being shorted by the polarizing voltage power supply. The 3 μ f, 1000 v. condenser in series with it is to prevent any polarizing voltage supply ripple from reaching the input of the bridge.

The null indicator is a vacuum tube voltmeter circuit. The series grid resistance is to limit grid current flow, since the voltage applied to the input circuit of the 6SJ7 is rather high for conditions of unbalance. The 1 megohm grid resistance is to make the input resistance of the null indicator equal the bridge output impedance. The unbalanced bridge condition slightly lowers this input resistance (due to grid current) but as the balanced condition is approached, the input resistance becomes approximately that of the grid resistance. The tube is designed for maximum voltage gain and is followed by a 6H6 diode rectifier. The first portion of the 6H6 (on the drawing) serves to rapidly discharge the coupling condenser from the 6SJ7, and the second portion rectifies the output and applies it as bias through an RC filter to the grid of the 6SF5. The plate resistance of the 6SF5 is so chosen with the voltage used, and the grid grounded, that the current in the plate circuit is limited to approximately 1 milliamperere. Contact voltage of the 6H6 will cause this value to be lower since it is actually applied as bias, but this initial adjustment will protect the meter should the 6H6 burn out, etc. It will also be noticed that should the coupling condenser become shorted, the positive voltage will not be applied to the grid of the 6SF5, but rather be harmlessly bypassed through the first portion of the 6H6. The power supply transformer has a 650 volt, center-tapped winding.

The whole amplifier and power supply is above chassis ground to prevent shorting out one arm of the bridge circuit. The power transformer core and shell should also be insulated from the chassis since capacity indications of the bridge will be lower than the true value. It is much easier to do this than to compensate for its effects in the bridge circuit.

The principle of this arrangement is that when the bridge is unbalanced the condition is reflected into the grid circuit of the 6SJ7, its amplified output rectified by the 6H6 and applied as bias to the grid of the 6SF5, caus-

NEW LOW PRICE!

APPROVED
Model A-200
SIGNAL

GENERATOR

- 8 R.F. Bands—100 Kc.—75 Mc.
- External Modulation 20 to 30,000 cycles.
- Internal Modulation at 440 cycles.

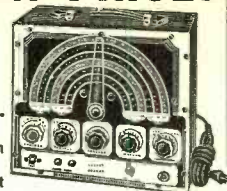

Former Price—\$49.50

For operation on 105-120 volts, 50/60 cycles A.C.

NOW only \$39.50 You Save \$10!

• Mail orders require 25% deposit, balance C.O.D. •
SCENIC RADIO & ELECTRONICS CO.
53 Park Place • Dept. R • New York 7, N. Y.

12 lbs. SURPLUS ELECTRONIC PARTS \$2.00

A gold mine of parts for repairmen, amateurs, and experimenters... sockets, condensers, resistors, transformers, coils, hardware, wire, etc., etc. An outstanding bargain in usable parts! Send \$2.00 cash, check or M.O. today! (Pay mail express charges on receipt.)

ARMY SURPLUS TU-5-B TRANSMITTER-TUNING UNIT

Range 1500-3000 KC.

Individually cartoned. Component parts value many times this special price of **\$2.39** (F.O.B. CHICAGO)

ELECTRONIC DISTRIBUTORS, Inc.

Dept. AS 620 W. Randolph St. Chicago 6, Ill.

ELECTRICAL TRAINING

Intensive 32 weeks' residence course in fundamentals of industrial electrical engineering, including radio, electronics. Prepares for technician, engineering aides. Approved for veteran training. 54th year. Catalog.

BLISS ELECTRICAL SCHOOL
7698 Takoma Ave.
Washington 12, D. C.

NOW *Sound*
FOR YOUR SILENT PROJECTOR
Economically

\$5995

Convert your 16mm silent projector to sound (regardless of make) with Apex sound head & radiofilm adapter. Guaranteed excellent performance. Write today for free information.

APEX VIDEO • 12209 J Branford St. • Roscoe, Calif.

SENSATIONAL VALUES

3-TUBE HI-FI PHONO AMPLIFIER KIT: tubes, volume & tone controls, output trans. & 5" PM speaker... **\$6.95**
Above Kit Assembled and Tested... **9.95**
HIGH GAIN CRYSTAL PICKUP... **1.94**
ALLIANCE PHONO MOTOR—9" TT... **3.69**
Portable Phono Case—for above kit... **4.95**
FILTER CONDENSER—3 mid-450 v... **.29**
12AB-12K7-25Z5-35L6 and others... **.59**
MIDGET ANTENNA LOOPS... **.39**
AC RUBBER LAMP CORD—100 ft. for... **1.88**

REMER RADIO
5904 S. Princeton Chicago 21, Ill.

MOTOR-GENERATORS

War Surplus machines built by Allis Chalmers Co. to U. S. Navy specifications. Brand new.
Input: 115 volts D.C. at 14 amps., 3600 rpm.
Output: 120 volts A.C., 60 cycles, single phase at 10.4 amps. One thousand watts continuous duty. Ball bearings. Splashproof. Fully covered. Centrifugal starter. Frequency adjustable to load.
Price 4.95. Tuckahoe, N. Y. \$57.50

ELECTRONICRAFT, INC.
Motor Div. Tuckahoe 7, New York
5 Waverly Place

Radio Technician and Announcers

A practical fifteen-month course in First Class Radiotelephone Operation and Announcing is offered by Don Martin School of Radio Arts. Most stations these days require combination men. We specialize in this type of training and maintain a placement bureau for our graduates. Serving the industry for ten years, the School of Radio Arts can train you. Write for our catalogue outlining the courses offered. Classes can be arranged so you can do part time work on the side.

APPROVED FOR VETERANS
DON MARTIN SCHOOL OF RADIO ARTS
1655 North Cherokee St. Hollywood 28, Calif.

RADIO NEWS

ing the tube to go into plate current cut-off. The 6SF5 high mu tube was chosen so that cut-off could be reached without too high a grid voltage. When the bridge is balanced, there is no input to the 6SJ7, hence no output to be rectified and applied as bias to the 6SF5, with the result that the meter indication increases to maximum. Consequently this circuit reads as a normal meter does, and at the same time provides protection to the meter as well as a higher input resistance as compared to the conventional a.c. meter.

The polarizing voltage transformer, T_2 , is a 650 volt transformer. It is connected as a half wave rectifier. The 3000 ohms in series with the cathode is to reduce the voltage to about 700 volts. The main object of this is to limit the inverse voltage across the 1V tube to as low a value as possible. The total current for this circuit is 5 ma. The entire bleeder circuit is composed of 2 watt resistors. No trouble has been encountered with this circuit; the 1V seems to be rugged enough to withstand the 1400 volts inverse voltage without any undesirable effects.

This circuit arrangement was selected for two reasons; accuracy of measurements, and simplicity and ease of operation. Leakage measurements were not incorporated within the instrument because it was felt that it would be a duplication of qualitative measurements. A leaky condenser

will show up in power factor determination just as easily as a condenser with a high series resistance, although it is possible to measure leakage current with an external milliammeter. A meter is simply connected in series with the capacitor under test and the combination connected to the terminal posts. However, before connecting the meter and condenser across the terminal posts it should be borne in mind that unless there is a polarizing voltage applied to the terminal posts damage might be the result from the raw a.c. being applied to the d.c. milliammeter.

Construction

The whole instrument is built on an 8"x17" chassis with an 8 3/4" relay rack panel for rack mounting. The first components mounted on the chassis are the power transformer for the null amplifier and the bridge supply transformers. These must be properly oriented in relation to each other to prevent any undesirable effects from them. One of the two can be mounted on the chassis, but the other's position and orientation must be determined by trial and error. The full line voltage is applied to the primary of the mounted transformer, and with either phones or an a.f. amplifier connected to the primary of the other it is rotated until the hum reaches its lowest volume. This will then be the position in which to mount it. The power

transformer for the polarizing voltage is then mounted on the other side of the chassis. The position of the tubes is not critical, although they should be arranged for the shortest possible leads. All wiring, except that of the bridge proper, is cabled and should be so arranged and positioned that the cables do not cross each other unnecessarily. All long bridge circuit leads should be as far removed from the chassis and adjacent wiring as possible. This is best done by rigidly supporting them on insulators. These wires should definitely be as short and as direct as is consistent with good design and construction. All resistors are rigidly supported on mounting strips. On the drawing there are only two active grounds shown, but in the unit itself there is a bus wire connecting all portions of the circuit requiring a ground, with the chassis itself being grounded at as many points as is possible. Unless this is done, erratic behavior of the instrument may be experienced.

The large "Capacitance" dial, 5 1/4" diameter, was made on a lathe and is mounted on a General Radio 3" skirt knob, type #637-S. The engraving was done after calibration of the potentiometer with a Wheatstone bridge. The calibration points on the dial can be determined by the equation:

$$R_p/R_r = C_p/C_s$$

where: R_r equals the range resistance; R_p equals the potentiometer (10,000

The BEST in SURPLUS

HICKOK VACUUM TUBE VOLTMETER

A quality service instrument at less than 1/4 of cost. These units are used but in good condition. Huge meter face for easy reading. Scales are 2.5-10-50-250-1000 D.C., A.C., Mills. Ohms - \$19.50
0-1000 Meg. Only 24 available.

FORGET FILTER TROUBLES with Oil Filled Condensers

WESTERN ELECTRIC 10,000 4 watt W.W. 1/2" shaft	1000	\$1.75
WESTERN ELECTRIC 10,000 4 watt W.W. 1/2" shaft	1000	1.95
WESTERN ELECTRIC 10,000 4 watt W.W. 1/2" shaft	1000	2.35
WESTERN ELECTRIC 10,000 4 watt W.W. 1/2" shaft	1000	1.95
WESTERN ELECTRIC 10,000 4 watt W.W. 1/2" shaft	1000	2.35
WESTERN ELECTRIC 10,000 4 watt W.W. 1/2" shaft	1000	2.35
WESTERN ELECTRIC 10,000 4 watt W.W. 1/2" shaft	1000	2.35

COLLINS AUTOTUNE TRANSMITTER

The outstanding 100 watt surplus transmitter 2 to 18 megacycles. Conversion in RADIO NEWS and CQ. As removed from military aircraft in excellent condition. Complete with tubes less dynamotor - \$77.50

POTENTIOMETERS

GENERAL ELECTRIC 5000 ohm 4 watt W.W. 1/2" shaft
WESTERN ELECTRIC 10,000 4 watt W.W. 1/2" shaft
T.S. 0,000 ohm Carbon 1/2" shaft
GENERAL ELECTRIC 20,000 ohm 4 watt W.W. 1/2" shaft
CENTRALSTAT 40,000 ohm 3 watt W.W. 1/2" shaft
CENTRALSTAT 100,000 ohm Carbon 2" shaft
CENTRALSTAT 200,000 ohm Carbon 1" shaft
T.S. 15,000 ohm Carbon Spst Switch 1/2" shaft
ALLEN BRADLEY 1 Meg. Spst Switch 1/2" shaft

29¢ 4 for 99¢
39¢ 3 for 99¢

POWER SUPPLY from RADAR UNIT BC-1073A

A beautifully constructed power supply operating from 110V 60 cy. source. It supplies 330V at 85 MA 6.3V at 7.5A. Cased transformers and oil filled condensers - in addition there are hundreds of molded condensers and resistors, switches, potentiometers, fuse holders, etc. BRAND NEW loss tubes. \$5.95

MICA TRANSMITTING CONDENSERS

SOLAR 85 002 MFD	500V DC Working	2.00
SOLAR 85 001 MFD	350V DC Working	.95
WECAPOL 60 002 MFD	350V DC Working	1.40
SARGAPO 002 MFD	250V DC Working	.80
GOBLITE 005 MFD	120V DC Working	.40
SARGAPO 02 MFD	120V DC Working	.40
SARGAPO 05 MFD	60V DC Working	.30
SARGAPO 02 MFD	60V DC Working	.40
ATROX 01 MFD	120V DC Working	.40

RCA RECEIVER

Model CRV 46151 A communications type receiver tunes 155 kc to 9 megacycles in 4 bands. Easily converted to 110V. Has calibrated dial, vernier drive knob. As removed from Navy aircraft with tubes and dynamotor \$17.50

CASED FILTER CHOKES

Beautifully Cased - Built by General Trans. and Acme

8 Henry 250 MA 5,000V. Inc.	\$2.49
10 Henry 250 MA	2.49
20 Henry 150 MA	1.49

DELUXE POWER SUPPLY KIT

The power transformer and oil filled filter condenser from the Hammett super-gra supplies 455V at 150 MA, 300V at 175 MA bias winding, 6.3V at 7.5A, 5V at 2A, 1V at 1A. The filter has four sections at 8 MFD at 600V, D.C. \$9.95

NO ORDERS UNDER \$2. WE WILL SHIP C.O.D.

THE HEATH COMPANY

BENTON HARBOR, MICHIGAN

Write for Complete List of Radio Components

**Surplus Super Special
Famous Weston Model 663
Volt-ohm-Milliammeter**

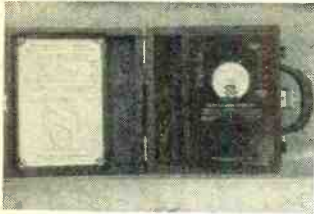

List Price
\$71.00

OUR PRICE
\$45.95

Brand New

IDEAL FOR—
LABORATORY, SCHOOL AND INDUSTRIAL USE.

RANGES: OHMS, (full scale) 0-200/1,000/10,000/-
100,000/1,000,000/10,000,000.

OHMS, (center scale) 0-5/25/250/2,500/-
25,000/250,000.

MILLIAMPERES, d-c—1/5/25/100.

VOLTS, d-c—2.5/10/50/250/500/1,000.

50 Micro Amp. Movement. Wire Wound Precision Multipliers in all voltage current ranges. Solid Dark Oak Case with leather handle. Size: 8 1/4" Wide by 9" High by 5 3/4" Deep. Complete with batteries and test leads.

20% deposit with order. Balance C.O.D.

Write for quantity discounts

All Equipment Guaranteed

**STANDARD RADIO-ELECTRICAL
PRODUCTS**

2507 WHITE PLAINS RD. NEW YORK 87, N. Y.

ORDER NOW

- SCR 5225 (with tubes, dynamotor, control box, and plugs) **\$39.50**
- BC 348 Army Receivers (New Condition). **\$49.50**
- 300 Ohm Amphenol Twin Lead, **\$ 2.90**
per 100 ft.
- 75 Ohm Amphenol Twin Lead, **\$ 2.00**
per 100 ft.
- Kilowatt 75 Ohm Amphenol Twin Lead, **\$ 7.20**
per 100 ft.
- Complete stock of 80 and 40 meter MONITOR
Crystals in holders, any frequency within 1
KC each **\$ 2.80**
- 3 Gang 410 Mmfd. Per Sect. Cond. **\$ 2.95**
Excellent quality
- National ACN Dials **\$ 3.00**
- 24G Transmitting Tube **\$ 1.49**
- 2C40 Lighthouse Tube **\$ 3.95**
- 2" PM Speaker (Bakelite Cased)
Used in Walkie Talkie **\$ 1.95**
- #12 Solid Enamel Antenna Wire, per 100 ft. **\$ 1.35**
- #14 Solid Enamel Antenna Wire, per 100 ft. **\$.98**
- SIREN, Commercial type hand operated,
very loud noise, gov't cost \$21.00. Spec. **\$ 4.95**

Send for Our Special Bulletin of
Government Surplus Items

DOW RADIO

1759 E. COLORADO ST. PASADENA 4, CALIF.
Pasadena Phone—SYcamore 3-1196
Los Angeles Phone—RYan 1 6683

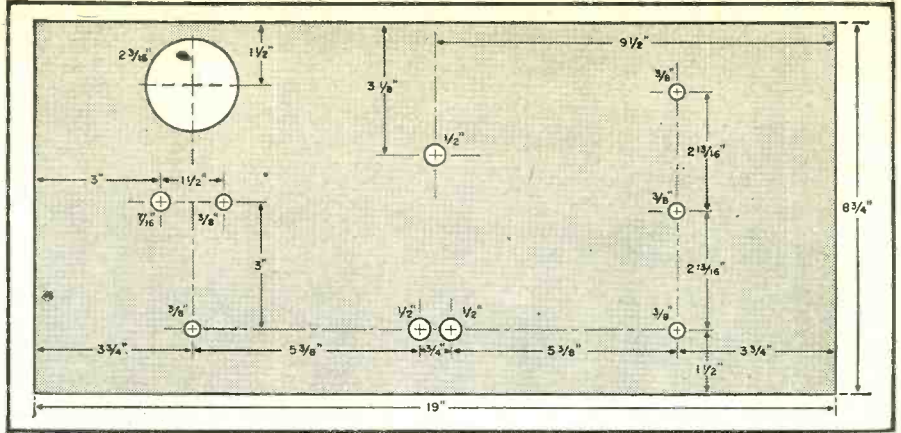

Panel layout shows actual location of component parts.

ohms); C_s equals the value of the standard condenser, and C_x equals the value of the unknown condenser.

The value of the unknown in the equation should be made equal to the highest value for the particular range under consideration, though it is recommended that the range be unity (1). By determining the highest point, it is only a matter of dividing the required resistance in the variable element by ten to determine the main dial divisions. The main divisions are then all subdivided into equal parts, this being a matter of preference with the constructor. For accuracy a reliable bridge should be used. An ohmmeter does not have the required degree of accuracy for this particular job. By using a bridge for both the dial calibration and in determining the resistance of the range resistors, the degree of accuracy can be maintained at an extremely high value. Once the dial is calibrated it will read and be applicable for all the ranges in conjunction with the multipliers for the instrument.

Before calibrating the final instrument it should be mounted in a metal cabinet. This is necessary if the calibration is to be reliable at all times since surrounding objects tend to affect the unshielded bridge.

The instrument must be calibrated

with a known capacitance standard. It is recommended that this calibration standard equal, or approximate, that of the internal standard. With the calibration condenser connected directly to the terminal posts, the bridge is balanced and the dial adjusted until its reading corresponds to that of the calibration standard. This is all that is necessary for calibration of the final instrument. The power factor control is also a linear function of the resistance, and hence the required potentiometer can be divided into ten equal parts of resistance, with these further subdivided if desired.

Results obtained with the completed instrument were very satisfactory. To check operation ceramic condensers rated at $12 \mu\text{mfd.}$ plus or minus 10%, or plus or minus $1.2 \mu\text{mfd.}$ which were available were used. Connecting them individually to the terminal posts showed them to be well within their rating, and by paralleling the combination the indication corresponded exactly to their arithmetical sum. Placing them in a series combination also indicated the correct result well within 2%. It is suggested that each range be checked in this manner to ascertain the reliability of each individual range and the over-all performance of the complete instrument.

-30-

Underchassis view of the home-built capacitance test bridge.

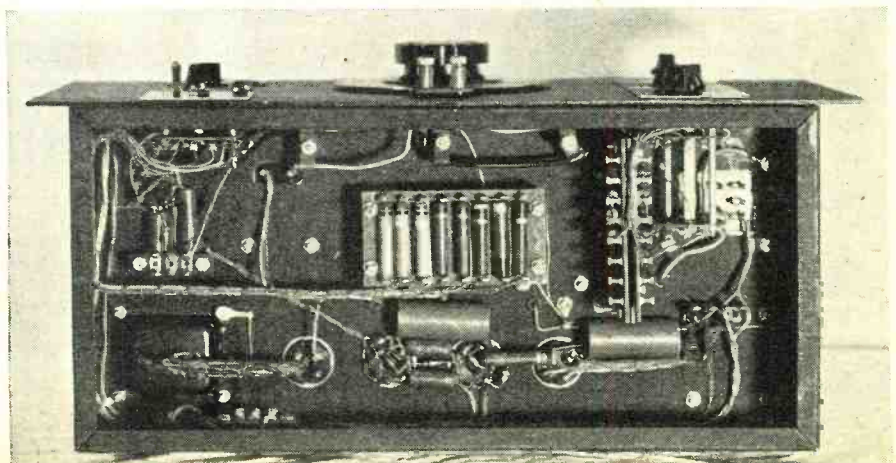

S.S.S.

"Servicing by Signal Substitution"

Learn about this modern dynamic approach to radio servicing with ONLY BASIC TEST EQUIPMENT.
... Fully described in a 120 page book available from your Precision Distributor or factory at 35¢.
... Schools are invited to inquire regarding quantity orders from our Educational Division.

PRECISION APPARATUS COMPANY INC.
ELMHURST 9, N. Y.

Manufacturers of Fine Test Equipment
RADIO • TELEVISION • ELECTRICAL • LABORATORY

Every Home a Bonanza!

(Continued from page 49)

who buy. Your calls should be made at the time of the day most suitable for interviewing housewives, usually in the morning between 9 and 11:30.

The canvassing must be done thoughtfully. Each call should be so handled as to yield the most information possible and create a friendly respect for your business. You must find out what radios and appliances are now owned, their age and condition. Without appearing inquisitive try to secure pertinent data about the family. Family statistics, such as age and sex of the children, birthdays, anniversaries, etc. are all valuable to the dealer, but in attempting to obtain this information remember that you are not a census taker and can't quiz the housewife. If during the course of your visit this data is volunteered, by all means jot it down for future reference.

After each call record the information you have secured on a generous sized card or several cards, separating like information from unlike to make for better reference. File these cards properly in a working file. Check these cards each day for the action necessary to direct attention to your product and to build good will.

Every time a sale is made the transaction should be used to yield pertinent information for your file and to create good will. Suppose you sell a washing machine, refrigerator or a sunlamp.

This sale provides an opportunity to get into the home in a way nothing else does. You make the delivery, you check on the installation, you visit several times to give service and, if you have done your job in a friendly and helpful way, the family talks to you confidentially and you can ask questions. You can discover what electrical equipment they haven't got but should have and can afford for each important room. You can begin to educate them. Carefully and subtly you can point out what equipment should be in the home. A complete package, such as a modern kitchen, might be worked out and offered, or related items played up, one at a time. You sell a washing machine and can then offer dryers, ironers, water heaters, and perhaps a fan. All these things make washday easier, quicker, and more comfortable.

During your visits to the home in connection with the sale, servicing, and installation of electrical equipment, you can often glean additional information about how the family lives. As an example, everyone likes to be remembered on his birthday. If such information is obtainable, you should have in your file the birthdates of your customers and prospects. Send them individual, personal birthday cards with an inconspicuous signature of your store and your signature as owner. A week or two before the birthday or wedding anniversary of the homemaker remind her husband that you have a particular appliance his wife would like to have, or one that would be appropriate for the occasion. Thus, you can solve his problem of selecting a gift, he can give something practical, and you have made a sale.

Perhaps you have discovered that an advertising specialty would be appreciated as a gift. Hundreds of such inexpensive items are available; appointment pads, ash trays, blotters, bottle openers, pencils, lighters, lucky coin pieces, desk rulers, envelope openers, fans, key tags and rings, license holders, needle books, thermometers, paper weights, school bags, serving trays and so on. If one of these advertising specialties is to be used, never send it out at a time when seasonal gifts are exchanged by members of the family. Advertising specialties are inexpensive and unfavorable comparisons with family gifts might be made. Send them out sufficiently long before or after Christmas (say) to be appreciated for what they are, a good will offering on your part.

You might also give away related samples with a purchase; floor wax or oil, moth crystals, insect sprays, soap powder or whatever else may go with one of the devices that has been purchased. Recipe books should be pre-

FOR EXTRA SALES-PROFITS IT'S ATR QUALITY PRODUCTS

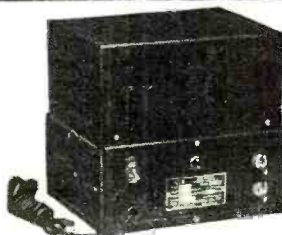

ATR "A"

BATTERY ELIMINATORS

FOR DEMONSTRATING AND TESTING AUTO RADIOS

New Models . . . Designed for Testing D.C. Electrical Apparatus on Regular A.C. lines. Equipped with Full-Wave Dry Disc Type Rectifier, Assuring Noiseless, Interference-Free Operation and Extreme Long Life and Reliability.

- Eliminates Storage Batteries and Battery Chargers.
- Operates the Equipment at Maximum Efficiency at All Times.
- Fully Automatic and Fool-Proof.



ATR AUTO RADIO

REPLACEMENT VIBRATORS

Designed for Use in Standard Vibrator-Operated Auto Radio Receivers. Built with Precision Construction for Longer Lasting Life.

ATR

STANDARD AND HEAVY DUTY INVERTERS



For Inverting D.C. to A.C.

Specially Designed for Operating A.C. Radios, Television Sets, Amplifiers, Address Systems, and Radio Test Equipment from D.C. Voltages in Vehicles, Ships, Trains, Planes, and in D.C. Districts.

Write for Our New Catalog—Just Off the Press!

AMERICAN TELEVISION & RADIO CO.

Quality Products Since 1931

ST. PAUL 1, MINN.

U. S. A.

LEARN NOW!
ELECTRONICS

- RADIO
- F.M. and TELEVISION
- PUBLIC ADDRESS SYSTEMS
- SHORT WAVE COMMUNICATIONS

Men! Women! Find successful careers in this fascinating field! Ample equipment for all to use in practical classes. *You start practice when you enroll!*

Approved for Veterans

HOLLYWOOD SOUND INSTITUTE

1040 N. Kenmore Ave., Dept. A
LOS ANGELES, CALIF.

PHONO AMPLIFIER KITS

3 Tube Phono Amplifier Kit	\$ 2.75
Completely wired and tested	3.25
Kit of tubes for above	2.15
5016, 3525, 12SK7	
5' Alnico P.M. Speakers	1.45
50L6 Output Transformer	55c
Shure Glider Crystal Pickup	1.95
Astatic Crystal Pickup	1.95
Alliance Phono Motor	3.25
RECORD PLAYER KIT consists of	
3 Tube amplifier, 5' Alnico P.M. speaker with matching output transformer, Astatic L-70 Crystal Pickup, Alliance Phono Motor, Walnut Finish Cabinet	15.50
Completely assembled and tested	17.75
PORTABLE RECORD PLAYER KIT consists of same as above, but with simulated leather carrying case	17.95
Completely assembled and tested	21.50
Maguire Automatic Record Changer V.M. Mixed Changer—Plays 10' and 12' records intermixed	17.95

DEALERS WRITE FOR SPECIAL QUANTITY PRICES

All prices F.O.B. our warehouse, New York

RAYTONE ELECTRONIC CO.
25 FRANKFORT ST., NEW YORK 7, N. Y.

RECORDS

LATEST & HARD-TO-GET BACK NUMBERS

Some slightly used and some brand new—Victor, Bluebird, Columbia, Okeh, Decca, Capitol, etc. Such artists as Glenn Miller, Benny Goodman, Harry James, Bing Crosby, Frank Sinatra, Gene Autry, Duke Ellington, Fats Waller, Guy Lombardo, Andrews Sisters, Kate Smith, Ink Spots, Mills Bros., etc.

BIG PROFITS Your opportunity to cash in on this new field that is sweeping the country. Specify the type of music that sells best in your territory such as Swing, Sweet Music, Cow-boy, Hill-billy, Polkas, Blues, etc. Your price \$13.90 per 100 records, f.o.b. Chicago, 2% off for cash with order. All shipments made within 48 hours.

CHAS. HOODWIN CO.
4419 Broadway, B-15, Chicago 40, Illinois
World's Largest Dealers in Used Records

ENTERTAINMENT—FURNITURE GROUP

Radio—home, auto and "ham" types
Television
Subgroup—Hearing aids and other electronic devices

LAUNDRY GROUP

Washing machines
Irons
Dryers
Ironers
Sewing machines

KITCHEN UTILITY AND FURNISHING GROUP

Refrigerators
Electric ranges
Dish washers
Kitchen cabinets
Frozen-food storage group
Subgroup—grills, mixers, toasters, waffle irons, juicers, coffee-makers, roasters

GENERAL UTILITY GROUP

Water heaters
Fans and ventilators
Vacuum cleaners
Waxers and polishers
Space heaters
Room coolers and humidifiers
Water supply systems
Electric clocks
Lamps and lighting fixtures
Flashlights
Fluorescent lights
Portable air conditioning units

FARM APPLIANCES

Water systems
Portable motors
Electric fences
Quick freezers
Milking machines and coolers
Poultry brooders
Ventilating fans
Health lamps

COSMETIC AND HEALTH GROUP

Razors
Tooth brushes and massagers
Curling irons and hair dryers
Vaporizers
Vibrators and massage devices
Electric pads and blankets
Sun lamps
Bottle warmers

Table 1. Major and traffic appliances which go to make up an "E" home.

sented to purchasers of refrigerators and ranges telling them "just how to mix, prepare, and cook the many palate-pleasing dishes which now become possible."

Briefly, your success as a dealer will depend, to a great degree, on your remembering the following points:

1. The market for radios and appliances is different from prewar.
2. Many more devices are being offered and others will come along after full reconversions are effected.
3. Competition is going to be keener because there will be more dealers and many of these dealers will be more aggressive than ever before.
4. More people to whom you can sell will be available.
5. They will have to be sold.
6. They are, however, more ready to be persuaded than ever before.
7. The first sale should be the prelude to many others.
8. You, Mr. Dealer, will have to sell them and make friends of them.
9. You, Mr. Dealer, will have to go out and canvass them.
10. You, Mr. Dealer, must have the

**EE-8 B
ARMY SIGNAL CORPS
FIELD TELEPHONE**

Portable field unit, complete with handsets, fully equipped with ringer, coils, condenser, generator and crank, can be used on C B lines. Various Manufactures. Regular \$28.50 value. OUR PRICE (with-out carrying cases): \$10.50 each. With carrying case, \$17.50 each. UNUSED. IMMEDIATE DELIVERY.

MASPETH TELEPHONE & RADIO CORPORATION

427 Flatbush Ave. Extension
Brooklyn 1, N. Y.
Telephone NEvins 8-5709

EASY TO LEARN CODE

It is easy to learn or increase speed with an Instructograph Code Teacher. Affords the quickest and most practical method yet developed. For learners of advanced students. Available tapes from beginner's alphabet to typical messages on all subjects. Speed range 2 to 40 WPM. Always ready—no QRM.



ENDORSED BY THOUSANDS!

The Instructograph Code Teacher literally takes the place of an operator-instructor and enables anyone to learn and master code without further assistance. Thousands of successful operators have "acquired the code" with the Instructograph System. Write today for convenient rental and purchase plans.

INSTRUCTOGRAPH COMPANY

4711 SHERIDAN ROAD, CHICAGO 40, ILLINOIS



**FLASH-O-TEST
CONTINUITY TESTER AND
FLASHLIGHT, COMBINED**

NEW! Nothing like it on the market.
USE: As probe light and testing continuity, shorts, open circuits, etc.
EQUIPPED WITH: Two batteries and bulb. Plastic case. Lunk leads with clip and prod.
\$2 POSTPAID. Immediate Delivery
STERLING ELECTRIC CO.
166 NO. SIERRA AVENUE
PASADENA 4, CALIF.

**RADIO ENGINEERING
TELEVISION
ELECTRONICS**

Courses in every phase of radio and electronics open to high school graduates. Thorough training, modern courses. Enrollments limited. Approved Veteran Training.

VALPARAISO TECHNICAL INSTITUTE
Dept. RS Valparaiso, Indiana

Radio Receiver & Transmitter, BC 222 (28 to 52 meg.), with circuit diagram and plug-in coils	\$7.50
Tubes for above, Nos. 30 and 33	1.91
12 feet Antenna	1.95
Aircraft Radio Receiver, CBY-46104, 1.5 to 3 meg. complete with tubes and 28 volt Dynanotor (12KB, 3-12SK7, 12A6, 12SR7)	3.00
Carbon Microphone T-17	1.39
45 volt "B" Battery	.49
Arcturus 299 Tubes	.19
4-prong Vibrators for Motorola (surplus)	1.00

RADIO PARTS SALES CO.

5220-5222 South Vermont Avenue
Los Angeles 37, Calif. TW. 9178

ROTA-BASE

NEW HANDY LAB. DIAL actually gives a "prong" picture of radio tube connections. Simply turn the dial to the tube number desired on the ROTA-BASE and complete correct connections are instantly indicated on the "prong" diagram. No more valuable time lost thumbing names or on lengthy readings. Filament, grid, plate, cathode, etc., to MORE THAN 300 tube types are given. PRICE NOW ONLY \$1.00 postpaid or sent C.O.D. plus postage. Order NOW money refunded if you are not delightfully pleased.

REED MFG. CO. 124 W. 4th St. Los Angeles 13, Calif.

Now! GUARANTEED FACTORY REBUILT VIBRATORS \$1.00 ea.

SEND OLD VIBRATORS. ANY MAKE OR KIND OF VIBRATOR REBUILT LIKE NEW. NON-SYNCHRONOUS - RESULT FOR \$1.50. SYNCHRONOUS TYPE - RESULT FOR \$1.50. 48 HOUR SERVICE - ENCLOSE REBUILT AND RETURN PROOF. BEST VIBRATOR CO. BOX 5802 - CLEVELAND 1, OHIO

finest of mailing lists to work on prospects through direct advertising.

11. You, Mr. Dealer, must show them how the related items work together to give them more leisure, greater comfort, and healthier homes by means of personal sales talks and through direct mail advertising.

12. Do you wonder, Mr. Dealer, when we say an "E" family might well be persuaded by you to put 20 to 25 per-cent of their home investment into radios and appliances?

Thus we say to you, Mr. Dealer, with all the emphasis at our command, you can do it with regular, consistent, thoughtful effort and by insistence on your part that both the wholesaler and manufacturer give you all the aid they are able and equipped to give, and that, finally, you ask the cooperation of the utility company's local office. They are as anxious as you are to see every home fully equipped with electrical devices of every kind, and if their help will do it, they will gladly give you the assistance you require.

-30-

Within the Industry

(Continued from page 30)

vision succeeding E. H. McCarthy who has retired from active business because of ill health.

Mr. Hendrickson, who joined the *Farnsworth Television & Radio Corporation* in 1939 as Sales Manager of the *Farnsworth Division*, served as Manager of the company's Field Expediting Division from 1942 to 1945. He served as Manager of the Chicago Distributing Branch from 1945 until his appointment to this new post.

* * *

ELLERY W. STONE, who has recently returned to this country following a distinguished war career, was elected a Vice-President of the *International Telephone and Telegraph Corporation* recently.

Holding the rank of Rear Admiral, Mr. Stone served as Chief Commissioner of the Allied Commission for Italy until recently. He has been associated with the *I. T. & T. System* or predecessor companies for more than twenty years. He was recalled to active Navy duty in 1943.

* * *

L. M. HEINEMAN, president of *Permo-flux Corporation*, recently announced his company's entry into the jobber field with a line of speakers, transformers, pickups, and microphones.



The new jobber line will be handled by the company's two plants. The Eastern territory will be served by the plant at 4900 West Grand Avenue in Chicago while Western jobbers will be supplied from the plant at 236 South Verdugo Road, Glendale, California.

-30-

BOB HENRY'S PLATFORM

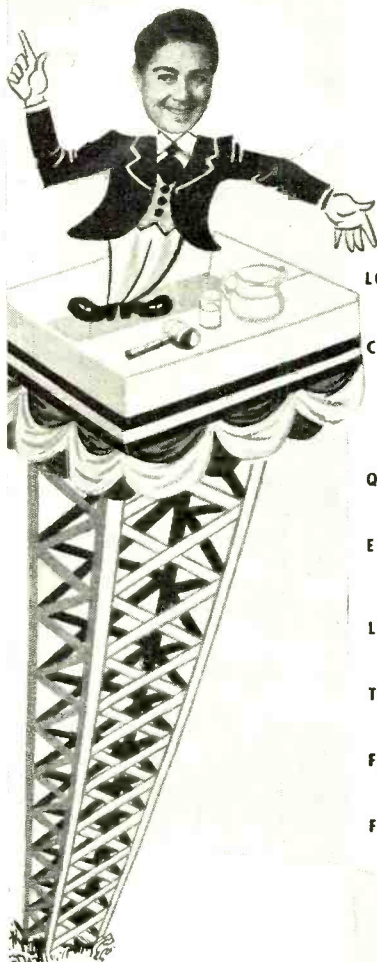

LOW PRICES

I guarantee to sell to you as cheap as you can buy anywhere.

COMPLETE STOCKS

Hallcrafters, National, Hammarlund, Collins, Millen, RME, Pierson, Temco, Meissner, Supreme Transmitters, Meck, Gordon, Amphenol-Mims, RCA, Vibroplex, Sonar, all other amateur receivers, transmitters, beams, parts, etc. If it is amateur or communications equipment—I can supply it.

QUICK DELIVERY

Mail, phone, or wire your order. *Shipment within four hours.*

EASY TERMS

I have the world's best time sale plan because I finance the terms myself. I save you time and money. I cooperate with you. Write for details.

LIBERAL TRADE-IN ALLOWANCE

Other jobbers say I allow too much. Tell me what you have to trade and what you want.

TEN DAY FREE TRIAL

Try any receiver ten days, return it for full refund if not satisfied.

FREE NINETY DAY SERVICE

I service everything I sell free for 90 days. At a reasonable price after 90 days.

FREE TECHNICAL ADVICE

and personal attention and help on your inquiries and problems.

Hallcrafters products slightly higher when shipped from Los Angeles Store.

*Write, wire
or phone today*

Butler, Missouri

HENRY RADIO STORES

Los Angeles 25, Calif.

"WORLD'S LARGEST DISTRIBUTORS OF SHORT WAVE RECEIVERS"

WANTED YOUR NAME FOR OUR MAILING LIST!!



5" PM Alnico Speaker.....\$1.25
5" Dynamic Speaker, 450 Ohm
Field.....1.89
Universal 4-4 Vibrator.....1.29
500 M Volume Control with AC
Switch. Best Make......55

UTILIPHONE MASTER AND SUBSTATION

List, \$19.95 — Net, \$13.95

SEND FOR OUR LATEST BARGAIN BULLETIN—YOU WILL SAVE!!!!
20% DEPOSIT ON ALL C.O.D. PLEASE INCLUDE POSTAGE.

RADIO EQUIPMENT CO.

377 East Main St.
Lexington, Kentucky

NO SURPLUS REGRETS

WHEN YOU BUY FROM

Mission Radio Inc.

We stock the products of leading manufacturers of radio parts for immediate delivery.

AVAILABLE NOW

POLYMER
V.T.V.M.

Model # 134 for R.F. to 300 mc. NET. **\$69.50**

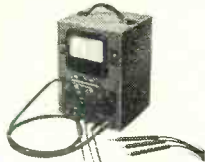

OSCILLOSCOPE
3" screen Model # 131
Gray crackle finish.
NET **\$78.50**

SYLVANIA

Test Equipment
Model # 139
Illustrated
\$79.50 NET

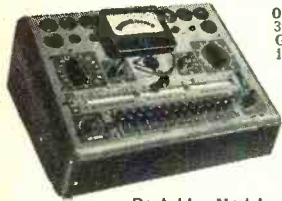

Portable Model #140—\$79.50 Net

All orders shipped within 4 hours of receipt.
20% deposit required on all mail orders.

MISSION RADIO INC.

814 S. Press Street

San Antonio, Texas

BONAFIDE VALUES



SHURE T17B
Push Button Carbon Mike
\$1.89
With Cord and Plug
Value \$12.00

SHURE CRYSTAL MIKE

\$6.95
With Stand, Base, and 7 Ft. Cable
Value \$18.50



Detrola Record Changer	\$14.69
Websters 56 Automatic Stop	25.95
Seeburg 2 Post Changer	23.97
Maguire 2 Pos. Changer on Base, Automatic Stop	14.95
A.C. Motor & Astatic L-70 Pick-up	4.75
5" PM Speaker (Alnico)	1.39
#3" Heavy Slug Speaker—Nylon Cone	1.98
#2" Heavy Slug Speaker or Mike Comb.	1.49
1/2 Meg. Vol. Cont. & Sw.—Lots of 6	.49
Federal Selenium Rect.—100 Mill—Lots of 8	.69
100 IRC Resistors Assorted Sizes & Watts	2.49

25% DEPOSIT, BAL. C.O.D. PLUS CHARGES
WRITE FOR LATEST CATALOG

BONAFIDE RADIO CO.

89 1/2 Cortlandt St., Dept. C, N.Y. 7, N.Y.

PRACTICAL TECHNICAL TRAINING FOR YOU

Specialize in Electronics, Radio, Electricity, Refrigeration, Heating and Air Conditioning, or Welding. Prepare in one year for position as Technician, or in two additional years secure your B.S. Degree in Electrical Engineering with major in Machinery or Electronics.

Write for booklet "Career Building"

MILWAUKEE SCHOOL OF ENGINEERING

"A Technical Institute"

HN - 847 N. Broadway and E. State, Milwaukee, Wis.

HAMS, SERVICEMEN, DEALERS

SEND FOR OUR

LATEST BARGAIN BULLETIN

CALIFORNIA RADIO & ELECTRONICS CO.

711 N. Vermont Ave.
Los Angeles 27, Calif.

Manufacturers' Literature

Readers are asked to write directly to the manufacturer for the literature. By mentioning RADIO NEWS, the issue and page, and enclosing the proper amount, when indicated, delay will be prevented.

ENGINEERING HANDBOOK

Cornell-Dubilier Electric Corporation is now distributing a new technical handbook entitled "Power Factor in Your Plant" written by W. C. King, a sales engineer.

This 208-page book has been prepared to answer many questions directed to Mr. King by maintenance engineers. In a thoroughly readable fashion, the author has provided the answers to many of the problems that confront the industrial plant operator.

The book may be ordered from *Cornell-Dubilier Electric Corporation*, South Plainfield, New Jersey. The price is \$3.00.

EQUIPMENT CATALOGUE

Concord Radio Corporation has announced the availability of the new Supplement No. 477 covering radios, electronic equipment and parts.

This 72-page catalogue lists hundreds of items of interest to the serviceman, amateur, hobbyist and electronic engineer including tubes, amplifiers, microphones, p.a. systems, test instruments, meters, batteries, condensers, resistors, etc.

A copy of this catalogue may be secured by writing *Concord Radio Corporation*, 901 W. Jackson Boulevard, Chicago, Illinois or from the company's Atlanta, Georgia office at 265 Peachtree Street.

RADIO CATALOGUE

Lafayette Radio of New York has announced the publication of a new summer flyer, No. C-39, which is now available for distribution.

The company has set special prices on many popular items such as tubes, transformers, inductors, condensers and resistors as well as ham gear, test equipment, radio sets, phono players, and stock equipment used by servicemen.

Several new lines including FM-AM radios, magnetic wire recorders, TV receivers and kits, etc. are also listed in this new flyer.

Copies of catalogue C-39 may be obtained by writing *Radio Wire Television Inc.*, 100 Sixth Avenue, New York, New York.

NEW OLSON CATALOGUE

The recently issued *Olson* catalogue has been designed to be carried in the serviceman's pocket or hung over his service bench.

In addition to hundreds of items including components, tubes, test equipment, antennas, amplifiers, intercoms, microphones and receivers, the new catalogue also lists five pages of free gifts which are being offered by the

company to servicemen who make purchases of radio materials from the company.

A copy of this new catalogue will be sent to readers who request it from *Olson Radio Warehouse, Inc.*, Dept. 89, 73 East Mill Street, Akron 8, Ohio.

NAMEPLATES

Premier Metal Etching Company have just issued a 2-page bulletin covering their partial line of etched and lithographed metal name and trademark plates.

Manufacturers of radio and electronic products are especially invited to avail themselves of the opportunity of looking over the company's line. The company maintains branch offices in leading cities, but requests for this bulletin should be made to *Premier Metal Etching Company*, 21-09 44th Avenue, Long Island City 1, New York.

REPLACEMENT TRANSFORMERS

A catalogue covering their line of replacement transformers has just been issued by *Crest Transformer Corporation* of Chicago.

The company's line which includes transformers for the radio industry, neon lighting, and power transformers for electric fence control, is illustrated and described in this 8-page catalogue.

Readers may secure copies of this publication by writing *Crest Transformer Corporation*, 1834-36 West North Avenue, Chicago 22, Illinois.

SHURE CATALOGUE

Two new 1947-48 catalogues which have just been issued by *Shure Brothers* feature new and simplified listings of the company's complete line of microphones and pickups.

Catalogue 157 covers the company's line of microphones and features the new Multi-Impedance "Unidyne" and "Sonodyne" dynamic microphones, the "Econodyne" dynamic and two new crystal microphones, the "Monoplex" and the "Versatex."

Catalogue 158 lists various pickups including the new "Muted Stylus" unit, cartridge, and needles, cartridge replacement packs, and the company's lever-type cartridges.

Copies of either or both of these catalogues are available from *Shure Brothers*, 225 West Huron Street, Chicago, Illinois.

SIGNAL BOOSTER

L. S. Brach Mfg. Co. has a new brochure describing the "Puratone Signal Booster" which is currently being distributed to those requesting it.

The unit described carries AM, FM and television antennas on the same

mast and is especially designed to provide noise-free demonstration of radio equipment. A shielded coaxial cable runs directly from the mast to the concealed amplifier on the display floor. From the amplifier a radiating wire may be placed around the display space in the store without direct wire connection to the radio set. One system serves any number of floor models. Dual wave traps in the video type AM-FM amplifier bring in all stations at an average tone-level.

A copy of the new brochure will be forwarded upon application to L. S. Brach Mfg. Co., 200 Central Avenue, Newark 4, New Jersey. -50-

Appliance Financing

(Continued from page 50)

ures on this potential durable goods market. Conservatively, it is estimated that approximately two billion dollars will be spent toward the purchase of major household appliances and home furnishings.

As to how these purchases will be made—with cash or by monthly installments out of current income—is a question that can only be conjectured. It is reasonable to assume, however, that a fairly large portion of these purchases will be made on the installment basis. The American public, as has been evidenced in the past, is installment-minded and many authorities believe that a program urging the continuation of savings and the retention of war bonds as nest-egg savings will be a hedge against inflation. If, during the postwar period, purchases of consumer durable goods are made substantially from income one of the inflationary factors will have been averted.

When a commercial bank decides on the basis on which to do this business it will select a dealer by conducting an investigation and making an analysis of his credit responsibilities and also by evaluating certain factors, some of which are as follows:

1. The dealer must be a good moral risk. The investigation should cover his entire history and background in order to establish, within reason, evidence that the risk is unquestionable. This is extremely important because of the large amount of credit extended to and through the dealer in relation to his net worth. Any financial institution that handles wholesale paper or retail paper (or both) for a dealer who is a poor moral risk or tricky in his business dealings is assuming a hazardous risk that may eventually result in a substantial loss.

2. There must be reasonable evidence that the dealer has the ability to manage his business on a sound basis.

3. He must have sufficient capital, exclusive of the financing of the floor plan and retail sales, so that his business can operate safely and profitably.

Of fundamental importance to banks when setting up their dealers on a time sales plan and when handling their ap-

Leo Offers You the FIRST LOW PRICED 250 WATT XMITTER KIT

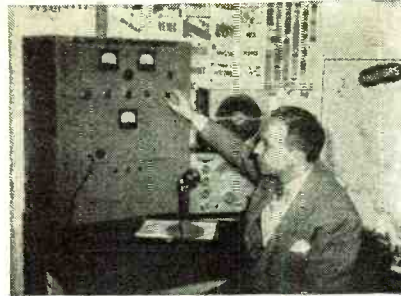

Leo Checking The New 250 Watt XMTR

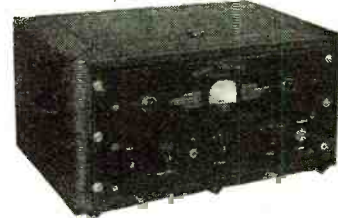

W.R.L. GLOBE TROTTER XMTR KITS

Amateurs the nation over are praising the performance of this high quality low cost rig. It's a 40 watt input kit including all parts, chassis, panel and streamlined cabinet. Write for export prices.

Cat. No. 70-300 Less tubes **\$69.95**

Cat. No. 70-312 Same as above

wired **\$79.50**

1 set coils, meters, tubes, extra... **17.15**

SCOOP RECEIVERS XMTRS FOR HAM BANDS

Leo has waited until now to stock those few good surplus items that hams can use with minor changes. Some new, some used—available at lowest prices yet offered. Write for detailed descriptions on items below.

BRAND NEW BC-348

in original WOODEN boxes The most popular Surplus receiver on the market. They're New!—not used. Complete with 9 tubes & dynamotor

only **\$54.50**

Converted to 110 volt AC operation by our engineers... **\$69.50**

Complete A.C. Conversion Kit... **6.50**

ARN-5A—11 tube Superhet. Will operate 6 meter band... **13.95**

BC-645—I.F.F. Xmtr-Receiver (15 tubes) **14.95**

BC-654—Xmtr-Receiver. 25 Watts output. Fine for 80. **12.95**

SCR-522—Xmtr-Receiver. Fine for 2 meter operation. **19.95**

SCR-274-N—Xmtr-Receiver. \$600 value **34.95**

We're making delivery now on our new 250 Watt Xmitter! In keeping with the times, we have designed for the first time a Xmitter Kit that meets the tremendous demand for a low cost, high quality unit which includes 6 meters at no extra cost. Will sell for about \$350, completely wired. Place your order now for fast delivery.

Including 6 Meters at No Extra Cost
LOW PAYMENTS—LIBERAL TRADE-IN.

HAM GEAR—we have it!

GET FAST DELIVERY FROM LEO!

Item	Cash Price	Down Payment
Hallcrafters S38	\$ 47.50	\$ 9.50
Hallcrafters S40A	89.50	17.90
Hallcrafters SP44	99.50	19.90
Hallcrafters SX42	275.00	55.00
Hallcrafters HT-9	350.00	70.00
RME VIF-152	86.60	17.32
RME-84	98.70	19.74
RME-45	198.70	39.74
Hammarlund HQ129X	161.40	32.28
Hammarlund SPC400X	334.05	66.81
National NC46	97.50	19.50
National I-10A	87.50	13.50
National NC173	179.50	35.90
National NC240DT or NC240DR	225.00	45.00
National HRO-5TAL or HRO-5RA	245.00	49.00
Pierson KP-81	367.65	73.53
Gen-Set Converters	39.95	7.99
Collins 70E-8	40.00	8.00
Bud VFO-21	52.50	10.50
Meissner Signal Shifter	120.00	24.00
Abbott TR-4B Special	45.00	9.00
New Micro-Match Unit	29.50	5.90
Millen R-9er	24.75	4.95
BB-27 10 meter converter F.B. for 348	27.50	5.50
Sonar Mobile MB-611 transmitter	72.45	14.49
MB-611 with power supply	81.43	16.29
WRL exciter unit wired	23.95	4.79
Millen 90800 exciter	37.50	7.50
Sonar XE-10 transmitter	39.45	7.89
Sonar VFX-680 transmitter	87.45	17.49
Workshop 28 megacycle beam 3 element	39.50	7.90
Workshop 8 element 28 megacycle type	100.00	20.00
Workshop 20 meter beam 3 element	120.00	24.00
Gordon Rotary Beam	225.00	45.00
Direct-O-Beam	117.00	23.40
New Beach ECO	32.50	7.50

4 Mfd 1500 Volt DC Oil Condenser... **\$ 1.29**

0-500 D.C. Mills G.E. 2 1/2" Round Meter **2.95**

0-1 D.C. Mills—3 1/2" Round Meter. **3.95**



FREE

World Radio Laboratories
Department R-8
Council Bluffs, Iowa

Send latest Free Flyer

Send data on WRL 250 Watt XMTR

Send more data on the Globe Trotter

Send data on your Good Surplus

Send more data on.....

Name..... Call letters.....

Address.....

City..... Zone..... State.....

8 TUBE CODE PRACTICE EQUIPMENT

OPERATES ANYWHERE - BATTERIES - AC - DC

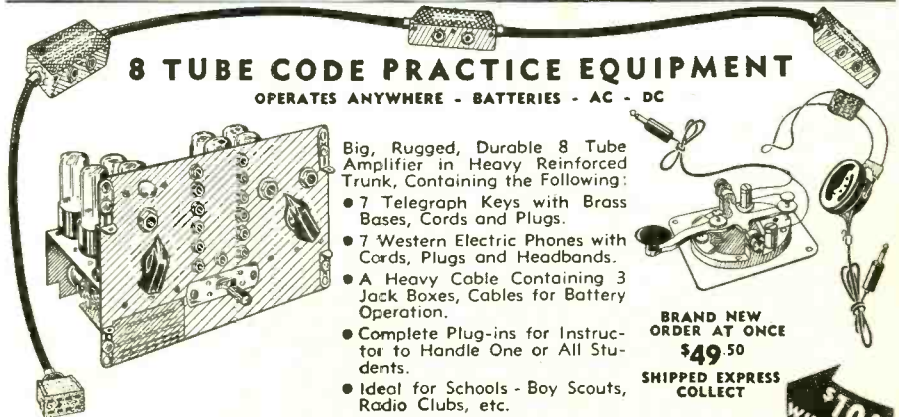

Big, Rugged, Durable 8 Tube Amplifier in Heavy Reinforced Trunk, Containing the Following:

- 7 Telegraph Keys with Brass Bases, Cords and Plugs.
- 7 Western Electric Phones with Cords, Plugs and Headbands.
- A Heavy Cable Containing 3 Jack Boxes, Cables for Battery Operation.
- Complete Plug-ins for Instructor to Handle One or All Students.
- Ideal for Schools - Boy Scouts, Radio Clubs, etc.

BRAND NEW ORDER AT ONCE **\$49.50**

SHIPPED EXPRESS COLLECT

\$10.00 WITH ORDER

MANUEL KLEIN 74 Cortlandt St., N. Y. 7, N. Y.

ELECTRICIANS! RADIOMEN!

Get this Valuable Book **FREE** for Merely Examining Coyne's NEW Pay-Raising

Tells How to Start Your Own Shop

3 VOLUME APPLIED PRACTICAL RADIO SET

Now!—a sensational new practical set of radio books, just off the press, gives you the "know how" on everything in Radio today! Basic principles to newest television and FM—how to construct, install, service, 600 illustrations, nearly 1,000 pages. Ideal for home training or field reference—backed by Coyne's 48 years of shop experience, to help you to bigger radio opportunities! . . . And here's our amazing offer! To prove the value of these great new books to you, Coyne will give you our new, practical "Business-Starting" book Free just for looking over the 3-volume set. **OFFER LIMITED—ACT NOW!** Just mail the coupon the 3-volume APPLIED PRACTICAL RADIO set for 7 days' free examination and include our 240-page book, "Starting & Operating a Profitable Radio or Electrical Business". Look the set over for 7 days. If you like it, then pay its low cost on easy terms as shown in coupon below. If you don't want the set, just return it and owe **NOTHING!** Either way, you keep the "Business-Starting" Book **A B S O L U T E L Y FREE.** **SEND NO MONEY** Coupon below is just a request to see the new set and receive your free gift book. Mail coupon today.

FREE BOOK COUPON

Educational Book Publishing Division,
Coyne Electrical & Radio School, Dept. C7-23
500 South Paulina St., Chicago 12, Illinois

Send me your 3 volume set, APPLIED PRACTICAL RADIO and my FREE gift, "Business-Starting" book. I'll either return the set in 7 days and owe nothing, or send you \$3 within 7 days and \$3 a month until \$10.75 is paid. Or I'll pay \$9.75 cash. Whether or not I keep the 3 Volume set, the Business-Starting Book is mine FREE as a Gift.

NAME _____ AGE _____
ADDRESS _____
CITY _____ Zone _____ STATE _____

PITCO LINE FILTERS

• 5 Amp, 110-220 Volts, A.C. or D.C.
• 10 Amp, 110-220 Volts, A.C. or D.C.

Highest Quality . . . Dependable Performance

Exhaustive tests and actual operating performance have definitely proven the superiority of the Pitco Line Filter over other designs. This dependable unit presents a solution to the problem of serious radio interference from power lines, motors, and appliances . . . provides inductance as well as capacitance, thereby assuring thorough filtering action.

The Pitco Line Filter plugs into the electrical outlet and can be connected at the receptacle of the filter with either the radio set or interfering device. Wherever installed, you'll find this sturdy, compact filter is unsurpassed for high quality and outstanding performance.

See the Pitco Line Filter at your local distributor today. He has both the 5 Amp. and 10 Amp. sizes ready for immediate delivery.

FOR COMPLETE DETAILS, SEE YOUR DISTRIBUTOR OR WRITE DIRECT.

Pittsburgh Coil Co., Carnegie, Pa.
Coils • Test Leads • Line Filters • Indoor Aerials

EATON'S EXTRAS!!

Popular replacement items at savings up to one-half! Standard brands. Fresh stocks. Prompt service. All orders below shipped prepaid in U.S.A.!

- 20-20 mfd. 150 v. Tubular electrolytic condensers. Kit of eight only \$5.00 postpaid.
- 8 mfd. 475 v. Tubular electrolytic condensers. Kit of twelve only \$5.00 postpaid.
- Kit of 25 tubular paper condensers in assorted capacities. Per kit only \$2.00 postpaid.
- Kit of 10 Solar tubular paper condensers, five each .01-.600v. and 1-600v. Per kit only \$1.00 postpaid.
- Kit of 5 Sprague tubular paper condensers, .5mfd. -400v. Per kit only \$1.00 postpaid.
- Oscillator coils for 12SA7's & etc. 456kc. I.F. Per kit of three only \$1.00 postpaid.

EATON'S Box 471 Logan, Utah

SHANEY'S
New **20 STEPS** to PERFECT AMPLIFICATION

SEND 3c STAMP FOR POSTAGE

AMPLIFIER CORP. of AMERICA
396-98 Broadway New York 13, N. Y.

pliance paper, is the manner in which the selling is done. Whether or not he employs canvassers, how he displays his inventory, and whether he uses price appeals are factors which will be considered in dealer relations.

Retail paper should be purchased on its merits and not on the basis of the dealer's endorsement. This policy is being largely followed even when a dealer is doing business on a full recourse basis. When selling an individual contract to a financial institution, with credit investigated before approval, the dealer has the right to feel that the financial institution will protect his interests by approving credits on such a basis that the experience on the paper will be satisfactory. Occasionally, sales managers may urge the bank to approve bad credits pointing out that the paper is endorsed. It has been found through experience that to purchase paper on bad credits under such circumstances obviously would be unfair to the dealer. Moreover, experience indicates that while a dealer may urge the purchase of paper on bad credits, often when he is called upon to honor his endorsement he will criticize the bank and possibly seek another financing connection.

Installment paper on appliances is as good as the dealer who creates it. A dealer with a satisfactory financial background may operate on a high-pressure sales basis, and the experience and the paper he creates may not be satisfactory even though reasonable care is used in passing upon the credits. On the other hand, if the dealer sells on a sound basis and the consumer is completely satisfied with the transaction it is often possible to approve credits of a lower grade and still have a satisfactory experience on the paper.

While it is true that a dealer has the right to sell his paper at the best price he can get (and he has a theoretical right to make his finance charges what he wishes if they are agreeable to the purchaser), paper should not be bought if misrepresentation or excessive charges enter into the contract since the bank is going to collect his payments. Arrangements should be made between the bank and the dealer and a definite understanding of the bank plan is important. The bank will tell the dealer what the basis may be for his price since the bank proposes to buy the paper arising from the sale and the quality of the paper will be affected by the justice of the price. A dissatisfied customer means collection problems, with the bank's prestige becoming involved if paper is accepted where charges are abnormally high.

It has been generally agreed that in order to obtain satisfactory volume and profit from retail time sales appliance financing it is necessary for a bank to meet the dealer's reasonable requirements for handling his merchandise purchases. This, of necessity, becomes a part of a bank's install-

AUTOMATIC IRON TESTER

for setting thermostats. Meter calibrated to read directly—cotton, silk, rayon, linen, wool. Also calibrated in degrees 0° to 800° F. Checks opens and shorts and temperatures on most all types of appliances complete.. **\$27.50**

AMPLIFIERS

5-Tube Guitar Amplifier with 12" speaker. Has 2 guitar and 1 micro input. Volume and tone controls, pilot light and fuse. Assembled complete in attractive cases. **\$84.50**
LIST PRICE **\$42.95**

DHD ELECTRONICS AND APPLIANCE CO.
3160 Menlo Drive • Glendale 8, California

The BUY of a LIFETIME

U. S. SIGNAL CORPS **5 Meter** ONLY **\$3.49**
SHORT WAVE XMTRS (72.2 Mc)

XMTR and TUBE Only Less mike, Batteries and Antenna

One 1½ volt dry cell and 67½ volts of B operates it. Just attach di-pole, key or mike, connect the batteries and it's ready to use. Signal Corps spec wired with silvered wire, mica condensers, and precision resistors. Highly stable circuit with Lo-Loss all-ported inductance. (Adjustable paddler.) Schematic supplied. Converts easily to walkie-talkie and Ham bands. Weighs less than a pound. Shipped by express only. No C.O.D.'s, No Parcel Post. A sacrifice at only \$3.49. Postal or express money order or certified check.

NEWARK SURPLUS MATERIALS CO.
324 Plane St., Dept. N, Newark 2, N.J.
SEND STAMP FOR GIANT CATALOG!

CORRESPONDENCE COURSES IN RADIO and ELECTRICAL ENGINEERING

ELECTRICAL ENGINEERING Get good grasp of wide electrical field. Prepare yourself at Low Cost, for secure future. Modern course. So simplified anyone can understand quickly.

RADIO ENGINEERING public address, photo-electric work. Trains you to be super-service man, real vacuum-tube technician. Servicemen needed badly. Diploma on completion. Many graduates earning big pay.

WRITE Send postcard for Free Copies of school catalog, full details, and \$25 course after deferred payment plan, experimental kits, etc. Lincoln Engineering School, Box 931-R103, Lincoln 2, Nebr.

BUILD YOUR OWN FAST FREEZER PLANS \$100

It's easy to build this household appliance and profitable to use. Save up to 75%. Operates on 110 or 32 volts. Plans show 5 sizes and are easy to follow. **ENJOY MAKING ONE OF** these freezers from new or used parts. No expert knowledge needed. Mail \$1.00 bill or check for complete plans and catalog.

5 sizes 8 to 40 cu. ft.
LE JAY MFG. CO., 454 LeJay Bldg., Minneapolis 8, Minn.

New Vinylite Frequency Record

33 1/3 & 78 RPM: 50 to 10,000 CPS; voice announcements; unmodulated grooves for checking rumble content. Available your local jobber or

UNIVERSAL RECORDING CORP.
20 North Wacker Drive Chicago, Illinois

MILES "TELEMIKE"

A midget unit (1 1/4"x1 1/4"x1 1/4") requiring no physical contact to telephone. BOTH SIDES OF TELEPHONE CONVERSATIONS for group loud speaker listening or for recording when used with standard amplifier or recorder. PRICE \$25.00 postpaid.

Write for details on our complete line of FILMGRAPH TELEPHONE—CONFERENCE—DICTATION—"TALKIE" RECORDERS & REPRODUCERS.

MILES REPRODUCER CO., Inc.
Dept. RN-8, 812 Broadway, New York 3, New York.

RADIO ENGINEERING I DEGREE IN 27 MONTHS

COMPLETE Radio Engineering Course. Bachelor of Science Degree. Courses also in Civil, Electrical, Mechanical, Chemical, Aeronautical Engineering, Business Administration, Accounting, Secretarial, Science. Graduates successful 64th year. Enter Sept., Jan., March, June. Write for catalog.

TRI-STATE COLLEGE 1687 College Ave. ANGOLA, INDIANA

ment sales program. Experience has also been that in dealing with dealers of established responsibility this business can be conducted on a safe and sound basis.

During the past few years, while merchandise has not been available for purchase, banks have streamlined their operations and formulated sound plans in order to give the dealer prompt and efficient service. It has been found that by having dealers and banks cooperate in a community program credits have been approved within a matter of hours. This often permits the dealer to consummate the sale and to make delivery of the merchandise within twenty-four hours.

Banks are willing and able to take care of their time sales dealers and dealers who cooperate fully will find the banks equally cooperative so that maximum mutual benefits will result. Some bad practices have been indulged in by shortsighted, unscrupulous dealers, but fortunately these are in the minority and their practices are short-lived. A bank will not condone an unsound operation, a fact which will be quickly recognized in the procedure that a bank will adopt. Banks realize the value of their appliance dealer customers and will do everything possible to cultivate this relationship.

Regardless of the kind of development that takes place in the consumer credit field independent banks with satisfactory dealer plans will continue to get their share of the business.

When a manufacturer wants a nationwide credit mechanism to take care of distributors and dealers, nothing can quite compare with the banking system and its 15,000 outlets. Banks have all the necessary machinery and many thousands of them have already had satisfactory experience in installment sales financing. These facts, together with the knowledge and technique acquired by banks that are becoming interested in all phases of consumer credit, give strong indication that the banking system will be able to render to appliance dealers efficient, prompt, and considerate treatment of both their wholesale and their retail financing.

American banking is eagerly looking forward to a sound, healthy economy in the period ahead. Banks all over the country realize that such an economy cannot flourish and grow without the lifeblood of adequate constructive credit.

Whether or not we can maintain high levels of production, consumption and employment in the years ahead or whether we return to the normal of the thirties after our immediate wants are supplied will depend entirely on the joint effort of distribution and finance. We will face a stupendous task of selling and financing an increase of thirty billion dollars annually over our best peacetime year, which was 1940. If we cannot sell America's increased production, our factories will not produce. Therefore,

bankers and distributors must work out new sales methods and sound consumer finance to sell more goods to more people than we have ever shown any ability to do if we are to prevent another depression. In the full realization that only through the wide use of consumer installment credit can present goals of production and sales be maintained, it is highly advisable for the nation's bankers to plan now in cooperation with the nation's industry in each community for the tremendous sales job which lies ahead.

-30-

ERRATUM

The circuit diagram appearing in the article "A Beginner's Transmitter" (June, 1947 issue, page 63) should show the negative "B" supply grounded. We regret this omission.

Photo Credits

Pages	Credit
39, 41, 104	Buhrle & Company
51, 53	Radio Wire Television, Inc.
44 (top left), 64	Radio Corporation of America
44 (top right)	National Slug Rejectors, Inc.
44 (bottom)	Tradio, Inc.
45, 47, 48, 136	Walter Steinhard, Staff Photographer
49	Julian Krupa, Staff Artist
50	Joe Tillotson, Staff Artist
57	Pelree Wire Recorder Corp.
68	Radio Luxembourg
78, 80	Arthur Haug, Staff Photographer

ANDERSON PIANO CO
AUTO PLATE
Type A-4 with Border
2-3/4" x 9-1/2". Price includes up to 12 letters. Add 15¢ for each letter over 12. Each \$3.50

ALPS RADIO & SOUND SERVICE
AUTO PLATE
Type A-5 without Border
2-3/4" x 9-1/2". Price includes up to 16 letters. Add 15¢ for each letter over 16. Each \$4.00

Type A-22 Microphone Stand Plate \$3.00 each
2-5/8" x 8-1/8" complete with snap-on brackets for attaching to microphone stand. Price includes up to 5 letters. Add 15¢ for each letter over 5.

If you are in the SOUND RENTAL, SOUND SERVICE, RECORDING, BROADCASTING, or RADIO SALES and SERVICE business it will pay to advertise your name with

Srepc Nameplates

These attractive plates are made of sturdy, light-weight cast aluminum with letters and borders raised and satin-finished against the baked crackle-enamel background. Black is standard but red, green, blue, gray or goldenrod may be had for 50¢ additional per plate. The maximum number of letters specified with each plate is standard, but most plates will accommodate additional letters.

Shure 55 555, 556	WE 633A	Turner U9S 99, 999	RCA 74B Jr. Velocity	Electro-Voice 726, 731
complete with side plates \$12.00 each	less side plates \$8.50 each	less side plates \$7.50 each with side plates \$10.50 each	less side plates \$7.50 each with side plates \$10.50 each	complete with side plates \$11.00 each

In addition to the above, we can furnish plates for Western Electric 639, 630A, 618A, RCA Models 44BX, 50, 77, 88A, MI-6203, MI-6206; Turner 211; Amperite PG; Astatic DN; and Electro-Voice V-1, V-2, and V-3 microphones. Write for information and prices on the entire line.

Prices on microphone nameplates include up to 5 letters on top plate, both front and back, and on side plates. For each additional letter over 5 add 30¢ for top plate and 30¢ per pair of side plates.

Delivery within 6 weeks
of receipt of your order

We specialize in plates made to order. If you have a special design, insignia or style of lettering you wish reproduced, write us today for a quotation

STANDARD RADIO & ELECTRONIC PRODUCTS CO.
135 E. SECOND ST DAYTON 2, OHIO.

TERMS: Orders under \$3.00, cash with order; orders over \$3.00 require 20% deposit, balance C. O. D.

All prices are net, f.o.b. Dayton, O.

**Musical Distinction WITH
ABSOLUTE FIDELITY AMPLIFICATION**



A new amplifier development now enables you to clearly identify all the instruments in a full orchestra! If you are one of those discriminating persons for whom anything less than the best is a disappointment, you are one for whom the ACA-100DC Amplifier was designed. Send for literature.

AMPLIFIER CORP. of AMERICA

**396-98 Broadway
New York 13, New York**

E·Z·MONEY

Days are on the wane, so be prepared for competitive selling, by ordering your copy of **RUSS FISHBURN'S** new promotion manual now.

**VOLUME SALES
PRODUCERS**

Outlines 23 quick and easy to read, proven sales promotions that pull crowds of customers to your store, and tells you how and what to promote to produce **FLOOR TRAFFIC**, and **INCREASE SALES**. Will fit any retail budget.

Don't wait for the approaching **WAR OF SALES**, order now.

\$3.50 Postage Prepaid, which will be refunded, if not completely satisfied.

RUSSELL G. FISHBURN

Sales Traffic Counselor
1018 E. Lasalle Ave., South Bend 17, Indiana

**RISCO HAS IT!
V. M. MIXER
CHANGER**

Plays 10" & 12" records at same time.

\$15.50

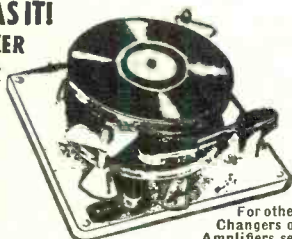

For other Changers or Amplifiers see July Radio News

PORTABLE PHONO ALL ELECTRIC

Plays 10" & 12" records. Self-starting motor. 5" P.M. spk.—High output. Brown, Red or Blue. 2-tone leatherette. May we substitute color?

FREE Catalog—24 Hr. Service. 25% on C.O.D. orders.

\$15 (\$13.50 in kit form)
NET

Risco Electronics
Wholesale Distributors
22 Warren St., N.Y. 7, WO 2-6952

Classified

Rate 20c per word. Minimum 10 words.

RADIO ENGINEERING

RADIO Engineering, Broadcasting, Aviation and Police Radio, Servicing, Marine Operating and Electronics taught thoroughly. Expenses low. Write for catalog. Valparaiso Technical Institute, Dept. N, Valparaiso, Ind.

FOR SALE

A COMPLETE semi-professional recording machine, mike, records, amplifier, etc., made by Radiotone, Inc., of Hollywood. First offer of \$125.00 takes it. Write for more information if interested. Kurth's Sound Equipment, Hutchinson, Minn.

HALLICRAFTERS receiver, Model SX28A super skyrider. Used only a few months. Will sell it for \$190.00. All letters answered. Kurth's Sound Equipment, Hutchinson, Minn.

IN Stock: New and used Hallcrafters, Hammarlund, National, RME, Pierson, Collins, Millen, Temco, Supreme, Harvey receivers and transmitters and parts. Reconditioned receivers: S-38 \$35.00, S-40 \$69.00, SX-42 \$199.00, SX-17 \$89.00, SX-28 \$139.00, Panadaptor \$59.00, HQ-129X \$129.00, RME-45 \$89.00, S-38, SX-28A, RME-69, NC-2-40D, HRO, SPC-400SX, SPC-400X, etc. Terms available. Shipped on approval. Send \$5.00. Pay rest C.O.D. Write: Henry Radio, Butler, Mo.

TELEVISION components for assembly of a modern 52-square inch screen receiver using the newest circuits and tubes. The only kit on the market featuring an aluminized cathode ray tube, A.F.C. on horizontal sync and a wired, pre-aligned r.f. tuner covering any combination from 1 to 13 television channels. Sound and Picture IF's are on one sub-chassis using new 6AH6 miniature tubes having a gm of 90001. The IF Strip and the 9000 volt RF Power Supply are sold in kit form. The main chassis is sold with all holes punched, or blank with suggested chassis layout print. All components individually priced. Our catalog lists television components exclusively and shows parts and circuits of the "hard to find items" you have been looking for. Send for it today. It's free! Television Specialties Co., 315 Madison St., Oak Park, Ill.

HALLICRAFTER SX-42 with R-42 matched speaker. New condition; both for \$259.50. Box 124, Somerset, Ky.

FREQUENCY meters BC-221; guaranteed good operation, good appearance, less batteries; \$29.00 each, 3 for \$75.00. ANB-H-1 Head Sets, T-17 Hand Microphones, 75c each, \$6.00 per dozen. Throat Microphones T-30, \$2.00 dozen. Cash with order or C.O.D. Erwin Sales Company, Roff, Okla.

SOLDERTAPE containing noncorrosive flux for small electronic work. Sixty inches 98c. We use M&G Hearing Aids Co., Dept. 73, P. O. Box 517, Wellston Station, St. Louis 12, Mo.

BARGAIN: Surplus Triplett a.c. ammeters 0-30 amps, 232JP and 332JP, \$2.25 ea.; Weston 689-1F 0-10, 0-1000 ohmmeter, \$8.95; postpaid. K&B Inst. Co., McQueeny, Texas.

F. M. WALKIE Talkie (B.C. 1000A) with 18 tubes, 2 antennas, hand set and ear phones. 42 to 48 Mc. Easily converted to 6 meters. Shipping wt. 62 lbs. Price, \$29.50. S.C.R. 610 (B.C. 659J) Portable F.M. Transmitter and Receiver, 14 tubes, antenna, built in loud speaker, 120 Crystals, etc. With vibrator and battery supply for 6, 12, 24 volt D.C. Frequency range 27 to 39 Mc. Shipping wt. 127 lbs. Price \$59.50. Used, sold as are, F.O.B. A&N Supply Company, Richmond, Va.

CHASSES; aluminum; built to order. 17x13x3; \$2.50. Other sizes, other prices. Send specifications for quotations and folder. John Heim, 713 W. Third St., Williamsport, Pa.

SURPLUS Stock new transformers. Thordarson, Stancor, Freed, etc. Write for list. Buck Engineering Co., Inc., Freehold, New Jersey.

24-28 VOLT Filament transformers, 3 amp., new, \$6.95 ea. RG-62-U Coax, 92 ohm, new, \$2.25 per 68 ft. roll. Aerotronics, Culver City Airport, Culver City, Calif.

WIRE recorder magazine. Limited quantity, made for Army, and Air Corps. New, includes 10,000 feet stainless steel wire, spools, level-wind, brake control, automatic switches, elapsed time indicator, etc. in a fully assembled, dust-proof unit. Price \$45.00. McCoy Sales Co., P.O. Box 335, Berea, Ohio.

LOWEST Prices. Radio Tubes, parts. Bargain lists 3c. Potter, 1314 McGee, Kansas City 6, Mo.

SELENIUM Rectifiers, full wave, 1/2 ampere, \$1.85; 1 ampere, \$2.50. Half wave 5 amperes, \$4.50; 2.2 amperes, \$2.25; 1.5 ampere, \$1.85. Bulletin. Burma Radio, Route 5, Grand Rapids, Mich.

FREE wholesale bulletin. Tubes, parts. Bargain prices. Henshaw Radio Supply, 3313 Delavan, Kansas City, Kansas.

RADIO Tubes—Dealers, order your needs—be surprised at prices. Address Radio Tubes, Box 108, Elizabeth City, N. C.

WRITE Dept. RN18 for our free wholesale list of Radio parts & accessories. R. C. Radio Parts & Distributing Co., 731 Central Ave., Kansas City 6, Kansas.

MAGNETIC Tape Recorder-Reproducer: the famous Brush Soundmirror model BK-401 for \$229.50; tape \$2.50 per reel. We handle a complete line of Brush magnetic recording equipment. Write for free literature. All prices F.O.B. Cleveland, Ohio; 25% deposit required on C.O.D. orders. Acme Electronics Co., 6523 Euclid Ave., Cleveland 3, Ohio.

SCOTT, SLR-12-B receiver. Range 5.55 to 15.6 mc, SW; plus standard. Excellent condition, steel cabinet, two speakers. Cost \$384, sell \$200. S. Washburn, 151 Clarke St., Syracuse, N. Y.

MARK 11 & 111 owners; Convert receiver section to six watt speaker set in one hour. Don't take set out of case. Nothing to buy but speaker. Guaranteed plans. \$3.00. C. L. McDaniel, Brooksville, Fla.

AN/APA-10 PANOSCILLOSCOPE, \$65.00; BC-645 VHF-1FF, \$16.50; PE-101-C, \$5.50; BC-654 (SCR-284A), \$14.75; BC-454, BC-455 Receivers, \$5.75; C-1 Autopilot Servo, \$9.50; UHF Ground Plane Antenna for RG-8U Coax, \$1.00; C-1 Autopilot Amplifier, 7 locals, 6 plate relays, \$5.75; 5SDG Selsyns, \$3.00/pair; Luminous Paint Kit, \$2.50; SCR211, 1-222-A Signal Generators; SCR211 (BC-211) Manual \$1.00 pp; RC-148-C UHF 60 cycle 115v equipment, new and complete, at less than 20c/lb. Free descriptive list. Engineering Associates, F/H Branch Box 26, Dayton, Ohio.

NEW bulk tubes 39c each: 1R5, 1S5, 1T4, 1A3, 1L4, 384, 2X2, 2Y2, 5Y3gt, 6SD7, 6SL7, 6AL5, 7E5, 12H6, 12A6, 12SL7, 80, 31, 35W4. Cartoned tubes 59c each: 12SA7, 12SK7gt, 12SQ7gt, 35Z5, 50L6, 35L6gt, 6SA7gt, 6BK7gt, 6SQ7gt, 6C5, 6K7gt, 6F6gt, 6V6gt, 6SN7gt, 12J5gt, 56, 57, 75, 76, 37, 38, 39, 6A8gt, 3Y4, 1H5gt. Two tube phono oscillator with tubes \$3.98. Bulk RCA 35Z5gt per hundred \$39.89. Porta power. Converts 1 1/2 volt battery radios to 110 volts ac. \$6.79. Sent C.O.D. Write for bulletin. Henshaw Radio Supply, 3313 Delavan, Kansas City, Kansas.

CHANGERS intermix V.M. \$15.95, 2 for \$29.95. Service Radio, 1312 W. Atkinson, Milwaukee, Wis.

PRICES Slashed. Radio Supplies. Kits, large variety. Tubes. Terrific Values. Bargain catalog free. Technical Laboratory, 341 Wilson Ave., Brooklyn 21, N. Y.

PERMEABILITY Tuners: A complete tuning unit for a superheterodyne broadcast radio, pre-tracked, matched oscillator coil mounted and wired, mica trimmers, fully adjustable, measures only 1 3/4" x 2" x 4" exclusive of 1/4" drive shaft. Complete with instructions and hookup diagram for only \$2.75 each, postpaid. Acme Electronics Co., 6523 Euclid Ave., Cleveland 3, Ohio.

RADIO tubes below list price, modern and old-type. Free list. Belltone Radio, 167-04 III Ave., Jamaica, N. Y.

MODEL 560 Vedolyzer. Best price. Robert H. Kraft, Hicksville, N. Y.

PERMEABILITY Tuner Unit. Includes adjustable antenna and oscillator coils along with permeability tuner in one complete unit. Add to I.F. and audio for complete set. Very new and latest. Regular price, \$4.50. Our price, \$2.50. McCoy Sales Co., P. O. Box 335, Berea, Ohio.

CONDENSER Kit. Very latest silver mica condensers, smallest made and most reliable in assorted values, thirty for \$2.00. McCoy Sales Co., P. O. Box 335, Berea, Ohio.

ARMY Surplus J-47 keys, new, 35c each. J-36 bugs, slightly used, \$5 to \$7.50 each. Victoria Radio & Sound, 1404 N. Liberty, Victoria, Texas.

WANTED

SX-24 OR SX-25 or equivalent. Robert Kraft, W2LPP, Hicksville, N. Y.

TELETYPEWRITERS used or new, parts, accessories. Box 447, % Radio News, 185 N. Wabash Ave., Chicago 1, Ill.

TRC7 RADIO Equipment, RT-53 Receiver-Transmitters, AS-12 Antennas, Box 448, % Radio News, 185 N. Wabash Ave., Chicago 1, Ill.

WESTERN Electric Carrier Telephone or Telegraph Filters, equalizers, repeating coils, etc. Also CF1 and CF2 carrier equipment and parts. Box 450, % Radio News, 185 N. Wabash Ave., Chicago 1, Illinois.

W E or Kuthe Type 394A Grid Controlled Rectifiers. Box 451, % Radio News, 185 N. Wabash Ave., Chicago 1, Illinois.

MEISSNER "Custom 12" Receiver or Meissner tuning unit 13-7616. Quote price. Donald W. Pegler, 1755 N. Craig Ave., Altadena, Calif.

CORRESPONDENCE COURSES

USED correspondence courses and educational books bought, sold, rented. Free Catalog. Educational Exchange, Henagar, Ala.

CORRESPONDENCE Courses and self-instruction books, slightly used. Sold. Rented. Exchanged. All subjects. Satisfaction guaranteed. Cash paid for used courses. Complete information and 100-page illustrated bargain catalog FREE! Write Nelson Company, Dept. 59, Chicago 5, Ill.

AMATEUR radio licenses. Complete code and theory preparation for passing amateur radio examinations. Home study courses. American Radio Institute, 101 West 63rd Street, New York City 23.

COMMERCIAL operators sample tests. Radio courses. Box 1298, Hollywood 28, Calif.

USED Correspondence Courses and Educational Books sold or rented. Inexpensive. Money-back guarantee. Write for Free Catalog listing 4000 bargains. — (Courses Bought.) — Lee Mountain, Pisgah, Ala.

SITUATIONS WANTED

AVAILABLE: Veterans trained in Sound Recording, Laboratory and Transmission Engineering. Experienced in the following measurements: Inter-modulation, Distortion, Gain/Frequency, Square Wave. Write, H. M. Tremaine, 1655 N. Cherokee, Hollywood 28, Calif.

HELP WANTED

LOOKING? Continuous Openings: 1st 'phone, 2nd telegraph operators; Sales Engineers, Announcer-technicians, Instructors. Radio's Reliable Resources, Employment Agency, Box 413, Philadelphia, Pa.

INSTRUCTORS in Electronics and Radio. Prefer former Navy Radio Technician instructors willing to locate in the Detroit, Mich., area. Write to Box 452, % Radio News, 185 N. Wabash Ave., Chicago 1, Illinois.

PATENT ATTORNEYS

PATENTS—U.S. and Foreign Patents Secured. Trade-marks and Copyrights registered. Searches made to determine Patentability and Validity. Patent, Trade-mark and Unfair Competition Causes. Lancaster, Allwine & Rommel, Registered Patent Attorneys, Suite 414, 815 15th St., N.W., Washington 5, D. C.

MISCELLANEOUS

QSL-SWLS postpaid! Free samples. W1HJI, P. O. Box 32, Manchester, N. H.

AMATEUR licenses. Have your license encased in plastic for durability and permanence, send ticket and 50c to S. C. Houston, W6ZM, 3164 Bona St., Oakland 1, Calif.

ELECTRIC meter laboratory. Electrical instruments, tube checkers, and analyzers repaired, checked and calibrated. Prompt and reliable service guaranteed. Hazleton Instrument Co., 140 Liberty St., New York 6, N. Y. Tel. Barclay 7-4239.

BUILD your own radio. 5-tube super kit complete with tubes and cabinet using 50L6, 35Z5, 12SA7, 12SK7, 12SQ7. Easy to wire. Your cost \$14.95. McGee Radio Co., 1330 Broadway, Denver 3, Colo.

ELECTRICAL instruments. All makes and models repaired. Correspondence invited. Haledon Elect. Instrument Co., 319 Belmont Ave. (Haledon). Paterson 2, N. J.

WHOLESALE Radio Service at reasonable rates, quick service, no job too big. Write for full information. Elkins Radio, Elkins, W. Va.

25 YEARS experience radio repairing at your fingertips. I've repaired 45,000 radios and have perfected system you can follow step by step. My methods are far simpler than any course published. Requires no calculations. Total price \$1.00 postpaid or C.O.D. Moneyback guarantee. Ross Radio Co., 14615 Grandriver, Detroit 27, Mich.

RADIOMEN, servicemen, beginners. Make more money, easily. \$250 weekly possible. We show you. Information free. Merit, 216-32R 132nd Ave., Springfield Gardens 13, N. Y.

PHONOGRAPH records cheap. Catalogue sent free. Paramount, NC-313 E. Market, Wilkes-Barre, Pa.

NOTICE!

In replying to Box Numbers, be sure to address letters to

RADIO NEWS

185 N. Wabash Ave., Chicago 1, Ill.

Note: This does not apply to Box Numbers where City and State are shown.

WAR SURPLUS SALES

RADIO - ELECTRICAL - ELECTRONIC EQUIPMENT - PARTS - SUPPLIES

Crystal Calibrated Signal Generator 1-222-A \$54⁵⁰

Operation from 110-117 volt, 60 cycle source, power consumed 40 watts. Self contained power supply.

COMPLETE WITH TUBES

Within the ranges of the FM and television IF freq and the Police, Taxi, Aircraft, RR, etc. VHF. Instruments are individually hand calibrated and use an accurate vernier-scale planetary dial.



A combination signal generator and heterodyne wavemeter. It consists of a 5 mercury crystal-controlled oscillator used as frequency standard calibrator, a variable two-range oscillator, an untuned detector with two stages of audio amplification, a sliding-rod stub antenna, a rough pi-type RF attenuator, a frequency calibration chart and a power supply. Coverage of the test oscillator on the low range setting is from 8 to 15 megacycles; the high frequency range coil covers from 45 to 76 megacycles and since the third harmonic is utilized, this gives a coverage of from 135 to 230 megacycles.

The signal generator cabinet measures 19 1/2" wide, 12" high, 7 1/2" deep; weight 50 lbs. Tubes in BC-1298 Power Supply — 16 — 6SN7GT; 1 — 5Y3GT/G; 2 — 6H6; 1 — 6SA7; 2 — 6V6GT; 1 — 6SJ7. Tubes in 1-222-A: 1 — 6J5; 2 — 9006; 2 — 6SJ7; 1 — 5Y3GT/G. An additional extra power supply and tubes, with many other small items including cables packed in wooden chest is included in this price. Gross wt. of entire equipment 490 lbs.

GENERAL ELECTRIC 0-30 DC Milliammeter—3" bakelite case. \$350

CRYSTAL DIODES 1N21B (1N34) See Radio News May issue page 50. Each 50c or 3 for \$1.25.

RECTIFIER & BATTERY CHARGER COMBINATION

No. RA91A—Selenium plate, full wave 115 or 230V AC; 50-60 cycle, single phase input; output is 8 to 48V DC at 2 to 15 amp; manually controlled, complete with overload input and output switches. 0-15 amp DC meter. Excellent for laboratories, servicemen, service-stations. Shipping weight 150 lbs. Price. \$3950

SUPREME—Model 537 \$995 VOLT-OHMMETER

BRAND NEW—EXPORT PACKED 3" Full Vision type Scale, with basic 100 Microampere D'Arsonval type movement.



A completely self contained pocket type multimeter, with functions for the measurement of DC voltage from 0.1 to 600 volts in 4 ranges. Measurement of resistances from 1 ohm to 1,000,000 ohms (1 megohm) can be made in 4 ranges. Height 5 3/4", width 3 3/8", depth 2 1/8". Shipping weight 3 lbs. Complete with operating instructions and circuit diagram.

GENERAL ELECTRIC

Tungar Battery Chargers

Model No. 6R-B33B2—1 to 12—6 volt batteries; 6 amp DC 115v AC, 60 cycle; complete with Tungar Bulb. Shipping weight approx. 40 lbs. \$2950

BEEDE METER, New, in black finish bakelite case, 3" round; 0-1000 MA DC. While they last only. \$195

Navy Standard Storage Battery

Brand New

Made by Gould Storage Battery Corp. 6 volt 15 amp hour. Excellent for amateurs, experimenters, radio servicemen, etc. Shipped dry, with complete instructions for charging. 4 3/8" x 4 3/8" x 6 3/8" high. Shipping weight 12 lbs. While they last. \$495



Prompt Delivery—Write Dept. RNA 25% deposit required on C.O.D. order Shipped F.O.B. New York. Min. Order \$2.00

MICHAEL STAHL, INC.

39 VESEY ST. Tel. Cortland 7-5980 New York 7, N. Y.

Opportunity Knocks

Build Your Own Business NOW!



With TRADIO . . . the radio FUNCTIONALLY DESIGNED for coin operation in Hotels, Motels, Stopovers, Clubs, Hospitals, Stations, etc. Big Earnings . . . Steady Income . . . No Clock To Punch . . . Full or Part Time!

• QUANTITY DELIVERIES DAILY

Get In On The Ground Floor In America's Fastest Growing Industry While It Is Still Young!

• ONLY SMALL INVESTMENT NEEDED

Send For Complete Information Today . . . No Routes Sold.

Write to **TRADIO, Inc.** Asbury Park, N. J. Dept. R.N. RIGHT NOW

THE SIMPLEST FM CONVERTER

Convert F. M sets operating in the old band (42-50 Mc) to receive New Band (88-108 Mc). Connects in series with antenna lead-in at the set. NO POWER REQUIRED. Works on all receivers with simple adjustment. Some receivers with no adjustment.

\$600 Not With Full Instructions Post Paid if Cash in Full \$1.00 with All C.O.D. Orders

CRYSTAL DEVICES CO.

P. O. Box 380 General Post Office New York 1, N. Y.

Order Direct or through your Local parts jobber

Jobbers! This New DeLuxe Line of

Replacement Volume Controls



Meets YOUR
Requirements!

NOW DELIVERING

This new deluxe line of volume controls is suitable for general replacement, and is expressly designed for jobbers. New "Metallic-carbon" resistance element affords smoother action and longer life.

And look at these features:

- 3" shaft with full-length flat for push-on knobs. Grooved every 1/4-inch along length for easy breaking off to size with simple tools!
- Complete range of ohms from 10,000 ohms to 2 meg-ohms, in all tapers.
- All controls available without switch, as well as SPST or DPST removable switch.
- Each control individually and attractively boxed.

Standard discounts to Jobbers

Write for literature!

AMERICAN VOLUME CONTROL CORP.
115 Liberty Street - New York 6, N. Y.

RADIO PARTS SOUND SYSTEMS ELECTRONIC APPARATUS

Depend on RADOLEK

Radolek's big Free Profit Guide Catalog and Profit Bulletin supplements keep you abreast of the rapidly changing radio situation. Buying from Radolek means greater values, better service and more profits. Make Radolek your buying headquarters.



RADIO PARTS



SOUND SYSTEMS

FREE
CATALOG

Large Stocks
Fast Service

SEND TODAY!

RADOLEK CO., Dept. B-129
801 W. Randolph St., Chicago 6, Ill.
Please send your FREE Profit Guide Catalog.

Name.....

Address.....

SAVE AT RADOLEK

INDEX OF ADVERTISERS August, 1947

Advertiser	Page	Advertiser	Page
A. C. Radio Supply Co.	146	Herbach & Rademan Co.	161
Abell Distributing Company, The	124	Hershel Radio Company	109
Allied Radio Corp.	9, 86	Highbridge Radio-Television & Appliance Co.	148
American Phenolic Corp.	133	Hi-Par Products Co.	128
American Radio Institute	138	Hollywood Sound Institute	152
American Sales Company	118	Hoodwin, Charles, Company	152
American Television, Inc.	24	Instructograph Company	152
American Television & Radio Co.	151	Jensen Manufacturing Co.	87
American Volume Control Corp.	160	J. F. D. Manufacturing Co.	88
Amperex Electronics Corp.	16	Johnson, E. F., Company	122
Amplifier Corp. of America	156, 158	Joseph, Irving	135
Apex Video	148	Kelnor Manufacturing Corp.	108
Arrow Sales, Inc.	74, 75	Klein, Manuel	144, 155
Ashe, Walter, Radio Co.	99	Lake Radio Sales Co.	106
Audel Publisher	120	Lectrohm, Inc.	120
Baltimore Technical Institute	140	Leeds Radio Co.	92
Beacon Television, Inc.	110	Lefay Mfg. Co.	156
Bell Telephone Laboratories	34	Leotone Radio Co.	72
Best Vibrator Company	138, 152	Lincoln Engineering School	156
Bliss Electrical School	148	Maguire Industries, Inc.	27
Bonafide Radio & Electronics Co.	154	Mallory, P. R., & Co., Inc.	33, 3rd Cover
Brooks Radio Distributing Corp.	143	Martin, Don, School of Radio Arts	106, 148
Bud Radio, Inc.	98	Maspath Telephone & Radio Corporation	152
Buffalo Radio Supply	94, 95	Melville Radio Institute	127
Burnell & Company	101	Merit Coil & Transformer Corp.	18
Burstein-Applebee Co.	125	Metropolitan Electronic & Instrument Co.	22
Buyers Syndicate	70	Miles Reproducer Co., Inc.	156
California Radio & Electronic Co.	154	Milwaukee School of Engineering	154
Candler System Co.	134	Mission Radio, Inc.	154
Cannon Electric Development Co.	123	Munger, Rex L., Co.	138
Capitol Radio Engineering Institute	36	Murray Hill Books, Inc.	20, 73, 104
Chicago Industrial Instrument Company	80	McGee Radio Company	84, 85
Centralab, Division of Globe-Union	14, 15	McGraw-Hill Book Company	142
Chicago Transformer, Division of Essex Wire	2nd Cover	McMurdo Silver Company	119
Chief Electronics, Inc.	132	National Company, Inc.	67
Cleveland Institute of Radio Electronics	31	National Radio Institute	3
Coastwise Electronics Co., Inc.	145	National Schools	21
Collins Audio Products Co.	122	Newark Electric Co., Inc.	141
Columbia Wire & Supply Co.	80	Newark Surplus Materials Co.	156
Communications Equipment Co.	83	Newcomb Audio Products Co.	70
Concord Radio Corporation	68	Niagara Radio Supply Corp.	121
Cornell Dubilier Electric Corp.	37	Northeastern Engineering, Inc.	133
Coyne Electrical School	142, 156	Offenbach & Reimus Co.	129
Crescent Industries, Inc.	30	Ohmite Manufacturing Company	79
Crystal Device Co.	159	Olson Radio Warehouse, Inc.	137
DHD Electronics & Appliance Co.	156	Onan, D. W., & Sons	76
Davega Stores	12	Opad & Green Company	136
DeBaugh Company	161	Peerless Radio	128
Deer & Taylor Company	161	Permoslux Corporation	137
DeForest's Training, Inc.	17	Pittsburgh Coil Company	156
Delco Radio, A General Motors Product	25	Potter Radio Company	122
Dow Radio Supply Co.	150	Precision Apparatus	150
Dynamic Television Associates, Inc.	132	Presto Recording Corp.	107
Eaton's	156	Price Radio Laboratories	146
Editors & Engineers	26	RCA Institutes	161
Electro-Impulse Labs.	100	R-L Electronic Corp.	116
Electro Products Laboratories	106	R & M Radio Company	113
Electronicraft, Inc.	148	Radio Corporation of America	162
Electronic Controls Co.	88	Radio Equipment Company	153
Electronic Distributors	148	Radio Ham Shack, Inc.	105
Electronics Institute, Inc.	70	Radio Kits Company	88
Electronic Technical Institute	135	Radio Maintenance Magazine	82
Electronic Supplies	130	Radio Parts Sales Company	152
Esse Radio Company	115	Radio Press	76
Fahnestock Electric Company, Inc.	111	Radio Shack, Inc., of Chicago, The	147
Farnsworth Television & Radio Corp.	29	Radio Supply & Engineering Co., Inc.	81
Federal Telephone & Radio Corp.	13	Radio Tuning Devices	132
Federated Purchaser, Inc.	110	Radio Wire Television, Inc.	96
Fishburn, Russell G.	158	Radionic Equipment Co.	148
G & G Genuine Majestic Radio Parts Service	139	Radolek Company	160
G & E Equipment Supply Co.	140	Ravac Electronics Corp.	100
General Cement Manufacturing Co.	76	Ray-lectron Company	144
General Electronics Distributing Co.	90, 91	Raytone Electronic Company	152
General Industries, The	103	Reed Mfg. Co.	152
General Test Equipment	132	Remer Radio	148
Greenlee Tool Co.	80	Rider, John F., Publisher, Inc.	19
Greenwich Sales Co.	102	Risco Electronics Wholesale Distributors	158
Hallcrafters Company, The	5	Rogers Industries, Inc.	138
Hammarlund Mfg. Co., Inc., The	38, 161	SNC Manufacturing Co., Inc.	10
Harvey Radio Company, Inc.	28	Sams, Howard W., & Co., Inc.	6
Heath Company, The	140, 149	Scenic Radio & Electronics Co.	148
Henry Radio Stores	153	Scientific Radio Products	147

Advertiser	Page
Simpson, Mark, Mfg. Co., Inc.	143
Snap-On-Tools Corp.	11
Sprague Products Company	93
Sprayberry Academy of Radio	7
Stahl, Michael, Inc.	159
Standard Electronics Co.	112
Standard Radio & Electronic Products Co.	157
Standard Radio-Electrical Products	150
Standard Transformer Corp.	23
Sterling Electronic Company	140, 152
Sun Radio of Washington, D. C.	89
Supreme Instruments Corp.	110
Supreme Publications	35
Sutton's, Bill, Wholesale Electronics	136
Sylvania Electric Products, Inc.	4th Cover

TAB	127
Technical Radio Parts Co.	116
Television Development Labs.	114
Telex, Inc.	77
Terminal Radio Corp.	100
Tradio, Inc.	159
Transvision, Inc.	8, 131, 161
Tri-State College	156

U. S. Radio Supply	141
Universal Radio Supply Company	126
Universal Recording Corp.	156
Utica Drop Forge & Tool Co.	76

Valparaiso Technical Institute	152
Variety Electric Company	78
Vision Research Laboratories	134

W & H Corp.	145
War Assets Administration	97
Ward Products Corp., The	69
Warren Distributors	121
Weller Manufacturing Co.	116
Wells Sales, Inc.	71
Western Radio Communications Institute	132
Weston Electrical Instrument	32
World Radio Laboratories, Inc.	155
Wright, Inc.	138

RCA Institutes, Inc.
 Offer thorough training courses in all technical phases of Radio and Television
WEEKLY RATES **DAYS—EVENINGS**
VETERANS: RCA institutes is approved under G. I. Bill of Rights
 For Free Catalog write Dept. RN-47
RCA INSTITUTES, Inc.
 A Service of Radio Corporation of America
 75 Varick St., New York 13, N. Y.

MINIATURE TEST OSCILLATOR
 Pocket size 1 1/4" round 5" long. Very convenient for servicing & aligning RF & Audio circuits. Supplies 60 cycle modulated RF; 100 KC to 5 MC gives continuous coverage for I.F., Broadcast & one Short Wave band on harmonics. Uses 6BA6 tube electron coupled for stability. 115 V. AC operated. \$7.95 postpaid or send \$1.00 and pay \$8.95: C.O.D. You must be satisfied or money cheerfully refunded.
DeBaugh Company Dept. RN-2
 400 Allegheny Avenue Towson 4, Maryland

NEWS ABOUT
THE LATEST IN RADIO PARTS—EQUIPMENT—ELECTRICAL DEVICES—brought to you in our monthly bulletins. ABSOLUTELY FREE! No obligation.
 WRITE TO
MANUFACTURING DIVISION
HERBACH & RADEMAN, INC.
ELECTRONICS SPECIALISTS
 522 MARKET ST., PHILA. 3, PA. • DEPT. C

12" TRANSVISION SCOOP!

NEW! SENSATIONAL! 12" TELEVISION KIT by TRANSVISION It's TOPS IN TELEVISION VALUE!

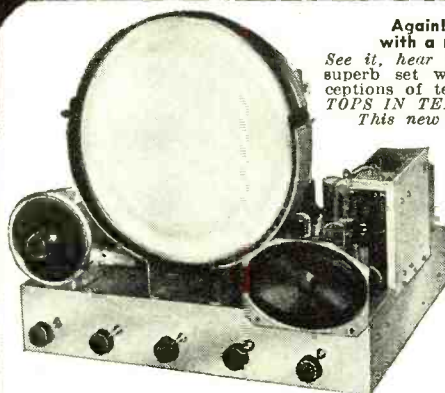

Again! Transvision leads the field with a magnificent 12" Television Kit!
 See it, hear it! The great performance of this superb set will shatter all your previous conceptions of television quality and value. It's the TOPS IN TELEVISION!
 This new Kit is available in two models:

STANDARD MODEL: Has 12" Picture Tube (magnetic type) Picture size 7 1/2" square inches, 7 1/2" x 10"
 Receives all 7 television channels now on the air with provision for Transvision factory to add new channels at no extra cost (except shipping charges)
 4mc band width for full picture definition
 9000 volts second anode potential for brightness and contrast
 3 stages picture I.F. 2 stages sound I.F. Ratio detector for sound provides best quality F.M. reproduction
 22 tubes and 12" picture tube
 maximum picture sensitivity (approx. 50 microvolts)
 stabilized synchronizing circuits to minimize interference on picture
 overall chassis size 20" wide x 18" deep x 18" high
 finest quality pre-tested parts throughout
 complete with SPECIALLY DESIGNED Folded Dipole Antenna and 60 feet of lead-in cable

DE LUXE MODEL: Has the same features as the above. Plus the following **ADDITIONAL FEATURES:**
 50-216mc continuous tuning including F.M. band and 13 television channels
 R.F. stage on all television stations and F.M. sound switch provided to cut off unused tubes when used as F.M. receiver.

Beautiful furniture-finish cabinet available.

See your local distributor, or for further information write to:

TRANSVISION INC., Dept. R.N. 385 North Ave., New Rochelle, N. Y.

FS-135-C
FREQUENCY STANDARD

Keeps you "ON THE BEAM"
 No more "hoping" you're in the band. Mount the FS-135-C Frequency Standard in your receiver, zero beat it with WWV and you'll have a frequency meter that is really accurate.

HAMMARLUND
 THE HAMMARLUND MFG. CO., INC., 480 W. 34TH ST., NEW YORK 1, N. Y.
 MANUFACTURERS OF PRECISION COMMUNICATIONS EQUIPMENT

TEACH YOURSELF
Radio & Electronics

Magi-Klips Kit
Build 18 Experiments at Home—No Tools!
RADIO RECEIVER, HOME BROADCASTER, PHOTOELECTRIC RELAY, CODE PRACTICE OSCILLATOR, SIGNAL TRACER, REMOTE CONTROL RELAY, Phonograph Transmitter, Intercommunication Amplifier, Code Transmitter, Radio Frequency Oscillator, Telephone Line Amplifier, Electronic Switch, Photograph Amplifier, Temperature Control Relay, Contact Detector, Electronic Metronome, Interval Timer (one-shot), Interval Timer (repeating).
 With a Magi-Klips kit you cover the entire field of radio and electronic engineering theory quickly in your spare time. It's simple to arrange the components for each circuit. No soldering. No tedious wiring. Kit operates on 110 v. AC or DC and includes 35Z5 rectifier, 50L6 power amplifier, 12SL7 double triode, powerful 4" speaker-mike, plate relay, broadcast and SW coils, tuning condenser and generous supply of resistors, condensers, chokes, extra wire. Parts worth double the price of kit.
 Kit's 48-page manual has complete instructions and diagrams easily followed by the beginner. Remember, you need no tools, except possibly a screwdriver, with a Magi-Klips electronic experimenter's kit. **\$2975**

COMPLETE MAGI-KLIPS KITS unassembled are also available. If you wish to assemble your own **MAGI-KLIPS Kit, specify \$1975** "knocked-down" on your order
 only complete
 Send today for your copy of **FREE** booklet, "Electronics Made Easy."
 Schools—MAGI-KLIPS Kits are excellent equipment for laboratory and classroom. Write for special discounts.
 Dealers—Some territories open. Write for your trade discounts.
DEER & TAYLOR COMPANY
 1340 Milvia St. Dept. N Berkeley 9, Calif.

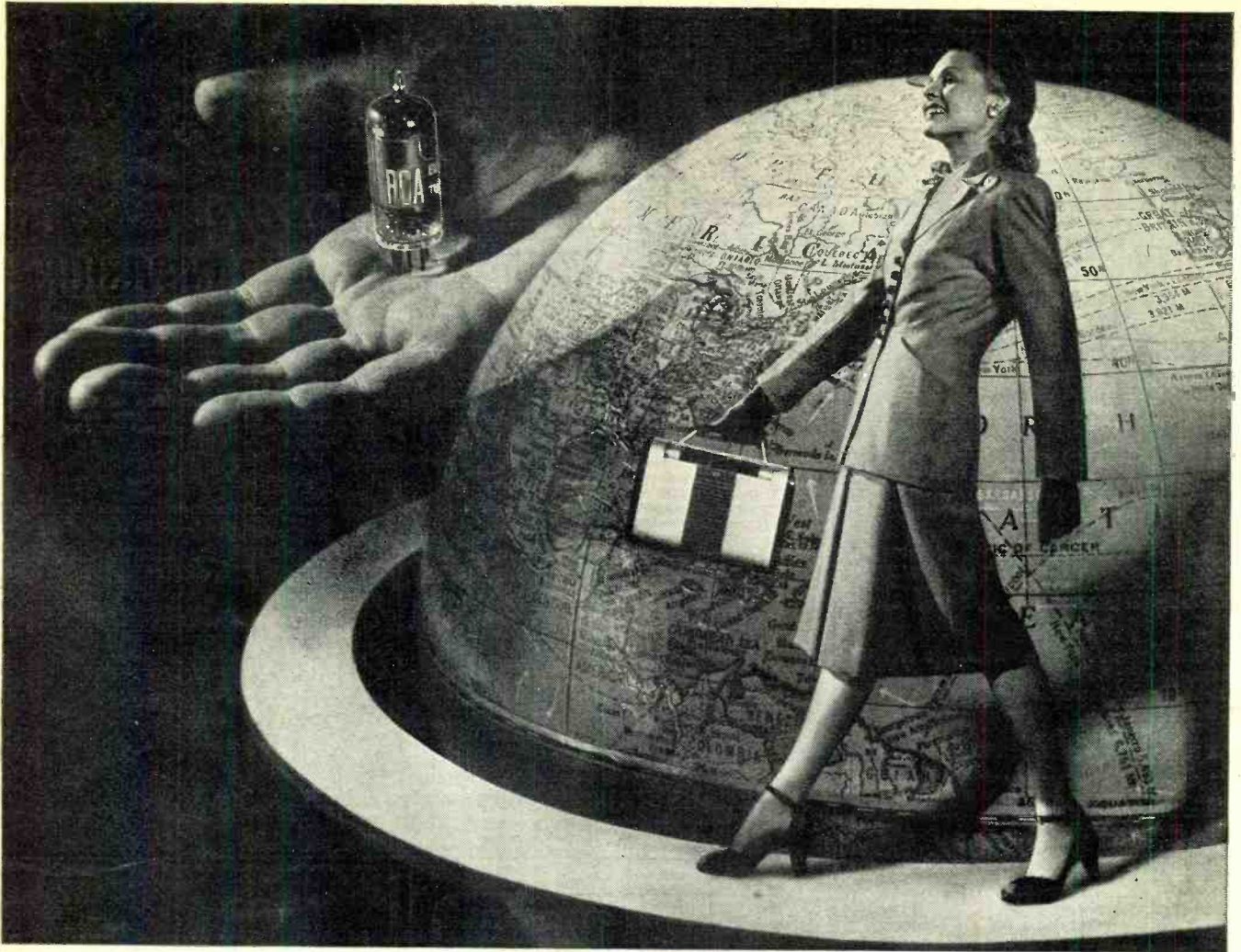

RCA Miniature Tubes enhance the tonal brilliance of RCA Victor Globe Trotter portable radios.

She shall have music wherever she goes!

Wherever you go with an RCA Victor Globe Trotter portable radio you'll enjoy richness and clarity of tone—volume enough for outdoor dancing—made possible through tiny tubes.

Miniature tubes save valuable space in small radios—space that can be used for larger and better loudspeakers and for longer lasting, radio-engineered RCA batteries.

These miniature tubes were developed by RCA Laboratories—a world center of radio and electronic research—and long a leader in development of electron tubes for all purposes.

At RCA Laboratories, the same research, experimentation and advancement that resulted in these improved tubes, keep all RCA products and services at the top in their particular fields.

When you buy a product bearing the name RCA or RCA Victor—a radio set, television receiver, Victrola radio-phonograph, a radio tube or phonograph record—you get one of the finest products of its kind that science has yet achieved.

"Victrola" T. M. Reg. U. S. Pat. Off.

Radio Corporation of America, RCA Building, Radio City, New York 20. Listen to the RCA Victor Show, Sundays, 2:00 P.M., Eastern Daylight Saving Time, over NBC.

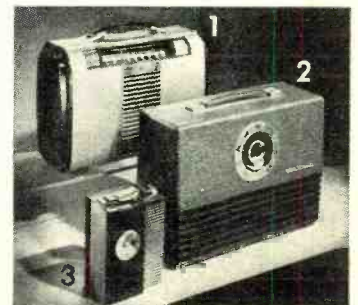

Ideal traveling companions. (1) RCA Victor "Globe Trotter" portable radio—operates on AC, DC, or batteries. (2) RCA Victor "Escort"—has a battery you can recharge from any ordinary AC electric outlet. (3) RCA Victor "Solitaire"—less than 6¼ inches tall!



RADIO CORPORATION of AMERICA

PRINTED IN U.S.A.

RADIO NEWS

Inside and out...

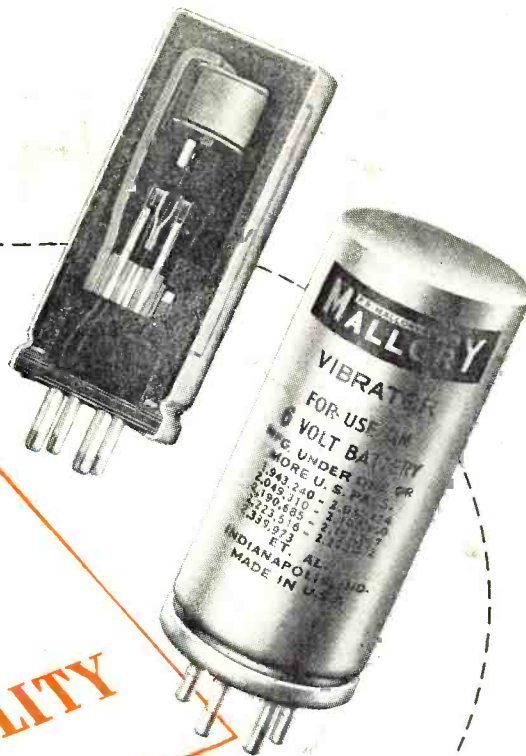

The Story of
MALLORY
VIBRATORS
 is a story of
PREMIUM QUALITY

THE Mallory vibrator is a collection of wire, steel, contacts, insulation, rubber and other materials—so assembled that it adds up to the finest product of its kind in the world. Clever engineering and precision manufacture tell the story in part. But it's **PREMIUM QUALITY** that adds the final touch.

For instance, the specifications covering all materials that go into Mallory vibrators are the most rigid that can be met by modern manufacturers. In addition, the materials are carefully matched item by item according to tolerance, so that each component "balances"

the other exactly. All Mallory vibrators are "selectively assembled" to give you dependable performance.

Extra heavy cans that deaden sound—high-grade clock spring steel that eliminates reed breakage—105-strand wire that defies vibration—special Mallory contacts that make for longer life—yes, Mallory vibrators include them all. But it's because every part is exactly matched that you get a true "Approved Precision Product." Mallory distributors are conveniently located and able to help you on *all* your vibrator problems.

See Your Mallory Distributor for a free copy of the 1947 Replacement Vibrator Guide

P. R. MALLORY & CO., Inc.
MALLORY

VIBRATORS . . . VIBRAPACKS* . . . CAPACITORS . . . VOLUME CONTROLS . . . SWITCHES . . . RESISTORS . . . FILTERS . . . RECTIFIERS . . . POWER SUPPLIES.

*Reg. U. S. Pat.-Off.

APPROVED PRECISION PRODUCTS

P. R. MALLORY & CO., Inc., INDIANAPOLIS 6, INDIANA

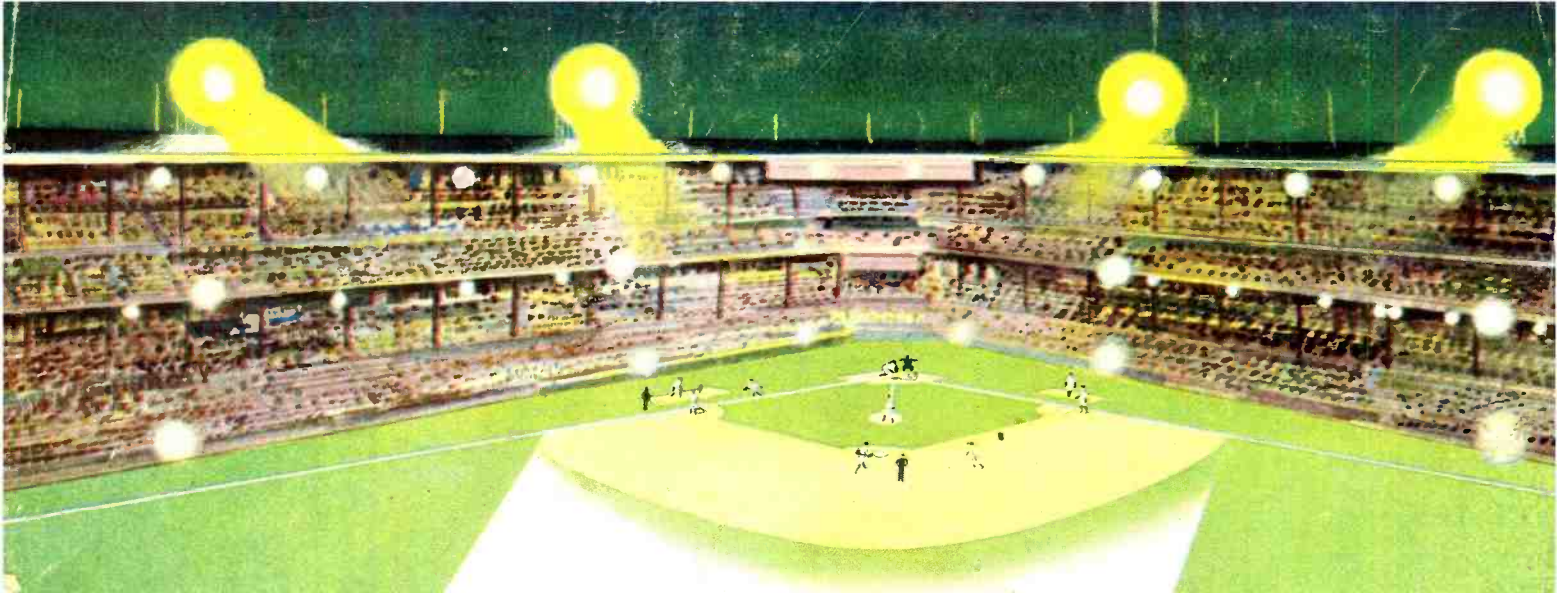

Why the *Lock-In* tube is at home **IN TELEVISION!**



ULTRA-HIGH FREQUENCIES... HANDLED WITH EASE

Sylvania Lock-In is *the* tube specifically engineered to more than satisfy the requirements of television equipment—handles ultra-high frequencies with ease! Electrical features include: short, direct connections . . . fewer welded joints—less loss; getter located at top . . . shorts eliminated by separation of getter material from leads.

STAYS PUT IN SOCKET... MECHANICALLY RUGGED

Specially designed "lock-in" locating lug on each tube keeps it in place—assuring firm socket contact. Improved tube mount keeps elements ruggedly supported on all sides. There are few welded joints and *no* soldered joints—the elements can't warp or weave.

COMPACT... MADE TO FIT SMALL SPACES

This famous Sylvania product is ideal for use in modern sets, where the tendency has been toward more compact units—has reduced overall height and weight. Has no top cap connection . . . overhead wires are eliminated! See *Sylvania Distributors* or write *Radio Tube Division, Emporium, Pa.*



SYLVANIA'S LOCK-IN TUBE...

...the radio tube whose electrical and mechanical superiority makes it the ideal choice for marine radar, equipment in the air, on the road, FM and television.

SYLVANIA ELECTRIC