

MARCH
1947
35c

Variable
Transmitter
- ext. filter
+ mod. amp.
60 kHz to 10 kHz
3 tube minivulans
tape receiver
2 w mod
3 w paper

RAID NEWS

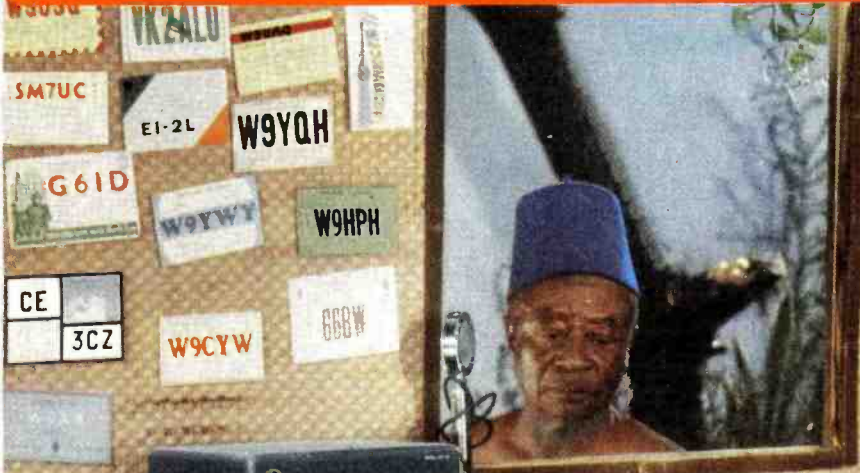

DALEAG WIS
LAURENCE THORSON
RN-56-141366-47



DRIVE
YOUR PRODUCTS
to market
with

alliance
MOTORS

ALLIANCE PHONOMOTORS
 —POWR-PAKT MOTORS in shaded pole induction and split-phase reversible resistor types rated from less than 1/400th h. p. on up to 1/20th h. p. for powering valves, switches, controls, driving turntables, fans, record changers and automatic devices.

THE NEW MODEL A shaded pole, induction-type Alliance Fan Motor for speeds from 500 to 1050 R.P.M. operates on 50 or 60 cycles at voltages up to 220, 1/30th horse power, size 4 3/8 x 2 3/4 inches. Porous bronze, oilless-type sleeve bearings. Open or fully enclosed construction. Approx. 8 to 40 oz. in. full load running torque, depending on stack length. Exceptionally quiet.

For continuous or intermittent duty. Runs clockwise or counter clockwise—not reversible.



SLOWER SPEEDS • LOWER CURRENT COSTS
QUIETER OPERATION • SMALLER SIZE

Here are four *big* advantages built into the new Alliance Powr-Pakt fan motors. Results are longer life — less repair — smoother performance. This new Alliance shaded pole fan motor reflects advanced engineering! Mass-produced at low cost. Write!

WHEN YOU DESIGN—KEEP

alliance

MOTORS IN MIND

ALLIANCE MANUFACTURING COMPANY • ALLIANCE, OHIO

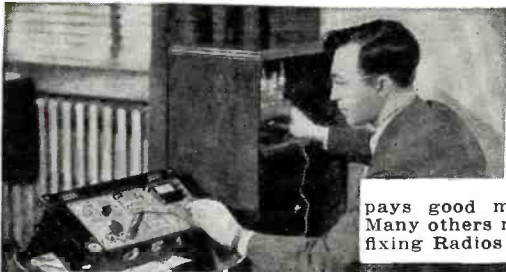

**Building this
A. M. SIGNAL GENERATOR**
gives you valuable experience.
Provides amplitude-modulated
signals for test and experiment
purposes.

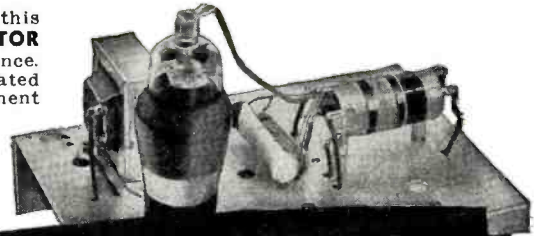

RADIO SERVICING
pays good money for full time work.
Many others make \$5, \$10 a week EXTRA
fixing Radios in spare time.

VETERANS

You can get this training right
in your own home under G. I.
Bill. Mail coupon for full details.

Learn RADIO by PRACTICING in Spare Time

with Big Kits of Radio Parts I Send You

Do you want a good-pay job in Radio—or your own money-making Radio Shop? Mail Coupon for a FREE Sample Lesson and my FREE 64-page book, "How to Be a Success in RADIO—Television, Electronics." See how N.R.I. gives you practical Radio experience at home—building, testing, repairing Radios with BIG KITS OF PARTS I send!

**Many Beginners Soon Make Good Extra Money
in Spare Time While Learning**

The day you enroll I start sending EXTRA MONEY JOB SHEETS. You LEARN Radio principles from my easy-to-grasp, illustrated lessons—PRACTICE what you learn with parts I send—USE your knowledge to make EXTRA money fixing neighbors' Radios in spare time while still learning! From here it's a short step to your own full-time Radio Shop or a good Radio Job!

**Future for Trained Men Is Bright in Radio,
Television, Electronics**

It's probably easier to get started in Radio now than ever before because the Radio Repair business is booming. Trained Radio Technicians also find profitable opportunities in Police, Aviation, Marine Radio, Broadcasting, Radio Manufacturing, Public Address work. Think of even greater opportunities as Television and Electronics become available to the public! Send for free books now!

Find Out What N.R.I. Can Do for You

Mail Coupon for Sample Lesson and my 64-page book. Read the details about my Course. Read letters from men I trained, telling what they are doing, earning. See how quickly, easily you can get started. No obligation! Just MAIL COUPON NOW in an envelope or paste it on a penny postal. J. E. Smith, President, Dept. 7CR, National Radio Institute, Pioneer Home Study Radio School, Washington 9, D. C.

My Course Includes Training in
TELEVISION ★ ELECTRONICS
Frequency Modulation



You build this
MEASURING INSTRUMENT yourself early in the course—use it for practical Radio work on neighborhood Radios to pick up EXTRA spare time money!

You build this **SUPERHETERODYNE CIRCUIT** that brings in local and distant stations. You get practical experience putting this set through fascinating tests.

**BE A SUCCESS in RADIO
I Will Train You at Home**

Sample Lesson FREE



Gives hints on Receiver Servicing, Locating Defects, Repair of Loudspeaker, I.F. Transformer, Gang Tuner, Condenser, etc., 31 illustrations. Study it—keep it—use it—without obligation! Mail Coupon NOW for your copy!



**GET BOTH 64 PAGE BOOK
SAMPLE LESSON FREE**

Mr. J. E. SMITH, President, Dept. 7CR
National Radio Institute, Washington 9, D. C.
Mail me FREE, without obligation, Sample Lesson and 64-page book about how to win success in Radio and Television—Electronics. (No salesman will call. Please write plainly.)

Age.....
Name
Address
City Zone..... State.....

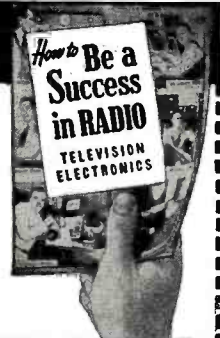

APPROVED FOR TRAINING UNDER GI BILL

Chairman of the Board and Publisher
WILLIAM B. ZIFF

President
B. G. DAVIS

Secretary-Treasurer
ARTHUR T. PULLEN

Vice-Presidents

GEORGE BERNER
Advertising and Sales Director

MICHAEL H. FROELICH
Editorial Director

H. J. MORGANROTH
Production Director

H. G. STRONG
Circulation Director

Art Director
HERMAN R. BOLLIN

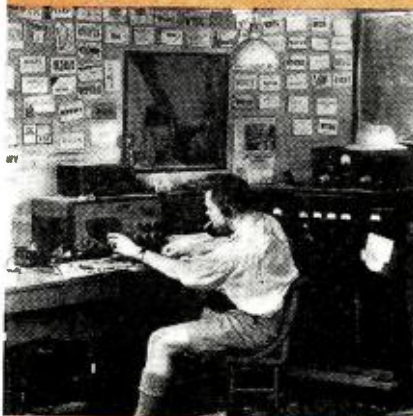

THE COVER: Part of the extensive array of communications equipment that will accompany the Gatti-Hallcrafters Expedition for use at the main base in South Africa.

EDITORIAL

OLIVER READ, W9ETI
Editor

WM. A. STOCKLIN
Asst. to the Editor

H. S. RENNE, Ex. WBPTS
Technical Editor

RAY FRANK, W9JU
Amateur Radio Editor

FRED HAMLIN
Washington Editor

PAUL H. WENDEL
Eastern Editor

GAITHER LITRELL
Western Editor

P. B. HOEFER
Assistant Editor

ARTHUR E. HAUG
WALTER STEINHARD
Staff Photographers

R. S. KUPJACK
Staff Artist

ADVERTISING

Advertising Manager
L. L. OSTEN

Midwestern Advertising Manager
JOHN A. RONAN, JR.

Manager, Eastern Division
CHARLES R. TIGHE

Manager, Western Division
WILLIAM L. PINNEY

BRANCH OFFICES

NEW YORK (1)
Empire State Bldg., W 17-0400

LOS ANGELES (14)
815 S. Hill St., TUcker 9213

WASHINGTON (4)
International Bldg., EXecutive 2502

TORONTO
21 King Street, East

LONDON
Ziff Davis, Ltd., Grampans Bldg.,
Western Gate, London, W.6

RADIO NEWS

Reg. U. S. Pat. Off.

First in radio

Average Paid Circulation over 130,000

MARCH, 1947

FOR THE SERVICEMAN-DEALER

A 10 KC. Suppressor.....	J. E. Kauke	46
Applying the IN34 as Discriminator for FM.....	Norman L. Chalfin	55
Practical Radio Course.....	Alfred A. Ghirardi	58
Packaged Radio Service.....	Robert M. Ellis	60
The Farm Market for Radio and Appliances.....	C. R. Elder	62
3" Oscilloscope.....	J. Carlisle Hoadley	63
RN Circuit Page		72

FOR THE AMATEUR

Variable Frequency Transmitter-Exciter.....	John F. Clemens, W9ERN	38
Compact 60-Watt Transmitter.....	Royden R. Freeland, W5EMH	41
A Handy 20-Watt Modulator.....	Rufus P. Turner, W1AY	50

OF GENERAL INTEREST

Generating Microwaves.....	Samuel Freedman	35
Midget 4-Watt Amplifier.....	Earl Snader, Jr.	40
Miniature All-Wave 3-Tube Receiver.....	W. E. Miller, W2HSV	44
Sonar—The Submarine's Nemesis.....	C. G. McProud	47
The Recording and Reproduction of Sound.....	Oliver Read	52
Around the Clock with Short-Wave English Newscasts.....		56
Chart of World Time Differences.....		146

DEPARTMENTS

For the Record.....	The Editor	8	Manufacturers' Literature	106
Spot Radio News.....	Fred Hamlin	18	Letters from Our Readers.....	142
Short-Wave	K. R. Boord	57	Biz Quiz	151
What's New in Radio.....		76	Within the Industry.....	154
Technical Books.....		166		



COPYRIGHT 1947
ZIFF-DAVIS PUBLISHING COMPANY
185 North Wabash Ave., Chicago 1, Ill.
VOLUME 37 • NUMBER 3



Member
Audit Bureau of
Circulations

RADIO NEWS is published monthly by the Ziff-Davis Publishing Company, 185 N. Wabash Ave., Chicago 1, Ill. Subscription Rates: in U.S. and Canada \$4.00 (12 issues), single copies 35 cents; in Mexico, South and Central America, and U. S. Possessions, \$4.00 (12 issues); in British Empire, \$5.00 (12 issues)—all other foreign countries \$5.00 (12 issues). Subscribers should allow at least 2 weeks for change of address. All communications about subscriptions should be addressed to: Director of Circulation, 185 N. Wabash Ave., Chicago 1, Ill. Entered as second class matter March 9, 1938, at the Post Office, Chicago, Illinois, under the Act of March 3, 1879. Entered as second class matter at the Post Office Dept., Ottawa, Canada. Contributors should retain a copy of contributions and include return postage. Contributions will be handled with reasonable care but this magazine assumes no responsibility for their safety. Accepted material is subject to whatever revisions and by-line changes that are necessary. Payment made at our current rates, covers all authors', contributors', or contestants' rights, title, and interest in and to accepted material, including photos and drawings.

Going places
(AGAIN)

hallicrafters



Hallicrafters famous radio equipment, sold and distributed around the world before the war and used with superb effectiveness in every theater during the war is once again on the move. Watch for latest details of the Gatti-Hallicrafters mobile radio equipped expedition to the Mountains of the Moon in deepest Africa—a new and exciting test for the ingenuity of hams and the performance of Hallicrafters equipment.

3

GREAT RECEIVERS designed and priced for hams who are going places too



Model SX-42 Described by hams who have operated it as "the first real postwar receiver." One of the finest CW receivers yet developed. Greatest continuous frequency coverage of any communications receiver—from 540 kc to 110 Mc, in six bands. FM-AM-CW. 15 tubes. Matching speakers available. **\$275⁰⁰**



Model S-40A Function, beauty, unusual radio performance and reasonable price are all combined in this fine receiver. Overall frequency range from 540 kc to 43 Mc, in four bands. Nine tubes. Built-in dynamic speaker. Many circuit refinements never before available in medium price class. **\$89⁵⁰**

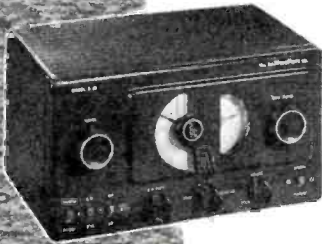

Model S-38 Overall frequency range from 540 kc to 32 Mc, in four bands. Self contained speaker. Compact and rugged, high performance at a low price. Makes an ideal standby receiver for hams. CW pitch control is adjustable from front panel. Automatic noise limiter. **\$47⁵⁰**

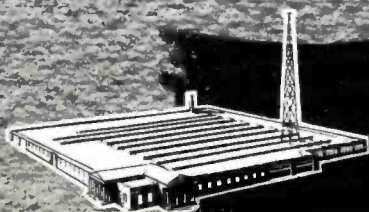

DEalers of *Skyfone* AVIATION RADIO/TELEPHONE

hallicrafters RADIO

THE HALLICRAFTERS CO., MANUFACTURERS OF RADIO AND ELECTRONIC EQUIPMENT, CHICAGO 16, U. S. A.

Sole Hallicrafters Representatives in Canada: Rogers Majestic Limited, Toronto-Montreal

IT'S FADA for '47

*The Radio of
TO-MORROW ... TO-DAY!*

FADA faces '47 with the greatest line of radio receivers in the history of radio. Each model is a gem of engineering achievement ... new clarity of reception, new beauty of design, new extra-durability. There is a FADA model for every room.

You can always depend upon the sales-appeal of FADA — the Radio of Tomorrow ... Today!

New!



MODEL 659
Short wave version of Model 652. 2 Wave Band Superheterodyne. American and foreign reception. Covers American broadcast and international short wave down to 16 meters.



MODEL P82
Tri-power portable Superheterodyne with Hi-Gain tuned RF stage in rich two-tone simulated leather covered wood cabinet. 5 tubes plus rectifier tube.

MODEL 1000
AC-DC Superheterodyne in beautiful gem-like "Fada-lucent" cabinets. Five Tubes plus Rectifier Tube.



FADA 5-tubes — plus-rectifier-tube models are equipped with the new FADA "Sensitive-Tone" ... assuring greater sensitivity and clearer reception.



MODEL 602
New Superheterodyne AC Table Model Radio Phonograph Combination with Automatic Record Changer in a Cabinet of Beautiful Mahogany Veneers.

YOU CAN ALWAYS DEPEND ON

FADA Radio

Famous Since Broadcasting Began!

FADA RADIO AND ELECTRIC COMPANY, INC., LONG ISLAND CITY, N. Y.

NOW SPRAYBERRY RADIO TRAINING

GIVES YOU 8 BIG KITS OF RADIO EQUIPMENT

WITH A COMPLETE 6 TUBE SUPER-HETERODYNE RECEIVER



YOU LEARN RADIO SERVICING
THROUGH INTENSIVE "SHOP-BENCH" PRACTICE

YOU DO EXPERIMENTS, CONSTRUCTION, TROUBLE-SHOOTING

I'll show you how to perform over 175 instructive Experiments—how to build countless Radio Circuits. You'll learn a new, fast way to test Radio Sets without mfg. Equipment.



I give you a fine, moving-coil type Meter Instrument on Jewel Bearings—with parts for a complete Analyzer Circuit Continuity Tester. You learn how to check and correct Receiver defects with professional accuracy and speed.

You'll get valuable experience and practice building this Signal Generator and multi-purpose Tester. Makes a breeze out of fixing Radios and you don't have to spend money on outside, ready-made equipment.

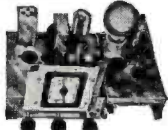

Soldering, wiring, connecting Radio parts . . . building circuits with your own hands—you can't beat this method of learning. When you construct this Rectifier and Filter, Resistor and Condenser Tester, etc., you get a really practical slant on Radio that leads to a money-making future.

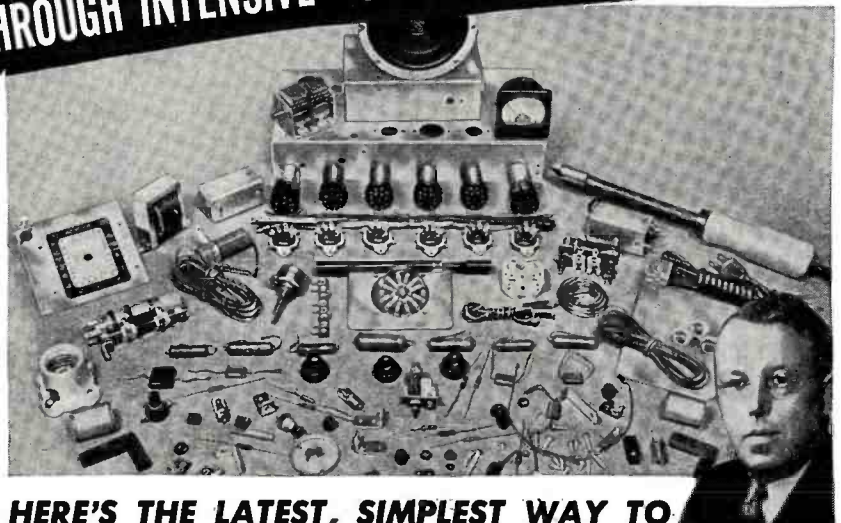

HERE'S THE LATEST, SIMPLEST WAY TO TRAIN at HOME for a GOOD LIVING in RADIO-ELECTRONICS & TELEVISION

I train your mind by putting you to work with your hands on a big 6-Tube Superheterodyne Receiver. And, believe me, when you get busy with real Radio Parts—8 big Kits of them—you really LEARN Radio and learn it RIGHT! You get the practical stuff you need to be useful in Radio, and that's what it takes to make money. You don't have to worry about what to do with these 8 Kits of

Parts. Step by step, I show you how to build circuits, test, experiment, trouble-shoot. And you don't need any previous experience. The Sprayberry Course starts right at the beginning of Radio! You can't get lost! Simplified lessons, coupled

with real "Shop" practice, makes every subject plain and easy to understand and remember.

A BUSINESS OF YOUR OWN . . . OR A GOOD RADIO JOB

Soon after you begin Sprayberry Training, I'll send you my sensational **BUSINESS BUILDERS**. You'll find out how to get and do neighborhood Radio repair jobs for nice profits and rich experience while learning. This sort of work can easily pave the way for a Radio Service business of your own. But with Sprayberry Training, you're not limited. You can swing into any one of the swiftly expanding branches of Radio-Electronics INCLUDING Radio, Television, FM, Radar, Industrial Electronics. Be wise! Decide now to become a fully qualified **RADIO-ELECTRONICIAN**. Get full details about my Training at once! Mail coupon below for my 2 big FREE Books.

SEND FOR THESE FREE BOOKS



"How to Read Radio Diagrams and Symbols"

Here's a valuable and wonderfully complete new book which explains in simple English how to read and understand any Radio Set Diagram. Includes translation of all Radio symbols. Send for this volume at once! It's free! Along with it, I will send you another Big Free book describing in detail my Radio-Electronic Training.

SPRAYBERRY ACADEMY OF RADIO

F. L. Sprayberry, President, Room 2537, Pueblo, Colorado

Please rush my FREE copies of "How to MAKE MONEY in RADIO, ELECTRONICS and TELEVISION," and "HOW to READ RADIO DIAGRAMS and SYMBOLS."

Name Age

Address

City State

(Mail in envelope or paste on penny postcard)

MAIL COUPON TODAY!

March, 1947

For the RECORD.

BY THE EDITOR



"SPINTITE"...
THE WRENCH
WITH THE Reach!

Spintite wrenches give maximum efficiency when space is at a minimum. Complex radio assemblies in compact cabinets leave little room for clumsy tools. Designed for the radio man who must meet these conditions, Spintites reach where other wrenches won't.

Spintite, the wrench built like a screw-driver, has a straight shaft, hollowed sufficiently to accommodate nuts through which the bolt protrudes. It comes in three types to fit square, hex or knurled nuts. Sizes vary from 3/16" to 5/8", completely covering the range of radio requirements for either repairs or assembly.

For increased accessibility, standardize on Spintite, a wrench that reaches those "tight spots" with ease.

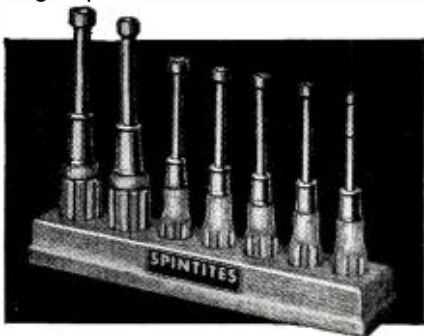

T-73 Set, has 7 sizes of hex heads. Shock-proof handles, and cold forged sockets assure safety and strength.



STEVENS • WALDEN
INCORPORATED
Worcester • Massachusetts

LEADERS responsible for the success of commercial television as it gathers momentum in 1947 must decide right now that "good taste" in programming might well be the only key to the door of average Mr. and Mrs. TV Prospect.

Commercial AM programming, in many cases, has failed to maintain its original prestige in the eyes of the public. Commercials have gone from bad to worse and as far as education is concerned, AM today has little to offer in educational prestige. If this germ is absorbed by television program writers and directors, we shudder to think of what future generations will glean from that plague. We don't mean that efforts are not being made to properly launch television to the public, but we do feel that the press in general is not fully cognizant of the danger of TV getting off to a bad start.

According to best estimates, there will be better than 75 television stations offering program service by the end of the present year. To date the FCC has granted more than 47 construction permits in 22 of the most populous states throughout the country. In addition, there are now 6 commercial television stations on the air. Add to this the 25 or 30 applications on file at the FCC and we find that television is growing by leaps and bounds.

There were many factors during the past year which hindered the expected progress of television. They included such familiar stumbling blocks as strikes, material shortages, etc. In spite of these difficulties, much progress was made. Some even claim that 1946 was a good year for television.

It is quite possible that a half million folks will own television sets by 1948. Television during the coming presidential campaign will make it possible for all candidates to be seen as well as heard. We'll bet that many a housewife will vote for her favorite politician if he has a bit more glamour than his opponent.

Many of you old timers remember back in 1924 when radio had the same opportunity during that presidential campaign as television will have in 1948.

Many companies are already producing television receivers. Most of them are table models but the big

stuff will come later when wood for cabinets becomes more plentiful. These manufacturers have done a great job, even though they did not reach the goal of nearly 200,000 sets which they had set for 1946. If it were not for material shortages, chances are that they certainly would have hit the jack pot.

Another handicap still to be overcome at this writing is the restriction on the building of satisfactory quarters for television stations. This includes both transmitter houses as well as studios and offices. It is, however, quite likely that the controls will be dropped in the very near future.

In a recent talk Mr. Edgar Kobak, president of the Mutual Broadcasting Company, pointed out that, "We must not forget our responsibility as licensees, or we may wind up not running this television business. Television is going to have a great deal more to do than the movies or radio in bringing understanding among people . . . and with that responsibility we have got to be very careful that we do not misuse it." Mr. Kobak has really got something there!

It won't be very long until our youngsters will be sitting in the living room tearing their hair out as Dick Tracy approaches the gunfire of six desperados. It will be very easy for television to influence these children. Radio programming at present is surely bad enough but salt will be poured into the wound if TV sacrifices its prestige in exchange for revenue without due consideration for the type of material that will be televised.

On the other hand, television can and should set its sights very high as far as good taste is concerned. By so doing, it will expand at a healthy rate. There will be no time to experiment with public opinion unless telecasters can assure their viewers that programs of high caliber are already programmed or are contemplated in the months to follow.

Television schools too, have a golden opportunity to campaign for decency and good taste in television programs. Yes, 1947 will be the "proving ground" for television. Many will butcher their opportunities while other organizations will band together to insist that good taste prevails. We'll bet (with our tongue in our cheek) on the latter. O.R.

RADIO NEWS

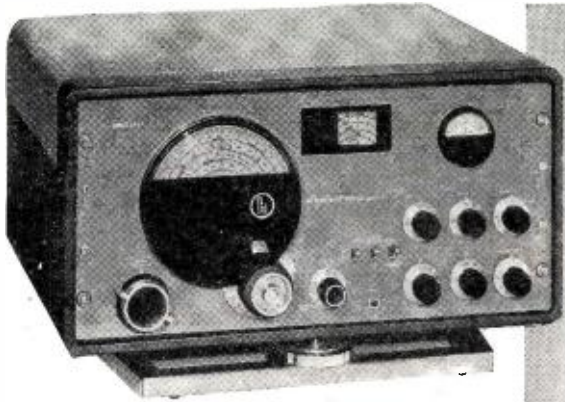

NEW!

HALLCRAFTERS SX-42

Here's the NEW SX-42—the receiver that sets a new standard in radio performance. Covers everything: Frequency range of 540 KC. to 110 MC. brings you high-fidelity broadcast reception—world-wide Short-wave coverage—PLUS true high-fidelity FM broadcast reception (all FM frequencies), and hi-fi phono reproduction. The new SX-42 is brilliantly designed to bring you more features, more operating thrills than you've ever thought possible. Wide-vision no-glare dials, AM-FM signal level meter, six-position selectivity control, dual IF system, separate sensitivity and volume control, NEW SIMPLIFIED controls for family use. Designed for top-flight reception—in the home, or for Amateur and Commercial communication work.

Net, less Speaker..... \$275.00

*Order Your
Communications Receiver
from ALLIED!*
IMMEDIATE DELIVERY

on most models

Time Payments

Trade-Ins Accepted

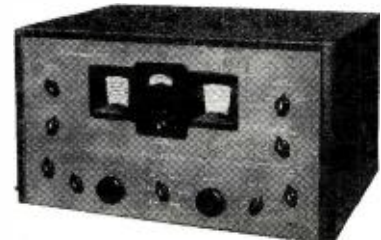
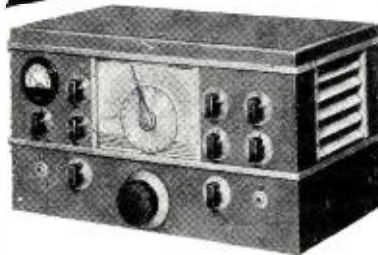

NATIONAL NC-2-40D

One of National's top receivers. Covers 490 KC. to 30 MC. range in 6 tuning bands. Has definite, accurate calibration for all bands. Features efficient single-dial control. Famous for its stable high frequency circuits. Frequency drift is reduced to a negligible value by temperature compensation. Has automatic band-in-use indicator. Wide-range adjustable series-valve-noise limiter. Flexible crystal filter. Special r.f. coupling circuits maintain full sensitivity.

Net, less Speaker..... \$225.00
Speaker in matching cabinet, Net.. \$16.44

HAMMARLUND HQ-129-X

Designed to meet the most critical demand of professional operators. Full range, .54 to 31 MC. accurately calibrated. Has 4 calibrated Ham bands and one arbitrary scale. Variable selectivity crystal filter. Low-drift beat oscillator for code and locating stations. Antenna compensator. Voltage regulation. Automatic noise limiter. Compensated oscillator to reduce drift during warm-up. Earphone jack. Three i.f. amplifier stages. Two audio stages. Speaker supplied in matching metal cabinet.

Net, with Speaker..... \$173.25

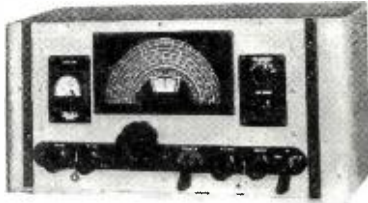

THE RME 45

The famous RME 45 Receiver delivers peak reception on all frequencies—550 to 34,000 KC. Features full-vision calibrated dial using a single control for two-speed tuning. Includes five Amateur bands with ample band-spread. Has DB-calibrated signal level meter; 5-step variable crystal filter; Automatic Noise Suppression; stable, variable-pitch beat oscillator, and a host of other features. Housed in handsome streamlined metal cabinet with matching speaker.

Net, with Speaker..... \$198.70

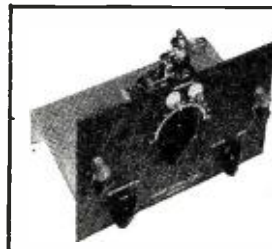

SPECIAL! NEW 2-METER TRANSCEIVER KIT

For the new 2-meter band! Uses 6N4 as mod.-osc. in transmit position and as super-regen. det. in receive position; 7C5 as mod. in transmitting, and as power audio amp. in receiving. Supplies current for single button carbon mike; has output transformer for coupling to speaker or headphones. Requires 250 v. at 75 ma., 6.3 v. at .65 amp. for power. Kit when completed measures 6" x 5" x 9". Includes all necessary parts and tubes (less mike, speaker and power supply). No. 83-220. **NET..... \$18.95**
Power Supply Kit. Includes all parts necessary to build power supply for transceiver. No 83-371. NET..... \$10.25

Other Communications Receivers

Hallcrafters S-38.....	\$47.50	RME-84.....	\$98.70
Hallcrafters S-40A.....	89.50	RME VHF-152 Converter.....	86.60
Hallcrafters S-41G.....	36.75	RME DB-20 Preselector.....	68.20
National NC-46.....	97.50	National HRO.....	274.35
NC-46 Speaker.....	9.90	Hammarlund SPC-400X.....	342.00

Net F. O. B. Chicago. Prices subject to possible change.



FREE! ALLIED'S Latest Catalog

ALLIED RADIO CORP., D. L. Warner, W91BC
833 W. Jackson Blvd., Dept. 1-CC-7
Chicago 7, Illinois

- Enter order for.....Model.....
- Enclosed \$..... Full Payment
 Part Payment (Balance C.O.D.)
- Send full information on Communication Receivers and Time Payment Plan, without obligation.
- Send FREE 1946 ALLIED Catalog.

Name.....
Address.....
City.....Zone.....State.....

ALLIED RADIO
Everything in Radio and Electronics



**"...ELEVEN YEARS
OF TROUBLE-FREE
PERFORMANCE"**

A typical RADIART VIBRATOR TESTIMONIAL

A typical example of the testimonials to Radiart performance which come in to us regularly from Radiart users everywhere is contained in a recent letter from a Mid-Western service man, Mr. W. E. Hopper, of North Vernon, Indiana.

Back in 1935, Mr. Hopper purchased and installed a Radiart Vibrator, type 3315. On October 14, 1946, eleven years later, Mr. Hopper wrote in to order a new Radiart to replace the original which had finally worn out AFTER ELEVEN YEARS OF TROUBLE-FREE PERFORMANCE!

This amazing record is only one of the many in our files attesting to the superiority of Radiart products. Designed to exacting specifications, of the highest quality materials, Radiart Vibrators, Vipowers and Aerials are as perfect as modern manufacturing methods can make them.

Ask to see these quality lines at your jobbers today or write for new illustrated Vibrator Guide and Catalog.

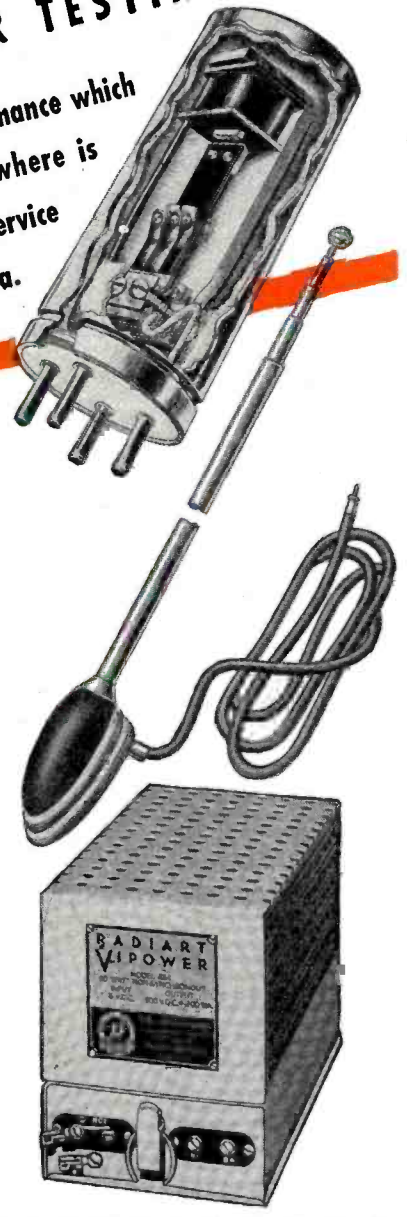

ELECTRONIC DISTRIBUTOR

MAGUIRE

936 N. MICHIGAN

THORDARSON AMPLIFIERS

Here is an amplifier line designed for true, brilliant sound reproduction. The last word in amplifier quality, these precision-built units are backed by 52 years of transformer manufacturing experience and 31 years of audio pioneering . . . See them at your jobbers today.



MEISSNER ANALYST

The modern service instrument. Designed to handle the receivers of today, yesterday and tomorrow with equal facility. Tests by the signal-tracing method . . . fastest, most reliable method to date . . . See it at your jobbers today.

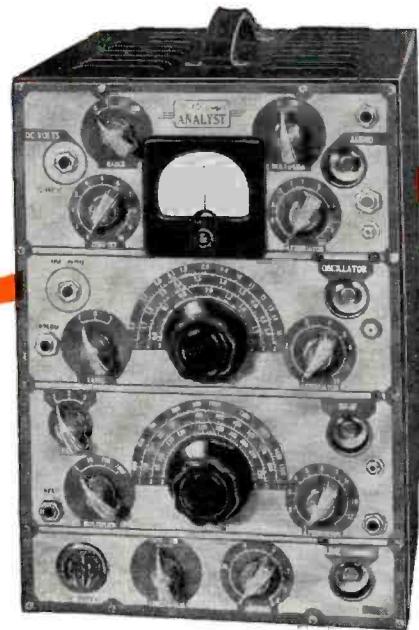

MEISSNER—THORDARSON RADIART
PRODUCTS IN PHOTO-FACT FOLDERS

EXPORT ADDRESS, SCHEEL INTERNATIONAL, INC.
4237-39 N. LINCOLN AVENUE, CHICAGO 18, ILLINOIS
CABLE HARSHEEL

AND INDUSTRIAL SALES DEPARTMENT

INDUSTRIES inc.
AVENUE, CHICAGO 11, ILLINOIS

Listen IT'S A Jensen SPEAKER!

COAXIAL SPEAKERS



MODEL HNP-51 COAXIAL (ST-122). A 15-inch articulated Coaxial with cone-type 1-f unit and horn-type h-f unit. Alnico 5 PM design throughout. Dividing network gives two-way performance. Wide-range response and excellent polar pattern. Ideal for FM receivers, high quality phonographs and similar applications, including monitoring. In Bass Reflex cabinet, response ranges from 50 to 15,000 cps. H-F Range Control lowers cut-off in four steps to suit program quality. Input impedance, 500-600 ohms. Maximum power rating in speech and music systems, 25 watts. List Price, \$125.00.

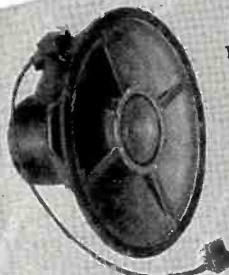

MODEL JAP-60 COAXIAL (ST-600). A 15-inch cone-type Coaxial with PM design. Furnished with H-F Range Control. Nominal input impedance, 500-600 ohms. Maximum power handling capacity in speech and music systems, 20 watts. List Price, \$96.00.

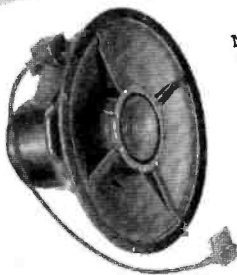

MODEL JHP-52 COAXIAL (ST-601). A 15-inch cone-type Coaxial like Model JAP-60 with efficiency approximately 4 db less. Furnished with H-F Range Control. Input impedance, 500-600 ohms. Power handling capacity in speech and music systems, 15 watts. List Price, \$65.00.



MODEL JCP-40 COAXIAL (ST-603). A 12-inch Coaxial at low cost. Ideal replacement and modernizing unit where 12-inch speaker is required. Simplified low-cost bridging network built. Terminals provided for addition of ST-606 Level Control. Nominal input impedance, 6-8 ohms. Power rating, 10 watts in speech and music systems. List Price, \$35.

4 COAXIAL SPEAKERS 8 REPRODUCERS 3 BASS REFLEX* CABINETS REPRODUCERS

UTILITY DESIGN (Brown Opaque Lacquer)



MODEL RA-151. Complete with Model HNP-51 Coaxial and H-F Range Control installed. List Price, \$181.15.

MODEL RD-151. Complete with Model HNP-51 Coaxial and H-F Range Control installed. List Price, \$201.00.

DELUXE DESIGN (Satin Finish Walnut)

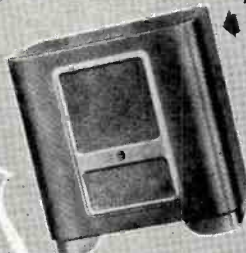
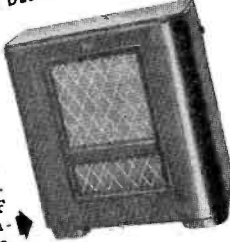

MODEL RA-153. Complete with Model JAP-60 Coaxial and H-F Range Control installed. List Price, \$142.15.

MODEL RD-152. Complete with Model JAP-60 Coaxial and H-F Range Control installed. List Price, \$162.00.

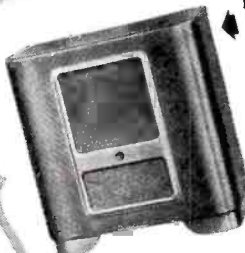
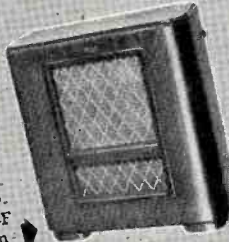

MODEL RA-154. Complete with Model JHP-52 Coaxial and H-F Range Control installed. List Price, \$121.15.

MODEL RD-153. Complete with Model JHP-52 Coaxial and H-F Range Control installed. List Price, \$141.00.



MODEL RA-124. Complete with Model JCP-40 Coaxial installed. List Price, \$94.15.

MODEL RD-122. Complete with Model JCP-40 Coaxial installed. List Price, \$114.00.

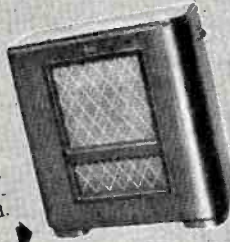

JENSEN MANUFACTURING COMPANY
6617 S. Laramie Ave., Chicago 38, U. S. A.
In Canada: Copper Wire Products, Ltd.,
11 King St., W., Toronto, Ont.
*TRADE MARK REGISTERED



Jensen

SPEAKERS WITH **ALNICO 5**
Designers and Manufacturers
of Fine Acoustic Equipment

Grasp the **NEW OPPORTUNITIES** in

RADIO ELECTRONICS AND TELEVISION *NOW!*

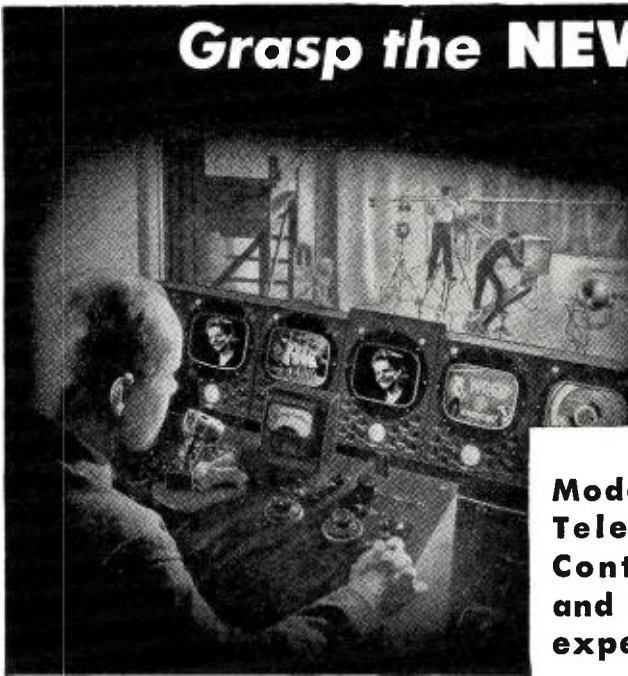

Modern Radio – FM Broadcast and Reception – Television – Industrial Electronics; Power, Control, Communications – new equipment and methods demand new technical ability and experience. Keep up to date with the latest.

MODERN RADIO EQUIPMENT FOR YOU TO USE AND KEEP



The very essence of National Shop Method Home Training is **EXPERIENCE**. You get actual experience by working with modern Radio and Electronic equipment—building many types of circuits. You may build a fine, long distance **MODERN SUPERHETERODYNE** signal generator, miniature radio transmitter, audio oscillator, etc.—many other standard actual operating pieces of equipment—conduct cathode ray and other experiments. This practical work advances with your training—**YOU LEARN BY DOING!**

Shop Method Home Training

By a Real Established Resident School with its own FM Studios, Shops and Laboratories.

TRAIN WITH ADVANCED TECHNIQUE

The good jobs in Radio Electronics now go to the men who are equipped to handle them. It takes training and experience. National Schools, one of the oldest and largest trade schools in the country, makes it possible for you to get this training right in your own home **IN YOUR SPARE TIME**.

National maintains modern resident training Studios, Shops and Laboratories where instructors and engineers are working constantly to improve training methods. **SHOP METHOD HOME TRAINING** is a logical extension of this practical system.

A **FREE** lesson that shows you how practical and systematic this new training method is will be sent you without obligation. You may keep and use this lesson to prove to yourself just how practical National Training really is.

Get one of the many **NEW JOBS** that demand new techniques and methods in Modern Radio. Get your share of the **NEW BUSINESS** that servicing the new sets and equipment demands. Experts agree that Radio, Television and Electronics present opportunities

much greater than ever before!

Radio is expanding with far-reaching improvements in reception. No one knows yet how great the Television market will be. Electronics will touch almost every walk of life—in industry and in the home.

TURN YOUR INTEREST IN RADIO INTO A CAREER THAT WILL ASSURE YOU SUCCESS AND SECURITY.

FIND OUT WHAT NATIONAL TRAINING CAN DO FOR YOU

Where do you stand today in modern industrial progress? What does the future hold for you? You owe it to yourself to investigate this opportunity. With National Training **YOU GET AHEAD FAST**—you may step into a good position or start a business of your own, with little capital, even before you complete your National Course.

Fit yourself for a career of independence, good earnings, success and security in one of the fastest growing fields in industry. For full information, just send your name and address on the coupon and mail it **TODAY**.

FREE LESSON



Get This Book FREE

This big book presents the facts about the field of Electronics and your opportunities in it together with full information about the advanced National Training. Read it and make up your own mind that National Training will equip you for a great future. No salesman will call on you from National. The book is **FREE** with your sample lesson. Clip and mail the coupon **TODAY!**



See What National Training Has Done For These Men

National Shop Method Home Training wins good jobs, independence and security. Take the word of National men who have established records in their favorite Radio, Television, or other branches of Electronics.



Clifford Hannah, Portage La Prairie, Manitoba, Canada, writes: "My training has brought results as I'm in line for another raise thanks to National's encouragement and thorough training."



Joseph Michel, Jr., Granite City, Illinois, writes: "I am enthused with National training. I am now earning \$225 a month as a radio operator and technician and \$20 a week more in my shop at home."



From O. K. Ivey, Washington, D. C., comes this endorsement: "I believe National offers the best course to be had... Keep up the good work."



Here's a statement from R. B. Wright, Blackfoot, Idaho: "Due to my training at National I was selected to instruct in the laboratory work of Navy and Marines."

Read what other enthusiastic students have written about National Training in the big 40 page book we will send you.

NATIONAL SCHOOLS

LOS ANGELES 37, CALIFORNIA EST. 1905



MAIL OPPORTUNITY COUPON FOR QUICK ACTION

National Schools, Dept. 3-RN

(Mail in envelope or paste on penny post card)

4000 South Figueroa Street, Los Angeles 37, California

Mail me **FREE** the two books mentioned in your ad including a sample lesson of your course. I understand no salesman will call on me.

NAME AGE.....

ADDRESS

CITY STATE.....

Include your zone number

Check here if veteran of World War II

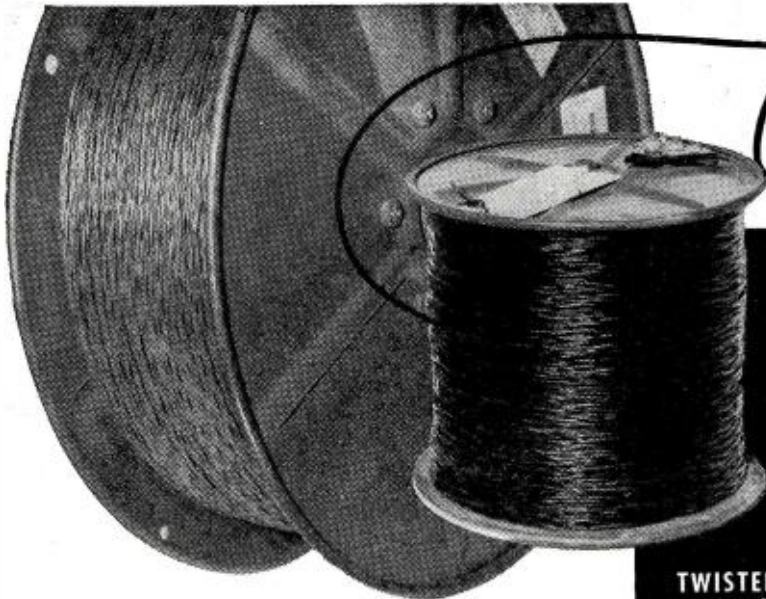

Wire

Plastic Coated Assault Wire

ON ORIGINAL STEEL REELS

TWISTED 2 CONDUCTOR 20-7 STRAND TINNED

- ★ WEATHER RESISTANT ★ DURABLE
- ★ LIGHT WEIGHT ★ FLEXIBLE

Available for Immediate Delivery at the following prices:

2,000 ft. steel reels (individually boxed).....	Per 1000 ft.	\$10.00
4,000 ft. pay out wooden reels (packed 2 reels per box).....	Per 1000 ft.	9.00
10,000 ft. steel reels.....	Per 1000 ft.	7.50
20,000 ft. steel reels (same wire but single conductor).....	Per 1000 ft.	3.00

The Above Wire is in Stock at these Jobbers:

All-State Distributing Co.
Dallas, Texas

Almo Radio Company
Philadelphia, Pa.

American Radio Corp.
Dover, New Hampshire

H. C. Baker Sales Co.
Roanoke, Va.

Bakersfield Radio Supply
Bakersfield, Calif.

Bessemer Radio Supply Co.
Bessemer, Ala.

Boe Distributing Co.
Dubuque, Iowa

Cabill-Electric Co.
Jackson, Miss.

Chambers Radio Supply Co.
Cincinnati, Ohio

Chase Hunt LaMont Co.
Springfield, Mass.

James W. Clary Company
Birmingham, Ala.

Commercial Radio & Sound
Henryetta, Okla.

Crabtree Wholesale Radio
Dallas, Texas

Crescent Radio Supply
Glasgow, Ky.

Denison Radio Supply
Denison, Texas

Electronic Distributors
Lexington, Ky.

Fentress Sound Equip. Co.
Oklahoma City, Okla.

Fitzpatrick Elect. Co.
Muskegon, Mich.

Fulton Radio Supply Co.
Jackson, Mich.

Geophysical Supply Co.
Houston, Texas

Harrison Equip. Co.
Houston, Texas

Herman Radio Supply Co.
Miami, Fla.

Louis M. Herman Co.
Boston, Mass.

Houston Radio Supply Co.
Houston, Texas

KLA Lab. Inc.
Detroit, Mich.

Lurtz Electric Company
Belleville, Ill.

March Radio Supply
Milwaukee, Wis.

Mid West Associated Dist.
Rockford, Ill.

Morten Dist. Co., Inc.
Fresno, Calif.

Murphy Sales Co.
Buffalo, N. Y.

Northwest Electronics
Spokane, Wash.

Peerless Electronic Equip. Co.
Louisville, Ky.

Pioneer Radio Supply Corp.
Cleveland 15, Ohio

Radio & Refrigeration Supply Co.
Cincinnati, Ohio

Radio & Television Equip. Co.
Santa Ana, Calif.

Radio Equip. Co.
Lexington, Ky.

Radio Products Sales
Denver, Colo.

Radio Products Sales
Los Angeles, Calif.

Radio Service Lab.
Manchester, N. H.

Radio Wire & Television Inc.
Boston, Mass.

Reld Dist. Co.
Birmingham, Ala.

R. G. Scheill & Co.
Hartford, Conn.

H. E. Sorenson Co.
Des Moines, Iowa

Sound Electronics Supply
Portsmouth, Ohio

Southeastern Radio Parts Co.
Atlanta, Ga.

Southern Radio Supply
Little Rock, Ark.

Southwest Radio Supply
Dallas, Texas

Thiele Winslow Co.
San Antonio, Texas

Toy & Novel
Yakima, Washington

Van Stickle Radio Supply
Indianapolis, Ind.

David White Radio Supply Co.
Little Rock, Ark.

Williamsport Radio Supply
Williamsport, Pa.

Other Wire Available from Wells

Field wire, No. 18 stranded, 7 strands (4 steel 3 copper) 2 conductor, rubber-covered, weather-proof, 2000 ft. reels.....	Per 1000 ft.	\$12.00
Field wire, same as above but single conductor, 2000 ft. reels.....	Per 1000 ft.	6.00
Aerial wire, No. 12 Phosphor Bronze, 7 strands No. 20.....	Per 1000 ft.	20.00
Aerial wire, No. 18 copper weld, solid, 3000 ft. reels.....	Per 1000 ft.	7.50
Single conductor, No. 20 shielded, overall braid, 1000 ft. reels.....	Per 1000 ft.	25.00
Single conductor, No. 20 shielded, stranded, outside bare shield, 1000 ft. reels.....	Per 1000 ft.	22.50
Single conductor, ANJC 48 No. 20 stranded, glass braid lacquered, 1000 V. insulation, 2000 ft. reels.....	Per 1000 ft.	12.00
Single conductor, No. 20 stranded, glass braid lacquered, 3000 V. insulation (for transmitters) 1000 ft. reels.....	Per 1000 ft.	16.00



Jobbers write for Wire Bulletin 110
Send your Wire Requirements to WIRE DIVISION

4717 W. MADISON ST., DEPT. R-3, CHICAGO 44, ILL.



HQ-129-X

choice of **THOUSANDS**



Hams are pretty shrewd individuals when it comes to selecting the gear they use. Many thousands knew what they wanted — they're using HQ-129-X receivers on the air every day. That, we believe, is one of the finest endorsements any product can achieve. Materials are still hard to get but hundreds of HQ-129-X's are being shipped every month.

36
BACKED BY

YEARS OF KNOW HOW

SEE THE HQ-129-X AT YOUR DEALER'S



HAMMARLUND

**THE HAMMARLUND MFG. CO., INC., 460 W. 34TH ST., NEW YORK 1, N.Y.
MANUFACTURERS OF PRECISION COMMUNICATIONS EQUIPMENT**

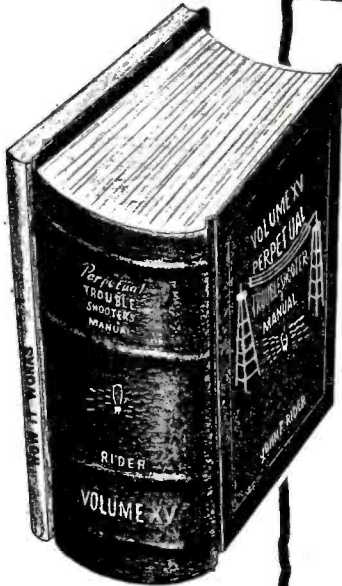

FIGURE IT OUT FOR YOURSELF . . .
WHAT ARE THESE FEATURES OF
RIDER MANUAL VOL. XV
WORTH TO YOU?

What, in dollars-and-cents, is it worth to you, to have the services of Volume XV at your fingertips; this year, next year—for as long as the receivers produced during 1946 keep coming to your shop for repair?

What is the cash value of the time-saving benefits you will get from the exclusive features of this latest Rider Manual? (Volume I is still paying profits to servicemen who bought it sixteen years ago!)

Below are highlights of Volume XV features. Figure it out for yourself. What are they worth to you? As supply is limited, order Volume XV today.

RIDER MANUAL

VOLUME XV — JUST OUT

2000 Pages (Plus 150 page "How It Works")

The greatest single volume of Rider Manual yet published! Nowhere else will you find anything to equal Volume XV in completeness and helpfulness. Nowhere else will you find the wealth of vital servicing data—receiver schematics, voltage data, alignment data, resistance values, chassis layouts and wiring, and trimmer connections for 1946 receivers. Nowhere else will you find such authoritative data so complete and so systematically bound in one volume, ever ready, year after year for quick, easy reference.

That's why, for seventeen years the experience of successful servicemen throughout the world has proved, "You Can't Go Wrong With a Rider Manual."

RIDER MANUALS—IN 15 VOLUMES

Volume XV	\$18.00
Volumes XIV to VII each volume.....	15.00
Volume VI	11.00
Abridged Manuals I to V (1 vol.).....	17.50
Record Changers and Recorders.....	9.00

RECORD PLAYER COMBINATIONS

Maximum coverage and all pertinent information on record players and changers in post-war combinations.

WHAT'S IT WORTH TO YOU?

"clarified schematics"

"Clarified schematics" do a job which you have had to do on every multi-band receiver and combination set coming into your shop. "Clarified schematics" break down the composite diagrams of hundreds of complicated multiband receivers, providing you with exclusive, individual schematics of each and every circuit as it exists with each turn of the wave band or equipment switch. With a "clarified schematic" before you, you save the time heretofore spent tracing out an original schematic to find which components are in operation under different positions of the wave band switch. We have saved this time for your shop, by doing it for you in our laboratories. On this one "plus" service we have spent tens of thousands of dollars in order to save you hundreds upon hundreds of hours each year.

WHAT'S IT WORTH TO YOU? . . .

SEPARATE BOOK — "HOW IT WORKS"

Accompanying each copy of Volume XV is the 150 page book "How It Works," a practical guide to the theories of operation of the new technical features of the latest receivers. It explains and illustrates the functions of those "gimmicks" and "gadgets" which cause time-wasting headaches when not recognized and understood by the serviceman.

WHAT'S IT WORTH TO YOU? . . .

"HAM" COMMUNICATION RECEIVERS

All popular "Ham" sets are covered in Volume XV. This information opens up a profitable market for the competent serviceman who can now offer "hams" the benefits of a local alignment service.

WHAT'S IT WORTH TO YOU?

SCOTT RECEIVERS

Volume XV brings you complete information on all Scott receivers. "Clarified schematics" on these sets break down even the control switching circuits.

WHAT'S IT WORTH TO YOU?

MAGNAVOX RECEIVER-AMPLIFIERS

Volume XV is the only place where you will find a complete compilation of the various receiver-amplifier combinations produced by Magnavox during the ten years between 1937 and 1946.

WHAT'S IT WORTH TO YOU?

**YEAR AFTER YEAR, AFTER YEAR
RIDER MANUALS**

Pour Out Profits For Servicemen

JOHN F. RIDER PUBLISHER, INC. • 404 4th AVENUE • NEW YORK 16, N. Y.

Export Div.: Rocke-International Corp., 13 E. 40 St., N. Y. C. Cable: ARLAB

RIDER RADIO BOOKS KEEP YOU IN TOUCH WITH SUCCESS

Inside the Vacuum Tube Solid concept of theory and operation	\$4.50
Understanding Microwaves Provides foundation for understanding	6.00
Radar Entertaining, revealing, in lay language	1.00
The Cathode Ray Tube at Work Accepted authority on subject	4.00
Frequency Modulation Gives principles of FM radio	2.00

Servicing by Signal Tracing Basic Method of radio servicing	4.00
The Meter at Work An elementary text on meters	\$2.00
The Oscillator at Work How to use, test and repair	2.50
Vacuum Tube Voltmeters Both theory and practice	2.50
Automatic Frequency Control Systems —also automatic tuning systems	1.75

A-C Calculation Charts Two to five times as fast as slide rule	7.50
Hour-A-Day-with-Rider Series—	
On "Alternating Currents in Radio Receivers"	
On "Resonance & Alignment"	
On "Automatic Volume Control"	
On "D-C Voltage Distribution"	\$1.25 each



This new Rider Book, soon to be announced, will be of lasting usefulness to everyone interested in any phase of radio.

What Kind of Tubular Paper Capacitor Do You Need?



The MALLORY Line of capacitors is really complete

MALLORY makes 75 different paper tubular capacitors to supply your "every need" and for your convenience. They range in rating from 400 volts to 1600 volts—and in size from $\frac{3}{8}$ " x 1" to $1\frac{1}{4}$ " x $2\frac{1}{2}$ ".

These paper tubulars are divided into two broad categories—wax impregnated and oil impregnated. Both are hermetically sealed to provide against atmospheric penetration. Both are carefully factory-tested so you get *all* the quality that Mallory puts into them.

Get the complete story from your Mallory Distributor or from the Mallory Catalog.

You save a lot of time if you check the Mallory Catalog for replacement parts as you need them. Do you have a copy? If not, see your Mallory Distributor.

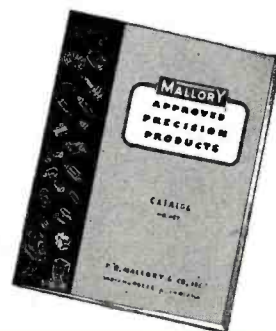

YOU EXPECT MORE AND GET MORE . . . FROM MALLORY

P. R. MALLORY & CO. Inc.
MALLORY

VIBRATORS . . . VIBRAPACKS® . . . CAPACITORS . . . VOLUME CONTROLS . . . SWITCHES . . . RESISTORS . . . FILTERS . . . RECTIFIERS . . . POWER SUPPLIES.

®Reg. U. S. Pat. Off.

APPROVED PRECISION PRODUCTS

P. R. MALLORY & CO., Inc., INDIANAPOLIS 6, INDIANA

performance
long life
economy

AMPEREX

Tubes

TYPE HF60: Topflight performance at moderate price. Ideal for small transmitters and amateurs. Widely used as generator of HF power in industrial and medical circuits.



TYPE 810: A versatile general purpose tube for nearly all types of service. Plate dissipation of 150 W. permits delivery of 475 W. continuous operation as Class C oscillator or amplifier.

TYPE HF100: An original Amperex contribution favoring operation with low voltage and high current. Special characteristics for HF circuits. Anode dissipation conservatively rated 100 W.



TYPE 1701: Thermionic, grid-controlled gas-filled tube. Heart of electronic "switch" controls in variable voltage and other electrical apparatus. Important to designers and experimenters.

And all other types you need.
Write for technical rating and data sheets.



AMPEREX

ELECTRONIC CORPORATION
25 Washington St., Bklyn 1, N. Y.
Cables "ARLAB" • in Canada and Newfoundland: Rogers Majestic Ltd.,
622 Fleet St. West, Toronto 28, Can.

Spot Radio News

* Presenting latest information on the Radio Industry

By **FRED HAMLIN**

Washington Editor, RADIO NEWS

ITEMS TO ADD to your radio believe-it-or-nots; "radaranges," which can cook faster and more efficiently than any stove; radio hypnotism, which has the British Broadcasting Corporation and English television experts in a dither, and an electric baby sitter far more efficient than any you can engage in your neighborhood—as what wouldn't be?

RADARANGES recently became official when the Federal Communications Commission gave the remote-control stoves a frequency—2450 megacycles. On the heels of this announcement comes word from the Raytheon Manufacturing Company, that tests show you can cook a hot-dog in from eight to ten seconds, gingerbread and biscuits in 29 seconds, hamburgers and onions in 35 seconds, and frozen foods without thawing. Raytheon claims this timing to be 95 per-cent better than any existing stove. The trick is that the radar heater warms from the inside out, while with conventional units it's just the opposite. But tell the girl-friend not to get her hopes up—radaranges will be too costly for home use. Raytheon plans to make a hundred thousand of them in the next few years—for railroad diners, airliners, and vending machines.

BBC'S HYPNOTISM experiment via television was conducted privately, and officials were more shocked than pleased by its success. Peter Casson; a young ex-Royal Navy enlisted man, put some of the BBC brass so soundly asleep that he had to get off the air and talk to them personally before they woke up. One of them, more imaginative than the rest, began to think with horror of a whole nation being put to slumber by some future Hitler in the days when television will be as common (he said) as regular radio is now. The British immediately buried this possibility in England by barring hypnotists from television studios. Casson countered with the plea that telehypnotism could be used to help cure stammering and other neurotic disorders—he was successful with shell-shock cases during the war—but the BBC rule remains. U. S. televisors took an equally dim view. Said John F. Royal, National Broadcasting System vice-president in charge of television: "We feel hypnotism could be potentially a very dangerous and risky

thing." No less ominous, perhaps, was his closing remark: "If people fall asleep watching our television," quoth he, "we trust it will be from natural causes."

THE BABY-SITTER DEVICE is the brain-child of a Washington, D. C., ex-electronics instructor, also a Navy man (U.S.). He is Keith C. Johnson, and has rigged equipment that broadcasts baby yells to and from his home and those of two neighbors, also with small children. The system amplifies baby sounds so that you can hear quiet breathing clearly in the receiver at the other end of the line. If the baby really tunes in with a howl, the loud-speaker nearby shakes the roof off. The trick is for the Johnsons to go to the movies, while one of the neighbors watches the kiddies by tuning in; another night, a neighbor goes to the movies, the Johnsons listen. Cost of the equipment, Mr. Johnson says, runs about \$15 per family—\$45 for his hook-up. In Washington, where baby-sitters are scarce, his device has created a sensation, but from where we sit (with an 18-month-old youngster upstairs) Johnson should be given dubious credit. Whoever heard of magnifying an infant yell—we can hear ours, when he gets going, for a mile upwind, without hook-up. We think that Mr. Johnson should be censured severely for aiding and abetting the situation.

THERE ARE a substantial number of good jobs in FM broadcasting, according to experts who recently attended the FM Association convention—first of its kind—in Washington. One of the delegates, Don Martin, of the School of Radio Arts in Hollywood, whose organization has been swamped with requests, estimates the grand total of openings to be more than 7000. This is on the basis that the average FM local station will have to have a manager, a sales manager, a production staff with a minimum of three announcers, a three-man technical staff, some kind of office manager, and a receptionist—ten persons in all. With (a conservative) 700 stations expected to be going by the end of 1947, he believes 7000 an equally conservative personnel figure. Speaking very generally—the talent of the individual, plus experience, and the city in which he works are important

The New **DELCO RADIO** Combination

For those
who demand
the *Best*



This handsomely styled, engineered-for-tomorrow radio-phonograph combination features the finest in AM and FM reception, with fourteen tubes plus rectifier, and a mammoth 15-inch speaker for full tone range. It provides push-button tuning—not only on the standard AM broadcast bands but on FM as well!

And the phonograph? Here again Delco offers the best of all that's new! A special lightweight tone arm, with sapphire permanent-point pick-up, gives amazing fidelity and tone quality . . . but that's not all! Its advanced design eliminates needle changing, makes records last years longer.

Add to these great features a smooth-action record changer with the extra capacity of fourteen 10-inch records or ten 12-inch records—an automatic shut-off that goes into action when the last record is played—and you realize that this instrument has *everything!*

To put this magnificent Delco combination in anything but the finest cabinet would be unthinkable. Expert craftsmen have produced cabinets of grace and distinction to give it the proper setting. Model R-1251 in walnut, and Model R-1252 in mahogany, are masterpieces of fine furniture.

Like other Delco portables and table models, this fine new Delco combination brings new honors to the trusted Delco name of General Motors. United Motors Service, General Motors Building, Detroit 2, Michigan.



Production is Improving

But there are still many shortages of materials and component parts which make it impossible to meet the large demand for Delco radios at this time. If your distributor is unable to fill your order for Delco radios promptly, keep trying. You can count on it that he's doing his best, and that we're doing ours to speed production.

DELCO RADIO A GENERAL MOTORS PRODUCT

Delco radios are distributed nationally by United Motors Service. See your United Motors distributor about the Delco radio line.



**Transformers designed and
fabricated by engineers of
specialized experience, for
service departments that
make the most exacting re-
quirements. This is Merit
principle and practice.**

EXPORT DEPARTMENT:

1791 Howard Street, CHICAGO 26, U. S. A.
Cable Address: MERIT



MERIT COIL & TRANSFORMER CORP.

TELEPHONE

4427 North Clark St.

Long Beach 6311

CHICAGO 40, ILL.

SPOT RADIO NEWS

factors—price tags on the jobs begin at \$60 per week for announcers, \$75 for a chief engineer, \$60 for operators. Combination men—Mr. Martin is training announcer-operators, for instance—get proportionately more. Supply of trained personnel, he reports, is far behind demand and “the need stands to be a real problem.” To get such jobs, if you are qualified, best bet according to the leaders with whom we talked is to contact your nearest FM station, especially if it has not yet started operations.

FM-ERS, INCIDENTALY, are the most optimistic businessmen in the nation today. With fewer than average transition problems after the war—they had nothing to “transition” from—with a brand-new gadget that has proved already that it fills a real need, and with RMA campaigning for “A Radio for Every Room—A Radio for Every Purpose”—FM manufacturers and broadcasters go into the spring proclaiming that 1947 is their year. Typical of the industry attitude is the recent statement by Prof. E. H. Armstrong, FM’s inventor, that the new-style radio business has a potential of \$100,000,000 a year on sets alone—and will go up from there. “The evidence indicates manufacturers can sell FM sets as fast as they can be turned out,” he added. A production of 5,000,000 FM sets in 1947 is predicted by W. R. David of the General Electric Company. Less than 150,000 were produced in 1946. David also predicts that nearly a thousand stations will be in operation before 1948 rolls round. He hails their coming as “the biggest thing that has ever happened in radio broadcasting, the FM transmitter business, or the FM receiver business.” . . . Roy Hofheinz, KTHT-KOPY, Houston, Tex., new FMA president, joined the others in predicting a banner year.

THE RADIO - IN - EVERY - ROOM campaign being conducted by RMA will—in case you don’t already know—play up FM. Edward R. Taylor of the Zenith Radio Corporation, Chicago, is in charge of the drive. He says FM will open a huge new field for sales efforts and is a compelling reason for increasing the number of radios in the home. The increased number of radio stations which FM is bringing on the air, he adds, makes it more imperative to have additional receivers so that every member of the family may get his favorite program, if necessary, at the same time. . . . He brings out a number of other interesting facts: About 90 per-cent of American homes now have at least one radio. One out of every three families has at least two. Most radio sets today are in the living room. Bedrooms run second, the kitchen a poor third. The great majority of radio receivers in the living room are consoles and radio-phonograph combinations, while the bedroom has the greatest number of midgets and table

Let Us Show You How to Prepare TO MAKE REAL MONEY QUICKLY!!



EX-G. I.

TEEN-AGE
YOUTH

OLDER MAN

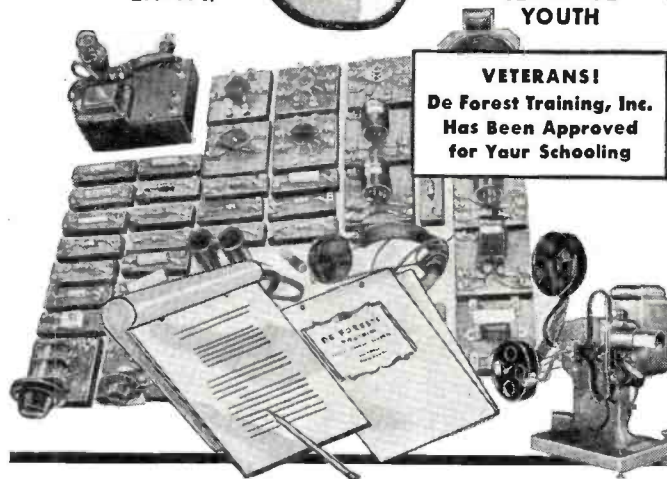

VETERANS!
De Forest Training, Inc.
Has Been Approved
for Your Schooling

Whether you are an ex-G. I., a teen-age youth, or an older man eager to earn real money...There can be a place for you in The Billion Dollar Field of Electronics and Radio

You will probably find no greater variety of money-making opportunities than in the fields of Electronics and Radio. Hundreds of men, who today either successfully operate their own businesses or hold important jobs in these fascinating fields, are graduates of DeFOREST'S TRAINING, INC.

Our Home Study or Residence courses, thorough in every detail, offer a unique combination of training advantages. We furnish you with a 16 millimeter Motion Picture Projector and 12 reels of valuable movie film. You also use 8 big kits of Radio-Electronic parts as shown on this page, enabling you to work out 133 MODERN EXPERIMENTS for valuable practical experience.

When you prepare to enter the exciting fields of Electronics and Radio, you will want every necessary home study benefit. DeFOREST'S TRAINING, INC. gets you off to a brighter future by supplying these major benefits at home; (1) Learn by Seeing from movies showing radio circuits in action as well as other clearly animated illustrations (2) Illustrated Loose-leaf lessons with handy fold-out diagrams help make our training easy to understand. (3) Learn-By Doing . . . in your home laboratory you have the opportunity to get real "SHOP METHOD" experience from the many commercial type Radio-Electronic parts you receive. (4) Employment Service . . . after you complete your training, our effective employment service helps you GET STARTED.

DeFOREST'S TRAINING, INC. offers the only Home Study or Laboratory training in the nation endorsed by the New York Museum of Science and Industry, Radio City, New York City.

NATIONALLY KNOWN RADIO STATION CONSULTING ENGINEER RECOMMENDS COURSES OF DeFOREST'S TRAINING, INC.



"Now is the time . . . to prepare to enter the fields of Radio and Electronics . . . no greater opportunity is afforded the high school student . . . the war veteran . . . or the man who is eager to make more money," says Ellery L. Plotts, nationally known Radio Station Consulting Engineer and former Special Research Associate at Harvard University's Radio Research Laboratories. "A study of the DeForest Training, Inc. courses enables me to highly recommend either the Home Study or Residence course."

EX-G. I. STUDENT LAUDS DeFOREST'S EMPLOYMENT SERVICE

"Dear Sir: Due to the fact that I am enrolled in your school, I am now employed by the Westinghouse Manufacturing Company instead of a steel mill. This is a great opportunity for me because this is a new branch opening in this territory and there is a great chance for advancement.



Elmer H. Havens
Lancaster, New York"

DeFOREST'S
TRAINING, INC.
CHICAGO, ILLINOIS

Without obligation, send for our valuable, information-packed book, "VICTORY FOR YOU." MAIL COUPON TODAY.



DeFOREST'S TRAINING, INC.
2533-41 N. Ashland Ave., Dept. RN-D3
Chicago 14, Illinois, U. S. A.

Send me your big book "VICTORY FOR YOU," showing how I may make my start in Radio-Electronics with your modern home training plan. No obligation.

Name Age

Address Apt

City Zone State

If under 16, check here for special information.

If a discharged veteran of World War II, check here.



**EASY ON THE EAR
WITH**

Smooth Power

• That's what counts with your customers! Give them faithful reproduction, free from wow and rumble, and your selling job will be easier and more profitable.

You'll get that fine performance from our complete *Smooth Power* line of phonomotors, recorders and combination record-changer recorders. They're carefully engineered and faithfully built for quick pick-up, constant speed and freedom from noise and vibration. They're *easy on the ear*.

They'll make fitting companions for your own fine products.

NOTE TO INDIVIDUAL USERS
Smooth Power Motors are sold only through established trade channels.

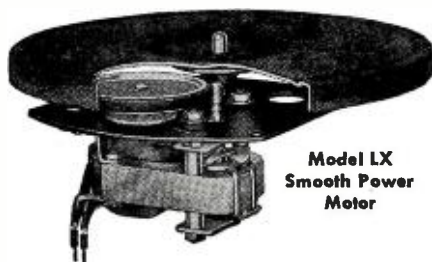

Model LX
Smooth Power
Motor



DEPT. MR • ELYRIA • OHIO

models. The kitchen runs second on midjets and third on table models. An estimated 20,000,000 pre-war radios are in need of replacement and Mr. Taylor expressed the opinion that many of them will be replaced by modern FM-AM receivers. . . . RMA is spending \$50,000 on the drive, but thousands more will go into national advertising by industry members of the Association and cooperating sales groups.

LATEST DIRECT COMPARISON of FM-AM stations issued by FCC shows that this year began with 553 cities or metropolitan districts in the U. S. which had one or more licensed AM stations, but of these, no FM application has been received from 208, or 38 per-cent. Geography is the major factor in this—more than half of the non-applicants are located in the West Central, Mountain and Pacific regions. More specifically, the states in the West Central region in which proportionately few AM cities have provided FM applicants include North and South Dakota, Nebraska, Kansas, Arkansas and Oklahoma. These six states of the eleven in the region have a total of 57 AM stations, but FCC has received FM applications from only 19, or one out of three. Similarly, Montana, Wyoming, Colorado, New Mexico, Arizona, and Utah have 44 AM cities, but only 8 FM applicants—one out of five. Washington and Oregon, with 29 AM's and 9 FM applications, rate one out of three. . . . But the West is not alone in thin FM states—Maine, New Hampshire, Vermont, Alabama, and Mississippi show little enthusiasm for the new media, if applications are an indication. It follows that FM is most active in eastern metropolitan areas and in the middlewest.

ALL OF WHICH is not to imply that AM broadcasting is not experiencing pretty good times itself, now that the war is over. Federal Communications Commission's most recent summary shows that a total of 365 permits for construction were granted for AM stations between VJ Day and last September 19. Of these, 187, or 51.2 per-cent, were issued in cities which had no existing radio station as of VJ Day. All such cities had populations of 50,000 or less. In addition, 82 construction permits, or 22.4 per-cent, were issued in cities with only one existing station and over half of these grants—57—went to cities of 50,000 or less. . . . The most common type of AM grant was for a 250 watt unlimited time station in a community of 50,000 or less. . . . More recent summaries are complete on FM activities. As of the first of this year, there were 136 stations on the air and construction permits granted since October 8, 1945, totalled 426. But AM still played an important role, even in the FM field. Of the permits issued, 74 per-cent were to persons already holding AM permits. An additional 12.6 per-cent

were issued to non-AM newspaper interests. Over-all, 36.3 per-cent of the applicants had newspaper connections.

FCC, WHOSE PROFESSIONAL HAMS did dramatic work during the war detecting enemy radio activities, is having equally good luck catching up with domestic violators in the post-war world. The Commission's detection of illegal stations is so accurate, indeed, that those in charge of it keep wondering why anybody would want to try to beat the game. More than 200 illegal operators have been apprehended since the war ended. Many of them are kids up to mischief, and are dealt with accordingly on a first offense; but an increasing number of adults, who know exactly what they are doing and are under the illusion that they can get away with it, are showing up on FCC records. For these the going can be tough—maximum penalty may run to \$10,000 or two years imprisonment—or both. . . . FCC does not take all the credit for its detection service, pointing out that 25,000 radio stations, 315,000 radio operators, and nearly 80,000 amateurs are always ready to report strange signals or an erratic "driver" in their bands. Hams "are especially quick to report," FCC says. Reports are relayed to FCC field offices and the Commission's 22 monitoring stations and from then on it's just a matter of time till the violator is run down. Why, in the face of this routine, illegal operators continue to crop up, is one of the minor mysteries at FCC headquarters in Washington these days.

ALTHOUGH, WHEN CONTRASTED with radio goings-on in this country, foreign activities seem small, they are nevertheless improving. In Japan, for instance, set production increased nine times its size between January and June of last year—from 8000 to 75,000. The Japs, like us, had tube trouble and total set production for the year was much less than we turn out in peak months. . . . Similarly, in England production for the year ending this spring was high for England—approximately 1,750,000 sets. Some 400,000 of these will be exported. The British Isles also report a new all-time high of radios in use—nearly 11,000,000. . . .

SUCH SAMPLINGS of the news from abroad indicate that U. S. manufacturers are far and away ahead of foreign competitors, and with this in mind the Radio Manufacturers Association has come out strongly through its export committee to urge the Federal government's support in protecting American interests. RMA's statement was made timely in light of the spring negotiations by the State Department on reciprocal trade agreements. RMA export committee chairman A. D. Keller has asked that trade barriers be withdrawn or reduced to "the point where our manufacturers

(Continued on page 153)

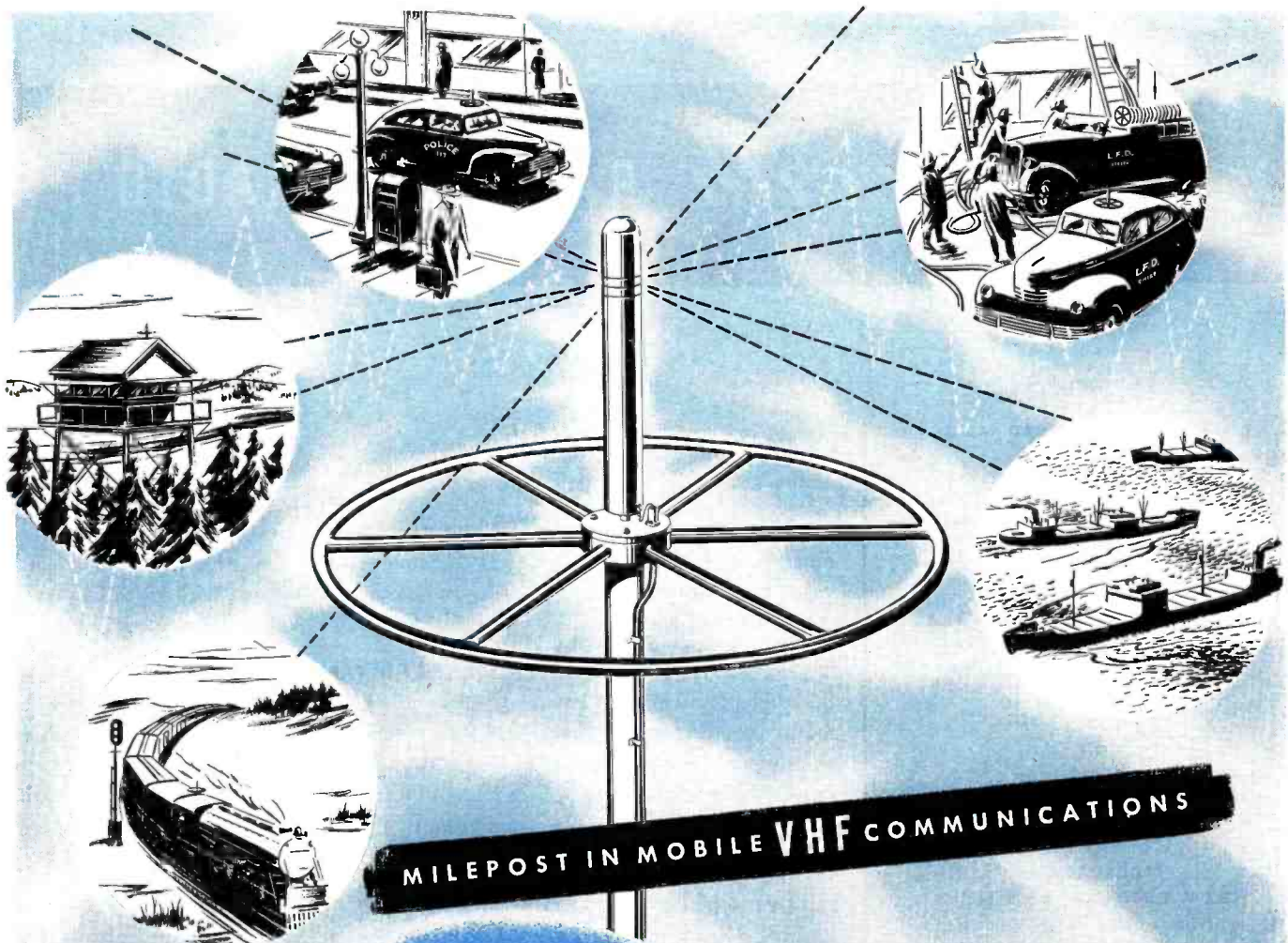

THE NEW

AMPHENOL

GROUND PLANE ANTENNA

Efficient VHF radio communications is a must in modern railroading. Used to expedite freight and express service, it is cutting hours from schedules, and eliminating waste time and money in switching operations.

Designed principally for use in the 152-162 mc band by railroads for "train-to-fixed-station" and "end-to-end" communications, the new Ground Plane Antenna illustrated is foremost among many new VHF radio components and accessories perfected by Amphenol engineers.

Providing maximum power radiation at low initial cost, this extremely rugged antenna consistently out-performs other antennas under normal and extreme conditions. It is easily and quickly installed, and has been thoroughly tested in main-line railroad installations.

Danger from lightning or contact with power lines is eliminated, as this antenna is at ground potential. The nature of its radiation pattern insures uninterrupted service during sharp "U" or "S" turns.

The Amphenol Ground Plane Antenna is also widely used by police and fire departments, by forestry, geophysical, power and petroleum field crews, for mobile marine installations, and many others. It is available with Ground Plane Skirt, as shown, for installations where a large metallic mounting surface is not available.

Write today for complete technical data on the Ground Plane Antenna, or for engineering aid in solving your VHF radio communications problems.



AMERICAN PHENOLIC CORPORATION
CHICAGO 30, ILLINOIS

COAXIAL CABLES AND CONNECTORS • INDUSTRIAL CONNECTORS, FITTINGS AND CONDUIT • ANTENNAS • RADIO COMPONENTS • PLASTICS FOR ELECTRONICS
March, 1947

Farnsworth RAILROAD RADIO

A MILESTONE IN RAILROAD RADIO!

"Modern railroad transportation systems cannot function to their maximum efficiencies without the use of modern communications networks. That is why the Santa Fe System maintains complete telephone and teletype, as well as telegraph systems along its entire thirteen-thousand-mile right-of-way. It is also the reason for Santa Fe's immediate and careful exploration of all new communications techniques, such as railroad radio, and accounts for the many 'firsts' contributed by the Santa Fe to the railroad communications art."

President
Atchison, Topeka and Santa Fe Railway



"RAILROADS ...

LIKE A GIANT CONVEYOR BELT"

"The war has emphasized the importance of American railroads. Like a giant conveyor belt, they link up the industrial, agricultural and mining areas of this country with the many thousands of markets that dot our land. With reconversion a fact, far-sighted railroad management is carefully exploring many technical war developments, and, in particular, radio, with the expectation that radio will help keep American railroads the safe, efficient and modern network of transportation which has so ably served the Nation during the war."

President, Toledo, Pelee & Western R. Co.



"THIS PIONEERING EFFORT ..."

"The Chicago and North Western Railroad, always interested in technological developments which promise improvement in the efficiency and safety of railway operations, participated in the first regular use of very high frequency railway radio. This installation went into operation in our Proviso Yards in September, 1940, and continued for over a year thereafter.

"We are happy that the technical and operating information secured from the pioneering effort was subsequently useful to the Army Ordnance Department and to the operators of the large Army Ordnance Plants in making their decision to use railroad radio in connection with the war effort.

"The case histories provided by the use of radio at Proviso and in the large ordnance plants were later to become an important part of the railroad testimony in the Federal Communications Commission hearing which brought about the present allocation of frequencies for railway use."

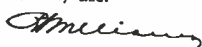
President,
Chicago and North Western
Railway System



Farnsworth radiotelephone systems, now ready to serve the Nation's railroads, provide:

(1) RELIABLE RADIOTELEPHONE CIRCUITS

Farnsworth guarantees its railroad radiotelephone systems for a period of one year—the same kind of comprehensive guarantee furnished with U. S. Government war-time radio equipment on which battles and lives depended.

(2) IMPROVED OPERATING SERVICES AND FACILITIES

Radiotelephone circuits between train crews and supervisory personnel permit industrial customer requirements to be fulfilled more rapidly; provide reliable and instantaneous communications even during adverse visibility conditions; enable the quick reporting of equipment failures and the more rapid and efficient dispatching of relief; permit crews instantly to report unscheduled stops to near-approaching trains.

(3) SAVINGS IN OPERATIONS

Railroads using modern radiotelephone circuits have reported through official Association of American Railroads documents convincing proof of the important money-saving, as well as safety-contributing abilities of radiotelephone circuits.

(4) LOW-COST INVESTMENT AND MAINTENANCE

Farnsworth equipment incorporates such important operating and maintenance features as standardized chassis with unitized construction, low-clearance antennas, automatically engaging plug-in type connectors, and special test circuits. The combination of these features, *found only in Farnsworth equipment*, guarantees maximum availability, flexibility, and usefulness with simplified low-cost maintenance. Yet, Farnsworth railroad radio equipment is priced competitively with other quality systems, many of which lack these special features.

For detailed particulars of Farnsworth Mobile Communications Systems, write Farnsworth Television & Radio Corporation, Dept. RN-3, Fort Wayne 1, Indiana.

"TO ATTAIN

STILL HIGHER STANDARDS OF SERVICE ..."

"An asset in which the Nickel Plate Road takes great pride is the high standard of service which it renders to the shipping public. With its record for outstanding performance during the war years back of it, the Nickel Plate is looking forward to the utilization of new technological developments, such as radio and teletype, in order to attain still higher standards of service and usefulness."



President,
The New York, Chicago & St. Louis R. R. Co.

The New York, Chicago & St. Louis R. R. Co.



"Train Radio to Aid in Operation of Pere Marquette's New Streamlined Trains"

"By virtue of their efficient and effective performance during the war, the nation's Railroads have won the respect and goodwill of the American people. It is essential that this public esteem be maintained. That is why progressive railroad managements are planning the use of many technical developments capable of making additional contributions to the safety and comfort of rail passenger service and why the new, streamlined passenger trains which Pere Marquette soon will put into operation are to be equipped with train radio communication systems."

President
Pere Marquette Railway Company



IS READY TO SERVE THE NATION

November 27, 1946

Mr. John Curtis, Manager
Mobile Communications Division
Farnsworth Television & Radio Corp.
Fort Wayne 1, Indiana

Dear Mr. Curtis:

I wish to thank you for your letter outlining the excellent progress which the Farnsworth Television and Radio Corporation has made in developing and producing various types of equipment for railroad radio communication. I was especially pleased to read that section of your report which quotes various railroad presidents who recognize that radio will enhance safety and efficiency in railway operations.

As you know, the Commission has been convinced for some time that a properly engineered railroad radio system will contribute to safety of life and property, both in preventing accidents and in reducing the seriousness of injury and damage after accidents. While safety is of paramount importance we also recognize and encourage the use of radio as a means of improving the overall efficiency of the railroads.

Sincerely yours,

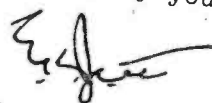

E. K. Jett,
Commissioner



Commissioner Ewell K. Jett has been a motivating factor in the development of radio communications since the pioneering days of the early 20th Century. From 1911-1929 he participated in the development of the Navy's use of what was then a new communications art. Since 1929, Mr. Jett has been associated with the Federal Communications Commission and its predecessor, the Federal Radio Commission, first as Assistant Chief Engineer; then, since February 1, 1938, as Chief Engineer. On February 15, 1944,

Mr. Jett was appointed Commissioner.

Throughout his career with the Navy and the Commission, Mr. Jett has been alert to the ever-increasing usefulness of radio in mobile operations. More recently, with the development of radio equipment for railway and highway services and Mr. Jett's origination of the Citizens' Radio Communication Service, his activities with the Commission have taken on even more significance to American economy and well-being.

Farnsworth

Television • Radio • Phonograph-Radio

Farnsworth Radio and Television Receivers and Transmitters • Aircraft Radio Equipment • Farnsworth Television Tubes • Mobile Communications and Traffic Control Systems for Rail and Highway • The Farnsworth Phonograph-Radio • The Capehart • The Panamuse by Capehart
March, 1947



MODEL 4604F



The Baron

Now! A 2-Band, Table Model with Console Features — Standard and Short Wave Reception with Interference Eliminator

Here's the kind of price-quality feature which brings extra business into a fine radio shop. Air King precision craftsmanship enables you to present to your most appreciative customers a 2-Band, high performance radio finished in rich American walnut. The set has superb good looks and exceptional tone. When you see how brilliantly it demonstrates and remember that it offers fine radio reception on both standard and short wave, anywhere in the country, you can see its great possibilities as a stepper-up of immediate sales income.

Note this combination of Air King Features—
Interference eliminator that blocks out code telegraph. Built-in Phonograph Jack to accommodate

automatic record changer. Convenient panel control for phonograph connection. 6 Tubes (including rectifier) with Superheterodyne circuit. 7 inch Selectorloop. Alnico #5 "Tone King" speaker.

Air King Products Company, Inc.
1523-29 63rd Street, Brooklyn 19, N. Y.

The Royalty of Radio Since 1920

AIR KING RADIO

Division of HYTRON RADIO & ELECTRONICS CORPORATION, Brooklyn, N. Y.
Export Address: Air King International, 75 West Street, New York 6, N. Y.

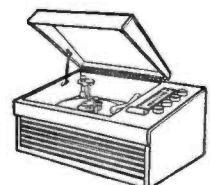
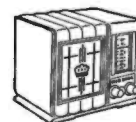
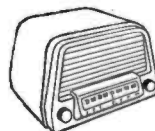
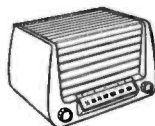

★ WE HAVE A LIMITED NUMBER OF DISTRIBUTOR AND DEALER TERRITORIES OPEN ★
26 RADIO NEWS

Learn **RADIO** TELEVISION ELECTRONICS

I'LL TRAIN YOU AT HOME IN YOUR SPARE TIME



For a Good Pay Job or
A BUSINESS OF YOUR OWN!

My Proven 2-Way Method Helps You Get into Radio *Quicker!*

HERE'S PROOF OF THE QUALITY OF H.R.T.I. TRAINING

1st, 2nd and 4th Prizes Won by
H. R. T. I. Students In Open Contest

With over 250 students and graduates from many Radio schools, as well as experienced radio men, competing to find the best Radio Technicians in Cuba . . . 7 out of the first 10 prizes were won by H.R.T.I. Graduates! These **PROVEN RESULTS** speak for themselves! You can't afford to gamble with your future. Choose the Radio School with the success record . . . H.R.T.I.

WHAT WINNER OF FIRST PRIZE SAYS:



"Your training methods are so practical, and so clear, that no one should have difficulty in learning. I found everything so easy that it makes me feel that anyone who takes your course can be sure of success."

LUIS ILLADA, Havana, Cuba

WHAT SECOND PRIZE WINNER SAYS:

"I am very happy about my success, but it is to you and the H.R.T.I. staff that I owe my success. I am deeply grateful to H.R.T.I. for I have received all and MORE than you promised when I enrolled."



ALFREDO RODRIGUEZ, Oriente, Cuba

WHAT WINNER OF FOURTH PRIZE SAYS:

"The 1st, 2nd and 4th prizes were won by H.R.T.I. students! This shows that H.R.T.I. is one of the best schools! Over 250 radio technicians competed. Among them were real experts of established radio shops as well as students of nearly every known school. You will notice, from the enclosed newspaper, that the 4th prize was won by me, and I owe it all to your easy method of teaching."

GODFREDO REYES, Oriente, Cuba

Find out about the money-making opportunities Radio offers you. Learn how you can qualify for a good-pay job or start a business of your own *without capital*. Send below coupon for my big FREE book, "Your Opportunities in Radio & Television," which tells of radio's vast opportunities and how **HOLLYWOOD RADIO & TELEVISION INSTITUTE** has been training men for success in Radio for over 17 years, in over 40 different countries, through its proven 2-WAY METHOD—**LESSONS PLUS HOME SHOP PRACTICE!**

YOU PERFORM OVER 300 RADIO TESTS AND EXPERIMENTS

I send you 9 kits of radio parts with which you make hundreds of interesting,

fascinating tests and experiments. You learn the "whys and hows" of radio *first hand, by doing*. Thus, you learn *more thoroughly, faster!*

MANY H.R.T.I. STUDENTS EARN MONEY IN SPARE TIME WHILE LEARNING

From the very start, through special "Spare Time Work Sheets," I show you how to earn money in spare time by doing good-pay radio jobs that abound in nearly every neighborhood. Many students earn \$5, \$10, and more a week while learning. A mighty good way to lay the foundation for a future radio business of *your own*.

Now is the time to start preparing for **YOUR** career in this fast-growing industry. Take the first step—send coupon for my big FREE Book today.

YOU GET 9 KITS OF RADIO PARTS WITH WHICH YOU PERFORM OVER 300 EXPERIMENTS

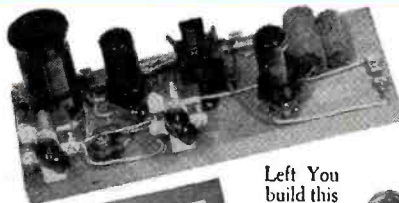

Left: You build this transformer coupled audio stage. (Experiment No. 260)



Above: You build this tuned radio stage, regenerative detector and audio amplifier. (Experiment No. 329)



Left: You build this Multi-purpose Shop Test Panel. 5 Test instruments in one.

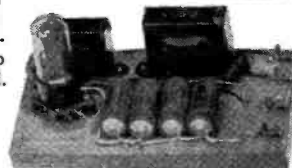

Left: You build this A. C. Power Supply.

YOU LEARN BY DOING

You build these and many other radio circuits and testers with the 9 kits I send you, to help you learn faster, more thoroughly. All kits become your property.



BIG FREE BOOK

HOLLYWOOD IS A WORLD CENTER

of radio broadcasting and manufacture—television—motion picture production. Thus, H.R.T.I. is in an excellent location to bring you modern, up-to-the-minute instruction.

Before you decide on *any* course you owe it to your future to find out about H.R.T.I. training. Read what graduates in 40 different countries say about this famous course. Just paste coupon on a postcard or send in envelope. No salesman will call.

HOLLYWOOD RADIO & TELEVISION INSTITUTE
810 West 6th Street, Los Angeles 14, California

C. H. Mansfield, President, Dept. E-1
Hollywood Radio & Television Institute
810 West 6th St., Los Angeles 14, Calif.

Send me your FREE book, "Your Opportunities in Radio, Television & Electronics" which explains your 2-way training method. (No salesman will call)

Name _____ Age _____

Address _____

City _____ Zone _____ State _____

DON'T PUT IT OFF, MAIL THIS COUPON AT ONCE!

BUY at NEWARK FOR REAL ECONOMY AND TOP QUALITY

Fresh Stock! NEWARK CRYSTALS

6-11-20-40-80 METERS

Here's more of these precision cut, low drift crystals! Accurately calibrated, fully guaranteed.

80 Meter Type	X1—	3500-4000
40 "	X2—	7000-7300
6 "	X3—	6250-6750
11 "	X4—	6797-6866
6 "	X5—	8335-9000 KC
20 "	X6—	14100-14300

Send your order now. We will fill from stock to nearest specified frequency.
Sensational value at... **88¢**
3 Asst. for only \$2.40

in Stock! GON-SET CONVERTERS

FOR 20, 10-11,
OR 6 METERS

A necessary and reliable adjunct to your present receivers. For fixed and mobile use. Built-in pre-selection. Well-constructed, complete with connecting cables. Your cost—each, any type... **\$39.95**
Special Noise Silencer... 8.25

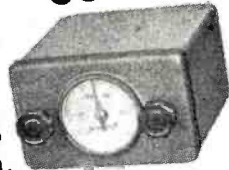

DETROLA RECORD CHANGER

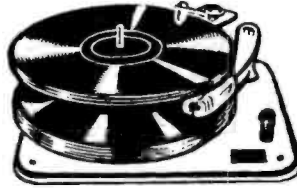

10" or 12" records. Free floating tone arm has high fidelity crystal pickup. Gearless, foolproof mechanism. Sensationally low price... **\$14.95**

Sturdy base, walnut finish, mounting holes and cutout provided. Your cost **\$2.49**

Build Your Own Record Player
A sturdy rim drive phonomotor — 78 r.p.m. Lightweight, high fidelity crystal pickup. Combination motor and turntable and pickup sell regularly for \$15. Now you can own both, less cabinet, for only



\$5.95

TWO-CHANNEL CONTROL BOX

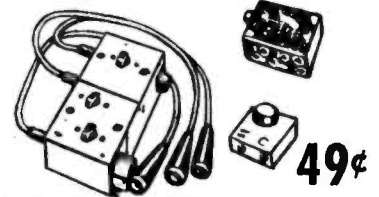

49¢

This 2 channel control box has wide and varied application in Ham shacks, P.A. and intercom work. Incorporates 4P. DT gang switches, 3 terminal plugs, several 1/4-watt resistors and illuminated dial light including bulb, three 5 ft. cables and plugs. Brand new — a terrific buy!

NEW DYNAMOTOR

POWER SUPPLY



A fortunate buy enables us to offer a sensational new low price. All brand new. Operates from 6-12 Volt battery. Delivers 500 V DC at 160 ma. Special, your cost **\$9.95**

Best Buy of the Year!

1 MIL METER

3 1/2 in. R. D. CASE
A sensational value, this meter has higher sensitivity than a comparable movement selling for many times this price.
Basic movement is 0.1 mil and has a resistance of only 75 Ohms, with special construction to provide excellent damping. Scale reads 0-2 MA, 0-40 MA—has internal multiplier of 100r.
Only 600 available at this extremely low Price—Order now. **\$3.95**



WESTINGHOUSE 3 1/2 AC VOLTMETER

RECTIFIER TYPE

A rectifier type AC Voltmeter having sensitivity of 2,000 ohms per Volt. Basic movement 0-500 Micro Amps with enclosed rectifier. Scale reading 0-2 Volt.
Round 3 1/2" Bakelite Case. Meter made to self for \$17.00. Now at Newark for only... **\$3.95**



0-500 MICROAMMETER

Just received an additional shipment of these outstanding 2 1/2" meters having a 0-500 MA movement, well damped, and with a 0-600 V. D.C. scale.
A swell meter for your rig or to have around the bench as a spare.
Don't fail to get yours at this especially low price **\$2.95**



Standard Receivers Now Available!

HALLICRAFTERS	
S-3 complete	\$47.50
S-40A complete	89.50
SX-42	275.00
NATIONAL	
HRO-5Tal complete	306.71
NC-240D with speaker	241.44
NC-46 with speaker	107.40
1-10A with tubes, less speaker and power supply	67.50
HAMMARLUND	
HQ-129X complete	173.25
SP-400X complete	342.00
RME-45 complete	198.70
RME-84 complete	98.70
Panadaptor	99.75
Temco 75 GA XMTR	495.00
Meck Transmitters	150.00

Mail orders filled promptly FOB New York or Chicago. Send 20% deposit with order. Prices subject to change.



T-17B MICROPHONE

Sturdy, high quality, lightweight 200 ohm single button carbon mike with press to talk button for transmitters, P.A., etc. Built in filter. **\$1.49**

DON'T MISS THIS!

Dynamic type earphone and microphone assembly that's a wonder of convenience, efficiency and compactness. 50 ohm impedance. 37" cord and plug. A TOP **\$2.95**
SPECIAL

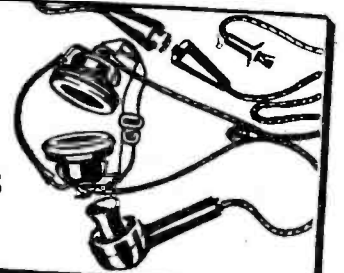

NEWARK'S SPECIAL FILTER CONDENSERS

Oil Filled — Oil Impregnated — Fully Guaranteed At Rated Voltages
Acclaimed by hams everywhere, these Newark condensers have been preferred favorites with amateurs for over ten years. Top quality at ridiculously low cost. Newark value at its best.

Cap. Mfd.	Working Voltage	Height	Width	Depth	Weight	Price
1	15 4000 D.C.	2 7/8	1 3/4	1	8 oz.	\$.89
1	1000 D.C.	2 1/8	1 3/4	1	12 oz.	.49
2	1000 D.C.	3 3/8	1 3/4	1	8 oz.	.49
2.5	1500 D.C.	4 3/8	1 3/4	1	12 oz.	.89
4	1500 D.C.	4 3/8	1 3/4	Rd. Can	8 1/4 lbs.	.99
4	3000 D.C.	4 1/2	3 3/4	1 1/4	2 1/2 lbs.	1.99
6	3000 D.C.	3 3/4	1 3/4	3 5/16	2 1/2 lbs.	3.75
6	3000 D.C.	4	3 3/4	2 1/4	2 1/2 lbs.	3.95
8	2000 D.C.	4 1/2	3 3/4	3 3/4	6 lbs.	3.25
8	3000 D.C.	7 3/8	6 1/2	2 1/2	2 1/2 lbs.	2.75
10	3000 D.C.	4 7/8	3 3/4	3 3/8	7 1/4 lbs.	3.95
13	1000 D.C.	3 1/2	3 3/4	3 3/4	3 1/2 lbs.	4.75
15	3000 D.C.	4 3/4	4 3/8	3 7/8	1 1/2 lbs.	2.25
1	2 1/2 600 D.C.	4 7/8	2 1/2	1 1/4	5 lbs.	5.25
1	4 800 D.C.	4 1/2	2 3/4	2 3/4	14 oz.	.80
1	6 1000 D.C.	4 1/2	2 3/4	2 3/4	2 lbs.	1.25
1	5 1000 D.C.	3 1/2	4 7/8	3 3/4	4 1/4 lbs.	1.75

*IN ONE CAN.

• MAIL ORDERS FILLED FROM EITHER NEW YORK OR CHICAGO

• Write: 242-G W. 55th St., N. Y. C. or 323-G W. Madison St., Chicago

NEW YORK
Offices & Warehouse
242 W. 55th St., N.Y. 19

NEWARK
ELECTRIC COMPANY, INC.

CHICAGO
323 W. Madison St.
Chicago 6, Ill.

New York City Stores: 115-17 W. 45th St. & 212 Fulton St.

RADIO NEWS

where you see the
name **STANCOR**
you can count on
QUALITY

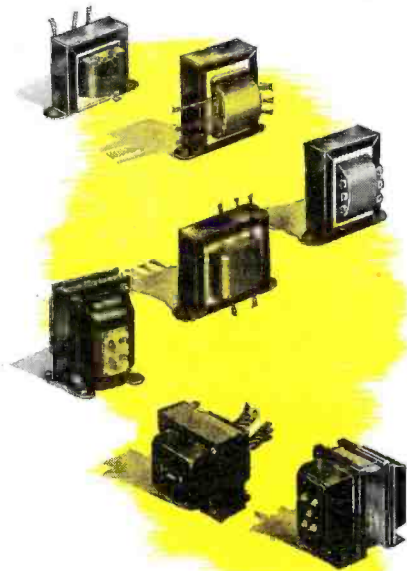
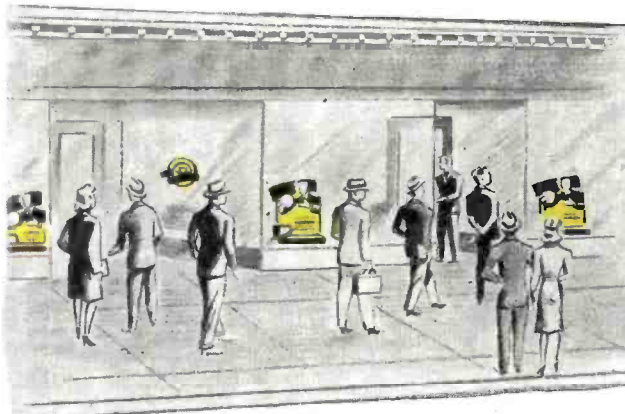

STANCOR stands for the highest standard of transformer performance... Wherever you see the black-and-yellow STANCOR merchandise display, you know you can rely on the product and the distributor who stands behind it. Yes, STANCOR stands foremost with radio service men... for the most complete selection of Replacement and General Purpose Transformers... and for advanced designs and universal application... Now, STANCOR adds new streamlined plant facilities to serve you better and faster... to help you make your service business bigger and more profitable.

standardize on **STANCOR**  **TRANSFORMERS**

STANDARD TRANSFORMER CORPORATION • CHICAGO, ILL.

SUPERIOR IS AT YOUR SERVICE

with a COMPLETE LINE of TEST INSTRUMENTS



IMMEDIATE SHIPMENT

Please place your order with your regular radio parts jobber. If your jobber does not handle our line kindly write for a list of jobbers in your state who do distribute our instruments or send your order directly to us.



Now you can SEE and HEAR

The signal with the new CA-12 SIGNAL TRACER

Always ready for instant use it takes less than five seconds to begin using this versatile unit. No maze of special cables—the Model CA-12 uses only one connecting cable. No line cord—the CA-12 operates on self-contained batteries. No tuning controls of any kind are used in this model.



FEATURES:

- Comparative intensity of the signal is read directly on the meter—Quality of the signal is heard in the speaker.
- Simple to operate—only one connecting cable—no tuning controls.
- Highly sensitive—uses an improved vacuum-tube voltmeter circuit.
- Tube and resistor capacity network are built into the detector probe.
- Built-in high gain amplifier—Alnico V. speaker.
- Completely portable—weight 8 pounds—measures 5 1/2" x 6 1/2" x 9".

The Model CA-12 comes complete with Detector Probe, test leads, self-contained batteries and instructions. Comes housed in heavy gauge crystalline cabinet with beautiful two tone etched front panel. **NET PRICE \$3485**

The New Model 670 SUPER METER

A Combination VOLT-OHM MILLIAMMETER plus CAPACITY REACTANCE, INDUCTANCE and DECIBEL MEASUREMENTS.

SPECIFICATIONS:

D.C. VOLTS: 0 to 7.5/15/75/150/750/1,500/7,500 Volts.

A.C. VOLTS: 0 to 15/30/150/300/1,500/3,000 Volts.

OUTPUT VOLTS: 0 to 15/30/150/300/1,500/3,000 Volts.

D.C. CURRENT: 0 to 1.5/15/150 Ma. 0 to 1.5 Amperes.
RESISTANCE: 0 to 500/100,000 ohms 0 to 10 Megohms.
CAPACITY: .001 to .2 Mfd. .1 to 4 Mfd. (quality test for electrolytics)
REACTANCE: 700 to 27,000 Ohms 13,000 Ohms to 3 Megohms.
INDUCTANCE: 1.75 to 70 Henries, 35 to 8,000 Henries.
DECIBELS: -10 to +18, +10 to +38, +30 to +58.

The Model 670 comes housed in a rugged, crackle-finished steel cabinet complete with test leads and operating instructions. Size 5 1/2" x 7 1/2" x 3" **NET \$2840**

The New Model 650 SIGNAL GENERATOR

Ranges: 100 Kilocycles to 35 Megacycles on Fundamentals; 25 Megacycles to 105 Megacycles on Harmonics.

- RF obtainable separately or modulated by the Audio Frequency.
 - Audio Modulating Frequency—400 cycles pure sine wave—less than 2% distortion.
 - Attenuation—3-step ladder type of attenuator (T pad).
 - Uses a Hartley Excited Oscillator with a Buffer Amplifier.
 - Tubes: 6J5 as R.F. Oscillator; 6SA7 as modulated Buffer and Mixer; 6SL7 as audio oscillator and rectifier.
- Complete with coaxial cable, leads and instructions.....

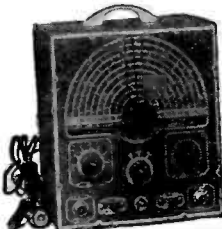

\$4875



The New Model 450 TUBE TESTER

Speedy operation—assured by newly designed rotary selector switch which replaces the usual snap, toggle, or lever action switches.

- Tests all tubes up to 117 volts.
- Tests shorts and leakages up to 3 Megohms in all tubes.
- Tests both plates in rectifiers.
- New type line voltage adjuster.
- Tests individual sections such as diodes, triodes, pentodes, etc. in multi-purpose tubes.
- Noise-Test—detects microphonic tubes or noise due to faulty elements and loose internal connections.
- Uses a 4 1/2" square rugged meter.
- Works on 90 to 125 volts 60 cycles A.C.

EXTRA SERVICE—May be used as an extremely sensitive condenser Leakage Checker. A relaxation type oscillator incorporated in this model will detect leakages even when the frequency is one per minute. **\$3950**

The New Model 600 SET TESTER

A NEW COMBINATION TUBE TESTER AND MULTI-METER. A complete testing laboratory all in one unit. Test tubes. Reads A.C. Volts, D.C. Volts, D.C. Currents, Resistances and Decibels.

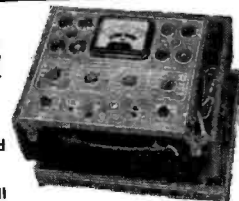

TUBE TESTER SPECIFICATIONS:

- Speedy operation—assured by newly designed rotary selector switch.
- Tests all tubes up to 117 Volts.
- Tests shorts and leakages up to 3 Megohms in all tubes.
- Tests leakages and shorts of any one element against all elements in all tubes.
- Tests both plates in rectifiers.
- Tests individual sections such as diodes, triodes, pentodes, etc., in multi-purpose tubes.
- New type line voltage adjuster.

MULTI-METER SPECIFICATIONS:

D.C. VOLTS: (At 1,000 Ohms Per Volt) 0 to 7.5/15/75/150/750/1,500 Volts.

A.C. VOLTS: 0 to 15/30/150/300/1,500/3,000 Volts.

D.C. CURRENT: 0 to 1.5/15/150 Ma. 0 to 1.5 Amperes.

RESISTANCE: 0 to 2,000/20,000/200,000 Ohms, 0 to 20 Megohms.

DECIBELS: (Based on zero decibels equals .006 Watts into a 500-Ohm line.) -10 to +18 D.B., +10 to +38 D.B., +30 to +58 D.B. **\$6250**

The New Model 400 ELECTRONIC MULTI-METER

A combination vacuum-tube voltmeter and volt-ohm milliammeter plus capacity, inductance, reactance, and decibel measurements.

SPECIFICATIONS:

D.C. V.T.V.M. VOLTS: (At 11 Megohms Input Resistance.) 0 to 3/15/30/75/150/300/750/1500/3000 Volts.

D.C. VOLTS: (At 1,000 Ohms Per Volt.) 0 to 3/15/30/75/150/300/750/1500/3000 Volts

A.C. VOLTS: (At 1,000 Ohms Per Volt.) 0 to 3/15/30/75/150/300/750/1500/3000 Volts.

D.C. CURRENT: 0 to 3/15/30/75/150/300/750 Ma., 0 to 3/15 Amperes.

RESISTANCE: 0 to 1,000/10,000/100,000 Ohms; 0 to 1/10/1,000 Megohms.

CAPACITY: (In MFD.) .0005—2, .05—20, .5—200.

REACTANCE: 10 to 5M (Ohms), 100—50M (Ohms), .01—5 (Megohms).

INDUCTANCE: (In Henries.) .035-14, .35-140, 35-14,000. **\$5250**

DECIBELS: -10 to +18, +10 to +38, +30 to +58. **NET**

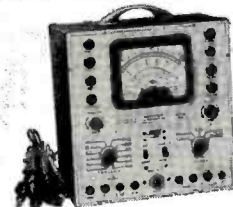

SUPERIOR INSTRUMENTS CO.

Dept. RN 227 FULTON ST., NEW YORK 7, N. Y.

You Can Add Up Your Income with a SOLDERING IRON!



YES, it's a fact that you may not have realized . . . but every minute your soldering iron is busy, you are busy making money. *And you can make even more money if you will suggest to your customers a complete "FIND AND FIX" treatment for sets.*

A complete "FIND AND FIX" reveals parts about ready to go as well as those that are shot, saves your customers extra trips, prevents the embarrassment of parts going sour right after leaving your shop.

IRC's Volume Control Cabinet, Resistor Assortment Kits and Basic Kit cut down unnecessary trips to your distributor for parts, give you more time for soldering . . . for making your time *pay*. Order from your local IRC Distributor today. International Resistance Company, 401 N. Broad Street, Philadelphia 8, Pennsylvania. *In Canada:* International Resistance Company, Ltd., Toronto, Licensee.

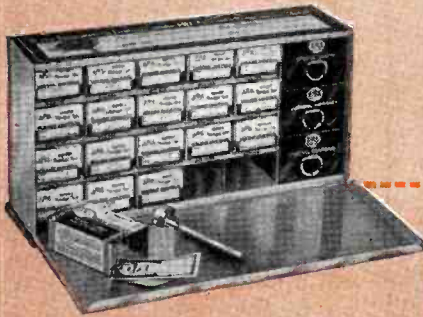

The IRC Volume Control Kit

18 All-purpose controls, 6 switches and 5 special shafts in an attractive factory-packed steel cabinet.*

The 3 IRC Balanced Resistor Assortments in Resist-O-Cabinets*

No. 1. 59 assorted insulated composition and power wire wound resistors, including adjustable types.

No. 2. 100 of the most used ranges in 1/2 watt insulated composition and insulated wire wound resistors.

No. 3. 83 top quality resistors in the 1-watt range.



The IRC Basic Kit

471 "basic" resistors in a wide variety of types and ranges, plus 6 additional bands for adjustable types. All metal cabinet.*

*Cabinets are furnished at no charge, not sold separately.



KEEP YOUR IRON
IN THE FIRE

INTERNATIONAL RESISTANCE COMPANY

Wherever The Circuit Says Ω

Copyright, 1947, International Resistance Company

Save SPACE, TIME and MONEY!

with the **PYRAMID "TYNEE-DRY"**

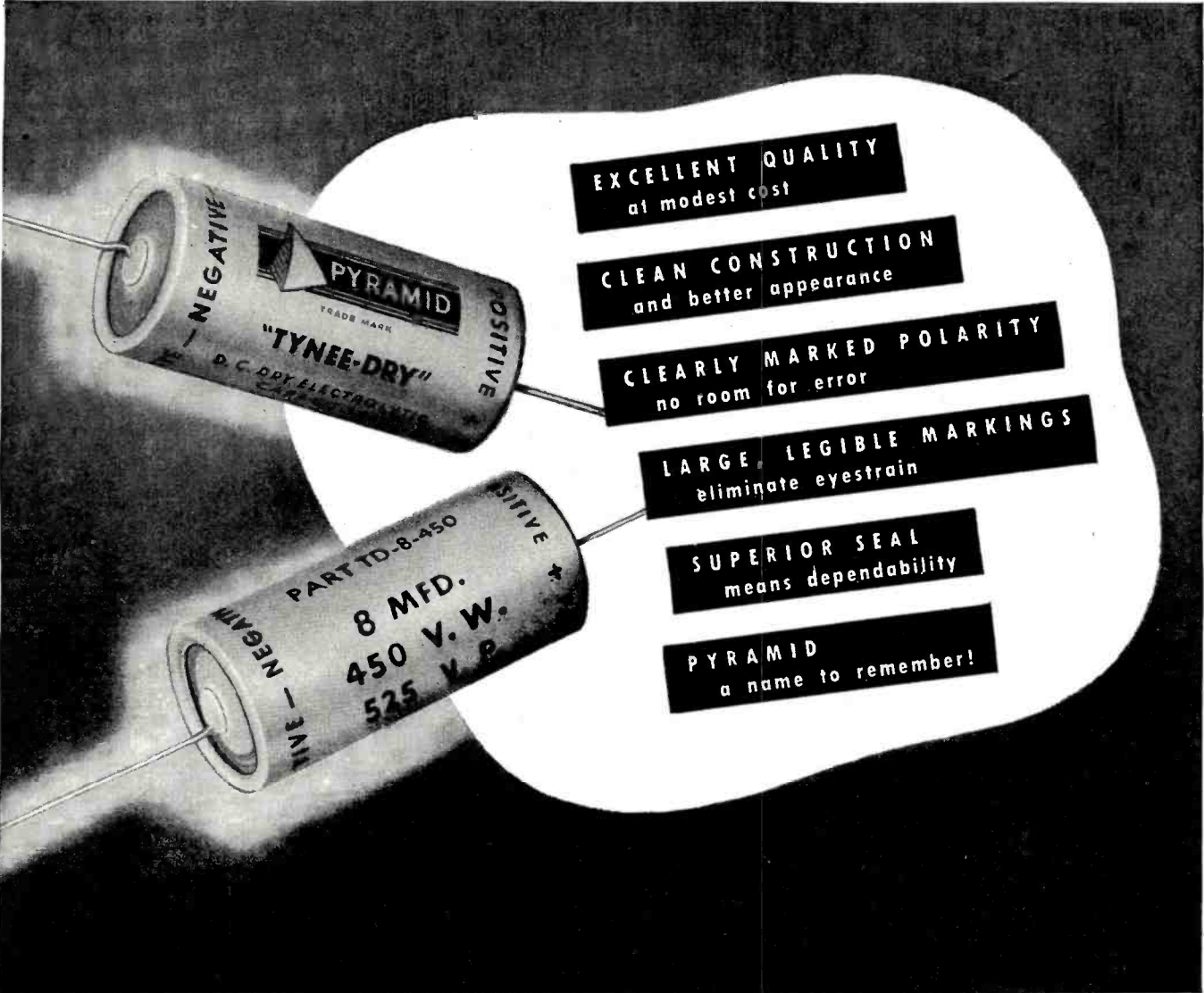

engineering and production controls provide maximum
quality within minimum space—and at
modest cost! Write for literature.

PYRAMID ELECTRIC COMPANY
JERSEY CITY 6, N. J.

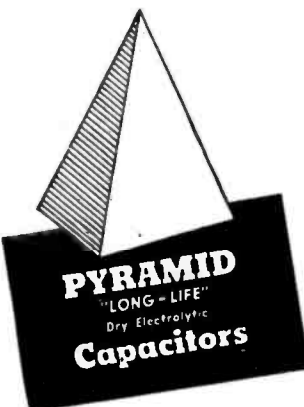

GENERATING MICROWAVES

By SAMUEL FREEDMAN*

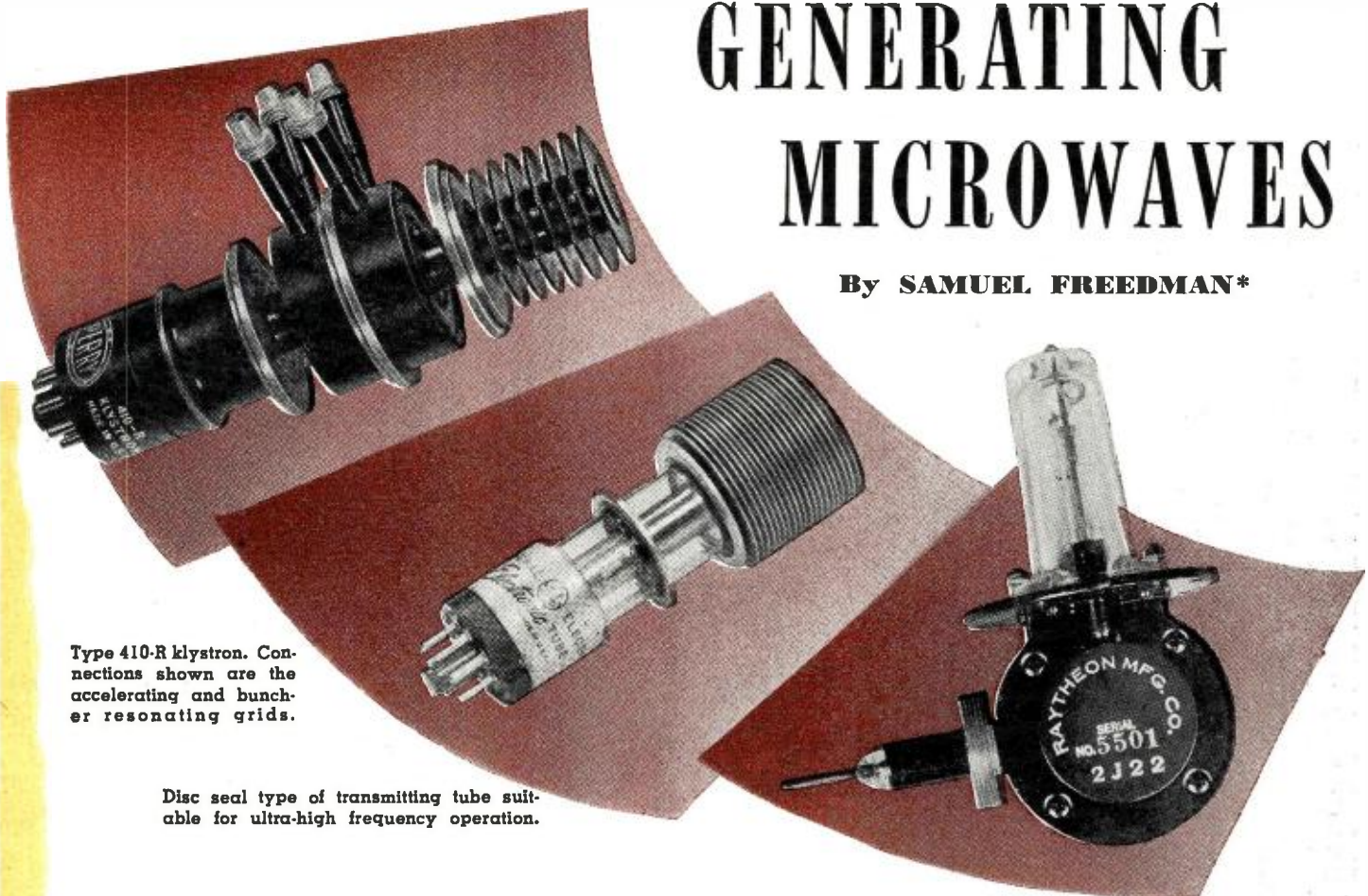

Type 410-R klystron. Connections shown are the accelerating and buncher resonating grids.

Disc seal type of transmitting tube suitable for ultra-high frequency operation.

Typical magnetron capable of developing about 300 kw. peak power for radar pulsed power transmission. It contains 8 cavities and is designed to operate fixed frequency in the 3000 mc. region. A magnet fits against the flat surfaces.

In generating microwaves various types of tubes may be used, ranging from conventional radio receiving tubes to the more expensive magnetrons; each and every one has its special advantage.

THE increasing utilization of radio principles for innumerable types of fixed, portable and mobile communication and navigation can only be achieved by the development of additional frequency spectrum.

Except in the most limited way, this must be accomplished by the development of tubes, circuits and techniques capable of functioning on wavelengths shorter than ever before put to common use. The utilization of shorter and shorter wavelengths have now brought us into the microwave regions known as the ultra-high and super-high frequency bands.

Ultra-high frequencies are those lying between 300,000 and 3,000,000 kilocycles. Super-high frequencies are those between 3,000,000 and 30,000,000 kilocycles. Together they represent those wavelengths shorter than 1 meter and longer than 1 centimeter. One centimeter today is by no means the stopping point. It is merely a convenient resting point on our road towards the infrared region which starts at about a hundredth of a centimeter. This will correspond to about three billion kilocycles.

Each time we halve the wavelength, such as from 2 centimeters down to 1 centimeter, we double the amount of frequency spectrum previously considered feasible to utilize. There is now no limit in sight as to the ultimate amount of frequency spectrum which may be developed in order to provide for existing or potential radio stations and services. The infrared light spectrum, and ultraviolet regions do not stop until a frequency of 25,000,000,000 megacycles has been reached.

Progress in the utilization of these frequencies becomes increasingly hampered as the wavelength is reduced. This is due to the wide differences of opinion between the conforming and non-conforming experts in their radio thinking. The conformists are much better educated and more formally trained as engineers and physicists. They also enjoy or dominate the best facilities and backing in their work. The non-conformists (which include

the author) have, however, made many worthwhile contributions to the art. They do it in direct conflict with prior mathematical and theoretical conceptions of the limitations believed to be involved. Past experience indicates that many revolutionary developments originate with non-conformists. The ultimate development of such ideas, however, require the large scale participation by the conformists. The latter make their advanced mathematics and theories fit the new facts or discoveries by taking into account some new relevant factor which was not previously known or adequately evaluated.

As tubes are utilized for microwaves, problems arise which were of little concern at the lower frequencies of the past. These problems are as follows.

1. *Inter-electrode capacitance* as represented by the metallic tube elements and the spaces between them. This capacitance, small as it may be, makes it difficult, or impossible, to resonate the associated circuit high enough in frequency or low enough in wavelength as required when operating on microwaves.

* The author is co-inventor of the Fonda-Freedman series of inventions which make possible the utilization of conventional radio tubes to generate ultra- and super-high frequencies. He is the author of the book "Two-Way Radio" published by Ziff-Davis Publishing Company.

TABLE 1. FUNCTIONAL COMPARISONS OF MICROWAVE TUBES

FUNCTION	BARKHAUSEN-KURZ	KLYSTRON	MAGNETRON (NEGATIVE RESISTANCE)	MAGNETRON (TRANSIT TIME)	LIGHTHOUSE & SMALL CONVENTIONAL TYPES	FONDA-FREEDMAN CONVENTIONAL TUBES
The PERIOD	Electrons remain in the inter-electrode space different lengths of time. Some less, some more, than one period of oscillation, depending on the phase of the oscillation when they leave the cathode.	Electrons remain in the drift space a time approximately equal for all of them. They cross either in the buncher or shorter than one period.	All electrons remain in the inter-electrode space less than one period of oscillation.	Electrons remain in the inter-electrode space more than one period of oscillation.	Electrons remain in the inter-electrode space less than one half of the period.	Electrons remain in the inter-electrode space more than, or as long as, one half the period of oscillation. It may also remain more than, or as long as one period for the alternative development.
INTERESTING BEGINNING OF ENERGY INTERCHANGE	When electrons leave the cathode.	When electrons cross the buncher.	When electrons leave the cathode.	When electrons leave the cathode. Critical.	When electrons leave the cathode.	When electrons leave the cathode.
INTERESTING END OF ENERGY INTERCHANGE	(a) When electrons with transit time longer than period strike the grid. (b) When electrons with transit time shorter than period strike the cathode.	When electrons cross catcher.	When electrons strike anode or are returned to cathode.	When electrons strike anode or are returned to cathode.	When electrons strike the anode.	When electrons strike the anode.
The OUTPUT	Energy is absorbed by the above electrons (b) and delivered by electrons (a). Useful output is the difference thereof.	Energy is absorbed by electrons in the buncher and delivered in the catcher. Useful output appears as the difference thereof.	More electrons strike negative section of the anode than the positive. Useful power output results from negative conductance.	Energy is absorbed from the d.c. field every positive half period and delivered to the a.c. field every negative half period. A smaller amount of power is absorbed from the a.c. field during the positive half periods. This is a loss.	Power output is effect of negative conductance. A loss appears as a result of grid conductance.	Power output is effect of negative (dynamic) conductance. There is no loss.
HOW OUTPUT IS OBTAINED	By making the grid positive and the plate negative. The electrons cross the grid several times before being collected on it.	By the special structure of the tube which results in velocity modulation in the buncher and electron bunches thereafter.	By deflecting the path of electrons by means of a magnetic field and use of proper relation between frequency and d.c. voltage.	Same as for other type magnetron.	By making the inter-electrode distance very small.	By making the inter-electrode distance large as in conventional tubes or otherwise, and adjusting the transit time to an integral multiple of (half) periods so that electrons flow in groups.
REQUIRED	That the anode be a grid which MUST be crossed by electrons, and that on the other side there be present a negative repelling plate.	That the catcher be crossed by electron bunches with the proper phase.	That the magnetic field be axial and have the proper intensity.	Same as for other type magnetron.	That the transit time be small when compared to the period of oscillation.	That the d.c. voltages be adjusted to produce the required phase relations between groups and a.c. voltages.
ENERGY LOSSES	Energy is wasted by the (b) electrons.	Energy is wasted in the buncher.	Energy is wasted by electrons striking back the cathode or absorbing power during positive half periods.	Energy is wasted by electrons arriving on the positive section of the anode.	Energy is wasted due to grid conductance.	None of these.
ADJUSTMENT ETC.	Not critical.	Not critical.	Critical.	Very critical. Requires high voltages. Frequency not very flexible.	Not critical. Limited power due to small electrodes.	Not critical nor limited in power.
APPROXIMATE MAXIMUM FREQUENCY	UHF	SHF	UHF	SHF	UHF	SHF
COST FOR TUBE	_____	Up to \$60 or more.	_____	Up to \$200 or more.	Up to \$20.	Conventional tube prices 50c and up.
FREQUENCY FLEXIBILITY	_____	Limited.	Limited.	Limited.	Unlimited.	Unlimited.

2. *Transit time* as represented by the amount of time which it takes an electron leaving the cathode to reach the plate or anode. Even though this time may be as short as a billionth of a second, it is equal to the time it takes 30 cycles to develop on a wavelength of 1 centimeter. When the transit time exceeds about an eighth of a cycle, the tube and circuit begin to seriously misbehave by conventional techniques.

3. *Phase shift or reversal* resulting from the fact that the electron leaving the cathode will arrive at the plate considerably different with respect to its relative position for the oscillating cycle.

4. *Miscellaneous factors* such as grid conductance, skin effect, dielectric losses, direct radiation by the tube elements and radiation of the connecting leads. These losses, while present and recognized, may be sufficiently controlled or compensated for by efficient techniques. They are not as serious as the first three problems enumerated above.

The principal consideration in microwave utilization is tubes to generate or detect such extremely high frequencies. This is achieved today by the following tubes or techniques:

1. The klystron or other forms of velocity modulated tubes.

2. The magnetron or tubes where a magnetic field serves in lieu of a grid.

3. The lighthouse or other forms of disc seal tubes.

4. Conventional tubes in special simple circuitry such as the Barkhausen-Kurz and the Fonda-Freedman techniques.

In any tube, three prime provisions must be recognized, namely: *a.* The production of electrons such as by heating of a cathode. *b.* The controlling of electrons produced by the cathode through the use of grids suitably biased or energized. The exception will be the magnetron where a magnetic field serves this purpose. *c.* The gathering up of the electrons and making them available as useful power in an external circuit. This is normally the function of the plate or anode. It ceases to be so in the case of the Barkhausen-Kurz technique or in certain types of velocity modulated tubes where the grid is kept more highly positive than the plate.

The klystron or velocity modulated tube is as different from a conventional tube as amplitude modulation differs from frequency modulation. A conventional tube depends primarily upon the numbers of electrons, whereas the velocity modulated tube depends on the changes in the velocity of electrons as they travel from the cathode to succeeding tube elements. Any impressed signal manifests itself by the speeding up or slowing down of the electrons. This includes the overtaking of slower moving electrons by faster moving ones with the result that they bunch up along the electron path.

This type of tube contains the fol-

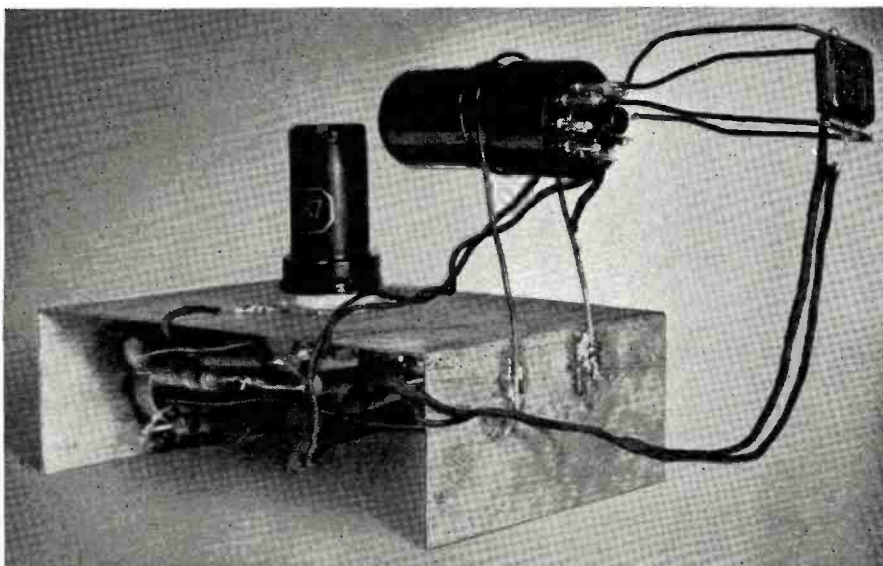

The first satisfactory working model of the Fonda-Freedman technique wherein a 6N7 tube developed frequencies in the 300-3000 mc. region. Author reports that later versions reached all frequencies between 100-50,000 mc. Photo shows complete transmitter exclusive of conventional power supply needed for either c.w. or tone transmission.

lowing: *a.* A heater to heat the cathode. *b.* A cathode to emit electrons. *c.* An electron gun or path to beam the electrons which are accelerated in the space between the cathode and the first pair of accelerating grids. *d.* A pair of closely spaced accelerating grids which are kept highly positive to attract and accelerate the electrons through its perforations to the buncher grids except for those which strike the grids. *e.* A pair of "buncher" or "resonator" grids which are acted upon by the electrons that were both accelerated and able to get through the accelerating grids.

The acceleration of the electrons in passing the highly positive accelerat-

ing grids corresponds to a small fraction of a cycle of time even at microwave frequencies. A radio frequency field in the buncher resonator produces an alternating or oscillating electric field between the buncher grids. Electrons in transit will either be speeded up, slowed down or proceed in a normal manner depending on the state of the oscillating field as the electrons pass the buncher grids. This change in velocity gives the tube technique the name of "velocity modulation." Since some electrons approach the grid as it becomes less positive while others do so as it becomes more positive, a situation exists

(Continued on page 125)

Author at work in his laboratory. Photo shows preliminary working models of microwave transmitting, receiving, modulating, and electromagnetic horn equipment.



Panel view of home-built unit. All amateur bands between 20-80 meters can be covered with 2 sets of plug-in type coils. Tuning condenser, C_{15} , is shown to the left and C_1 to the right.

By
JOHN F. CLEMENS,
W9ERN

**Complete construction data for a
50-watt transmitter-exciter, with
built-in power supply and using
a variable frequency oscillator.**

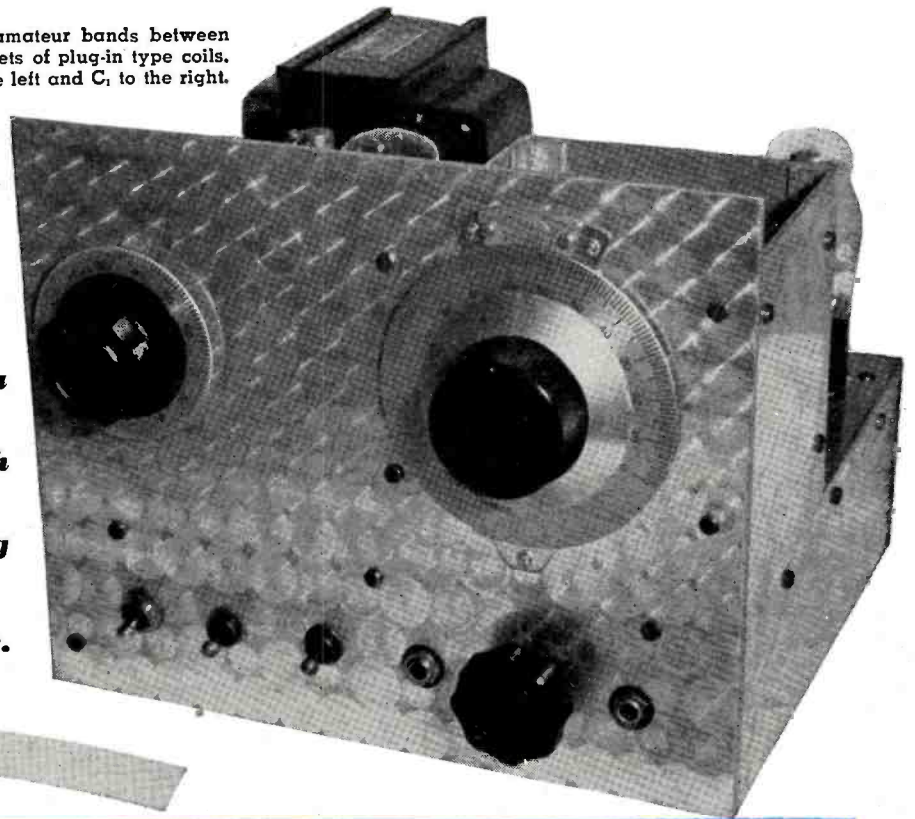

Variable Frequency

TRANSMITTER-EXCITER

FOR those whose ham activities are restricted to a limited space, some ingenuity is necessary to build a transmitter which will permit a reasonable degree of operating success. The transmitter described here was designed primarily for compactness and makes a fine low-power transmitter or exciter for the operating table. For transmitters of under 100 watts an e.c.o. is almost a necessity these days as there is little chance of blasting a channel through the QRM. Considerable care has been expended on the e.c.o. in this transmitter to secure freedom from drift and roughness. Oscillator keying permits break-in operation and monitoring in the receiver. The keying is free from clicks and chirp and the signal quality will require no apology. Although this rig is operated on forty and eighty meters, a new set of coils will permit operation on twenty. Ten meter operation cannot be obtained without another doubler stage, unless the e.c.o. is operated on forty meters, and although several commercially built transmitters have adopted this expedient, it can hardly be considered good practice.

An investigation of numerous e.c.o.'s has revealed several facts which should be of interest to anyone planning a variable-frequency exciter.

First of all, mechanical stability is of prime importance. Although this fact is so well known as to be a truism, the method of achieving this mechanical stability does not always result in improved electrical stability. The only major item worthy of special mention is the method in which the e.c.o. tuning condenser is mounted, i.e., on a sub-panel attached, not to the chassis, but to the front panel. This method of mounting, in conjunction with the use of the *National* Type N dial which mounts on the front panel, prevents thrust forces from being transmitted to the variable condenser bearings. Those who have built e.c.o.'s have probably experienced instability from thrust force on the tuning condenser which is manifest as a frequency variation when the panel on the v.f.o. is touched or pushed. A double-bearing tuning condenser is used as an additional measure to in-

sure stability. In tests with a number of different models, the double-bearing type of condenser showed a marked superiority over single-bearing types in eliminating backlash. The *National* Type N dial has proven satisfactory for v.f.o. use since it has high torque, no backlash, perfectly smooth action and a vernier scale which can be read accurately to one part in 1000. Other components of the oscillator, the tube, coil, and associated parts, are also rigidly mounted inside the e.c.o. compartment. The tube and coil sockets are raised one inch above the chassis by brass spacers so that the underside of these sockets is also inside the shield chamber.

The cut-and-try method of determining the tuning range of the oscillator can be eliminated by a few simple calculations. As an example, let us suppose it is desired to cover 1750 to 2000 kilocycles with the e.c.o. When doubled, this will, of course, tune the entire 80 meter band. From the formula, $f = 1/2\pi\sqrt{LC}$, it is evident that frequency varies inversely as the

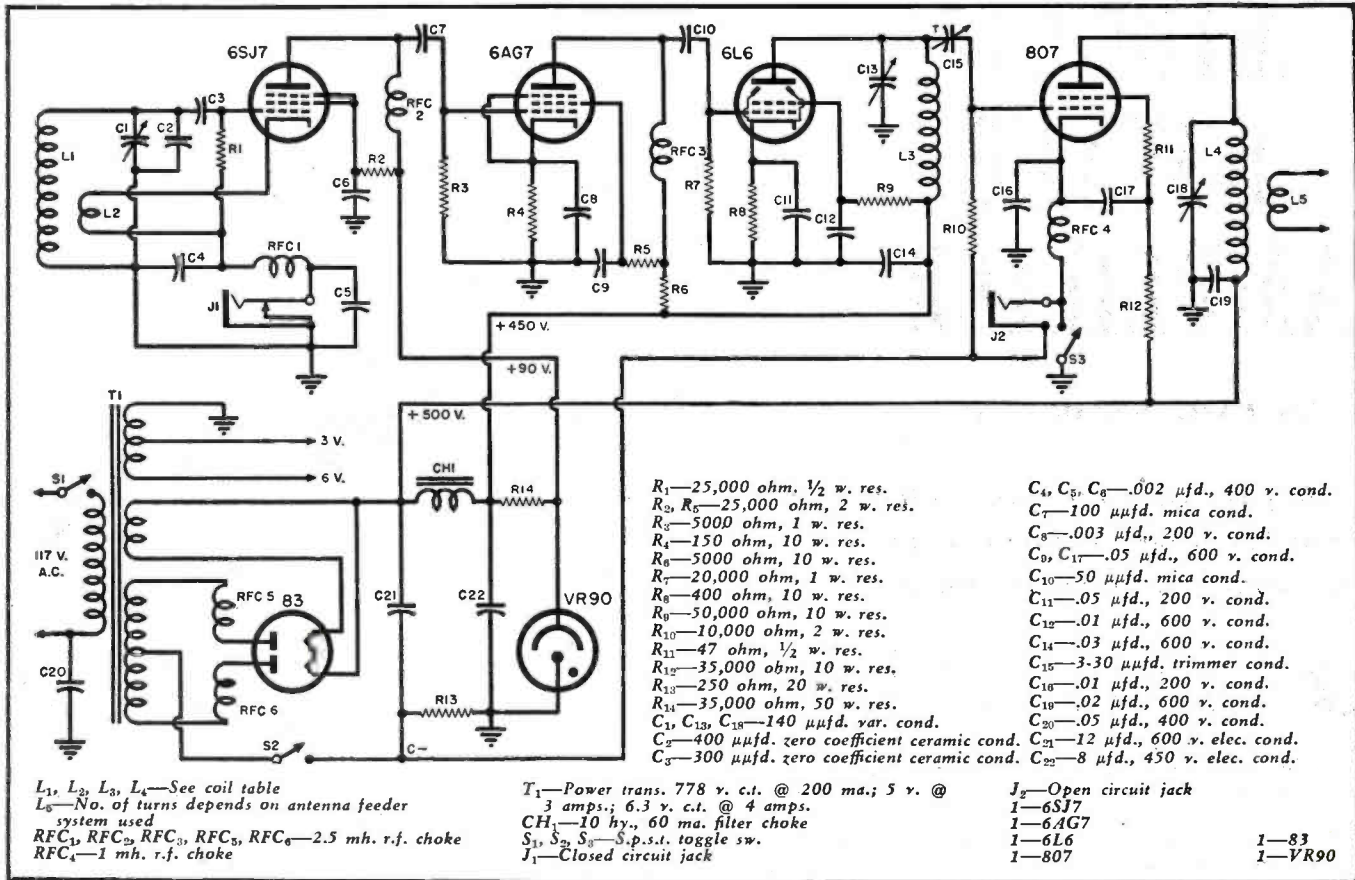

Schematic diagram of transmitter-exciter. In constructing this unit provision has been made for either oscillator or final amplifier keying.

square root of the tuning capacity. Therefore, the capacity ratio (maximum capacity across the tuned circuit divided by minimum capacity across the tuned circuit) will be the square of the frequency ratio. The inverse relationship may be forgotten since it only means that the highest frequency will be obtained at minimum capacity

and vice versa. The frequency ratio in this case is 2000/1750, or 1.142. The square of 1.142, or 1.306 is therefore the needed capacity ratio.

We must now decide what size tuning condenser to use, remembering that high-C circuits are a must for e.c.o. stability. The largest capacity generally available in the midget va-

riety of condenser is the popular 140 μ fd. type and we will choose this value. We may estimate its minimum capacity at about 15 μ fd. We have, therefore, a variable capacity of 140 - 15 or 125 μ fd. We now know that $(125 + C)/C = 1.306$ from which $C = 408 \mu$ fd. C in the above equation is the
(Continued on page 158)

Rigid mounting of all parts is desirable for stable operation. Variable condenser shown is in the 6L6 plate circuit.

The oscillator stage (top view) is built in the shield box shown in upper left hand corner to provide circuit isolation.

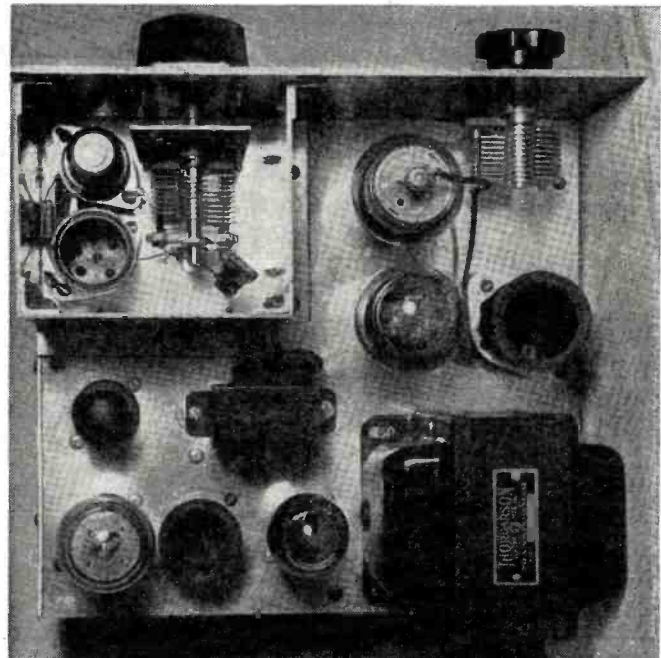
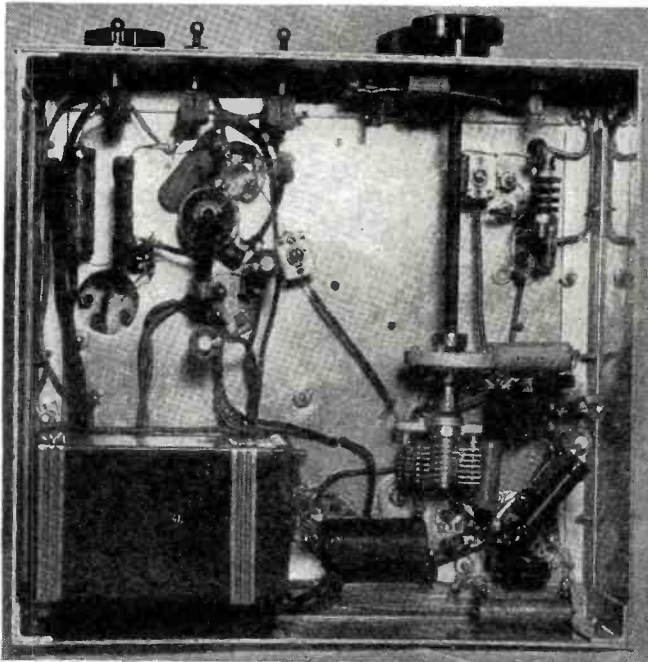

MIDGET 4-WATT AMPLIFIER

By EARL SNADER, Jr.

A compact, easy-to-build audio amplifier that features both phono and microphone inputs.



Over-all view of home built amplifier. Note that input jacks are located on the side flanges of the unit.

ONE of the chief difficulties encountered in the construction of high gain audio amplifiers is the presence of hum. This difficulty, involving the use of a certain minimum number of filter components and provisions for shielding, places severe limitations on the minimum size necessary for high gain amplifiers with any significant level of output. It is extremely difficult to conserve in space to a significant degree in the construction of amplifiers of this type.

Here is an amplifier which is unique on several counts. Most obvious is its small size. With the tubes inserted, the over-all measurements are four inches wide by three inches deep by only five inches high. Phonograph amplifiers with these approximate di-

mensions are relatively common. But this amplifier includes a microphone channel, designed to operate from the output of a low level crystal or dynamic microphone. It also has a separate phonograph channel, designed to operate from the output of a crystal phonograph cartridge of the low-voltage type. The power output stage of this amplifier consists of two 25L6 tubes operating in push-pull, driven by a 6SC7 which serves as amplifier and phase inverter. The microphone pre-amplifier tube is a 6SJ7. A 25Z6 is used as the rectifier. The two 25L6

tubes develop a power output of four watts, and this can be realized from either the microphone or phonograph channels separately or together. The mixing of the two channels is done through a resistance network permitting the output level of the one channel to be adjusted with no appreciable effect upon the other. With either or both the controls turned on full the hum level in the output of the amplifier is almost inaudible. The amplifier can be used for public address work in applications requiring four watts power or less, for playing phonograph records, or for making recordings. It is very efficient for the amount of space which it occupies. It will operate from 110 volts, either a.c. or d.c. All parts except the microphone and loudspeaker are built into the unit.

The amplifier is built on a standard 4" by 3" by 2" utility box. All five tubes and the filter condenser unit are mounted on the top cover of this box. The cover is taken off by removing the screws along each edge. The holes for the microphone and phonograph gain controls are drilled into the one 2" by 4" side of the utility box. This side serves as the front panel. These holes are bored midway from top to bottom, and 1 1/8 inches from each end. The power switch is mounted in a hole midway between these two holes. The jacks for the microphone and phonograph inputs are of the standard microphone jack type, and are mounted at each end of the utility box, toward the front. The speaker jacks are mounted in the back, and an additional 3/8" hole is drilled in the back to accommodate the line cord. The output transformer and filter choke are mounted at both ends inside the box.

(Continued on page 102)

Schematic diagram of five-tube audio amplifier. The a.c.-d.c. operation not only simplifies operation of unit but reduces component cost.

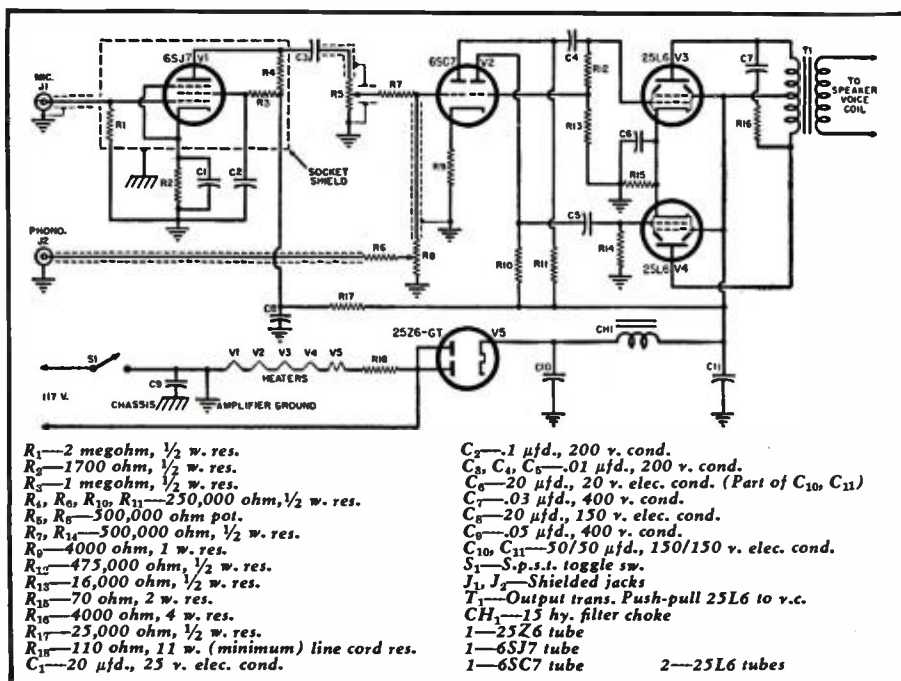

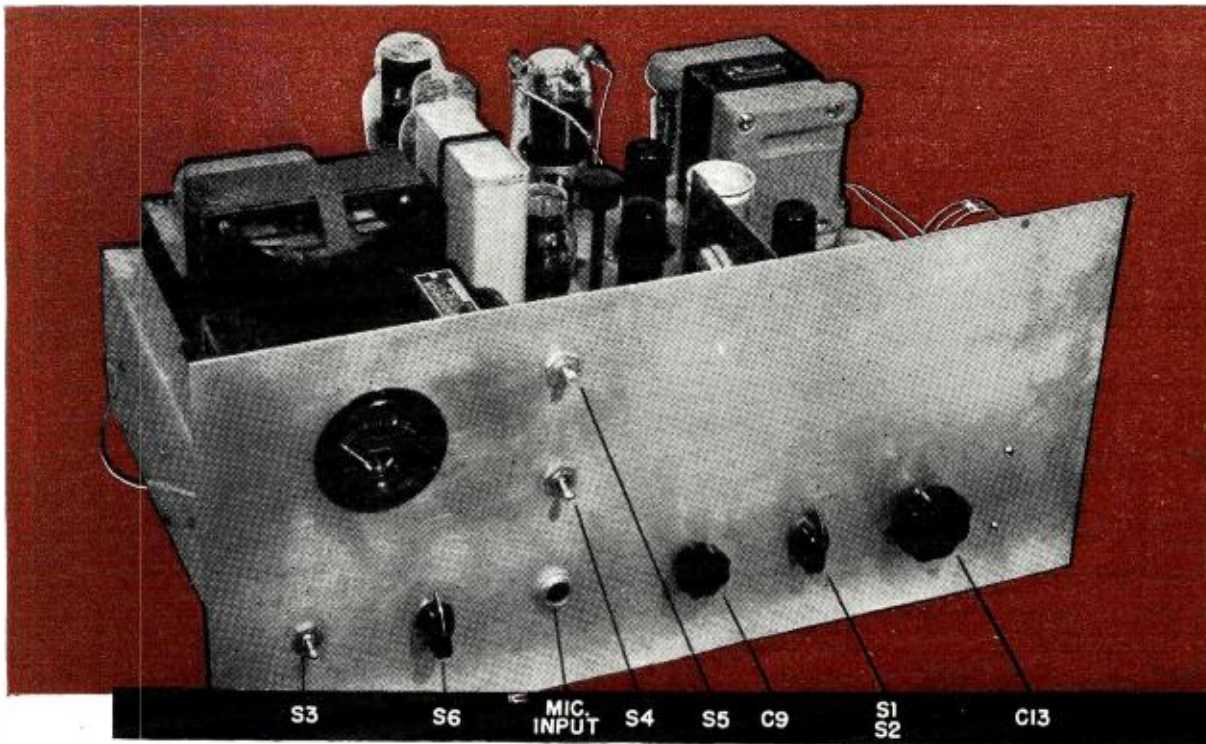

Fig. 1. Panel view of home built transmitter. The entire unit, including the necessary power supplies, is built on a single conventional sized chassis.

Compact 60-Watt Transmitter

By ROYDEN R. FREELAND, W5EMH

Complete construction details for a transmitter covering all amateur bands between 10-80 meters.

WITH the return of the amateur bands several months ago, a lot of hams were faced with the problem of getting a rig back on the air. Many amateur stations were broken up by the war when the operator was called into the Army, or moved to a new location; the old equipment being sold or too big for the new location.

The problem was to get a transmitter on the air that would be compact, versatile, and ready for operation on any of the bands when they became available. The transmitter shown in Fig. 1 is the author's solution to the problem.

The line-up of the transmitter is a 6J5 oscillator, 6AG7 buffer-multiplier, and an 815 final with an input power of 60 watts. Band-switching is used in the oscillator and buffer-multiplier stages while plug-in coils are used in the final to give coverage of all the amateur bands from 80 meters through 10 meters. A second 815 with its speech amplifier and driver stages supplies audio power for modulation. The entire transmitter, which is built on a single chassis, is powered from two power supplies.

Fig. 2 shows the schematic diagram of the transmitter. The oscillator is a modified Miller recommended for high-frequency crystals (harmonic crystals); however it works equally well on low frequency crystals. The oscillator operates with either an 80, 40, or 20 meter crystal according to the output frequency desired. For 10

meter operation either a 40 or 20 meter crystal may be used. The oscillator tank coil is tapped and switch S₁ shorts portions of the coil for coverage of the different bands. Only 150 volts is applied to the oscillator plate circuit which insures stable operation with low crystal current.

The output of the oscillator is capacitively coupled to the 6AG7 buffer-multiplier stage. This stage operates as a buffer, doubler, tripler, or quadrupler as required. The tank coil of the 6AG7 is tapped similarly to that of the oscillator and output frequencies are provided in the various switch positions as shown in Table 1.

In addition to the 10 meter band covered by positions 3 and 4, the 11 meter and 15 meter bands may also be covered in these positions when appropriate crystals are used. The 6AG7

has very low interelectrode capacitances and requires no neutralization when operating as a buffer amplifier. In addition, the 6AG7 requires very little driving power. Both cathode and grid-leak bias are used in this stage, the cathode bias limiting the plate current of the tube when no excitation is present. The screen grid voltage for the 6AG7 is regulated at 150 volts while 300 volts is applied to the plate. The output of the buffer-multiplier stage is link coupled to the balanced grid circuit of the final amplifier.

The 815 push-pull final amplifier tube operates as a straight Class C amplifier on all bands. Plug-in coils are used in both the plate and grid circuits to cover the frequency range. As is the usual case with this tube, it is necessary to neutralize the stage. However, the neutralization is not critical. To eliminate the possibility of parasitic oscillations, the centers of the grid and plate tank coils are left floating and, in addition, parasitic chokes are inserted in the plate and grid leads. The 815 is plate and screen grid modulated for phone operation. The screen grid voltage is obtained through a dropping resistor from the 400 volt plate supply.

Table 1. Various output frequencies can be obtained by simply rotating switch S₁.

Switch Position	Crystal Freq. in Meters	Output Freq. in Meters
1	80	80
2	40	40
3	40	10
4	20	20
5	20	10

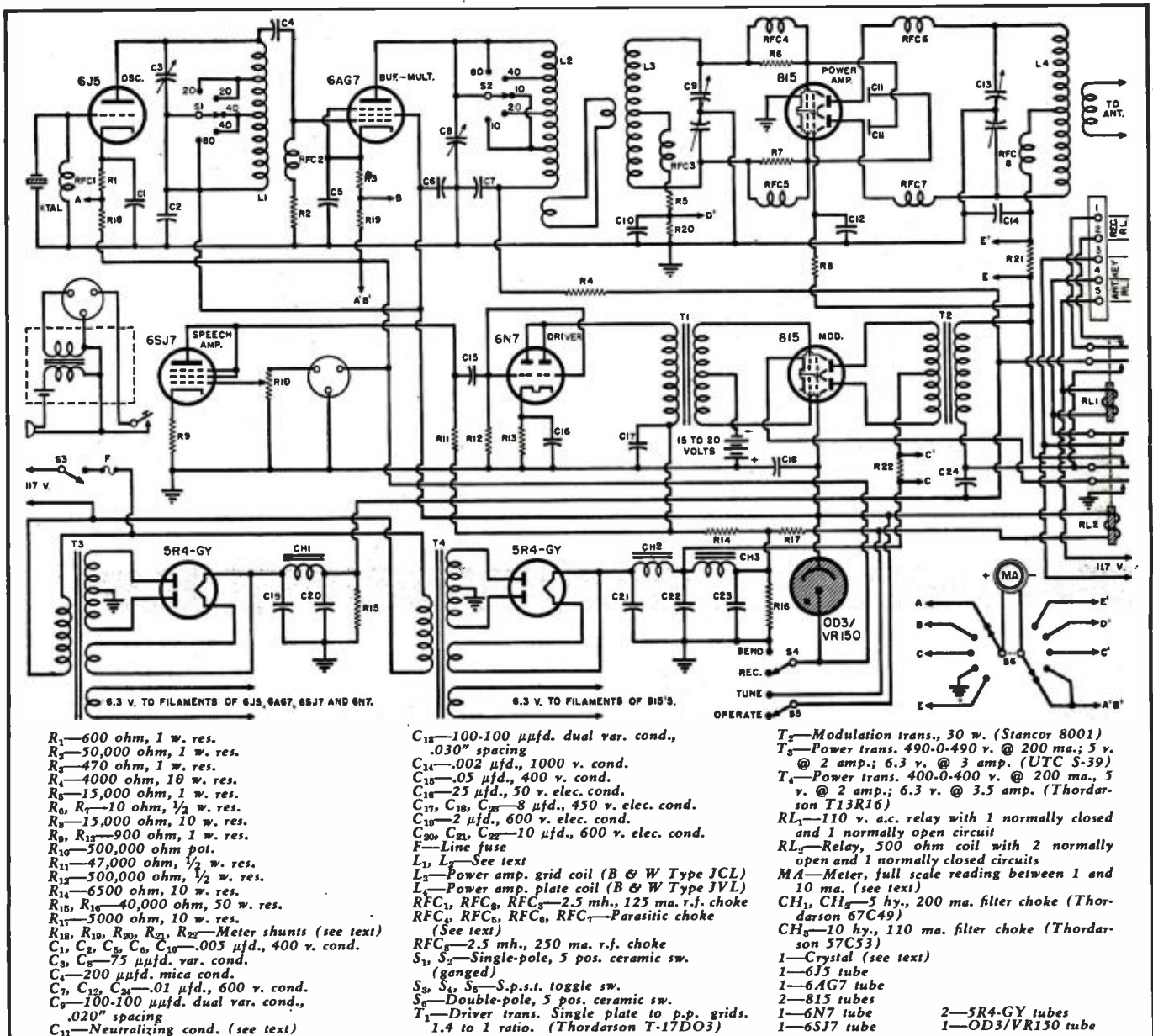

Fig. 2. Complete schematic of the transmitter. The microphone used is a single button carbon type with a push-to-talk switch. The microphone to grid transformer and the single flashlight cell for microphone current are built into a small steel case. Connections are made to the amplifier by means of a three contact plug and jack.

For 100 per-cent modulation of the final amplifier with 60-watts input, approximately 30 watts of audio is required. The 815 modulator is capable of supplying 40 watts of audio with a plate voltage of 400 volts and operating Class AB. Fixed battery bias is used, the bias being between 15 and 20 volts and adjusted so that the no-signal plate current is 20 ma. The screen grid voltage for the modulator is regulated at 150 volts. It is essential that the screen grid voltage remain constant with varying screen current if rated power output is to be received from the stage. The modulation transformer presents a load of 6000 ohms to the modulator tube, the secondary impedance of the transformer being 2500 ohms.

The 6N7 driver stage operates Class A, and is capable of supplying 400 mw. to the 815 modulator which is sufficient to drive the stage to rated output.

The 6SJ7 speech amplifier is connected as a triode and gives sufficient gain when using a carbon microphone. This tube can be connected as a pentode for use with a high-level crystal microphone.

All circuits of the transmitter are powered from two 400 volt power supplies. One power supply delivers plate and screen-grid voltage to the r.f. final amplifier and plate voltage to the buffer-multiplier stage. The second power supply delivers voltage to all of the other circuits. The oscillator plate, buffer-multiplier screen-grid, and modulator screen-grid circuits are connected to the second power supply through the regulator circuit made up of the regulator tube OD3/VR150 and resistor R_{17} .

One meter is used to measure the currents in the various circuits of the transmitter. Switch S_6 connects the meter to the circuit being measured.

Five circuits are metered as follows: oscillator cathode, buffer-multiplier cathode, modulator plate, final grid, and final plate.

The control circuit of the transmitter is made up of three switches (S_1, S_2 , and S_3) and two relays (RL_1 and RL_2). The control circuit functions in such a manner that the exciter stages can be tuned with no voltage being applied to the final; either phone or c.w. operation may be used; and push-to-talk action is available. In addition a circuit is brought out to terminals on the rear of the transmitter for operation of a receiver relay circuit. Also external connections are provided for operation of an antenna relay. For c.w. operation the key is placed in series with the coil of relay RL_1 which controls the high-voltage to the final amplifier. It was necessary to place RL_1 in series with the high-voltage lead instead of the cath-

ode lead of the final stage because it was found that the cathode of the 815 had to be grounded directly at the socket to eliminate parasitic oscillations.

The control circuit works briefly as follows. Relay RL_2 has its 500 ohm coil connected in the regulator tube circuit, and thus closes when the various tubes connected to the regulator draw current. The three sets of contacts on RL_2 perform the following operations; one closes the coil circuit of relay RL_1 ; the second set closes the cathode circuit of the modulator; and the third set short-circuits the secondary of the modulation transformer during c.w. operation. Thus when relay RL_2 closes relay RL_1 will close. One set of contacts on RL_1 applies high-voltage to the final amplifier as previously mentioned. A second set of contacts on RL_1 operates the external receiver-relay circuit. Relay RL_2 is closed by switch S_1 which is the "Send-Receive" switch. In the "Send" position, S_1 grounds the cathode circuits of the oscillator, buffer-multiplier, and regulator tubes placing these tubes in operation and closing RL_2 . Switch S_2 is the "Tune-Operate" switch and in the "Tune" position this switch short-circuits the coil of RL_2 thus preventing RL_1 from closing and applying high-voltage to the final. Switch S_3 is paralleled by the push-to-talk circuit of the microphone. Switch S_4 is the power switch.

Construction

The transmitter is built on a chassis 13 inches by 17 inches by 4 inches. The panel measures $8\frac{3}{4}$ inches by 19 inches. The transmitter was built this particular size so as to fit into a small table relay-rack cabinet.

The layout of parts can be seen in Figs. 3 and 4. It will be noticed that power transformer T_1 is uncased. It was necessary to remove the case to get the transformer into the space available.

The tuning controls for the oscillator and buffer-multiplier stages are operated from behind the panel. If desired these controls can be brought out to the panel through flexible couplings. The coils for the oscillator and buffer-multiplier are constructed as shown in Fig. 5. Both coils are wound on 1-inch polystyrene rod and coated with *Duco* cement after winding. The coil taps may be connected to the bandswitch positions as shown in Fig. 2 or as desired by the builder depending upon the crystals available and the various frequency combinations wanted.

The 815 final amplifier tube is mounted horizontally with the socket key down. It is essential when mounting the tube horizontally that the key be on a vertical line either up or down. The tube mounting plate is an angle bracket made of $\frac{1}{16}$ -inch copper and acts as a shield between plate and grid circuits. The vertical portion of the bracket measures $4\frac{1}{2}$ inches by $4\frac{1}{2}$ inches.

The neutralizing capacitors for the

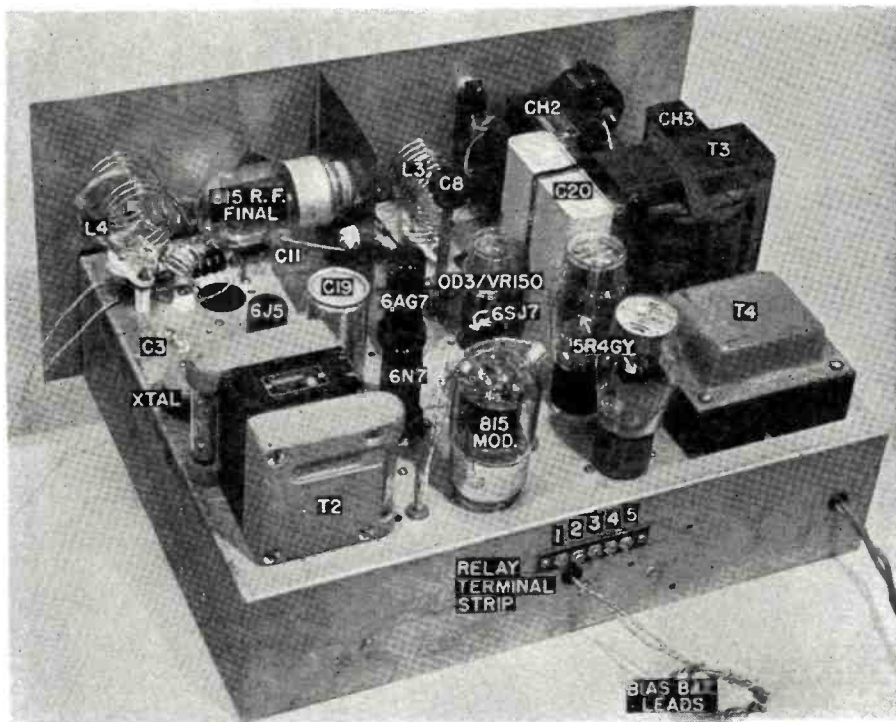

Fig. 3. Top-rear view of transmitter shows proper placement of component parts.

final can be seen in Fig. 3. Each capacitor is made of a $\frac{1}{2}$ -inch square piece of copper soldered to the end of a short length of No. 14 wire which extends up along side the tube from a feed-through insulator. The plates of the tube act as the other plate of each capacitor.

The parasitic chokes for the plate circuit of the final amplifier (RFC_6 and RFC_7) are wound of hook-up wire and are self-supporting. Each choke consists of 9 turns $\frac{1}{2}$ -inch in diameter. The parasitic chokes (RFC_4 and RFC_5) in the grid circuit of the

final are wound directly on parasitic resistors R_6 and R_7 , respectively. Each choke coil consists of 11 turns of No. 22 wire close-wound.

The final tank capacitor C_{13} is mounted below the chassis as shown in Fig. 4. To prevent any stray capacitive coupling between capacitor C_{13} and other circuit elements, it is necessary to shield the capacitor. The shield extends the full depth of the chassis (4 inches). When the bottom cover plate is placed on the chassis the capacitor is shielded electrostatically. (Continued on page 82)

Fig. 4. Under chassis view. Note that all critical components are well shielded.

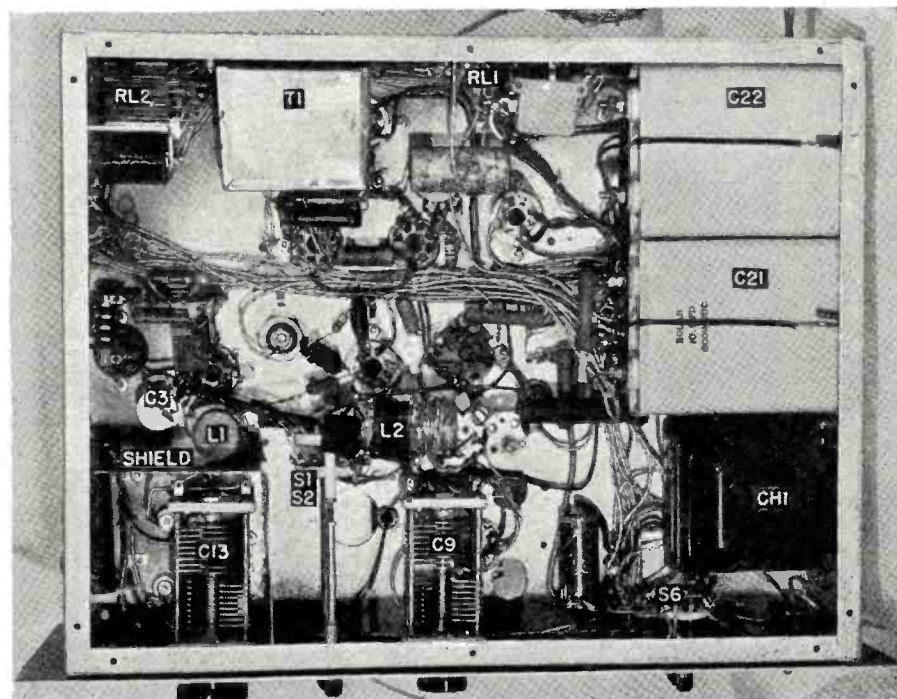

Miniature all-wave 3-tube RECEIVER

By

W. E. MILLER, W2HSV

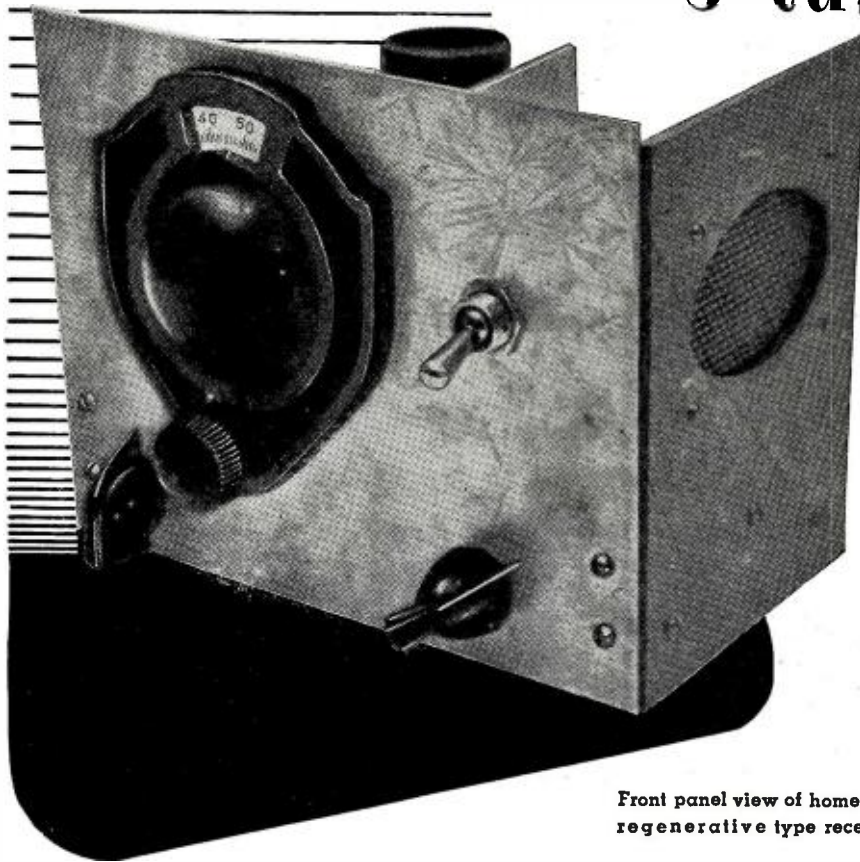

Front panel view of home-built regenerative type receiver.

This all-wave receiver, using plug-in coils, can be built by the experimenter at a reasonable cost.

Schematic diagram of three-tube receiver. Battery operation permits reduced cost.

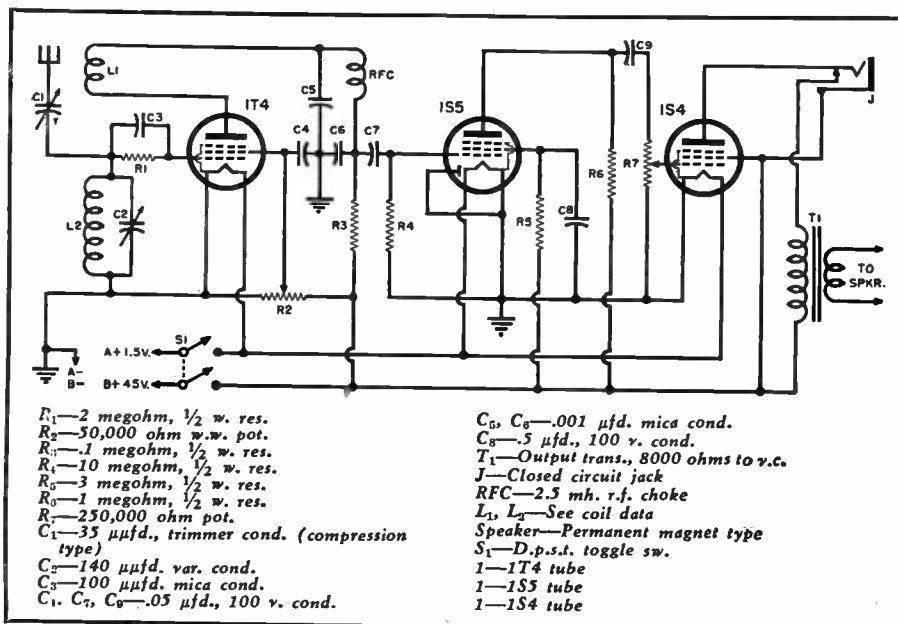

THE receiver described in this article is conventional in circuit but the use of miniature tubes permits more than average efficiency in design and also results in a set which is small enough to set on the palm of the hand. It is simple enough to be built by a newcomer to radio while its excellent performance and diminutive size make it attractive to the more advanced hobbyist, and to those who might want a portable receiver. This receiver will compare favorably with the smaller super-heterodyne sets, particularly on short waves. With a thirty foot antenna strung across a room, the British Broadcasting Corporation in London was received on the receiver's two-inch loudspeaker with volume comparable to most local stations. Background noise in the set is negligible so that even weak signals stand out. In code reception this is especially advantageous.

Inspection of the circuit diagram indicates that a 1T4 is used as a regenerative detector, a 1S5 as a resistance coupled first audio stage, and a 1S4 as a resistance-coupled audio stage. A 1L4 may be used interchangeably with the 1T4 and will give equally good results. In place of the 1S4, a 3Q4 or a 3S4 may be used with proper filament connections. All these tubes will be recognized as those in use in many commercial miniature portable sets. The chassis of this set measures 6" x 3" x 1 $\frac{3}{4}$ " high and a panel 6 $\frac{1}{4}$ " x 5" is used. For the filaments of the tubes a 1 $\frac{1}{2}$ volt dry cell is required while a single 45 volt B battery is sufficient for plate voltage.

Regeneration in the 1T4 detector stage is controlled by a 50,000 ohm potentiometer which varies the voltage applied to the screen grid of this tube. An r.f. bypass filter to ground, consisting of the r.f. choke and C_5 and C_6 , is used in the plate circuit of the 1T4 to prevent any r.f. from entering the subsequent audio stages and thereby causing instability. The 1S5 is a standard resistance-coupled amplifier, as is the 1S4. Though use of resistance coupling instead of impedance coupling might possibly decrease the maximum possible output, elimination of a bulky coupling choke is an aid in keeping the set small. In any event, the use of two audio stages, rather than a single one, amply makes up for any slight loss of volume in the resistance coupling. The diode plate

in the 1S5 is grounded and only the pentode section is used. A 250,000 ohm potentiometer, R_1 , acts as a volume control and is necessary for strong stations, particularly when earphones are being used. The output of the 1S4 is fed into an output transformer, T , and a two-inch magnetic speaker. The .2 watt output of which the 1S4 is capable is ample to drive the small speaker. A 3Q4 or 3S4 would give somewhat higher output. A closed circuit jack, J , in the output circuit permits the use of earphones. The speaker is automatically silenced when the phones are plugged in. With the phone plug removed the speaker is in the circuit.

The set was built on a masonite baseboard supported by wooden side-pieces with a masonite strip screwed to the back, as shown in the photograph. Masonite was used because it is easier to work than metal, and from this standpoint is more suitable for a beginner, though a metal chassis could be used and would provide better shielding. However with the following scheme this was found unnecessary. Metal sheets of approximately $\frac{1}{16}$ " thickness and cut to the proper size, are inserted between the r.f. and audio stages both above and below the baseboard. Any tinsmith will cut some galvanized iron to size for a few cents. Both shields are vertically in the same plane and a single pair of screws passing through lips on the end of each shield binds them both to the baseboard. The panel is of metal; aluminum, steel or galvanized iron will do. The shields can be grounded very simply by bending a soldering lug into a right angle and soldering one end of it to the shield and the other end of the lug to the panel. This is easily visible in the photograph. If a metal chassis is used, the shields will be automatically grounded when they are screwed to the chassis which is already at ground potential and the soldering lug method can be dispensed with.

Placement of the various parts can be most easily seen from the photographs. The 140 μ fd tuning condenser, C_2 , is mounted on the front panel with the tuning coil directly behind it. The 1T4 is beside this condenser near the front panel. On the other side of the shield are the 1S5 and 1S4 tubes, the 1S4 being nearer the front panel. A double-pole, double-throw switch, S_1 , in the A+ and B+ leads, and the speaker which mounts on a piece of masonite, $4\frac{3}{4}$ " x 3", screwed to the side of the chassis, comprise the remainder of the parts mounted above the baseboard. Below the baseboard, on the r.f. side are the 50,000 ohm potentiometer, R_2 , and the resistors, condensers, and choke comprising the r.f. circuit. The lead from the r.f. choke to the .05 μ fd. coupling condenser, C_1 , passes around the metal shield to the audio section wherein are mounted the parts for the audio stages. The 250,000 ohm volume control is mounted on the

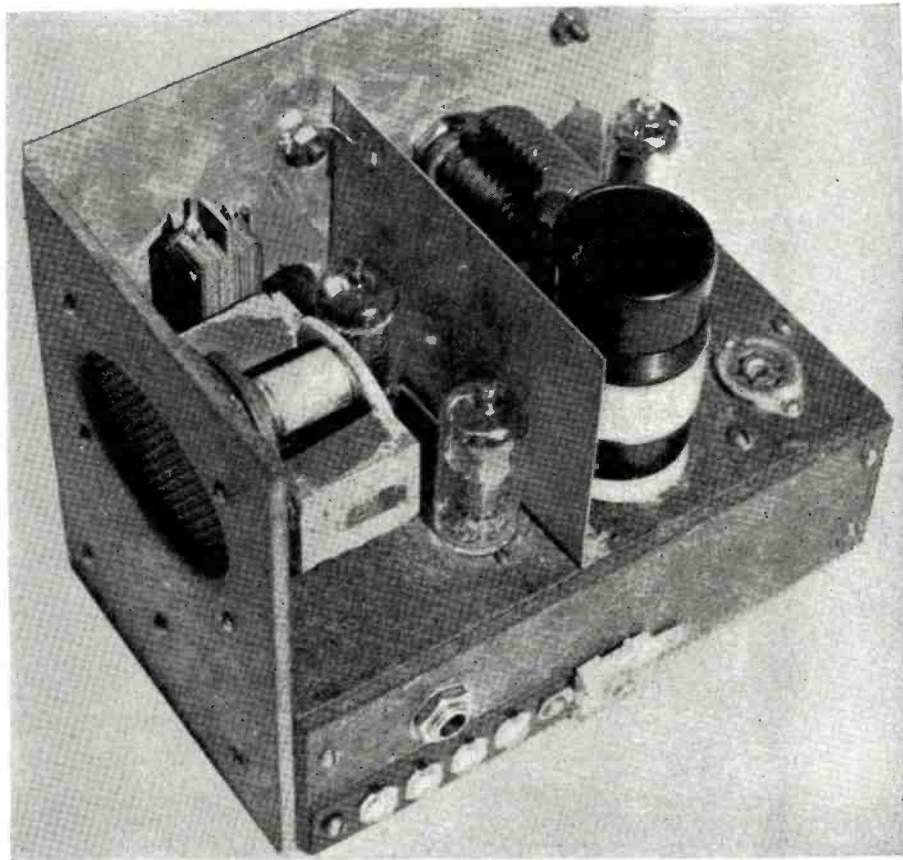

Top-rear view of completed receiver. Shield partition shown is necessary.

front panel and the output transformer is bolted upside down to the baseboard. On the strip of masonite across the back are mounted the phone jack, the antenna trimmer condenser, C_3 , and a four terminal strip for the A+, B+, ground (A- and B-), and antenna connections. This arrangement permits the use of very short leads, an essential for short waves.

The chassis is so tiny, however, that almost any arrangement will be satisfactory so far as lengths of leads are concerned. All connections should be soldered and as short and direct as possible.

The coils used can be any standard two winding type, or they can be wound from the data given in the (Continued on page 152)

Under-chassis view shows neat arrangement of the various component parts.

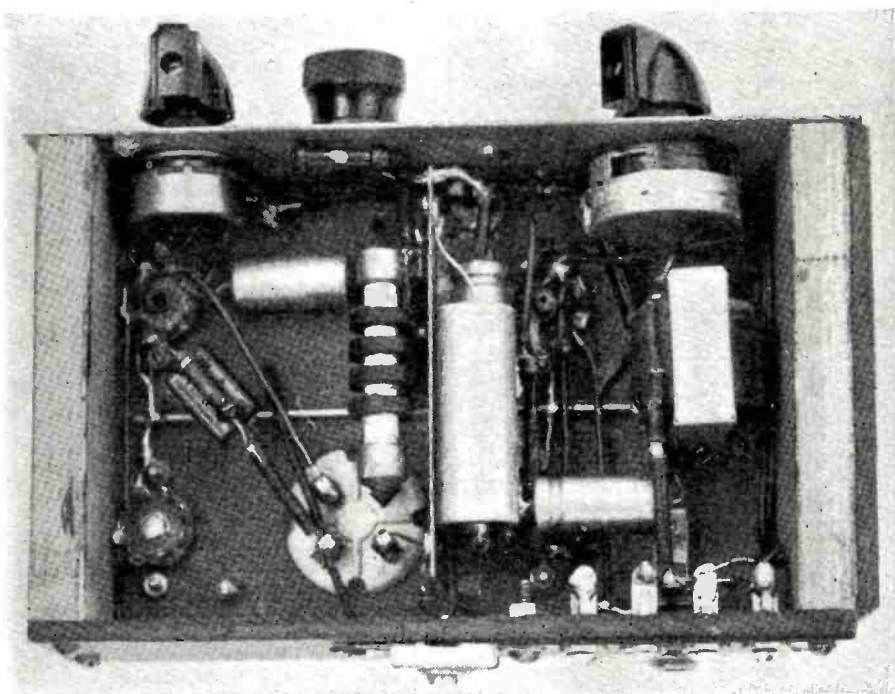

A 10 KC. SUPPRESSOR

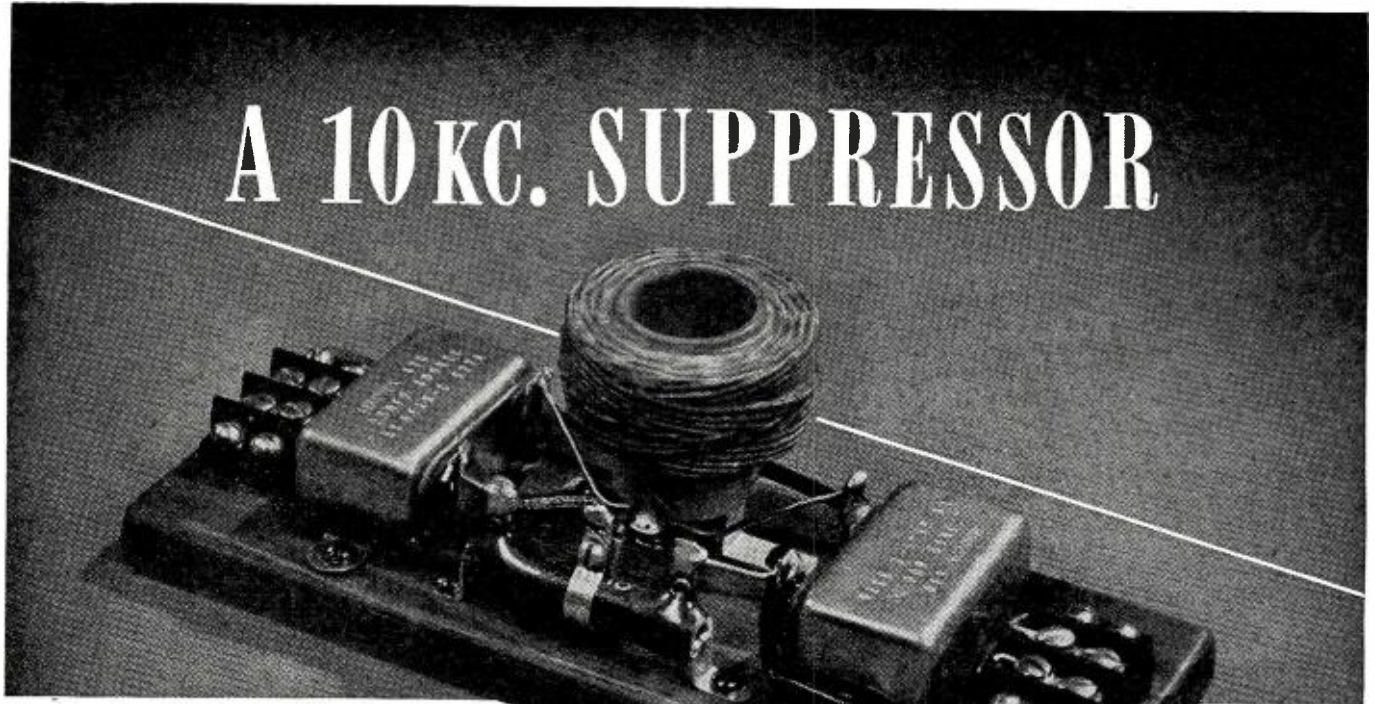

By J. E. KAUKE

When revamping a radio receiver for higher fidelity, a 10 kc. filter must be incorporated.

10 kc. filter built by the author. The adjustable resistor permits the complete cancellation of heterodyne squeal. Heavy hook-up wire is used.

TO ADDICTS of high-fidelity radio reception, there is probably nothing quite as objectionable as the annoying 10 kc. interstation squeal. True, it can be eliminated by filters, and one popular high-fidelity coil kit includes such a network, which may

be tuned for maximum suppression at 10,000 c.p.s. Most factory-built, high-fidelity receivers have similar filters in the plate circuit of the first a.f. amplifier.

However, most filters used for this purpose begin to cut off around 6000 or 7000 c.p.s., and response is not back to normal until about 15,000 c.p.s., which is beyond the usable range of the set and speaker.

A filter to remove a very narrow band from the audio spectrum without an appreciable effect on adjacent frequencies demands an inductance with very high Q . With iron-cored coils, a very high Q is hard to obtain. Yet when used in a plate circuit, or in the cathode circuit of an infinite impedance detector, the inductance required is in the order of 2 henries. The cost of such a coil is prohibitive as an air-core inductor, and with the best available core material, a Q of 150 is about the maximum attainable. It is clear that some other approach is necessary to find a suitable solution.

In the first place, the Q of an air-core coil is roughly proportional to the frequency, provided the coil is wound to optimum dimensions. Secondly, if the circuit in which the filter is placed is of low impedance, the required in-

ductance becomes much lower, and an air-core coil is practicable. Therefore, why shouldn't the filter be placed in the low-impedance speaker circuit? In two-way speaker systems, which are commonly used with high-fidelity receivers, it is still simpler, since it is possible to put the 10 kc. filter in the circuit of the high-frequency unit only. As a series resonant trap is to be used, the coil should have as low a resistance as possible in order that the suppression will be sufficient.

The circuit of Fig. 1A was chosen for a start. The coil has an inductance of 1.02 mh., and the entire filter is placed in the leads going to the high-frequency unit of a two-way speaker system. The coil consists of one pound of #16 d.c.c. wire—wound with two strands in parallel to obtain a minimum of resistance (#13 wire would do just as well, and be much easier to wind). The coil was wound by hand as a "universal" winding, with each turn overlapping the previous one, which is rather a difficult job, but with heavy wire and the judicious use of some small strips of scotch tape, it was found possible to construct such a coil. The "core" was a 2½" paper tube, with the "throw" or width of the coil equal to ¾". The specified amount of wire winds into a coil ¾" thick, these dimensions being chosen to insure a high Q . The inductance of the completed coil measured 1.02 mh. with a Q of 25 at 1000 c.p.s.

The simple series resonant circuit of Fig. 1A across a 16 ohm high fre-

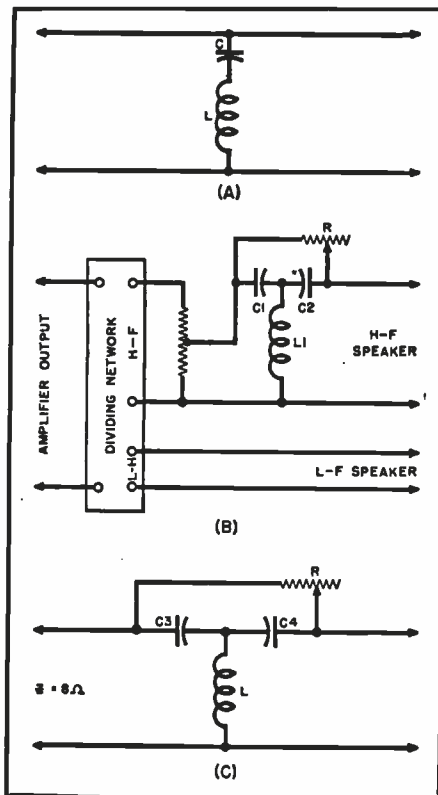

Fig. 1. (A) Basic series-resonant trap circuit used to eliminate 10 kc. whistle. (B) Connection of resistance-compensated trap circuit in high frequency leg of output circuit from dividing network. (C) Recommended filter for use in 8-ohm speaker circuit. L is .6 mh. line filter choke with turns removed to resonate at 10,000 c.p.s. with capacitors C_1 and C_2 .

SONAR— The Submarine's Nemesis

By C. G. McPROUD

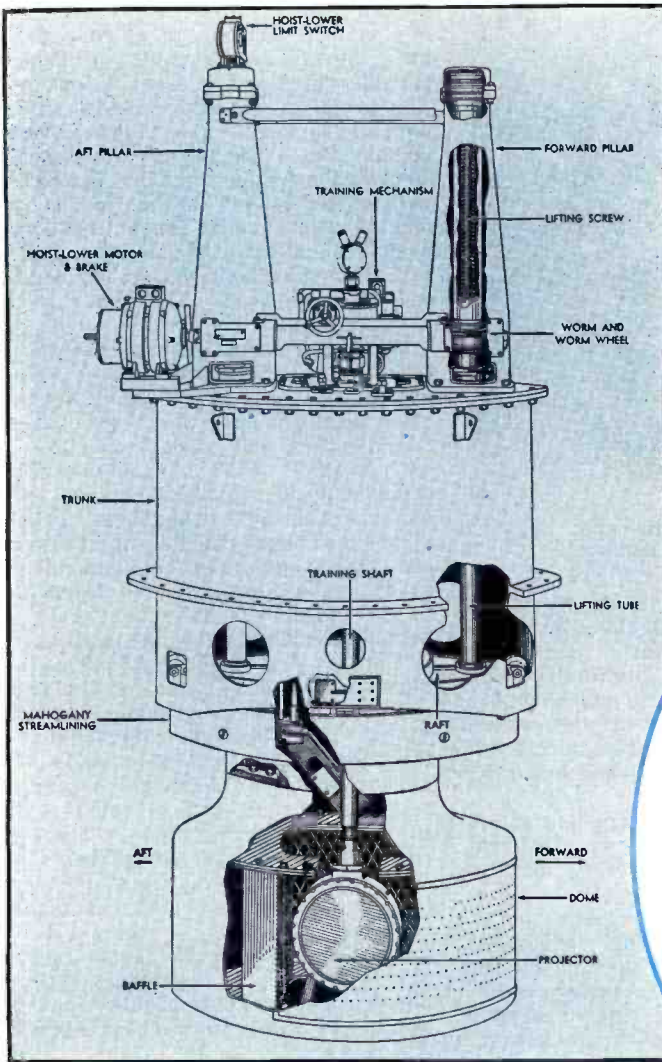

Fig. 1. Cutaway drawing of sonar dome and retracting gear.

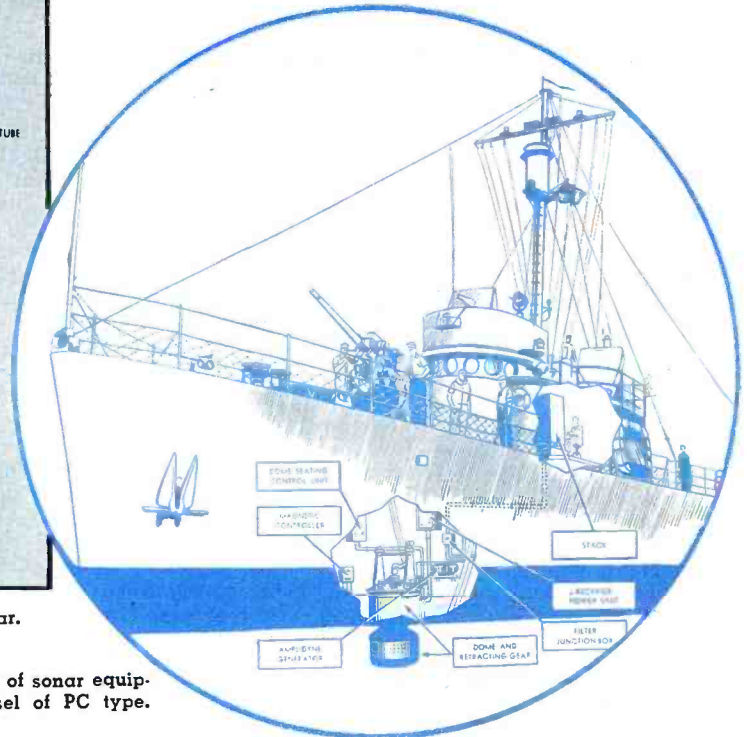

Fig. 2. General arrangement of sonar equipment in anti-submarine vessel of PC type.

The Navy has termed sonar a "major factor in the defeat of the U-boat and the winning of the Battle of the Atlantic" for the Allies.

“CONTACT—zero four zero—sixteen hundred yards,” calls the sonar operator. Only seven words, but on an anti-submarine ship they are the signal for the start of a beehive of activity. Five principal performers bend every effort to keep a finger of sound on the enemy submarine until they can put on it a more effective “finger”—TNT. Two hundred other scared, sweating performers are tense with excitement, each doing his own job—reading depth charges, relaying telephoned orders, checking engine gauges, or executing any of the multitude of different jobs on a destroyer, DE or SC. All have only one objective—a successful attack.

The story of sonar cannot be told without acknowledging the efforts of those whose duty it was to handle a maze of electronic equipment. Radar

has more glamor; loran is more spectacular; but the Navy calls sonar “a major factor in the defeat of the U-boat and the winning of the Battle of the Atlantic.” Nine hundred and ninety-six enemy submarines were sunk during the war. The majority of them were detected by the sonar equipment and attacked on the basis of information supplied by it.

Informed readers are almost as familiar with radar as they are with radio itself. Sonar has received less publicity in the technical press, yet the methods employed in detecting unseen submarines are just as fascinating as those used to detect unseen airplanes.

Sonar principles are similar to radar—the time is measured between the transmission of a pulse and the reception of an echo bouncing back from the target. Simple as that. But in

sonar, the signal is not an electrical wave—it is a sound wave at a frequency between 18 and 24 kc. The transmitter is a typical master oscillator power amplifier with the output feeding a “projector” which converts the electrical signal into supersonic mechanical vibrations.

Projectors of various types are used. In the magnetostriction type, several hundred nickel tubes are imbedded in a one-inch thick diaphragm. Each tube is surrounded by a coil of wire which carries the signal voltages. Fig. 8 shows the construction of the projector used with the QCQ-2 equipment. The varying magnetic field induced by the coil causes the tubes to shorten and lengthen alternately, and this activity causes the diaphragm to vibrate. The resonant frequency of the diaphragm is very sharp, the response being down 50 per cent at a frequency two per cent off the peak. Such selectivity results in a high signal-to-noise ratio.

Crystal projectors employ a large number of Rochelle salt or ammonium-

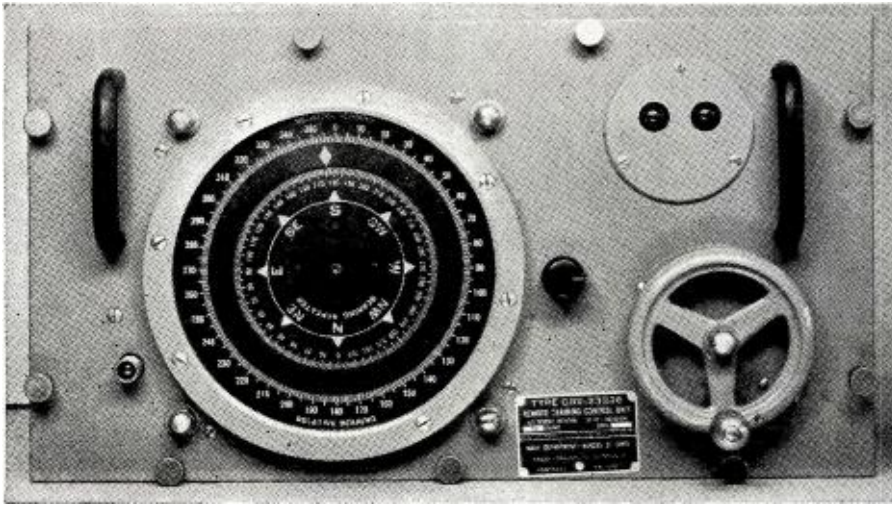

Fig. 3. QCC-2 training control panel, showing indicator for true and relative bearings, and handwheel for control of projector rotation.

dihydrogen-phosphate (ADP) crystals arranged in rows. Each has two electrodes, and they are connected in parallel. The output of the driver amplifier is fed to these crystals, and the vibration caused by the piezoelectric action is transmitted to the sea water through castor oil surrounding the crystal blocks. A sound-transparent rubber cover keeps the oil in, the water out. The ADP crystal, developed during the war by *Bell Telephone Laboratories* has the same piezoelectric properties as Rochelle salt, but is less subject to rupture from high signal potentials, and may be worked to higher temperatures. Crystal projectors are about 80 per cent efficient, whereas magnetostriction projectors have an efficiency of around 10 per cent. A comparison of these figures would seem to indicate

that the crystal projector would be used exclusively, but the added advantage of the greater selectivity is of more importance than efficiency. Recently developed projectors employ a tuned back-plate for the crystal array, with some increase in selectivity, but not to the extent possible in the magnetostriction type.

A typical sonar system consists of a transmitter to furnish the electrical output signal, a receiver to amplify the weak echoes, an indicator to measure the time from the transmission of the pulse or "ping" to the reception of an echo, the projector, and means for rotating the projector under water. The larger anti-submarine ships have the projector mounted in a retractable streamlined dome, located about 30 feet back from the bow. This dome and retracting gear, as it is called, is shown in detail in the drawing of Fig. 1. The illustration also shows the location of the dome and retracting gear aboard ship.

The dome proper is a streamlined structure with a .020" stainless steel sound window, extending on each side about 135 degrees from the forward end. This window is spot welded to expanded metal reinforcing. The entire structure is mounted in an opening in the keel, with the bottom of the dome in the retracted position flush with the bottom of the hull. The dome is carried on a steel raft, which is raised and lowered by means of the

lifting screws in the two pillars. The mahogany streamlining is shaped to the contour of the hull to reduce turbulence when the dome is lowered. The projector is carried on its shaft, which is rotated by the training mechanism. Since the top of the dome is open to the water, the dome is flooded with water at all times. In the retracted position, the top of the dome is seated against a gasket, so that the projector may be removed for necessary maintenance while the ship is waterborne.

We have mentioned briefly the transmitter, or "driver," as it is called in sonar. In the QCC-2 equipment of RCA manufacture, the output stage consists of a pair of 811's in class B, with two more 811's as rectifiers. The driver amplifier for this equipment is capable of an output of 400 watts, this power being concentrated in a pulse of one-quarter second or less, transmitted at six-and-a-quarter-second intervals. These pulses are inaugurated by a mechanical keying arrangement which is part of the "indicator." This indicator is used to measure the time required for the sound wave to travel to the target and be reflected back. Since sound travels at a speed of approximately 4300 feet per second in salt water, and since it must make the round trip from the projector to the target and back, it is seen that the time required for the sound wave to "range" an object 1600 yards distant is two seconds. A target at 400 yards requires a half second for the round trip. These are relatively long times—compared to radar, for example—so a simple arrangement will suffice as an indicator. Some equipment uses a disc making one revolution in 1 1/4 seconds for targets closer than 1000 yards, and a slower rate of revolution in 6 1/4 seconds for 5000 yard maximum. When the target is at a greater distance than 5000 yards, the keying is made to occur at every other revolution of the disc. A synchronous motor drives the disc which moves behind two scales, calibrated in 0-1000 and 0-5000 yards, around its circumference. A neon light is mounted behind a slit in the disc. As the slit passes the scale "zero," cam actuated contacts energize the oscillator, and a pulse is emitted from the projector. This pulse travels horizontally through the water. If a submarine, reef, or

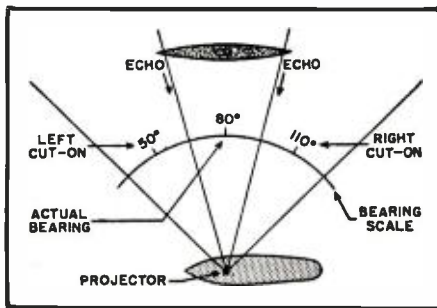
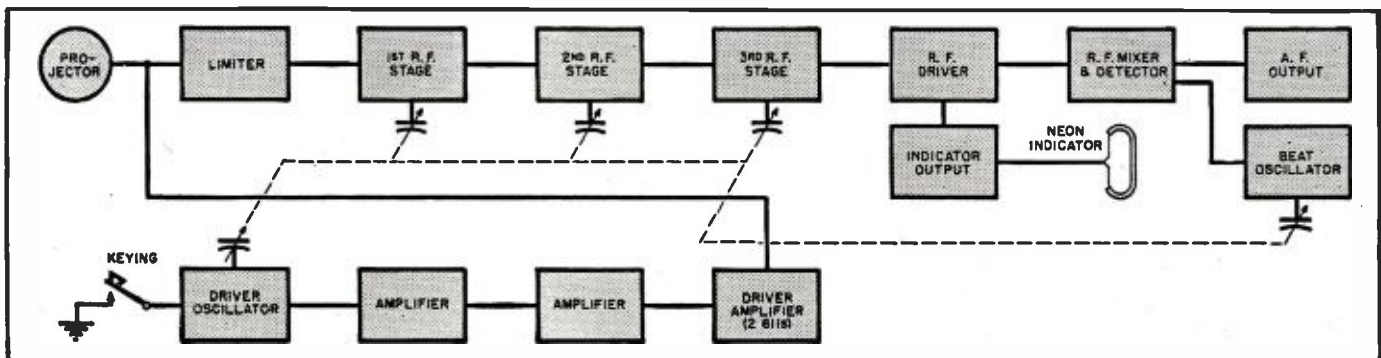

Fig. 4. Determining bearing of target by midpoint between two cut-on points.

Fig. 5. Block diagrams illustrating functional operation of RCA QCC-2 sonar equipment.



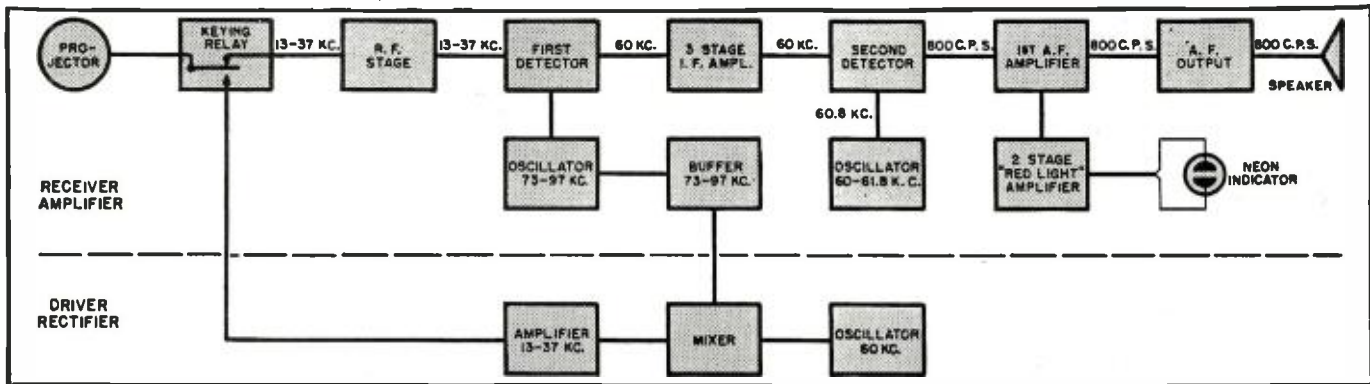

Fig. 6. Block diagram of Submarine Signal Company's WCA-2 sonar equipment. Tuning receiver also tunes driver rectifier, so that both receiver and transmitter are always tuned to the same frequency.

school of fish is in the path of the sound beam, it is reflected back as an echo, received by the projector acting as an underwater microphone, amplified by the receiver, and the output signal causes a flash of the neon tube. During this time, the disc travels a distance proportional to the range of the target, and the position on the scale of the echo flash indicates the range.

Another type of indicator is that used in the QCQ-2 equipment. The principle of operation is the same, although the mechanical construction is considerably different. The flashes of light from a long neon tube are observed through a hole in a thin steel belt, motor-driven at a constant speed.

Both t.r.f. and superheterodyne circuits are used in sonar receivers. Equipment manufactured by the *Submarine Signal Company* uses the superheterodyne, consisting of an r.f. stage, local oscillator, first and second detectors, and i.f. and a.f. amplifiers, shown in block schematic form in Fig. 6. The detectors are copper oxide "varistors," so called from their use as variable resistors. With an i.f. of 60 kc., it is necessary for the oscillator to be tuned simultaneously with the r.f. stage to a frequency 60 kc. above that of the signal. A three-stage i.f. amplifier with variable selectivity feeds another varistor as the second

detector, where it is mixed with a heterodyne oscillator frequency of 60.8 kc., resulting in an audio tone of 800 c.p.s. This audio signal is fed through separate amplifiers to the neon indicator, and to a loudspeaker. The audible signal is used to indicate the relative motion of the target with respect to the ranging vessel by means of the Doppler effect.

For an explanation of this, consider the pitch of a locomotive whistle as a train approaches, passes, and recedes from a listener. As the train is approaching, the pitch is higher than when it is passing, and still lower as the train recedes. Sound waves from the approaching train have, besides their own velocity, the additional velocity imparted by the movement of the train; hence, more vibrations reach the ear in a given time, causing a sound of higher pitch. The reverse is true as the train recedes.

Applying this principle to sonar, it is seen that the echo from a stationary object will have the same pitch as the reverberation, both of which are heard by the operator. (Reverberation is the sound reflected back to the projector from air bubbles and infinitesimal particles in the water.) But if the target is moving toward the ranging vessel, the echo gets an extra impetus from this motion, and the pitch is higher. A target moving

away will return an echo of lower pitch. Thus the operator can judge the target movement.

Returning to a description of the equipment, the receiver used by the QCQ-2 equipment employs a t.r.f. circuit. A five-gang condenser tunes three r.f. stages, a heterodyne oscillator tracking 800 c.p.s. below the signal frequency, and another oscillator tracking with the r.f. stages. This circuit is the master oscillator for the driver, and two additional stages following the oscillator tube provide enough signal voltage to actuate the driver amplifier. Fig. 5 shows the entire system in block form. With this equipment, the operator can tune
(Continued on page 139)

Fig. 7. QCQ-2 sonar "stack." From top to bottom, receiver-indicator-driver oscillator, training control, and driver amplifier.

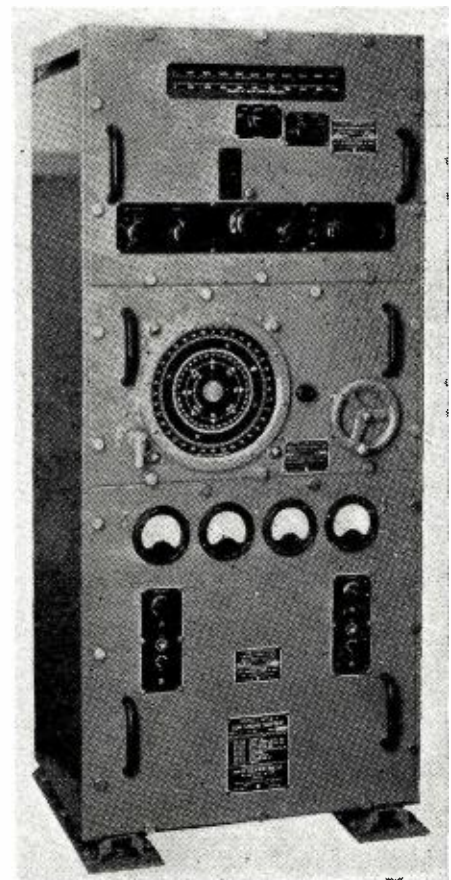
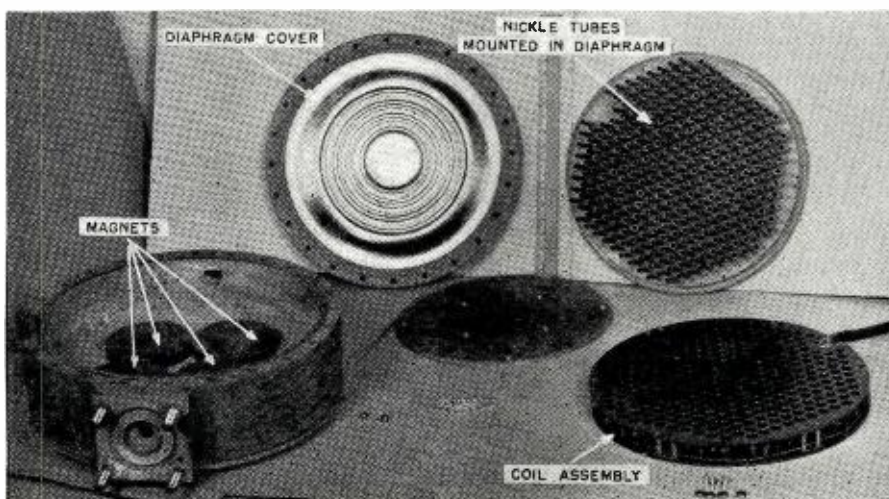

Fig. 8. Disassembled view of QCQ-2 magnetostriction projector.



A Handy 20-Watt Modulator

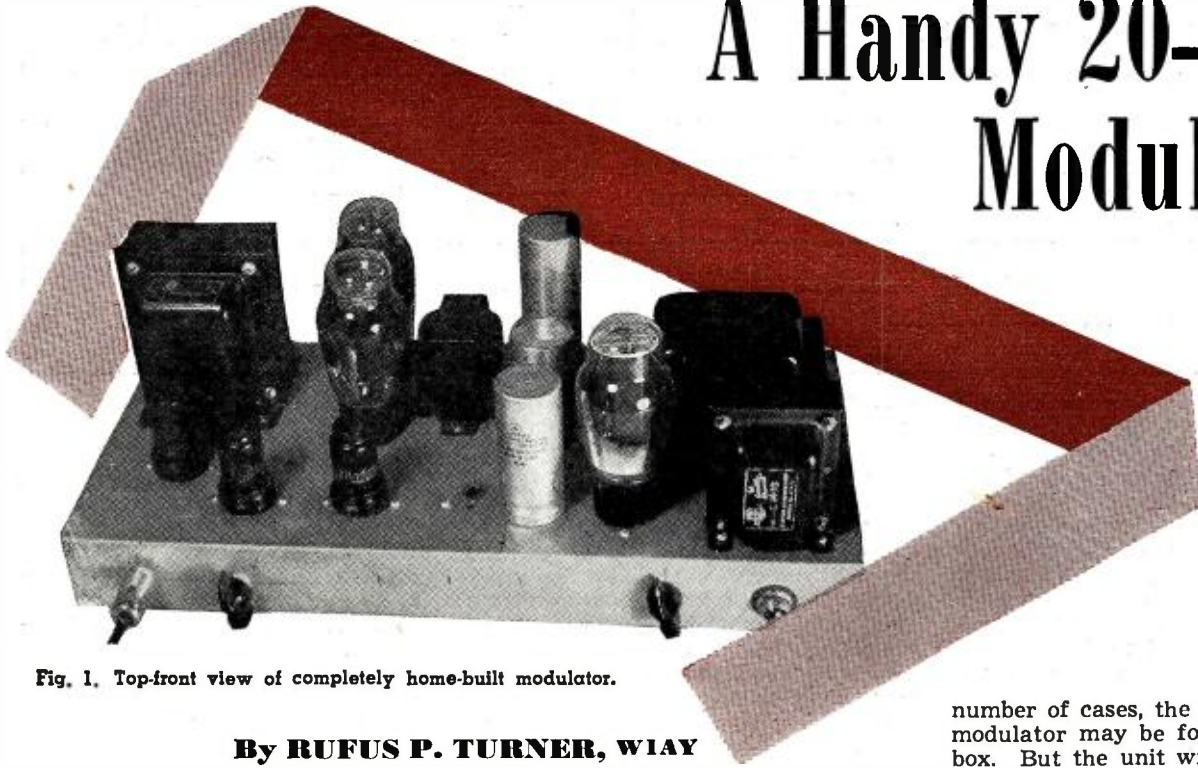

Fig. 1. Top-front view of completely home-built modulator.

By **RUFUS P. TURNER, W1AY**
Consulting Eng., RADIO NEWS

Construction details for an inexpensive modulator that can be used with most types of amateur rigs.

THOSE choice, new ultra-high frequencies certainly are inviting. The thrill of making circuits oscillate or amplify at hundreds—and even thousands of megacycles and of sending out beams with antenna arrays you can hold in your hand is not easily passed up. Lots of hams already are exploring our new territory and firing up on our returned u.h.f. bands, as well. We have a lot of catching up to do.

For some indistinct reason, the usual amateur procedure is to spend days on end developing a new u.h.f. rig, with no thought as to audio, and upon completing the job to discover that almost as much more time must be spent building a modulator. A

steady carrier is none too useful! Few hams keep on the shelf a ready-built and rarin' to go audio unit suitable for modulating experimental u.h.f. rigs. Heretofore, your author has been no exception.

The ham who intends to do any amount of experimenting with u.h.f. gear will not question the advisability of keeping a small modulator on hand. Fortunately, most experimental, fixed-station u.h.f. transmitters run plate inputs of 40 watts or less. A complete, self-powered modulator delivering 20 watts or so and accommodating any of the usual amateur microphones will therefore be adequate for amplitude-modulating these rigs 100 per-cent. In a large

number of cases, the parts for such a modulator may be found in the junk box. But the unit will not be expensive even if built "from scratch."

The modulator described in this article is simple and foolproof and was built primarily for experimental u.h.f. use. Between experiments, it has been used successfully as a speech amplifier to drive a zero-bias modulator in the big rig (through a coupling transformer for matching a 500-ohm line to zero-bias class B grids) and is recommended as standard equipment for other u.h.f. experimenters. It has enough over-all gain to handle amateur crystal and dynamic microphones and enough wallop to modulate the low-powered gear most likely to be used in u.h.f. experiments. The unit is inexpensive and straightforward in design and requires no coddling to get going or to keep in top operating condition.

General Description

The power output of the modulator is approximately 24 watts. The tube lineup is 6SJ7-6C5-6C5-push-pull 6L6's, class AB₁. The power supply is built on the same chassis, making the unit completely single-packaged. Over-all gain is approximately 100 db. With the layout shown in Fig. 5, hum level is low enough to be of no practical consequence in communication work.

External views of the unit are given in the photographs, Figs. 1 and 2. Fig. 4 is an under-chassis view. These photographs, together with the layout drawing (Fig. 5) show completely the structural aspects of the modulator.

The output transformer employed by the author provides two modulating impedances—500 ohms and 2800 ohms. Lack of additional impedances has caused little trouble, however, since it has been easy to adjust the

Fig. 2. Rear chassis view. From left to right along chassis flange are: two relay contacts, power line receptacle, fuse holder, and terminal strip for modulation output transformer.

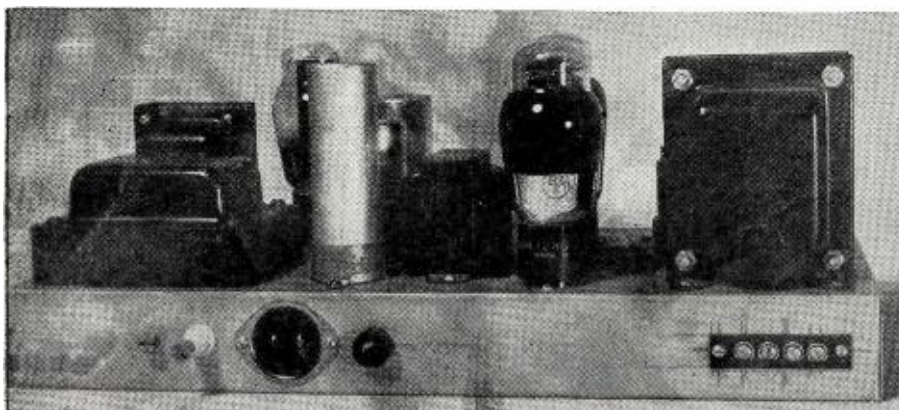

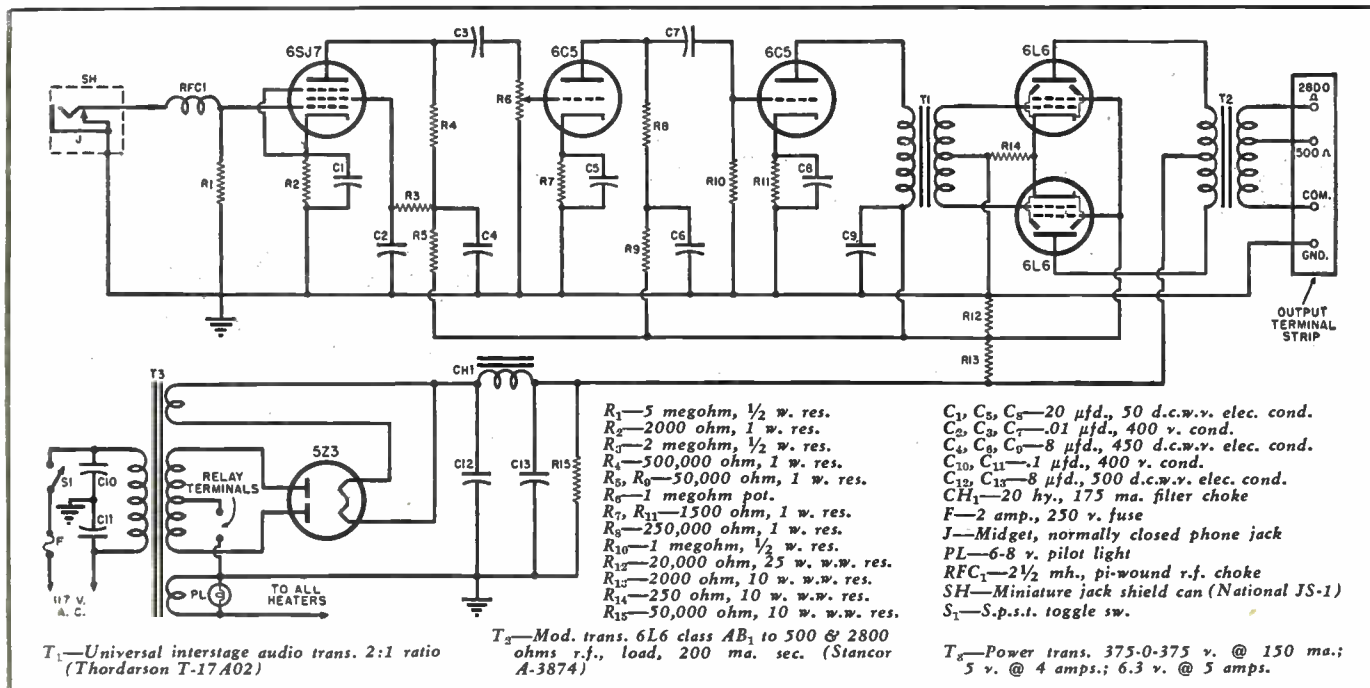

Fig. 3. Schematic diagram of 20-watt modulator. The circuit is simple and no trouble should be experienced in duplicating it.

d.c. plate input of various u.h.f. oscillators and amplifiers to correspond to an impedance of 2800 ohms. The 500-ohm output has been used for cathode modulation and also occasionally to feed the 500-ohm primary winding of an external multimatch modulation transformer or the primary of a 500 ohm to push-pull grids transformer in a *zero bias* modulator.

Operating as it does without degeneration, distortion in the modulator is tolerable. However, an individual builder may, if he desires, add degenerative feedback to the push-pull 6L6 stage with a slight decrease in power output.

Since, for experimental reasons, the author desired complete manual control of gain, no automatic modulation circuit was included. But an individual builder may obtain an a.m.c. simply by rectifying a portion of the audio output (e.g., with a capacitance-coupled 6H6 tube or crystal diode) and feeding a portion of the rectified voltage, regulated by means of a potentiometer, back through a resistance-capacitance filter to the suppressor of the 6SJ7 tube. The suppressor must, of course, first be disconnected from the cathode terminal.

Electrical Details

The complete circuit diagram of the modulator is given in Fig. 3.

The 6SJ7 high-gain input stage provides the highest voltage gain. The two succeeding 6C5 stages each have medium gain. The push-pull 6L6 stage is self-biased and its screen voltage is supplied by the voltage divider R_{12} - R_{13} . Decoupling filters, comprised of 50,000-ohm resistors R_5 and R_6 and 8 μ fd. capacitors C_4 and C_6 , insure stable operation of the first two amplifier stages.

The self-contained power supply is

a conventional capacitor-input circuit comprised of transformer T_3 , the 5Z3 rectifier tube, filter section CH_1 - C_{12} - C_{13} , and bleeder resistor R_{15} . The power supply components are mounted on the end of the chassis farthest from the amplifier input stages, in order to minimize hum.

Radio-frequency feedback, unusually troublesome at ultra-high frequencies, is discouraged by complete shielding of the microphone jack, J , with a small shield can (See SH in Fig. 3) and inclusion of a 2 $\frac{1}{2}$ milli-henry r.f. choke, RFC_1 . All metal tube envelopes are grounded by connecting the No. 1 socket pins to chassis through the shortest possible leads. If metal 6L6 tubes are used in the output stage, their envelopes *must* be grounded in this same manner.

The 1-megohm potentiometer R_7 is the amplifier gain control. The under-chassis view (Fig. 4) shows this

control mounted as close as possible to the control grid terminal of the second 6C5 socket.

All resistors except R_{12} , R_{13} , R_{14} and R_{15} are small-sized carbon units. Each resistor in the latter group is a 10 watt wire-wound unit except R_{12} which is 25 watts wire-wound.

Transformer T_2 was selected because its two output impedances satisfied most requirements. The author has found it easy to adjust the plate input of various u.h.f. oscillators and amplifiers to a value corresponding to 2800 ohms. Thus, a rig operated at 300 plate volts will offer an impedance of 2800 ohms when its plate current is adjusted to 107 milliamperes, a 350-volt oscillator or amplifier shows 2800 ohms at 125 plate mls, etc., etc. (Impedance in ohms equals plate volts divided by plate amperes.) The 500-ohm winding is almost uni-

(Continued on page 161)

Fig. 4. Under-chassis view shows wiring and position of component parts.

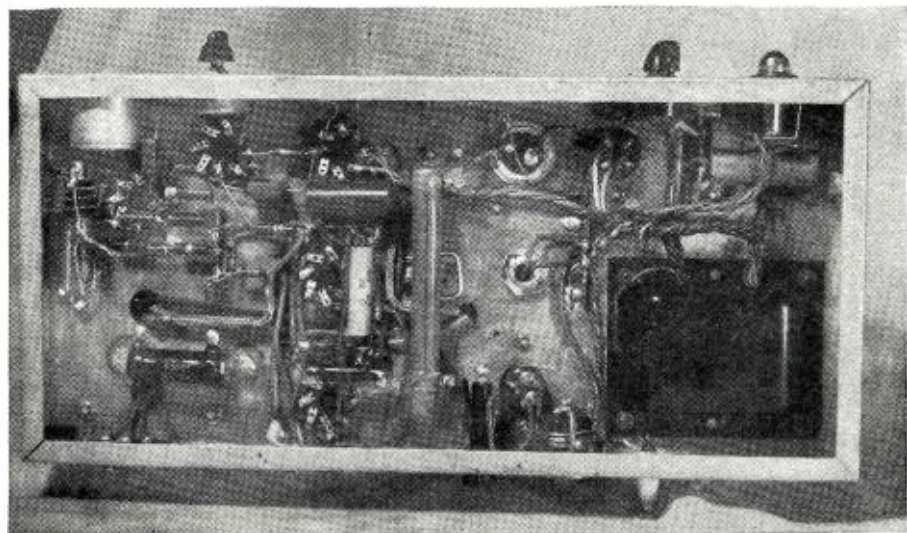

The RECORDING and REPRODUCTION of SOUND

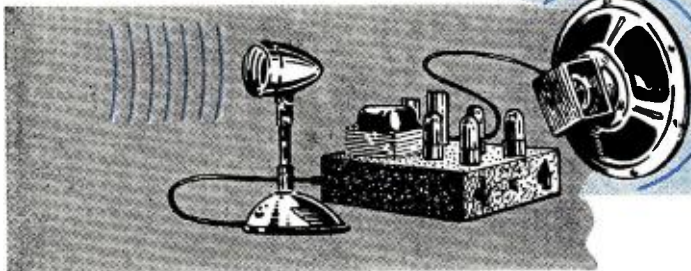

By OLIVER READ

Editor, RADIO NEWS

Part 1. The behavior of sound waves — introduction to a new series of articles covering the history, development, and applications of all currently known methods employed for the recording and reproduction of sound. Mechanical, electrical, and electronic methods will be covered, including sound on wire, disc, tape, film, etc.

TO FULLY understand the many problems which enter into the recording and reproduction of sound, we must first take into consideration the basic concept of sound. We must understand and fully appreciate the characteristics of sound or we cannot apply satisfactory techniques to obtain a true facsimile of the original sounds we expect to reproduce.

Webster defines *sound* as follows: "Sensation due to stimulation of the auditory nerves and auditory centers of the brain, usually by vibrations transmitted in a material medium (commonly air) affecting the organ of hearing—vibration energy which oc-

casions such a sensation. Sound is propagated by progressive longitudinal vibratory disturbances (sound waves)." Thus, it becomes apparent that the source of sound lies in the realm of physics, while the effect of sound is a physiological consideration. The engineering of sound consists of controlling the cause so as to produce the desired effect.

The theory of *sound waves* may be explained in simplified form thusly: If a small stone is dropped into a pool of still water, waves will be set up which will travel in all directions away from the point of impact. If our original stone were small in physical

size, only waves small in height would result. However, if a large stone were dropped into the still water, we would discover that we have generated waves having a greater height. The up and down movement of the waves represents the *amplitude* or the intensity of the waves.

Differing from the behavior of water waves, sound particles of air do not move up and down and across in the pattern in which waves move but all move in the same direction. These particles of disturbed air literally bump one another as they travel through space. The air, therefore, is alternately compressed and rarefied.

The number of waves passing any fixed point per second represents the *frequency* or number of waves per second. Therefore, the *frequency* depends upon the number of waves traveling past one spot during an interval of one second. If we tie a string to a stone which is immersed in still water and move it up and down at the rate of 100 times per second, we will send out waves from the point of impact at the rate of 100 per second. In the study of acoustics we refer to *frequency* in terms of cycles per second, abbreviated c.p.s.

Now suppose we took a large stone and moved it up and down very slowly in and out of the water, we would then set up waves at a lower frequency but, due to the greater displacement of the water by the object, we would create waves of greater amplitude.

The top of the wave is referred to as the *crest*, while the bottom is known as the *trough*. One *cycle*, as far as one wave is concerned, would be one complete wave beginning from its normal still point, building up to a crest, passing again through its still point,

Fig. 1. Frequency range of musical instruments and those covering the human voice.

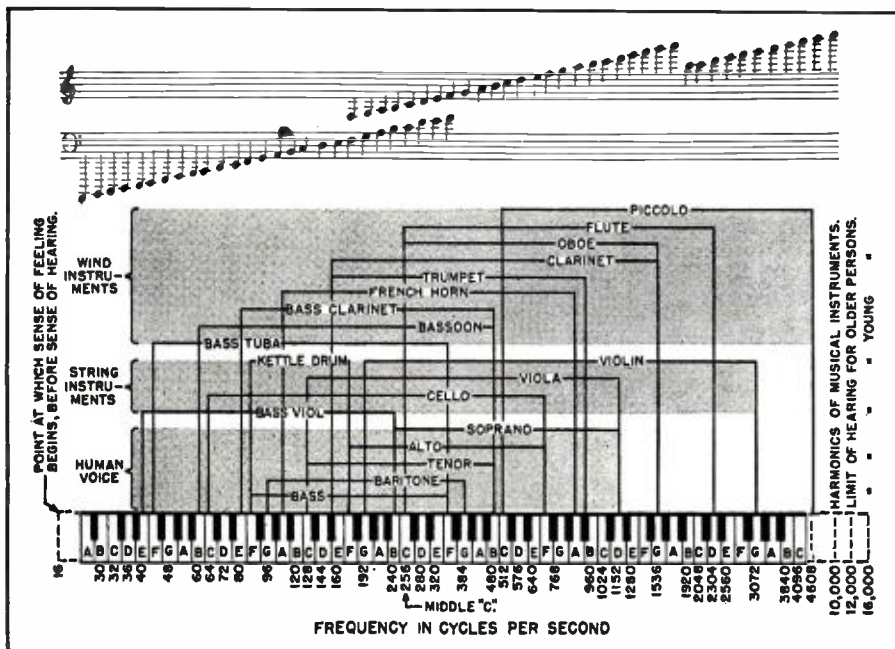

down to the lowest point, the trough, and its return to its normal position. See Fig. 4D.

Sound waves are not limited to but one frequency. In fact the speaking voice is made up of a variety of *complex waves*. These are continually varying in both frequency and amplitude. In other words, if we raise our voices in *pitch*, we are actually increasing the *frequency* and the *louder* we talk, the greater will be the *amplitude* of the sound waves sent out by our speaking mechanism.

All sound waves are composed of frequency, intensity, periodicity, and waveform.

1. *Frequency* is the speed of vibration or number of complete cycles per second. Frequency also determines pitch. If we double the speed of vibration, we raise the pitch one octave. For example, a note having 1000 vibrations or cycles per second would be raised by one octave if the frequency were doubled to 2000 c.p.s.

2. *Intensity* is the amplitude or power of vibration. Intensity therefore determines the loudness of a sound. If the pressure of a sound wave is doubled in intensity, we increase the power by about 3 decibels. The *decibel* is a ratio of power and not a quantity.

In the behavior of sound waves various ranges of intensities and pressures are so great that it is necessary to have some means which will conveniently measure volume or amplitude. The *decibel* is a unit used for expressing the magnitude of a change in either a sound level or a signal level. One decibel is the amount that the pressure of a pure sine wave tone must be changed in order for the change to be just barely detectable by the average human ear. The amount of change in power level expressed in decibels is equal to ten times the common logarithm of the ratio of the two powers. $db. = 10 \log_{10} P_1/P_2$.

3. *Periodicity* is the lack of, or the existence of, rhythm in sound. Therefore, musical sounds are *periodic*, while street noises, the jingle of keys on a chain, etc. are *non-periodic*.

4. *Waveform* is a direct pattern of vibration. Most fundamental sound waves are modified by secondary vibrations. The *timbre* of sound is determined by the waveform. Thus it is possible to distinguish particular notes played on various musical instruments such as the violin and the flute.

Distortion

If a microphone, radio tuner, pickup, amplifier or speaker is incapable of reproducing a true picture of the original sound waves, *distortion* will occur. This distortion may come from either mechanical or electrical defects in the system. *Mechanical distortion* may be caused from such conditions as having a needle in a phonograph pickup move because it has not been tightened thoroughly by means of the needle set screw. In other words, vibrations set up within the pickup could

not transmit or move the needle in perfect cadence with the original electrical vibrations. The needle would be permitted to move freely and to follow vibrations of its own choice instead of moving in perfect unison with the armature in the pickup.

Many reproducer (loudspeaker) cones vibrate at some particular frequency not found in the music that is fed to the speaker for reproduction. The resulting buzzing effect would be a form of *mechanical distortion*. The above illustrations are typical but many others may be encountered throughout the equipment if care is not exercised to adjust each and every part which might cause mechanical distortion.

Generally speaking, a sound is said to be distorted when the waveform is altered in transmission or when the intensity of any frequency is suppressed or exaggerated out of its natural proportions.

Electrical distortion is caused by the inability of the microphone, amplifier or speaker to give a true reproduction (facsimile) of frequency. For example; the delicate diaphragm on a microphone may become warped from excessive heat, etc. As pressure from the sound waves strikes this distorted diaphragm, the resulting currents

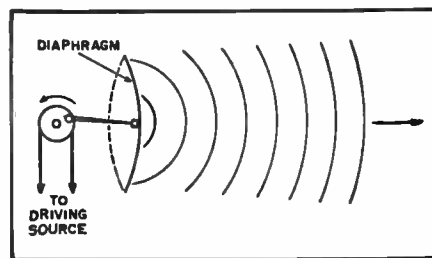

Fig. 2. Sound waves created by the movement of a mechanically-driven diaphragm.

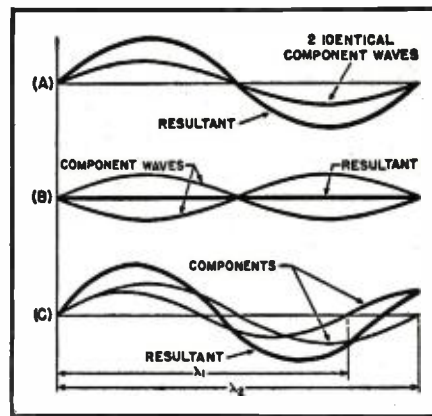
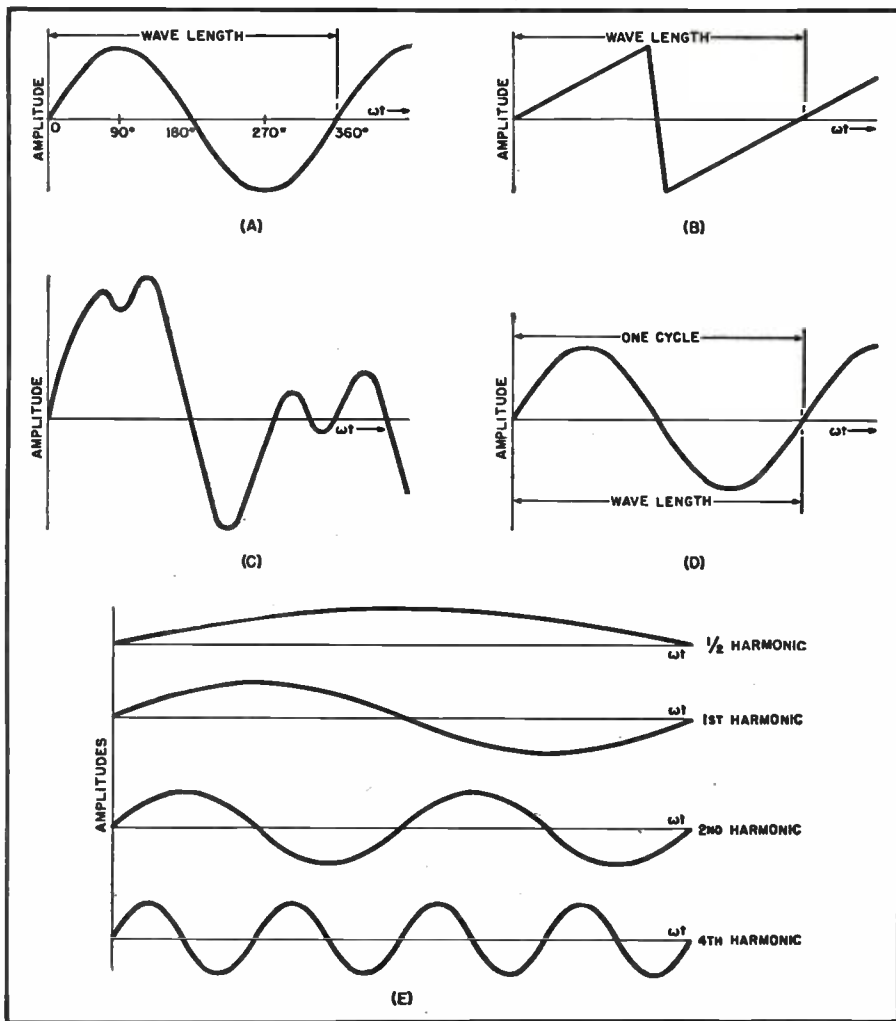

Fig. 3. The combination of two harmonic waves vibrating at the same frequency.

Fig. 4. Illustrating the characteristic behavior of wave motion: (A) sine or cosine. (B) periodic. (C) random. (D) one cycle and (E) harmonics.



would become distorted. There are many forms of electrical distortion. A poorly designed amplifier, overloaded audio stages, impedance mismatching and improper biasing will all result in electrical distortion.

The Ear

There are three main divisions to the human ear: (a) The outer ear, which is made up of the visible portion of the ear and the canal which is not visible. (b) The middle ear, which is the receiver for sound approaching the eardrum and the conducting media for sounds through a chain of three small bones (the ossicles), to the inner ear. (c) The inner ear is the delicate container filled with fluid in which is immersed the nerve ends which perceive sound and which also transmit messages to the brain. The part of the inner ear that perceives sound is called the cochlea. There is still another part of the inner ear in the form of semi-circular canals which give us our sense of balance.

Speech

Speech has a frequency range of from approximately 100 to 8000 c.p.s. There are three principal components

to speech. They are listed as follows:

1. The *fundamental* range (or voice). 100 to 400 c.p.s.
2. The *vowel* range. 300 to 2500 c.p.s.
3. The *consonant* range. 2000 to 8000 c.p.s.

The above are approximate ranges and do not necessarily indicate the proportion of sounds that occur in each division. Sounds having very low frequencies possess the most power and result in naturalness and apparent loudness. High frequency sounds provide intelligibility. If we eliminate all sounds below 1000 c.p.s., we take but little from the clarity of the sound, but we do notice that the sound appears to be unnatural. However, if we eliminate sounds above 1000 cycles, we find that the speech is unintelligible but, as far as volume is concerned, there is little, if any, apparent change.

Speech may be considered as a series of *periodic* sound waves, emitted in a certain sequence. Association of particular sound sequences with particular ideas is the distinguishing feature between speech and noise. The so-called "scrambled" speech systems serve as an excellent illustration of this point. In such a system, spoken

sounds are distorted by specially designed circuits and then transmitted in the distorted form. The receiver must have a rectifying circuit to convert the wave impulses back to their original undistorted form rendering it intelligible to the human ear.

Music

That sound we choose to call music consists of a sequence of single tones or a sequence of several tones played in unison. Pure single tones are harmonic in waveform and the key or pitch is determined by the frequency (with certain modification to be discussed later). The scale is an ascending series of tones with definite frequency intervals. Fig. 6 shows a portion of a standard piano keyboard for one octave on each side of middle C. The frequencies noted represent a so-called tempered scale which divides an octave into twelve equal intervals. The relative frequencies of the tempered scale (omitting sharps and flats) are shown below for one octave:

Key	Relative Frequency
C	1.000
D	1.122
E	1.260
F	1.325
G	1.498
A	1.682
B	1.887
C	2.000

The combinations of two or more tones make up a periodic composite sound. Here again the psychological phase of music shows up, for if the new sound is pleasing to the ear, it is called harmonious. If, on the other hand, the sound is irritating, the combination of tones is said to be in discord.

Frequency Range

If a tone is maintained at a constant intensity but its frequency is raised and lowered, high and low frequency points will be reached beyond which there will be no sensory perception by the ear. Generally this *frequency range* extends from 30 to 16,000 c.p.s. The frequency range for conversational speech is from about 100 to 8000 c.p.s., as mentioned previously. In terms of power, conversational speech will vary over about 40 db. and the intensity of the loudest sound will be about 10,000 times that of the weakest.

A large symphony orchestra, with instruments producing an abundance of bass notes and overtones extends over practically the entire frequency range of the ear—30 to 16,000 c.p.s. The over-all volume range of a symphony orchestra from the softest passages through the loudest passages and peaks runs about 70 db. or an intensity range of 10,000,000 times.

Reproducing systems for highest fidelity should have a frequency range that is uniform from about 30 to 16,000 c.p.s. and a volume range of 70 db.

Of equal importance, the original sounds must be reproduced at the same power levels as were present in

(Continued on page 88)

Fig. 5. Conversion chart for standard 500 ohm db. meter across impedances from 2-4000 ohms.

POWER LEVEL (db.)	VOLTS 500 OHM LINE	POWER WATTS 0 db. = 6 mw.			
-20	0.1730	0.00006	+25	30.8010	1.89740
-19	0.1990	0.00007	+26	34.5590	2.3886
-18	0.2180	0.00009	+27	38.7760	3.0071
-17	0.2340	0.00011	+28	43.5070	3.7857
-16	0.2730	0.00015	+29	48.8160	4.7660
-15	0.3000	0.00018	+30	54.7720	6.0000
-14	0.3390	0.00023	+31	61.4550	7.5535
-13	0.3890	0.00030	+32	68.9540	9.5093
-12	0.4450	0.00039	+33	77.3680	11.9716
-11	0.4860	0.00047	+34	86.8080	15.0713
-10	0.5477	0.00060	+35	97.4000	18.9747
-9	0.6145	0.00070	+36	109.2850	23.8865
-8	0.6895	0.00090	+37	122.6200	30.0710
-7	0.7737	0.00110	+38	137.5820	37.8570
-6	0.8681	0.00150	+39	154.3690	47.6600
-5	0.9740	0.00180	+40	173.2050	60.0000
-4	1.0928	0.00230	+41	194.3400	75.5350
-3	1.2262	0.00300	+42	218.0500	95.0930
-2	1.3758	0.00370	+43	244.6600	119.7160
-1	1.5437	0.00470	+44	274.5100	150.7130
0	1.7321	0.00600	+45	308.0100	189.7470
+1	1.9434	0.00750	+46	345.5900	238.8650
+2	2.1805	0.00950	+47	389.0700	300.7100
+3	2.4466	0.01190	+48	435.6000	379.5000
+4	2.7451	0.01500	+49	487.0100	474.3700
+5	3.0801	0.01890	+50	547.7200	600.0000
+6	3.4559	0.02380	+51	616.0300	759.0000
+7	3.8776	0.03000	+52	688.7400	948.7500
+8	4.3507	0.03800	+53	770.4000	1185.9400
+9	4.8680	0.04740	+54	871.2000	1518.0000
+10	5.4772	0.06000	+55	974.0300	1897.5000
+11	6.1600	0.07590			
+12	6.8100	0.09480	Impedance DB.		
+13	7.7368	0.11970	4000 ohms Subtract 9		
+14	8.7100	0.15070	2000 ohms Subtract 6		
+15	9.7400	0.18970	600 ohms Subtract 1		
+16	10.9285	0.23880	500 ohms 0		
+17	12.2620	0.30070	250 ohms Add 3		$E = \sqrt{WZ}$
+18	13.7578	0.37850	24 ohms Add 13		where:
+19	15.4369	0.47660	15 ohms Add 15		$E =$ a.c. volts
+20	17.3205	0.60000	10 ohms Add 17		across load
+21	19.4340	0.75530	8 ohms Add 18		$Z =$ loaded line
+22	21.8050	0.95090	6 ohms Add 19		impedance.
+23	24.4660	1.19710	5 ohms Add 20		$W =$ watts.
+24	27.4510	1.50710	4 ohms Add 21		
			2.5 ohms Add 23		Cond. in Series
			2 ohms Add 24		with db. meter
					= .25 μ fd.

Applying the 1N34 as Discriminator for FM

The germanium 1N34 crystal provides greater audio output with less residual hum than a conventional 6H6 vacuum tube

By
NORMAN L. CHALFIN

FOR most of us, to hear about crystal detectors again brings back the old days of the cat's whisker and tedious attempts at adjustment to the most sensitive spot on the crystal. That crystals can be applied in modern receivers makes one think of clothing style cycles, where the same fashions reappear periodically. The new crystals are of different materials than those the old timers knew. The 1N34 with which this paper is concerned is a germanium crystal. Other crystals of iron pyrites and of silicon have been used in wartime applications, as have uranium oxide crystals. Most applications have been the uses as detectors and mixers at the microwave frequencies. We shall concern ourselves here with their use as a second detector (discriminator) for FM receivers.

Two receivers in the author's home—one for television reception and the other for FM—were rewired to include the unit shown in Fig. 1 in order to determine how well the germanium 1N34 crystal rectifiers could be used as discriminators. The television receiver was built up originally from a kit and its sound channel was designed for AM reception, therefore, the reception of the sound channel, which is FM under present standards, had to be accomplished by "side-slope" detection. This is not a satisfactory way to receive FM signals. In order to improve this condition the sound i.f. coil, which in this receiver was a solenoid coil with primary and secondary on the same form, was made into a discriminator coil by the simple expedient of centertapping the secondary and coupling the hot side of the primary with a 50 μ f.d. capacitor.

March, 1947

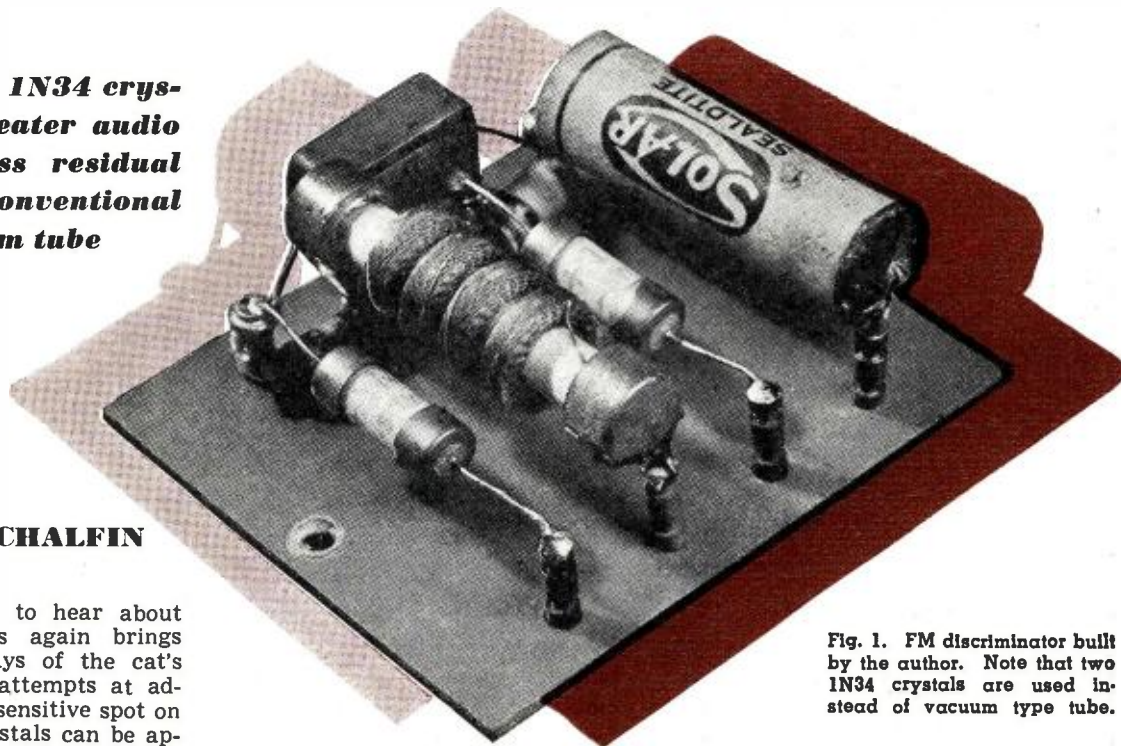

Fig. 1. FM discriminator built by the author. Note that two 1N34 crystals are used instead of vacuum type tube.

to this centertap. The sound i.f. amplifier was pressed into service as a limiter and a pair of 1N34s were wired as the discriminator. The circuit of this arrangement is shown in Fig. 3. A sketch of the detector i.f. coil tuned discriminator is shown in Fig. 5.

For comparison, a 6H6 was wired into the circuit. It was found that the 1N34 delivered more audio to the a.f. amplifier than the vacuum tube. There was no residual hum with the 1N34 while with the 6H6 there was a detectable 60 cycle ripple when observed on the oscilloscope. The hum from the 6H6 could not, however, be heard on the speaker.

Since the experiments herein described were performed, Sylvania has announced the 1N35. This comprises two 1N34s in a single assembly. The

two units are "matched." The 1N35 can be used exactly as has been described above and as illustrated in the diagrams.

There are also available at many of the parts suppliers' shops 1N21 crystal detectors from wartime sur-
(Continued on page 150)

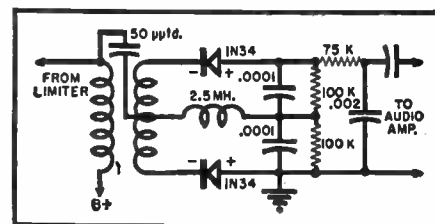
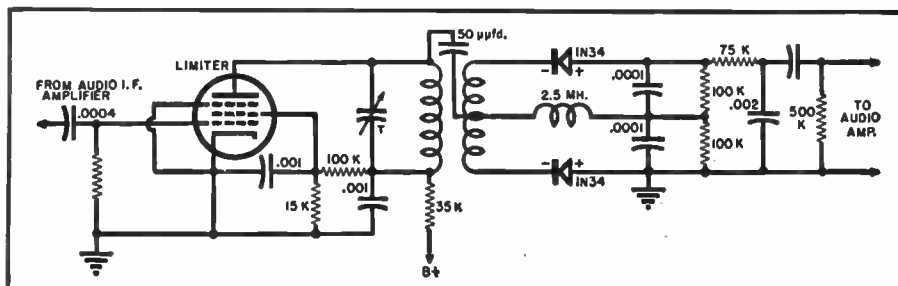

Fig. 2. Circuit diagram of a conventional Foster-Seeley discriminator using 1N34 germanium crystal detectors.

Fig. 3. Circuit diagram of FM broadcast discriminator using two 1N34 crystals. This circuit is similar to a television sound i.f. system except for bandwidth, for television ± 25 kc. deviation is used, while for FM ± 75 kc. deviation is needed.



AROUND THE CLOCK WITH SHORT-WAVE ENGLISH NEWSCASTS

EST	LOCATION	CALL	FREQ.*	EST	LOCATION	CALL	FREQ.*	EST	LOCATION	CALL	FREQ.*
7:00 a.m.	Bandoeng, Java	PLP	11.000V	8:00 a.m.	London	GSK 26.100 GRF 12.085 GSO 15.180 GSD 11.780 GSI 15.260 GVS 21.710 GRA 17.718 GSF 15.140 ZFY 6.000	26.100 12.085 15.180 11.780 15.260 21.710 17.718 15.140 6.000	10:00 a.m.	Vatican	HVJ	9.660 5.970VI 9.600
7:00 a.m.	Chungking	XGOY	6.143V 7.152					10:00 a.m.	London (GOS, Radio Newsreel)	GRY GSF GSN GSSJ GSP GSH GSV GSK GRF GSO	15.140 11.820 21.530 15.310 21.470 17.810 26.100 12.095I 15.180I
7:00 a.m.	Montreal, Quebec	CFCX	6.005								
7:00 a.m.	Toronto, Ontario	CFRX	6.070	8:00 a.m.	Georgetown, Br. Guiana (BBC)						
7:00 a.m.	Halifax, Nova Scotia	CHNX	6.130								
7:00 a.m.	Sydney, Nova Scotia	CJCX	6.010	8:00 a.m.	Makassar, Celebes (Mon., Wed., Fri.)	Radio Macassar	9.360V				
7:00 a.m.	Los Angeles (AFRS)	KGEI KCBA/F	8.530 8.750	8:00 a.m.	Akashwani, Mysore, India	VU7MC	6.065				
7:00 a.m.	Melbourne (BBC, Radio Newsreel)	VLR2 VLH3	6.150 9.580	8:00 a.m.	Montreal, Quebec	CFCX	6.005	10:05 a.m.	Stockholm (To North America)	SBT SDB-2	15.155 10.780
7:00 a.m.	Moscow (To North America)	Radio Centre	11.630 11.720 15.180V 15.360 17.820	8:00 a.m.	Toronto, Ontario	CFRX	6.070	10:10 a.m.	Rangoon, Burma (Headlines)	Radio Rangoon	9.543
7:15 a.m.	Helsinki (Lah-ti), Finland	OIX2 OIX4	8.505V 15.180	8:00 a.m.	Halifax, Nova Scotia	CHNX	6.130	10:15 a.m.	Melbourne (To Britain)	VLC4 VLG9 VL8 VLB9	15.320 11.900 11.760 9.615
7:15 a.m.	Los Angeles (AFRS, At Dictation Speed)	KGEI KCBA/F	8.530 9.750	8:30 a.m.	Leopoldville	OTCS OTC2 (or 9.745V)	17.770 9.252	10:15 a.m.	Bandoeng, Java	PLP	11.000V
7:15 a.m.	London (European Service, At Dictation Speed)	GRI GRX GVU GSE	9.410 8.690 11.770 11.660	8:30 a.m.	Bucharest (irreg.)	Radio Bucharesti	9.252	10:30 a.m.	Delhi	AIR	6.110 9.590 3.495 11.850 9.670 6.190 7.210 11.870
7:30 a.m.	Georgetown, Br. Guiana (Caribbean News Bulletin)	ZFY	6.000	8:30 a.m.	Melbourne (To Forces)	VLA8 VLG9	11.760 11.900				
7:30 a.m.	Melbourne (To Forces)	VLC4 VLB8 VLG9	11.760 15.320 21.600 11.900	8:45 a.m.	Rangoon, Burma	Radio Rangoon	9.543				
7:30 a.m.	Singapore	Radio Malaya	15.300 15.275 11.735V	8:45 a.m.	London (European Service, At Dictation Speed)	GRI GWO GVU GVX	9.410 9.625 11.770 11.930	10:30 a.m.	Bombay Madras New York	WCBN WCBX WCRX WGEO WRUL WLWL KZPI	15.270 17.830 21.570 15.330 15.290 17.955 9.710
7:30 a.m.	Delhi	AIR	6.770 4.980 7.280 11.850 15.280 7.240 7.210 (or 6.010) 7.260 (or 4.920)	9:00 a.m.	Chungking	XGOY	6.143V 7.152 9.730 11.680 11.695V 7.010 6.054 9.695 6.015I 9.540 11.840	10:55 a.m.	Manila	KZPI	9.812I
								11:00 a.m.	Johannesburg, So. Africa (BBC)		6.007
								11:00 a.m.	Capetown (BBC)		5.877V
								11:00 a.m.	Colombo, Ceylon (BBC)	Radio SEAC Radio Colombo	11.770 6.075 4.900
								11:00 a.m.	Delhi (BBC)	AIR	6.110 9.590 3.495 11.850
7:30 a.m.	Colombo, Ceylon	Radio SEAC	11.770 6.075	9:00 a.m.	Colombo, Ceylon	Radio Colombo	4.900				
7:45 a.m.	Pnompenh, Fr. (irreg.)	Radio Indo-China	12.364V	9:00 a.m.	Saigon, Fr. Indo-China	Radio Saigon	11.780 4.810				
7:45 a.m.	Moscow (To North America, Moscow, Newsreel)	Radio Centre	11.630 11.720 15.180V 15.360 17.820	9:00 a.m.	Kuala Lumpur, Malaysia (Relayed from Singapore)	Kuala Lumpur	6.175				
7:45 a.m.	London (European Service)	GRI GWO GVU GVX	9.410 8.625 11.770 11.930	9:00 a.m.	Los Angeles (AFRS)	KNBI KNBA KNBX KCER KGEX KWID KRHO	6.060 9.490 11.790 9.700 11.730 9.570 9.650 6.070	11:00 a.m.	Bombay (BBC) Madras (BBC)	ZFY	6.000
8:00 a.m.	Los Angeles (AFRS)	KGEI KCBA/F	8.530 9.750	9:00 a.m.	Toronto, Ontario	CFRX	6.070	11:00 a.m.	Georgetown, Br. Guiana (BBC)		
8:00 a.m.	Moscow (To North America)	Radio Centre	7.360 11.630 11.720 11.890 15.180V 15.440I 9.565V 9.540	9:00 a.m.	Halifax, Nova Scotia (Sun.)	CHNX	6.130	11:00 a.m.	Melbourne (To West U.S.)	VLG4 VLC6 VLA8	11.840 9.615 11.760
8:00 a.m.	Melbourne (BBC, followed by A.B.C. at 8:05 a.m.)	VLR2 VLH3	6.150 9.580	9:00 a.m.	Singapore (BBC)	Radio Malaya	4.776	11:00 a.m.	Addis Ababa, Ethiopia (BBC)	Radio Addis Ababa	9.620V
8:00 a.m.	Perth (BBC, followed by A.B.C. at 8:05 a.m.)	VLW7	9.520	9:20 a.m.	Singapore	Radio Malaya	15.300 15.275 11.735V 6.770 6.143V 7.152	11:00 a.m.	Nairobi, Kenya	VQ7LO	4.950
8:00 a.m.	Brisbane (BBC, followed by A.B.C. at 8:05 a.m.)	VLO2	7.215	9:30 a.m.	Chungking (Pres Dis-patches to America, At Dictation Speed)	XGOY	6.143V 7.152	11:00 a.m.	Hamburg, Germany	BFN	7.290
8:00 a.m.	Colombo, Ceylon (BBC)	Radio SEAC	11.770 6.075	9:30 a.m.	Melbourne (To Forces)	VLA8 VLC4 VLG9	11.760 15.320 11.900 15.180	11:00 a.m.	Chungking	XGOY	6.143V 7.152
8:00 a.m.	Tokyo (AFRS)	JLR	6.015 4.880V	9:30 a.m.	Delhi	AIR	9.670 9.590 7.210 11.870 3.360V 4.920	11:00 a.m.	Moscow (To Britain)	Radio Centre GRH	11.630I 9.825
8:00 a.m.	London	GSN GRY GSV GSJ GSH	11.820 9.600 17.810 21.530 21.470	10:00 a.m.	Vatican	HVJ	15.095	11:00 a.m.	London (ES)	GVY GVO GSI GSN GSB GSP GSH GSV GRF GSO GSF GRO GSD GVS GVP	11.955 18.080 15.260 11.820 9.510 15.310 21.470 17.810 12.095 15.180 15.140 18.025 11.750 21.710 17.700
								11:15 a.m.	Bandoeng, Java	PLP	11.000V
								11:30 a.m.	Accra, Gold Coast (BBC)	ZOY	7.300 4.915
								11:30 a.m.	Georgetown, Br. Guiana (BBC)	ZFY	6.000

(Continued on page 110)

*Frequencies shown are in megacycles; to convert to meters, divide 300 by the frequency in megacycles, or 300,000 by the frequency in kilocycles; 1000 kcs. equal 1 megacycle.

NOTES: A. B. C.—Australian Broadcasting Commission (domestic network). AFN—Armed Forces Network. AFRS—Armed Forces Radio Service. AIR—All India Radio. AS—African Service. BBC—Relay from London. BFN—British Forces Network. ES—Eastern Service. FES—Far-Eastern Service. GOS—General Overseas Service. I—Frequency used irregularly. NAS—North American Service. PS—Pacific Service. RNE—Radio Nacional de Espana. RNF—Radio Nationale Francaise. SABG—South African Broadcasting Corporation. SEAC—Southeast Asia Command. V—May vary in frequency from that noted.



International SHORT-WAVE



Compiled by **KENNETH R. BOORD**

THIS month we are taking our ISW readers on a brief survey of radio in a picturesque, little country of Europe—Holland—the land of tulips, dykes, and windmills. We dedicate this issue of ISW to the pioneer short-wave broadcaster on the Continent—a voice long heard around the world—PCJ, “*The Happy Station of a Friendly Nation.*” To the capable staff of “*The Happy Station*” we extend heartiest congratulations on this twentieth anniversary of PCJ, and to *Radio Nederland* goes our sincere best wishes for the future of this “*International World Program Station.*”

The Story of PCJ

The history of PCJ actually dates back to 1926, when the first short-wave transmitter was constructed in the Philips Laboratories in Eindhoven, where many expensive experiments were conducted. Of these experiments, Eddie Startz, versatile announcer at the station, relates:

“The object was not record-breaking—in such case a less carefully designed transmitter would have been sufficient—but to find out whether a really reliable wireless transmission over very long distance was possible.”

In order that readers may have a few details of the Philips experiments, we quote from a 1929 pamphlet about PCJ, as prepared by Mr. Startz:

“Since we proved that the radio-waves, under 100 meters, possess special advantageous features for radio transmission and make it possible to bridge the biggest distances with small power, radio has been revolutionized. The extraordinary feature of the short waves were soon utilized for telegraph communications; but short-wave radio telephony proved, until recent years, practically impossible.

“To telegraph from Holland to the Indies on the long waves (over a thousand meters) it proved necessary to use a power of some 300 kw. The long wave telephony transmitter of the Transatlantic Service (approx. 500 km.) also used a power of some hundreds of kilowatts.

“For wireless telephonic communications with the Dutch East Indies, on a very long wave, it would be impossible to construct a transmitter of sufficient power to bridge the 20,000 km.

“But the results obtained with short-wave telegraphy made one wonder if it were not possible to establish a telephony service over the same dis-

tance with short waves. Only experiments could prove if this were possible, and if so, to what extent.

“The Philips Laboratories at Eindhoven, with their innumerable resources, were certainly the best equipped to conduct such expensive experiments.

“Not only was thought given to a possible two-way connection in the near future with the Indies (which has come into existence in the meantime) but also of a possible worldwide broadcast service. The wavelength (31.28 meters, or a frequency of 9590 kcs.) was chosen with a view to obtaining good universal reception.

“Telephony transmissions on ultra short wavelengths are often unsuccessful, because of the inconsistency of the transmitted wavelength. With the usual modulating and receiving systems the speech currents delivered by the microphone are intended solely to vary the amplitude and not the frequency of the oscillations generated by the transmitter. Unfortunately, if

no special precautions are taken, there will be ‘frequency-modulation,’ as it is called by the engineers, and this would cause a very bad distortion.

“In the Philips transmitter, call-sign PCJ, this difficulty has been overcome by the use of an oscillating quartz-crystal, which keeps the transmitting frequency constant between very close limits.

“Some crystals show the so-called piezoelectric effect, discovered by Madame Curie. If such a crystal is compressed, an electromotive force is generated on its surfaces; the reverse is true, too—if an e.m.f. is applied, the crystal contracts.

“In a crystal oscillator this property of a thin plate of quartz crystal, capable of oscillating mechanically at a very high frequency, is utilized to generate a current of very constant frequency.

“In the PCJ transmitter the crystal generated high frequency currents are amplified and multiplied several times
(Continued on page 94)

One of the newest devotees among short-wave listeners is David Van Wallace of Mount Clemens, Michigan. David, a former Notre Dame student, is completely paralyzed as the result of a broken neck suffered from a dive into the University pool. Unable to operate a conventional receiver, two former Notre Dame alumni, Raymond Durst and William Maher of Hallicrafters called upon the company engineers to design a special radio chassis with huge wheels and long levers replacing knobs and switches. The slightest brushing movement of Mr. Van Wallace’s hand will manipulate the controls. Receiver was donated by The Hallicrafters Company.



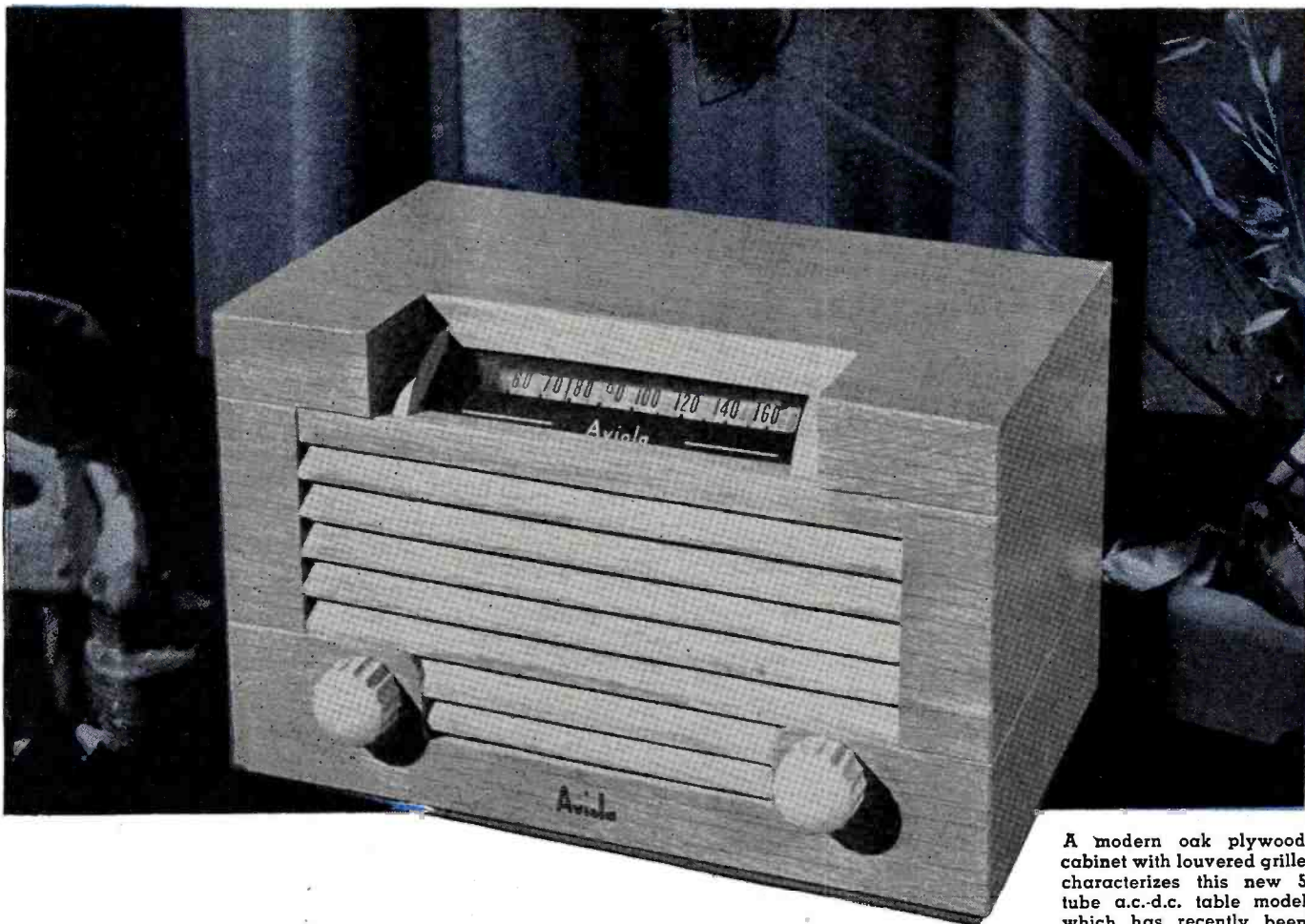

A modern oak ply wood cabinet with louvered grille characterizes this new 5 tube a.c.-d.c. table model which has recently been added to the Avia line.

Practical RADIO COURSE

By
ALFRED A. GHIRARDI

Part 52. The i.f. amplifier in superheterodyne receivers; what it accomplishes, and operating characteristics that influence its design.

BEFORE proceeding to study the intermediate frequency (i.f.) amplifier it will be instructive to briefly review the basic operating principle of the superheterodyne receiver so that the important roles played by the i.f. amplifier will be clearly understood. The functional block diagram of a typical AM superheterodyne is illustrated in Fig. 1.

We have learned that the modern superheterodyne usually employs a tuned r.f. preselector stage into which all the signals received by the antenna are fed. The main function of its variable-tuned circuits is the rejection of certain interfering signals that may be present along with the desired signal—particularly those of *image* frequency, since neither the mixer nor the i.f. amplifier following it are ca-

pable of discriminating between such signals and the desired signal. Consequently, rejection of all interfering signals of image frequency must be accomplished *ahead* of the mixer. Preselector circuits that when tuned to the desired signal will reject all possible interfering image-frequency signals are employed for this purpose. The variable-tuned signal circuits in the preselector shown in Fig. 1 are assumed to be adjusted to pass mainly the *desired* signal, *B*, of the three incoming signals *A*, *B*, *C* appearing simultaneously in the antenna circuit.

Following the preselector is the "frequency-converting" or "translating" arrangement wherein any received signal (unmodulated c.w., audio modulated, or video modulated) transmitted by the preselector is "con-

verted" or translated to a *similarly modulated* signal of new fixed carrier frequency. To perform this change in frequency (*frequency conversion*), an arrangement comprising an adjustable-frequency r.f. oscillator and a mixer is employed. Both units considered together comprise the *frequency converter*. The modulated input r.f. signal voltages and the unmodulated r.f. voltage (of suitable frequency) generated by the oscillator are both properly applied to the *mixer* portion of the frequency converter (see Fig. 1), so as to cause them to heterodyne within the mixer to produce a plate current having several "combination" frequencies. Among these are components of "sum" ($f_{osc.} + f_{sig.}$) and "difference" ($f_{osc.} - f_{sig.}$) frequencies—both of which are really carriers of new frequencies but which still carry the modulations of the input carrier.

Of these, the desired component of *the desired signal* (usually the component of *difference* frequency) is selected by the fixed-tuned plate load circuit and passed on to the highly efficient and selective fixed-frequency *intermediate amplifier* whose function it is to further attenuate all the other (undesired) output components and signals appearing in the output circuit of the frequency converter, and to greatly amplify the desired component of the desired signal (usually called the *i.f. signal*) to the required level

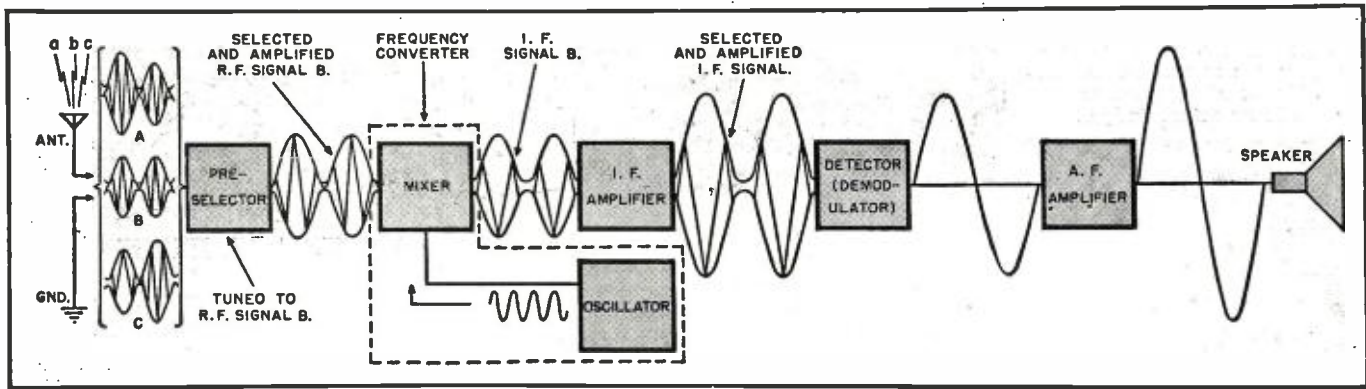

Fig. 1. Functional block diagram of a typical AM superheterodyne receiver showing the successive changes that the desired modulated incoming signal B undergoes as it progresses successively through the preselector, frequency converter, and i.f. amplifier of the receiver.

before it is applied to the detector or demodulator tube.

The I.F. Amplifier

From the foregoing it is clear that the intermediate-frequency amplifier can be defined as that portion of a superheterodyne receiver that lies (electrically) between the plate circuit of the frequency converter and the input of the detector or demodulator. It is essentially a highly efficient and selective fixed-tuned high-frequency amplifier which derives its input signal from the plate circuit of the frequency converter, since this is the point at which the i.f. currents first appear. Since the i.f. amplifier provides the principal gain and adjacent-channel selectivity of the superheterodyne receiver, its operation and design merit careful attention and they will be treated at some length in this and succeeding lessons of this series.

Advantages of Superheterodyne over T.R.F. Receiver System

The advantages of the superheterodyne receiver system over the straight t.r.f. receiver employing an equal number of high-frequency amplifier stages and tuning circuits are:

1. In a properly adjusted and aligned

¹ Even when the i.f. is a higher frequency than the signal frequency, improved gain and selectivity may be obtained owing to the greater possible efficiency that may be realized in fixed-tuned circuits of proper design as compared with a variable-tuned system.

superhet receiver, it makes no difference what the carrier frequency of the desired signal being received is; the frequency converter always converts it to the single frequency for which the i.f. amplifier of the receiver is designed—the i.f.—and most of the amplification and selection is accomplished at this one frequency. Since the signals the i.f. amplifier is called upon to amplify are always of this one carrier frequency, *fixed-tuned* circuits (tuned to this predetermined i.f.) can be employed in it. This results in more nearly constant over-all receiver sensitivity and selectivity over the waveband since their efficiency does not depend on the particular frequency of the received signal as is the case in a t.r.f. receiver.

2. Higher possible gain per stage may be realized in the i.f. amplifier than in a t.r.f. amplifier, especially when the i.f. is a lower frequency than the signal frequency.¹

3. Improved selectivity also results, especially when the i.f. is a lower frequency than the signal frequency, since a narrower response curve (higher selectivity) may be obtained than is possible at the signal frequency.¹

4. Better control of over-all fidelity (as regards sideband cutting) is obtainable because it is more easily possible to control the shape of the over-all resonance curve of the fixed i.f.

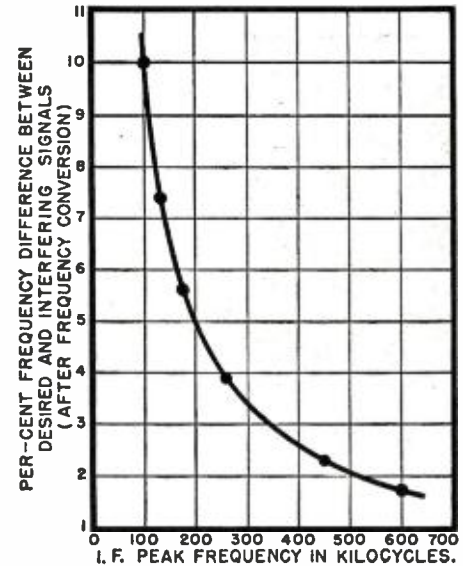
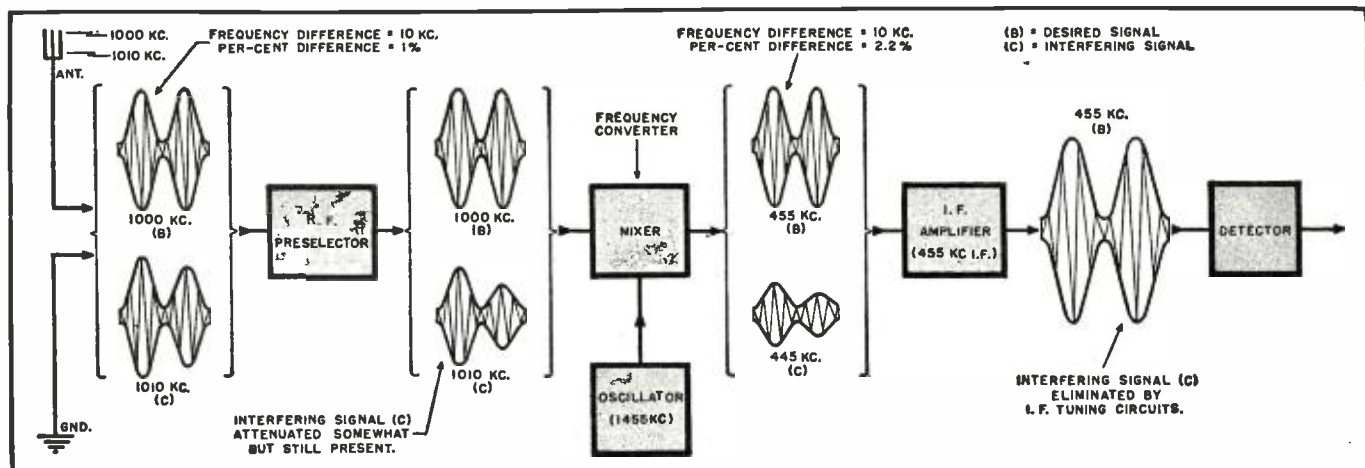

Fig. 3. Graph shows the effect of i.f. values employed in receiver upon the per-cent frequency difference between wanted and adjacent-channel interfering signals (after frequency conversion). The greater this frequency difference the greater will be the selectivity advantage of the i.f. amplifier.

tuning circuits to a definite desired characteristic for all incoming signals. It is possible, by means of simple tuning adjustments, to shape this over-all

(Continued on page 147)

Fig. 2. Block diagram illustrates the effect of superheterodyne frequency conversion of two interfering signals upon the per-cent difference between their carrier frequencies, and upon the selectivity problem involved in their separation.



↓ Start of disassembly operation. Here, chassis, speakers, record changers are removed from cabinets. Disassembly instructions are prepared from actual study of unit.



↑ Howard W. Sams, originator of PhotoFacts service.

↓ One section of Engineering Analysis Division. Here, each piece of equipment is subjected to an analysis, including replacement parts check, study of parts values and other important items.



↑ Initial preparation of radio receiver chassis includes general inspection of all components and all accessories used with the unit.



↑ Here, original speaker equipment is studied for the purpose of recommending accurate replacement. This is typical of the parts replacement analysis. Replacement recommendations are made only after checking against the actual physical and electrical characteristics of the original component.

↓ Specially constructed copper test booths are used when analyzing and otherwise checking the r.f. and i.f. coils. Findings are cross checked against those given by manufacturer.

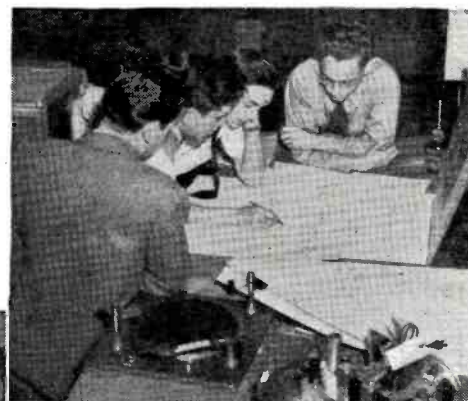

↑ Here, a schematic diagram is being corrected to conform with the actual circuit as it exists in the processed receiver. This particular service precludes errors which may have occurred between the drafting rooms and production lines at the factory.



← This job requires the services of expert personnel. These engineers are shown measuring the stage gain and overall performance of various receivers under analysis.

↑ A tough assignment and one requiring a great amount of patience is the tracing of unknown circuits and the preparation of schematic drawings. The average serviceman could be stumped on this job.

By
ROBERT M. ELLIS

PROBABLY the weakest link in the radio industry for many years has been the absence of a pipe-line between the set manufacturer and the radio serviceman. Millions of dollars have been spent on promotion, advertising, and good will gestures, but only a few manufacturers have undertaken to supply the serviceman with data on his receivers that would offer more than mediocre help. Instead, too much time was spent analyzing the competitive market and the race was run to see who could produce a six-tube job for thirty-five cents less than the guy across the street.

At the end of the war Mr. and Mrs. Public were eager to buy the maze of new sets that had been promised to them. They had been told that the new models would be far better than those they had previously used in their homes. Unfortunately, in many cases, these were but idle rumors and thousands of receivers appeared in the radio servicemen's shops for major repairs after having been in service for but a few hours. Servicemen reported that they had found poor substitutes, "rats' nests" type of construction, innovations in circuit design, and trick tuning assemblies. A further contribution to the sale of aspirin were the many omissions and errors in original parts lists which accompanied the postwar receivers. In fact

PACKAGED RADIO SERVICE

It takes many specially trained experts and considerable equipment to prepare complete and accurate service data on complicated radio and television sets. Here is how it is done by one alert organization.

many of these sets came through without a schematic.

To solve this dilemma and to make the radio serviceman the really important figure he should be in the industry, *Howard W. Sams & Co., Inc.*, was founded on April 1, 1946. Their objective was to furnish complete pictorial, schematic, and photographic data on all postwar sets and to supply these to the radio repairman in the form of "PhotoFact Folders."

To tackle such a tremendous project required highly detailed planning and coordination. It was necessary to build up a staff of experts, each specializing in certain parts of the sets depending upon his particular qualifications and background. From a small beginning, the staff now includes approximately forty-five employees.

The "machinery" needed to compile and publish a single "Folder" presents an interesting study in organization and technique. The process of analyzing the set, called the "disassembly process" by the staff, is conducted by a group of qualified men, each specially trained for his job.

Each major group of components is classified—the responsibility being assumed by one man. For example; the

capacitor specialist examines all the fixed capacitors in each piece of equipment assigned to him. He lists them all in the order of their use and prepares a separate specification sheet for each capacitor. One of each of these sheets is forwarded to each of the cooperating component parts manufacturers, together with recommendations for proper replacements. Later he checks these for electrical and mechanical specifications and, if practical and workable, he then lists the item as a correct replacement for the capacitor used in the original set.

The same technique is used in analyzing replacements for fixed resistors, volume controls and tone controls. Speakers are measured both electrically and mechanically and the cooperating speaker manufacturers are asked to recommend suitable replacements on the basis of these specifications submitted to them by the speaker specialist. When the replacement speaker is received, it is checked against the original speaker in the set. Power transformers, audio transformers, and chokes are the responsibility of still another analyst. Proper replacements for these are selected by the same process as mentioned.

Of great importance is the measurement and analysis of r.f. and i.f. coils found in the maze of receivers coming into the organization for test. Great care is exercised to see that no errors creep in.

As far as the processing of the receiver itself is concerned, a complete voltage and resistance analysis of the set is made and recorded. Important details, usually overlooked by manufacturers, such as dial-cord stringing, are sketched and marked for future reference and are later incorporated in the finished "Folder." This one operation alone has saved countless dollars in valuable time to thousands of servicemen. It is a well known fact that only one out of four possible stringing contortions is correct.

The final step in the analysis consists of an over-all performance check including a study of stage gain and alignment. The manufacturer's schematic diagrams and parts lists (if available) accompany each receiver as it goes through the hands of the various analysts. As a matter of fact, only about 7 out of every 10 receivers are furnished with a parts list. This means, at best, that the servicemen

(Continued on page 144)



↑ View of drafting department. Diagrams, retouching and final art work for folders are prepared here under the guidance of Analysis Division experts.



↑ Draftsman coding pictorial diagrams and schematics with identifying parts numbers to provide uniform, easy reference to accompanying service data.

↓ A specialist checks parts functions of a record changer. From the data compiled, "exploded-view" pictorials and repair and adjustment data will be prepared.



→ Photographing the chassis. A special technique is used so that all parts are readily identifiable in the pictorial diagrams.

→ Have you ever spent a few hours trying to restring the dial cord on a set? The drawing being prepared shows the one and only correct way to do it.





The Farm Market for RADIO and APPLIANCES

By **C. R. ELDER**

Extension Editor, Iowa State College of Agriculture

Don't overlook the ever-growing farm market as a profitable source of increased income for you.

EVERY time a rural farm home is connected to an electric high-line, radio and appliance stores can ring up approximately \$700 in their cash registers—in terms of potential business.

That's what a recent survey of some 10,000 Iowa farm users of electricity indicate they spend for electrical equipment and appliances.

This survey, conducted by the Iowa Rural Electric Cooperative Association, in cooperation with the Iowa State College, further indicates that farmers now enjoying electricity intend to buy \$260 worth of appliances

in addition to those they are now using.

Put these two sources of potential business together and it would appear that the rural market is destined to become the most fertile field in the radio and appliance business.

Electricity on farms is still in its infancy. In Iowa, for example, less than one farm in seven had highline service 10 years ago. Today more than half of the farms have been electrified. Of the 107,000 farms which had power line service in 1940, 56% were serviced by cooperatives under the Rural Electrification Administra-

tion. Of the farms now being electrified, 5 are being added to REA lines and one to lines of private utility companies.

During the war years farm income was about twice the average income for the 10-year period from 1934 to 1943. Even if prices decline somewhat, farmers should be in a relatively strong position to maintain high purchasing power during the next few years. Much of the accumulated capital of farm families has been definitely earmarked for farm and home improvements. Many of these improvements, such as installation of running water, modern kitchens, farm ventilation and heating systems, require electric service for their most successful operation. This means that the demand for rural electrification should increase along with the average consumption per farm.

It is anybody's guess as to what extent electricity will eventually be used on farms. The kwh. consumption has been on the constant increase and there is no indication that the peak has been reached.

During the first year that cooperatives operated in Iowa the average consumption was 52 kwh. per month. In the seventh year of operation this average had jumped to 109 kwh.

It must be remembered, too, that many of the farms included in the seventh year of operation (1943) had been connected to the highline for a relatively short time—and at a period when equipment and appliances were practically nonexistent because of war time shortages.

(Continued on page 116)

Tabulation of electrical equipment now being used, or to be purchased, as indicated by a survey made among 10,000 users of electricity on Iowa farms.

Home Equipment	Percentage Using Equipment	Percentage That Intend to Buy	Farm Equipment	Percentage Using Equipment	Percentage That Intend to Buy
Radio	95.9	13.9	Separator	52.5	13.3
Washing Machine	94.4	11.0	Barn Lights	60.6	4.5
Iron	87.6	11.1	Poultry House Lights	49.9	12.9
Refrigerator	67.6	29.5	Chick Brooder	39.1	15.8
Toaster	58.3	11.9	Farm Water Pump	29.4	13.3
Vacuum Cleaner	42.4	23.6	Hog House Lights	28.8	11.2
Fans	31.7	14.4	Poultry Water Heater	15.0	13.1
Home Water Pump	26.4	17.7	Milking Machine	12.2	8.2
Clock	26.2	12.3	Electric Fence	14.0	5.7
Waffle Iron	21.4	11.5	Elevator	4.8	8.1
Heating Pad	14.0	8.5	Pig Brooder	6.0	4.6
Range	10.3	16.5	Stock Tank	2.4	7.6
Water Heater	5.5	14.1	Feed Grinder	3.3	6.1
Sewing Machine	6.5	11.1	Fanning Mill	6.2	1.5
Coffee Maker	10.2	7.3	Corn Sheller	3.4	3.3
Freezer Storage Case	.5	6.7	Dairy Water Heater	.9	1.4

3" OSCILLOSCOPE

By
J. CARLISLE HOADLEY

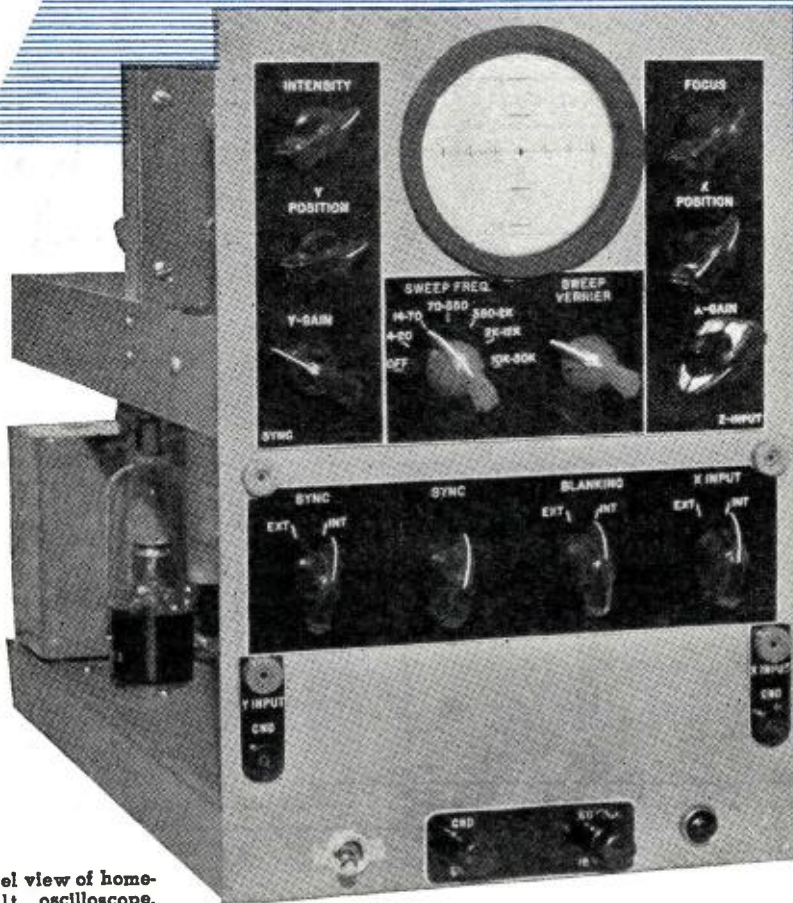

Panel view of home-built oscilloscope.

Complete details for the home construction of a cathode-ray oscilloscope, along with important practical information on the use of this unit.

THE most useful and versatile instrument to be found anywhere for use in a service shop, research lab., or on an experimenter's bench is the cathode-ray oscilloscope. Here in one instrument we have a peak reading voltmeter which does not load a circuit appreciably, an accurate method of comparing or determining frequency, the only method of properly and rapidly aligning wide band AM, FM and television receivers, a method of measuring modulation percentage, and the only means of observing the actual gyrations of alternating current waveforms and the study of transient waveforms. For a large part of electronic work it is indispensable and in the service shop its use is going to become more important and more necessary as FM and television receivers begin to come to the shop for repair.

The best way to fully understand
March, 1947

the oscilloscope and realize its capabilities is to build and use one. We, therefore, present a 3" oscilloscope which will be adequate for most jobs. The design is flexible enough to allow additions to qualify it for special uses.

An oscilloscope consists, primarily, of a cathode-ray tube, a sweep circuit, amplifiers, two power supplies and necessary associated controls.

The cathode-ray tube consists of a cathode located at the base end of a long vacuum tube. There are, then, a succession of grids and anodes, four deflecting plates and a fluorescent screen, located at the other end of the tube. Fig. 2 shows the relative arrangement. The electron beam is focused and directed at the center of the fluorescent screen by means of the proper potentials being placed on the tube's elements. The first, or intensity, grid has applied to it a voltage negative in respect to the cathode which

may be varied by a potentiometer. This pot is on the front panel and is the intensity control. It effects a change in intensity by varying the amount of electrons flowing from the cathode which are allowed to hit the screen. A positive potential which is also controlled from the front panel is placed on the focusing electrode. The deflecting plates effect electrostatic deflection of the electron beam by the application of external voltages.

As the electron beam may be taken as negative, if a positive potential is put on a deflection plate, the beam will be attracted toward that plate, provided the other plate is grounded. Conversely, if a negative potential is placed on the same plate, the beam will be repelled. As the plates are arranged in pairs at right angles to each other, the beam may be deflected either horizontally or vertically, according to the choice of plates; or, if voltages are applied to the vertical and horizontal plates simultaneously, the deflection will be in both directions at once. Therefore, the spot may be moved, by manipulation of the voltages on the plates, to any point on the face of the tube. If these voltages are d.c. and applied to the tube directly, then the spot will assume a new position, as determined by the magnitude of the voltage.

We have, therefore, what is in effect an electrostatic voltmeter. All that need be done is to put a known voltage on, say, the vertical deflection plates, and observe how many volts it requires to deflect the spot one inch. When we place an unknown voltage on the tube we merely measure the deflection of the spot. Knowing the sensitivity of the tube in volts-per-inch, we accurately determine the unknown voltage. This is a very sensitive method as it draws an almost immeasurable current from the source. One can measure even the voltage across a small charged condenser.

If we place an a.c. voltage of known frequency on one set of plates and an unknown frequency to the other set, we can determine not only the peak-to-peak value of either a.c. voltage, but we can also find the frequency difference between the two a.c. voltages if it is not too great, i.e., 10-1 or less. We will note a pattern on the screen, the shape of which is dependent upon the frequency relation be-

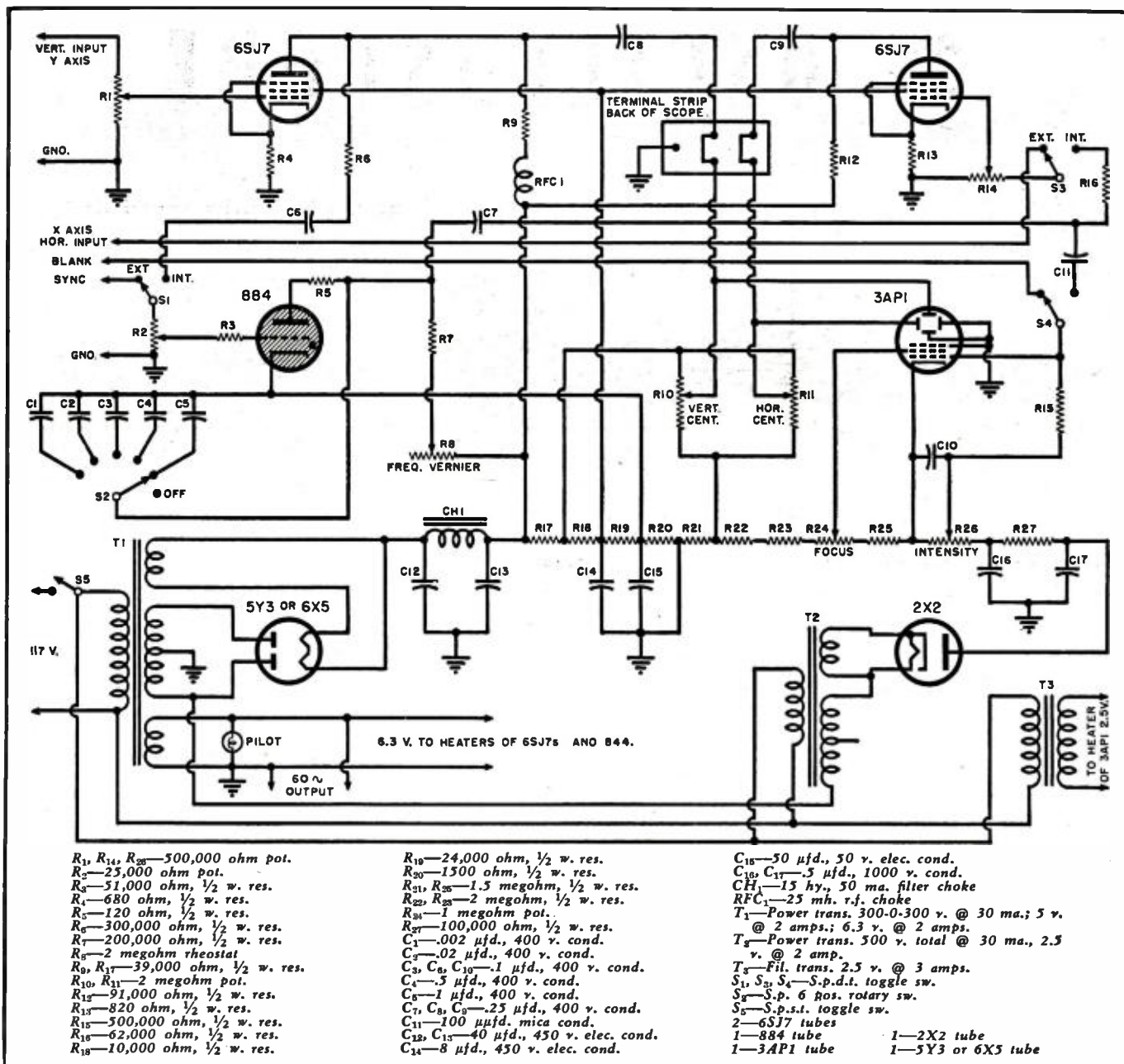

Fig. 1. Schematic diagram of 3" oscilloscope. The frequency range of the sweep oscillator is 6 c.p.s. to 30 kc. Should a 6X5 rectifier be substituted for the 5Y3, it will not be necessary for the power transformer to have a 5 v. winding.

tween the a.c. voltages. If they are the same, we will get an ellipse; if one is twice the other, we get a figure 8. Note that this figure has two loops. As the frequency difference increases the number of loops denotes the factor by which one frequency is greater than the other. This is very useful in calibrating test equipment and works as well at radio frequencies as it does at audio frequencies.

If we wish to examine an alternating current voltage, either sinusoidal or otherwise, it is necessary to place on one set of deflection plates, usually the horizontal ones, an alternating voltage, linear in time and variable in frequency to constitute a time base or sweep. This merely starts the fluorescent spot from the left hand side of the tube and moves it to the right hand side at a constant speed. How many times per second it is

moved is variable by means of a panel control. If we apply an alternating voltage to the other set of deflection plates (the vertical ones), the spot will trace out an a.c. wave in its true proportions in respect to time. The horizontal plates are usually referred to as the X axis plates and the vertical plates as the Y axis. The picture drawn with the above described sweep will appear in the same relation as the assumed X and Y axis on a mathematical graph.

An important part of an oscilloscope is the sweep circuit. This is the little electronic hand which writes the waveform shapes on the face of the cathode-ray tube. The circuit is shown in Fig. 3.

The heart of the circuit is the tube, in this case an 884. This tube is a gas filled triode. The addition of this gas has the result of changing the

characteristics of the triode. For instance, with 5 volts bias on its grid it is cut off and no current flows. As the plate potential is applied, condenser C charges up. As it has to charge through resistor R, it takes a certain time to reach any given voltage. When it does charge to a certain critical voltage, the gas in the 884 tube ionizes and the tube conducts. Unlike a high vacuum tube, increasing the grid voltage will have no effect on the tube after it has once started conducting. The only way to turn it off is to remove the plate voltage.

Fortunately, this is exactly what happens. The instant the tube conducts, its resistance becomes very low and it rapidly discharges condenser C. When the voltage on condenser C falls below the critical value, the tube stops conducting. Condenser C then starts to charge again to repeat the

cycle. Changing the value of R changes the speed at which C can be charged. The resultant waveform is shown in Fig. 4. Therefore, the frequency of the resultant saw-tooth waveform can be changed.

The value of C also has an effect on the frequency. The higher the capacity, the longer it takes to charge it through a given resistor. Therefore, by switching capacitors and providing a variable resistance in series, a wide frequency range may be covered. In the oscilloscope described, the frequency range is 6 c.p.s. to 30,000 c.p.s.

This oscillator is, however, rather unstable, which is undesirable as this would cause the inspected waveform to dance back and forth; but this very instability is put to work. A bit of the signal is injected into the grid of the sweep oscillator tube. The tube will lock in with the fundamental or a multiple of the inspected waveform frequency. This causes the picture to stand still on the face of the tube. The amount of synchronizing voltage is varied by a potentiometer in the grid of the sweep oscillator tube. It is well to note here that too much sync should never be used, as it will distort the waveform under observation.

We could use the entire voltage rise of the condenser as it charges up but for the fact that it is not linear, but tends to charge rapidly at first and then more slowly, actually in the form of an exponential curve. This would not give a time base which was linear with time and would, consequently, distort the waveform under observation. We, therefore, use only the initial fast charging part which is reasonably linear and we amplify this small saw-tooth to the proper size to more than sweep the width of our 3" tube.

This amplifier tube has in its grid a volume control so that we can vary the amplitude of this sweep voltage and spread out or crowd together groups of waveforms to gain different perspectives on the observation thereof. This control is necessary when we wish to use an external sweep voltage. The amplifier must have a flat frequency response from six to, at least, thirty thousand cycles-per-second so that it will amplify the sweep without distortion. Actually, its response should be several times wider, as the frequency components involved at the discharge time may be as high as 500 kc. or more.

As we increase the frequency of our sweep oscillator, the rise of the saw-tooth becomes shorter and shorter but the fall remains relatively constant. There comes a time, therefore, when they are nearly equal. The forward trace on the tube, then, is no brighter than the back trace. The back trace becomes annoying, as it confuses the waveform that we are inspecting—it may be removed by a blanking voltage.

Simply stated, this voltage reduces the intensity of the cathode-ray tube to zero during the back cycle. A

portion of the sweep voltage is fed into the intensity grid of the C-R tube through a small condenser. The positive rise of the sweep only makes the intensity grid more positive and increases the brilliance slightly at the beginning of the sweep. The fall of the saw-tooth, however, is negative and this negative voltage drives the intensity grid negative, shutting off the electron beam and blanking the tube during the flyback time. The coupling condenser must be large enough to couple the flyback voltage but small enough not to pass the saw-tooth rise frequency.

This blanking voltage may be removed at will by means of a switch. The intensity grid is brought out to a binding post so that external blanking or a calibrating voltage may be injected.

If a sine wave of a known frequency is introduced, the tube will be blanked on every other half cycle. This will be apparent by the sweep taking the form of a series of dashes as in Fig. 6. Knowing the frequency of the sine wave, we can determine the frequency of a waveform which we have placed on the vertical deflecting plates. This input to the scope constitutes the Z axis input. If the builder desires, a Z axis amplifier may be included, together with an amplitude control. This amplifier may be the same as the Y axis amplifier (Fig. 1) and the values copied. Fig. 7 shows how this would be arranged.

All the waveforms we wish to investigate must be of sufficient amplitude to deflect the electron beam an inch or so. The deflecting plates have a sensitivity of from 40 to 50 volts per inch of deflection, so an amplitude of less than 10 volts is not easy to study, due to its small size.

We must, therefore, provide a Y axis amplifier, the response of which

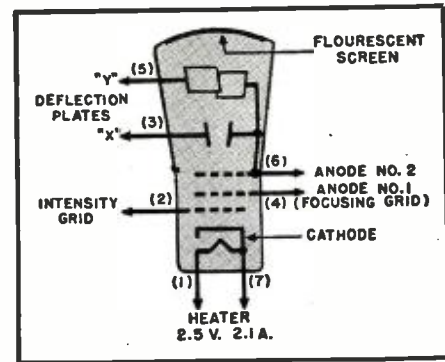

Fig. 2. Illustrating the relative positions of the various elements which make up the 3AP1 cathode-ray oscilloscope tube.

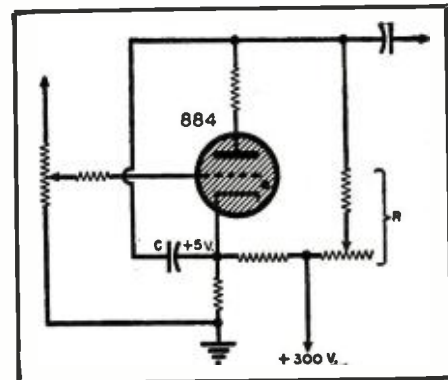
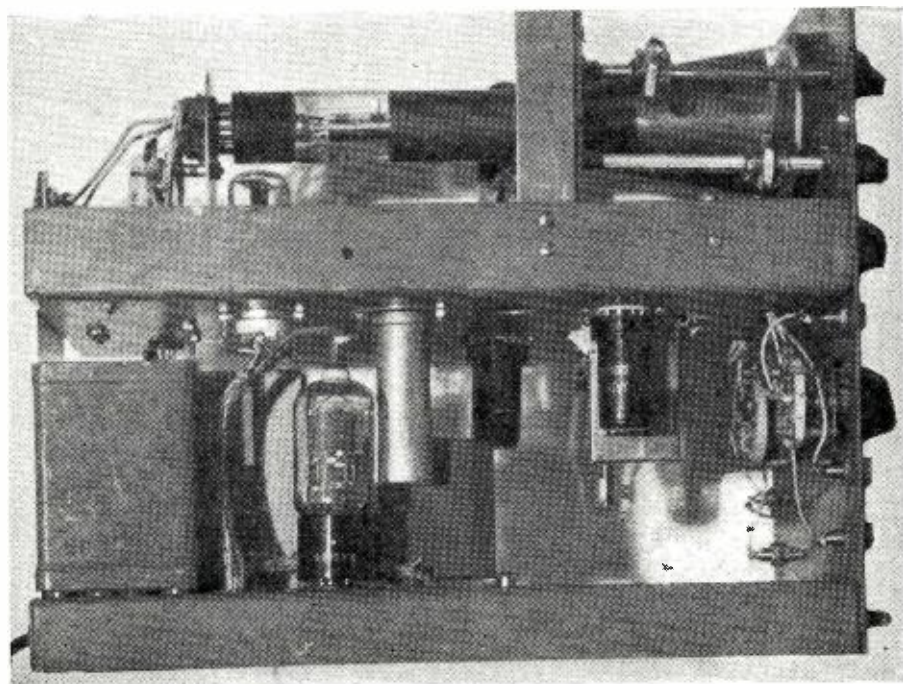

Fig. 3. Diagram of scope sweep circuit.

will be determined by the use to which we intend to put the oscilloscope. If we are interested in audio frequencies only, say from 20 to 50,000 cycles-per-second, the amplifier, Fig. 1, will suffice. It will still have some gain at 1 megacycle, although it would be better to feed a frequency this high directly to the deflection plates.

If you are interested in radio frequencies in the order of a megacycle

Side view of completed instrument with cover removed to show placement of parts.



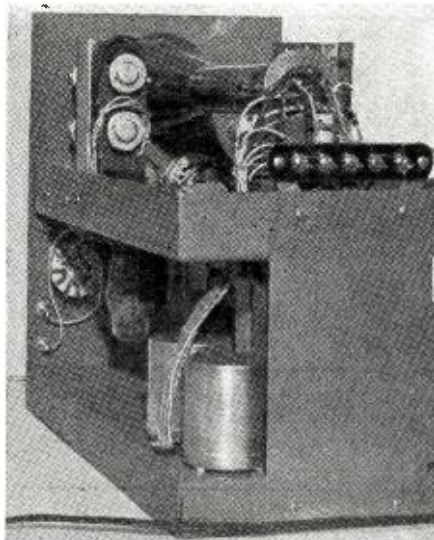

Rear view of completed oscilloscope.

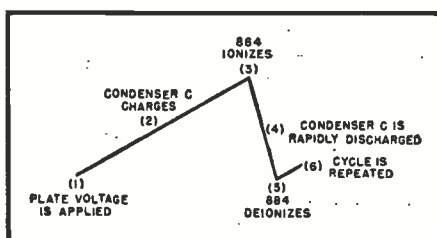

Fig. 4. Wave shape of sweep circuit.

and of an amplitude of five volts or less, then a more extensive Y axis amplifier will be necessary. If the proper display of square waves of high recurrence rate is desirable the response should be flat to at least a megacycle.

The conventional methods of controlling amplitude are unusable at megacycle frequencies because of the input capacity of the tube, combined with the series resistance introduced

when the amplitude control is in intermediate position. A much superior system consists of a cathode follower and a frequency compensated attenuator. A potentiometer in the cathode circuit of the cathode follower provides continuous variable output. Fig. 5 shows the circuit. The amplifier which follows the cathode follower must fall in the video amplifier class, being flat from 20 c.p.s. to a megacycle or more.

This means not only careful design but extreme care in construction, as wiring capacity can have a profound effect on response. As a matter of fact, a carelessly wired video amplifier may only go to 500 kc., whereas, a properly wired one will go to over two megacycles!

Every wire in the grid or plate circuit must be kept above the chassis to avoid additional capacity. The output capacity is high enough as it is, as it consists of the output capacity of the tube, the capacity of the deflection plates of the cathode-ray tube, plus the wiring capacity. The effect of this total capacity can be reduced by lowering the load resistor in the amplifier tube's plate circuit. This lowers the circuit impedance.

We may also resort to inductive peaking to increase the response. Simply stated, we pick an inductance which resonates with the total capacity at a frequency above which the response has fallen off substantially. The effect of the inductance is to increase the load impedance gradually at the frequency at which the response starts to fall off, until its resonant frequency is reached. Beyond this point we are on the capacitive side of the resonance of the combination coil and capacitance and the response will fall off rapidly. The formula for computing this inductance is $L = KR^2 C$. L is the inductance in henries, R is

the resistance in megohms, C is the capacity in microfarads and K is an assumed constant, usually between .42 and 0.5.

Of course, to properly use this formula you must know the total capacity in the plate circuit. All these capacities can be found in tube manuals but the circuit capacity must either be measured or assumed. To lower the effect of this capacity we have lowered the plate resistance in the tube's plate. This also lowers the tube's gain, so we will probably need another stage. This puts quite an additional drain on the power supply, not to mention additional filtering and bypassing, so its necessity must be weighed by the individual constructor.

The power supply for our scope must include two d.c. voltages. First, a well filtered 300 volt supply to run the amplifier and the sweep circuit—a 60 milliampere transformer will suffice; second, a supply for the purpose of providing proper accelerating voltages for the cathode-ray tube. This latter supply has an output of about 1000 volts at 2 milliamperes. *This is a dangerously high potential and should be handled with due caution.*

The wiring in the high voltage circuit should be done with well insulated wire. The focus and intensity pots must not be mounted directly to metal but mounted on a piece of bakelite which can then be supported on the chassis. The photographs show this item of construction.

A separate 2.5 volt winding must be provided for the 3AP1 tube, as the cathode is connected to the filament within the tube and the cathode is 1000 volts above ground. A 2.5 volt winding must be provided, also, for the high voltage rectifier, the 2X2. In addition we must provide a filament winding for the low voltage rectifier and a filament winding of 6.3 volts for the amplifier and sweep tube. This is quite an array of windings, but the Allen B. DuMont Laboratories (Passaic, N. J.) can supply all these windings on one transformer for about ten dollars. If you desire, two receiver power transformers plus an extra 2.5 volt filament transformer can be used. The filament transformer supplying the 2X2 tube must be insulated for at least 1500 volts, and preferably 2000 volts. This is also true of the winding supplying the 3AP1 and the transformer which supplies the high voltage.

Centering voltage is obtained by applying equal amounts of positive voltage from the low voltage supply and a negative voltage from the high voltage supply across the centering pots so that the trace may be shifted up or down and to either side.

The way that the chassis is arranged was carefully planned. The upper chassis was made from 1/16" soft iron. This provides good magnetic shielding from the power transformers. This is necessary as the 3AP1 is very sensitive to magnetic deflection from an external magnetic field.

Fig. 5. Circuit diagram of wideband Y axis amplifier and attenuator.

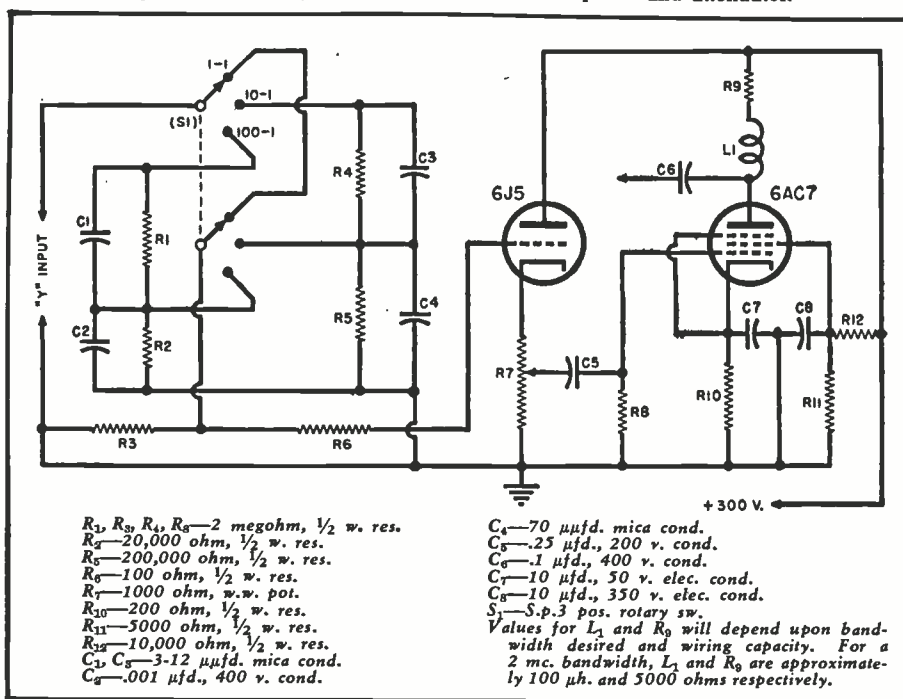

RADIO SERVICE MEN

**COMPLETELY ILLUSTRATED
25 BIG ISSUES FOR ONLY \$4⁰⁰**

Contain over 2000 pages of valuable material for you. . . Vital and up-to-the-minute information on servicing AM-FM and TELEVISION . . . HINTS and KINKS . . . layout and installation of PUBLIC ADDRESS and SOUND SYSTEMS . . . the how and why of operating all kinds of TEST EQUIPMENT . . . use of TOOLS of every kind . . . NEWS of the trade . . . plus monthly departments containing complete reviews of your TRADE LITERATURE for which you can write . . . CONSTRUCTION articles on how to lay out your shop . . . build equipment . . . speed all operations . . . SAVE TIME in ordering. . . how to stock . . . and more. Over 25,000 satisfied servicemen have already subscribed to this completely illustrated magazine.

NOW RUNNING

COMPLETE SERIES ON: • PA AND SOUND SYSTEMS • HOW TO SERVICE TELEVISION • USING THE OSCILLOGRAPH

COMING:

- A SERIES ON FM
- REPORTS FROM THE ORGANIZATIONS
- ALSO ARTICLES ON AM, TEST EQUIPMENT AND MANY MORE



RADIO MAINTENANCE MAGAZINE
460 Bloomfield Avenue, Montclair, N. J.
Please enter my subscription as follows:

RM-3

For 12 Issues
at \$2.50

For 25 Issues
at \$4.00

- CHECK ENCLOSED
 BILL ME LATER

NAME.....
ADDRESS.....
CITY.....ZONE.....
STATE.....
OCCUPATION.....
TITLE (Service Mgr., etc.).....
Employed by.....
State whether Employer is a Service Organization,
Dealer, Jobber or Manufacturer

**NOT SOLD AT NEWSSTANDS
BY SUBSCRIPTION ONLY**

ONE ISSUE FREE IF PAYMENT IS ENCLOSED

March, 1947

67

New 1947 profit makers

PROVED BY THE '46 LINE

YES, PROFITMAKERS—BECAUSE...

Stromberg-Carlson's is a complete, broad line, with all the latest scientific features that sound equipment customers are looking for.

experience in the production of fine radios, telephones, and telephone switchboard equipment—equipment with records of years of dependable service.

BECAUSE—

These sound systems meet every standard in every situation—from the most elaborate of industrial requirements to the simple room-to-room installation.

BECAUSE—

Stromberg-Carlson Sound Systems have *proved* to be sound sales builders and sound profit makers with scores of satisfied dealers, in 1946...

BECAUSE—

"Manufactured by Stromberg-Carlson" means designed and engineered by matchless skills and

AND BECAUSE—

The 1947 market for this quality equipment promises to be the biggest, brightest ever!

Here are a few typical products

PORTABLE SOUND SYSTEM, MODEL PS32



Portable system in a three-section, compact case. 15 watt amplifier with one phonograph and two microphone inputs, two heavy duty Alnico V reproducers, and 25 feet of durable cord with connectors attached. One case acts as the reproducer receptacle for connecting in cascade.

AMPLIFIER, MODEL AU 35



One phonograph and three microphone high impedance inputs, separate base and treble controls, 50 watt divided output with separate master volume control. Additional amplifier jack for tandem operation. Hum adjuster, resistor board construction and rugged copper plated steel chassis. Underwriters approved.

AMPLIFIER, MODEL AR 37

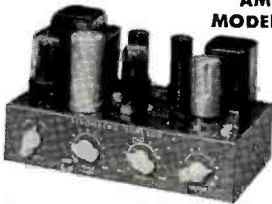

Two input jacks, one provides equalization network for crystal pick up, the other may be bridged across 500-600 OHM circuits, without change in level. Treble attenuation and boosts, base boost, base compensator volume control, separate gain control and fidelity control give the finest in record and wired-music reproduction.

SOUND SYSTEM, MODEL SS 750

A completely pre-engineered system. Incorporates AM-FM radio tuner, record changer, controls, and 90 watts of audio-power divided into four output circuits. Wired for optional remote control turret. Rugged all-metal cabinet with glacier-grey finish. Underwriters approved.

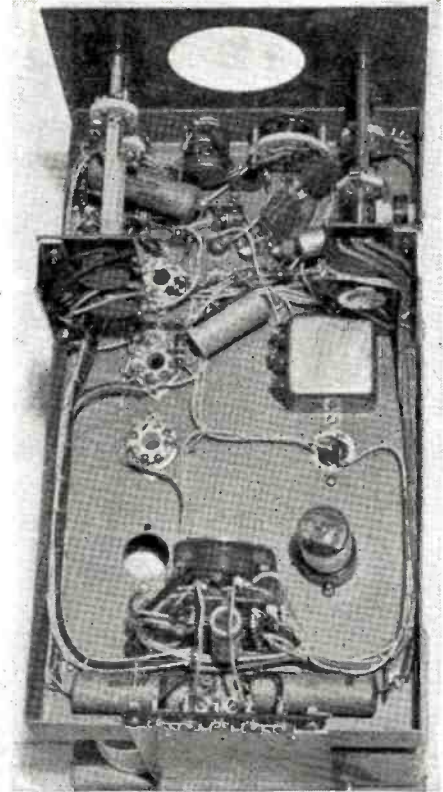
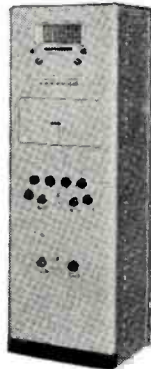

Top view of oscilloscope. The case and cathode-ray tube have been removed to show relative position of parts. Note in particular that the top chassis has been mounted in an inverted position.

Furthermore, the method of mounting the tubes upside down on the upper chassis provides very good shielding from the power supply wiring and also effects short leads from the tubes to the panel controls and from the tubes to the deflecting plates of the cathode-ray tube. Standard commercial chas-

Same view as above with the exception that the 3" cathode-ray tube is shown mounted in its proper position in unit.

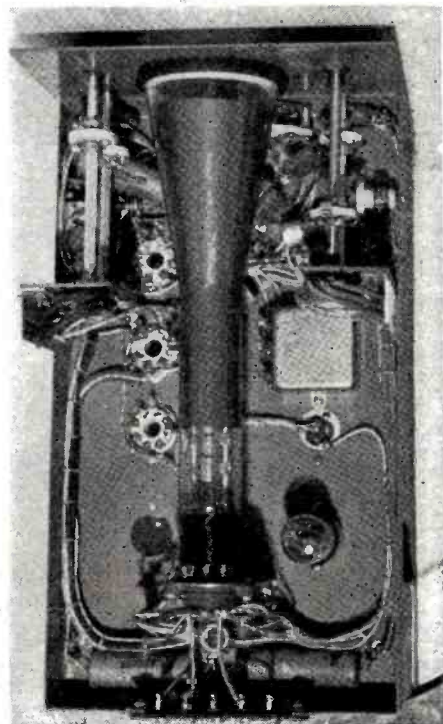

STROMBERG-CARLSON

STRAIGHT-LINE



COMMUNICATION





Writing with your voice

Years ago Alexander Graham Bell dreamed of "a machine that should render visible to the eyes of the deaf, the vibrations of the air that affect our ears as sound." He never realized that dream, but his researches led to the invention of the telephone.

Today Bell Telephone Laboratories have turned the dream into a fact — translating the spoken word into readable pictures.

By this new invention of the Laboratories, the talker speaks into a microphone. Vibrations of the voice are unraveled through electronic circuits, and then are reassembled as luminous patterns which travel across a screen. Each syllable of sound has a distinctive shape and intensity.



S I E N S U N R A V U L S S P E E T S H

Science unravels speech

Visible speech is still in its infancy, and is not yet available to the public. But educators of the deaf are now evaluating it. Indications are that the deaf can learn to read the patterns and, by comparing the patterns their own voices make with the patterns of correct speech, can improve their diction.

Patterns of visible speech also provide a means for analyzing and recording sound in the study of phonetics and of languages. Eventually, visible speech may make possible visual telephony for the deaf.

This is but one of many contributions by Bell Telephone Laboratories to the understanding and control of sound.



BELL TELEPHONE LABORATORIES EXPLORING AND INVENTING, DEVISING AND PERFECTING FOR CONTINUED IMPROVEMENTS AND ECONOMIES IN TELEPHONE SERVICE

*Just
Out!*

CONCORD
Bargain Catalog of
RADIO
Equipment
FOR
Immediate Shipment



Just off the press—48 exciting pages of radio parts, equipment, and supplies for dealers, servicemen, amateurs, maintenance, testing, building and experimenting—Thousands of items NOW IN STOCK and ready for IMMEDIATE SHIPMENT! Big feature sections of Radio Sets, Communication Receivers, Amplifiers, Ham Gear, Record Players and Portables, Record Changers and complete Sound Systems. Page after page of bargains and special values in top-quality standard-make radio and electronic parts.

Mail Coupon NOW for FREE COPY

Mail coupon below TODAY for your FREE COPY of this latest Concord Buying Guide and Bargain Catalog of Radio and Electronic needs you can order for SAME DAY SHIPMENT from complete stocks in Chicago and Atlanta.

CONCORD

RADIO CORPORATION
LAFAYETTE RADIO CORPORATION
CHICAGO 7, ILL. ATLANTA 3, GA.
901 W. Jackson Blvd. 265 Peachtree St.

CONCORD RADIO CORP., Dept. E-37
901 W. Jackson Blvd., Chicago 7, Ill.
Yes, rush FREE COPY of the new
Concord Bargain Catalog.

Name.....
Address.....
City..... State.....

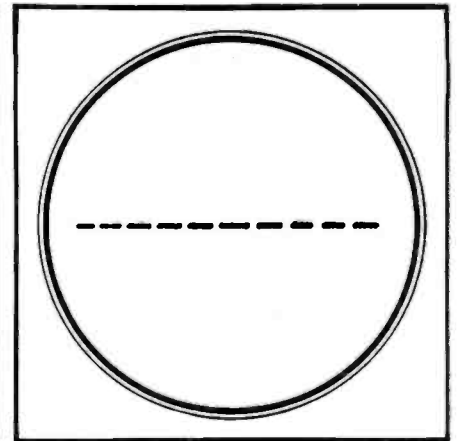

Fig. 6. Horizontal sweep with calibrating wave applied to intensity grid. This wave may be applied direct to intensity grid, or through Z axis amplifier. See Fig. 7.

sis and panel may generally be used.

This model used two chassis 8" x 14" x 2", although these dimensions can be changed somewhat without disturbing the operation appreciably. The panel should be of iron or steel. The panel on the back provides access directly to the deflection plates when the jumpers are removed. This facilitates d.c. voltage measurements and introduction of high voltage, high amplitude waveforms directly to the deflection plates. The inputs are made to tip jacks, although the constructor can use binding posts if he so desires.

The front panel in the present model has engraved control labels. The proper lettering can be done with black or white ink directly on the panel and then given coats of clear lacquer to preserve it.

The photographs show clearly the manner of construction and the lay-
(Continued on page 163)

Under-chassis view of power supply.

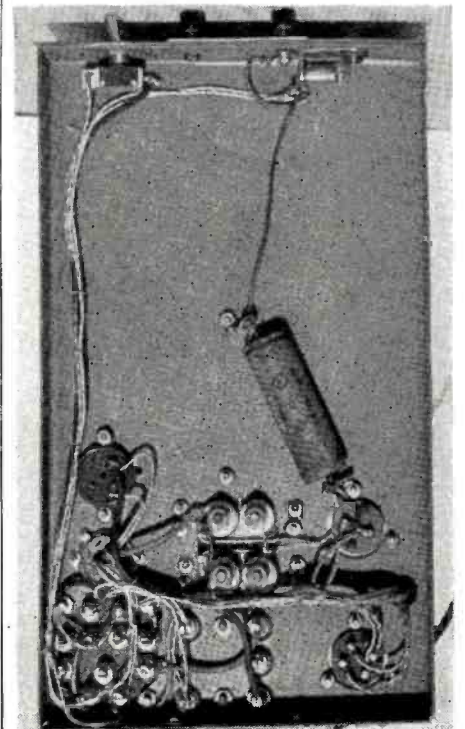

Two Ghirardi Books that teach you to REPAIR ANY RADIO EVER MADE



A. A. GHIRARDI
Let Radio's foremost technical author help you start training NOW for a profitable future.

HERE'S HOW TO LEARN TO BE A PROFESSIONAL REPAIR EXPERT ... AT HOME! without an Instructor!



HERE'S HOW TO MAKE 9 OUT OF 10 RADIO TROUBLES EASY TO REPAIR
Only \$5.

YOUR MONEY BACK

Order either or both of these big books now! Use coupon! Read them for 5 days. Then, if not more than satisfied, return them AND EVERY CENT OF YOUR MONEY WILL BE CHEERFULLY REFUNDED — no questions asked!

MODERN RADIO SERVICING

The Only Complete Book on Modern Professional Radio Repair

A. A. Ghirardi's MODERN RADIO SERVICING is the only single, inexpensive book that gives a complete, easily understood course in radio repair work by modern professional methods. Written so simply you can understand it easily without an instructor. Read from the beginning, it takes you step by step through all phases of the work. Used for reference by busy servicemen, it serves as a beautifully cross-indexed book for "brushing up" on any type of work that puzzles you.

TEST INSTRUMENTS—TROUBLESHOOTING—REPAIR

MODERN RADIO SERVICING includes a thorough explanation of all Test Instruments. Tells exactly how they should be used, where,

when, and why. Even gives all data for the construction of test equipment in case you want to build your own! Tells how to make preliminary trouble checks on complicated jobs. How to analyze ANY circuit scientifically. How to interpret instrument readings. How to test and repair components, how to make installations, adjustments, etc.—and how to Start a Successful Service Business of Your Own! Nothing is omitted or condensed. It is a book of "Know How" that will help fit you for the really big paying jobs in all sorts of Radio-Electronic-Television repair—because it teaches you RIGHT! 1300 pages. 720 Self-Test Review Questions. 706 helpful illustrations and diagrams. Only \$5 complete (\$5.00 foreign) on our 5-DAY MONEY-BACK GUARANTEE.

RADIO TROUBLESHOOTER'S HANDBOOK

What to Do—How to Do It—In Making Specific Repairs on OVER 4800 MODELS

Radio servicemen everywhere say that Ghirardi's big 744-page, manual-size RADIO TROUBLESHOOTER'S HANDBOOK helps them turn out *twice as much work in a given time!* Beginners and those who like to fix radios for themselves and for friends find this giant Handbook a quick, easy way of locating and repairing radio receiver troubles without expensive shop equipment. 9 times out of 10 it tells exactly how to repair a set—without any elaborate testing whatever.

NOT A STUDY BOOK!

There's no magic about it. Just plain, common sense! Over 400 pages of the Handbook contain carefully indexed listings of common trouble symptoms, their causes and remedies for over 4800 home receivers, auto radio, and record changer models of 202 manufacturers. Just look up the make and model you want to repair.

Then follow clear, easy instructions that the Handbook gives you. Shop tests have shown that 9 jobs out of 10 can be repaired in this manner. Tedious testing is eliminated. Service work becomes a lot easier. You handle two jobs in the time normally required for one.

300 PAGES OF EXTRA HELP!

In addition, 300 pages contain service hints; i-f alignment peaks for over 20,000 superhets; transformer trouble data; the most complete tube information you've ever seen; and hundreds of graphs, diagrams, charts, color codes, etc. Everything is carefully indexed so you can find what you want QUICKLY. Hundreds of users say the HANDBOOK has paid for itself by the time it saved them on the *very first job*. \$5 complete (\$5.50 foreign) on our 5-DAY MONEY-BACK GUARANTEE.



SPEED UP

SERVICE WORK WITH GHIRARDI GADGETS

Ghirardi Gadgets troubleshoot radio sets with lightning speed. Just flip a card, and there before you are the "remedies" and "tests" to make for whatever "trouble" symptoms you find!

HOME RADIO GADGET—Spots 400 different troubles in Power Unit, Receiver Circuits Proper, Tubes, Loudspeaker, Antenna, Ground, Batteries, etc. Covers such symptoms as "Hum," "Weak," "Noisy," "Inoperative," "Intermittent Reception," "Fading," and many more. Tells what tests to make. Suggests the remedy for each trouble.

Only 50c

AUTO-RADIO GADGET—Spots 444 special auto-radio troubles in all possible trouble-sources for 11 common symptoms including "Hum," "Weak," "Noisy," with and without car and engine at rest, "Noisy" when car is coasting with ignition off, "No Reception," "Intermittent," "Fading," "Distortion," and "Oscillation." Only 50c

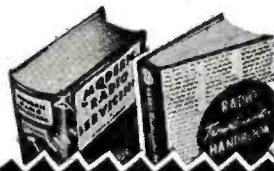

MONEY-SAVING OFFER

Let Ghirardi's RADIO TROUBLESHOOTER'S HANDBOOK save you time on common radio jobs. Let MODERN RADIO SERVICING train you in scientific servicing "Know How." Get BOTH big books at special price of only \$9.50 (\$10.50 foreign). Use coupon today.

MAIL ORDER rush coupon!

Dept. RN-37, Murray Hill Books, Inc., 232 Madison Ave., New York 16, N.Y., U.S.A.

Enclosed find \$..... for books checked; or send C.O.D. (no foreign C.O.D.'s) for this amount plus postage. If not fully satisfied, it is understood I may return books within 5 days for refund.

RADIO TROUBLESHOOTER'S HANDBOOK, \$5 (\$5.50 foreign) MODERN RADIO SERVICING, \$5 (\$5.50 foreign)

MONEY-SAVING COMBINATION OFFER—Both the Handbook and Modern Radio Servicing—over 2040 pages—only \$9.50 for the two (\$10.50 foreign).

HOME RADIO GADGET, 50c AUTO RADIO GADGET, 50c

Name.....

Address.....

City & Dist. No..... State.....

YOU'LL NEVER GO WRONG ON A GHIRARDI BOOK!

MORE SMASH BUYS at National Radio Distributors

IMMEDIATE DELIVERY
FAMOUS NATIONAL RADIO KITS!

Now! The new and improved post war design. All component parts perfectly matched and fully guaranteed against defect. Modern plastic cabinet features dust proof back. All kits complete with the new Alnico 5 P.M. speaker and full instructions for easy assembling. 110 V. A.C./D.C. 220 V. \$1.00 additional. White cabinet available \$1.00 additional.



- N.R. 1-4 TUBE T.R.F., uses 12SK7, 12SJ7, 50L6 & 35Z5 tubes. Your Net.....\$10.95
Kit of 4 matched tubes. Your Net..... 3.50
- N.R. 7-5 TUBE SUPERHETERODYNE, uses 12SA7, 12SK7, 12SQ7, 50L6 & 35Z5 tubes, and features built-in loop antenna. Your Net.....\$10.95
Kit of 5 matched tubes. Your Net..... 4.50
- N.R. 5-5 TUBE SUPERHETERODYNE "TWO" HAND, uses 12SA7, 12SK7, 12SQ7, 50L6 and 35Z5 tubes. Built-in antenna. Your Net.....\$13.95
Kit of 5 matched tubes. Your Net..... 4.50
- N.R. 6-6 TUBE SUPERHETERODYNE, uses 2-12SK7, 12SA7, 12SQ7, 35L6 and 35Z5 tubes. Your Net.....\$13.75
Kit of 6 matched tubes. Your Net..... 5.50

THIS MONTH'S SPECIALS

- RADIO TUBES**, all standard brands, all fully guaranteed.
- 12SK7, 12SQ7, 25L6 or 50L6. Each. Net.....\$0.83
 - 25Z5, 25Z5, 6A7, 6A8 or 30L6. Each. Net..... .74
 - 1A7, 1H5, 1N5, 12SA7 or 6Q7. Each. Net..... .99
- Send us your complete list.
- PHONO MOTORS**, self-starting, 9" turn-table.
- Your Net..... 2.95
 - Russell Ballantyne, 9" turn-table. List \$7.30.
Net..... 4.29
 - Alliance Model 80, 9" turn-table. List \$6.40.
Net..... 3.76
- CRYSTAL PICK-UP ARMS**, Feather-weight, standard brands. List \$4.50. Net..... 1.95
- 3 TUBE AMPLIFIERS**, tone & volume controls, uses 12SQ7, 50L6 & 35Z5 tubes. Approx. size 5"x3"x1 1/4". Your Net..... 2.95
- 2 TUBE PHONO-OSCILLATORS**, good for approx. 100 ft., uses 12SA7 and 35Z5 tubes. Approx. size 5"x3"x1 1/4". Your Net..... 3.50
- OUTPUT TRANSFORMERS**, to match 25L6, 50L6, 2A3, 6A3, 6B4, 6Y6, 25AC5, 25B6, 25N6, 35A5 or 48 tubes. Your Net, ea., \$0.59. 10 for.... 5.50
- CRYSTAL RADIO SETS**, completely assembled, attractively boxed. Net..... 1.07
- HEADSETS**, single earpiece, 1000 ohm. Your Net 1.19
- 2 VOLT WILLARD BATTERIES** for G.E. portables. List \$9.00. Your Net..... 3.50
- RESISTOR KITS**, consists of 100 1/2, 1 & 2 watt, 60-70 different values. Individually boxed. Your Net..... 1.95
- CONDENSER KIT**, paper tubular type, all 600V all fully guaranteed. .001 to .1 mfd. inclusive. Value \$15.00. Your Net..... 5.95
- AERIAL KITS**, contains everything necessary to put up good broadcast aerial. Individually boxed, with instructions. Your Net..... .75
- VOLUME CONTROLS**, with switch, 2" shaft. Ass't sizes from 5,000 ohms to 2 megohms (please specify). Each \$0.59. 10 for..... 5.50
- AUTO AERIALS**, triple chrome admiralty brass, 66" long, 3 section. Each \$1.95. Carton of 25.45.95
- CORD SETS**, 6' A.C. rubber cord and plug. Set, each \$0.19. 10 for..... 1.75
- 6' Heater cord, for irons, toaster, etc. Each \$0.44. 10 for..... 4.25
- 6' Broiler cords, heavy duty, High & Low. Each \$0.65. 10 for..... 6.00
- 10' Extension cords, with cube tap end. Each \$0.39. 10 for..... 3.50
- SPEAKERS**, 4" P.M. Alnico V. Ea. 1.49
- 5" P.M. Alnico V. Ea. 1.59
- 6" P.M. Alnico V. Ea. 1.95

Deduct 10% for Case Lots of 20 Speakers

BRIGHT STAR FLASHLIGHT & BATTERY DEALS

- THE SCOUT:** 12 Plastic Flashlights, ass't colors. List \$1.25. Net.....\$0.83
- 144 Size "D" Flashlight batteries. List \$0.10. Net each06 1/2
- Total Cost \$19.92 Total Profit \$10.08
- Mounted on beautiful counter display card, no extra cost.
- THE 1900:** 6 Plastic Flashlights, ass't colors. List \$1.25. Net.....\$0.83
- 48 Size "D" Flashlight batteries. List \$0.10. Net each06 1/2
- Total Cost \$8.10 Total Profit \$4.20
- Mounted on beautiful display card, no extra cost.
- THE 570:** 6 All Metal Flashlights. List \$0.78. Net each\$0.52
- 48 Size "D" Flashlight batteries. List \$0.10. Net each06 1/2
- Mounted on beautiful display card, no extra cost. Total Cost \$6.24 Total Profit \$3.24

Write for the new "Free" catalog. It's just out!
At least 25% with order. We will ship balance C.O.D.
Cable Address "Enardee"

National Radio Distributors

899a Southern Blvd., New York 59, N.Y.



CIRCUIT PAGE

(FOR PARTS LISTS SEE PAGE 86)

RADIO NEWS, MARCH, 1947

GRANTLINE MODELS 500, 501

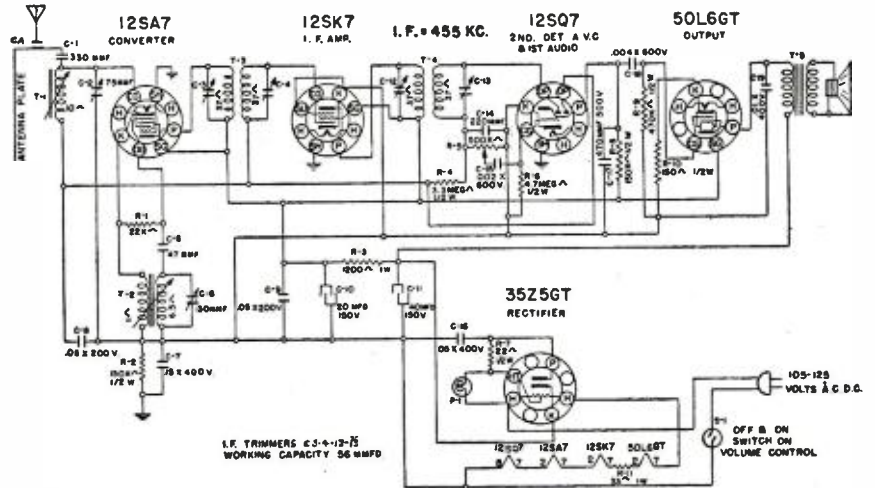

RADIO NEWS, MARCH, 1947

AIR KING MODEL 4608A

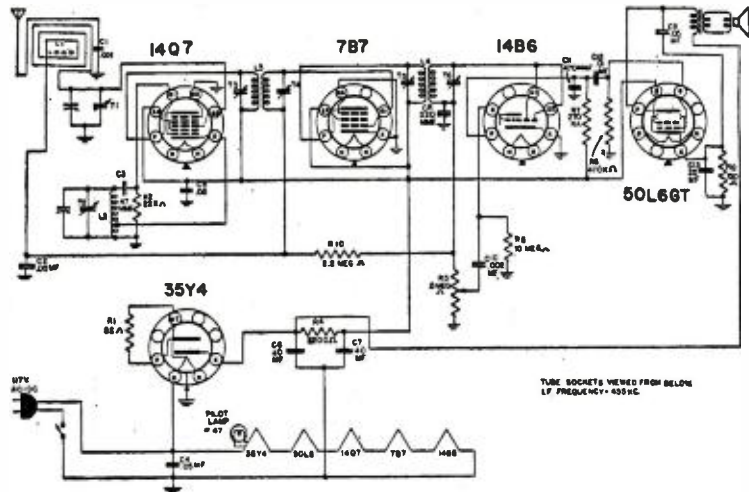

RADIO NEWS, MARCH, 1947

MAJESTIC MODELS 7C432, 7C447

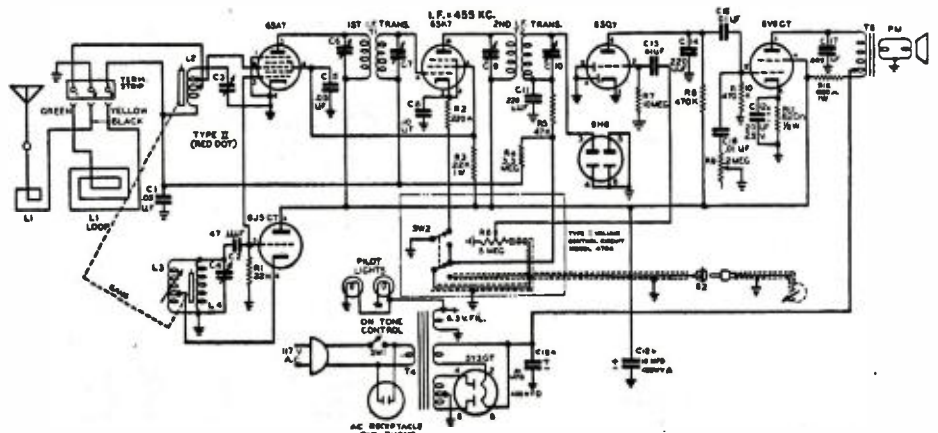

Here, and on following pages, are circuit diagrams and parts lists of many new postwar radio receivers. Radio News will bring to you other circuits as quickly as possible after we receive them from manufacturers.

RADIO NEWS, MARCH, 1947

CROSLEY MODELS 56XTA, 56XTW

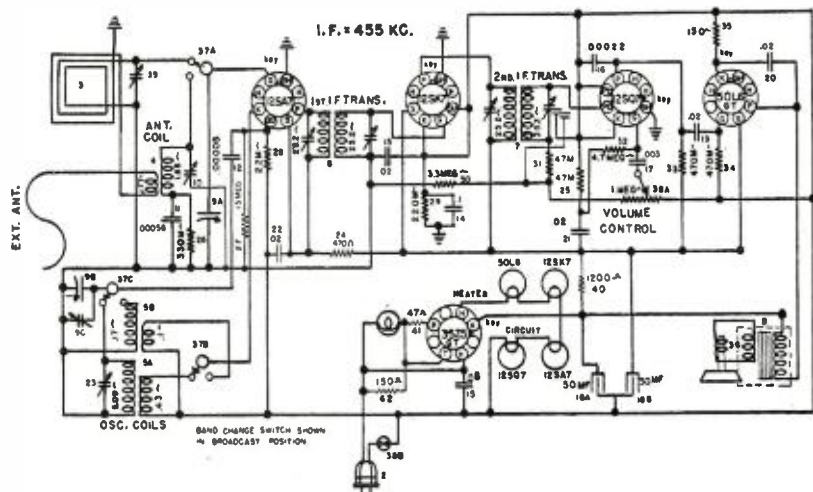

RADIO NEWS, MARCH, 1947

ZENITH MODELS 4K016, 4K035

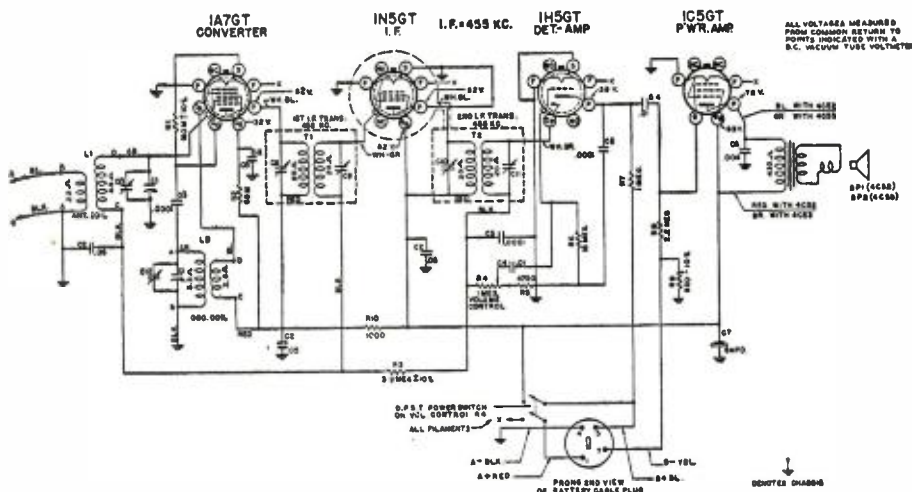

RADIO NEWS, MARCH, 1947

BELMONT BOULEVARD

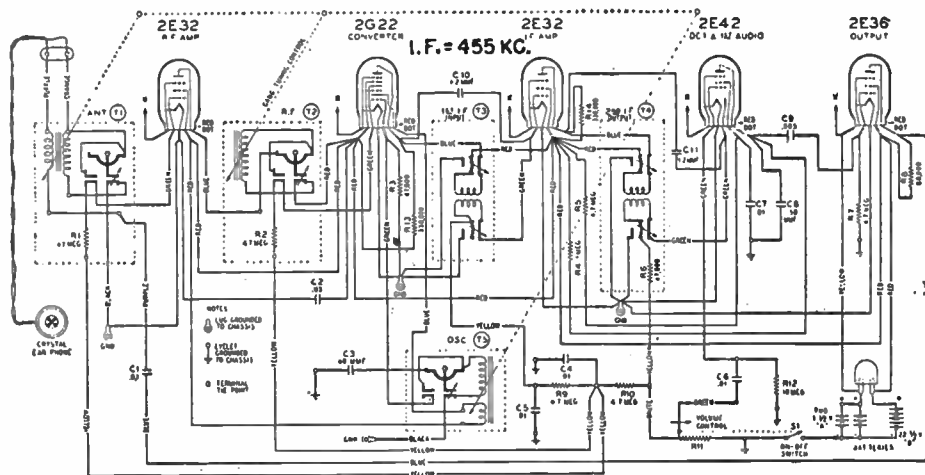

March, 1947

RADIOMEN! Here's the Way to Bigger Pay
A Complete Practical Set of **RADIO** Home Study and Reference Books for Only \$9.75 CASH PRICE



Yours **FREE** To Try 7 Days

NOW — a new 1947 set of practical, "down to earth" books for the man who wants to get ahead in RADIO and realizes he must know modern radio and television to handle a bigger job. "Applied Practical Radio" gives the radio worker the information he needs to advance in his job or radio business. Yet, this great set is written simple enough for the beginner. This is the only set of its kind in America today.

APPLIED PRACTICAL RADIO Tells All in 3 Handy Volumes

Here is practical, working knowledge of RADIO as it is used TODAY—from basic principles to latest advances in Television. The facts are boiled down, including the "know how" to construct, install and service all types of Radio and Television apparatus. Unique picture instruction method takes equipment apart to show what makes it work and how to keep it going.

FREE! 1 year of Consultation Service & Tech Bulletins included

Everything New in Radio Made Easy

The hundreds of interesting up-to-the-minute subjects covered include Frequency Modulation, Television, Auto Radio, Public Address Systems, Multi-Band Receivers, High Frequency and Short Wave—everything in radio today from A to Z. Over 1000 pages with 600 illustrations and new diagrams.

10 to 1 GUARANTEE
Set must earn 10 times its cost or Coyne sends money back on its return at end of 1 year.

Send No Money — See Books Free

But don't take our word for that these great books can do for you—see them yourself. Just fill in coupon below and mail it today. Coyne sends you "APPLIED PRACTICAL RADIO" to look over 7 days FREE. If you feel set isn't everything we say AND MORE, just return it at our expense and you owe nothing. If you keep the set you need pay only \$3 after 7 days and \$3 a month to total \$10.75. Or I'll pay \$9.75 cash price in 7 days. Include 1 yr. FREE Consultation Service, Technical Bulletins and 10 to 1 Guarantee. You can't lose on this offer, so don't delay—send that coupon NOW.

Backed by Coyne School' 20 years of Radio shop experience

COYNE ELECTRICAL SCHOOL
Radio Division, Dept. 37-T4,
CHICAGO 12, ILL.



FREE TRIAL COUPON

EDUCATIONAL BOOK PUBLISHING DIVISION,
COYNE ELECTRICAL & RADIO SCHOOL, Dept. 37-T4,
300 S. Paulina St., Chicago 12, Ill.
Send me Coyne's new 3-Volume Set, "APPLIED PRACTICAL RADIO" for FREE examination. After 7 days I'll either return it and owe nothing, or pay \$3 and \$3 a month to total \$10.75. Or I'll pay \$9.75 cash price in 7 days. Include 1 yr. FREE Consultation Service, Technical Bulletins and 10 to 1 Guarantee.
NAME..... AGE.....
ADDRESS.....
TOWN..... ZONE..... STATE.....
I Send C.O.D. I'll pay postman \$9.75 plus C.O.D. fee. Same money back guarantee after 7-day trial.

McGEE OFFERS YOU THE BEST VALUES IN RADIO AND PHONO-KITS

EVERY KIT COMPLETE • FACTORY ENGINEERED • SIMPLIFIED DIAGRAMS

During the past 15 years, we have designed and sold thousands of complete radio kits. We know that it takes matched parts and correctly designed circuits to please you. We are now going a step further, by offering you, not only schematics, but parts layout sheets. Photographs

of the top and bottom of a completed radio kit. This assures you of correct and rapid assembly. All chassis are punched and designed to fit their respective cabinets. All parts, resistors and tubes are furnished, nothing else to buy. Order with confidence.

RADIO-PHONO COMB. KIT



Build this beautiful portable combination radio phonograph. We furnish everything. Beautiful two tone portable case. Latest rim drive phono motor. Astatic crystal pick-up. All parts to build high quality 5 tube AC-DC radio. Tunes broadcast 550 to antenna. 6" Alnico 5 PM speaker. Tubes 12SA7, 12NK7, 12SQ7, 50L6 and 35Z5. Simple diagram furnished. Kit Model RP-12. Your Cost \$29.95

1650 KC, has tone control, loop antenna, 6" Alnico 5 PM speaker. Tubes 12SA7, 12NK7, 12SQ7, 50L6 and 35Z5. Simple diagram furnished. Kit Model RP-12. Your Cost \$29.95

WALNUT CABINET RECORD PLAYER

Beautifully made, highly polished walnut cabinet with hinged lid. Plays 10" records with lid closed. Latest rim drive phono motor and high output. Astatic crystal pick-up. High power JT-5, push-pull 3 tube AC-DC phono amplifier (wired and tested). Heavy duty 5" Alnico 5 PM speaker. Single record player kit Model WL-3. Your Cost \$19.95



After carefully designing the record player and cabinet shown above (Model WL-3), we decided that it should also be offered as a radio-phonograph combination. The cabinet is both attractive and small (12x12x8). The radio kit part of this unit is similar, except for the dial, to our Kit Model RP-12 shown in column 3 of this page. We furnish all parts: tubes, phono motor, pick-up, etc. Easy to follow diagram. Kit Model WL-3R. Net. \$29.95

Build this High-F. A.—Radio Kit PRK-8

- Standard Broadcast Superhet 550 to 1650 KC
- New Positive Drive Permeability Tuner
- 12" Dynamic Speaker
- Push-Pull 6V6 Output Stage 15 Watts
- 456 KC I. F.
- Dual Tone Controls (Bass and Treble)
- Phono and Crystal Mike Inputs
- A Fine Power Amplifier and Radio Kit
- All Parts and Simple Easy-to-Follow Diagram Furnished

Here is something new in radio. A real 15 watt power amplifier, with bass and treble controls. Has extra gain stage for crystal or dynamic mike. And on the same chassis, a standard superhet radio receiver. We furnish all parts, knobs, escutcheon plate and tubes: 6SA7, 6SK7, 6SR7, 6SN7, 6SQ7, 2-6V6, and 5Y3. No Cabinet. An actual photo of top and bottom of completed chassis makes wiring and assembly very easy. Model PRK-8. Your Net. \$24.95
Crystal Mike and Stand \$7.95 extra

20 WATT UTILITY AMPLIFIER KIT

Build this 20 watt utility 110 volt AC, 20 Watt power amplifier. Ready punched aluminum chassis, size 12 x 6 x 2 1/2 inches. Has two input circuits, one mike and one phono. Mike stage has 135 DB gain, for crystal or dynamic mike. Has bass and treble controls. Designed for use with PM speakers; has 8-16 ohm output transformer. All parts, controls, transformers and easy-to-follow diagram furnished. Including tubes: 2-6SN7, 6J5, 2-616GA, 5Z3. Kit Model 20-LX. Net. \$17.95
12" G. E. 12 watt Alnico 5 PM speaker, \$9.50 extra. Astatic crystal mike and desk stand, \$7.95 extra.

3-WAY PORTABLE KIT

Build this powerful, 5-tube, 3-way portable kit. Operates on 110 volt AC or DC, or self contained batteries. Receives broadcast 550 to 1650 KC. Incorporates a standard superhet circuit with A.V.C. and loop. Has 5" Alnico 5 PM speaker, 2 gang condenser. All parts, batteries and diagram furnished, including tubes: 117Z6, 1R5, 1T4, 185 and 384. This kit was engineered too late to show a picture of the attractive portable walnut cabinet, which is approx. 7 x 9 x 4 1/2 inches. A real kit. Remember, we furnish everything. Kit Model 3-ZA. Your Net. \$17.95

PHONO-MOTORS—PICKUPS—CART

RIM DRIVE PHONO MOTOR 9" TURNTABLE. SPECIAL \$3.95

LATEST GENERAL INDUSTRIES DUAL SPEED TURNTABLE. MODEL D. YOUR NET. \$15.90

NEW SHURE GLIDER PICK-UP; NO NEEDLE NOISE. REGULAR \$3.50 VALUE. SPECIAL AT \$2.29

NEW CURVED ARM ASTATIC AS USED ON MOST 1946 equipment. Reg. \$3.50 value. SPECIAL \$2.29

LATEST IN PHONO-KITS

High Power Push-Pull Amps

You can save money by assembling your own record players. All the kits listed below are complete; nothing else to buy. In 15 or 20 minutes any of these kits will be ready to sell to your customers.

*The model JT-5 high power push-pull 3 tube AC-DC amplifier is furnished with all record player kits complete; wired and tested and furnished with tubes and speaker. The push-pull circuit assures good response even at low volume. For servicing convenience and connecting to pick-up, a schematic diagram is furnished.

KIT J-15 SINGLE RECORD PLAYER. Attractive ready cut walnut finished cabinet with latest 78 RPM phono motor and light weight crystal pick-up and *JT-5 push-pull AC-DC amplifier and 5" Alnico 5 PM speaker. This player will surprise you in appearance and performance. Kit J-15 Dealers. Net \$15.95 complete

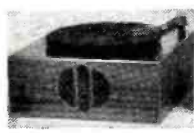

KIT J-16 AUTOMATIC RECORD PLAYER. Beautiful walnut finished, made to fit cabinet; latest single post automatic record changer and *JT-5 high power push-pull AC-DC amplifier (wired and tested) and heavy duty 5" Alnico 5 PM speaker. This kit makes a deluxe home record player. Kit J-16 Dealers. Net \$29.95 complete
Kit J-16A. Same as J-16 except with leatherette base instead of walnut. Dealers. Net \$26.95 complete



KIT J-17 PORTABLE SINGLE RECORD PLAYER. Attractive tan leatherette covered portable case with latest 78 RPM rim drive phono motor and light weight crystal pick-up and push-pull AC-DC amplifier *JT-5 (wired and tested) and 5" heavy duty Alnico 5 PM speaker. A real hot special. Kit J-17 Dealers. Net \$19.95 complete

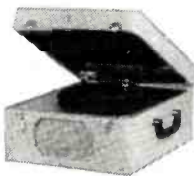

KIT J-18 PORTABLE AUTOMATIC RECORD PLAYER. Beautiful portable leatherette case and latest single post automatic record changer and *JT-5 3 tube AC-DC push-pull amplifier (wired and tested) and heavy duty 6" Alnico 5 PM speaker. We have sold hundreds of these to our dealers and they keep coming back for more. A real value. Kit J-18 Dealers. Net \$33.95 complete



KIT J-19 SINGLE RECORD ATTACHMENT. Attractive walnut finished base with motor cut out, latest 78 RPM rim drive phono motor and light weight high output crystal pick-up. Easily attached to any radio or amplifier. Kit J-19 Dealers. Net \$9.95 complete
Model B-4 phono oscillator (fits under base). Dealers. Net \$3.69

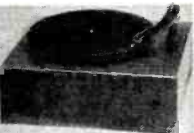

HOME RECORDER KIT J-K6. Dealers. Net \$59.95
Consists of latest General Industries dual speed 33 or 78 RPM record-play-back mechanism. Beautifully made to fit walnut cabinet and a complete kit of parts to build a high quality recording amplifier with push-pull 6V6 outputs. All parts, tubes, 5" PM speaker. Astatic crystal mike and diagram furnished. This amplifier can also be used as a 15 watt PA system. Provisions made to connect 12" PM Speaker, 12" G. E. PM Speaker and wall baffle \$16.95 extra. Net Kit J-K6 \$59.95.



G.I. RECORDER MECHANISMS

Latest 1947 General Industries recording assemblies with 4 ohm magnetic cutters and crystal play back arms.

Model 12445—78 RPM. Net	\$24.50
Model 15790—33 and 78 RPM. Net	28.95
Model 19810—Automatic changer with cutter, 78 RPM. Net	40.10

Write for latest bargain flyer of radios, parts kits, tubes and war surplus.

1947 — COMPLETE RADIO KITS

SENSATIONAL PEE WEE AC-DC KIT Model K-PW. Size 6 1/2 x 5 x 3 1/2 inches. Very small in size; uses pee wee tubes 1R5, 1T4, 185 and 384 and new dry disc rectifier. Conventional superhet circuit with AVC; 2 gang condenser. Receives broadcast 550 to 1700 KC. This set when wired according to our diagram will make a hot little personal radio. This kit is priced complete; just as all our kits are, with tubes, cabinet and speaker; nothing else to buy. Net \$11.95

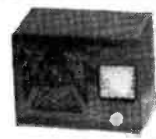

5-TUBE AC RADIO KIT superhet circuit using new permeability tuning unit. Covers broadcast 550 to 1700 KC. Beautiful walnut cabinet 12x7x6 5" A5 PM speaker. Everything complete, includes 6SA7, 6SK7, 6SQ7, 6R6 and 5Y3 and diagram Model K-5A. Net \$16.95

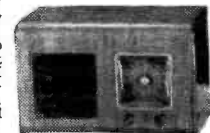

KIT K-7A 7 tube AC superhet 550 to 1700 KC. Has push-pull audio stage with tone control and 6 1/2 in. Alnico 5 PM speaker. Conventional circuit with AVC. Similar in appearance to model K-5A except has slightly larger cabinet. Everything complete including diagram and tubes 6SA7, 6SK7, 6116, 6SN7, 2-6V6, 5Y3. A real value. Net \$19.95

OUR LEADER KIT \$9.95. 2 gang cond. AC-DC 4 tube TRF kit 550 to 1600 KC Kit K-4R, a TRF job with a walnut cabinet and 5" Alnico 5 PM speaker. All parts furnished; including tubes and diagram. Has direct drive dial and a very simple standard circuit. An ideal kit for the student or experimenter. Just a few hundred to sell. Very Special at only \$9.95



NEW PLASTIC CABINET AC-DC SUPERHET KIT. Cabinet size 10 1/2 x 10 1/2 x 10 1/2 inches. Attractive slide rule dial. Positive drive permeability tuner. Receives broadcast 550 to 1650 KC. Has latest Alnico 5 PM speaker; loop antenna; all parts, simplified diagram and tubes 12SA7, 12NK7, 12SQ7, 50L6 and 35Z5 furnished. Kit P-48 Net \$12.95



4 TUBE 1 1/2-90 VOLT FARM RADIO KIT. Offered in same cabinet as the above Kit Model P-48. The same high gain broadcast superhet circuit. Complete with 4 tubes: 1R5, 1T4, 185, 384 and diagram. Less battery pack. Kit Model P-48. Your Cost \$10.95

DELUXE AC-DC KIT J-D5 Beautiful walnut cabinet and all the parts to build a broadcast 5 tube AC-DC radio. Superhet with slide rule dial, 2 gang tuning condenser and loop aerial. Everything furnished; includes speaker and tubes 12SA7, 12NK7, 12SQ7, 35Z5 and 50L6 and diagram. Kit J-D5. Net \$14.95



SHURE GLIDER CARTRIDGE. SPECIAL \$1.79
LATEST ASTATIC CARTRIDGE \$1.79

TWO-TUBE PHONO OSCILLATOR, \$3.69

Complete, wired and tested. 800 to 1500 KC. Model B-4. Has audio gain stage for proper power output. Complete with tubes ready to operate. \$3.69.
Mike Oscillator, model C-4 is similar to model B-4 except has added gain stage for crystal mike. Complete with 3 tubes and fader control \$4.95. Crystal mike \$4.90 extra.

ASTATIC CRYSTAL PICK-UP WITH NEW NYLON N11. Cartridge and replaceable Sapphire needle. Very Special \$5.95

FLUORESCENT BED LAMP. 110 Volt AC. All Plastic construction. Complete with 8 watt lamp. Offered in walnut or Ivory. Dealers. Net \$14.95
Power supply to convert 1 1/2-90 volt or 2-90 volt farm and portable radio to 110 volt AC operation. Easily wired to set. Completely wired and tested; with tube and instructions. J-P2. Dealers. Net \$5.95
2 Gang condenser, oscillator coil and loop; all matched. Special \$1.95
2 Gang condenser, 7/8" shaft, cut back section. Special \$1.49
456 K.C. First and Second high gain I. F. Trans. Special Each .49
3 or 4 wire 456 oscillator coils. .24
Small loop antennas. .39

McGEE RADIO COMPANY

Send 20% Deposit — Bal. Sent C.O.D.
1225 McGEE ST., KANSAS CITY, MISSOURI

LEARN ELECTRIC MOTOR REPAIR!



**A PROFITABLE
ADDITION TO
ANY RADIO SERVICE
BUSINESS**

This big
book shows
you how—every
step of the way—
only \$5

IT PAYS TO SPECIALIZE IN SOMETHING DIFFERENT

There's good money in electric motor repair! The field is not crowded—and what could be a finer, more profitable addition to your already established radio service business? Every home you visit on radio work has many motor-driven appliances. Be the man who can repair them!



ELECTRIC MOTOR REPAIR, the unique new book by the publishers of the famous Ghirardi Radio-Electronic books, teaches you the work from the very beginning. Explains every detail of motor trouble diagnosing, repair and rewinding. Covers a-c and d-c motors, synchronous motors and generators and BOTH mechanical and electrical control systems.

A "BENCH" BOOK

Based on what you can learn from this big book alone, you can train for prompt, profitable motor service. Quick reference guides for use right at the bench show exactly how to handle specific jobs. Invaluable for beginners or for daily reference in busy shops. Unique Duo-Spiral Binding divides book into 2 sections permitting text and related illustrations to be seen AT THE SAME TIME. Book contains more than 900 diagrams and illustrations.

Send coupon now! Practice from **ELECTRIC MOTOR REPAIR** for 5 days. If not more than satisfied, return book and every cent will be cheerfully refunded.

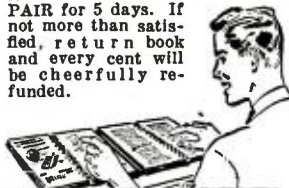

NO RISK COUPON mail today

Dept. RN-37, Murray Hill Books, Inc.,
232 Madison Ave., New York 16, N. Y.

Enclosed is \$5 (\$5.50 foreign) for a copy of **ELECTRIC MOTOR REPAIR** Book; or send C.O.D. for \$5 plus postage (no foreign C.O.D.'s). In either event, if not satisfied, it is understood I may return book in 5 days for complete refund of my money.

Name

Address

City & Dist. No. State

What's New in Radio

POWER SUPPLIES

Two new models of their line of electronically regulated power supplies have been introduced by *Furst Electronics* of Chicago.

Models 310-A and 310-B have been specifically designed for production and laboratory tests of a.c.-d.c. re-



ceivers, sound amplifiers and similar electronic equipment, universal motors and appliances powered by such motors, and other equipment designed to operate from d.c. power lines.

Output voltage is continuously adjustable over a range which exceeds the variations of line voltages usually encountered. The adjustment may be made by means of a control knob on the front panel. The adjusted output voltage will remain constant regardless of load variations or voltage variations in the a.c. power line, according to the manufacturer.

Full details on either or both of these units will be supplied upon request to *Furst Electronics*, 800 W. North Avenue, Chicago 22, Illinois.

PORTABLE PHONOGRAPH

Lewyt Corporation of Brooklyn, New York has recently introduced several new models of radios, phonographs and radio-phonograph combinations.

One of the unique presentations in this line is the "Hat Box" phonograph, Model 215. This portable unit is housed in a well-constructed carrying case covered with high luster plastic



patent similar in appearance to patent leather and trimmed in russet, saddle stitched leather. The interior of the case is lined in red morocco grain. A three tube amplifier, a 5" Alnico V magnetic speaker and a featherweight "glider" crystal pickup, equipped with a permanent, genuine sapphire needle

provides faithful reproduction of recorded music. The phonograph operates on 105-125 volts, a.c.

Information about this model and others in the company's line will be forwarded to those requesting it from *Lewyt Corporation*, 60 Broadway, Brooklyn 11, New York.

COMBINATION UNITS

Dearborn Industries of Chicago is currently offering two automatic radio-phonograph combinations for distribution to radio dealers.

Both of the units, the Model 500W console and the Model 100W table model, are available in either Swedish modern wheat finish or a rich walnut finish.

The 500W includes storage space for record albums, a six tube superheterodyne receiver and automatic record changer. The unit stands 35" high, is 19" deep and 21" wide.

The 100W table model combination has a five tube superheterodyne receiver and an automatic record changer which will handle ten and



twelve inch records. This unit is 18" x 14" x 14".

Prices and delivery data on these and other combination radio-phonographs in the company's line will be sent to dealers upon application to *Dearborn Industries*, 122 W. Hubbard Street, Chicago 10, Illinois.

FM-AM TUNER

A new FM-AM tuner which provides high-fidelity reception in the high frequency FM band as well as the standard broadcast band has been announced by *Browning Laboratories, Inc.* of Winchester, Massachusetts.

Incorporating a number of modern features, this unit has separate r.f. and i.f. systems for both bands and the entire r.f. section for the FM band uses miniature tubes for highest efficiency.

The tuning range on the FM band extends from 87 to 109 mc. and on the broadcast band from 530 to 1650 kc. The Armstrong circuit is employed in the FM section with two cascade limiters to ensure maximum noise rejection. Bandwidths of i.f. amplifiers are such that high fidelity audio output is realized, according to the manufacturer. Provision is made for using the

E. H. Rietzke, President of CREI, Invites You to Write for this

Free Significant Analysis of Job Opportunities in Radio-Electronics

EVERY RADIOMAN

Who Wants to Hold His Job
or Advance to a Better Job

WILL WANT TO READ THIS LETTER!

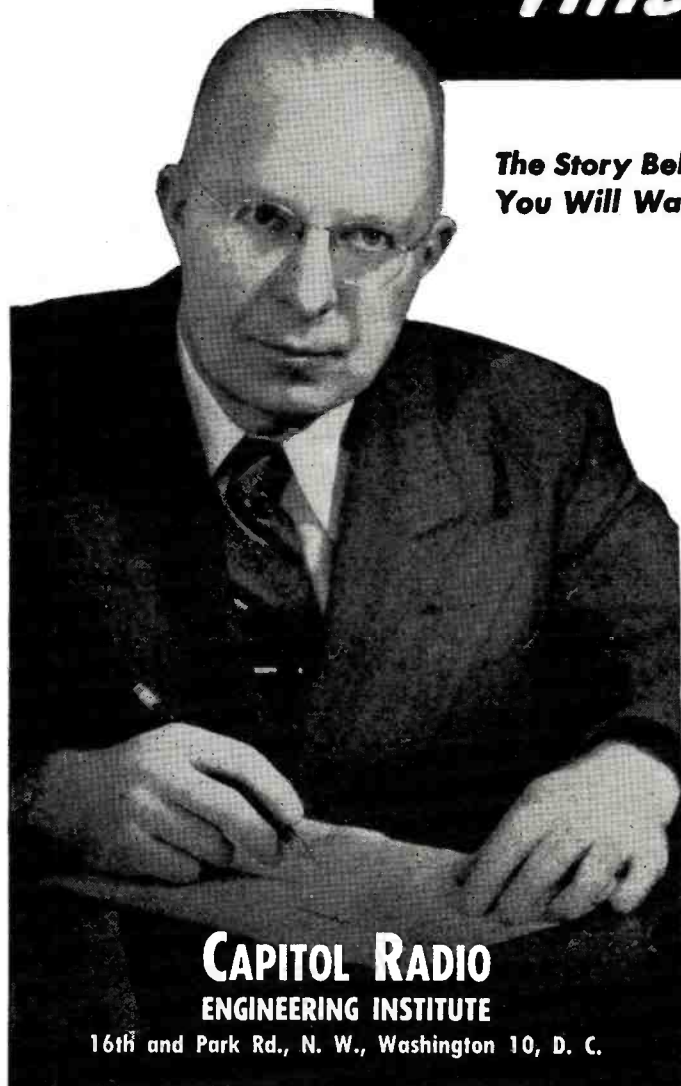

The Story Behind This Interesting Letter

You Will Want to Read . . . Our advertising agents, realizing that vital changes are taking place in the radio industry, asked me to give them a factual report of the unprecedented job opportunities created by the almost unbelievable expansion of the radio industry.

My letter to them contains some pertinent viewpoints on the subjects of **COMPETITION—INDUSTRY EXPANSION—OPPORTUNITIES**. These are first-hand observations based on my own experiences . . . a great deal of time spent in the field and constant contact with leaders in the radio industry.

The immediate reaction of our agency upon reading this letter was that it contained so much inspiration and information that it should be reproduced for thousands of radiomen to read. Therefore, this unusual advertisement to invite you to send for, and read, this letter.

It is doubtful if many radiomen realize the actual things that are happening. That is why I think you will want to read this letter. You are invited to send for your personal copy today.

E. H. Rietzke
President, CREI

MAIL COUPON FOR FREE COPY • NO OBLIGATION

Capitol Radio Engineering Institute
16th and Park Road, N. W., Dept. RN-3
Washington 10, D. C.

Gentlemen: Please send me FREE, Mr. E. H. Rietzke's
Analysis of Job Opportunities in Radio-Electronics.

NAME.....
POSITION.....AGE.....
ADDRESS.....
CITY.....ZONE.....STATE.....

CAPITOL RADIO
ENGINEERING INSTITUTE

16th and Park Rd., N. W., Washington 10, D. C.

new 300 ohm twin lead cables* for antenna systems. The same antenna is used for both FM and AM obviating the necessity for separate lead-ins.

The tuner, exclusive of power supply, is 7 $\frac{3}{8}$ " x 13 $\frac{1}{2}$ " x 9". The power

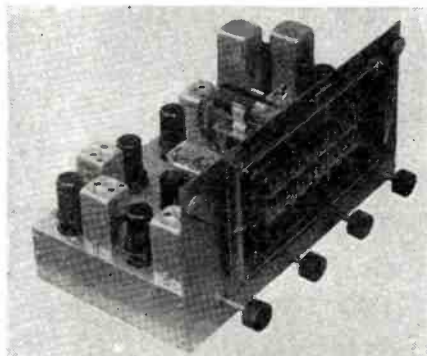

supply is a small separate unit designed to be mounted in cramped quarters.

When the same unit is provided for professional installations, the tuner comes in leatherette with rack panel mounting. Space has been provided in this unit for the power supply.

Browning Laboratories, Inc., Winchester, Massachusetts will furnish additional data upon request.

CEMENT AND SOLVENTS

JFD Manufacturing Company of Brooklyn, New York are now offering their line of radio cements, solvents and carbon tetrachloride in four new sized packages which have been rede-

signed for the convenience of the user.

All of the items in the line are now available in 4, 8, 16 ounce and 1 gallon sizes. The radio cement line comes with brush affixed directly to the metal cap.

Additional details on these newly packaged items will be furnished by *JFD Manufacturing Company*, 4117 Fort Hamilton Parkway, Brooklyn 19, New York.

PORTABLE BRIDGE

Especially designed to facilitate production testing and radio servicing, *General Electric Company's* Electronics Department has recently announced the availability of a new portable condenser-resistor bridge, Type YCW-1 which is capable of measuring a wide range of capacity, resistance and other electrical characteristics of condensers.

The instrument which features push-button switching will also measure the turns ratio of transformers.

The YCW-1 will measure capacity from .000005 to 200 μ fd. in three convenient ranges and resistance from 5 ohms to 20 megohms in two ranges. Using the Wien bridge principle with standards of plus or minus one for capacitance and plus or minus two percent for resistance, bridge balance is indicated by a sensitive visual indicator tube. Measurements are obtained by varying a potentiometer with a knob and a pointer until a maximum shadow angle is obtained on

the indicator tube; capacitance and resistance values are also indicated by the pointer.

Further information and specifications sheets on this new instrument will be furnished by the Specialty Division, *General Electric Company's* Electronics Department, Wolf Street Plant, Syracuse, New York.

ACOUSTICEL MICROPHONE

Of interest to amateurs and servicemen handling recording and p.a. work is the new BA-105 "Acoustical" microphone recently added to *The*

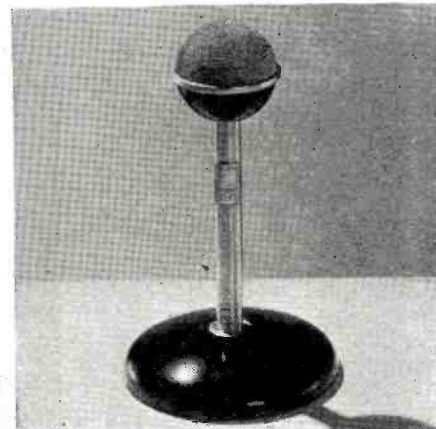

Brush Development Company's line of crystal mikes.

The new unit provides essentially flat response from 40 to 6000 c.p.s. with high output. The output level is (Continued on page 157)

ESSE SPECIALS!

- **MARKER BEACON RECEIVER BC-341-A.** Complete with tubes. Price\$4.95 ea.
- **BC-434 and BC-524 AIRCRAFT RECEIVER** made by Setchell, Carlson and Detrola. Your choice. Price\$4.95 ea.
- **BC-274-N COMMAND SET.** Complete with 3 receivers: 3-6 Mc, 6-9.1 Mc and 190-550 Kc. Two transmitters, modulator and mounting racks. All tubes and crystals included. Price\$24.95 ea.
- **BC-211 and BC-221 FREQUENCY METERS** complete with tubes and crystals. Price\$35.00

- **INTERVALOMETER.** Used to release bombs at various intervals with electronic timer that can be adapted to other purposes such as photography, etc. Price\$1.75 ea.
- **24 V. 600 Watt GRIMES RETRACTABLE LANDING LIGHTS.** Excellent motor for model locomotives, etc. Wire 4 lights in series for powerful flood light operated from 110 V. AC or DC supply. Price\$3.50 ea.
- This equipment has been removed from surplus aircraft and is only slightly used—some not at all. Order while the supply is plentiful. Prices are F.O.B. location.

TERMS: CASH WITH ORDER OR 25%—BALANCE C.O.D.

ESSE All Items Shipped Collect
RADIO COMPANY
130 W. NEW YORK ST., INDIANAPOLIS 4, IND.

TUBES! TUBES!

6SK7	} 40c each
6B4G	
5U4G	
6SA7	
6H6	
6H6C	
6SN7	
6AG5	
5T4G	
VR150-30	
6SL7GT	
6SN7GT	
6N7	
6AG7	
6AC7	
6SJ7	
2X2	} 50c each
6L6	
VR105	

Sold in quantities of 10 or more only. These are new tubes removed from radar components. Tubes are checked thoroughly before shipment. However, to make these prices possible, no returns, exchanges or guarantee can be allowed.

ESSE Specials!



Brand New Meters

- 2" 0-100 Ma. DC McClintock Co. \$3.45
- 2" 0-150 V. DC Gruen. 3.45
- 3" 0-10 Ma. DC Westinghouse. 4.50
- 3" 0-500 Ma. DC Westinghouse. 4.50

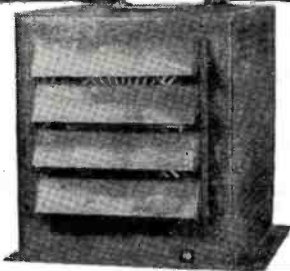

Electromode Hot Air Heater

This is a heater used to heat the trucks of the SCR-299 mobile units — which proved highly successful during the war. Operates from 110 V. AC or DC—1,500 watts. Contains blower unit for forced air heating which can also be used for fan during warm weather. Thermostatically controlled with motor protect Thermotron.

Price..... \$29.50

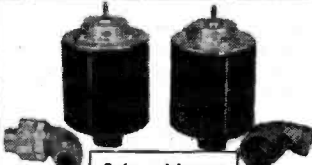

Selsyn Motors

Use in pairs for direction indicators of beams, wind, etc. Operate from 10-15 V., 60 cycle AC.

Price, each..... \$1.75

Includes plug.

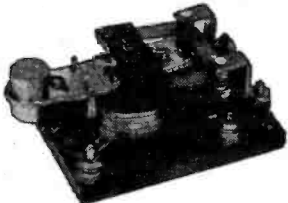

Leach Relay — 24 V. DC

Res. 160 ohms. Poles 3 and 4 make when magnetized. 5 and 6 when unmagnetized.

Price, brand new, each..... \$1.95

Relay — SPDT Type

5 ma. 5000 ohm DC resistance.

Price..... \$0.85



PE-103 Dynamotor Unit

Brand new. Used to power your field or mobile transmitter. Designed for use with the BC-654 transmitter and receiver. Input—6 V. DC. 21 amps.; 12 V. DC. 1 amp. Output—500 V. DC. 160 Ma. Filtered output. Hi-Current relay switches, and overload protect switches self contained in unit. Shipped in original overseas moisture-proof container. Wt. of unit 53 lbs.

Price, brand new, each..... \$ 9.95

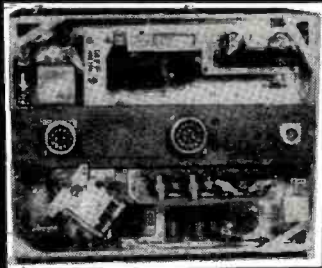

SCR-522 100-156 Mc. Receiver and Transmitter

One of the most interesting and useful pieces of surplus equipment. Designed for plane and ground station use, this unit offers remote control of any four pre-selected crystal controlled frequencies in the spectrum of 100-156 Mc. This spectrum covers facsimile, air navigation aids, airport control, railroad, police, urban telephone, as well as the amateur band 144-148 Mc. October Radio News gives details for converting the SCR-522 receiver section, BC-624.

Transmitter section, BC-625, its voice amplitude modulated and has an output of 8-9 watts.

Tubes used and included: 2—B32, 3—12A6, 1—6G6, 2—6SJ7, 1—12J5GT, 3—12SG7, 1—12CB, 1—9002, 3—9003, 1—12AH7GT

Used, with tubes, less dynamotor and remote control.

Price..... \$29.75

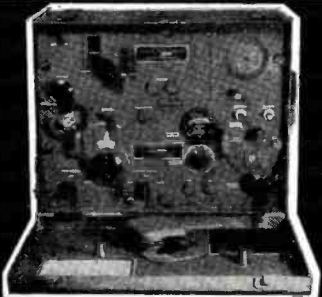

BC-654-A Receiver and Transmitter

Truly the best buy of Army surplus. Frequency range 3800 to 5800 KC—calibration every 10 KC—with crystal oscillated check every 200 KC—power output 17 watts, voice or CW. Shipped as received from Signal Corps Repair Laboratories. Some in new condition with spare tubes, others lacking some tubes. Weight, 45 lbs.

Price..... \$17.95

PE-104 Vibrator Power Supply for operation of BC-654-A receiver from 6 V. or 12 V. storage battery.

Price, new..... \$4.95

AN/ART-13 Collins Autotune Transmitter

A modern, compact, lightweight, high-powered transmitter. For frequency range 2-18.1 Mc. on any of its 11 auto tune crystal controlled or master oscillator channels. December Radio News gives conversion details for converting 24 V. DC operation to 117 V. AC. These units removed from planes. Checked and guaranteed. Weight, 67 lbs.

Price..... \$134.50

1 COMPLETE WITH DYNAMOTOR UNIT

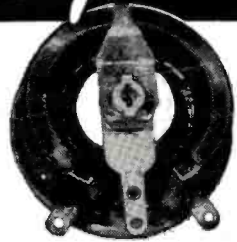

Ohmite

150-watt Model L Potentiometer, 7.5 and 500 ohms.

Price, brand new, each..... \$1.95

Ohmite Model J — 50-watt Potentiometer, 6 ohm.

Price..... \$1.25

Ohmite Model M — 25-watt Potentiometer, 350 ohm.

Price..... \$0.85

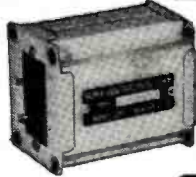

Filter Choke

20 Henry, 50 Ma., 200 ohms DC.

Price 75¢



Triplatt Model 650-5C-AC Voltmeter and Output Meter

Scale 1.5, 6, 15, 60 and 150 V. 4000 ohms res.

Price, brand new, with test leads..... \$13.50

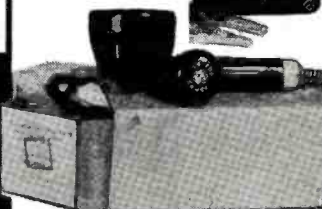

T-17-B Microphone

Brand new. A single button, carbon mike, hard to beat—and at the price. When ordering without additional merchandise, enclose 25¢ additional for postage and handling.

Same as above but used, either bakelite or aluminum model.

Each..... 95¢



Headphones

Signal Corps 4,000 ohm magnetic and headband.

Price..... \$1.87

Headphone Extension Cords for Signal Corps phones. PL-55 plug on one end. JK-26 on other. 60" length—used.

Price..... \$0.75



Thordarson T-92R21, Plate and Filament — Secondary 389.0-389 at 200 Ma. 5 V 3 amp., and 6.3 V 5 amp. 110 V. 60 cycle pri. A real replacement transformer for large sets.

Price, brand new..... \$3.75

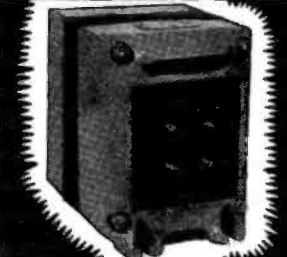

Thordarson—1060 V. CT secondary 300 VA. Pri.—200, 220, 240 V. 60 cycle AC

Price, brand new..... \$6.50

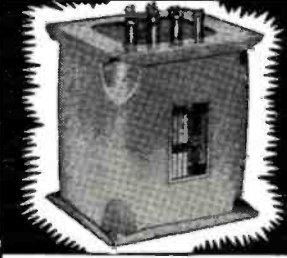

Thordarson—110 V. 60 cycle pri. sec. 440 V. CT 150 Ma. and 5 V 3 amp.

Price, brand new..... \$2.25



Filament Transformer

5 V. CT. 7.5 amp. 110 V. 60 cycle pri.

Price, brand new \$1.50



Ceramic Stand Off Insulator

Use for stand off or mount two base to base for feed-thru insulator. Size 1 1/2" high, base diameter 2 1/8". You can't afford to be without them at the price.

Sold in dozen lots only \$0.05

Price, each.....

TERMS:
CASH with ORDER
or 25%
BALANCE C.O.D.
All Items
Shipped Collect

ESSE Radio Company

130 W. New York St. Indianapolis 4, Ind.



Here's a preview of ALLIED Sound for 1947 in this smoothly-styled, brilliantly engineered 30 Watt De Luxe Portable System. New stabilized inverse feedback circuit delivers high output, usable right up to its peak. Flexible operation is provided by two microphone and one phono channels, each with separate control. Has bass-treble tone control. Amplifier and speakers are safety-fused. Amplifier gain on microphone is 128 db; on phono, 80 db. Frequency response: 50-10,000 CPS. System covers up to 4,000 persons, or up to 20,000 square feet.

Complete 30 Watt System includes: 30-Watt De Luxe Amplifier with tubes; 2-12" Safused Dynamic Speakers, with 30-ft. cables and plugs; 1-Cardax Unidirectional Microphone with floor stand and 20-ft. cord and plug. Complete in handsome luggage-type split portable carrying case, 22"x20"x15". Carrying wt., 60 lbs. For 110 volts, 60 cycles A.C. (Less phono top which is optional.)

Complete System Only..... \$10575



See your ALLIED Catalog No. 111 for the world's largest and most complete stocks of quality radio and sound equipment—at today's lowest prices! Count on ALLIED for fast service, expert help. If you haven't a copy of Catalog No. 111—send for it now—it's FREE for the asking.

ALLIED RADIO
ALLIED RADIO CORP.
 833 W. Jackson Blvd., Dept., 1-C-7, Chicago 7, Ill.
 Ship 30-Watt Portable System described above. \$..... enclosed.
 Send full details on ALLIED Sound.
 Send FREE Radio Catalog No. 111.
 Name.....
 Address.....
 City.....Zone.....State.....

EXTERNAL S-METER FOR HALLICRAFTER S20R AND S40 RECEIVERS

By GUY DEXTER

A LARGE number of *Hallcrafters* S20R Sky Champion receivers are in use at amateur stations. A very useful accessory for this receiver is an external S-meter. The Sky Champion has a 5-pin socket in the rear for plugging-in an external S-meter; but since the war, few of these meters have been obtainable. In view of the shortage, no ham would object to building his own S-meter if the circuit and calibration data were offered to him.

Fig. 1 gives the circuit diagram of an external S-meter that works excellently with the S20R receiver. Table 1 gives the calibration data. In all ordinary cases, the reader may mark off his own meter scale according to the data given in Table 1, no further calibration being necessary. The only parts required to build this useful instrument are a 0-1 d. c. milliammeter, five 1-watt carbon resistors, a 10,000-ohm wirewound potentiometer, and a standard 5-pin plug. The entire instrument may be built into one of the small sloping-front meter boxes. If an illuminated meter is employed, the 6.3-volt dial light may be connected through the cable leads to pins 1 and 5 of the plug. This circuit may be used also with the new *Hallcrafters* S40 receiver which apparently has superseded the S20R Sky Champion.

Potentiometer R_2 is used to set the meter initially to zero. Resistor R_3 is a shunt used to multiply the meter range to 0-2 milliamperes. If a milliammeter having an internal resistance of some value other than 100 ohms is employed, a different value must be used for R_3 . Shunt resistor R_3 always must equal the internal resistance of the milliammeter. It is best to select and adjust the value of R_3 for any individual meter very carefully in a test circuit (until a standard 1-milliamper d. c. input deflects the meter half-scale) before wiring the meter and R_3 into the S-meter circuit.

The author's calibration points were obtained in this manner: After connecting the S-meter to the receiver, a laboratory standard signal generator was connected to the input terminals of the receiver, and both generator and receiver were set to 3 megacycles (a convenient lower-frequency test point). The weakest readable input signal was found to be $2\frac{1}{2}$ microvolts. This deflected the milliammeter to its first scale division (0.02 ma.) and this point was designated S-1. The test signals corresponding to the other S points then were predetermined according to 6 db. spacing (2 to 1 microvolt ratios) between each two successive points from S-1 to S-9, and 5 db. spacings (1.78 to 1 microvolt ratios) between each two successive points above S-9. The signal gen erator output then was set successively to these levels and the meter deflections recorded. If the reader has access to a microvolt-calibrated signal generator, he may repeat the calibration process with his own receiver. It is advisable to use a test frequency lower than 4 megacycles and one on which no radio stations are apt to be picked up during the tests. However, as pointed out earlier in this article, the meter scale may in all ordi-

SIGNAL STRENGTH	MILLIAMMETER DEFLECTION
50 db. above S-9	0.87
45 " " "	0.85
40 " " "	0.83
35 " " "	0.80
30 " " "	0.78
25 " " "	0.76
20 " " "	0.73
15 " " "	0.70
10 " " "	0.66
5 " " "	0.64
S-9	0.54
S-8	0.48
S-7	0.41
S-6	0.34
S-5	0.28
S-4	0.20
S-3	0.14
S-2	0.06
S-1	0.02

Table 1. Dial calibration of S-meter.

nary cases be marked off simply according to the data given in Table 1.

The meter is simple to use: (1) Insert S-meter plug in meter socket in rear of receiver. (2) Switch-on receiver, throwing receiver standby switch to "RECEIVE." (3) Switch-on a. v. c. (4) Switch b. f. o. off. (5) To turn on S-meter, advance receiver r. f. gain control all the way to the right until switch on this control clicks. (6) Temporarily ground receiver antenna terminals to prevent signal pickup, and set meter to zero by adjusting potentiometer R_2 in S-meter circuit. *At frequent intervals during normal use of receiver, S-meter zero should be inspected, always grounding antenna terminals temporarily or detuning receiver dial to prevent signal pickup, and R_2 should be adjusted to return meter pointer to zero.* (7) After setting meter to zero, tune in signal and read its intensity on meter scale.

Whenever the S-meter is used, a. v. c. must be switched on and b. f. o. off, and the r. f. gain control must be advanced all the way to the right until the S-meter switch on this control is heard to click on. The positions of the audio gain control, noise limiter switch, and tone control do not affect indications of the S-meter.

This S-meter does not give flattering indications of signal strength, neither is it especially "scotch" in perform-

Fig. 1. Circuit diagram of S-meter. All resistors are 1 watt and the internal resistance of meter movement is 100 ohms.

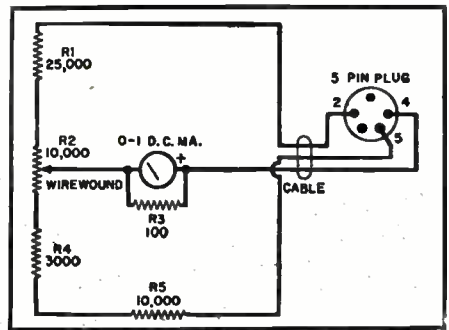

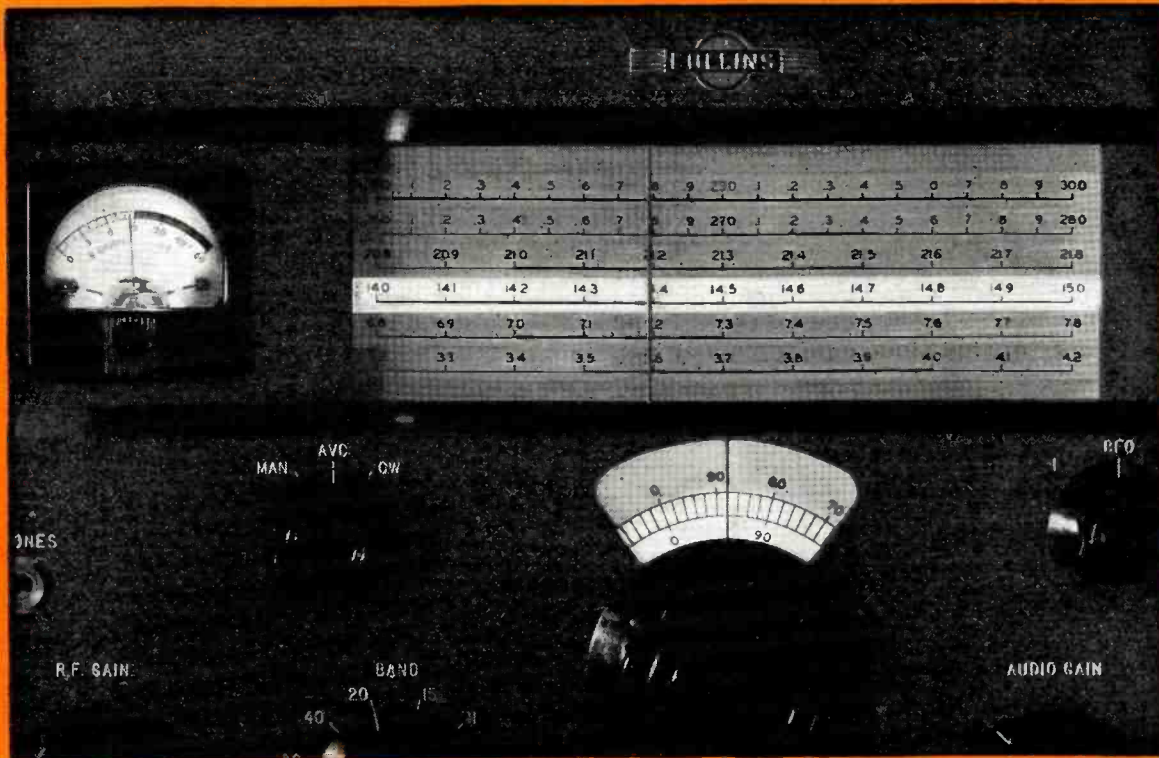

The Collins Band-Lighted Dial Gives You

Added Pleasure

Wherever the Collins 75A receiver is shown—ham-fests, fairs, club meetings—the band-lighted dial wins enthusiastic endorsement from all who can crowd close enough to see it. And no wonder! It's so easy to use, both visually and mechanically, that once you've used it you'll see why it ranks high among the many new features of this receiver.

Here's how it works. The dial amply covers six amateur bands—80, 40, 20, 15, 11 and 10 meters. When you turn on the filament supply, the dial lights are turned on. *But only the band selected for use is lighted!* There's no band pointer to get out of adjustment, no feeling for the detent action, and *no scanning the dial to see where the frequency indicator is!* With only one band lighted at a time you just naturally read the correct figures at first glance.

The vernier dial, which gives you directly the exact frequency to within 1 kc (2 kc on 11 and 10

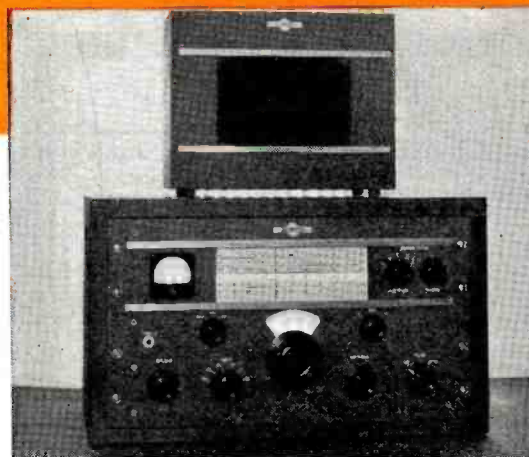

meters), works the same way. Only the band you're listening to is lighted. The frequency shown in the photograph is 14,394 kc.

The band-lighted dial is further proof of Collins interest in amateurs. In every equipment designed and built for amateurs by Collins, you'll find engineering that advances the art of amateur radio.

FOR RESULTS IN AMATEUR RADIO, IT'S . . .

COLLINS RADIO COMPANY, CEDAR RAPIDS, IOWA

11 W. 42nd St., New York 18, N. Y.

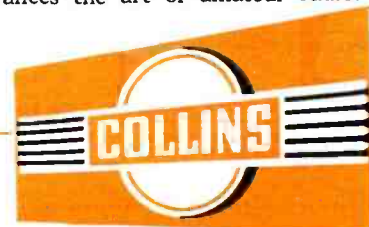

458 S. Spring St., Los Angeles 13, Calif.



ESTABLISHED 1906

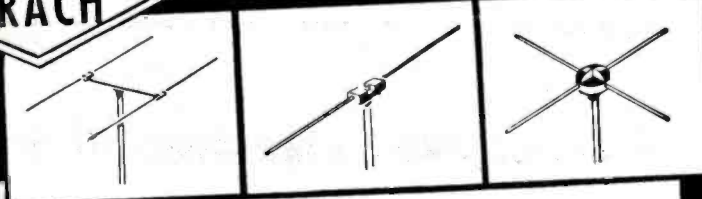

ANTENNA SYSTEMS for USERS of PRIVATE BRANDS

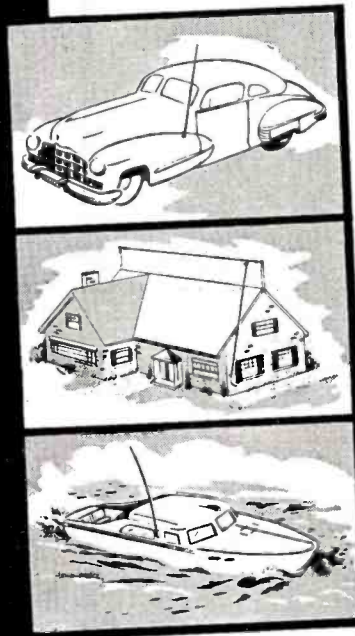

We manufacture the following, under private labels and trademarks:

AUTOMOBILE ANTENNAS . . . every variety, including types that can be raised and lowered from inside the car.

RESIDENTIAL ANTENNAS . . . AM and FM, for homes, stores and multi-family buildings. Complete lines of noise-reducing systems incorporating latest patented developments of coupling transformers.

FM, AM and TELEVISION . . . Dipoles with or without reflectors, folded dipoles, turnstile, radiating types and other combinations for roof, sidewall and other mountings.

MARINE ANTENNAS . . . Collapsible and transmitting types for every purpose.

For POLICE and other mobile units . . . roof-top antennas for ultra-high frequencies.

WE INVITE INQUIRIES AND CONSULTATIONS.

L. S. BRACH MFG. CORP.

200 CENTRAL AVENUE NEWARK, 4 N, J.



WORLD'S OLDEST AND LARGEST MANUFACTURERS OF RADIO ANTENNAS AND ACCESSORIES

PRE-EXAM TESTS FOR Commercial Radio Operator FCC LICENSE EXAMINATIONS



DON'T TAKE A CHANCE—AVOID FAILURE ON FCC COMMERCIAL RADIO OPERATOR LICENSE EXAMINATIONS!
USE NILSON'S COMPLETE PRE-EXAMINATION TESTS AND COACHING SERVICE
Enables You To

- Rehearse the FCC license examinations
- Practice the procedure
- Practice the multiple-choice examination methods used by FCC
- Check your knowledge
- Locate your weak points
- Correct your weak points before taking the actual examination

Prepared by Arthur R. Nilson, Famous Co-author of Nilson and Hornung's RADIO OPERATING QUESTIONS AND ANSWERS
Cleveland Institute of Radio Electronics, RN-3 Terminal Tower, Cleveland 13, Ohio

Cleveland Institute of Radio Electronics
RN-3 Terminal Tower, Cleveland 13, Ohio
Please send information about Pre-Exam Tests.

Name.....
Address.....
City..... Zone..... State.....

ance. Several hundred tests made by the author in the laboratory and on received signals both in the broadcast and amateur bands (as well as comparison with S-meter response in a number of competitive receivers) indicate that the calibration data given in Table I is fair in every respect.

An individual builder who cannot afford to tie up his one and only 0-1 milliammeter in an S-meter can mount all of the parts in a small box and provide a small jack for plugging-in the meter when needed for this purpose.

-30-

60-Watt Transmitter

(Continued from page 43)

ically on all sides and no difficulty is experienced from stray feedback. Since the oscillator tank circuit is quite close to C_{13} such feedback could present a problem.

The value of meter shunts for the various stages will depend upon the size meter used. Any meter having a full scale reading between 1 ma. and 10 ma. may be used. The meter shown in Fig. 1 is one purchased from Army surplus and happened to read 7 ma. full scale. Since the meter scale was calibrated from 0 to 3, the shunts were wound to make the full-scale milliampere reading a multiple of the scale reading; i.e., 9, 60, 150, and 300 ma. The shunts are wound of 1-ohm per foot resistance wire and the actual value determined by connecting the meter and shunt in a calibrating circuit. The calibrating circuit consists of a variable resistor, 1½-volt battery, and a calibrated meter which covers the ranges desired.

Operation

Tune up of the transmitter is done in the conventional manner. While tuning the oscillator and buffer-multiplier stages and neutralizing the final, switch S_2 should be kept in the "Tune" position. Switch S_1 should be in the "Send" position.

With no crystal in the circuit, the oscillator cathode current will be approximately 6 ma. With crystal in the circuit and oscillating, the oscillator cathode current will be approximately 18 ma. The current during non-oscillating periods is limited by cathode resistor R_1 . The best method of tuning the oscillator is to tune for maximum grid current on the final. The oscillator can be roughly tuned by adjusting for maximum plate current on the buffer-multiplier stage, and later the tuning can be touched up to give maximum drive to the final.

The cathode current of the buffer-multiplier with no excitation will be approximately 8 ma. With excitation the cathode current will rise to about 20 ma. The best method to use for adjusting the buffer-multiplier stage to resonance is to tune for maximum grid current on the final stage.

When using the 6AG7 as a buffer, 10 to 15 ma. grid current can be obtained on the 815. When operating under this condition it will be neces-

Majestic

**RADIO AND
TELEVISION CORPORATION**
War Assets Administration Division

Announces to
DEALERS and JOBBERS

A Comprehensive List of

TRANSMITTING TUBES

Write for our list which is a most complete one. However, if upon receipt you find it does not include numbers which you want, kindly let us have your specific requirements. We will do everything possible to fill them as our stock is being constantly augmented.

125 West Ohio Street Chicago 10, Ill.
Whitehall 6710

Look to
WARD
the Leader!

The world's leading
producer of auto
aerials presents
models unsurpassed
in . . .

DESIGN { Each smart looking model is engineered and equipped to fit every car on the road.

QUALITY { Every model has been tested and approved by car and radio set manufacturers.

DOLLAR VALUE { Always "most for the money" Ward aerials are going down in price Feb. 1, 1947. List prices will be from \$2.95 up.

Write us for full information!

IN CANADA: Atlas Radio Corp., 560 King Street, West, Toronto, Ontario, Canada
EXPORT DEPARTMENT: C. O. Brandes, Mgr., 4900 Euclid Avenue, Cleveland 3, Ohio



WARD
Aerials

THE WARD PRODUCTS CORP.
1523 EAST 45th STREET
CLEVELAND 3, OHIO

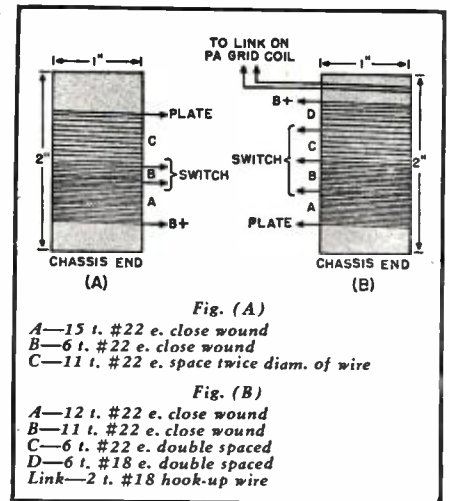

Fig. 5. Coil data. (A) Oscillator coil, L₁. (B) Buffer-multiplier coil, L₂.

sary to reduce the grid current to the rated value of 3 to 4 ma. by detuning the grid circuit of the final slightly. Approximately 8 ma. grid current can be obtained when doubling in the 6AG7 stage, and approximately 4 ma. when quadrupling.

After the tuning of the 815 grid circuit has been completed, the stage should be neutralized. Neutralization will not be found critical, and a spacing of about $\frac{3}{8}$ inch between each neutralizing plate and the tube envelope will be approximately correct. This will, of course, depend upon the individual circuit construction.

For tuning the final plate circuit, set the meter switch to read final plate current, throw switch S₁ to "Operate", and tune the final tank capacitor for minimum plate current. Resonant plate current will be 10 to 15 ma. The final can then be loaded to rated plate current of 150 ma. The final screen-grid current under loaded conditions will be approximately 15 ma.

The plate current of the modulator should be checked before beginning operation, and the bias adjusted so that the no-signal plate current is 20 ma.

When operating c.w., the key is connected between terminals 3 and 4 of the relay terminal strip on the rear of the transmitter. Switch S₂ is placed in the "Tune" position. For phone operation switch S₂ is placed in the "Operate" position. Switch S₁ controls the carrier for both c.w. and phone. With c.w. operation, S₁ in the "Send" position places the exciter stages in operation and closing the key then puts the final amplifier on the air. With phone operation S₁ puts all stages in operation.

The transmitter has been in use on the 10 meter and 80 meter bands for several months with very pleasing results. Even on 75-meter phone where the QRM is plenty had this little transmitter has stepped right out. Reports received from England averaged an S7 or better. So it is no joke—you can work out with low power.

—50—

RADIO NEWS

Don't Waste Time Figuring How to Take It Apart

PHOTOFACT*

FOLDERS

give you complete
disassembly
instructions



Do you lose valuable time discovering how to take out chassis, speakers and record changers from some of the new combinations? Are you familiar in all cases with *the proper sequence of removal*? Whenever the procedure is complicated, PHOTOFACT FOLDERS give you complete disassembly instructions—enable you to do an efficient job without damaging panels, dials, grilles or any other parts of the set. Better still, you're sure of getting them back together again in the quickest possible time.

That's not all PHOTOFACT FOLDERS do. They make it easy to diagnose trouble, locate defective parts, decide on adequate replacements and *get them in a hurry*. They do this by means of exclusive numbered photographs, full-page easy-to-read schematics, complete parts listings, record changer anal-

yses and many other helps that assist you in making *up to twice as many repairs a day*.

PHOTOFACT FOLDERS are the result of actually examining and testing the instruments covered. They are based on *original research*—not on “canned” or copied information. They cover *all* the latest radios, phonographs, record changers, recorders, communications systems and power amplifiers. Sent to you in sets of 30 to 50 folders, they cost only \$1.50 a set. This includes membership in the Howard W. Sams Institute. Actually they cost you nothing for they pay for themselves over and over again in time saved.

Over 25,000 radio service engineers use and depend on them! Give servicing worries the go-by! Spend less time, do better work—and more of it—by seeing your distributor or by using the convenient coupon.

PUBLICATION DATES

Set No. 13 . . . February 10
Set No. 14 . . . February 25

Cut this out and MAIL OR TAKE IT TO YOUR DISTRIBUTOR. If you do not know his name and address, send it directly to Howard W. Sams & Co., Inc., 2924 East Washington Street, Indianapolis 6, Indiana, and we will see that your nearest distributor gets it. In Canada, write to A. C. SIMMONDS & SONS, 301 King Street East, Toronto, Ontario. Canadian Price, \$1.75.

- Send Set No. 14 (Feb. 25)
- Send Set No. 13 (Feb. 10)
- Send Set No. 12 (Jan. 25)
- Send Set No. 11 (Jan. 10)
- Send me Volume 1 (including Sets Nos. 1 to 10) with De Luxe Binder, \$18.39. Individual Sets Nos. 1 to 10, \$1.50 each.
- Send me a De Luxe Binder (at \$3.39)

My (check) (money order) (cash) for is enclosed. (If you send cash, be sure to use registered mail.)

PLEASE PRINT

Name _____

Address _____

City _____ Zone _____ State _____

Company Name _____

My Distributor's Name _____

City _____

*Trade Mark Reg.

HOWARD W. SAMS & CO., INC. RADIO PHOTOFACT SERVICE

In Canada—write to A. C. SIMMONDS & SONS, 301 King Street East, Toronto, Ontario

We Insist on Keeping PRICES DOWN!

● Our policy has been value for high-quality merchandise . . . and, despite high prices, we adhere to our principles.



No. 55 TRANSMITTING TUBES at LOWEST PRICES EVER!

We are still doing it . . . as long as we can!
866A75c 810\$2.45
80795c 811 1.95
250TH\$7.95 813 5.95
Send for our price list on Transmitting and Spacial Purpose tubes.



No. 66 SELENIUM RECTIFIER

100 MA—for use in AC-DC sets replacing rectifiers etc. Packed 12 to a box. Minimum sale 12...ea. 90c



No. 110 U.T.C. TRANSFORMERS

No. VM3—125 Watt Mod. Transformer \$18.00
No. VM4—300 Watt Mod. Transformer 30.00
No. VM5—600 Watt Mod. Transformer 69.00



No. 88 AMATEUR SURPLUS PARTS BULLETIN

Send for new issue listing brand new and practical components. All perfect equipment from W.A.A. and at such low prices that we give all our friends the break.



No. 99 AMATRON PAMPHLET

We would like to have listed the special surplus equipment made by Amatron, but space and time did not permit. A "flash" pamphlet, listing Amatron Power Transformers, Filament Chokes and Audios is yours for the asking. Drop us a card.

TEST EQUIPMENT

RCA # 195A Volt Ohmyst	\$ 69.50
RCA # 162C Chanalyt	162.50
RCA # 167B Test Oscillator	63.75
WESTON # 697 V.O.M.	26.52
WESTON # 779 Analyzer	76.46
WESTON # 785 Circuit Tester	87.02
WESTON # 798 Mutual Conductance Tube Checker	187.09
HICKOK # 125 V.T.V.O.M.	94.95
HICKOK # 191X Microvolt Generator	145.92
HICKOK # 203 Electronic V.T.V.M	79.80
HICKOK # 288X Signal Generator	144.60
HICKOK # 534 Tube & Set Tester	138.30

25% deposit, balance C.O.D.

Please include sufficient payment for transportation. Over payment will be refunded.

Write to Dept. R-2

Standard Parts Corp.

235 MAIN ST. HEMPSTEAD, N. Y.

Parts Lists

(FOR CIRCUIT DIAGRAMS APPEARING ON PAGES 72 AND 73)

BELMONT BOULEVARD

Part No.	Code and Description
C-9B9-82	R ₅ —47,000 ohm, 1/2 w. res.
C-9B3-98	R ₄ —1 megohm, 1/2 w. res.
C-9B9-106	R ₆ , R ₇ —4.7 megohm, 1/2 w. res.
C-9B9-84	R ₆ —68,000 ohm, 1/2 w. res.
C-9B3-37	R ₁₀ —10 megohm, 1/2 w. res.
C-9B9-92	R ₁₀ , R ₁₁ —330,000 ohm, 1/2 w. res.
A-8J-10295	C ₁₁ , C ₁₂ —0.03 μfd., 150 v. cond.
A-8G-11083	C ₃ —40 μfd. cond.
A-8J-10297	C ₈ , C ₇ —01 μfd., 150 v. cond.
A-8J-10298	C ₈ —50 μfd., 150 v. cond.
A-8J-10296	C ₉ —005 μfd., 150 v. cond.
A-13G-11303	C ₁₀ , C ₁₁ —1.2 μfd., ±.2 μfd. (two wires)

CROSLY MODELS 56XTA, 56XTW

Part No.	Code and Description
AW-134994	4—Ant. coil
AW-134993	5A, 5B—Osc. coil (two sections)
AW-137495	6—First i.f. trans.
AW-134158	7—Second i.f. trans.
B-135165	9A, 9B, 9C—Variable cond.
AB-135088	10—Trimmer cond.
GC-210685-143	11—580 μfd. mica cond.
39004-5	12—50 μfd., mica cond.
39001-80	13, 19, 20, 21, 22—.02 μfd., 600 v. cond.
39001-19	14—.1 μfd., 600 v. cond.
39001-17	15—.05 μfd., 600 v. cond.
39004-9	16—220 μfd. mica cond.
39001-76	17—.003 μfd., 600 v. cond.
B-137649	18A, 18B—50/30 μfd., 150/150 v. elec. cond.
39294-11	23—Trimmer (part of item #10)
39294-17	24—470 ohm, 1/2 w. res.
39294-28	25—4700 ohm, 1/2 w. res.
39294-38	26—330,000 ohm, 1/2 w. res.
39294-27	27—15 megohm, 1/2 w. res.
39294-27	28—22,000 ohm, 1/2 w. res.
39294-34	29—220,000 ohm, 1/2 w. res.
39294-23	30—3.3 megohm, 1/2 w. res.
39294-35	31—47,000 ohm, 1/2 w. res.
39294-29	32—4.7 megohm, 1/2 w. res.
39294-8	33, 34—470,000 ohm, 1/2 w. res.
AD-137664	35, 42—150 ohm, 1/2 w. res.
W-135808	36—Speaker and trans. assembly
C-46846-6	37A, 37B, 37C—Band change sw. assembly
39015-26	38A, 38B—1 megohm vol. control and sw.
39015-9	39—Trimmer cond. (part of item #3)
	40—1200 ohm, 1 w. res.
	41—47 ohm, 1 w. res.

MAJESTIC MODELS 7C432, 7C447

Part No.	Code and Description
9-184	R ₁ —22,000 ohm, 1/2 w. res.
9-208	R ₂ —220 ohm, 1/2 w. res.
9-320	R ₅ —22,000 ohm, 1 w. res.
9-206	R ₆ —3.3 megohm, 1/2 w. res.
9-201	R ₇ —47,000 ohm, 1/2 w. res.
13-19	R ₈ —5 megohm vol. control
9-160	R ₉ —10 megohm, 1/2 w. res.
9-211	R ₉ —470,000 ohm, 1/2 w. res.
14-6	R ₁₀ —2 megohm tone control (on sw.)
9-207	R ₁₀ —470,000 ohm, 1/2 w. res.
02-83	R ₁₁ —820 ohm, 1/2 w. res.
9-169	R ₁₂ —1000 ohm, 1 w. res.
9-269	R ₁₃ —18,000 ohm, 1/4 w. res.
5-40	C ₁ —05 μfd., 200 v. cond.
6-159	C ₂ , C ₃ —47 μfd., 500 v. cond.
	C ₄ , C ₅ —Trimmers (part of tuning unit)
5-77	C ₆ —05 μfd., 600 v. cond.
5-39	C ₈ , C ₇ —Trimmers (part of T ₁)
	C ₈ —1 μfd., 200 v. cond.
	C ₉ , C ₁₀ —Trimmers (part of T ₂)
6-151	C ₁₁ , C ₁₂ —220 μfd., 500 v. cond.
19-26	C _{12A} , C _{12B} , C _{12C} —30/10/20 μfd., 400/400/25 v. elec. cond.
6-112	C ₁₃ —01 μfd., 200 v. cond.
6-132	C ₁₅ , C ₁₆ —01 μfd., 400 v. cond.
5-61	C ₁₇ —005 μfd., 600 v. cond.
5-57	C ₁₉ —01 μfd., 200 v. cond.
3-159	T ₁ —First i.f. trans.
3-160	T ₂ —Second i.f. trans.
12-27, or 12-26	T ₃ —Output trans.
2-16	T ₄ —Power trans.

GRANTLINE MODELS 500, 501

Part No.	Code and Description
C-9B1-78	R ₁ —22,000 ohm, 1/2 w. res.
C-9B1-26	R ₂ , R ₃ —150,000 ohm, 1/2 w. res.
C-9B2-63	R ₅ —1200 ohm, 1 w. res.
C-9B1-34	R ₆ —3.3 megohm, 1/2 w. res.
101196	R ₆ , S ₁ —500,000 ohm vol. control and sw.
C-9B1-35	R ₆ —4.7 megohm, 1/2 w. res.
C-9B1-42	R ₇ —22 ohm, 1/2 w. res.
C-9B1-29	R ₈ —470,000 ohm, 1/2 w. res.
C-9B1-52	R ₁₀ —150 ohm, 1/2 w. res.
C-9B2-44	R ₁₁ —33 ohm, 1 w. res.
C-8F3-6	C ₁ —47 μfd. mica cond.

124100	C ₂ , C ₃ —Ant. and osc. trimmers
108157C	C ₃ , C ₄ , T ₃ —Input i.f. coil assembly
C-8F3-11	C ₆ —330 μfd. mica cond.
C-8D-10953	C ₇ —15 μfd., 400 v. cond.
C-8D-10770	C ₈ , C ₉ —.05 μfd., 200 v. cond.
119-92	C ₁₀ , C ₁₁ —20/40 μfd., 150/150 v. elec. cond.
108157C	C ₁₂ , C ₁₃ , T ₄ —Output i.f. coil assembly
C-8F3-10	C ₁₄ —220 μfd. mica cond.
C-8D-10761	C ₁₅ , C ₁₆ —.01 μfd., 400 v. cond.
C-8D-10813	C ₁₆ —.05 μfd., 400 v. cond.
C-8F6-121	C ₁₇ —470 μfd. mica cond.
C-8D-10788	C ₁₈ —.004 μfd., 600 v. cond.
111136B	T ₁ —Antenna coil assembly
110126	T ₂ —Osc. coil assembly
B-18A-11124	T ₅ —4" PM dynamic speaker and trans.

ZENITH MODELS 4K016, 4K035

Part No.	Code and Description
63-654	R ₁ —180,000 ohm, 1/4 w. res.
63-594	R ₂ —68,000 ohm, 1/4 w. res.
63-669	R ₃ —3.9 megohm, 1/4 w. res.
63-1235 or 63-1351	R ₄ —Vol. control
63-587	R ₅ —4700 ohm, 1/4 w. res.
63-976	R ₆ —15 megohm, 1/4 w. res.
63-271	R ₇ —1 megohm, 1/4 w. res.
63-600	R ₈ —2.2 megohm, 1/4 w. res.
63-634	R ₉ —820 ohm, 1/4 w. res.
63-583	R ₁₀ —1000 ohm, 1/4 w. res.
22-1453 or 22-1454	C ₁ —Two-gang var. cond.
22-829	C ₂ —05 μfd., 200 v. cond.
22-162	C ₃ —0001 μfd., 600 v. cond.
22-196	C ₄ —01 μfd., 600 v. cond.
22-448	C ₅ —004 μfd., 600 v. cond.
22-684	C ₇ —8 μfd., 150 v. elec. cond.
	C ₈ —First i.f. trans., pri. (on T ₁)
	C ₉ —First i.f. trans., sec. (on T ₁)
	C ₁₀ —Second i.f. trans., pri. (on T ₂)
	C ₁₁ —Second i.f. trans., sec. (on T ₂)
	C ₁₂ —Broadcast osc. (on C ₁)
	C ₁₃ —Broadcast ant. (on C ₁)
S12024	L ₁ —Antenna coil
S12014	L ₂ —Osc. coil assembly
95-814	T ₁ —First i.f. trans.
95-839	T ₂ —Second i.f. trans.

AIR KING MODEL 4608A

Part No.	Code and Description
R ₁ —22 ohm, 1/2 w. res.	
R ₂ —22,000 ohm, 2 w. res.	
R ₃ —2200 ohm, 1/2 w. res.	
R ₅ —Vol. control & sw.	
R ₆ —10 megohm, 1/4 w. res.	
R ₇ —270,000 ohm, 1/2 w. res.	
R ₈ —470,000 ohm, 1/4 w. res.	
R ₉ —150 ohm, 1 w. res.	
R ₁₀ —2.2 megohm, 1/4 w. res.	
C ₁ —005 μfd., 400 v. cond.	
C ₂ , C ₃ , C ₅ , C ₆ —.05 μfd., 400 v. cond.	
C ₈ —47 μfd., 500 v. cond.	
C ₉ , C ₇ , C ₁₃ —40/40/25 μfd., 150/150/25 v. elec. cond.	
C ₆ —220 μfd., 500 v. cond.	
C ₁₀ —002 μfd., 400 v. cond.	
C ₁₁ —470 μfd., 500 v. cond.	
C ₁₂ —01 μfd., 400 v. cond.	
L ₁ —Loop aerial	
L ₂ —Osc. coil	
L ₃ —First i.f. trans.	
L ₄ —Second i.f. trans.	

NOISELESS RECEIVER CHECKING

SERVICEMEN may welcome this suggestion for cutting down the noise usually present in the service shop when several receivers are undergoing intermittent checks or routine operating tests.

In order to eliminate noise, unsolder the speaker voice coil leads and put a little pilot light socket across the transformer. Screw a small Christmas tree light bulb or a 6-volt pilot bulb in and let it wink.

Connect the signal generator in the usual manner. Turn up the volume so the lights are fairly bright, then any variation in the output will be easily discernible H.H.

→ → **NEW**
SOON...THE

The NC-173 is the wholly new product of months of post-war research, prompted by war-time advances in radio technique.

The new "Double Diode" noise limiter and the new AVC system are effective on both phone and CW. The voltage-regulated oscillator circuits are extremely stable. The frequency range includes the 6-meter amateur band. (0.54 to 31 and 48 to 56 MC.)

The NC-173 offers all the features you expect in a fine receiver. A glance at the illustration below will suggest the versatility of its adjustments and the handiness of its controls, but only a trial will prove its thoroughbred qualities. Study the advanced design of its 13-tube circuit, appraise its modern styling and challenge its performance with the toughest conditions that crowded amateur bands can offer.

Here is a receiver a man can be proud to own. See it at your dealer's within the next 30 days.

NATIONAL NC-173



Est.  1914

NATIONAL
COMPANY, INCORPORATED
Malden, Mass.

THE MOST DISTINCTIVE NAME IN RADIO COMMUNICATIONS

7 Days Free Examination

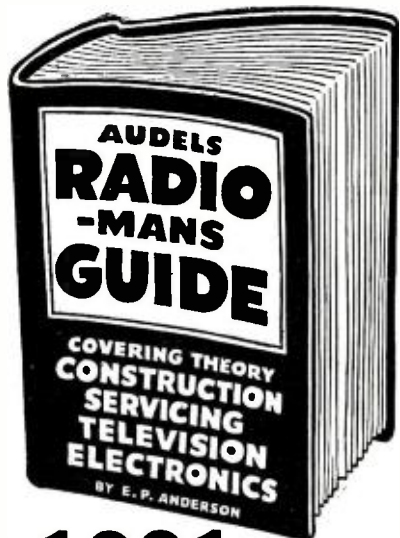

1001 RADIO FACTS AND FIGURES

AUDELS RADIOMANS GUIDE—914 Pages, 633 Illustrations, Photos, Wiring Diagrams, 38 Big Chapters, covering Radio Theory, Construction, Servicing, including Important Data on Developments in Television, Electronics and Frequency Modulation, Review Questions and Answers, Calculations & Testing. Highly Endorsed—Indispensable for Ready Reference and Home Study.

\$4 COMPLETE • PAY ONLY \$1 A MONTH
Step up your own skill with the facts and figures of your trade. Audels Mechanics Guides contain Practical Inside Trade Information in a handy form. Fully Illustrated and Easy to Understand. Highly Endorsed. Check the book you want for 7 days' Free Examination.

Send No Money. Nothing to pay postman.

CUT HERE

MAIL ORDER

AUDELS, Publishers, 49 W. 23 St., NEW YORK 10, N. Y.

Please send me postpaid for FREE EXAMINATION books marked (x) below. If I decide to keep them I agree to mail \$1 in 7 Days on each book ordered and further mail \$1 monthly on each book until I have paid Price. Otherwise, I will return them.

- RADIOMANS GUIDE, 914 Pages . . . \$4.
- ELECTRICIANS EXAMINATIONS, 250 Pages . . . 1.
- WIRING DIAGRAMS, 210 Pages . . . 1.
- ELECTRICAL DICTIONARY, 9000 Terms . . . 2.
- ELECTRICAL POWER CALCULATIONS, 425 Pgs. . . 2.
- HANDY BOOK OF ELECTRICITY, 1340 Pages . . . 4.
- ELECTRONIC DEVICES, 216 Pages . . . 2.
- ELECTRIC LIBRARY, 12 vol., 7000 Pgs., \$1.50 vol. . . 1.
- OIL BURNER GUIDE, 384 Pages . . . 4.
- REFRIGERATION & Air Conditioning, 1280 Pgs. . . 4.
- POWER PLANT ENGINEERS Guide, 1500 Pages . . . 4.
- PUMPS, Hydraulics & Air Compressors, 1658 Pgs. . . 4.
- WELDERS GUIDE, 400 Pages . . . 1.
- BLUE PRINT READING, 416 Pages . . . 2.
- SHEET METAL WORKERS Handy Book, 388 Pgs. . . 1.
- SHEET METAL PATTERN LAYOUTS, 1100 Pgs. . . 4.
- AIRCRAFT WORKER, 240 Pages . . . 2.
- MATHEMATICS & CALCULATIONS, 700 Pgs. . . 2.
- MACHINISTS Handy Book, 1600 Pages . . . 4.
- MECHANICAL Dictionary, 968 Pages . . . 4.
- AUTOMOBILE GUIDE, 1540 Pages . . . 4.
- DIESEL ENGINE MANUAL, 400 Pages . . . 2.
- MARINE ENGINEERS Handy Book, 1280 Pages . . . 4.
- SHIPFITTERS Handy Book, 272 Pages . . . 1.
- MECHANICAL DRAWING COURSE, 160 Pages . . . 1.
- MECHANICAL DRAWING & DESIGN, 480 Pgs. . . 2.
- MILLWRIGHTS & Mechanics Guide, 1200 Pgs. . . 4.
- CARPENTERS & Builders Guides (4 vols.) . . . 6.
- PLUMBERS & Steamfitters Guides (4 vols.) . . . 6.
- MASONS & Builders Guides (4 vols.) . . . 6.
- MASTER PAINTER & DECORATOR, 320 Pgs. . . 2.
- GARDENERS & GROWERS GUIDES (4 vols.) . . . 6.
- ENGINEERS and Mechanics Guides . . . 12.
- Nos. 1, 2, 3, 4, 5, 6, 7 and 8 complete . . . 1.
- Answers to Practical ENGINEERING . . . 1.
- ENGINEERS & FIREMANS EXAMINATIONS' . . . 1.

Name _____

Address _____

Occupation _____

Employed by _____ RN

Sound Recording

(Continued from page 54)

the studio. This is important if proper balance between the lower and higher frequencies is to be maintained.

When a sound is reproduced at a higher level than that of the original, the low bass frequencies will appear to be *accentuated*. If the sound is reproduced at a lower level than the original, bass frequencies will appear to be *attenuated* (suppressed) with respect to other portions of the frequency spectrum.

Noise

Noise is usually considered to be *random* sound waves with little or no periodicity. That does not completely define noise for certain "noises" are associated with certain commonplace events; for instance, the creaking of doors or gates, the clicking sound made by walking on a hard surface with leather heels, etc. The hum of an electric motor is considered noise, yet an analysis of the sound by means of an oscillogram would indicate a definite periodicity. Again it seems that the distinction between the classification of sounds is psychological in origin and relative to the observer.

The Technical Aspects of Sound

Sound is usually characterized as wave motion of which there may be three forms, namely, harmonic, periodic, and random.

Waves are propagated disturbances and may be *transverse* or *longitudinal*, depending upon the direction of the disturbance.

In a *transverse* wave, the particles of the medium vibrate in a direction perpendicular to the direction of propagation. For example, in a water wave, the individual particles of water move up and down, while the direction of wave motion is along the surface, or perpendicular to the particle motion. Thus, a water wave is a *transverse* wave.

A *longitudinal* wave is so named because the particles of the medium vibrate in a direction parallel to the direction of propagation. In a sound wave, for example, the individual particles of air move back and forth in the same direction that the wave is traveling. Thus, a sound wave is a *longitudinal* wave.

A *wavefront* may be classified as *plane* or *spherical*. Since a wave in general spreads out uniformly in all directions from its source or origin, the wavefront will be spherical close to the source. However, at some distance from the source the curvature is practically zero, and the wave is considered to be a *plane* wave. If a pebble is dropped in a still pond, circular waves will spread out in all directions, but by the time they have traveled a considerable distance, the waves will be essentially straight. Thus, a wave which starts out spher-

ical (or circular in two dimensions) eventually becomes essentially a *plane* wave.

Harmonic Motion is a wave pattern of the sine or cosine curve type as in Fig. 4A. All harmonic motion can be described by an equation of the form:

$$y = A \sin \omega t$$

where: y = displacement of the disturbance, A = maximum displacement (which occurs at 90° and 270°), ω = circular frequency (to be defined in detail) in degrees per second, t = time after disturbance is initiated.

Periodic Motion is a wave pattern compounded from two or more harmonic motions of different frequencies as in Fig. 4B. Periodic motions are analyzed by determining the various harmonic components. The character of any periodic motion is controlled by the number and magnitude of its various harmonic components.

Random Motion is a conglomeration of harmonic motions exhibiting little or no periodicity. Speech, squeaks, scraping, etc., all produce random motion unless they are sustained for long periods. The number of harmonic components is so great and their duration is so irregular as to make the harmonic analysis of random motion a practical impossibility. A typical wave pattern of random motion is shown in Fig. 4C.

Harmonic and periodic motions have certain defining characteristics which must be considered. These are:

Cycle, which is a sequence of events or motions that recur in exactly the same order in certain time intervals. For example, the motion of a pendulum started from one side, allowed to swing to the opposite and back to the starting side, comprises one complete cycle. This is illustrated in Fig. 4D.

Period is the time required for the motion to complete one set of recurring values, or one cycle. It is usually defined by the symbol T .

Frequency is the rate at which the cycles recur and is usually presented in one of two ways. If the frequency is given as ω , it is known as the circular frequency and has the dimensions, radians per second. The frequency may also be given as cycles per second or the symbol f in which case it is connected to the circular frequency by the relation: $f = \omega/2\pi$

Wavelength is the distance between two corresponding points on harmonic or periodic waves (Fig. 4A) and is denoted by the symbol λ .

Fundamental Frequency is the low-

Fig. 6. Diagram illustrates section of a piano keyboard and shows tempered scale for one octave on each side of middle C.

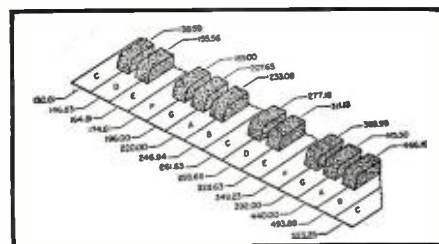

RHS TELEVISION-SCOPE-POWER EQUIP'T

BUILD YOUR OWN HIGH-SPEED PHOTO FLASH

As described in Dec., 1946, issue of Radio News (page 52). COMPLETE with Diagram, Parts, Wire, and Flash Tube (Amglo 51Q4X). SPECIAL.....\$49.95

OSCILLOSCOPE KIT

- 5CPI Cathode ray tube.....ea. \$6.95
 - Socket for 5CPI....." 1.98
 - Anode button for 5CPI....." .35
 - 2X2A Rectifier tube....." 1.25
 - Plate cap for 2X2A ceramic....." .25
 - Socket for 2X2A ceramic....." .20
 - Xformer, 1600v at 4ma., 700v ct at 150ma., 6.3v at 8A. 115v 60 cyc....." 8.50
 - Condenser, oil 5-2000v....." 2.10
- ORDER SEPARATE OR COMPLETE KIT.....Special \$16.95

OIL CONDENSERS

- | | |
|------------------------|---------------------------|
| 1 mfd. 600v.....\$0.35 | 1 mfd. 2000v...\$0.95 |
| 2 mfd. 600v......60 | 2 mfd. 2000v... 2.10 |
| 4 mfd. 600v......75 | 3 mfd. 2000v... 2.95 |
| 8 mfd. 600v..... 1.10 | 4 mfd. 2000v... 3.95 |
| 10 mfd. 600v... 1.40 | 10 mfd. 2000v... 6.95 |
| 1 mfd. 1000v... .90 | .05 mfd. 3000v... 1.95 |
| 2 mfd. 1000v... 1.05 | .25 mfd. 3000v... 2.95 |
| 4 mfd. 1000v... 1.10 | 1 mfd. 3000v... 3.50 |
| 8 mfd. 1000v... 2.00 | 1 mfd. 5000v... 6.85 |
| 10 mfd. 1000v... 2.40 | 2 mfd. 4000v... 7.60 |
| 15 mfd. 1000v... 2.60 | .1 mfd. 7000v... 3.95 |
| 25 mfd. 1000v... 5.95 | 1 mfd. 9000v... 14.95 |
| 24 mfd. 1500v... 6.95 | .0056 mfd. 9000v... 14.95 |

ANTENNA REFLECTORS

for Collinear & Corner Reflector Antennas

Get more DX—Directionalize your antenna. 31"x60" rigid screen reflector and 3/4 tubing frame.....\$4.95
Order two for Corner Reflector antenna.

WESTON SENSITROL RELAYS

110V—A.C. Reset—Model 705
0-500 Microamps.
0-50 Microamps.
2-0-2 Microamps.

SPECIAL—YOUR CHOICE.....\$12.95

RELAYS

Sigma #4RJ 2000 ohms SPDT. Can adjust to less than 1ma.....\$1.98

HIGH CAPACITY CONDENSERS

- 2400 mfd.—50WVDC.....\$1.95
- 4000 mfd.—18WVDC..... 1.95
- 4000 mfd.—30WVDC..... 2.95
- 1000 mfd.—15WVDC..... .99

TUBES (Brand New) ARMY-NAVY INSPECTED

1E7G	\$.125	836	\$.295
2A11	4.95	837	3.75
2C40	3.95	828A	3.99
2D21	1.50	838	3.95
2V3G	1.75	841	1.75
2I1	6.95	861	89.95
3AP1	5.95	866	.99
3BP1	6.95	872A	2.75
311	6.95	814	7.95
5BP1	6.95	884	1.50
5BP4	6.95	885	1.50
6AB7	1.25	8003	9.95
6AC7	.95	8005	4.95
6AG5	1.10	8016	1.95
6AG7	1.25	8025A	4.95
6AJ5	1.98	91P1	14.95
6AK5	1.60	954	.99
6AL5	.99	955	.99
6AR6	1.29	956	.99
6AS6	1.29	957	.99
6AS7	1.29	9001	1.19
6C4	.75	9002	.99
6C5	.90	9003	.99
6F6	.99	9004	.99
6J4	2.25	9005	1.10
6J5	.90	9006	1.15
6J6	.99	15E	4.95
6L6	1.59	1619	.99
6Q4	1.25	1625	.89
6SL7	.99	1626	.89
6SN7	.99	250TH	14.95
6V6	1.19	2050	1.50
6SH7	.89	2051	1.50
7A4	1.45	257B/8001	
801	2.30		14.95
802	1.15	28D7	1.95
803	9.95	30	.89
804	8.95	35T	3.50
805	5.50	304TH	16.95
807	1.05	726A/C	7.50
809	2.25	100TH	7.95
810	3.55	1N21	.49
811	2.95	1N23	.49
813	7.95	2C26A	.99
815	3.95	3E29	3.75
VR90/30	.99	CK1006	1.98
VR105/30	.99	HF200	14.95
VR150/30	.99	HK24G	1.49

VT 127A. 3.00

3 1/2 KILOWATT TUBE (New) JAN-128A (Federal). SPECIAL.....\$75.00

MODULATION XFORMER Government Rating

40 watt audio (Westinghouse). Separate plate and screen windings. Z ratio 3:1—can use push-pull 803's, 100TH's 813's, HK254's. SPECIAL.....\$24.95

POWER SUPPLY FOR MARK 1-11-111 BC-19 OR OTHER EQUIPMENT

12 Amp-12v D.C. from 110v A.C. Unnecessary to tear set apart. Leave set portable. COMPLETE READY TO PLUG IN.....\$32.50

SELENIUM RECTIFIERS Full Wave Bridge Types

Input	Output		
18v ac...	12v dc	5-Amp...	\$4.95
18v ac...	12v dc	10-Amp...	7.95
18v ac...	12v dc	15-Amp...	10.95
18v ac...	12v dc	30-Amp...	16.95
36v ac...	28v dc	5-Amp...	7.95
36v ac...	28v dc	10-Amp...	13.95
36v ac...	28v dc	15-Amp...	19.95

Federal's New Midget Selenium Immediate Delivery 1.60

CARBON PILE REGULATOR

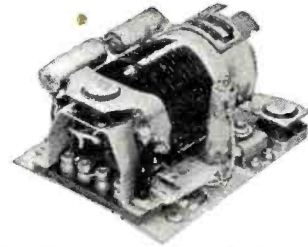

115V, 60 Cycles, 500 Watt LOAD, 750 W. AIR BLAST. Uniform voltage to all equipment at any load to 500 watts. Regulates voltages to test bench and sets under test. Line voltage regulator for output of gas driven generators. Regulates line voltage from outlets in the average home. Used in rural areas where line voltage surges. Excellent Buy at.....\$14.95

TRANSFORMERS—115v ac 60 cyc Hi-Voltage Insulation

6500v at 4 ma.....	\$ 9.95
6000v at 2 ma.....	7.95
3950v at 4 ma, tap at 1250v-1 ma.....	7.50
3710v at 10 ma.; 2.5v at 3A; 2.5v at 3A.....	9.95
2500v at 10 ma.....	6.50
2100v at 10 ma.....	6.50
4000v at 2 ma.....	6.50
442-0-442v at 1000 ma.....	9.95
2.5v at 10 amps.....	3.25
6.3v at 6.6 amps.....	3.25
6.3v at 21.5 am.; 2.5 at 2 amp.; 6.3 at 2 amp.....	6.95
2.5v at 3 amp.....	3.95
5v at 115 amp.....	14.95
5v at 190 amp.....	17.50

FILTER CHOKES—HI-VOLTAGE INSULATION

12 Hy.—100 ma.....	\$2.35	12 Hy.—300 ma.....	\$3.95
4 Hy.—250 ma.....	3.95	15 Hy.—30 ma.....	1.95
10 Hy.—150 ma.....	3.95	20 Hy.—90 ma.....	2.25
4 Hy.—600 ma.....	5.95	75 Hy.—8 ma.....	1.95

JOHNSON TUNING CONDENSERS

200FD20.....	\$3.95
250F20.....	2.39
250E30.....	2.39

PORTABLE FM XMITTER

Freq. range 72-82 MC. Easily Doubled to 2 Meters. Complete Brand New with diagram, 5 tubes, microphone, and collapsible antenna. Special—(less batteries).....\$17.50

VIBRATOR POWER SUPPLY VOLTAGE REGULATED

6v or 12v dc Input. Delivers: 1.5vdc at 700ma; 1.5vdc at 700 ma; 7.5vdc at 300 ma; 90vdc at 45ma; 90vdc at 25 ma; 150vdc at 45ma. COMPLETE with VR90/30; CK1005; & Vibrator.....\$14.95

MICA CONDENSERS, SANGAMO

.001-20,000v.....	\$9.95	.004-8000v.....	\$2.25
.0005-20,000v.....	9.95	.002-8000v.....	2.25
.005-8000v.....	2.25	.006-6000v.....	1.95
.0025-8000v.....	2.25	.007-5000v.....	1.75
.005-8000v.....	2.25	.003-8000v.....	2.25

NATIONAL DRIVE UNIT ONLY

PW-0 or NPW-0.....\$2.95

All material is new and guaranteed, unless otherwise specified.

No mail orders for less than \$2.50—20% deposit required with all orders.

RADIO HAM SHACK Inc.
63 DEY STREET • NEW YORK 7, N. Y.

LEOTONE MONTHLY SPECIALS

- ### SERVICEMEN'S KITS
- #1-R.F. Antenna & Osc. coils: 10 asstd. \$0.98
 - #2-Speaker Cones; 12 asstd. 4" to 12" moulded & free-edge (magnetic incl.). Less voice coil. CONDENSERS: 50 asstd. .00001 to .2mfd. 200-600WV Clearly marked. .2.00
 - #3-Tubular By-Pass Condensers; 50 asstd. .001 to .25mfd 200-600 Standard brands. .2.49
 - #4-Dial Scales; 25 asstd. airplane & slide-rule (acetate & glass included). .2.98
 - #5-Escutcheon Plates; 25 asstd. airplane slide-rule & full vision type. .2.98
 - #6-Knob; 25 asstd. wood & bakelite, including setcrew & push-on types. .1.00
 - #7-Wafer Sockets; 12 asstd. to 7 prong .25, 50 for. .1.00
 - #8-Voltage Dividers; 10 asstd. standard multi-tapped High Wattage included. .1.98
 - #9-Shield Cans; 15 asstd. for tubes, coils, transformers, etc. .1.00
 - #10-Mica Sadders & Trimmers; 15 asstd. incl. multiple & ceramic base types. .69
 - #11-Volume & Tone Controls; 10 asstd. wire-wound & carbon. Less switches. .1.49
 - #12-Wire-Wound Resistors; 15 asstd. ohmages 5 to 20 watts. .98
 - #13-1 P. Coils; 6 asstd. including shielded & slug tuned Peaks unmarked. .1.95
 - #14-Dial Windows; 12 asstd. sizes incl. flat & moulded acetate and convex glass. .1.29
 - #15-Bakelite Coil Forms; 18 asstd. Popular sizes up to 3" Diameter. .98
 - #16-High Resistance Units; 25 asstd. carbon, ferrule-ended. 50,000 to 5 megohms. .49

RADIO HARDWARE TREASURE. Over 1000 screws, nuts, washers, lugs, etc. PLUS handy 36 compartment cardboard kit box. \$0.59

TUBES: Perfect condition, but NOT in sealed cartons. Guaranteed for 90 days. #26, 27, or 56-22; #24 or 75; #27, #18, #9, #6D, #6B, or #6K7-39; #50, #6A3, #6AB, or #6F5. \$5.95

- Brand New R.C.A. UX-200 tubes in sealed cartons (triode detector), 8 for. \$1.00
- Phono Scratch Filler Transformer (7/8"x1 1/2"x9/16") with hookup diagram showing alternate use in UHF Quench Osc. circuit. .39
- EXPERIMENTAL TUBES. 20 asstd. sizes & base types for testing, research, etc. Fully tested. \$1.00
- Victor Power Transformers for models R-32, 43, 52, or 75 Unshielded. \$5.95

!!! Surplus Specials!!!

- DYNAMOTORS (Navy BY.9/ARC-1) DC input: 26V. DC output: 360V. #333ms. Black crackle finish, mtg. base. 3 1/2"x3 1/2". \$3.95
- DPDT TOGGLE SWITCHES (H&H), external lugs. 6A/125V. Bakelite case, split ball. .39
- 2 conductor transmission cable. Flexible twist ed. stranded, tinned rubber covered. Ideal for communications. 1 A. or high electrical work. 3c ft.: 250 ft. \$5.00

16" N.B.C. RECORDINGS; for home. P.A. systems, demonstration, etc. Each contains 2 complete different 15 min. "Voice of the Army" dramatic programs with music. Over 60 different titles, such as: Wings of Paradise, V-E Day, Combat Dog, etc. 3 1/3" 5 asstd. records. \$1.49

- Weston #301, 0-50 Voltmeter (modulation) A.C. rectifier, 1000 ohms per volt. 3" bakelite. \$3.95
- SEL-SYN 5G SYNCHRO-TRANSMITTERS; 115V; 60 cycle. Brand new. Operate in pairs as trans. & follower. 3 1/2"x5". Per pair (shpg. wt. 12 lbs.). \$10.49
- 4 TUBE AMPLIFIER (2-7C5, 7B7, 7Y4). Used as electronic supercharger control 110V, 400 cycle. Contains: power trans., 7 condensers (mica & oil), 7 resistors, 4 local sockets plus other components worth several times the price. Black crackle finish case; slide-in chassis. 8 1/2"x4 1/2"x3 1/2". 1.49
- EARPHONE HEADBANDS (HS-33). Leather covered; adj. 7 resistors. With PL-54 & double phone cord. .39
- PL-54 plug & 13" tipped dble. phone cord. .19

ALNICO MAGNETS

- #1-1 Bar, 3 1/4"x1 1/2"x1 1/2". \$0.39
- #2-1 Bar in shorter lengths. .12
- #3-Face 1 1/4"x1 3/4"x3/8" high. .98
- #4-Heavy duty bar, 2 1/2"x1 1/2"x5/16". .98
- #5-Face 3/4"x5/8"x3/8" high. .39
- #6-Polished, face 7/8"x9/16"x3/8" high. .35
- #7-Polished bar, 9/16"x1 1/2"x1/8". 20 for. \$1.00
- #8-Face 1/2"x1/2"x3/8" high. .10
- #9-ALNICO V, h'shoe, poles 3/8" sq.; 1 1/2" high. .75
- #10-ALNICO V, h'shoe, poles 9/16" sq.; 1 1/2" high. .98
- #11-ALNICO V, h'shoe, poles 1"x1 1/2". 5.95
- #12-Horseshoe, ea. pole 1 1/16" O.D.; 2 1/2" high. .29
- #13-Similar to #12; 3/4"x3/8"x7/16". .35
- #14-Finished, hv. duty bar; 3"x1 1/2"x 1/8" Magnetized lengthwise, wide or narrow sides. 1.29

PROMPT SERVICE ON ALL SPEAKERS & PHONO PICKUP REPAIRS. Minimum Order \$2.00-20% Deposit Required on All Orders. Please Add Sufficient Postage. WRITE DEPT. RN-3.

LEOTONE RADIO CO.
MAKERS OF CONES AND FIELD COILS
65-67 DEY STREET NEW YORK 7, N.Y.
WORTH 2-0284-5
12,000 SQ. FT. OF RADIO PARTS

est component frequency of a periodic wave motion.

Harmonic Frequency or overtone, when applied to music, is that component of a periodic wave motion whose frequency is an integral multiple of the fundamental frequency.

Sub-Harmonic Frequency is that component of a periodic wave whose frequency is an integral submultiple of the fundamental frequency.

An *Octave* is the interval between two waves whose frequencies are in the ratio of 1:2.

Each of these above four terms is illustrated in Fig. 4E.

Behavior of Sound Waves

From a purely physical concept, sound can be considered as an alteration in pressure, displacement of particles, or the velocity of particles in elastic media. These pressure or velocity changes are produced by a *transducer*, which is an electro-mechanical or electro-acoustic system for converting electrical vibrations into mechanical or acoustical vibrations respectively. Microphones and loudspeakers are typical transducers as is the sounding diaphragm of Fig. 2. The motivating source for the diaphragm can be mechanical (as shown) or electrical as in the case of a loudspeaker. Since sound is a particular type of wave motion, it becomes desirable to consider particular behavior of waves.

1. If two harmonic waves pass through the same point while vibrating at the same frequency, the resultant wave formed by adding the displacements will also be a harmonic wave.

2. Conversely, any harmonic wave can be resolved into a number of component harmonic waves. This principle is covered by *Fourier's Theorem*.

3. If two harmonic waves start at the same point and experience similar displacements at the same time, they are said to be *in phase* with each other. However, if one wave lags or leads the other, then they are said to be *out of phase* (Fig. 3B). It is customary to denote phase difference in angular units as that part of 360 degrees or 2π radian.

Almost everyone has witnessed some example of wave interference. For instance, in Fig. 3A, the component waves (both are identical and appear as one) form a harmonic wave at twice the original amplitude. This is said to be *constructive interference*. In Fig. 3B the component waves are of the same frequency and amplitude but 180 degrees out of phase, and therefore, cancel each other in what is called *destructive interference*. The resulting wave caused by the superposition of two waves of almost, but not quite the same frequency as in Fig. 3C has the characteristic of *beats*, i.e. alternate periods of constructive and destructive interference. Beat phenomena are particularly important in their application to superheterodyne reception.

When two identical waves travel with the same speed but in opposite

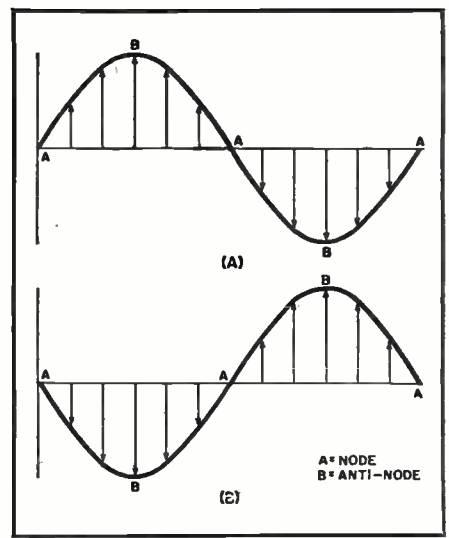

Fig. 7. Illustrates displacement of waves.

directions, the resulting wave is known as a stationary or *standing wave*. While there is no translational motion, the vibratory displacements persist. The displacements are of equal magnitudes for distances one-half wavelength apart and the wave takes the form shown in Fig. 7A at some particular time and then reverses as shown in Fig. 7B. As can be seen from the figure, certain portions of the wave experience little or no displacement. The points of maximum displacement are called *anti-nodal points* or *loops* and the points of zero displacement are called *nodal points*. Standing waves are of great importance in the theory of antenna design.

The Speed of Sound

The speed of sound in any medium is a function of the density and elastic qualities of the medium.

The variation of the speed of sound with temperature is expressed by the formula:

$$v_t = v_0 \sqrt{1 + \frac{t}{273}}$$

where:

- v_t = velocity at temperature t
- v_0 = standard velocity at 0°C
- t = temperature in degrees C

The speed of sound in air at one atmosphere pressure at 0°C is approximately 1088 ft/sec. while at 100 atmospheres the speed of sound is 1150 ft/sec.

Pitch and Intensity

The pitch of a sound is best characterized by its frequency, except for certain psychological effects. The audible range is known to be between 16 and 20,000 cycles per second, but the average ear does not hear below 30 cycles per second nor above 16,000 cycles. However the pitch, as received by the human ear, is not a direct function of the frequency and varies with the intensity. This effect has been investigated in considerable detail by Fletcher.¹

¹ Fletcher, H. "Speech and Hearing," D. Van Nostrand, New York, 1929.

NEW

Simpson Model 305RC Tube-Tester with "No Backlash"* Roll Chart



With the addition of the new Simpson "No Backlash"* Roll Chart to the 1947 version of our Model 305, this famous instrument becomes beyond question the finest tube-tester on the market in its price range. Read the description of this new Roll Chart in the panel below.

Model 305RC provides for filament voltages from .5 volts to and including 120 volts. It tests local, single ended tubes, bantams, midjets, miniatures, ballast tubes, gaseous rectifiers, acorn tubes, Christmas tree bulbs, and all popular radio receiver tubes.

Like other Simpson tube-testers, the Model 305RC incorporates 3-way switching which makes it possible to test any tube regardless of its base connections or the internal connections of its elements. This method, the result of exhaustive research and expensive construction, protects the Model 305RC against obsolescence to a degree not enjoyed by competitive testers. No adapters or special sockets are required. In addition to having a complete set of sockets for every tube now on the market, this tester has a spare socket, to provide for future tube developments.

The Model 305RC has provision for testing pilot lamps of various voltages as well as Christmas tree bulbs. It tests gaseous rectifiers of the OZ4 type—also tests ballast tubes direct in socket for burnouts and opens. Has neon bulb of proper sensitivity for checking shorts. This tube-tester is fused, and has the latest improved circuit. It provides for line adjustment from 100 to 130 volts, with smooth vernier control.

Model 305RC is distinguished for its beautiful exterior. It has a two-tone metal panel in red and black on a satin-finished background. Sockets and controls are symmetrically arranged for quick operation. The large, modern, fan-shaped instrument has an exceptionally long scale. It has "good" and "bad" English markings, also a percentage scale for matching and comparing tubes. Cases, both portable† and counter style, are made of strongly built hardwood, durably and beautifully finished.

Size, 11"x11"x6". Wt. 10 lbs. Shipping wt., 15 lbs.
Dealer's net price, portable or counter model.....\$59.50
For 60 cycle 115 volt current only.

For 220 volt or 60 cycle, add..... 7.50
Standard Model 305, with book-type speed chart 49.50

Counter Model 305RC. Same instrument as portable model, but set in fine walnut finished hardwood case, with tilted, easy-to-use panel.

†Finished hardwood cases are standard on portable models. When these are not available, the instrument is housed in attractive simulated-leather covered case.

SIMPSON ELECTRIC COMPANY
5200-5218 W. Kinzie Street, Chicago 44, Illinois
In Canada, Bach-Simpson, Ltd., London, Ont.

* 6 Exclusive Features Make This the Finest Roll Chart Ever Designed for Tube-Testers

- "No Backlash" feature of this Roll Chart automatically takes up all slack in the paper chart and, by keeping it in constant tension, makes it impossible to turn the selector wheel without turning chart. Gives precision selection at all times. Also prevents chart from tearing or getting out of alignment.
- Gearing is such that only 6 turns of selector wheel will run the entire length of the 12½ ft. chart.
- Easy to read. The clear Lucite window is just wide enough to show 2 tube settings, or both settings on a multi-purpose tube.
- Entire unit removable by taking out four screws. Just lift from receptacle to make new entries or install new chart.
- Chart ingeniously fastened to rollers, affording easy replacement and constant alignment.
- Rigid, light-weight construction. Gear driving mechanism incorporates heavy-duty precision brass gears and parts.



Simpson

INSTRUMENTS THAT STAY ACCURATE

While intensity is popularly considered to be synonymous with loudness, a distinct difference exists between the two. The former is a pure physical quantity while the latter is psychological in origin. In a strict physical sense, intensity is defined as the average rate of flow of energy per unit area in a direction normal to the rate of flow. It is expressed by the formula:

$$I = \frac{1}{2} \frac{(p_{max})^2}{\rho_0 c}$$

where p_{max} = the maximum pressure developed above the steady pressure for no disturbance, c = wave velocity, ρ_0 = medium density, I = intensity in watts/sq. cm.

The equation may also be written in the form:

$$I = \frac{1}{2} \rho_0 c \omega^2 d_{max}^2$$

where d_{max} = maximum displacement and ω = circular frequency = $2\pi f$.

For acoustic measurements, the choice of the equation depends on whether the recording instruments respond to pressure or displacement variations.

Current practice now employs the decibel as a relative measure of intensity. The bel (so named after Alexander Graham Bell) is defined as follows:

$$b = \log_{10} \frac{I_1}{I_2}$$

where I_1 and I_2 are the absolute intensities.

The bel is a large unit, an intensity ratio of 10 to 1 being equivalent to only 1 bel. This would mean dealing with rather small numbers, so it is customary to use the decibel, which is one tenth of a bel. Thus the numbers with which we deal are 10 times as large when speaking of decibels as they are when speaking of bels. To convert to decibels, the value in bels must be multiplied by 10. Thus:

$$\text{db.} = 10 \log_{10} \frac{I_1}{I_2}$$

An intensity ratio of 10 to 1 would thus be equivalent to 10 db., and 3 db. would be equivalent to an intensity ratio of 2 to 1.

On the other hand, the loudness of a tone is a function of its frequency and intensity and can be defined as the magnitude or stimulus it creates in the auditory system. This implies a relative measure of loudness and some reference level must be established for comparison. The tone emitted at 1000 cycles at 0 db. is taken as this level and the loudness of any particular tone is determined by adjusting the reference tone until it sounds as loud as the one being tested. The increase in intensity of the reference tone is interpreted in terms of loudness units. Fletcher and Munson have done much work along this line and their results have been published in the "Journal of the Acoustical Society of America."

Obviously, a certain amount of human error is bound to be injected into such measurements, however, correlation by statistical methods has yielded some very valuable information.

The db. meter used for measuring sound levels has a scale which is usually calibrated from -10 to +6 db. This type of meter is usually calibrated for use across an impedance load of 500 ohms and is actually a voltmeter of the rectifier type. Many systems do not standardize on 500 ohm lines and there are many occasions when it is desirable to use a standard meter across voice coils of speakers, etc. having different impedances.

Fig. 5 shows how such meters may be used across loads of from 2 to 4000 ohms. For example, reference to the table in Fig. 5 will show that if a 500 ohm meter is used across a speaker voice coil of 8 ohms, 18 db. must be added to the meter reading.

Multipliers are needed, as with any other voltmeter, if an additional range over +6 db. is desired. For average meters, the resistance required will be approximately 5000 ohms-per-volt.

In the transmission and reproduction of sound, consideration must be given to the human ear as a transducer (here the sound waves are transformed into a stimulus for the auditory system.) The ear exhibits certain non-linear characteristics which affect the fidelity with which sounds are received. For instance,

(Continued on page 157)



NEW NAVY DYNAMOTORS EICOR DC, GTD overseas packed. 4V insp HI eff. CONT. duty. Input 12V/4A or 24V/2A output 500V/50ma; Input 275V/110 ma & 12V/3A. Either UNIT \$1.95 or both units (2) & filter \$3.49. Wgt. 9 lbs., 7 1/4" L x 2 1/4" H x 1 1/4" W. Adaptable to 6V operation. Alnico Field.

WE BEACHMASTER INPT & PP DRIVER TRANSF 6V6/805's \$ 6.95

THERMADOR TRANSF CASED S.C. CONT DUTY. PRI 200 to 440V/50-60cy; SEC 8800VCT/6KV 2.7Amps 45.00

Collins choke 6Hy/1.2amp/30ohm/12500V wkg... 16.00

Bendix 1339 Model I Voltage Regulator 115V... 3.75

Condr GE Pyranol 15mfd/330VAC/1000WVDC... 2.95

Condr GE 4 section 28mfd/660VAC/2000WVDC... 9.90

Electrolytic CD-20/20mfd-450VDC @ 85. Two for 1.50

Condr GE Pyranol 1mfd/500WVDC, 3 for... 1.00

STANCOR 6.4V/12A; 6.4V/10.6A; 5V/3A; 5V3A HV ins. 4.95

"TAB"

That's a Buy



New Remote Control Unit RM-53 (RC-261)

For force operation of transmitter distances up to 1/2 mile from radio set. Complete with manual. Contains PL55 & PL68 cords & plugs. jacks M A l l o r y 4PDT switch. Two 4mfd oil condens. Transformer multi-tap UTC-600ohm CT line to G. line to 150 or 250ohms. KURMAN sensitive 4MA Relay DP one normally open, other closed. Toggle switch; bushings & waterproof box.

\$3.49

"TAB" SPECIAL WITH T17 CARBON MICROPHONE \$5.25

4 1/2%	8 1/2%	110% (REST 1%)
1500	2000	4000
5000	5100	7500
10000	15000	17000
50000	100000	130000
140000	147000	168750
229000	250000	850000

"TAB" SPECIAL 3 for \$1.00

PRECISION WIRE WOUND RESISTORS. ICR, SHALLCROSS, MEPCO, INST. RES. CO., OHMITE FOR METERS, BRIDGES, AMPLIFIERS.

25000 284000 314000 333500

38300 40000 402000 422000

458000 478000 3 for \$1.50

500000 600000 700000 3 for 1.95

1MEOPHM 1% accy 3 for 2.45

SPRAGUE 10Mv 10KV MEGOMAX MFA1 \$1.75

SPRAGUE 12Mv 12KV MEGOMAX MFA1 1.95

IRC WW1/4 of 1% Hmctally Sealed Navy Resistors (\$24) 1.69

WRITE FOR OTHER SIZES FROM STOCK

STANCOR 335VCT/323ma & 450V/325ma; 115V/60C PRI \$4.50

CHOK 50Hy/125ma cased mferred GHT 2.50

Transf. 10V/25A; 2.5V/3A; 77V/7ma; 115V/60C. Raytheon cased 840VCT/110ma; 540VCT/21ma; 5V/3A; 5V/3A; 6.3V/1A; 6.3V/.6A; 115V/60cy Pri & Two 10V/10ma Hmctly cased Chokes & Oil Condr Two 2.5 & 5mfd/600WVDC 8.95

Hmctly cased choke 10Hy/150ma. Two for 3.25



NEW SELSYNS TYPE XXI AC SYNCHRONOUS 115V

60cy—Made for Gunfire control. Guaranteed Ordnance Insp. Hi-accuracy. Continuous duty. Packed for overseas shipment, complete with Insp. Calibration report.

Per pair **\$7.95**

GR VARIAC 200CU/880W/with Dial & K. \$14.95

GR VARIAC 200B/170W new S. C. 9.95

SYLVANIA GERMANIUM CRYSTALS IN34. 1.39

TBY NEW VIBRAPACK & storage battery will last 47/40AH; output 1.6V/30ma; 3V 375ma; 1.5V/200ma; 1.5V/200ma. 9.95

WE DYNAMIC MIKE & 20' CORD 9.95

KENYON DYNAMIC MIKE TO G TRANS. 1.95

TRANSF L to L/500; 333; 250; 200; 125; 50 ohms + 1DB 1.95

TRANSF CASED PRI 105 to 250V/50-60cy; Sec 2240VCT 800ma; 12V/4.5A; 19.2V/2.5A; 2.5V/10A 11.50

ANTENNA A-27 (PHANTOM)

New in metal box with calibration card 2 to 4.5mc's; useable as dummy antenna load frequencies to 28mc's contains Variable Xmitting Cardwell or Millen Type 12515 condenser 18 to 175mmf (\$7.50) Easily converted to Split Stator & 2 Ward Leonard plague resist Non Incl 12ohm/40watt incl. Manual & Spare leads.

SPECIAL \$1.95



IF YOU DON'T SEE IT—WRITE FOR IT

Crystals IN21, 22, 23, 25 GTD 4 for \$1.50

Condr oil 20 mfd/600WVDC (1-2-4-5-8mfd) 1.50

LS-3 Perm Mag 6" hvy duty Spkrs (LN) 4.95

\$2 Min. order FOB N.Y.C. Add Postage all orders and 25% deposit. Worth 2-7230. Send for catalog 300. Specialists in International Export. School. College & Industrial trade. Money Back Guarantee.

"TAB" • DEPT. RN3, 6 CHURCH ST., NEW YORK 6, N. Y., U. S. A. • "TAB"

Corner Church and Liberty Streets, Room 200

RADIO DIAGRAMS

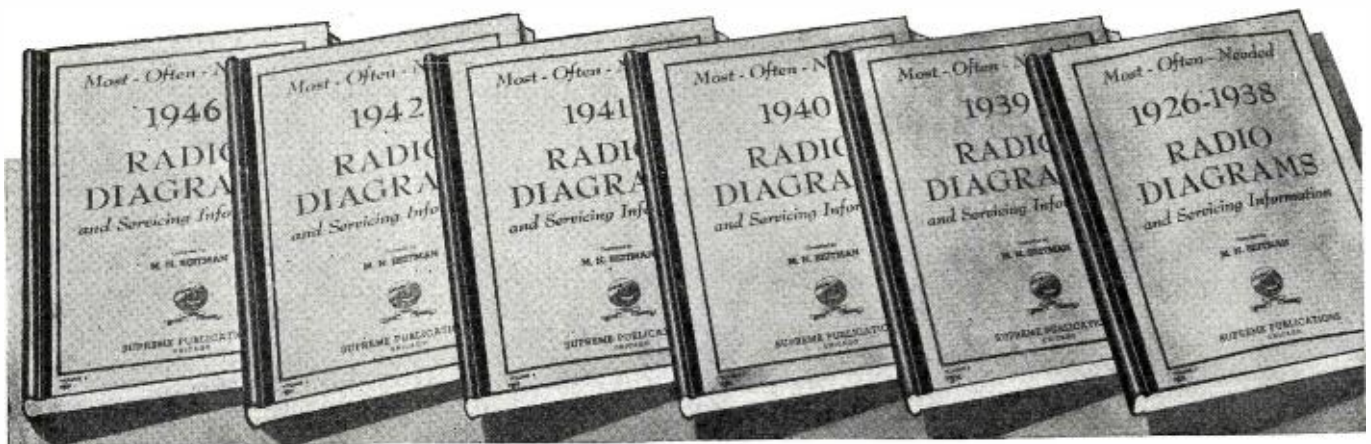

Covering 1946, 1942, 1941, 1940, 1939,] [1926-1938
 Each manual contains between 192 and 240 pages. Price each \$2.00] [This volume \$2.50

LEARN RADIO
 Home-Study Radio Course
 ONLY \$2.50 COMPLETE

Let this 22-lesson course help you fix and adjust any radio set. Easy-to-understand explanations; hundreds of simplified diagrams, pictures, practical hints. Quickly learn how to make needed tests, locate faults, complete the repair. Includes many lessons for beginners.

MANY ADVANCE LESSONS

Learn new speed-tricks of radio fault finding, case histories of common troubles, servicing short cuts, extra profit ideas. Many large lessons on the use of regular test equipment, explanation of signal tracing, television to the minute, recording dope. With this information you will save enough time on a single radio job to pay the special \$2.50 price for the complete course of 22 money-making lessons. Many active servicemen used this reduced price radio training for brush-up and study of new service methods. Reprinted in 1946 with information on signal-tracing, television, visual alignment, P.A., photocells, etc. All about AVC, how to use an oscilloscope, what is feedback, resonance action, and every other fact you must know to be more expert in your work. Large size: 8½x11 inches, 224 pages and index. **\$2.50**
 Order without any risk. Price only.....



Compiled by M. N. Beirman, radio engineer, teacher, author, and serviceman.

You can simplify and speed up all radio repairs with SUPREME PUBLICATIONS manuals. Service radios faster, better, easier, save money and time, use these most-often-needed diagram manuals to get ahead in radio servicing. At unbelievable low cost (only \$2 for most volumes) you are assured of having in your shop

and on the job, needed diagrams and essential repair data on 4 out of 5 sets you will ever service. Every popular radio of every make, from old-timers to new 1946 sets, is included. Clearly printed circuits, parts lists, alignment data, service hints are the facts you need to improve your servicing ability. Save hours each day, every day, let these six volumes furnish diagrams for 80% of all sets. See picture of these attractive manuals above. Each volume has between 192 and 240 pages, large size: 8½ x 11 inches, each with index. Manual style binding. Send coupon today. Satisfaction guaranteed.

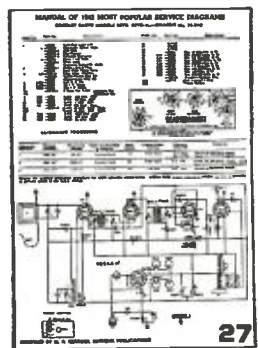

Actual Page size 8½x11"

Most Popular Models Made by:

R. C. A., Zenith, Philco, Sears, Fada, Emerson, Belmont, Detrola Radio, Majestic, United Motors, G.E., Westinghouse, Arvin, Stewart-Warner, Admiral, Delco, Stromberg-Carlson, Western Auto, Wards, Sparton, Motorola, Gamble, and many others.

FIX ANY RADIO

Amazing New Invention



New, revolutionary different COMPARISON technique permits you to do expert work on all radio sets. Most repairs can be made without test equipment or with only a simple meter. Many point-to-point, cross-reference, circuit suggestions locate faults instantly. Covers every radio set—new and old models. 24 large, trouble-shooting blueprints. Charts for circuit analysis. 114 tests using a 5 cent resistor. Price, only..... **\$1.50**

Guarantee

All manuals sent on 10-day trial basis. You must be entirely satisfied or your money will be refunded.

Supreme Publications
 (In business 14 years)
 CHICAGO 12, ILL.

- ★ ★ STEWART-WARNER MANUAL 50c
- ★ ★ ARVIN DIAGRAM MANUAL 50c
- ★ ★ GENERAL-ELECTRIC MANUAL 50c
 64 pages of popular circuits. Size: 5½ x 8½ inches

RECORD PLAYERS & RECORDERS MANUAL

Just what you need to repair quickly thousands of automatic record changers, manual players, phono pick-ups, wireless oscillators, recorders, and combinations. Hundreds of mechanical and electrical diagrams. Instructions for adjustment and repair. Most popular units of all makes. 128 large pages, 8½ x 11 in. Price, postpaid, only..... **\$1.50**

See Your Radio Jobber or Send Coupon ▶

March, 1947

Supreme Publications

PUBLISHERS OF RADIO BOOKS, MANUALS, AND DIAGRAMS

NO RISK TRIAL ORDER COUPON

SUPREME PUBLICATIONS, 9 S. Kedzie Ave., Chicago 12, ILL.

Ship the following manuals: (Satisfaction guaranteed or money back)

- | | | |
|---|---|--|
| <input type="checkbox"/> Radio Servicing Course..... @ \$2.50 | <input type="checkbox"/> 1946 | PRICED
AT ONLY
\$2.00
EACH |
| <input type="checkbox"/> Simplified Radio Servicing... @ 1.50 | <input type="checkbox"/> 1942 | |
| <input type="checkbox"/> Stewart-Warner Manual @ .50 | <input type="checkbox"/> 1941 | |
| <input type="checkbox"/> Arvin Diagram Manual..... @ .50 | <input type="checkbox"/> 1940 | |
| <input type="checkbox"/> General-Electric Manual @ .50 | <input type="checkbox"/> 1939 | |
| <input type="checkbox"/> Record Players and Recorders... 1.50 | <input type="checkbox"/> 1926-1938 @ \$2.50 | |

- I am enclosing \$..... send postpaid.
- Send C.O.D. I am enclosing \$..... deposit.

Name:

Address:

In New Jersey...
...it's **VARIETY**

RADIO KIT

AC-DC 5-TUBE SUPERHET

Modern Plastic Cabinet Built-in Aerial. Complete with Tubes including: 50L6, 35Z5, 12SK7, 12SA7, 12SQ7. **\$18.95** with tubes
\$14.45 less tubes

RADIO KITS by "EASY BUILT"

Model No. 2



Model No. 2 Kit. AC-DC. Electric Battery Kit with Cabinet complete with Tube, Special Variable Condenser, Earphones, Resistors, Hardware and Special Fittings. Completely Wired Tube Socket. Diagram on Mounting

Base—Ready Cut and Drilled. **\$5.01 each**

Model No. 2B. Battery operated, easy tuning, attractive wood finish cabinet. Complete with Tube, Coil, Battery, Headphone, Hardware and Base. List Price \$4.98. **Special \$3.33**
Kit No. 1 **\$2.13**
Kit No. 1X **\$2.13**

Federal Teleco SELENIUM RECTIFIER

Replaces Rectifier Tube. **\$1.09 each**
6 or more. **.99c each**

Famous Brand

VOLUME CONTROLS WITH SWITCH

75c each 10 for **\$6.96**
5,000, 10,000, 25,000, 50,000, .1 meg., .25 meg., .35 meg., .5 meg. 70,000 ohm tap, .5 meg., .5 meg 50% tap, 1 meg., 1 meg 50% tap, 2 meg 50% tap. Outside diam 1 1/4", shaft length 3", flat 3/4".

RESISTOR CABINETS

All wood construction. Six shelves, 24 compartments **\$3.89**

R.C.A.-T65 CABINET

Packed in original carton. Beautiful inlaid veneer with grill cloth. Speaker baffle for 5" speaker. Rubber feet. **\$4.95 each.** Three for **\$14.00**

Bargain! Guaranteed!

100 Assorted Bypass Condensers

Value **\$11.00**

Special \$6.95

SPECIAL! 20 x 20 150 WV, Electrolytic condensers, Fresh stock, guaranteed. 10 for **\$4.95**
Value \$8.75.

WELLER SPEED IRON

Saves Time and Money. Soldering heat in 5 seconds. For Radio, Electronic, Telephone, Telegraph, Test, Repair, Laboratory, etc. Complete with 2 extra tips. Net **\$12.95**

SUPERIOR

Model 670
Super-Meter



A Combination Volt-Ohm Milliammeter plus Capacity Reactance Inductance and Decibel Measurements.

Complete with test leads and instructions **\$28.40**

Write Dept. N-3 for our FLYER. 20% Deposit with order required. Please add sufficient postage. Excess will be refunded.

Variety ELECTRIC CO., Inc.
601 Broad St., Newark 2, N. J.

International Short-Wave

(Continued from page 57)

until the desired transmitting frequency is obtained. These currents are applied to a large watercooled transmitting valve (tube) type TA 12/20000 K having an input of 25-27 kilowatts at a plate voltage of 8000-12000 volts.

"The generation of high powered short waves only became possible by the use of watercooled transmitting valves (tubes), a Philips specialty."

The Results

For an account of PCJ's appearance on the air, we quote from a front-page story in "The Wireless World and Radio Review," London, of April 27, 1927:

"For the second time in the short history of broadcasting it has been left to Holland to steal a march on this country and, in fact, on Europe, generally. It will be remembered that some long while before broadcasting here was introduced, British amateurs were accustomed to listen to the broadcasting station at The Hague which, with the call-sign PCGG, sent out regular Sunday afternoon concerts, mainly for the benefit of listeners here. Now again Holland sets the example by leading the way to short-wave broadcasting. On the 15th of March the station PCJ, established at the Philips Lamp Laboratories at Eindhoven, in Holland, communicated by wireless telephony with the Dutch station at Bandoeng, in the Dutch East Indies. The transmission was carried out on a wavelength of approximately 30 meters.

"Since that initial success fairly regular broadcasting has been conducted. Now, as we go to press, comes the announcement that the Sydney station, 2BL, has successfully re-broadcast one of the programs. We congratulate Holland, and the Philips Company in particular, on the enterprise shown in establishing this broadcasting record, more especially so as the purpose is apparently to provide a means for long-distance broadcasting, and advantage has been taken of the peculiar suitability of the 30-meter wavelength.

"It will be of interest to observe whether this example set by Holland will be followed by other countries in Europe."

Eddie Startz tells me that "the very first transmissions of PCJ during March 1927 became a huge success, as next morning a telegram was delivered in Eindhoven stating that the transmission was received with incredible strength, steadiness and purity by a radio-amateur at Bandoeng (Java, Dutch East Indies). Subsequent transmissions proved that this result was not due to sheer luck, but that a really reliable communication was established. The stream of reports began to flow to the transmitter at Eindhoven. Reports were received from all parts of the world.

"During 1927, several relays of the Daventry (England) station, destined for the British Dominions, were successfully carried out.

"And in June 1927, the PCJ station had the great honor of receiving H.M. the Queen of Holland and H.R.H. Princess Juliana in its studio. The royal address to the Dutch East and West Indies was received with perfect clearness as stated in a radiogram received at Eindhoven exactly eight minutes after the last word was spoken by Her Majesty. On April 28 of that year, Beethoven's 9th Symphony, played by the Amsterdam orchestra and conducted by Dr. Willem Mengelberg, was broadcast to the world.

PCJ Today

The PCJ transmitter is now situated at Huizen, near the shores of the Zuider Zee. It has ten stages, with an output of some 30 kw. and a cooling-tower is used to keep the water-temperature of the cooling system at a constant low level.

The two antennas in use are both of the directional type. The first consists of a system of 8 sets of 3 vertical doublets, which are fed in phase, thus having the result of concentrating the energy. This beam is supported by two fixed masts and is oriented towards the Dutch East Indies.

The second antenna is of unique construction—the only one of its type in the world. This antenna is supported by a pair of 200-ft. wooden masts, fixed together on one under-carriage. This is fitted with 8 sets of two wheels, so that the whole structure can revolve upon two circular rails by means of two electric motors. In cases of need, two or three men can do the job. (One day in 1944, the station engineers loosened the brakes—and a fresh breeze did the rest!)

This revolving antenna consists of four sets of three vertical dipoles and as many reflector dipoles for 9590 kcs. One quarter-wavelength behind this system there is a similar one acting as reflector, which is fed with a voltage 90 degrees ahead in phase as compared with the antenna itself. The feeder is connected with the antenna feeder led over the rails by means of a bridge.

Studios from which the programs of PCJ emanate are located at Hilversum, about 20 miles southeast of Amsterdam, where the medium-wave broadcasts are also prepared and radiated.

Mr. Startz points out that "at the present time the transmitters are no longer operated by the Philips Laboratories, but by a semi-State institution called *Radio Nederland*, but all the credit for putting the Overseas Services from Holland into motion—until the war broke out—is due to the enterprise, foresight, and perseverance of Philips Radio, a thoroughly Dutch concern, with which I am still in close contact."

As to medium-wave radio service in Holland, two medium-wave transmit-

Fahnestock Clips

RADIO'S GREATEST CONVENIENCE



FAHNESTOCK SPRING BINDING POST GRIPS THE WIRE BY THE ACTION OF A SPRING

No tools required to make the connection. Grips the wire with just the right pressure for good electrical contact. Simply press down, insert the wire and let go. Does not injure wire, hence connection can be made or opened as often as desired. Available in large variety of types and sizes to fit any radio purpose and any requirement as to position, space or method of attachment. You will find them in the better sets.

Positive contact; cannot jar loose. Brass or bronze—nonrusting.

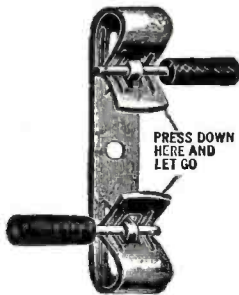
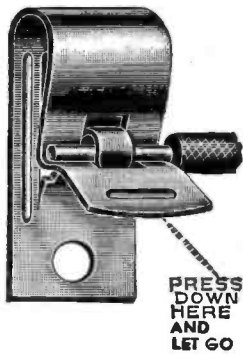

FAHNESTOCK ELECTRIC COMPANY, Inc.

46-44 ELEVENTH STREET
LONG ISLAND CITY 1, N. Y.

Dept. 12

Please send us at once, Descriptive Literature, Prices and Delivery Schedule on

FAHNESTOCK CLIPS

For
Name
Address
City..... State.....



Large Vacuum-Packed Tin of Delicious

PLANTERS PEANUTS

ABSOLUTELY FREE!

Olson's New "Gift-of-the-Month"

The treat's on Olson—and what a treat! A big Half-Pound Tin of Planters famous Jumbo Peanuts—fresh, plump and tender! It's FREE to Olson customers. Why not be an Olson customer and get our free gifts, as well as really good radio parts?

Just fill out and mail the coupon below, and you're a member of Olson's FREE Gift-of-the-Month Club. No dues, we pay the gift bill! No obligation.

This month, a \$10 purchase brings you one half-pound tin of Planters Peanuts FREE; a \$20 purchase brings you TWO tins, etc.

If you do not have our latest Bargain Catalog, paste this coupon on a postcard and mail today!



RADIO WAREHOUSE, INC.

73 E. MILL ST., DEPT. 69, AKRON, OHIO

Please enroll me in Olson's Gift-of-the-Month Club and send me your catalog. If I order this month, I will receive free Planters Peanuts as offered above.

NAME _____
ADDRESS _____
CITY _____ STATE _____

SURPLUS TUBES AT

BARGAIN PRICES:

All Tubes New & Sold Under New Tube Guarantee

USED DYNAMOTORS
— input 12 V.D.C. — 2.3 A., output 250 V.D.C. — .05A, 5000 R.P.M. constant duty, approx. size 4 1/2" x 2 1/2" dia.

Special \$2.10

NEW #631P1/SNA — Glass Strobotron tubes. Each \$4.25

ALL PRICES F.O.B.

NEW YORK CITY, N. Y.

Mail Orders Promptly Filled

Highbridge Radio-Television and Appliance Co.

340 CANAL STREET Dept. 1N.

NEW YORK 13, N. Y.



5CP1	3.95	884		5L6G	1.20
5BP1	4.95	885	0.99	6L7	.99
5BP4	4.95	8012	1.05	6SD7	.99
5JP1	3.95	15E	1.25	6SH7	.65
3BP1	3.45	15R	1.25	6SN7	.65
354	.89	E-1148	.69	6SK7	.89
9002	.89	2026	1.30	12SK7	.69
1619	.89	EP-50	.79	6X4	.80
1625	.70	VR105	.99	6Y6G	.69
1629	.89	2050	1.30	12A6	.89
1631	.89	7193	.99	12C8	.99
1633	.89	UH50	3.95	12SN7	.79
1644	.99	10Y	.99	37	.79
2C40	2.30	5R4GY	.99	106	.49
2C43	4.25	864	.60	12SQ7	.87
3C45	1.40	6X5	.89	34	1.05
100TH	8.25	843	2.75	30	.80
2051	1.35	811	2.00	83	.80
801A	2.05	6F8	.92	6K7	.92
802	2.05	6SJ7	.74	104	.79
803	7.95	75	.75	6B8G	.79
805	5.25	70L7	1.65	6AC7	.79
813	7.50	1R5	.79	6AG7	.99
826	4.25	2X2A	1.05	39/44	.60
6307	.80	3A4	.79	5Y4	.63
1616	.99	304	.89	5Y3	.63
717A	1.05	6AB7	.89	6W7	.69
713A	.85	6AR5	.84	12SF7	.79
371A	1.29	6AK5	1.05	6SK7	.69
1960	.75	6AL5	1.30	617	.80
835	1.75	6C4	.89		
837	2.10	6G5	.64		
866	1.25	6HG7	.59		
865	1.05	6J5GT	.56		
		6J5GT	.51		

(Minimum Order on Tubes \$2.00)

ters are operated on 400 m. and 300 m., respectively. The programming is made by a half dozen independent associations—a neutral, a socialistic, a Catholic, a Protestant, and some smaller ones, all representing some major cultural current prevailing in Holland. There is a tax on radio sets from which the costs for the programs are derived. Broadcasting in Holland is still in the process of reorganization following war's end.

PCJ During the War

And that brings us to an important question that has oftentimes been asked: "What happened to PCJ during the war?"

Our answer to this question comes from a broadcast made by Mr. Startz shortly after PCJ returned to the airwaves after Germany's defeat:

"Here is the story in a nutshell. It began on the night of May 10th, 1940. The starlit sky over Holland was filled with the roar of planes. At 4 o'clock in the morning, PCJ's chief engineer broke the bad news . . . we were at war with Germany!

"There it was! The worst had happened!

"I slipped on my clothes and five (Continued on page 129)

10 KC. Suppressor

(Continued from page 46)

quency speaker gave an attenuation of 14 db. as shown by the dotted curve of Fig. 2. This was not considered sufficient. Reference to an article entitled "Graphics of RC Networks" by Robert C. Paine in the May, 1944 RADIO-ELECTRONIC ENGINEERING edition of RADIO NEWS indicated a higher possible attenuation at the resonant frequency by the use of a resistor to balance out the resistance of the coil. The resulting circuit is shown in Fig. 1B, and the curve obtained with the final form of the filter is shown in Fig. 2 as the solid line. Figure 3 shows the curve plotted on the more conventional semi-log paper, and shows to better advantage the extreme sharpness of the filter network. C₁ and C₂ together resonate with the induct-

STANDARD WARRANTY PLAN

At a recent meeting of the Association of Electronic Parts and Equipment Manufacturers recommendations were made for the adoption of a standard warranty to be used by manufacturers who sell radio parts distributors.

The proposed warranty contains certain provisions intended to bring out uniformity in the handling of defective products. The period of warranty is left for determination by the individual manufacturer.

The warranty has been submitted to the Sales Managers Club, Eastern Group, for its comments and will then be submitted to the Radio Parts Coordinating Committee for further discussion.

UNIVERSITY REFLEX CONSTRUCTION

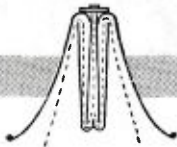

Engineered for efficiency and quality

University Speakers

The conversion efficiency of UNIVERSITY loudspeakers over the useful speech frequency range is 35 to 50 percent! Parallel to this superior sensitivity, is naturalness of tone and a ruggedness which permits every model to be unconditionally guaranteed for one year. Magnets of higher magnetomotive force, greater rigidity and concentricity of voice coils resulting in smaller air-gap clearances, better heat dissipation in the voice coil, diaphragms with a higher fatigue characteristic, and exclusive "rim centering" construction are a tribute to UNIVERSITY design.



UNIVERSITY LOUDSPEAKERS • INC

225 VARICK STREET
NEW YORK 14, N.Y.



MODEL LH
WITH 5AH DRIVER—
High efficiency reflex speaker, best for all-around, high-power P. A. use.

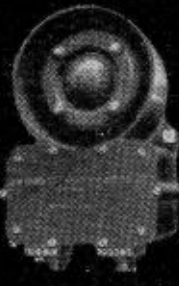

MODEL MM-2TC—
Submergence and explosion proof, may be cleaned with live steam—for ship, railroad or mine.

Pat. Pend.

BETTER VALUES from ARROW!

now offers the

FAMOUS COMMAND SET

ARMY SURPLUS — Principal Components of RADIO SET SCR-274-N
Includes 2 transmitters, 3 receivers, 1 modulator, 4 dynamotors, control box, etc.
Original Cost Over \$600.00—now complete for **ONLY**

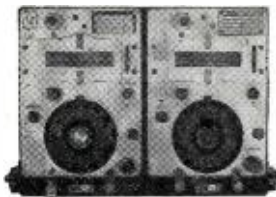

RADIO TRANSMITTERS
BC-457-A 4—5.3 mc Ind. cost **\$10.95**
BC-458-A 5.3—7mc Ind. cost **\$10.95**

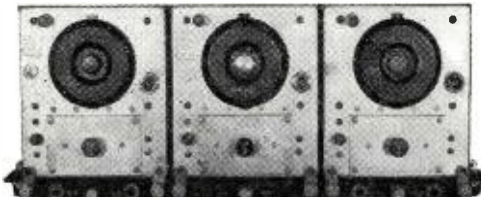

RADIO RECEIVERS
BC-454-A 3—6 mc Ind. cost **\$6.95**
BC-453-A 190—550 kc Ind. cost **\$8.95**
BC-455-A 6—9.1 mc Ind. cost **\$6.95**



MODULATOR UNIT
BC-456-A Ind. cost..... **\$6.95**

\$34⁹⁵

A BUY YOU CANNOT OVERLOOK! ORDER AT ONCE!

These components are practically new and have had ferry time only . . . complete with tubes . . . original cost over \$600.00 . . . this tremendous value for only \$34.95 complete . . . less than the tubes originally cost! Individual cost of dynamotors, \$4.95 each . . . Ind. cost of Remote Control Unit (BC-450-A) \$2.95.

COAXIAL CABLE

26 Ft. of COAXIAL CABLE RGU8, 52 ohm, with 2 amphenol plugs, one at each end.....ea. **89c**

ARMY AIRCRAFT RECEIVER Model BC-946-B

Broadcast Band from 520 to 1500 kc. Tube complement: 3—12SK7, 1—12SR7, 1—12SN7, 1—12A6, & 1—12K8. Designed for dynamotor operation but is easily converted to 110 or 32 volt operation. Has two I.F. stages and three gang condenser. Comes packed in sealed carton complete with tubes and instruction manual, but less dynamotor..... **\$12.95**

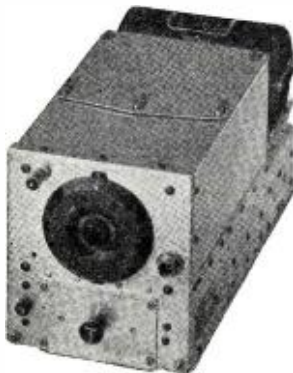

Dynamotor D M 32A. Each..... **\$4.95**

HEADPHONES

Signal Corps, 8000 ohms and 200 ohms, each..... **\$2.49**
2000 ohms, Trimm, each..... **\$1.79**

POWER TRANSFORMER—NAVY TYPE

159 ma; 6.3V at 6.5 amps; 5V at 3 amps..... Each **\$3.29**

SURPRISE PACKAGE

For the experimenter, radio serviceman, handy man, repairman, "ham," hundreds of valuable miscellaneous radio parts. 10 pounds..... **\$1.59**

ANTENNA

10 1/4 foot sectional antenna, collapsible. AN-131A..... **\$1.29**

Wholesalers, dealers, institutions, and other quantity purchasers . . . write, wire, phone for quantity prices.

SUPREME FOUNDATION METER

40 Micro Amps. 25,000 ohms per volt. 4 1/2" square. Mfd. by Supreme Instruments Corp. Each..... **\$8.95**

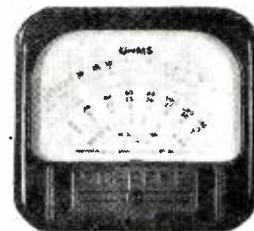

HICKOK 2 1/2" 0-150 Volt AC Voltmeter Each..... **\$2.49**

3 1/2" AUTOMATIC TIME METER

60 cycle 110 volts. This time meter consists of a cyclometer driven by a Teiechron synchronous motor. Connect to an electric circuit; it will measure and indicate the number of hours or minutes that the circuit is in use. Shpg. wt., 61 lbs.—list \$17.00. Your cost..... **\$4.95**

PLUGS

PL55 Plugs.....each **20c** PL68 Plugs.....each **20c**

JACKS

JK 26.....each **20c**

CARBON MIKE

T-17-B Carbon mike.....each **\$1.49**



VEEDER-ROOT METER and CASE

Counts number of feet of trailing wire antennae; number turns when winding on coil applicable for many uses; flexible shaft can be attached and connected to another device for counting without direct attachment; speed 300 ft. per minute for reeling out; beautiful bakelite case, jeweled dialite, pilot light enclosed, 3 position switch, counts up to 1000. Each..... **95c**

All shipments F.O.B. Chicago. 20% deposit required on all orders.

Dept. C

ARROW SALES, INC.
59 WEST HUBBARD STREET • CHICAGO 10, ILLINOIS
Telephone: SUPERIOR 5575

Do YOU Own a BC-312 RECEIVER?

Convert to
AC Operation
with

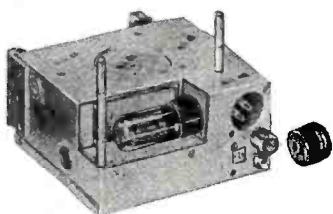

The RA-20 Power Pack

Eliminate batteries, and makeshift messy power supplies. RA-20 Power Pack fits right into dynamotor compartment. Takes just FIVE MINUTES to install.

Can also be used with many other similar receivers and equipment designed for dynamotor or battery operation.

PRIMARY: 110-120 volts 60 cycles AC.

SECONDARY: delivers 250 volts DC at 95 mfls. 12 volts at .3 amps. 12 volts CT at 2. amps.

RA-20 Price, Complete with rectifier tube and plug..... **\$9.95**

They're all BRAND NEW!

- SERVICEMEN • HAMS
- LABORATORIES

Need this

"8 DRAWER" EQUIPTO STEEL Shop CABINET



Remarkably useful assembly! Contains eight drawers having four compartments each, a total of 32 compartments! Overall width 25 1/2", height 10", depth 12". Olive green baked enamel finish. Equipto 8 drawer cabinet **\$11.50**
Lengthwise dividers, additional 11c each

MAIL ORDERS: 25% Deposit, Balance C.O.D.

Federated Purchaser
INCORPORATED
distributors of RADIO-ELECTRONIC and SOUND EQUIPMENT
80.81 PARK PLACE, N. Y. 7
Phone: WH 4-2080

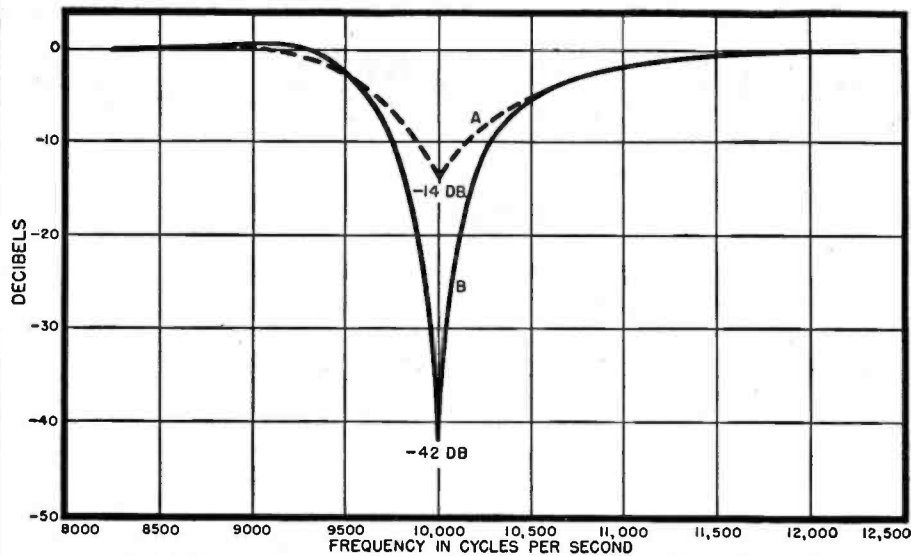

Fig. 2. Attenuation curve (dotted) for circuit shown in Fig. 1A. Solid curve shows attenuation obtained for properly adjusted circuit in Fig. 1B.

ance at 10,000 c.p.s. With the circuit set up as in Fig. 1B, with a 15 ohm rheostat in place as R and adjusted for maximum suppression at 10,000 c.p.s., the solid curve of Fig. 2 was obtained, showing a loss of 42 db., which very effectively eliminates the objectionable frequency. This curve was obtained with a value of 10 ohms for R . Since R is equal to four times the effective resistance of the coil, the resistance of coil L is therefore 2.5 ohms. At 10,000 c.p.s., the coil has a reactance of 64 ohms, and the Q is therefore X/R , or $64/2.5$, or approximately 26. Referring to the curve of Fig. 2, it will be noted that it is flat to 9200 c.p.s., and only down 6 db. at 9600 c.p.s. On the other side of the resonant frequency, the curve is down 6 db. at 10,600 c.p.s., down 2 at 11,000 c.p.s., and flat at 12,000 c.p.s. Thus it is seen that a very small part of the frequency spectrum is "clipped" out of the over-all response.

This sounds almost ideal, but there is a disadvantage to this filter. There is a loss of about 2 db. in the main pass band of this filter. In the original circuit, the filter was inserted in the high-frequency leads of a speaker system in which the impedance was 16 ohms. R was determined to be 10 ohms. The reactance of each capacitor at 1000 c.p.s. for example, is 1280 ohms, so the shunting effect of the capacitors is negligible. But the resistor R is in

series with the circuit, and the loss due to it is approximately 2 db. When used in the circuit of a high-frequency horn, this disadvantage may be overlooked since the high efficiency of the high frequency speaker is such that there is generally some attenuation in that circuit between the dividing network and the speaker itself. This attenuation can be reduced by the necessary amount to compensate for the loss in the filter.

A Practical Filter and Circuit

To avoid the necessity of winding the coil, it is entirely possible to make this filter from standard parts. The *J. W. Miller Company* of Los Angeles makes a line filter coil, #7825, which will serve for the inductance in speaker circuits having an impedance of around 8 ohms. This coil has an inductance of .6 mh., which calls for a capacitor of 42 μ fd. to resonate at 10,000 c.p.s. Since this value is not a standard commercial size, C_1 and C_2 are each .25 μ fd. paper capacitors. Connect them as in Fig. 1C, using a 15 ohm, 10 watt adjustable resistor (*Ohmite* #1007). If an audio oscillator and a sensitive a.f. voltmeter is available, the variable resistor can be adjusted for maximum suppression with very little effort. This combination of coil and capacitors will resonate at around 9200 c.p.s., assuming they have values close to their ratings.

Fig. 3. Curve shown is the same as that illustrated as a solid curve in Fig. 2 except for the fact that it is plotted on semi-log frequency response paper to show extreme sharpness of the attenuation peak.

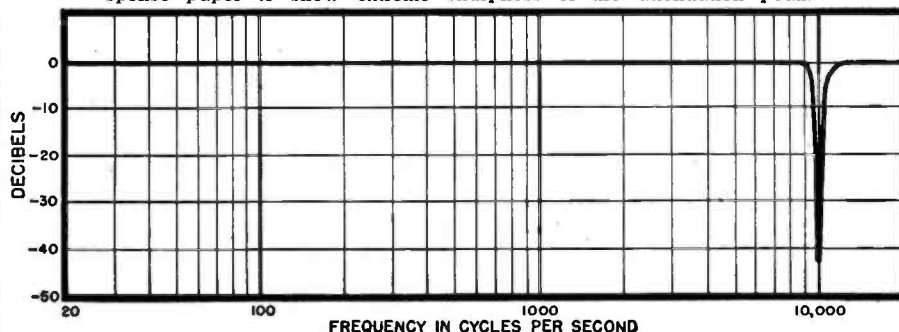

Metropolitan

fills Mail Orders Same day received!

New TELEVISION RECEIVER KIT



Easy to assemble. No knowledge of television required. Complete easy-to-follow instruction sheet gives you all the knowledge you need. Finished Television Receiver has a picture that is clear and sharp . . . comparable to a moving picture.

All necessary components are included: nothing is required except a screw driver, cutting pliers and a soldering iron. Only the highest quality standard parts are used—the list price value of these parts alone is more than \$300. 110 volts, 60 cycles AC.

FACTORY GUARANTEE—set guaranteed to operate satisfactorily if directions are followed exactly. Servicing of component parts and assembled parts will be performed by the factory **\$159⁵⁰** at factory costs.

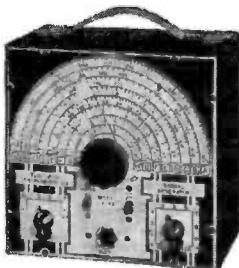

The New Model B-45 BATTERY OPERATED SIGNAL GENERATOR

for servicing AM FM Television Receivers
Self-modulated Signal Generator, providing a highly stable signal. Generates R.F. frequencies from 150 Kilocycles to 50 Megacycles (150 Kc. to 12.5 Mc. on Fundamentals and from 11 Mc. to 50 Mc. on Harmonics). R.F. is obtainable separately or modulated by the Audio Frequency.

Direct reading—all calibrations are etched on the front panel. Complete with shielded test lead, self-contained, batteries and instructions. **\$277⁵**
Net.....

We carry nearly 5,000 instruments in stock. All models listed below are available for immediate delivery.

(1) PRECISION APPARATUS INSTRUMENTS

832S—31 Range AC-DC Multi-Range Tester.....	\$23.04
844P—34 Range AC-DC 600 volts AC and DC VOLT-OHM MILLIAMMETER....	32.20
856P—44 Range Super-Sensitive, 20,000 ohms per volt AC-DC TESTER.....	49.94
864—AC-DC VOLT-OHM-DECIBEL-MILLIAMMETER with large 9" meter.....	59.60
912P—Dynamic Mutual Conductance Tube Tester.....	61.20
E-200—A.M.-F.M. and Television Signal Generator.....	64.15
EV-10P—6000 volts AC and DC Vacuum Tube Multi-Range-Meter.....	71.81
920P—Combination Dynamic Mutual Conductance Tube Tester, Battery Tester and 33 Range AC-DC Multi-Range Set Tester.....	84.22
954P—Combination Dynamic Mutual Conductance Tube Tester, Battery Tester and 37 Range Super-Sensitive AC-DC Multi-Range Set Tester, 20,000 ohms per volt DC.....	99.20

(2) SUPREME INSTRUMENTS

543—Multi-Tester.....	\$18.95
589—Tube and Battery Tester with Roll Chart.....	48.95
599—Tube and Set Tester with Roll Chart.....	62.50
565—Vacuum Tube Voltmeter.....	63.50
576—Signal Generator.....	68.95
805—Combination Tube and Set Tester with Roll Chart.....	89.50
546—Oscilloscope.....	89.75

(3) McMURDO SILVER CO.

905—"Sparx" Dynamic Signal Tracer.....	\$39.90
904—Capacitance Resistance Bridge.....	49.90
900—"Vomax" Vacuum Tube Voltmeter.....	59.85
906—A.M.-F.M. Signal Generator.....	89.90

(4) RADIO CITY PRODUCTS

447—Multi-Tester.....	\$17.95
448—Multi-Tester.....	24.50
322—Dynoptimum Tube Tester.....	41.50
461-P—Sensitive Multi-Tester 20,000 ohms per volt DC.....	42.63
664—Electronic Multi-Tester.....	45.00
705—Signal Generator.....	49.50
315—Rollchart Tube Tester.....	59.50
802N—Combination Tube and Set Tester.....	59.50
668—V.T.V.O. Capacity Meter.....	73.01
805—Combination Tube and Set Tester.....	89.50
665A—V.T. "Billionaire" Insulation Tester plus VTVM.....	92.61

(5) SUPERIOR INSTRUMENTS

CA-11—Signal Tracer.....	\$18.75
670—Super Meter.....	28.40
CA-12—Audible-Visual Signal Tracer.....	34.85
450—Tube Tester.....	39.50
650—Signal Generator.....	48.75
400—Electronic Multi-Tester.....	52.50
600—Combination Tube and Set Tester.....	62.50

(6) SHALLCROSS MFG. COMPANY

Decade Resistance Boxes.....	\$13.50
Portable Galvanometers.....	27.50
630—Wheatstone Bridge.....	75.00
637—Kelvin Wheatstone Bridge.....	100.00
638-2—Kelvin Wheatstone Bridge.....	150.00

(7) ALLEN B. DUMONT LABORATORIES

185A—Electronic Switch and Square Wave Generator.....	\$105.00
274—5" Oscilloscope.....	115.50

(8)

WATERMAN "Pocket" Oscilloscope.....	55.00
MONITOR Crystalliner Signal Generator.....	57.50
Bliley Crystal Controlled Signal Generator.....	69.50
WESTON—689-1F Ohmmeter, including leather carrying case, list \$25.50....	14.85
200—Electronic Measurements Mutual Conductance Tube Tester.....	49.85

TERMS: 25% deposit, balance C. O. D.
or Full Payment with order

SEND FOR FREE CATALOG!

Metropolitan ELECTRONIC & INSTRUMENT CO.
Dept. R, 6 MURRAY STREET Cable Address: METRONICS
NEW YORK 7, N. Y., U. S. A. Phone: BARclay 7-5556

NEW

While Bud Radio, Inc., does not adhere to tradition by equipping its Engineering and Sales Departments with coon-skin caps, they are still pioneers in the Radio Parts Industry. Constantly on the alert for new ideas they have discovered another "MUST," that is the answer to your needs.

The NEW BUD OES, RES AND VES SERIES OF COILS are of the variable end-link design. They are available in 75 watt, 150 watt and 500 watt sizes.

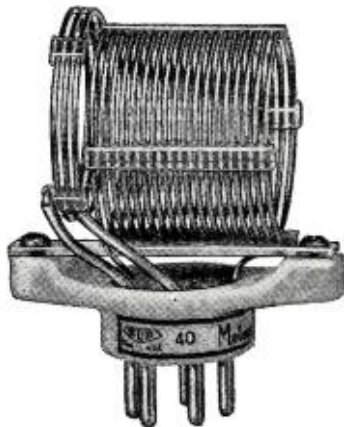

The variable end-link design was utilized as a means of making coils which can be used to greatest efficiency with beam power tubes. To make a coil with built-in link, that will be satisfactory in operation on various circuits, an adjustable link is necessary. BUD has taken care of both of these needs in the NEW ADJUSTABLE LINK COIL.

See them at your local distributor today! Have them in your rig tomorrow!

BUD Can Supply All Your Needs!

... with the latest types of equipment including: condensers, chokes, coils, insulators, plugs, jacks, switches, dials, test leads, jewel lights and a complete line of ultra-modern cabinets and chassis.



To resonate at 10,000 c.p.s., remove a few turns at a time from the coil until the circuit offers a maximum suppression at 10,000 c.p.s. If no a.f. oscillator is available, this will have to be done by ear, using the station from which the most trouble with the 10 kc. whistle is encountered. The number of turns to be removed will be somewhere between 8 and 12, so it is suggested that it be done very carefully.

If an accurate bridge is available, connect the two capacitors in parallel, and measure their capacitance. Then calculate the required inductance by means of the formula (for a frequency of 10,000 c.p.s.): $L = .254/C$ where L is in millihenries and C is in microfarads. Then using the bridge, the coil may be adjusted to the required inductance.

The same circuit can be used in 500 or 600 ohm lines, using good coils with an inductance in the order of 300 to 500 mh. When the resistance is adjusted for the coil selected, the rejection is theoretically infinite at the resonant frequency. Both capacitors should have the same value, and the adjustment of the resistance is critical.

When connected in low-level circuits, it is simple to compensate for the insertion loss by increasing the gain of the following amplifier by the required amount.

This filter is not recommended for use in speaker circuits where a large amount of power is being supplied, since the losses are too great, but for ordinary residence radio use, it will generally be satisfactory to install it in this manner, since the speaker power requirements are rarely high enough for the losses to be objectionable.

-50-

ELIMINATE GLARE FROM PROBE LAMP

A PROBE lamp of the type shown, unless shielded, is difficult to look past at a near point—such as in a dark corner of a radio chassis.

A small piece of adhesive or friction tape applied on one side as illustrated will improve the usefulness of this tool. H.L.



Clippard ELECTRONIC VOLT-OHMMETER, MODEL 406

We invite comparison of this instrument with any at any price for appearance, ruggedness, accuracy, stability. 0-1 to 1,000 volts From Jobber. U.H.F., A.C., D.C. 0-1,000 or F.O.B. Cincinnati. megohms. Pen-type dual-diode A.C. probe. No extras to buy. Send for details or order today.

\$89.50 NET

CLIPPARD INSTRUMENT LAB., INC.
1125 Bank St., Dept. 5, Cincinnati 14, Ohio

SCARCE TUBES

WE HAVE 'EM!

AT GOOD DISCOUNTS

All Popular Standard Brands . . . New . . . Guaranteed . . . Sealed Cartons

OZ4, 11A6, 1JL5, 1P5, 2A3, 5Z4, 6A8, 2A5, 2A6, 6E5, 6F5, 6J8, 6K5, 6K8, 6P5, 6Q7, 7A8, 7B8, 7B5, 7B7, 7C8, 7F8, 7L7, 12A8, 12F3, 12J7, 12X7, 12Z3, 14Q7, 14R7, 25A7, 25L6, 25Y5, 25Z5, 25Z6, 30, 32L7, 33, 35, 35A5, 35Y4, 39Z3, 43, 45, 47, 50A5, 56, 57, 58, 59, 70L7, 71A, 84, 11L7, 11M7, 11N7, 11P7, 11T3, 11T6, 11T8, 11T9, and many others.

THIS MONTH'S SPECIALS

- 5 Tube All-American Kit (50L6, 35Z5, 12SA7, 12SK7, 12SQ7) \$3.85
- 25Y5 (Exact replacement for 25Z5) .75
- ACORN TUBES, Guaranteed 954, 955, 956, 957 49c each
- 6AK5 Tubes, Guaranteed 75c each
- HEARING AID TUBES, all types 501 49c each
- 6AH6 TUBES 49c each

CONDENSERS

Brand new Individually boxed Fully guaranteed for 1 year. Used by leading Radio Manufacturers at a price you can't beat.

20/20 MFD. 150 volts. 45c
8 MFD. 450 volts. 32c
16 MFD. 450 volts. 45c
20 MFD. 150 volts. 32c

Special Discounts on All Large Orders Write or Wire for Catalog —We Ship Anywhere



COMMERCIAL RADIO
36 BRATTLE ST., BOSTON 8, MASS.

Department N

RADIO NEWS

Save up to 80% at Sun Radio...

ON BRAND NEW
RADIO TUBES!

War Surplus
Equipment!..

AT A FRACTION OF THEIR
ORIGINAL GOVERNMENT COST

ALL STANDARD BRAND TUBES

Number	Price	Number	Price	Number	Price
0Z4	\$1.45	6F5	\$1.00	12SF5GT	\$1.00
1A7	.80	6F6	.95	12S17GT	.10
1B4	.80	6F7	.50	12SK7GT	.10
1B7	.80	6F8	.10	12SL7GT	.20
1C5GT	1.00	6G6	1.00	12SN7GT	.95
1D5	.80	6H6	.75	12SQ7GT	1.10
1D8GT	1.10	6J7	.80	12SR7	.00
1E4	.80	6J8	.30	14A7	.50
1E5	.90	6K6	.85	14B6	.40
1E7	1.00	6K7	.85	14B8	.60
1F4	.80	6K8	.30	14C5	.60
1F5	.80	6L5	1.10	14C7	.60
1F7	.90	6L6	.95	14F7	.60
1G4	1.30	6L7	.40	14H7	.60
1G6	1.25	6N7	1.40	14J7	.60
1H4	1.70	6P5	1.40	14N7	.20
1H5	.70	6P7	.80	14S7	.60
1J5	.75	6R7	1.30	14W7	.85
1J6	.80	6R7	.20	14Y4	.60
1LA4	1.95	6S7	.20	18	.25
1LB4	1.95	6SA7	1.00	19	.75
1LC6	2.70	6SF5	.70	20	1.00
1LD5	1.95	6SJ7GT	.70	22	.90
1LH4	1.95	6SK7GT	.80	24A	1.10
1LN5	1.95	6SL7GT	1.00	25L6GT	.75
1N5	1.30	6SN7GT	.85	26	.70
1R5	1.25	6SQ7GT	1.00	30	1.00
1S4	1.25	6T7	1.00	31	1.00
1S5	1.25	6U6GT	1.00	32L7GT	.95
1T4	1.25	6U7	1.00	33	1.00
1T5	1.50	6V6	1.10	34	.80
1V	1.00	6V7	1.00	35W4	1.08
2A6	.75	6W7	.20	36	.30
2B7	.75	6X5GT	1.00	37	.75
2E5	.65	6Y6G	1.00	38	.85
2X2/879	.90	7A4	1.00	39/44	.80
2Z2/G84	.45	7A5	1.00	41	.85
3A8	1.95	7A6	1.00	42	.85
3Q5	1.95	7A7	1.00	45	.80
3S4	1.25	7B4	1.00	46	1.00
5U4	1.00	7B5	1.00	49	.95
5V4	1.60	7B6	1.00	50	1.75
5X4	1.10	7B8	1.00	50L6	1.24
5Y3GT	.70	7C5	1.00	55	.50
5Y4	.75	7C6	1.30	57	.80
5Z3	.95	7C7	1.00	57	.75
6A5	1.70	7E6	1.00	59	.80
6A6	.80	7E7	1.30	76	.75
6A8	1.00	7F7	1.30	77	.75
6A5G	1.70	7H7	1.50	78	.75
6AC5GT	1.00	7J7	1.50	79	.85
6AF5	1.00	7L7	1.50	80	.60
6AF6	1.60	7N7	1.50	81	1.50
6B4	1.50	7Q7	1.00	82	.85
6B7	.95	7R7	1.30	83	1.30
6B8	1.00	7S7	1.30	83V	1.95
6C5	.95	7V7	1.50	84/624	1.10
6C6	1.00	7Y4	1.30	89	1.40
6C7	.45	7Z4	1.30	99	1.50
6C8	1.25	12BE6	1.44	11ZL7GT	2.35
6D6	.75	12F5GT	1.00	11Z6GT	1.60
6D7	1.00	12J5GT	1.00	XXB	1.50
		12SA7GT	1.30	XXFM	1.50
				XXL	1.50

10% discount given for orders over 100 tubes

All items F.O.B. Washington, D. C. Orders \$30.00 or less, cash with order. Above \$30.00, 25% with order, balance C.O.D.

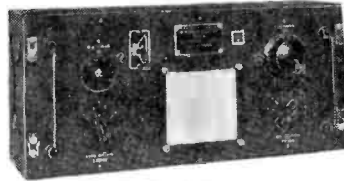

R.F. TUNING UNIT

Comes in a beautiful black cracked aluminum cabinet with two Variable Transmitting Condensers and two Vernier dials, one heavy duty ceramic four position wafer switch, two or more mica condensers 2,500 Working Volts and coils wound on porcelain ribbed forms.

Yours for only \$3.89

No. TU5B	1500 to 3000 KC
No. TU6B	3000 to 4500 KC
No. TU7B	4500 to 6200 KC
No. TU8B	6200 to 7700 KC
No. TU10B	10,000 to 12,500 KC

Please specify model



NAVY
V.H.F. RADIO
TRANSMITTER

\$9.95

LESS BATTERY
BRAND NEW

Battery operated (67 1/2 V.B. and 1 1/2 V.A.) Frequency 80 to 105 M.C. Complete with 2-1G4 tubes and full instruction manual.



HALLICRAFTER SP4
PANORAMIC ADAPTER

For immediate delivery. Easily installed in any Set. Shipping charges \$99.50 prepaid in full to your home.

RHOMBIC RECEIVING ANTENNAE

Complete with all accessories including 2200 feet of No. 14 copper weld wire, 50 feet of heavy twin X lead 72 ohm good up to 2 KW, dozens of insulators, pulleys, neon lightning arrestors, ground rod...less poles.

\$24.95

WALKIE TALKIES

\$69.95
EACH

\$129.90
SET

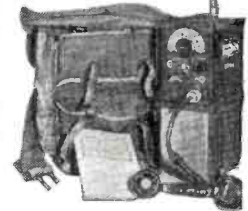

SCR195 Walkie Talkies, brand new, weight 27 1/2 pounds including knapsack. Range up to 25 miles in open country. Frequency 52.8 to 65.8 MC. Transmitter and receiver with regular hand set. Complete ready to operate with spare parts.

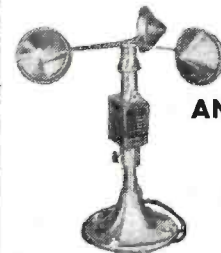

NAVY
ANEMOMETER

\$14.95

Less Batteries
Battery 60c

Beautiful precision designed instrument that will enable you to determine the Wind Velocity in miles per hour. Complete instructions. 6 Volt battery operated. Brand new.



Complete 4 Tube
INTERPHONE
AMPLIFIER

Yours for only
\$8.95

Comes in an aluminum cabinet 9 1/4 x 4 1/4 x 5 1/4 inches with two 12J5GT and two 12A6 tubes; also Electric Dynamotor 28DC Volt input and 250 V DC output at 60 MA. Complete instructions and diagram for high fidelity phonograph or speech, 110 Volt operation. Greatest offering ever made in War Surplus Electronics!

SCR 536 B2
HANDIE
TALKIE
CHASSIS



Comes completely wired with 1-1R5, 1-1T4, 1-1S5, 2-3N4 Tubes and two 455 KC Iron core I.F. transformers less antenna, output coil, and crystals.

\$9.95



OHM METER
WESTON #689

A beautiful instrument for accurate work. Scale 0-10 ohm and 0-1000 ohm scaled to read 1/20 of an ohm with ease. This 2 1/4" round meter is housed in a black bakelite case 1 1/4" x 2 3/4" x 5". Complete with heavy duty felt-lined leather case and lock net.

\$14.97

SUN RADIO
OF WASHINGTON, D. C.

938 F STREET, N. W. WASH. 4, D. C.

LEONARD VALUES

ELECTRONIC MEASUREMENTS



VOLOMETERS

Model 101B
OPEN FACE 4" METER \$20.95 NET

OPEN FACE 101A
3" METER \$17.50 NET

PORTABLE

101AP 3" Meter..... \$21.50 net

101BP 4" Meter..... \$24.95 net

Here is an unusually attractive, exceptionally low priced volt-ohm-milliammeter. It is a rugged, flexible instrument, combining features which are not available in competitive models selling for more than double this price.

SPECIFICATIONS

- 5 DC Voltage Ranges (approx. 1000 ohms per V.) 0 to 6-60-300-600-3000 Volts.
- 4 AC Voltage Ranges 0 to 12-120-600-1200 Volts.
- 8 DC Current Ranges 0 to 6-60-600-milliamperes.
- 4 Resistance Ranges 0 to 200-2000-200,000-20 megohms.

SPEAKER SALE

4" PM ALNICO #5.....	\$1.73
5" PM ALNICO #5.....	\$1.89
6" PM ALNICO #5.....	\$2.89
8" PM ALNICO #5.....	\$4.45
12" PM ALNICO #5.....	\$8.45
12" Dynamic 1600 ohm.....	\$7.34

PERMABILITY TUNING UNIT

Replaces Gang Cond. \$2.68 NET
Oss. Coil & Ant. Coil.....

Loop to Match..... \$1.05 NET

PLUG-IN ELECTROLYTIC CONDENSER

60-30-30 mfd 450 V.D.C.W.

G-147 SPECIAL LIMITED QUANTITY 83c

6L6 PUSH PULL OUTPUT 35 WATT

Completely shielded. Class AB1. Primary 6600 Ohms-Sec. 2-4-8-15-500 Ohms.

F-147 SPECIAL LIMITED QUANTITY \$3.89

PHONO MOTOR and PICK UP KIT

SPECIAL

\$5.95

Complete

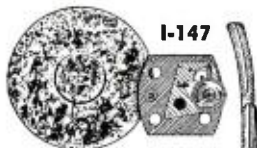

Crystal pick-up—Top quality constant speed motor.

ELECTROLYTIC CONDENSERS

ETCHED—FOIL—CARDBOARD ENCASED—METAL ENCASED

8-450.....	38c	8-8-450.....	65c
16-450.....	56c	20-20-150.....	65c
30-150.....	40c	40-40-150.....	73c
40-150.....	42c	50-30-150.....	75c

Have a complete stock on hand of Sprague, Amperite, Aerovox, B & W, Turner, I.R.C., Shure, and other nationally known parts and equipment. Dealers and Servicemen supplied.

Send 25% deposit with order—balance Express Collect. Orders under \$5.00 send check or money order plus postage.

LEONARD RADIO INC.
69 CORTLANDT ST.
NEW YORK 7, N.Y.

4-Watt Amplifier

(Continued from page 40)

The actual wiring of the tube sockets, etc., is done first. As much of the wiring on the underside of the top plate as possible is completed before this plate is placed on the main part of the utility box. Wires going to the two volume controls, the power switch, the two input jacks, the output transformer, and the filter choke are terminated at solder lug terminal strips located at strategic places to be connected to those components after the top plate is in place.

Adequate filtering and shielding within the amplifier is necessary to keep hum at a minimum. The filtering is provided for by the filter choke with two 50 μ d., 150 w.v. filter con-

densers bypassing it, and by the 25,000 ohm decoupling resistor R_{11} , and the 20 μ d., 150 w.v. decoupling condenser bypassing it. Shielding is provided by placing a small coil shield can over the underside of the 6SJ7 tube socket after all wiring connections have been completed. The wires to the cathode resistor and condenser, the screen bypass condenser, the "B" plus decoupling condenser ("B" plus power supply), and also to the coupling condenser C_3 are brought out from under this shield can by making small notches around its edge to clear each of these wires. The wire to the microphone jack is brought out through a grommet inserted in the top of this shield can. Several things should be carefully noted in the manner of shielding and grounding the various wires in the amplifier. The wires running between the two gain controls,

RADIO SHOP AT BARKER BROS.

By MARK McMILLIN

BARKER BROS., Los Angeles, recently opened its newly enlarged and decorated Radio Shop, which has at once established itself as one of the finest on the Pacific Coast. One-half block in length, and conveniently situated on the huge oblong mezzanine, the new shop is extremely spacious, colorfully decorated in the modern style, and unusually complete in every detail.

Beige and soft turquoise, with touches of off-white, are the colors used in the handsome decorations. The carpeting is of light beige, with chairs of a lighter shade. The woodwork and walls are of soft turquoise, trimmed with off-white. Likewise the counters and display racks are of the same tones. All lighting is indirect.

At one end of the department are eleven audition rooms, five large and six small. The shop is equipped with all

the leading makes of radios, phonographs, and combination sets, including Hoffman, General Electric, Zenith, Crosley, Westinghouse, Tempo-Tone, Musaphonic, Sentinel, Packard-Bell, RCA Victor, Emerson, Echophone, and others. In addition, the shop carries a complete line of records and record albums and all the other accessories to appeal to radio and phonograph fans.

At the far end of the department, the entire wall is covered with a huge frosted glass map of the world, showing the radio waves joining the various hemispheres. This is indirectly lighted from behind, and is especially appealing to patrons and other visitors. The new Radio Shop is so comfortable, handsome, and completely equipped that it has rapidly become one of the favorite shopping spots of Los Angeles shoppers.

—30—

The well-planned Radio Shop at Barker Bros., Los Angeles, is one-half block in length and handsomely decorated in modern style. The world radio map, to be seen on the rear wall, is a feature which has found wide appeal among the store's patrons.



AMATEURS!

WHAT ARE YOU GOING TO BUILD?

Fill Out the **SPRAGUE** Questionnaire

WE'LL GIVE YOU THIS HANDY TESTER

for only 25¢ to cover cost of packing and mailing.

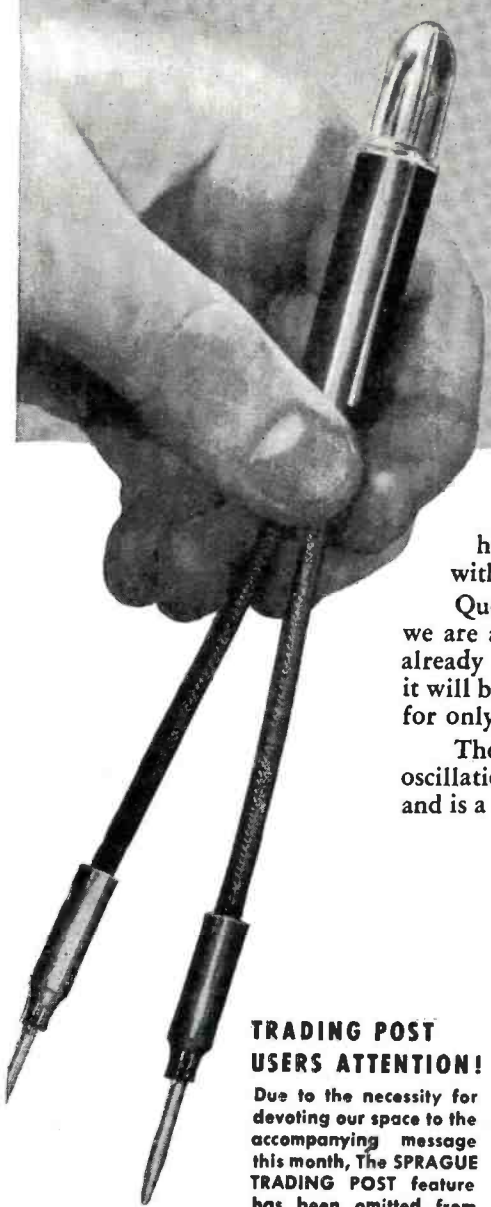

Here's how you can help us: Sprague Capacitors and Koolohm Resistors have never been matters of guesswork. Now, to tie them in even more closely with amateur requirements, we are conducting an extensive research.

Questionnaires have already been mailed to several thousand amateurs. In them, we are asking about future building plans and needs for their rigs. If you have not already received a questionnaire, write for one today. You'll enjoy filling it out — it will be mighty helpful to us — and to repay you, we'll send a Sprague Handy Tester for only 25c cash or stamps to defray cost of packing and mailing.

The Handy Tester tests ac-dc voltages up to 500v; indicates r-f and parasitic oscillations; checks charge on high-voltage capacitors, distinguishes a.c. from d.c. and is a tool of dozens of other uses.

Sorry, but of course we've got to limit this offer — and the questionnaires — only to licensed amateurs.

Write today to Dept. RN-37

TRADING POST USERS ATTENTION!

Due to the necessity for devoting our space to the accompanying message this month, The **SPRAGUE TRADING POST** feature has been omitted from this publication. It will appear again next month.

SPRAGUE

PRODUCTS COMPANY

NORTH ADAMS, MASS.

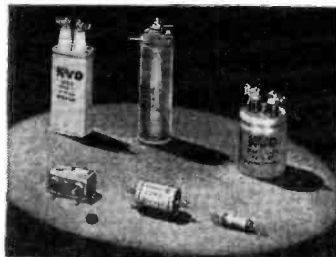

PAPER DIELECTRIC

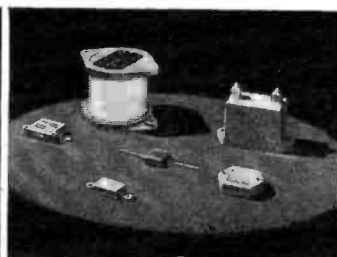

MICA CAPACITORS



DRY ELECTROLYTICS



KOOLOHM RESISTORS
Trademark Reg. U.S. Pat. Off.

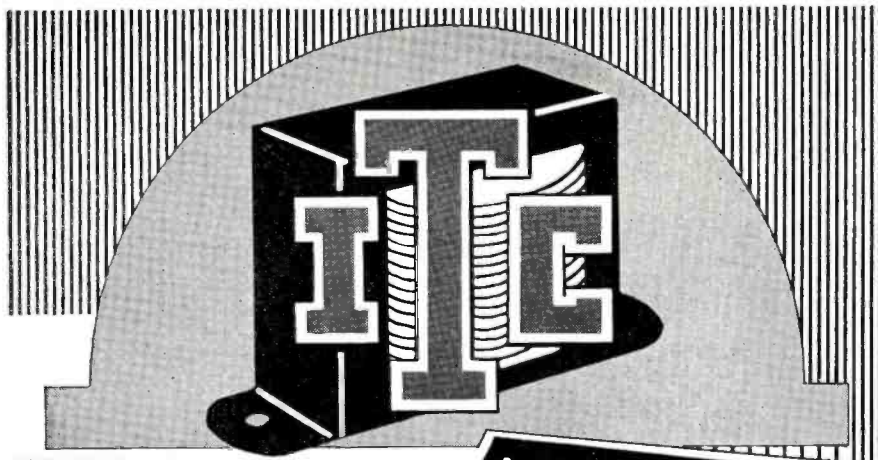

THE MASS production of transformers with close tolerance standards is the rule rather than the exception at ITC. Quality control, careful engineering and better construction mean a finer unit which fills exacting customer requirements.

THAT is why we say that our transformer is really *A Precision-Built ITC Product.*

COPYRIGHT, 1947, ILLINOIS TRANSFORMER COMPANY

**A PRECISION BUILT
ITC
PRODUCT**

Illinois TRANSFORMER COMPANY
412 S. GREEN STREET • CHICAGO 7 • ILLINOIS

**GET YOUR
FCC Commercial Radio Operators' LICENSE**

Now...

IT'S EASY IF YOU FOLLOW OUR PLAN!

Thousands of new jobs are opening up—FM, TELEVISION, MOBILE COMMUNICATION SYSTEMS, are only a few of the new radio fields which require licensed operators.

TIME IS IMPORTANT TO YOU!

You can get your License quickly with NILSON'S MASTER COURSE IN RADIO COMMUNICATION and exclusive CIRE Workbooks of Instructional Aids. Saves you many hours of random, undirected study. Assures a minimum of time in getting your ticket.

FREE BOOKLET tells you the Government Requirements for all classes of commercial licenses—Sent immediately upon receipt of coupon.

Approved for Veteran Training Under G-I Bill of Rights

CLEVELAND INSTITUTE OF RADIO ELECTRONICS
RN-3 TERMINAL TOWER CLEVELAND 13, OHIO

MAIL THIS COUPON

CLEVELAND INSTITUTE OF RADIO ELECTRONICS
RN-3 Terminal Tower, Cleveland 13, Ohio

Gentlemen: Please send information about your Home Study Course for preparation for FCC Commercial License Examinations (this course does not cover amateur license examinations).

Name _____

Address _____

City _____ Zone _____ State _____

If a Veteran check here

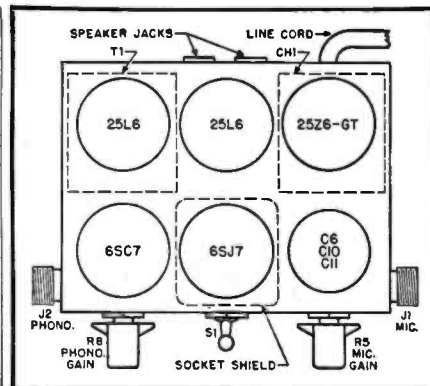

Mechanical layout shows relative position of the various component parts.

and from the gain controls to the amplifier assembly proper should be shielded. All ground connections in the microphone pre-amplifier circuit (the 65J7) should be grounded at one place. Hum will be introduced if this instruction is not carefully followed. It should be noted that the shielding on all wires, and the ground return circuit from the microphone and phonograph jacks, is connected to the amplifier ground and not the chassis ground. The only shielding connected to the chassis ground is the can covering the base of the 65J7. All other shielding is connected to the amplifier ground. Since this is a.c.-d.c. equipment and the amplifier ground must necessarily be connected directly into one side of the line power cord, the chassis is isolated from the amplifier ground by the condenser C₆. The microphone and phonograph input jacks must be insulated from the chassis by fiber grommets. These jacks, as has been already stated, are grounded to the amplifier ground.

Beyond the observations that have just been made, the points in the construction of this amplifier are conventional. It should be noted that the filter condenser is grounded to the amplifier ground, and is mounted on the chassis by an insulating fiber plate.

-30-

SERVICEMEN GET RAISE

SEATTLE, Washington radio and appliance servicemen have been granted a 15% wage increase and a 40-hour week for all shops by terms of a new contract recently signed by the Association of Appliance Dealers and the Radio Service Unit, Local B-77 of the I.B.E.W.

The new agreement affects nearly 250 servicemen employed by approximately 175 radio and appliance dealers, service shops and furniture stores with service departments. Department stores are covered by another contract.

Retroactive to October 1, 1946, the wage rate for full-time and part-time journeymen was raised from \$1.30 to \$1.50 per hour while the rate for shop managers was lifted from \$1.45 to \$1.65, thus maintaining the 10% differential over the journeyman wage.

Other contract changes further define holiday pay and shop manager provisions.

-30-

RADIO NEWS

Get an **EYEFUL** of these values!

BEST BUYS

in **PARTS** and **EQUIPMENT**



GC

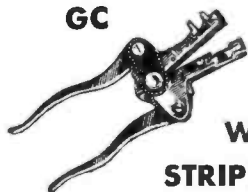

WIRE STRIPPER

Automatic Model \$ 4.80
 Standard Model 3.60
 Deluxe Complete Kit 10.20
 Extra Blades, any size90

TALK-A-PHONE INTER-COMS



KR-4010 Special Deluxe Master \$35.70
 RU-4335 Sub-Station 9.77
 4433 Cable, per 100 feet 6.20
 KR- 40 Deluxe Master 41.30
 RU- 43 Deluxe Sub-Station 13.27

Look at This Buy!

Portable Voice and Code Radio RECEIVER-TRANSMITTER

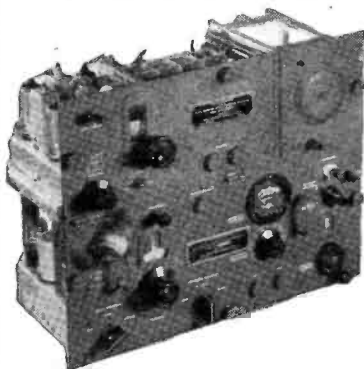

BC-654-A is a combined transmitter and receiver designed for portable or vehicular operation. The frequency range of both transmitter and receiver is continuous from 3700 to 5800 kilocycles; all stages gang tuned by anti-back lash worm gear dial mechanisms.
 The BC-654-A is 18" wide, 14" high, and 9½" deep. Weight 44¾ pounds. Power required for Receiver—1.5, 45, and 90 volts D.C. Power required for Transmitter—1½, 6, 51, 84 volts D.C. and 500 volts D.C. at 160 ma. Operates from Dynamotor PE-103-A.

Extra Special \$22.95

Complete with case less dynamotor
 One-third deposit with order, balance C.O.D., F.O.B. shipping point.

TUBES — ALL TYPES

Ask to be placed on our tube mailing list. Send us your orders.

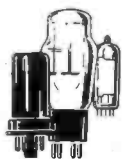

LAST MINUTE SPECIALS

Weller Soldering Gun \$12.95
 Clarkstan 2 Meter Ring Tuner 4.80
 Clarkstan Needle Pressure Gauge 1.80
 BA-303 Hushatone 6.83
 Brush Model "A" Headphones 7.20
 Brush Vibromike 10.26
 IF Transformers69
 Resistor Kit (100 Asst. Resistors) 2.55
 Replacement Loops48
 Bar Knobs, 10 for45
 Appliance Cord, 6-foot length19
 Antenna Hanks, 20 ft., 10 for 1.50
 JT-30 Astatic Mike with stand 10.17
 GC Alignment Kit 3.90
 GC Neutralizing Kit 4.50
 Antenna Kit—50-ft. Wire, Insulators73
 Riders Manuals—X, XII, XIII, etc. 15.00

WIRE

SV-18-2 Cord, 250 feet \$9.63
 Hook-Up Wire, 100 feet51
 RCA Bright Picture Wire, per foot05
 Aerial Wire, 50-foot coils71
 Rubber Covered Lead-in, per foot01

RG-8-U CABLE

Flexible Coax

Impedance 52 ohms. Maximum operating voltage, 4000 volts.
 1 to 100 feet, per foot \$0.08
 100 feet and up, per foot05½

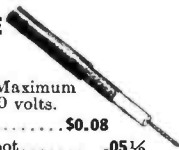

PEERLESS—HALDORSON—STANCOR TRANSFORMERS

P-38—660 volt CT at 50 ma-5 volt 2A-6.3 volt 1.6A \$3.18 Net
 P-39—700 volt CT at 75 ma-5 volt 3A-6.3 volt 2.5A \$3.81 Net
 P-40—825 volt CT at 200 ma-5 volt 3A-6.3 volt 6A CT \$7.89
 P-41—750 volt CT at 300 ma-5 volt 4A-6.3 volt 5A-2.5 volt 10A \$15.48

RCA and CINAUDAGRAPH SPEAKERS

12" PM—2.8 oz. magnet \$9.33
 6" 1000 Ohms Field 3.95
 6" 4 Ohms Field (auto) 3.95
 5" PM 3.27
 4" PM 2.25
 6" Elliptical 4.62



ALLIANCE and WEBSTER Phono Motors

Alliance \$3.91 Webster \$6.17

Sturdy replacement motor and turntable designed for long life.

TEST EQUIPMENT

Simpson 260 Multimeter \$38.25
 Simpson 230 Multimeter 26.50
 Triplett 666H Multimeter 20.00
 Speco Signal Tracer 49.50
 Speco Capohmist 16.95
 McMurdo Silver Spartz 39.90
 McMurdo Silver Vomax 59.85
 McMurdo Silver CR Bridge 49.90
 Jackson 645 ETVT 75.00
 Speco Signal Tracer (battery) 29.95
 Monitor Frequency Standard 37.50
 0-1 MA DeJur Meter 4.25
 0-500 MA Triplett 3" 4.50
 8½" Marlon Foundation Meter 20.00
 Triplett Signal Generator 88.50
 Triplett 20,000 Ohm p/u Meter 58.50

BC-645—VMF IFF RECEIVER-TRANSMITTER

Ideal for converting to high frequency receiver-transmitter.
 A 15-tube Interrogator Transponder designed for airborne use. It will operate from either a 12VDC or 24 VDC power source when used with the PE-101 dynamotor. The receiver is fixed tuned to 470 mc. but can be tuned from 461 mc to 493 mc. Can be made to tune in the 425 mc to 450 mc amateur band.
Ask for conversion instructions and schematics. \$17.95

D & H DISTRIBUTING CO. INC.

311 S. CAMERON ST.
 HARRISBURG, PENNA.

PARTS
 DIVISION

31 E. LEE STREET
 BALTIMORE 2, MD.

"IT'S **D & H** FOR DEPENDABLE PARTS SERVICE"

**Part One of Our
GENERAL CATALOG
Is Ready Now!
Send for Yours, FREE!**



This new 16 page section of our general catalog is jam-packed with real savings for amateurs, experimenters, and servicemen. Send for yours today. Order from WRL, the only "personal service" radio parts mail order house in the nation.—LEO WOGFQ.

**ORDER YOUR RECEIVER
FROM LEO, TODAY!**

We carry all types and models. RME 45, HQ 129X, and all National models in stock for immediate delivery. Collins receivers available soon. Buy on our easy payment plan—lowest terms in the country. Liberal trade-in allowance.



**Tops For Performance
WRL Globe Trotter KIT**

Here's What WOPFB, Chilhowee, Mo. Says About the Globe Trotter:

"I want to thank you for bringing out such a wonderful transmitter as the Globe Trotter. For such small power it really packs a strong signal."

Many other actual field reports of amateurs using the Globe Trotter testify to its excellent performance. It's the hottest ham equipment on the market today. The WRL Globe Trotter is capable of 40 watts input on C.W. and 25 watts input on phone on all bands from 1500 KC through 28 Megacycles. Incorporates the Tritet Oscillator using a 40 meter Xtal; Heising choke modulation; three bands, all pretuned; 10, 20, and 80 meters; two power supplies, one for 807 final and modulator tubes, one for speech amplifier and oscillator stage.

IMMEDIATE DELIVERY

*All prices quoted are domestic. Write for export prices.

40 WATT INPUT. Cat. No. 70-300. . \$69.95

Complete including all parts, chassis panel, streamlined cabinets, less tubes, coils and meter.

No. 70-312 Same as above, wired by our engineers\$79.50
1 Set Coils, Meter, Tubes\$15.15 Extra



Address Dept. RN-3, Council Bluffs, Iowa.

Manufacturers' Literature

Readers are asked to write directly to the manufacturer for the literature. By mentioning RADIO NEWS, the issue and page, and enclosing the proper amount, when indicated, delay will be prevented.

OHM'S LAW CALCULATOR

Ohmite Manufacturing Company of Chicago has announced the availability of their new Ohm's Law Calculator which incorporates several unique features.

The new calculator, like the previous ones, provides a simple and handy means of evolving resistance calculations. With one setting of the slide it gives the answer to any Ohm's Law problem. It will also solve parallel resistance and series capacitance problems and will multiply, divide, and find squares and square roots. The range covers all currents, resistances, voltages and wattages commonly encountered in industrial and radio work.

All computing scales of the new calculator are printed on one side. On the opposite side are given the Composition Resistor Color Code and the catalogue number of stock resistors and rheostats of various resistance values manufactured by the company.

Copies of this calculator are selling for 25 cents and may be secured from Ohmite Manufacturing Company, 4937 Flournoy Street, Chicago, Illinois.

APPLIANCE PROMOTION

Of interest to radio dealers who handle an appliance line is the new 24-page, full-color book issued by General Electric Company.

The booklet, entitled "Does Your Home Have a Place for Living," covers suggested plans for various appliance installations in the modern home. The planning of various service areas is discussed fully and completely illustrated.

Dealers who wish to secure a copy of this handy guide to electrical living should address their requests to the Advertising Division, General Electric Company, Bridgeport, Connecticut. The booklet carries a charge of ten cents per copy.

RECEIVING TUBES

Radio Corporation of America has recently issued a new 16-page booklet entitled "Receiving Tubes for Television, FM and Standard Broadcast" which is currently available for distribution.

This booklet charts the characteristics and socket connections of the company's line of receiving tubes, including projection and direct-view kinescopes. All types are listed in numerical-alphabetical sequence of type designations for the convenience of the user. Metal and miniature types are separately identified. Information on discontinued tube types has been included for the benefit of radio servicemen.

An added feature is the special chart which classifies RCA receiving tubes according to their functions and their cathode voltages.

Copies of Form 1275-B are 10 cents each and may be obtained from RCA distributors or direct from Commercial Engineering, Tube Department, Radio Corporation of America, Harrison, New Jersey.

SERVICE MANUAL

A complete service manual, covering every model of "Porta Power" together with full parts lists, is being offered by General Transformer Corporation of Chicago.

Designed specifically to aid radio servicemen and dealers, this manual contains full servicing information to speed repairs.

Copies will be sent to those who request them from General Transformer Corporation, 1260 West Van Buren Street, Chicago, Illinois.

ELECTRONIC COMPONENTS

Of interest to design engineers and purchasing agents is the new Catalogue 200 recently issued by Cambridge Thermionic Corporation of Cambridge, Massachusetts.

This new 20-page, tabbed-section catalogue contains specification sheets covering the company's line of terminal lugs, terminal boards, slug-tuned coils and swagers.

Copies of Catalogue 200 will be forwarded upon request to Department 8, Cambridge Thermionic Corporation, 445 Concord Avenue, Cambridge, 38, Massachusetts.

TUBE BOOKLET

Just off of the press and available from the company's distributors is the new RCA 16-page booklet, "Power and Gas Tubes for Radio and for Industry."

This booklet contains technical information on 138 RCA water- and air-cooled power tubes, voltage regulators, thyratrons, ignitrons and gas rectifiers. Each tube is covered by a text description and ample tabulated data, together with a terminal diagram.

Copies of this publication (PG-101) are available at RCA distributors or from Commercial Engineering, Tube Department, Radio Corporation of America, Harrison, New Jersey. The booklet is priced at 10 cents a copy.

HYTRON TUBE GUIDE

Hytron Radio and Electronics Corporation is currently distributing copies of their new "Reference Guide for Miniature Electron Tubes."

Designed to be inserted in regular servicing binders, this guide lists in

Men! You Need "All-Around" Training for Tomorrow's Better Jobs in



RADIO-ELECTRONICS and TELEVISION

"Learn by Doing"

A FEW FASCINATING WEEKS of STREAMLINED TRAINING

You like Radio work. But if you're really serious about making it your lifetime career, GET PRACTICAL TRAINING NOW. Don't be satisfied to putter along in a "one-operation" no-future job. Prepare for better pay and advancement with Coyne all-around training in Radio.

Many Branches Included

Here in the great shops of Coyne in Chicago, you're trained in everything from basic principles and Radio construction and Radio Servicing to F.M. (frequency modulation), public address systems, television and radio-phonographs. You can even get valuable added training in Electric Refrigeration for still more opportunities in the years ahead. Coyne gives "all-around" training! 48 years of success.

Work on Real Equipment

You work on real actual equipment and expert instructors give you necessary theory in blackboard lectures and demonstrations. In a few WEEKS you're ready for a real future!

Starting Your Own Radio Shop

Want to be your own boss, with a fine-paying radio shop of your own? We show you how to set one up and operate it successfully. Hundreds of Coyne graduates are doing it. You can, too. Send now for details.

Get the Facts—FREE!

Our new giant Radio Opportunity Book has dozens of shop pictures, facts about Radio and Television jobs, our plans to help you. Rush coupon today. No obligation; no salesman will call. You alone will decide. But don't delay. Act NOW.



B. W. Cooke

Send for Details on Our STUDENT FINANCE PLAN

If you don't have much cash, we'll arrange to finance most of your tuition and you can pay it back in easy monthly installments after you graduate. We'll even help you get a part-time job if you wish, so you can EARN WHILE LEARNING. Our LIFETIME EMPLOYMENT SERVICE is free to Coyne Graduates. Coyne Training is the finest investment you can make.

MEN WITH PHYSICAL DISABILITIES
ANY MAN WITH A PHYSICAL DISABILITY whether a Veteran or not may qualify for Coyne training at no cost to them for tuition or subsistence. Check coupon for details.

THE HOME OF
COYNE

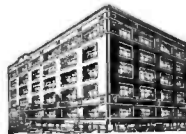

VETERANS!

Coyne is also equipped to train those who qualify for training under the G. I. Bill of Rights. Check the coupon for special G. I. Bulletin.

B. W. COOKE, Director

Founded 1899

COYNE ELECTRICAL SCHOOL

RADIO DIVISION

500 So. Paulina Street, Dept. 37-1K, CHICAGO 12, ILLINOIS

B. W. Cooke, Director Radio Div.,
COYNE ELECTRICAL SCHOOL,
500 S. Paulina St., Dept. 37-1K
Chicago 12, Ill.

I want to build a REAL FUTURE for myself. Send your big FREE BOOK on Radio, also details of your Student Finance Plan. Check if you are interested in information on the following:

- Send special G. I. Bulletin
- Send details on Physical Disability

NAME.....

ADDRESS.....

CITY..... STATE.....



Electronic Voltmeter Ohmmeter

A stable bridge circuit type vacuum tube meter for measuring AC-DC voltages and ohms. Actual tests establish its superiority. Simple to operate. Hand calibration and hand calibrated multiplier resistors assure constant accuracy and stability.

Measures DC volts up to 600 with constant input resistance of 11 megohms. Resistor in the DC probe permits readings in signal-carrying circuits. Positive or negative indications through a reversal switch. Net price, \$75.00.

Meter Ranges: DC 0-3; 0-30; 0-150; 0-300; 0-600. Multiply by 4 with external probe. AC 0-3; 0-30; 0-150; 0-300. Ohms 0-1000; 0-10M; 0-100M; 0-1 Meg; 0-100 Meg.

Thanks to your response, increased production enables us to pass this saving on to you.

New Low Price!
Formerly \$80.00 **59.50** Complete with Multiplier Probe

ELECTRONIC MANUFACTURING CO.
714 RACE STREET HARRISBURG, PENNSYLVANIA

Radio Service Man HOW MUCH IS YOUR TIME WORTH? "SAVE IT"

By using Verified Speakers and making the first installation a permanent installation.

WRIGHT, Inc.

2231 UNIVERSITY AVE.

ST. PAUL 4

MINNESOTA

ELECTRICAL TRAINING

Intensive 32 weeks' residence course in fundamentals of industrial electrical engineering, including radio, electronics. Prepares for technician, engineering aides. Approved for veteran training. 54th year. Catalogs.

BLISS ELECTRICAL SCHOOL
7698 Takoma Ave.
Washington 12, D. C.

ANTENNAS!

FM Television and Amateur Rotary Beams; Fixed Beams; 2-6-10-20 Meters. ELEMENTS, COAXIAL CABLE. Send for Circulars.

S/C LABORATORIES, INC.
20-22 Van Wagenen St., Newark 4, N. J.

easy-to-read tabular form the tube type, description, ratings, circuit applications and typical operation and characteristics of over fifty miniature tube types. Basing diagrams are also included on this single chart.

A copy of this guide may be secured by writing *Hytron Radio and Electronics Corporation*, Salem, Massachusetts.

MULTI-ANALYST

Details of the company's new "Multi-Analyst" are contained in a four-page bulletin being distributed by *Electronic Instrument Co., Inc.* of Brooklyn, New York.

This test instrument, which is suitable for all types of radio servicing including AM, FM and television receivers, is completely described and its operation explained in this free bulletin.

Copies of this publication are available from *Electronic Instrument Co., Inc.*, 926 Clarkson Avenue, Brooklyn, 3, New York.

TECHNICAL BULLETINS

Division Lead Company of Chicago has announced the availability of four new technical bulletins covering two models of wire strippers, their rosin core solder and the company's line of rosin fluxes.

Details of the wire strippers are contained in Bulletins 1-A and 2-A, while the solder is described in Bulletin 3-A. Information about the fluxes is contained in the publication designated Bulletin 4-A.

Any or all of these bulletins is available to *RADIO NEWS* readers upon request to *Division Lead Company*, 836 West Kinzie Street, Chicago, 22, Illinois.

FM PROMOTION KIT

General Electric Company's Transmitter Division is currently distributing a new, complete promotion kit for FM stations to be used in the building of local audiences.

Bound in an easy-to-handle portfolio-type cover, the kit outlines proved methods of building audiences for new FM stations. Titled "How to Build an Audience for Your New FM Station," the package covers such subjects as promotion, programming, advertising, publicity, and personnel information.

Among the ready-to-use material is a complete set of spot announcements, window banners for radio-dealer tie-ins, newspaper advertisements and the first issue of a publicity clip sheet which will be published and distributed monthly as a continuing service to purchasers of *General Electric* FM transmitters.

Prospective FM station owners and those already on the air with *GE* equipment should contact the Receiver Division, *General Electric Company*, Bridgeport, Conn. for their copy of this kit.

SANGAMO PAPER TUBULAR CAPACITORS

ARE NOW MOLDED IN PLASTIC

...just like micas!

Paper Tubular Capacitors, molded in Thermo-Setting Plastic! Designed for use in all circuits calling for Paper Tubulars. Plastic Molding means no leakage. Capacity values remain more stable and moisture is completely sealed out. No wax to run at

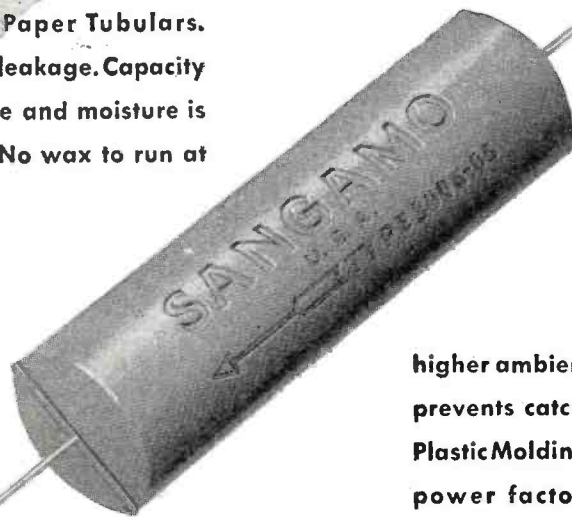

higher ambient temperatures. Smooth finish prevents catching dirt and dust. All in all, Plastic Molding assures longer life and lower power factor. Specify Sangamo Plastic Molded Capacitors wherever you use Paper Tubulars.

...try these tests

WITH SANGAMO PLASTIC TUBULARS



WRITE NOW for the New Sangamo Capacitor Catalog for full information on the Sangamo Line.

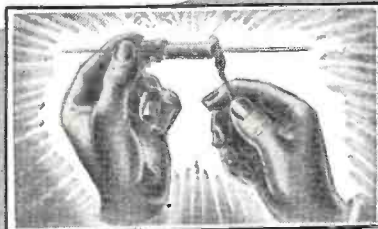

NO WAX TO MELT....even heat as intense as is encountered in soldering, will not cause leakage in the case or at the lead joint.

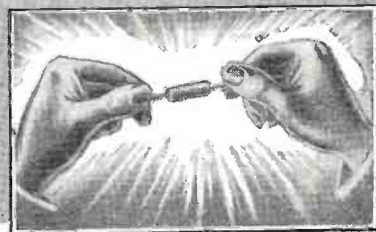

LEADS WILL NOT PULL OUT...Plastic Molding so tightly seals the leads in place, that under all conditions of normal use, leads will stay put.

SANGAMO ELECTRIC COMPANY SPRINGFIELD ILLINOIS

Bob Henry says:

MOST MODELS IN STOCK

For Immediate Delivery

Most models listed below are in stock . . . ready for immediate delivery:

- Hallcrafters S38 complete. \$ 47.50
- Hallcrafters S40A..... 89.50
- Hallcrafters SX 42..... 275.00
- Hammarlund HQ-129X and speaker..... 168.00
- Hammarlund SP-400-X and speaker..... 342.00
- National NC-2-40D (complete with speaker)..... 241.44
- National HRO-5TA1 and HRO-5RA1..... 274.35
- National NC-46..... 97.50
- National 1-10A with tubes and coils..... 67.50
- RME-45 complete..... 198.70
- RME-84 complete..... 98.70
- Pierson KP-81 complete.... 342.00
- Panoramic panadapter complete..... 99.75
- Temco 75GA transmitters.. 495.00
- Meck 60T transmitters..... 150.00
- Gordon, Amphenol, other rotary beams.
- Millen 90800 ECO..... \$42.50
- Millen 90800 exciter 37.50
- Millen 90281 power supply. 84.50
- Millen 90902 scope..... 42.50

The new Hallcrafters and Collins receivers, transmitters, VFO, etc. as fast as available. Prices subject to change.

THE delivery situation is much improved. I can make immediate delivery of most receivers and other apparatus. Take advantage of the extra service and selection you get by dealing with me, based on my reputation as the world's largest distributor of short wave receivers. Send me your order now. Send five dollars and I will ship at once C.O.D. Or order on my 6% terms. I finance the terms myself to give you better service and save you money. Trade-ins accepted. Tell me what you have to trade, and let's make a deal. Besides having all amateur receivers and transmitters, I also have a complete stock of all other amateur apparatus and parts, also test equipment, etc. I have real bargains in the really good war surplus. Write, phone, wire or visit either of my stores.

**BOB HENRY
WOARA**

HENRY RADIO STORES

**BUTLER, MISSOURI, AND
LOS ANGELES 25, CALIF.**

**"WORLD'S LARGEST DISTRIBUTORS
OF SHORT WAVE RECEIVERS"**

Around the Clock

(Continued from page 56)

EST	LOCATION	CALL	FREQ.*
12:00 noon	Br. Guiana (Caribbean News Bulletin)	AFRS	2.390
12:00 noon	Quarry Heights, Canal Zone	Radio Centre	9.610 9.740 15.360 11.630
12:00 noon	Moscow (To Britain)	Radio Centre	9.610 9.740 15.360 11.630
12:00 noon	New York	WCBN WCBX WCRC WGEO WRUL WRUW	15.270 17.830 21.570 15.330 15.290 17.750
	Schenectady Boston	WRUL WRUW	6.100 6.170 7.290
	Via Munich, Germany		6.100 6.170 7.290
12:00 noon	Munich (Frankfurt), Germany	AFN	6.080
12:15 p.m.	Hamburg, Germany	BFN	7.290
12:30 p.m. (Thurs. only)	Omdurman, Anglo-Egyptian Sudan	Radio	13.320 9.650I
12:30 p.m. (except Sun.)	Johannesburg, So. Africa		6.095 3.450
12:40 p.m.	Stockholm	SBT SDB-2 SBP	15.155 10.780 11.705I
12:45 p.m.	Ankara, Turkey	TAP	9.465
1:00 p.m.	Nairobi, Kenya (BBC)	VQ7LO	4.950 6.060
1:00 p.m.	Hamburg, Germany	BFN	7.290
1:00 p.m.	Accra, Gold Coast (BBC)	ZOY	4.915
1:00 p.m.	Salzburg, Austria (AFRS)	KOFA	7.220
1:00 p.m.	London (GOS, Twenty-Four Hour News, followed by Home News from Britain at 1:10 p.m.)	GVR GWG GSP GVX GSO GRF GSF GRH GSD GVS GVZ GSI GSI GVW GRY GSN	21.675 15.110 15.310 11.930 15.180 12.095 15.140 9.825 11.750 21.700 9.640 15.260 11.700 9.600 11.820
1:00 p.m.	London (AS)	GSN	11.820
1:00 p.m.	Montreal, Que.	CFCX	6.005
1:15 p.m.	Vatican	HVJ	9.660 5.970V 15.095I
1:25 p.m.	Nairobi, Kenya	VQ7LO	4.950 6.060
1:30 p.m.	Winnipeg, Manitoba	CKRK	11.720
1:45 p.m.	Brazzaville	FZI	9.440 11.970 17.530VI
1:50 p.m.	Milan (Originating in Rome)	Radio Italiana	11.810 9.630
2:00 p.m.	Cincinnati	WLWR1 WLWO WLWR	15.250 15.350 17.800
2:15 p.m.	Montreal, Quebec (To Europe)	CKCS CHOL	15.320 11.720
2:20 p.m. (except Sat.)	Bern (To North America)	HEI7	18.325V
2:30 p.m.	London (AS, Radio Newsreel)	GVW GRY GSN	11.700 9.600 11.820
2:45 p.m.	Montreal, Quebec (To Europe, Canadian Commentary)	CKCS CHOL	15.320 11.720
2:55 p.m.	Lourenco Marques, Mozambique	CR7AA CR7BJ CR7AB CR7BD	5.860 9.645I 3.493 15.230
3:00 p.m. (except Fri.)	Capetown, So. Africa (SABC)	Johannesburg (SABC)	6.095 3.450 7.290
3:00 p.m.	Hamburg, Germany	BFN	7.290
3:00 p.m. (Sun. 3:35 p.m.)	Madrid	RNE	9.389
3:00 p.m.	London (GOS)	GWG GRF GSE GWA GRH GSD GRW GVZ GSO	15.110 12.095 9.510 6.125 9.825 11.750 6.150 9.640 15.180
3:00 p.m.	Georgetown, Br. Guiana (BBC)	ZFY	6.000

3:00 p.m.	Halifax, Nova Scotia	CHNX	6.130
3:30 p.m.	Sofia, Bulgaria	Radio Sofia	9.390 7.670
3:30 p.m.	Belgrade, Yugoslavia	Radio Belgrade	6.100V
3:30 p.m.	Prague	OLR2A	6.010
3:45 p.m.	London (AS)	GVW GRY GSN	11.700 9.600 11.820
3:45 p.m.	Brassaville	FZI	9.440 11.970 17.530V
3:45 p.m.	Munich, Germany		6.100 6.170 7.290 5.877V
3:45 p.m.	Capetown, So. Africa (BBC)	Johannesburg (BBC)	6.095 3.450
3:50 p.m.	Bern	HERS	11.865
3:50 p.m.	Warsaw	Radio Polskie	6.115V
4:00 p.m.	United Network, U.S.A.	KNBA KCBF KWID KNBX KCBA	21.610 17.850 17.780 15.340 15.240
4:00 p.m.	Melbourne (To Britain, Europe)	VLA4	11.770
4:00 p.m.	London (GOS, Radio Newsreel)	GRF GWA GVZ GRW GVY	12.095 6.125 9.640 6.150 11.955
4:15 p.m.	New York	WCBX WCRC WGEO WRUL WRUW TAP	9.490 11.830 15.330 15.290 11.730 9.465
4:30 p.m. (Mon., Thurs. Sun., Postbag)	Ankara, Turkey to Britain: (Talk)		
4:30 p.m.	London (European Service)	GSW GWL GRO GRG	7.230 7.210 6.180 11.680
4:45 p.m.	Montreal, Quebec (To Europe)	CHOL CKLO	11.720 9.630
4:45 p.m.	London (NAS)	GWH GSC GRH	11.800 9.580 9.825
4:45 p.m.	Melbourne (To Forces (To Britain, Europe)	VLB6 VLC10 VLA4	15.200 21.680 11.770
5:00 p.m.	Los Angeles (AFRS)	KGEI KGEX	15.130 15.210
5:00 p.m.	Via Honolulu	KRHO	17.800
5:00 p.m.	United Network, U.S.A.	KNBA KCBF KWID KNBX WBOS KCBA	21.610 17.850 17.780 15.340 15.250 15.240
5:00 p.m.	Hamburg, Germany	BFN	7.290
5:00 p.m.	Moscow (To Britain)	Radio Centre	6.160 7.300 7.330 9.680
5:00 p.m.	Via Kiev		6.020
5:00 p.m.	Halifax, Nova Scotia	CHNX	6.130
5:00 p.m.	Munich (Frankfurt), Germany	AFN	6.080
5:00 p.m.	Salzburg, Austria (AFRS)	KOFA	7.220
5:00 p.m.	Quito, Ecuador (Relayed from United Network, U.S.A.)	HCJB	12.455 15.115 9.958
5:05 p.m.	Los Angeles (AFRS, At Dictation Speed)	KGEI KGEX	15.130 15.210
5:15 p.m.	Via Honolulu	KRHO	17.800
5:15 p.m.	Brazzaville (To Britain)	FZI	9.440 11.970 9.984 6.024
5:15 p.m.	Kingston, Jamaica (World News)	ZQI	4.700
5:30 p.m.	Halifax, Nova Scotia	CHNX	6.130
5:30 p.m.	St. John's Newfoundland	VONH	5.970
5:30 p.m.	Edmonton, Alberta	VE9A1	9.540
5:30 p.m.	London (European Service)	GSA GRJ	6.090 7.320
6:00 p.m.	London (GOS)	GSE GWA GRH GSD GVY ZFY	9.510 6.125 9.825 11.750 11.955 6.000
6:00 p.m.	Via Georgetown, Br. Guiana		
6:00 p.m.	Los Angeles (AFRS)	KNBA KNBI KCBR	21.610 17.770 15.330

(Continued on page 112)

TELEVISION-

*Does it Hold
A Future
For You?*

SPECIAL INVITATION TO WAR VETERANS

With extensive new training facilities under the personal supervision of the famed inventor of the radio vacuum tube, Dr. Lee de Forest, we are able to accept additional applications from Veterans for Television training under the G.I. Bill of Rights. For qualified men who are seriously considering entering a residence school, we have a limited number of Home Study Courses which are available free of charge. Your success with this course will not only help you to decide your own future in Television but will also aid us greatly in qualifying you for residence training.

Send your name and address for your Eligibility Questionnaire. If you qualify under the simple rules, you may start your Home Study Television Course at once and entirely without cost or obligation to you.

American Television Laboratories, Inc.

5050 BROADWAY • CHICAGO 40, ILLINOIS

CLARION SOUNDMIRROR*

*Trade Mark Reg. U.S. Pat. Off.—Patents Pending

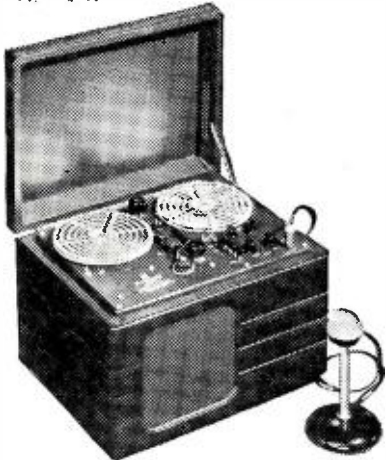

THE BRUSH MAGNETIC HOME RECORDER-REPRODUCER is a completely self-contained unit. Having its own speaker, amplifier, and microphone. One-half hour recording time on reels of magnetic recording tape. Tape is erasable, re-usable. Simply plug into AC line.
Price F.O.B. \$229.50

Mail-A-Voice

Model BK-501. "Letters" can be folded and mailed! Records magnetically on coated paper discs. Self contained amplifier, mike, compact carrying case. Ready to record and playback.
For 110 volt, 60 cycle AC use... \$49.50
Twenty Recording Blanks..... 1.45

ALTEC LANSING



603 DIA-CONE 15-Inch*

Model 604 DUPLEX. Full 2-way multi-cellular speaker that reproduces the entire FM range, from 50 to 15,000 cycles, without intermodulation or distortion.
Model 603 DIA-CONE: (illustrated) Follows close at the heels of the Duplex in quality, but easier on your budget.
Model 600 DIA-CONE: High fidelity in a smaller-sized, lower priced speaker.
AMPLIFIERS: A comp. line of quality equip.
TRANSFORMERS: Input, interstage, and output. Transmission range of 20-20,000 cycles (±1 db).
* Models 603 and 600 employ the exclusive Dia-Cone principle, reproducing high and low freq. from separate diaphragms.

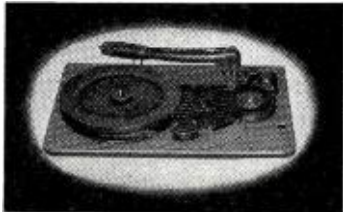

The CLARION MAGNETIC WIRE RECORDER Model A. One full hour of recording. Full range fidelity in recording and reproduction. Records from standard phono records, radio and microphone. ALL YOU NEED IS A RADIO OR AMPLIFIER. Model A (as illustrated) with Crystal Mike, Spool of Wire, 40 K.C. Oscillator, Schematic Diagrams, Instruction Manual. F.O.B. \$97.50
Additional Spools Wire..... 5.50
Write for Prices & Additional Information
SEND FOR OUR BARGAIN FLYER
30% Deposit with C.O.D.'s
Many other items and specialties. QUALITY SOUND & RECORDING EQUIPMENT.
CLARION SOUND ENGINEERING CO.
363 Victory Blvd., Staten Island 1, N. Y.
Gibraltar 7-8033

EST	LOCATION	CALL	FZEO.*				
		KWIX	15.290	8:00 p.m.	London (NAS)	GWH	11.800
		KGEI	15.130			GSC	9.580
		KGEK	15.210			GRH	9.825
		KRHQ	17.800			GSL	6.110
6:00 p.m.	Via Honolulu	KCBF	17.850	8:00 p.m.	London (GOS,	GSB	9.510
	United Net-	KWID	17.760		followed	GRW	6.190
	work, U.S.A.	KNBX	15.340		irreg. by	GSD	11.750
		WBOS	15.250		Home News	GWA	6.125
		KCBA	15.240		from Britain		
		KOFA	7.220		at 8:10 p.m.)		
6:00 p.m.	Salzburg, Aus-			8:00 p.m.	Georgetown,	ZFY	6.000
	tria (AFRS)				Br. Guiana		
6:00 p.m.	Quarry	AFRS	2.390		(BBC)		
	Heights,			8:05 p.m.	Stockholm (To	SBU	9.535
	Canal Zone				North	SDB-2	10.780
6:00 p.m.	Halifax, Nova	CHNX	6.130		America)		
	Scotia			8:10 p.m.	Leopoldville	OTC2	9.745V
6:25 p.m.	Kingston,	ZOI	4.700		(To North		
(except Sun.)	Jamaica				America)		
	(Headlines)			8:15 p.m.	Colon, Panama	HP5K	6.005
6:25 p.m.	Moscow (To	Radio	11.890V	8:30 p.m.	Moscow (To	Radio	7.300
	North	Centre	9.480		North	Centre	7.240V
	America)		7.240V		America)		9.480
			7.300		Via Kiev		6.020
			7.360	8:30 p.m.	Rangoon,	Radio	9.543
			15.230		Burma	Rangoon	
	Via Komsomolsk		6.020		(Headlines)		
6:30 p.m.	Montreal,	CKRZ	6.060	8:45 p.m.	Bern (To	HER3	6.165I
	Quebec (To	CKRA	11.750	(except Sat.)	North	HEI4	9.539
	Latin America)				America)	HER5	11.865I
6:30 p.m.	Sydney, Nova	CJCK	6.010	9:00 p.m.	Honolulu	KRHQ	17.800
	Scotia				(AFRS)		
6:30 p.m.	Toronto,	CFRX	6.070	9:00 p.m.	United Net-	KCBF	17.850
	Ontario				work, U.S.A.	KNBX	15.340
6:30 p.m.	St. John's	VONH	5.970			WBOS	15.250
(irreg.)	Newfoundland					KCBA	15.240
	(Messages)					KCBR	11.790
6:45 p.m.	London (NAS)	GWH	11.800	9:00 p.m.	Colombo, Cey-	KWID	9.570
		GSC	9.580		lon (BBC)	Radio	4.900
		GRH	9.825	9:00 p.m.	Quarry	Colombo	
7:00 p.m.	Brazzaville (To	FZI	9.440		Heights,	AFRS	2.390
	North		11.970		Canal Zone		
	America)		9.984	9:00 p.m.	Edmonton,	VE9AI	9.540
7:00 p.m.	London (GOS,	GSB	9.510		Alberta		
	Radio	GSD	11.750	9:00 p.m.	Paris (To	RNF	9.550
	Newsreel)	GVY	11.955		North		11.845V
		GRW	6.150		America)		9.520I
7:00 p.m.	Los Angeles	KNBA	21.610	9:00 p.m.	Kingston,	ZOI	2.330
(AFRS)		KNBI	17.770	(Sun. only?)	Jamaica		
		KCBR	15.330	9:00 p.m.	St. John's,	VONH	5.970
		KWIX	15.290		Newfoundland		
	Via Honolulu	KRHQ	17.800		Sydney, Nova	CJCK	6.010
7:00 p.m.	United Net-	KCBF	17.850		Scotia		
	work, U.S.A.	KWID	17.760	9:20 p.m.	St. John's	VONH	5.970
		KNBX	15.340	(irreg.)	Newfoundland		
		WBOS	15.250	9:30 p.m.	Delhi	AIR	15.190
		KCBA	15.240				7.290
		WLWO	11.790				6.190
7:00 p.m.	Melbourne (To	WRUW	9.550				9.670
	East U.S. and	VLA9	21.600				11.760
	Canada)						6.150
7:00 p.m.	Moscow (To	Radio	11.890V		Bombay		6.085
	North	Centre	9.480		Madras		6.010
	America,		7.240V	9:30 p.m.	Calcutta		9.510
	Moscow		7.300		London (GOS)	GSB	11.955
	Newsreel)		7.360	10:00 p.m.		GVY	15.120
	Via Komsomolsk		6.020	10:00 p.m.	Colombo, Cey-	Radio	6.075
	Prague (to	OLR5A	15.230	10:00 p.m.	Colon, Panama	HP5K	6.005
(irreg.)	North America)			10:00 p.m.	Quarry	AFRS	2.390
7:15 p.m.	Prague (to	OIX2	9.505V		Heights,		
(or 7:25 p.m.)	Finland	OIX4	15.190	10:00 p.m.	Canal Zone		
(ti),	(To North			10:00 p.m.	Honolulu	KRHQ	17.800
	America)			10:00 p.m.	(AFRS)		
7:15 p.m.	Leopoldville	OTC2	9.745V	10:00 p.m.	Sydney, Nova	CJCK	6.010
(To North				10:00 p.m.	Scotia		
America)				10:00 p.m.	Vancouver,	CBRX	6.160
7:15 p.m.	Georgetown,	ZFY	6.000	10:00 p.m.	B. C.		
	Br. Guiana			10:00 p.m.	London (GOS,	GSB	9.510
	(Caribbean News				Twenty-	GSD	11.750
	Bulletin)				Four Hour	GRW	6.180
7:30 p.m.	Winnipeg,	CKRX	11.720		News)	GSL	6.110
	Manitoba					GRH	9.825
7:30 p.m.	Moscow (To	Radio	7.300	10:00 p.m.	Melbourne	VLG5	11.880
	North	Centre	7.240V	(To Forces)		VLC9	17.840
	America)		9.480	10:30 p.m.	Paris (To	VLA9	21.600
	Via Kiev		6.020		North	RNF	9.590
7:30 p.m.	London (NAS,	GWH	11.800		America)		11.845V
	Radio	GSC	9.580	10:30 p.m.	Delhi	AIR	9.522I
	Newsreel)	GRH	9.825				15.190
		GSL	6.110				21.510
8:00 p.m.	Los Angeles	KNBA	21.610	10:45 p.m.	Panama City	HOXA	15.100
(AFRS)		KNBI	17.770	11:00 p.m.	Honolulu	KRHQ	17.800
		KCBR	15.330		(AFRS)		
		KWIX	15.290	11:00 p.m.	Quarry	AFRS	2.390
	Via Honolulu	KRHQ	17.800		Heights,		
8:00 p.m.	United Net-	KCBF	17.850		Canal Zone		
	work, U.S.A.	KNBX	15.340	11:00 p.m.	London (GOS,	GWA	6.125
		WBOS	15.250		followed by	GRY	9.600
		KCBA	15.240		Home News	GRX	9.890
		WLWO	11.790		from Britain	GSB	9.510
		KWID	9.570		at 11:05	GSD	11.750
		WRUW	9.550		p.m.)	GWO	9.625
8:00 p.m.	St. John's	VONH	5.970	11:00 p.m.	Colombo, Cey-	Radio	15.120
	Newfoundland				lon)	SEAC	6.075
8:00 p.m.	Quarry	AFRS	2.390	11:00 p.m.	Winnipeg,	CKRO	6.150
	Heights, Canal				Manitoba		
	Zone			11:15 p.m.	London (GOS,	GWA	6.125
8:00 p.m.	Moscow (To	Radio	7.300		Radio	GRK	9.690
	North	Centre	7.240V		Newsreel)	GSB	9.510
	America,		9.480			GSD	11.750
	Moscow Newsreel)		6.020			GWO	9.625
	Via Kiev		5.120				
8:00 p.m.	Colombo,	Radio	6.075				
	Ceylon	SEAC	6.075				
	(BBC)		7.185I				

(Continued on page 114)

General Electric RT-1248 15-Tube Transmitter-Receiver

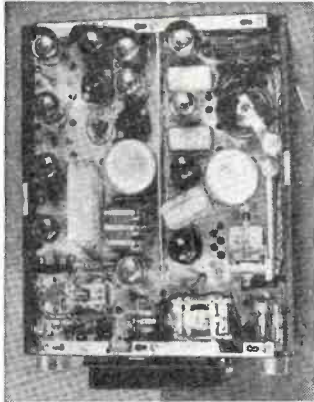

TERRIFIC POWER (20 watts) on any 2 instantly selected, easily pre-adjusted frequencies from 435 to 500 Megacycles. Transmitter uses 5 tubes including a Western Electric 316 A as final. Receiver uses 10 tubes including 955's as first detector and oscillator, and 3-7H7's as IF's, with 4 slug-tuned 40 MC. IF transformers, plus a 7H7, 7E6's, and 7F7's. In addition unit contains 8 relays designed to operate any sort of external equipment when actuated by a received signal from a similar set elsewhere. Originally designed for 12V operation, power supply is not included, as it is a cinch for any amateur to connect this unit for 110V AC, using any supply capable of 400V DC at 135 MA. The ideal unit for telephone use as in a taxicab, or for any kind of remote control applications as with drone airplanes. Instructions and diagrams supplied for running the RT-1248 transmitter on either code or voice, and for using the receiver as either an AM or FM set. As an FM set, the receiver section of the 1248 is capable of better results than almost any of the commercial FM sets on the market, largely as a result of the superb engineering and meticulous workmanship employed in constructing the converter, oscillator and IF sections. Your cost \$29.95.

Supplied in original cartons with 15 tubes. 10% less if ordered in lots of 2 or more. If desired for marine or mobile use, the dynamotor, which will work on either 12 or 24 V.D.C. and supply all power for the set, is only \$15.00 additional.

BENDIX SCR-522—Very High Frequency Voice Transmitter-Receiver—100 to 156 MC. This job was good enough for the Joint Command to make it standard equipment in everything that flew, even though each set cost the Gov't \$2500.00. Crystal Controlled and Amplitude Modulated—High Transmitter Output and 3 Microvolt Receiver Sensitivity gave good communication up to 180 miles at high altitudes. Receiver has 10 tubes and transmitter 7 tubes, including 2-832's. Furnished complete with 17 tubes, and D.C. Dynamotor power supply for 12 or 24 volts, also remote control boxes and cable connectors. We include complete diagrams and instructions for the simple conversion of the 522 to full 110 Volt 60 Cycle operation. Your cost—\$44.50.

General Electric 150-Watt Transmitter

Cost the Government \$1800.00. Now Only \$44.50!!!
(Can be used by amateurs without any changes or modifications!)

This is the famous transmitter used in U. S. Army bombers and ground stations during the war. Its design and construction have been proved in service, under all kinds of conditions, all over the world. The entire frequency range is covered by means of seven plug-in tuning units which are included. Each unit has its own oscillator and power amplifier coils and condensers, and antenna tuning circuits—all designed to operate at top efficiency within its particular frequency range. Transmitter and accessories are finished in black crackle, and the milliammeter, voltmeter, and RF ammeter are mounted on the front panel. Here are the specifications: **FREQUENCY RANGE:** 200 to 500 KC and 1500 to 12,500. (Will operate on ten and twenty meter band with slight modification). **OSCILLATOR:** Self-excited, thermo compensated, and hand calibrated. **POWER AMPLIFIER:** Neutralizes class "C" stage, using 211 tube, and equipped with antenna coupling circuit which matches practically any length antenna. **MODULATOR:** Class "B"—uses two 211 tubes. **POWER SUPPLY:** Supplied complete with dynamotor which furnishes 1000 volts at 350 MA. Complete instructions are furnished to operate set from 110V AC. **SIZE:** 21 1/2 x 23 x 9 1/4 inches. Total shipping weight, 250 lbs., complete with all tubes, dynamotor power supply, seven tuning units, antenna tuning unit and the essential connector plugs. These transmitters are priced to move fast; order today, and be the proud owner of one of the finest rigs obtainable.

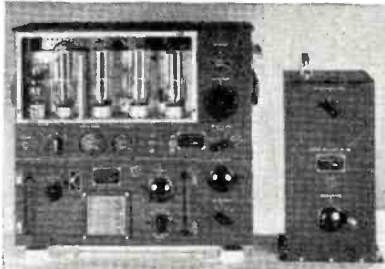

Six Band Communications Receiver BC-348 R

Featuring coverage from 200 to 500 KC and 1500 to 1800 KC on a direct reading dial with the finest vernier drive to be found on any radio at any price—extreme sensitivity with a high degree of stability—crystal filter—BFO with pitch control—antenna compensation—standard six volt tubes. Contains a plate supply dynamotor in compartment within the handsome black crackle finish cabinet, the removal of which leaves plenty of room for installation of a 110V, 25 or 60 cycle power supply. These receivers, which make any civilian communications receiver priced under \$200.00 look cheap and shabby by comparison, are only \$44.50. Power supply kit for conversion to 110V, 25 or 60 Cycle is only \$8.50 additional.

274 N COMMAND SETS, including 3 separate 6 tube superhet receivers, 2 separate transmitters, each with 40 watts output, and a 24 V. dynamotor unit. Barstain price for all 6 pieces complete with tubes—\$39.95.

Instrument Bargains of a Lifetime!!!!

NEW BC-221 FREQUENCY METERS with calibrating crystal and calibration charts. A precision frequency standard that is useful for innumerable applications for laboratory technician, serviceman, amateur, and experimenter, at the give-away price of only \$39.95.
RADAR OSCILLOSCOPES—Complete with 27 tubes including 5" cathode ray tubes—\$39.95.
RADAR RECEIVER INDICATOR OSCILLOSCOPES—Complete with 29 tubes including 3" cathode ray tubes—\$39.95.

AIRCRAFT MARKER BEACON RECEIVER—Complete with 3 tubes and sensitive relay to control external circuits from received signals. Just the receiver you have been waiting for to control models, open doors from a distance, etc. Priced at only \$4.95.
AIRPLANE INTERCOM AMPLIFIER—Complete with 4 tubes in aluminum case—\$4.95.

BC-654 Transmitter-Receiver—Brand new, complete with 200 Kc. calibrating crystal and 17 tubes—\$39.95.

SERVICEMEN

Check This Column for Lowest Prices on Quality Parts

TUBES: A warehouse full, including the new miniatures. Order all types you need. We'll try to supply you completely. Special this month: Sylvania 6V6Gt—\$3 for \$2.00; RK-75 or 307 Transmuting tubes only \$2.50 each; 6L6G—99¢; 8SDT (replaces 6SK7)—59¢.
POWER TRANSFORMERS—Half-shell type, 110V 60 cy. Centertapped HV winding. Specify either 2.5 or 6.3V filament when ordering.
For 4-5 tube sets—650V, 40MA, 5V & 2.5 or 6.3V...\$1.49
For 5-6 tube sets—650V, 45MA, 5V & 2.5 or 6.3V... 1.75
For 6-7 tube sets—675V, 50MA, 5V & 2.5 or 6.3V... 1.90
For 7-8 tube sets—700V, 70MA, 5V & 6.3 or two 2.5... 2.35
For 9-11 tube sets—700V, 100MA, 5V & 6.3 or two 2.5V 2.85
For 9-15 tube sets: 600V, 150MA; 5V & 6.3V... 2.95
TRANSFORMERS—All types in stock. **AUTO-TRANSFORMERS:** Steps up 110v to 220v, or steps down 220v to 110v—\$1.95. **FIL. TRANS.:** 6.3v, 8 Amps.—\$1.99; 5v, 10 Amps.—\$1.99. **Universal Output Trans.** 8 Watt—89¢; 13 Watt—\$1.29; 30 Watt—\$1.89. **AUDIO TRANSFORMERS:** S. Plate to S. Grid: 3:1—79¢; S. Plate to P.P. Grids—79¢; Heavy Duty Class AB or B, P.P. Inputs—\$1.49; Midget Output for AC-DC sets—69¢; **MIKE TRANSFORMER** for T-17 Shure microphone, similar to UTC uncancer type—\$2.00.
MICROPHONES—All types, nationally known brands. Bullet crystal—\$5.45; Bullet Dynamic—\$7.45; Mike Jr.—60¢; Handy Mike—90¢; Lapel Mike—93¢; Shure T-17 Mikes, with push to talk switch—99¢.
CONDENSERS—**PAPER TUBULAR** 600 WV—001—8¢; .002—8¢; 005—8¢; .01—9¢; .02—9¢; .05—10¢; 1—10¢; 25—25¢; 5—36¢; **ELECTROLYTICS:** 8mf, 200v—20¢; 10mf, 35v—20¢; 30mf, 150v—23¢; 20/20mf, 150v—35¢; 30/20mf, 150v—46¢; 50mf, 150v—48¢; 3mf, 475v—35¢; 16mf, 350v—65¢. **OIL-CONDENSERS:** 4mf, 600v—49¢; **VARIABLE CONDENSERS:** 3 gang 350mf—83¢; 7.5-20mf, 1750v. Extra long shaft Hammarlund—only 69¢; Miniature Variable condensers: 25mf—39¢; 50mf—49¢; 75mf—49¢; 100mf—54¢; 140mf—69¢.
PERMEABILITY TUNERS—Attractive slide-rule dial, compactly replaces dial, tuning condensers, oscillator and antenna coils in broadcast band receivers. Special \$3.43.
WILLARD rechargeable 2 volt storage batteries for G.E. portable radios \$2.95.
SPEAKERS—PM dynamic type—4"—\$1.55; 5"—\$1.55; 6"—\$1.95; 8"—\$3.95; 10"—\$5.95; 12"—\$7.50.
CRYSTAL PICK-UPS—Two nationally known makes, one \$1.90, the other at \$2.29.
PHONO-MOTORS—110V, 60 Cycle, with turntable—\$4.25.
HEADPHONES—Highest quality Signal Corps headsets with sponge rubber ear cushions. 12" cord and plug \$1.00. 5" rubber covered patchcords with phone plug and socket—25¢.
RELAYS—Guardian SPST 12-24v, has heavy duty 15 Amp. Contacts—\$1.25; Guardian 12 to 24v D.C. triple make, single break relay, 5 for \$3.75; Sigma supersensitive 2000 ohm D.C. SPDT itelay. (May be adjusted to operate on less than 1 Milliamperes)—\$2.50.
SELENIUM RECTIFIERS—Dry disc type 1 1/2" by 1", 1.2 Amp. maximum, suitable for converting DC relays to AC, for supplying filament source in portable radios, converting DC meters to AC applications, and also may be used in low current chargers—90¢.
METER RECTIFIERS—Full wave, may be used for replacement, or in construction of all types of test equipment—\$1.25. Half Wave—90¢.
FILTER CHOKES—200, 300, 400, 500 ohm light duty—59¢; 200 ohm hvy. dty.—99¢; 250 MA, 35 ohms DC res. Made for U. S. Navy. Fully shielded—\$1.95.
LINE FILTERS—110v—each unit contains two 2 mfd. oil filled condensers and a 15 amp. iron core choke. This filter has innumerable uses such as oil burner line filter, etc. A ten dollar value for 99¢.
PHONO AMPLIFIERS—A real AC, 110V, 60 Cycle, 6 Watt Amplifier suitable for PA systems and phonographs; with a husky power transformer. Complete with tubes—\$12.95.
PUBLIC ADDRESS AMPLIFIERS—25 Watts peak output, 5 tubes, separate controls for Microphone and Phono Inputs. \$65.00 value for only \$32.00.
WIRE—No. 18 POG 2 conductor parallel zipcord, brown. 250' spools—\$5.25, 500' spools—\$9.95. No. 18 PO brown rayon covered parallel lampcord, 500' spools—\$12.25. No. 18 SV round rubber covered double wire for wash machines, vacuum cleaners, etc. 250' spools—\$6.95. Rubber covered mike cable 250' spools—\$23.00. All kinds hook-up wire 10 per ft., transmission line, 50 ohm impedance 100ft., cut to any length, 8c per ft. Single stranded conductor shielded lead with brown rubber over shield, super special, \$1.20 per 100 ft., \$10.00 per 1000 ft.
PORTABLE AIR COMPRESSOR—Attaches to any 1/4 H.P. motor. Just the thing for refinishing radios, painting cars, blowing out chassis, etc. 100 lb. gauge and syphon type gun with 12 1/2 feet of rubber hose included. Pressure adjustable to stay constant at any value up to 100 lbs.—Net price—\$22.25 prepaid.

Famous Collins Autotune Transmitter

This is the well known unit used in Army and Navy planes that features automatic motor tuning of any of 11 front-panel pre-selected frequencies up to 18,100 Kc., as well as the manual tuning possible any time. The transmitter operates on voice, CW, and MCW on all frequencies. This beautifully designed unit uses an 813 final, and push-pull 611's as modulator, measures 2 3/4 x 13 3/4 x 11, and weighs 70 lbs. Estimated average power output is 150 Watts. Plans provided for easy 110v. conversion. Complete with 24v. dynamotor & all tubes & connectors, only \$139.95.

110 Volt Power Plant

110V, 60 Cycle generator direct-connected to gasoline engine. Worth a million for emergency or standby service for hospitals, theaters, hotels or for general service in hunting lodges, camps or boats. Can gift at \$175.00. We can also supply the above unit for the same price with a direct coupled 32 volt D.C. generator, in which case we include absolutely free our \$29.95 32 Volt D.C. to 110 Volt A.C. converter which can also be used to supply 110V. A.C. from batteries or farm lighting plants.

RADIOMEN'S HEADQUARTERS WORLD WIDE MAIL ORDER SERVICE!!!

MILO

Your "Q" for Quality

Famous SIMPSON

#215 VOLT-OHM MILLIAMMETER

5000 Ohms per Volt Resistance Ranges to 4 megohms Current Ranges 0-250 microamps to 500 MA Voltage Ranges to 5000 Volts D.B. range minus 12 to plus 3 Can also be used as output meter



Complete with Leads \$32.50

SUPREME 542

4 DC Mil ranges DC Volt range from .1 V. to 1500 V. 4 resistance ranges .1 Ohm to 2 megs. 4 AC Volt Ranges .1 V. to 600 V. 4 output ranges 0-6 to 600 4 D.B. ranges of -6 to +50 Built for Punishment and Accuracy



\$26.15

VOLOMETER #100

Made by Electronics Measurement Corp.

6 D.C. Volt Ranges 0-3 to 6000 Volts (1000 Ohms per V.) 6 AC Volt ranges (1000 Ohms per V.) 0-3 to 6000 Volts 4 DC current ranges 0-6 to 600 mils. 3 Resistance ranges 0-3000 to 30 megohms. 4 D.B. ranges -10 to plus 8-20-34-48



\$21.95

Federal 100 MA Rectifiers Replace 29 rectifier tubes. Instant Rectification Replaces Power Transformer in Voltage Doubler Circuits. Technical literature, including Circuit application with every order. 1-5 \$1.09 6-49 \$0.99 In Stock - Immediate Delivery

- Famous Make 45 Volt battery for portables \$1.35
• Ohmite 25 watt 15 ohm rheostat .59
• Ward-Leonard 25 watt 25 ohm rheostat .59
• 6.3-6 Amp Heavy duty filament trans. 1.96
• Clarostat 1000 Ohm V C .29
• Mica 5000 Volt Test .0039 mfd. .29
• Mica 1200 Volt Test .01 mfd. .29
• Mica 600 Volt Test .01 mfd. .19
• DPST 12 amp. toggles .59

(\$2 minimum order on above items) Do you have a tube problem? Let Milo solve it - quickly. We carry a complete line of Famous Tung-Sol tubes. Rider Manuals in Stock.

MILO

If not rated, 20% with order, balance C. O. D. Dept. N

Radio and Electronics Corp.

200 Greenwich St., N. Y. 7, N. Y. BEekman 3-2980-1

(Cable Address) "MILOLECTRO NEW YORK"

Table with 8 columns: EST, LOCATION, CALL, FREQ., EST, LOCATION, CALL, FREQ. It lists various radio stations and their frequencies across different time slots and locations.

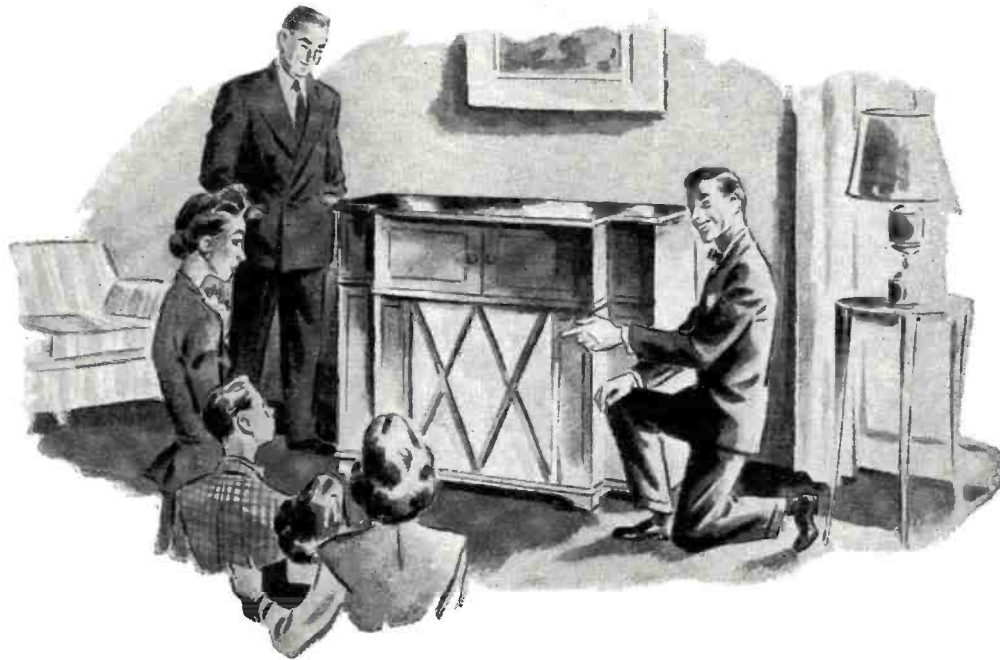

Try This!

Call those of your customers who own fine radios—*people to whom you have sold radios or homes in which you have serviced radios*. Tell them you have a speaker that will make their old sets sound as fine as any brilliant 1947 model. Arrange to demonstrate this Altec Lansing speaker* in their homes. Suggest that they invite neighbors and friends to witness the amazing demonstration. The Altec Lansing Dia-Cone will so greatly improve tone quality and performance that further sales talk will be unnecessary.

Model 600 Dia-Cone



12-inch speaker

*Designed for installation in those fine sets where ultra-high fidelity sound reproduction is desired. This speaker employs the exclusive Dia-Cone principle, reproducing high and low frequencies from separate diaphragms.

ASK YOUR JOBBER ABOUT AVAILABILITY OF THIS SPEAKER.

ALTEC

LANSING CORPORATION

1161 N. Vine St., Hollywood 38, Cal.
250 W. 57th St., N. Y. 19, N. Y.

"KEEP ADVANCING WITH ALTEC LANSING"

FOR THE FINEST IN BROADCAST RECEPTION
THE COLLINS 25-C BAND PASS

HIGH FIDELITY TUNER

BETTER
THAN
20 KC
BAND WIDTH

●
DELAYED,
AMPLIFIED
A.V.C.

●
VOLTAGE
REGULATED
POWER
SUPPLY

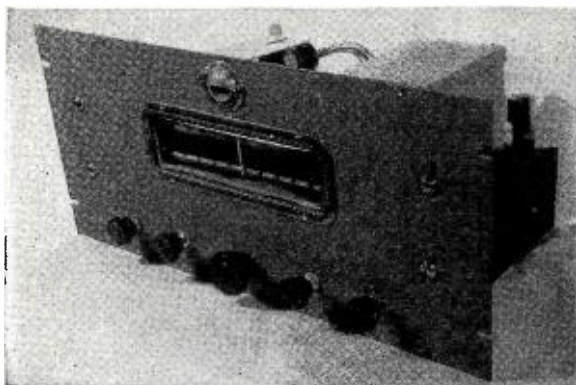

10 KC
FILTER

●
550-1600
KC
COVERAGE

●
8 TUBE
CIRCUIT

DELIVERY OF THE 25-C FROM STOCK

Watch for Our Custom High-Fidelity FM and FM-AM Tuners

We have a complete line of Speech Input Equipment
for FM Broadcasters and Recording Studios

COLLINS AUDIO PRODUCTS CO.

126 PARK ST.

WESTFIELD, N. J.



Low Cost Precision

Bridge type construction assures ruggedness and continued accuracy.

Manufacturers who use large quantities of meters are continually swinging over to DALE Instruments. In addition to our standard models, we also build meters to your specifications. Special dials—Special cases. PROMPT deliveries. You may depend upon our delivery promises. Prices you want to pay.

DALE Instruments—Div. of ELECTRONIC DEVELOPMENT CO.

4412 N. 23RD ST.

OMAHA, NEBRASKA

U.S.A.

METERS



2 1/2" and 3 1/2"
ROUND

2" and 3"
SQUARE



4 1/2" Rectangular

Farm Markets

(Continued from page 62)

An indication as to the possible consumption of electricity on farms might be found in Benton County, Iowa. This relatively prosperous county has had power-line service to a large percentage of its farms for several years. The monthly consumption of rural electricity users in that county is 462 kilowatt hours each. And even in this county, users indicate that they are not using as many appliances as they would like, or will be using once equipment becomes available. Many Benton County farm homemakers, for example, are anxiously awaiting the day when they can replace the old cob burner in the kitchen with a fancy new electric range.

In spite of the most optimistic estimates of possible farm consumption, many farmers now find their original wiring installations are already falling far short of carrying the load—both in the home and around the farm buildings. Right now, thousands of farmers are having their service installations revamped—heavier wire, more circuits, more power outlets. They find needs for electric power that they never dreamed of when electricity first came to their farms.

Then they were thinking of electric lights, a few small motors, and household gadgets—maybe even an electric refrigerator. Nowadays, they're thinking about large motors on the elevator and feed grinder, a milk cooler, welding equipment, ventilating systems and artificial drying for hay and grain crops. And the good woman is thinking about electric ranges, automatic water heaters and freezer-storage cabinets.

If the figures of the Iowa survey are
(Continued on page 120)

DIAL POINTER ON PORTABLE RADIO

SOME portable radios do not have a dial lamp and use a white line on a disk behind a translucent dial face.

This white line fades out in time—making station identification difficult.

A narrow strip of white adhesive tape placed in the position of the original white line is easy to see and makes dialing easy. H. L.

REPAIRMEN AND MANUFACTURERS GUARANTEED! RADIO TUBES!

Miniature 3 Way Portable Kits 1R5, 1T4, 1S5, 3Q4, 117Z3.

Miniature 12 Volt Kits
12BE6 Replacing 12SA7
12BA6 Replacing 12SK7
12AT6 Replacing 12SQ7
35W4 Replacing 35Z5
50B5 Replacing 50L6

G.T. 12 Volt Kits
12SA7 12SQ7 12SF7 12A6 or 50L6 35Z5
LARGE QUANTITY OF FOLLOWING TYPES
3Q5 6SK7 6K6 6F6 6G6 6P5 6SJ7 32L7
Send list of requirements of tubes not listed

LE-HI ELECTRICAL COMPANY
680 Broadway Newark 4, N. J.
HUMBOLDT Dept. RN-100 HUMBOLDT
5-3530 5-3531

FILMGRAPH PAT'D Conference Recorders

UNINTERRUPTED
Longtime (up to 12 hours) Conference
& Telephone Recordings on Safety Film
Models for Dictation "TALKIES"

ECONOMICAL
PERMANENT
INSTANTANEOUS
PLAY-BACK

MILES REPRODUCER CO., INC. 912 BROADWAY, N.Y. 3 · RN-3

RADIO COURSES

Servicing, Broadcast Engineering, Commercial Operating,
Television

INDIVIDUAL LABORATORY WORK!—LEARN BY DOING!
DAY AND EVENING CLASSES

Approved by the Maryland State Department of
Education and the Veterans Administration
FREE TO VETS—TEXTBOOKS, TOOLS, TEST SET

Write for Bulletin
BALTIMORE TECHNICAL INSTITUTE
1425 Eutaw Place—Dept. R. Baltimore 17, Maryland

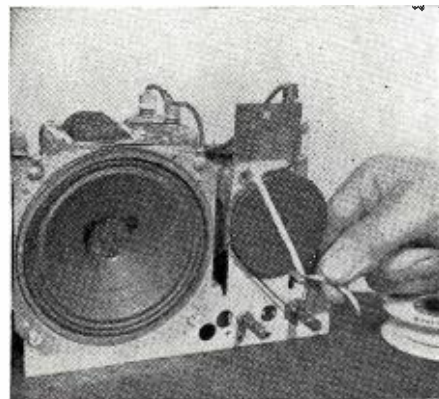

RADIO NEWS

LET THESE WAA DISTRIBUTORS HELP YOU

Save with surplus

The War Assets Administration has appointed a representative group of competent well established distributors to help dispose of war-surplus electronic tubes and equipment. We suggest that you get in touch with the distributor nearest you. He will know the items available and how they can aid in solving your electronic problems.

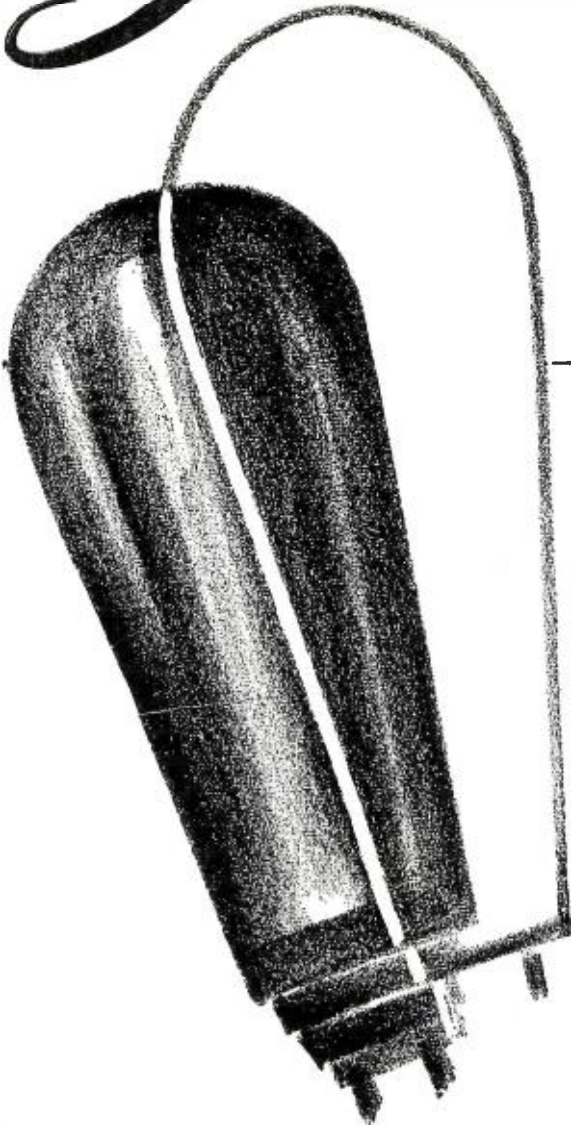

**Here is an up-to-date list of
WAA approved distributors.**

- | | |
|---------------------------------------|------------------------|
| BOSTON, MASS. | |
| Automatic Radio Mfg. Co., Inc. | 122 Brookline Ave. |
| Technical Apparatus Co. | 165 Washington St. |
| BUCHANAN, MICH. | |
| Electro-Voice, Inc. | Carroll & Cecil Sts. |
| CANTON, MASS. | |
| Tobe Deutschmann Corp. | 863 Washington St. |
| CHICAGO, ILL. | |
| American Condenser Co. | 4410 Ravenswood Ave. |
| Majestic Radio & Television Corp. | 125 W. Ohio St. |
| EMPORIUM, PENN. | |
| Sylvania Electric Products, Inc. | |
| FORT WAYNE, IND. | |
| Essex Wire Corp. | 1601 Wall St. |
| LOS ANGELES, CALIF. | |
| Cole Instrument Co. | 1320 S. Grand Ave. |
| Hoffman Radio Corp. | 3761 S. Hill St. |
| NEWARK, N. J. | |
| Standard Arcturus Corp. | 99 Sussex Ave. |
| Tung-Sol Lamp Works, Inc. | 95—8th Ave. |
| NEW YORK, N. Y. | |
| Communication Measurements Laboratory | 120 Greenwich St. |
| Electronic Corp. of America | 353 W. 48th St. |
| Emerson Radio & Phonograph Corp. | 76—9th Ave. |
| Hammarlund Mfg. Co., Inc. | 460 W. 34th St. |
| Newark Electric Co., Inc. | 242 W. 55th St. |
| Raytheon Mfg. Co. | 60 E. 42nd St. |
| Smith-Meeker Engineering Co. | 125 Barclay St. |
| SALEM, MASS. | |
| Hytro Radio & Electronics Corp. | 76 LaFayette St. |
| SCHENECTADY, N. Y. | |
| General Electric Co | Bldg. 267, 1 River Rd. |
| WASECA, MINN. | |
| E. F. Johnson Co. | 206—2nd Ave., S. W. |

ELECTRONICS DIVISION
OFFICE OF SURPLUS DISPOSAL

WAR ASSETS ADMINISTRATION

425 Second St., N.W.

Washington 25, D. C.



Build a TELEVISION

To stimulate its radio and television training programs, this famous resident radio and television school is offering men interested in television this unusual opportunity.

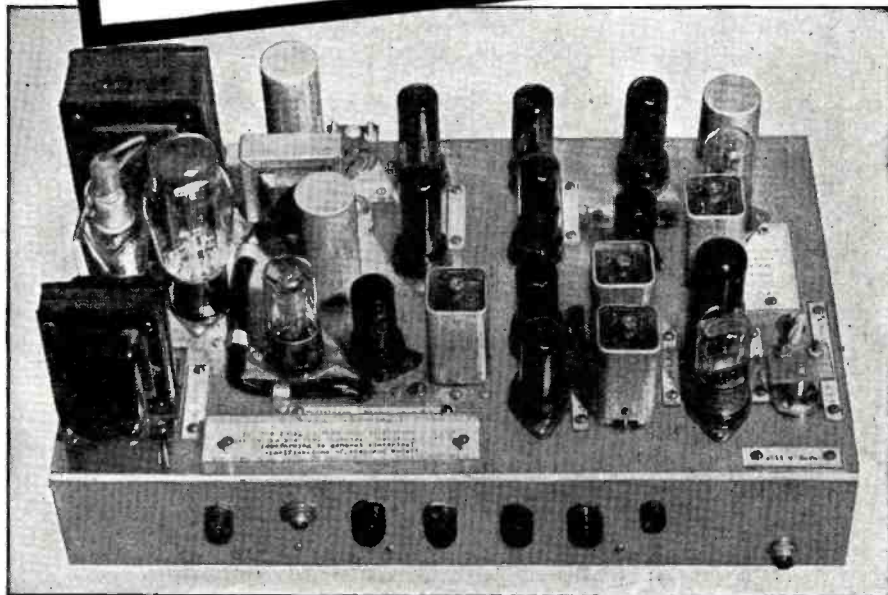

You can build a direct viewing television chassis similar to the one pictured above, complete with all tubes, including speaker and 7-inch picture tube right in your own home by following carefully the exact instructions sent to you by this famous television school, located square in the HEART of America's television manufacturing and broadcasting industry. Mail the coupon on the next page to get full details.



Here is a typical scene showing an instructor checking the construction completed by the two students in the background.

If you are unable to leave home to go to a resident school, N.Y.T.I. of N.J. can supply you with all the parts to build a television chassis in your own home. You will be supplied with exactly the same instructions and directions with which the school's resident students are equipped, when they reach the stage in their training that calls for television set construction. If you already have a sound radio background, with experience in building radio receivers, you will be surprised to find how much you can learn about television by studying the directions, and building this set.

N.Y.T.I. of N.J. is one of America's leading resident schools in television for men seeking dependable, thorough, up-to-the-minute training in the various fields of radio and television.

The schooling offered by N.Y.T.I. of N.J. is particularly useful to those who recognize the high-earning possibilities of technical training in radio and television and are willing to tackle the class and laboratory work offered.

A grammar school education definitely is required. Moreover, N.Y.T.I. of N.J. requires that a student be earnest, sincere and radio-minded. Students without proper mathematical backgrounds are taught the radio and television mathematics and theory they need.

A considerable number of out-of-

Bob Cohen, shown checking the television set he has built, to make sure there are no engineering inaccuracies.

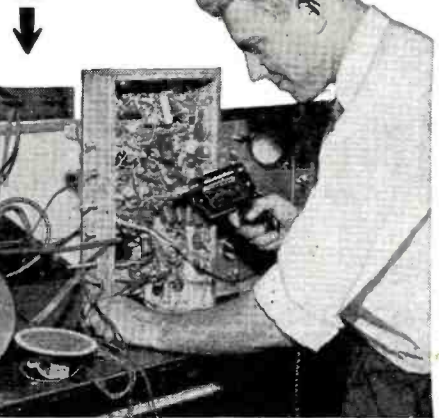

MAIL THE COUPON TO GET FULL

SET *Right in Your Own Home!*

state students attend the school because of its excellent, practical type of radio and television courses, so difficult to get anywhere else. Living quarters are obtainable by single students. Married students are requested not to bring their families until they can find suitable accommodations for them.

You Put Into Practice Everything You Learn

Students at N.Y.T.I. of N.J. particularly like the way the school puts into practice what it teaches. You may actually build a 17-tube television chassis. You also help build as many as 7 radio receivers of different types, a total of 75 electronic educational devices. Class study and laboratory study, in the proper combination, increase interest—and your hands get as smart as your head.

A 17-tube, experimental, television chassis may be built by all resident students of television, and may be kept as their own property, if they so choose.

Located in the Heart of the Radio, Electronic and Television Industry

The New York Technical Institute of New Jersey is in Newark, N. J., just across the river from New York City (only 20 minutes from Broadway by subway or train). The school is located in the heart of America's great radio and television industry. Such leading television, radio and electronics manufacturers as R.C.A., Western Electric, DuMont, Federal, Westinghouse and Edison are nearby. This means that the school offers numerous advantages, as it is in touch with the most recent developments.

Highly qualified television and radio instructors are here in abundance. Equipment is easier to get. Television students are offered exceptional advantages in this great electronic center.

Coupon Brings Full Information — FREE

The school issues a special Bulletin which illustrates and describes its truly exceptional laboratory facilities and equipment. This Bulletin also describes classes that may be attended, housing conditions, costs, hours, etc. If you are interested in Television—you will want to read this Bulletin. You can have it *free*, merely by mailing the coupon at right.

The school will also be happy to send you complete information about the television kits and directions which are now available to you if you desire to build your own television chassis at home.

Just fill out the coupon at right and mail it NOW to:
New York Technical Institute of New Jersey, Dept. 1B,
158 Market Street, Newark, N. J.



Instructor demonstrating theory of light in connection with study of optical systems used in projection type television receivers.



Big picture television, 16"x21 1/4", "in the flesh" at N.Y.T.I. of N.J. All types of television receivers are available for student use and instruction in the resident school.

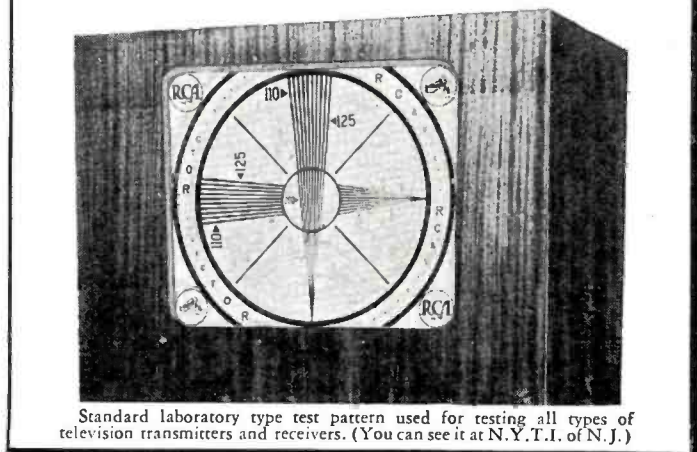

Standard laboratory type test pattern used for testing all types of television transmitters and receivers. (You can see it at N.Y.T.I. of N.J.)

**New York Technical Institute of New Jersey, Dept. 1B
158 Market Street, Newark, New Jersey**

- Check here if you wish to receive the Special FREE Bulletin describing the resident school of the New York Technical Institute of New Jersey located in Newark, N. J.—including its facilities, equipment, courses offered, costs, hours, etc.
- Check here if you wish complete information about building a television chassis in your own home.
- Check here if you are a War Veteran.

Name.....Age.....

Address.....

City.....Zone.....State.....
(N.Y.T.I. of N.J. employs no salesmen to call.)

INFORMATION *Free*

THE BUYS OF THE MONTH FIELD MIKE



- SIG. CORPS T-21B**
- 2 Tube res-coupled Amp.
 - Condenser Mike
 - Remote Control Relay
 - Rugged Construction

FIELD ARTILLERY microphone Sig. Corps type T-21B designed to be arranged in the field in computed geometric pattern for the purpose of determining range and intensity and direction of gunfire. Internal 2 stage res. coupled amp uses 1 type "30" and 1 type "32" tubes. Contained relay controls filament circuit from remote point on applying "B" volt. Condenser mike head designed to respond at detonation freqs. IDEAL for use with geophysical sonde, explosion warning, well "sounding" and mine safety equip. Housed in rugged brass cylinder. Dim. 7" dia. X 16 1/4" H. Diagram supplied. All units brand new (less tubes) in sealed cartons.

YOUR COST \$23.50
IN LOTS OF 10 \$19.50 EA.

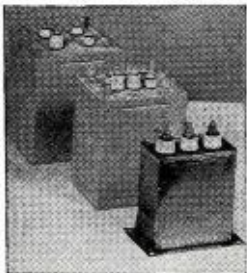

HIGH VOLTAGE KIT

2500 V. DC
Up to 50 MA.

\$14.00

In Lots of 10

\$12.50

Contains following list of three (3) hermetically sealed components, made by outstanding mfrs.

- 1 ea.—Trans. Pri.-115 V 60 V, Sec. 3000 V-50 MA.
- 1 ea.—Trans. Pri.-115 V 60 V, Sec. 6.3 V & 2.5 @ 3 amps Hi-insul.
- 1 ea. Condenser, oil 3 sec.-.2 mfd. ea. 4000 VDCW.

RACON—Dwarf Type

Excellent for Paging, Marine, Handy-Talkies, Etc.



\$475 LOTS OF 10
Each **\$425** Ea.

- PM Driver Unit—15 Ohm Impedance
- 5 Watt Nominal
- Waterproof—Blastproof
- Trumpet 12" long—5" Mouth

805's JAN Approved. Boxed **\$5.95**

AMERTRAN SILCOR—J-871—Hi-Fidelity Output Trans.; 1 1/4 ohms to 500 ohms to vari-tapped primary and sec. (Diagram Furnished).
Each **\$1.50**
In Lots of 10. Each **\$1.25**

0-200 MILLIAMMETER SQUARE
2 1/4" Sq. **\$2.95**
In Lots of 10. Each **2.60**

DYNAMIC 100-125 ohms—High Level Output. Use with any multiple line to grid input. Rugged. Use with your favorite mike stand. 1 1/2" x 1 1/2"
Each **\$1.50**
In Lots of 10. Each **1.25**

SOCKETS—829—832 CERAMIC WAFER.
Each **30c**
In Lots of 100. Each **20c**

I.F.'s 30 M.C. SHIELDED—2"x3/4"x3/4" Slug Tuned—Tele.—F.M. Use with interstage coupling capacitor (diagram supplied). Each **50c**
In Lots of 10. Each **40c**

6" PM SPEAKERS—1.47 oz. slug. Less Output Transformer. In Lots of 25. Each **\$1.55**

SERVICE SPECIALS

8 MFD—250 V. Tubulars C-D. Metal Cased (in Lots of 100). Each **20c**

.5 MFD—400 V. Tubulars. Metal Cased (in Lots of 100). Each **25c**

MINIATURE TUBE SHIELDS. 1 1/2" Overall (in Lots of 100). Each **4c**

ALL MERCHANDISE FULLY GUARANTEED
Minimum Order—\$5.00

20% Deposit with Order—Balance C.O.D.

All Orders F.O.B., N. Y.

KELVIN ELECTRONICS

74 Cortlandt Street, New York 7, N. Y.

any indication, there's a billion dollar business waiting for radio and appliance dealers in that one state alone. And, incidentally, those figures should be fairly reliable as an indication of farmers' buying intentions. They were carefully checked by the Statistical Laboratory at Iowa State College which operates in cooperation with the Bureau of Agricultural Economics. To that billion dollars add the potential business from 47 other states and what it adds up to is not peanuts! Then there is normal replacement business to think about.

Four electrical appliances far overshadow all others in terms of popularity, the Iowa survey shows. When the juice is turned on the first things the family buys are a radio and a washing machine, an iron and an electric refrigerator.

A radio is No. 1 in popularity. In Iowa 96% of all farm families with electricity have radios. Some families have more than one receiver and a radio in the dairy barn is not uncommon. About 14% of the families said they intend to purchase new radios soon. While you occasionally see a swanky console model receiver in farm homes—most of them can be classed in the low priced bracket.

An electric washer is more popular even than an electric iron. More than 94% of the farm families surveyed have electric washers. Many of these are older machines which have been converted to electric power by the replacement of the gasoline motor with a quarter-horse electric job. Today one farm family out of every 10 which has highline power is in the market for a new washer.

However nearly all farm homemakers have an electric iron to go with their washer—87.6% of all electrified farm homes. Here again, more than

one farm housewife out of every 10 wants a new iron. Chances are she has the nickels and dimes stored away for its purchase—in the teapot on the top cupboard shelf.

The first really good sized cash lay-out for electrical equipment goes for a refrigerator. Over two-thirds of the families with current available have refrigerators. The other 29.5% are going to buy them as fast as they come off the assembly lines. Refrigerators for farm families run a little larger in size than those the average city dweller buys. A 9-cubic foot box is not uncommon. Most folks, however, wish they had purchased a larger refrigerator than they did. Shopping for groceries is largely a once-a-week job for the average farm housewife. So the refrigerator should be large enough to store a week's supply of perishables. There are more mouths to feed and it takes more to fill them up.

Home-freezer-lockers? Probably the sale of this much talked and promoted postwar dream will come a little slower than most manufacturers realize. Nearly every farm family would like to have one, it's true. But there are so many other things that they would like to have that the freezer storage case will have to wait for a while. Furthermore, farm families being rather shrewd and sometimes conservative—would just as soon have their city cousins try them out first. The cost—both initial and operational—looks a little high to a lot of folks, too. In Iowa about one farm home in 200 now has a home locker and about one family in 15 indicated they hope to purchase one. One appliance dealer in eastern Iowa kept a list of people who made inquiries for lockers during the war years. He had 125 people on that

Charles Golenpaul of Aerovox, Sam Poncher of Newark Electric, and Margaret McGowan of the Show Staff draw the slips which assigned 158 manufacturers' booths and the 10 half-booths which will be used in the exhibition hall at the Radio Parts and Electronic Equipment Show to be held at Hotel Stevens in Chicago, May 11th to 16th.



SAVE! ON THESE AND THOUSANDS OF OTHER BARGAINS IN STOCK FOR IMMEDIATE DELIVERY

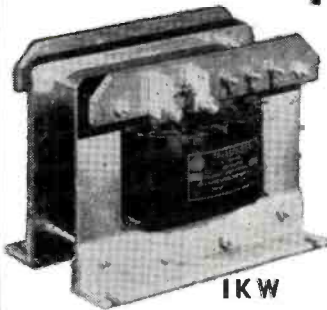

1KW Modulation Transformer
SPECIALLY PRICED AT **\$14.95**

We have a real value in a modulation transformer. This item, made by RCA TO BROADCAST SPECIFICATIONS, is conservatively rated at 550 Watt audio to modulate that new KW rig. Really rugged construction with protective flashover gaps which are adjustable. Terminals and gaps are mounted on a "Mycalex" terminal board. The laminations that make up this transformer are of high audio quality and are extremely thin, making it impossible for the core to "chatter or talk." Audio Watts—550 Sec. #1—450 Mils Sec. #2—80 Mils Turns Ratio—Pri. Sec. #1-1:1 Pri. Sec. #2-5:1 Pri. Sec. #2 Tap-25:1 Impedance Ratio—Pri. #1-1:1 Sec. Pri. Sec. #2-25:1 Pri. Sec. #2 Tap-625:1 DC Resistance—Pri., 135 ohms Sec. #1 112 ohms; Sec. #2 90 ohms Transformers insulation tested: Pri. 3000V.; Sec. #1-1-1000V.; Sec. #2-2000V. to the rest of the coils and core. Primary center-tapped for Class "B" modulators. Secondary #2 will carry 80 Mils to modulate screens of beam power or screen grid tubes. Primary will match any Class "B" tubes up to 10,000 ohms plate to plate, such as 810's, 75T's, 8005's, 2B12's, 2B3's, 6Y512's, 211's, 813's, 820's, 805's 2032's. Size 9 1/2" wide, 7 1/2" deep, 7 1/4" high. Heavy channel iron mounting brackets. Weight approx. 40 lbs.—Cat. No. MT-100

Something You Can't Be Without
PIN STRAIGHTENER
For miniature tubes—Gov't cost \$4.80 our price—Cat. No. P10 **49c**

MICA CAPACITATOR
Mica capacitor .002 MFD 3000 WVDC Cat. No. RT-101 **49c**
IF TRANSFORMER
IF transformer, mounted in aluminum shield can, 1500 KC, with air trimmer, impedance coupled type—Cat. No. T-18 **95c**
30MC IF TRANSFORMER
30 MC IF transformer in square aluminum can, silver slugged tuned—Cat. No. T-20 **29c**



Butterfly Condensers
Ideal for high frequency work.

Type A—frequency range 75 to 300 megacycles to be used with 955 tubes. Cat. No. BC-1
Type B—frequency range 300 to 1000 megacycles to be used with 368AS doorknob tube. Cat. No. BC-2

Sockets part of assembly on both. **95c each**

Order by Catalog Numbers!

CONDENSERS

CATALOG NO.	CAP. MFD.	WORKING VOLT%	YOUR COST
C110	1	5000 OIL	\$3.95
C111	3	4000 OIL	\$4.95
C112	1	1000 OIL	44c
C113	4	500 OIL	49c
C114	8	600 OIL	95c
C115	2	600 OIL	49c

VARIABLE CONDENSERS
100 MMFD variable APC type—Cat. No. T-21 **59c**
30 MMFD variable APC type—Cat. No. T-22 **25c**
12 MMFD variable 1/4" shaft—Cat. No. T-23 **30c**

CHOKES

Thordarson 8 HY 150 M choke—Cat. No. FC-201 **95c**
Thordarson 8 HY 175 M choke—Cat. No. FC-202 **\$1.49**
Thordarson 12 HY 25 M choke—Cat. No. FC-203 **39c**
Thordarson 8 HY 350 M choke—Cat. No. FC-204 **\$4.95**

Thordarson T48003
Thordarson 2H-7H 550 MA swing choke size 4 1/4 x 5 1/4 x 5 1/4 square black crackle case. Cat. No. FC-205 **\$5.95**

Filament Transformers

Thordarson 6.3 V—4 amps., 6.3 V—4.5 amp., 9.7 V—5 amp., pri. 110 V AC 25 or 60 cy—Cat. No. FT-11 **\$1.95**

Thordarson pri. 110 V 60 cy.—sec. 6.3 V 6 A, CT—Cat. No. FT-12 **\$1.49**

Thordarson 110 V 60 cy. pri., sec. #1—2.5V 10 A CT, 3000 V ins., sec. #2 10 V 3.25 A, Two 5 V 3 A; 6.3 V 1 A—Cat. No. FT-13 **\$4.95**

All Orders F.O.B. Detroit

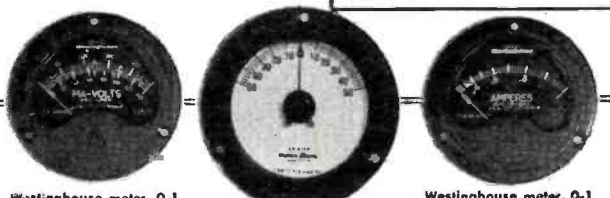

Westinghouse meter, O-1 MA movement, 2" round case, scale calibrated 0-140 and 0-500. Includes mounting hardware. Cat. No. M-101. **\$2.95**
Western Electric meter, 4" round, zero center, 0-1/2 MA each side. Cat. No. M-102. **\$3.95**
Westinghouse meter, O-1 RF amps, 2" round case, internal thermocouple, in original box, includes mounting hardware. Cat. No. M-103. **\$2.95**

SHALLCROSS ACRA-OHM WIRE WOUND RESISTORS

2,000 ohm 60,000 ohm
3,300 ohm 65,000 ohm
9,000 ohm 70,000 ohm
15,000 ohm 75,000 ohm
18,000 ohm 100,000 ohm
25,000 ohm 160,000 ohm
30,000 ohm 600,000 ohm
50,000 ohm
±1W 39c each
3 for \$1.00

1 MEG. .89c

SELSYN MOTORS

The ideal way of indicating the position of rotary beams, wind indicator, etc. (400 cycle). Line cord and instructions for 110 VAC operation furnished.—Cat. No. SM-100. **2 for \$3.95**



DYNAMOTOR
Power supply—inputs 6 or 12 V, output 300 VDC at 160 MA, mounted on box with circuit breakers, relays, interference filter and two 10 H. cables. U. S. Govt. surplus. Cat. No. DM-101. **\$9.95**

Transmitter and Receiver
Has been widely used on the 144 MC band. Shipping wt. 100 lbs. U. S. Govt. surplus. Your price, less tubes and power transformer. **\$14.95**
Cat. No. RT-102.

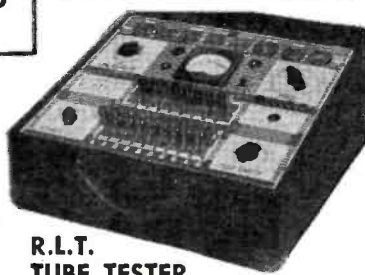

R.L.T. TUBE TESTER
Tests all tubes up to 177 V. • Tests shorts and leakages. • Tests individual sections. • Works on 90-125 V 60 cycle AC. • Comes in portable cabinet complete with all operating instructions with Rd. Cat. No. TT-100 **PRICED AT ONLY \$49.95**

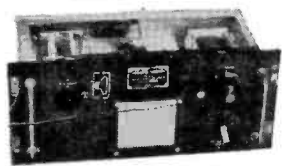

TUNING UNIT
Tuning unit BC 375. Approx. 65 MMFD cond., coils, RF chokes, dials, assid. mica condensers 2500 WVDC, over \$50.00 in parts. Cat. No. TU-101. **\$3.75**

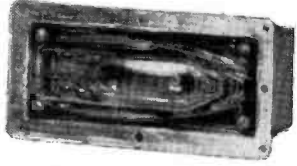
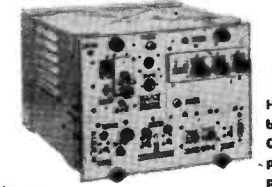

PHOTO FLASH TUBE
Photo Flash Tube. High speed photo flash tube, 12,000,000 lumens light output. Stops all action. Ignition coil included on back of bulb. 10,000 flashes. Diagrams furnished on request. Your cost Cat. No. PF-101. **\$8.95**

Receiver and Transmitter
SCR-522 USED In good cond. 100-156 MC receiver and transmitter complete with 18 tubes. Cat. No. RT-10 **\$29.95**



Hot Spot Specials

- Asst. resistors 1/2 watt fully insulated in popular ohmages per 100—Cat. No. R-5. **\$1.49**
- Asst. mica condensers per 100—Cat. No. C-12. **\$1.95**
- Wafer sockets 4-5-6-7 & 8 prong per 100—Cat. No. WF-4. **\$2.95**
- 12" Utah P. M. Spooker Alnico #5 with 6F6 output transformer—Cat. No. ST-100. **\$6.95**
- Asst. knobs push on wood & plastic per 100—Cat. No. KP-100. **\$1.95**
- 6J4—\$1.50, 6J6—95c, JS-210. **49c**
- 75,000 ohm 200 W bleeder—Cat. No. B-75. **49c**
- 955-0004 tubes—Cat. No. T-99. **65c**
- Sockets for acorn tubes—Cat. No. AT-10. **19c**
- 8-8 MFD 350 WVDC, 20 MFD 150 WVDC, round can—Cat. No. RC-88. **69c**

Write for **FREE** Bulletin

HERSHEL RADIO CO.

5249 GRAND RIVER DETROIT 8, MICHIGAN

20% DEPOSIT REQUIRED ON ALL C.O.D. ORDERS

for a flawless
flow of
POWER
CHOOSE

WEBSTER
M-15
**PHONOMOTOR AND
TURNTABLE ASSEMBLY**



Whether for pilot runs, or for your experimental use, the Webster M-15 phono assembly will meet most needs for a superior phono motor. Featuring the famous Webster motor, it delivers a smooth — more than ample — flow of power. Operates on 105-125 V., 60-cycle current — is readily adaptable to 50-cycle operation. The Webster Improved Rim Drive and accurately gauged 9-inch steel turntable reduce wow in the completed record player. Turntable is heavily cushioned with long-fibre flock.

SEE YOUR DISTRIBUTOR



WEBSTER CHICAGO
5610 BLOOMINGDALE AVE.
CHICAGO 39, ILLINOIS
33 years of Continuous Successful Manufacturing

list. A few weeks ago his manufacturer queried as to how many of the new appliances he could use immediately. He got out his list of potential customers and started calling them on the telephone. How many people do you suppose were ready to place an order? Not one!

High on the homemaker's priority list are a toaster and a vacuum cleaner. Of the homes where electricity is now available, you'll find a toaster in 58% of them; a vacuum cleaner in 42%. It would seem that the vacuum cleaner salesman will have a lot of places to sell his wares. Nearly one farm family in four wants to buy one.

About one family in four has a water system with an electric pump. Another 18% plan to install them just as soon as they are available.

The automatic water heater business should also be good. Only 1 family in 20 now has one in opera-

tion, but 14% have indicated they intend to make such a purchase soon.

One electrified farm home in 10 has an electric range. But if farm women have their way there will be an electric range in one out of four farm homes.

Other items that the farm homemaker has her eye on are ironers, sewing machines, waffle irons, coffee makers, heating pads, clocks, and automatic furnaces. In fact, a door-to-door salesman should be able to make a sale for each of the items in one out of 10 calls.

Farm homemakers haven't thought too much about such items as dishwashers. They seem quite a luxury to her as yet. She is still trying to get used to the convenience of such things as push-button lighting and not having to fight a balky gasoline engine when she washes.

When it comes to the farm production side of the picture, chick brood-

**FCC PRELIMINARY PROPOSAL
REGARDING THE CITIZENS' BAND**

THE Federal Communications Commission is interested in securing the cooperation of manufacturers and others in preparing technical requirements for equipment to be used in the Citizens' Radiocommunication Service.

The Commission proposes, through subsequent regulations to be adopted, that the 460-470 mc. band be used as follows: 460-462 mc., Class A stations at fixed locations exclusively; 462-468 mc., Class A and Class B stations; 468-470 mc. Class A stations exclusively. It is proposed that Class A stations be permitted a frequency tolerance of .02 per cent, whereas Class B stations would be given much wider latitude with a permissible tolerance of .2 per cent. All Class B transmitters, however, would be initially adjusted by the manufacturer or the individual builder of composite equipment to operate within .2 per cent of the center-band frequency of 465 mc.

Controls for adjustment of the carrier frequency of the transmitter shall not be accessible from the exterior of any unit unless such accessibility is specifically approved by the Commission.

Class A transmitters shall be designed, constructed, and adjusted by the manufacturer to operate on a frequency or frequencies within the band 460-470 mc. subject to the condition that the communication band shall not at any time extend beyond the limits of the 460-470 mc. band. Under all conditions of use in the Citizens' Radiocommunication Service, the transmitter shall be inherently incapable of emitting electromagnetic waves of interference field strength outside the band 460-470 mc.

Class B transmitters shall be designed, constructed, and adjusted by the manufacturer to operate initially, under average conditions, within .2 per cent of the frequency 465 mc. Under all conditions of use in the Citizens' Radiocommunication Service, the transmitter shall be inherently incapable of emitting electromagnetic waves of interference field strength outside the band 462-468 mc.

The operating frequency at any time during the period of test shall not deviate more than .02 per cent for Class A transmitters or more than .2 per cent for Class B transmitters from the operating frequency measured as soon as possible during the initial period of test operation, under any or all of the following test conditions: gradual and sudden ambient temperature variations from 0 to 150 degrees F.; barometric pressure variations corresponding to those from sea level to 12,000 feet above sea level; relative ambient humidity from 5 to 95 per cent; atmosphere containing high saline content such as encountered on oceans; movement of objects in the immediate vicinity of the equipment under test; power supply voltage variations normally encountered under actual operating conditions; length of test periods to be equivalent to those which will be encountered under the most severe conditions of operation for which the unit may be used.

The transmitting equipment shall be inherently incapable of operating at a power input of more than 50 watts to the anode (plate) circuit of the electron tube or tubes which supply energy to the radiating system.

The transmitter shall not be capable of producing emissions of any type other than A-0, A-1, A-2, A-3, A-4 or FM unless it is shown after operation under an experimental license that another type of emission is necessary for a definite purpose in the Citizens' Radiocommunication Service.

When radiating amplitude-modulated waves of any type, the percentage of modulation shall not exceed 100 at any time.

When radiating any type of authorized emission, including FM emission, the communication band of the emitted waves shall not exceed .2 mc.

Controls for any adjustment of the receiver which might result, due to improper adjustment thereof, in the radiation of interfering emissions should not be accessible from the exterior of any unit.

WAR SURPLUS! RADIO PARTS

COMPARE THESE VALUES

Industrial Terminal Board 14 Pole 6Vx 11x3 1/2	0.25
RG/BU Coax Cable 52 Ohm Per Foot	.05
Flexible Tuning Extension Shaft, 90° Angle, 13" Long	.25
Electrolytic Condenser Round Can-3x1 1/2-130 Mfd 300 V, 40 Mfd 50V, 20 Mfd 50V, 19 Mfd 50V	.75
Electrolytic Condenser 8-8 475V 39x1 1/4	.75
Filter Choke 20 Ohm 8 Hy 80 Ma Plus	.75
5 600V Condenser	1.00
Filter Choke 300 Ohm 15 Hy, 150 MA 3x 2 1/2x2 1/4	1.00
Filter Choke 1.5 Ohm 1500 VDC 30 Hy, 2.5 Amps	1.50
Filter Choke Heavy Duty 200 Ohm 275 Ma, 18 Hy, 2000 VDC 5 1/4x4 1/4x3 3/8	3.00
R.F. Coil 6 Turns on 3/4" Dia Shielded	.50
Oscillator Coil Shielded, 2.5 Mc. C.T. Permeability Tuned 42 Turns on 3/4" Dia, 2x1 3/8	.75
I.F. Midge Transformer 2x1 1/4 2.1 to 2.4 Mc Permeability Tuned	.75
Industrial Rotary Switch On-Off 20 @ 125V, 2x 1/2	.75
Aircraft Toggle Switch 1 1/2x1 1/2x1 1/2 S.P.C.	.50
Aircraft Toggle Switch 5 Amp @ 110 V.D.P. Position 1 1/2x1 1/2x1 1/2	.25
Transmitter Tank Rotary Heavy Duty Switch, 8 Contacts D. Pole	.75
Padder Condenser 50 to 250 Mmfd	.15
10 for \$1.25; 100 for \$10.00	
17 Plate Midge Condenser 125 Mmfd-Fixed 1 1/2x1 Ceramic	.20
10 for \$1.75; 100 for \$15.00	
Variable Condenser 5 Plate 12 Mmfd-Screw Tune 1 1/2x1 Ceramic	.20
10 for \$1.75; 100 for \$15.00	
Variable Midge Tuning Condenser Band Spread 5 Mmfd 5 Plate Ceramic form 1 1/2x1 1/2 Shaft	.35
10 for \$3.00; 100 for \$25.00	
Permeability Tuning Slug-With Threaded Screw Four Sizes-Midge, Small, Medium, Large	.05
10 for \$0.40; 100 for \$3.00	
Aircraft Pilot Lite for Chassis Mt. Bayonet Type Universal Socket-Red and Green	.25
Resistor Fixed W.W. Adjustable 10 1/2x1 5/8 Ohm 50 Watt	.75
Resistor Fixed W.W. 9 1/2x1 60 Watt 6250 Ohm	.75
Variable Coupling Coil Pri-9 Turns on 2 1/2" Form Vari. Sec. 6 Turns 2" Form with Tuning Unit Complete 10 to 25 Watts	1.50

Super Values! UNIVERSAL AC-DC Frequency 2-30MC PREPARED KITS Build Your Own— RECEIVER-TRANSMITTER-AMPLIFIER

BUILD A RECEIVER!

Kit Includes:

- 1 Chassis 5x3 3/4x3
- 2 Octal Sockets
- 2 Condensers 100 MMFD
- 1 RF Choke 2.5 M.H.
- 4 Resistors 1-50 M 1-3 Meg., 1-5 M 1-250 M
- 1 Slug Tuned Coil
- 1 5M Ohm Volume
- 2 Filter Condensers
- 1 Toggle Switch
- 1 Roll Coil Wire
- Hook-up Wire and Hardware
- 2 Mica Condensers .003 Diagram Included
- 2 Tubes 1-12 SN7 1-6 SL7
- 1 Condenser 330 MMFD
- 2 125 Ohm 10 Watt W. Resistors

Special Value \$4 Per Kit

BUILD A TRANSMITTER!

Kit Includes:

- 1 Chassis 5x3 3/4x3
- 2 Octal Sockets
- 1 Toggle Switch
- 2 10 Watt W.W. Resistors 125 Ohm
- 2 Mica Condensers .003
- 1 100 M Resistor
- 1 Roll Coil Wire
- 2 Tubes 1-12 SN7 1-6 SL7
- 2 Slug Tuned Coils
- 1 Filter Condenser
- 1 RF Choke 2.5 M.H.
- 1 Key Diagram Included
- 1 100 MMFD Mica Condenser
- Hook-up Wire and Hardware

SUPER VALUE \$4 Per Kit

BUILD AN AMPLIFIER (AC-DC)

Kit Includes:

- 1 Chassis 5x3 3/4x3
- 3 Octal Sockets
- 1 1/2 Meg Volume Control
- 2 10 Watt W.W. Resistors 125 Ohm
- 1 Resistor 5M 1/2 Watt
- 3 Tubes 1-12 SN7 2-6SL7
- 1 Toggle Switch
- 4 Mica Condensers
- .005 MFD
- 2 Filter Condensers Diagram Included
- Hook-up Wire and Hardware

SUPER VALUE \$5 Per Kit

SPECIAL RADIO—FM—TELEVISION—AND ELECTRICAL PARTS

A Perfect Deal for Radio Repairmen—Amateurs and Experimenters

25 pounds of surplus includes:

- 1 Motor Chassis
- Cabinet
- Relay
- Condensers
- Resistors
- Transformer
- Coils
- Sub Assemblies
- Wire
- Hardware, etc., etc.

WORTH AT LEAST \$50.00
The same as above
—10 lbs. \$3

25 lbs

all for \$5

LOW PRICED PARTS!

R.F. Choke Low Frequency 200 Ohm 40 Ma, 152 M. Hy.	10 for \$1.25; 100 for \$10.00
Hi-Freq. R.F. Chokes 60 Ma. 3x1 1/4	10 for \$1.25; 100 for \$10.00
R.F. Chokes 2.5 M.H. Res. 20 Ohm 25 Ma. 1 3/8x3/4	4 P.I. Ea.15
10 for \$1.25; 100 for \$10.00	
Resistor Fixed Glass Tubular 20 Watt 31, 500 Ohm 48x3/8	Ea.50
Resistor Fixed Glass Tubular W.W. 10 Watt 5K Ohm 48x3/8	Ea.35
Edison Lamp Socket Base 60 Watt 2k Ohm Heater Resistor	Ea.50
10 for \$4.50; 100 for \$40.00	
Resistor Fixed 1 Neg. 20 Watt 2x1"	Ea.75
10 for \$6.00; 100 for \$50.00	

IRVING JOSEPH
220 S. Halsted St.,
Chicago 6, Ill.

Buyer and Distributor of
Surplus Stocks

All items listed above are subject to prior sale. Terms cash with order F.O.B. Chicago, Ill. Remit only exact amount of purchase. If prepaid include postage charges.

FREE! Radionic Catalog



Thousands of items, illustrated, described and priced in our new 1947 catalog. Hams, Servicemen, Experimenters, Engineers, Schools, Institutions, Govt. Dept. Industrial Organizations, Laboratories, etc., will find this book a great help in their search for "hard-to-find" equipment.

CHANCELLOR TUBE PRICES REDUCED

RADIONIC Is Pleased To Present This New Schedule Of Low Prices:

Where List Price Is	Chancellor Net Is	Where List Price Is	Chancellor Net Is	Where List Price Is	Chancellor Net Is
\$0.95	\$0.44	\$1.25	\$0.59	\$2.20	\$1.03
1.05	.50	1.35	.64	2.65	1.24
1.10	.52	1.50	.71	3.20	1.49
1.15	.55	1.80	.85	3.90	1.81

Order now by type number. Or, send for list of available tubes to Dept. 53. Our on-hand stock varies constantly. Most shipments made within 24 hours.

Chancellor Phono Player Kit

Sim. Leather Portable Case	5" Alnico Speaker with out. trans.
Ballantine Motor	Needle Cup
Astatic L72 Pick-up	
3 Tube Phono-amp	ENTIRE KIT \$21.45
Kit of Tubes	

FTR Rectifier

Each	\$1.09	6 foot zip cord with molded rubber plug	Each	\$0.29
In lots of 12	93c	In lots of 50		\$11.00

TERMS: In U.S.A. payment in full with order. (Include sufficient for postage.) Or, 25% with order, Balance C.O.D.

MAIL TODAY

RADIONIC EQUIPMENT CO.
170 Nassau St., Dept. 53, New York 7, N. Y.
Please send me a FREE copy of your 1947 catalog.

Name

Address

MASCO 8 Watt Amplifier and P. A. System Available Again!

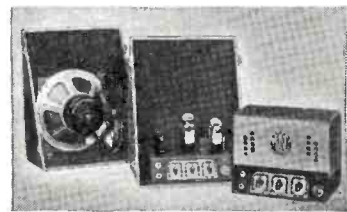

MAS-808 Portable system consists of a Model MA-808 amplifier with tubes and cover, mounted in an attractive split carrying case, one heavy duty 10" PM speaker, with 25 feet of cable and plug

MA-808 amplifier less cover, with tubes
Streamlined cover for above amplifier

It's RADIONIC for Everything ELECTRONIC

RADIONIC
EQUIPMENT COMPANY

170 NASSAU STREET
NEW YORK 7, N. Y.

Telephone WO 2-0421

Cable Address "CHANSLOR"

WHAT IS THE
FREQUENCY OF YOUR
DOLLAR\$?



**SUPREME Model 576
Oscillator.**

SUPREME Oscillators cannot measure the wave length of your dollars, but they can increase the frequency by which they find themselves stopping in your cash register.



**SUPREME Model 561 A.F.
and R. F. Oscillator.**

See these and other SUPREME Testers at your Authorized SUPREME Distributor.



OR, write for new catalogue No. 446 for complete details and descriptions.

SUPREME

**SUPREME INSTRUMENTS CORP.
GREENWOOD, MISS., U.S.A.**

EXPORT DEPT:
The American Steel Export Co., Inc.,
374 Madison Ave., New York 17, N. Y.

ing and poultry house lighting seems to get first call. It is rather surprising to note that 40% of the electrified farms have electric chick brooding equipment. It is not so surprising that 15% of the farms are ready to buy a brooder—largely because of the safety factor. About half of the farms have lights in the poultry house to stimulate winter egg production. Another 13% have poultry lighting equipment on their postwar lists.

It is interesting to note that only 60% of the farms with electricity available have the barn wired. About 30% have lights in the hog house. In this connection one farmer in 16 uses electric pig brooders, but the practice is growing rapidly.

Nearly 30% of the farms have running water in the farm buildings. But 15% more farmers intend to buy electric pumps soon.

One farm in 8 has an electric milking machine. Another 8% is in the market.

Electric poultry water heaters are popular and stock tank heaters are becoming more so.

Only one farm in 8 has an electric powered cream separator. But here again is a wideopen opportunity. One farmer in two intends to buy a separator.

Most of the equipment to be purchased on the strictly farm side of the picture are those that are powered by small motors. Power equipment for the farm shop with an electric tool grinder at the top of the list, will be popular. Since farming is becoming more and more a highly mechanized business, electric welders are going to be in great demand.

But don't expect a great number of large motors for stationary power to be purchased very soon. A few grain elevators are being electrified, as are fanning mills and corn shellers. But until a hammer mill can be put on the market that can be powered by a three-horse electric motor, and operate automatically, they will not be too popular. Mark Collier, a Muscatine County, Iowa, farmer, explains that he can hardly afford to own a large electric motor for a few jobs, when he already has a big investment in his farm tractor.

The farm market is a quality market. Farmfolks for the most part will be buying dependable equipment made to stand up under the strain of hard everyday use without breakdown interruptions. They will be buying from established or reputable dealers with a record of service. What's more they will want equipment and appliances made by manufacturers with a record for dependability—who will stand solidly behind their dealers.

State College, the U. S. Department of Agriculture, Rural Electric Associations and Public Utilities all are making every effort to provide farmers with information that will enable them to make wise selections. They will also attempt to provide information that will assist the new purchaser

Portable Electric Phonograph



Model EPP-247

A completely self contained all electric full portable instrument. High fidelity amplifier and Alnico P. M. speaker. Excellent tone quality. Sturdily built handsome two-tone leatherette covered carrying case with handle. Plays 10 and 12 inch records with cover closed. For 110-120 volts 60 cycle AC only. Size: 17½" long, 13" wide, 7¼" high. Shipping weight: 15 lbs. Complete with tubes ready to operate.

\$27.50

20% Deposit required on all orders.

F.O.B.
Factory

AUTOCRAT RADIO CO.

Dept. RN

3855 N. Hamilton Avenue, Chicago 18, Ill.

HERE IT IS!



**DYNAMIC TYPE EARPHONE
& MICROPHONE ASSEMBLY**

\$4.95

BRAND NEW

NEW 807 TUBES.....\$1.25 ea.

BC-654-A TRANSMITTER

Frequency range 3800 to 5800 KC. Stabilized M.O., buffer, P.A. circuit using suppressor grid modulation. Less tubes however, we \$14.95 include two 307's. Slightly used.....

BC-654-A RECEIVER

Superheterodyne with the following tube line up 3—1N5GT, 1—1A7GT, 1—1H5GT, & 2—3Q5GT. Audio output 100 Milliwatts. Slightly \$9.95 used. Less tubes.....

POWER UNIT PE-103

Operates from a 6 or 12 volt storage battery to supply 500 volts d.c. at 160 ma. Cables for battery connections are furnished. \$12.95 Slightly used.....

WRITE FOR OUR MONTHLY BULLETIN

RADIO Equipment

DISTRIBUTORS

709 S. Main St., Los Angeles 14, California

RADIO NEWS

to get the most out of the particular price of equipment purchased.

Utility concerns, both public and private, are urging land grant colleges to provide complete and unbiased information relative to the selection, use and operation of electrical equipment. And further, that necessary research be conducted to determine the required facts.

It is of course well recognized that by far the greatest majority of manufacturers are desirous of producing a reliable product. But it must also be recognized that the large potential purchasing power of farm people will induce a few manufacturers to place some new equipment on the market before it has been adequately tested.

And remember, too, farmers are the best judges of quality in the world. They are shrewd bargainers and are not easily misled by the smooth "high-pressure" salesman. They've seen him before.

—30—

Generating Microwaves

(Continued from page 37)

where electrons leaving the cathode later than others actually travel faster and overtake slower electrons.

The magnetron is a diode functioning by the effect of a powerful fixed or electromagnet through which electrons leaving the cathode must pass or cut through in order to reach the anode. The magnetic field causes the electrons to have the following behaviors: a. If electron travel is parallel to the magnetic field flux, it will have little or no effect on the electrons in their transit from cathode to anode. b. If electron travel is at an angle to the magnetic field flux it will be subjected to efforts of the magnetic

OLD TIMERS' NITE

THE Delaware Valley Radio Association of Trenton, New Jersey will sponsor its Third Annual Old Timers' Nite, and banquet on Saturday evening, March 22, 1947.

The affair will be held in the Terrace Room of the Stacy-Trent Hotel, West State Street and Willow in downtown Trenton. A turkey dinner will be served promptly at 6:30 p.m.

Guest speakers will include Old Timers in the wireless field and men who have been prominent in all branches of radio for many years. W2ZI's (ex-W3ZI) famous collection of old time wireless gear will be on display. Many Old Timers of the area are expected to turn out for the event. Door prizes will be awarded and a special award will go to the "Grand OM" whose radio experience dates back to the earliest days of wireless.

Reservations must be made before March 15th with Ed. G. Raser, W2ZI, Secretary, Delaware Valley Radio Association, 315 Beechwood Avenue, Trenton 8, New Jersey. The tariff is \$4.00 per person up until March 15th, with late comers being assessed \$5.00 for tickets purchased at the door.

—30—

March, 1947



BARGAIN SPECIALS

FOR "GE" PORTABLES

2 volt Willard type 20-2 the exact replacement in Pre-War Model LB 530 "GE" Portable Radios. Also for other sets. Gangs nicely in multiples of 3 for 6 volts. In Plastic Case size 3 31/32 x 3 1/2 x 5 1/2" high. Shipped Dry. Uses standard battery electrolyte available everywhere. Regular List Value \$8.75 No. 5A142, Every One Brand New.



Each... **\$3.95**

The FINEST in HEADPHONES



Type P23. The Choice of the Air Corps headphones, highly sensitive, 8000 ohm impedance, bipolar magnets. Extremely comfortable sponge rubber ear cushions — stainless steel leather covered headband—concealed terminals—Six Foot Cord with PL55 plug. EVERY ONE BRAND NEW in Original Factory Cartons.

Stock No. 5A134 \$13.50 value. **\$2.95**
An Outstanding Buy, Only.....

CODE PRACTICE SET

Consist of a top quality key and a Signal high frequency adjustable buzzer mounted on a black bakelite base, equipped with binding posts, ready for quick and simple connections to the 4 1/2 volt battery included. Complete ready to use.



Stock No. 5A145
Each **\$2.95**
Only.....

Complete Nothing Else to Buy

CODE PRACTICE OSCILLATOR

Complete Nothing Else to Buy



Operates from 110 volts AC or DC. Plenty of Volume from Quality Midget Speaker. Complete with tube, high grade key, cord and plug—

Just Plug It In and it is ready to operate.

Stock No. 5A146 **\$8.95**
A REAL BUY. Each.....

8000 OHM IMPEDENCE HEAD SET



Sturdy, hi-quality, built on the hearing aid principle. Ear fitting soft rubber cushions attached to receivers shuts out outside noise. Comfortable, light metal band easily shapes to contour of head. Comes complete as shown with 6 FOOT CORD and matching transformer. Cost to build many times the price we ask.

17A420, In Original Cartons. Special Each... **\$2.95**

RESISTOR ASSORTMENT

Quality makes, insulated, RMA color coded assortment of 100 (50 one watt and 50 one-half watt) all popular capacities. Handy color code chart included

\$1.95

No. 18A74 Per assortment

RF AMMETER



G.E. type D W 52. 4 Amperes, 2% accuracy. EXPANDED scale. 2.19" diam. body. Has internal thermocouple. List Price \$19.75

No. 20A840 **\$3.43**
Special Each.....



COMING SOON

A New Complete B-A Catalog containing the latest in radio and electronic parts and devices, newest ham gear, gadgets, new surplus items. If you haven't already requested one do so now

MASTER HARDWARE ASST.

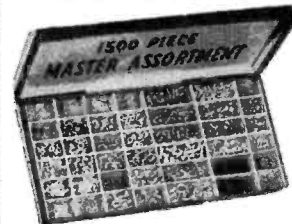

Machine Screws Nuts Washers Soldering Lugs Grommets Spacers Rivets Eyelets Etc. Etc.

42 Individual Compartments, each containing a different type of most selected and often needed hardware. A total of over 1500 pieces. Including a wide variety of sizes, length and heads. This assortment will prove to be worth many times its small cost just to have it on hand when needed. Every Piece Clean, Bright and New. No. 3A35. An Outstanding Value... **\$2.45**

KRAEUTER PLIERS

Round Nose. A handy plier for shaping wire, metal and all around radio work. Made of forged steel with polished head.



No. 11A15. Overall length 6" Each... **95c**

WILLARD 2 VOLT



Compact Rechargeable Storage Battery in Spill-Proof Clear Plastic case. Only 2 3/8" square and 6" overall high—(About the size of the ordinary #6 Dry Cell) make it applicable for a wide range of uses where battery power is needed. Rating 24 AH. Gangs nicely for other voltages in multiples of 2 volts. Shipped Dry. Uses standard battery electrolyte available everywhere. Every One In Original Factory Carton.

No. 5A133. While Our Stock Lasts. Special Each... **\$2.95**

Order from this ad. Every Item Listed is GUARANTEED BRAND NEW, TOP QUALITY GOODS.

Terms—Cash with order or C.O.D with 20% deposit Add Postage.

BURSTEIN-APPLEBEE

EVERYTHING IN Company

RADIO AND ELECTRONIC DEVICES

1012-14 MCGEE STREET, KANSAS CITY 6, MISSOURI

Sensational, Amazing

**NO ELECTRICITY — NO TUBES
NO BATTERIES — NO TUNING**

MYSTERY RADIO



Yes, this new MYSTERY RADIO provides instant reception from the nearest broadcasting station—just put little ear piece into your ear and attach wire clips to aerial and ground, presto—you have reception.

- So small, it will fit in the palm of your hand.
- Usually works swell by just attaching clip to aerial, bed spring, screen door or wire fence, etc.
- Nothing to wear out—no parts to replace.

Send check or money order for postpaid delivery. Dealer inquiries invited on quantity.

TAYBERN EQUIPMENT CO.
DEPT. RN-3
120 GREENWICH STREET NEW YORK 6, N. Y. PRICE COMPLETE

\$245

field. This will cause the electron to deviate from a straight course. It will take a spiral or circular course depending on the speed of the electron and the strength of the magnetic field. It can even travel in a circle in the intervening space between cathode and anode and not even reach the plate. This deviation, due to the effect of the magnetic field, is called the electron's "trajectory path."

The lighthouse or disc seal tube is similar to a conventional tube except that the cathode, grid and anode are constructed in simple, parallel planes or layers instead of being fitted axially one around the other. Such tubes make it possible to reduce the inter-electrode distance between the elements to a very few thousandths of an inch. The electron transit time therefore becomes very small so that a tube working by conventional principles can reach a much higher frequency before phase shift becomes excessive.

Conventional tubes in special circuitry may generate microwaves by either the Barkhausen-Kurz or the Fonda-Freedman techniques. The former has been abandoned because of its low efficiency while the latter is becoming increasingly important as the information is made public after war-time secrecy requirements.

The Barkhausen-Kurz method develops microwaves by reversing the potentials normally used in conventional vacuum tubes. The grid is made highly positive while the plate is made zero or even slightly negative in potential with respect to the cathode. The behavior is as follows:

When no signal is present

1. Electrons from cathode are accelerated by the highly positive grid.
2. Some electrons pass through the grid wire openings and continue in the direction of the plate due to their acceleration by the grid.

3. The plate being slightly negative with respect to the cathode, as well as very much negative with respect to the grid, the electron slows down and stops before it can reach the plate.

4. The electron then is attracted back to the highly positive grid.

5. If it misses the grid wire again, it may reach the cathode.

When signal is present

1. Electron leaves the cathode as in the no signal case.

2. It is accelerated by the positive grid which is now increasingly positive or negative by the amount of the signal voltage so that it has a corresponding acceleration or deceleration.

3. The electron passes through the grid wires (except for those which strike the grid) and may manage to reach the plate if the grid was more positive. If the grid was more negative it will stop further from the plate.

4. Those electrons which do not reach the plate will turn back as in the no-signal case.

The efficiency of this type of oscillator is 1 to 5% and therefore unpopular.

RESISTORS

**CARBON INSULATED
AND WIRE WOUND**

A Complete Range
in 1/2 - 1 - 2 Watt
5% - 10% - 20%

In Stock at All Times

ASK FOR OUR NEW PRICE LIST

LEGRI S COMPANY, INC.
846-850 Amsterdam Avenue
New York 25, N. Y.
Phone: ACademy 2-0018

NOW AVAILABLE FROM STOCK!



SOLAR

Model CF-1-60
EXAM-ETER

With Exclusive Patented Solar "Quick-Check" Circuit. A sturdy, reliable instrument designed to simplify and speed up electronic servicing.

- Quality Checking of Capacitors Under Actual Operating Conditions.
- Capacitance—10 mmf. to 2000 mf. mfd.
- Power Factor—0 to 55 per cent.
- Leakage Current—At Voltages Up to 550 Volts.
- Insulation Resistance—3 to 10,000 Megs.
- Resistance—100 Ohms to 7.5 Megs.
- DC Vacuum Tube V.M.—0-550 Volts.
- AC Vacuum Tube V.M.—10 to 50 Volts.
- Complete with Tubes and Test Leads, Ready to Operate.

\$59.70

ADSON RADIO CO.
221 FULTON ST., NEW YORK 7, N. Y.

RADIO-TELEVISION TECHNICIAN'S COURSE

- New Classes starting every 5 weeks.
- Either morning or afternoon classes. Full or Part time.
- Approved for veterans—Public Law No. 346 and No. 16.

Write for Free Bulletin on Courses

HOLLYWOOD SOUND INSTITUTE, Inc.
1040 N. Kenmore Ave., Los Angeles MO 1-2345



SURPLUS BARGAINS!!

HRO-W Nat'l receiver w/9 sets general coverage coils 50 KC to 30 MC, spare tubes, parts, 110 VAC and 6VDC packs. Brand new less spkr. One at \$269.00

NC-100 Nat'l, 540 KC to 30MC, w/spkr. less xtal. Used.....\$80.00

OSCILLOGRAPH, 3" Dumont 224-A has everything, like new.....\$195.00

DECIBEL METER, 2 1/2" Westinghouse -10 db to 6 db, 0-1.9V.....\$5.95

RF METER, 0-5 A. Weston 425...\$6.95

KILOVOLTS, 0-2.5 DC Weston 9.95

MILLIAMPS, 0-1 DC, remove mult. 0-10 VDC scale, Simpson.....\$3.95

MILLIAMPS, 0-100 DC Weston. 4.95

VARIABLE CONDENSER, 500 MMF Nat'l EMC-500, original boxes, \$1.95

TRIMMERS, half-silvered ceramic 5-20 mmf..... five for \$1.00

MICA, 50 Ass't incl. silver.....\$2.50

Send for FREE list

Postage additional. \$2 minimum.

TERMS: Net Cash, 25% deposit COD's.

HAMS SUPER SPECIAL

CLOSE OUT. Transmitter BC-653-A, AM, 100 watts CW, 22 watts phone, 2 MC to 4.5 MC 80 meters. Incl. 807, two 1613, two 814. Brand new w/spare tubes, diagram, less dynamotor. A real bargain at.....\$59.95

FILTER CONDENSER, oil-filled C-D, 6 mfd, 1500 V., rectangular can.....\$2.25

ELECTRONIC SUPPLIES, 317 E. 2nd, Tulsa 3, Okla.

- Electric Utilities.
- Gas Utilities.
- Water Utilities.
- Fixed Public Services.
- Geophysical Services.
- Bus Communication.
- Truck Communication.
- Taxi Communication.
- Common Carrier Urban Mobile Services.
- Common Carrier Highway Mobile Services.
- Coastal Telegraph and Telephone Services.
- Coastal Harbor Stations.
- Provisional Radio Stations.
- Motion Picture Radio Stations.
- Rural Radiotelephone Services.
- Television.
- Facsimile.
- Relay Press Services.
- Police/Fire/Forestry/Sheriff Conservation, etc.
- Transit Utilities.
- Educational Broadcasting.
- Citizens Radiocommunication Service.
- Radar.
- Amateur Radio.
- Meteorological Radio Stations.
- Aviation Glide Path Stations, Localizers, Markers, etc.
- Railroad Radio.

Table 2. FCC allocation of frequencies in the microwave region between 300 and 30,000 mc. that may be utilized by these services.

The Fonda-Freedman technique which some Navy patent attorneys have called the "Electron Grouping" principle utilizes conventional tubes energized in the normal way. The voltages applied may be exactly those specified in manufacturer's tube manuals for tubes used on lower frequencies. Correct functioning is obtained by either of two methods:

Out-of-phase Method

$$\text{Transit time} = \frac{n}{f}$$

In-phase method

$$\text{Transit time} = \frac{2m + 1}{2f}$$

where: *n* is any number not including zero.

m is any number including zero.
f is the frequency.

In the case of the out-of-phase method, the tube will generate ultra- and super-high frequencies if the transit time is equal to any number of periods of oscillation such as 1, 2, 3, etc.

In the case of the in-phase method, the tube will also generate ultra- and super-high frequencies if the transit time is equal to any odd number of half periods of oscillation such as 1/2, 3/2, 5/2, etc.

The efficiency of the Fonda-Freedman technique is high. Its disadvantage or advantage, depending upon the utilization, that causes much concern is the fact that the tube develops a series of discrete frequencies. This series may be shifted to reach any part of the frequency spectrum but will not exist as a single frequency except where resonating provisions are made available. Half the frequencies in the discrete series may be highly attenuated and eliminated with

March, 1947

TOMORROW'S PRODUCTS TODAY...

STOCK DELIVERY



TEST INSTRUMENTS

Compact — Accurate — Priced Right!

- Jeweled Meter • Range Selector Switch
- All multipliers bridge tested for 1% accuracy
- Zero adjustment—built in batteries
- Molded bakelite case only 3-13/16" x 2-7/8" x 2"



MODEL 450A Volt—Ohm—Milliammeter

A fine instrument having a sensitivity of 1000 ohms per volt.
Ranges: Volts DC, 0-5/10/50/500/1000;
Mills DC, 0-1;
Ohms full scale, 0-5000/50,000/500,000;
Ohms center scale, 30/300/3000.

NET complete with batteries **9.75**

MODEL 451A AC-DC

Volt—Ohm—Milliammeter

A dependable instrument of wide utility—sensitivity 1000 ohms per volt.
Ranges: Volts AC, DC, and Output Ranges, 0-10/50/100/500/1000;
Ohms full scale, 500,000.
Ohms center scale, 7200.



NET complete with batteries..... **13.65**

MODEL 451B

Same instrument as above but has 2500 ohms per volt sensitivity.

NET complete with batteries..... **15.15**



MODEL 452A Volt—Ohmmeter

A superb instrument—100 microampere meter gives 10000 ohms per volt sensitivity.
Ranges: Volts DC, 0-10/50/100/500/1000;
Ohms full scale, 0-2000/20,000/200,000/2 Megs;
Ohms center scale, 30/300/3000/30,000.

NET complete with batteries..... **13.65**



MODEL 312

Volt—Ohm—Milliammeter

An economy pocket meter featuring a 2" moving vane meter.
Reads: AC-DC volts, 0-25/50/125/250;
Mills AC-DC, 0-50;
Ohms, 100,000;
mfd. .05-15.
Jacks provide range selection.

NET Complete with cord and plug..... **6.00**

CONDENSER SPECIALS

Guaranteed first quality.

"The best at the lowest price"

Mfd.	Voltage	Net
10	25	27¢
25	25	36¢
100	25	52¢
10	50	32¢
8	150	32¢
16	150	42¢
20	150	44¢
30	150	47¢
20/20	150	70¢



Attention GI JOE!

Here's Your Opportunity to

Start Your Own RADIO SERVICE SHOP

Complete Starting-in-Business Package Stocks of

TEST EQUIPMENT TUBES, PARTS, TOOLS **\$350 up**

Act quickly! Meet the pent up demand for radio service. Turn your special service training into a profitable business of your own. No fuss. No worry. Here's everything you need—\$350 up. Details upon request. Write, wire or phone.

PHILCO BEAM OF LIGHT

Selenium cell only, no holder, postpaid..... **1.80**
(Puts new life in Philco Chargers.)

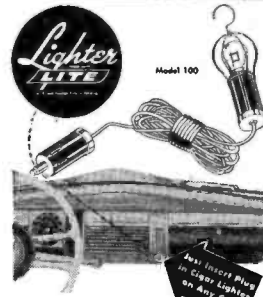

"One with every car radio service job"

Emergency trouble lite. 12' cord reaches anywhere on car. Insert plug in cigar lighter on any car. Gives light—where needed—when needed—a "natural" for installing and servicing car radios—use it—sell it to your customer—for added profit.
1 lighter lite in box **2.50**
1 dozen..... **1.88 ea.**
2 dozen..... **1.67 ea.**
4 dozen..... **1.50 ea.**

SHORT WAVE RECEIVERS

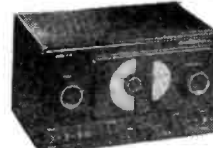

- HALLICRAFTERS S-38..... **39.50**
- S40 (REPLACES S20R)..... **79.50**
- HAMMARLUND HQ129X..... **161.40**
- SPEAKER IN MATCHING CABINET..... **11.85**

20% deposit required on all C.O.D. orders.
2% transportation allowance on orders of \$25.00 or more accompanied by payment in full.

RADIO SUPPLY & ENGINEERING CO., Inc.
129 SELDEN AVE. DETROIT 1, MICH.

SEND FOR FREE BARGAIN BULLETIN

GOVERNMENT SURPLUS

We have on hand a large selection of Radio and Electronic Equipment purchased from the United States Government, and solicit your inquiry on practically any equipment or component parts used by the Army or Navy. Listed below are only a few of the many items we now have in stock.

AMP METERS, ANALYZERS, ANTENNAS

- Bulbs, 1/4 w. neon 110 v., screw base, 10 for.....\$ 1.49
- Bulbs, pilot, #44 & #47, box of ten50
- Condensers, variable National type SSU, heavy duty 2 plates 50 MMF 1.75
- Meters, Western Electric, 2 MA DC scale 0-20 FS-2MA D-168142 3 1/2" 5.50
- Meters, Weston Model 506, 0-150 MA DC, 2" 3.00
- Relays, 115 V AC 60 C 30 Amp 3.95
- Relays, 115 V 60 C will carry 2 Amps 1.35
- Resistors, 100 Asst. 1/4, 1/2, 1 Watt 2.50
- Sockets, Steatite 4 prong, 10 for Spark Plug Suppressors, 50 for Telephone Handsets TS-9K.... 3.95
- Tuning Unit, plug in for TCE-2 Navy Transmitter in metal carrying case. Unit has two double spaced transmitting type Variable condensers, one fixed temperature compensating condenser, two transmitting Coils, one Variable tuning coil, several switches, insulators, etc. Has more than \$50.00 worth of component parts. Only 14.95
- Switch-Rotary, Ganged, 2 position, 4 sections Silver Plated Contacts Isolantite insulation 3.50
- Switch, Toggle, Panel mount, shank 1/2" x 1/2" DPST-20 Amp/250 V75
- Switch, treadle type..... 3.00
- Special Flyers on—Connectors, amphenol, cannon and phone; Circuit Breakers; Dynamos; Meters; Potentiometers; Resistors; Test Equipment; Transformers; Transmitters & Receivers; Tubes.

We have in stock small quantities of Amplifiers, analyzers, cable assemblies, Co-Ax cable, converters, Frequency meters, multimeters, V.O.M. Meters, movie projectors, oscilloscopes, power supplies, rheostats, Signal Generators, Signal Tracers, speakers, tube testers, and vibrapacks. Send for current offering. State items interested in.

SPECIAL \$25.00 OFFER

On a deposit of \$5.00 we will ship you C.O.D. Freight Collect a large quantity of Government Surplus Radio Items subject to your inspection and approval. If, after inspecting you are not more than satisfied, return to us Freight Collect and all it will have cost you will be freight charges one way. You should be able to dispose of a few of the items that you may not need for the entire cost. This is the cheapest way we can sell you War Surplus Radio Material. Our warehouses are filled with thousands of choice Government Surplus Radio Items. Lots of them we do not have in sufficient quantity to advertise nationally and the cost of inventorying, itemizing, corresponding, etc., would only increase their cost, therefore we make this offer. If you wish to mention a few items you desire we will endeavor to include them in this assortment.

Above Prices F.O.B. Baltimore

THE ABELL DISTRIBUTING CO.
5 E. Biddle Street, Baltimore 2, Maryland

their power going into the remainder by simple condenser tuning provisions. More elaborate control requires special provisions such as wave guides and cavities correct for the desired frequency and incorrect for the superfluous frequencies. Strong indications are currently being obtained in the range of 100 to 1000 megacycles. Feeble indications have already been detected as high as 50,000 megacycles from a 6N7 tube even though no more than a pair of headphones to which was attached a silicon or galena crystal detector, was the method used to measure the maximas and minimas in terms of wavelength.

Little information has thus far been disclosed on the Fonda-Freedman developments as the inventors are not free to discuss same since patent arrangements are not as yet completed.

In appreciating the use of micro-

waves or in preparing to procure such facilities, readers are cautioned that the most satisfactory techniques and equipment have not yet been made known or sold to the public. Much secrecy has existed and continues to exist as firms invent, develop and compete in order to have a complete and more novel microwave communication system. They have their sights trained on the microwave relay networks, radar, and two-way radio communication fields.

Table 1 compares the various tubes and techniques which have successfully generated microwave frequencies to date. The Federal Communications Commission has allocated frequencies in the microwave region between 300 and 30,000 megacycles which may be utilized by the services or groups shown in Table 2.

-30-

DELUXE PHONOGRAPH OSCILLATOR*

This simple, easy-to-build unit will give high-quality performance when used either with a crystal phono pickup or a crystal microphone. Output is sufficient to operate a radio receiver located 50 to 75 feet away.

The oscillator portion utilizes the control grid, screen grid, and plate of a 12SK7 tube. The audio modulating voltage is impressed on the suppressor grid, and the per-cent of modulation may be varied by adjusting R3, which controls the cathode potential of the 12SK7.

The power supply consists of a selenium rectifier and filter circuit, and provides d.c. for both the plate and heater of the 12SK7 tube. This reduces the

*Schematic diagram for this unit was supplied through the courtesy of Federal Telephone & Radio Corporation.

possibility of hum modulation due to a.c. operation of the heater, eliminates the need for a transformer, and reduces the amount of heat dissipated within the unit. The total d.c. current drain is under 200 ma., so a 200 ma. rectifier or two 100 ma. units in parallel may be used.

To adjust for proper operation, the unit is turned on and a phonograph record played. The radio receiver is tuned to a clear spot on the dial, preferably in the neighborhood of 1600 kc. Condenser C6 is then adjusted until the signal is heard at maximum loudness on the radio receiver. This means that the radio receiver and the tuned circuit L1-C6 are both tuned to the same frequency. R3 is adjusted for maximum clarity of the audio signal, and the unit is ready for operation.

-30-

Either voice or recordings can be transmitted with this simple phono oscillator.

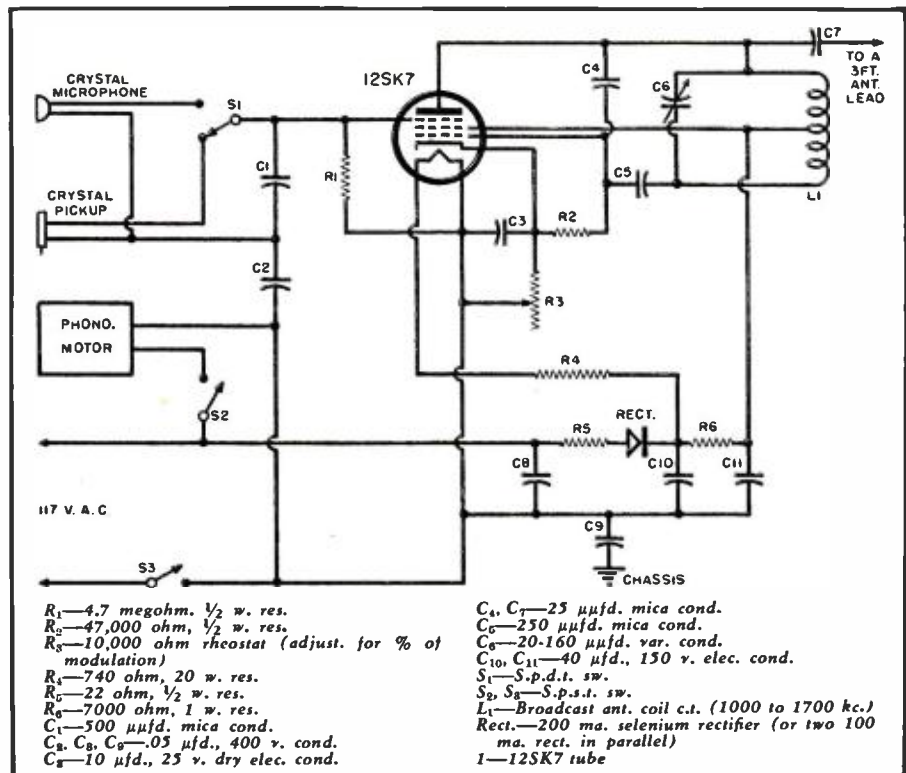

International Short-Wave

(Continued from page 96)

minutes later—though still with a peacetime beard—I sat behind the wheel, driving full-throttle to the station. We went on the air and told a stunned world what was happening. Like thieves at night, the German Wehrmacht, armed to the teeth, flooded over our borders and the peaceful soil of Holland resounded with the rattle of tanks and the heavy thud of hobnailed, ugly Kraut-boots. The brutes were coming. They dropped out of the air, machine-gunned our roads, bombed our towns, while Goebbels' poisonous propaganda bombarded us with lies and threats: 'We come as friends . . . or we shall smash you!'

"For four days and nights, PCJ reported the coming of the hordes and the stubborn resistance of a small army that fought bravely to stem the onslaught of a vastly superior enemy. Then came the blow that shook the earth for miles . . . PCJ was blown up in the air by ourselves—rather than let it fall into the hands of the enemy! And what was not destroyed by the explosion was consumed by the flames of a roaring fire. Our pride, the big rotating beam antenna—the only one in the world—a masterpiece of skill and engineering, lay pole-axed along the ground. It was a ghastly sight. After 12 years of short-wave pioneering and goodwill programs to the world, PCJ, the 'Happy Station,' was no more . . .

"'Vat happened here,' asked two Nazi officers who came to see the destruction. 'Oh, somebody must have pushed the wrong button,' I suggested, wild with rage inside.

"'The 'rong button? . . . what do you mean?' said the Boche, giving me a dirty look. He pointed to the sky where a squadron of German bombers flew in westerly direction. They were flying low showing their crosses on the wings to rub in their prowess and their power. 'See that,' said the German. 'They are heading towards England and in a few weeks we'll be standing on the ashes of London.' 'Sez you!' I thought, while trying to find a German equivalent, which I did not. Instead, I simply said, 'I doubt very much you will ever get there!'

"The Nazi took my remark with arrogant superiority. He was convinced the Fuehrer had calculated every possibility and every trick. But the Dutch knew better. As a seafaring people, they instinctively knew that the little stretch of water and the Bulldog behind it could do more than all the Goebbels' propaganda ever concocted.

"The war went on and the Gestapo moved in. PCJ had to be rebuilt by forced labor, to pump the German propaganda overseas. That's when yours truly beat it, retiring from radio for the entire period of the war. A broadcaster became a listener—out-

March, 1947

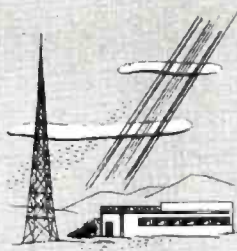

RADIO STATION STANDBY

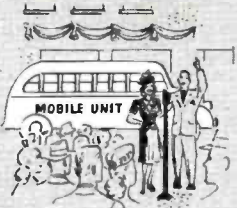

MOBILE RADIO UNITS



GEOPHYSICAL SURVEY

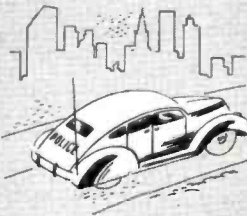

MUNICIPAL SIGNAL STANDBY

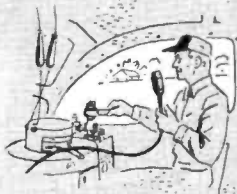

RAILROAD RADIO

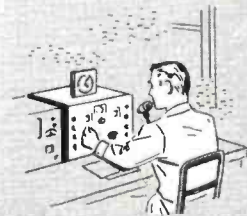

AMATEUR RADIO



"SPOT" RECORDING

A.C. OR D.C. POWER

PORTABLE, STANDBY OR STATIONARY for Electronics Uses

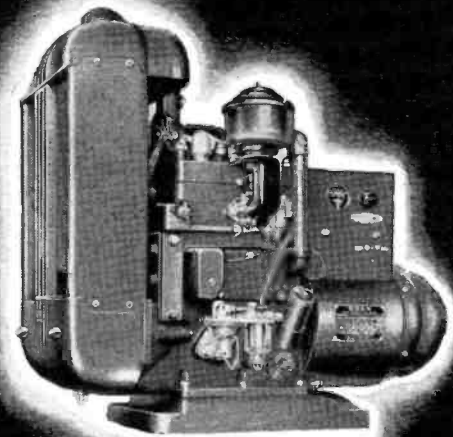

Onan Electric Plants are completely self-contained, dependable power units built in a wide range of sizes and standard voltages.

Lightweight, one or two-cylinder, air-cooled models offer the maximum in portability for many applications. Portable A.C. models—350 to 3,000 watts; portable D.C. models—600 to 5,000 watts.

Although widely used for intermittent service as standby units, Onan two, four, and six-cylinder water-cooled plants are built for continuous heavy-duty operation . . . stationary or mobile. A.C. models—3 KW to 35 KW; D. C. models—3.5 KW to 10 KW.

WRITE FOR FOLDER

ONAN Electric Plants are available in many sizes and models. ALTERNATING CURRENT: 350 to 35,000 watts in all standard voltages and frequencies. DIRECT CURRENT: 600 to 10,000 watts, 115 and 230 volts. BATTERY CHARGERS: 500 to 3,500 watts; 6, 12, 24 and 32 volts.

D. W. ONAN & SONS INC.

4728 Royalston Ave.

Minneapolis 5, Minn.



HARVEY HAS COLLINS TRANSMITTERS



IT'S HERE!

... the NEW Collins transmitters with all the features you've ever wanted in a transmitter. 500 watts input on CW, 375 on phone. The 30K with its associated 310A Exciter Unit combines the desires of hams with brass in their blood and also those who want only a push-to-talk button.

LOOK AT THESE FEATURES:

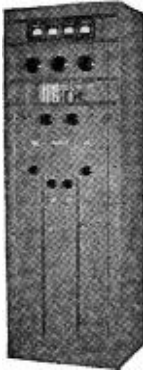

- fully metered
- vfo controlled
- band switching
- 115 v. ac power source
- 80, 40, 20, 15, 11, 10 meters
- 3 pairs antenna terminals
- 100% modulation
- clean, sharp keying
- smooth modern styling
- remote control
- speech clipper

Get all the details from Harvey... place your order now for immediate delivery... be the first to get on the air with this superb job. Price complete with Exciter

\$1250

Just as soon as delivered Harvey will have the other excellent Collins units, the 32V transmitter, the 70-E8 precision vfo, the 75A precision receiver. Harvey has all the best.

Telephone: **1-800-368-1800**

HARVEY
RADIO COMPANY INC.
103 West 43rd St., New York 18, N. Y.

side listening in. How he squirmed through the intricate net of endless Nazi trickery is a story for some other time.

"Shortly before the invasion came in 1944, a storm swept through the high antenna masts of PCJ's rotating beam, putting the directional mechanism on the circular rails out of order. Through clever sabotage of the engineers, the mechanism proved irreparable with the result that for the remainder of the war, all Nazi broadcasts were directed to the North and South Poles, where polar bears enjoyed excellent reception!

"When the armies got locked near Arnhem in the starvation winter of 1944-45, the retreating enemy pillaged and looted everything that they could lay their hands on. So after four and one-half years of hiding it, PCJ's ample file and fine records—collected from all parts of the globe for the enjoyment of its listeners—was carried away and was never seen again.

"Finally, when after many years of anxious waiting, liberation came to starving Holland, PCJ was demolished again—now by the Germans. Yet, fortunately, they had no time to blow it up entirely, while some idiots even thought they would be back. And so after a few good meals with allied rations, PCJ's engineers spit in their palms and went to work to rebuild in record time the 'Happy Station' to bring again to the world that well-known spirit of Peace, Cheer and Joy (PCJ)—thanks to the great Allied Victory!"

And so it was that once again PCJ took its rightful place among the greatest of short-wave broadcasters! Once again its "Happy Station Program" is the star feature on the Netherlands Overseas Services, having such a far-flung audience of assiduous friends that it can easily be considered as one of the most popular features aired on short-waves around the globe. Eddie tells me "the audience is growing by the month, and the underlying spirit being the fostering of friendly and peaceful relations by mixing music with human-interest stories, is once more proving the reason for its success."

Mr. Startz is planning for a worldwide PCJ Birthday Party—celebrating the 20-year jubilee of the station—this spring, probably some time during March. Announcement will be made well in advance over the microphone, in the "Happy Station Programs," which are now radiated as follows:

Sundays and Wednesdays—10:30 a.m.-12 noon, 15.22, 11.73, 6.02, to East and Near East; 4-5:30 p.m., 11.73, 9.59, 6.02, to Africa and Mediterranean; 9:30-11 p.m., 11.73, 9.59, 6.02, to the Americas. *Tuesdays*—3-4:30 a.m., 11.73, 9.59, 6.02, to Pacific, Australia, and New Zealand. (These times are EST.)*

Reports to PCJ are always wel-

* Unless otherwise indicated, all times mentioned herein are American EST, 5 hours BEHIND GMT.

REAL BONAFIDE VALUES

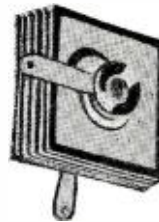

92¢

-Lots of 12.

Federal Selenium Rectifier Replaces All Rectifier Tubes Sample \$1.09



SHURE CRYSTAL MIKE

With Base & Cable Reg. \$18.50 **\$6.95**

Home Recorder & Playback with Mike. Regular \$99.95..... **\$79.50**

Detrola Changers..... **\$17.50**

Government Surplus Special 5 1/2 foot Earphone Ext.—JK26-P.L.54..... **49c**

Permoflux Nylon Cone 3" heavy slug Speaker..... **\$1.98**

100 I.R.C. Resistors—Asst. Sizes & Watts..... **\$2.49**

Government Surplus Phones..... **1.98**

35Z5-50L6-12SG7-12SK7-12SA7 Standard Tube Kits..... **4.49**

Astatic L-70 Pick-Up..... **2.95**

Pocket Volt-Ohmmeter..... **14.75**

2" PM Speaker..... **1.39**

Shure T-17B Push Button Carbon Mike. **2.39**

TERMS: 25% Deposit Required with Order. Balance C.O.D. Plus Mailing Charges.

BONAFIDE RADIO & ELECTRONICS CO.

89 1/2 CORTLANDT ST. NEW YORK 7, N. Y.

DHD 5-TUBE GUITAR AMPLIFIER, AUTOMATIC PHONOGRAPH, & PORTABLE P. A. SYSTEM

ONE unit that meets ALL requirements of musical and voice reproduction.

- Webster Model 56 Record Changer
- Two large 10" speakers enclosed in infinite baffles for adequate coverage of most all auditoriums.
- Two input jacks for musical instruments
- One input jack for microphone
- 25 feet of speaker cord for EACH speaker
- All combined in two easily portable cases.

Records may be played to accompany an instrument plugged into the instrument jack... Beginners can learn music by following the record being played... Records can be accompanied by voice... Automatic changer can play records during intermissions... Microphone may be lugged into mike jack and mixed with guitar or instrumental music—or used separately as a Public Address System.

LIST PRICE **\$159.50**
OUR SELLING PRICE **102.75**

DHD ELECTRONICS AND APPLIANCE CO.
3025-R South Flower St., Los Angeles 7, Calif.

came and an attractive verification card answers all correct reports; address, PCJ, Postbox 150, Hilversum, Holland (Netherlands).

Facts About Holland

Before a closing comment from Mr. Startz, here are a few pertinent points about The Netherlands.

The Kingdom of the Netherlands (*Koninkrijk der Nederlanden*), in northwestern Europe, has an area of 12,862 square miles, with a population (estimated, January 1, 1944) of 9,090,000. Amsterdam is its capital.

Holland is bounded by Germany on the east, Belgium on the south, and the North Sea on the west and north. Its surface is flat, with an average height above sea level of 37 feet, and with about one-fourth of its land below sea level, reclaimed and protected by dykes, of which there are 1500 miles. Drainage of half of the shallow Zuider Zee, which covers 1350 square miles, with an opening into the North Sea about 19 miles wide, designed to add 900 square miles to the cultivable land—"polders"—has been under way since 1920.

The Hague is the official residence of H.M. Queen Wilhelmina and the seat of her Government—but Amsterdam is the sole capital of the Kingdom and the inauguration of the King or Queen—in accordance with the constitution—takes place in that city.

Cereals, potatoes, sugar beets, and other crops are raised. Dairy products are an important industry; the cheese products are famous and the cattle high grade. On the very special type of soil found on the edge of the polders and the sand dunes along the coast, tulips and other flowering bulbs and roots are grown. The Dutch bulb is not indigenous to Holland but originated in Persia, whence it was taken to Holland 375 years ago. The village of Boskoop, with 600 nurseries, is the largest center in the world for flowers and ornamental plants, it is claimed.

Most important industries before World War II were shipbuilding, the manufacture of machinery, textiles (including rayon), and chemical products; also brewing and distilling and flour milling. Amsterdam is famous for diamond cutting; Delft, for pottery.

Canals, of which there are 4817 miles, are most important in internal communication and transportation; elaborate systems are in the cities and feed the harbors. The Rhine and the Scheldt reach the sea through the Netherlands and carry enormous traffic, the Scheldt carries traffic including that from Antwerp (Belgium).

The Dutch Constitution assures a hereditary constitutional monarchy. Executive power rests exclusively in the Sovereign and the States-General of two Chambers. Universal suffrage for citizens of both sexes over 25 years of age and proportional representation are in force.

The reigning Sovereign is Queen Wilhelmina Helena Pauline Maria

March, 1947

SILVER "VOMAX"



IMITATION . . .
SINCEREST OF
FLATTERY

The true worth of "VOMAX" is proven not alone by overwhelming preference by service technicians, by research laboratories. It gets top rating through the copying of its new inventions by at least four manufacturers! No imitation provides the range, utility or universality exclusive to "VOMAX". Recognized by those "in the know", sales of "VOMAX" far exceed those of any would-be competitor. So, cost to you of the genuine original "VOMAX" is from 10% to over 65% lower than its imitations. Only \$59.85 net.

So superior as to be imitated, "VOMAX" stands unequalled. It alone gives you the astronomically high meter input resistance so necessary to servicing AM, FM and TELE receivers — a feature not obtained by imitations. Add a total of 51 voltage, current, resistance and db. ranges. That's why "VOMAX" is the overwhelming choice of experts — be it for use or copying. Can you afford less than the best — when the best costs you least?

"SPARX"

"QUICKEST TROUBLE
FINDER EVER"

says J. P. FITZGERALD



of his new "SPARX" visual-aural dynamic signal tracer, writing from Madison, Wisc.: " . . . cannot afford to be without this valuable instrument one minute. It is the quickest trouble-finding apparatus I have ever used." To repair any radio you've first got to find the trouble. "SPARX" will locate r.f., i.f., a.f. trouble in 30 seconds per tube! Think what that means in profits to the thousands of your competitors already using "SPARX". It will boost your profits, too . . .

"SPARX" is the same great "buy" at only \$39.90 as "VOMAX", world's most popular, most copied, universal vacuum-tube voltmeter. Of matching size and style, thousands in use prove its vital worth to every service technician interested in guarding his profits. "SPARX" traces signals through a receiver from antenna to speaker, circuit by circuit, locating trouble points, both audibly and visually. Its speaker switches to panel jacks for shop test use — another SILVER plus-value.

Send Post Card for Catalog for new measuring equipment, communication receivers, transmitters, kits, parts. See them at your favorite Jobber.

OVER 36 YEARS OF RADIO ENGINEERING ACHIEVEMENT

McMurdo Silver Co., Inc.

1249 MAIN ST., HARTFORD 3, CONNECTICUT

WE SHIP ANYWHERE IN THE WORLD

Internationally Famous

FLANAGAN RADIO CORP.

NOW! ALL RADIO TUBES AT WHOLESALE PRICES RIGHT DOWN THE LINE FROM A TO Z INCLUDING HARD-TO-GET AND CRITICAL TYPE TUBES.

PHILMORE SUPERTONE KIT



RETAIL \$4.00

YOUR COST \$2.40

PHILMORE SUPER RADIO CRYSTAL SET



RETAIL \$1.90

YOUR COST \$1.14

PHILMORE JUNIOR MICROPHONE



RETAIL \$1.25

YOUR COST 75¢

SINGLE UNITS ADD 25¢ POSTAGE

STANDARD PACKAGE

- 4 Supertone Kits
- 4 Super Radio Crystal Sets
- 4 Junior Microphones

RETAIL \$28.60

YOUR COST \$17.16

Shipped Prepaid Upon Receipt of Check or Money Order Anywhere in the United States and Canada.

FREE CATALOG

Send for free catalog and prices of hard-to-get Radios, Radio Tubes, Radio Parts, Pickups, Motors, Condensers, Tube Checkers, Volt and Ohm Meters, Signal Generators, Signal Tracers, etc.

FLANAGAN RADIO CORP.

America's Largest Stock of Radio Tubes
N. E. Cor. 7th & Chestnut Sts.
Phila. 6, Penna.—U. S. A.

who succeeded on the death of her father (Willem III), November 23, 1890, and who was crowned September 6, 1898. Heir to the throne is Princess Juliana, only daughter, who is married to Prince Bernhard of Lippe-Biesterfeld.

Germany invaded The Netherlands on May 10, 1940, and occupied the country. Queen Wilhelmina and her cabinet escaped to England and established the Government in London. The Netherlands declared war on Japan, December 8, 1941, and on Italy, December 11, 1941. German troops surrendered on May 4, 1945.

Army service is compulsory with every man liable from the ages of 20 to 40.

Entire liberty of worship and conscience is guaranteed.

Education is obligatory from ages seven to thirteen; instruction is free or subject to a small fee, in both public and denominational schools; teachers are paid by the State. There are several fine Universities.

Tribute to SW Radio

In closing, we leave with you a tribute to short-wave radio as paid by Eddie Startz in an early publication of PCJ (1929):

"Short-wave broadcasting as we know it today is the outcome of many years' indefatigable research and profound study of short-wave technique and propagation phenomena. The larger short-wave stations radiate their programs to every corner of the world, building a mysterious bridge between the loneliest spots of the earth and civilization, from Arctic to Antarctic, from Continent to Continent. Short waves encircle the world, they convey messages of all kinds from and to every conceivable spot, conquering the old enemy, distance, that used to be such a barrier to the progress of mankind. That is why papers write, people talk, and engineers think about it. Short-wave broadcasting means that a long-cherished dream of mankind—the elimination of distance—has come true in the fullest sense of the word. Listeners are scattered over the entire earth and are particularly numerous in the tropics and in the isolated regions where man is deprived of the comforts of civilization. That is where short waves reign supreme, as the longer waves do not reach so far, or if they do, they are drowned by the severe atmospherics which are such a distress to the listener.

"In the remote corners of our world, at the outposts of civilization, in the desert or on the high seas, up in the peaks of the Himalaya mountains or the Cordilleras de los Andes wherever man is shut off from the rest of the world, there we shall find the short-wave fan. For him short waves are the only link with his fellowmen at home and are his only diversion. For him stations like PCJ mean home and all it stands for, conjured up and made audible by the mere turning of a tiny knob of his short-wave receiver . . .

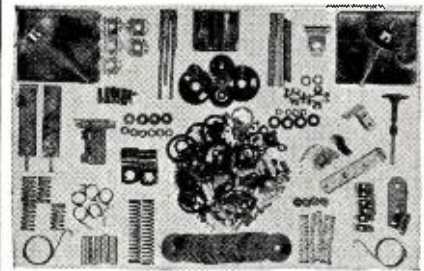

2 1/2 POUNDS OF PARTS!

★ GEARS
★ SHAFTS
★ BUSHINGS
★ SPACERS
★ SPRINGS
★ RIVETS
★ BRACKETS
★ CLAMPS

Hundreds of Pieces
A-1 Quality
Complete Assortment
Postpaid **\$1.29**
Outside of U.S.A. Add 50c

Deluxe Radio Parts Assortment

\$5.00
PER KIT

Contents Include All This:

- Throat Mike
- Motor or Dynamotor
- Transformers
- Knobs
- Coil Forms
- Condensers
- Contact Points
- Terminal Boards
- Switch Box
- Resistors
- Insulators
- Relays
- Fuse Holder
- Switches
- Chokes
- Tube Sockets
- Pilot Lite w/Bulb
- Flexible Shafts

• And Many Misc. Small Parts

SHIPPING WEIGHT OVER 20 LBS.
SEND ONLY \$5.00 FOR EACH KIT WANTED
NO C.O.D. ORDERS FILLED
ALL SHIPMENTS BY RAILWAY EXPRESS
CHARGES COLLECT

GEORGE BROOKS & ASSOCIATES
220 SOUTH HALSTED STREET CHICAGO 6, ILLINOIS

Vacuum Cleaner Replacement

CORD SET

Consists of 21 feet of round rubber jacketed cord with molded rubber plug. Open ends of cord stripped and tinned ready for attaching. Underwriters approved, each \$0.82



Heavy Duty Extension

CORD SET

Ideal for extending power to Motors, Washing Machines, Portable Tools, etc. Ten feet of constant service round rubber jacketed cord with non-breakable rubber plug on one end. Other end has female connector. Underwriters approved, each \$0.75



6 ft. 18 Ga. POSJ Cord Set

Excellent all-rubber replacement cord for radios, lamps, small appliances, etc., with molded rubber plug. Each \$0.20

We carry in stock for immediate delivery many types of wire and cable in gauges of from 23 to 2, in addition to various types of multi conductor cable for many uses. We also manufacture cord sets and cables to specifications. Send us your inquiries for prompt attention.

Our new catalog will be ready for distribution shortly. Write for your copy today.

COLUMBIA WIRE & SUPPLY CO.
5740 Elston Ave. Chicago 30, Ill.

the magic portal beyond which lies the outside world . . .

"It cannot be denied that in long-distance transmission there is a fascinating something decidedly worthy of the term 'romance.' There is a thrill for both listener and speaker, through the personal contact that is maintained between two people who are separated from each other by such tremendous distances as only short waves will bridge."

Of his long years before the PCJ microphone, Eddie Startz reports that one of his most interesting early experiences "was the rebroadcast of the 1929 PCJ Christmas program for the United States. This transmission was picked up with perfect strength in America and was rebroadcast by the National Broadcasting Company over a large network of stations extending over the entire country. So successful was this experiment that we received over 3000 letters from listeners, enthusiastically expressing their appreciation of our efforts. A good many of these communications were from our countrymen abroad, who were deeply moved when listening to their mother-country over such a great distance. Another remarkable feature in the history of the station was when the old world was again linked up with the new—but this time with the South American Continent. Under the auspices of the Brazilian Ambassador in Paris, a concert played in the French metropolis was transmitted by PCJ to Brazil, where it was successfully rebroadcast at Pernambuco, Rio de Janeiro, and Sao Paulo."

As to his method of conducting the "Happy Station Programs," Eddie makes this comment: "Although I can safely say that short-wave listeners are a very grateful and appreciative audience, experience shows that they like to be treated individually. Listeners appreciate hearing their countries and towns mentioned during the programs (especially at *Mailbag* time), and it is often difficult to do justice to everyone at a time, considering the innumerable listeners of the station. . . . But in my mind I have been with listeners all over the globe, talking to them in their own language, while interposing personal remarks and calling many by name, thanking them for their reports and cooperation. The PCJ family is large and a universal spirit of sportsmanship prevails among the listeners."

"It is indeed a great satisfaction to note the interest and sympathy for the 'Happy Station Programs,' which is so distinctly reflected in the thousands of letters pouring in from listeners all over the world. Not only do these reports and messages of appreciation contain valuable material for our engineering staff, but they are equally valuable as a stimulus to our future efforts in broadcasting. The communications might be compared to the spontaneous response of a theatre audience without which the actor would be unable to play his role effectively."

Dependable MICROPHONE PLUGS by CANNON ELECTRIC



Judy Canova, radio star, broadcasting over NBC in Hollywood, with Hal Gerard and Joe Kearns. RCA microphone is equipped with Types "O" or "P". ALL RADIO NETWORKS USE CANNON MICROPHONE PLUGS.



Left: Type "O3-42" Receptacle and "O3-11" Plug on Western Electric table type mike used by Columbia Broadcasting Co. Center and Right: Other large network mikes use type "O" for cable extension. The latchlock device prevents accidental disconnection resulting from jerks or strain on cord.



Left: Microphone with "P-42" Receptacle and P-CG-11 Plug used for platform public address. (Photo courtesy Reiss P. A. Systems, Detroit). Right: Mike used by CBS-Hollywood, with P-CG-12 plug shown in hand. As in the case of the above Type "O", two mating "P" plugs can be used conveniently for cable extension where receptacle is not an integral part of the microphone itself.

The New lightweight Type "XL" is standard equipment on the equally new RCA "Announce" Microphone which has a unique construction in the stem, allowing the plug to swing into the stem with a cover. Relief spring on XL-3-11 plug protects cord from sharp bends. Adapters are available to users of microphones such as the Turner (second to right) for those desiring to convert to Cannon "XL" Plugs.



TYPE "O"

Two plugs and six receptacle styles available in this series. One oval insert arrangement with three 30-amp. contacts for No. 10 B&S stranded wire.



TYPE "P"

Five plugs and nine standard receptacle styles available in six insert arrangements; two to six 30-amp. contacts, one eight 15-amps. for No. 14 B&S stranded wire.



TYPE "XL"

Two small plugs and four receptacles with zinc shells carry three 15-amp. contacts for No. 14 B&S stranded wire. Equipped with compression gland and relief spring.

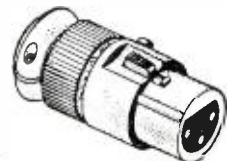

TYPE "XL"

Two steel shell XL plugs for rough, heavy-duty usage. Same insert arrangement as above. Integral clamp construction and leading XL features.

Write Dept. C-228 for C-46A Condensed Catalog, describing all above connectors and list prices. Available from jobbers everywhere.



CANNON ELECTRIC DEVELOPMENT COMPANY

3209 Humboldt Street, Los Angeles 31, California

Canada & British Empire — Cannon Electric Co., Ltd., Toronto, Ontario • World Export Agents (excepting British Empire) Frazer & Hansen, 301 Clay St., San Francisco 11, Calif.

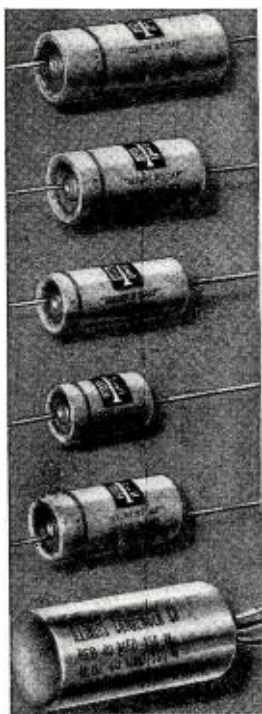

Illinois . . . Your perfect source for

ELECTROLYTIC CAPACITORS

to meet your needs

Our new plant is humming . . . turning out Capacitors of finest quality . . . serving our growing list of customers. At Illinois as always, the emphasis is not on quantity but on quality condensers of lightweight, compact construction endowed with ruggedness for long life. Latest and most modern production equipment, newest manufacturing techniques and the rigid control standards of our trained engineering staff is guarantee of the best in Capacitors.



Your copy of our latest catalog is ready for you. Write for it today.

ILLINOIS CONDENSER CO.
1616 NORTH THROOP STREET • CHICAGO 22, ILL.

YOU OUGHTA SEE ME IN CIVVIES!!

RADAR POWER SUPPLIES CONVERTED FOR YOUR APPLICATION

- QUALITY COMPONENTS:
- QUALITY CONSTRUCTION:
- QUALITY PERFORMANCE:
- BUILT BY WESTERN ELECTRIC:
- 115V., 50-60 CYCLE INPUT:
- EXCELLENT REGULATION FROM 90-130V. INPUT & FROM NO-LOAD TO FULL-LOAD RATING:

MODEL 3
Voltage range: 210-320VDC.
Max. load rating: 0.400 Amp.
Tube Complement: 2-836; 6-6L6; 2-6SF5; 1-VR105; 1-VR150.

Both models are supplied in attractive modern black wrinkle finish cabinet. The front panel is a standard 19" relay rack panel 10½" high. Separate filament & plate circuit controls are provided on the front panel along with the voltage control.

MODEL 8
Voltage range: 590-950VDC.
Max. load rating: 0.225 Amp.
Tube Complement: 2-836; 2-6L6; 2-6SF5; 1-VR105; 1-VR150.

PRICE EITHER MODEL: \$152.00, NET, F.O.B. FACTORY

CAMBRIDGE ELECTRONICS CORPORATION
208 SOUTH PULASKI STREET
BALTIMORE 23, MARYLAND

"Through this reaction on the part of the listener, the enthusiasm is continually kept alive. It is for this reason that when addressing the microphone I know that I am not merely talking to a lifeless instrument but that my words are heard by countless numbers of short-wave friends in almost every country under the sun!"

NAVE WILL Verify

From H. H. Holton, Commander, U.S.N., Officer in Charge, Radio-Television Section, Office of Public Information, Navy Department, comes this official information regarding NAVE, the transmitter of the Navy Antarctic Expedition:

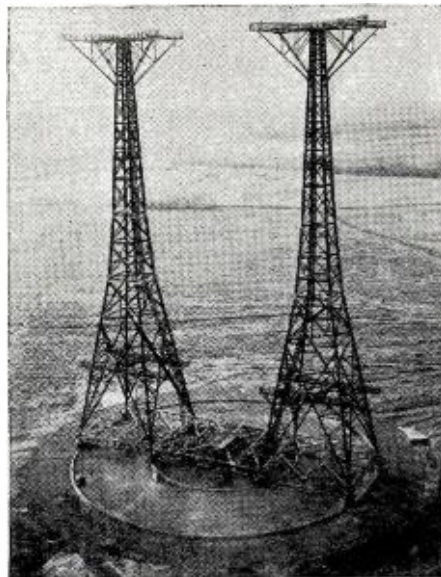

PCJ's rotating beam antenna, the only one of its kind in the world. The prewar one was destroyed by the Dutch rather than let it fall into the hands of German invaders.

"The Navy Antarctic Expedition has provided aboard the U.S.S. *Mount Olympus* broadcasting facilities for equal use among the four major (U.S.) radio networks.

"Since Navy responsibility for the broadcast ends once the signal has left the *'Mount Olympus'* antenna, the networks have arranged to pick up the signal through RCA and Press Wireless. The frequencies allotted for use by the Naval Communication Service are 9.280, 9.670, 12.265, 15.930, 17.820, and 20.040. In addition, RCA has been utilizing its own frequencies. Naturally, the use of any one frequency has not been standardized yet because of varying and unpredictable atmospheric conditions.

"Considerable thought had been given communication with radio amateurs, but since the communication personnel with the expedition are fully engaged with normal operating communications, audio-radio broadcasts to the American people through the four major networks, radioteletype, radio-photo, and establishing communication with the Navy airplanes making reconnaissance flights over the Antarctic continent, time and personnel are just not available for amateur radio communications.

"If radio listeners and amateurs wish to verify reception of *'NAVE'*, it is requested that they mail their requests to the Radio-Television Section, Office of Public Information, Navy Department, Washington 25, D. C., U.S.A.

"It must be borne in mind that the operating radio log is being maintained aboard the *'Mount Olympus'* and that there is no mail service to the Antarctic. Therefore, answer to requests for confirmation of radio reception will require five to six months. Please advise your readers not to send requests for confirmation to the *'Mount Olympus.'* Such requests will be handled here. It is also urged that amateurs refrain from trying to raise NAVE in view of the expedition's present work-load."

Information on reception of NAVE comes from Bill Arthur and Lynn McLaughlin, Charleston, West Virginia, who have been carefully monitoring NAVE:

"NAVE has been using a transmitter which they rate as 350 watts, but a 2.5 kw. transmitter was picked up in the Canal Zone and is probably now in use. While schedules of NAVE are for the most part irregular, they usually contact the United States around 7:30 a.m. and 6:30 p.m. EST (1230 and 2330 GMT), daily.

"Thus far, the 17.82 frequency has been heard more here than the others, although it usually suffers interference from U.S. broadcasters in the 16-meter band.

"Apparently, NAVE uses a variable frequency oscillator—or equivalent—as frequencies can be shifted by small

amounts in order to avoid too much interference from other nearby transmitters.

"At times the contacts have not been too successful, in fact sometimes have not been completed. However, we have usually been able to read both sides here.

"Press Wireless contacts have included WBE, 19.580; WBH, 22.780; WHJ, 17.440; WBG-5, 15.610; WJS, 15.700; WJQ, 10.010; WRP-2, 23.450. RAC contacts have included WBU, 21.26; WQE, 18.920; WLL, 17.900; WQD, 18.960; WQV, 14.800; KQZ, 17.980; KEL-2, 21.220; KES-3, 10.620; KLL, 13.720; and others."

If tests on the 20.040 frequency are successful, I believe it is quite likely that it will be used a great deal in the future. Watch for this "high" one!

Re Newscast Table

The *English* newscast table compiled for this issue of the ISW Department was prepared with a view of serving readers in many countries. Not all stations listed will be audible in any given area. Since this table should also serve to some extent as a worldwide log, an effort was made to include all *known English* news periods. It must be remembered, however, that station schedules are subject to change without notice, and that changes are taking place almost daily.

Especial thanks go to Paul Dilg and August Balbi, California, and to Roger Legge, New York, for their valuable assistance in the preparation of the table.

Australia's DX Sessions

Direct via airmail from Ernest H. Suffolk, DX editor for *Radio Australia*, comes this timely information:

"*Radio Australia* seeks DXers reports on signals, guarantees to verify all correct reports, and will answer all letters. An old-time DXer, Graham Hutchins, has been engaged to attend to this matter and is now on the staff of *Radio Australia* for this purpose alone. I will acknowledge and give a 'cheerio' over *Radio Australia* for all reports addressed to the DX Editor, Radio Australia, Melbourne, Victoria, Australia.

"Current schedules for the DX programs are:

"Saturday, to Eastern U.S. and Canada, 7:20 p.m. over VLA9, 21.600; Sunday, to Western U.S., 12:25 a.m., over VLB8, 21.600 (or VLB9, 9.615), VLC4, 15.32, VLA4, 11.770 (or VLA8, 11.760), and VLG7, 15.160; Saturdays, to British Isles, 5:15 p.m., over VLB6, 15.200, VLA4, 11.770, and VLC10, 21.680."

Addresses

The following station addresses were sent us by Pat Casey, New York:

HH3W, P.O. Box A117, Port-au-Prince, Haiti; CFCX, 1231 St. Catherine Street, W., Montreal, Quebec, Canada. Reports to CMAN, CMCY, COCY, CMHI, COHI, CMJN, CMKV, CMKN (some of these are medium-wave outlets) may be addressed to Ra-

March, 1947

NEW! here it is THE GREAT *Lafayette* RADIO CATALOG

FREE!

144 Value-Packed Pages

LAFAYETTE IS THE WORLD'S
LARGEST RADIO SUPPLY HOUSE



NO more waiting! It's here — now — Lafayette's great 25th Anniversary Radio Catalog. And what a catalog it is. Packed with everything you can imagine in radio and electronic equipment. Such items as radio parts, complete sets, phono-radio combinations, build-it-yourself kits, amplifiers, microphones. Yes, and ham gear, public address systems, automatic record changers, tools, test instruments.

EVERYTHING HANDSOMELY ILLUSTRATED — Fully Described

All the tried-and-tested standard equipment is listed — *also many items so recently developed they're shown here for the first time*. Everything is in stock — economy priced — ready for super-speed delivery. *There's nothing you could possibly want in radio and electronic equipment that you won't find in this amazing catalog*. Your free copy will be mailed the day we receive the coupon below. Don't wait — mail it NOW!

HAMS!

We are stacked with Hammarlund, National, R.M.E. and Hallicrafter receivers. Everything you need in capacitors, resistors, tubes, meters, transformers, relays, switches, etc. Immediate Delivery!

EXPERIMENTERS!

No matter what you are building, all the parts you need are in the new Lafayette Catalog. Everything for building, experimenting, repair and maintenance in radio and electronics.

Lafayette Radio

RADIO WIRE TELEVISION, INC.
100 Sixth Avenue, New York 13
110 Federal Street, Boston 10
24 Central Avenue, Newark 2

LAFAYETTE RADIO,

Dept. RC-7, 100 Sixth Avenue, New York 13, N. Y.

Rush FREE CATALOG at once to:

Name.....

Address.....

City..... Zone..... State.....

MAIL COUPON BELOW . . . NOW!

*Clip
and paste
on penny
postcard*



Continuous sweep, 20 to 17,000 cycles per second . . . Electronic-eye Calibrator and Output Indicator . . . Load-matching Output Transformer . . . For measuring Receiver Fidelity . . . For measuring Audio Amplifier Frequency Response . . . For measuring Transmitter Modulation Characteristics . . . For Accurately tuning Musical Instruments. MODEL WA-54A—\$100.00 net.*

RCA HIGH FREQUENCY VOLTOHMIST
Flat from 30 cps. to 250 mc. . . For Television and FM . . . For HF and VHF Measurements . . . For measuring Positive and Negative Voltage Peaks . . . Polarity Reversing Switch . . . Full-wave Diode Rectifier built into Probe. MODEL WV-75A—\$125.00 net.*

RCA WIDE RANGE PORTABLE OSCILLOSCOPE
Flat to 5 megacycles . . . Sawtooth and triggered Time Base . . . Time delay and Signal Expansion . . . High Vertical Deflection Sensitivity . . . For High Speed Transients . . . For Short Pulsed Voltages . . . For Television. MODEL WO-79A—\$475.00 net.*

*Prices subject to change without notice



dio Havana Cuba, Apartados 770-799, Havana, Cuba. * * *

Spanish Stations Skeds

From K. Dobeson, England, official agent for the Spanish Broadcasting Network, we have received this information:

"Spain is desirous of receiving reports on Spanish radio stations, either sent to them direct at Radio Nacional de Espana, Madrid, Spain, or to me at Globe Hotel, Chichester, Sussex, England. All queries will be answered.

"Madrid, Radio Nacional de Espana, 40 kw., 32.02 m., 9.369, is scheduled 2:45-5 p.m. and 6:30-9 p.m.; in Russian at 2:45 p.m.; *English*, 3 p.m.; *Arabic*, 3:30 p.m.; *Spanish*, 3:45 p.m.; to African colonies; *French*, 4 p.m.; *Portuguese*, 4:30 p.m.; *German*, 4:45 p.m.; *Italian*, 4:52 p.m.; at 6:30 p.m. is beamed directly to *Hispanoamerica* in Spanish. Other programs are being planned, including one to North America; there are irregular broadcasts to North America now, such as on November 2 when there was a talk by the Scotsman, Halliday Sutherland.

"Alicante, Radio Falange de Alicante, 37.7 m., 7.940, is scheduled 8:30-10 a.m. and 3-6 p.m.

"Madrid, Radio SEU, approximately 42.55 m. (sometimes changes frequency because of interference), usually is heard around 7.010, is scheduled 10 a.m.-2 p.m. and 3-6:30 p.m., irregularly to 7 p.m.

"Cuenca, Radio Nacional de Espana en Cuenca, 42.25 m., 7.100, is scheduled 8-10 a.m. and 3-7 p.m.

"Oviedo, FET22, Emisora de la Falange de Oviedo, 42.6 m., 7.042, is scheduled 6-7 a.m., 7:30-9 a.m., and 2-6 p.m.

"Valencia, Radio Mediterraneo de Valencia, 3 kw., 42.63 m., 7.0372, is scheduled 7-9 a.m. and 2-6 p.m.

"Malaga, Radio Nacional de Espana en Malaga, 42.79, 7.012, is scheduled 8-10 a.m. and 3-7 p.m.

"Valladolid, FET1, 6 kw., is scheduled 7:30-9 a.m. and 3-6 p.m.

"Tenerife, 'Club Tenerife,' EAJ43, 20 kw., 41.28 m., 7.267, is scheduled 6:30-8 a.m. and 12:30-5 p.m.

"Spanish Morocco, Tetuan, 'La Voz de Espana en Africa,' 49.45 m., 6.070, 20 kw., is scheduled 2-7 p.m.

"Tangiers, approximately 42.5 meters (7.059) and on one other frequency in the 41-m. band, uses Spanish, opens at 1:30 p.m., is heard at 3 p.m. in England, and is presumed to closedown either at 6 or 7 p.m.; this one may not belong to the Spanish Broadcasting Network, but is received with good strength here in England." * * *

Last Minute Tips

Direct from Dr. Siegmund Guggenberger, Public Administrator of the Austrian Broadcasting System (*Radio Wien*), comes this late news of broadcasting activities in Austria: "All these last months we had to contend with almost unsurpassable difficulties, and still we attained remarkable success with the reconstruction of the Austrian Broadcasting System. This

ELECTRONIC COMPONENTS

- New Army-Navy Preferred type 5CP1 Cathode-ray precision tubes, with life expectancy approx. 2000 hrs. (6-lbs.) . . . \$7.95
 - New 3B71 Army-Navy pref. C.R. tube (2-lbs.) . . . 5.95
 - Sockets for above, with tube 45c; otherwise90
 - New 5CP1 shields with bracket & grommets, cad. plated (5-lbs.) . . . 1.25
 - New 9002 954, 955, 956 Acorn tubes, not rejects, each, postpaid89
 - New National ceramic acorn sockets 35c each. 4 for . . . 1.00
 - Westinghouse 4 1/2" dia. 0-200 D.C. Microammeter 6.50
 - Westinghouse 4 1/2" dia. 0-150 D.C. Voltmeter . . . 5.50
 - Westinghouse 4 1/2" dia. 0-20 D.C. Milliammeter 4.95
 - Miniature 1/2 wave selenium rect. 18v. 1/2-1ma., 5 for . . . 1.00
 - Matched pairs sel. rect. for meters, 1/2-1ma., 2 for50
 - 100 ft. spaghetti 1/2 HV cambric, 1/2 plastic 1.00
 - 12-18v electr. controlled carbon voltage regulator (3-lbs.)65
 - 115/15v-3A, 1-4-2A & 230/30v-3A, 2.8v-2A, 80 cyc. 50 watt herm. sealed xformer, black crinkle (4-lbs.) . . . 1.00
 - New Dynamotor 12v to 250v DC 50 ma (4-lbs.) . . . 2.50
 - New Dynamotors 24v DC to 240v DC 30 ma (6-lbs.) . . . 2.50
 - New Dynamotors 24v DC to 270v DC 120 ma (7-lbs.) . . . 3.25
 - New Dynamotors 24v DC to 450v DC 200 ma (11-lbs.) . . . 4.25
 - Relay 24v DC DPDT, 10 amp contacts89
 - Heavy duty Sig. Corps telegraph key, sil. cont. & sw. (1-lb.)89
 - Code practice set, excellent key, buzzer, batteries, ready to operate, postpaid . . . 2.75
 - Hl to low imp. headset xformer with jack & plug49
 - Wired Ampl. chassis 3"x7"x2", 2-3 sockets, pot. resistors, conds. . . .75
 - Balantine microphone amplifiers, less tubes & 39 tubes (5-lbs.) . . . 2.50
 - Heavy Punched Al. chassis 4 3/8"x6 1/2"x2 1/4" (3-lbs.) 3 for . . . 1.00
 - Heavy punched Al. Chas. 2"x6 1/2"x7 1/2" 5 soc. (3-lbs.) 3 for . . . 1.25
 - Heavy punched Cad. pla. 2 3/4"x7"x1 1/2" 11 soc. (5-lbs.) 2 for . . . 1.00
 - Octal ceramic ring sockets fits above 2 chas. (1-lb.) 10 for . . . 1.00
 - 200 squeeze-on term. lugs for 16/22ga wire (1-lb.) . . . 1.00
 - Squeeze-on terminal tool and cutter. (1-lb.) . . . 1.65
 - 200 silver plated soldering posts for term. boards (1-lb.) . . . 1.00
 - 7 lb. kit ass. 1 1/2" linen bakelite 2"x10"; 4"x 5" (5-lbs.) . . . 1.79
 - Cardwell 365 mfd. single section var. cond. (1-lb.) . . . 1.65
 - 2 gang ball bearing; 365 mmfd. per section (1-lb.) . . . 1.75
 - Master oscillator heavy duty precision tuning dial 20-1 ratio (5-lbs.) . . . 8.50
 - Selsyn 115v/60cy. trans. & recv. (1-lbs.) . . . 2.65
 - 2 for 57.6v/400 cy. differential generators (adds or subtracts electrical angles) (3-lbs.) each . . . 1.25
 - RG-34/U 72 ohm Coax 28' lengths handles 2Kw., per foot 6.5 cents
 - Antenna, Osc. R.F. & peaking coils, kit of 10 (1-lb.) . . . 1.25
 - Russell 115v/60cy. phono motor, 10" turntable. Metal tool punch 7"x4"x1 1/2" hooks on belt, 29c (1/2-lb. each) 4 for . . . 1.00
- Please include sufficient shipping postage, 20c per post required on all C.O.D. orders. Write for FREE electronic bargain list.

OHMEYER ENGINEERING LABS.
Fairview Blvd. Dept. C. Hempstead, N. Y.

Started FOR SERVICE!



THE NEW MULTIPLEX MODEL 458

Volts - Ohms - Mils - Output

Back of the bench, out of the way, but easily readable and always ready for instant use. Those are the features that have made the Multiplex Model 458 V.O.M. a shop and laboratory favorite. All popular ranges of A.C. and D.C. volts, A.C. and D.C. mils, ohms and output are conveniently available. Readings are sharply visible on the big 5 1/2" meter.

VOLTS DC: 0-5/10/50/100/500/2000
VOLTS AC: 0-12.5/25/125/250/1250
MILLIAMPERES DC: 0-1/10/100
MILLIAMPERES AC: 0-2.5/25/250
OHMS FULL SCALE: 1000/200,000/2,000,000
OHMS CENTER SCALE: 50/2250/22,500
OUTPUT: -5 to +55 Decibels

The Multiplex Model 458, built to high industrial standards, is priced remarkably low—only \$26.00 net. Write today for new circular.

CHICAGO INDUSTRIAL INSTRUMENT CO.
219 West Chicago Avenue
CHICAGO 10, ILLINOIS

was due to a great extent to the amicable attitude of all the foreign broadcasting organizations. We were spurred in our work, however, by another idea still: Although Austria is but a little country, it is within the focus of world political interests. Foreign countries generally get their information from authorities who—in spite of their friendly disposition—might not always have the necessary insight into Austrian affairs which might enable them to judge fairly. The voice of Austria itself—its radio—shall speak to the world again. We expect to reconstruct our big radio station—Bisamberg—and to realize the reunion of all the Austrian broadcasting stations in the near future. Then we shall make it our noblest task—following the good Austrian tradition—to offer a standard program which will find an echo in all foreign countries.”

Overseas radio journals report that “a powerful new short-wave station, to be called ‘Radio Haiti,’ is to commence operation early in 1947. It will be the most powerful station in the West Indies, having a power of 150 kw. There will be three transmitters, providing beam services to Europe, Africa, North, Central and South America. Programs will be radiated in four languages—French, English, Spanish, and Portuguese. The following channels have been allocated: 6.077, 6.200, 9.563, 9.620, 11.815, 11.820, 15.300, 17.150, 21.500, and 21.670.” (*Short Wave News, London*) (*Your ISW editor would appreciate further information on “Radio Haiti,” as it becomes available.*)

At last report, the two short-wave transmitters long reported under construction in New Zealand had not taken to the airwaves, the holdup being the building of suitable antenna arrays. Site of the transmitters is at medium-wave 2YA, just outside Wellington.

Around the New Year the following interesting letter was sent out by Yves Samsioe, an official of Radiotjänst (The Swedish Radio), Stockholm: “Hereby just a few lines from the Swedish Broadcasting Corporation to thank you for your collaboration this year and for the excellent reports of reception you sent us. A new year is now coming, a year, we hope, of peace and prosperity. We don’t know yet what we can offer you in radio questions, I mean programs a.s.o., but we can assure you that we are doing our best to make this year of 1947 a better one than 1946. We shall still be working with our 12-kilowatt transmitters even this year, but the programs will be a little bit different, more music and especially more announcements telling: ‘This is the Swedish Broadcasting Corporation.’ Please continue listening to us and send us reception reports. They are, we assure, most useful to us. Address is Radiotjänst, Kungsgatan 8, Stockholm, Sweden (Sverige).”

Mr. Samsioe has informed me that Radiotjänst is considering the possibility
March, 1947

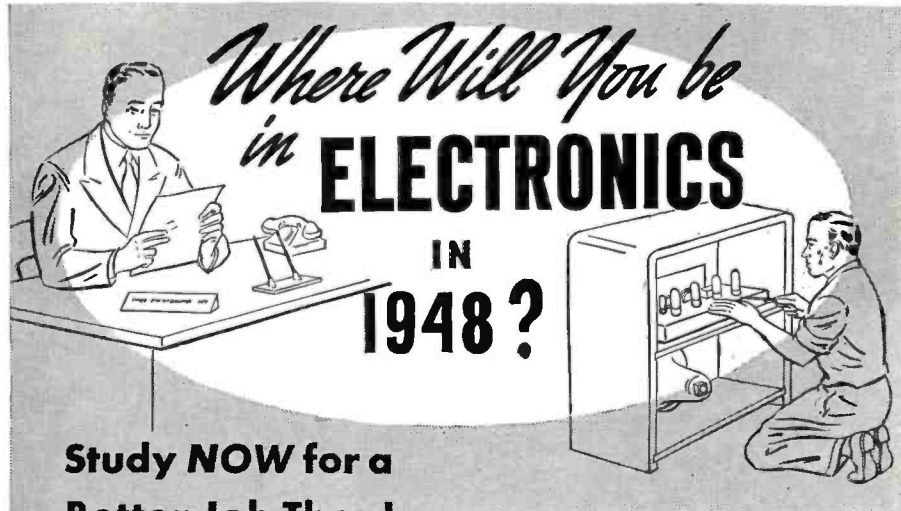

Where Will You be
in **ELECTRONICS**
IN
1948?

**Study NOW for a
Better Job Then!**

THIS NEW WORLD OF ELECTRONICS is moving at a rapid pace. War born developments equivalent to twenty years of research are here. Still newer techniques are coming out with surprising speed. Have you the basic technical knowledge to keep pace with these developments?

MORE THAN EVER BEFORE, a sound basic knowledge of up-to-date, fundamental engineering of radio-electronics is an essential to a better job—promotion—increase in pay.

THESE NEW TECHNIQUES MEAN BRAND NEW JOBS in brand new fields! But they demand men who have knowledge and training—men who know the WHY as well as the HOW. Regardless of your past practical experience, the future demands that you must now acquire a **solid foundation** of theory if you expect to forge ahead in this new world of electronics.

IT COSTS YOU NOTHING TO INVESTIGATE—The coupon on a post-card will bring full information of the CIRE plan of personalized instructional aids and coaching service, with qualified competent instructors, and systematic, progressively arranged study assignments in recognized, approved texts—these are only a few of the many superior advantages of CIRE’s plan of spare-time home study training for professional self-improvement.

Cleveland Institute Courses offer complete Technical Training ranging from low-level to college-level.

A. Master Course in Radio Communication. Covers fundamentals of Radio and includes complete preparation for FCC Commercial License Examinations.

B. Advanced Course in Radio Communication Engineering. A college-level Radio Engineering Course.

C. Specialized Television Engineering. Including post-war Television Techniques.

ALL COURSES INCLUDE

The Remarkable Workbooks of Instructional Aids, prepared by the instructing staff of Cleveland Institute.

Choose the course best suited to your needs—Start with the section you are qualified to enter—Use the economical CIRE “Pay-As-You-Go Plan.”

You may enroll for individual sections for highly specialized training. Study any one or more of the following sections if you do not require a complete course—

1. Mathematics of Radio.
2. Fundamentals of DC and AC Theory.
3. Essentials of Radio Communication.
4. Communication networks.
5. Advanced Radio Telephony for the Broadcast Operator.
6. Audio and Radio Components and Systems (Design of Receiver and Transmitter Equipment).



Write today for free, descriptive booklet—“THIS NEW WORLD OF ELECTRONICS HOLDS OPPORTUNITY FOR YOU.” No obligation.

CLEVELAND INSTITUTE OF RADIO ELECTRONICS

Contractors to the Canadian Broadcasting Corporation

RN-3 TERMINAL TOWER, CLEVELAND 13, OHIO

Approved for Veteran Training Under “G-I Bill of Rights”

-----**(MAIL THIS COUPON)**-----

Cleveland Institute of Radio Electronics, RN-3 Terminal Tower, Cleveland 13, Ohio.
Gentlemen: Please send information about your home study courses in Radio Electronics.

NAME.....	I desire training in
ADDRESS.....	I have had experience in broadcasting <input type="checkbox"/> servicing <input type="checkbox"/> operating <input type="checkbox"/> mfg. <input type="checkbox"/> CAA <input type="checkbox"/> Army-Navy <input type="checkbox"/> amateur <input type="checkbox"/> other.....
CITY.....	I am a High School Grad. <input type="checkbox"/> College <input type="checkbox"/> Degree.....
ZONE..... STATE.....	<input type="checkbox"/> Check here for Veteran Enrollment Information.

ANOTHER RESCO SCOOP

Brand New! **SAVE 77%** OFF LIST PRICE

ARMY SURPLUS ALIGNMENT TOOLS

Take advantage of guaranteed 70% to 77% discounts from established list prices! Each made to rigid Army specifications. Guaranteed perfect or money back! Write for quantity prices. Include postage with cash orders.

5-IN-1 NEUTRALIZING AND COMPENSATING TOOL ICA NO. 1022

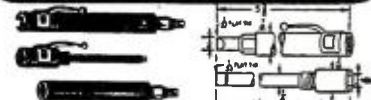

Made of Fenolite—fully insulated. 5/16" end 1/4" nut wrench, key slot. Neutralizing screw driver and heavy duty all metal screw driver included.

List Price \$1.50 Resco's Price **45¢**

ALIGNMENT TOOL ICA NO. 1015



Narrow shaft neutralizing tools made of bone fibre—screw nib inserted on one end, and narrow screw driver on other end. Used on late models R.C.A. receivers for aligning trimmers, push buttons, etc.

List Price 95c Resco's Price **30¢**

INSULATED NEUTRALIZING WRENCH HEXED — FULL LENGTH ICA NO. 980



Made of sturdy black "Fenolite", hexed all the way through. Entire length of the inside of the tube is broached so that when one part wears out or breaks, just saw off part and continue using the neutralizing wrench.

NO. 980 A 3" B 3 3/8" C 1 1/4"

List Price 35c Resco's Price **8¢**

ALIGNMENT TOOL SIMILAR TO GENERAL CEMENT NO. 5016



Made of bone fibre, combination tool that can be used for most purposes. Consists of screw driver with metal nib, 5/16" hex wrench, 1/4" hex side wrench and 1/4" hex end wrench slotted.

List Price \$1.35 Resco's Price **40¢**

ALIGNMENT SCREW DRIVER GENERAL CEMENT NO. 5000

Low Inductance metal tip screw driver made of Gentflex material — strong — durable, completely insulated, 1/4" diameter x 6" long.

List Price 40c Resco's Price **12¢**

BELDEN MIKE CABLE



No. WIMC — single conductor crystal microphone cable.

Pr. 5c 100 Ft. \$4.50 1000 Ft. \$40

SPST TOGGLE SWITCH

3/8" shank single pole; single throw.

25¢ Each 10 For \$2.25

WRITE FOR NEW FREE BULLETIN

Radio Electric SERVICE CO. OF PENNA., INC.

7TH AND ARCH STREETS, PHILA. 6, PENNA. Branches: 5133 Market St. and 3145 N. Broad St. in Phila. Also in Wilmington, Del., Easton, Pa., Allentown, Pa., Camden, N. J.

ity of a weekly "goodwill" DX session for short-wave listeners "around the world." The pattern would probably include good music and acknowledgement of letters and reception reports received from listeners. Details will be announced as soon as they are available.

Incidentally, Stockholm is now using SDB-2, 10.780, to parallel SBT, 15.155, in the daily North American beam (English and Swedish), 10-10:55 a.m.

An unknown Chinese station has been heard lately between 9:15-11 a.m. on about 6.390; call sounds something like "XPRA"; sign-off is with the Chinese National Anthem. XGOUS, Nanking, has been heard around 8:30-9:15 a.m. lately on various frequencies, including 6.935, 7.530, 7.548, and 7.090; relays press dispatches and appears to be experimental. (Dilg)

The Chinese station (listed by Australians as XMTA) on about 12.115 is being heard in Sweden around 5:45-7 p.m., usually with news in Chinese at about 5:45 p.m.; uses various calls so is evidently relaying a number of stations; among calls heard are XGON, XGNC, XNGR, XNTX, XNY, and XNTR. (N. Johnson) Other Swedish reporters list location as Yanan; if so, may be Communist-controlled. From "Down Under," location is reported as Shanghai, and is said to have English news irregularly around 6:30 a.m. Has been heard irregularly by Paul Dilg, California, early mornings, but no English has been noted.

A Chinese station on 9.555, believed to be Chungking, is being heard in Sweden between 8:45-9 a.m. (N. Johnson) XOPD, Hangchow, is listed on this frequency.

On about 4.230, Paul Dilg, California, has recently been hearing an AFRS station in Nanking, China, giving an "XM.." call, around 9 a.m.-12 noon. May be a harmonic.

Early in January, time of the "evening" Radio Australia beam to Eastern North America was changed; is now heard 6:30-7:45 p.m., with news at 7 p.m., over VLA9, 21.600. Officials of Radio Australia inform me that this change was effected that "reception might be more clear." Tests conducted on VLC4, 15.320, late in December, in an effort to find a satisfactory outlet to parallel VLA9 in this transmission, were poor, due to interference from a U.S. transmitter.

SVL, 7.295, Athens, Greece, has poor signal due to interference; scheduled 2:58-3:45 p.m. with Greek news at 3 p.m.; program is interspersed with swing records, off with march; no English noted. (Bromley)

ZBW, Hongkong, appears to be on 9.540 currently; has weak to fair signal here in the East around 6-7:45 a.m. (when carrier of Australia's VLB comes on); uses mostly Chinese dialects, is scheduled to relay the BBC news from London at 6 a.m.

LKQ, 11.735, Fredrikstad, Norway, relaying Oslo, is verifying reports from Administration of Telegraphs, Radio Dept., Broadcast Division, Oslo, Norway (Norge). Is heard in New

POTTER'S BARGAINS

We still have

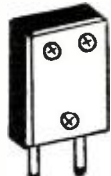

80 Meter XTALS 74¢ with holders

3,500 to 4,000 KC. Specify frequency to nearest 10 KC., and first and second choice. Large holders.

OUR NEW LOW PRICED CRYSTALS

80 Meters, Your frequency within 10 KC. \$0.74
40 Meters, Your frequency within 10 KC.79
20 Meters, 3rd Harmonic Oscillators... 1.49
1816-1856 KC. for F.M.79

The new crystals are in holders. All are made to your order. Please allow 10 days for delivery.

Crystal Finishing Kit

- Consists of the following:
- 2 blanks to be ground to 80 meters.
- 2 blanks to be ground to 40 meters.
- 2 crystal holders for above.
- 2 grades of lapping compound.
- Instructions for finishing.

SPECIAL 79c

Rough Blank Kit No. 1, 12 rough blanks, well assorted as to thickness so as to finish to various frequencies. Special 79c
10 assorted crystal holders. Thousands sold and still going strong. Only 99c. Postage 3 lbs. extra.

POTTER RADIO CO.

1312-14 McGee St., Kansas City 6, Mo.

HOPP Plastic RADIO DIALS

DIAL WINDOWS, NAME PLATES, GAUGES, CALCULATORS, SCALES, CHARTS, ETC.

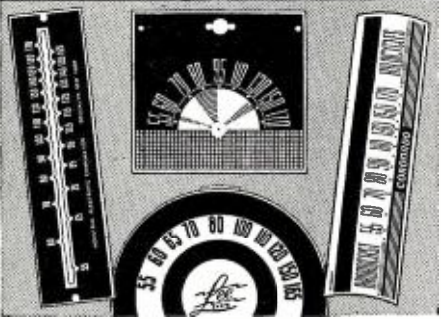

PLASTIC RADIO DIALS have endless possibilities in design, size, shape and color combination. Attractive and durable, our radio dials, windows and scales are preferred by many leading Radio manufacturers.

Not only for dials, but for numerous other electronic and electrical applications, Laminated Plastics are preferable.

Consult with our artists and engineers regarding applications for your particular purpose. Or . . . send us your blue prints or samples for quotation.

THE HOPP PRESS, INC.

460 W. 34th STREET, NEW YORK 1, N. Y.

ESTABLISHED 1893

RADIO NEWS

York with a fair signal from 5:45 to about 7 a.m. fadeout. (Beck) LKJ, 9.540, Oslo, is heard with bad QRM in Sweden at 1:35 p.m.; on about 6.180, Oslo is heard between 4-4:15 p.m. (N. Johnsson) The Oslo transmitter on about 6.180 is heard in New York signing off at 5 p.m. (Beck) Also heard in Sweden around 12:30 p.m. (B. Nilsson)

Radio Dakar, Fr. West Africa, listed on 15:345 but now operating on about 15.388, is being heard widely from 1:30-5 p.m. daily, sometimes longer; has especially good signals in the East. Strong signals are still being heard from this station on its 11.712 frequency, 2:15-2:30 a.m.

Acknowledgements

In order to provide more space for "Last Minute Tips," individual acknowledgements are being omitted. Our sincere thanks go to each person who contributed to the ISW Department this month. For location of reporters credited with individual items herein, please refer to "Acknowledgements" in previous issues.

-50-

Sonar—Sub's Nemesis

(Continued from page 49)

both the receiver and the driver with one control, and adjustment of both to the resonant frequency of the projector is greatly simplified.

In the *Submarine Signal Company's* WCA-2 equipment, often used on submarines, part of the h.f. oscillator voltage is fed to the driver amplifier, where it is mixed with a frequency generated by another oscillator tuned to the i.f. of the receiver, as shown in the block diagram of Fig. 6. In this equipment, the operator can tune both the receiver and oscillator simultaneously, as in the QCQ-2, but the driver amplifier for the WCA-2 equipment is generally installed in another part of the ship from the receiver and indicator stack.

Since the sound beam from the projector is highly directive, having a width of about 20 degrees, it is possible to use it as an indication of the bearing of the target. Even with a beam of this width, it is necessary to define the edges of the target by determining the "cut-on" points, as shown in Fig. 4. The midpoint between the cut-on points is then considered the bearing of the target.

A synchro system actuates a motor control circuit, such as an amplidyne, to direct the sound beam to any desired bearing. The operator turns a hand wheel which rotates a synchro generator. Another synchro is geared to the training motor. One of the rotors is supplied with 115-volt, 60-cycle, a.c., while the other is connected to the amplidyne amplifier. When the two rotors are 90 degrees apart electrically, no voltage is induced in the second one. When the control synchro is turned by the operator, the

For the
UHF
GANG!

Don't miss the
article on this
UHF Preselector in
March issue of CQ!

1.5 KW. PLATE TRANSFORMER

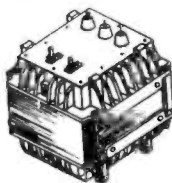

Primary:— 115 volts AC — 60 cycles. Secondary:— 1470 volts CT at 1.2 amperes. 1450 volts at 800 ma when used in bridge rectifying circuit. For the KW rig using 304-TL, 4-250A, 250TH, 810's etc. Will handle both RF final and modulator. Capable of heavy over loads. Hermetically sealed — oil filled — with cooling fins. Size: 11x10x9. **14.95**
Your cost



SECONDARY FREQUENCY STANDARD

For precision frequency measurements.

- Complete with spares.
- 1000 KC to 45,000 KC.
- 1000 — 100 — 10 KC Check Points.
- 100 to 250 V., 25-60 cycles.

A Buy at
29.50

**SURPLUS
RADIO, INC.**

30 MUNSON ST.,
PORT WASHINGTON, N. Y.

UHF PRESELECTOR

The Highest Gain Preselector Made!
STOP DREAMING! HERE IT IS!

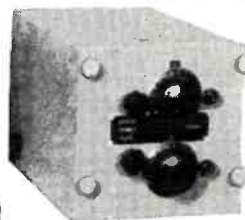

The most efficiently designed unit of its type which has ever been made available to the amateur. Complete with 3-GL446A tubes, spare parts, cables and sturdy wood carrying case.

Original cost \$275. **39.50**
Your cost

All units Brand New
FREQUENCY RANGE: 175 Mc. to 220 Mc. Easily

adapted to cover the following bands.
224 Mc: 144 Mc: 54 Mc: 28 Mc.

FEATURES

- Extremely high gain.
- Two grounded-grid lighthouse stages.
- Tuned cathode and plate circuits.
- R.F. circuits individually shielded with silver-plated brass.
- Disk type vernier trimmers.
- National velvet vernier dials.

MODULATOR KIT

Complete Transformer Set
150 Watts audio

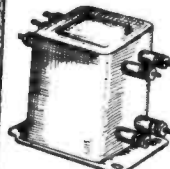

1. Microphone or line to grid. Carbon or Dynamic—150-250 ohms to grid. Size: 2 3/4 x 1 3/4 x 1 3/4.
2. Driver Transformer. Parallel 6V6's or similar to class B grids. Split separate secondary windings. Size: 2 3/4 x 1 3/4 x 1 3/4.
3. Modulation Transformer. Pri: 18,000 ohm plate to plate. Sec: 1. — 8000 - 10,000 ohms 2. — 3000 ohm screen winding.

For class B 811's 809, TZ20, TZ40 etc. to 813, 803, 254, 125, or other pentodes or triodes. Will modulate 300 watts of RF. Frequency response ± 1DB 300 — 4000 cps. Size: 4x5x2 3/4.

Complete **8.95**
set

Tube Complement for above modulation set: 2-811's; 1-813; 2-866A's. All tubes RCA or G.E. Complete set of Tubes. Net over \$25.00 **16.95**
Your cost

All transformers matched, herm. sealed gray case with ceramic stand-offs. Their permalloy cores afford extremely small size and weight for portable and compact transmitters. The finest modulation set ever made.

Coming Soon . . .

Contests with prizes worth thousands of dollars. Be sure to get your name on our mailing list NOW to be eligible.

SURPLUS RADIO, INC.

R-3

30 Munson St., Port Washington, N. Y.

Please send me a FREE copy of your Bargain Catalog at once, and details of the contests as they are formulated.

Name _____

Address _____

City _____

State _____

LAKE Amplifying Systems

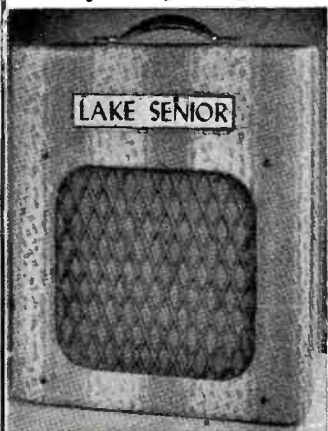

Excellent-ly designed, compact amplifiers, ideal for students, professional entertainers, homes, factories, schools, etc. Perfect for voice, musical instruments, pickups and contact microphones; clear, rich tones; heavy plywood in luxurious leatherette-covered stream-lined portable cabinets.

As listed below:

No.	Watts	Inputs	List	Your Cost
A18	18	4	\$10.00	\$6.68
A15	15	3	9.50	6.26
A12	12	2	8.50	5.45
A 8	8	3	7.50	5.45
A 6	6	3	7.00	4.10
A 5	5	2	6.00	3.28
AC-DC	8	3	75.00	44.10

HAWAIIAN ELECTRIC GUITAR

Beautiful black plastic, trimmed with chrome. 23" scale, 4 1/2 octaves of playing range. List \$50.00. Your Cost.....**\$29.40**



DeLuxe PHONO CABINET

Covered in luxurious, genuine brown leatherette, has deluxe brass hardware throughout, made completely of plywood with brown plastic handle, has padded top and

bottom. Motor board 14" x 14" x 1 1/2". Overall dimensions 18" L. x 15" W. x 8" H. Your net price.....**\$8.95**

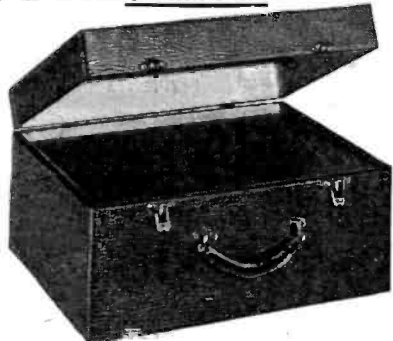

Portable Phonograph case, of sturdy, durable plywood, in handsome brown leatherette finish. Inside dimensions 16 1/2" long, 14" wide, 9 1/2" high. Has blank motor board. As illustrated above, specially priced at.....**\$6.95**

Also blank table cabinets of walnut veneer in the following sizes, with speaker opening on left front side: (*Note: *7 has center speaker grill.)

#1 — 8 1/4" L x 5 1/2" H x 4" D	\$1.95
#2 — 10 1/4" L x 6 5/8" H x 5" D	\$2.75
#3 — 13 1/4" L x 7 7/8" H x 6 1/2" D	\$3.25
#7 — 10 1/2" L x 7" H x 5 1/2" D	\$2.50

*Speaker Opening in center of front side.

All types of radio cabinets and parts are available at Lake's Lower prices. A large stock is listed in our catalog.

SERVICEMEN—RETAILERS

Write for our new, illustrated 16-page catalog NR-116. It's free. Get on our mailing list! Write for our Special Catalog on Microphones, Amplifiers and Sound Equipment!

Order from Lake! You'll make no mistake!

Dept. A

Lake Radio Sales Co.
615 W. Randolph Street
Chicago 6, Ill.



Front view of WCA-2 "stack."

voltage induced in the rotor of the second synchro is applied through a transformer to the grids of two tubes. The plates of these tubes are fed with a.c. The amplifier is essentially a grid controlled rectifier circuit, and the direction of rotation of the training motor is controlled by whichever tube is conducting. This explanation is considerably simplified, since the amplifier controls the amplidyne generator, which in turn furnishes armature current of the correct polarity for the desired rotation of the training motor armature. This type of control is used in much of the sonar equipment, the most common being the QCS, QCT, and QCQ-2 models. The Western Electric QBF employs a three-arm "potentiometer" device which supplies a.c. voltage of correct amplitude relationships to a large synchro training motor directly, thus simplifying the control circuits. The "potentiometer" is actually a transformer with the brushes making contact with the windings at the proper points to furnish the necessary motor voltages.

All of these systems employ a separate synchro link between the training gear and the operator's stack. This bearing indicator shows the projector bearing, with respect to the ship's heading, on a fixed scale, and the absolute bearing on another scale rotating in synchronism with the ship's gyro-compass system. The training panel for the QCQ-2 equipment is shown in Fig. 3.

So far we have described some of the equipment used for echo ranging of submerged objects in a horizontal direction from the ship. If, however, the projector were turned 90 degrees around a horizontal axis and directed downwards, the equipment could indicate the depth of the water below the ship. This is exactly what is done in echo sounding equipment. Since the projector used for sounding does not need to be rotated, it becomes a fixed unit mounted flush with the hull. In many such installations, one pro-

WAR SURPLUS SALES

RADIO - ELECTRICAL - ELECTRONIC EQUIPMENT - PARTS - SUPPLIES

NEW Navy RBL3 Low Frequency Radio Receiver

T.R.F. type receiver, with regenerative detector designed to cover 6 bands frequency range of 15 to 600 Kc.; suitable for reception of voice, MCW, ICW, and CW signals. Operates on 115 v. 50-60 cycles AC. 7 Tubes supplied with set. Also metal box containing spare equipment—condensers, resistors, switches, tubes, replacement power transformer and other misc. items. Everything complete. **\$49.50** Only.....

WESTERN ELECTRIC or SYLVANIA types 1N21A & 1N23A Crystals; 35¢ each or **\$1.00** 3 for.....

RCA, HYTRON or SYLVANIA 807 Tubes, each.....**.99**

SUPERIOR 2 KVA Power Stats; input 115 volt AC, 50-60 cycle single phase,—output voltage range 0-135 volt; maximum rated output current 15 amp available over entire range of output voltage; weight approx. 20 lbs.**\$29.50**

SUPERIOR 2 KVA 3 1/2 KW power stats, 2 in tandem, each 115 volt AC single phase. Same as the above but twice the input and output voltage.....**\$54.50**

HIPOWER quartz Crystal units, type CF5, 5000 KC. complete with holder.....**\$1.95**

Standard rack cabinets heavy gauge steel, gray crackle finish; panel opening 19" wide, 27" high.....**\$12.95**

PHILCO TANK ANTENNA—all aluminum, copper weld, dark grey finish; 12 feet long, in 3 sections; weight 10 oz.; base 5/16" dia., tip 1/8". **\$0.98**

Very special.....
Prompt Delivery—Write Dept. RNM
25% deposit required on C.O.D. order
Shipped F.O.B. New York. Minimum Order \$2.00

MICHAEL STAHL, INC.

39 VESEY ST.
Tel. COrtland 7-5980 New York 7, N. Y.

THE BIGGEST BARGAIN ON EARTH!

One of the best Vacuum tube Volt-Ohm-Milliammeters ever built. For only \$44.85. (Built to sell for \$52.50) (Used on atom Bomb). Furthermore—10 days FREE TRIAL.



0-1000 in six ranges DC and AC 6 3/4 in. probe. Flat response from 20 cycles to over 20 kcs. 0-200 meter 4 1/2 inch scale. Reads direct, no graphs to follow, uses 6SN7—6H6—6X5—Black crackle case 10 x 8 x 7 made by St. Clair Engineering Corporation.

Send money in advance and if not satisfied in ten days return meter and get your full amount refunded less postage. 20% deposit if ordered C.O.D.

TAKE IT — TRY IT — TEST IT

RADIO EQUIPMENT COMPANY
377 East Main Street
LEXINGTON, KENTUCKY

jector is used as the transmitting unit, and another is used for receiving. Simplified equipment of this type is in general use on all ships, some being equipped with continuous recorders, making a permanent record of the depth of the water as the ship pursues its course.

Sonar, like radar, is rapidly finding peacetime uses. Compact sounding equipment is being developed for even the smallest pleasure cruisers; powerful systems are capable of locating schools of fish for commercial fishermen; sunken ships can be located with sonar equipment; in one case, even, a sunken airplane was located in 160 feet of water at the bottom of a lake.

Numerous types of circuits are required to make a complete sonar system effective. In some models, a cathode-ray tube is used to indicate to the operator when he has the projector trained directly on a target, or when it is one or two degrees to the right or left. This equipment is known as the Bearing Deviation Indicator, and it is a great help to the operator in giving accurate target bearing to the conning officer. To make an effective attack, the target information must be obtained quickly and accurately; the bearing, course, and speed of a submarine must be known, and there can be no guesswork. How well sonar has done this is evidenced by the number of submarine sinkings—nine hundred and ninety-six submarines would make a formidable fleet for any country. But those, at least, will never fire another torpedo, thanks largely to sonar.

-50-

REPAIRING HINT

IN MANY of the older types of receivers you may be called upon to service, the ganged tuning condenser plates short out or scratch against each other causing the set to be dead or noisy. Sometimes no amount of mechanical "juggling" will separate the misaligned plates. The cause seems to be inconsistent plate spacing on the rotor shaft and/or the stator. The spacing usually is normal in the center but misaligned in opposite directions at one or both ends. The last resort seems to be one of bending plates—a bad practice and one which, if successful, is time consuming.

By disconnecting the coil from the bad section or sections and connecting a 6-volt storage battery across the section, the touching edges can be burnt with no damage to the condenser or the battery. However it is not a recommended procedure when the plates rub firmly together. Be sure and rotate the plates while the battery is connected so that too much burning will not occur.

To give more clearance and to prevent the job from "bouncing back" the rotor can be swung through its range a second time with a slight pressure against the spring.

If this procedure does not clear the plates, it will at least give a good indication where the plates are touching.

March, 1947

NEW SURPLUS AT LOWEST PRICES

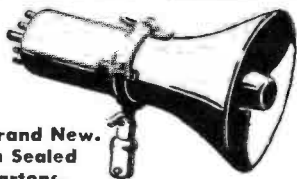

Brand New.
In Sealed
Cartons.

25-WATT P-A RE-ENTRANT SPEAKER Jensen Driver Unit UTC Transformer

• An excellent speaker. Built for the Army. Jensen driver unit alone weighs 9 lbs. UTC line-matching xfmr 250, 500, 1000 and 2500 ohms. Metallic diaphragm voice-coil assembly. 20" overall. Horn 13" dia. Fitted with swivel, lock nut and sleeve for standard pipe stand. One of the greatest surplus bargains ever offered

ONLY \$1790

Single Lots
In Lots of 25—
\$15.46 ea.

32-Foot Portable 4-Section

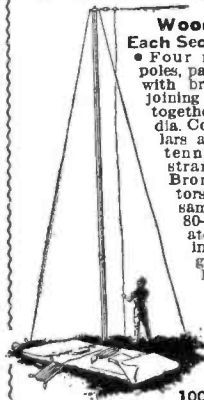

Wooden MAST
Each Section 8ft. long.
• Four round wooden poles, painted olive drab, with brass ferrules for joining the 4 sections together. Poles 1 1/2" dia. Complete with collars and fittings. Antenna wire, 100-ft. stranded Phosphor-Bronze, with insulators. Ground wire, same as antenna, 80-ft. Hand-operated reel for winding antenna and ground. Packed in heavy canvas kit, suitable as sleeping bag. The entire kit.
COMPLETE, ONLY \$895 ea.
100 Lots—\$8.00 ea.

DYNAMIC MIKE and PAIR of DYNAMIC PHONES

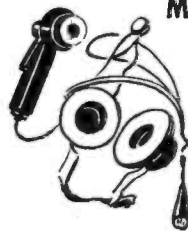

\$2.95

Never Again At This Price!

• Usually sold for \$6.00 to \$9.00, we offer this combination dynamic mike and pair of dynamic phones for a small fraction of their worth. The supply is very limited. You are urged to order quickly.

In Lots of 10 or more \$2.75 ea.
Please add postage for 2 pounds.

WHIP AERIAL

• New-Signal Corps Type. 7-ft. long. Telescopic Monel Metal. Rust-proof. Ideal for autos, housetops, fishing poles, etc.

98c ea.

In Lots of 10, 95¢ ea.
(Add 25¢ for Postage.)

FLASH!! SCR-522—ONLY \$49.50. Famous Airborne Set

• H-F Transmitter-Receiver, 100-156 Mc. Complete Conversion data available now. Ideal for 2 1/2 Meter Ham Band, 2-Way Police, Fire and Marine Services, VHF Airborne. Just Released at this new, LOW price.

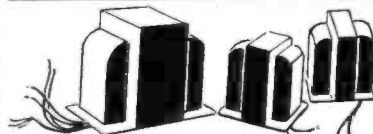

90 Mil XFMR and 2 Chokes
For Less Than Net Price of Transformer Alone!!!

• Brand new, fully encased, standard HADLEY 700-CT power xfmr (6.3v, 2.5a, 3v, 3a), and TWO Hadley fully encased 125 Ma. 12 Hy. Filter Chokes. Ideal for push-pull 6V6 Amp. ONLY \$3.95 for all THREE!!! Never Again At This Price!!!

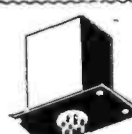

LOOK!

• Tobe Co. dual 8-600 V. paper condenser oil impregnated. Metal case. 4-prong socket at bottom. Amazing Buy at only 75¢ ea.
In doz. lots 70¢ ea.

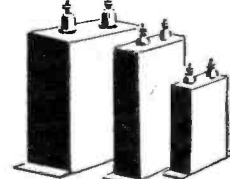

OIL CONDENSERS
At Lowest Prices!

GE Pyranol. 8mf. 1000v \$1.95
C-D Oil. 4-mfd. 1000v. .98
Aerovox 4-mfd. 600v oil .79
Going Fast! Order Quickly!

NEW BC-645 I-F-F

Transmitter-Receiver

420-450 Mc., 460-490 Mc.

For Less Than the Net Worth of the Tubes Alone.

• Complete conversion diagrams with each set for ham bands, citizens' communication, etc. Magnificent Workmanship. Tubes include W-E doorknob 316A. Parts alone worth \$50.00.

OUR PRICE..... **\$16.85**

with 13 tubes (All standard).
Brand New—In Sealed Cartons

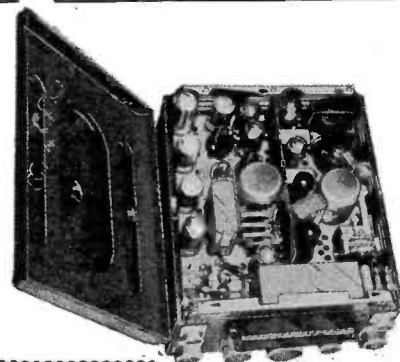

HALLICRAFTER ARR-7 COMMUNICATIONS RCVR.

550-Kc to 42-Mc. (Similar to SX-28A).

• Only a few were released. None will be available in future. This is a GREAT receiver, with 3 RF stages (one re-radiation suppressor r-f), 12 tubes. Motor and manual tuning. S-meter. I-F selectivity control, crystal filter, AVC, phasing control, ANL, etc. Also furnishes video output for scope, and panoramic output for scanning. Complete with tubes and xtl, but without power supply. Power requirements: 270v, at 135 ma. New, in sealed cases. **YOUR VERY LAST CHANCE TO GET ONE at \$159.50, with tubes, crystal and beautiful LS-3 Jensen or Magnavox PM speaker in black metal cabinet. Only 15 on hand. Order by telegraph, TODAY!**

Send 20% Deposit. Balance C.O.D. We Ship Anywhere in U.S.A.

OFFENBACH AND REIMUS CO.

372 Ellis Street

San Francisco 9, Calif.

'Phone: ORdway 8551



"THE HOUSE OF A MILLION RADIO PARTS"

Thousands of
Satisfied
Users!

TRANSVISION

**TELEVISION
KIT...A HIGH QUALITY
TELEVISION RECEIVER**

ready for Easy,
Rapid Assembly

ENGINEERED
BY
TELEVISION
SPECIALISTS



Easy-to-Assemble: No knowledge of television required. COMPLETE easy-to-follow INSTRUCTION SHEET gives you all the knowledge you need.

This Kit INCLUDES SOUND, all component parts, and the following:—

1. Specially designed Television Antenna.
2. A \$30.00 Lectrovision seven-inch Picture Tube . . . plus ALL other tubes.
3. Pre-tuned R-F unit.
4. Finished front panel.
5. All solder, wire, and 60 feet of low loss lead-in cable.

Operates on 110V.; 50-60 cycles A.C.

Price: complete with ALL tubes, \$159.50. Shipment will be made approximately 2 weeks after receipt of order. \$25.00 deposit required on all orders, balance C.O.D.

Trade Inquiries Invited

We believe that the comparative quality of this set is superior to other available sets. It has been acclaimed by major television schools throughout the country. For full information write to:

TRANSVISION, INC. Dept.
R. N.

385 North Ave. New Rochelle, N. Y.

Enclosed find \$.....deposit. Please ship.....Transvision Television Kits C.O.D. to

Name

Address

City & State.....

LETTERS from our readers

REQUEST GRANTED

I MAKE a special point of mentioning RADIO NEWS magazine to new classes to encourage and stimulate interest in radio.

"Its over-all accuracy in diagrams and illustrations is remarkable, as I well realize errors can creep into any drawing and are not, always, very apparent.

"The request for more 'semi-technical' articles on test equipment is on behalf of large classes who besiege me during my spare time for such information.

"Your fine magazine has printed many good v.t.v.m. designs, but few have told how to use a meter of different sensitivity in the same circuit.

"A question that comes up repeatedly is how to design high resistance multiplier for vacuum tube voltmeters. I am sure an article on this information would interest thousands in the radio field who have the equipment but not quite enough 'know how.'"

George W. Kelly
Chicago, Illinois

We have long recognized the need for certain material designed for those new radio men who are daily joining the "fraternity." Now that the RADIO NEWS staff is back to its prewar strength, we will be able to build, design, test and describe new equipment suitable for the beginning or intermediate radio man. This service will be furnished in a monthly department and should provide plenty of practical, easy-to-built equipment for our readers.

* * *

SERVICE DATA

I AM prompted by your recent editorial in the January issue about servicemen and service data to blow off a bit of long-pent up steam on the same subject. I have been in this somewhat bewildering business ever since 1928, and practically all of that period has been spent wondering if there wasn't something we could do about that same headache.

"This chronic condition has been aggravated by the 1946 and 1947 receivers. With everyone else I have had the troubles you mention with the new jobs. A goodly part of it, in my opinion, can be attributed to faulty engineering. I have seen cases of dial-drive design that could be improved on by a NRI graduate on his first set! I have long wished that all design engineers could be made to serve a year in the field, repairing some of their (or rather others') creations, before they were permitted to commit some of the atrocities they foist upon us. The rest of the trouble can be attrib-

uted to nothing but sloppy workmanship. If the average service shop put out the class of solder joints, etc. that are being found in quantities in the new receivers, they would be out of business in a month. This condition can, and definitely should be, corrected. The new receivers are a long way from coming up to past standards of material and workmanship.

"Having relieved myself of fifteen years' gripes, here are a few constructive suggestions.

"1. Paste in each cabinet a chart showing the location of various trimmers, especially for the multi-band sets. Leave out of service manuals, etc., the long alignment processes. Most reputable servicemen are familiar with this process. Better still, stamp trimmer numbers, etc., on the chassis by the holes.

"2. Make parts which need most frequent replacement more accessible. Filter condensers, coupling condensers, etc. are often buried beneath a mass of wiring, or even transformers, chokes, etc.

"3. Mark i.f. frequencies on transformer cans. This has been done by some manufacturers for years and I consider it a great help.

"4. Simplify some of the horribly complicated dial drive systems now in use. It seems to me the same result could be accomplished without the maze of pulleys, dingbats, etc. on some sets.

"5. Mark limits of pointer travel and alignment frequencies on backs of "blind" dial faces. In other words, when you take the set out of the cabinet and leave the dial scale in it, it is really aggravating to have to spend an unnecessary half-hour shoving the set in and out of the box to find out where you are on the scale.

"6. Make all speaker leads, phono pick-up leads, etc. plug into the chassis and leave the wiring on the speaker, etc. (Also the loop antenna leads.) This would make for much easier handling of the chassis after removal from the cabinet.

"Thanks for bearing with me thus far. I would like to see some more discussion on this subject, just to see what some of the other boys think about it.

Jack Darr
Ouachita Radio Service
Mena, Arkansas."

Well, what do the rest of you servicemen think about Mr. Darr's suggestions?

* * *

METAL LOCATORS

I HAVE been a constant reader of RADIO NEWS for the last ten years or more. There have been very

Available for Immediate Delivery!

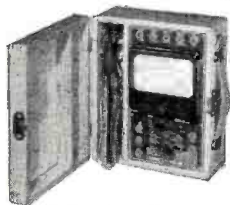

ELECTRONIC MEASUREMENT VOLTMETER

The fact that resistances between 1/20 OHM and 20 MEGS and AC voltages between 25 CYCLES and 1 MEG-CYCLE in frequency can be measured with this unit, makes it a handy and very valuable instrument.

Matched-pair multiplier resistors accurate within 1%. Meter accurate within 2%.

Price \$24.95
Size: 7 1/2" x 8 3/4" x 3 3/4". Complete with test leads.

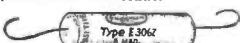

GUARANTEED TUBULAR CONDENSERS

- 8 MFD—450V—
10 or more..... 25c ea.
 - Less than 10..... 27c ea.
 - 20 MED—150V—
10 or more..... 26c ea.
 - Less than 10..... 28c ea.
 - 20X20 MFD—150V—
10 or more..... 45c ea.
 - Less than 10..... 49c ea.
- All fresh stock



"Cub" A.C.-D.C. Amplifier

The "CUB" works with phono pickup, mike, or stringed instrument on A.C. or D.C. current. Its small size and extreme portability makes it the ideal unit for bingo games and is a source of constant amusement at small gatherings. The "CUB" is contained in a heavy gauge steel case with a baked golden lacquer finish. Dimensions 8 1/2" x 8 1/4" x 4 1/4". Wght. 7 lbs. A real buy at an amazingly low price.
With tubes \$23.46

SIGNAL CORPS OUTPUT METER "146"

A war surplus bargain made by Triplet for the U. S. Army.



Meter has 5 ranges, 1 1/2v, 6v, 15v, 60v, 150v. Meter resistance 4000 ohms. Can be used on A.C. voltmeter as well as an output meter. Used in conjunction with a signal generator, the "146" is an invaluable aid in "sounding" your alignment jobs by indicating the intensity of the output of the radio, thus eliminating guesswork involved in trying to peak a set with ear alone. Complete with high quality test leads with clips and black moulded bakelite case measuring 6" x 3"
..... \$11.95



"A-200" Reliable Signal Generator

A conventional type generator, ruggedly built for maximum stability. Covers a range of 100 K.C. to 25 M.C. on fundamentals, 18 M.C. to 50 M.C. on 2nd harmonic and 27 M.C. to 75 M.C. on 3rd harmonic and 400 cycle audio. Its grey crackle finish case with multi-colored scales gives this generator an attractive finish. Priced for immediate sale \$49.50



R. T. L. TUBE CHECKER

MODEL 130. Slide switch operation. For all standard 4, 5, 6, 7, octal miniature series with two spare positions. Filament selective. D.C. voltmeter range 0 - 10 - 100 - 1000. Portable model—leatherette covered wood case with cover.

\$51.00

TUBES Complete line of all "Hard-to-get critical tubes." Send us your order and we will surprise you with delivery!

P.M. SPEAKERS

- 4" ALNICO #5. Net \$1.47
- 5" ALNICO #5. Net \$1.59
- 5" ALNICO #5. Net \$1.69
- 5" ALNICO #5. Net \$1.98
- 6" ALNICO #5. Net \$2.98
- LATE SPECIAL..... 4" LSL Army Type P.M. Portable phono-record changer leatherette cabinet \$8.95

- 6' A.C. parallel rubber cord sets with molded plug. 10 for..... \$1.80
- 1 meg. volume control with switch. (Knurled shaft) \$0.69

ANTENNA KITS—25 feet of lead in wire. 50 feet of antenna wire, ground straps, glass insulators and nail knobs. \$0.79

Ask for Our New FREE Catalog!



The Radio Shack Inc. CHICAGO
630 W. RANDOLPH STREET CHICAGO 6, ILL.

P. A. Systems - Amplifiers

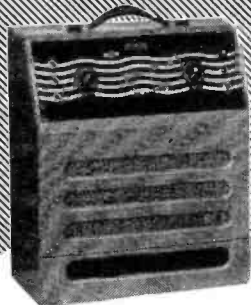

MASCO MUSICAL AMPLIFIER

- Full 15 Watts Undistorted Output.
- Frequency Response - 30 to 12,000 Cycles.
- Inputs: One Mike, Two Instruments.
- 110 Volts - 60 Cycles - 95 Watts.
- Heavy Duty 12" Dynamic Speaker.
- Unsurpassed for realistic reproduction of reed, string and percussion instruments. Complete with tubes but less contact microphones.

MODEL MAP-15 \$86.60 LIST PRICE MODEL T-31W25A \$125.00 LIST PRICE

MASCO 25 WATT 6 and 110 Volt AMPLIFIER

- Phono Operation on both 6 Volts D.C. and 110 Volts A.C.
- Two Mike Inputs.
- Outputs: 2, 4, 8, 15, and 500 Ohm.
- Extra Heavy Duty Vibrator.
- A truly universal amplifier for sound car, outdoor or indoor use. Complete with tubes.

MODEL MC-25P \$138.00 LIST PRICE MODEL PA-31W1E \$195.45 LIST PRICE

Thordarson 25 WATT BEAM POWER AMPLIFIER

- Inputs: Two Microphone, One Phono.
- Output to Speaker or Line 4, 8, 15, 125, 250 and 500 Ohm.
- Mike and Phono Mixing.
- Frequency Response - Plus or Minus 1 db from 30 to 10,000 Cycles.
- 110-120 Volts - 50-60 Cycle - 128 Watts.
- Complete with tubes.

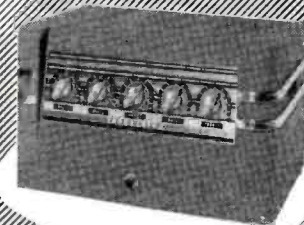

BELL PORTABLE 15 Watt P. A. System

- 15 Watts Undistorted Output.
- Three Input Channels.
- Illuminated Sloping Control Panel.
- Twin Heavy Duty 10" Speakers.
- Inverse Feedback Stabilizer.
- Complete with tubes, 25 ft. speaker cables, crystal microphone with 15 ft. cable and desk type mike stand.



WE CARRY COMPLETE LINES OF SOUND EQUIPMENT. P.A. SYSTEMS & AMPLIFIERS - Altec, Bell, Masco, Newcomb, Thordarson. INTERCOMS - Bell, Conversafone, Masco, Operadio. HORNS & DRIVERS - Atlas, Racon, University. HI-FIDELITY SPEAKERS - Altec, Jensen, Stephens. MICROPHONES - Astatic, Electro-Voice, Shure, Turner.

Write for latest manufacturers' bulletins on any equipment in which you are especially interested.

Do you have a sound installation problem? Write us giving full details. Our two sound experts will be glad to assist you.

Cast Aluminum NAME PLATES for Microphones and Stands



STANDARD RADIO & ELECTRONIC PRODUCTS CO.
135 East Second Street, Dayton 2, Ohio

MAIL ORDERS SHIPPED WITHIN 24 HOURS 20% DEPOSIT REQUIRED

SEND FOR LIST OF ALL AVAILABLE SOUND EQUIPMENT

REAL SAVINGS

IMMEDIATE DELIVERY

SPEAKERS

5" P. M. 1 oz. ALNICO 5 MAGNET \$1.39

6 for \$8.00

4" Alnico 5 Magnet.....\$1.35
6" PM 2.15 oz. Alnico 5 Magnet..... 2.39
8" PM 20 oz. Slug..... 4.95
12" PM 20 oz. Slug..... 8.95

VOLUME CONTROLS

1/2 MEG with switch and 2" shaft 75c

6 for \$4.25

Kit of 10 assorted controls, without switch.....\$1.95

WIRE

Approximately **400** ft. of Wire in assorted colors and gauges, solid and stranded in 2 to 4 feet lengths, per pkg. **99c**

2 pkgs. for \$1.90

No. 20 shielded wire, stranded, per ft.\$.03
Radio Grade spaghetti, per ft.01
No. 20 solid pushback, per ft.01

TRANSFORMERS

70 MIL POWER TRANSFORMER 600 V. 6.3V @ 3 Amp. C.T., 5V @ 3 Amp. \$2.95

3 for \$8.00

50 Mil Power 500V, 6.3V @ 2 Amp. 5V @ 2 Amp. \$1.95
50L6 Output59
6V6 Output69
4 Watt Universal Output..... 1.09
8 Watt Universal Output..... 1.29

STANDARD 4 PRONG UNIVERSAL REPLACEMENT NON-SYNCHRONOUS VIBRATOR, each \$1.39

CONDENSERS

TUBULAR PAPER CONDENSERS
All 600 Volt test

MFD.	PRICE PER EACH	100	MFD.	PRICE PER EACH	100
.01	.08	\$ 6.50	.001	.08	\$ 6.50
.02	.08	6.50	.002	.08	6.50
.05	.10	8.00	.005	.08	6.50
.1	.12	9.00	.006	.08	6.50
.25	.17	13.50	.5	.26	22.50

"ILLINOIS" ELECTROLYTICS

MFD.	VDC.	PRICE	MFD.	VDC.	PRICE
10	25v	.25	50	150v	.50
100	25v	.55	8	450v	.38
12	50v	.38	10	450v	.43
16	150v	.35	16	450v	.55
20	150v	.38	20	450v	.60
24	150v	.38	40	450v	.88
30	150v	.40	100	15v	.49

"ILLINOIS" DUALS

MFD.	VDC.	PRICE	MFD.	VDC.	PRICE
16-16	150v	.58	50-30	150v	.76
20-20	150v	.65	8-8	450v	.65
30-30	150v	.70	10-10	450v	.70
40-20	150v	.70	20-20-20	150v	.99

10% discount on all electrolytics if purchased in lots of 10 or more. Mica Condensers, all sizes, 8c each.

RESISTOR & MICA KITS

Resistor Kit of 100 Insulated resistors in popular values of 1/4, 1/2, 1 & 2 watt.....\$1.95
Mica Condenser Kit of 30 Micas in popular values, .01, .0001, .0002, etc. 2.00

12 lbs. SURPLUS RADIO PARTS \$2.00

A gold mine of parts for repairmen, amateurs, and experimenters. sockets, condensers, resistors, transformers, coils, hardware, wire, etc., etc. An outstanding bargain in usable parts! Send \$2.00 cash, check or M.O. today; (Pay small express charges on receipt.)

All items subject to prior sale

20% with order, balance C.O.D. We prepay express on \$50.00 orders in U.S.A. Write for catalog.

ELECTRONIC PARTS, Inc., Dept. A3

622 W. Randolph St. Chicago 6, Ill.

few copies missed, even though most of them were purchased at local newsstands. Even during my stay in the service (44 months), some of the boys had the magazine mailed to the ship from the States.

"I was a Radio Tech in the Navy, having completed Navy schools in radio, radar, and sound gear. I finished my secondary at Navy Pier in Chicago.

"For a long time I have been interested in radio metal locators. With interest I have followed the two articles of recent months by Osborne.

"I am especially interested in the final article to appear, using radar methods, or pulsing. When will the article appear—or has publication been cancelled? It seems such a long time to wait—or am I impatient?

Carl Spiner Phylm

Misenheimer, North Carolina."

For Reader Phylm and the many others who have asked for more information on metal locators we have tentatively set another article on the subject for April.

-30-

Packaged Radio Service

(Continued from page 61)

would have no technical information on 3 out of every 10 receivers if he depended solely upon the manufacturer for service data and literature.

To fill this gap, engineers draw up a schematic diagram of every set for which no drawings are available before the set is processed. These are checked for accuracy and for the proper selection of replacements by direct comparison with those in the actual receiver. Many errors are uncovered in the process of analysis, either in the diagrams or parts lists. Careful tabulation shows that about 60% of all receivers analyzed are accompanied by data that is in error. Many reprint services or manuals which merely copy and reproduce the original manufacturer's diagrams and data will have the same high percentage of errors, as has been proven in thousands of cases. This has long been a plague to the serviceman.

To offset any possibilities of error, each piece of equipment received for processing is carefully unpacked and a series of photographs is made of the external cabinet. If any difficulty is encountered in removing the chassis from the cabinet, a disassembly instruction sheet is made up for inclusion in the folder covering that piece of equipment. It is a fact that many table models are much more difficult to disassemble than their big brothers, the consoles.

The next step is the taking of additional photographs of the top and bottom of the chassis. The technique employed has been worked out so as to assure the easiest identification of each component. After the set is processed through the disassembly line, two men re-draw and re-work the schematic diagrams and any necessary corrections are made. They cross-

WANTED!

Articles by Radio Amateurs

2000 to 2500 words

Covering any material of genuine interest to radio amateurs, such as:

- Transmitters
- Receivers
- Antennas
- Test Equipment

Articles should be typewritten (double spaced) and accompanied by suitable diagrams, photos, and parts lists. Liberal payment will be made upon acceptance.

Address all communications to

Box 419

RADIO NEWS

185 North Wabash Avenue
Chicago 1, Illinois



PRECISION MOVEMENT
DEPENDABILITY UNLIMITED

Burlington INSTRUMENTS

Alnico Magnets in all DC Instruments—phosphor bronze control springs—perfectly aligned jewel supports—non-shifting balance weights—added to many other superior construction features enables Burlington to maintain critical characteristics.

All ranges AC or DC available in 2 1/2", 3 1/2", 4 1/2" sizes, rectangular and round.

Inquiries invited for your specific requirements.

BURLINGTON INSTRUMENT COMPANY
913 Fourth Street Burlington, Iowa

check their findings against those provided by the analysts.

Another man devotes his full time to the identification and proper coding of each component shown on the pictorial diagrams or photographs. Thus it is possible to identify every item in the receiver from any or all of the following sources; the schematic diagrams, the parts list, and the pictorial diagram. Many "exploded view" diagrams are included. These are vital in the identification of parts used in complicated record changers, etc.

Data covering corrections, additions, and modifications on receivers made subsequent to their original production runs is published in the form of separate sheets and issued as such information becomes available.

Every effort is made to provide the radio serviceman with complete and accurate information when new receivers start coming into his shop. But there are additional problems of both a specialized and general nature which need to be solved. To answer these problems, and as a supplementary service to the "Folders," the Howard W. Sams Institute has been established and it maintains a complete library of factory service literature, circuit diagrams, service hints and kinks that cover nearly every radio receiver ever manufactured in the U. S. This information is made available free to subscribers to the "Photo-Fact Folder" service.

New techniques were employed by the armed forces during the war to illustrate complicated mechanical and electrical equipment. No time could be wasted on old hunt-and-pick methods. No one can deny that a picture is worth a thousand words and not only do photographs explain the subject simply but an over-all picture is gleaned which makes for a more complete understanding of what makes the thing tick. We here at the Institute believe that the service provided by our organization is destined to streamline the profession of radio servicing.

-50-

OUTPUT TESTER FOR MICROPHONES AND PHONOGRAPH REPRODUCERS

FREQUENTLY it is desirable to know whether a microphone or a sound reproducer is satisfactory. Unfortunately this can not be done by a simple continuity test; however an equally simple test may be performed if one has a crystal earphone at his disposal. The method follows.

Disconnect the unit to be tested from the amplifier and connect to earphones. If the unit is a phonograph reproducer, place the pickup arm on a record and operate in the usual manner. When testing a microphone, a slight tapping on the microphone will serve as a sound source. If the tested unit is satisfactory, the reproduction in the phones will be of excellent quality, clear and distinct.

W. L. F.

March, 1947

NEW SHURE CARTRIDGE "PACK" HANDLES REPLACEMENTS FOR 58 CARTRIDGES!

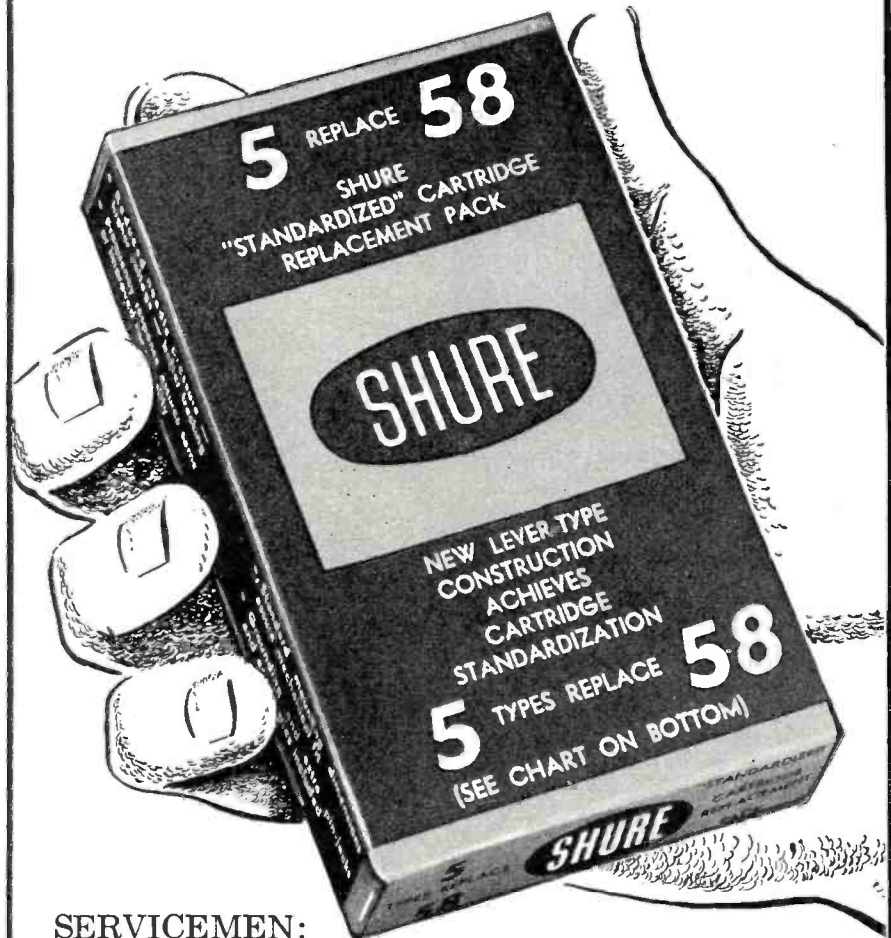

SERVICEMEN:

Solves your service problems with phonographs and record changers . . . builds new profits! 5 crystal cartridges have been "standardized" to replace 58 different popular types of all makes—a feature made possible by the new, post-war Shure Lever System. The "Pack" contains the 5 Shure Lever-Type Cartridges, including Model W57AN with the sapphire-point needle. Specific cross-reference chart for exact cartridge replacement is printed on carton. Your Shure Distributor has the "Packs" in stock. Write or call him now!

MODEL W50 . . . LIST PRICE \$25.75 . . . CODE: RUPAC

Manufactured under Shure Patents—Licensed under Patents of the Brush Development Company

SHURE BROTHERS, Inc.

Microphones and Acoustic Devices

225 West Huron Street, Chicago 10, Illinois

CABLE ADDRESS: SHUREMICRO



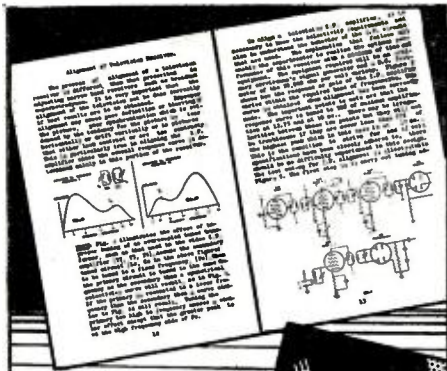

Television 1947!



Amateurs, Experimenters, Radio Servicemen... Now you

have access to the secrets of post-war television. Vision Research Laboratories now brings you in its new series of television booklets complete and detailed plans for the construction of a 5- or 7-inch television-FM receiver! The plans in these books incorporate all of the latest design features plus a detailed parts list. There is no need to wade through textbooks to get this necessary information. These booklets furnish you with all of the information needed for the construction of television receivers, sweep alignment generator, etc.

NOW AVAILABLE "Design and Construction of a Modern 5- or 7-inch TELEVISION RECEIVER" and "Design and Construction of a Visual Alignment SWEEP SIGNAL GENERATOR."

Each booklet contains: Many pages of theory and practical design information. Detailed sketches, layout photographs and schematic diagrams. In addition, each booklet is furnished with an 11 x 17 inch wall chart working diagram.

Order direct or through your local distributor!



P.O. BOX # 52, Kew Gardens 15, N. Y.

Enclosed is \$.....(Check or money order) for:

No. of Copies

.....Television Receiver Booklet at \$2.00 ea.

.....Sweep Generator Booklet at \$2.00 ea.

Name.....

Address.....

City.....Zone.....

State.....N3

CHART OF WORLD TIME DIFFERENCES

Adjustments of local clocks to accord with the adoption or abandonment of daylight-saving time have now been made in most countries where the additional hour during summer-time is the rule, those in the northern hemisphere moving back an hour, those south of the equator an hour forward. The chart below includes changes in clock-time up to and including October 31, 1943. Both the standard and current clock-time differences are given. The standard time of any area is governed, of course, by the local longitudinal difference from the Greenwich meridian, each 15 degrees of longitude equaling a time difference of plus one hour east of the meridian; minus one hour west of it. Adjustments of the standard variation to meet local convenience have been allowed for in the standard-time references below.

Area	Difference in hours from GMT		Area	Difference in hours from GMT	
	Standard Time	Clock Time		Standard Time	Clock Time
ABYSSINIA.....	+ 2	+ 3	LIBYA:		
ADEN.....	+ 3	+ 3	(a) Western.....	+ 1	+ 2
ALASKA:			(b) Eastern.....	+ 1	+ 3
(a) Ketchikan-Skagway.....	- 8	- 8	MADAGASCAR.....	+ 3	+ 3
(b) Skagway-141 w. long.....	- 9	- 9	MALAYA.....	+ 7½	+ 7½
(c) 141 w. long-62 w. long.....	- 10	- 10	MALTA.....	+ 1	+ 1
(d) 162 w. long-westernmost point.....	- 11	- 11	MAURITIUS.....	+ 1	+ 4
ALGERIA.....	GMT	GMT	MEXICO CITY.....	- 7	- 6
ANGLO-EGYPTIAN SUDAN.....	+ 2	+ 2	MOROCCO (French).....	GMT	GMT
ARGENTINA.....	- 4	- 3	MOROCCO (Spanish).....	GMT	+ 1
AUSTRALIA:			MOZAMBIQUE.....	+ 2	+ 2
(a) Victoria, New South Wales, Queensland, Tasmania.....	+ 10	+ 10	NATAL.....	+ 2	+ 2
(b) N. Territory, S. Australia.....	+ 9½	+ 9½	NEW FOUNDLAND.....	- 3½	- 3½
(c) W. Australia.....	+ 8	+ 8	NEW GUINEA (British).....	+ 10	+ 10
AUSTRIA.....	+ 1	+ 1	NEW GUINEA (Dutch).....	+ 9	+ 9
BALI.....	+ 7½	+ 7½	NEW ZEALAND.....	+ 12	+ 12
BELGIAN CONGO.....	+ 1	+ 1	NICARAGUA.....	- 5½	- 6
BELGIUM.....	GMT	+ 1	NIGERIA.....	+ 1	+ 1
BERMUDA.....	- 4	- 4	NORWAY.....	+ 1	+ 1
BOLIVIA.....	- 4	- 4	NYASALAND.....	+ 2	+ 2
BORNEO (British).....	+ 7½	+ 7½	PALESTINE.....	+ 2	+ 2
BORNEO (Dutch).....	+ 7½	+ 7½	PANAMA CANAL ZONE.....	- 5	- 5
BORNEO (Islands East of and including Dutch Timor).....	+ 7½	+ 8	PARAGUAY.....	- 4	- 4
BRAZIL:			PERSIA.....	+ 3½	+ 3½
(a) East, including all Coast.....	- 3	- 3	PERU.....	- 5	- 5
(b) West.....	- 4	- 4	PHILIPPINE ISLANDS.....	+ 8	+ 8
BRITISH GUIANA.....	- 3½	- 3½	POLAND.....	+ 1	+ 1
BRITISH HONDURAS.....	- 6	- 6	PORTUGAL.....	GMT	GMT
BRITISH SOMALILAND.....	+ 3	+ 3	PORTUGUESE GUINEA.....	- 1	GMT
BULGARIA.....	+ 2	+ 2	RHODESIA:		
BURMA.....	+ 6½	+ 6½	(a) Northern.....	+ 2	+ 2
CANADA:			(b) Southern.....	+ 2	+ 2
(a) ATLANTIC ZONE: New Brunswick, Nova Scotia, Prince Edward Island, Quebec (East of Pied de Mont).....	- 4	- 4	RUMANIA.....	+ 2	+ 2
(b) EASTERN ZONE: North-West Territory (East), Ontario, Quebec (West of Pied de Mont).....	- 5	- 5	SAUDI ARABIA.....	+ 3	+ 3
(c) CENTRAL ZONE: Manitoba, North-West Territory (Central).....	- 6	- 6	SEYCHELLES.....	+ 4	+ 4
(d) MOUNTAIN ZONE: Alberta, North-West Territory (Mountain), Saskatchewan.....	- 7	- 7	SHANGHAI.....	+ 8	+ 9
(e) PACIFIC ZONE: British Columbia, North-West Territory (West).....	- 8	- 8	SIAM.....	+ 7	+ 7
CEYLON.....	+ 5½	+ 5½	SIERRA LEONE.....	+ 7½	+ 7½
CHILE.....	- 4	- 4	SINGAPORE.....	GMT	+ 1
CHINA:			SPAIN.....	GMT	+ 1½
(a) Manchuria.....	+ 9	+ 9	SPANISH GUINEA.....	+ 6½	+ 6½
(b) 110 e. long. and 125 e. long.....	+ 8	+ 8	SUMATRA.....	+ 1	+ 1
(c) 95 e. long. and 110 e. long.....	+ 7	+ 7	SWEDEN.....	+ 1	+ 1
COLOMBIA.....	- 5	- 5	SWITZERLAND.....	+ 2	+ 2
CYPRUS.....	+ 2	+ 2	SYRIA.....	+ 2½	+ 3
CZECHOSLOVAKIA.....	+ 1	+ 1	TANGANYIKA.....	GMT	+ 1
DENMARK.....	+ 1	+ 1	TANGIER.....	+ 2	+ 2
DUTCH GUIANA.....	- 3½	- 3½	TRANSJORDAN.....	+ 1	+ 1
ECUADOR.....	- 5	- 5	TRIPOLITANIA.....	+ 1	+ 1
EGYPT.....	+ 2	+ 2	TUNISIA.....	+ 2	+ 2
FALKLAND ISLANDS.....	- 4	- 4	TURKEY.....	+ 2½	+ 3
FIJI ISLANDS.....	+ 12	+ 12	UGANDA.....	+ 2	+ 2
FINLAND.....	+ 2	+ 2	UNION OF SOUTH AFRICA.....	+ 2	+ 2
FRANCE.....	GMT	+ 1	U.S.S.R.:		
FRENCH CAMEROONS.....	+ 1	+ 1	(a) Moscow.....	+ 2	+ 3
FRENCH EQUATORIAL AFRICA (BRAZZAVILLE).....	+ 1	+ 1	(b) Kuibyshev.....	+ 3	+ 4
FRENCH GUIANA.....	- 4	- 4	(c) Transcaucasia.....	+ 3	+ 4
FRENCH GUINEA.....	- 1	GMT	(d) Tashkent.....	+ 4	+ 5
FRENCH INDO-CHINA.....	+ 7	+ 8	(e) Tomsok.....	+ 5	+ 7
FRENCH WEST AFRICA:			(f) Khabarovsk.....	+ 9	+ 10
(a) Mauretania.....	- 1	- 1	UNITED STATES:		
(b) French Sudan.....	GMT	GMT	(a) EASTERN ZONE: Connecticut, Delaware, Florida, Georgia, Maine, Maryland, Massachusetts, New Hampshire, New Jersey, New York, North Carolina, Ohio, Pennsylvania, Rhode Island, South Carolina, Vermont, Virginia, West Virginia.....	- 5	- 5
(c) Niger Territory.....	+ 1	+ 1	(b) CENTRAL ZONE: Alabama, Arkansas, Illinois, Indiana, Iowa, Kansas, Kentucky, Louisiana, Michigan, Minnesota, Mississippi, Missouri, Nebraska, North Dakota, Oklahoma, South Dakota, Tennessee, Texas, Wisconsin.....	- 6	- 6
THE GAMBIA.....	- 1	GMT	(c) MOUNTAIN ZONE: Arizona, Colorado, Idaho, Montana, New Mexico, Utah, Wyoming.....	- 7	- 7
GERMANY.....	+ 1	+ 1	(d) PACIFIC ZONE: California, Nevada, Oregon, Washington State.....	- 8	- 8
GIBRALTAR.....	GMT	+ 1	URUGUAY.....	- 3½	- 3
GOLD COAST.....	GMT	GMT	VENEZUELA.....	- 4½	- 4½
GREECE.....	+ 2	+ 2	WEST INDIES:		
GREENLAND.....	- 3	- 3	(a) Bahamas.....	- 5	- 5
GUATEMALA.....	- 6	- 6	(b) Barbados.....	- 5	- 5
HAWAIIAN ISLANDS.....	- 10½	- 10½	(c) Cuba.....	- 5	- 5
HOLLAND.....	GMT	+ 1	(d) Dominican Republic.....	- 5	- 5
HONGKONG.....	+ 8	+ 9	(e) Haiti.....	- 5	- 5
HUNGARY.....	+ 1	+ 1	(f) Jamaica.....	- 5	- 5
ICELAND.....	- 1	- 1	(g) Leeward Islands.....	- 4	- 4
INDIA:			(h) Martinique.....	- 4	- 4
(a) India generally.....	+ 5½	+ 5½	(i) Nassau.....	- 5	- 5
(b) Assam.....	+ 6½	+ 6½	(j) Puerto Rico.....	- 4	- 4
(c) Bengal.....	+ 6½	+ 6½	(k) St. Lucia.....	- 4	- 4
IRAQ.....	+ 3	+ 3	(l) St. Vincent.....	- 4	- 4
ITALY.....	+ 1	+ 1	(m) Tobago.....	- 4	- 4
JAPAN.....	+ 9	+ 9	(n) Trinidad.....	- 4	- 4
JAVA.....	+ 7½	+ 7½	(o) Turks Island.....	- 5	- 5
KENYA.....	+ 2½	+ 3	YUGOSLAVIA.....	+ 1	+ 1
LEBANON.....	+ 2	+ 2	ZANZIBAR.....	+ 2½	+ 3
LIBERIA.....	- ½	- 1			

Courtesy of "London Calling" magazine of the British Broadcasting Corp.

Practical Radio Course

(Continued from page 59)

resonance curve to give us any desired compromise between selectivity and sideband response with the assurance that this compromise will hold unchanged for every station received. Furthermore, its constancy permits of judicious "faking" of the audio amplifier response to strengthen the high notes if we find that we cannot get the degree of selectivity we desire without undue cutting of sidebands in the i.f. tuned circuits.

5. It is possible to provide a choice of more than one over-all fidelity characteristic in a given receiver through the use of simple variable selectivity arrangements in the i.f. amplifier. This is especially important in high-fidelity AM receivers, communications type receivers, etc.

6. The i.f. fixed-tuned circuits are cheaper and occupy less space than would an equal number of variable-tuned signal-frequency circuits as there is no need for ganged variable tuning capacitors.

7. The absence of variable tuning capacitors reduces the possibility of widespread feedback occurring within the i.f. amplifier and makes preventive shielding of the circuits easier.

8. Since the total r.f. gain is ob-

tained in amplifiers operating at two different frequencies, the possibility of over-all-feedback is reduced.

Image-Frequency Rejection

It will be remembered from previous discussions of the operation of the preselector that its main responsibility is to reject interfering signals of *image* frequency. Since the mixer will convert these to a frequency equal to the i.f. employed in the receiver, they will not be rejected by the tuned circuits of the i.f. amplifier. Consequently if they are to be rejected at all, the preselector, located ahead of the frequency converter, must do it.

Adjacent-Channel Selectivity

By adjacent-channel selectivity is meant the ability of the receiver to choose between the simultaneously received signals of the broadcasting stations operating on adjacent frequency channels. For American AM broadcasting stations, the usual frequency allocation of adjacent-channel stations is such that there is a 10 kc. separation between their carrier frequencies.

Let us consider the problem of selecting the signal of a 1000 kc. station from that of the adjacent-channel 1010 kc. station. The frequency difference between these two signals is 10 kc., or $10 \times 100/1000 = 1\%$. If a t.r.f. receiver were used for reception, this

frequency difference would be maintained throughout the entire r.f. amplification system since both signals would progress through it unchanged in frequency. In order to obtain sufficient selectivity to select the desired signal from the interfering one, a cascaded series of t.r.f. amplifiers (all tunable) would have to be employed with the ultimate aim of achieving a cumulative resonance curve for the entire r.f. system that would be sharp enough to sufficiently attenuate the undesired signal 1% away in frequency so that it would not create annoying interference with the desired signal. This would necessitate the use of quite a number of tuned stages, each having its own variable tuning capacitor in the tuning gang. The resulting receiver would be quite bulky and costly.

If a superheterodyne receiver were used for the reception, it would have to meet the same selectivity requirement. The tuned circuits of the preselector provide some attenuation of adjacent-channel signals. However, the amount of adjacent-channel signal attenuation provided by the two tuned circuits in the usual 1-stage preselector would not be sufficient to completely eliminate interference from strong signals of such close frequencies. Fortunately, the very nature of the superheterodyne process makes a high degree of adjacent-channel selectivity inherent in the *i.f. amplifier*, and

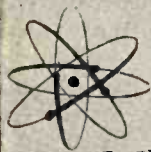

Hams' Paradise

EVERYTHING IN RADIO, ELECTRONIC, AND COMMUNICATIONS SUPPLIES

GIGANTIC SURPLUS CLEARANCE SALE!
LOWEST TUBE PRICES IN HISTORY!
COMPLETE STOCK AVAILABLE FOR IMMEDIATE DELIVERY!
WE GUARANTEE TO SAVE YOU MONEY—NOW!

Here is your chance to stock up on spares because when present stock is depleted, prices will go back to normal. These tubes are offered for immediate shipment subject to prior sale. All of these tubes are standard brands and have passed JAN inspection and are guaranteed by Niagara. Write for your copy of our complete list today. Be sure that you get our prices before you buy as we can save you many dollars. CHECK NIAGARA PRICES FIRST!

NIAGARA RADIO SUPPLY CORP.
160 Greenwich St.
New York 6, N. Y.
Please send your Gigantic Price List 2 RN and Special Tube List.

Name
Address
City Zone State

- COMPLETE STOCK OF SUPPLIES
- Transformers, Plate, Filament, Combination, Audio, etc.
 - Condensers, Transmitting, Receiving, etc.
 - Filter Capacitors, Trimmers, Padders
 - Milliammeters, Voltmeters, Ammeters, Microammeters
 - Plugs, Crystals, Dials
 - Test Equipment, Relays, Switches
 - Cables, Connectors, Power Supplies
 - Vibrators, Dynamotors, Rectifiers
 - Cables, Resistors, Rectifiers
 - Amplifiers, Receivers, Transmitters

Clip and mail convenient coupon below for your copy of our new Giant Price List 2 RN and Special Tube List for the greatest bargains in HAM History

MAIL COUPON TODAY!

NIAGARA RADIO SUPPLY

160 Greenwich St., New York 6, N. Y.



The Industrial iron for DELICATE WORK

DRAKE 400
SOLDERING IRON

For soldering in tight corners or delicate units, you can't beat the Drake 400. And this mighty mite has the long life and dependable performance necessary for industrial work. It is the only substantial industrial iron offering this combination of features.

DRAKE 400
LIST \$4.95

WEIGHS ONLY 8 OZ.
60 WATT RATING

1/4" TIP
IRON 9 INCHES LONG

DRAKE ELECTRIC WORKS, INC.
3656 LINCOLN AVE. CHICAGO 14, ILL.

the amount required may be obtained very largely by proper design of its tuning circuits and without reference to any other part of the receiver. Let us see why this is so.

How I.F. Amplifier Provides Adjacent-Channel Selectivity

Let us assume that the fixed-tuned circuits in the intermediate amplifier of the superheterodyne receiver employed in the preceding discussion are peaked at the now-standard i.f. of 455 kc. In the preselector circuits of the receiver there is a difference of $1010 - 1000 = 10$ kc. = only 1% between the frequencies of the desired 1000 kc. signal and the interfering 1010 kc. adjacent-channel signal. If the selectivity of the preselector is insufficient to prevent the undesired 1010 kc. carrier from getting through rather strongly to the mixer, both signals will be acted upon by the 1455 kc. oscillator signal and the mixer and will have their carriers converted into carriers of lower frequencies, as illustrated in Fig. 2. Both frequency-converted signals will be present in the input of the i.f. system. The carrier of the desired signal will have a frequency of $1455 - 1000 = 455$ kc. That of the interfering signal will have a frequency of $1455 - 1010 = 445$ kc. It is evident that the frequency separation is still 10 kc., but the percentage difference is now $10 \times 100/455$, or approximately 2.2%. Therefore, while the original frequency difference is only 1%, it is approximately 2.2% after the two signals have undergone frequency conversion and reached the intermediate amplifier. Consequently the relative adjacent-channel selectivity problem in this case is approximately 2.2 times simpler for the i.f. circuit than for the r.f. preselector circuit of equal selectivity. In comparison it will be seen that an improvement of $2.2/1 = 2.2$ times has been obtained from a selectivity standpoint by heterodyning the 1000 kc. wanted signal to 455 kc., with respect to adjacent-channel selectivity. The adjacent-channel selectivity of the i.f. amplifier is often called the *arithmetical selectivity*.

Effect of Signal Frequency on Selectivity of I.F. Amplifier

To determine the effect of signal frequency upon the adjacent-channel selectivity of both the r.f. preselector and the i.f. amplifier assume now that signals of higher frequencies—1500 kc. for the desired signal and a 1510 kc. for the undesired adjacent-channel signal—are applied to this same receiver. The frequency difference between these two carriers is still 10 kc. The percentage difference, however, is now $10 \times 100/1500 = 0.66\%$, which means that the relative adjacent-channel selectivity problem is more difficult for the preselector now than it was in the case of a 1000 kc. signal.

However, after these two signals have been "converted" to the lower frequencies by the action of the 1955

ELECTRICIANS! RADIO MEN!

Earn More Money!

Get this new GIANT SIZE

ELECTRICAL and RADIO TROUBLE SHOOTING MANUAL
GUARANTEED BY COYNE



Yours 10 Days Free!

OVER 500 Large Size Electrical and Radio Shop Prints -How to read and use them

NEEDED by Electrical and Radio Workers, beginners, old timers! Nothing else like it. Saves time, helps boost your pay. **4 GREAT BOOKS IN ONE!** 1. New Step-by-Step Trouble Shooting Course. 2. 600 Shop Prints. 3. Electrical-Radio Dictionary. 4. Spare Time Jobs. **FREE!** 1 year Technical Counsel by mail from COYNE staff, on trouble-shooting problems. **SEND NO MONEY!** See offer below. Satisfaction guaranteed by the famous COYNE "Learn-by-Doing" Electrical School. **RUSH COUPON TODAY!**

Educational Book Publishing Division
COYNE ELECTRICAL SCHOOL, Dept. 37-73, **FREE TRIAL COUPON**
500 S. Paulina St., Chicago 12, Ill.

Send, postage-paid, Coyne's new Electrical and Radio Trouble Shooting Manual. In 10 days I'll either return it or send \$3, then \$3 monthly until total of \$1.00 is paid. Cash price: \$2.50—you save 55c. Same 10-day free trial and return privilege.

NAME _____ Age _____
ADDRESS _____
CITY _____ Zone _____ STATE _____

The BUY of a LIFETIME!

U. S. SIGNAL CORPS **only**
5 Meter SHORT WAVE TRANSMITTERS **\$3.49**
(72.2 Mc.)
Xmtr & Tube only
Less miko, batteries and antenna.

One 1 1/2 volt dry cell and 67 1/2 volts of B operates it. Just attach di-pole, key or mike, connect the batteries and it's ready to use. Signal Corps spec wired with silver wire, silver-mica condensers, and precision resistors. Highly stable circuit with Lo-Loss silver inductance. (Adjustable paddler.) Schematic supplied.

- Converts to walkie-talkie and Ham bands.
- Weighs less than a pound.
- Shipped by express only. No C.O.D.s. No Parcel Post.
- A sacrifice at only \$3.49. Postal or express money order or certified check.

NEWARK SURPLUS MATERIALS CO.
324 Plane St. Dept. N. Newark 2, N. J.
Send stamp for our giant Catalog

RECORDS

LATEST & HARD-TO-GET BACK NUMBERS

Some slightly used and some brand new—Victor, Bluebird, Columbia, Okeh, Decca, Capitol, etc. Such artists as Glenn Miller, Benny Goodman, Harry James, Bing Crosby, Frank Sinatra, Gene Autry, Duke Ellington, Fats Waller, Guy Lombardo, Andrews Sisters, Kate Smith, Ink Spots, Mills Bros., etc.

BIG PROFITS Your opportunity to cash in on this new field that is sweeping the country. Specify the type of music that sells best in your territory such as Swing, Sweet Music, Cow-boy, Hill-billy, Polkas, Blues, etc. Your price \$13.90 per 100 records, f.o.b. Chicago, 2% off for cash with order. All shipments made within 48 hours.

CHAS. HOODWIN CO.
4419 Broadway, W15, Chicago 40, Illinois
World's Largest Dealers in Used Records

kc. oscillator signal and the mixer, their frequencies will be 1955—1500 = 455 kc. and 1955 - 1510 = 445 kc. respectively. The percentage difference between these two frequencies is still 2.2%. It is evident that while the adjacent-channel selectivity of the preselector decreases with increase of signal frequency, that of the i.f. amplifier remains constant over the whole of the tuning range of the receiver.

In practice the decrease in selectivity of the preselector as the signal frequency increases is modified somewhat by the fact that it is usually possible to obtain higher values of Q at high frequencies than at low, so that the selectivity does not fall off as rapidly as one might expect as the signal frequency is raised. Nevertheless the fact remains that the higher the operating frequency the lower the adjacent-channel selectivity of the preselector. It will be remembered that trouble due to adjacent-channel interference in the old t.r.f. receivers occurred mostly at the high-frequency end of the band!

As most of the adjacent-channel selectivity in practical superheterodynes is obtained in the i.f. amplifier, it is substantially independent of the signal frequency and, ignoring the effect of the preselector circuits, the rejection of an adjacent-channel interfering signal is just as good at one end of the tuning band as it is at the other. This is a definite advantage of the superheterodyne receiver. The second great

I.F. Peak	Freq. of wanted signal (after conversion)	Freq. of interfering signal (after conversion)	% Freq. difference between wanted and interfering signals (after conversion)
100 kc.	100 kc.	90 kc.	10%
130 kc.	130 kc.	120 kc.	7.7%
175 kc.	175 kc.	165 kc.	5.7%
260 kc.	260 kc.	250 kc.	3.9%
455 kc.	455 kc.	445 kc.	2.2%
600 kc.	600 kc.	590 kc.	1.66%

Chart shows the effect of i.f. peak value on the per-cent frequency difference between wanted and interfering signals. The greater this percentage difference in frequency the more easily the two signals will be separated and the unwanted signal attenuated in the i.f. tuning system of the superheterodyne receiver.

advantage is that since the i.f. circuits employ fixed-tuning we can use as many as are necessary to provide adequate selectivity and gain without complicating the signal-tuning operation of the receiver or making it unduly expensive.

How I.F. Value Employed Affects Selectivity of I.F. Amplifier

While we are on the subject of adjacent-channel selectivity of the i.f. amplifier it will be well to investigate how it is affected by the value of i.f. employed in the receiver. This was an important consideration affecting the standardization of receiver i.f.'s by the RMA a few years ago.

In order to determine the effect of the i.f. value employed in the receiver

* These are some of the i.f. peaks that have been employed in AM broadcast-band superhet receivers during the past fifteen years—before the standardization of i.f. peaks by the RMA.

upon the adjacent-channel selectivity of the i.f. amplifier it will only be necessary to calculate the per-cent frequency difference that results, after frequency conversion, in a receiver to which a wanted 1000 kc. signal and an interfering 1010 kc. signal are applied and which employs the following successive values of i.f.—100 kc., 130 kc., 175 kc., 260 kc., 455 kc., and 600 kc.² The results are tabulated above and illustrated graphically in Fig. 3. It is apparent that the lower the i.f. employed in the receiver the greater will be the arithmetical selectivity advantage, or the percentage frequency separation of wanted and interfering adjacent-channel signals after the frequency conversion has taken place. The greater this percentage difference in frequency the more easily the two signals will be separated and the unwanted signal attenuated in the i.f.

RADIO RECEIVING TUBES from

TUBES	YOUR COST				
	If the Retail Price of the Tube Is	QUANTITIES 1 TO 5	QUANTITIES 6 TO 49	QUANTITIES 50 TO 100	QUANTITIES 101 TO 500
	\$0.95	\$0.56	\$0.51	\$0.48	\$0.45
	1.05	.62	.56	.52	.49
TUBES	1.10	.66	.59	.55	.52
	1.15	.70	.63	.59	.56
	1.25	.74	.67	.63	.59
	1.35	.82	.74	.70	.66
TUBES	1.50	.92	.83	.78	.74
	1.80	1.09	.99	.92	.89
	2.20	1.35	1.23	1.14	1.09
	2.65	1.66	1.50	1.40	1.33
TUBES	3.20	2.00	1.81	1.68	1.60
	3.90	2.44	2.20	2.05	1.96

20% with Order—Balance, Including Postage, C.O.D. Reliable, Prompt Service

Present Conditions Make It Impossible to Accept Orders for Tubes of Any Given Make. However, Radiomart, Inc., Warrants that Tubes Shipped Will Be New and of the Best Standard Brands.

RADIOMART, INC., 149 Riverdale Avenue, Yonkers, New York

Radiomart
INC.

ORDER NOW

TUBES TUBES TUBES
TUBES TUBES TUBES
TUBES TUBES TUBES
TUBES TUBES TUBES

BUILT-IN QUALITY
 Made Our Famous
RADIO & PHONO KITS
 A National Success!
 THE IDEAL KITS FOR
 STUDENTS • SCHOOLS
 HOSPITALS • SERVICEMEN
 AMATEURS



Our Model S-5 uses the universally accepted superheterodyne circuit containing the following tubes: 12SA7, 12SK7, 12SQ7, 50L6, 35Z5 and tunes from 550 Kc to 1600 Kc. Model S-5 (illustrated) Complete Kit including tubes, Bakelite cabinet and brand new illustrated instructions, showing simple, detailed, step-by-step diagrams.



Model S-6X... a 6-tube 2-band receiver kit, equipped for either 110 or 220 volts, AC or DC covers the following ranges: 550 Kc 1600 Kc 6-16 Mc Complete and ready for assembly.



COMBINATION RADIO & PHONO KIT

- 5 tube superheterodyne radio
 - Beautiful walnut finish cabinet
 - 5" Alnico V Speaker
 - Astatic L-72 pick-up
- Ready for assembly.

All Kits Are Furnished Complete, Less Wire & Solder
 Direct Shipments to All Parts of the World!
 25% Deposit on C.O.D. Orders.
 Write for FREE Catalog.

RADIO KITS COMPANY

Dept. K
 120 Cedar Street, New York 6, N. Y.

Radio Technician and Announcers

A practical nine-month course in First Class Radiotelephone Operation and Announcing is offered by Don Martin School of Radio Arts. Most stations these days require combination men. We specialize in this type of training and maintain a placement bureau for our graduates. Serving the industry for nine years, the School of Radio Arts can train you. Write for our catalogue outlining the courses offered. Classes can be arranged so you can do part time work on the side.

APPROVED FOR VETERANS

DON MARTIN SCHOOL OF RADIO ARTS
 1655 North Cherokee St. Hollywood 28, Calif.

RADIO TUBES

Most Critical Types in Stock
 50L6, 1A7, 35Z5, etc.
 Brand New, in Sealed Cartons
 100% Guaranteed
 Repairmen and Dealers, Write For
 List at Trade Discounts

RADIO-EXPERTS
 178 E. 33rd Street Paterson 4, N. J.

If this were the only factor involved, it would appear to be advantageous to employ as low a value of i.f. as possible in a superheterodyne. However, several other important conflicting considerations (for example that of image interference) enter into the selection of the i.f. to be employed and place a definite, practical limit on how low it may be made. We shall learn more about this in the next lesson of this series.

(To be continued)

1N34 Discriminator

(Continued from page 55)

plus equipment stocks. These are less expensive than the units described and have been found to work equally well. The wiring of these units is the same as for the 1N35 and 1N34.

Fig. 4 shows a Summerhays discriminator which differs from the more

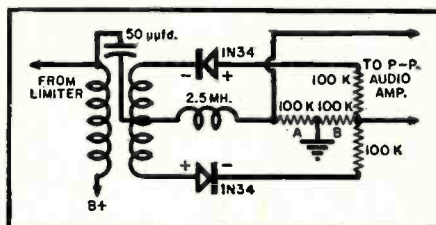

Fig. 4. Circuit diagram of Summerhays discriminator applied to push-pull grids. This arrangement delivers greater output than the Foster-Seeley circuit shown in Fig. 2. For single-ended operation output may be taken across A or B.

familiar Foster-Seely discriminator in that the two rectifiers are wired to provide rectification in opposite polarities. Two advantages of this type of discriminator are that it can be readily fed to a push-pull amplifier as shown in Fig. 4, and the output, whether single ended or push-pull exceeds that of the Foster-Seely. Another advantage is that where a center frequency indicator for tuning purposes is desired the Summerhays system delivers more current and therefore a less sensitive meter can be used without d.c. amplification. Amateurs should find this circuit and the others described in this paper very effective for inclusion in receivers for reception of amateur FM transmissions.

It should be mentioned in passing that the 1N34 functions equally well when used as a detector for AM, either in domestic or communications receivers.

-30-

Fig. 5. Conversion of i.f. transformer to a discriminator transformer.

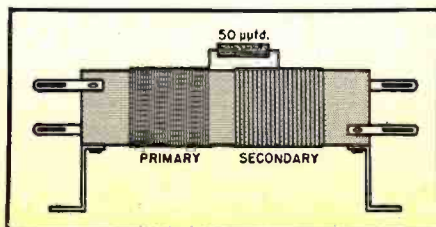

LOOK WAR SURPLUS

Nationally known Brands
 subject to prior sale

- CENTRALAB CONDENSERS**—3000 VDC, 50 mmfd, type 850, silver ceramic..... 10 for \$1.39
SPRAGUE CONDENSERS—metal encased, oil impregnated, tubular, 600 VDC, .1 mfd.
 25 for \$2.19 100 for \$8.49
CRYSTALS—Sylvania type IN21.
 2 for 98c 25 for \$11.98
JACKS—Signal Corps type JK34A, short phone jack.
 10 for 98c
MICAMOLD CONDENSERS—molded-in-bakelite, 400 VDC, .01 mfd.
 25 for \$1.09 100 for \$3.98
IRC, Type A B RESISTORS—cement coated, 10,000 Ohm, 10 Watt.
 25 for \$2.19 100 for \$8.49
SILVER CERAMIC, Erie type, feed-thru Condensers, 1000 Volts, 50 mmfd 100 for \$1.49
PILOT LIGHT ASSEMBLY—Very high grade, movable lens and shutter.
 10 for \$1.39 100 for \$12.49
BANANA PLUGS—Beryllium Copper, Signal Corps type, overall length 3/4" with 8-32 thread.
 25 for 54c 100 for \$1.98
WARD LEONARD RESISTORS—Adjustable, 10 Watt, 75 Ohms.
 25 for \$2.19 100 for \$8.49
SHAKEPROOF—tinned phosphor bronze soldering lugs, accommodates up to size 14 conductor.
 500 for 98c 1000 for \$1.79
JONES TERMINAL STRIP—high grade, 10 terminal.
 25 for \$2.98 100 for \$11.49

Write for circular listing many other outstanding values. Special discount on quantities. SHIPPING EXTRA.
ERIE SUPPLY CO. 88 EXCHANGE ST. ROCHESTER, N. Y.

NOW AVAILABLE

SERVICE DEALERS

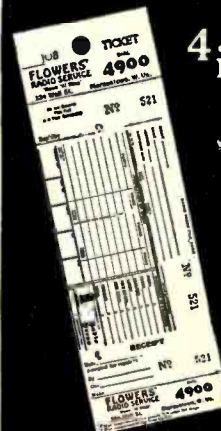

4 in 1
 Job Cards
 Shop Cards
 Postal Notices
 Storage Signals

JOB CARD STYLING

A
 STYLED TO ORDER
 "CUSTOM TAILORED"
 SERVICE

Radio Press MORGANTOWN WEST VIRGINIA

AMPLIFIER
 For Call System
 or Phono-
 Amplifier

\$2.95



COMPLETE WITH TUBES
 COMPACT—WIRED
 READY TO OPERATE
 USES 35Z5-50L6

N. J. INDUSTRIAL CO.
 309 ELM ST., NEWARK 5, N. J.

RADIO COURSES

- RADIO OPERATING • CODE
- RADIO SERVICING — ELECTRONICS

• REFRIGERATION SERVICING

Personal Counselling Services for Veterans
 Write for Latest Trade & Technical Catalog
Y.M.C.A. TRADE & TECHNICAL SCHOOLS
 7 W. 64th Street New York City

BIZ QUIZ

Test Your
Sales Ability

One of a series of sales aptitude tests especially prepared for RADIO NEWS by Mr. George Speer, Director of Institute for Psychological Service, Illinois Institute of Technology.

1. Do you like to imagine how you'd change things, if you could? (a) *Seldom* (b) *Sometimes* (c) *Frequently*
2. When someone criticizes you, do you (a) *Feel hurt.* (b) *Think about it for awhile and then forget it.* (c) *Ignore it entirely.*
3. If you see an accident, do you (a) *Quickly take an active part in giving help* (b) *Offer to help* (c) *Watch others*
4. When you find that other people disagree with your opinions do you (a) *Become discouraged* (b) *Pay no attention* (c) *Try to prove that you are right*
5. When you attend a meeting do you usually (a) *Heckle the speaker* (b) *Ask questions of the speaker* (c) *Listen quietly to the speaker*
6. If you were able to travel, would you (a) *Take a conducted tour* (b) *Go with friends who help plan the trip* (c) *Prefer the adventure of traveling alone*
7. If you are suddenly called on to speak in public, do you find it (a) *Easy and enjoyable* (b) *Fairly easy but not enjoyable* (c) *Difficult and unpleasant*
8. Do your political or social beliefs tend to be (a) *Definitely radical* (b) *Progressive but not radical* (c) *Conservative*
9. When you attend a football or baseball game do you intentionally make remarks easily overheard by those around you? (a) *Frequently* (b) *Occasionally* (c) *Never*
10. Have you ever asked for contributions to a cause in which you were interested? (a) *Yes* (b) *No*
11. A fellow employee has told some stories about you which are uncomplimentary and unjustified, but not serious. Will you (a) *Confront him and demand an explanation* (b) *Feel badly, but decide not to do anything* (c) *Ignore it entirely*
12. When dealing with a very important person in the community do you feel self-conscious (a) *Greatly* (b) *A little* (c) *Not at all*
13. When you vacation do you prefer (a) *A quiet secluded place* (b) *A moderately active resort* (c) *A lively resort*
14. Have you ever pretended you were busy or in some other way avoided meeting or serving a customer? (a) *Never* (b) *Sometimes* (c) *Frequently*
15. If you feel a customer is being dictatorial and domineering do you (a) *Try to treat him the same way* (b) *Behave normally, but wish you didn't have to* (c) *Feel and behave normally*
16. Do you prefer (a) *Never or seldom to be alone* (b) *To be with others about half the time* (c) *To be by yourself a great deal*
17. When people watch you work do you (a) *Feel nervous* (b) *Pay no attention to them* (c) *Do your best work*
18. You have greeted very familiarly a customer whom you believed to be an acquaintance. When you discover he is a stranger to you are you embarrassed (a) *Very much* (b) *Somewhat* (c) *Not at all*
19. Do you prefer companions (a) *Of your own sex* (b) *Of both sexes* (c) *Of the opposite sex*
20. When making decisions do you (a) *Act on the spur of the moment frequently* (b) *Sometimes act quickly, but usually after thinking things over* (c) *Almost always think things over before acting*

(Answers on page 155)

March, 1947

CURRENT CONVERSION with ATR QUALITY PRODUCTS



**ATR
"A"**

BATTERY ELIMINATORS

For Converting A.C. to D.C.

New Models . . . Designed for Testing D.C. Electrical Apparatus on Regular A.C. lines. Equipped with Full-Wave Dry Disc Type Rectifier, Assuring Noiseless, Interference-Free Operation and Extreme Long Life and Reliability.

- Eliminates Storage Batteries and Battery Chargers.
- Operates the Equipment at Maximum Efficiency at All Times.
- Fully Automatic and Fool-Proof.

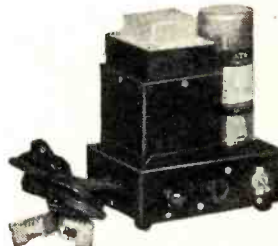

**ATR
LOW POWER
INVERTERS**

For Inverting D.C. to A.C.

Another New ATR Model . . . Designed for Operating Small A.C. Motors, Electric Razors, and a Host of Other Small A.C. Devices from D.C. Voltage Sources.

**ATR
STANDARD
AND HEAVY
DUTY
INVERTERS**



For Inverting D.C. to A.C.

Specially Designed for Operating A.C. Radios, Television Sets, Amplifiers, Address Systems, and Radio Test Equipment from D.C. Voltages in Vehicles, Ships, Trains, Planes, and in D.C. Districts.

Write for Our New Catalog—Just Off the Press!

AMERICAN TELEVISION & RADIO CO.

Quality Products Since 1931

ST. PAUL 1, MINN.

U. S. A.



✓ STABILITY

Stay put with PRs! X-ray orientation guarantees uniform cut for maximum low-drift performance . . . drift limited to less than 2 cycles per MC per degree.

✓ ACCURACY

Guaranteed accurate within .01 per cent of specified frequency or better. When doubling and quadrupling accuracy is absolutely necessary.

✓ POWER OUTPUT

PRs are designed to give maximum power output from the exciter stage. They will stand up under high voltages and currents.

✓ ACTIVITY

PRs give you high activity. They "come in" instantly on phone . . . key without chirps, even at high bug speeds, without excessive "backing off."

✓ Unconditional Guarantee

Every PR Precision CRYSTAL is guaranteed unconditionally by the makers of fine crystals since 1934.

✓ EXACT FREQUENCY at NO EXTRA COST

You pay no premium for the exact frequency you want (integral kilocycle). PR makes a special effort to keep its jobbers supplied with EVERY FREQUENCY available to amateurs.

10 Meters—PR Type Z-5 \$5.00
20 Meters—PR Type Z-3 3.50
40 and 80 Meters—PR Type Z-2 2.65



CORRESPONDENCE COURSES IN RADIO and ELECTRICAL ENGINEERING

ELECTRICAL ENGINEERING Get good grasp of wide electrical field. Prepare yourself at Low Cost, for secure future. Modern course. So simplified anyone can understand quickly.
RADIO ENGINEERING Extra fine course in radio, public address, photo-electric work. Trains you to be super-service man, real vacuum-tube technician. Servicemen needed badly. Diploma on completion. Many graduates earning big pay.
WRITE Send postcard for Free Copies of \$25 Either school catalog. Full details, all Course about deferred payment plan, experimental kits, etc. Lincoln Engineering School, Box 908-RN-3, Lincoln 2, Nebr.

PEN-OSCIL-LITE

Extremely convenient test oscillator for all radio servicing; alignment • Small as a pen • Self powered • Range from 700 cycles audio to over 600 megacycles u.h.f. • Output from zero to 125 v. • Low in cost • Used by Signal Corps • Write for information.

GENERAL TEST EQUIPMENT
38 Argyle Buffalo 9, N. Y.

All-Wave Receiver

(Continued from page 45)

coil table. If commercially wound coils are purchased, some alteration may be needed, as there may be evident in the operation of the set a persistent squeal on which variation of the regeneration control will have no effect. This is due to too much oscillation and can be remedied by removing one or more turns from the plate or tickler coil until, by trial and error, the squeal disappears. No more than 45 volts should be used as plate voltage. A single 1½ volt flashlight cell may be used for filament supply but its life will not be long at the .2 ampere drain for the filaments. For short periods of portable operation, however, the flashlight will be sufficient. A No. 6 dry cell will give much longer service. Only about .01 ampere is drawn from the "B" battery so that a small portable type will do. One additional tube socket may be seen towards the rear on the r.f. side in the photograph. This will indicate how the sockets are mounted to the masonite baseboard. However this socket is not used; an r.f. stage can be added later on if desired. If a metal chassis is used, all ground connections should be soldered directly to the chassis or panel at the nearest point. If a baseboard other than metal is used, a piece of tinned bus bar wire may be run the length of the board and all ground connections which cannot be made to the metal panel can be made to this bus bar. This bus bar can be seen in the bottom view of the set running approximately midway between front and rear. A hole must be put in the lower shield to permit the passage of the bus bar. Both the panel and the bus bar must be connected to the ground or B— post. Particular care should be taken in wiring in the tube sockets. All the miniature tubes use the same type of socket but the same pins are not used for the various tubes and it is fairly easy to make an error in wiring if one is not careful.

The operation of the set is similar to that of any regenerative receiver. Stations are indicated by a squeal or whistle during tuning. Backing off the regeneration control until just beyond the point of oscillation will permit a phone station to come in clearly.

Winding specifications for constructing various plug-in coils.

BAND (METERS)	L ₁	L ₂
Broadcast	100 t.*	25 t.*
200-80	54 t.*	16 t.*
80-40	23 t.*	8 t.*
40-20	10 t.*	6 t.*
20-10	6 t.**	4 t.*

All coils are wound in the same direction with No. 28 enameled or d.s.c. wire. The spacing between L₁ and L₂ is 1/8". Coil forms are 1 1/4" diam. and 2 1/2" long with a 4-prong base.

* Closewound
** 1/8" between turns

ORDER NOW

BC 312 Army Receivers (New Condition) . . . \$59.95
Signal Corps 1-222A Signal Generator
Range 8-15 MC, 150-230 MC \$69.95
300 Ohm Amphenol Twin Lead,
per 100 ft. \$ 2.90
75 Ohm Amphenol Twin Lead,
per 100 ft. \$ 2.00
Kilowatt 72 Ohm Amphenol Twin Lead,
per 100 ft. \$ 7.20
5 Volt, 26 Amp. Trans. (20,000 V. ins.
uncased) \$ 4.95
3 Gang 410 Mmfd. Per Sect. Cond.
Excellent quality \$ 2.95
2" PM Speaker (Bakelite Cased)
Used in Walkie Talkie \$ 1.95
Signal Corps Telegraph Key \$ 1.10
VT 127 Tubes (Equivalent to 100 TL) . . . \$ 3.50
Jan 6 AK5 Tubes \$ 1.95
#12 Solid Enamel Copperweld Antenna Wire,
per 100 ft. \$ 1.35
5" PM Army Communications Speaker,
Metal Case, 4000 Ohm Output, Matches
Exactly BC 312, BC 348, etc. \$ 2.95

Send for Our Special Bulletin of Government Surplus Items

DOW RADIO

1759 E. COLORADO PASADENA 4, CALIF.
Pasadena Phone—SYcamore 3-1195
Los Angeles Phone—RYan 16683

RANGEMASTER

MODEL 10

BY BRADSHAW

A COMPLETE SERVICE INSTRUMENT



The model 10 rangemaster covers 22 ranges. A unique system of range selection mini-mizes test lead changes. Three direct reading capacity ranges.

Three A.C. current ranges for checking current drain of electric motors and appliances. All in One Rugged, Compact, Attractive Unit.

COVERS THESE RANGES

A.C. VOLTAGE: 1-10-100-500-1000 Volts
D.C. VOLTAGE: 10-100-500-1000 Volts.
A.C. CURRENT: .05-.15 .5-1.5 5-15 Amperes
D.C. CURRENT: 1-10-100-1,000 Milliamps
RESISTANCE: RX100 RX1,000 Ohms
CAPACITANCE: .001-.1 .01-1 .1-10 Mfd.

Available in Kit Form for Only \$16.95 or Factory Assembled. Ready to Use.

SEND FOR DESCRIPTIVE LITERATURE

BRADSHAW INSTRUMENTS CO.
942 Kings Highway, Brooklyn 23, New York

A TOOLSHOP IN YOUR HAND



Smooth, steady power at your fingertips for buffing scratched cabinets, metals, corroded tube and socket pins; removing burrs; sanding, etc. Grinds, drills, saws, engraves, etc. AC or DC. Wt. 12 oz. 25,000 r.p.m. In steel case with 40 accessories postpaid, \$27.50. Handee only with 7 accessories, \$20.50. Satisfaction guaranteed. Order now! Prompt delivery.

FREE! 52-Page Manual
CHICAGO WHEEL & MFG. CO.
1101 Monroe St.,
Dept. RE, Chicago 7, Ill.

HANDEE TOOL OF 1001 USES

In the Rocky Mountain Region It's RADIO & TELEVISION SUPPLY CO.

ELECTRONIC EQUIPMENT

152 Hobson Avenue, Pueblo, Colo.
P.O. Box #892

"If we don't have it, we'll get it—
or it can't be had! Phone 5729"

Phone stations can also be received by tuning the receiver to zero beat with the incoming signal. For reception of code stations, the receiver can be left in an oscillating condition. Oscillation is indicated by a hissing sound in the speaker or the phones or by a click when the finger is touched to the stator plates of the tuning condenser. If there is no apparent click, the set is not oscillating.

Both the stability and the sensitivity of the set will be found to be good. The quality of voice signals compares favorably with commercial sets, if the volume is kept low. The speaker is not designed to carry too much audio output. Only a short antenna is required but one as long and as high as possible should be used for maximum results. A good ground is almost an essential. A connection to a waterpipe or to a bar of metal buried a couple of feet below the earth's surface will do well. The entire set, including tubes and miscellaneous components, can be built for about eight dollars.

-50-

Spot Radio News
(Continued from page 22)

will have a fair opportunity to compete." The committee requested that a "most favored nation" clause be included in all agreements. Good exports mean jobs to "a large number" of U. S. workers, RMA pointed out, adding: "Because of our large industry and mass production, we in the United States are in a position to appropriate large sums of money for engineering and research and thus have for many years been world leaders in radio engineering and in the development and manufacture of radio transmitters, sets, parts and tubes. Because of the superiority of the American product, many people in foreign countries prefer American-made radio equipment. We enjoy a unique position and are desirous of retaining this leadership. . . . Involved in the reciprocal trade negotiations this spring are: Australia, Belgium, Brazil, Canada, Chile, China, Cuba, Czechoslovakia, France, India, Lebanon, Luxembourg, Netherlands, New Zealand, Norway, Union of South Africa, Russia, United Kingdom, and the colonies of all of these nations.

PRODUCTION in this country, untrammled by OPA controls, continues to boom. Latest RMA consensus points toward a total of from 12,000,000 to 20,000,000 sets before year's end. Minimum estimates among RMA members average 13,400,000 sets; maximum, 18,000,000. . . . RMA also reports that television receiver production is increasing steadily, usually breaking a record each month. Radio receiving tube output is hitting new peaks. . . .

-50-

March, 1947

**JUST A MINUTE, BROTHER...
YOU PAY ASHE LESS CASH
IF YOU TRADE IN NOW!**

GET AN ASHE TRADE-IN DEAL!
It pays to deal with a leader in the field! Just tell us what test equipment or receiver you have to trade and we'll quote you our best deal, allow you top dollar! Stocks are large and well rounded-out now, our service is speedy—allowances are . . . well, see for yourself!

**TEST EQUIPMENT
IN STOCK FOR IMMEDIATE DELIVERY**

Hickok	Waterman
Jackson	Du Mont
McMurdo Silver	Special Products
Precision	Feiler
Radio City	Meissner
Simpson	Hanlan
Triplett	Industrial Instrument
Reiner	Monitor Piezo
Robson-Burgess	Weston
RCA	Sprague
Chicago Industrial	Cornell Dubilier
Bliley	Coastwise Electronic

AMPLIFIER CHASSIS
Stock Up At A Big Saving!

With Covers. De Luxe style, chrome trim, gray enamel.

No.	Size	Reg. Price	Sale Price
3973	7x17x9	\$4.95	\$3.72
3974	10x14x9	5.40	4.03
3975	10x17x9	5.70	4.28

Standard, with cover, gray enamel.
3983 10x14x9 3.51 **2.64**

NEWEST RECEIVERS IN STOCK

National	Hammarlund
Hallicrafter	RME

PLENTY OF EXCITING BUYS!

MEISSNER RECEIVER KITS, 6-tube AC-DC, with tubes \$25.20

REVERSIBLE MOTOR, 1/2 to 2 RPM, 50 inch lbs. torque, with conversion instructions for rotary beam drive . . . 4.95

LIGHTWEIGHT PHONO PICKUP with permanent stylus cartridge, real surplus special 5.25

BALLENTINE PHONO MOTOR and turntable, precision product 4.44

SAM'S PHOTO FACTS, every issue available, your choice 1.50

ARMY-NAVY HORNS
Limited Quantities! Save!

NAVY GRAY HORNS—Navy surplus, 15 W unit, 15 ohm voice coil \$22.05

ARMY SURPLUS HORNS—25 W re-entrant type, 15 ohm voice coil 31.40

SIZZLING SUPER-SPECIALS

Model 371 Chicago Industrial Instrument Volt-Ohm-Milliammeter \$4.56

Model 312 Chicago Industrial Inst. AC-DC Volt Ohm-Milliammeter 5.88

Model 450 Chicago Industrial Compact Volt-Ohm-Milliammeter 9.55

Hell-Box Hardware Assortment of thousands of useful screws, nuts, bolts, lugs, clamps, etc. . . . 2.40

Write for Free Catalog
WOPGI WOGTF WOZIP
WOLDO WOIYD WOUJH

Walter Ashe
RADIO CO.
1125 PINE ST. ST. LOUIS, MO.

CAREERS in RADIO
INTENSIVE COURSES—Thorough, technical education for progressive men and women.
Licensed by the State of New York

1. **RADIO TECHNICIAN**—The MRI General Course. Includes F.M. & Television. Prepares for FCC Broadcast Licenses.
2. **RADIO & TELEVISION SERVICING**—Prepares for employment as Repairman on Standard Broadcast, F.M. & Television Receivers.
3. **RADIO COMMUNICATIONS**—Prepares for FCC Operators' License. Leads to position as Merchant Marine or Flight Radio Officer; Commercial Operator.
4. **FUNDAMENTAL RADIO MATHEMATICS**—The MRI Preparatory Course. Required pre-training for students lacking a basic mathematical background.

MELVILLE RADIO INSTITUTE
45 W. 45th St., N. Y. 19, BR 9-5080
"The Radio School Managed By Radio Men"

MELVILLE RADIO INSTITUTE
45 West 45th St., New York 19, N. Y.
GENTLEMEN:
Send me FREE information about your school. RN
Name.....
Address.....
MAIL THIS COUPON NOW

RADIO CHASSIS PUNCH



Saves hours of work cutting clean, accurate holes in radio chassis—for connectors and other receptacles. Simply insert cap screw in hole to be enlarged (drill small hole if necessary), turn with ordinary wrench to force punch through the metal. No reaming or filing—hole is smooth and clean. No distortion—die supports metal. Ten sizes from 3/4" to 2 1/4"; also up to 3 1/2" for meters. Write for free catalog 33E to Greenlee Tool Co., 1883 Columbia Ave., Rockford, Ill.



Specials!

HIGH FIDELITY AMPLIFIER \$46.50

25 WATT—UNDISTORTED
2 MIKE INPUTS—ONE PHONO INPUT
2-TONE CONT. BASS-TREBLE
HI IMP INPUT—UNIV. OUTPUT

ACCESSORIES

Heavy Duty 12" PM Speaker... \$9.90
Walnut Veneer 12" Speaker Baffle 5.65
Mod. 34X—Turner Crystal Mike. 17.40
Microphone Cable, per ft. .06
60" Heavy Base Mike Stand... 7.50
Table Mike Stand... 1.79
Automatic Record Changer... 22.95

SURPLUS

20-20-250V. F.P. Avox Cond.
49c; 10 for... \$4.50
Spark Plug Suppressors, Bracket
Type or Screw, 18c Ea.; per
100... 12.50
Distributor Suppressors, 18c Ea.;
per 100... 12.50
Ford Yoke Type Dist. Cond., 45c
Ea.; 10 for... 3.95
Auto Antenna 66" Cowell 3 Sec.. 2.49
Shure T17 Hand Mike Sw. & Plug 2.95
110V. D.C. Relay D.P.D.T. 1.95
Wafer Switch, 9 Pos. Single Pole .49
Two Conductor Inter. Com. Wire
100 ft. for... 1.75

Free Delivery on All Cash Orders
25% DEPOSIT ON C.O.D. ORDERS

Massey's RADIO SUPPLY

2992 EIGHTH ST.
RIVERSIDE, CALIFORNIA

Within the INDUSTRY

M. MARKOWITZ was recently named vice-president in charge of manufacturing by the board of directors of *Air King Radio Products Company, Inc.*, manufacturers of the *Air King* line of radios and radio-phonograph combinations.



Mr. Markowitz has been associated with the company for the past twenty years, during which time he served in many capacities with the *Air King* organization. His experience in the purchasing, fabrication of materials and mass production fields will be fully utilized in his new position.

FEDERAL TELEPHONE AND RADIO CORPORATION has announced that eighteen FM transmitters have been built and shipped by the company in recent months.

Stations soon to begin operating with this equipment represent 12 states bounded by New York and Minnesota on the north and Texas and Florida on the south. Most of these installations are of the 3 kw. type although some stations will go on the air with the company's 10 kw. units.

JOHN J. WILD, formerly associated with the *Television Equipment Sales Section of General Electric Company* as assistant sales manager, was recently named sales manager for the *Potter Instrument Company of Flushing, New York.*



Mr. Wild, who is a graduate of Georgia Tech, will be in charge of the merchandising of the company's line of electronic counting, timing, and industrial control equipment.

GEORGE T. DEANEY has been named purchasing agent of the *Weston Electrical Instrument Corporation of Newark, New Jersey*, succeeding A. R. Briggs, who recently retired after 45 years' service with the company.

Mr. Deaney joined the *Weston* organization in 1926 under its cooperative plan of industrial engineering training. He completed this training in 1928, the same year he received his B.S. in Electrical Engineering from Newark College of Engineering.

During his 18 years with the company, Mr. Deaney has worked as a

time study engineer, department foreman, and cost estimator. His most recent position was that of department head in charge of mechanical engineering.

* * *

ELECTRONIC APPARATUS, INC. of New York has recently acquired the controlling interest in *Tuck Electronic Corporation* of Jersey City, N. J.

G. Emerson Pray, senior engineer and director of *Tuck Electronic Corporation*, was elected president of that company and also named director and vice-president of the parent company.

The new subsidiary of *Electronic Apparatus* will continue to maintain its operations at the Jersey City plant where the company manufactures, designs, and develops specialized industrial and electronic testing apparatus.

* * *

LOUIS S. KIMBALL has been recently named vice-president in charge of operations for the *Colonial Radio Corporation*, manufacturers of private brand radio receivers.



In his new position, Mr. Kimball will make his headquarters at the main plant, Buffalo, New York but will also have charge of the company's operations at the Bloomington, Illinois and Riverside, California factories.

Mr. Kimball has been associated with *Sylvania*, parent company of *Colonial*, since 1942 when he joined the organization as manager of the *Fluorescent Fixture plant*. He was later promoted to the post of general manager of the *Fixture Division* in 1945. He was connected with *General Motors' Frigidaire Division* for sixteen years prior to joining *Sylvania*.

* * *

WILLIAM F. COTTER has been appointed chief engineer of *Scott Radio Laboratories, Inc.* of Chicago.

Mr. Cotter has long been associated with the radio engineering field, having played an important role in the development of point-to-point duplex telephone, ship-to-shore telephone systems, police radio communications systems, and home receivers.

He has been associated with *Stromberg Carlson*, *American Bosch Magneto Company*, and *Federal Telephone and Telegraph Company* of Buffalo, New York. He is a member of several professional engineering societies and holds executive positions with the A.I.E.E., I.R.E. the Radio Manufacturers Association and the Radio Technical Planning Board.

Mr. Cotter succeeds Marvin Hobbs, former chief engineer with the company, who resigned to engage in consulting engineering on radio broadcast equipment.

* * *

DONALD T. McCOY will cover the Ohio sales territory for the *Belden Manufacturing Company* of Chicago, manufacturers of cable and wire.



Included in the lines that Mr. McCoy will handle are *Belden's* automotive, radio, arc welding, cable and neon sign equipment. Mr. McCoy is a recent graduate of the company's sales training and expansion program. He was discharged from the Army last April with the rank of 1st Lieutenant in the Corps of Engineers. His formal educational training was completed at Marmion Military Academy, Aurora, Illinois.

* * *

JACK E. SNYDER is the new manager of the export division of *Concord Radio Corporation* of Chicago. He will supervise the extension of the company's service to the radio and electronics industry throughout the world.

Mr. Snyder has been associated with *Concord* for the past sixteen years.

* * *

WILLIAM MAC MURTRIE has been appointed to the post of General Purchasing agent of the *Philco Corporation*.



He has been associated with the company since 1935 when he joined the purchasing department. In 1938 he was placed in charge of the Chicago office of the company's purchasing department and later became divisional purchasing agent for the automobile radio division with offices in Detroit.

His promotion to assistant general purchasing agent came three years ago, during which time he was a key figure in handling the production of airborne radar equipment for the Army and Navy.

* * *

PYRAMID ELECTRIC COMPANY of Jersey City, New Jersey, has recently acquired a 30,000 square foot, single story plant at Paterson, New Jersey, to handle increased production of dry electrolytics, as well as several types

HARRISON HAS IT!

ALL STANDARD LINES

We are **Factory Authorized Distributors** for the top quality manufacturers and we now have in stock lots more new, latest improved production Ham gear! Visit our stores today, for everything you need. We promise you fresh, clean material—quicker—at the lowest current prices—and, above all, our sincere desire to be friendly, helpful service.

As one of the world's largest distributors of Communications Equipment, we are delivering plenty of

• RECEIVERS

Right Now! ALL MAKES—practically all models. If you want your new set in the quickest possible time send your order to **HARRISON!** For example:

HALLICRAFTERS—	
S-38.....	\$47.50
S-36A, FM-AM-CW—27.8 to 143 Mc.....	\$89.50
S-37—130 to 210 Mc.....	\$97.50
S-42—New FM-AM—54 to 110 Mc.....	\$275.00
HAMMARLUND—New "Super-Pro"	
SFC-400-X—55 to 30 Mc.....	\$334.05
Speaker in Cabinet—	\$133.20
HQ129X, complete with speaker in cabinet.....	\$173.25
NATIONAL—	
NC-240-D—Complete with speaker.....	\$241.44
HRO-5TA-1—Complete with pack and speaker.....	\$303.00
RME-45—Complete with speaker.....	\$198.70
RME-84—Complete with speaker.....	\$98.70
Collins 75A-1.....	\$375.00
Panoramic Adapter.....	\$99.50

• TRANSMITTERS

Meck 60T.....	\$150.00	Sonar Narrow Band FM Exciter.....	\$39.45
Temco 75-GA.....	495.00	Collins 70 E 8	
Collins 32V-1.....	475.00	VFO Unit.....	40.00
Temco 500 GA.....	1800.00		

• TEST EQUIPMENT ?

Certainly! Harrison has it! We can supply practically anything for the Amateur, Serviceman, and Laboratory. Here are a few of the many items we have in stock right now for immediate delivery to you—(Even if what you want is not listed here, send us your order—we'll do the rest!)

• MULTIMETERS

Supreme 543.....	\$18.95	RCP 424 AP.....	\$33.50
Precision 832-S.....	23.04	Simpson 260.....	38.95
Supreme 542 M.....	26.15	RCP 461 AP.....	43.50
Weston 564.....	28.80	Triplet 625-N.....	45.00
Triumph 333-S.....	29.70	Triplet 2405.....	56.75
Simpson 215.....	32.50	Supreme 592.....	58.95
Precision 844.....	\$33.20		

• OSCILLOSCOPES

National CRU.....	\$39.90	RCA 155-C.....	\$115
Dumont 274.....	99.75	RCA 160-B.....	185
Waterman Pocketscope.....	\$66.00		

• VACUUM TUBE VOLTMETERS

Silver "Vomax".....	\$59.85	Jackson 645.....	\$75.00
RCA-195-A.....	69.50	Hickock 125.....	79.80
			\$94.75

• SIGNAL GENERATORS

Jackson 640.....	\$49.00	Supreme 576.....	\$68.95
RCP 705.....	49.50	Triplet 2432.....	88.50
RCA 167-B.....	63.75	Bitley 1A Crystal Oscillator.....	69.50

• TUBE CHECKERS

RCP 315.....	\$59.50	Jackson 636 CP.....	\$62.50
Precision 912.....	61.20	Precision 915.....	\$4.41

• TUBE AND SET TESTERS

Hickock 534.....	\$138.30
Silver "Sparks" Signal Tracer.....	39.90
Supreme 562 Analyzer.....	127.00

HARRISON HAS IT!

HARRISON SELECT SURPLUS BARGAINS

The cream of the surplus market! Good—new—guaranteed material. Top value, always. You don't "take a chance" when you buy anything from Harrison!

★TUBES—3C24/24G HF Triode.....	\$1.49
FIVE for \$5.96	
3E29/829B.....	\$3.89
9002, 9003 FIVE for.....	\$2.49

★ANTENNA TUNER—BC 939-A (Hallcrafters AT-3) Complete with condensers.....	\$29.95
---	---------

★ROTARY COAXIAL COUPLING—Continuous rotation. 52 ohm constant impedance—coaxial sockets each end. Lapp.....	\$7.75
---	--------

★CRYSTAL CONTROLLED CALIBRATOR AND MONITOR—Navy CGQ-61033. With spares.....	\$4.95
(With batteries.....)	\$5.95

★KW MODULATION TRANSFORMER—1:1 ratio. Conservative 550 Watt Audio rating. Screen winding. 38 1/4 lbs.....	\$17.95
---	---------

Antenna Wire. No. 10 Phosphor Bronze. stranded. 125 feet (2 insulators at 75 ft.).....	\$1.97
--	--------

Stranded No. 8 copper wire. Heavy insulation. 125 feet in 7 foot lengths.....	\$1.19
(Please see our previous ads for full descriptions of above items)	

BC 406-A 16 Tube UHF Receivers

Been getting such FB reports from our customers about the swell Signal Corps Radar receivers that we just had to get more for you.

6 acorn tube RF circuit. Tuned to 205 mc.; four IF stages; Thordarson heavy duty power transformer delivering 350 volts at 145 ma.; four choke and oil condenser filters; 115 volt 60 cycle operation; chassis 10 1/2 x 25 1/2, in metal case. Slightly used but fully guaranteed.

Complete with tubes: 5—954, 1—955, 4—6SK7, 2—6SJ7, 1—6SN7, 1—6SF5, 1—6N7, 1—5T4. Also with 11 Watt. 3/4 RPM, 115 Volt AC Motor.....

• COMPACT VIBRATOR PACK

FB for transceivers, portable receivers, etc.! Delivers: 135 volts at 30 ma; 67 1/2 volts at 8 ma; 1.5 filament or 6.3 heater, bias, and microphone voltages.

Completely filtered—neon tube voltage regulator—remote load-start relay—ruggedly made for dependable Navy use. 1 1/4" x 3 3/4" x 4". Weights only 2 lbs. Works on any 6 volt DC source.

Complete vibrator pack, less only battery (use it on four flashlight cells, your car battery, etc.).....

With a clip-in RECHARGEABLE Willard Storage Battery. Unbreakable, NON-SPILL, plastic case.....	\$5.50	With TWO clip-in Willard Primary batteries. (See our Dec. QST ad.).....	\$5.75
(110 V AC .2 Amp Trickle charger.....)	\$3.45		

MAIL ORDERS? Certainly! Just list everything you want (items in this ad, or any ad, magazine, or catalog) and include remittance. Prompt shipment.

Vy 73 de

Bil Harrison, W2AVA



HARRISON RADIO CORPORATION

10 WEST BROADWAY • NEW YORK CITY 7

PHONE—BArclay 7-9854 • EXPORT DEPT.—CABLE—"HARRISONRAD"

[JAMAICA BRANCH—172-31 Hillside Ave.—REpublic 9-4102]

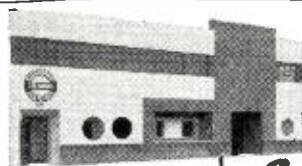

WE TRAIN YOU AT HOME

Learn RADIO SERVICING



We furnish you, without additional cost, KITS from which you MAKE YOUR OWN TEST EQUIPMENT. Knowledge gained in building and using these KITS helps you to MAKE MONEY as you learn.

ALL CLASS ROOMS HAVE NEW and LATEST EQUIPMENT.

Day and Evening Resident Training also available.

WE PREPARE YOU... Earn big money! START your own spare-time business. Soon after enrolling we send you our Added Income job sheets. Radio principles easily learned with our ILLUSTRATED lessons. Soon you can make repairs on radios while still learning. Your FULL TIME radio shop or good RADIO position is but the next step!

MAIL COUPON FOR OUR FREE 1947-1948 YEAR BOOK

Electronic Technical Institute—Dept. No. 1
771 Venice Blvd., Los Angeles 15, California

Name..... Address.....

City..... State.....

Occupation..... Age.....

ANSWERS TO BIZ QUIZ			
1. a	6. c	11. a	16. a
2. c	7. a	12. c	17. c
3. a	8. b	13. c	18. c
4. c	9. a	14. a	19. c
5. b	10. a	15. c	20. a

ARE YOU A SALESMAN? Give yourself 5 points for each answer you had checked correctly. A score of 45 is average, and 75 or better is very good indeed.



PRECISION ELECTRONIC REGULATED POWER SUPPLY
Immediate Delivery

Type A:—Variable from 210 to 335 V.D.C. at 400 M.A.
Type B1:—2 Ranges: Variable from 400 to 600 V.D.C. & 600 to 890 V.D.C. at 125 M.A.

Built for the U. S. Army as part of power supply of RA-57-A, but never used. Adapted to civilian use by mounting on 12 1/4" panel, black crackle finish, and installing meters, brackets, chassis, pilot lights, switches, fuses, etc. Fits any standard 19" rack or cabinet. Complete with tubes and ready to plug in.

All units checked and inspected at 150% of rated load before shipment

Specifications:
Input: 115 V. 50-60.
Regulation: Less than 1/20 V. change in output voltage with change from 105 to 140 V.A.C. input voltage and from no load to full load (over wide latitude at center of variable range).
Ripple: Less than 5 Millivolts at all loads and voltages.
Tubes used in Type A: 2—836; 6—6L6; 2—6SF5; 1—VR150; 1—VR105.
Tubes used in Type B: 2—836; 2—6L6; 2—6SF5; 1—VR150; 1—VR105.

Construction Features:
Weston 301 (or equal) ammeter and voltmeter. • Can vary voltage by turning small knob located on front of panel. • Separate switches, pilot lights and fuses for filament volts and plate volts. • All tubes located on shockmount assemblies. • Fuses mounted on panel and easily accessible. • Rigid construction. Individual components were designed to withstand the most severe military conditions and are greatly under-rated. (Negative output available at slightly higher price)
Some of the current users of these power supplies are:— electronic laboratories; aircraft, metallurgical and chemical research labs.; technical schools; commercial and amateur radio stations, etc.

NET PRICE
Type A—\$179.00 F.O.B. Baltimore
Type B1—\$175.00 F.O.B. Baltimore
Subject to change without notice
Approx. shipping weight, 100 pounds
NATIONAL RADIO SERVICE CO.
Reisterstown Rd & Cold Spring Lane
Baltimore 15, Md.

RADIO
RADIO Technician and Radio Communications courses. Register now for new classes starting first MONDAY of each month. Day and Evening Classes.
AMERICAN RADIO INSTITUTE
101 West 63d St., New York 23, N. Y.
Approved under GI Bill of Rights.

GET ON SUN'S MAILING LIST!
SUN RADIO
& ELECTRONICS CO., Inc.
122-124 QUANE ST. - NEW YORK 7, N. Y. - Barclay 7-1848

of condensers which are expected to be added to the company's line in the near future.

The general offices of the company will remain at the main plant located in Jersey City, New Jersey.

* * *

WALTER E. HARVEY has joined *P. R. Mallory & Co., Inc.* of Indianapolis as manager of the Wholesale Division.



Mr. Harvey has been placed in charge of distribution and merchandising of the company's line of radio and electronic replacement parts.

He has been long associated with the wholesale jobbing trade, having been connected with *Thermoid Company*, manufacturers of automotive and industrial rubber products. He has also held executive posts in several national trade associations.

* * *

KINGS ELECTRONICS CO. of Brooklyn, New York has recently announced a new service to manufacturers of television equipment.

The company, manufacturers of television antennas, variable condensers, coaxial cable connectors, microphone plugs, and jacks, is making available the services of its television engineering staff to assist manufacturers with their special television and FM antenna requirements.

Companies who wish to avail themselves of this service are asked to contact **J. H. Robinson**, vice-president, *Kings Electronics Co.*, 372 Classon Avenue, Brooklyn 5, New York.

* * *

ALFRED T. JOHNS is the new production manager of *Lear, Incorporated's* Home Radio Division.



With seventeen years' in the radio industry, thirteen of which were with *Sparks Withington Company*, three with *International Detrola* and a year with *John Meck Industries*, Mr. Johns brings to his new position a wealth of experience in production methods.

* * *

KENNETH A. NORTON has been named chief of the newly established Frequency Utilization Research Section of the Central Radio Propagation Laboratory at the National Bureau of Standards.

Mr. Norton, who is an authority on radio wave propagation, rejoins the Bureau's staff from the War Department where he served during the war as a consultant on radio propagation to the Chief Signal Officer and as assistant director the *Dr. W. E. Everett's* Operation Research Group.

He will direct the activities of this new section which was activated to investigate the utility, for specific ap-

The HOUSE OF A MILLION RADIO PARTS

BARGAINS IN TUBES BRAND NEW INDIVIDUALLY BOXED

11L4List	\$2.20Your Cost	\$.99
1R5List	2.20Your Cost	1.09
1S5List	2.20Your Cost	1.09
1T4List	2.20Your Cost	1.09
2B7List	1.80Your Cost	.99
2X2/879List	3.20Your Cost	1.50
3A5List	2.20Your Cost	.99
3Q4List	2.20Your Cost	1.09
3S4List	2.20Your Cost	1.09
5Y3GTList	.95Your Cost	.55
6AC7List	3.20Your Cost	1.60
6AG5List	3.20Your Cost	1.90
6AK5List	3.20Your Cost	1.90
6B4GList	2.65Your Cost	1.40
6B7List	1.80Your Cost	.99
6B8List	2.65Your Cost	1.40
6C8List	2.20Your Cost	1.09
6D6List	1.35Your Cost	.69

Thousands of other tubes and radio supplies on hand. Write for bulletin No. 56.
LIFETIME SOUND EQUIPMENT CO.
311 Jefferson Ave. Toledo 2, Ohio

FREE BOOK SHOWS SHORT CUT TO CODE SPEED

ENDORSED BY CHAMPIONS For Amateur or Commercial Radio

Qualify at home, in spare time, by easy, simplified system. You can learn code or gain greater speed and skill in sending and receiving by the same system that has made code champions and radio telegraph experts. **FREE BOOK OF FACTS** explains Course. It's absolutely free. Rush your name for it today.

CANDLER SYSTEM CO.
Dept. 2-C, P. O. Box 928 Denver, Colo.

PHONO PLAYER KITS

TABLE MODEL, dual tube amp. five inch speaker, light weight crystal pickup, attractive two-tone cabinet and quiet rim drive motor. **MODEL RNP4. Complete..\$15.95**
WIRELESS PHONO PLAYER, tune it in on any radio. MODEL RN5W. Complete 14.35
PHONOGRAPH ATTACHMENT, plays through any radio. MODEL RN5A.... 9.85

AMPLIFIER KITS

3 tube kit. RN3.....\$3.80
2 tube kit. RN2.....2.60
1 tube kit. RN1.....2.10
Phono Oscillator kit. RNIW.....2.90

Tubes are available for all amplifier and oscillator kits and are supplied with all complete player kits.
Send for list of special low prices on record player parts.
HALLMARK ELECTRONIC CORP.
592 Communipaw Ave., Jersey City 4, N. J.

AMAZING NEW Pocket or Purse Size RADIO!

Small as a Pack of Cigarettes! Weighs only a few ounces—Beautiful black chrome plastic case. Uses new war born crystal diode, Hi-Q-slide dial. No tubes—batteries or electric "plugs-in." Usually receives local broadcasts without outside aerial wires.

GUARANTEED TO PLAY when used according to instructions sent with each radio! You can use it at home, in offices, hotels, cabins, in bed, etc.—lots of fun—real entertainment!

SEND ONLY \$1.00 (cash, money order, check) and pay postman \$2.99 plus delivery fees on arrival or send \$3.99 for postpaid delivery. Complete as shown Ready to Play with self-contained personal phone. For Gits—children will love it—grown-ups too! An exceptional value—order yours and enjoy the many good radio programs coming! Don't be without your Pa-Kette Radio another day! (All foreign orders \$5.00 U. S. cash.)
PA-KETTE ELECTRIC CO., Dept. RN-3, Kearney, Neb.

lications, of various portions of the radio frequency spectrum. He has been associated with the Bureau of Standards intermittently since 1929, having been granted leaves of absence to serve with the FCC and the War Department.

-30-

Sound Recording
(Continued from page 92)

harmonics of a fundamental tone are generated at different intensity levels. This may be compared in a sense to higher resonant modes of a vibrating mechanical system and their general effect is to reduce fidelity of the original tone.

There is a definite phase effect existing between the sound wave and generated harmonics in the ear and the effect contributes to the distortion experienced in hearing. As may be expected, there are definite intensity limits between which speech and music are reproduced with perfect fidelity.

There are many factors affecting the quality of a tone. Among these are the harmonic content, pitch, and intensity. The *quality* of a tone is also called *timbre* and should be distinguished from *fidelity*. *Timbre* is a relative quality of sound while *fidelity* is a true measure of the accuracy with which a sound is reproduced. While much has been done in measuring *timbre*, the results are subjective. "Fullness," "richness," "brassy," "metallic," are some of the terms used in describing the *timbre* of a sound.

(To be continued)

What's New in Radio
(Continued from page 78)

50 db. below 1 volt dyne/ cm² open circuit.

Designed in an attractive combination of black molded plastic and satin chrome finish, this high impedance unit can be used with any amplifier or recorder employing high impedance input. The microphone is supplied complete with an 8 foot cable, plug and removable base which allows conversion from a desk to hand mike at will.

The Brush Development Company, 3405 Perkins Avenue, Cleveland 14, Ohio will supply additional data to those who ask for it.

COMBINATION RADIO

Air King Products Company, Inc. has recently introduced its new table model radio-phonograph combination, "The Crown Princess," to the trade.

Designated as the Model 4704, this unit is styled with simple dignity which fits into any decorative scheme, modern or period. This model comes in satin walnut finish accented by an edge-lighted dial, and features an automatic record changer for ten and twelve inch records, a featherweight low-pressure tone arm, permanent

Nationally Known AUTOMOBILE ANTENNAS

Side Cowl—3 Section 66"
Sturdy, Rust Proof
\$4.75 LIST \$2.13 NET

Deluxe Side Cowl—4 Section 100"
Sturdy, Rustproof
\$7.45 LIST \$3.36 NET

Top Cowl (Fender Mount) — 3
Section 56"
\$5.95 LIST \$2.58 NET

Universal Cowl or Fender
Mount—3 Section 68"
\$5.95 LIST \$2.58 NET

All are complete, ready for installation.
All are chrome-plated.

VIBRATORS—Standard 4-Prong,
\$1.40 each.
10 FOR \$12.50

CONDENSERS—.005 mfd. 1200
V DC Buffer Condensers
19 CENTS EACH—10 FOR \$1.50
100 FOR \$12.50—1000 FOR . \$100.00

STANDARD DISTRIBUTOR AND SPARK PLUG SUPPRESSORS
17 cents each 10 for \$1.50 100 for \$12.50
STANDARD VIBRATOR TRANSFORMERS \$0.98 each

CROWE REMOTE CONTROL AUTO HEADS
For All Makes, All Years . . . \$3.82 each
Tone Controls 1.71 "
Volume Controls73 "

SPECIAL—SPECIAL—SPECIAL
St. Clair Vacuum Tube Voltmeter—6
DC Voltmeter Ranges—6 AC Voltmeter
Ranges—Ohmeter Range from 0.1 Ohms
to 1000 Megohms—Accuracy 2% Plus
or Minus
FORMERLY \$52.50, NOW \$42.50

A COMPLETE LINE OF TUBES ARE NOW AVAILABLE

Write for Our Latest Catalogue

RADIO PARTS COMPANY
612 W. Randolph Dept. "N" Chicago 6, Illinois

HEXACON ELECTRIC SOLDERING IRONS

..tagged for the big jobs!

TYPE P-150 (illustrated)

MINNEAPOLIS HONEYWELL

Westinghouse

Bendix

STROMBERG CARLSON

Western Electric

Follow the leaders—and use HEXACON! For rugged, heavy duty work or for light intricate work . . . here's the answer. One reason is "Balanced Heat"—dissipating excessive element-impairing heat—and minimizing element burn-outs and tip replacements. Another is their lightweight. Literature is available describing the complete HEXACON line of screw tip and plug tip irons from 40 to 700 watts, and with tip diameters ranging from 1/4" to 1 1/4".

HEXACON ELECTRIC CO.
119 W. Clay Ave., Roselle Park, N. J.

HEXACON

HIGH-QUALITY, LONG-LASTING SOLDERING IRONS

NOW—A REALLY HIGH-POWERED— Radio Engineering Library

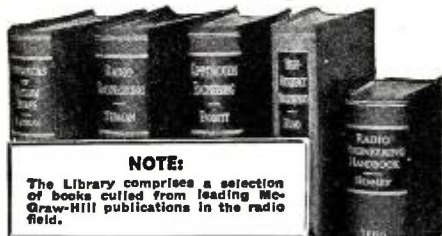

NOTE:

The Library comprises a selection of books culled from leading McGraw-Hill publications in the radio field.

- especially selected by radio specialists of McGraw-Hill publications.
- to give most complete, dependable coverage of facts needed by all whose fields are grounded on radio fundamentals.
- available at a special price and on easy terms.

THESE books cover circuit phenomena, tube theory, networks, measurements, and other subjects—give specialized treatments of all fields of practical design and application. They are books of recognized position in the literature—books you will refer to and be referred to often. If you are a practical designer, researcher or engineer in any field based on radio, you want these books for the help they give in hundreds of problems throughout the whole field of radio engineering.

- 5 VOLUMES, \$559 PAGES, 2558 ILLUSTRATIONS**
1. Eastman's FUNDAMENTALS OF VACUUM TUBES
 2. Terman's RADIO ENGINEERING
 3. Everitt's COMMUNICATION ENGINEERING
 4. Hund's HIGH FREQUENCY MEASUREMENTS
 5. Henney's RADIO ENGINEERING HANDBOOK

10 days' examination. Easy terms. Special price under this offer less than books bought separately. Add these standard works to your library now; pay small monthly installments, while you use the books.

10 DAYS' FREE EXAMINATION—SEND COUPON

McGRAW-HILL BOOK CO.
330 W. 42nd Street, New York 18, N. Y.

Send me Radio Engineering Library, 5 vols., for 10 days' examination on approval. In 10 days I will send \$2.50 plus few cents postage, and \$4.00 monthly till \$26.50 is paid, or return books postpaid. (We pay postage on orders accompanied by remittance of first installment.)

Name

Address

City and State

Company

Position RN 8-47

Now for EVERY WORK SHOP! NEW Invention Electroplates by BRUSH



Easy to Plate CHROMIUM
GOLD, SILVER, NICKEL, COPPER
... For Pleasure and Profit!

If you have a workshop—at home or in business—you need this new Warner Electroplater. At the stroke of an electrified brush, you can electroplate models and projects—you can replat worn articles, faucets, tools, fixtures, silverware, etc. with a durable, sparkling coat of metal—Gold, Silver, Chromium, Nickel, Copper or Cadmium. Method is easy, simple, quick. Everything furnished—equipment complete, ready for use. By doing a bit of work for others, your machine can pay for itself within a week. So make your shop complete by getting a Warner Electroplater right away. Send today for FREE SAMPLE and illustrated literature. ACT AT ONCE!

WARNER ELECTRIC CO., Dept. L-30
1512 W. Jarvis Chicago 26, Ill.

FREE Details & Sample!

WARNER ELECTRIC CO., 1512 W. Jarvis, Chicago 26, L-30
Gentlemen: Send Free Sample and Details to:

Name

Address

City State

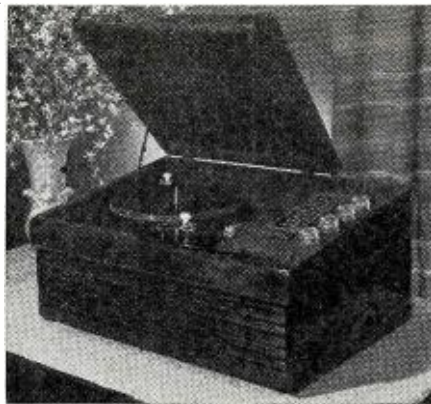

needle, crystal pickup, a.v.c., full range tone control and built-in aerial.

The company will gladly furnish information on this, and other units in the line to those writing *Air King Products Company, Inc.*, 1523 Sixty-third Street, Brooklyn 19, New York.

Transmitter-Exciter

(Continued from page 39)

value of fixed capacitance which must be shunted across the coil so as to cover the frequency range of 1750 to 2000 kilocycles. From this example we may derive the general relation, $C = \Delta C / (f_r^2 - 1)$ where ΔC is the variation in tuning capacity (maximum minus minimum capacity of tuning condenser) and f_r^2 is the square of the highest frequency divided by the square of the lowest frequency.

A popular misconception regarding e.c.o.'s is that the position of the cathode-tap affects the drift. While the cathode tap adjustment does have an effect on the frequency vs. supply voltage characteristic and may thereby cause chirpy keying, it does not affect the drift characteristic. This drift, usually evidenced by a gradual change in frequency toward lower frequency as the oscillator warms up, is almost entirely due to temperature, humidity, and other random variations affecting the physical characteristics of the oscillator components, principally the tuning condenser and coil form. In attacking drift, therefore, we must attempt to eliminate these variations. In ordinary amateur construction there is little control over humidity variations, but changes of the ambient temperature inside the oscillator compartment may be reduced to negligible proportions. Cyclic heating of the oscillator components does not produce exact reproduction of components because of the poor retrace characteristics of most of our insulating materials and for this reason it is more practical to eliminate temperature variations rather than attempt to stabilize the temperature of the oscillator compartment at some value which must necessarily be higher than the highest value of the ambient temperature.

Practically all the heat in the oscillator compartment has the tube as its

A REAL SCOOP!

MINIATURE EXTRA-SENSITIVE HEADPHONES



Signal Corps Type HS-30 and matching transformer plus extra ear plugs at 1/10 original cost.

\$2.49
NET

POSTPAID

IMMEDIATE DELIVERY

- Wide Frequency Response
- High or Low Impedance
- Featherweight-Adjustable Headband

Electronic Supply Corp.

40-14 Greenpoint Avenue, Long Island City 4, N. Y.

Radio Men Needed

The Finest in Radio Training

Train for well-paid positions in Radio Engineering, Television, Electronics. Thorough courses in frequency modulation, math, mechanical drawing, construction, repair, aviation and police systems, sales and service, broadcasting.

APPROVED FOR VETERANS
UNDER G. I. BILL

Low Tuition and Living Costs. Fine Climate—Hunting and Fishing.

New classes start each month. Write
COL. HAROLD C. WASHBURN, Director
Dept. I Clovis, New Mexico

Benson Radio Institute

BUFFALO'S LEADING SUPPLY HOUSE

In the BUFFALO Area
see DYMAC INC. for your
radio and electronic parts and
equipment

Dymac INC.

2329-31 Main Street, Buffalo 14, N. Y.

- ★ Fine Walnut Cabinet
- ★ Tone Control
- ★ Phono Jack
- ★ Gold Rim Dial
- ★ 5" Ainico 5 P. M.

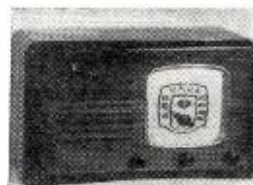

Fine quality, conventional 5 tube AC-DC superhet (550 to 1650 KC). Variable tone control; A.V.C. and phono jack. Beautifully constructed; highly polished walnut cabinet (Size 6 x 7 x 12"). The newly designed permeability tuning mechanism give very high sensitivity and selectivity. Priced complete with tubes: 12SA7, 12SK7, 12SQ7, 50L6 and 35Z5. Dealers' Net, \$18.95 each. In lots of 6, \$17.95 each. Send 20% deposit with order. Balance will be sent C.O.D.

MARCO RADIO CO.
1227 McGeo St. Kansas City 6, Missouri

JOBBERS! QUANTITY BUYERS!
SAVE MONEY
with MID-AMERICA'S
Sensational
Values!

FREE MONTHLY BULLETINS

Here's proof of the BIG BARGAINS in radio parts and electronic equipment MID-AMERICA offers EVERY MONTH to qualified quantity buyers through special bulletins and flyers. Check the outstanding buys listed here against what you've been paying—then get MID-AMERICA'S FREE CATALOG and BIG MONTHLY BARGAIN BULLETINS!

- RELAYS
- CONDENSERS
- TRANSFORMERS
- METERS • SWITCHES
- MID-AMERICA Bargains

5" Dynamic Speaker, 450 ohm field, hum bucking coil, double shielded 50Lb transformer (lots of 20) \$2.95 ea. **ELECTROLYTIC CONDENSERS** with strap: 50/30 mfd—150 VDCW (lots of 100) 59c ea. 20 mfd—150 VDCW (lots of 100) 39c ea. 16 mfd—500 VDCW 1" Dia. Mallory FP (lots of 100) 79c ea. **ALUMINUM CONDENSER:** 4 mfd—600 VDCW oil filled paper, 4 1/2" high x 1 1/2" dia., equiv. to 8 mfd—600 VDCW electrolytic; (lots of 100) 79c ea. **DPT ROTARY RADIO PHONO or BAND SWITCH,** 1/2" shank 1 1/2" shaft (lots of 100) 39c ea. **ALLIANCE PHONO MOTOR,** rim drive with 9" turntable (lots of 6) \$3.75 ea. **ASTATIC HIGH FIDELITY PHONO PICKUP** with Astatic L-72-A xtal (lots of 25) \$1.85 ea. **50L6 GT TUBES,** std. brands (lots of 500) .70c ea. For LOWER PRICES on LARGER QUANTITIES than those listed here write, wire MID-AMERICA'S store address, Dept. E-37

MID-AMERICA CO. Inc.
STORE: 2412 S. MICHIGAN AVE. CHICAGO 16, ILL.
WAREHOUSE: 2307 S. ARCHER AVE. CHICAGO 15, ILL.

**Here Today...
And Here
TOMORROW!**

Are you an Electronic Equipment Manufacturer looking for a highly satisfactory—and, above all else, stable source of transformers?

Kenyon, for over 20 years, has served and pleased people just like you. And will continue to serve and please indefinitely. So if you are having "here today and gone tomorrow" trouble on transformer supply—come to Kenyon!

THE MARK OF EXCELLENCE

**KENYON
TRANSFORMER CO., Inc.**
840 BARRY ST., NEW YORK, N. Y.

March, 1947

source. Tube heating is made up of the heater and plate and screen grid dissipations. The 6F6, popular as an e.c.o., is a serious offender from the standpoint of heater dissipation since it has a .7 amp. heater which, even in the absence of plate dissipation, heats the envelope enough to make it uncomfortable to touch. One of the best e.c.o. tubes from the standpoint of reduced heat dissipation (and for several other reasons) is the 9001. Compared to the 6F6, the 9001 with its 150 ma. heater represents a 450% reduction in heat dissipation. In the transmitter described, the less expensive 6SJ7 was used as oscillator, operating the heater at three volts. At this voltage the heater current is considerably under 300 ma. and the reduction in heat, again compared to the 6F6, is over 500%. The tube envelope barely becomes warm to the touch.

Plate dissipation is the other major item to be reduced. The literature available on the subject emphasizes that low-power input to a self-controlled oscillator results in improved stability. However, low power to many amateurs means anything under five watts, which is enough to heat the oscillator compartment to a considerable extent. In the transmitter described herein, the combined plate and screen grid input is .09 watt, (90 volts at 1 ma.), or about 10% of the heater power dissipation. Needless to say, the heating is negligible. Tests have shown the oscillator to be re-

WHAT PRICE GOOD WILL?

WITHOUT his knowing it, every salesman is building something into the warp and woof of his life that is worth more than the dollars and cents he takes each year from his efforts.

The name of this something is good will.

Good will is another name for the number and intensity of the business friendships a salesman is able to build for himself—and keep.

A good many attempts to put a value on good will have been made, but the clearest was published in the newspapers a few years ago when a firm of investment bankers bought the automobile business of the Dodge Brothers.

The amount paid for that business was 170 million dollars—all cash. The physical assets of the Dodge concern amounted to little more than half that—100 million dollars. But here were hardheaded New York bankers paying 70 million dollars for what?

For good will. For two words—Dodge Brothers. And they considered it a very great bargain.

It was. For good will is a constant asset. Plants can burn down, physical assets can be dissipated, but if a man or a firm has good will, he has the only thing in business which has a constant and growing value.

Take care of your good will and your good will will take good care of you.

That sentence sounds as if repeater Gertrude Stein had written it, but it is good selling if not good language.

G & E COLUMN O'BUYS

Immediate Delivery
every item guaranteed!



"Mercury" Electric SOLDERING IRON

Best quality at bottom prices. 6 ft. (3,000 cycle) approved heater cord with rubber plug. AC/DC. Screw tip. Elements Cartridge Type. Rapid Heating Iron.

- No. 4 80-watt 1/2" dia. tip. Special, ea. \$2.25
Lots of 6, ea. 1.58
- No. 5 100-watt 1/2" dia. tip. Special, ea. 3.50
Lots of 6, ea. 2.85
- No. 6 150-watt 1" dia. tip. Special, ea. 4.25
Lots of 6, ea. 3.60

Handy Radio Shop RATCHET SET

Compact, can be carried in pocket in its sturdy metal container. 1/4" drive tools. Set consists of 4 single hex, 4 double hex and 3 double square sockets, connector, heavy duty ratchet wrench, Spintite nut driver with plastic handle and Universal driver with cross bar. A high grade set priced amazingly low!



No. 9273 17 pc. set only **\$5.50**

2-DAY CLOCK

Westclox Watchman's Clock. An accurate and handy timing device. With slight alterations it can also be used for off-on control of many electrical appliances. Clock is enclosed in an all-metal case, comes with 365 timing faces. Has 11 hour hand only.



No. 1308 An amazing buy at only **98c ea.**

APPLIANCE CORDS

Ideal for replacements on radios and lamps: 6-ft. 2-wire No. 18 brown rubber cord with plug. No. 9285, lots of 10—20c ea.; lots of 50—18c ea.

FIBRE WASHER ASST.
Over 1000 pcs.; popular sizes used in elec. & radio work. No. 3202, per box. **79c**

AUTO RADIO CONDENSER

Sprague Vibrator. Sturdy, oil-impregnated unit. Ford Type. cap. .5 mfd. In dozen lots only. No. 1303 Lots of 12. special at **25c ea.**

RUBBER-HANDLE PLUGS

Heavy duty, top quality, handle grip plugs; fit all appliance cords. Fresh stock. No. 3210. Lots of 10, 12 1/2c ea.—lots of 50, 11 1/2c ea.—lots of 100, 10 1/2c ea.



RADIO SPAGHETTI TUBING
30" length. 2 popular sizes. Asst. in bundle of 25 pieces. No. 9277; per bundle, \$1.00.

AVAILABLE NOW! WHOLESALE ONLY!

Send check or money order—Terms net cash F.O.B. Chicago

Free! NEW G&E CATALOG

Illustrated. Value-packed with hundreds of other hard-to-get items for Servicemen, Repairmen & Dealers. Send for it now! Coupon brings it fast!



G & E EQUIPMENT SUPPLY CO.

Dept. RN-3, 400 N. Sangamon St., Chicago 22, Ill.

I want your new free Radio & Electrical Repair Parts Catalog.

Name

Address

City Zone State

Sigmon's - WEST VIRGINIA'S
LARGEST RADIO SUPPLY HOUSE!

AMPLIFIER for GUITAR OR PHONO

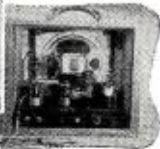
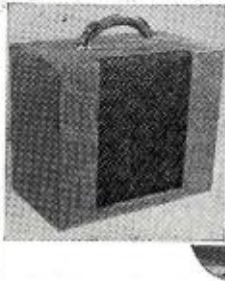

- ★ TUBES: 6SJ5, 6J5, 6L6, 5V4G
- ★ 4 Tubes—Hi Gain
- ★ Two Microphone or Instrument Inputs
- ★ Phone Input
- ★ 6½ Watts—Beam Power

- ★ Solid Wood Cabinet
- ★ Aeroplane Cloth Covered
- ★ Tone Control
- ★ Heavy Duty 8" Speaker
- ★ Complete with Tubes

Complete with Tubes—List \$59.50 **Your Cost \$37.00**

VMI BRUSH CONTROL MIKE—Net \$10.40
MM TURNER CONTACT MIKE—Net \$ 9.45

PHONO AMPLIFIER

3 Tube AC-DC
Uses: 50L6, 3Z5, 12SR7,
and 450 ohm speaker
Net \$5.97



FOR LATEST CATALOG WRITE TO...

Sigmon's
RADIO SUPPLY
CHARLESTON, W. VA.

EASY TO LEARN CODE

It is easy to learn or increase speed with an Instructograph Code Teacher. Affords the quickest and most practical method yet developed. For beginners or advanced students. Available tapes from beginner's alphabet to cryptic messages on all subjects. Speed range 5 to 40 WPM. Always ready—no QRM.



ENDORSED BY THOUSANDS!

The Instructograph Code Teacher literally takes the place of an operator-instructor and anyone to learn and master code without further assistance. Thousands of successful operators have "acquired the code" with the Instructograph System. Write today for convenient rental and purchase plans.

INSTRUCTOGRAPH COMPANY

4711 SHERIDAN ROAD, CHICAGO 40, ILLINOIS

ROTA-BASE

NEW HANDY LAB. DIAL. Simply turn the movable dial to the tube number desired on the ROTA-BASE and complete, correct connections are instantly indicated on the "prong" diagram. Filament, grid, plate, cathode, etc., to more than 300 tube types are given. No more valuable time lost on lengthy reading or thumbing of pages, ROTA-BASE actually gives a "prong" picture of the connections. PRICE NOW ONLY \$1.00. Postage prepaid or sent C.O.D. plus postage. Money back if not delightfully pleased.

REED MFG. CO. 124 W. 4th St. Los Angeles 13, Calif.

RADIO ENGINEERING TELEVISION ELECTRONICS

Courses in every phase of radio and electronics open to high school graduates. Thorough training, modern courses. Enrollments limited. Approved Veteran Training.

VALPARAISO TECHNICAL INSTITUTE
Dept. RS Valparaiso, Indiana

80 & 40 Meters

L₁, L₂ 1750-2000 kc., 19 t. #26 d.c.c., diam. 1¼", winding length, ¾". Sec. 5 t. #26 d.c.c. interwound at gnd. end of grid coil.

L₃ 3500-4000 kc., 19 t. #22 d.c.c., diam. 1¼", winding length, ¾".

L₄ 80-40 meters, 19 t. #22 d.c.c., diam. 1½", winding length, ¾".

40 & 20 Meters

L₁, L₂ 3500-4000 kc., 10½ t. #22 d.c.c., diam. 1¼", winding length, ¾". Sec. 3 t. #22 d.c.c. interwound at gnd. end of grid coil.

L₃ 7000-7300 kc., 14 t. #24 d.c.c., diam. 1¼", winding length, ¾".

L₄ 40-20 meters, 10 t. #22 d.c.c., diam. 1½", winding length, ¾".

Details for constructing coils for 20, 40, 80 meter operation.

markably stable, holding zero-beat with commercial stations at 7.5 mc. for hours at a time after a warm-up period only long enough to allow the tube heater to arrive at a stable temperature. Since the heater voltage is reduced, the warm-up time required to bring the tube to operating temperature is slightly longer than would be necessary with 6 volt operation but does not exceed one minute.

As a further commentary on the cathode-tap adjustment, tests showed no difference in performance from the value of feedback which would barely sustain oscillation to that value which caused squegging. The voltage regulator tube gives better than .5% regulation of the oscillator supply voltage because of the low oscillator current drain. Since the voltage is so well regulated, the cathode-tap has no chance to cause chirpy keying.

The oscillator is followed by a 6AG7 biased to class "A" operating conditions. The 6AG7 combines the high gain characteristics of the television series such as the 1852 with the high plate dissipation rating of the 6V6. Since it is well-screened, it affords additional isolation of the oscillator from the higher level stages. A 6L6, 6V6, or 6F6 may be used in the doubler stage with practically the same results. This stage is tuned to twice the e.c.o. frequency.

Careful attention to short leads and adequate bypassing will pay dividends in freedom from parasitic oscillations and spurious coupling between stages. Mica bypass condensers were found to be insufficient and were replaced with higher capacity (and cheaper) paper condensers which completely cured all parasitic troubles.

The 807 final amplifier stage has a combination of fixed and grid leak bias for oscillator keying. The 807 may also be keyed, and in this type of operation the fixed bias is not used, resulting in somewhat more output. Power input is approximately 43 watts with oscillator keying and 54 watts with final amplifier keying. A switch is provided in the 807 cathode lead to permit frequency setting of

SOME NEW ITEMS IN TELETRON TELEVISION COMPONENTS

YOKE MATCHING TRANSFORMERS:

No. YT-111H. For matching 5 mh. HORIZONTAL windings, such as utilized in TELETRON No. DY-18 and No. DY-2L Deflection Yokes. Output taps for Peaking and Return Trace Time control provided. Utilizes low-loss "HIPERBIL" core, giving very high transformer efficiency. In rounded-corner black wrinkle can 2¾" W. x 2¾" D. x 3¾" H. Stud mounting. Lug terminals..... **\$26.40**

No. YT-113H. Physically and electrically identical to No. YT-111H. but constructed with conventional transformer iron..... **\$12.75**

No. YT-112V. For matching the VERTICAL windings of Magnetic Deflection Yokes. Five different output taps giving step-down ratios of 20:1 to 8:1 are provided to accommodate a wide variety of circuit conditions. Housing identical to above transformers..... **\$10.95**

TELETRON Deflection Yokes, Focus Coils, Ion-trap Magnets, and Blocking Oscillator Transformers also available.

The TELETRON Television line is now available at many leading jobbers. Write for latest complete catalog and name of your nearest supplier.

THE TELETRON COMPANY
1988 East 59th Street Cleveland 3, Ohio

ELECTRONIC VOLT-OHMMETER

\$11.85 110 VOLTS AC 20 RANGES
0.5/10/30/100/500/1000/5000 volts DC and AC. 0-1,000,000,000 ohms in six overlapping ranges. Sensitivity: over MILLION OHMS per VOLT on 5 volt range.

Complete kit includes all component parts, tubes, punched and drilled chassis and beautifully enameled panel. Easily assembled and wired. Special slideback circuit developed during war by scientist at the California Institute of Technology gives amazing sensitivity and flexibility while completely eliminating necessity of batteries and expensive meter. Each instrument is individually calibrated. Dial scale over nine inches long!

In addition to performing the usual volt-ohm functions, this instrument easily measures these voltages: SUPERHET OSCILLATOR, AVC, AFC, TRUE GRID BIAS AT THE GRID, BIAS CELLS without affecting the circuit. Measures the exact leakage resistance of INSULATION, TUBES, CONDENSERS. It can be used with a signal generator for SIGNAL TRACING.

STERLING ELECTRONIC COMPANY
Dept. 3
166 N. Sierra Bonita Ave., Pasadena 4, California

ARMY RADIO PHONES



They're Weather — Water and Shock Proof —

When we say they are made to Army specifications, that's enough assurance they must be of best quality. These Army Radio Phones are perfect and were O.K.'d by Signal Corps Inspectors. These Dynamic Mikes and Receivers were used on aircraft and tank inter-communication systems. Use them for recording.

for batteryless phone, for pocket size set loud speaker or talk through your radio set. We bought a good many of these Radio Phones, they are brand new, and cost a great deal more than you can get them for. A complete dynamic hand mike, 2 earphones, head-band, cord set. A wonderful buy for only... **\$345**

Send check or Money Order. FOB warehouse
LEEDS RADIO CO.
75 Vesey St. Dept. RNM New York City 7

MARCH SPECIALS

100 Assorted Resistors ¼, ½, 1, Watt... \$ 1.98
Postage Stamp Molded in Bakelite Mica .05/2
000175, Each \$1.00.
Special: Loop Antennas. Retail for34
Each
Plastic Cabinets 6"x5½"x9¾"..... 1.68
50 M.A. 750V. C.T. 0.3V. 5V. B Mount
Heavy duty, \$1.98 each, or 10 for 18.50
Choice of: 6AG7 tubes or 6AC7 tubes, Each78
These Net Prices Subject to Prior Sale
Send for Our Monthly Bulletin Now

G. F. BEARD
242 W. Brookdale Fullerton, Calif.

WIRELESS PHONO OSCILLATOR

Transmits recordings from phono pickup or voice from mike to radio without use of wires up to 500 ft. Neatly Designed. NO LICENSE REQUIRED.
Complete Kit, less tubes..... \$3.49
Above Kit assembled and tested..... \$4.49
A Kit of tubes 12SA7, 3Z5..... \$2.49

Write for FREE Parts Catalog.
Immediate delivery, 10% deposit with C.O.D.
CONSTANT ELECTRIC
112 Cornelia Street Dept. 10 Brooklyn 21, N.Y.

the e.c.o. without QRM to other stations. With a 140 μ fd. tank condenser both the 40 and 80 meter bands may be covered with one plate coil. The 807 operates as a frequency-doubler for 40 meter output but the output is almost as great as in straight-through operation. The tank coil socket is mounted on spacers above the chassis so that the leads to the coil will be out of the proximity of the 807 grid circuit. There is no reaction on the frequency as the 807 tank circuit is tuned through resonance.

The power supply is conventional, using condenser input to obtain approximately 500 volts for the 807. The total drain from the power supply with the 807 loaded is 170 ma. With a 12 μ fd. input condenser the output is T9. The fact that the 807 plate and screen current does not flow through the filter choke actually aids the filtering since the choke is not saturated with d.c. Also, there is a phase difference in the ripple voltages applied to the 807 output and input circuits which tends to cancel the hum in the carrier. This transmitter was used quite successfully on phone with many complimentary reports.

-30-

20 Watt Modulator

(Continued from page 51)

versally applicable, as is, to cathode modulation. Output windings of the transformer shown will handle 200 ma. d.c.

For modulating "inflexible" u.h.f. rigs, the 500-ohm output of the modulator might be applied to the 500-ohm primary of a multimatch modulation transformer such as *Stancor* A-3834 or A-3866.

An individual builder may prefer to use another type of output transformer in the T_2 position to give a variety of output impedances. This is permissible. The plate-to-plate impedance of the primary will have to be 9000 ohms, and the secondary should be capable of carrying 200 milliamperes d.c.

The two relay contacts in series with the high-voltage center tap of power transformer T_2 may be connected to terminals of the transmit-receive relay in the transmitter. This will allow the modulator to be switched off automatically during reception periods without extinguishing the tube heaters. If relay control is not desired, the relay contacts may be omitted or may be connected together temporarily by means of a short jumper wire.

Mechanical Details and Wiring

The modulator is built on a 17" x 8" x 2" metal chassis. A 17" x 8" x 5" ventilated metal cover fits over the top of the unit and is secured to the left and right ends of the chassis by means of self-tapping screws. This cover was removed for the photographs, Figs. 1, 2, and 4.

March, 1947

UNGAR Points

THE WAY TO BETTER SOLDERING

A LITTLE IRON THAT WILL DO A BIG IRON'S WORK

Built for speedy accurate soldering, this powerful little pencil iron will perform rugged heavy duty jobs as well as those requiring intricate exactness.

Check these points!

QUICK HEATING . . . 90 SECONDS

LIGHTWEIGHT 3.6 OUNCES

HANDY SIZE 7 INCHES

SAVES ELECTRICITY . . 20 WATTS

No. 536 Pyramid Tip, made from Tellurium

No. 539 Chisel Tip, made from Tellurium

No. 537 Pencil Tip, made from Elkaloy A, Tip 1/8" dia.

No. 538 Chisel Tip, made from Elkaloy A, Tip 1/8" dia.

Light as a feather

Perfect balance

UNGAR Electric Tools Co.

BOX 2255, TERMINAL ANNEX - LOS ANGELES 54, CALIF.

SEE YOUR NEAREST RADIO OR HOBBY DEALER

JFD NEW "BIG 4" SERVICEMEN'S BASIC KIT!

**A Great New
TIMESAVER
For Radio Servicemen!
FOUR Basic Radio Service
Kits in ONE Package**

COMBINATION List Price \$33.35

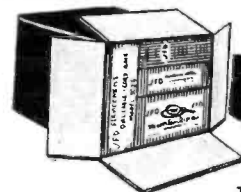

\$10.00 SPECIAL
Servicemen's
NET COST

JFD "BASIC-KIT"

For Radio Servicemen
Starting a Repair Business

• • •

For Established Radio
Servicemen Who want to
Save Time and Energy

These 4 Popular JFD Kits have everything needed for 25% of all radio service work.

- **B25A Belt Kit.** Assortment of 25 Dial Belts in Metal Container. Includes FREE 64-page JFD Servicemen's Manual, listing belts for more than 1500 set models.
- **770 Ballast Kit.** Contains five JFD Improved Aircooled AC-DC Adjustable Ballasts. Suitable for more than 95% of a ballast tube replacements.
- **5C25 Dial Cable & Cord Rack.** Contains 5 Metal Spools of fast-moving dial cables and cords.
- **BP-100-MC Plug Assortment.** 100 radio battery plugs, in 25 different popular types. Sturdy Metal Container. Includes FREE Battery plug folder with technical data and schematic diagrams of all plug types.

J.F.D. MANUFACTURING CO.

4109-4123 FT. HAMILTON PARKWAY, BROOKLYN 19, N. Y.

SALE!

ON
TEST INSTRUMENTS!

— STANDARD BRANDS —
TRIPLETT • SIMPSON • SUPREME
DUMONT • RADIO CITY PRODUCTS
McMURDO-SILVER • SPEGO, etc.

IMMEDIATE DELIVERY from STOCK

TUBE TESTERS • SIGNAL GENERATORS
• VOLT-OHM-MILLIAMMETERS
• SIGNAL TRACERS • VACUUM
TUBE VOLTMETERS • OSCILLO-
SCOPES • ANALYZERS • COMPLETE
TUBE AND SET TESTERS.

SPECIAL BUY!
12" P.M. SPEAKERS

Ainco 5 magnet, 6-8 ohm v.c. \$9.95
12 watts capacity. Lots of 10
Single units.....\$10.50 each

MANY OTHER VALUES!

Boxed antenna kits—74c.
Lots of 6 each.....\$.69
Replacement loop antennas—39c.
10 for 3.50
5" 1000 ohm dynamic speaker.... 1.85
5" FM speakers, 1 oz. ainco 5.... 1.65
Detroit automatic record changers.... 18.26
35Z5GT tubes, boxed. Lots of 10,
each63
#30 RCA tubes, boxed. Lots of 10,
each74
12SQ7GT, boxed. Lots of 10, each. .83
All-wave noise-reducing antenna sys-
tem—with matched coupler..... 5.58
3-tube portable electric phonographs 27.50
Chromium plated microphone stand
—65"..... 6.70
12" polished walnut speaker baffle.. 4.80

SEND FOR NEW 1947 CATALOG!
— FREE ON REQUEST! —

Please Send 25% Deposit
with C.O.D. Orders

**SCENIC RADIO
& ELECTRONICS CO.**

Dept. R-3
53 PARK PLACE • NEW YORK 7, N. Y.

USEFUL BARGAINS

At Greenwich Sales

BASE MOUNT for antenna mast; very sturdy. Provision for mounting on roof, side of house, a 2x4, etc. Heavy duty insulator 2 3/4 x 2" deep, has a metal binding post and threaded rod fixed to it. Unit is mounted on a brass case 3x3; contains 2 heavy duty springs to act as shock absorbers. These are fixed to a steel frame 5x6 which is completely punched for easy mounting. Complete with a dozen carriage bolts, nuts, washers, wing nuts and additional supporting brackets. Brand new, for the price of the hardware alone...\$2.50

SIGNAL CORPS AC LINE FILTER that really works. Hook it to your neighbor's receiver (or your own) and eliminate some of that BCI. Brand New.....\$1.25

BATTERY BOX black crackle finish; 6 1/4 x 6 1/4 x 7 1/2. Internally wired for 90—67 1/2—1 1/2—4-3 volts. These voltages stamped on bakelite panel which contains binding posts for same. 8 binding posts inside. Carrying handle and 4 locks. Brand New.....\$1.25

Brand New RCA 813\$6.25
" " " 866A85
" " " 807 1.05
" " " 884 1.00

Other Transmitting Tube Specials

Build that Scope you've been thinking about. A 3AP1 needs only 600 volts. Any receiving power transformer will do the job. 3AP1 Brand New and guaranteed.....\$4.00

25% deposit required on all C.O.D. orders.
Prompt delivery assured.

Write for Bulletin NR

GREENWICH SALES CO.

59 Cortlandt St. — Whitehall 3-3052
New York City 7, N. Y.

All parts must be secured firmly to the chassis before wiring is started. 10-32 screws are used to mount the transformers and filter choke. Liberal use is made of lock washers.

In each of the first two amplifiers stages, it is imperative that all ground returns be run to one grounded lug. This common lug preferably should be located at a central point. This perhaps does not make the neatest appearing arrangement, but it is the most efficient electrical assembly of a high-gain audio stage. Such common ground connections in the various stages should be connected together by means of a length of heavy bus wire. The chassis must not be depended upon as a return conductor.

Leads between jack *J*, radio-frequency choke *RFC*, and the control grid terminal of the 6SJ7 socket must be enclosed in shield braid and the braid must be connected to chassis at each end of its length.

A tightly-twisted pair made of heavy hookup wire must be run between the heater terminals of the amplifier tube sockets and the 6.3-volt winding of transformer *T*₃. This line must be kept close to the chassis. One side of the heater line must be grounded to chassis at one point (preferably at the power transformer), but under no circumstances should the chassis itself be employed as one leg of the heater circuit.

In Figs. 2 and 4, the chassis receptacle for the 115-volt line plug may be seen along the rear lip of the chassis. This is a handy attachment, since it permits complete removal of the line cord-plug assembly. It is an added refinement, however, and may be omitted if cost is to be kept down or space conserved.

From left to right along the front lip of the chassis (See Fig. 1), are mounted the microphone jack (*J*), gain control (*R*_g), on-off line switch (*S*₁), and pilot light (*PL*). In Fig. 1, the microphone plug is shown inserted into the input jack. Each of these components is mounted as close

as possible to the rest of the circuit with which it is associated.

The hole seen on top of the chassis between the third metal tube and the electrolytic capacitor, in Fig. 1, was intended originally for leads to a volume level meter on the front of the dust cover. After several tests, however, this meter was finally dispensed with.

In order to prevent core vibration, all assembly screws and nuts in the transformers and choke must be tightened carefully before these components are mounted on the chassis. It is not uncommon for these screws to loosen in shipment.

Before the final mounting is completed, the core of the filter choke must be set in the direction which results in the least hum pickup by the first amplifier stages. The correct direction must be determined experimentally by rotating the choke while listening to the hum in a speaker connected to the modulator output terminals. Thus, the entire modulator must have been wired and in working condition before this test can be made. The mounting of transformers and choke shown in Figs. 1 and 5 was found to be the best arrangement for components of the make and type specified. If an individual builder uses these same parts, he may follow the indicated layout to the letter.

In wiring the modulator, long leads are to be avoided in all stages. Each component must be placed as close as physically possible to other components to which it is to be connected. Grid and plate leads must be kept far enough apart to prevent undesired feedback coupling.

Testing

Because of the straightforward nature of the modulator, no adjustments or elaborate tests are necessary to place the unit into operation.

After assembly and wiring have been completed and have passed inspection, the modulator may be

Fig. 5. Mechanical layout of chassis showing relative location of parts.

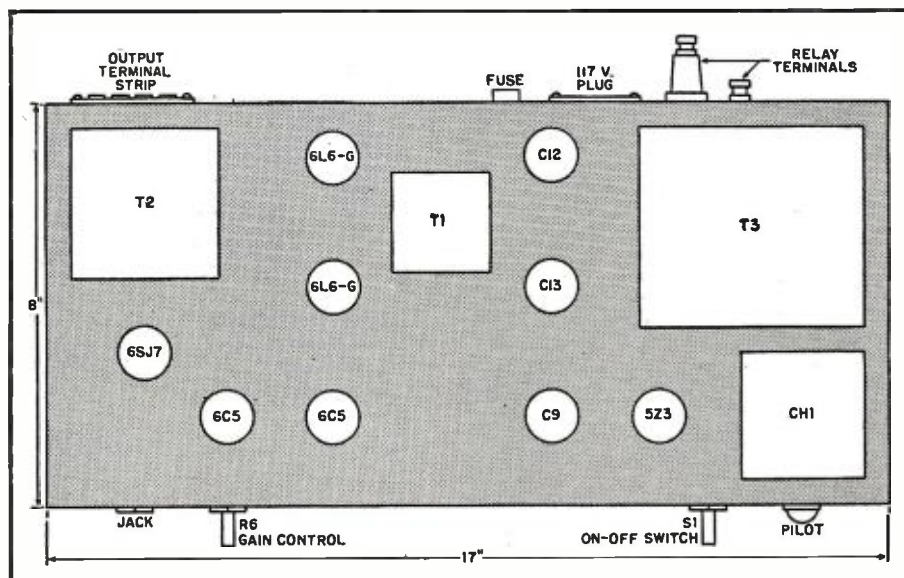

famous for GREAT VALUES

RADIO KITS

Five Tube Superheterodyne Kit

In a Walnut Veneer Wood Cabinet (size 12"x8"x6") contains complete parts for a 5 Tube superhet kit (less wire and solder) but including tubes (6SK7, 6SQ7, 6SA7, 12SN7, 25L6).
Price, each..... **\$13.95**

Six Tube Two Band Superheterodyne Kit

In a solid color wood cabinet (green, red), contains all parts (except wire and solder) to construct a high grade 2 band superheterodyne receiver covering regular broadcast and short wave bands. Tubes consisting of 2-6SK7, 1-6SQ7, 1-12SN7, and 25L6 included.
Price..... **\$17.75**

Intercommunication System

A low priced two-way system for executives, professionals and home use. Consists of a master and one remote.
Your Price..... **\$17.25**

Phono Oscillator

Wireless phono oscillator transmits recordings for crystal pickup or voice from carbon mike to radio without wires.
Price..... **\$3.45**

Mallory Line Filter—useful in eliminating noises from offending electric appliances by installing the filter at source. Compares favorably with filters listing at \$10.00.
Your Cost..... **\$3.45**

ALL PRICES ARE F.O.B. NEW YORK CITY.

Write for our new catalogue showing new test equipment, tubes and a large variety of new replacement parts. We ship anywhere promptly.

RADIO DEALERS SUPPLY COMPANY

135 Liberty St. New York 6, N. Y.

NOW
The TOWER
You've Been
WANTING!

For Directional Beam Antenna and dozens of other uses.

RUGGED
Aluminum alloy throughout. Guaranteed to support 200 lbs. with an area of 5 sq. ft. in 70 mile wind!

SIMPLE
Triangular, tapered, self-supporting, light weight, 30 ft. tower can be assembled anywhere, using only wrenches, erected by hand. Ladder rungs built into one side.

ECONOMICAL
Buy the height you need: 10, 20 or 30 feet. All fastenings and metal parts of footing furnished. Reasonably priced.

Write immediately for Brochure
FREE!

FABRICATED LIGHTMETALS CO.
42 W. 15th ST., NEW YORK 11, N. Y.

March, 1947

checked by connecting a speaker with 500-ohm input to the 500-ohm output terminals of the unit, and switching on the power. With the gain control "wide open," both hum and hiss should be negligible and there should be no whistles, squeals, or motor-boating. *Do not use headphones for this test.*

An audio-frequency signal of 1 millivolt or less fed into the input jack, J, from a low-distortion audio oscillator, should give a strong, clear signal in the speaker. Effectiveness of the gain control may be checked while this signal is passing through the amplifier by swinging potentiometer R₄ through its entire range. If blocking or plugging of the signal occur near the maximum volume setting of R₄, reduce the signal from the oscillator.

If d.c. voltage measurements are to be made at the socket terminals, use a voltmeter with very high input resistance, preferably an electronic type such as the *VoltOhmyst Jr.* or *Vomax*. Test meters with a sensitivity rating of 1000 ohms per volt or less will give erroneous readings.

Some advantages may be realized by matching the 6L6 tubes used in the output stage. A simple plate and screen current test usually will be sufficient and the easiest one for most amateurs to make, although a matching of transconductances would be much better. It is not imperative, however, that these tubes be matched.

-50-

3" Oscilloscope (Continued from page 70)

out of tubes and parts. The focus, intensity, and two centering posts are brought to the front panel through flexible insulated couplings, panel bushings and extension shafts. Be sure to insulate the resistors in the high voltage bleeder circuit properly. The circuit diagram is shown in Fig. 1.

The finished scope should be enclosed in a metal cabinet so that the unit will be electrostatically and magnetically shielded. The exact size and shape will depend on the size and shape of the chassis you use.

When the unit is finished, turn it on and you should observe a trace on the tube provided all the switches are turned to internal position, the sweep amplitude control is advanced, and the sweep frequency switch is set to any of the frequency ranges. Adjust the focus and intensity controls until the trace is sharp and bright enough to be easily observed. The trace or spot should not be left motionless when it is bright, as it will burn the screen.

Connect the Y axis input to the 60 cycle output on the front of the scope and adjust the controls until you become familiar with their operation. In some cases, it may be necessary to ground the scope to a water pipe by means of the ground binding post at the bottom of the front panel.

All the Science of BASIC RADIO- ELECTRONICS in one 3½ lb. book



ONLY
\$5
Complete

WRITTEN FOR
BEGINNERS

36 COURSES IN ONE

If this big 972-page Book were broken into monthly lessons and sold as a "course" you'd regard it as a bargain at \$50 or more!



A. A. Ghirardi's famous 972-page, 3½ lb. RADIO PHYSICS COURSE book with its 500 illustrations and 856 Self-Test Review Questions can teach you basic Radio-Electronics quicker, easier and at far less cost

START NOW!

than you may have thought possible! It has given more people their start in Radio than any other! It is used more for home study and was more widely used in U. S. Army Signal Corps and Navy wartime training programs than any other book of its type!

LEARN IN A FEW WEEKS!

RADIO PHYSICS COURSE is written for beginners who want to learn at home in spare time. Many who never even studied a circuit diagram before have completed it in a few weeks. Every basic subject is fully covered. Nothing is omitted. You'll be pleased how quickly it has you understanding subjects that other books and courses make seem too complicated. Send coupon today! Our 5-DAY MONEY-BACK GUARANTEE protects you absolutely.

"Better than a \$150 Course!"

"I had already taken a \$150 radio course," writes Gerard Champagne of Montreal. "but since reading RADIO PHYSICS COURSE, I put the other one away. Ghirardi's is the book I need because it teaches so clearly!"

NO RISK COUPON mail today

Send, RN-37, Murray Hill Books, Inc., 232 Madison Ave., New York 16, N. Y., enclosed find \$5 (\$5.50 foreign) for a copy of Ghirardi's 972-page RADIO PHYSICS COURSE book; or send C.O.D. for \$5 plus postage (no foreign C.O.D.'s). In either event, if not satisfied, it is understood I may return book in 5 days for complete refund of my money.

Name

Address

City & Dist. No. State

**YOU'LL NEVER GO WRONG
on a GHIRARDI BOOK!**

163

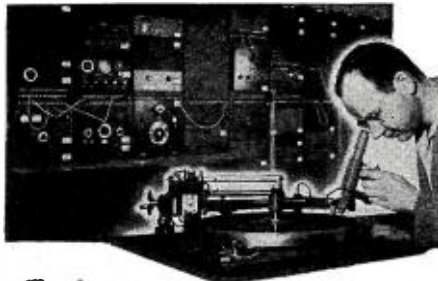

School of SOUND RECORDING and TRANSMISSION ENGINEERING

Learn sound recording and transmission engineering techniques of the professionals, as used in Motion Picture, Broadcast, F-M, Television, and Commercial Recording Studios.

A nine months practical engineering course, devoted exclusively to the technique of sound recording and transmission measurements. Well equipped studios, professional recorders and circuit laboratory containing latest model test equipment installed for student training. A portion of our laboratory is pictured above.

● New classes admitted the first School day of Jan., Apr., July, Oct.
H.M. Tremaine
 Director
 Affiliated with the Don Martin School of Radio Arts
 Approved for Veterans

Write for literature • Sound Department
Don Martin SCHOOL OF RADIO ARTS
 1655 Cherokee • Hollywood 28, California

U.S.R.S. MONTHLY SPECIAL

RADIO CITY PRODUCTS

SIGNAL GENERATOR

New post-war model 705. Frequency range 95K-100MC. Fundamentals in 5 continuous bands variable from 95K-25MC. Modulated or unmodulated output. 30% at 400 cycles. Individually shielded R.F. circuits, coil assembly and attenuator. Housed in durable metal cabinet.



46-110 SIGNAL GENERATOR—Net. . . \$49.50

PORTABLE TUBE AND SET TESTER



Model 802N incorporates all the newest circuits. Tests all receiving tubes, neon and pilot bulbs. Jeweled light on-off indicator. Housed in sturdy oak case. Comes complete with test prods and instructions.

46-101 PORTABLE TUBE AND SET TESTER—Net. . . \$59.50

R. C. P. COUNTER TUBE TESTER

MODEL 322. Tests all tubes, standard, miniature and sub-miniature. Tests leakage and shorts between elements. Line fuse protects against burn-outs.

46-100—TUBE TESTER—Net. . . \$41.50

Write for Free Illustrated Flyer

U.S.R.S.

U. S. RADIO SUPPLY
 5116 HARPER AVENUE
 CHICAGO 15, ILLINOIS
 DEPT. NE 3

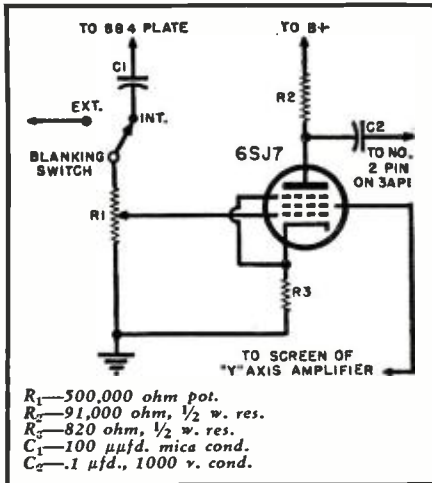

Fig. 7. Circuit diagram of Z axis amplifier. This unit can be incorporated as an additional feature of cathode-ray oscilloscope.

Let us now measure an unknown a.c. voltage. The a.c. voltage brought out at the bottom of the front panel is from one of the 6.3 volt filament windings; although its r.m.s. value is 6.3 volts, its peak-to-peak value is 17.8 volts or, roughly, 18 volts. We can, by holding a ruler against the front of the C-R tube, adjust with the Y axis gain control this waveform to exactly one inch in height. By measuring the height of an unknown voltage with the ruler we can determine the value of an unknown voltage. Remember that the peak-to-peak value (distance from top of positive peak to bottom of negative peak) of a sine wave is 2.82 times the r.m.s. value. The Y axis amplitude control must not be touched after the calibration is made or the calibration will change. If the unknown voltage is greater than can be measured on the 3" tube with an 18 volt per inch sensitivity then set the 18 volts equal to 1/4 inch, etc.

If we want to measure a d.c. voltage, then the jumper on the Y axis deflection plate at the back of the scope should be removed and a known d.c. voltage applied directly to the plates. The spot will move to a new position and remain there. The distance is measured and then the distance an unknown voltage moves the spot is measured and compared with the calibration distance. If a very large voltage is to be measured, a voltage divider of very high resistances should be placed across it. The resistance values should be accurately known. 5% carbon resistors will suffice in most instances if their wattages are not exceeded.

To find an unknown frequency, one has several choices. First, you can compare it with the frequency calibration of the internal sweep by turning the sweep knob to minimum and adjusting the sweep frequency knobs until one cycle appears on the screen. This is a rough frequency determination, but will suffice in some cases. To more accurately determine the frequency, compare it with a known fre-

KLYSTRON TUBE
 2K25/723A/B \$5.75 ca.
 Osc. for 3cm. operation

CAVITY RE-ENTRY osc.
 2500-3000 MC. Uses
 Lighthouse Tube \$1.95 ca.

BEDEE METER
 O-200 D.C. Mico-amps \$3.29 ca.

METER RECTIFIERS
 HALF-WAVE \$0.89 ca.
 FULL WAVE \$1.59 ca.

WRITE FOR CATALOG ALSO
 QUANTITY PRICES

AMERICAN SALES COMPANY
 1811 WEST 47th ST., CHICAGO 9, ILLINOIS

Guaranteed Factory Rebuilt Radio

VIBRATORS—\$1.00

6 volt Non Synchronous Vibrators \$1.00 ea. 6 volt Synchronous, 12, 32, and 110 volt Vibrators \$1.25 ea. Defective parts replaced. **48 HOUR SERVICE.** For the very prompt service enclose remittance and return postage. We rebuild any make or kind of radio vibrators. C.O.D. orders accepted. Send your old vibrators to

BEST VIBRATOR CO.
 Box 5802-A, Cleveland 1, Ohio

NOW IN STOCK

Standard Brand Tubes
 All Numbers Now on Hand 40% Off List Prices.
Crystal Pickups

ASTATIC WEBSTER SHURE Your Pick \$1.95

Alliance Phono Motors
 With 8" or 8" Turntables.
 Self Starting.
 Buy As Many As You Want.

Special \$3.60
 25% Required on C.O.D. Orders.

CONSOLIDATED RADIO SALES CO.
 Wholesale Distributors
 768 Amsterdam Ave. New York 25, N. Y.



RCA Institutes, Inc.

Offer thorough training courses in all technical phases of Radio and Television

WEEKLY RATES **DAYS—EVENINGS**
VETERANS: RCA Institutes is approved under G. I. Bill of Rights
 For Free Catalog write Dept. RN-47
RCA INSTITUTES, Inc.
 A Service of Radio Corporation of America
 75 Varick St., New York 13, N. Y.

SERVICE MEN!

- RCA Radiotron
 - Sylvania
 - Tungsol
 - Raytheon
- Tubes, Parts & Equipment**
 Write for our latest bulletin, Dept. N3

Distributors of **RADIO EQUIPMENT**

CHIEF ELECTRONICS

104 MAIN STREET, POUGHKEEPSIE, N. Y.



TRUCK FOR APPLIANCES

Rolls like baby buggy on 4 big (Dual) 8" rubber tires; resilient, quiet, durable; Chrysler Oilite bearings. Easily handles refrigerators, and all appliances up to 1000 lbs., 54" ht., 24" nose; 13" web strap. Also handles crates, boxes, bags, etc. \$31.95 f.o.b. Over 10,000 Handeek trucks sold by mail. Send back express collect if not satisfied. Order Monday—get Friday, from

HANDEEK CO., Dept. RN-3, Bloomington, Ill.

RADIO NEWS

quency from the 60 cycle line frequency, an audio oscillator or a signal generator. If neither of the latter is available there are a few, common sources of known frequency. The output from a full-wave rectifier is 120 cycles per second. WWV, the standard frequency station, broadcasts a 440 cycle note and a 4000 cycle note on exactly 5 megacycles, which can be picked up on all-wave superheterodynes.

The unknown frequency is introduced into the Y axis amplifier. The known frequency is applied to the X axis amplifier by switching the X axis switch to external and turning the sweep frequency switch to the off position.

The modulation envelope of a phone transmitter may be observed by applying some r.f. from a coupling coil placed in the field of the transmitter's tank coil directly onto the vertical deflection plates. Distortion in audio amplifiers is easily located and eliminated.

Receiver signal tracing is possible with the scope, and the location of noise and intermittents is also possible. Receiver alignment is best done with a scope, and requires an oscillator which has its frequency swept through an adjustable range. There are several sweep frequency signal generators available on the market, as are frequency modulated signal generators. These generators also generate a sweep which is applied to the X axis of the scope.

There are a host of other uses for your scope which you will discover as you use it. There is no substitute for this convenient window through which you can actually see what is going on in a circuit.

-50-

STUDS MAY DAMAGE SPEAKER CONE

RADIO speaker cones are often damaged by piercing the cone with the sharp end of the mounting studs when removing or replacing the speaker.

Grasp the speaker as shown and guide it carefully into place—keeping the mounting studs lined up with the holes in the speaker rim—to avoid damage to the cone. H. L.

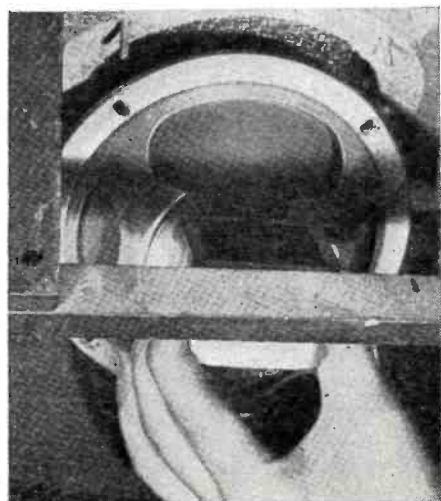

March, 1947

10 Watts of Quality!

THE NEW CLARK PA-10a

● The Clark reputation for quality broadcast studio equipment carries through the PA series of Public Address Amplifiers. The new PA-10a ten watt amplifier is basically the same as the famous Clark model PA-10 but with refinements that make it a greater value than ever. The PA-10a is in the low price field and yet its terminal strip mounting of small components compares with the most elaborate speech equipment.

SOME PA-10a FEATURES

Less than 3% distortion at 10 watts output.
 Hum level at least 60 db. below full output.
 Virtually flat response from 50 to 10,000 cycles.
 High impedance microphone and phono input channels.
 Selection of four output impedances: 4, 8, 16 and 500 ohms.
 Tube complement: 2-6SJ7; 1-6J5GT; 2-6V6GT; 1-5Y3GT.

See the Clark PA-10a and other Clark models at your Jobbers or write direct for Technical Bulletin No. 134.

Clark Radio Equipment Corp.
 4636 RAVENSWOOD AVENUE • CHICAGO 40, ILLINOIS

Dial Belt Kits

G-C SERVICEMEN'S DIAL BELT KITS

Specially designed no-slip replacement belts for all sets. No stretch. Easy to install. Kits of various quantities supplied with Steel Box.

No. G-25—Kit of 25 Belts, List \$6.70

Inspection Lite

G-C INSPECTION LITE

Just the light for service work, lights up hard-to-see corners. Handy many ways.

No. 705... List \$1.50

G-C No. 5024—PROFESSIONAL ALIGNMENT KIT

Complete alignment and neutralizing kit in leatherette case. Contains 30 different tools; can completely service any set. Handy to carry in roll-type case.

List..... \$19.95

G-C ELECTRONIC CHEMICAL LABORATORY

Ideal for all hams, experimenters and servicemen. 19 different bottles and chemicals in hvy. steel rack (free rack). Perfect chemical set-up for servicing.

No. 998..... List \$11.12

Available at all leading distributors. Write for catalog

RADIO DIVISION DEPT. H

GENERAL CEMENT Mfg. Co., Rockford, Ill., U. S. A.

Manufacturers of over 3,000 products • Sales offices in principal cities

165



PREPARED ASSORTMENTS GUARANTEED FIRST QUALITY

Cat. No.	Quantity	Description	Price
1001	100	1/2 Watt Resistors, All Insulated	\$2.98
1002	100	1 Watt Resistors, All Insulated	3.98
1003	100	2 Watt Resistors, All Insulated	4.45
1004	50	Wire Wound Resistors Ass't'd	3.98
1005	10	Watts	2.98
1006	50	200 Volt Paper Condensers	2.48
1007	50	400 Volt Paper Condensers	3.48
1008	50	600 Volt Paper Condensers	4.25
1009	50	Mica Condensers	2.98
1010	20	Dry Electrolytic Filter Condensers	6.75
1011	10	Resistance and Line Cords	3.98
1012	100	Wafer Sockets	4.50
1013	100	Plastic and Ceramic Sockets	8.50
1014	10	25 Ft. Rolls Hookup Wire—Ass't'd Colors	1.98
1015	10	50 Ft. Rolls Hookup Wire—Ass't'd Colors	3.25
1016	10	100 Ft. Rolls Hookup Wire—Ass't'd Colors	6.75
1017	10	Volume and Tone Controls—No Switches	1.98
1018	50	Large Bakelite Knobs Push On	6.50
1019	50	Large Bakelite Knobs Set Screw	7.85
1020	50	Small and Medium Knobs Push On	3.50
1021	50	Small and Medium Knobs Set Screw	3.75
1022	100	Small Bar Knobs	5.50
1023	100	Large Bar Knobs	6.75
1024	100	ft. Spaghetti and Vinylite	.98
1025	50	Paddlers and Trimmers	3.45
1026	10	Coils I.F., R.F. Ant. and Osc.	3.98
1027	50	Pilot Lamps	2.49
1028	20	Toggle and Slide Switches	3.98
1029	20	Wafer and Ceramic Band Switches	3.98
1030	20	Auto Generator Condensers	2.98
1031	20	Auto Suppressors	2.98
1032	25	Electrical Wiring Devices, Plugs, Cans, Bases, Heater Plugs, etc.	2.75
1033	50	Electrical Wiring Devices, Plugs, Cans, Bases, Elements, Fuses, etc.	5.00
ELECTRICAL APPLIANCES AND PARTS			
Double Burner Electric Stove Streamlined			\$ 6.25
Electric Broiler Deluxe type			12.50
Fluorescent Desk Lamp, Brown, Blue or Rust			6.25
Fluorescent Kitchen Unit			8.35
Electric Phonograph			29.90
Replacement Stove Element 680 W.			.12
Replacement Electric Iron Element 550 W.			.35
Replacement Toaster Element			.75
Electric Iron Cord Set, Bakelite Plug			.45
Electric Iron Cord Set, Switch Plug			.85
8 ft. Extension Cord with Cube Tap			.45
6 ft. Rubber Replacement Cord			.21

SEND FOR TRUTONE COMPLETE RADIO AND ELECTRICAL LIST

Terms: 25% deposit required with order. Balance C.O.D. Merchandise sent prepaid if full remittance accompanies order.

TRUTONE PRODUCTS CO.
303 West 42nd Street, Dept. N, New York (18), N. Y.

R-L SPECIALS for IMMEDIATE delivery

SIGNAL GENERATOR

Range from 100 kc to 75 mc. Multicolor dial has eight scales in color for easy reading. Large plastic pointer assures fine frequency tuning. Handsome gray crackle finish metal case is ruggedly built for absolute stability.

B2880—Net **\$49.50**



WIRELESS PHONOGRAPH WITH AUTOMATIC RECORD CHANGER



No wires to connect. Just plug in and play through radio. 45 minutes of uninterrupted plays of 10 or 12 inch records without reloading. For 110 V. 60 cycle operation. Complete with open type walnut veneer cabinet.

Shipping weight 14 1/2 pounds.
B6200—Net each **\$28.50**

Write for FREE Parts Catalog



731 West Washington Boulevard
Dept. N CHICAGO 6, ILLINOIS

Technical BOOKS

"THE PEOPLE LOOK AT RADIO"
by Paul F. Lazarsfeld and Harry Field. Published by *Chapel Hill, The University of North Carolina Press.* 151 pages. Price \$2.50.

This book covers the results of a survey made by the University of Denver's National Opinion Research Center at the behest of the National Association of Broadcasters. The findings were later analyzed and interpreted by the Columbia University's Bureau of Applied Science. These results are incorporated in this report to the broadcasters from the American people.

Several surprising results were discovered in the course of this survey. If you are a "commercial hater" you are definitely in the minority. 62 percent of the people polled expressed their preference for radio programs with advertising; 35 per-cent wanted their program material without product plugs, while 3 per-cent had no opinion on the subject.

Many other interesting facts about the part radio plays in the instruction, education and entertainment of the public are included in this book.

"THE DECIBEL NOTATION" by V. V. L. Rao. Published by *Chemical Publishing Company, Brooklyn, New York.* 176 pages. Price \$3.75.

Since the "decibel notation" was first used in 1924 in connection with telephone engineering there has been no text in the English language which made any attempt to explain the origin, development and applications of decibel notation until the appearance of Mr. Rao's book.

In covering his subject, the author has delved into the development of the logarithmic unit, zero levels and level signs, decibel meter and decibel graphs, sound levels and phon calculations.

Technical personnel in the radio and acoustics field should find this book of great assistance in their work. The many graphs and tables which are used extensively throughout the text material have many practical applications.

-30-

ERRATUM

It has been brought to our attention that on page 12 of the January issue in "Spot Radio News" we were guilty of giving away fourteen minutes of Station WQQW's time to free advertising messages. The sentence should read "No commercials will be permitted longer than one minute" says station policy. "At least fourteen minutes free of advertising will precede and fourteen minutes free of advertising will follow each commercial." Our apologies to Station WQQW.

Photo Credits

Pages	Credit
Cover Photo	Black Box Studios
35 (left)	Sperry Gyroscopes Co.
35 (center)	General Electric Co.
35 (right)	Raytheon Mfg. Co.
40	Walter Steinhard, Staff Photographer
48, 49, 140	Radio Corporation of America
57	The Halliburton Co.
58	Aviola Radio Corp.
62	"The Oregonian"
102	Baker Bros.
134	Station PCJ, Holland

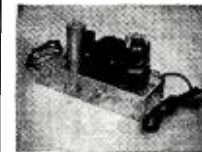

Model 80

PHONO AMPLIFIER
•
IMMEDIATE DELIVERY
•
ORDER NOW!

A SOLUTION TO YOUR AUDIO PROBLEMS
A.C. Only—4 watts output. Tone and volume control. Wired and tested. Complete with 6J5, 6V6 and 80 type tubes.
Unit Price **\$10.50**

SOUND PRODUCTS CO.
80 MAIN STREET, WHITE PLAINS, N. Y.

Supplying Every Electronic Need

- For the—
- Radio Service Man
 - Amateur
 - Student
 - Experimenter
 - Industrial

Write For Illustrated Price List



DALLAS 2608 ROSS AVE. TEXAS

RADIO ENGINEERING!

COMPLETE Radio Engineering Course. Bachelor of Science Degree. Courses also in Civil, Electrical, Mechanical, Chemical, Aeronautical Engineering, Business Administration, Accounting, Secretarial, Science, 64th year. Enter Mar., June, Sept., Jan. School now filled to capacity. No applications can be accepted until further notice.

TRI-STATE COLLEGE 1637 College Ave. ANGOLA, INDIANA

BUILD YOUR OWN FAST FREEZER PLANS \$1.00

It's easy to build this household appliance and profitable to use. Save up to 75%. Operates on 110 or 32 volts. Plans show 5 sizes and are easy to follow. ENJOY MAKING ONE OF these freezers from new or used parts. No expert knowledge needed. Mail \$1.00 bill or check for complete plans and catalog.

LE JAY MFG. CO., 484 LeJay Bldg., Minneapolis 8, Minn.

SUPER-HET KIT, \$9.75!!

Plastic Cabinet—uses 50L6, 35Z5, 12SH7, 12SA7
Kit of 4 matched tubes for above kit \$3.95
Wireless Phono Oscillator kit 2.95
Above kit, wired & tested 3.95
Kit of matched tubes for wireless 2.35
3-Tube phono amplifier kit 2.75
Above kit, wired & tested 3.75
Kit of matched tubes for phono 3.15

All kits are complete with instructions.

RADIONIC DESIGN

709 E. 5th Street New York 9, N. Y.

CONDENSERS

50 paper and mica condensers \$1.00. Brand new, fine assortment, popular sizes. Wt. app. 1 lb. f.o.b. Cash, check or M. O.
Kensington, P.O. Box 91, Bklyn. 18, N. Y.

- SPECIAL—War surplus (U. S. Signal Corps) Beacon Receivers.
 - Incorporates Superheterodyne circuit; Three gang tuning condensers; 1—6K7 RF; 1—6SA7 Osc. & Converter; 1—6SK7 IF; 1—6SF7 Detector & 1st Audio; and 2—25L6's Output; 2—IF X'mers.
 - Good operating condition.
 - Priced right at **\$5.95 ea. POSTPAID**
- E. L. LUTTRELL (Radio Service)**
ALBUQUERQUE 821 1/2 South 3rd Street NEW MEXICO

Classified

Rate 20c per word. Minimum 10 words.

RADIO ENGINEERING

SLIDE Rule Short Cuts, with Positive location of the Decimal Point. Easier, Quicker AC-DC calculations. Nothing else like it. Second Edition—\$1.50 postpaid. W. P. Miller, 536 "F" St., San Diego 1, Calif.

RADIO Engineering Broadcasting, Aviation and Police Radio, Servicing, Marine Operating and Electronics taught thoroughly. Expenses low. Write for catalog. Valparaiso Technical Institute, Dept. N, Valparaiso, Ind.

FOR SALE

MAGNETIC Wire Recorder: Magazine with 10,000 feet stainless steel wire, contains recording, re-producing and erasing heads with level-wind control, two spools with automatic brake and high speed rewind. Switches for warning, stop and overrun. Add your motor and amplifier and make 8000 cycle recorder. Brand new—made for Government and in original packages. Price, while they last, \$15.00. Sent COD with \$5.00 prepayment. Rotary Beam Antenna Motors: reversible, geared-head motor, can operate 200 lb. beam, 1½ and 3 R.P.M. torque 75 in. lbs. 12 volts D.C.—Operate from A.C. with transformer and dry disc rectifier. Relays and switches built-in. Made for Government, cost \$115. Our Price, while they last, \$5.50. Sent COD with \$3.00 prepayment. Radioco, 1110 Marshall Bldg., Cleveland, Ohio.

SPEAKER Cones replaced, prompt service, satisfaction guaranteed, 3, 4, or 5 inch, \$2.25; 6 inch, \$2.75; 8 inch, \$3.25; 10 inch, \$4.50 up; 12 inch, \$4.95 up. National Radio Distributors, 899 Southern Boulevard, New York City 59, N. Y.

QSL CARDS that stand out! Individualized, original cartoon by W2EA (ex-8EA) incorporating your ideas, personality, etc. Reasonable, but not cheap. Send stamps for specimens. Harrison Radio Corp., 9 West Broadway, N. Y. C.

ONE complete No. 19—Mark II Tank—transmitting and receiving set. Or will trade for good radio test equipment or new bicycle parts. J. C. Stradley, 15 Rice St., Hamlet, N. C.

25 MODEL 1100-A Karadio medium frequency nine tube crystal controlled mobile radio receivers. Tuning range 2 to 3 megacycles. Complete with tubes and crystal for operation on 2726 kilocycles. In good condition. 3 Temco model 25A-IF, 25 watt output, mobile transmitters. Tuning range 2 to 3 megacycles. Tubes—6L6-Oscillator, 2/807-final, 6C5-amplifier, 6N7 driver, 2/6L6-modulators. Dynamotor power. Fair condition. For operation on 2726 kilocycles. 1 Kaar model PTL-22X, 22 watt output, mobile transmitter. Tuning range 2 to 3 megacycles. Tubes—HY-69-oscillator, HY-69-final, 2/HY-69-modulators. Dynamotor power. For operation on 2726 kilocycles. In excellent condition. 1 General radio model 775-A frequency monitor. Complete with tubes and crystal for monitoring 2726 kilocycles. New, in excellent condition. For sale by Southern Natural Gas Company, P.O. Box 2563, Birmingham, Ala.; % Lucien C. Bomar.

STOP That Hum! Rubbing, blasting and tearing with "Volcoil" solution. Large bottle, treats 12 cones, \$1.00 postpaid. Lasts for years. Saves repairs. Radio Research Products, W. Malloy, Mgr., Room 29, 1230 E. 63rd St., Chicago, Ill.

DUAL microammeter, 200 microamps each, ¾" diameter Westinghouse, \$3.50. 1-0-1 milliammeter, 2½" diameter, \$2.00. Oil filled capacitors, .25 mfd, 4000 WVDC, 85c. 3" Cathode ray scope, radar indicator ID-93/APG-13A, 115V 400cps, complete with 11 tubes, new, \$25.00. Write for list. Rubin Radio, Shrewsbury, N. J.

SX-28A HALLICRAFTER in A1 condition, \$190. S. Palasek, 62 Main St., Port Washington, N. Y.

ERECO Beam Rotator. High torque output 1-3 RPM. Selsyn indicators, attractive control panel. Reversing switch. Watertight. 110VAC operated. Models from \$37.50 to \$50. Build your own kits from \$17.50 to \$25.00. Write for Photos, Literature. Dealers' inquiries invited. Manufacturer Eresco, 1006 Hewitt, Everett, Washington.

DYNAMOTORS. Transmitting, SCR 274, DM 33's; 28 volts input; 575 Volts @ 180 Ma. output. Reconditioned and guaranteed. \$4.65 each; \$3.65 in lots of three. 25% deposit on C.O.D.'s. Airborne Communications, Inc., Lunken Airport, Cincinnati 26, Ohio.

JENSEN JHP-52 Speaker, Cabinet, Amplifier, practically new. Earl H. Swen, Gilby, N. D.

3 EACH Navy QBG Underwater Echo Ranging and Listening Equipment complete with spare parts. \$75 Each. F. Harrison, 506 5th Ave., Asbury Park, N. J.

NEW Bell amplifiers, systems. Free List. B and B Sound, Sheboygan, Wis.

SIGNAL TRACER: Save \$17.45. I'm closing shop. Will sell brand new SPECO Model STAP AC-DC for \$27.50. Cost me \$44.95. Send check, money order or C.O.D. to M. H. B. Hoffman, 4112 Galatin St., Hyattsville, Md.

March, 1947

A. 4-TUBE video amp. chassis—Contains valuable ceramic sockets, terminal strips, chokes, condensers, etc. Real buy for the amateur. \$2.50.
B. Complete well filtered DC power supply conservatively rated at 375V-140 milli—Features two CD 16 mfd.-600V. filter capacitors and separate 6.3V filament supply. Uses two 6x5's—Connections are brought to terminal strips, less tubes, \$5.95.
C. Westinghouse Oil filled Condensers, 10 mike 600V, rectangular can, \$2.50. D. 5" P.M. Speaker, Magnet 2.15 ounce, Alnico #5, \$1.59. Belmont Radio Supply, 1921 Belmont Ave., Chicago 13, Illinois.

FREE wholesale bulletin, Tubes, parts. Bargain prices. Henshaw Radio Supply, 3313 Delavan, Kansas City, Kansas.

SELENIUM Rectifiers, full wave, ½ ampere, \$1.85; 1 ampere, \$2.50. Half wave 5 amperes, \$4.50; 2.2 amperes, \$2.25; 1.5 ampere, \$1.85. Bulletin. Bursma Radio, Route 5, Grand Rapids, Mich.

LOWEST Prices. Radio Tubes, parts. Bargain lists 3c. Potter, 1314 McGee, Kansas City 6, Mo.

RADIO Tubes—Dealers, order your needs—be surprised at prices. Address Radio Tubes, Box 108, Elizabeth City, N. C.

RECORDING Discs—Presto's famous 16" green label double face glass base recording blanks, only \$1.35 each, guaranteed perfect. Recording Specialties, P.O. Box 84, St. Albans, New York.

WANTED

HIGH grade Frequency Meter, Low resistance bridge, and resistance standards. Henry Wagner, 4411 Indianapolis Blvd., East Chicago, Indiana.

RIDER Manuals Wanted, 1 to 5. Write A. Lopes, 780 E. 214 St., New York City.

HALLICRAFTER SX-28A or SX-42. Dr. M. E. Tate, Somerset, Ky.

ATTENTION Manufacturers! Wanted three tube superhet (12SA7, 12SQ7, 70L6). Three band (15-40, 55-1.5, 6-20 MC). IF 455. Dial printed well-known European stations. Phono connection. Line voltage 110. Lots of thousands. Interested also for other small types and parts. Mors Telsiz Atelyesi, Sisli P.K. 66, Istanbul, Turkey.

CORRESPONDENCE COURSES

USED Correspondence Courses and Educational Books Bought, Sold, Rented; Free Catalog. Educational Exchange, Henagar, Ala.

CORRESPONDENCE Courses and self-instruction books, slightly used. Sold. Rented. Exchanged. All subjects. Satisfaction guaranteed. Cash paid for used courses. Complete information and 100-page illustrated bargain catalog FREE! Write Nelson Company, Dept. 59, Chicago 5, Ill.

AMATEUR radio licenses. Complete code and theory preparation for passing amateur radio examinations. Home study and resident courses. American Radio Institute, 101 West 63rd Street, New York City.

USED Correspondence Courses and Educational Books sold or rented. Inexpensive. Money-back guarantee. Write for Free Catalog listing 4000 bargains. — (Courses Bought.) — Lee Mountain, Pisgah, Ala.

PATENT ATTORNEYS

PATENTS—U.S. and Foreign Patents Secured. Trade-marks and Copyrights registered. Searches made to determine Patentability and Validity. Patent, Trade-mark and Unfair Competition Causes, Lancaster, Allwine & Rommel, Registered Patent Attorneys, Suite 414, 815 15th St., N.W., Washington 5, D. C.

INVENTORS—Steps to be taken in obtaining patent protection available upon request. Victor J. Evans & Co., 248-C Merlin Bldg., Washington 6, D. C.

SITUATIONS WANTED

EX-CHIEF Radio Operator Merchant Marine, First Class Radiotelegraph, Second Class Radiotelephone. Five years' experience, age 27, Draft classification 1-G, desires job with future. Harold Cantor, 99 Brainerd Rd., Allston, Mass.

NAVY trained radar-radio technician-engineer with M.A. degree wants position. Box 443, % Radio News.

HELP WANTED

JOBS With a Future. Foreign and Domestic positions await interested persons. 1947 Copyrighted listing covering thirty Major Fields only one dollar to sincere applicants. Boston Trading Company, Box 332, Boston 1, Mass.

MISCELLANEOUS

FRENCH radio businessuan, reliable, competent, first class references, wishes to represent American radio firm in France. Write to Louis Matigot, 50 North Drive, Huntington Station, N. Y.

RAILWAY telegraphy. Be a railroad telegrapher. Operators are in great demand. Salaries from \$3,200 up. For information write to Bell Telegraph Ry. Institute, 10 Parker Ave., Suite 9, San Francisco 18, Calif.

GUARANTEED Wholesale radio repairs. Just send us the radio prepaid, we repair and return C.O.D. 24 hours' service. We fix them all. Akerberg Radio Laboratories, Stanley, N. D.

WHOLESALE Radio Service at reasonable rates, quick service, no job too big. Write for full information. Elkins Radio, Elkins, W. Va.

ELECTRICAL Instruments. Meters repaired and converted. Inquiries solicited. Haledon Electrical Instrument Co., 319 Belmont Ave., Haledon, N. J.

CUSTOM Built Equipment for less than "factory-built" prices! How? Write Custom Equipment Laboratories, Box 623, Cedar Rapids, Iowa.

25 YEARS' experience in radio repairing at your fingertips for \$1.00. I've repaired 45,000 radios and have perfected a system which you can follow step by step. My methods are far simpler than any other course on the market and requires no calculations. Send \$1.00 to Ross Radio Company, Dept. C, 14615 Grand River, Detroit 27, Michigan.

U. S. GOVERNMENT SURPLUS ELECTRON TUBES

Type	Your Cost	Type	Your Cost
2AP1.....	\$2.50	803.....	\$8.50
2X2/879.....	.90	807.....	1.00
3AP1.....	3.50	810.....	2.75
3BP1.....	3.50	812.....	2.00
5BP4.....	6.00	829A.....	3.00
6AK5.....	1.50	866A.....	.75
7EP4.....	15.00	921.....	.75
HK24G.....	2.00	922.....	.75
100TH.....	4.75	923.....	.75
HF200.....	8.50	1851.....	.95
450TL.....	15.00	1852.....	.75
U801A/801.....	2.00	1853.....	.75
802.....	1.50	2050.....	.90

SUBJECT TO PRIOR SALE



509 Arch Street
LO 3-4559

Phila. 6, Pa.
LO 3-0513

Send and Receive Code

with this PROFESSIONAL



TELEGRAPH PRACTICE SET

Same as used by U. S. Signal Corps. Learn code quickly and have loads of fun with your "private" intercom system.

List Price \$9.95
YOUR COST Only \$6.75

Complete with everything
No distance limit between stations. Send \$2.00 with order, pay balance to postman.

Satisfaction Guaranteed!

AUDIO SALES CO. 11 WARREN ST.
NEW YORK 7, N. Y.

AVAILABLE NOW May, 1947, Issue of TELEVISION NEWS

Sound and Vision on the Same Carrier
and other feature articles

8 Pages, 10c

Send 10c in coin to
ZIFF-DAVIS PUBLISHING COMPANY
Dept. AE-5, Circulation
185 North Wabash Avenue
Chicago 1, Illinois

RADIO SERVICEMEN: SPECIALS

SELENIUM RECTIFIER—Replaces 11726, etc. \$0.99
SAPPHIRE PHONO NEEDLE (10,000 Plays)99
DIAL CORD KIT—60 Ft. Ass'd & 6 Springs99
KNOB KIT—20 Ass'd Screw & Spring99
RESISTOR KIT—100 Ass'd ¼ to 1 Watt99
BY PASS COND. KIT—35 Ass'd .005 to .199
SPEAKER GRILLE CLOTH—6 Ass'd 6" x 6"49
ANT. & OSCIL. or ANT. & RF. COIL SETS49
SPEAKERS—4" or 5" PM, ALNICO 51.59
TUBE SHIELDS or FP. COND. MTG. PLATES04
RADIOS—5 TUBE SUPER HET MODEL
NATIONALLY KNOWN BRANDNET 18.95
Write Today for Bargain Bulletin

RADIO DISTRIBUTING CO., Pasadena 18, Cal.

Television for Radiomen

By EDWARD M. NOLL

A Manual Specifically for the Radio Repairman and the Television Beginner \$5.00

Old York Road Publishing Company announces publication of a television manual for radiomen. "Television for Radiomen" by Edward M. Noll, is the stepping-stone from radio to television for the practical radioman and student. It picks the radioman up where he left off in his studies, gives him a special short radio review slanted for television and, then, launches into television. It approaches television in a manner different from any other book or text—a manner which gives you television in a more compact easier-to-understand style.

The manual's five big chapters, abundantly illustrated with more than 175 descriptive figures are:

Chapter I—Radio Review Slanted for Television. Study this chapter and get a new perspective on circuit theory—a perspective slanted for television.

Chapter II—A Complete Television System. If you want a birdseye view of the entire television system it's here. It gives you that necessary overall picture of television functions before you dig into the details. This is a discussion of the modern, FCC approved television system—today's television, not yesterday's. Study this chapter—you'll be pleased with your progress.

Chapter III—Transmitter and Receiver Circuit Functions. Inasmuch as a television system is a tightly interlocked system, to obtain a thorough understanding of receiver functions it is necessary to know what goes on at the transmitter. Thus we start to trace our television signal at its source, the television pick-up tube.

Chapter IV—Receiver Circuit Details and Antenna Systems. Discussion of receiver circuit details continues in this chapter until a complete analysis of receivers has been made. A large portion of this chapter is devoted to receiving antennas. Read it and you'll be able to erect the proper antenna for a specific location and distance from the transmitting station.

Chapter V—Installation, Adjustment, Alignment, and Trouble-Shooting. If it's practical data you want, and practical application of the knowledge you have gained from previous chapters, this is the chapter for you. The radio repairman will value highly the data and procedures presented for him in chapter five. Study chapter five and develop a methodical adjustment and repair procedure.

Edward M. Noll, author of "Television for Radiomen," is a television instructor at Temple University, manager of Television Tech, and frequent contributor to the leading trade magazines. He was a former staff-member of the Philco television station WPTZ. As an additional feature with the sale of "Television for Radiomen" we will inaugurate a new information service (subscription rate of only \$1.50 to buyers of the manual) to supply you with new data as it becomes available and released. First printing of this quarterly progress review is scheduled for late spring. Sign up today for manual and information service. Write to:

OLD YORK RADIO PUBLISHING CO.
419-421 Johnson St. JENKINTOWN, PA.

RADIO PARTS SOUND SYSTEMS ELECTRONIC APPARATUS

Depend on RADOLEK

Radolek's big Free Profit Guide Catalog and Profit Bulletin supplements keep you abreast of the rapidly changing radio situation. Buying from Radolek means greater values, better service and more profits. Make Radolek your buying headquarters.



RADIO PARTS
SOUND SYSTEMS

FREE
CATALOG

Large Stocks
Fast Service

SEND TODAY!

RADOLEK CO., Dept. B-124
601 W. Randolph St., Chicago 6, Ill.
Please send your FREE Profit Guide Catalog.

Name.....
Address.....

SAVE AT RADOLEK

INDEX OF ADVERTISERS

March
1947

Abell Distributing Company, The.....128	G & E Equipment Supply Co.159
Adson Radio Co.126	General Cement Mfg. Co.165
Air King Radio..... 26	General Industries, Inc., The..... 22
Alliance Manufacturing Company, 2nd Cover	General Test Equipment Co.152
Allied Radio Corp.9, 80	Greenlee Tool Co.154
Almo167	Greenwich Sales Co.162
American Phenolic Corporation..... 23	Haldorson Company, The.....169
American Radio Institute.....156	Hallcrafters Company, The..... 5
American Sales Company.....164	Hallmark Electronics Corp.156
American Television Labs., Inc.....111	Hammarlund Mfg. Co., Inc., The..... 15
American Television & Radio Co.....151	Handees Co.164
Amperex Electronics Corporation..... 18	Harrison Radio Corporation.....155
Arrow Sales, Inc.97	Harvey Radio Co.130
Ashe, Walter Radio Co.153	Henry Radio Stores.....110
Audel Publishers88	Hershel Radio Co.121
Audio Sales167	Hexacon Electric Co.157
Autocrat Radio Co.124	Highbridge Radio-Television & Appliance Co.96
Baltimore Technical Institute.....116	Hollywood Radio & Television Institute.. 27
Beard, G. F.160	Hollywood Sound Institute.....126
Bell Telephone Laboratories..... 69	Hoodwin, Chas., Co.....148
Benson Radio Institute.....158	Hopp Press, Inc.138
Best Vibrator Company.....164	Illinois Condenser Co.134
Bliss Electrical School.....108	Illinois Transformer Corp.104
Bonafide Radio & Electronics Co.130	Instructograph Company160
Brach, L. S., Mfg. Corp.82	International Resistance Company..... 31
Bradshaw Instruments152	Jensen Manufacturing Company..... 12
Brooks, George & Associates.....132	J.F.D. Manufacturing Co.161
Bud Radio, Inc.100	Joseph, Irving & Associates.....123
Buffalo Radio Supply.....113	Kelvin Electronics120
Burlington Instrument Co.144	Kenyon Transformer Co., Inc.159
Burstein-Applebee Co.125	Lake Radio Sales Co.140
Cambridge Electronics Corporation.....134	Lansing, Altec115
Candler System Co.156	Leeds Radio160
Cannon Electric Development Company.. 133	Legri S Company, Inc.126
Capitol Radio Engineering Institute..... 77	Le-Hi Electrical Company.....116
Chicago Industrial Instrument Co.136	LeJay Mfg. Co.166
Chicago Wheel & Mfg. Co.152	Leonard Radio, Inc.102
Chief Electronics164	Leotone Radio Co.90
Clarion Sound Engineering Co.112	Lifetime Sound Equipment Co.156
Clark Radio Equipment Company.....165	Lincoln Engineering School.....152
Cleveland Institute of Radio Electronics82, 104, 137	Luttrell, E. L.166
Clippard Instrument Laboratory.....100	Maquire Industries, Inc.10, 11
Collins Audio Products Co.116	Majestic Radio & Television Corp. 84
Collins Radio Company..... 81	Mallory, P. R., & Co., Inc.....17, Third Cover
Columbia Wire & Supply Company.....132	Martin, Don, School of Radio Arts...150, 164
Commercial Radio100	Massey's Radio Supply.....154
Communications Equipment Co. 83	Melville Radio Institute.....153
Concord Radio Corp.70	Merit Coil & Transformer Corp. 20
Consolidated Radio Sales Co.164	Metropolitan Electronic & Instrument Co. . 99
Constant Electric Company.....160	Mid-America Co., Inc.159
Coyne Electrical School.....107	Miles Reproducer Co., Inc.116
Coyne Electrical School.....73, 148	Milio Radio & Electric Corp.114
Crabtree's Wholesale Radio.....166	Murray Hill Books, Inc.71, 76, 163
Croname, Inc.170	McGee Radio Company74, 75, 158
DeForest's Training, Inc. 21	McGraw-Hill Book Company.....158
D. & H. Distributing Co., Inc.105	McMurdo Silver Co., Inc.131
D H D Electronics & Appliance Co.130	National Company, Inc. 87
Dow Radio Supply Company.....152	National Radio Distributors..... 72
Drake Electric Works, Inc.148	National Radio Institute..... 3
Dymac, Inc.158	National Radio Service.....156
Editors & Engineers.....32, 33	National Schools 13
Electronic Development Company.....116	Newark Electric Co. 28
Electronic Manufacturing Co.108	Newark Surplus Materials Co.148
Electronic Parts, Inc.144	New Jersey Industrial Co.150
Electronic Supply Corp.158	New York Technical Institute of New Jersey118, 119
Electronic Supplies126	Niagara Radio Supply Co.147
Electronic Technical Institute.....155	Offenbach & Reimus Co.141
Erie Supply Co.150	Ohmeyer Engineering Labs.136
Esse Radio Company.....78, 79	Old York Road Publishing Co.168
Fabricated Lightmetals163	Olson Radio Warehouse, Inc. 95
Fada Radio & Electric Company, Inc. 6	Onan, D. W., & Sons.....129
Fahnestock Electric Company, Inc. 95	
Farnsworth Radio & Television, Corp. .24, 25	
Federated Purchaser, Inc. 98	
Flanagan Radio Corp.132	

Pa-Kette Electric Co.	156
Petersen Radio Company, Inc.	152
Potter Radio Co.	138
Pyramid Electric Company.....	34

RCA Institutes, Inc.	164
R-L Electronic Corp.	166
Radio Dealer Supply Company.....	163
Radio Distributing Co.	167
Radio Electric Service Co.	138
Radio Equipment Company.....	140
Radio Equipment Distributors.....	124
Radio-Experts	150
Radio Ham Shack, Inc.	89
Radio Kits	150
Radio Maintenance Magazine.....	67
Radiomart, Inc.	149
Radio Parts Company.....	157
Radio Press	150
Radio Shack, Inc., The.....	143
Radio Supply & Engineering Co.	127
Radio & Television Supply Co.	152
Radio Wire Television, Inc.	135
Radionic Designs	166
Radionic Equipment Co.	123
Radolek Co.	168
Reed Mfg. Co.	160
Rider John F., Publisher, Inc.	16

Sams, Howard W., Co., Inc.	85
Sangamo Electric Co.	109
S/C Laboratories, Inc.	108
Scenic Radio & Electronics Co.	162
Shure Bros., Inc.	145
Sigmon's Radio Supply.....	160
Simpson Electric Company.....	91
Sound Products Co.	166
Sprague Products Company.....	103
Sprayberry Academy of Radio.....	7
Stahl, Michael, Inc.	140
Standard Parts Corp.	86
Standard Radio & Electronic Products.....	143
Standard Transformer Corp.	29
Sterling Electronics Company.....	160
Stevens Walden, Inc.	8
Stromberg-Carlson Co.	68
Sun Radio & Electronic Co.	156
Sun Radio of Washington, D. C.	101
Superior Instrument Co.	30
Supreme Instruments Corp.	124
Supreme Publications.....	93
Surplus Radio, Inc.	139
Sylvania Electric Products, Inc. Fourth Cover	

T A B.....	92
Taybern Equipment Co.	126
Telectron Company, The.....	160
Transvision, Inc.	142
Tri-State College	166
Trutone Products Co.	166

U.S. Radio Supply.....	164
Ungar Electric Tools Co.	161
United Motors Service, Div. General Motors Corp.	19
Universal Radio Supply Co.	136
University Loudspeakers, Inc.	96

Valparaiso Technical Institute.....	160
Variety Electric Company.....	94
Vision Research Laboratories.....	146

War Assets Administration.....	117
Ward Products Corporation.....	84
Warner Electric Company.....	158
Webster-Chicago.....	122
Weller Mfg. Co.	169
Wells Sales, Inc.	14
World Radio Laboratories, Inc.	106
Wright, Inc.	108

YMCA Trade & Technical Schools.....	150
-------------------------------------	-----

March, 1947

NEW SOLDERING GUN

Heats in 5 Seconds



SPECIAL SOLDERING GUN ADVANTAGES

TIP STAYS TINNED
NO BURNING



SEE WHERE
YOU SOLDER



SOLDER AROUND
CORNERS



Service and maintenance men can save time by the fast heating of the Soldering Gun. By use of the new induction principle, 5 second soldering heat is supplied from a light weight built-in transformer.

The loop type tip gives you other advantages that are important in soldering. Good balance with weight close to your hand makes it easier to use. The narrow tip gets in between a lot of wiring with ease. Connections can be made without burning insulation. The tip can be formed readily to work in tight places.

See your radio parts distributor for a demonstration, or write direct for descriptive bulletin.

- ★ 100 Watts 115 Volts 60 Cycles
- ★ Intermittent Operation With Trigger Switch
- ★ Can't Overheat or Burn Out
- ★ Impact Resisting Case
- ★ Handle Stays Cool
- ★ Good Balance—Weight Close To Hand

810 PACKER ST.

WELLER MFG. CO. Easton, Pa.

FOR trouble free operation and easy
EASY INSTALLATION - REPLACES WITH A
VACUUM SEALED TRANSFORMER

HALLDORSON
Vacuum Sealed
TRANSFORMER

Designed by the Service Engineer, W.L. Kern

A SIGN of the TIMES

The sellers' market has become a buyers' market... however, well-established manufacturers are still going strong... we, at HALLDORSON, are proud of our unbroken record of supplying industry with the finest since 1913... our new and more complete line of transformers is worthy of your consideration.

JOBBER: Get on our mailing list today!

THE HALLDORSON COMPANY
4500 Ravenswood Avenue • Chicago 40, Illinois

HALLDORSON Vacuum Sealed TRANSFORMERS

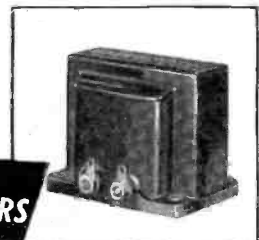

CRONAME *Facilities*

FOR ELECTRONIC COMPONENTS
AND FINE METALCRAFT

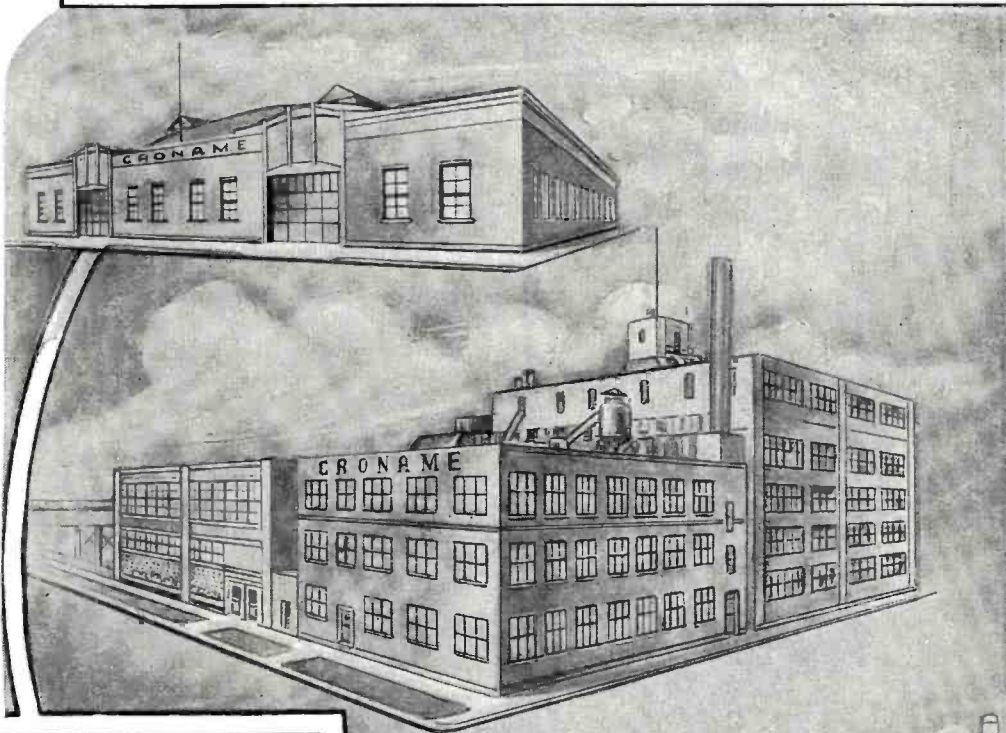

ENGINEERING
ETCHING
LITHOGRAPHING
EMBOSSING
ENGRAVING
STAMPING
ALUMINUM WELDING
& HEAT TREATING
ASSEMBLIES
SOLDERING
METAL FINISHING
PLATING

ANODIZING
PARKERIZING
OXIDIZING
FLUORESCENT
PHOSPHORESCENT
DECORATED GLASS
GLASS DIALS
DECORATED PLASTICS
FORMED PLASTICS
RADIO TUNING UNITS
REMOTE CONTROLS

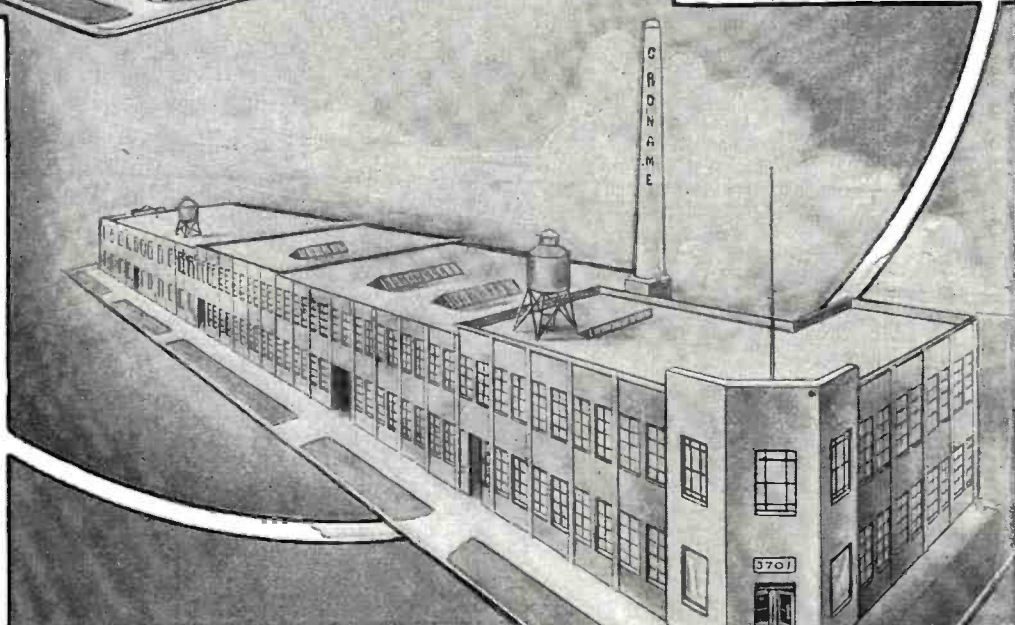

OVER 40 YEARS EXPERIENCE IN FINE METALCRAFT



CRONAME
INCORPORATED

3701 RAVENSWOOD AVENUE
CHICAGO 13, ILLINOIS

Look for this symbol of
PREMIUM QUALITY

**APPROVED
 PRECISION
 PRODUCTS**



Your guarantee of **PERFORMANCE** at no extra cost

The words "Approved Precision Products" on a Mallory box mean something more than an advertising slogan. They're your guarantee of *premium quality*—a guarantee backed by fifteen years of performance.

They're reminders that more Mallory-made vibrators are in use today than all other makes combined... that Mallory capacitors are universally preferred because they're backed by the most rigid purity-control standards

in the industry... that Mallory resistors, fixed and variable, are justifiably famous for closer tolerances, extra dependability.

"Approved Precision Products," too, mean a *complete line* of parts—parts that are sold through carefully-selected, conveniently-located distributors with the *capacity* and *desire* to serve you well. Look for the words "Approved Precision Products." They're not a symbol of higher cost—just that

YOU EXPECT MORE AND GET MORE FROM MALLORY

P. R. MALLORY & CO., Inc.
MALLORY

VIBRATORS . . . VIBRAPACKS* . . . CAPACITORS . . . VOLUME
 CONTROLS . . . SWITCHES . . . RESISTORS . . . FILTERS
 . . . RECTIFIERS . . . POWER SUPPLIES.

*Reg. U. S. Pat. Off.

APPROVED PRECISION PRODUCTS

P. R. MALLORY & CO., Inc., INDIANAPOLIS 6, INDIANA

FOR A GREAT PERFORMANCE—



**—THE HIGH AND MIGHTY
SYLVANIA *Lock-In* TUBE!**

If you're looking for a tube that's small, compact . . . of extreme strength . . . easily able to handle ultra-high frequencies — then your search is ended. Installing Sylvania's famous Lock-In Tube into your radio set — FM or television equipment — assures superior performance.

And no wonder . . . for, into every phase of the development of this tube has gone the finest in engineering skill. Each part of the Lock-In has been tested and re-tested, assuring a finished product of unsurpassed quality.

The next time you buy, insist on the Sylvania Lock-In Tube. Rely only on the best. Meanwhile, check these outstanding electrical and mechanical advantages:

Lock-In locating plug . . . also acts as shield between pins. Short, direct connections . . . fewer welded joints — less loss. Getter located on top . . . shorts eliminated by separation of getter material from leads. No top cap connection . . . overhead wires eliminated. Reduced overall height . . . space saving. Stays put in mobile and portable rigs.



AND HERE'S THE LAST WORD in tube testers—another outstanding product of Sylvania Research. Like the Lock-In, the Counter Tube Tester (shown) embodies the finest in engineering and styling.

All controls easily set for each tube to be tested. Little or no special knowledge required for operation. Designed with extra sockets and switch contacts for easy modernization. This unit is the sign of a progressive establishment.

**SYLVANIA
ELECTRIC**

Emporium, Pa.

MAKERS OF RADIO TUBES; CATHODE RAY TUBES; ELECTRONIC DEVICES; FLUORESCENT LAMPS, FIXTURES, WIRING DEVICES; ELECTRIC LIGHT BULBS