

RADIO NEWS

MARCH
1946
35c
In Canada 40c



KN-52-5977-4-47
C J PARSONS CRE USN
214 FARRAGUT AVE
ORANGE TEXAS
D

A rugged performer with a big voice and keen ear!



Collins AN/ARC-2 Autotune transmitter-receiver

The AN/ARC-2 Autotune transmitter-receiver was designed and is built by Collins for two place and larger military aircraft. It is an example of the experience, design ingenuity and manufacturing skill also available, in the Collins organization, to commercial users of communication equipment.

Transmitter, receiver and dynamotor are all contained in the same case. The weight and space requirement of the AN/ARC-2 is considerably less than that of the equipment it replaces. Any one of eight pre-tuned channels is immediately and automatically available by means of the Collins Autotune, operated either at the main panel or by remote control. The transmitter and receiver operate on the same frequency and are tuned simultaneously by a single set of controls.

This equipment, including its Autotune mechanism, functions reliably at all temperatures from -58° to $+140^{\circ}$ F, all altitudes from sea level to 40,000 feet, and all conditions of humidity up to saturation.

The Collins organization specializes in fulfilling exacting requirements. We will welcome an opportunity to make recommendations regarding your needs in the field of radio communication equipment. Collins Radio Company, Cedar Rapids, Iowa;
11 West 42nd Street, New York 18, N. Y.

Remote
Control
Box



IN RADIO COMMUNICATIONS, IT'S . . .

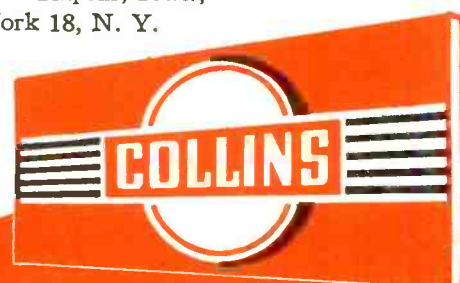



I Will Show You How to Learn RADIO by Practicing in Spare Time

I Send You 6 Big Kits of Radio Parts

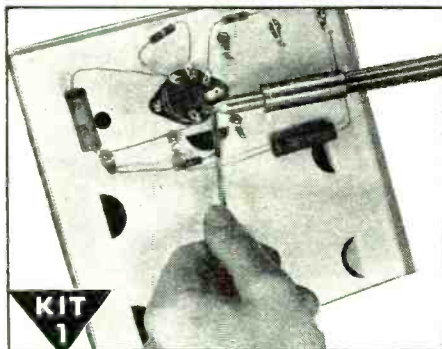

KIT 1
I send you Soldering Equipment and Radio parts; show you how to do Radio soldering; how to mount and connect Radio parts; give you practical experience.

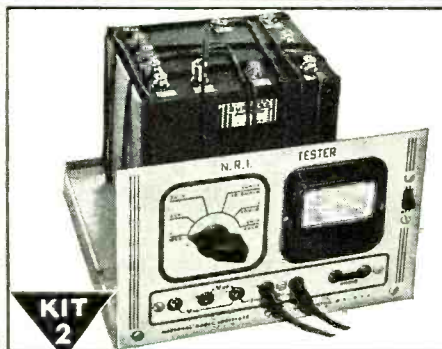

KIT 2
Early in my course I show you how to build this N.R.I. Tester with parts I send. It soon helps you fix neighborhood Radios and earn EXTRA money in spare time.

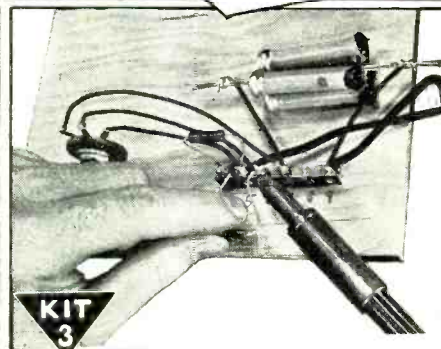

KIT 3
You get parts to build Radio Circuits; then test them; see how they work; learn how to design special circuits; how to locate and repair circuit defects.

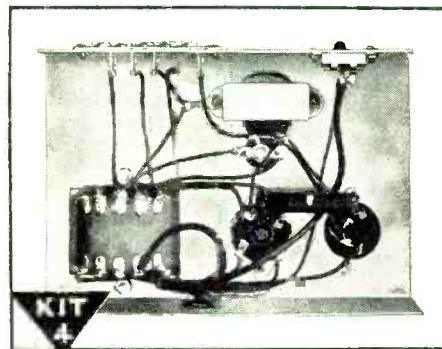

KIT 4
You get parts to build this Vacuum Tube Power Pack; make changes which give you experience with packs of many kinds; learn to correct power pack troubles.

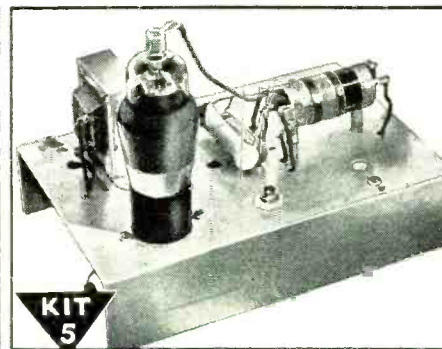

KIT 5
Building this A. M. Signal Generator gives you more valuable experience. It provides amplitude-modulated signals for many tests and experiments.



KIT 6
You build this Superheterodyne Receiver which brings in local and distant stations—and gives you more experience to help you win success in Radio.

I Will Train You at Home - SAMPLE LESSON FREE

Let me send you facts about rich opportunities in Radio. See how knowing Radio can give you security, a prosperous future. Send the coupon for FREE Sample Lesson, "Getting Acquainted with Receiver Servicing," and my FREE 64-page book, "Win Rich Rewards in Radio." See how N.R.I. trains you at home. Read how you practice building, testing, repairing Radios with SIX BIG KITS of Radio parts I send you.

Radio parts I send—USE your knowledge to make EXTRA money in spare time.

Many Beginners Soon Make \$5, \$10 a Week EXTRA in Spare Time

The day you enroll I start sending EXTRA MONEY JOB SHEETS to help you make EXTRA money fixing Radios in spare time while learning. You LEARN Radio principles from my easy-to-grasp Lessons—PRACTICE what you learn by building real Radio Circuits with

Radio parts I send—USE your knowledge to make EXTRA money in spare time.

Find Out What N.R.I. Can Do for YOU

MAIL COUPON for Sample Lesson and my FREE 64-page book. It's packed with facts about opportunities for you. Read the details about my Course. Read letters from men I trained, telling what they are doing, earning. Just MAIL COUPON in an envelope or paste it on a penny postal. J. E. Smith, President, Dept. 6CR National Radio Institute, Pioneer Home Study Radio School, Washington 9, D.C.

Future for Trained Men is Bright in Radio, Television, Electronics

The Radio Repair business is booming NOW. There is good money fixing Radios in your spare time or own full-time business. Trained Radio Technicians also find wide-open opportunities in Police, Aviation, Marine Radio, in Broadcasting, Radio Manufacturing, Public Address work, etc.

Think of the boom coming now that new Radios can be made! Think of the backlog of business built up in ALL branches of Radio! Think of even GREATER opportu-

Our 32nd Year of Training Men for Success in Radio

Good for Both—FREE

MR. J. E. SMITH, President, Dept. 6CR National Radio Institute, Washington 9, D. C.

Mail me FREE, without obligation, Sample Lesson and 64-page book about how to win success in Radio and Television—Electronics. (No salesman will call. Please write plainly.)

Age

Name

Address

City State 4PR
(Please include Post Office Zone Number)

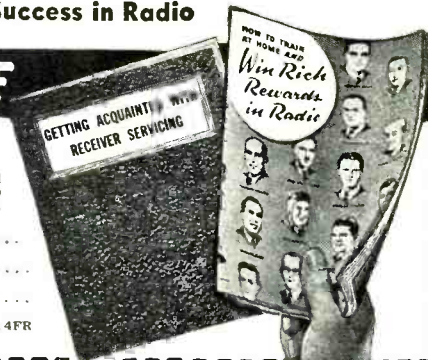

My Radio Course Includes TELEVISION • ELECTRONICS FREQUENCY MODULATION

AMATEUR

Low Power Aircraft Transmitter..... *Alvin B. Kaufman* 29
 V.H.F. Heterodyne Frequency Meter..... *A. A. Goldberg, W2HKU* 32
 350 Watt—5 Band Transmitter..... *Herbert S. Brier, W9EGQ* 40
 Home Built Signal Shifter..... *Sol Heytow, W9FAL* 48
 Milwaukee Hams Hold Contest..... *John H. Davis* 72
 Installation and Operation of V.H.F.
 Ground Transmitter and Receiving Station..... *Andrew R. Boone* 76

SERVICE

R. F. Probe Design..... *Donald F. McAvoy* 35
 Service Considerations in Megacycle Bands..... *C. J. Sheridan* 38
 Practical Radio Course..... *Alfred A. Ghirardi* 46
 Synchronizing and Separation Circuits..... *Edward M. Noll* 54
 Determining the Resistance of a Sensitive D. C. Meter..... *Guy Dexter* 80

GENERAL

For the Record..... *The Editor* 8
 Spot Radio News..... *F. D. Walker* 12
 Arctic Oil Exploration..... *John H. Roberts* 25
 The 1946 Radio Parade..... 30
 International Short-Wave..... *Kenneth R. Boord* 44
 Spotting Hurricanes and Thunderstorms by Radar..... *S. R. Winters* 45
 QTC..... *Carl Coleman* 51
 Radio Teletype in the AACS..... *Lt. Robert Lambe* 52
 What's New in Radio..... 62
 New Radio Dispatching System..... *John E. Hubel* 68
 Technical Book and Bulletin Review..... 84
 Within the Industry..... 106
 Manufacturers' Literature..... 130

EDITORIAL

OLIVER READ, W9ETI
Editor

WM. A. STOCKLIN
Ass't to the Editor

HAROLD S. RENNE
Technical Editor

RAY FRANK, W9JU
Amateur Radio

FRED HAMLIN
Washington Editor

E. H. SEHNERT
Chief Draftsman

R. S. KUPJACK
Staff Artist

ADVERTISING

L. L. OSTEN
Advertising Mgr.

JOHN A. RONAN, JR.
Midwest Adv. Mgr.

WM. L. PINNEY
Western Adv. Mgr.



Cover Photo

By ARTHUR HAUG

War veteran returns to his radio servicing profession. Using latest test equipment and knowledge obtained during his military service, finds himself better equipped to repair new radio and electronic equipment. Photograph was taken at the Triplett Electrical Instrument Company's plant in Ohio.

COPYRIGHT, 1946 ZIFF-DAVIS PUBLISHING COMPANY
 185 N. Wabash Ave., Chicago 1, Ill.

BRANCH OFFICES: NEW YORK, WASHINGTON, LOS ANGELES, TORONTO

WILLIAM B. ZIFF
Publisher

B. G. DAVIS
General Manager

C. R. TIGHE
Ass't to the Publisher

GEORGE BERNER
Advertising Director

HERMAN R. BOLLIN
Art Director

H. G. STRONG
Circulation Director

H. J. MORGANROTH
Production Director



RADIO NEWS is published monthly by the Ziff-Davis Publishing Company, 185 N. Wabash Ave., Chicago 1, Ill. Subscription Rates; in U. S. \$3.00 (12 issues), single copies 35 cents; in Mexico, South and Central America, and U. S. Possessions, \$3.00 (12 issues); in Canada \$3.50 (12 issues), single copies 40 cents; in British Empire, \$4.00 (12 issues); all other foreign countries \$4.00 (12 issues). Subscribers should allow at least 2 weeks for change of address. All communications about subscriptions should be addressed to: Director of Circulation, 185 N. Wabash Ave., Chicago 1, Ill. Entered as second class matter March 9, 1938, at the Post Office, Chicago, Illinois, under the Act of March 3, 1879. Entered as second class matter at the Post Office Dept., Ottawa, Canada. Contributors should retain a copy of contributions and include return postage. Contributions will be handled with reasonable care but this magazine assumes no responsibility for their safety. Accepted material is subject to whatever revisions and by-line changes that are necessary. Payment, made at our current rates, covers all authors', contributors', or contestants' rights, title, and interest in and to accepted material, including photos and drawings.

Other Ziff-Davis Publications: Radio & Appliances, Radio-Electronic Engineering, Plastics, Flying, Popular Photography

hallicrafters *new Model* S-40

New beauty and perfect ventilation in the perforated steel top

Separate electrical bandspread with inertia flywheel tuning.

Tuning range from 540 kc to 42 Mc continuous in four bands

Self-contained, shock mounted, permanent magnet dynamic speaker

All controls logically grouped for easiest operation. Normal position for broadcast reception marked in red, making possible general use by whole family.

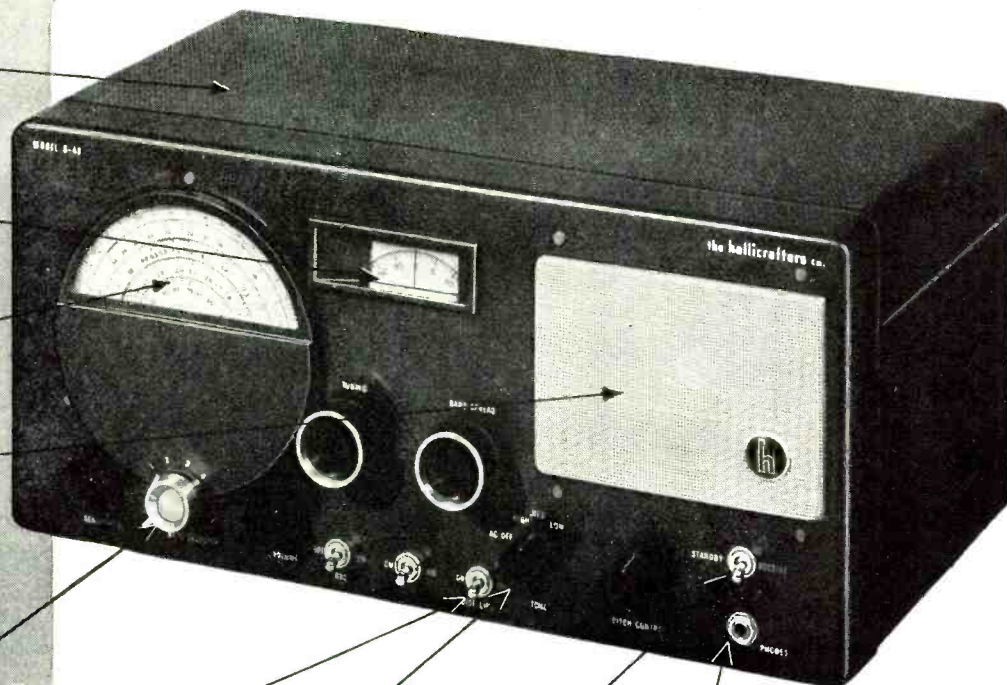

Automatic noise limiter

3-position tone control

Standby receive switch

Phone jack

(APPROXIMATELY)
New design, new utility in a great \$79⁵⁰
new communications receiver . . .

Here is Hallicrafters new Model S-40. With this great communications receiver, handsomely designed, expertly engineered, Hallicrafters points the way to exciting new developments in amateur radio. Read those specifications . . . it's tailor-made for hams. Look at the sheer beauty of the S-40 . . . nothing like it to be seen in the communications field. Listen to the amazing performance . . . excels anything in its price class. See your local distributor about when you can get an S-40.

INSIDE STUFF: Beneath the sleek exterior of the S-40 is a beautifully engineered chassis. One stage of tuned radio frequency amplification, the S-40 uses a type 6SA7 tube as converter mixer for best signal to noise ratio. RF coils are of the permeability adjusted "micro-set" type identical with those used in the most expensive Hallicrafters receivers. The high frequency oscillator is temperature compensated for maximum stability.

From every angle the S-40 is an ideal receiver for all high frequency applications.

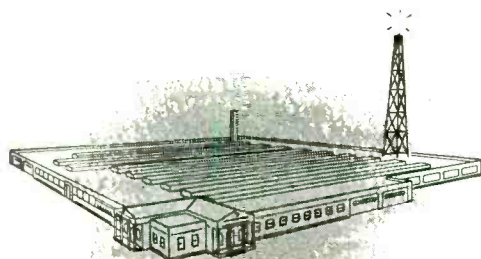

hallicrafters RADIO

THE HALLICRAFTERS CO., MANUFACTURERS OF RADIO AND ELECTRONIC EQUIPMENT, CHICAGO 16, U. S. A.

Sole Hallicrafters Representatives in Canada: Rogers Majestic Limited, Toronto - Montreal



COPYRIGHT 1945 THE HALLICRAFTERS CO.

March, 1946

**SALES
PROMOTION
BUILDS
FADA
sales!**

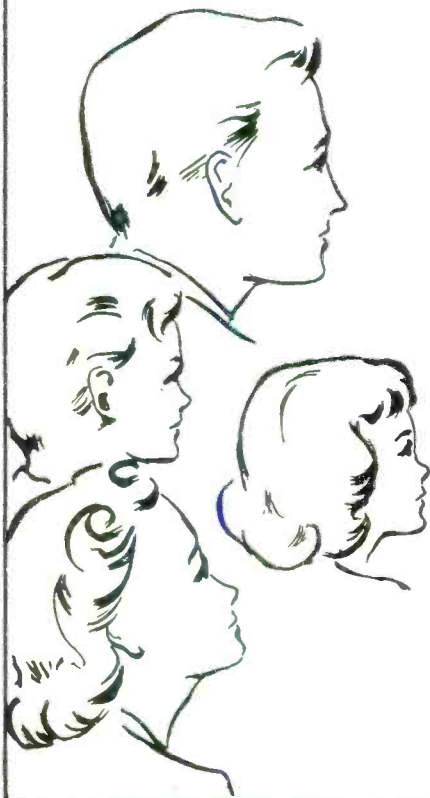

Yes . . . THERE'S MORE TO IT THAN MEETS THE EYE!
YOUR FADA DEALER FRANCHISE HAS AN INTRINSIC
VALUE THAT GROWS AND GROWS AS TIME GOES BY.

For the name FADA has been synonymous with the very best in radio since broadcasting began. And the cumulative good will; the pent-up public acceptance for FADA radios is carefully nurtured and cultivated by an ingenious, fertile sales promotion plan.

Here are some of the point-of-sale dealer helps already available:

- Colorful decalcomanias for windows and showrooms . . .
- Window streamers that bring prospective customers into your showrooms . . .
- Illuminated FADA NEON clocks and NEON signs that attract immediate attention . . .
- Sturdy, beautiful display stands to hold FADA Table model radios.

And there's more and more material ready—mats for newspaper advertisements . . . complete portfolios of glossy photographs and electros for use in your promotion.

All this is backed by a terrific consumer campaign in newspapers, magazines, billboards and radio. This constructive plan of promotion is designed to assure FADA dealers a steady, profitable volume of FADA sales!



YOU CAN ALWAYS DEPEND ON

**FADA
Radio**

Famous Since Broadcasting Began!

FADA RADIO AND ELECTRIC COMPANY, INC., LONG ISLAND CITY, N. Y.

RADIO NEWS

I'LL SHOW YOU HOW TO SUCCEED IN RADIO

Here's the right training for Big Post-War Pay!

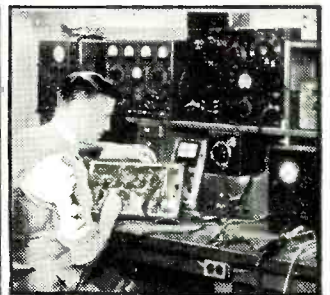

A RADIO SERVICE BUSINESS OF YOUR OWN

A GOOD JOB IN RADIO & TELEVISION BROADCASTING

RADIO-ELECTRONIC SERVICE ENGINEER



F. L. Sprayberry, one of the country's foremost Radio Teachers.

BE A RADIO-ELECTRONICIAN

NOW YOU CAN PREPARE AT HOME IN SPARE TIME FOR AMAZING OPPORTUNITIES AHEAD IN RADIO — ELECTRONICS — TELEVISION



I SUPPLY A FULL RADIO SET for practical easy LEARNING

SPRAYBERRY TRAINING GIVES YOU BOTH TECHNICAL KNOWLEDGE—SKILLED HANDS

There's only one right way to learn Radio Electronics. You must get it through simplified lesson study combined with actual "shop" practice under the personal guidance of a qualified Radio Teacher. It's exactly this way that Sprayberry trains you... supplying real Radio parts for learn-by-doing experience right at home. Thus, you learn faster, your understanding is clear-cut, you acquire the practical "know how" essential to a good-paying Radio job or a Radio business of your own.

I'll Show You a New, Fast Way to Test Radio Sets Without Mfg. Equipment

The very same Radio Parts I supply with your Course for gaining pre-experience in Radio Repair work may be adapted through an exclusive Sprayberry wiring procedure to serve complete, fast, accurate Radio Receiver trouble-shooting. Thus, under Sprayberry methods, you do not have one cent of outlay for manufactured Test Equipment which is not only expensive but scarce.

The offer I make you here is the opportunity of a lifetime. It's your big chance to get ready for a wonderful future in the swiftly expanding field of Radio-Electronics INCLUDING Radio, Television, Frequency Modulation and Industrial Electronics. Be wise! NOW'S the time to start. Opportunities ahead are tremendous! No previous experience is necessary. The Sprayberry Course starts right at the beginning of Radio. You can't get lost. It gets the various subjects across in such a clear, simple way that you understand and remember. And, you can master my entire course in your spare time. It will not interfere in any way with your present duties. Along with your Training, you will receive my famous BUSINESS BUILDERS which will show you how to make some nice profits while learning.

Prepares You for a Business of Your Own Or Good Radio Job

My training will give you the broad, fundamental principles so necessary as a background, no matter which branch of Radio you wish to specialize in. I make it easy for you to learn Radio Set Repair and Installation Work. I teach you how to install and repair Electronic Equipment. In fact, you'll be a fully qualified RADIO-ELECTRONICIAN, equipped with the skill and knowledge to perform efficiently and to make a wonderful success of yourself.

JUST OUT! FREE!

"How to Read Radio Diagrams and Symbols" a valuable new book which explains in simple English how to read and understand any Radio Set Diagram. Provides the quick key to analyzing any Radio circuit. Includes translations of all Radio symbols. Send for this FREE book now, and along with it I will send you another big FREE book describing my Radio-Electronic training.

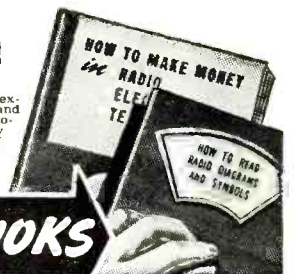

GET FREE BOOKS

Read What Graduate Says "One Job Nets About \$26.00"

"Since last week I fixed 7 radios, all good paying jobs and right now I am working on an amplifier system. This job alone will net me about \$26.00. As long as my work keeps coming in this way, I have only one word to say and that is, 'Thanks to my Sprayberry training,' and I am not afraid to boast about it."—ADRIEN BENJAMIN, North Grosvenordale, Conn.

DON'T PUT IT OFF!

Get the facts about my training—now! Take the first important step toward the money-making future of your dreams. All features are fully explained in my big, illustrated FREE Catalog which comes to you along with another valuable FREE book you'll be glad to own. Mail Coupon AT ONCE!

SPRAYBERRY ACADEMY OF RADIO
F. L. Sprayberry, Pres.
Room 2538
Pueblo, Colorado

Please rush my FREE copies of "HOW TO MAKE MONEY IN RADIO, ELECTRONICS and TELEVISION," and "HOW TO READ RADIO DIAGRAMS and SYMBOLS."

Name Age.....
Address
City State.....
Tear off this coupon, mail in envelope or paste on penny postcard.

AUDAX

RELAYED-FLUX
Microdyne

The Importance of SPECIALIZATION

Aside from outstanding and long-acknowledged technical skill—our “Specialization Formula” is probably as fully responsible for the world-renowned AUDAX quality as any other single factor.

We proudly concentrate all our energies and resources upon producing the BEST pick-ups and cutters. Because we are specialists in this field, much more is expected of us. Because the production of fine instruments like MICRODYNE is a full time job, it stands to reason that we could not afford to jeopardize our reputation—EVER—by making pick-ups a side-line.

Now that Victory is ours, you may expect AUDAX improvements, refinements . . . master-touches to heighten the marvelous facsimile realism of AUDAX reproduction.

AUDAX COMPANY
500-N Fifth Ave., New York 18, N.Y.

Creators of Fine Electronic-Acoustical Apparatus Since 1915

Send for complimentary copy of our informative

“PICK-UP FACTS”



“The Standard by Which Others Are Judged and Valued”



For the **RECORD.**

BY THE EDITOR

THE insatiable thirst for knowledge, for improvement, for answers to problems is a basic factor which makes America great. This urge will burst the bonds of any temporary condition which acts as a depressive on our economy.

We hear the ringing of a billion dollar school bell clearly above the tumult of strikes, unrest, dissatisfaction with things as they are. It's calling us forward to a new era of prosperity, better living through better understanding. We don't mean that this bell is ringing only for the hundreds of thousands who pour through the doors of our organized schools, colleges and universities. The call is reaching multitudes who have long since finished their formal schooling and now seek to add to their fund of knowledge in specialized fields.

During the war the “training within industry” program of the government developed crowded class rooms in the vast majority of industrial plants. There, executives, supervisors and workers alike thronged to learn more about subjects which were entwined with their daily lives.

Today we find industry spending millions of dollars on educational programs for men on their own staffs, wholesalers, retailers and consumers. The instruction includes better business methods, sales methods and utilization of products. Every known educational technique is employed, films, lectures, brochures, booklets. We are impressed by the broad gauge thinking behind these training programs.

A stirring example is to be found in the sales training course sponsored jointly by the Edison Electric Institute and the National Electrical Wholesalers Association. This course is still in preparation although the first part has been completed. It represents the expenditure of \$130,000 and the time and best thought of a committee of 22 men whose combined business brain power is unmeasurable. The sponsoring organizations are making the course available to any group of men who are willing to pay a share of the original cost of preparation.

We noted with interest the solemn warning issued at a preview of this course. “There is no known substitute for the school of hard knocks.”

In this statement we find an irrefutable law governing the application of any knowledge gained through any educational plan or program. We can go to school the rest of our lives, memorize the books and sturdily answer any question hurled at us from the books, but until we face reality in the application of the knowledge we have

acquired, such knowledge is valueless.

It's in the variants which result from application of knowledge that we discover a true education.

The “ham” who has learned the code never becomes a “ham” until after he spends hours on the air. The engineer who proudly flaunts his diploma is not truly an engineer until he applies his learning to doing. An ex-member of the Signal Corps can't exploit his training on radar or other electronic devices until he encounters the variants involved in peace-time electronic equipment. A salesman may know by heart the procedures and psychological factors which lead to conclusion of a sale, but until he has met rebuffs by the hundreds and learned the ways to adjust his knowledge to individual situations he may get very few names on the dotted line.

Yes, the thirst for knowledge is answering the gigantic clangor of our American school bell. This is our assurance of progress. If the students will but realize they have always to cross the lintel of the school of hard knocks after their text books are stowed away and make up their minds to “take it” no matter what the discouragements, we will continue as the leader of the world, the greatest nation in history. If we who study fail to face the coldness inherent in the practical application of all education we will have wasted our precious hours of educational acquisition.

We must apply our knowledge to really grow in intellectual stature.

WE'D suggest to ex-servicemen seeking employment in the radio industry that if you are making personal calls carry with you a neatly typed resumé of your background and experience. Set it up on an 8½”x11” sheet of white paper. You can have a quantity of these resumé forms prepared at reasonable cost by multi-graph or mimeograph at a local “letter shop.” Such shops are listed in classified telephone directories, usually under “Letter Service and Addressing.”

The resumé should include your name, address, phone number, complete educational background, schools attended, scientific and vocational subjects passed, business experience, army training and service, hobbies. Don't fold the sheets, carry them flat in a large envelope so they will be in perfect condition to leave with the person who interviews you.

If you are conducting a mail campaign be sure to enclose a resumé sheet with your letter. Type all letters or have them typed for you. . .OR

RADIO NEWS

For Earliest Delivery... ORDER YOUR NEW COMMUNICATIONS RECEIVER

Now from **ALLIED**

AVAILABLE ON
Time Payments
TRADE-INS ACCEPTED

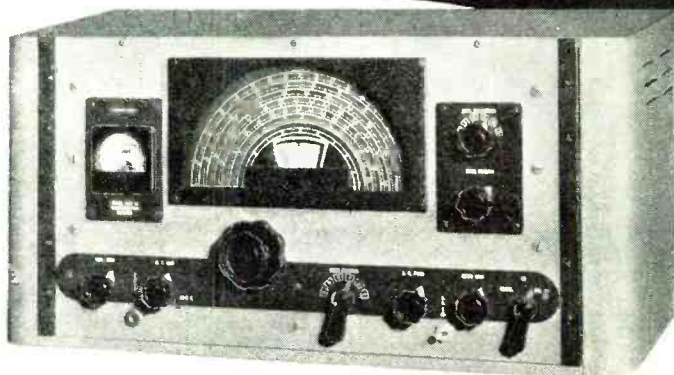

RME 45

The new RME 45 Receiver delivers peak reception on all frequencies—500 to 33,000 Kc. Full vision calibrated dial using one control for two-speed tuning. Five Amateur bands with ample band spread. DB calibrated signal level meter. 5 step variable crystal filter. Automatic Noise Suppression. Stable, variable pitch beat oscillator. Streamline cabinet with matching speaker. Net, with Speaker... \$166



HAMMARLUND HQ-129X

Designed to meet the most critical demands of professional operators. Full range .54 to 31 Mc., accurately calibrated. 4 calibrated Ham bands and one arbitrary scale. Variable selectivity crystal filter. Low drift beat oscillator for code and locating stations. Antenna compensator. Voltage regulation. Compensated oscillator to reduce drift during warm-up. Automatic noise limiter. Earphone jack. 3 i.f. amplifier stages. 2 audio stages. For phone or CW. Net..... \$129
Speaker, net..... \$10.50



HALLICRAFTERS S-40

Sensational new Hallcrafters receiver! Offers many advanced design and performance features at a popular price. Simple to operate. Frequency range 550 Kc. to 44 Mc. in 4 bands. Wide vision main tuning dial accurately calibrated. Separate electrical bandspread dial, inertia flywheel tuning. Beat frequency oscillator. A.V.C. switch. CW/a.m. switch. Standby/receive switch. Automatic noise limiter. Separate RF and AF gain controls. Three position tone control. "Micro-set" permeability adjusted coils in RF section. Internal dynamic speaker. Net..... \$79.50
(Subject to OPA approval)

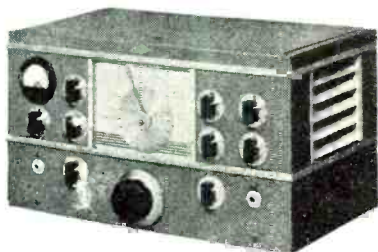

NATIONAL NC-2-40C

One of National's top receivers. 490 Kc. to 30 Mc. range in 6 tuning bands. Definite, accurate calibration for all bands. Actual single dial control. Stable high frequency circuits. Frequency drift reduction to a negligible value by temperature compensation. Automatic voltage stabilization. Wide range adjustable series-valve-noise limiter. Flexible crystal filter. Phonograph or high level microphone pick-up jack. Special r.f. coupling circuits maintain full sensitivity. Net..... \$225
Speaker in matching cabinet, net..... \$15.00

Other Communications Receivers

Hallicrafters SX-25.....\$94.50	Hallicrafters S-36A.....\$415.00
National HRO.....197.70	Hammarlund 400X.....318.00
RME DB-20 Preselector.. 59.30	Hammarlund 400SX.....318.00
Hallicrafters SX-28A.....223.00	Hallicrafters S-37.....591.75

Net, F. O. B. Chicago (All prices subject to change)

Free... SEND NOW FOR ALLIED'S NEW 1946 CATALOG

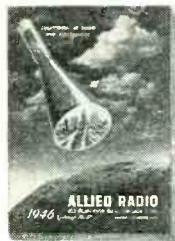

Here's your handiest, most complete 1946 Buying Guide for everything in radio! Includes latest communications receivers, Ham gear, code apparatus, parts, kits, tubes, tools, books, test instruments, public address and other equipment. 10,000 items at your finger tips... largest and most complete stocks under one roof. Nationally known makes. Fastest service—from one central source. Experienced staff of licensed radio amateurs to help you.

ALLIED RADIO CORP., D. L. Warner W91BC
833 West Jackson Blvd., Dept. 1-C-6
Chicago 7, Illinois

Please enter order for _____ Date.....
_____ Model.....
 Enclosed \$..... Full Payment
 Part Payment (Balance C.O.D.)
 Please send full information on Communications Receivers and Time Payment Plan, without obligation.
 Send FREE new 1946 Allied Catalog.

Name.....
Address.....
City..... Zone..... State.....

ALLIED RADIO

Everything in Radio and Electronics

833 West Jackson Blvd. • Chicago 7, Illinois



STAR NOW TEAMED



IMPORTANT!
 For Faster, Better and More Complete
 Service to All Customers,
Maguire Industries, Inc.,
formed its new
Electronic Distributor
and
Industrial Sales Department
 This New Department Will Assume All
Merchandising, Sales & Customer Relation
 Duties and Responsibilities Essential in
 Marketing the Combined Products of the
Thordarson, Meissner & Radiart Divisions

★ ★ ★

**ELECTRONIC DISTRIBUTOR AND
 INDUSTRIAL SALES DEPARTMENT**

PERFORMERS... TOGETHER!

ONE SALES SOURCE... ONE MARKETING RESPONSIBILITY
YOUR GUARANTEE OF BETTER SERVICE!



MEISSNER

COMPONENTS AND KITS

Meissner precision built components include Antenna, R.F. and Oscillator Coils; plastic, standard and Ferrocart Transformers; Cartwheel and replacement Windings; Coils, Chokes and Accessories.



MEISSNER ANALYST

SERVICE INSTRUMENTS

Meissner Analyst operates by the "signal tracing" method, fastest and most reliable. Furnished complete, ready to go to work. Portable Signal Calibrator designed for accurate checking and adjusting of radio equipment.



RADIART

RUST-PROOF AERIALS



RADIART RUST-PROOF AERIAL

A complete line of newly designed aerials to fit all cars; cowl, fender and under hood types. Featuring water-proofed leads, "static muffler" magic ring and permanent all metal anti-rattler.



VIBRATORS

Radiart Correct Replacement Vibrators are individually engineered to meet exactly the physical as well as the electrical requirements of each application.



THORDARSON

TRANSFORMERS

Quality built and precision-engineered for all requirements; replacement, communications, sound amplifier, industrial, experimental and amateur. Tropex-impregnated for protection against moisture, salt air and humidity.

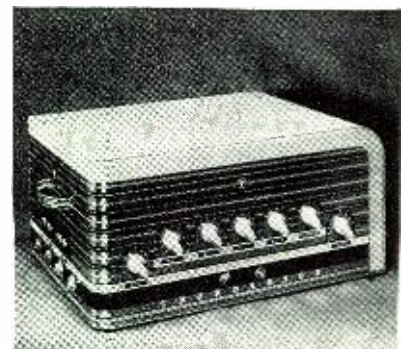

THORDARSON TRU-FIDELITY AMPLIFIER

TRU-FIDELITY AMPLIFIERS

True-Fidelity Amplifiers, in new modern designs, feature advanced tone compensation, conservative ratings, ample ventilation for continuous operation, low hum level, multiple input channels, and maximum flexibility of controls.

MAGUIRE INDUSTRIES, INC.

936 NORTH MICHIGAN AVENUE, CHICAGO 11, ILLINOIS

Designed for



Application

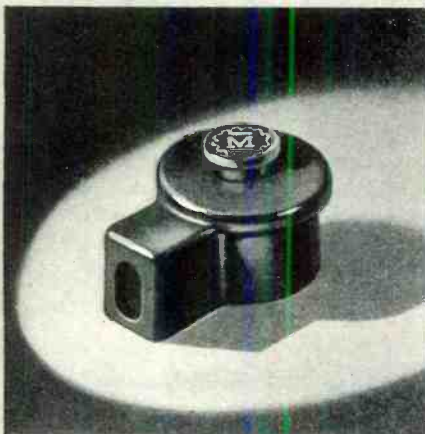

THE NO. 36011

Snap-Lock Plate Cap

For Mobile, Industrial and other applications where tighter than normal grip with multiple finger 360° low resistance contact is required, the new No. 36011, "Designed for Application" Plate Cap is now available. Contact self-locking when cap is pressed into position. Insulated snap button at top releases contact grip for easy removal without damage to tube. Molded black bakelite, to fit all tubes with 9/16" diameter contact ferrule.

**JAMES MILLEN
MFG. CO., INC.**

MAIN OFFICE AND FACTORY
**MALDEN
MASSACHUSETTS**



Spot Radio News

★ Presenting latest information on the Radio Industry.

By **F. D. WALKER**

Washington Reporter

A SURVEY CONDUCTED BY FCC for the Senate Small Business Committee discloses that the principal items of FM station equipment—transmitter, antenna, and control console—for operation in the new 88-108 mc. band will cost substantially less than estimates made for such equipment in the old 42-50 mc. band in 1944.

The probable prices of six major items of broadcast equipment for a 250 watt station range from a minimum of \$6,420 to a maximum of \$14,500; for a 1 kw. station, from \$10,020 to \$20,010; for a 3 kw. station, from \$12,420 to \$24,427; for a 10 kw. station, from \$22,020 to \$34,566; and for a 50 kw. station, from \$73,520 to \$85,110. The six items are transmitters (including patent royalties), antenna (but not supporting structures), control consoles, remote pick-up (wire line), turntables, and monitors.

As far as delivery dates are concerned, FCC reports that the transmitter deliveries will be the limiting factors, since antenna and consoles are available now. For orders placed in November, 1945, a transmitter for a 250 watt station can be obtained by June, 1946; for a 1 kw. station, by April, 1946; for a 3 kw. station, by May, 1946; for a 10 kw. station, by July, 1946; and for a 50 kw. station, by January, 1947. However, first deliveries on orders placed before Nov. 1, 1945, were made in January of this year for 250 watt stations and in February for 1 kw. stations. Other deliveries on orders placed before that date: 3 kw. station, May, 1946; 10 kw. station, June, 1946; 50 kw. station, August, 1946.

THE WAR DEPARTMENT has made available to U.S. industry, details of the assembly and use of a new German machine for recording code or voice messages on magnetic tape, and a description of the German Stereophon system for sound recording on film.

Experimental tests on the magnetic tape recorder indicate that it records code and voice messages very satisfactorily. However, attempts to record music with it have met with poor results. Since the amplifying equipment is reasonably good, it is assumed that this lack of fidelity is caused by characteristics of the magnetic tape. The equipment, which operates on a.c., is designed primarily for connection to a radio receiver for recording and to headphones for playback. The signal

from the receiver passes through an amplifier to the recording head, which magnetizes the coating on the tape.

The exact composition of the tape is not yet known. It appears to be a plastic composition, coated with material having high magnetic qualities. Though extremely thin, the tape is fairly strong and capable of being demagnetized and re-used many times without signs of wear or deterioration. The thinness of the tape permits a length of about 850 meters (about one-half mile) to be wound on a reel. That length provides a recording time of about 45 minutes at average ribbon speed.

An electronic oscillator is used to drive a synchronous motor to provide tape speeds which are continuously variable up to 120 centimeters per second. A ribbon speed of 18 centimeters per second is sufficient for recording most telegraphy signals, but a higher speed (about 72 centimeters per second) is recommended by the manufacturer for high-speed telegraphy or telephony. One of the interesting features of the machine is the pitch restoring head. This device, used when the tape is played back at speeds other than the recording speed, permits restoration of the original pitch.

The Stereophon system is reported to have the important advantage of giving excellent three-channel reproduction of great dynamic range and low noise level with the use of a sound track having a total width of only 2.65 millimeters. The recorder has a signal frequency range of 23 to 10,000 cycles; dynamic range of 60 decibels without resort to expansion and compression; distortion of less than 3 percent over the whole dynamic range; film noise of 70 decibels below the greatest amplitude; and a film velocity of 45 centimeters per second. Developmental work on the recorder began in 1938 and in 1942 it was converted by government order into an explosion power recorder, for which it is well suited.

A TENTATIVE PATTERN for the allocation of metropolitan and rural FM channels in the U. S. has been established by FCC. It does not include community stations, because it has not been considered practical to set up a basic allocation system for that type of station.

The number of channels indicated for each city, or area, normally ex-

RADIO NEWS

...100% Guaranteed



Marion Glass-to-Metal Truly Hermetically Sealed Electrical Indicating Instruments are 100% guaranteed for six months. After this period we will replace any 2½" or 3½" type, ranging from 200 microamperes upward, for a flat fee of \$1.50, regardless of whether the instrument has been overloaded, burned out, or in any way mistreated, provided the seal has not been broken. We will replace, for a flat fee of \$2.50, any 2½" or 3½" instrument, with sensitivity greater than 200 microamperes, under similar circumstances.

An important blanket guarantee...

For the user of electrical indicating instruments, this guarantee is highly significant. It precludes the need for him to maintain his own repair department, and it minimizes the correspondence and red tape that formerly enmeshed most replacement transactions. Moreover, he is assured of receiving his replacement within a reasonably short period at a saving of considerable time and money. It is our faith in the quality and performance of Marion "hermetics" that prompts us to make this guarantee which is offered to customers in all parts of the world. You can buy and use them with confidence.

**Marion Glass-to-Metal Truly Hermetically Sealed
2½" and 3½" Electrical Indicating Instruments**

Ready soon - the new Marion Catalog, containing information of value to all users of electrical indicating instruments. Reserve your copy now.



MARION ELECTRICAL INSTRUMENT CO.
MANCHESTER, NEW HAMPSHIRE
EXPORT DIVISION
452 BROADWAY - NEW YORK 13, N. Y., U. S. A.
CABLES: MORHAWER

THE ORIGINAL SPINTITE

WORKS LIKE A SCREW DRIVER
Speeds Production!

Standard Sizes, Hex, Square or Knurled, Chuck Type with many Tools for many uses Radio and Electrical Shops Need them

SPINTITE T-8 SET With Stand
7 Popular Sizes Plastic Handles

WALDEN WORCESTER WRENCHES

Send for Catalog No. 141 picturing a full line of Automobile, Aircraft and Radio Tools.

STEVENS WALDEN, INC.
468 SHREWSBURY STREET
WORCESTER, MASSACHUSETTS

ceeds the number of existing AM stations by 50 to 100 per-cent. The allocation plan uses as a basis, an effective radiated power of 20 kilowatts and antenna height of 500 ft. above average terrain. The separation of co-channel stations varies from that required by ground wave interference (principally in the Eastern U. S.) to the separation required for freedom from tropospheric interference 1 per-cent of the time or less. The FCC points out it is probable that many of the service areas which are being determined for these cities may exceed or be less than that provided by this power and antenna height, and accordingly interference may be more or less than that now considered.

In general, the separation of stations increases toward the western part of the U. S. where the expected demand for channels will be less and where added protection for weak signals will be provided. Since in many cases it is likely that the service areas established will be smaller than those provided by 20 kw. effective radiated power and 500 ft. antenna heights, the number of metropolitan channels available for assignment may be increased.

It also is probable, FCC reports, that many existing standard broadcast channels, increasing the number of unused metropolitan channels in an area. Ten community channels may provide as many as five such assignments in some cities, depending upon the demand for such facilities. Only a few channels have been designated for a number of small cities, particularly in the west, since it appears that this would supply the probable demand. In such cases, of course, more channels are available for assignment and will be provided where required.

In several instances there appears a lack of sufficient channels to meet the probable need for assignments. When the demand grows in these areas, it is usually possible to re-allocate channels from adjacent areas where the demand is less and where service may already be sufficient. As a result, a lack of channel listing for a particular locality does not necessarily mean that a channel cannot be made available there, should the need develop. The FCC emphasizes that this plan is a guide to the manner in which FM channels can be expected to be allocated, but the allocation pattern is tentative only. Channels listed for particular cities and their areas will not be followed in a hard and fast manner; departures will be made from the plan wherever it is desirable or necessary.

RADIO LISTENING POSTS which systematically searched the air waves over the Atlantic ocean played a major part in the defeat of the German U-boat menace by providing the Navy with a day-by-day account of the

movement of enemy submarines. Known technically as HF/DF, or high frequency radio direction finders, the electronic equipment was housed in stations dotting the coastline on both sides of the Atlantic and also in mid-ocean islands, such as Ascension Island.

This network of direction finder stations continually searched the air waves for enemy submarine broadcasts, noted their bearings, and then fixed the position of the subs by determining their bearings from several widely-separated shore stations. These fixes were correlated and radioed daily to ships in the Atlantic and were supplemented by additional bearings taken by warships in the immediate vicinity of the broadcasting subs. This continual plotting of subs in the Atlantic enabled the Navy to reroute convoys so they could avoid individual subs or "wolfpacks" lying in wait. More important, these fixes enabled carriers and warships of the U. S., the British and Canadian fleets to locate and sink enemy subs. The Navy spent approximately \$2,000,000 on the program in the Atlantic.

Besides its use in the detection of submarines, HF/DF also was employed to locate downed U. S. aircraft in cooperation with the Coast Guard's air-sea rescue service. The principle here was the same as in the detection of enemy craft, the taking of cross radio bearings on the aircraft in trouble. High frequency radio direction finders also were used to locate enemy radar. Other uses of HF/DF are as counter measures equipment, radio intelligence monitors, trackers for radio controlled weapons and planes, navigational aid for ships and planes, air-sea rescue equipment, and in meteorological work.

THE CHANNELS OR FREQUENCY BANDS available for television broadcast stations are as follows: Channel one, 44-50 mc.; channel two, 54-60 mc.; channel three, 60-66 mc.; channel four, 66-72 mc.; channel five, 75-82 mc.; channel six, 82-88 mc.; channel seven, 174-180 mc.; channel eight, 180-186 mc.; channel nine, 186-192 mc.; channel ten, 192-198 mc.; channel eleven, 198-204 mc.; channel twelve, 204-210 mc.; channel thirteen, 210-216 mc.

Channels 1 through 5 and 7 through 13 are available for assignment to radio services other than television, if it can be shown that no interference will result. Channels 2 through 13 are available for assignment to rural stations, but FCC has not determined the service area of rural stations. Channel 1 is assigned exclusively for community stations. Channels 2 to 13, inclusive, can also be used for community stations, provided a sharing arrangement can be worked out. Metropolitan stations may be assigned to television channels 2 through 13. They are designed primarily to serve a single

(Continued on page 129)



More Alliance phonomotors are running turntables, record changers and radio tuning controls than any other kind!

One reason is because they've always given maximum trouble-free service. Another reason why they dominate the radio industry year after year is because Alliance combines quantity production, precision engineering, and low unit cost.

That's why not only the leading manufacturers prefer Alliance motors . . . but why jobbers, retailers and service shops want them for the replacement market, too!

The New Model 80 "Even-Speed"

Alliance phonomotor shown here is just one of several precision built motors now made by Alliance. It will operate on 110 or 220 volts, 50 or 60 cycles, at 16-watt input. Motor and idler plate are shock mounted, fan ventilation insures cool running, and larger bearings with ample oil reservoirs prolong life. Available with 8, 9 or 10 inch turntable top.

New Uses—Shaded pole, continuous and intermittent duty motors with design variations are now made for radio and electronic control devices, and for actuation of automatic dispensers, push-button controls, toys, motion displays, valves, fans, and heating controls.

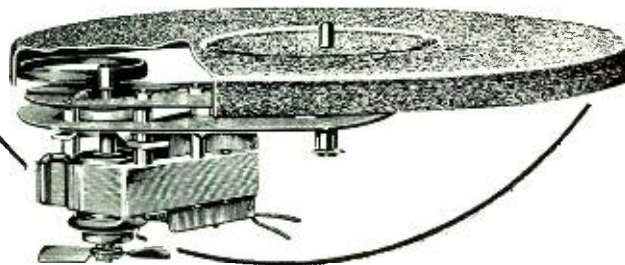

WHEN YOU DESIGN—KEEP

alliance
MOTORS IN MIND

ALLIANCE MANUFACTURING COMPANY • ALLIANCE, OHIO

ALLIANCE TOOL AND MOTOR LTD., TORONTO 14, CANADA



Wave Makers

"A leaping trout awakens the still pool to life in waves that move in silent rhythm."

In the same way, when you speak over the telephone, vibrating electric currents speed silently away with the imprint of your voice over the wire and radio highways of the Bell System.

Tomorrow, the vibrations will be the living pictures of television. All are examples of wave motion.

How to produce, transmit and receive electrical wave motion is the basic problem of the communication art.

Bell Telephone Laboratories, which exist primarily to invent and

develop better communications for the Bell System, devote the teamed efforts of physicists and mathematicians to the production and control of electric waves in all forms.

Out of these fundamental studies have come the discoveries which keep the Bell System at the forefront of the communication art.



BELL TELEPHONE LABORATORIES

EXPLORING AND INVENTING, DEVISING AND PERFECTING, FOR THE CONTINUED IMPROVEMENT OF TELEPHONE SERVICE
March, 1946

17

RCA-815—push-pull beam-power tube. A hot type for all three bands.

RCA-829-B—push-pull beam-power tube. Full output to 200 Mc.

RCA-832-A—push-pull beam-power tube. Ideal for UHF.

RCA-1624—companion to RCA-807, but with 2.5 v. quick-heating filament.

RCA-807—single beam-power tube. A favorite for 28 and 50 Mc.

RCA-813—the "big brother" of the beam-power tube family.

6

OUTSTANDING

RCA BEAM POWER TUBES

for Current Amateur Bands

Whether you intend working 28, 50 or 144, the beam-power principle will provide you with more sock for less money

AS A GROUP, RCA beam-power tubes require less drive and deliver more output at lower plate voltage, than any other representative type of transmitting tube. You get the same results with fewer stages, smaller tubes and a less elaborate power supply.

Moreover, it is seldom necessary to neutralize a beam-power stage, which means that you can build a multi-band transmitter capable of quick band changing without re-neutralizing for each frequency.

Remember, too, that the unusual characteristics of beam-power tubes make them efficient as modulators, frequency doublers and modulated finals.

The Fountainhead of Modern Tube Development is RCA

COMPARATIVE TECHNICAL DATA*
(R-F Amplifier, Class C. Telegraphy, CCS)

Tube Type No.	Plate Watts	Driv. Pow. at Tube	Max. Rat. Freq. Mc.	Plate Volts	Amateur Net Price
807	60	0.2	60	500	\$1.95
813	360	0.5	30	2000	18.00
815	60	0.2	125	400	4.50
829-B	120	0.7	200	500	17.00
832-A	36	0.2	200	500	13.00
1624	54	0.5	60	600	2.40

*For detailed operating conditions, see the Radio Amateur's Handbook or the RCA Transmitting Tube Guide



TUBE DIVISION

RADIO CORPORATION of AMERICA

HARRISON, N. J.

SOON WE'LL PHONE HOME FROM AUTO

RADIO INDUSTRY POISED FOR BIG BOOM

Big Boom in FM Broadcasting

MARKET FOR 100 MILLION RADIOS REVEALED BY PENNSYLVANIA SURVEY

COAST TO COAST NETWORK BEING PLANNED FOR FM

Let TODAY'S HEADLINES Guide You to TOMORROW'S OPPORTUNITIES

Learn RADIO ELECTRONICS DeFOREST'S MODERN "A-B-C" WAY .. at Home

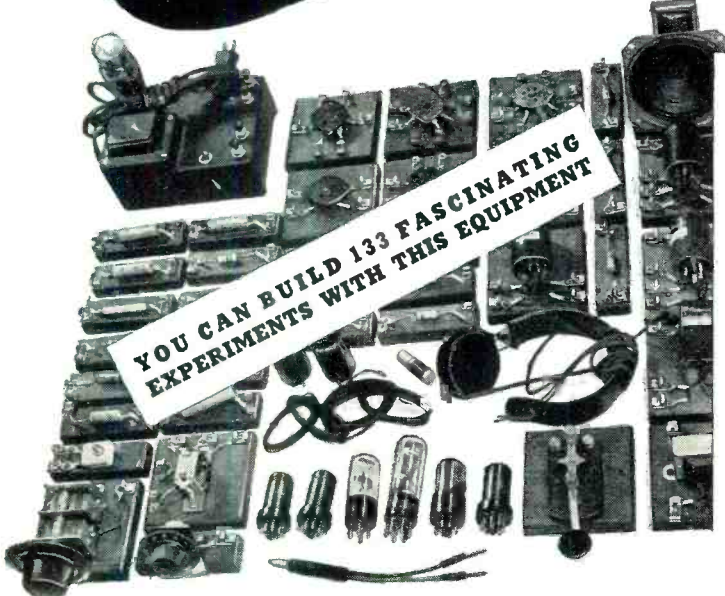

YOU CAN BUILD 133 FASCINATING EXPERIMENTS WITH THIS EQUIPMENT

Plan your future the way business men do: Watch the headlines! Pick a field that's "in the news"—one with many opportunities for interesting, PROFITABLE EMPLOYMENT or a good chance for establishing a BUSINESS OF YOUR OWN with little capital. Pick a field that offers a variety of interesting opportunities—a field with one of America's most promising futures . . . and see how you may MAKE YOUR START TOWARD A PLACE IN THIS FIELD BEFORE JOB COMPETITION BECOMES ACUTE. Write for DeForest's Big, Free, Illustrated Book—"VICTORY FOR YOU." Learn how DeForest's prepares you at home, in your leisure time—without interfering with the work you are now doing—then helps you make your start in the vast BILLION DOLLAR Radio-Electronics field.

You Get EMPLOYMENT SERVICE

DeForest's Employment Service offers you the advantage of long and favorable contacts with some of America's foremost Radio-Electronics concerns. "VICTORY FOR YOU" tells you how this Service has helped many to their start in Radio-Electronics. You'll see how DeForest students and graduates are prepared to win and to hold good paying jobs—how DeForest students start businesses of their own with little, if any, capital.

A You "LEARN-BY-DOING" at Home with Practical Equipment

Enjoy a "Home Laboratory." DeForest's provides 8 BIG KITS OF RADIO ASSEMBLIES AND PARTS to give you valuable practical experience at home. Build modern Radio Receivers and Circuits that operate. Build Electric Eye Devices, an Aviation Band Receiver, a Public Address System, a Wireless Microphone and numerous other fascinating experiments—in fact, 133 in all, in your spare time at home. NEW colorful Kit Supplement tells you about DeForest's "Home Laboratory," and how you use valuable Radio parts and sub-assemblies to get real practical experience as you learn.

VETERANS!

Big things are happening at DeForest's for veterans! See how we can prepare you without cost for a GOOD JOB or a BUSINESS of your own in the vast Radio-Electronic opportunity field.

C WELL-ILLUSTRATED LOOSE-LEAF LESSONS

DeForest's provides 90 loose-leaf lessons prepared under the supervision of the man often referred to as the "Father of Radio"—Dr. Lee DeForest, inventor of the Audion Tube, and holder of over 300 important patents. . . . ACT PROMPTLY! See how you can learn Radio the

modern A-B-C DeForest's way—by Reading . . . by Doing . . . by Seeing at Home. Mail coupon Now!

B Home MOVIES Help You Learn FASTER...EASIER

With DeForest's, you use a genuine DeVRY 16 mm. Motion Picture Projector and exciting training films to help you learn some of Radio's fundamentals FASTER . . . EASIER. SEE what happens inside of many circuits you are working on. SEE how electrons function. SEE how RADIO waves are changed into sound. Get DeForest's big, free book! Use it as a key to show you the way to Radio-Electronics job opportunities of today and tomorrow—the opportunities the headlines tell about.

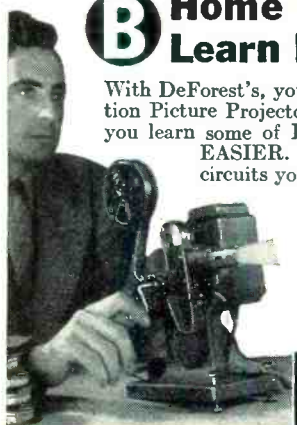

SEND FOR FREE BOOK & SUPPLEMENT TODAY!

DeFOREST'S TRAINING INC., Chicago, Ill.

DeFOREST'S TRAINING, INC., 2533-41 N. Ashland Ave., Dept. RN-C3 Chicago 14, Illinois, U. S. A. Send me both your big book "VICTORY FOR YOU" and Kit Supplement, showing how I may make my start in Radio-Electronics with your modern A-B-C home training plan. No obligation.



Name _____ Age _____
Address _____
City _____ Zone _____ State _____
 If under 16, check here for special information. If a discharged veteran of World War II, check here.

DON'T SETTLE FOR LESS THAN:

THE MOST

Complete!

There are three essentials to the successful operation of any radio repair shop: 1. Competent personnel; 2. Good test equipment; 3. Complete service data. All are of equal importance, so don't compromise with quality in your manuals, don't settle for less than the most complete source of authorized information. Remember, if you are called upon to service any and all models of radio receivers, only Rider Manuals can meet your needs.

Rider Manuals represent the only single source upon which you can depend for all the information you need on such vital material as receiver schematics, voltage data, alignment data, resistance values, chassis layouts and wiring, trimmer connections — in fact all the things that lead to quick diagnosis of troubles in ailing receivers.

—And they're complete! Since the publication of Volume I over 42,000 models have been covered—only Rider Manuals contain wiring diagrams on Scott receivers. (These diagrams were received officially from the E. H. Scott Radio Labs., Inc.)

So, see your jobber and place your order today to guarantee fastest possible delivery.

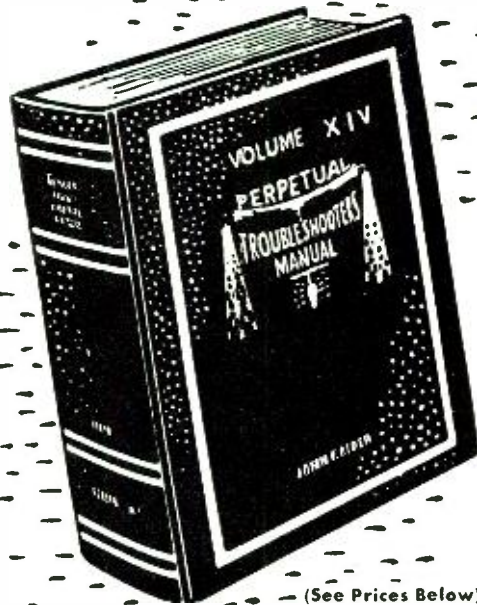

(See Prices Below)

GET ON THE MAILING LIST FOR "SUCCESSFUL SERVICING"

A monthly paper, dedicated to the financial and technical advancement of the electronic and radio maintenance man. Free distribution—Just

MAIL COUPON

JOHN F. RIDER PUBLISHER, INC.
404 (b) FOURTH AVE., NEW YORK, N. Y.

NAME _____

ADDRESS _____

CITY _____

STATE _____

YOU MUST STUDY TO KEEP UP TO DATE

Just Out "INSIDE THE VACUUM TUBE"...424 Pages, \$4.50

RIDER MANUALS (14 VOLUMES)
 Volumes XIV to VII . . . \$12.50 each volume
 Volume VI . . . 9.50 each volume
 Abridged Manuals I to V
 (1 volume) \$15.00
 Automatic Record Changers and
 Recorders 7.50
 The Cathode Ray Tube at Work
 Accepted authority on subject 4.00

Frequency Modulation
 Gives principles of FM radio \$2.00
 Servicing by Signal Tracing
 Basic Method of radio servicing 4.00
 The Meter at Work
 An elementary text on meters 2.00
 The Oscillator at Work
 How to use, test and repair 2.50
 Vacuum Tube Voltmeters
 Both theory and practice 2.50

Automatic Frequency Control Systems
 —also automatic tuning systems . . \$1.75
 A-C Calculation Charts
 Two to five times as fast as slide rule . 7.50
 Hour-A-Day-with-Rider Series—
 On "Alternating Currents in Radio Receivers"
 On "Resonance & Alignment"
 On "Automatic Volume Control"
 On "D-C Voltage Distribution" . . 1.25 each

JOHN F. RIDER PUBLISHER, INC. 404 FOURTH AVE., N. Y. 16, N. Y.

Export Division: Rocke-International Electric Corp. 13 E. 40th Street, New York Cable: ARLAB

—and Don't Forget

RIDER MANUALS

are Now Complete in 14 Volumes

They Provide Schematics and Essential Servicing Data on American Made Radio Receivers.

PLEASE PLACE YOUR ORDER WITH YOUR REGULAR RADIO PARTS JOBBER. IF YOUR LOCAL JOBBER CANNOT SUPPLY YOU, KINDLY WRITE FOR A LIST OF JOBBERS IN YOUR STATE WHO DO DISTRIBUTE OUR INSTRUMENTS OR SEND YOUR ORDER DIRECTLY TO US.



The New Model CA-11 SIGNAL TRACER

Simple to operate . . . because signal intensity readings are indicated directly on the meter!

Essentially "Signal Tracing" means following the signal in a radio receiver and using the signal itself as a basis of measurement and as a means of locating the cause of trouble. In the CA-11 the Detector Probe is used to follow the signal from the antenna to the speaker — with relative signal intensity readings available on the scale of the meter which is calibrated to permit constant comparison of signal intensity as the probe is moved to follow the signal through the various stages.

Features:

- ★ SIMPLE TO OPERATE — only 1 connecting cable — NO TUNING CONTROLS.
- ★ HIGHLY SENSITIVE — uses an improved Vacuum Tube Voltmeter circuit.
- ★ Tube and resistor-capacity network are built into the Detector Probe.
- ★ COMPLETELY PORTABLE — weighs 5 lbs. and measures 5" x 6" x 7".
- ★ Comparative Signal Intensity readings are indicated directly on the meter as the Detector Probe is moved to follow the Signal from Antenna to Speaker.
- ★ Provision is made for insertion of phones.

The Model CA-11 comes housed in a beautiful hand-rubbed wooden cabinet. Complete with Probe, test leads and instructions.....Net price

\$18⁷⁵

The New Model 450 TUBE TESTER

Specifications:

- Tests all tubes up to 117 Volts including 4, 5, 6, 7, 7L, Octals, Loctals, Bantam Junior, Peanut, Television, Magic Eye, Hearing Aid, Thyratrons, Single Ended, Floating Filament, Mercury Vapor Rectifiers, etc. Also Pilot Lights.
- Tests by the well-established emission method for tube quality, directly read on the scale of the meter.
- Tests shorts and leakages up to 3 Megohms in all tubes.
- Tests individual sections such as diodes, triodes, pentodes, etc., in multi-purpose tubes.
- New type line voltage adjuster.
- NOISE TEST: Tip jacks on front panel for plugging in either phones or external amplifier will detect microphonic tubes or noise due to faulty elements and loose internal connections.
- Works on 90 to 125 Volts 60 Cycles A.C.



SPEEDY OPERATION assured by newly designed rotary selector switch which replaces the usual snap, toggle, or lever action switches.

The model 450 comes complete with all operating instructions. Size 13" x 12" x 6". Net weight 8 lbs. **\$39⁵⁰** Our Net Price.....

The Model PB-210 MULTI-METER

Features:

- ★ SPEEDY!
- ★ PUSH-BUTTON OPERATION!

Measures:

- ★ A.C. Volts
- ★ D.C. Volts
- ★ D.C. Current
- ★ Low Resistance
- ★ High Resistance
- ★ High Resistance
- ★ Low Capacity
- ★ High Capacity
- ★ Decibels

Specifications:

5 A.C. VOLTAGE RANGES: 0 to 10/50/250/500/1000 Volts
 5 D.C. VOLTAGE RANGES: 0 to 10/50/250/500/1000 Volts
 5 OUTPUT METER RANGES: 0 to 10/50/250/500/1000 Volts
 4 D.C. CURRENT RANGES: 0 to 1/10/100 Ma. 0 to 1 Amp.
 2 CAPACITY RANGES: .0005 Mfd. to .3 Mfd. .25 Mfd. to 100 Mfd.
 3 DECIBEL RANGES: —10 to +15; +10 to +35; +30 to +55
 4 RESISTANCE RANGES:
 0 to 2,000/20,000/200,000 Ohms. 0 to 20 Megohms

Model PB-210 comes housed in hand-rubbed oak portable cabinet, complete with cover, self-contained battery, test leads and instructions. Net Price.....

\$35⁷⁵



SUPERIOR INSTRUMENTS CO.

Dept. RN 227 FULTON ST., NEW YORK 7, N. Y.

RADIO NEWS

Grasp the **NEW OPPORTUNITIES** in

RADIO ELECTRONICS AND TELEVISION NOW!

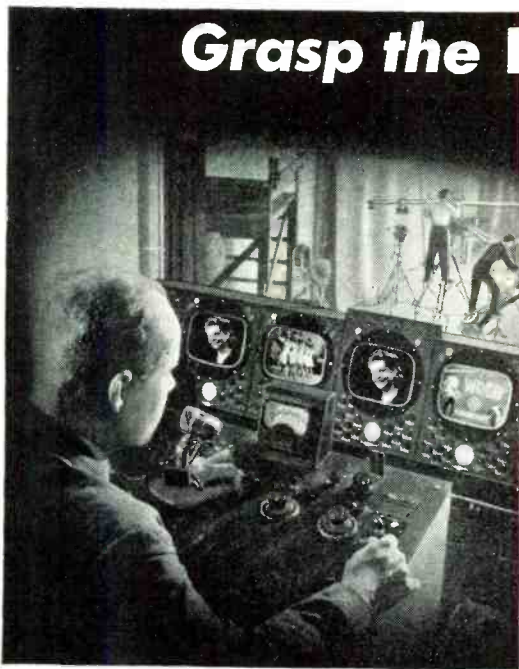

Modern Radio—FM broadcast and reception—
Television — Radar — Industrial Electronics;
power, control, communications — new equip-
ment and methods demand new technical ability
and experience. Keep up to date with the latest

MODERN ELECTRONIC LABORATORY FOR YOU TO USE AND KEEP



The very essence of National Shop Method Home Training is **EXPERIENCE**. You get the actual experience by working with modern Radio and Electronic equipment—building circuits and instruments. You may build a fine, long distance **MODERN SUPERHETERODYNE**, signal generator, miniature radio transmitter, audio oscillator—many other full sized, actual, operating pieces of equipment and instruments—conduct cathode ray and hundreds of other experiments. This experimental laboratory work advances with your training and you actually *learn by doing*. Send the coupon and get the full details of how such an offer can be made.

SEE WHAT NATIONAL TRAINING HAS DONE FOR THESE MEN!

National Shop Method Home Training wins good jobs, independence and security quickly. Take the word of National men who have established records in their favorite Radio, Television, or other branches of Electronics:



Joseph Grumich, Lake Hiawatha, New Jersey writes: "My latest offer was \$5,800.00 as Radio Photo Engineer but I'm doing well where I am now engaged. I am deeply indebted to National."

Here's a statement from R. R. Wright, Blackfoot, Idaho: "Due to my training at National I was selected to instruct in the laboratory work of Navy and Marines."



From O. K. Ivey, Washington, D. C., comes this endorsement: "I believe National offers the best course to be had. Keep up the good work."

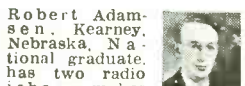

Robert Adamson, Kearney, Nebraska, National graduate, has two radio jobs — makes double pay as a radio instructor and as engineer at Station KGFV. He writes: "I am proud of My National training and appreciate the cooperative spirit."

Read what hundreds of other enthusiastic students have written about National Training. Send in your coupon today.

SHOP METHOD HOME TRAINING

By a Great Established Resident School

Get one of the thousands of **NEW JOBS** that demand new techniques and methods in modern radio. Get your share of the **NEW BUSINESS** that servicing the new sets and equipment demands. Experts agree that Radio Television and Electronics presents the next great industrial boom!

Radio is expanding farther and faster than ever with great improvements in reception. Radar is already a 2-billion-dollar-a-year business. No one knows yet how great the Television market will be. Electronics touches almost every walk of life—in industry and in the home.

TURN YOUR INTEREST IN RADIO INTO A CAREER THAT WILL ASSURE YOUR SUCCESS. Mail the coupon below for a list of the great opportunities in this field—today and in the near future.

Get the Proper Training

The good jobs in Radio Electronics now go to the men who are equipped to handle them. It takes training and experience. **National Schools**, one of the oldest and best established technical trade schools in the country, makes it possible for you to get this training and experience right in your own home **IN YOUR SPARE TIME**.

National maintains one of the biggest resident training shops and laboratories in the United States where instructors, scientists and engineers are working constantly to improve and advance training methods. **SHOP METHOD HOME TRAINING** is a logical extension of this practical system.

A **FREE** lesson that shows you how practical and systematic—how sound, simple and easy this new training method is will be sent you without obligation. You may keep and use this lesson as you see fit. Fill out and mail the coupon below.

Investigate this Proposition
Where do you stand today in modern industrial progress? What does the future hold for you? You owe yourself this opportunity. It may never come again. With National training **YOU GET AHEAD FAST**—you may step into a good position or start a business of your own, with little or no capital, even before you complete your National course.

Fit yourself for a career of independence, good earnings, a lifetime of success and security in one of the fastest growing fields in the World. But make up your own mind. Get the information first hand. Put your name and address on the coupon and mail it today.

Get this Book FREE

This big book presents the facts about the field of electronics and your opportunities in it together with full information about the advanced National Training. Read it and make up your own mind that National Training will equip you for a great future. No salesman will call on you from National. The book is **FREE** with your sample lesson. Send the coupon or write.



FREE LESSON



NATIONAL SCHOOLS

LOS ANGELES 37, CALIFORNIA EST 1905



MAIL OPPORTUNITY COUPON FOR QUICK ACTION

National Schools, Dept. RN-3
4000 South Figueroa Street, Los Angeles 37, California

(Mail in envelope or paste on penny post card)

Mail me **FREE** the two books mentioned in your ad including a sample lesson of your course. I understand no salesman will call on me.

NAME AGE

ADDRESS

CITY STATE

Include your zone number

Another New Jensen Coaxial

... WITH Compression-type HIGH-FREQUENCY SPEAKER

This new postwar PM Coaxial—with Alnico 5 design in both h-f and l-f units—is a fitting companion to the model with field coil l-f unit previously announced.

Like its field coil counterpart, this new PM Speaker combines in one coaxial assembly a horn-type h-f speaker with a cone-type l-f unit. The cone of the l-f unit forms a part of the h-f horn, thereby dispensing with a separate horn. An integral two-channel network gives the desired cross-over.

Distribution characteristics of this Coaxial are excellent and, when installed in a suitable enclosure such as a Bass Reflex cabinet, its performance covers the entire useful frequency range.

This new model is now being tooled for production and, when ready, complete specifications and prices will be issued to the trade in Data Sheet TD-132.

TYPE HNP-50 (15-inch) Alnico 5 design in both l-f and h-f units. Power rating, 25 watts maximum, in speech and music systems. Input impedance 16 ohms. List price approximately \$125.



Jensen
SPEAKERS
WITH
ALNICO 5

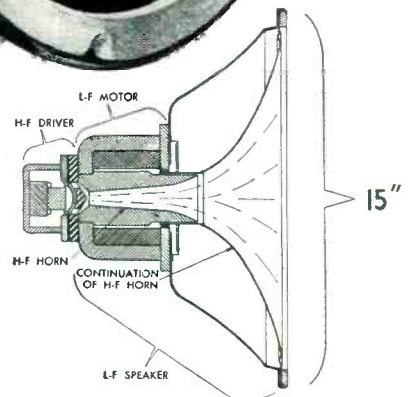

TYPE HNF-50 (15 inch) Alnico 5 design h-f unit; field coil l-f unit. Power rating 25 watts maximum, in speech and music systems. Input impedance 16 ohms. Field 14 to 20 watts. List price approximately \$100.

OTHER COAXIALS NOW AVAILABLE

* See No. 3 JENSEN Monograph: "Frequency Range in Music Reproduction," for discussion of useful frequency ranges.

JENSEN RADIO MANUFACTURING CO., 6617 South Laramie Ave., Chicago 38, Ill.

In Canada: Copper Wire Products, Ltd., 137 Oxford Street, Guelph, Ontario.

Specialists in Design and Manufacture of Fine Acoustic Equipment

RADIO NEWS

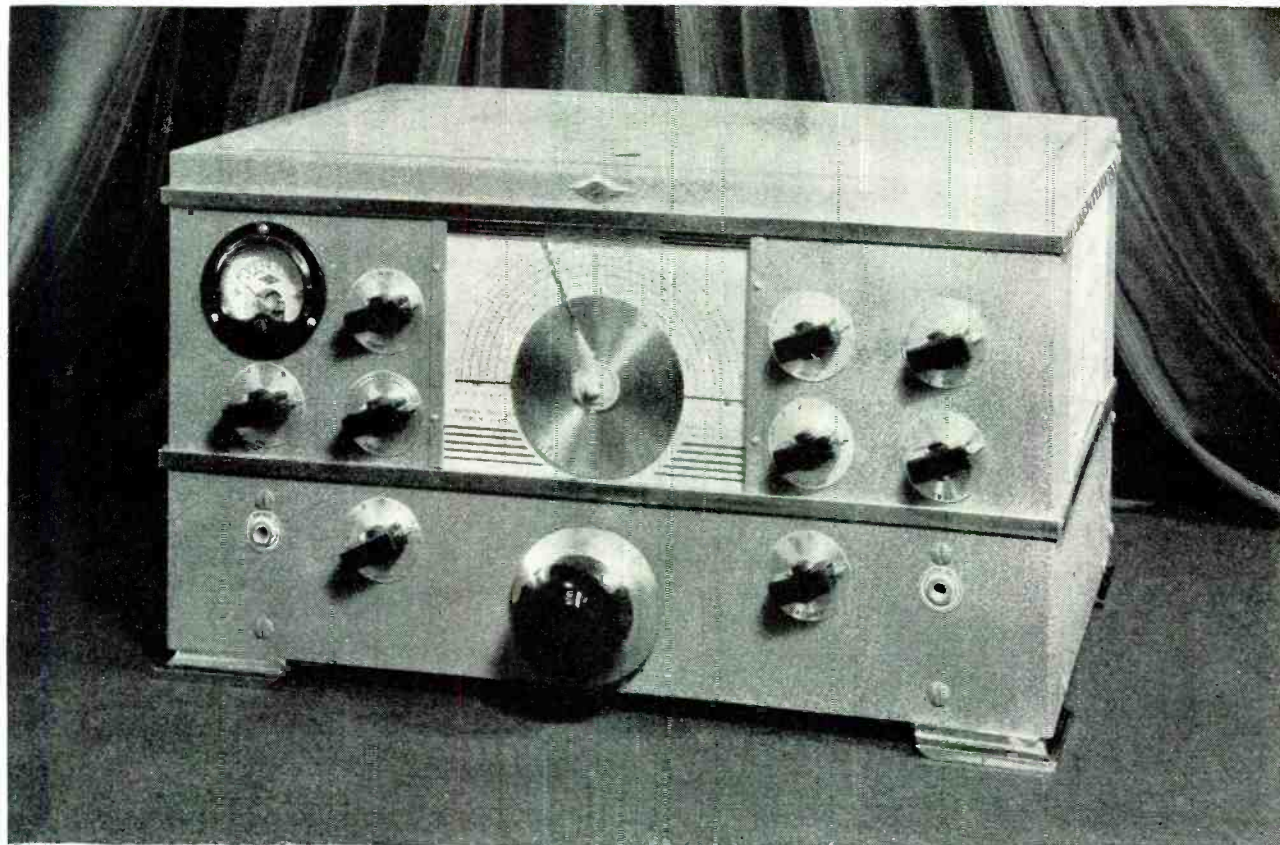

THE NC-2-40C

This superb new receiver reflects National's intensive receiver research during the war period. Many of the NC-2-40C's basic design features stem from the NC-200, but to them have been added circuit and construction details that set it apart as a performer. Stability and sensitivity are outstanding. A wide range crystal filter gives optimum selectivity under all conditions. The series-valve noise limiter, the AVC, beat oscillator, tone control and S-meter are among the many auxiliary circuits that contribute toward the all-around excellence of the NC-2-40C. See it at your dealer's.



NATIONAL COMPANY, INC.
MALDEN, MASSACHUSETTS, U.S.A.

MALDEN
MELROSE
★★★★

POST WAR SERIES-400

"Super-Pro"



**FULL COVERAGE
.54 — 30 MC.**

1—FULL COVERAGE

2—VARIABLE CRYSTAL SELECTIVITY

3—VARIABLE I.F. SELECTIVITY

4—FULL BAND SPREAD

5—IMPROVED NOISE LIMITER 6—ADJUSTABLE S METER

Greatly Improved Performance

This is the greatest "Super-Pro" ever offered to the professional or amateur operator. Your new 400 Series "Super-Pro" covers the broadcast band as well as the 10 meter amateur band and its performance is greatly stepped-up through war-time developments.



HAMMARLUND

THE HAMMARLUND MFG. CO., INC., 460 W. 34TH ST., NEW YORK 1, N.Y.
MANUFACTURERS OF PRECISION COMMUNICATIONS EQUIPMENT

Arctic Oil Exploration

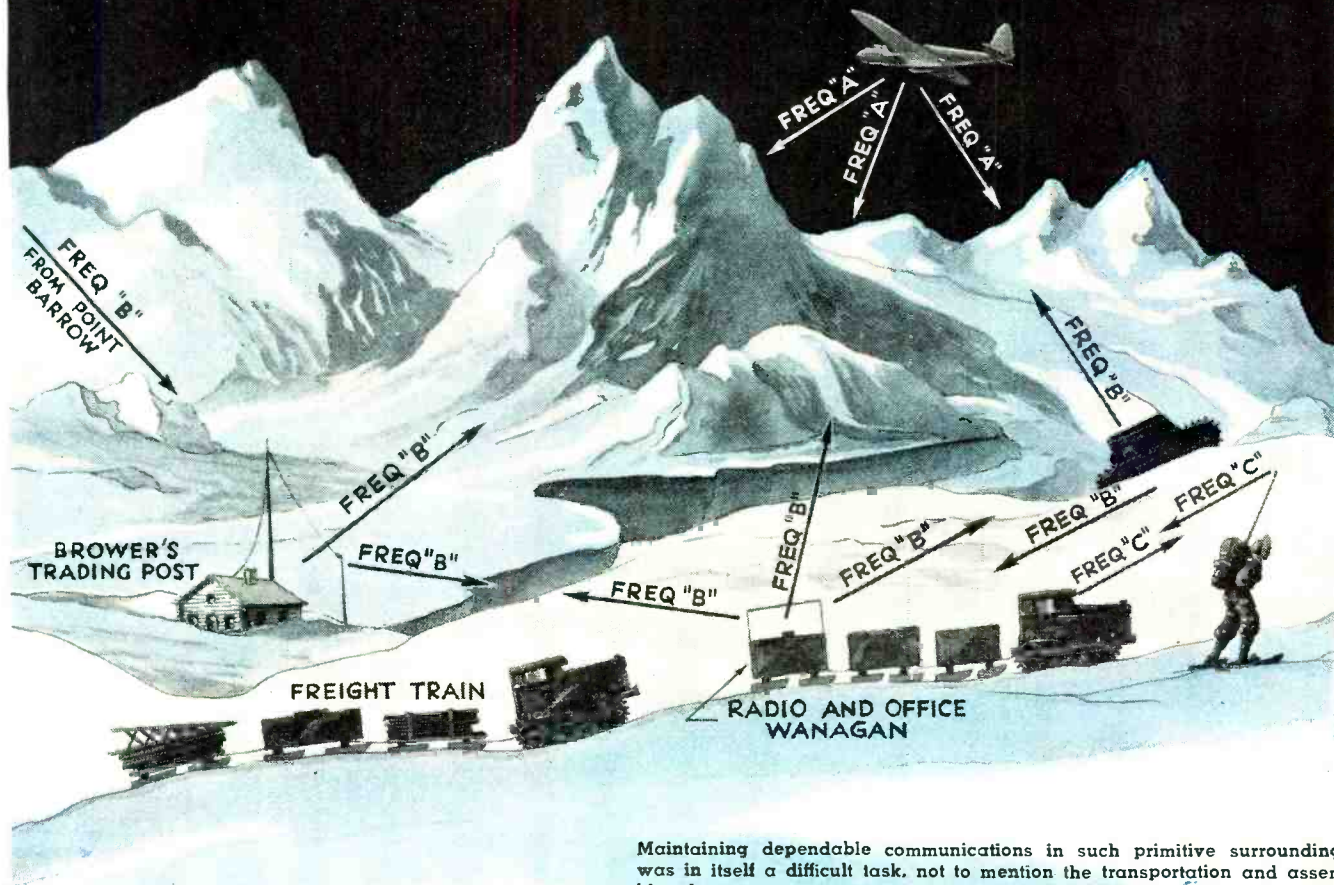

Maintaining dependable communications in such primitive surroundings was in itself a difficult task, not to mention the transportation and assembly of so many various types of equipment. It was necessary to utilize the combination of stationary, portable, mobile, and aircraft equipment. Frequencies "A", "B", and "C" do not actually represent any particular frequency, but serve to indicate point to point communication channels.

By **JOHN H. ROBERTS**

Radio Engineer
Alaska Communication System

AS THE Arctic ice pack moved north, clearing Point Barrow, Alaska in mid-summer of 1944, several hundred Seabees of a Naval exploration party were hurriedly landed from a ship that had been awaiting this chance to make a land-fall. With the Seabees came tons of foodstuff, supplies, tractors, and oil drilling machinery, for they were to explore Naval Petroleum Reserve No. 4, an area about the size of Indiana, and survey its potential oil resources.

As the ship hastily departed to escape the returning ice pack, the Seabees turned to the task of building a base camp against the coming winter, knowing that at least a year would pass before ships could again reach Point Barrow, for only during a brief period each summer do the ice floes of the Arctic Ocean free this most northerly point in U. S. Territory to steamer navigation. Until the following summer, all additional supplies would have

March, 1946

Arctic conditions present new difficulties in transporting, setting up, and maintaining radio communications. Author describes how these difficulties were met by radio technicians of a Naval oil expeditionary force. Although radio was not used to locate oil deposits, it was an essential factor in maintaining communications with isolated exploratory groups.

to be flown in from Fairbanks, 500 miles to the southeast.

The air route from Fairbanks to Point Barrow has long been used by bush pilots transporting mail, freight and furs, but none of them were fond of the trip. The Endicott Mountains, sudden storms, changing weather, lack of intermediate landing fields, and radio and weather stations were all hazards that made flying schedules uncertain. Now, flights over the route had to be maintained on a reliable schedule if the expedition was to operate unhindered. Contracts had been

made with commercial firms to fly the route for the Navy, but radio stations, ranges, beacons, and landing fields were needed.

With the authority of the Commanding General of the Alaskan Department to go ahead, a plan for AACS stations over the route was worked out by a conference between representatives of the Signal Office, Alaskan Department, the Third Wing, Army Airways Communication System, and Northwest Plant Engineering Agency-Alaska Communication System. The plans called for AACS stations at



Loading the plane at Barrow preparatory to taking off for Fairbanks. Radio equipment has made scheduled flights possible over this route.

Point Barrow, Umiat, and Bettles. Operating with the existing airways station at Ladd Field, Fairbanks, these stations could provide the necessary contact points along the route. The new stations were to be equipped with low, medium, and high frequency radio equipment for point-to-point, ground-to-air, and weather circuits. Radio aids to navigation in the form of A-N four course loop ranges and homing beacons of the aerophare type were planned for Point Barrow and Umiat. As the CAA had ranges in operation at Bettles and Fairbanks, only aerophare beacons were required at those points.

With a deadline to be met and the threat of approaching winter, the Signal Airways crews of Army Communication's Service tackled the job of installing the airways radio facilities. Using existing buildings, erecting knock-down prefabricated structures, and in one case moving into a newly completed CAA radio station, the job was done in remarkable time. Remarkable, considering the conditions, for all antenna masts were set in perpetually frozen ground requiring that pole holes be dug by steam thawing or chipping the concrete-like frozen earth. Each station with the exception of Bettles required a complete gaso-

line engine driven power system for this was pioneering and no light and power companies existed. Likewise, control and telephone pairs from the operations building to the range site and other facilities had to be provided by the installers, for Bell Telephone has not added the Alaskan frontier to its subscribers. In such an installation radiomen with amateur experience found their ingenuity at improvisation paying dividends and the new experience gained more than offset the physical discomforts.

A brief description of the activities and organization of the NWPEA and ACS is probably advisable at this point. The NWPEA is a branch of the world wide Signal Corps Plant Engineering Agency, operating in the Northwest Sector. In Alaska the NWPEA has been attached to the Alaska Communication System, charged with the fixed airways installations for the Army Airways Communication System, usually known as AACS. Both Plant Engineering Agency and the Alaska Communication System are components of the Army Communications Service, Signal Corps organization responsible for the provision of fixed military communications throughout the world. NWPEA has been rapidly expanded into a smooth working engineering

Seabee camp at Point Barrow. Oil derrick shown was erected for the purpose of carrying on drilling experiments in frozen ground.



agency. The Alaska Communication System, under the direction of Col. Fred P. Andrews, is a branch of the Signal Corps which for years operated the commercial cable, telegraph and radio circuits in Alaska as well as handling Army Administrative traffic. Soon after Pearl Harbor, a plan was evolved to make use of the sub-Arctic operating and engineering experience of the ACS by expanding the organization to handle the wartime Signal Corps construction in Alaska. The ACS is now responsible to the Alaskan Department for the operation of the military administrative networks within Alaska, between Alaska and the States, and between Alaska and Canada; the engineering and installation of all fixed Signal Corps communication systems within Alaska including cable, radio, and telephone. In addition to the above, the ACS engineers install, maintain, and operate all public commercial radiotelegraph circuits within Alaska and commercial radiophone and radiotelegraph circuits between Alaska and the continental United States. Add to this certain military tactical installations, multiply by the size of Alaska, spice with war urgency, chill with ice and snow, and you will have a small idea of the toil and headaches involved in such an enterprise.

Landing fields were scraped out at Umiat and Point Barrow where a mixture of Arctic beach sand and tundra was utilized. With landing fields at all points and the installation of the radio equipment, the tempo of flights along the route was stepped up to a reliable schedule as the weather information and radio aids to navigation made night flights and instrument flying possible.

An incident which illustrates the dependency of Alaska on radio and the airplane occurred during the Bettles installation. A PEA crew member was stricken with appendicitis and a trip to the hospital in Fairbanks was necessary. The patient was unable to stand a trip of that length by dog team and weather conditions prevented the rescue plane from landing at Bettles. Radio information from the Fairbanks doctor prescribed ice packs. With the outside temperature at 70 degrees below, this was easy. A rubber hot water bottle was filled with cold water and placed outdoors for a few minutes. The water turned to slush ice and was applied to the patient. Two water bottles thus alternated held the infection in check for three days until a plane could land, load the patient, and carry him to Fairbanks and recovery.

The improvement in air travel, brought about by the use of radio, directed attention to the possibility of its use by sections of the exploration party. To make an oil exploration survey of an area of more than 30,000 square miles would be a considerable job without the hazards of weather. With Arctic winter conditions in a barren land, without roads and with few trails, every safety precaution is necessary. The proper use of radio

could assist greatly in directing operations, contacting the scout plane, and saving needless trips. In case of emergency, radio communication would help safeguard the lives of the personnel.

To deliver the drilling machinery to the test hole sites during the exploration, it would be necessary to use "cat trains" consisting of several sleds drawn by huge caterpillar type tractors. For this purpose a number of freight sleds and wanagans were constructed at the Point Barrow camp. The wanagans are inclosed shelters mounted on sled runners and are required to provide bunk rooms, galley, mess hall, and machine repair shop for the cat train crews while freighting across the frozen Arctic plains. It is necessary that the freighting be done in the winter, for only then would the heavy sleds slip easily over the snow on the frozen tundra without bogging down, or be able to traverse the rivers on the ice. Freighting and scouting the trail under Arctic winter conditions would mean possible exposure to severe blizzards and temperatures as low as 70 degrees below zero. The protection of the wanagans could mean the difference between life and death.

In a conference between Lt. Commander W. H. Rex, Commanding Officer of the Seabee detachment, Colonel I. L. Kaufmann, Signal Officer of the Alaskan Department and Lt. Col. W. L. Wardell, Area Officer in Charge for the ACS, a plan of radio communication was worked out.

Usually frequencies in the range from 75 kc. to 500 kc. are used for dependable Arctic and sub-Arctic communication over the distances involved. Experience has proven the low frequencies to be less affected by polar ionospheric disturbances than the higher frequencies. The disadvantages of the lower frequencies include the large antennas required to secure efficiency and the transmitter power required to blast through static and provide a strong ground wave. As the radio equipment would be mainly mobile, smaller air transportable units which could be operated from a small power unit were favored. Weighing these factors, decision was made to use frequencies in the order of 3000 kc. Frequencies in this band were known, from experience, to be reliable up to several hundred miles with low power. By installing several fixed stations and equipping the several units of the expedition, contact with another station for relay or direct communication should always be possible. Furthermore, the frequencies would be within the range of the radio equipment in the ski-equipped plane of Sig Wien, veteran Alaskan pilot working with the expedition. With this plan in mind, the radio equipment was selected by Colonel Kaufmann from available standard Signal Corps sets, noted for their ruggedness and reliability. Sets were required for fixed base stations, a cat train station



The Naval Petroleum Reserve No. 4 is located at the most northerly point of Alaska. It was in this territory, where sub-zero temperatures prevailed, that the expeditionary force had to set up and maintain communications for oil exploration party.

in a wanagan, in the two snow jeeps and for foot scouts locating trail ahead of the cat trains while negotiating dangerous or difficult terrain.

The SCR-543 set was selected for the fixed stations and the radio wanagan. This set combines a 45-watt radio-phone transmitter with a sensitive receiver and is similar to the Halli-crafter HT-14. It is equipped with a lightweight gasoline engine driven generator to power the transmitter and receiver and to recharge the receiver standby battery which is also the starter battery for the power unit. For use in the snow jeeps, a vehicular set of about 25 watts output was selected (SCR-245). This set is powered by the 12-volt vehicle battery and equipped with a whip antenna. The foot scouts would need a small lightweight set of moderate range and the famous "handie-talkie" (SCR-536) set proved a natural for this use.

In December, 1944, information was received in the Anchorage office of the ACS that the equipment was at Point Barrow awaiting installation. Two radio installation experts of long Army and amateur experience were sent North. Arriving at Fairbanks they were issued fur parkas, caps and mittens, heavy woolen underwear, woolen sox, and mukluks, a loose-fitting fur-legged skin boot patterned after a type which the Eskimos have used for years. Thus equipped, they were flown to Point Barrow.

Point Barrow in mid-December is

not an easy place to make a radio installation. In addition to the cold, the work was further complicated by the almost total darkness that prevails. The sun does not rise above the horizon, though about two hours of murky daylight marks mid-day. All work had to be done with the aid of artificial lights.

The Point Barrow base camp radio equipment was installed in the AACS station, using an SCR-543 set. Luckily, a spare antenna was installed and available for this set, for erecting antenna poles in permanently frozen ground is a slow and toilsome job.

The wanagan radio installation was the most critical for it might be miles from an experienced radio technician and badly needed in an emergency on the trail. As sufficient equipment was available, a dual installation of identical equipment was made using two SCR-543 sets. At the frequency to be used the Marconi antenna would not work efficiently without either a ground or a counterpoise. As the wanagan would be moving, an earth-ground was impracticable. The problem was solved by covering the wanagan's sub-floor with carefully bonded, 1/4" mesh hardware cloth. Overlaid with a finish floor of plywood, this screen provided an effective counterpoise when connected to the ground terminal of the set. The two power units were installed in insulated cabinets and equipped with exhaust and air vents to the outside. For this, as



Ice delivery in Barrow. Winter water supply is ice cut in a nearby lagoon. Dog teams and sleds, as shown here, have proved useful in trail breaking and are used to supplement airplanes and snow-jeeps in preliminary exploration.

well as every other job requiring mechanical skill, the Seabees were ready and able to demonstrate their skill. This spirit of cooperation did much to speed the installation work. The whip antenna furnished with the SCR-543 was designed for vehicular use where only limited space was available. Since the wanagan had larger dimensions, an antenna which would put a greater length of wire in the air was possible. Two masts at diagonal corners of the wanagan extending 12 feet above the roof provided supports for a "distorted Z" antenna approximately 50 feet long. Tuned up to this antenna the set required less loading than the whip and provided a field strength pattern that was substantially non-directional.

The "snow jeeps" were quite simple as the sets are of a vehicular type. The standard whip antenna was used on these track driven vehicles and the set is of a type successfully used in tanks, however, it needed every bit of its inherent durability when the snow jeep, traveling across the unmarked tundra would suddenly drop off the cornice of a snowdrift and continue on its way disturbing neither the jeep or radio. What happened to the occupants, however, is another story. Field tests indicate that a reliable range of at least 25 miles could be expected with this set.

After the installations at Point Bar-

row were completed, the technicians were flown to a trading post operated by Tommy Brower, a son of the late Charles "King of the Arctic" Brower, located about 75 miles from Point Barrow along the route to Umiat. This trading post had been chosen for a standby and relay station. An SCR-543 set was soon set up amid the furs and trade goods, using a Marconi Antenna; reliable contact with Point Barrow was established and a schedule arranged. It is here that the technicians were introduced to quok, small frozen fish which are eaten raw. Here also they learned the value of fur parkas while tying down the airplane in a 45-mile per hour gale with the temperature at 10 degrees below zero and the air full of driven snow particles. The trading post, like many dwellings in the far North, is maintained at a temperature of 40 degrees in the winter. This saves fuel and eliminates the bother of removing too many outer garments as would be necessary when coming into a warm house.

Back in Barrow the installers completed the testing of the sets and checked the handie-talkies which proved practical despite the cold which reduces the activity of the dry batteries. By wearing a battery belt within the parka to prevent freezing of the batteries and small earphones which fit within the ear flaps of a fur

Village of Barrow, Alaska. This is the most northerly settlement in United States territory and was the location of the oil exploration base camp.



cap, the set was effectively winterized.

During the tests two cold weather phenomena occurred which are of interest:

After the radio equipped snow jeeps had been exposed to 10 degrees below zero weather for a few hours the quartz crystals in the transmitter refused to oscillate until tapped or shaken by starting the jeep engine. The second phenomena also associated with temperatures of minus 10 degrees or lower was the refusal of the carbon microphone to modulate the transmitter. When warmed, it performed perfectly but apparently failed when cold, due to a trace of moisture freezing and immobilizing the carbon granules. The task of thawing the frosty carbon microphone under an armpit was never sought.

With the installations at Point Barrow and Tommy Brower's complete and the installations at Umiat being handled by another crew, the installers completed the instruction of operators. Eight days of round-the-clock work, without regard for sleep, had finished the job and they were ready for Christmas in Anchorage.

Recent reports from longer range cross-country tests on field trips indicate all radio equipment performing beyond expectation. While radio won't locate the oil, it is rendering valuable assistance to the Navy Oil experts drawn from the oil fields of California, Oklahoma, and Texas under the direction of Geologist, Lt. William Foran, who can find it.

While the radio communications set-up described in this article was not actually used to locate the oil deposits, the use of two-way radio formed a very vital link between the work crews, each performing their assigned task.

The fact that all types of radio equipment was used, portable, mobile, and fixed makes this installation of interest to those in the radio field.

The lessons and experience gained by this group in the operation of Arctic radio communications should prove of value to commercial air lines who plan to establish regular routes flying the "top of the world." Specialized problems, engendered by sub-zero weather and high winds, were investigated and, in some instances, conquered by this group of Seabees and radio men who set up the radio installations for this important Arctic expedition.

Many of their techniques can easily be adapted for future installations of radio beacons, transmitters, and radar to guide commercial craft across the frozen wastes of the North.

There is still a great deal of pioneer work to be done, not only on the spot, but in the laboratories and factories making equipment for such installations. However, since this expedition has served to crystallize the problems to be met, some improvement should be possible, so that when commercial installations are made, the path will be smoother for those who come afterwards.

Low Power AIRCRAFT TRANSMITTER

By ALVIN B. KAUFMAN

Electronic Engineer

Efficient design and compactness as described herein are important factors in mobile amateur equipment.

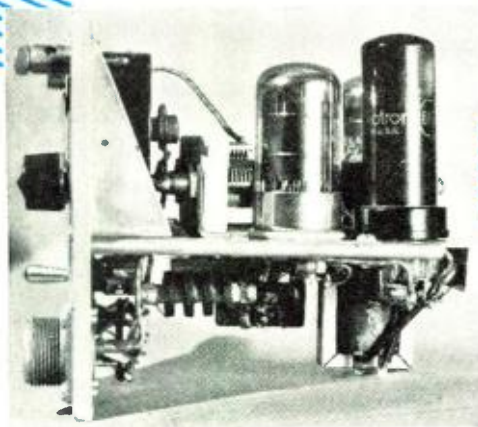

Side view of completed transmitter. For maximum power output an external 300 volt plate supply is required.

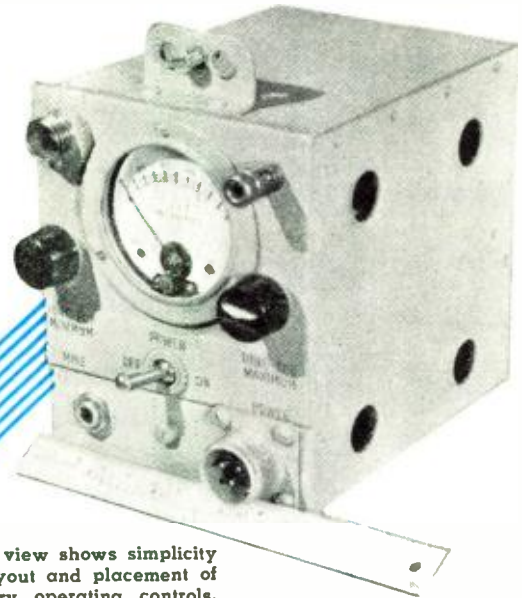

Front panel view shows simplicity of panel layout and placement of all necessary operating controls.

THE fundamental design of a lightweight aircraft transmitter having the features required by and for the light plane field involves numerous engineering problems.

Fundamentally, three things are required to make a transmitter suitable for light aircraft use. These are a maximum weight of five pounds (not including power supply), break-in operation, and a carrier power of approximately five watts. Other factors, such as securing the minimum of standby drain on the power supply are desirable.

Reasonable "voice quality," consistent with size requirements is a valuable attribute of this unit. A minimum of tubes should be used and these interchangeable if possible.

Contrary to general opinion, here is an ideal spot for suppressor grid modulation. The average engineer invariably complains about the low efficiency of a suppressor grid modulated stage as compared to that of a plate modulated r.f. stage. However, we are interested in the over-all plate current or power required by the complete transmitter. Consider the transmitter now under discussion. Let us com-

pare its final stage and modulator with that of the conventional plate modulator stage. We will ignore both crystal stages as these will draw approximately the same power. The suppressor grid tube in this case will draw about 50 milliamperes at 300 volts which, at 33% efficiency, will put out a carrier of 5 watts. Its modulator tube draws approximately 2 milliamperes at this plate voltage supply. Thus, the final and modulator total 52 milliamperes plus about 12 milliamperes screen current or a grand total of 64 milliamperes. Now, a conventional r.f. stage runs approximately 75% efficient. Thus at 300 volts its plate current would be 22 milliamperes for a 5 watt carrier. That really looks good, but let us add the modulator plate current before we come to any conclusions. A class A modulator runs around 25% efficient and to modulate the 6.6 watts in the final you would have to put out about 3.3 watts of audio for 100% modulation . . . depending upon the speech waveform. A typical tube to use for such a modulator would be a 6V6. At 25% efficiency the tube would draw approximately 43 milliamperes unmodulated

plate and screen current at 300 volts plate supply. This is verified by any tube manual. Thus the plate current of the final and modulator of this type transmitter would run approximately 65 milliamperes as compared with 64 of the suppressor grid transmitter. Not only this, but the tubes such as the 6V6's which would be used as modulator and final; would draw a total of .9 amperes filament current as compared with .8 for the transmitter under discussion. One tenth of an ampere is something to consider if operating from dry cells, which incidentally is highly practical for this transmitter.

That is where the standby switch comes in. A transmitter is only operated for minutes at a time as compared with hours for a receiver and that is why low current capacity dry batteries may be used. The standby switch turns on the filaments while the microphone, through its switch operating a relay, turns on the plate supply to all stages. Thus, when getting ready to transmit, the standby switch is thrown and, in a few seconds, break-in operation may start. It is not necessary to short the receiving antenna when transmitting, as in light plane use, for the receiver is tuned to 278 kc. while the transmitter is operating on 3105 kc.

(Continued on page 86)

Table model radio-phonograph with new type automatic record player. Record is inserted in slot, door closed, player plays record, stops itself, automatic adjustment. Model 1201. **Philco.**



Six tube a.c.-d.c. table model radio with standard and shortwave bands. Molded plastic cabinet. Newly designed dial gives a "three dimensional" effect. Modern grille design. Model 220 **G.E.**

Table model television receiver which features small size chassis. Unit is not in production as yet, model shown is engineering unit only. Company expects to produce these shortly. **Farnsworth.**

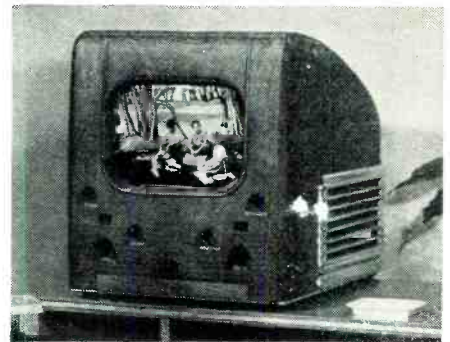

Plastic table model radio in ivory finish. A.C.-D.C. operation with illuminated radial dial. Maroon plastic tuning knobs and milled gold-color trim match numerals on dial. Model 420. **Philco.**

The 1946 RADIO

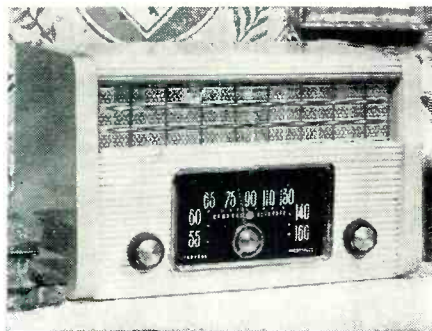

Deluxe a.c.-d.c. five tube superheterodyne table model radio with blond mahogany cabinet in two-toned finish. Metal escutcheon and control knob inserts. Modern grille design. Model 105. **G.E.**



Mahogany Hepplewhite-style Pembroke drop leaf table type radio with 6 tubes, two-bands. Push-button tuning. Phonograph jack for use with external player. Model 9001-E. **Stewart Warner.**

Chairside model radio-phonograph with handy controls, moving dial and illuminated lucite pointer. Available in walnut or bleached woods. Plays 10" or 12" records. Model EK-264. **Farnsworth.**

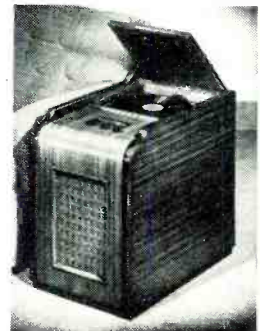

Television receiver with picture size of approximately 3 feet by 4 feet. Unit also incorporates radio and phonograph units. "Tele-Symphonic Super-Screen" design. Model T506. **U. S. Television.**

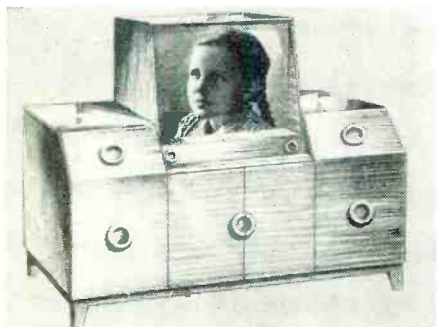

Combination radio-phonograph with standard, FM and foreign shortwave reception. Record player accommodates ten 12" or twelve 10" records. Period design with metal drawer pulls. Model 14-AM-76-PA. **Sparton.**

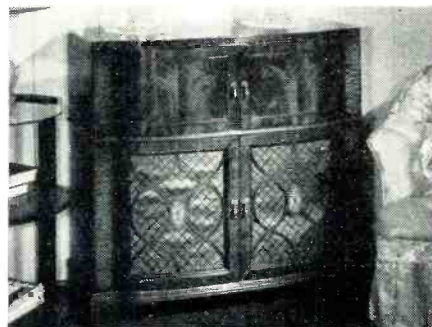

Modern combination radio-phonograph in blonde wood. Horizontal grille. Equipped for FM, standard, and foreign broadcast reception. Automatic record changer. Model 10-AB-76PA. **Sparton.**

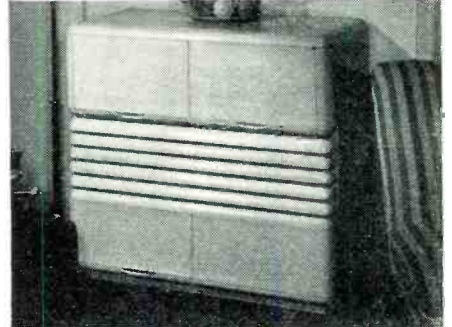



Single band, six tube a.c.-d.c. table model receiver. Plastic cabinet in walnut color. Slide-rule dial for easy tuning. Modern grille, three plastic tuning knobs in contrasting finish. Model 9002-A. **Stewart Warner.**

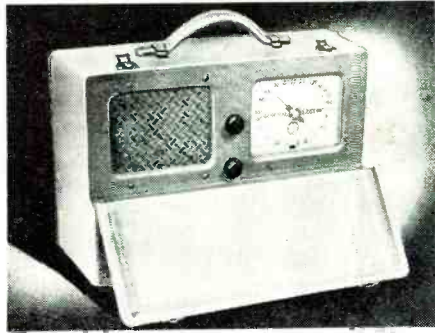

Lightweight portable for battery or house current operation. "Beam-a-Scope" antenna. Available in gray airplane cloth, simulated English saddle leather. Size 10 1/4" x 15" x 6 1/4". Model 254. **G.E.**

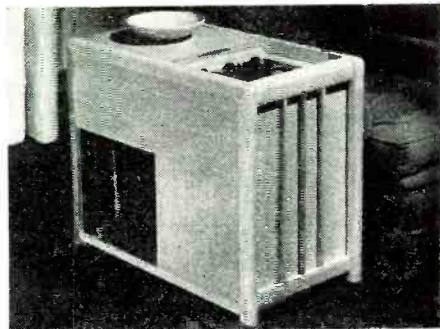

Chairside type radio-phonograph with record storage space included. Automatic push-button tuning. Available in mahogany, white oak, prima vera and walnut. Size 30" x 17" x 25 1/2". "Chairside." **Magnavox.**

PARADE



Table model radio-phonograph combination. Radio which lifts out, can be used independently. "Duo Receiver." **Westinghouse.**

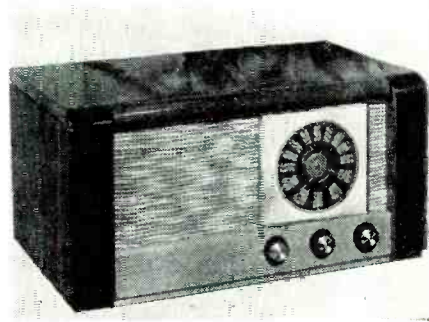

Five tube a.c. table model radio-phonograph in American walnut and maple finish. Operation of turntable is automatic with placing of tone arm on record. Model 106. **G.E.**

Six tube a.c.-d.c. table model radio with push-button tuning. Cabinet finished in two-toned walnut. Multi-weave speaker grille. Size 13 3/8" x 9" x 7 15/16". Standard broadcast reception. Model 321. **G.E.**

Six-tube table model radio with top-mounted moving dial and brightly illuminated lucite pointer. Two bands, standard and shortwave. Finished in quartered mahogany Model ET-063. **Farnsworth.**

Five tube, two-toned, table model receiver. Picture frame cabinet of Thermo-Set walnut plywood, front panel in blonde mahogany with dark louvres. Two bands, a.c.-d.c. operation. Model 902-W. **Howard.**

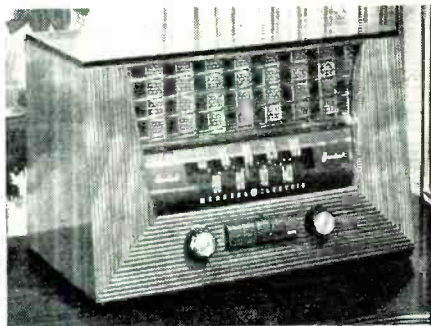
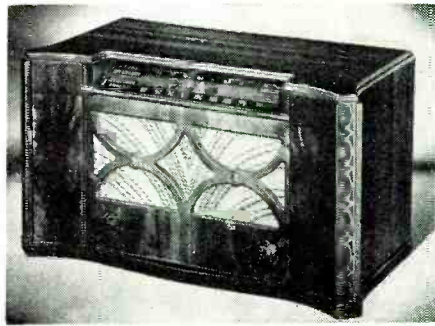
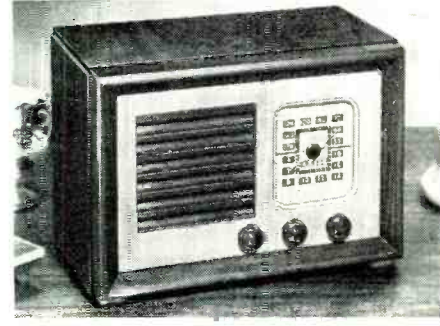

Table model radio with 6 tubes. Modern blonde mahogany or walnut finish. Two-bands and self contained "aero vane" loop antenna. Six-inch electrodynamic speaker. Model 65T21B. **Motorola.**



Radio-phonograph console with standard and shortwave reception, present and new FM band. Push-button and manual tuning. Modern cabinet design. Size of unit 36" x 34" x 18 1/2". "The Futura." **Stromberg-Carlson.**



Authentic Chippendale design radio-phonograph with optional FM chassis. Eight station automatic pushbutton tuning. Shortwave band. Available in mahogany, walnut, or white oak. "Belvedere." **Magnavox.**

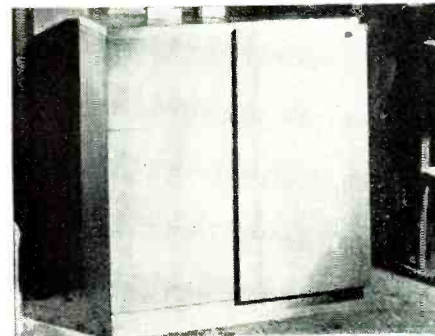

V.H.F. Heterodyne

FREQUENCY METER

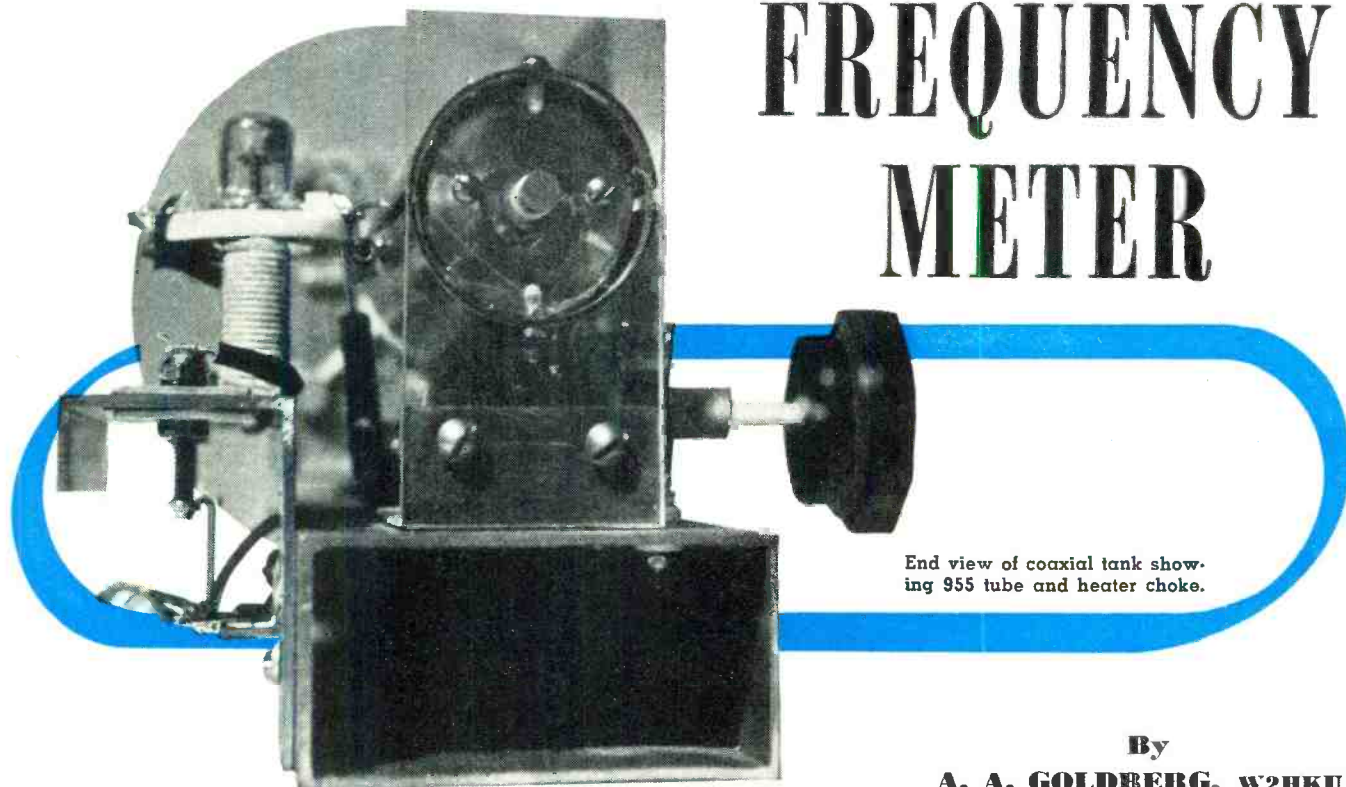

End view of coaxial tank showing 955 tube and heater choke.

By
A. A. GOLDBERG, W2HKU

***Practical application of the split concentric-tuned oscillator
used in the construction of a highly accurate frequency meter.***

VERY-HIGH and super-high frequencies are coming into their own. With frequency allocations clarified and defined by the Federal Communications Commission, these microwavelengths become the concern of every one interested in radio.

The general public through television, FM, "walkie-talkies" and mobile telephones will become a large market for microwave equipment. Airlines will use, and are using, landing beams, very-high frequency radio-telephony and radar safety devices. The fields of meteorology, medicine, law enforcement, science research, industry and others will prove fertile fields for very-high and super-high frequency usage.

When the "boys come home" and amateur radio once more becomes the hobby of thousands, amazing changes will take place. Some low frequencies will be gone but in their stead will be hundreds of megacycles extending clear up to 30,000. The amateur will use the microwaves, not only for the fine technical possibilities, but also to get away from the overcrowded lower frequencies.

Gone are the days of haphazard experimentation with little worry about frequency. The new FCC allocations above 30 mc. make it imperative that stations stay within assigned channels. Rough methods, such as "Lecher Wires" or crude absorption wavemeters, are satisfactory for finding an approximate frequency but are inadequate for closer measurements.

Many experimenters will be building very-high frequency transmitters as well as receivers. One frequency measuring device capable of use with both transmitters and receivers is the heterodyne frequency meter. To refresh the reader's mind, a heterodyne frequency meter consists of a stable, variable r.f. oscillator, a detector, and

an audio amplifier. A useful addition is an audio oscillator to modulate the r.f. output. (See Fig. 1.)

When the heterodyne frequency meter is used for measuring a transmitter frequency, a portion of the transmitter r.f. is injected into the detector where it is mixed with the oscillations from the local r.f. oscillator. The resultant audio beat is amplified by the audio amplifier to sufficient headphone volume. When the local oscillator is tuned for a zero beat, the local oscillation and the incoming r.f. are on the same frequency.

When the heterodyne frequency meter is used to calibrate a receiver, the r.f. output of the heterodyne frequency meter is loosely coupled to the receiver. If the receiver has a beat frequency oscillator, pure continuous waves can be used. If, however, the receiver is made for amplitude or frequency modulation reception, a modulated r.f. output from the frequency meter must be obtained. When the zero beat or modulated tone is heard in the receiver, the frequency can be determined from the frequency meter calibration.

Fig. 1. Block diagram of frequency meter.

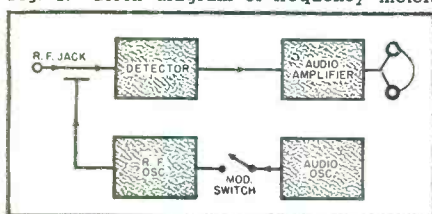

The measurement accuracy will depend upon:

- The oscillator electrical stability.
- The oscillator mechanical stability.
- Accuracy of dial calibration.
- Care with which the measurement is taken.

The first and most important problem in designing a heterodyne very-high frequency meter is the oscillator. Low-frequency variable oscillators, making use of lumped capacity and inductance, are relatively easy to build. Making a stable, variable oscillator for frequencies above 100 mc. is, however, more difficult. Just five years ago this problem would really have been "tough." Today, with improved tubes and circuits, the experimenter will have less trouble. Some of the newer circuits that lend themselves nicely to the above problem are the variable LC tuner, the variable length coaxial line tuner, the "butterfly" tuner and the split concentric tuner. These are shown in Fig. 2.

The variable LC tuner is easy to build and will provide good frequency coverage. Since both the inductance and capacitance are varied simultaneously, the optimum LC ratio can be maintained. The disadvantages, however, of this type tuner are:

- A sliding contact is necessary, making for poor stability and aging characteristics. The average experimenter will find it difficult to build an efficient sliding contact for very-high frequencies.
- The inherent low "Q" of this circuit, due to contact resistance and insulation problems, will cause oscillator instability.

Another wide range tuner is the variable length coaxial line type. Again a sliding contact of elaborate design is necessary, making it inadvisable for the home constructor.

The "butterfly" tuner is becoming more and more popular for wide range, very-high and super-high frequency circuits. A frequency coverage ratio of as high as 3:1 can be obtained. Since both inductance and capacity are varied simultaneously, an efficient LC ratio can be maintained. Sliding contacts are not used and the entire unit can be made from sheet aluminum or copper. This tuner would serve quite nicely in a heterodyne frequency meter.

The heterodyne frequency meter described in this article uses a split concentric tuned oscillator. Good stability is obtained because of the high circuit "Q" and the lack of sliding contacts. Frequency coverage ratio will depend upon the spacing of the elements. The oscillator described here is continuously variable from 280 to 430 mc., a frequency ratio of 1.53:1. This is accomplished with an element spacing of $\frac{1}{16}$ ". If element spacings of $\frac{1}{64}$ " are used, ratios of 2:1 or better may be obtained.

Operation of the split concentric tuned oscillator is easy to understand. Basically, the circuit is an ultraudion

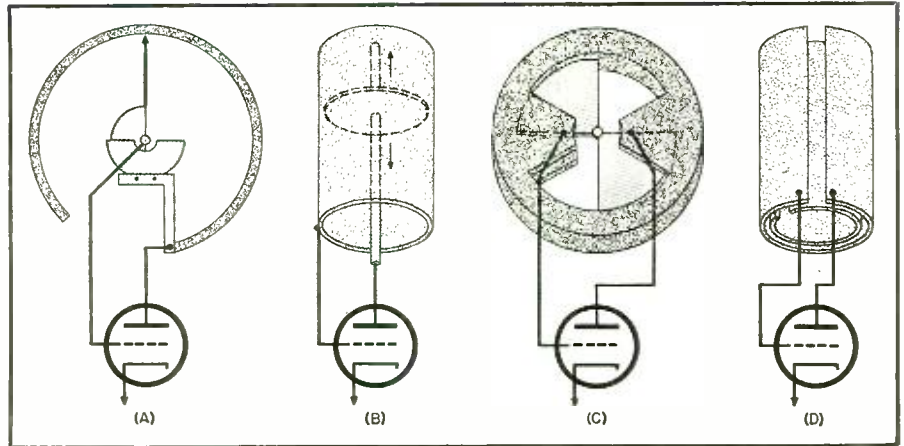

Fig. 2. Wide range v.h.f. tuners. (A) Variable "LC" tuner, (B) variable-length coaxial line tuner, (C) "butterfly" tuner, and (D) split concentric tuner.

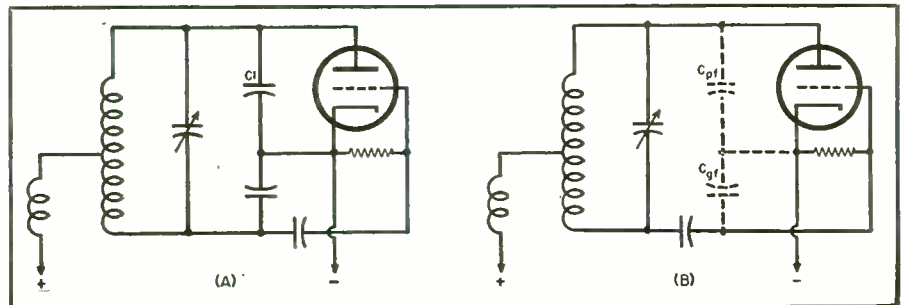

Fig. 3. Comparison between Colpitts (A) and ultraudion (B) oscillators.

which, in turn, is a modified Colpitts oscillator. Fig. 3 shows the comparison. The capacitors, from plate to cathode, C_1 , and cathode to grid, permit grid-plate feedback in the Colpitts circuit resulting in sustained oscillations. In the ultraudion oscillator, the plate-filament capacity (C_{pf}) replaces C_1 and the grid-filament capacity (C_{gf}) replaces the other. Either the grid, filament or plate ends can be at r.f. ground potential. Slightly better stability results in having the entire oscillator floating above ground.

The split concentric tuned tank consists of a wide single turn inductance

inside of which is another wide single rotatable turn. With a single slot stator and a single slot rotor, the full tuning range is accomplished by 180° rotor rotation. Lowest frequency occurs when the two slots are oriented 180° apart. Highest frequency occurs when the two slots coincide. (See Fig. 6.) Frequency change is brought about mainly by capacitance change. Although inductance changes do occur, they are negligible.

A variation of the fundamental split concentric tuner is for the rotor to have two slots, 180° apart. This type tuner has the disadvantage of halving

Front panel view showing proper placement of various operating controls.

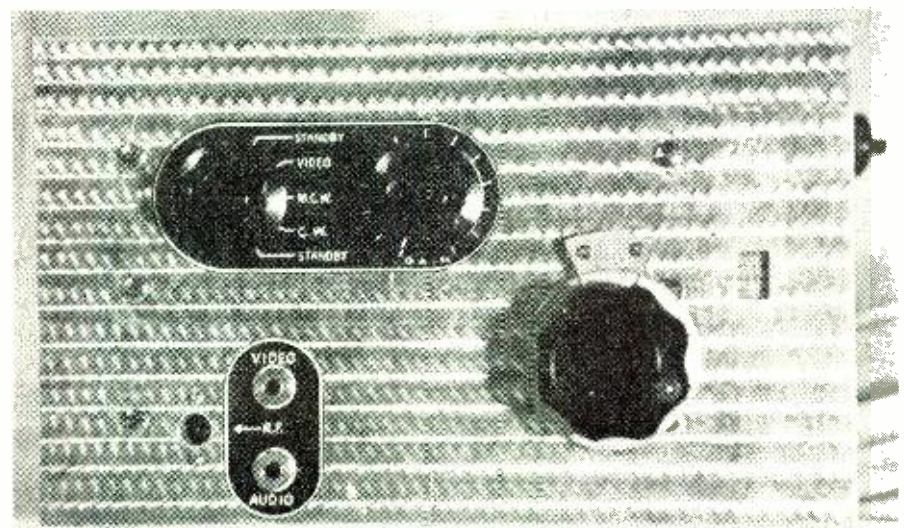

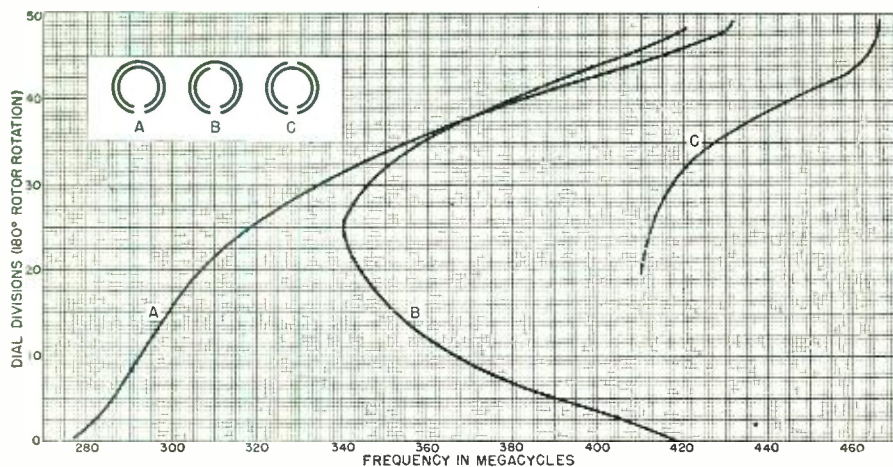

Fig. 4. Frequency vs. dial divisions of three different types of split concentric tuners. (A) Single slot rotor with single slot stator, (B) double slot rotor with single slot stator, and (C) single slot rotor with double slot stator.

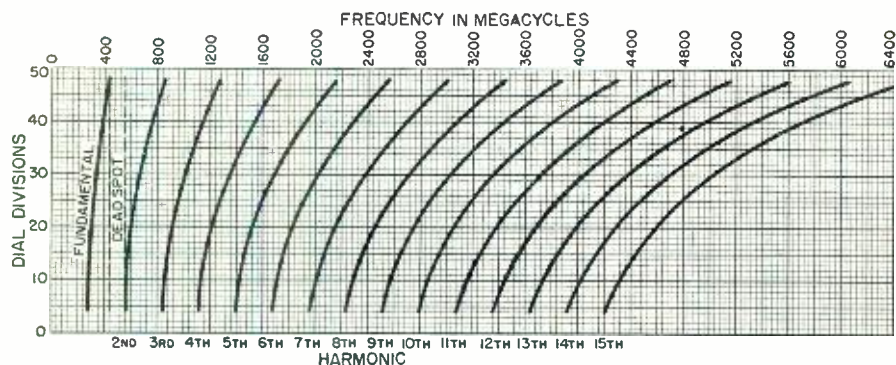
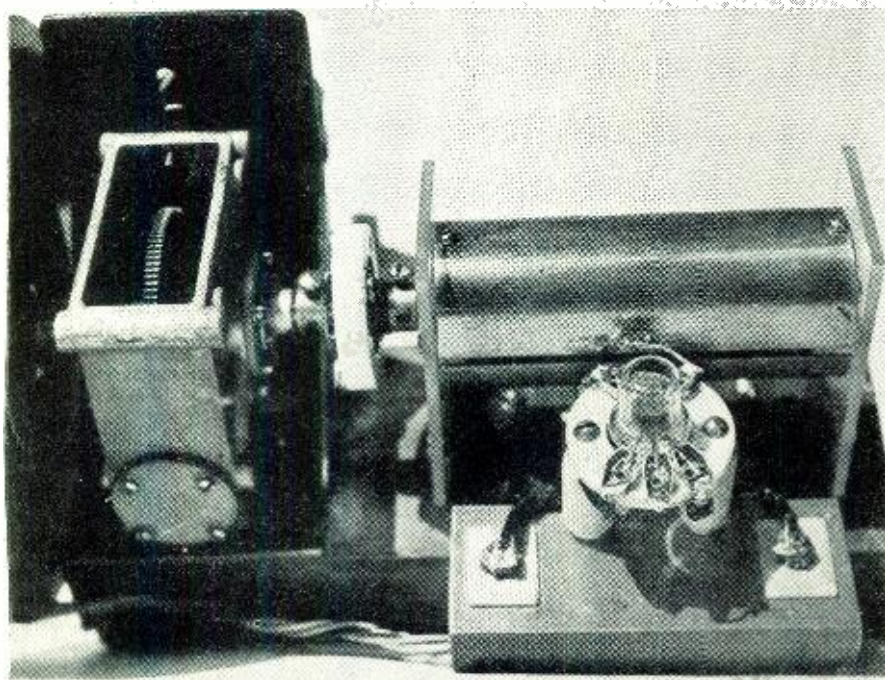

Fig. 5. Harmonic relationships up to 15th harmonic for concentric tuned frequency meter.

the frequency range. An additional disadvantage is that the entire frequency coverage is accomplished by only 90° rotor rotation. See Fig. 4, curve "B."

Another variation is the double slot stator and single slot rotor. In this case, instead of the tank inductance being concentrated in the stator, it is now mainly in the rotor. The oscilla-

Worm gear driven coaxial tank condenser showing short leads used to connect the 955 oscillator tube directly to the center point of the tank circuit.



tor grid and plate are capacitively coupled to the rotor and oscillations result. As the rotor is rotated, however, the grid and plate shifts away from the high impedance point until, finally, oscillations cease. This circuit is only useful for extremely small frequency tuning ranges. See Fig. 4, curve "C".

Still another variation of the basic circuit is the two slot stator and two slot rotor. Again the frequency range is decreased by 90° rotor rotation. Extremely high frequencies are possible with a comparatively large tuner. The writer obtained a frequency coverage between 511 and 561 mc. with a stator 4 inches long and 1½ inches in diameter.

If the split concentric tuned oscillator is used in a signal generator or receiver, it may be necessary to extend the frequency range by band switching. One method of doing this would be to connect loading coils into the double slot stator, double slot rotor tuner. (See Fig. 7). The disadvantage of loading coils is the lowering of the circuit "Q" to such an extent that oscillations may cease. As more and more lumped inductance is added to the circuit, the tuning range per coil decreases rapidly. A point is finally reached where the tuning range per coil becomes so small as to not warrant its use. The tuning range, as in all double slot rotor tuners, is covered by 90° rotor rotation.

The v.h.f. heterodyne frequency meter described here uses a 955 tube in an ultraudion oscillator circuit. A single slot rotor, single slot stator concentric tuner is used. With a tuner of the dimensions shown in Fig. 8, a fundamental frequency range of 280 to 430 mc. is obtained. (See Fig. 4, curve "A".) Since the author had only hand tools to work with, the tuner element spacings are not less than 1/16". Closer spacing, however, would increase the frequency range.

Harmonic operation extends the useful range of the frequency meter up to 3000 mc. by use of the 7th harmonic. Higher frequency operation may be possible; the author, however, had no means of determining it. Since the fundamental frequency ratio is less than 2:1, a blank spot exists in the harmonic coverage. In this case, the frequencies between 430 and 560 mc. cannot be measured. If this blank in the operating range is to be eliminated, the fundamental oscillator frequency ratio must be at least 2:1 or better. (See Fig. 5.)

A 9006 diode is used as a mixer. The interelectrode capacities within this tube will determine, to a great extent, the operating efficiency at the higher frequencies. The higher the capacity, the lower the efficiency. An efficient mixer would be a crystal rectifier, but the poor overload characteristics and extreme care necessary to prevent surge currents makes the use of this unit inadvisable.

(Continued on page 125)

R.F. PROBE DESIGN



This 100 kc. to 125 mc. probe may be constructed without the use of special parts or tools.

By
DONALD F. McAVOY

*Theoretical considerations
necessary in development of
efficient high-frequency probes*

THE probe described in this article is primarily designed for use with a multi-range, d.c. electronic voltmeter which has an input resistance of 10 megohms (or more) and a sensitivity of 3 volts (or less) full-scale deflection on its low-voltage range. Thousands of such d.c. instruments are in use today. When so used, the combination makes available an excellent signal tracing device which is usable at any frequency between 60 cycles and 125 megacycles.

At frequencies above 100 kc. the rectified d.c. output of the probe is equal to the peak value of the applied voltage. For voltages with sinusoidal waveform, the peak value is equal to 1.414 times the r.m.s. value. For voltages of non-sinusoidal waveform, such as square wave, pulse, and saw-tooth voltages, the peak value may or may not equal 1.414 times the r.m.s. value. The probe will, however, allow measurement of the peak value of any voltage regardless of its harmonic content, providing the frequency is between 100 kc. and 125 mc.

At frequencies below 100 kc., the rectified d.c. output of the probe gradually falls off in amplitude until, at 60 cycles, it is approximately 20% of the peak value of the applied voltage. This attenuation with frequency occurs because, at the lower frequencies the RC time constant of capacitor C_1 and the load resistance becomes shorter in comparison with the time

required for a period (1 cycle) of the applied voltage. The attenuation can be eliminated by the use of a large value of capacitance for C_1 , but this means an increase in the physical size of the capacitor. The increase in physical size, as is explained later in this article, decreases the efficiency of the probe at the higher frequencies. In any event, the attenuation does not appreciably detract from the usefulness of the probe at the lower frequencies because comparison measurements of voltages are usually sufficient for signal tracing or stage gain tests when performing service work.

Another advantage of the probe is that its maximum efficiency begins at 100 kc., the upper frequency limit at which the majority of test oscilloscopes are capable of checking signals of low voltage levels.

The input impedance of the probe is so high, even at the higher r.f. frequencies, that measurements may be taken without appreciable loading or detuning of the circuit under test. This input impedance is a complex function of the frequency of the applied voltage and consists of resistive and reactive components.

Resistive component. The presence

Fig. 1. Cross-sectional illustration showing details of probe assembly.

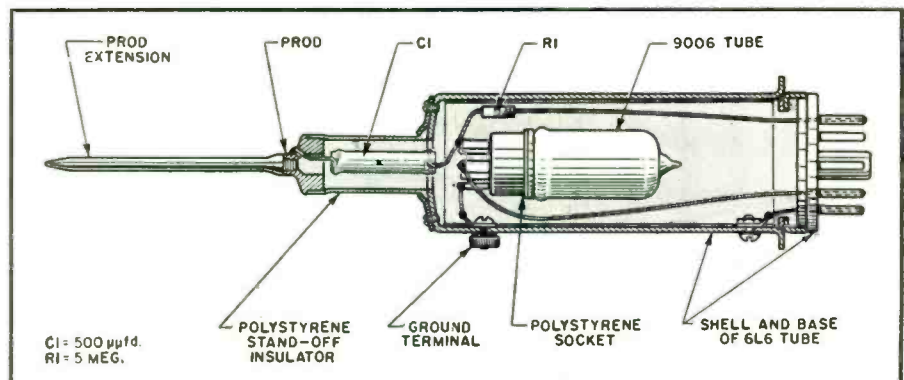

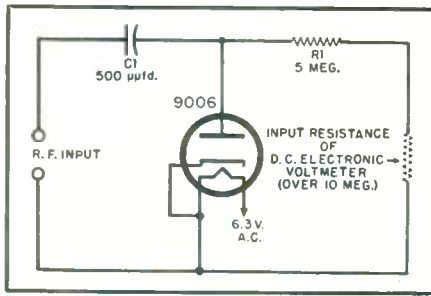

Fig. 2. Schematic diagram of probe circuit showing simplicity of design.

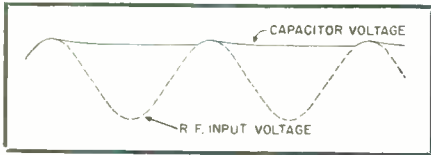

Fig. 3. Relationship between capacitor voltage and sinusoidal r.f. input voltage of constant amplitude. The horizontal axis represents time.

of the resistive component causes loading of the circuit under test with a resulting consumption of power from that circuit. If this loading were to become appreciable, the readings obtained would not be true indications of the applied signal voltage.

The lumped resistance of the probe circuit and the plate resistance of the diode tube are the two principal factors which determine the magnitude of the resistive component at the lower frequencies. Fig. 2 shows a schematic diagram of the probe circuit.

The lumped resistance is equal to the combined value of resistor R_1 (5 megohms) in series with the input resistance of the d.c. electronic voltmeter (10 megohms or more). Thus, the lumped resistance of the circuit is at least 15 megohms, an exceedingly high value.

It is important that the resistors be of the proper type for r.f. work.

Because the resistance value of ordinary carbon resistors decreases rapidly as the frequency is increased, their use is not recommended. For example, an ordinary carbon resistor rated at 1 megohm for d.c., and having a $\frac{1}{4}$ -inch diameter, will only have a resistance value of approximately 150,000 ohms at 3 megacycles. At still higher frequencies, its value falls to a very low percentage of its d.c. rated resistance. Ceramic resistors, such as IRC Metalized Resistors (or similar types) are preferred. These components are constructed of a very thin filament surrounded by a ceramic material, and have inherently low distributed capacitances and low dielectric losses with a resulting improvement in their high frequency characteristics. Physically, the resistors selected should be the smallest obtainable.

The plate resistance of the diode tube shunts the lumped resistance of the circuit and also shunts the circuit being tested. This resistance varies with the amount of the electron conduction within the tube. When the diode current is zero, the resistance is practically infinite. When the diode current is high, the resistance falls to a very low value. Because of the parts values selected and the circuit employed, the diode rectifier conducts only during a part of the positive alternations of the applied voltage. In fact, as will be explained later, the time of conduction is extremely short in comparison with the non-conducting period. For this reason, the mean tube current is very low and, conversely, the plate resistance is very high. In fact, at the higher frequencies, the input impedance of the probe remains constant, regardless of whether or not the tube is supplied with heater voltage.

At the higher frequencies, several other factors, in addition to those given above, seriously affect the magnitude of the resistive component of input impedance. Dielectric hysteresis

of insulating materials, high-frequency resistance (skin effect), and electron transit time effects combine to reduce the value of the resistive component.

Polystyrene insulation is used in those parts of the probe which carry appreciable amounts of r.f. energy in order to keep dielectric losses at a minimum. See Fig. 1, a cross-sectional drawing of the probe.

Skin effect is reduced by making the input conductors carrying r.f. current as short as practicable.

Electron transit time effects are practically eliminated by the use of a type 9006 u.h.f. diode tube. Standard receiver type tubes become unusable at the higher frequencies because of their low shunt impedance at these frequencies.

Reactive component. The presence of the reactive component causes a detuning of the circuit under test. This quadrature effect can usually be compensated for by a slight readjustment of a tuning control. Even though the reactive component does not cause power to be consumed from the circuit, its presence is objectionable and becomes detrimental when retuning of a circuit is not possible or practicable.

The reactive component is created by the distributed capacitances of the probe, including the plate-cathode capacitance of the diode tube. Because of the tube type selected, however, the latter capacitance is extremely small (1.2 micromicrofarads). The physical layout of parts (Fig. 1) is such that other distributed capacitances due to wiring are kept at a low value. It will be noted that the prod itself is used as a housing for capacitor C_1 in order to utilize the prod length and, in this way, reduce the physical length of the wiring.

A long, slender prod is advantageous because many of the test points which must be reached when making measurements are located in crowded areas. This is especially true when working on small equipment, such as radio receivers.

It is interesting to note that those capacitances due to wiring between resistor R_1 and the d.c. electronic voltmeter circuits have little effect on the dynamic value of input impedance.

Radiation and Stray Pickup

The free space wavelength of a radio wave at 125 mc. is approximately 95 inches. Over copper conductors, such as the prod and ground leads of the probe, however, the velocity of propagation is somewhat slower and a 125 mc. wavelength corresponds to approximately 86 inches. Thus a quarter-wave would be over 21 inches, which is not comparable to the physical length of the prod. For this reason, radiation losses are negligible. In a reciprocal manner, stray pick-up is not induced to any extent and the meter readings respond only to the actual voltage under test.

Theory of Operation

The probe uses a simple rectifier
RADIO NEWS

Fig. 4. A d.c. electronic voltmeter with probe connected and ready for use.

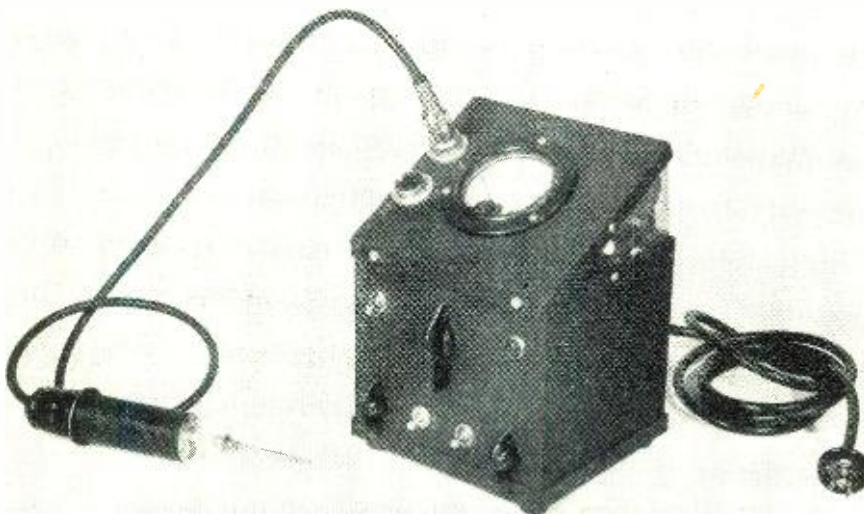

circuit (Fig. 2) consisting of a type 9006 diode tube and an RC network (capacitor C_1 , resistor R_1 , and the input resistance of the d.c. electronic voltmeter).

During the positive alternation of the initial cycle of an applied r.f. voltage, the plate of the diode becomes positive with respect to its cathode and the tube conducts. At this time, the plate resistance of the tube falls to a low value and capacitor C_1 quickly charges through this low resistance path. At the peak of the positive alternation, the capacitor voltage rises to approximately the peak value of the applied voltage. The charge of the capacitor is such that the plate of the capacitor connected to the plate element of the tube is negative with respect to the other capacitor plate.

During the negative-going excursion of the applied r.f. signal, current flow through the diode is cut off because the charge of the capacitor makes the plate of the tube more negative than its cathode. The capacitor then slowly begins to discharge through the RC network. The RC time constant of the network is sufficiently long, even at the lower r.f. frequencies, so that the capacitor retains most of its charge during the entire negative excursion of the applied voltage.

At the positive peak of succeeding cycles of r.f. input voltage, the diode again conducts and the capacitor regains that part of its charge which leaks off through the RC network. Thus, the diode current consists of a series of bursts or pulses, each pulse lasting for a small fraction of the time required for a complete cycle of applied voltage. While the diode is not conducting, its plate resistance is infinitely high and it is this fact, as previously mentioned, which makes possible that high input impedance of the probe.

Fig. 3 graphically illustrates the relationship between the capacitor voltage and an r.f. input voltage of constant amplitude.

That part of the capacitor charge which leaks off through the RC network is utilized for measurements. The leakage current through the network causes voltage drops across the individual resistances in the network. These voltage drops are directly proportional to the capacitor voltage and, thus, the voltage input of the d.c. electronic voltmeter is directly proportional to the peak value of applied r.f. voltage.

It is interesting to note the relationship between the discharge time of capacitor C_1 and the duration of one cycle of applied voltage. Assume a 10 mc. signal is applied to the probe's input terminals and that the input resistance of the d.c. electronic voltmeter is 15 megohms. In this case, the RC time constant of the network would be 1/100th of a second (0.0005 times 20 megohms equals 0.01 second). The duration of a cycle of the r.f. voltage, on the other hand, is only 1/10,000,000th of a second (10 megacycles

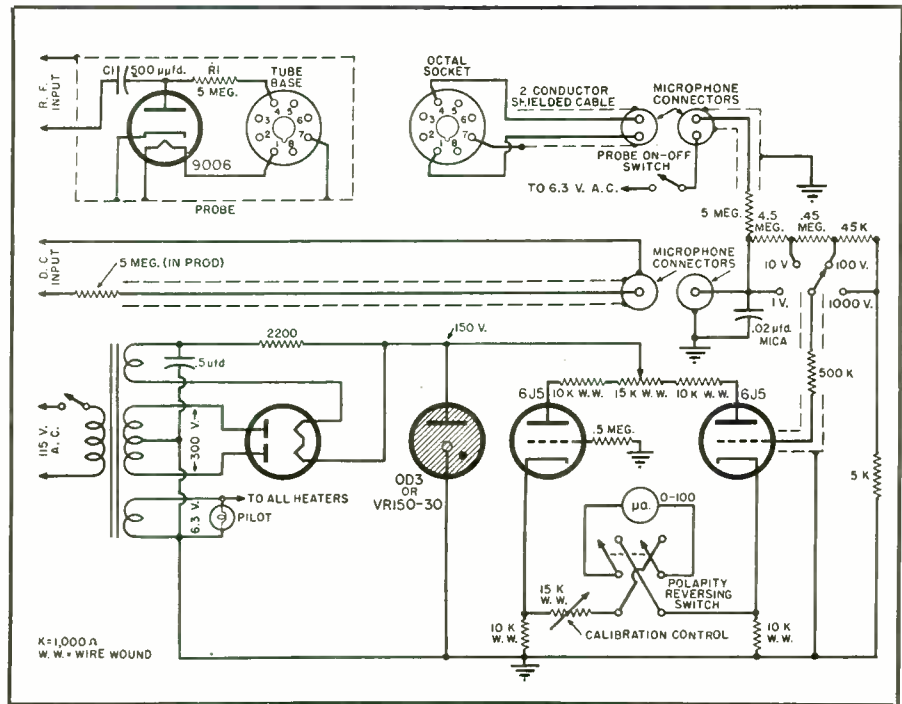

Fig. 5. Schematic diagram of a d.c. electronic voltmeter showing probe connections.

equals 10,000,000 cycles). Thus, if the capacitor were charged and the probe then disconnected from the r.f. signal source, the capacitor would discharge to 33% of its peak value in the same time required for the 10 mc. signal to go through 100,000 alternations. Or, the r.f. signal is 100,000 times faster than the RC network.

One fact has been omitted from the above discussion, namely, the presence of zero signal diode current. Even when no voltage is applied to the probe's input terminals, a minute current flows around the circuit comprised of the tube, resistor R_1 , and the input resistance of the d.c. electronic voltmeter. This current is caused by stray electrons leaving the cathode of the tube and striking the plate element even when the plate does not have a positive potential to attract the electrons. Although such current is extremely small, it is sufficient to cause a potential of approximately 1 volt to appear across the resistors. Thus, a small value of negative voltage is ap-

plied to the d.c. electronic voltmeter when no r.f. signal is being measured. This voltage is sufficient to upset the d.c. zero adjustment of the voltmeter. A slight zero adjustment is therefore required when switching from d.c. to r.f. voltage measurements, or vice versa. If desired, however, this adjustment may be eliminated by incorporating a bucking voltage in the voltmeter. Such circuits are quite common and are usually comprised of either a battery and resistor combination or a diode tube and resistor network.

Construction

The shell of a type 6L6 tube from which the original elements have been removed, and a small polystyrene stand-off insulator comprise the housing for all probe parts. A metal rod or prod extension, threaded on one end, may be screwed into the prod for ordinary usage, or may be removed when making high-frequency measurements. The original base of the

(Continued on page 132)

Fig. 6. D.c. test leads consisting of a shielded, single-conductor cable and ground lead.





A more modern type signal generator. This unit has a frequency range of 100 kilocycles to 120 megacycles.

SERVICE CONSIDERATIONS In Megacycle Bands

By C. J. SHERIDAN

Engineer, Triplett Electrical Instrument Co.

In servicing FM and television receivers, new techniques and higher frequency test equipment must be employed.

TODAY the business of radio servicing is undergoing great expansion in both personnel and scope. Thousands of returned veterans are taking steps to set themselves up in this field enhanced by wartime development of devices which operate in the megacycle ranges. They see a bright future, the realization of which will depend upon the start they make right now.

Former members of the Armed Forces received valuable training in radar, various types of specialized electronic devices, and a wide variety of communications equipment. As background material this experience will serve well as a basis for radio repair work. But it must also be remembered that running a repair business involves operating a service shop on a paying basis. Commercial sets will not be as standardized as components built for military use. Adaptability, ingenuity, and common horse sense must keynote their efforts. Past experience has shown that almost a sixth sense must be developed to speed up trouble shooting.

Commercial broadcasting in FM and

television is already an accepted fact in the east and a few large mid-western cities. It brings up many new problems requiring changes in servicing methods and new test equipment. With present tieups in production these problems do not have to be solved overnight because of the relatively few FM and television sets in use throughout the nation. But future prospects call for a greatly expanded repair field and it is therefore necessary that you as an individual repairman analyze the situation from the long term viewpoint. You will have to evaluate your present techniques and equipment with regard to future requirements. Just as today you are called upon to service all types of home and automotive AM sets, it will not be long until you will be called upon to render the same quality attention to FM and television receivers.

The standards of manufacture and operation of these new type receivers are considerably higher than in regular AM equipment which means a heavier load on the serviceman. Certain manufacturing and servicing shortcuts used in AM will not work

for FM and television because of much higher fidelity requirements.

To the repairman, test equipment is the most vital factor in this situation and requires that care be exercised in its purchase. Also it should be used correctly and to the full scope of its capacity.

Small shops usually have part of their test equipment permanently mounted, while certain units are kept portable for servicing calls. It is fairly easy to acquire portable tube checkers, volt-ohm-milliammeters and test oscillators. In the shop fixed equipment, such as signal tracers and oscilloscopes, can be used for more accurate work or analysis of special troubles. The latter lends itself to a wide variety of applications where visual responses are helpful.

The well equipped serviceman will find that his present instruments will handle most of his needs in FM for the time being. For instance, the FCC recently allocated new FM bands in the range of 88-108 mc. Most good quality signal generators reach these wavelengths with a fundamental. (The Triplett Model 1632 shown on

front cover has a top fundamental of 120 mc.). If the fundamental cannot be used, the second harmonic can.

The present trend would indicate that television picture transmission will be AM, while the sound carrier will be frequency-modulated. This, together with regular FM receivers, promises to give the serviceman plenty of contact with frequencies above 100 mc. The important question causing much concern is, will FM present a more difficult servicing problem. The answer is yes; however, if fundamentals are mastered to properly understand FM circuit operation, there is no reason why trouble shooting cannot be made a systematic and efficient process.

Before a discussion of FM, a few brief points are presented on television. Microwave propagation is characteristically line-of-sight transmission disregarding refraction effects and therefore lends itself to restricted areas in the unobstructed range of the transmitter. Various methods have undergone exhaustive tests in an attempt to find an economical way of providing coast to coast programming. These include radio relay links, wherein repeater transceivers are mounted on towers and make use of very small beam angles of parabolic reflectors for highly directive focusing of r.f. energy. Coaxial cable and wave guides have been used to "pipe" broadcasts from one section of the country to another. Westinghouse has proposed "Stratovision" which has an airborne transmitter operating in a plane at high altitude levels with radio link connection to the studios. Here the effective transmission range is greatly increased as a function of antenna height. None of these systems provide the perfect answer. Each has its particular good features and drawbacks not only from the engineering standpoint but from economic considerations as well.

Apart from transmission complexities, there is the problem of receiving these high frequency carriers and this also applies to FM. It is necessary to have an antenna which is relatively free from physical obstructions—trees, buildings, hills, etc. This means antenna installation will be of prime importance, and one which will interest the serviceman, since he may well figure in erection work and certainly will be concerned with maintenance.

There are two general ways in which a carrier may be modulated. The most common is amplitude modulation where the envelope of the peak value of the carrier varies according to the intelligence. The other type of modulation is angular of which there are two sub-classes, phase and frequency. In the former the instantaneous phase of the carrier is varied at the audio rate, while in the latter the instantaneous frequency varies at the audio rate. The frequency deviation is a function of the amplitude of the modulating signal. As the frequency deviation or "swing" is increased it is necessary to increase band widths to

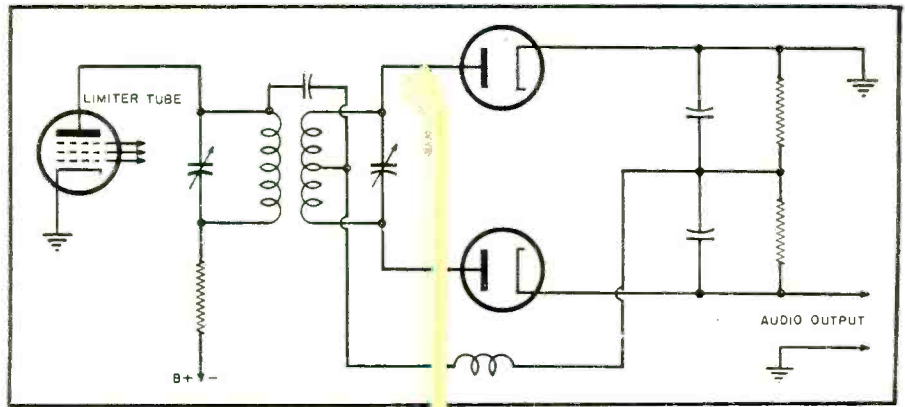

Fig. 1. Circuit diagram of a typical discriminator stage.

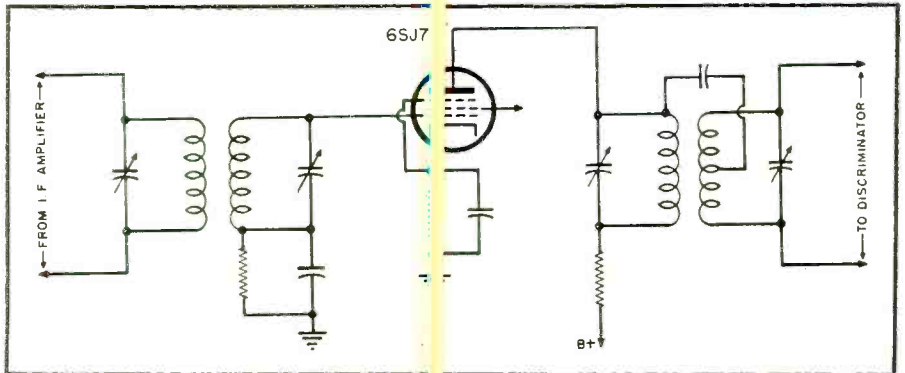

Fig. 2. Wiring diagram of a conventional limiter stage.

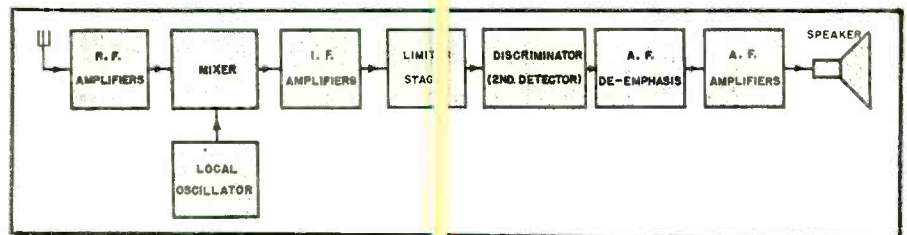

Fig. 3. Block diagram of a frequency modulated receiver.

faithfully reproduce the transmitted intelligence.

In an FM receiver the r.f. stages, local oscillator, and the complete audio system are in principle the same as in an AM set.

The main differences are:

Conventional type unimeter, suitable for measuring voltages up to 5,000 volts.



1. The second detector stage in FM is a special circuit commonly called a discriminator. This stage converts a variable frequency i.f. to a fluctuating d.c. voltage whose polarity depends upon whether the frequency being de-

(Continued on page 92)

Transconductance type tube tester designed for measuring latest type tubes.

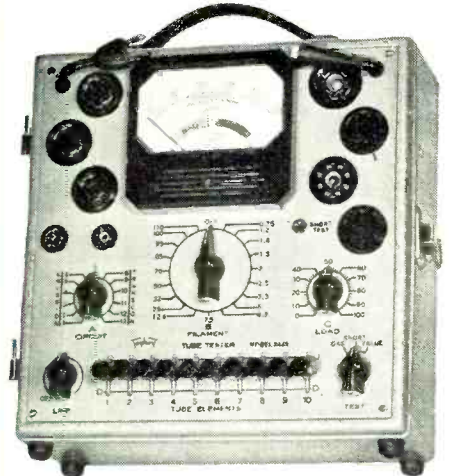

350 WATT - 5 BAND TRANSMITTER

By
HERBERT S. BRIER
W9EGQ

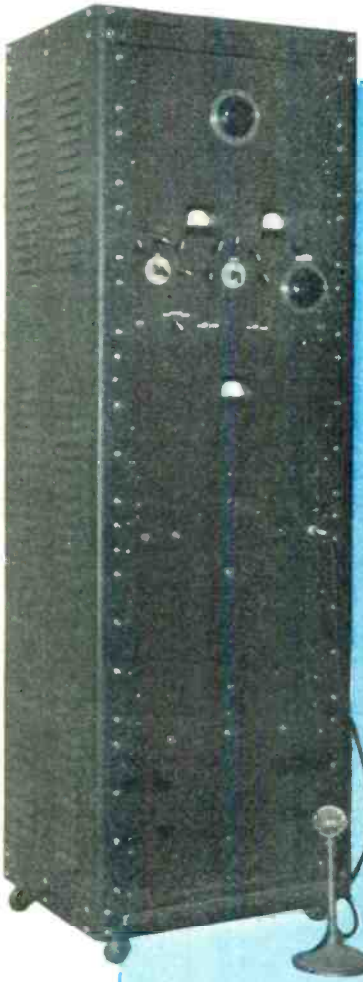

Extreme simplicity is apparent in the front view of the transmitter. Professional appearance is obtained by employing an enclosed cabinet.

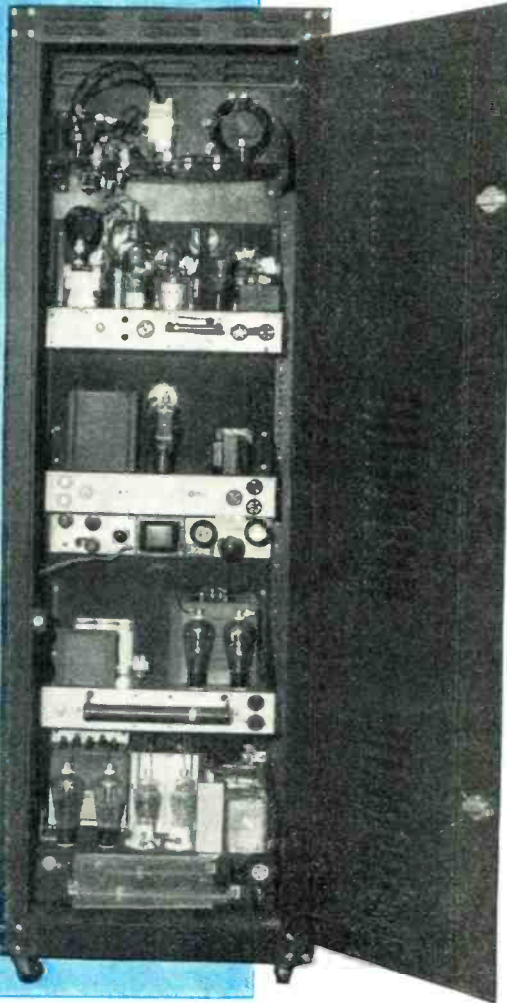

Internal view shows (top to bottom) antenna tuner, r.f. section, modulator, speech amplifier, modulator power supply, and r.f. power supply.

COMPLETELY self-contained, except for microphone and key, this transmitter covers all amateur frequencies between 3.5 and 29.7 megacycles, including the proposed 21 megacycle band. Bands are changed by switching pre-tuned tank circuits in the exciter, changing the amplifier tank coil, and selecting the proper taps on the antenna tuner.

Quality on phone is excellent, with absolutely no hum. More than enough gain is available for any microphone. On c.w., keying the buffer gives clean, clickless keying. A brief discussion of each section will highlight the features of the transmitter.

The three stage radio frequency sec-

tion is built on one 17" chassis. Capacity coupling is used between stages and works excellently. Link coupling between the driver and final amplifier stage has become such a generally accepted procedure that most of us do not realize that it is actually less efficient than capacity coupling when the separation between stages is not great. The necessity of making up losses in another tuned circuit and in the coupling circuit is the explanation. On the higher frequencies, where the added capacity of the grid circuit of the following amplifier across the driver tank precludes a reasonable L/C ratio, this statement is less true, but capacity coupling works extremely

well on all frequencies covered by this transmitter.

In order to match the comparatively low impedance of the 100-TH grid to the plate impedance of the 807, each buffer coil is tapped for excitation purposes. Tapping a coil in this manner sometimes invites parasitic oscillations, but once the amplifier is neutralized, no trace of instability is apparent. One adjustment of the neutralizing condenser holds for all bands. The 100 μ fd. per section tank condenser is a compromise value. A smaller one would permit a larger coil to be used on 28 megacycles, with a slight increase in efficiency, but then an excessively large coil would be required to tune 3.5 megacycles, and a reasonable "Q", when loaded, could not be obtained. Even with this condenser the output is approximately 250 watts, so actually very little has been lost by using the larger condenser.

The oscillator is slightly unconventional in that it is a tritet on all bands except 3.5 megacycles, where it becomes a Pierce oscillator. Crystals for any band will oscillate when plugged into the 3.5 megacycle crystal socket, but the crystal current is rather high, and it is impossible to multiply frequencies in the oscillator; so it is not recommended for any but 3.5 megacycle crystals. The diagram shows three crystals and a tuned coil in the oscillator grid circuit. The 3.5 megacycle crystal is used for 3.5 megacycle output, the 7 megacycle crystal for 7, 14 and 21 megacycles, and the 14 megacycle crystal for 14 and 28 megacycles. If the oscillator plate voltage is increased, enough output is available from the oscillator on 28 megacycles to drive the 807 to full output when using 7 megacycle crystals. However, when this is done, the excitation to the 807 on other bands is excessive, and, of course, crystal heating is increased. Two milliamperes of grid current on the 807 is optimum, more actually reducing the output, and it is no trick to obtain seven to ten milliamperes on 7 and 14 megacycles with 300 volts on the oscillator. Output from the oscillator when tripling to 21 megacycles is reduced somewhat, but is more than adequate. The tuned coil is used to couple

RADIO NEWS

an external variable frequency oscillator to the transmitter. When this is done, the oscillator tube is used as a frequency multiplier. Removing the coil permits the use of another crystal in this socket. A toggle switch shorts out the cathode coils for operation with this coil, or on the fundamental crystal frequency.

A baffle shield between the buffer and oscillator, and the 807 base shield, plus 50 ohm carbon resistors in the screen and control grids completely tame the 807. These suppressor resistors increase the driving requirements a trifle, but often make an 807 easier to handle. They have been installed and removed several times. It was finally decided that they were a slight help on 28 megacycles, so were left in. A combination of cathode and resistance bias is used, the cathode resistor mainly as a convenient method of adjusting excitation to the 100-TH. The lower the resistance, the higher the grid current to the 100-TH, and the greater the plate current of the 807. The 807 operates as a straight amplifier on all bands.

Practically any piece of wire can be loaded with the antenna tuner. Placing the antenna change-over relay in the link circuit allows the benefit of the tuning network to be obtained on "receive" as well as "transmit." Putting the relay in this position has the further advantage of greatly reducing the r.f. voltages across it. Grounding

L_1	—3 t., wound $\frac{1}{4}$ " below L_2 coils.
L_2	—3.5 mc. 35 t., #18 p.e., close wound $1\frac{1}{2}$ " dia. 7 mc. 18 t., #18 p.e., close wound $1\frac{1}{2}$ " dia.
L_3	—7 mc. tritet coil, $5\frac{1}{2}$ t., $1\frac{1}{2}$ " dia., #20 p.e., spaced wire dia., self-supporting. (Oscillator output slightly greater on fourth harmonic if 6 t. are used, but crystal current is increased.)
L_4	—14 mc. tritet coil, 6 t., 1" dia., #14 wire, $\frac{3}{4}$ " long.
L_5	—7 mc. 12 t., $1\frac{1}{8}$ " dia., $1\frac{1}{2}$ " long, #18 wire.
L_6	—14 mc. 6 t., $1\frac{3}{8}$ " dia., $\frac{3}{4}$ " long, #14 wire.
L_7	—21 mc. 5 t., $1\frac{3}{8}$ " dia., $\frac{3}{4}$ " long, #14 wire.
L_8	—28 mc. 4 t., $1\frac{1}{4}$ " dia., $\frac{7}{8}$ " long, #14 wire.
L_9	—3.5 mc. 28 t., $1\frac{5}{8}$ " dia., $1\frac{1}{2}$ " long, #20 wire.
L_{10}	—7 mc. 15 t., $1\frac{1}{2}$ " dia., $1\frac{1}{2}$ " long, #18 wire.
L_{11}	—14 mc. 7 t., $1\frac{1}{2}$ " dia., 1" long, #14 wire.
L_{12}	—21 mc. 6 t., $1\frac{1}{2}$ " dia., $1\frac{1}{2}$ " long, #14 wire.
L_{13}	—28 mc. 4 t., $1\frac{1}{4}$ " dia., 1" long, #14 wire.
L_{14}	—3.5 mc. 36 t., $2\frac{1}{2}$ " dia., spaced slightly less than wire dia. 7 mc. 20 t., $2\frac{1}{2}$ " dia., $4\frac{1}{4}$ " long, #12 wire. 14 mc. 10 t., $2\frac{1}{2}$ " dia., $4\frac{1}{4}$ " long, #10 wire. 21 mc., use 14 mc. coil.
L_{15}	—28 mc., 6 t., $2\frac{1}{2}$ " dia., $4\frac{1}{4}$ " long, $\frac{3}{16}$ " copper tubing.
L_{16}	—3 t., $2\frac{1}{2}$ " dia., close wound, #14 wire. L_{11} coils split with $\frac{3}{4}$ " gap in center to accommodate L_{15} .
L_{17}	—12 t., $2\frac{1}{2}$ " dia., $4\frac{1}{2}$ " long, #12 wire, split in center, and tapped $2\frac{1}{2}$ and $4\frac{1}{2}$ t. from each end.
L_{18}	—3 t., #14 wire, wound around center of L_{16} .
L_{19}	—30 t., $\frac{3}{8}$ " dia., $4\frac{1}{2}$ " long, tapped every 3 t.
L_{20}	—6 t., #14 wire, wound around center of L_{18} , tapped every t.

Table I. Coil specifications giving complete details for the construction of all coils.

one side of the link reduces harmonic transfer to the antenna, but insulating the link well enough to prevent flash-overs, especially on modulation peaks, becomes a problem.

Little need be said about the speech amplifier and modulator. An r.f. filter in the first grid lead prevents r.f. which

may be picked up by the microphone cable from causing feed-back in the speech amplifier. Before it was installed, when using some antennas on 28 megacycles it was impossible to advance the gain control more than 30% without encountering feed-back. Now it can be run wide open with no trace

Fig. 1. Circuit diagram of speech amplifier. Socket #1 is connected to socket #3 of the modulator chassis, Fig. 2.

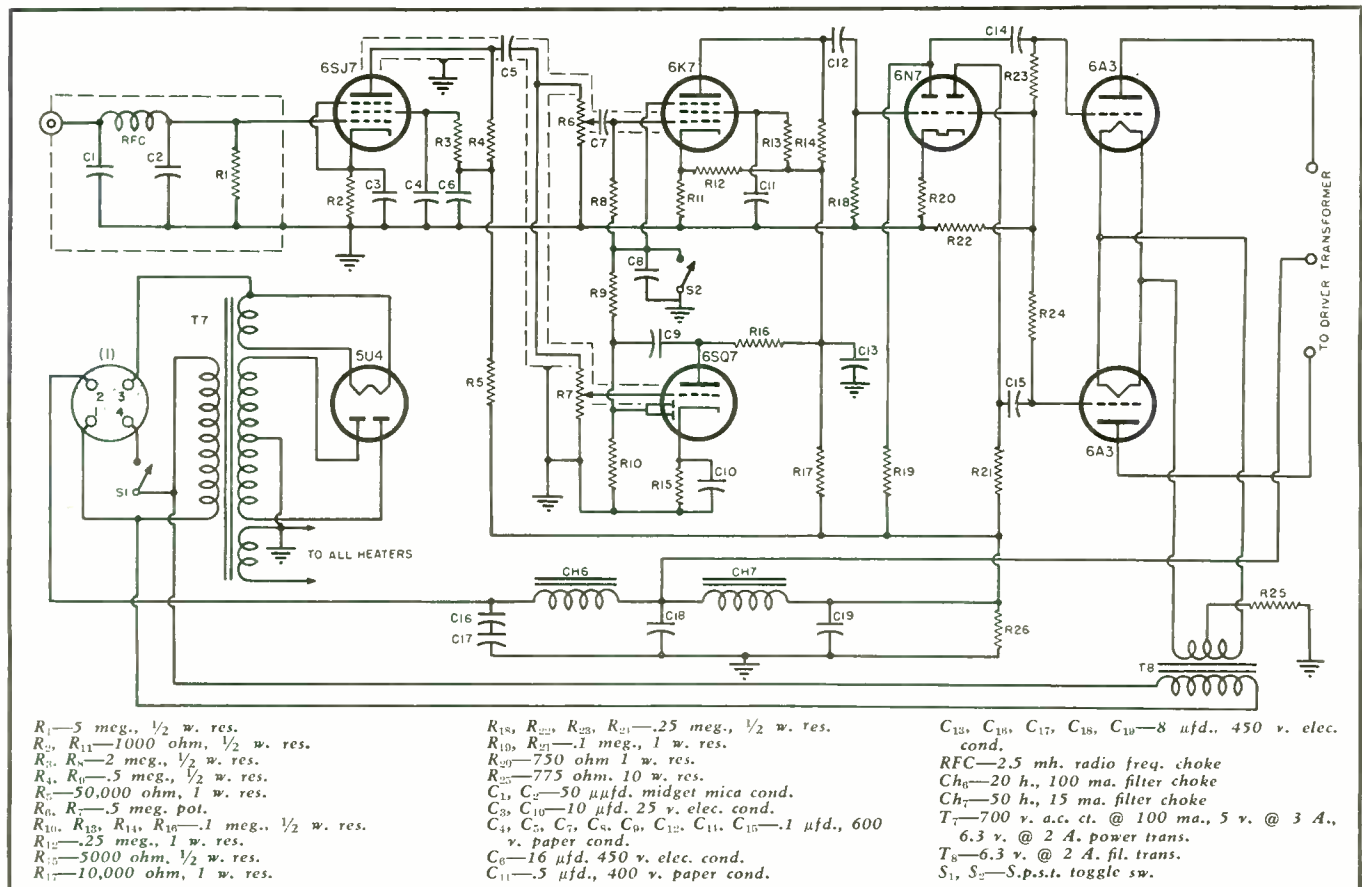

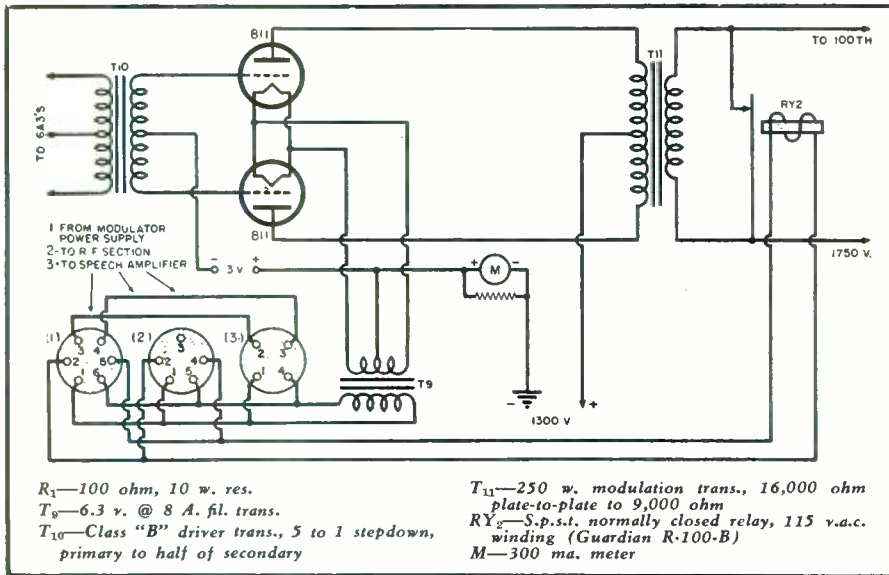

Fig. 2. Schematic diagram of the modulator. Socket #1 connects to socket #2 of the modulator power supply. Fig. 6. Socket #2 connects to socket #3 of the r.f. unit. Fig. 3. Socket #3 connects to socket #1 of the speech amplifier. Fig. 1.

of feed-back. The only effect the filter has on normal operation is to reduce the output from the microphone a trifle. This reduction is equivalent to that resulting from increasing the length of the microphone cable three or four feet. The volume compressor, consisting of the 6K7 and 6SQ7, permits the average level of modulation to be increased considerably without exceeding 100% on peaks. Originally, a 6L7 was used as the controlled tube, but the 6K7 gives smoother results with less tendency to block. The tubes are interchangeable in the socket with no change in wiring. Push-pull triodes

with plenty of step down in the driver transformer assure excellent regulation in the driver. Gain from the speech amplifier is quite high. With the compressor set for maximum compression, the gain control is run only about half way open for 100% modulation when talking at a low level a few inches from the microphone. Still more gain can be obtained by bypassing the 6K7 cathode to ground.

Three volts of bias on the 811 modulators keep the no-signal plate current down to 45 milliamperes. The tubes are zero-bias up to 1250 volts on the plates, but the voltage of the modula-

tor power supply approaches 1400 volts under idling conditions, and the resulting 65 milliamperes of plate current caused the plates to run a little red at no signal. A normally closed relay across the output terminals of the modulation transformer protects it and the 811's from keying surges when the transmitter is used on c.w. Also the opened contacts act as a safety gap if the modulator should be accidentally operated without load.

The power supplies are conventional, all except the speech amplifier supply and bias pack using mercury vapor rectifiers and choke input filter systems. The resistance of the high voltage bleeders is considerably higher than recommended for best voltage regulation when using 5 to 25 henry swinging chokes, but is satisfactory. 25,000 ohms is the calculated value, which would mean a bleeder current of over 50 milliamperes for the modulator supply, and 70 milliamperes for the 1750 volt supply. The idling current of the modulator tubes, plus the 20 milliamperes bleeder current, brings the minimum current drain on this supply above 60 milliamperes, so its voltage regulation is excellent. Somewhat better regulation may be obtained from the 1750 volt supply by reducing its bleeder resistance to 25,000 ohms, but larger chokes will be required, and 120 watts will be dissipated in the bleeder.

An examination of the various diagrams will show the interlocking switching arrangement. No high voltage can be applied unless the filaments are on; the exciter supply must be on before the 1750 volt supply can be

Fig. 3. Wiring diagram for the r.f. unit. Socket #1 connects to socket #1 of the antenna tuner, Fig. 4. Socket #2 connects to 600 volt output of the r.f. power supply chassis, Fig. 5. Socket #3 connects to socket #2 of the modulator. Fig. 2.

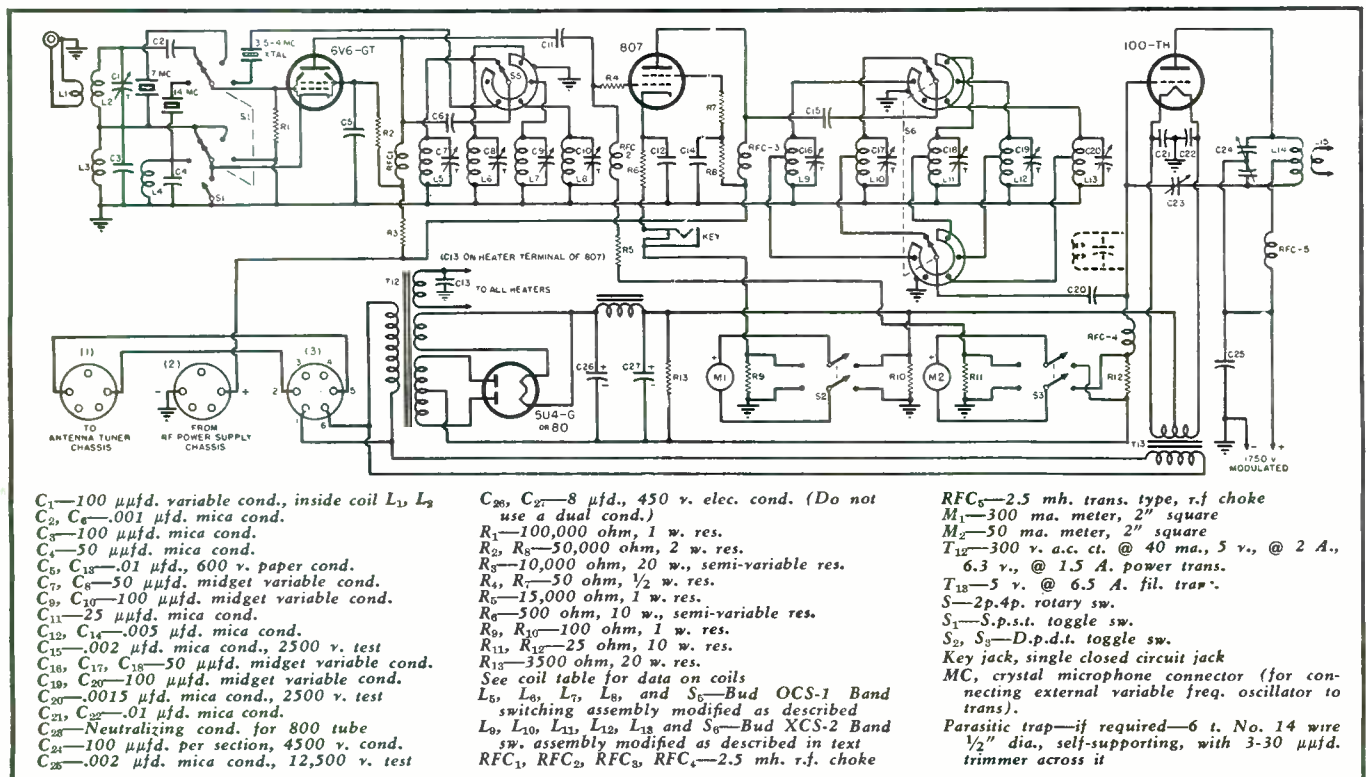

turned on, and both must be on before the modulator supply can be turned on. Turning on the modulator supply unshorts the modulation transformer by energizing relay, RY_2 , and applies plate voltage to the speech amplifier through RY_3 . (This relay takes up less room and costs less than extra filament transformers for the speech amplifier.) After the filaments are on, S_3 , or RY_1 in parallel with it, controls the transmitter in regular operation. The relay is operated by a d.p.d.t. switch, which permits single switch operation of both transmitter and receiver.

Constructional details can be gleaned from a careful study of the pictures. Professional appearance is assured by building the transmitter in a deluxe type rack cabinet with rounded corners. Combined panel heights are $61\frac{1}{4}$ ".

The radio frequency section was built on a $17" \times 10" \times 3"$ chassis, because when it was built new chasses were not obtainable. However, it is suggested that one $17" \times 12" \times 3"$ be used with the rear of the high voltage tank condenser set even with the rear of the chassis. The picture of the r.f. section shows this condenser mounted directly to the chassis, but it has since been mounted on stand-off insulators, and the rotor bypassed to ground through a high voltage mica condenser. The mica condenser is mounted under the chassis between the filament transformer and the rear of the chassis. It is almost a necessity to use the tank condenser specified in order to get all the parts in the space available. Its shaft is cut off short, and fastened to the dial with a high voltage shaft coupler. Use a metal shaft extension, and be sure the panel bushing is grounded for protection if the coupling should break down. If a metal panel is used, the bushing will, of course, be automatically grounded. The panel is $10\frac{1}{2}"$ high, and the condenser mounts with shaft $2\frac{3}{8}"$ in from the right hand edge, and the same distance up from the chassis.

Mount the oscillator coil assembly so that its shaft is in corresponding position on the left of the panel and the buffer coil assembly in the center. Considerable modification of both these assemblies is necessary if commercial ones are used. The 1.75-3.5 megacycle coil is removed from the oscillator unit, and the former 1.75 megacycle contact is connected to the 3.5 megacycle crystal socket; the tap is removed from the 7-14 megacycle coil, and the coil used only for 7 megacycles. New coils are wound for 14 and 28 megacycles, and the former 28 megacycle coil is used for 21 megacycles. Before mounting on the panel, set the stop so all six switch positions are available. The sixth, vacant, position is used with the external VFO when output is desired on the same frequency band that the grid coil is tuned to, the 6V6 then being impedance coupled to the 807.

The buffer coil unit has all link windings removed, the 1.75 megacycle coil is discarded; a few turns are re-

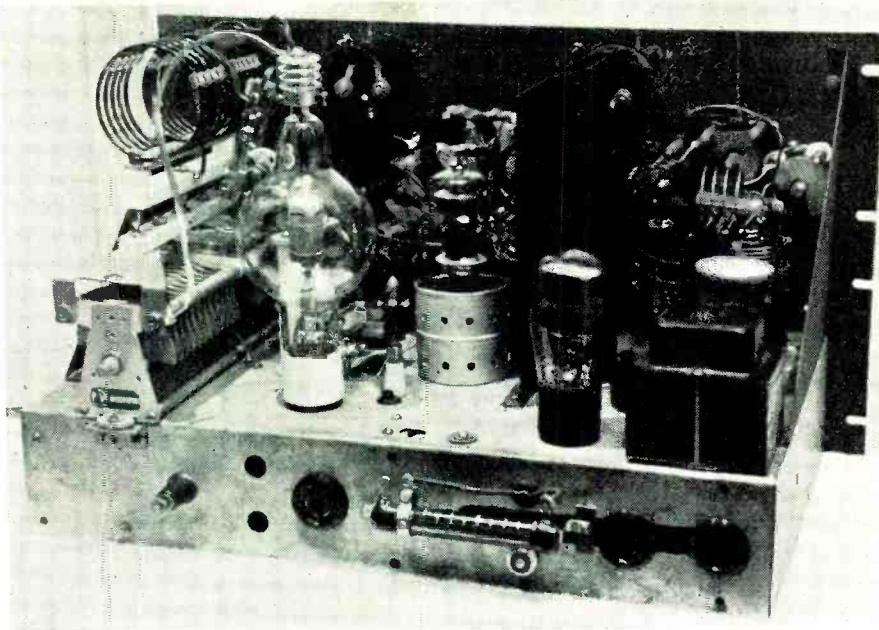

Rear view of the r.f. chassis. The tuning condenser has since been mounted on standoff insulators with the rotor bypassed to ground through a mica condenser.

moved from the 3.5, 7 and 14 megacycle coils; the 28 megacycle coil is used for 21 megacycles, and a new 28 megacycle coil is wound. All coils are tapped one-third the total turns from the plate end. While these changes are being made, the leads are bent slightly to increase the spacing between the coils and the variable condensers. The coils will tune without removing turns, but the loaded "Q" is improved by doing so. Complete dimensions are given in the coil table.

Single bearing condensers are

mounted on the panel on a $2\frac{1}{4}"$ radius around their respective band switches, and are connected directly across the individual coils. Before the knobs are put on the condenser shafts, a lock washer is slid over each shaft, and the knob firmly pressed against it while the set screw is tightened. This makes the condensers turn harder, and reduces the possibility of accidentally detuning one while turning a band switch.

Along the bottom of the panel are,
(Continued on page 119)

Modulator power supply. Schematic diagram for this assembly is shown in Fig. 6.

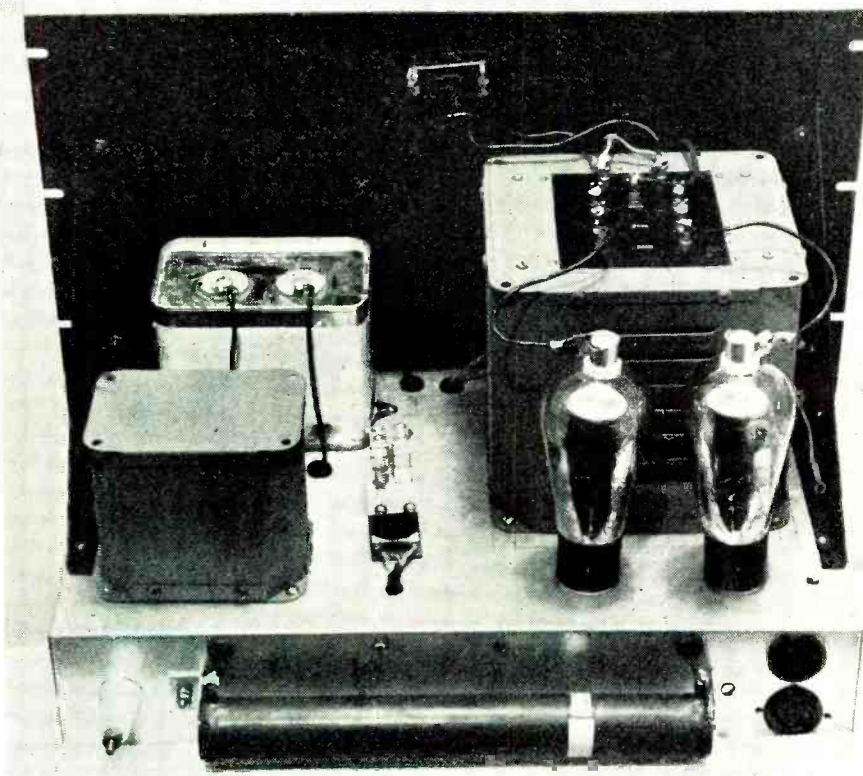



International SHORT-WAVE

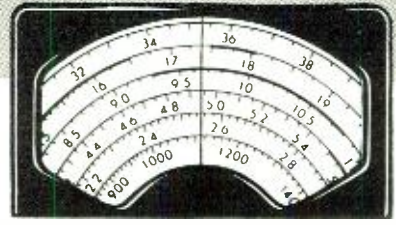

Compiled by **KENNETH R. BOORD**

FROM Hilversum, Holland, I have just received a letter from *Edward Startz*, master-of-ceremonies of the "Happy Station" programs recently resumed by PCJ, 15.220 and 9.590, relating to "PCJ's 'resurrection' after 5 years of dreadful oppression." Many readers of RADIO NEWS who were numbered among Mr. Startz's listeners to his "Happy Station" programs over PCJ—from 1928 to the German occupation of Holland—will be glad to know that he is back on the job as usual, with great plans for future programs from "The Happy Station."

He writes: "I am flying to England today for a visit on broadcasting matters for about a week, but before hopping off I'd like to answer your last letter. We are still much handicapped by the fact that there is little coal and therefore we have to be very economical as to the power, and besides, because of our limitations in using our broadcast time—which after these years has been split up by other stations—things are still very difficult. The Eastern program on 19.71 meters (15.220) you are listening to is re-transmitted at night, starting at 1 GMT (8 p.m. EST) on our old wavelength of 31.28 meters (9.590), but as WLWO, Cincinnati, and also a BBC transmitter for South America operate on or around that frequency, this broadcast is not coming through to the Western Hemisphere. *Please try to listen to this 31-meter broadcast (a recording of the 19-meter program, portion of 8-9 a.m. EST on 15.220), and let me have a report.*

"Most of our programs are, of course, in Dutch and are principally for the time being meant for our distressed countrymen in the Indies and in the second place in the rest of the world.

"The Happy Station' Programs, however, are as I conducted them from 1928 on—with the exception of the war years—and are meant for the entire world: it is our *International Program*.

"I, personally, have luckily squirmed through the German occupation after many hardships and naturally complete absence from the 'mike.' Now I am holding Roll Call around the world in the two, still short programs on Wednesdays and Sundays to pick

up our lost audience, which, however, in the form of a huge mail, is showing up again very enthusiastically. As soon as our nightwave is clear again, I hope our great American audience of before the war will be flocking in again. It will be a feast when that happens. Meanwhile, please remember me to all friends in the USA.

"All my recorded broadcast material was 'gypped' by the Germans—I mean 'Germs!'—and I am having a busy time building up again from the start. With the support of *The Happy Station's* great goodwill in the States, however, I shall soon make up for the loss sustained in the last years. As to the 'Happy Hour' of PCJ, please have all mail addressed to me personally at PCJ."

Come on, DXers, let's send reports to our old friend, Edward Startz, M.C., "Happy Station Programs," c/o PCJ, Postbus 100, Hilversum, Holland (Netherlands); remember, *he's especially interested in reception reports on the repeat broadcast, 8-9 p.m. EST on 9.590, directed to the Western*

From PCJ, "The Happy Station," Hilversum, Holland, comes this late photo of Edward Startz, master-of-ceremonies of the "Happy Station Programs", from 1928 to the German occupation of Holland five years ago. The welcome voice of Mr. Startz—known to thousands of SW fans throughout the world in prewar days—has returned to the airwaves, with the "Happy Station Programs" once more from PCJ, 15.220, 8-9:30 a. m. EST, on Wednesdays and Sundays, with a recorded repeat from 8-9 p. m. over 9.590.



Hemisphere. He'll keep us informed of further developments at that end.

* * *

DENMARK ON THE AIR?

Henry M. Henriksen, Racine, Wisconsin, writes: "A friend of ours has just received a cable from Copenhagen, Denmark, stating that the Danish SW stations are now on the air again as follows:

"From 11:35 a.m. to 3 p.m. EST daily over OZU, 7.260; OZF, 9.520; and OZH, 15.320."

Most sources list the 31-meter band Danish transmitter as on 9.518. (*Your short-wave editor is especially interested in reception reports on these transmitters.*)

* * *

THE MIDDLE EAST CALLS

Recent copies of the "Forces' Radio Times," produced by the Forces' Broadcasting Service, A.W. 5, G.H.Q., M.E.F., in conjunction with the BBC, Cairo, Egypt, have just been received, giving schedules for Middle East SW transmitters as follows:

Radio Levant—Located in Beirut, Lebanon—8.11 (37 meters) and 731 kcs. (411 meters)—News, 5:25-5:30 a.m.; Records at Random, 10:45 a.m.; News and Evening Serenade, 11 a.m.; various features, 11:15-11:45 a.m. It appears that this is just a *portion* of the daily schedule having to do with the program "for Forces in the Lebanon and Northern Palestine," being relayed from Station JCLA, Beirut, on 1,080 kcs. (277.8 meters).

JCKW—Located in Jerusalem, Palestine, as short-wave service of Station JCPA (795 kcs., 377.4 m.)—JCKW is on 7.22 (41.55 meters). JCPA operates "for Forces in Palestine" while JCKW is used "for rest of Middle East." According to the printed schedule, JCKW (relaying JCPA) signs on at 11:30 p.m. with "Musical Clock" and frequent time announcements; news from BBC at 1 a.m.; sign-off for this period is at 1:30 a.m., some days at 1:40 a.m. JCKW takes to the air again at 4 a.m. and runs to close down at 4 p.m., with News and Home News from the BBC at 12 noon, and News followed by Sports Summary at 3 p.m.; a program for Indian Troops is carried between 6-7 a.m.; dance music is scheduled from either 3:10 or 3:15 p.m. to close down at 4 p.m. Most Saturdays, JCKW runs a test transmission to 8 p.m. EST.

(Continued on page 110)

Unless otherwise indicated, all time referred to herein is Eastern Standard Time, (EST).

Radar works for peace as it did for war, now plotting the paths of hurricanes and thunderstorms. Entire areas can be prewarned, thus saving lives and property.

By
S. R. WINTERS

On September 16th, at 2:20 am., A.A.F. Center radar sets at Orlo Vista, Florida, were registering "echoes" from the dense rain clouds accompanying a major hurricane up the peninsula. Here the storm is seen as a figure six as it moves north toward Orlo Vista (marked by white area at top).

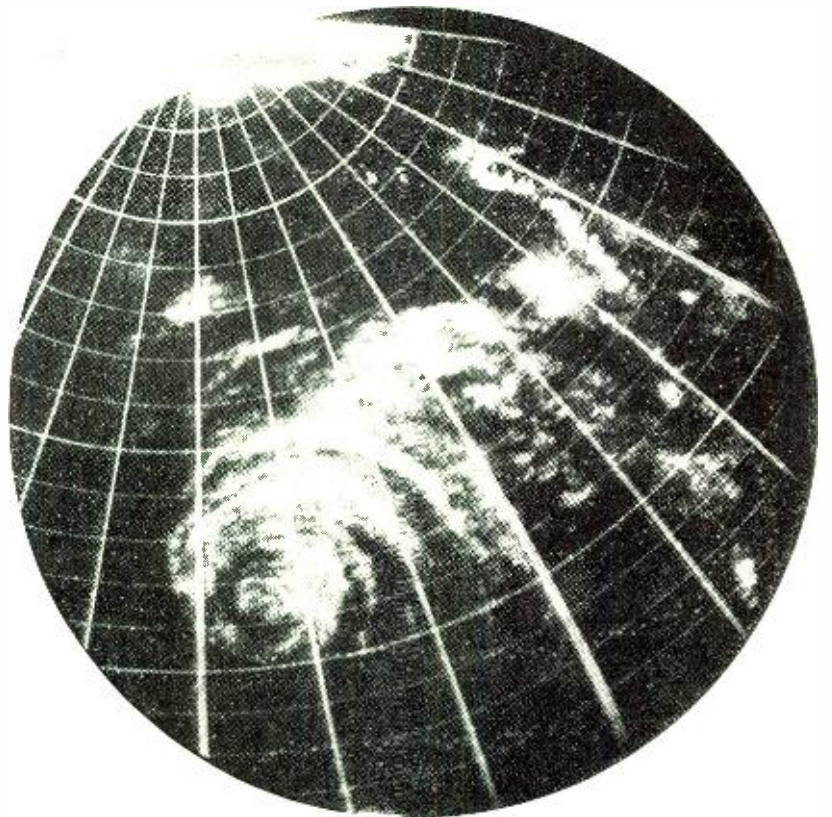

BESIDE a sand-swept road leading to Florida's State Sanatorium, near Orlo Vista, and amidst a tropical setting of orange groves and shrubbery infested with Spanish moss, is a hut fashioned from wood and canvas. Within it is a maze of complicated gadgets—a radar system, if you please—and the crew of meteorologists and electronic experts are detecting the approach of thunderstorms and possibly devastating hurricanes.

About 18 years ago this writer described the initial efforts of the U. S. Navy Department in using directional antennas and other radio equipment in tracking down hurricanes at sea. Then such an innovation was so startling as to completely bewilder the imagination. Even now, with atomic energy being harnessed and with radar broadening our scientific horizons and lifting blankets of fog and darkness,

Spotting Hurricanes and Thunderstorms by RADAR

as it were, our minds still stagger at such departures as radar hurricane detection. However, with citrus groves as a backdrop for their observations—and with rolls of sand piled high in the adjacent roadway—the radar crew and weathermen in the wood-and-canvas hut near Orlo Vista found Nature, strangely enough, obliging

them with an honest-to-goodness hurricane for detection and study.

The Army Air Forces Center, with headquarters at Orlando, about 6 miles from Orlo Vista, had authorized a project involving the detection of thunderstorms by means of radar. Then the September fifteenth tropical

(Continued on page 100)

→ Taken at 3:30 p.m., September 16th, this picture shows what appeared on the radar scopes operated by A.A.F. Center weather officers as the hurricane's center passes within ten miles of Orlo Vista. Large white area in center is caused by radar echoing from 17,000-ft. cloud banks around the hurricane's central "eye."

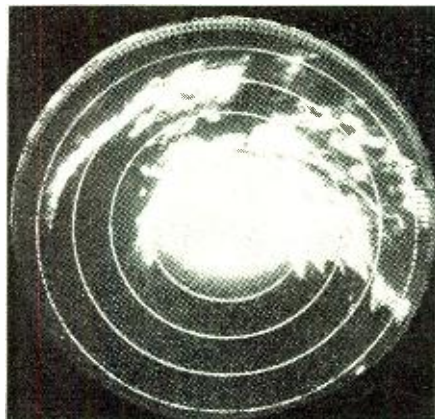

→ As the hurricane, losing violence, passes the radar station at Orlo Vista and continues towards Jacksonville, Florida, less severe storminess shows up on the radar scope. This picture was taken at 6:00 p.m., September 16th, when the center of the hurricane was located approximately 40 miles northeast of the radar station.

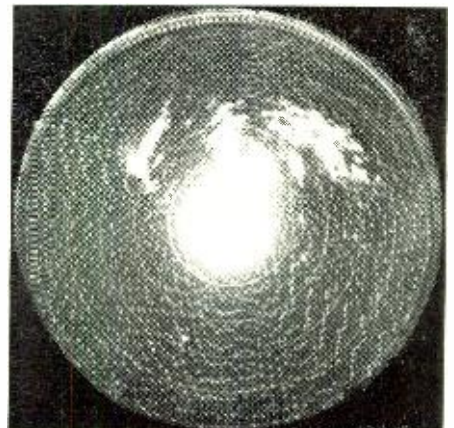

March, 1946

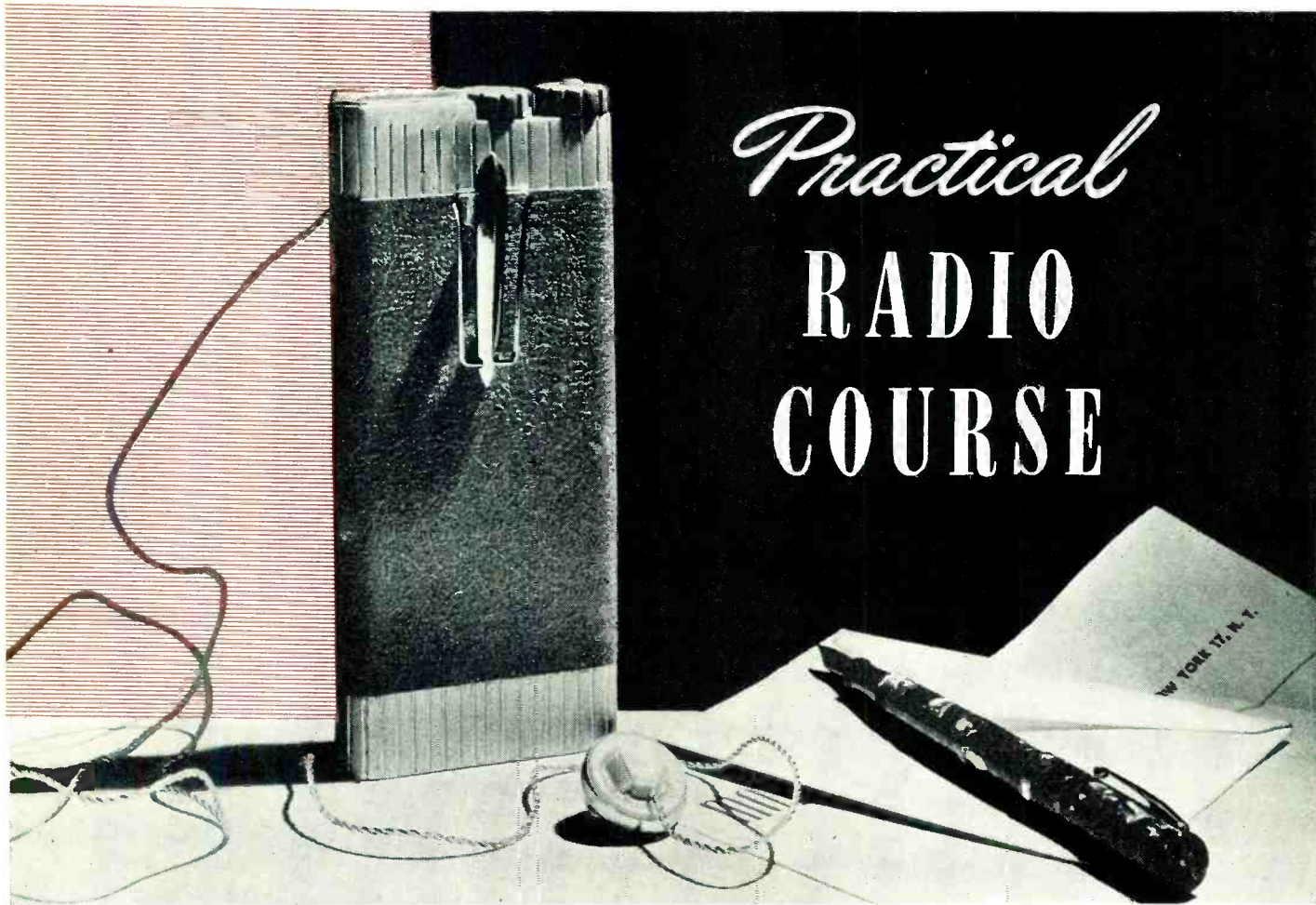

Practical RADIO COURSE

This pocket model receiver, weighing 10 ounces with batteries, was engineered by Belmont Radio Corp. and is scheduled for early civilian production. It measures 3"x3/4"x6 1/4" and employs sub-miniature tubes designed by Raytheon Mfg. Co.

Part 42. Covering various easily applied methods of minimizing and compensating for oscillator frequency drift in superheterodyne receivers.

By **ALFRED A. GHIRARDI**

THE frequency-determining circuits of the oscillator of a superheterodyne receiver are designed, of necessity, to be very sharply tuned. After the receiver has been properly tuned to receive a particular desired signal, any change that may occur in the electrical constants of these circuits will cause the oscillator frequency to change or *drift*. This will so shift the frequency of the resulting intermediate carrier that the i.f. amplifier will be mis-tuned to it, by an amount that depends upon the amount of oscillator frequency drift. A small change in the frequency of the intermediate carrier may result only in distortion of the signal; also, results in loss of volume as well, and if the i.f. stages are sharply tuned it is possible that the station may be lost altogether.¹

The various causes, and effects, of drift in the frequency of the super-

heterodyne's oscillator were discussed in the last two articles of this series. It was found that of the many causes that contribute to it, *change of temperature* is generally the most important, with changes of tuning adjustments, occurring in push-button tuned receivers, ranking second. The popularization of push-button tuning, and the increased use of short-wave and ultra-short-wave, fixed-tuned receivers for a wide variety of mobile applications that subject them to wide ranges of temperature (police and emergency radio, aircraft radio, military radio, etc.), have accentuated the necessity of finding simple, inexpensive, yet effective methods of minimizing oscillator frequency drift caused by temperature changes. Considerable research has been directed to the problem, with

¹ Fig. 2 in *PRACTICAL RADIO COURSE*, Part 40, January 1946 issue of *RADIO NEWS*.

the result that effective and satisfactory remedies have been developed.

Four Methods of Approach to the Frequency Drift Problem

There are four general methods of approach to the solution of the oscillator frequency stability problem. They are:

(1) Improvement in the operating stability of each component in the frequency-determining circuits, and improvement in the mounting and physical location of these components in relation to such sources of heat as the power output and rectifier tubes, power transformer, voltage-dropping resistors, etc.

(2) The application of corrective means for compensating or neutralizing the over-all shift that remains in a well-designed oscillator.

(3) The use of an oscillator whose frequency is accurately controlled and stabilized by quartz crystals of the various frequencies required—for push-button tuned receivers.

(4) Providing Automatic Frequency Control (AFC) so that even if the oscillator frequency tends to drift slightly, it is corrected automatically.

Reduction of Drift by Improved Component Design and Location

Even though methods (2), (3), or (4) are employed, it still is good de-

sign practice to reduce the frequency drift in any receiver by judicious design of all components in the frequency-determining circuits in order to improve their operating stability by method (1). Accordingly, receiver manufacturers, insofar as production costs in the particular receiver model will permit, attempt to use well-designed tuning coils, capacitors, band switches, etc., specially protected from the effects of moisture, and arrange all parts and wiring so they will not alter their position as a result of heating, shock, vibration, etc. They also attempt to secure advantageous component and circuit arrangements wherever possible, such as that of employing the relatively stable powdered iron-core type tuning inductors in the oscillator tuning circuit of push-button receivers instead of using the less stable ordinary mica trimmer capacitor arrangement. Also, those components which contribute most to the frequency drift are protected as much as possible from receiver-generated heat by mounting them as far away from power and rectifier tubes, transformers, heat-generating resistors, etc., as is possible. Ample spacing and adequate ventilation assist materially. Of course, in small midget and portable receivers this becomes difficult—for all components must be mounted quite close together in a confined cabinet, and the entire assembly usually becomes quite hot after a short time. For example, in one receiver investigated, the temperature of the chassis at a point near the oscillator tube increased approximately 15° C. during the first hour after switching the receiver on. The temperature of the air increased about 13° C., and that of the top of the oscillator tube (6J5, a metal type) increased by approximately 50° C. The temperature between the base of the tube and the socket increased 30° C.

Paradoxically, a receiver so constructed that the critical circuit elements are fairly well removed from the heat source may take the longest time to "settle down," simply because a greater time is required for that part of the receiver to reach a stable temperature. The total drift, of course, will be less than in the case of a set having the oscillator tuning components mounted near tubes or power supply components.

After all such refinements have been incorporated, any objectionable frequency drift that is still present may either be compensated by method (2), or its effect corrected by method (4)—the use of AFC.

Compensating for Temperature-Induced Frequency Change in Tuned Circuits

The normal temperature coefficient of the components in tuned circuits is usually *positive*, that is, the inductance

² For a discussion of silvered-mica and ceramic-dielectric type fixed and adjustable capacitors see Part 41, *PRACTICAL RADIO COURSE* in the February 1946 issue of *RADIO NEWS*.

(*L*) of the coils and the capacitance (*C*) of the capacitors both increase with an increase in temperature. Therefore, since the resonance frequency of the tuned circuit is equal to

$$f = \frac{1}{6.28 \sqrt{LC}},$$

it normally *decreases* as the temperature increases.

Thus far in this discussion, attention has been directed to the various more important causes of oscillator frequency drift; also to the fact that if the oscillator frequency is higher than that of the incoming signal its thermal drift is compensated partially by the drift in the i.f. stages. However, since the i.f. amplifier tuning circuits operate at a fixed frequency, whereas that of the oscillator operates at a variable frequency, the drift of the former will vary with temperature in a rather simple relationship whereas that in the oscillator will also vary with the frequency. Hence, the i.f. amplifier drift cannot be made to compensate the oscillator drift over any but a very small range of oscillator frequencies. However, it is in a direction that does help.

After all possible design precautions have been taken to increase the frequency stability of the oscillator, recourse may be made to methods of compensation for neutralizing the remaining over-all drift that results, if a low order of over-all drift is to be attained. This involves designing *either* the tuning inductor or tuning capacitor so it has a temperature characteristic that will enable it to *compensate the remaining over-all frequency drift*, or using an oscillator-trimmer capacitor that has the proper compensating characteristic.

The use of a special design of iron-core tuning coil that provides some frequency compensation was explained in the article of last month. Such coils have been successfully employed in push-button tuned receivers to effect partial compensation. The solution that is more widely employed involves the use of a temperature-compensating type of oscillator main tuning (or trimmer) capacitor that has the proper *value* and *characteristic* of negative temperature coefficient *i.e.*, whose capacitance *decreases* by the

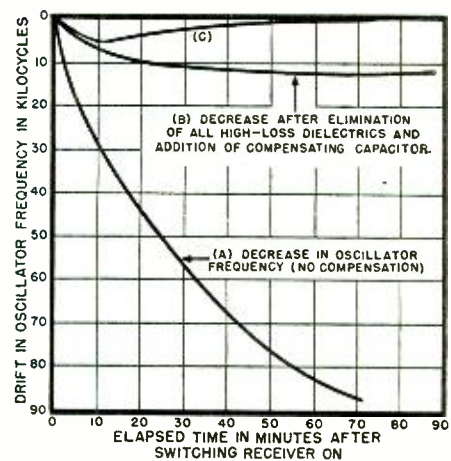

Fig. 1. Curves illustrating oscillator frequency drift (decrease) on short-wave band of superheterodyne receiver before and after improving design of components and applying effective frequency-drift compensation to the osc. circuit.

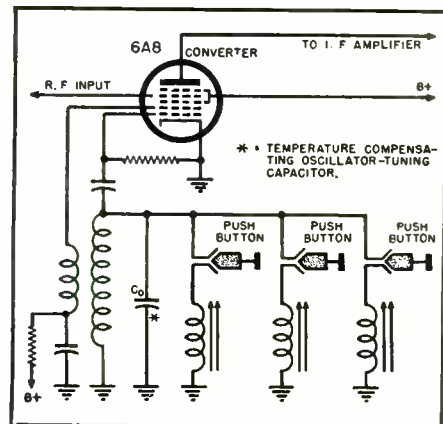
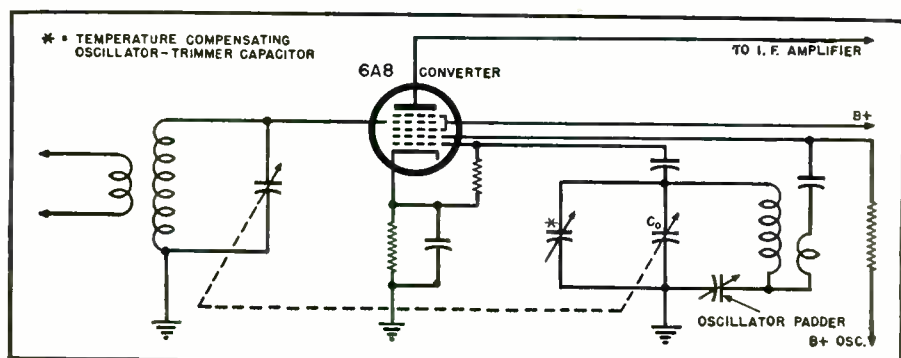

Fig. 2. Temperature-compensating type fixed oscillator tuning capacitor employed to reduce oscillator frequency drift in push-button tuned RCA Victor 87K receivers.

proper amount with increase of temperature. The development of the ceramic-dielectric type of fixed and adjustable capacitors² to the point where well-controlled mass production is possible has widely increased their use for this purpose. However, it must be realized that use of this type of compensation results in some uncompensated drift in variable-frequency tuning circuits (such as that of the superhetero-
(Continued on page 96)

Fig. 3. Application of temperature-compensating type oscillator trimmer capacitor employed to reduce oscillator frequency drift in manually-tuned Fada 6A80 receiver.



HOME BUILT

SIGNAL SHIFTER

By SOL HEYTOW, W9FAL

Complete construction details for a variable frequency oscillator. The output of this instrument can be used to replace 20 or 30 meter crystals, by using the present crystal stage as a frequency doubler.

AS THE pending return of amateurs to the lower frequency bands has stimulated a great deal of construction interest, a must to most operators is some means of variable frequency control, in order to cope with the crowded conditions that will prevail. It is probable with the increased activity in the entire radio spectrum that "out of band" operations will be dealt with much more severely than in the past.

Examination of all available literature on variable frequency oscillators revealed none that exactly suited the

writer's requirements. Some of the commercial units when available would be satisfactory, but this would entail a wait of several months until the manufacturers catch up with the great demand. Space requirements indicated that any unit used at this location would of necessity have to be small in size and still maintain all the desirable characteristics. Accordingly, an attempt was made to ascertain whether a satisfactory unit including its own power supply could be built in a compact cabinet.

The unit described is essentially the

same as the *Meissner De Luxe* Signal Shifter, but requires only half the space of that unit.

Needless to say, there are many obstacles encountered in building a satisfactory unit in such a small space. The first model tried had had frequency drift due to the heating of components, and some mechanical instability. By the trial and error method, and continual work, a satisfactory unit was finally evolved. As may be seen from the photographs, the entire unit was constructed to fit into a grey wrinkle finished cabinet only 8" high, 12" long by 8" deep. The panel of this unit is 8" x 10".

The circuit used is simple and straightforward with a 6F6 used as an electron coupled oscillator, capacity coupled to a 6L6 buffer-doubler. Output is made to a link winding, which may be coupled into the regular crystal stage of an existing transmitter, or used to drive a final amplifier. The output on all bands is somewhat over 20 watts.

The conventional power supply, using a "brute force" filter system consisting of two heavy duty filter chokes and three electrolytic condensers supplies sufficiently smooth power to eliminate any possibility of frequency modulation of the oscillator. Power is supplied by a 5Z4 rectifier, and voltage stabilization achieved by means of a VR-150 and VR-105 voltage regulator. This allows a total plate voltage of 255 volts for the oscillator and buffer stage, while the screen of the oscillator is regulated at 150 volts.

A two-gang, 3 position switch allows the choice of either remote control of the unit from the a.c. supply of the transmitter, or manual control. For simplicity and convenience, plug-in coils are used. As the requirements were for output on the 160 and 40 meter bands, only coil specifications for these bands are given. Tuning for

Fig. 1. Bottom view of the completed unit. All wiring in the r.f. section must be as short as possible to obtain maximum frequency stability.

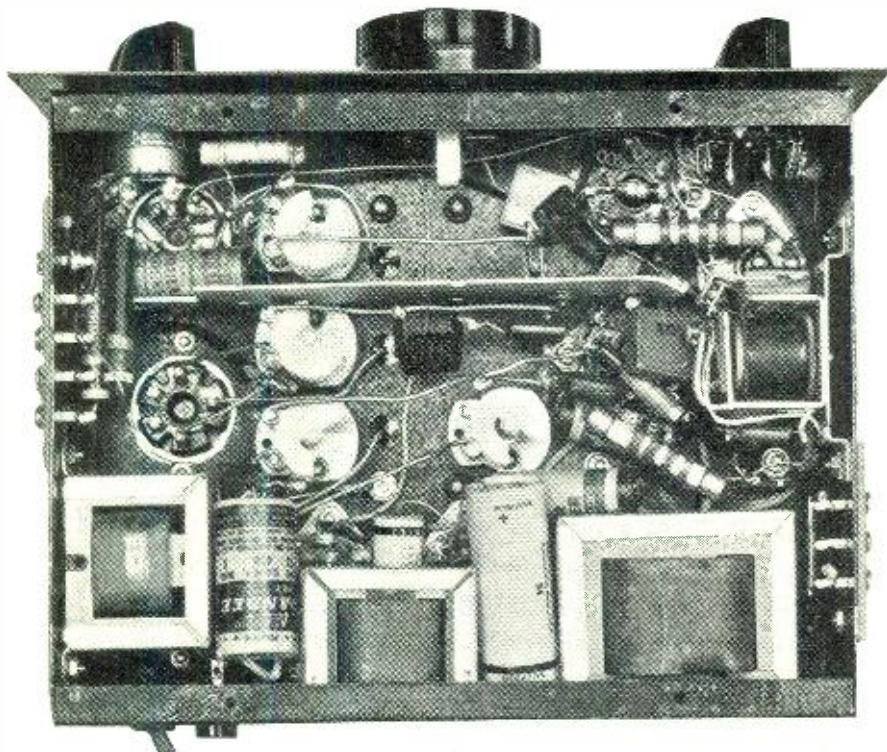

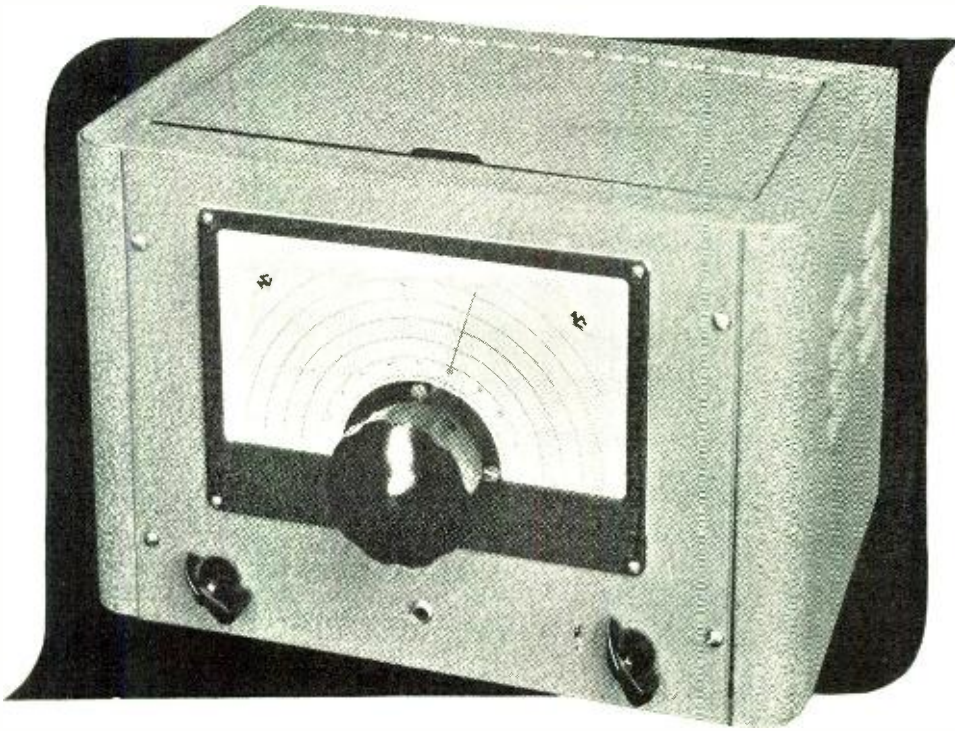

Fig. 2. Front panel view. The dial scale is calibrated by zero beating an accurate frequency standard against the oscillator. ←

knob controls S_{1a} and S_{1b} . The keying jack, J_1 , is located in the center of the panel just below the tuning knob. A large National type ACN dial provides an easily read scale and a smooth tuning action.

The placement of parts underneath the chassis may be seen in Fig. 1. The large filter choke L_2 is mounted at the lower right hand corner with L_1 located at the lower center. The key click choke, L_3 , is located on the left hand edge of the chassis just below the keying terminal strip. The terminal strip on the right hand edge is the one marked "To A.C. on Trans."

The relay, Ry_1 , is located about the center of the right hand edge of the chassis. A shield plate serves to isolate the oscillator section from the balance of the unit and to prevent interaction between stages. The temperature compensating condenser, C_3 , is the result of considerable "cut and try." As finally adopted in this unit, it consists of a 150 $\mu\mu\text{fd.}$, negative temperature coefficient, shunted by a 50 $\mu\mu\text{fd.}$ zero temperature coefficient type. The 150 $\mu\mu\text{fd.}$ unit is of the .002 $\mu\text{fd./}\mu\text{fd.}$ style. With this combination of values, the oscillator reaches rock-like stability in less than 15 minutes from a cold start and does not vary from zero beat over a period of several hours. Originally the relay, Ry_1 , was connected between the grid of the oscillator and ground. Inasmuch as this is a very critical point in the circuit, any slight motion of the armature of the relay caused frequency variation with mechanical vibration of the unit. Changing this connection so that relay

all stages is ganged by means of C_2 , C_{10} and C_{11} . The condenser shown in the photographs has since been replaced by another unit which allowed the oscillator grid circuit section to be double spaced. The chassis used is 7" by 9" by 2" deep, with black wrinkle finish. Coils are mounted in shield cans along the left edge of the chassis with the gang condenser centered on the chassis and mounted by means of its spade lugs. These spade lugs are fitted into live rubber grommets which are mounted in clearance holes in the chassis, in this manner affording mechanical cushioning of the condenser to provide greater stability. The ground to the condenser is made to only one point, in order to maintain all r.f. circuits at the same potential.

The ganged tuning condenser C_2 , C_{10} , C_{11} is constructed of a reworked 3-gang broadcast unit, originally of 450 $\mu\mu\text{fd.}$ per section. Alternate rotor and stator plates are removed to make double spaced sections. The oscillator section C_2 consists of 7 rotor plates and 6 stators, while C_{10} and C_{11} consist of 5 rotors and 4 stators each. Great care will be necessary in removing the condenser plates to prevent damage to those remaining. The easiest way to accomplish this is by means of a pair of long nose pliers, grasping the plate firmly near the point at which it is anchored and working it gently back and forth. Care should be taken not to distort the stator framework as these plates are removed.

To the right of the gang condenser, and close to the panel, the 6F6 oscillator is mounted with the 6L6 buffer located directly behind it. The VR-150 and the filter condenser C_3 are mounted along the right hand edge of the chassis, with the power transformer T_1 mounted at the right rear corner. Di-

rectly to the rear of the gang condenser may be seen the VR-105 and the 5Z4 rectifier. Trimmer condensers C_1 , C_6 and C_{15} are mounted underneath the chassis, between the gang condenser and the plug-in coils. The neutralizing condenser C_{17} , necessary only when working straight through on the buffer, is mounted underneath the chassis just to the right of the rear section of the gang condenser.

Referring to the front view of the V.F.O. the left hand knob controls the on-off switch, S_2 , while the right hand

Fig. 3. Top chassis view showing placement of component parts. The three shielded, plug-in coil assemblies are shown mounted towards the left side of the chassis.

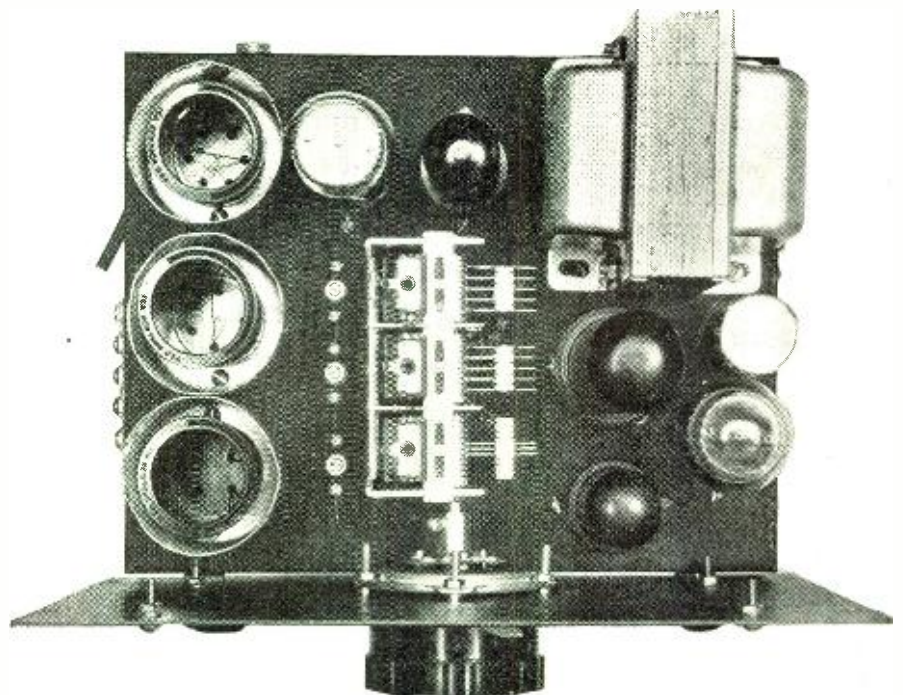

BAND	OSC. GRID	OSC. PLATE	BUFFER PLATE
160	74 t. # 26 p.e. 1½" long. Start at pin # 1, tap at 20½ t. to pin # 3, finish at pin # 2, connect pins # 3 & # 4 together.	54½ t. # 26 p.e. 1¼" long. Start at pin # 4, finish at pin # 3, no tap. Connect pins # 2 & # 3 together.	77½ t. # 26 p.e. 1¾" long. Start at pin # 2, tap at 20¼ t. to pin # 3, finish at pin # 5. Connect pins # 4 & # 5 together. Link winding 13 t. # 26 p.e. at "cold" end of coil, to pins # 1 & # 6.
40	40 t. # 22 p.e. 1¼" long. Start at pin # 1, tap at 11½ t. to pin # 3, tap at 19½ t. to pin # 4, finish at pin # 2.	36 t. # 24 p.e. 1¾" long. Start at pin # 4, tap at 16¼ t. to pin # 3, finish at pin # 2.	17¼ t. # 22 p.e. 1¾" long. Start at pin # 3, tap at 9¼ t. to pin # 4, finish at pin # 5. Link 6¼ t. # 22 d.c.c. interwound at "cold" end of coil, to pins # 1 & # 6.

Table I. Coil specifications giving complete details for their construction. These coils are wound on 1¼" diameter forms, and mounted in shield cans.

grounded the cathode instead of the grid eliminated this difficulty.

All wiring in the r.f. section must be rigid for maintenance of calibration and mechanical stability. In the unit described, this wiring was of #14 tinned wire, and run in the most direct manner.

RFC₂ is necessary to prevent parasitic oscillation in the grid circuit of the 6L6. It is probable that this would

not be needed in all cases, but its inclusion eliminates one source of difficulty.

When construction has been completed, tubes and coils should be inserted in their respective sockets, power applied and the voltages at various points checked. Assuming that all is in order, operation of the unit may be determined by listening to the output in a receiver. For oscillator

keying, a jumper should be connected between terminals 1 and 2 on the terminal strip, and an additional jumper between terminals 3 and 4, with a key inserted in the keying jack. Keying should be clean, and free from chirps and clicks. If buffer keying is desired, a jumper should be placed between terminals 2 and 3, and also between 4 and 5 on the terminal strip.

In the event that the keying is chirpy or has clicks or thumps, some experimentation with the values of R₀ and C₂₂ should be tried. The values shown gave satisfactory keying, but this may vary slightly depending upon the placement of component parts.

If it is not possible to clean up the keying by adjustment of R₀ and C₂₂, L₃, the key click choke should be adjusted by changing its air gap. This choke was originally one of the small replacement type chokes sold for a.c.-d.c. midgets, and was altered by having several layers of wire removed from its winding. The air gap, as originally supplied, consisted of a 5 mil piece of fibre paper. This was replaced by a piece of light cardboard to give a gap of approximately 15 mils.

(Continued on page 116)

Fig. 3. Schematic for the variable frequency oscillator. Entire unit, including its own power supply, employs only five tubes.

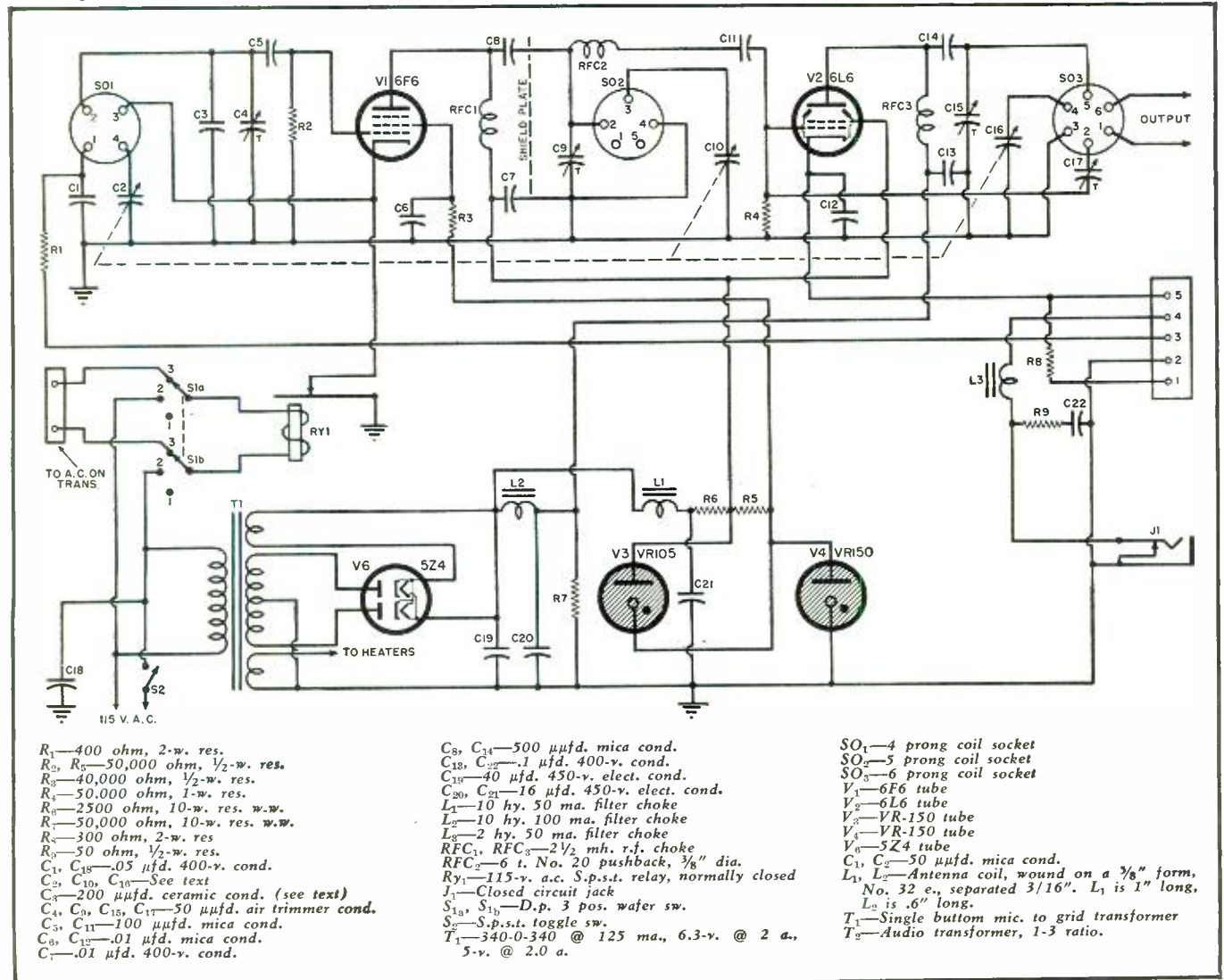

LEROY MEADOR was in port for a few days recently aboard his C-3 and is getting ideas about a vacation to his Texas home. Al Weis, 2nd with Roy actually did leave for an extended vacation which puts Bill Duffy up to 2nd. W. R. Hume was in a short while ago aboard his Liberty. D. M. Frantz on vacation to his home town in Texas after signing off the Sea Centaur in the big town. A. D. Sealey was in for some time while his Liberty was tied up for repairs.

Bob Pheysey with UFCO accounting department after working with Tropical Radio for several years. Charlie Shanholtzer up to the big city, after fifteen years in the tropics, as radio inspector with TRS Co. F. Pedersen, well known marine serviceman, has taken over the radio department at Arnessen Electric Company. George Broster, formerly with Raytheon, is now assistant to the general mgr. of Tropical Radio.

CHARLIE GUTHRIE, WSA radio inspector, is back on the job again after a prolonged illness—glad to see you around again, "C.G."—Charlie's position as head of the radio division was taken over temporarily by his able assistant Dave Carruthers. George Mathers, on the sick list, is recovering down in West Virginia and resting up a bit—hope to see you back on the job again soon, George.

Note from S. Swetozoff who has been flying with the Ferry Command, and is interested in getting into commercial radio operating via the airlines. R. K. Davis, for many years with TRT in New York, has resigned to enter business for himself in upstate New York, best of luck, "R.K". Nace Campbell, another old timer in the marine field, has recently joined the staff of TRS Co. in New York as radio inspector.

A DISCHARGE system was recently set up for merchant seamen with thirty-two months of "substantially continuous service" in the Merchant Marine. . . . WSA will recruit no men between the ages of 18 and 25 unless they have been disqualified for any military service or are eligible only for limited service. Service, according to the new system, includes periods of hospitalization, medical treatment, internment by the enemy, or allowable credit for shore leave. A seaman released from further duty is not subject to induction, but a qualified applicant's certificate of "substantially continuous service" must be accompanied by a notation that he is eligible to be relieved from any future consideration for classification into a class available for service. Local draft boards, however, still have the final word. As civilians, it was pointed out, these men between the ages of 18 through 25 were subject to draft upon leaving the maritime service even though they had served faithfully and continuously throughout the war period. Admiral Emory S. Land, War



By **CARL COLEMAN**

Shipping Administrator, pointed out the need for merchant seamen of all ratings in the transportation of troops to the United States, to feed and supply occupation forces throughout the world, to carry relief supplies to liberated countries, and to start the flow of United States post-war foreign commerce. Admiral Land and General Hershey expressed confidence that even seamen qualified for discharge under the new plan and who had been freed from further service by their draft boards would stay on the job "as long as they are needed."

"The relief from further consideration for service and the re-employment and other benefits accorded such men in recognition of continuous and faithful service," they declared, "should be an added incentive to those who have served less than the required period to remain in the service until they have earned these rights and benefits."

GLOBE WIRELESS notified shipping organizations recently that it has completed plans to rehabilitate and expand its extensive network of radio communications in the Pacific into an important international system. An announcement by R. Stanley Dollar, president, stated that Globe has acquired from IBM Corp. its interest in Radiotype, the high speed radiotypewriter, to be used as its transmit-

ting and receiving medium. While the extent of the company's expansion has not been disclosed, restoration of normal service throughout the Pacific areas will be undertaken first, with the installation of post-war equipment designed to provide rapid modern facilities for the public. Brig. Gen. Walter P. Boatwright has been appointed vice-pres. in charge of production and Globe also has acquired the services of Walter S. Lemmon, engineer and inventor, who becomes vice-president. Mr. Lemmon will bring into Globe a group of engineers who were associated with him in the development of radiotype.

Prior to the war, Globe employed a large number of radiomen, and with the above expansion in view apparently will be in a position to employ still more men than in the past.

While on the subject of expansion, Press Wireless has organized a subsidiary to be known as Press Wireless Manufacturing Corporation, it was announced by A. Warren Norton, president of Press Wireless. Mr. Norton will head the new company and Ray. H. De Pasquale, former director of manufacturing of P. W., has been elected vice-president and general manager.

H. B. KOCH, J. P. McNeill and Edward Stetson have all recently joined the shore staff of TRS Co. in New York. T. J. Curtis is now with NBC as transmitter engineer. E. C. Sittler, marine radio inspector in New York, is expecting to resign shortly and enter business on his own. Best of luck in the new venture, Ed. Sid Adler, former Broadcast Organizer for ACA, is back in the organization now, after three years in the Army. . . . The Atlantic Branch of ACA Broadcast Department has initiated a program calling for the publication of a month-

(Continued on page 82)

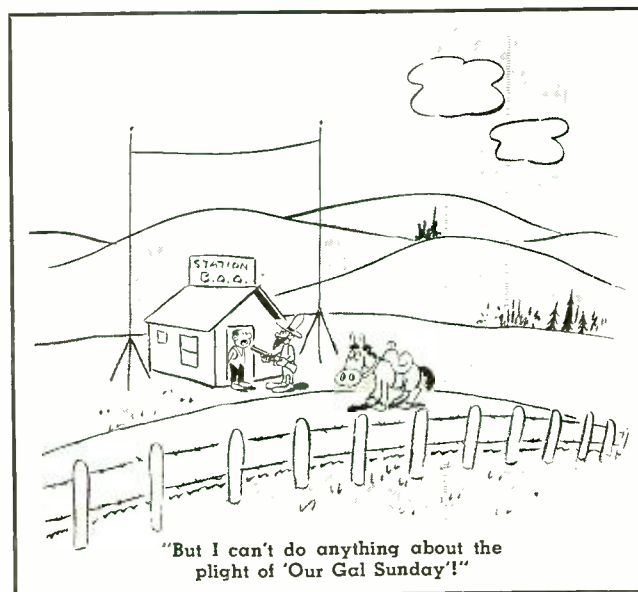

RADIO TELETYPE in the AACCS

Radioteletype simplified the transmission of vital weather information to the AAF throughout the world

By

LT. ROBERT LAMBE



It takes miles of perforated tape to flash vital weather information through to the AAF stations. Here the weather tape is being inspected prior to placing it in transmission distributor for broadcast to AACCS Caribbean receiving stations.



Three radio installation technicians put the finishing touches on 10 kw. transmitters at AACCS master station, Miami.

SERGEANT SETH B. GRAY, flight radio operator from Las Vegas, Nevada, stepped from the nose wheel hatch of his B-29 at Batista Field and walked right into a question.

"Did you know that radioteletype broadcasts by AACCS make it possible for you to get weather information both in flight and on the ground?"

A quizzical look passed over the sergeant's face. "Radioteletype broadcast? What the blazes is that?"

When the Gypsy Task Force, an aptly named group of men and B-29s from the Second Air Force, pulled their successful invasion of the Caribbean, even the Army Airways Communications System didn't know what radioteletype *broadcasting* was. Now the AACCS is operating a master broadcast station in Miami and three receiver stations at bases of the Gypsy Task Force, for the sole purpose of relaying weather information that covers an area commensurate with the range of the Superfort.

The AACCS has been using radioteletype for the rapid handling of both weather and operational messages for a long time, but the advent of the B-29, with its super range, made it necessary to use radioteletype much

the same way that a commercial station broadcasts.

The story of why, how, and what this broadcasting by radioteletype does, sounds dry, but there's drama in every drop of sweat that rolled off the back of the Pfc. in the Signal Corps who worked 18 to 20 hours a day to get the equipment installed in what has since been nicknamed *Eleven Hectic Days*. Little could he know that what he was doing would vitally affect the safety of a B-29 and its crew in far off Kansas.

The Gypsy Task Force was organized by the Second Air Force to give tactical training to B-29 crews. Tactical training for one of these "babies" meant some really long flights and a lot of over-water time to prepare them for the long haul from Saipan to Tokyo and back.

The Caribbean was selected as the training ground and three bases spread out over the Antilles were chosen. A lot of ground and water had to be covered by B-29 crews from Walker or Salina to reach Puerto Rico or Jamaica or Cuba and there was a lot of weather to be encountered. Operations and weather officers had to have a picture of the weather covering both the U. S. and the South Atlantic. Pilots

had to keep in constant touch with the ground through their radio operators to be forewarned of changes in weather that they might encounter during one of their tremendous flights. It would require the most complete and bulky supply of weather information ever compiled at one spot. It was up to the AACCS to get this weather information to the bases of the Gypsy Task Force in a hurry.

The communications system already



A Gypsy comes home to "roost"—B-29 of the Gypsy Task Force, combat training unit of the Second Air Force, taxis to its parking strip after landing at Batista Field, Cuba. It is the AACS that gets the weather information to the men who fly these sky-giants.

in operation in the Caribbean by the AACS, though overburdened, had been sufficient to handle both weather and operational traffic until the Gypsies arrived. The weather information required by the long range of the B-29 more than doubled the demand, plus the fact that with a flock of B-29s in the area there would be many more operational messages to handle. The AACS had to do something, and quick.

To Captain Francis V. Long, operations officer of the 8th AACS Wing in Miami, once the youngest ham in the U. S. (12 years old), fell the task of getting this mass of weather information through. Landline teletype facilities, supplying the vitally necessary weather information from all over the U. S., terminated at Miami. Radioteletype and c.w. circuits from the South Atlantic poured weather information north to Miami. Still, Gypsy bases in the Caribbean needed all this information so that weather officers could clear flights from Borinquen Field, Puerto Rico, to Salina, Kansas.

All the information needed by sta-

tions *down the line* was on hand at Miami. Captain Long conceived the idea of a *master* radioteletype broadcast station in Miami, with receiving stations installed throughout the Caribbean and the South Atlantic.

Then began the *Eleven Hectic Days*. The Gypsy Task Force was to begin large-scale activities on March 1st, and the request for this vast service went to AACS on the 17th of February. Eleven short days to requisition material and equipment from all over the U. S., get it to Miami and the three bases in the Caribbean . . . and *install* it. What followed was one of the smoothest jobs of cooperation between members of the different branches of the Army that has ever been performed.

The request for the installations went to Colonel H. C. Nichols, C.O. of the Southeast Sector, Army Communications Service-plant Engineering Agency, the Signal Corps organization that engineers and installs equipment to be operated by the AACS.

Requisitions for the equipment went to Philadelphia headquarters of Plant Engineering Agency by tele-

phone, teletype, and Western Union. Colonel Will Parker, C.O. of PEA, assigned a triple-A priority and the wheels began to turn. It was immediately seen that rail shipment of the material would completely destroy all chance of meeting the March 1st deadline. So the Signal Corps went air-minded and there was formed the "Nichols' Air Line, Inc."

The Gypsy Task Force supplied seven cargo planes, Miami Army Air Field produced two more, and the 8th AACS Wing another two, all at the disposal of Colonel Nichols. Operations schedules were set up and the planes shuttled back and forth between depots in Utah, Kentucky, Ohio, and Philadelphia to Miami where cargoes were transshipped to the Caribbean bases. Installation crews went along.

Preliminary surveys were already made and by February 24th equipment was on hand at all four of the stations and installation had begun. Signal Corps men found themselves erecting steel towers by lantern light and working 24 hours a day.

(Continued on page 70)

An AACS maintenance man goes up an antenna at one of the Gypsy Task Force Bases.



Every twenty-four hours, 75,000 weather messages pour into this receiver room for the central Caribbean Gypsy Task Force from the Miami radioteletype master station.

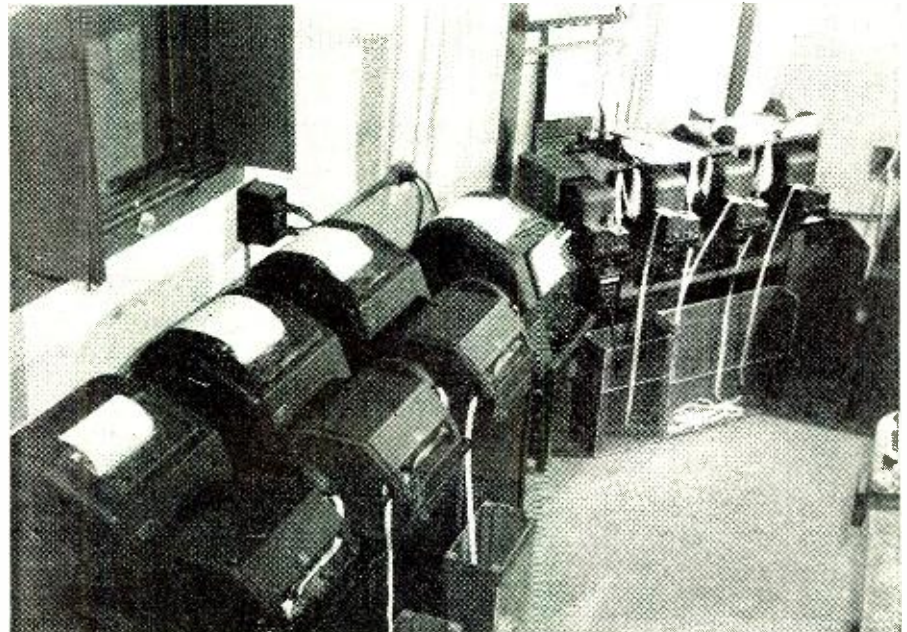

SYNCHRONIZING and SEPARATION CIRCUITS

Part 12. The basic principles involved in the design of sync and separation circuits employed extensively in television receivers.

By **EDWARD M. NOLL**
Television Tech Enterprises

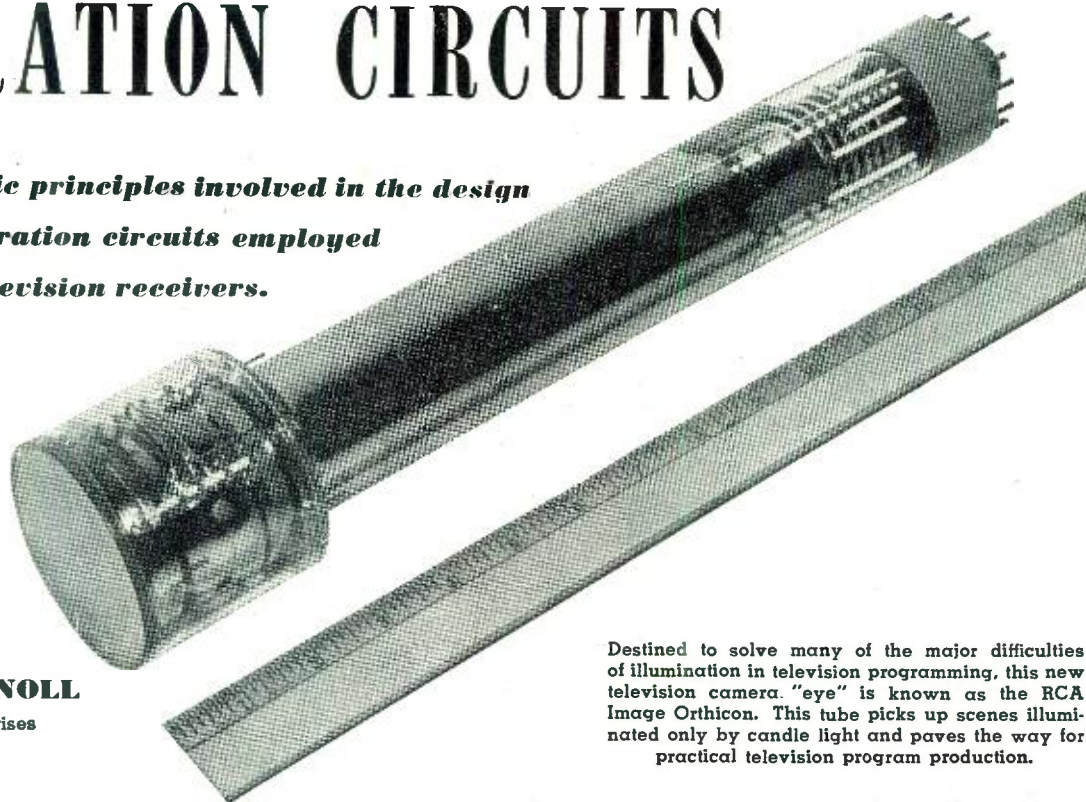

Destined to solve many of the major difficulties of illumination in television programming, this new television camera "eye" is known as the RCA Image Orthicon. This tube picks up scenes illuminated only by candle light and paves the way for practical television program production.

THE sync and separation circuits of the television receiver remove the sync from the composite television signal, segregate the horizontal and vertical sync, and apply these control pulses to the vertical and horizontal sawtooth oscillators. The separation of sync from picture is performed in a rectifier circuit driven by a portion of the i.f. signal or in a circuit which is driven by a detected composite signal. There are numerous methods for segregating horizontal and vertical sync pulses, a number of which will be discussed.

Sync Separation

Three typical separators are shown in Fig. 1. The first one is driven by

a composite video signal, the sync of which is removed by limiting action. For complete theory on limiting action, refer to the previous installments on frequency-modulation limiters, Part 8, and d.c. restoration, Part 10. In this circuit, the plate voltage is low, cathode grounded, and the grid bias is essentially zero with no signal applied. When the positively polarized composite signal is applied, the tip of the sync pulses draw grid current which, flowing through the grid resistor, develops an average grid bias. Plate voltage and value of grid resistor and capacitor are properly chosen to develop an average grid bias considerably beyond cut-off, and the only time plate current flows is dur-

ing the sync pulse interval, which is the most positive portion of the composite signal. Thus, the blanking level of the composite signal is coincident with the cut-off bias of the tube, Fig. 2, and only the portions of the composite signal (sync pulses) greater in amplitude than the blanking level, cause plate current to flow. The separation circuit is automatic over a substantial range of signal amplitudes because any signal strength variation also causes a variation in the grid current and average grid bias of the separator tube. Consequently, the blanking level remains essentially coincident with the cut-off bias.

The plate voltage of the separator is very low to insure an early plate current cut-off bias, and the grid resistor is reasonably high to develop a high average bias with only a small amount of limiting.

A second separator, Fig. 1B, uses a single diode to remove sync from the composite signal. In this circuit, the input resistor-capacitor combination maintains a high average bias between plate and cathode, and the only time the diode conducts is during the sync pulse intervals (high-amplitude portion of composite signal). Thus, the diode current drawn through the large resistor R_1 , during the sync intervals develops a high average bias (sustained by large capacitor C_1)

Fig. 1. Three alternative circuits that can be used for sync separation.

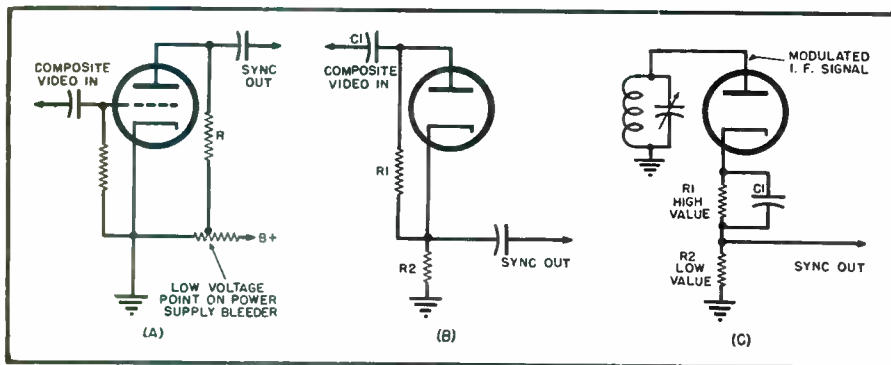

across R_1 , which must first be overcome before signal appears across R_2 , the low value output resistor. The values of R_1 and C_1 have been chosen to prevent diode current flow except during the intervals the signal is in excess of the blanking level (sync pulse intervals). The sync pulses are taken off across the low value resistor R_2 , which is unbypassed and, therefore, follows the instantaneous changes in diode current.

In the separator circuit of Fig. 1C, the modulated i.f. carrier is applied to a diode which rectifies the i.f. signal. The average diode current flowing through large resistor R_1 again develops an opposing diode bias (sustained by capacitor C_1) which must first be overcome before there is diode current flow. Thus, there is no signal across R_2 until, during sync pulse intervals, the instantaneous modulation exceeds the modulation percentage of the blanking level.

Sync Segregation

After sync has been removed from the composite signal, the horizontal and vertical pulses must be properly segregated. The sync circuits of the deflection channels must perform the following tasks: (1) synchronize horizontal oscillator, (2) synchronize vertical oscillator, (3) prevent loss of horizontal synchronism during vertical sync intervals, and (4) prevent dissimilarity and loss of synchronism because of the interlaced pattern.

Possibly the simplest circuits used to segregate horizontal and vertical pulses are the differentiating and integrating networks shown in Fig. 3.

For example, the resistor-capacitor combination of Fig. 3 is obviously frequency-critical, because the higher the frequency, the lower the capacitive reactance becomes, and the greater the output across the resistor. However, as long as a sine wave is applied, there is no distortion, only a gradual reduction in amplitude as the frequency decreases. Now, if a non-sinusoidal waveform, such as a rectangular sync pulse, is applied which has components from a very-low frequency to a couple megacycles, the unequal amplification distorts the shape of the pulse. This characteristic can be used to advantage in separating the high- and low-frequency components of a rectangular pulse. Thus, if the capacitor, Fig. 3A, has a low capacity, and the resistor is of fair value, the low reactance of the capacitor at high frequencies permits the higher frequencies to appear across the resistor. However, the increasing reactance of the capacitor prevents the low frequencies from reaching the output. Now, since the sides, leading and trailing edges of a rectangular pulse, represent high-frequency components (fast change of voltage per unit time), they appear almost in their entirety across the output, Fig. 3A, while the flat-top of the rectangular pulse is a low frequency (very little change in voltage per unit time) and does not

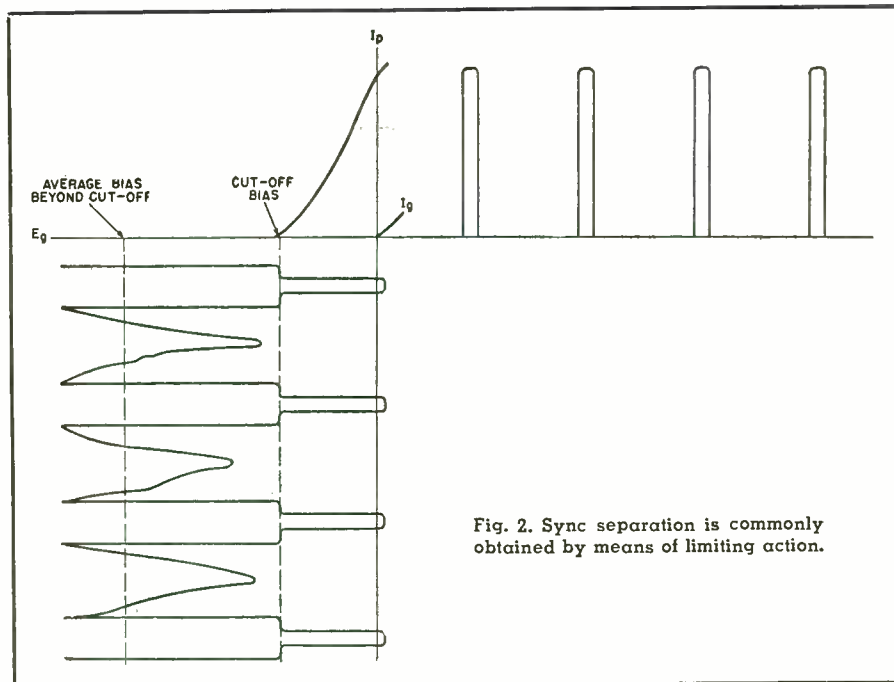

Fig. 2. Sync separation is commonly obtained by means of limiting action.

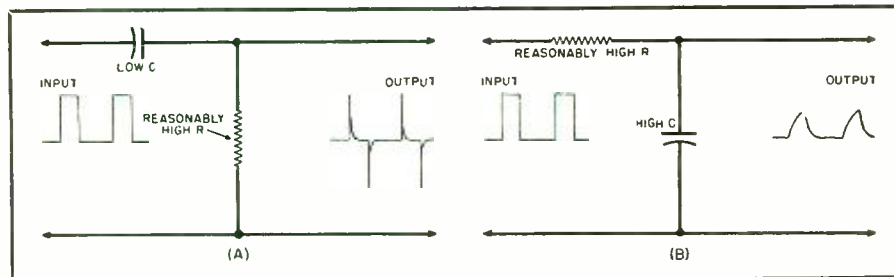

Fig. 3. Rather simple, yet effective, circuits that may be used to segregate horizontal and vertical pulses. (A) The differentiator. (B) The integrator.

appear across the resistor. Another way of looking at the same circuit is to assume that the rectangular pulse is an electronic switch; the leading edge of the pulse is the build-up of voltage when the switch is closed, the capacitor charging rapidly through the resistor and developing the leading edge across the resistor. During the flat-top, a steady potential is applied and the capacitor discharges. Again, at the instant the rectangular pulse drops down, the capacitor charges and discharges in the opposite direction, developing the negative trailing edge across the resistor.

It must be remembered that, with any individual or combination of sinusoidal waves impressed upon the resistor-capacitor combination, there

is no distortion of the individual sine wave components, only unequal attenuation of the sine wave components exists, causing the relative distribution to change. This, in turn, causes the composite shape of a combination of sine waves to change. Thus, the rectangular pulse, consisting of many sine waves in harmonic relation, has its appearance changed by unequal transfer of its many component frequencies.

If the position of the capacitor and resistor is reversed and the capacitor increased to a high value, forming an integrator network. Fig. 3B, the low-frequency components of the signal are dominant in the output. Consequently, the fast change in voltage, leading edge of pulse, can not charge

Fig. 4. Circuits that are employed to segregate horizontal and vertical sync.

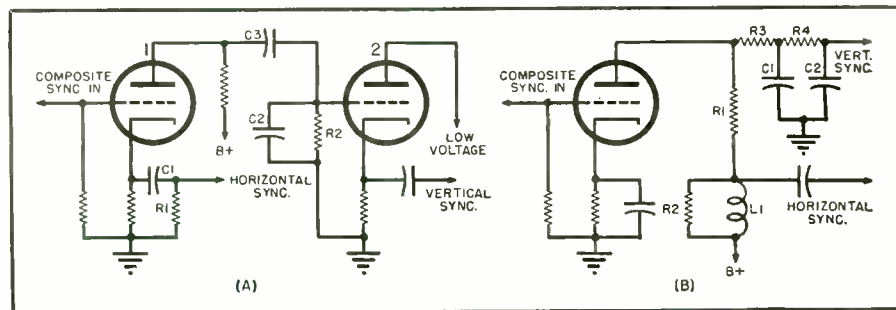

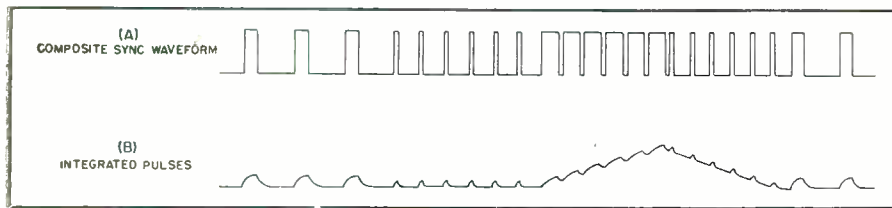

Fig. 5. Composite sync waveform after separation (A) and after integration (B).

the capacitor instantly through the long time constant of the resistor-capacitor combination. Instead, the voltage rises slowly and reaches its maximum value some time after the pulse has reached the low-frequency flat-top portion of the pulse. Likewise, the same time is required for the capacitor to discharge after the trailing edge of the pulse. When the time constant is properly chosen, the capacitor has discharged only partially before the next pulse arrives and reinforces the original charge on the capacitor, each pulse adding a small charge until the cumulative potential on the capacitor is sufficient to synchronize a low-frequency oscillator.

Typical Circuits

Some typical sync circuits are shown in Fig. 4. As shown in Fig. 4A, the composite sync, after separation from the composite picture signal, is applied to tube 1, which has output taken off across its cathode resistor and across its plate resistor. Across the cathode resistor, a differentiating network, R_1 and C_1 is connected. The low value of C_1 and the short time constant of the combination permits only the leading and trailing edges of the composite sync pulses to appear across the resistor; the sharp positive leading edges synchronize the horizontal sawtooth oscillators. Now, if we observe drawings A and B of Fig. 6, it is apparent that the leading edges of each of the composite sync pulses,

horizontal, equalizing, and vertical, develops a positive pip. Thus, the horizontal oscillator continues to be synchronized even during the vertical and equalizing pulse intervals. In fact, it is only for this reason that the vertical pulse interval consists of six individual pulses (serrated vertical pulses) instead of one long continuous pulse which would synchronize the vertical oscillator all right, but would allow the horizontal to slip out of synchronism.

The composite sync is also taken off the plate of tube 1 and fed through capacitor C_2 to the grid of tube 2. In the grid circuit of tube 2 is a resistor-capacitor combination with a very long time constant and a large capacitor, C_2 . As each pulse is applied, capacitor C_2 slowly charges and then slowly discharges through R_2 , Figs. 5A and 5B. The time constant is chosen to permit complete discharge of the capacitor between horizontal pulses, preventing the cumulation of a charge on capacitor C_2 which would cause firing of the vertical oscillator by the horizontal pulses. The same condition exists during the equalizing pulse intervals; however, during the vertical pulse intervals the capacitor develops a cumulative charge.

The six vertical pulses are of longer duration, giving the capacitor more time to charge and reach a higher amplitude. What is more, there is less time between pulses, permitting the capacitor to discharge only a short

interval. Thus, a charge gradually accumulates across the capacitor during the vertical pulse interval and finally reaches a level sufficient to synchronize the vertical oscillator. Vertical sync is taken off the cathode of tube 2.

It is apparent that sync segregation is not truly separation, but is instead proper use of the high and low frequency components of all the various sync pulses. In fact, the composite waveform is applied to both horizontal and vertical input circuits. In the horizontal circuit, the leading edges of all pulses, vertical, horizontal, and equalizing, are used to provide continuous horizontal synchronization; in the vertical circuits, all pulses are integrated, but only the long duration, short spaced vertical pulses develop a cumulative charge to synchronize the vertical.

Another sync circuit, shown in Fig. 4B, uses a single tube to segregate horizontal and vertical sync. Composite sync is applied to the input of the tube which has two separate plate load circuits. The horizontal plate load consists of a series resistor, R_1 , damping resistor, R_2 , and inductor L_1 , across which a differentiated horizontal output appears. Thus, it is apparent that a series resistor-inductor combination functions similarly to the resistor-capacitor combination; however, output appears across the inductor, for it has an increasing reactance as frequency rises. Therefore, the leading and trailing edges of the pulses appear across the inductor, while the small reactance presented to the low frequencies prevents their appearance. The damping resistor, R_2 , is necessary to prevent self-resonant effects in the inductor.

The vertical sync plate load consists of two resistors, R_3 and R_4 , and two capacitors, C_1 and C_2 . This circuit is similar to the integrating circuits discussed in detail earlier with the exception that it is a two-section affair. The dual arrangement permits effective integration and less loss in signal amplitude.

Equalizing Pulses

The three major functions of the equalizing pulses are: (1) prevent loss of horizontal synchronization with interlacing, (2) prevents pairing of lines, and (3) permits transmission of identical vertical intervals between fields and frames.

To best understand the functions of the equalizing pulses, refer to Fig. 6, which shows the composite sync waveform between fields, drawing A and the composite waveform between frames, drawing C. Drawings B and D show the respective differentiated waveforms before application to the horizontal sweep oscillator. Differentiated pulses marked with an S are the pips which actually synchronize the horizontal oscillator. It is apparent that the leading edges of all horizontal pulses sync the oscillator; however, only alternate leading edges of

Fig. 6. Composite sync waveform between fields (A), and between frames (C). (B) and (D) show the result of differentiating these waveforms.

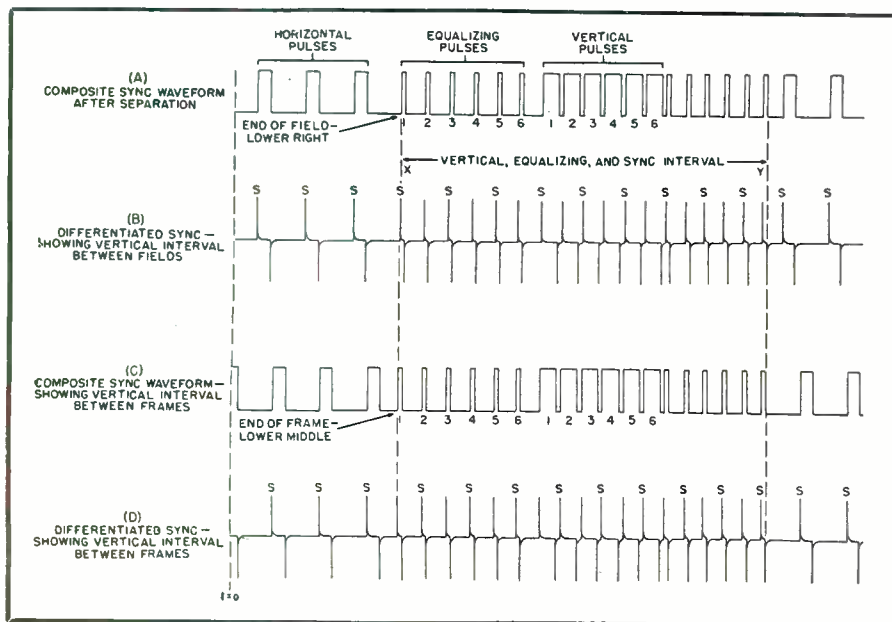

OHMITE

RITEOHM PRECISION RESISTORS

Non-Inductive... Pie-Wound... 1% Accurate

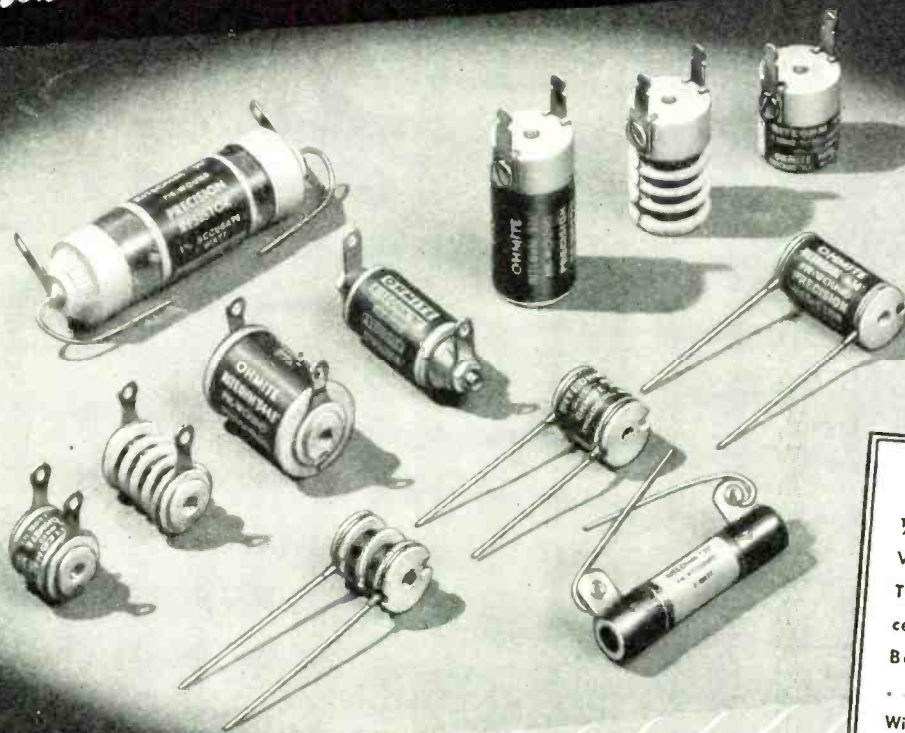

NEW

1/2 Watt and 1 Watt
Vacuum Impregnated
Types... Hole in
center for Through-
Bolt Mounting
... Equipped with
Wire Leads or Lugs

Available from Stock... or Made to Order

OHMITE presents a *new* line... a *full* line... of finer precision resistors! Every type... every size... ready for every need! Each Riteohm is designed and built with all the specialized skill and experience that have made OHMITE units the standard in this field. However critical the application... consistent accuracy and reliability are assured. In these Riteohms, you get *time-proved protection against humidity, temperature and corrosion.*

Ideal for use in voltmeter multipliers, laboratory equipment, radio and electrical test sets, attenuation pads, and in electronic devices requiring *extremely accurate* resistance components.

AVAILABLE FROM STOCK in 1/2 watt and 1 watt units in a wide range of values, in various types of mountings and terminals... or made to order. Complete line of 6 different series includes non-inductive pie-wound vacuum impregnated units... single-layer wound vitreous enameled units... and non-inductive pie-wound hermetically glass sealed units. Some units are in a range of 0.1 ohm to 2,000,000 ohms. *Get full facts today!*

OHMITE MANUFACTURING CO., 4885 Flournoy St., Chicago 44, U. S. A.

Send for Bulletin No. 126

This handy Riteohm Bulletin makes it easy for you to select the exact units for your needs. Gives complete data... lists stock units and made-to-order units... includes dimensional drawings. Write for it now.



Be Right with **OHMITE**

RHEOSTATS • RESISTORS • TAP SWITCHES • CHOKES • ATTENUATORS

Radio Parts

IMMEDIATE SHIPMENT!

Electronic Equipment

Mail Coupon Below for New CONCORD CATALOG—FREE!

32 pages of money-saving bargains in hundreds of standard-line, top-quality radio and electronic parts. Note these typical CONCORD values—



OHMITE Model G POTENTIOMETER

15 Ohms,
75 Watts,

\$1.95

1/4" diam. shaft. 5B2075.



Time Delay Relay

15 Amp. contacts, timed at 60 sec. + or - 3 sec. for 115 V.

60c operation. 5B4097..... **\$4.95**



PRECISION RESISTOR

12 megohm, 10 K.V. Sprague ferrule mounting type 5B121..... **\$4.95**



VACUUM CAPACITOR

12 mmfd., 20,000 volts. Overall size: 6 1/2" x 2 1/4". 5B3169..... **\$3.95**

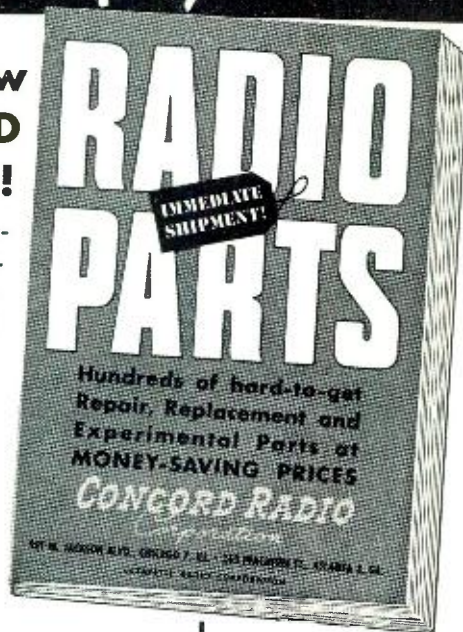

ORDER TODAY for shipment tomorrow from CONCORD

Huge stocks in TWO convenient warehouses—one in CHICAGO and one in ATLANTA—are ready NOW to make IMMEDIATE SHIPMENT of radio and electronic parts and equipment of dependable, nationally-known quality—and at Victory Clearance prices that mean important savings on Meters, Condensers, Transformers, Resistors, Controls, Switches, Relays, Test Equipment, Generators, Microphones, Tools, and hundreds of Repair, Replacement and Accessory Parts. Whatever your needs, see the surprising values offered in CONCORD'S New Catalog. Mail the coupon for your FREE copy now.

CONCORD
RADIO CORPORATION
Lafayette Radio Corporation
CHICAGO 7, ILL. ATLANTA 3, GA.
901 W. Jackson Blvd. 265 Peachtree Street

CONCORD RADIO CORPORATION
901 W. Jackson Blvd.
Dept. E-36, Chicago 7, Ill.
Please RUSH FREE copy
of CONCORD'S new 32-page
CATALOG.

Name.....
Address.....
City..... State.....

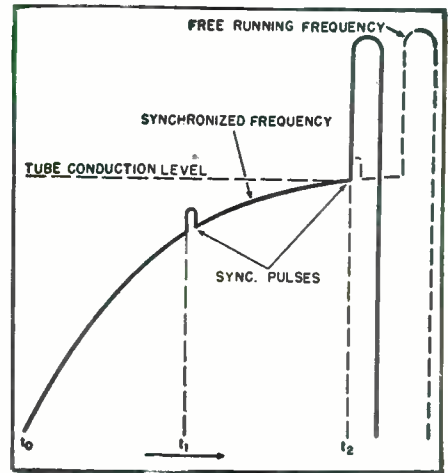

Fig. 7. Grid cycle of a blocking oscillator showing sync pulses.

equalizing and vertical pulses sync the horizontal because they occur at twice the repetition rate of the horizontal cycle. Fig. 7 demonstrates why only the alternate leading edges synchronize the sweep oscillator. If the repetition rate is twice the horizontal sweep recurrence rate, a sync pulse also reaches the oscillator at approximately the midpoint of the sweep cycle. However, as shown on the grid waveform in Fig. 7, this pulse occurs at a point where the grid has not yet approached (grid capacitor has not discharged sufficiently through the grid resistor) the conduction level and, consequently, the sync pulse does not initiate a feedback cycle or affect the operation of the oscillator. On the other hand, the second sync pulse, which occurs when the grid is almost at the conduction point, has sufficient amplitude to reach the conduction level and initiate the feedback cycle. The dotted waveform of Fig. 7 shows the free-running grid cycle of the vertical oscillator, and approximately at what point the second sync pulse occurs. This would be the waveform if the second sync pulse had no influence on starting the grid sharply positive.

Further observation of Fig. 6 shows that between fields, Fig. 6B, the horizontal oscillator is synchronized by the odd-numbered equalizing and vertical pulses, while between frames, Fig. 6D, it is synchronized by the even-numbered equalizing and vertical pulses. Synchronizing occurs in this sequence because the end of a field occurs at the lower right, and the end of a frame at the lower middle. Thus, between fields, Fig. 6A, the last horizontal is exactly one horizontal interval away from the first equalizing pulse and synchronization falls in with the odd-numbered equalizing and vertical pulses; between frames the last horizontal, Fig. 6C, is one-half a horizontal interval away from the first equalizing pulse and a full horizontal interval away from the second equalizing pulse, and synchronization falls in with the even-numbered equalizing and vertical pulses.

For Peak Performance

Depend on
**RAYTHEON BONDED
ELECTRONIC TECHNICIANS**

Bonded by



A "STAR SALESMAN" FOR YOU!

Every customer who comes to your counter will see this effective wall banner. It tells them you're a dependable, square-dealing Raytheon Bonded Electronic Technician — and brings them back to spend money with you.

This selling wall banner is only one of many carefully designed sales-aids — displays, decals, mailing pieces, job record cards — for you to use in building a lasting, money-making radio service business. Bonded service means better customer relations. See your Raytheon distributor today.

Another reason why it pays to qualify as a Raytheon Bonded Electronic Technician.



Excellence in Electronics

RADIO RECEIVING TUBE DIVISION

NEWTON, MASS. • NEW YORK • CHICAGO

Here's a soldering iron with . . .

**HEAVY
POWER**
(225 WATTS)

**LIGHT
WEIGHT**
(14 OUNCES)

made possible by
**KWIKHEAT'S
BUILT-IN
THERMOSTAT**

- ★ HEATS IN ONLY 90 SECONDS
- ★ MAINTAINS PROPER HEAT
- ★ CAN'T OVERHEAT
- ★ LESS RETINNING NEEDED
- ★ TIPS LAST LONGER
- ★ COOL, SAFE HANDLE
- ★ LIGHT WEIGHT

The Kwikheat Soldering Iron has ample reserve power for your soldering jobs—225 watts held in check by a thermostat built right into the iron*—maintaining ideal temperature for perfect soldering—preventing overheating (which causes deterioration in other irons)—prolonging life of tips and eliminating the need for constant retinning. Besides these big advantages, the Kwikheat Iron is hot, ready to use only 90 seconds after plugging in. It is extremely light (14 ounces), well-balanced, and has a safe, cool handle. No wonder Kwikheat is a sensation wherever it is used. Ask your jobber. With choice of #0, 1, 2, 3, or #5 tips. \$11.00

6 INTERCHANGEABLE TIP STYLES

- | | | | | | | | | | | | |
|---|----|---|----|---|----|---|----|---|----|---|----|
|  | #0 |  | #1 |  | #2 |  | #3 |  | #4 |  | #5 |
| \$1.25 | | \$1.25 | | \$1.25 | | \$1.25 | | \$1.75 | | \$1.25 | |

*patented

VANATTA



kwikheat

THERMOSTATIC SOLDERING IRON
A Division of
Sound Equipment Corp. of Calif. • 3903 San Fernando Rd., Glendale 4, Calif.

Consequently, there is no loss of synchronism between frames or fields. Likewise, the six lagging equalizing pulses permit the horizontal to fall in step and begin active scan at the top middle for a new frame or at the top left for the second field.

As for vertical synchronization, the equalizing pulses simplify transmitter and receiver circuits by permitting identical vertical intervals between fields and between frames. Thus, the vertical intervals between X and Y are identical in drawing A and C of Fig. 6, and both vertical intervals, after integration, appear as shown in Fig. 5B. Interlaced scanning is therefore possible with identical vertical pulses and freedom from pairing. Pairing is caused by dissimilarity in the vertical intervals which cause the even-numbered horizontal scanning lines to be other than mid-way between the odd-numbered horizontal lines. When pairing is present, the lines on the scanning raster appear in pairs instead of arranged equidistant from top to bottom. The equalizing pulses act as an effective buffer between horizontal pulses and vertical pulses, and prevent the dissimilarity existing at the start and conclusion of field and frame scanning from affecting the vertical integration. With this precaution, the vertical charge and discharge rates and amplitudes are the same between fields and frames; the vertical oscillator is locked in at the point on each integrating cycle, and the horizontal lines are spaced equidistant from top to bottom of the scanning raster.

-30-

Camera Focusing by Radar

AUTOMATIC focusing of motion picture, television, and large still cameras may sometime be possible through the application of the range-finding principles of radar.

Although present-day radar measures distances in terms of thousands of yards, future developments in the art may make it possible to measure distances in terms of feet.

The use of radar, or its principle, in the automatic control of optical focusing systems could ease considerably the strain of constant attention to focusing, which is the lot of most cameramen.

One difficulty in such an arrangement might be that, if the radar focusing beam should inadvertently wander off the principal subject, such as an actor, and strike a background fifteen feet away, the cameraman might be embarrassed to find his subject completely out of focus in a split second.

Perhaps an adjustable time-delay circuit could be incorporated to permit such accidental mis-direction of the electronic focusing beam to occur without de-focusing the camera, for a brief moment, allowing time to re-frame the subject.

Also, the change-of-focus mechanism could be designed with a suitable lag to accommodate shifts to various focal planes at normal rates of change.

-30-

SILVER

"VOMAX"

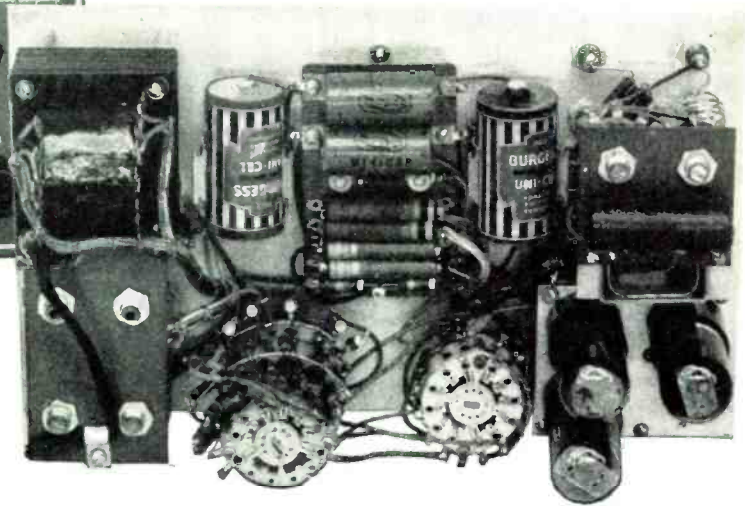

Of construction and quality unmatched by meters selling at far higher prices . . . giving performance exceeding that of three separate instruments costing nearly four times its price . . . it is no wonder we are told that "VOMAX" is today the standard of comparison.

"VOMAX" is new . . . different . . . and outstandingly superior . . . because it is a brand new post-war v.t.v.m. . . . and truly universal. With "VOMAX" you can measure every voltage required in radio servicing . . . even in the design laboratory. Not only does it enable you to measure d.c. and a.c. voltage at meter resistance so high as not to affect the circuit being measured, but "VOMAX" at last lets you measure a.f. and r.f. voltages from 20 cycles to over 100 megacycles . . . resistance from .2 ohms through 2,000 megohms is "duck soup" with "VOMAX" . . . as is direct current from 50 microamperes through 12 amperes.

Add to all this new visual dynamic signal tracing . . . direct measurement of every voltage from receiver antenna to speaker voice coil . . . and you know why many government departments, serious industrial, radio engineering, university research laboratories . . . and service technicians by the thousands clamor for "VOMAX."

"VOMAX" makes you the master, no longer the victim, of tough service problems. Your favorite jobber . . . among nearly 500 progressive SILVER distributors all over the country . . . can give you prompt delivery from his regular monthly allotment . . . if you order now . . . for only **\$59.85 Net**

Measures EVERY Voltage

1. Brand new post-war design . . . positively not a "warmed-over" pre-war model.
2. More than an "electronic" voltmeter VOMAX is a true vacuum tube voltmeter in every voltage resistance db function.
3. Complete visual signal tracing from 20 cycles through over 100 megacycles by withdrawable r.f. diode probe.
4. 3 through 1200 volts d.c. full scale in 6 ranges at 51 and in 6 added ranges to 3000 volts at 126 megohms input resistance. Plus-minus polarity reversing switch.
5. 3 through 1200 volts a.c. full scale in 6 ranges at honest effective circuit loading of 6.6 megohms and 8 mmfd.
6. 0.2 through 2000 megohms in six easily read ranges.
7. - 10 through + 50 db. (0 db. = 1 mw. in 600 ohms) in 3 ranges.
8. 1.2 ma through 12 amperes full scale in 6 d.c. ranges.
9. Absolutely stable—one zero adjustment sets all ranges. No probe shorting to set a meaningless zero which shifts as soon as probes are separated. Grid current errors completely eliminated.
10. Honest factual accuracy: +3% on d.c.; +5% on a.c.; 20% through 100 megacycles; +2% of full scale, +1% of indicated resistance value.
11. Only five color-differentiated scales on 4" D'Arsonval meter for 51 ranges (including d.c. volts polarity reversal) eliminate confusion.
12. Meter 100% protected against overload burnout on volts ohms db.
13. Substantial leather carrying handle. Size only 12" x 7" x 5".

OVER 34 YEARS OF RADIO ENGINEERING ACHIEVEMENT

McMurdo Silver Company

1240 MAIN STREET, HARTFORD 3, CONNECTICUT

March, 1946

Send postcard for free catalog of measurement and communication equipment.

WHAT'S NEW IN RADIO

SOLDER FLUX

Superior Flux Company, Cleveland, Ohio, is now manufacturing a new organic soft solder flux, known as "Superior No. 30 Supersafe Soft Solder Liquid Flux" and is described as more effective than common rosin fluxes and which does not normally leave a corrosive residue.

This new flux is recommended by its manufacturer particularly for applications where rosin-alcohol is unsatisfactory or where zinc chloride or similar strong acid fluxes cannot be used because of the corrosion factor. It may be used in soldering copper, steel, silver, brass, various alloys, and electroplated parts such as nickel plate, silver plate, and cadmium plate.

PRIVATE AIRCRAFT RADIO

Galvin Manufacturing Company, Chicago, is now introducing its new Motorola "Navigator" Radio incorporating the features of radios previously used only on large commercial planes at a fraction of the weight and a fraction of the cost.

This new private aircraft radio is a single, self-contained transmitter and receiver. The range of the transmitter is approximately 25 to 30 miles, depending upon such factors as plane altitude and weather conditions. The receiver range is equal to or better than the best commercial receivers used by airlines and transports, according to the manufacturer.

Among the many features of the new Motorola "Navigator" is the automatic reeling antenna. Upon reaching cruising speed, the antenna automatically reels out, and on return to gliding speed, controls retract the antenna and retune the transmitter. Intertelephone communication between pilot and passengers can be carried on

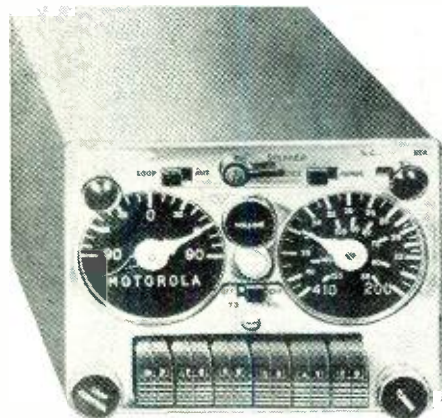

while receiving radio signals. Call letters can be easily reset on push buttons while in flight by merely rotating disks which contain the entire alphabet.

The transmitter, receiver and power

supply are contained in one compact unit, size 4¾" x 6" x 9½" deep, weighing 12 pounds.

VACUUM TUBE VOLTMETER

A new portable, vacuum tube multi-range tester with all zero-center vacuum tube voltmeter ranges is now

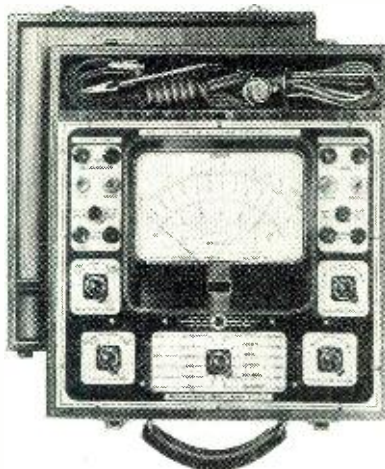

being produced by the *Precision Apparatus Company*, Elmhurst, N. Y.

This tester also includes direct reading megohmmeter, milliammeter, ammeter, output, and decibel meter plus standard sensitivity 1000 ohms-per-volt a.c.-d.c. voltmeter ranges. It employs a stabilized bridge circuit using only three tubes, a 6C5, 6X5, and VR-150, and incorporates a full 7" size rectangular meter.

The unit is designed to permit rapid checking of voltages, currents, and resistances encountered in television, photo-electric, FM, AM, or any high sensitivity circuits without disturbing the operation of the circuits under analysis. The instrument is furnished in a hardwood walnut finished case with removable cover and tool compartment, complete with tubes, ohmmeter battery, and testing probes and over-all dimensions are approximately 12 x 13 x 6 inches.

MAGNETIC OVERLOAD AND JAMMING RELAYS

A new type AYJ relay for d.c. operation which will provide almost instantaneous magnetic overload protection on general purpose and mill motor applications has been developed by *Westinghouse Electric Corporation*.

This new type AYJ relay is also designed to prevent damage to hoist, windlass, and capstan equipment when the load or cable jams on marine control. The single-break, normally closed, main contacts and the double-break, auxiliary contacts are suitable for carrying 5 amperes continuously and for interrupting a d.c. inductive coil load of 150-volt-amperes maxi-

mum. These relays are operated by a series or copper strap wound type of coil. Coils and coil studs are available for currents ranging from approximately 75 to 625 amperes. The coils and auxiliary contact parts are insulated from the relay frames for 600 volts.

Further information concerning the AYJ relays may be secured from the *Westinghouse Electric Corporation*, P.O. Box 868, Pittsburgh 30, Pa.

MIDGET LUGS

Cambridge Thermionic Corporation is now offering Midget Lugs in addition to their line of Terminal Lugs. These new Midget Lugs combine all the advantages of the standard size lugs, according to the manufacturer, and are especially applicable where space is limited.

All-Set Terminal Boards which are lined bakelite and furnished complete with lugs ready for use are also available. The third in *C.T.C.'s* line of new components is the LS3 slug tuned i.f. inductor coil.

These new components are the product of *Cambridge Thermionic Corporation*, 445 Concord Avenue, Cambridge 38, Mass.

VARIABLE TRANSFORMER

Standard Electrical Products Company, Dayton, Ohio, has announced the LR-5 Adjust-A-Volt Variable



Transformer for radio servicemen, amateurs, and experimenters.

This new type transformer operates from 115 volts a.c. and has variable output ranging from 70 to 140 volts continuous in .4 of a volt steps. Among its features is the isolated primary which means a.c.-d.c. sets may be checked without the danger of the usual "hot chassis." The output rating is 5 amperes.

The cover of this transformer has mounted an on-off switch, a ½" red pilot light, and a fuse extractor post with fuse and the outlet receptacle. A 2½" bar knob increases voltage when turned clockwise from

For **BETTER TUBES** and **FINER SPEAKERS**—Rely on

Aireon

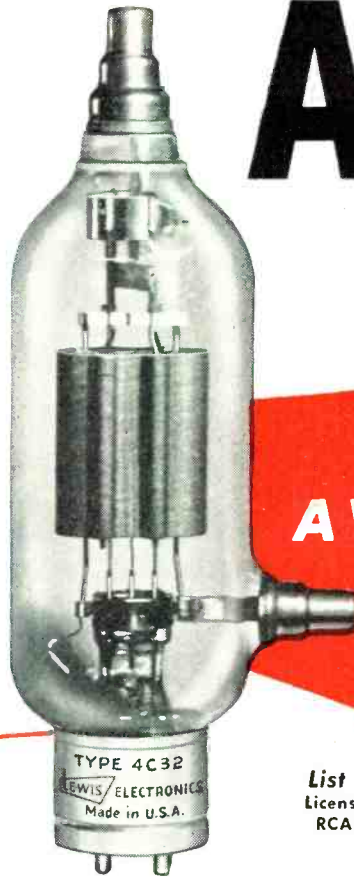

4C32 A Work Horse

for
industrial heating
and
diathermy use

List \$24.50
Licensed under
RCA Patents

- No more loose terminals from excessive heating in service.
- Pure copper terminals for grid and plate connections welded directly to the glass bulb. A technique formerly employed only on tubes of many times the cost of 4C32.
- More filament watts, giving longer life and ability to withstand harder usage.
- The LEWIS process of treating graphite plates insures long, gas-free life.

Filament Voltage	10.0 volts ac
Filament Current	4.5 amps
Amplification Factor	30
Mutual Conductance	5500 micromhos
Plate Dissipation	200 watts
Maximum Power Output	600 watts
Approximate Driving Power	10 watts

Inter-electrode Capacitances

Grid Plate	5.8 mmf
Input, Grid-Filament	5.5 mmf
Output, Plate-Filament	1.1 mmf
Frequency Limit for Maximum Ratings	60 mc
Base	4 pin Jumbo

At your dealers everywhere.

Manufacturers of all types of transmitting tubes—from 35 watt West Coast type triodes to 35 kilowatt external anode, multi-grid tubes. —A new member of the Aireon family.

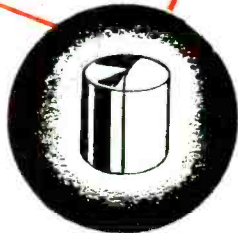

Cinaudagraph Speaker

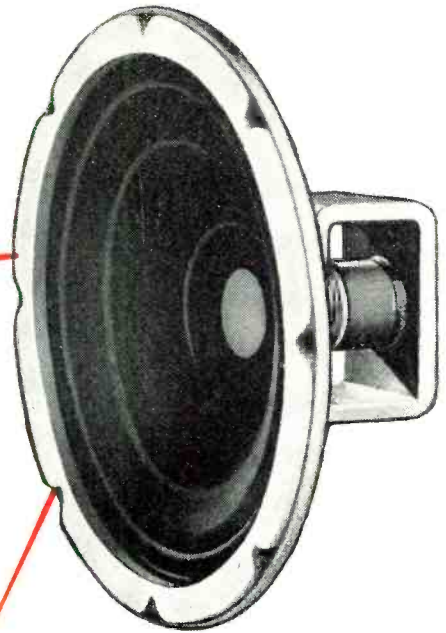

.. Engineered for High Fidelity

True High Fidelity, long-lasting and trouble-free, is built into the design, construction and materials of every Aireon Cinaudagraph Speaker. The result of exacting research and precision workmanship, Aireon Cinaudagraph Speakers incorporate many electronic and acoustical developments for stamina and tone. Special polyfibrous cones... Acim voice-coil forms... Alnico 5 "the miracle metal" in the magnet structures... ribbon wire voice coils... are plus factors which give Aireon Cinaudagraph Speakers more efficient performance.

All P.M. Models of Aireon Cinaudagraph Speakers use Alnico 5, the miracle metal that gives you 4 times the performance without size or weight increase.

Lewis Electronics
Los Gatos, Calif.

Subsidiaries of
Aireon
MANUFACTURING CORPORATION

Cinaudagraph
Speakers, Inc.

3911 SOUTH MICHIGAN AVENUE
CHICAGO, ILLINOIS

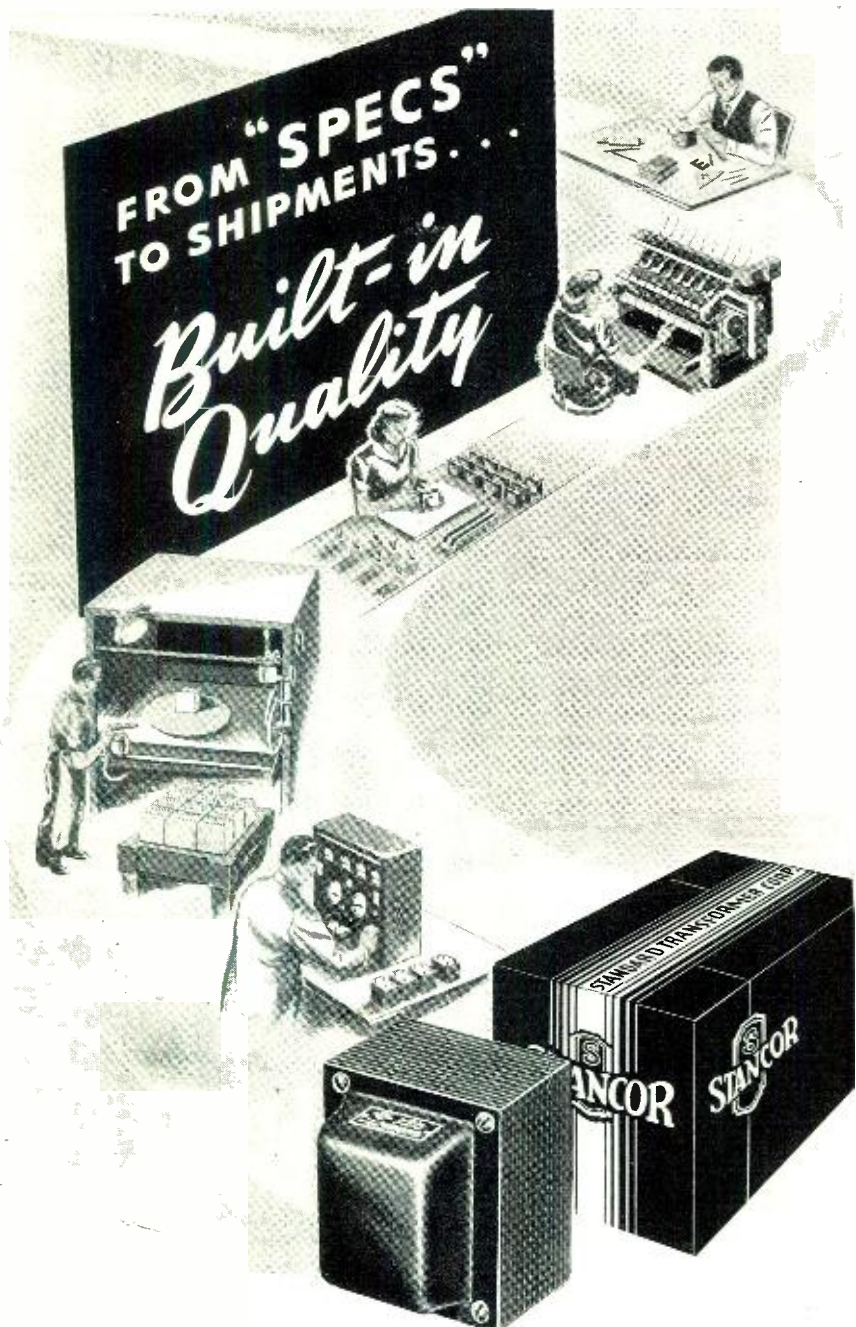

Radio servicemen, amateurs and electronic engineers have long demanded durable transformers with versatile adaptability. Stancor has consistently met these demands with manufacturing products with highest quality materials and workmanship in each separate production operation . . . engineering, coil-winding, laminating, assembling, finishing, testing and final packaging.

Today over 80% of all Universal Power Transformers now in use are replaceable with a Uni-dapt Stancor catalog item. For all transformer replacements, think first of Stancor.



STANCOR
STANDARD TRANSFORMER CORPORATION
1500 NORTH HALSTED STREET CHICAGO 22, ILLINOIS

70 to 140 volts, through an arc of approximately 320° and a scale under this knob calibrated from 70 to 140 volts designates the output voltage. The scale is graduated in 5 volts steps.

The Adjust-A-Volt Variable Transformer is available in a black crackle enamel finished cabinet measuring 9 7/8" x 6 3/4" x 5 1/2".

RAILROAD LOUDSPEAKER

A new railroad-type loudspeaker adaptable for mounting on locomotive exteriors, within locomotive cabs, in a caboose, or in switchyards has been announced by Operadio Manufacturing Company.

This loudspeaker is engineered to produce a maximum of voice identi-



fication, intelligibility, and volume and is specially designed to withstand dirt, wind, and water. Among its outstanding features is the entirely new pressure neutralizing grill and filter, which completely eliminates air pressure on the diaphragm when loudspeaker is used on the exterior of an engine or caboose. Slip stream filtration avoids accumulation of soot or dirt and speaker housing is completely sealed and weatherproofed. Waterproof terminal cover permits external connection without opening unit, and fittings are designed for standard railroad conduit and unions.

Further information on this new loudspeaker may be obtained by contacting Operadio Manufacturing Company, St. Charles, Illinois.

TETRODE TUBE

Production of a new high-frequency tetrode tube, 3D23, designed for fixed or mobile operation, has been announced by Lewis Electronics, Los Gatos, California, subsidiary of Aireon Manufacturing Corporation.

This tube has achieved unusually low inter-electrode capacities by virtue of its top plate connection and low loss ceramic base. Operation is possible up to 250 megacycles with full power input and up to 400 with half power input. Maximum power output is 130 watts (35 watts plate dissipation) making the tube highly suitable as a radio power amplifier in

(Continued on page 117)

723 OUT OF 817!

Recently, a group of 817 radio instructors, students, repair men, radio men in the armed forces, in broadcast stations, big manufacturing plants, etc. were asked what they think of the various books and courses for the study of basic Radio-Electronics. 724 of these men—NINE OUT OF TEN—said that, in their opinion, GHIRARDI'S RADIO PHYSICS COURSE was their first choice—far better than any other AT ANY PRICE!

"IT'S THE BEST OUT OF 20" SAYS CHIEF ENGINEER

From F. S. Bailey, Chief Engineer, Radio Operator's School, Brownsville, Texas comes this sweeping endorsement of Radio-Electronic's greatest basic training book: "We find Ghirardi's RADIO PHYSICS COURSE the best book out of 20 or more that we have tried—both as a complete course in Radio Physics, and for all other branches. It is best for beginners as well as those who already know something about Radio . . . It is giving our students the very best for their money!"

Who said it costs a lot of money to LEARN RADIO-ELECTRONICS?



Only \$5 COMPLETE

and it IS complete!
(\$5.50 foreign)

972 pages—Over 500 illus.

Used more widely by Army, Navy, and civilian schools and colleges and for more home study than any other book or course of its kind.

THE BOOK THAT MAKES IT EASY FOR BEGINNERS TO LEARN AT HOME . . . without an instructor



Send the coupon today! Examine Ghirardi's RADIO PHYSICS COURSE in your own home! See for yourself how this giant book at ONLY \$5 gives

complete basic training that can pave your way to a good-paying job or a business of your own in Television, Frequency Modulation, Facsimile, Broadcasting, Communications, Radio Servicing, Industrial Electronics and so on down a long list of glittering opportunities.

This one big 972-page, profusely illustrated book gives just the training you need—ALL YOU NEED—easier, better, faster and at FAR LESS COST. It backs up theory with actual practice. No previous training necessary. It starts right in at the beginning. Every step is made crystal clear in both text and over 500 illustrations. Many beginners who never even saw a circuit diagram before have completed it in a few weeks. Thousands of Ghirardi-trained men now hold important Radio-Electronic positions. No training AT ANY PRICE is more widely endorsed by the experts themselves!

AS SIMPLE AS A-B-C

Ghirardi's RADIO PHYSICS COURSE makes Radio-Electronics-Television amazingly easy to learn. Everything is explained carefully and thoroughly in a clear, easy style. No involved mathe-

maties! No lessons to wait for. You get your training QUICKLY while the big money-making opportunities still beckon on every side. You'll be amazed and pleasantly surprised to find how soon RADIO PHYSICS COURSE has you understanding every phase of this fascinating subject—how it enables you to grasp subjects that other books and courses make seem highly complicated. Best of all, you buy it on an UNRESERVED 5-DAY MONEY-BACK GUARANTEE BASIS. Every cent of your money will be cheerfully refunded if you are not more than satisfied. You cannot lose! Send coupon today!

YOUR MONEY BACK IN 5 DAYS

if Ghirardi's RADIO PHYSICS COURSE doesn't teach you Radio-Electronic-Television fundamentals EASIER, FASTER and at LESS COST than any other book or course. You be the judge!

ALL THE FACTS ON A LITTLE-KNOWN SUBJECT . . . Now Available



Don't buy, specify, use or replace Capacitors blindfolded! Save time, save money, and increase your service efficiency by really knowing all about this vital subject! No Radio-Electronic component is more important or less understood than the Electrolytic Capacitor and many new and improved types are now fast coming into general use. This new book, THE ELECTROLYTIC CAPACITOR, by Alexander M. Georgiev at last explains the entire subject. It tells what types to use and where and how to use them properly. Explains the advantages and disadvantages of each—how to make emergency repairs and includes a wealth of other invaluable data. Over 200 pages. 80 illustrations. Only \$3 (\$3.25 foreign).

Murray Hill Books, Inc.,
Dept. RN-36, 232 Madison Ave., New York 16, N. Y.

- Enclosed please find \$5 (\$5.50 foreign) for which rush me a copy of A. A. Ghirardi's 972-page RADIO PHYSICS COURSE BOOK or
- Send C. O. D. for \$5 (no foreign C. O. D.'s) plus postage. In either case, it is understood I may return the book within 5 days of its receipt and have my money refunded if not fully satisfactory.
- THE ELECTROLYTIC CAPACITOR, \$3 (\$3.25 foreign). \$..... enclosed or Send C. O. D. (U. S. A. only) for this amount plus postage.

Name.....

Address.....

City & Dist. No..... State.....

New RADIO DISPATCHING SYSTEM

This system provides police, fire department, and other emergency services of the city of Milwaukee with the most modern and efficient radio communications equipment available.

By JOHN E. HUBEL

IN SEPTEMBER of 1945, the city of Milwaukee put into service new radio dispatching equipment that is said to be the *last word* in apparatus for the use of the police department of the city, the sheriff's department of the county, the Milwaukee fire department, as well as the suburban police and fire departments, and other emergency services of the area. The Federal Bureau of Investigation and the Wisconsin State Motor Vehicle Department also make use of the new dispatching equipment, which differs from the old system in that the latter had only one dispatching board with one dispatcher, who had to take all of the incoming calls from the district commanders, put the calls on the air, keep a record of all calls dispatched, a record of all police cars in and out of service, as well as telephone all replies from the mobile units back to the commanders, all of which resulted in the loss of considerable time.

With the new system, the work is divided between three men, operating the new board, as illustrated—each of the three sections being exactly alike.

The commands sent out and the replies from the police cars can be heard by the commanding officer giving the orders on a speaker in his office. Only those calls concerning him will come over his speaker. The mobile transmitters are of four different frequencies; the city of Milwaukee uniformed police, the city detectives, the fire department, and the county cars and those in the suburbs. These four monitoring lines which are underground cables from the receiving site are connected through the dispatching board to the various offices so that the calls to and from county cars are not heard by the city police officers, etc. But if a call concerning all units is transmitted, it can be fed into all the offices by the dispatcher by pressing an all-unit key; or a call from the cars can be switched into all offices in like manner.

The new equipment transmits messages from headquarters to squad cars, from such cars to headquarters, and from one car to another. At present there are 120 police vehicles with mobile transmitters, equipped with talk-back facilities, arranged in four

groups with each group having its own frequency. Arrangements have also been made for additional frequencies, should they be needed to avoid interference between messages. If a squad car is transmitting information that is of such nature that all other police cars should receive it promptly, the dispatcher at the new board, by operating the controls, can make possible the direct broadcasting of such a message over the main radio transmitter of the police department, station WPDK, so that all cars with receivers tuned to this station will receive the information directly as it is broadcast from the squad car from which the original message was started.

All of this switching is accomplished by means of keys and relays and specially designed line amplifiers. There are nineteen of the special amplifiers of five different types used in this system, all of them being designed for an input of 0 (db). Six units have an output of 10 watts, five of 8 watts, and four of 2½ watts, with four having an output of 0 (db), used mainly as buffers with no gain. There are also four line monitoring amplifiers with an output of about 2 watts and a built-in speaker.

On the new board, each of the three positions is equipped with a panel with the necessary controls and signals for direct telephone communication from and to officials, the broadcasting station, and the radio repair shop. Then there is another panel at each position at the board for remote control of the broadcasting station and the necessary signals for co-ordinating the dispatching equipment and of the radio station. Another panel, with maps, is equipped with lights and controls for supervision and reminder purposes. As the controls are interlocked it would be impossible to put out a call from another mike until it is shown that one broadcast has been completed.

The main radio station feeds an antenna which is an end-fed, $\frac{3}{8}$ wave, base-loaded vertical radiator which is a self-supported tower 262 feet high, mounted on insulators, with the receiving antenna, a $\frac{1}{2}$ wave coaxial, mounted on top, which is part of the 2450 kc. main transmitting antenna. To keep the coaxial line feeding the receivers from the coaxial antenna from being hot to ground when the station is on the air, it is brought down the tower to a voltage node point, then jumped to the center of the tower, and insulated from it the rest of the way down. The antenna being base-loaded, made this point a cut-and-try proposition to find. It was found by placing an r.f. ammeter from the coaxial line to ground and sliding a jumper up and down the tower and

The newly designed and constructed dispatching board. The operation of the board is divided between three men, each of the three sections being exactly alike.

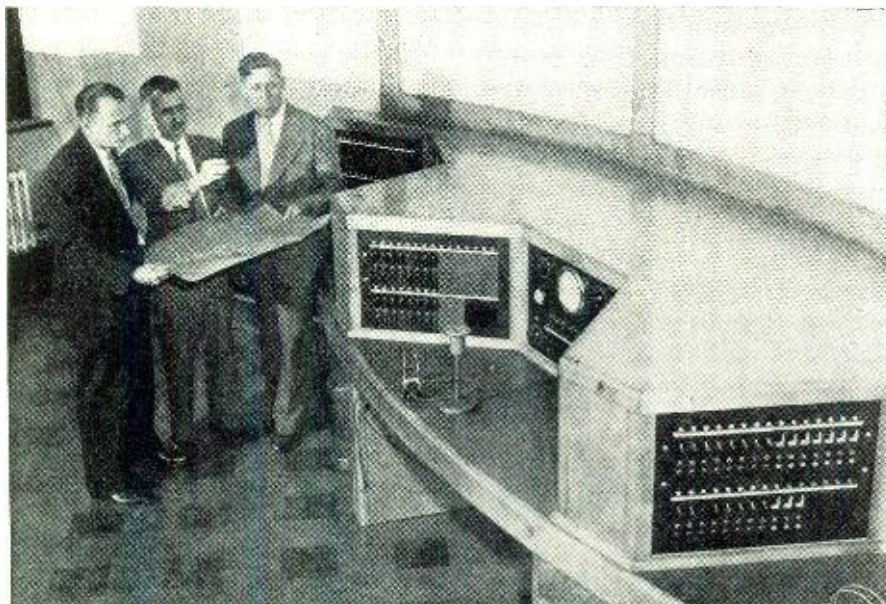

OVER AND OVER AGAIN THE IMPOSSIBLE BECOMES POSSIBLE

Over and over again, Hytron has licked the problem of making smaller and smaller radio tubes. Its BANTAM GT, which other tube engineers said was impossible, telescoped glass receiving tubes to the T-9 bulb (bantam and loktal), and has since become the most popular receiving tube.

Next Hytron sweated out development of the BANTAM JR.—the first subminiature. The HY155 was soon superseded by the even tinier HY255.

It was only natural that the Navy and OSRD should turn to Hytron in 1940, to design diminutive, rugged tubes for the VT or variable time fuse. Fired from a gun, such tubes, despite their size, must withstand 20,000 G's and 475 rps.

Months of research at Hytron resulted in the smallest tube which has ever been mass-produced. The tube's internal cubic volume is approximately half that of the smallest competitive tube. Again new horizons were explored by Hytron. New techniques and production equipment solved fabrication, assembly, glass, and exhaust problems.

The same skills which created the BANTAM GT, the BANTAM JR., and the smallest VT-fuse subminiature are now concentrated primarily on production of Hytron GT's and T-5½ miniatures for home receivers. You can count, however, on Hytron's continuing leadership in vacuum tube development.

ALL TUBES ACTUAL SIZE

OLDEST MANUFACTURER SPECIALIZING IN RADIO RECEIVING TUBES



HYTRON

RADIO AND ELECTRONICS CORP.



MAIN OFFICE: SALEM, MASSACHUSETTS

It's SOUND ADVICE to Consult **MURDOCK**



Headphones Engineered to YOUR Requirements

Hearing efficiency is increased when MURDOCK Headphones are on the job. Their "hear-ability" has been demonstrated through two wars.

The widespread preference for them is a tribute to MURDOCK'S 42 years' insistence on highest quality standards . . . the same quality "yardstick" that William Murdock applied to his first radio phones which he patiently put together by hand way back in 1904.

On special or difficult assignments MURDOCK engineers can create Headphones to meet your particular needs. For finest listening performance, be sure to consult MURDOCK!

Write for Catalog

JOBBERS!

MURDOCK Headphones are again available in greater quantities. Write us today for full details.

WM. J. MURDOCK CO.
203 Carter St., Chelsea 50, Mass.

line until the current on the meter read zero.

The main transmitter is a *Western Electric* Model 71B, one kilowatt AM job, and all the mobile equipment is *Motorola*. The mobile transmitters are FM model FMT30D, and the mobile receivers are AM Model T69-18. The station receivers are FM Model FSR13B. The station also has three AM monitor receivers on 2382 kc. and 31.5 mc.

At the dispatching boards there are nine dispatchers; three to an 8 hour shift, three radio engineers, one on each 8 hour shift at the transmitter, and two relief men, and there are also four radio mechanics to maintain the equipment.

This dispatching equipment at the Safety Building (near downtown Milwaukee), which is a block-long and block-wide structure, and houses the Milwaukee police department and the county sheriff force, is connected to the main station transmitter and receiver at the 3rd precinct police station at 47th and Vliet Streets, some four miles west of the Safety Building, through an underground telephone cable. The reason for the location of the main station transmitter and receiver at such a distance from the Safety Building is that the antenna tower is located at one of the highest elevations in the city. The site of the Safety Building having a very low elevation, as well as being a very noisy location for radio receiving, makes it practically impossible to operate a radio station there. As is well known, for best results in wave communication, it is very important to get the antenna as high as possible and also that man-made static be at a minimum. Therefore, the location at 47th street, in a residential district, was selected for the radio station site.

The entire cost of the radio system is reported to be in excess of \$100,000. The original equipment was put into operation about fifteen years ago and has served its purpose well. In recent years intensive study and surveys were conducted to ascertain the need for improvement in the system, culminating in the installation of the new dispatching equipment. A committee, formed some time ago for such study, consists of Edward F. Ilgner, superintendent of the bureau of electrical service for the city, who had general direction of the installation of the new equipment; Daniel J. Gellerup, chief engineer of the Milwaukee Journal radio station, WTMJ; William F. Seemuth, president of Electro-Pliance Distributors; Victor A. Pieper, superintendent of that company; George Bauer, chief electrician of the Milwaukee fire and police alarm system of the bureau of electrical service, and Herbert F. Wareing, radio engineer of the Milwaukee police department.

In discussing the improvement that is being made possible by the installation of the new dispatching equipment, Mr. Ilgner said, "There are now about sixty police and fire officials in Mil-

waukee county having authority to issue orders to emergency vehicles. Last year our transmitting station handled more than 87,000 broadcasts to the emergency vehicles. For the sake of order and efficiency it would be extremely impractical to give each official access to the radio transmitter so that he could personally broadcast orders. It is also impractical that each of these officials have radio receivers in their offices for receiving acknowledgments or other calls from vehicles.

"It is also necessary that calls originating from any individual car, regardless of its transmitter frequency, be heard by any and all cars of the system. The orderly operation of all this mobile equipment and its coordination with fixed radio equipment is the function of the new dispatching headquarters."

-30-

Teletype in the AACS

(Continued from page 53)

The new broadcast system went into test operations on February 28th; and on the deadline the next day, weather information totaling more than 75,000 word-groups a day was being funneled through Miami to the bases of the Gypsy Task Force on a 24-hour schedule.

It was mid-March when Sergeant Gray had that question thrown at him, just a couple of weeks after radioteletype broadcasting had been born. It was no wonder that he didn't know what the blazes it was! Today, though, when Sergeant Gray calls a ground station at one of the three Gypsy bases he can get weather information that's right up-to-the-minute concerning any part of the U. S. or the South Atlantic.

The Army Airways Communications System, the AAF Weather Wing, the Second Air Force, and Southeast Sector Plant Engineering Agency, can look back over those eleven hectic days and smile at the thousands of events that got together to start a new innovation in radioteletype and weather communications.

Today operators at WYI, the AACS station at Miami, feed miles of tape each day into reperforating machines —tapes that look like a mere jumble of holes on an endless piece of paper, but that in split seconds become weather information being automatically typed out on machines at the Gypsy bases 24 hours a day.

It must seem an unglamorous job to stand at a machine for six or eight hours a day and feed tape after tape into it, but operators like Pfc. Howard F. Bleeker of Iowa Falls, Iowa, can swell with pride at the knowledge that without radioteletype broadcasting of weather information to the South Atlantic, the Gypsy Task Force, with all the prowess this unique organization displayed in the war, might just as well have stayed home.

-30-



IMMEDIATE DELIVERY for all radio service replacements

Now it's N. U. Panel Lamps, as month by month the N. U. line of quality tubes and parts grows broader . . . opens up more avenues for profitable business for service engineers. And now, you can pick up extra sales of panel lamps *by the box*. That smart looking new vest-pocket N. U. package of 10 lamps does it! Countless numbers of replacements are needed, for radios, cars, flashlights, and other uses. *Order now from your N. U. Distributor.*



Vest-pocket box of 10 lamps—easy to sell that way—and profitable!



Complete line of types for all radio dials, panel boards, tuning meters, instruments, auto radios, flashlights, parking lights, coin machines.



The right bulb for every job—engineered to initial equipment standards—builds your reputation for accuracy and good work.



Torsion-tested filament wires . . . torque tested basing cement . . . shock and vibration tested bulbs . . . all combine to assure better service—*longer*.

NATIONAL UNION RADIO CORPORATION, NEWARK 2, N. J.



NATIONAL UNION RADIO TUBES AND PARTS

Transmitting, Cathode Ray, Receiving, Special Purpose Tubes • Condensers • Volume Controls • Photo Electric Cells • Panel Lamps • Flashlight Bulbs

**NEW
MODELS**
Available Now!
of ATR
QUALITY PRODUCTS



ATR
"A"

BATTERY ELIMINATORS
FOR CONVERTING A.C. TO D.C.

New Models . . . designed for testing D.C. electrical apparatus on regular A.C. lines. Equipped with full-wave dry disc type rectifier, assuring noiseless, interference-free operation and extreme long life and reliability.

- Eliminates Storage Batteries and Battery Chargers.
- Operates the Equipment at Maximum Efficiency at All Times.
- Fully Automatic and Fool-Proof.



ATR

LOW POWER INVERTERS
FOR INVERTING D.C. TO A.C.

Another New ATR Model . . . designed for operating small A.C. motors, electric razors, and a host of other small A.C. devices from D.C. voltages sources.

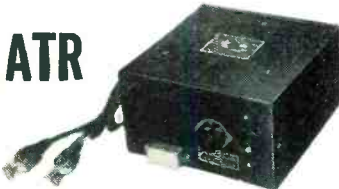

STANDARD AND HEAVY DUTY INVERTERS
FOR INVERTING D.C. TO A.C.

Specially designed for operating A.C. radios, television sets, amplifiers, address systems, and radio test equipment from D.C. voltages in vehicles, ships, trains, planes, and in D.C. districts.

WRITE FOR NEW CATALOG—
JUST OFF THE PRESS!

AMERICAN TELEVISION & RADIO CO.
Quality Products Since 1931
ST. PAUL 1, MINN. U. S. A.

MILWAUKEE HAMS Hold Contest

By JOHN H. DAVIS

WHEN the FCC let down the bars to amateur transmission, it did not take long for Milwaukee hams to get back on the air with their hobby. Equipment had been made ready when it became known that the GO sign would soon be given. While no special encouragement seemed to be necessary to have the hams get busy, it was decided by the Milwaukee Radio Amateurs Club to stage a contest on the air, as a way to express the club's thanks and appreciation to the War Emergency Radio Service personnel for the fine job that was done by their organization during the war years. Every contest participant was asked to invite a fellow WERS member. It was the first on-the-air contest to be held by this club.

Members were invited to compete on the 112 megacycle band. Rules of the contest were broadcast to members by the chairman of the contest committee, *Joseph T. Collins*, W9PYM. These rules were as follows:

All duly licensed radio amateurs, club members, and non-club members were eligible to participate in the contest, which was held on Sunday, October 7th, 1945.

Fixed station, portable mobile, and portable operation was permissible, including all WERS installations.

Each contestant was asked to forward a copy of his log to the contest chairman. This had to be postmarked not later than midnight of October 8th. For scoring purposes, each log had to indicate the exact location of the rig at the beginning of each QSO. Each station log also indicated, in addition to the usually required data, the number issued to the station worked, and the number received from the station worked. The numbers had to be different for each QSO and were issued consecutively.

Winners in the contest were decided upon the basis of total points, each airline mile counting for one point, with fractional miles computed to the nearest tenth of a point. The contest chairman used a large scale map for computing airline miles. Each QSO counted for two points, and the first QSO with any station was the one considered in the scoring.

First, second, and third prizes were awarded. A committee was appointed to assist the contest chairman in figuring the scores and interpreting the rules of the contest.

Milwaukee radio amateurs have resumed their weekly meetings which were disrupted by the war ban on activities. The men are looking at a gas engine from which pressure waves were picked up and examined on the oscillograph screen. They are (from left to right) Dave Elam, Electro Products Co., Milwaukee; Harry Halington, Chicago engineer who gave the demonstration; R. A. Koenig, vice-president, Milwaukee Radio Amateurs' club; Emil Felber, treasurer; John Scarvaci, president; Erwin Krein, secretary.



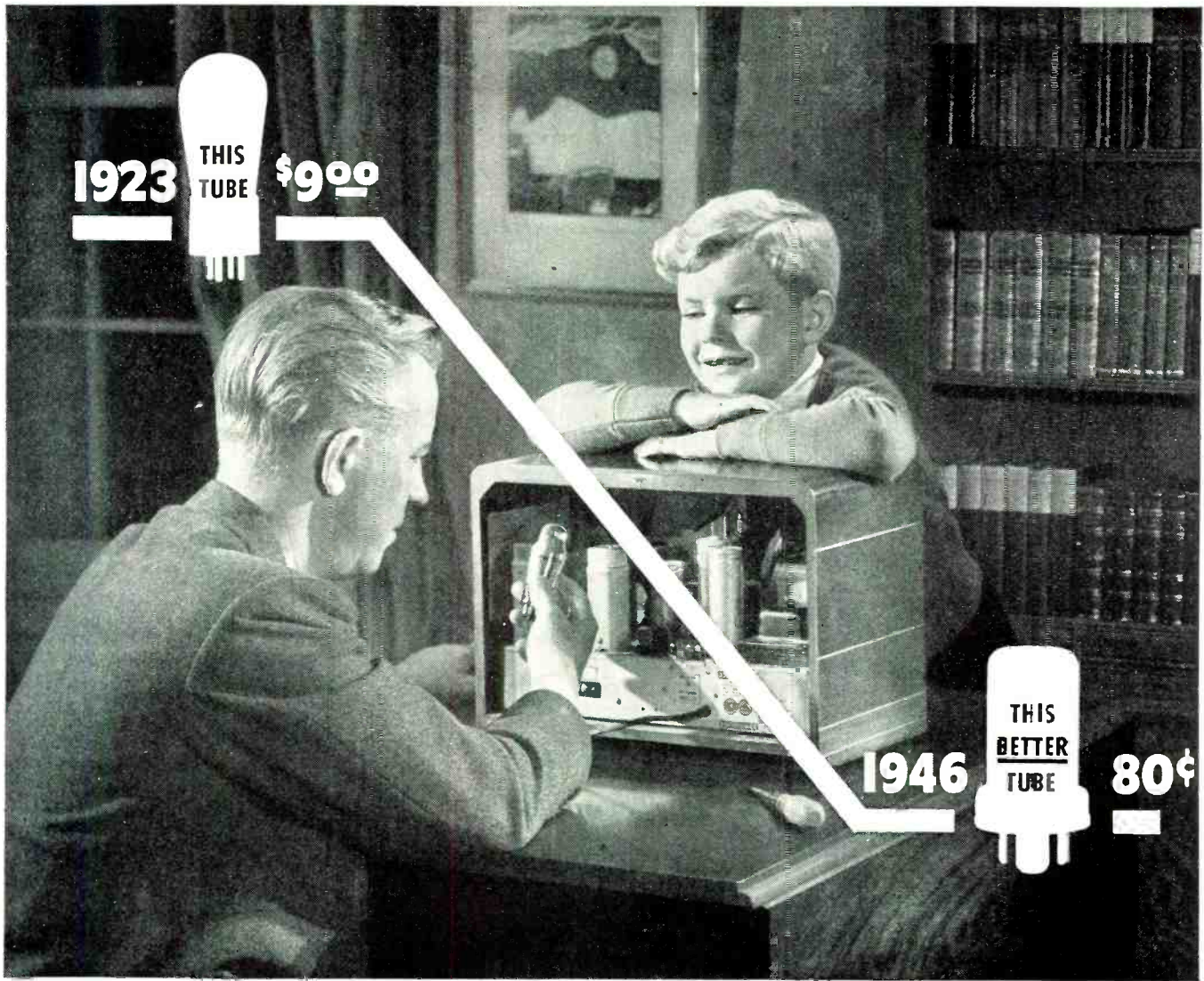

TODAY—A complete radio set for less than half the cost of the tubes alone in 1923!

• Today you can buy a six-tube table model radio for about \$25. A little over twenty years ago the six tubes alone cost \$54—*nine dollars apiece*.

Think of it—from \$9 to 80¢. You can buy *eleven* of these more powerful, longer-lasting radio tubes today for what you used to pay for only *one!*

This was brought about through RCA's combination of research, engineering skill, manufacturing efficiency and our American philosophy of making something *better—for less*.

Such progress means far more than simply a saving of \$8.20 on every radio tube. It means that radio has been

brought within the easy reach of practically everyone in this country.

There are now *fifty million* more radios in America than there were twenty years ago. Almost everyone depends upon broadcasting in some measure for entertainment, news, education.

Research and pioneering at RCA Laboratories contributed many of the scientific advances that so greatly improved and extended the services of radio to the American people.

Radio Corporation of America, RCA Building, Radio City, New York 20, N. Y. . . . Listen to The RCA Victor Show, Sundays, 4:30 P.M., Eastern Time, over the NBC Network.



The new 1946 RCA Victor Table Model (56X) costing about \$25. With our civilian production increasing, you can again look to RCA for the finest instruments of their kind that science has yet achieved. The principle of making it better—for less—applies to RCA Victor radios, television sets, Victrola radio-phonographs . . . every product bearing the RCA label.



RADIO CORPORATION of AMERICA

Two Ghirardi books THAT TEACH YOU TO DO ANY REPAIR JOB ON ANY RADIO EVER MADE!



Meet Alfred A. Ghirardi—the man who makes Radio easy to learn!



HOW TO TEST A RADIO IN 2 MINUTES or less!

Want to repair your own radios—without months of specialized service training? Want to repair sets for friends for fun or profit? Or, if you are already a radio serviceman, do you want to learn how to diagnose radio troubles in 2 minutes or less and fix sets TWICE AS FAST and TWICE AS PROFITABLY—without a lot of unnecessary testing? Then order Ghirardi's RADIO TROUBLE-SHOOTER'S HANDBOOK today—on a 5-Day Money-Back Guarantee!

START A SERVICE BUSINESS .. GET A BETTER PAYING JOB!

There's a real future for you in servicing—and Ghirardi's MODERN RADIO SERVICING is just the book to start you on it without delay. And remember: Radio is just the beginning! What this big book teaches you about Radio servicing, Test Instruments, and modern technical procedure is exactly the training you need to fit you to "grow up" with the fast-expanding Electronics profession in all of its servicing phases! It gives you real PROFESSIONAL Training . . . for only \$5 COMPLETE!

MODERN RADIO SERVICING

THE BOOK THAT GIVES COMPLETE MODERN Professional TRAINING

Once in a blue moon a technical book is written that is so important, so complete and so easy to understand that it is used and recommended universally by members of a profession. Ghirardi's MODERN RADIO SERVICING is exactly that kind of a book as leading radio men everywhere will quickly tell you!

TEST INSTRUMENTS, TROUBLE-SHOOTING, REPAIR

Actually, MODERN RADIO SERVICING is the only single, inexpensive book giving a complete, easy-to-understand course in modern Radio repair work in all of its branches—branches that lead right through to all types of Electronic equipment. Written so simply you can understand it without an instructor! Read from the beginning,

it takes you step by step through all phases of the work. Used as a reference book by busy servicemen, it serves as a beautifully cross-indexed volume for "brushing up" on any type of work that may puzzle you.

Included is a thorough explanation of all Test Instruments, telling exactly how they should be used and why (it even gives complete data for making your own Test Equipment if you prefer!); Receiver Troubleshooting Procedure and Circuit Analysis; Testing & Repair of Components; Installations; Adjustments; etc., etc.—also, How to Start a Successful Radio-Electronic Service Business. 1300 pages, 720 self-testing review questions, 706 helpful illustrations and diagrams. Only \$5 complete (\$5.50 foreign).

RADIO TROUBLE-SHOOTERS' HANDBOOK

MAKE MONEY REPAIRING RADIOS

This 4 lb. Handbook Shows Exactly How to Diagnose and Repair Common Troubles in Practically Every Radio in Use

Speed up radio repair work! Eliminate needless, tedious testing! Handle common radio troubles fast and profitably. Make spare time money repairing sets for friends and neighbors—without a lot of costly equipment or experience.

Symptom of the radio to be repaired. Four times out of five, the HANDBOOK will show you step by step just what to do—in a fraction of the usual time. Ideal for either busy service shops or service beginners. Pays for itself in time saved on the very first job.

HUNDREDS OF SERVICE HINTS

Over 300 additional pages include service hints; i-f alignment peaks for over 20,000 superhets; transformer trouble data; the finest tube information you've ever seen; color codes; and hundreds of graphs, diagrams, charts, etc.—all carefully indexed so you can find what you need in a hurry. Price only \$5—on 5-DAY MONEY-BACK GUARANTEE BASIS. Use Ghirardi coupon at bottom of adjoining page.

SAVE TIME ON EVERY JOB

Ghirardi's famous 744-page, manual-size RADIO TROUBLE-SHOOTER'S HANDBOOK shows what to do—exactly how to do it. Over 400 pages give common trouble symptoms, their causes and remedies for over 4800 receiver, auto radios and record changers of 202 different manufacturers. Just look up the Make, Model and Trouble

YOUR MONEY BACK IN 5 DAYS

Murray Hill Books, Inc.,
Dept. RN-36, 232 Madison Ave., New York 16, N. Y.

Enclosed find \$_____ for books checked; or send C.O.D. (in U.S.A. only) for this amount plus postage. If not fully satisfied, I may return the books within 5 days and receive my money back.

3rd Edition RADIO TROUBLESHOOTER'S HANDBOOK \$5 (\$5.50 foreign)

Ghirardi's MODERN RADIO SERVICING \$5 (\$5.50 foreign)

Special MONEY-SAVING COMBINATION: MODERN RADIO SERVICING and RADIO TROUBLESHOOTER'S HANDBOOK (both books) \$9.50 (\$10.50 foreign).

Name.....

Address.....

City & Dist. No..... State.....

Special MONEY-SAVING OFFER

Get both of these big books at our special Money-Saving price—a complete servicing library of over 2040 pages for only \$9.50. (\$10.50 foreign.)

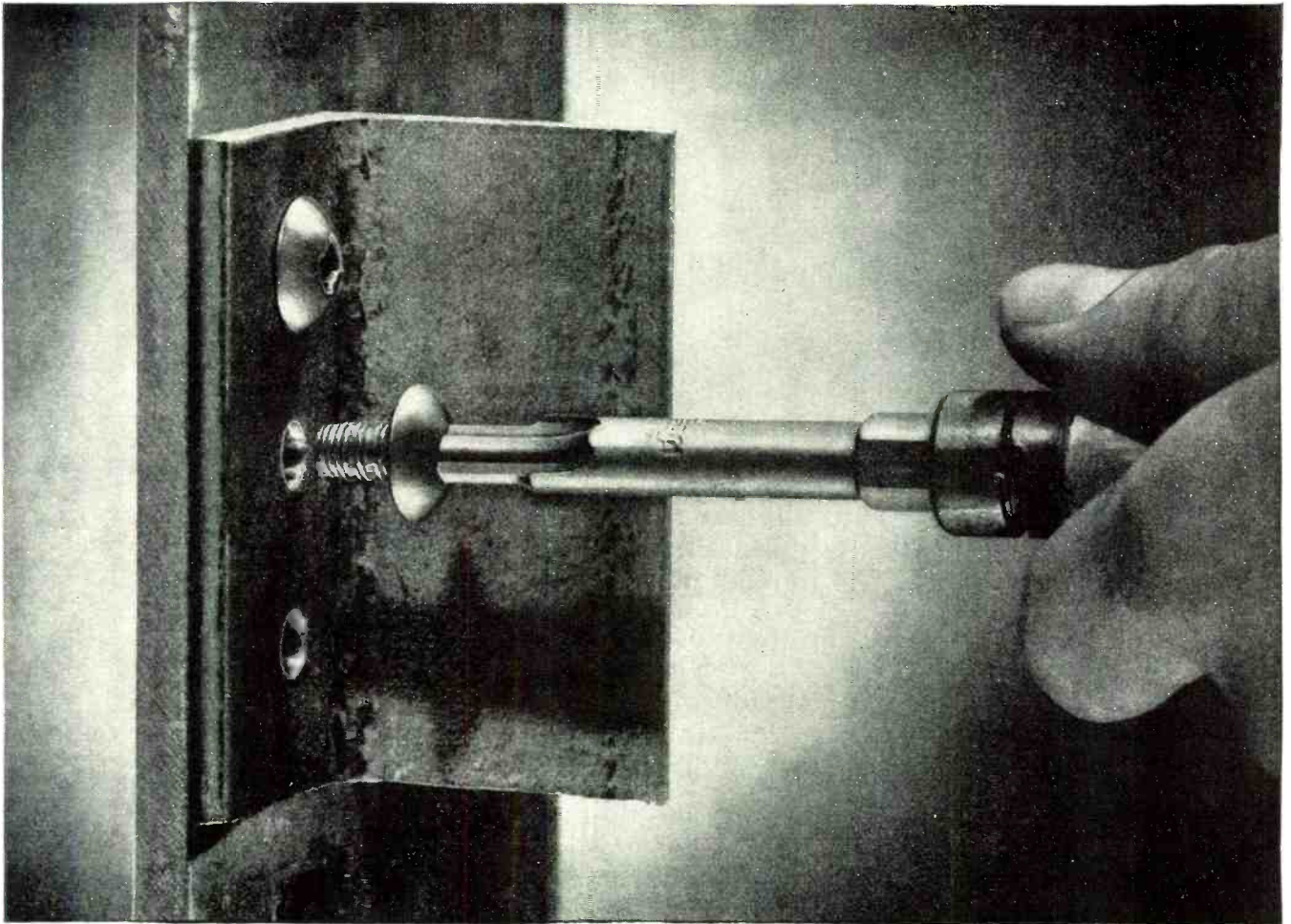

COMMON
SCREWDRIVER

TYPE "A"
ASSEMBLY BIT

There Is No Tougher Test

in assembly than the driving of thread-forming screws; especially where the thickness of the metal equals or exceeds the diameter of the screw. This is the critical spot where CLUTCH HEAD'S special features, of both screw and driver, challenge point by point comparison... for lower cost, efficiency, speed, and safety.

- ✓ Rugged Type "A" Bit construction for longer uninterrupted service and longer total life, plus simplified reconditioning, means fractional tool maintenance and assembling costs.
- ✓ Automatic dead-center entry with the Center Pivot for the speed and certainty of *straight* driving.
- ✓ Square instead of "tapered" engagement... a *straight-sided* driver contacting *straight-walled* Clutch recess... eliminates ride-out and reduces end pressure to a minimum.
- ✓ Positive engagement for definite torque drive; no chewed-up heads; no hazard of slippage to injure manpower or damage materials.
- ✓ The CLUTCH HEAD Lock-On which carries screw and bit as a unit for fast one-motion driving.
- ✓ And... an ordinary type screwdriver will service CLUTCH HEADS.

You are invited to make your own test of these and other exclusive advantages by asking us to mail

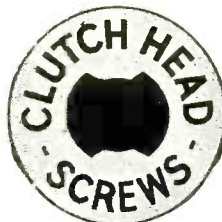

you package assortment of CLUTCH HEAD Screws, sample TYPE "A" Bit and fully illustrated brochure.

UNITED SCREW AND BOLT CORPORATION

CLEVELAND 2

CHICAGO 8

NEW YORK 7

March, 1946

73

NEW and
Ready for you!

ALLIED'S 1946 CATALOG

of Radio and Electronic Supplies

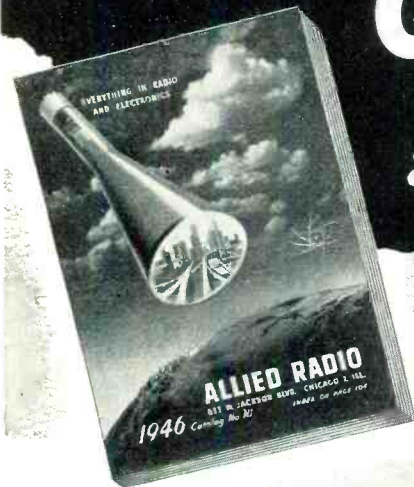

FREE
Send for it Now!

LARGEST AND MOST COMPLETE STOCKS

Today's handiest, most complete *Buying Guide!* Brings you latest, finest values in parts, tubes, kits, tools, books, test instruments, communications receivers, Ham gear, public address and other equipment. Places at your finger tips over 10,000 items of nationally known guaranteed quality. Makes available to you the world's largest and most complete stocks under one roof . . . ready for rush delivery. Enables you to get everything you need in radio and electronics from one dependable, central source. Send for this new 1946 Catalog now. Save time, work and money!



NEW RADIO SETS

Parade of new 1946 models, including phonoradios, and latest communications receivers covering broadcast, short-wave and amateur bands. Beautiful styles! Wonderful performance! Outstanding values!



HANDY RADIO BOOKS

Specially prepared by Technical experts for radio training and for helpful reference.

Radio Formulas & Data, Dictionary of Radio Terms, Radio Circuit Handbook, Radio Builders' Handbook, Simplified Radio Servicing, Radio Data Handbook — Six Books No. 37-799, 75c.

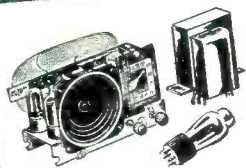

OVER 10,000 ITEMS

Biggest section of quality parts and equipment for engineers, dealers, servicemen, soundmen, amateurs, builders. All leading makes, at lowest prices. Send for Free Catalog now.

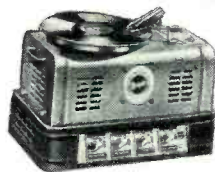

NEW P.A. EQUIPMENT

Sound systems for every public address requirement. Complete listing of amplifiers, speakers, microphones, accessories. Newest developments with many exclusive features.

ALLIED RADIO CORP.
833 W. Jackson Blvd., Dept. 1-C-6
Chicago 7, Illinois

Date

- Send FREE New 1946 Catalog.
 Send Six Books No. 37-799 (75c enclosed)

Name

Address

City..... Zone..... State.....

ALLIED RADIO

Everything in Radio and Electronics

At the first meeting of the club after the contest, the announcement of results was made to members, as follows:

First Prize: *Charles Meyer*, W9GVL, 196 points, 154 miles, on 30 watts.

Second prize: *Herbert Baker*, W9GSP, 138.65 points, 118.65 miles, 8 watts.

Third Prize: *Cyril Shallow*, W9SQK, 115.9 points, 83.96 miles, 55 watts.

The total mileage was obtained by adding up the distance for each call made. The wattage did not count. As in bridge, there had to be a booby prize, and this went to one of the members who usually drags in the calls on ordinary occasions. The prize was a roll of friction tape, and the reason for the low score was the fact that the operator had an idea which he thought would be a winner. With a mobile unit he drove out to Government Hill, near Delafield, Wisconsin, some 30 miles southwest of Milwaukee, to get height by going to the top of the 60 foot tower on the hill. The hill is about 1235 feet above sea level, so that he was operating at a height of about 1300 feet. To his surprise, he got practically nothing, except a few calls. As it takes an hour to get back home from the hill, little time was left to make a large number of calls within the limited time for the contest.

The writer had the pleasure of listening in on one of the receivers, and interest of two of the members taking part in the contest ran high, as contact after contact was made by one member, the other handling the log.

—50—

An anti-radar device developed by the Signal Corp to jam enemy radar. Aluminum foil, known as "chaff" or "reflector" was dropped by the lead aircraft in a bombing formation thus providing effective protection for the other planes. Small insets show the effect of this aluminum foil on the scope readings. The left hand inset demonstrates the picture on an unjammed scope while the right hand picture demonstrates the effect when the foil is saturating the scope with spurious radar reflections.

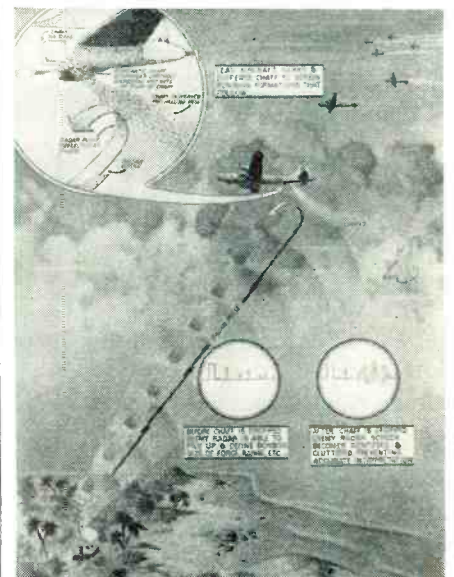



Where Will YOU Be in 1950?

**Enjoy Security and Good Pay! Prepare NOW
With CREI Modern Technical Training and
Step Ahead of Competition into a Good Job!**

**CREI Offers you a Proved
Program of Self-Improvement to Keep Pace with
Modern U.H.F. Advancements and Enables You to
Go After — and Get a
Secure Radio Job!**



Yes, there are GOOD JOBS . . . for GOOD men! The easy jobs are gone and once again knowledge and ability are the requirements for the good-paying jobs. Competition is opening up. The fight to HOLD good jobs—to SECURE better ones is just starting. Employers once again can afford to be "choosy" . . . to select the best man for the best job. In the face of this show-down situation—*where do YOU stand?*

CREI home study training in Practical Radio-Electronics Engineering can equip you to meet the requirements to *hold* your job—or advance to a *better* one. No matter what your past radio-electronics experience has been—no matter what your training—you must actually start anew to gain the confidence born of knowledge. By adding CREI training to your present radio experience you can safeguard your future and keep pace with such new developments as U.H.F. Circuits, Cavity Resonators, Pulse Generators, Wave Guides, Klystrons, Magnetrons and other tubes. Are you equipped to handle them? CREI

is equipped to *help you*, by providing the know-how and ability that is required.

In our proved method of instruction, you learn not only *how*, but *why!* Easy-to-read-and-understand lessons are provided well in advance, and each student has the benefit of personal guidance and supervision from a trained instructor. This is the basis of the CREI method of training for which many thousand professional radiomen have enrolled since 1927.

It's up to you now to decide your course. What you do today will be the answer to where you will be in 1950 and the years after. It costs you nothing to read the interesting facts . . . to learn how CREI can help you enjoy the security you want . . . the better-paying job that can be yours. Write for particulars *now!*

CAPITOL RADIO Engineering Institute

HOME STUDY COURSES IN PRACTICAL RADIO-ELECTRONICS
ENGINEERING FOR PROFESSIONAL SELF-IMPROVEMENT

RN-3, 3224—16th Street, N. W., Washington 10, D. C.

Contractors to U. S. Navy—U. S. Coast Guard—Canadian Broadcasting Corp.
Producers of Well-trained Technical Radiomen for Industry.

**• WRITE
TODAY for
FREE
BOOKLET**



**"Your Opportunity in the
New World of Electronics"**

If you have had professional or amateur experience—let us prove to you that we have something you need to qualify for a better radio job. To help us to intelligently answer your inquiry—PLEASE STATE BRIEFLY YOUR BACKGROUND OF EXPERIENCE, EDUCATION AND PRESENT POSITION.

Member: NATIONAL COUNCIL OF TECHNICAL SCHOOLS

for everything in
ELECTRONICS
 and **EQUIPMENT**
 follow
ARROW!

An Exceptional Value!

**3 Tube AC-DC
 PHONO AMPLIFIER**

Completely wired, with tubes and ready to operate. Uses a dynamic speaker 450 ohm field. Tubes: 14B6, 50A5 and 35Z5.
 Complete with tubes, less speaker



only **\$795**
 net

Turner Microphones

Model 22X Crystal

Reproduces clean and sharp. Tilting head. Removable 7 foot cable. Built-in windgag for outdoor operation. High level—52DB. Range 30-7,000 cycles.

\$1088 Net



Model 99 Dynamic-Level—52DB. Range 40-9,000 cycles. 20 foot cable

\$1911
 net

**We Carry a Complete Stock of
 SHURE, AMERICAN, ASTATIC
 and Electrovoice Microphones**

**SUPERIOR
 Model PB-100
 VOLT-OHM-
 MILLIAMMETER**

All-purpose test instrument. Direct reading, push-button operation. Self-contained battery. Hand-rubbed oak cabinet



\$2840
 net

SPECIFICATIONS:

D.C. VOLTAGE: 0 to 5/25/50/250/500/2500.
 A.C. VOLTAGE: 0 to 10/50/100/500/1000.
 OUTPUT METER: 0 to 10/50/100/500/1000 Volts.
 D.C. CURRENT: 0 to 10/250/ Ma. 0 to 2.5 Amp.
 RESISTANCE: 0 to 10,000/100,000 Ohms. 0-1 Meg.
 DECIBELS: -10 to +15; 0 to +35; +30 to +55.

Attention . . . HAMS!

**We Carry Full Stocks of
 BARKER & WILLIAMS COILS**
 (25 watts to 1 KW. All bands including 15 meters)

**G.E. TRANSMITTING TUBES
 BUDD RADIO PRODUCTS
 STANCOR TRANSFORMERS
 HUDSON AMERICAN
 TRANSFORMERS
 CARDWELL VARIABLE
 CONDENSERS**

Write to us for anything in **ELECTRONIC PARTS and EQUIPMENT**. Get on our mailing list and keep informed as merchandise becomes available.

ARROW
ELECTRONICS COMPANY
 82 CORTLANDT ST., NEW YORK 7, N. Y.
 COrtlandt 7-2935 — 2998

**Installation and Operation of
 V.H.F. GROUND TRANSMITTER
 and RECEIVING STATION**

By **ANDREW R. BOONE**

The peculiarities of topography and radio waves must be considered as important factors in designing and constructing v.h.f. broadcasting equipment.

MORE than once, especially early in the war, very-high-frequency radio communications have failed to contact airplanes. In some cases, this has been due to the peculiarities of topography and radio waves. For example, reception may be excellent to a mountain range but, beyond the mountains, planes and ground are simply out of touch with each other.

The answer to this vexing problem is the forward relay in conjunction with v.h.f. ground transmitter and receiver stations.

It is because very-high-frequency radio waves travel along a line of sight, much like beams of light, that the forward relay was brought into service. In general, anything that limits light will limit these waves. The earth's curvature is an example. A high-flying airplane, at about 20,000 feet, can transmit and be heard about 180 miles. At low altitude, say 1000 feet, communication may be limited to 50 or 60 miles.

Because anything that stops light also stops very-high frequencies, natural obstacles like mountains can cut off v.h.f. broadcasting as effectively as the curvature of the earth. There's just one way to get communication into such a dead area, installation of a forward relay, controlled from the home base. So it's plain to be seen why we must use relays if we want to get any distance with v.h.f.

While the home base set-up may look elaborate, it's really quite simple. The point is, regardless of how many trucks and towers are used the whole thing boils down to nothing more than an assembly of mobile transmitters and receivers mounted on trucks.

The transmitter unit consists of a truck containing two transmitters. The receiver unit is a truck containing two BC-639 receivers. These, then, are the basic units. They carry their own power supply and even their own collapsible antennas.

Some units are operated from an area control room, but one receiver and one transmitter truck could be eliminated and the remaining two units handled from the operations tent

of a squadron in an advanced tactical area, or controlled remotely as a forward relay.

With what is known about the v.h.f. line-of-sight principle, it's not difficult to understand why a particular open location is selected. The ideal spot, of course, would be one on top of a rounded hill, to get the antennas as high up as possible. But if one can't have that, a flat place with no big natural obstacles nearby is next best.

An excellent spot is one where the trees will hide most of the equipment, yet the mast will be in the open. A 75 foot mast is used, and it must clear the treetops by a healthy margin.

Standing a 75-footer up on end becomes chore number one. To begin with, the mast will rest on a base plate, so the plate must be secured firmly to the ground. Then, since guy wires will have to hold the mast up, four anchors, 90 degrees apart, are screwed into the ground to hold them. Guy wires will be attached to the anchor chain and then, when the anchors are all in place, the mast sections can be taken out of the truck where they have been stored and laid out on the ground ready for erection. Because the mast is 75 feet long, the crew must have 75 feet clear in one direction.

Now, running up the center of the mast are the coaxial antenna cables. These have to be threaded up through the mast, starting at the bottom. When the cable has to be bent, it is bent in long, smooth curves. Making a sharp bend in a piece of coaxial cable can displace the internal beads and from then on it's about as useful as an old garden hose.

When the cables have come all the way through, they are brought out over the slots of the top section and threaded through the cable clips on the truss, with one cable going to each side of the spreader. When the cable plugs have been placed in the antenna sockets, it's time to go back and assemble the mast.

The cable is attached at the upper end of the joint by a snap-clip to hold it. At each joint, there's a snap clip to hold the cable. The bolts should be firm, but not too tight. Now the

A few of the Johnson "Standards"

CONDENSERS

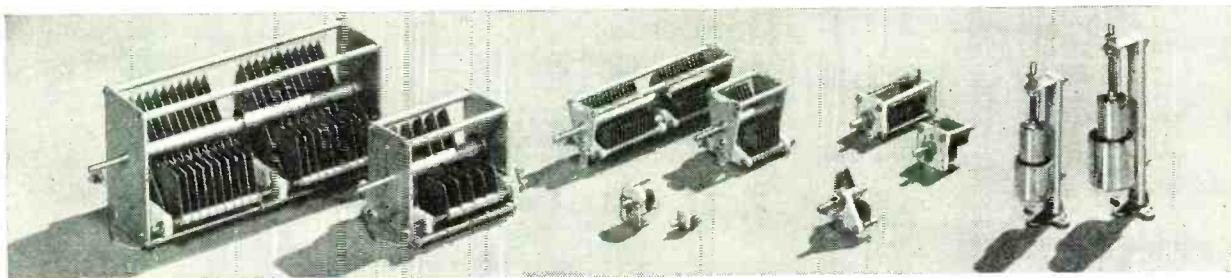

TUBESOCKETS

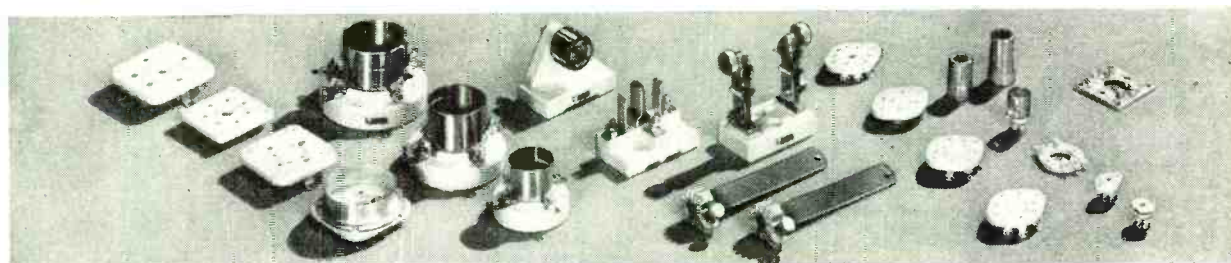

INDUCTORS

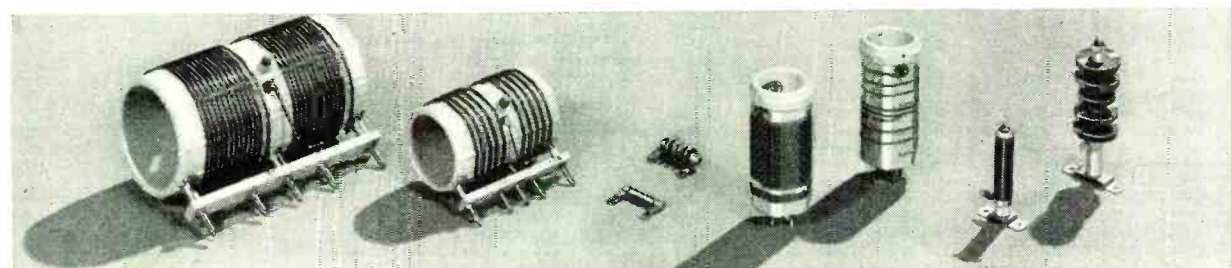

HARDWARE



These are Johnson "standards"!

Condensers, tube sockets, inductors, and chokes, plugs and jacks, shaft couplings, tube caps, inductor clips, hardware, and insulators (not shown), all are the best that can be had . . . backed by Johnson's more than twenty years experience in the manufacture of radio-electronic parts.

If you are entering your "Dream" transmitter in the All Amateur Transmitter Contest be sure to use Johnson parts to assure a prize winning rig.

Application blanks for the All Amateur Transmitter Contest may be obtained from your favorite jobber or write directly to us.

Whether you are designing industrial electronic equipment, commercial broadcast installations or "the dream transmitter" be sure to specify Johnson products . . . the "standards" engineered to meet both standard and special requirements.

Johnson products are stocked by leading radio-electronic parts jobbers.

Write for
General Products Catalog
No. 968-Z

JOHNSON

a famous name in Radio



E. F. JOHNSON COMPANY • WASECA • MINNESOTA

March, 1946

77

It's NEW! It's POST-WAR
SUPREME Model 565
VACUUM TUBE VOLTMETER

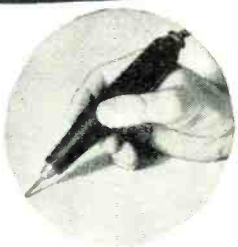

NEW PROBE Streamlined Hand Fitting. Incorporating new High Frequency Diode

RANGES:
 DC 0-1, 2.5, 10, 50, 250, 500
 AC 0-1, 2.5, 10, 50, 250
 EXTENDED TO 5000 VOLTS BY EXTERNAL MULTIPLIERS

INPUT RESISTANCE:
 DC—80 megohms on 1 volt range; 40 megohms on 500 volt range
 AC—40 megohms on 1 volt range; 20 megohms on 250 volt range

INPUT CAPACITY OF PROBE: 5 micro-micro farads

FREQUENCY RANGE:
 Negligible frequency error from 50 cycles to 100 megacycles.

SUPREME INSTRUMENTS CORPORATION GREENWOOD MISSISSIPPI

First Choice

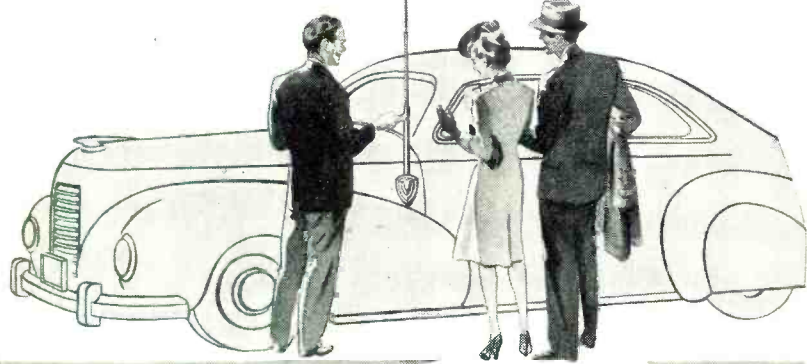

... OF AMERICA'S AUTO DEALERS

The same precision workmanship and the same fine quality mark Ward Antennas now as before the war. But now there are added reasons of new design and newly-engineered efficiency which will give Ward Antennas an even greater margin of preference with America's auto dealers. For extra profits that satisfied customers always bring, order Ward—world's finest antennas for car and home.

Buy Victory Bonds
THE WARD PRODUCTS CORPORATION
 1523 E. 45th St., Cleveland 3

WARD

Antennas

mast is fastened to the base, bolts always being tightened by hand, never with a wrench.

From now on, it's pretty much a matter of coupling sections, attaching guys and raising the mast.

Now for the coaxial cable which connects the antenna with the truck. This particular cable is usually buried at least a foot underground. This makes it secure and gives it plenty of protection.

Putting up the two masts is the hardest actual work in getting the sets in shape for their job. Once the masts are up, it's time to provide for a power supply.

Because there are two trucks, a transmitter and a receiver, there must be two masts. For the same reason, there must be two power generators. And, of course, if this unit is going to stay out for any length of time, there are some other things that will be needed, like shelter, and food.

Meanwhile, the radio crew still has some work to do. For instance, the transmitter has to be tuned. The first thing here is selecting the proper crystals for the operating frequency. There's just one thing to remember when selecting crystals; the transmitting frequency is 18 times the frequency marked on the crystal. The frequency of the crystal is determined by dividing the operating frequency by 18. One crystal goes in each transmitter.

Now, to tune the transmitter, the operator first sets all the switches in the *Off* position, the Tune-Operate switch in *Tune*, the Remote-Local in *Local*, and the Variac counter-clockwise. Now he can safely turn on the main line switch and adjust the Variac to 230 volts.

Next, he turns on the master filament switch, and then it's time for a rest, because it takes just about a minute for the filaments to warm up.

So, he sets the meter switch on the Oscillator Panel at *CO* (Crystal Oscillator), the left hand meter switch on the Amplifier Panel at *C-one* (first cathode), and the right hand meter switch at *G-one* (first grid).

Now he sets the aerial and coupling dials to zero, and the other dials to approximate dial settings. It is now time to re-check the Variac setting, to see that it's at 230 volts.

With the master high voltage switch on, the operator tunes the crystal oscillator for minimum cathode current. He watches for the flicker, holds it, and carefully turns the dial up until he increases the cathode current one and a half to three mils.

With the meter switch in first trebler, the first trebler can be tuned for minimum cathode current. Then the same thing over again with the second trebler, and again with the doubler, and again with *IPA* (Intermediate Power Amplifier).

The grid current should reach maximum as the cathode current reaches minimum. Next, the power amplifier is tuned for maximum current on the

Two big NEWARK stores well stocked to serve your needs and staffed by people who know and can help solve your problems.

THIS MONTH'S FEATURES

THE FAMOUS NEWARK BARGAIN OIL-FILLED, OIL-IMPREGNATED FILTER CONDENSERS

FULLY GUARANTEED AT RATED VOLTAGES

Capacity	Working Voltage	Height	Width	Depth	Wt.	Price
1 mfd.	1500 V.D.C.	2 3/8"	1 3/4"	1"	4 oz.	\$.79
4 mfd.	1000 V.D.C.	3 1/4"	2 1/2"	1 1/4"	12 oz.	1.50
4 mfd.	3000 V.D.C.	3 3/4"	1 3/4"	3 3/8"	1 1/4 lbs.	3.75
1.5 mfd.	1000 V.D.C.	2 7/8"	1 3/4"	1"	8 oz.	.59
5 mfd.	2000 V.D.C.	4"	3 3/4"	1 1/4"	1 lb. 4 oz.	2.15
5-5-15 mfd.	*1000 V.D.C.	4 3/4"	3 1/2"	3 3/4"	4 1/4 lbs.	1.75
* In Metal Can						
8 mfd.	2000 V.D.C.	4 1/2"	3 3/4"	2 1/2"	2 1/2 lbs.	2.75
.25 mfd.	*2000 V.D.C.	3 3/4"	1 3/4"	1"	6 oz.	.69
* Special Porcelain Insulators						
10 mfd.	3000 V.D.C.	4 3/8"	3 3/4"	3 1/4"	3 lbs. 8 oz.	4.75
13 mfd.	1000 V.D.C.	3 3/4"	3 1/2"	1 3/4"	1 3/4 lbs.	2.25
15 mfd.	3000 V.D.C.	4 3/4"	4 3/4"	3 3/8"	5 lbs.	5.25
15 mfd.	4000 V.D.C.	2 7/8"	1 3/4"	1"	8 oz.	.89
8 mfd.	3000 V.D.C.	7 3/8"	6 1/2"	3 3/4"	7 lbs. 4 oz.	3.95
2 mfd. & 4 mfd.	600 V. metal can	4 7/8"	2 1/2"	1 1/4"	14 oz.	.80



HALLICRAFTERS

SX-28A	Super Skyrider with crystal, less speaker..	\$223.00
S-20R	Sky Champion with built-in speaker.....	60.00
S-22R	Skyrider Marine with built-in speaker.....	74.50
SX-25	Super Defiant with crystal, less speaker...	94.50
S-39	Sky Ranger portable, AC/DC and battery.	110.00
SX-36	FM/AM receiver.....	415.00
S-37	V.H.F. FM/AM receiver.....	591.75
PM-23	10" PM speaker in cabinet for use with SX-25, SX-28A.....	15.00

McELROY KEY

The Deluxe — Model CP 810.....\$9.78

GENERAL ELECTRIC METERS

0-500 D.C. MA. 2" round Bakelite case.....\$3.50

HAMMARLUND

HQ-129X (with tubes)..... \$129.00
 ASPC-21CX..... 318.00
 ASP-210SX..... 318.00
 Available for rack mounting at same prices

NATIONAL

NC-2-40C and speaker..... \$240.00

RME

RME-45 and speaker..... \$166.00



ABBOTT TR-4

Compact, efficient 2 1/2 meter transmitter-receiver \$39.00

TUBE BARGAINS

Many famous makes, popular types at ridiculously low prices! Write for list!

NEWARK TRANSFORMER BARGAINS

45556 778 V.C.T. at 200 M.A. 115 V. 60 Cycle 6.3 V.C.T. at 5A 5V. at 3 amp. 9 lbs..... \$3.95
 45557 15 H. 150 M.A. 200 ohm 2000 V. Insulation 5 1/2 lbs.. 1.95

CLOSE OUT ON METERS. \$4.95 EACH

Western Electric Micro-ammeter. Bakelite case fits 3 3/4" hole. Radium

dial 150-0-150. Can be used with 0-200 micro and amp scale costing 15c additional. Excellent as a 5,000 ohm-per-volt meter or null, sound level and galvanometer indicator. Instruction included. No priority required.

4 1/2" square 0-200 Micro-ammeter.
 4 1/2" square 100-0-100 Micro-ammeter.

NEWARK GUARANTEE

All merchandise advertised carries the usual Newark Electric guarantee of complete satisfaction!

Get Your Name on Our Mailing List

Be first to get announcements of merchandise available, special bargains, etc., etc. Send name and address on post card. State whether amateur, engineer school, industrial or service man. Address orders and inquiries to Dept. RN at NEWARK store nearest you.



ALL PRICES SUBJECT TO CHANGE WITHOUT NOTICE

CHICAGO
 Newark ELECTRIC Company
 NEW YORK

115-117 W. 45th St.
 NEW YORK 19
 BRyant 9-4735
 (Adolph Gross)

"Dependable Service is the Foundation of our Business"

323 W. Madison St.
 CHICAGO 6
 DEArborn 0083
 (Sam Poncher)



but not for long!

The final condenser arced over and blew out the rectifiers. Had he used BUD scientifically produced components the log entry would not have read "transmitter broke down!"

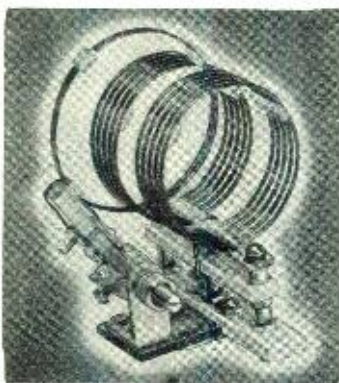

All coils are of the air-wound type to promote efficiency. The use of a variable link to the plate tank as a means of varying the loading of an R. F. stage is effectively utilized in this type of inductance.

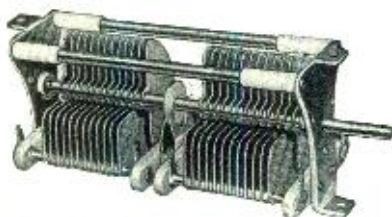

To reduce losses to an absolute minimum this condenser features BUD electro-soldered plate assemblies. This assures correct plate spacing, overall rigidity, and light weight.

THIS IS A COMBINATION THAT CAN'T BE BEAT AND INSURES YOUR RIG AGAINST ELECTRICAL FAILURES.

BUD Can Supply All Your Needs! . . .

. . . with the latest types of equipment including: condensers, chokes, coils, insulators, plugs, jacks, switches, dials, test leads, jewel lights and a complete line of ultra-modern cabinets and chassis.



BUD RADIO, INC.

CLEVELAND 3, OHIO

grid meter and the anode dial for minimum current on the cathode current meter.

The Tune-Operate switch is placed in *operate* position and the anode dial returned for minimum. The maximum increase of cathode current on the cathode current meter is obtained by turning the aerial dial toward 100.

Successively, the coupling is increased until the cathode current meter shows not more than 75 mills, a check is made of the current with the meter switches in *C-two* and *G-two* position. At this point, the set is allowed a variation between 72 and 78 mills of cathode current and four to five mills between tubes on the grid current. With the grid meter switch on monitor, from 2½ to 10 mills grid current should be recorded.

All that's left is the volume control. The operator speaks into the micro-

phone and adjusts volume control on PN-10-A for 110 mills on the modulator meter, and that's the way the transmitter is tuned. Of course, the operator has to go through the same thing on the second transmitter, so while that's going on, let's drop over to the receiver and watch that tuning job.

Fortunately it's a whole lot simpler though it's really two jobs—tuning the frequency meter and tuning the receivers themselves.

With the power on, and the voltage of the PN-15-A at 230 volts the frequency meter is turned on with the standby switch left in the standby position.

We've got two frequencies this time, so two crystals go into the frequency meter. We tune to only one at a time, selecting with the crystal selector switch.

DETERMINING THE RESISTANCE OF A SENSITIVE D.C. METER

By GUY DEXTER

VERY often, it is necessary to know the internal resistance of a d.c. milliammeter or microammeter with reasonable accuracy. This is necessary, for example, when ordinary shunts must be calculated for increasing the range of the meter or when balancing-circuit resistors must be calculated for a v.t. voltmeter in which the meter will be located.

Determination of the meter resistance poses something of a problem for most experimenters. The main difficulty is that the sensitive meter movement will not stand the battery voltage of most Wheatstone bridges and ohmmeters. If the meter manufacturer's catalogue is handy, the approximate resistance may be found among the other information listed for a given type of meter. But, often as not, the catalogue is not available—and when it is, it may not fill the

METER	R ₁	R ₂
0-10 ma.	300	5
0-5 ma.	500	10
0-1.5 ma.	2000	50
0-1 ma.	3000	150
0-500 µa.	5000	1000
0-200 µa.	10,000	1500
0-100 µa.	20,000	2500
0-50 µa.	50,000	2500
0-30 µa.	70,000	2500

Table 1 shows the full scale values of R₁ and R₂ for various sizes of meters.

bill completely. (A 0-1 d.c. milliammeter might be listed in a prewar—or early wartime—catalogue as having an R_m value of 33 to 54 ohms. But if the meter was manufactured after adoption of A. S. A. standards, it will have a resistance of 105 ohms. Similar changes will be found in the case of microammeters of various ranges).

A practical scheme for checking the internal resistance of any d.c. milliammeter or microammeter is illustrated in Fig. 1. Connect the meter to a single dry cell and wirewound rheostat, as shown in (A), and adjust the rheostat (R_1) for exact full-scale deflection of the meter. Next, connect a second wirewound rheostat (R_2) into the circuit without disturbing the setting of R_1 , and adjust R_2 until the meter reading drops *exactly* to half-scale. Lastly, remove R_2 from the circuit without disturbing its setting, and measure its resistance at this setting by means of a convenient Wheatstone bridge or ohmmeter. This measured resistance will equal the internal resistance of the meter.

Table 1 shows the *full-scale* values which R_1 and R_2 must have for various sizes of milliammeters and microammeters. These values will permit maximum ease of adjustment and safety to the meter under test.

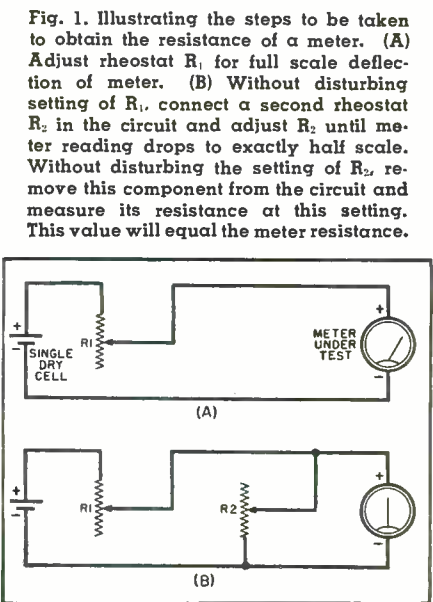

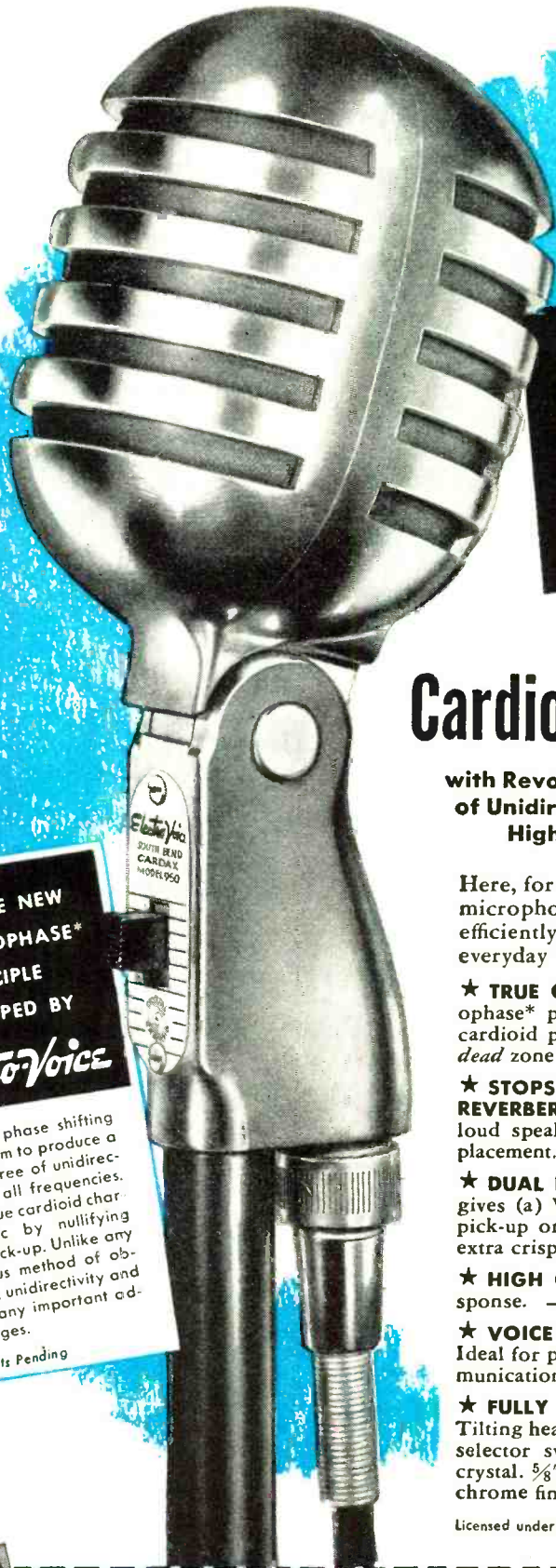

Electro-Voice
ANNOUNCES THE
CARDAX

A NEW
Cardioid Crystal Microphone

with Revolutionary New **MECHANOPHASE*** Principle of Unidirectivity . . . Dual Frequency Response . . . High Output . . . and other big features!

Here, for the first time, you get *all* these features in *one* microphone! With amazing flexibility, new **CARDAX** efficiently serves many applications . . . easily solves everyday problems of sound pick-up and reproduction!

★ **TRUE CARDIOID POLAR PATTERN** New E-V Mechanophase* principle gives wide-angle front pick-up in true cardioid pattern over wide frequency range. Sound at rear *dead* zone cancels out and is not reproduced.

★ **STOPS FEEDBACK—CUTS BACKGROUND NOISE AND REVERBERATION PICK-UP** Permits nearly double usable loud speaker volume. Simplifies microphone and speaker placement. Assures finer reproduction of just the sound wanted.

★ **DUAL FREQUENCY RESPONSE** Screw control on back gives (a) Wide range flat response for high fidelity sound pick-up or (b) Wide range with rising characteristic for extra crispness of speech or high frequency emphasis.

★ **HIGH OUTPUT LEVEL** —57 db for flat frequency response. —48 db for rising frequency response.

★ **VOICE AND MUSIC PICK-UP EXACTLY AS DESIRED** Ideal for public address, recording, remote broadcast, communications . . . indoors and outdoors.

★ **FULLY EQUIPPED FOR CONVENIENT OPERATION** Tilting head. Built-in "On-Off" switch. Dual frequency range selector switch. Cable connector. 20 ft. cable. Bimorph crystal. $\frac{5}{8}$ "-27 thread. New modern functional design. Satin chrome finish. **CARDAX Model 950, List Price \$37.00**

Licensed under Brush Patents. Electro-Voice Patents Pending.

EXCLUSIVE NEW MECHANOPHASE* PRINCIPLE DEVELOPED BY Electro-Voice

Utilizes a phase shifting diaphragm to produce a high degree of unidirectivity at all frequencies. Gives true cardioid characteristic by nullifying back pick-up. Unlike any previous method of obtaining unidirectivity and has many important advantages.

*Patents Pending



SEND FOR BULLETIN NOW
Get full facts about amazing new **CARDAX!** Describes **Mechanophase**. Shows how dual frequency response selector works. Includes diagrams and response curves.

No Finer
Choice Than

Electro-Voice
MICROPHONES

ELECTRO-VOICE, INC., 1239 South Bend Ave., South Bend 24, Indiana
Export Division: 13 East 40th St., New York 16, N. Y., U.S.A.—Cables: Arlab

Internal Stress ?

We reduce it for better plastic parts

CUTTING 'WAY DOWN on internal stress gives your plastic application greater strength and stability under stress, as well as better dimensional stability under severe temperature change—in many cases, simplifies retention of tolerances when cooling. It produces a far better molded piece.



Like this. With the standard molding practices of a few years ago, molding this vacuum cleaner housing called for a 150 ton press. We produce it now in a 75 ton press, and



get a *better* cure and a finer finish, too. That's Heatronics (radio frequency pre-heating) for you — and only a couple of its many benefits, at that.

Let us show you how Heatronic molding can help *you*. We've been custom molders since the birth of the industry — developers of Heatronics since we pioneered its use in plastic molding. We're large enough and perfectly equipped to handle *any* job — not so large that our top men lose sight of the jobs you give us. Try us and see.



Complete molding facilities — from design to finished product — are at your service here. Just ask for a Kurz-Kasch engineer.

Kurz-Kasch

For Over 28 Years Planners and Molders in Plastics

Kurz-Kasch, Inc., 1429 South Broadway, Dayton 1, Ohio. Branch Sales Offices: New York • Chicago • Detroit • Los Angeles • Dallas • St. Louis • Toronto, Canada. Export Offices: 89 Broad Street, New York City

**TECHNICAL BOOK
& BULLETIN REVIEW**

"ELECTRONICS DICTIONARY,"
by Nelson M. Cooke and John Markus. Published by McGraw-Hill Book Company, New York, New York. 433 pages. Price \$5.00.

This glossary contains nearly 6,500 terms used in radio, television, industrial electronics, communications, facsimile, sound recording, etc. In addition to the word definitions, many of the terms covered in this book are described by means of photographs or diagrams of the unit being defined.

The dictionary is well cross-indexed, thus giving the student all of the technical terms commonly applied to a single unit, operation or action. Definitions are straight forward and easily understood, with all terms fully explained or demonstrated.

This dictionary is particularly recommended for engineers, students industrial and public libraries, advertising agencies and schools. The definitions are clear enough to be understood by the layman and yet have the technical accuracy demanded by the engineer and technician.

"INSIDE THE VACUUM TUBE,"
by John F. Rider. Published by John F. Rider Publisher, Inc., New York, New York. 407 pages. Price \$4.50.

An elementary treatment of the vacuum tube which includes a discussion of tube characteristics, the operation of various tube types and applications of vacuum tubes to specific electronic problems.

The author has covered this subject without resorting to complicated mathematics or advanced electronic theory. The first chapter deals with an introduction to the electron and then continues to a discussion of electron emission, movement of charges, space charge and plate current, fundamentals of tube characteristics, the diode, the triode, static characteristics of triodes, triode dynamic characteristics and load lines, dynamic transfer characteristics, voltage amplification, the tetrode and pentode vacuum tubes, the cathode circuit, power amplifiers, and miscellaneous vacuum tubes.

A careful study of this book should give the reader a good background for more advanced vacuum tube theory and circuits. The book is particularly recommended for the student, amateur, and serviceman.

"PRINCIPLES OF RADIO FOR OPERATORS," by Ralph Atherton. Published by The Macmillan Company, New York, N. Y. 331 pages. Price \$3.75.

This elementary radio text is based on a course given by the author to Navy radio operators and includes fundamental electrical and radio theory which should be of value to all students of the subject.

Genuine **DRAKE 100-Watt**
SOLDERING IRON

A GREAT Olson BUY!
Perfect for general radio work. The element is wound with highest quality Nichrome on ambers mica. Finished in fine gun-metal. Has 6-ft. cord and 3/8" plug-in tip. Underwriters Laboratories Approved.

\$2.49 PLUS 15c POSTAGE

OLSON 10¢ SPECIAL

6-Inch STEEL RULE and Depth Gauge

Handy, accurate Tempered Steel pocket rule. Quick-reading 64th graduations. Pocket clip. A big dime's worth! (Send for our free catalog.)

SPECIAL STAND INCLUDED FREE with each Iron!

This offer good only in U. S. A.

MAIL TODAY **OLSON RADIO WAREHOUSE**
73 E. Mill St., Dept. 11, Akron, Ohio

Send me — 100-watt Drake Soldering Iron(s) @ \$2.49 plus 15c postage
Send me — Steel Rule and Depth Gauge(s) @ 10c. I enclose _____

NAME _____
ADDRESS _____

TRUTONE

SPECIAL Introductory Offer
10c per Pack 12 for \$1.00 Postpaid
RADIO HARDWARE

Cat. No.	Machine	Screws	Cat. No.	Screws	Quantity
	Size	Quantity		Size	
501	4-36 x 1/4	16	508	8-32 x 3/4	12
502	4-36 x 1/2	16	509	8-32 x 1/2	12
503	4-36 x 3/4	13	510	8-32 x 1/4	11
504	6-32 x 1/4	15	511	8-32 x 1	7
505	6-32 x 1/2	14	512	10-32 x 1/2	10
506	6-32 x 3/4	12	513	10-32 x 3/4	8
507	6-32 x 1	8	514	10-32 x 1	6
Self Tapping Screws					
515	4 x 1/2	8	518	8 x 1/2	7
516	6 x 1/4	8	519	10 x 3/8	7
517	6 x 3/8	8	520	10 x 3/4	6
Metal Washers					
521	For No. 6	25	523	For No. 10	25
522	For No. 8	25			
Hexagon Nuts					
524	4-36 x 1/4	16	526	8-32 x 5/16	14
525	6-32 x 5/16	15	527	10-32 x 3/8	8
Lockwashers					
528	For No. 6	15	530	For No. 10	15
529	For No. 8	15	531	For 3/8"	8
Assortments					
532	Wood Screws				10
533	Grommets				4
534	Cable Clamps				6
535	Dial Springs				2
536	Spade Bolts				7
537	Set Screws				5
538	Fibre Washers				15
539	Soldering Lugs				15
540	Rivets				15
541	Mounting Nuts				4
542	Grip Caps				4

We Can Supply All Types of Radio Hardware
WRITE FOR OUR COMPLETE CATALOGS
DEALERS } Write for complete
JOBBERs } catalogs and discounts

TRUTONE PRODUCTS CO.
303 W. 42nd St., New York 18, N. Y.

JUST PUBLISHED

TWO-WAY RADIO

By SAMUEL FREEDMAN

This new 506-page book is the first important portrayal in which the mechanics and applications of two-way radio are described for all forms of fixed, mobile, or portable communications. It is presented in non-mathematical form and in language fully understandable to those using or intending to use such facilities.

The book explains two-way radio planning and use from every standpoint: power supply; mobile and fixed stations; types of antenna systems; amplitude and frequency modulation equipment; induction radio and guided carrier systems; micro-waves; use by railroads, police, fire, forestry, highway and public transport systems; marine and aeronautical applications; maintenance and repair; licenses and regulations; and typical installations in municipal and patrol systems.

87 ILLUSTRATIONS . . . Charts—Diagrams—Equipment—Applications

TWO-WAY RADIO is complete, comprehensive and profusely illustrated. The book is the culmination of the author's 26 years experience in all forms of radio and electronics, as an operator, engineer, inventor, author, teacher and consultant of two-way radio facilities. Price \$5.00

Send check or money order direct to publisher: **Ziff-Davis Publishing Company, 185 North Wabash Avenue, Chicago 1, Illinois**

New!

Series 200

A RELAY BY GUARDIAN with Interchangeable Coils

BUILT IN TWO PARTS

A.C. Coil Assemblies available for 6 v., 12 v., 24 v., 115 v.
D.C. Coil Assemblies available for 6 v., 12 v., 24 v., 32 v., 110 v.

★ Two basic parts—a coil assembly and a contact assembly—comprise this simple, yet versatile relay. The coil assembly consists of the coil and field piece. The contact assembly consists of switch blades, armature, return spring, and mounting bracket. The coil and contact assembly are easily aligned by two locator pins on the back end of the contact assembly which fit into two holes on the coil assembly. They are then rigidly held together with the two screws and lock washers. Assembly takes only a few seconds and requires no adjustment on factory built units.

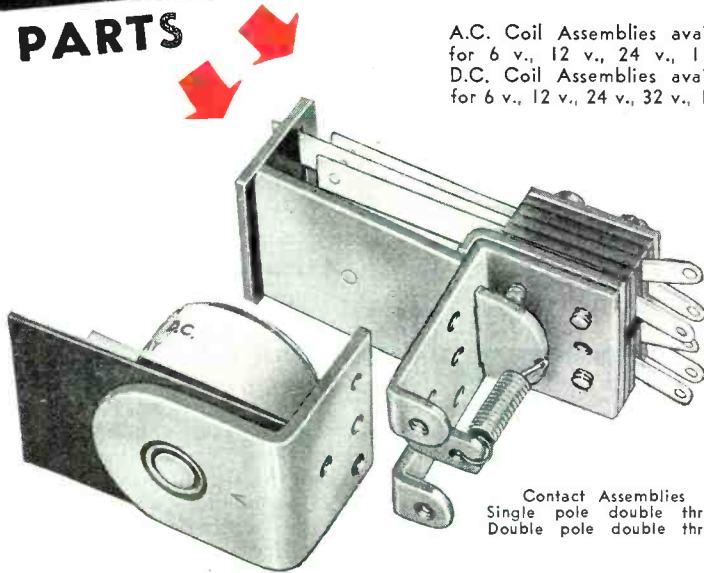

SERIES 200 RELAY

Contact Assemblies
Single pole double throw
Double pole double throw

On Sale at Your Nearest Jobber NOW!

See it today! . . . this amazing new relay with interchangeable coils. See how you can operate it on any of nine different a-c or d-c voltages—simply by changing the coil. Ideal for experimenters, inventors, engineers.

TWO CONTACT ASSEMBLIES

The Series 200 is available with a single pole double throw, or a double pole double throw contact assembly. In addition, a set of Series 200 Contact Switch Parts, which you can buy separately, enables you to build dozens of other combinations. Instructions in each box.

NINE COIL ASSEMBLIES

Four a-c coils and five d-c coils are available. Interchangeability of coils enables you to operate the Series 200 relay on one voltage or current and change it over to operate on another type simply by changing coils.



Your jobber has this sensational new relay on sale now. Ask him about it. Or write for descriptive bulletin.

GUARDIAN ELECTRIC

1630-C W. WALNUT STREET

CHICAGO 12, ILLINOIS

A COMPLETE LINE OF RELAYS SERVING AMERICAN INDUSTRY

Attention GI JOE!

Here's Your Opportunity to be First to

Start Your Own RADIO SERVICE SHOP

Complete Starting-in-Business
Package Stocks of

TEST EQUIPMENT
TUBES, PARTS, TOOLS

\$350 up

Act quickly! Meet the pent up demand for radio service. Turn your special service training into a profitable business of your own. No fuss. No worry. Here's everything you need—\$350 up. Details upon request! Write, wire or phone



TRIPLETT Volt-Ohm-Milliammeter

A. C.-D. C. Volts
0-10-50-250-1000-5000
at 1000 ohms per volt.

D. C. Milliamperes
0-10-100-500

Ohms 0-300-250,000

Case Black molded
3 1/8" x 5 1/8" x 2 1/8"

\$16.00 net

Good News!

ALL
PRIORITIES LIFTED

HALLICRAFTERS SX-28A

\$223



SUPER DEFIANT	SX25	\$94.50
SKY CHAMPION	S20R	60.00
SKYRIDER MARINE	S22R	74.50
SKY RANGER	S39	110.00
ECHOPHONE	EC1A	29.50

ORDERS FILLED AS RECEIVED!!!

AMPLIFIERS

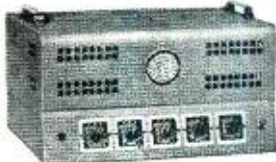

Complete
with tubes.

17 Watt **30.30**

25 Watt **42.60**

35 Watt **54.60**

50 Watt **70.50**

17 Watt with Phono-top	42.30
25 Watt with Phono-top	52.20
35 Watt with Record-changer	89.10

PHILCO BEAM OF LIGHT

Selenium Cell only, no holder

1.80

20% deposit required on all C.O.D. orders. 2% transportation allowance on orders of \$25.00 or more accompanied by payment in full.

Write for
FREE CATALOG

RADIO SUPPLY & ENGINEERING CO., Inc.

129 SELDEN AVE. DETROIT 1, MICH.

Mr. Atherton has begun his discussion by developing the nature of electricity and then has continued with batteries, circuits, magnetism, motors and generators, meters, waves, inductance, capacitance, vacuum tubes, power supplies, radio receivers, communications receiver, transmitters, radiophone transmitter, and antennas. By using homely similes the author has made the subject understandable without resorting to the use of mathematics.

Each chapter includes a section devoted to related experimental procedures, review questions and a listing of films which are available on the subject covered in the chapter. This visual training and bibliography is a valuable adjunct to those setting up radio courses for high schools and industrial schools.

A rather elaborate appendix includes radio symbols, a mathematics review, RMA color codes, trouble shooting, and tables of receiving and transmitting tube characteristics with socket connections.

This book is recommended for the beginning radio student or for home study of the subject.

-30-

Aircraft Transmitter

(Continued from page 29)

The tubes used in this transmitter were selected for specific reasons. The 7C7 tubes were selected because of their low filament current of .15 amperes and because of the loktal base and general sturdiness. Triodes were preferable but none with cathode construction (minimizes microphonics) of such a filament current were available. Of course, certain bantam tubes were available but these were not considered due to the high plate supply voltage to be used. The suppressor grid stage called for a small tube of high plate dissipation and, of course, with the suppressor grid coming out on a separate pin. This last condition made tubes such as the 6F6 impossible to use and left the 6AG7 which, in any case, is perfectly suited for the job. The 6AG7 has the advantage of an



Top view of the aircraft transmitter showing compactness of assembly and proper placement of component parts.

extremely high transconductance, good plate dissipation, and requires little r.f. excitation.

The crystal oscillator is of the conventional Pierce type, exciting the final stage through capacity coupling. The final stage secures all of its bias through r.f. excitation . . . it being impractical to use cathode bias or battery supply for any of the bias in this stage. Rather than lower the efficiency or add weight, it is better to lose the price of an inexpensive tube if the excitation fails for any length of time. Normally in a light plane installation the transmitter panel is visible and any failure of excitation may be noted at once by the final plate current meter.

The modulation of a suppressor grid tube usually calls for the suppressor grid to be biased negatively until the plate efficiency falls somewhat less than 35%. As only reasonable voice quality is required, symmetrical modulation is not required. Thus the secondary of the modulation transformer is bypassed for r.f., but no bias supply is placed between it and ground. This saves the use of an extra dry cell battery. With no bias on the suppressor grid, the negative modulation peaks

Wiring diagram of the three-tube aircraft type transmitter.

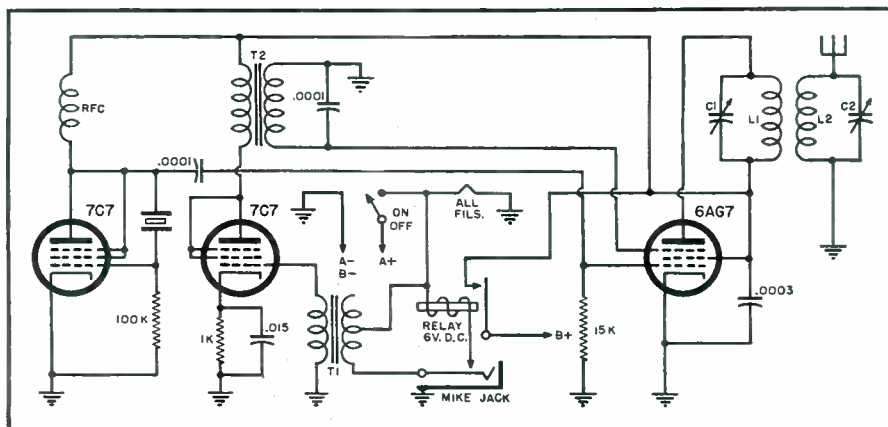

Men! You Need "All-Around" Training for Tomorrow's Better Jobs in

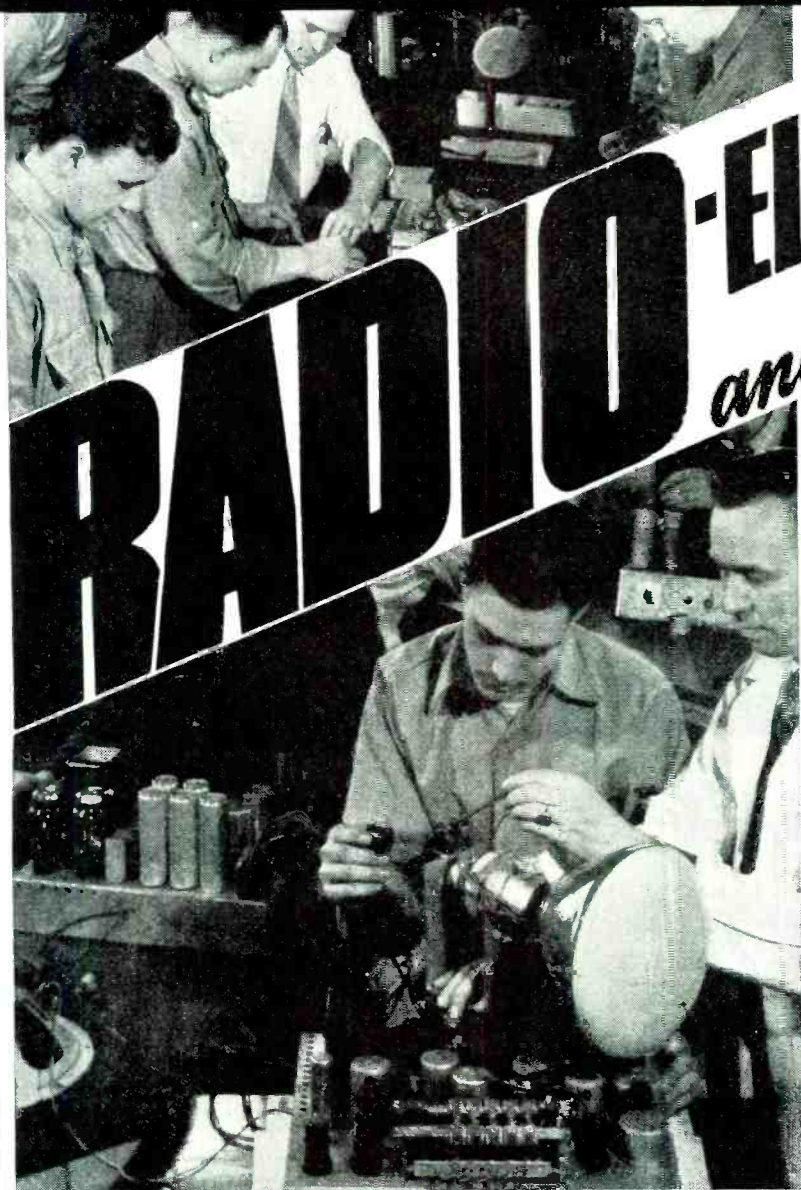

RADIO-ELECTRONICS and TELEVISION

"Learn by Doing"

**— 12 FASCINATING WEEKS
of STREAMLINED TRAINING**

You like Radio work. But if you're really serious about making it your lifetime career, **GET PRACTICAL TRAINING NOW.** Don't be satisfied to putter along in a "one-operation" no-future job. Prepare for better pay and advancement with Coyne all-around training in Radio-Electronics-Television.

Many Branches Included

Here in the great shops of Coyne in Chicago, you're trained in everything from basic principles and Radio construction, to F. M. (frequency modulation), electronic controls, public address systems, television and radio-phonographs. You can even get valuable extra training in Industrial Electronics and Electric Refrigeration at no extra cost, for still more opportunities in the years ahead. Coyne gives "all-around" training!

Work on Real Equipment

You work on real actual equipment and expert instructors give you necessary theory in blackboard lectures and demonstrations. In 12 WEEKS OR SO—you're ready for a real future!

Starting Your Own Radio Shop

Want to be your own boss, with a fine-paying radio shop of your own? We show you how to set one up and operate it successfully. Hundreds of Coyne graduates are doing it. You can, too. Send now for details.

Get the Facts — FREE!

My new giant Radio Opportunity Book has dozens of shop pictures, facts about Radio and Television jobs, my plans to help you. Rush coupon today. No obligation; no salesman will call. You alone will decide. But don't delay. Act NOW.



H. C. Lewis

Send for Details on My STUDENT FINANCE PLAN

If you don't have much cash, I'll arrange to finance most of your tuition and you can pay it back in easy monthly installments after you graduate. We'll even help you get a part-time job if you wish, so you can **EARN WHILE LEARNING.** My **LIFETIME EMPLOYMENT SERVICE** is free to Coyne Graduates. Coyne Training is the finest investment you can make.

MEN WITH PHYSICAL DISABILITIES

Also facilities for men with physical disabilities, whether due to war or other causes. Check coupon for special information.

THE HOME OF
COYNE



VETERANS!

Coyne is also equipped to train those who qualify for training under the G. I. Bill of Rights. Check the coupon for special G. I. Bulletin.

H. C. LEWIS, Pres.

Founded 1899

COYNE ELECTRICAL SCHOOL
RADIO-ELECTRONICS DIV.

500 So. Paulina Street, Dept. 36-1K CHICAGO 12, ILLINOIS

H. C. Lewis Pres., Radio-Electronics Div.,
COYNE ELECTRICAL SCHOOL,
500 S. Paulina St., Dept. 36-1K
Chicago 12 Ill.

I want to build a **REAL FUTURE** for myself. Send your big **FREE BOOK** on Radio-Electronics, also details of your Student Finance Plan. Check if you are interested in information on the following:

- Send special G. I. Bulletin
- Send details on Physical Disability

NAME.....

ADDRESS.....

CITY..... STATE.....

ANNOUNCING...

3 Leaders in the NEW WESTERN LINE



1. IMMEDIATE DELIVERY PORTABLE P. A. SYSTEMS With Improved Tone Control. Complete 3-channel public address system, portable, 20 watts*. Twin 10" speakers, mounted in bass reflex, choice of microphones, indoor or outdoor speakers. Separate controls for 2 microphone inputs, and 1 phono-input. Complete equipment carried in 2 smart airplane luggage cases—total weight only 73 lbs. for Model WE-220 illustrated.

*Also available in 5 to 50 watts.

2. SMALL CENTRALIZED SOUND DISTRIBUTION SYSTEMS FOR SCHOOLS. Exclusively designed and built for school requirements by WESTERN sound engineers. Early delivery assured. Junior Model combines 2-way communication with radio and electric phonograph. Serves 20 classrooms.

3. NEW DUPLEX INTERCOM. SYSTEM for office, industrial, and commercial use. Built-in microphone adds true voice fidelity. One-way, 2-way, and multiple communicating, in one system. Exclusive features, designed by WESTERN. Intercoms from 1 to 20 stations now in production.

SEND for literature and name of your nearest distributor.

**WESTERN SOUND & ELECTRIC
LABORATORIES, INC.**

MILWAUKEE, WISCONSIN

Pioneer manufacturers of Centralized, Portable and Recording and Inter-Communication Systems

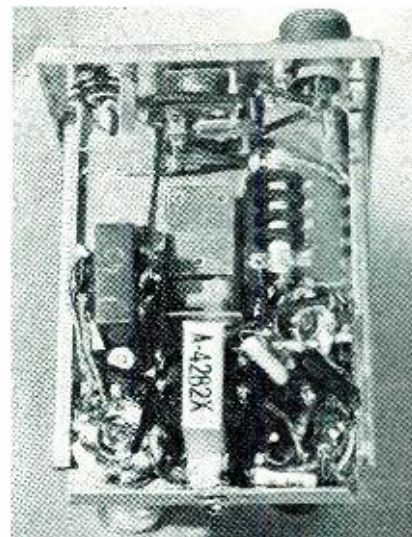

Bottom view of the transmitter. The entire unit weighs approximately 2½ pounds, excluding the power supply. The transmitter has been designed to operate with a 6 foot length antenna.

are undistorted while the positive peaks are clipped off. This corresponds practically to single-ended, class "B" modulation and in actual practice produces acceptable quality for voice modulation.

The modulator for this transmitter employs a 7C7 tube connected as a triode. It is biased for class "A" operation and, with the transformer load, produces a peak secondary voltage of around 100 volts with close but normal voice into any standard Air Corps type hand microphone. There is nothing unusual about the modulator.

The only meter required for tuning and observing the operation of the transmitter is that which is placed in the final plate current stage. It indicates very accurately when the tank is resonated (if the antenna loading is first detuned) and then following this the antenna loading is adjusted for maximum loading. It indicates failure of the crystal stage by an excessive plate current reading and modulation failure . . . if, in this case, the needle does not move slightly with modulation.

For maximum power output, a 300 volt plate supply is required, but the transmitter will operate satisfactorily at reduced output on plate supplies as low as 45 volts.

The antenna length should not exceed eight feet nor be shorter than three feet when used with this transmitter. Six feet of antenna appears to load the transmitter best. The antenna problem is one not to be touched upon lightly, but one which is beyond the scope of this article.

In conclusion, referring back to the use of suppressor grid modulation, let me remind the readers that for the same power output this type of modulation does away with heavy transformers. The result is a lightweight unit. The unit pictured and described weighs just 2½ pounds.

-30-

NEW SOLDERING GUN

THE SPEED IRON*



Patent Applied For

100 Watts 115 Volts 60 Cycles

Soldering Heat in 5 Seconds

Wherever you have a soldered joint in radio, electrical or electronic repair and service work, the Speed Iron will do the job faster and better.

The transformer principle gives high heat—in 5 seconds—after you press the trigger switch. Convenient to hold with a pistol grip handle, the compact dimensions of this new soldering tool permit you to get close to the

*T.M. Reg. U. S. Pat. Off.

joint. The copper loop soldering tip permits working in tight spots. The heat is produced by the high current flowing through the soldering tip—permitting direct and fast transfer to the soldered connection.

If you want to save time on soldering jobs with a tool that is ready to use in 5 seconds, get a Speed Iron today. See your radio parts distributor or write direct.

WELLER MFG. CO.
517 NORTHAMPTON ST.

EASTON, PA.

The sign of Quality



Centralab RADIOHMS

For ALL Replacement Jobs

For more than two decades servicemen have recognized the "CRL" in the Centralab diamond as a symbol of Quality . . . and so today as in those early pioneer times . . . wise servicemen "always specify Centralab".

Centralab

Division of GLOBE-UNION INC., Milwaukee

PRODUCERS OF



Variable Resistors
Bulletin 697



Selector Switches
Bulletin 722

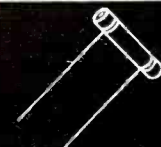

Tubular Ceramic
Capacitors
Bulletins 630 and 586

There's a Trip

in this broader ___ brand-new line!

No matter what your requirements, there's a Triplet for you! Every model of this brand-new, broader line features improvements to help you save time and render more accurate service. Included are *all* those elements required for modern servicing—*greater* readability . . . *longer* scale length . . . *larger* instruments . . . *wider* ranges . . . compact cases styled in keeping with modern merchandising, an important quality of each model. *Every* provision has been incorporated to make the new Triplet line the best—*mechanically* and *electrically*—geared to your specific needs. So plan your tests with Triplet in '46!



Model 3212—Counter type, short-open element, standardized value, tube-tester with roll chart.



Model 666H—Pocket size volt-ohm-milliammeter.

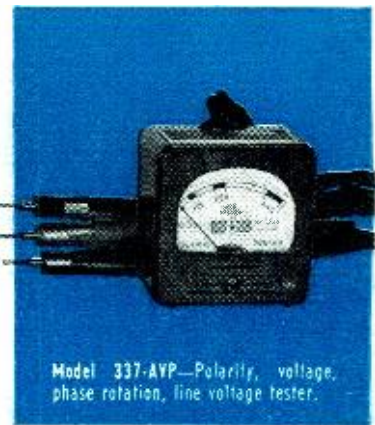

Model 337-AVP—Polarity, voltage, phase rotation, line voltage tester.



Precision first -----

Let's for You.



Model 2405—Ultra-sensitive AC-DC volt-ohm-milliammeter-ammeter.



Model 1632—Ten-range, AC, 100 KC-125 MC, signal generator with internal modulation.

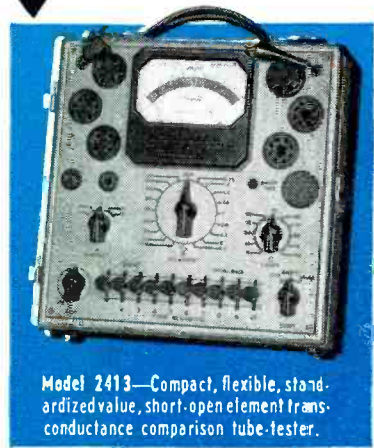

Model 2413—Compact, flexible, standardized value, short-open element trans-conductance comparison tube-tester.

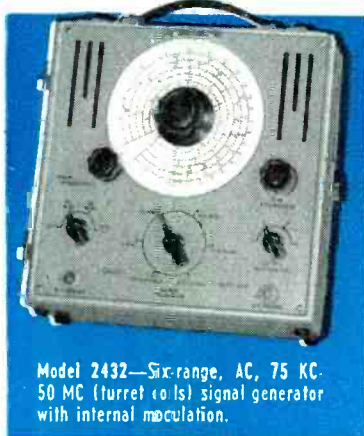

Model 2432—Six-range, AC, 75 KC-50 MC (turret coils) signal generator with internal modulation.

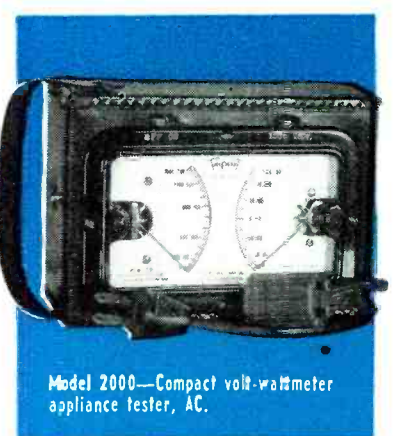

Model 2000—Compact volt-wattmeter appliance tester, AC.

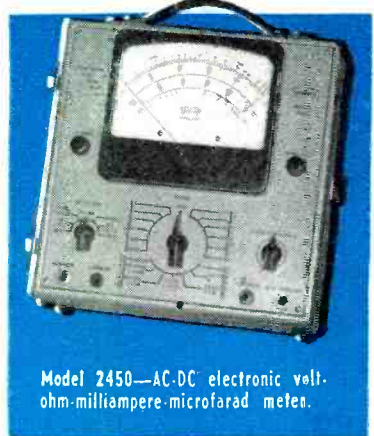

Model 2450—AC-DC electronic volt-ohm-milliamperemicrofarad meter.



Model 2425—Transconductance micro-mho scale tube tester with gas check.



Model 625W—Portable, ultra-sensitive, multi-range volt-ohm-milliammeter.



Model 2400—AC DC volt-ohm-milliamperemeter.

...to last... Triplet

The Triplet Electrical Instrument Company



Bluffton

Ohio

Radio Headquarters

for 25
years

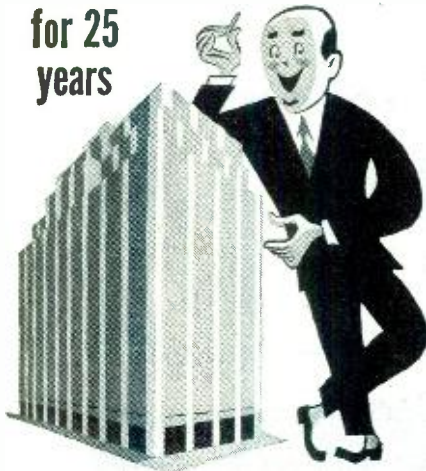

**We ship at once—parts,
equipment, whatever you need!**

This house began its career almost as early as Broadcasting itself! Today, 25 years later, we're the world's largest radio supply house! **Standard Lines:** National, Hammarlund, R. C. A., Hallicrafters, Bud, Cardwell, Bliley, and all the others!



SUPERSPEED SERVICE Orders shipped out same day received, on most goods.



ENGINEERING SERVICE If your engineering problem requires special equipment, we'll make it.

FREE!

Latest bargain flyer includes test instruments, record changers, communication receivers, ham transmitting tubes and a host of electronic items you need today.



Originators and
Marketers of
the Famous

Lafayette Radio

**Radio Wire
Television Inc.**

NEW YORK 13 BOSTON 10 NEWARK 2

Cut out coupon, paste on penny post card, mail today

R. W. T. Dept. RC-6
100 AVENUE OF THE AMERICAS, NEW YORK 13

Gentlemen: Send me **FREE** copy of your Latest Bargain Flyer C-36, packed with latest electronic equipment and components.

NAME _____

ADDRESS _____

CITY _____ ZONE _____ STATE _____

92

Service Considerations

(Continued from page 39)

ected is above or below the center frequency point.

2. FM receivers have one and more, often two, limiter stages which precede the discriminator for the purpose of removing all amplitude modulation which may have been superimposed on the carrier. Most FM detector circuits are balanced to provide a very low response to AM signals.

3. Following the discriminator is an audio-frequency de-emphasis or de-accentuator *RC* filter (time constant 100 μ sec.). It is standard practice in FM transmitters to step up the carrier components modulated by the higher a.f. signals (in the range of 5 to 15 kc.) for the purpose of improving the transmitted signal-to-noise ratio. In this audio band more noise seems to be present than in the lower frequencies. Consequently to hear the modulated output with proper relative sound intensities it is necessary to have this low pass filter perform the reverse operation to that introduced in the transmitter.

4. The gain from the antenna to the limiter stages must be sufficiently high for these stages to function properly. If the gain falls off, the limiter stages may or may not pass undesired AM depending upon the type of limiters in use.

5. A much higher i.f. frequency is used because of the wide band widths involved. For the old type FM sets the i.f. frequency is around 4 to 5 mc. with half-power points 150-200 kc. apart. Since the i.f. stages are not nearly as selective as in an AM set, center frequency adjustments are not critical. Resistors are used to lower

circuit *Q*'s for wide band responses.

Testing the discriminator with an ordinary signal generator is accomplished by setting the unmodulated signal of the test oscillator to the correct i.f. frequency. With this as the discriminator input, a high impedance d.c. voltmeter or VTVM is used to measure output of the stage. If the discriminator is adjusted correctly (the usual variable is the secondary tuning condenser) the output should be zero. Attention is called to the fact that in using any voltmeter for this measurement, it is necessary to be certain which diode cathode is grounded or if the output center tap is grounded. (See Fig. 1.) This would affect the ground reference level and interpretation of the readings. By varying the frequency of the test oscillator in known steps, it is easy to record the stage output voltage versus frequency. The discriminator is identical in design to an automatic frequency control circuit.

The limiter stages are adjusted so the peak voltage of a normal signal will be a slight amount above zero bias so that clipping action takes place because the grid is driven positive. This is accomplished by grid leak biasing on a sharp cutoff pentode or in some cases a series grid resistor in combination with normal resistance coupling, acting as an overdriven amplifier. Although there are many types of limiter circuits, basically, they all operate as Class C amplifiers relying on grid current to supply the proper bias for the clipping operation. There is nothing specific which can be said to cover all kinds generally. With reference to the one shown in Fig. 2, it may be seen that one simple way to check if the stage is functioning at all is to measure the d.c. voltage across the grid leak combination. Beyond this

An American G.I. in Foggia, Italy, operating captured German anti-aircraft fire-control radar, and wearing a German helmet, portrays the feeling of frustration which must have gripped the Nazis when the allies started using jamming devices which included thin strips of tinfoil, shown in the picture. Millions of these strips, known as "Window" or "Duppel" were dropped by Allied bombers and returned echoes which confused the German anti-aircraft radars.



RADIO NEWS

CRONAME *Facilities*

FOR ELECTRONIC COMPONENTS
AND FINE METALCRAFT

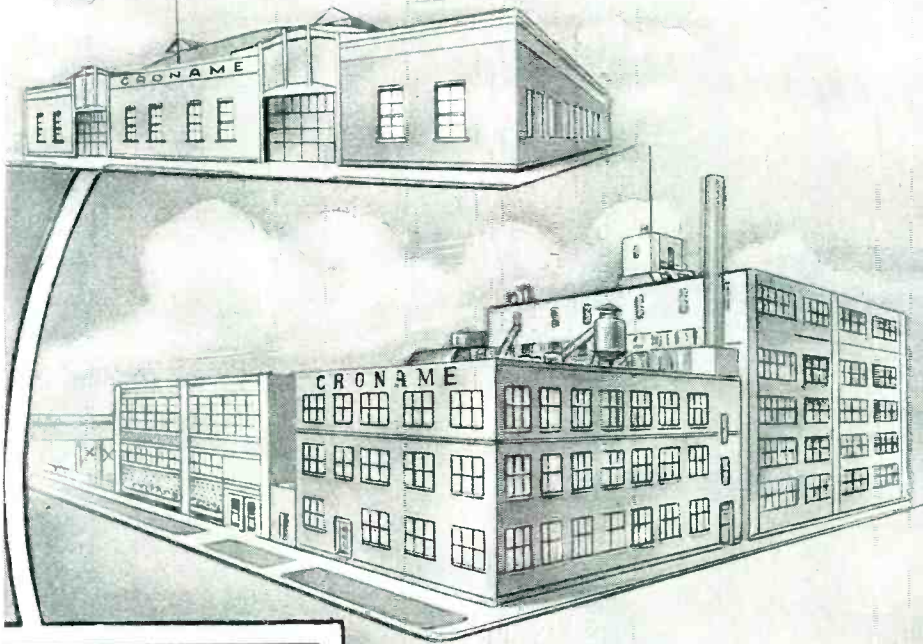

ENGINEERING
ETCHING
LITHOGRAPHING
EMBOSSING
ENGRAVING
STAMPING
ALUMINUM WELDING
& HEAT TREATING
ASSEMBLIES
SOLDERING
METAL FINISHING
PLATING

ANODIZING
PARKERIZING
OXIDIZING
FLUORESCENT
PHOSPHORESCENT
DECORATED GLASS
GLASS DIALS
DECORATED PLASTICS
FORMED PLASTICS
RADIO TUNING UNITS
REMOTE CONTROLS

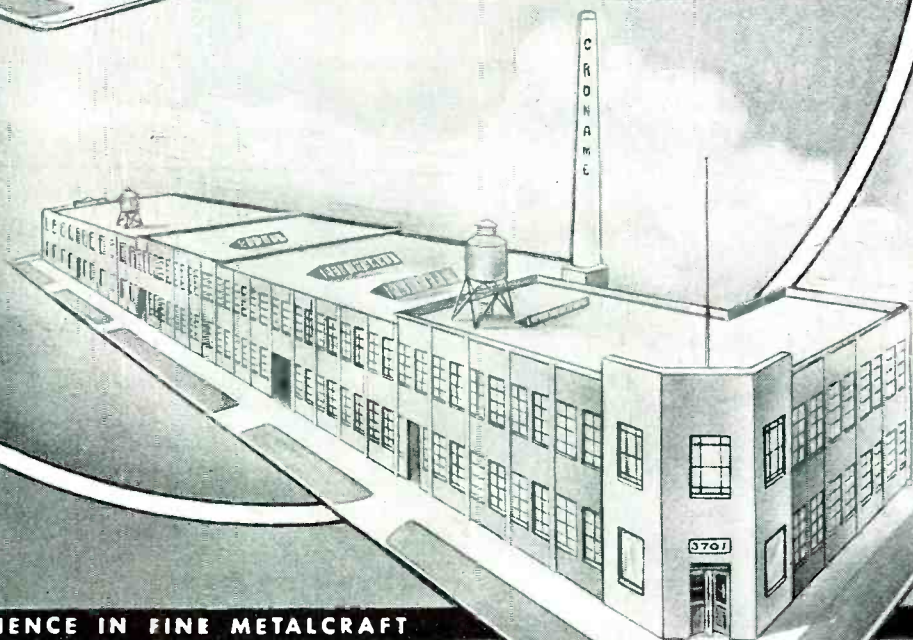

OVER 40 YEARS EXPERIENCE IN FINE METALCRAFT



CRONAME
INCORPORATED

3701 RAVENSWOOD AVENUE
CHICAGO 13, ILLINOIS

SOUND REPRODUCTION at its BEST



MODEL KX-30
30-WATT AMP.

THE Newcomb range of tone effects far exceeds usual amplifier performance. Overload and volume level indicators guide operator when not in position to hear loudspeakers. Master volume control regulates overall volume without disturbing balance between various input mixer controls. The protective keylock cover prevents accidental misadjustments.

An amplifier to satisfy the most discriminating judge of sound equipment. Any way you look at it, or listen to it, you'll appreciate this powerful piece of sound engineering.

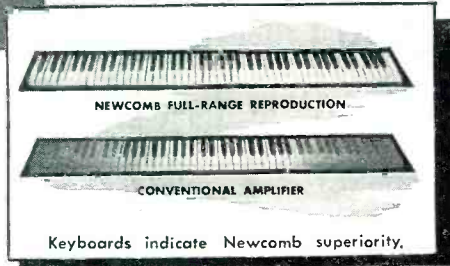

Exclusive plug-in transformer permits changing standard high impedance inputs to low without rewiring.

Write for specifications of complete line of Newcomb amplifiers.



THE SOUND OF QUALITY

Newcomb

AUDIO PRODUCTS CO.

MANUFACTURERS

DEPT. F 2815 S. HILL STREET, LOS ANGELES 7, CALIFORNIA

**HEXACON
ELECTRIC
SOLDERING
IRONS**

..tagged for
the big jobs!

TYPE P-150
(illustrated)

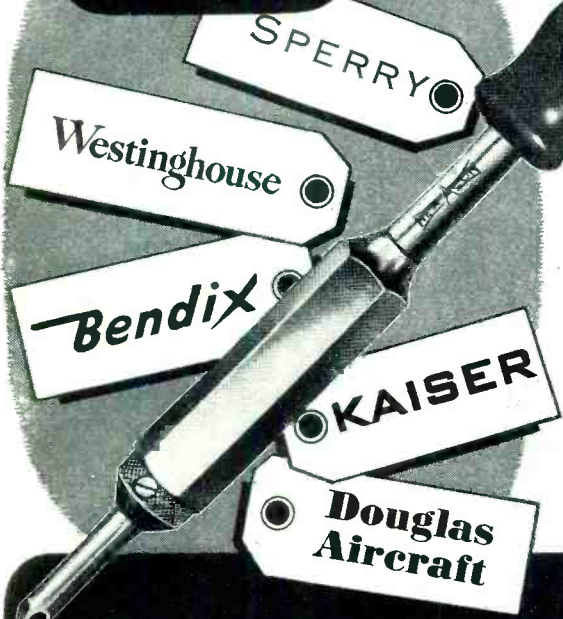

Follow the leaders—and use HEXACON! For rugged, heavy duty work or for light intricate work... here's the answer. One reason is "Balanced Heat"—dissipating excessive element-impairing heat—and minimizing element burn-outs and tip replacements. Another is their lightweight. Literature is available describing the complete HEXACON line of screw tip and plug tip irons from 40 to 700 watts, and with tip diameters ranging from 1/4" to 1 3/4"

HEXACON ELECTRIC CO.
119 W. Clay Ave., Roselle Park, N. J.



HIGH-QUALITY, LONG-LASTING SOLDERING IRONS

there is no easy method of using a meter to get the complete picture as the operating point and load line data would be needed. The stage might be performing as a Class C amplifier below the operating point for which the limiter was designed. It is possible to use an oscilloscope whose range is adequate to operate directly with such high frequency inputs and observe input and output wave shapes. Most scopes do not have this frequency range; however, a test oscillator can be used and heterodyned against limiter input in a mixer stage which will provide the same wave form at any desired lower frequency within the capabilities of the available scope. Then the output could be observed in a similar manner.

Because the limiter stages require a given minimum signal, usually one or two r.f. amplifiers are employed to have ample gain throughout the set. The r.f. section is not used with the idea of image suppression, but to provide a higher gain and improved signal-to-noise ratio. The first stage in any receiver determines the noise introduced by the receiver itself, and it has been found that an r.f. amplifier is quieter than a mixer stage fed directly from the antenna.

One salient feature of an FM set is the excellent noise suppression action in the over-all system. Noise voltages regardless of source can be thought of as being both AM and FM. In an AM receiver, the AM noise components add directly to signal amplitudes and are amplified right along with the signal and heard in the output. In an FM system, however, the AM noise components are completely eliminated by the use of limiter stages and a balanced detector. The FM noise components can not be eliminated, but are minimized by increasing the amount of frequency swing for a given signal, thus insuring a very high signal-to-noise ratio.

In general, the practice of using instruments and oscilloscopes carelessly must be avoided. Inasmuch as the frequencies involved in the i.f. sections are on the order of 5 to 10 mc. and carriers much higher, a very small circuit element can drastically affect set operation. For example, the reactance of a 5 μfd. condenser at 100 mc.:

$$X_c = \frac{1}{2\pi f C} = \frac{1}{2\pi \times 100 \times 10^6 \times 5 \times 10^{-12}}$$

$$= \frac{10^6}{1000\pi} = \frac{1000}{\pi} = 318\omega$$

or practically a dead short. Many instrument input capacities are considerably higher than a μfd. so the suggestion to carefully select points in the circuit for the use of test equipment measurements cannot be too strongly emphasized. In any balanced circuit, such as a discriminator, it is especially hazardous to disturb tuned elements with test leads. It is quite possible to change resonant tuning to such an extent that the circuit will not even ap-

Here it is!

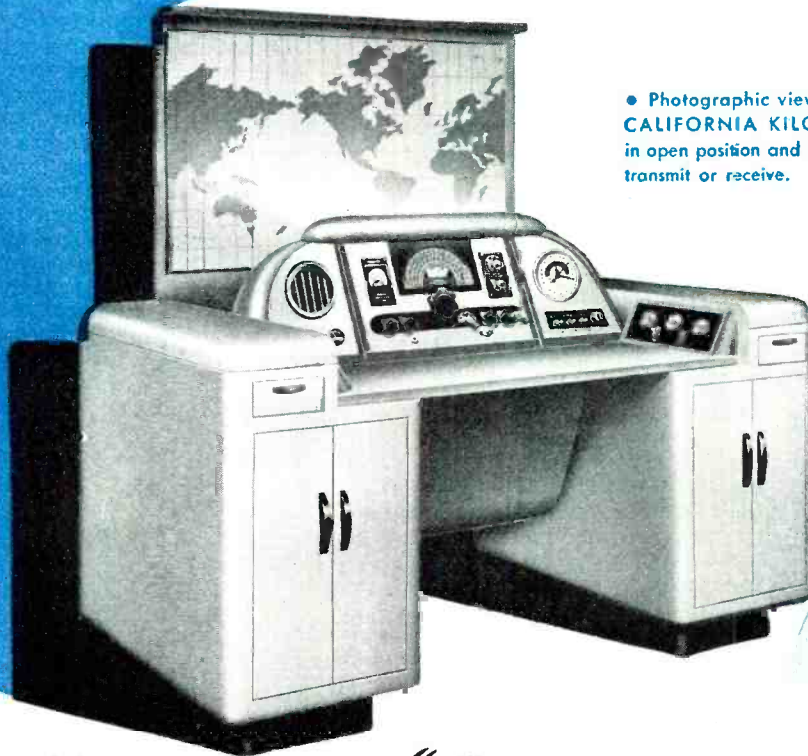

• Photographic view of the CALIFORNIA KILOWATT in open position and ready to transmit or receive.



The **KLUGE** "California Kilowatt"

Myron E. Kluge, President of Kluge Electronics, Inc., proudly presents to the radio amateurs of the world a new sensation in radio history, The CALIFORNIA KILOWATT—a "one package" 1000 watt amateur radio station designed and engineered to bring amateur radio out of the attic and the shack and into the living room.

About the size of an ordinary desk, the CALIFORNIA KILOWATT is simply and beautifully designed to fit into your den or living room as neatly and harmoniously as an additional piece of furniture with no clutter or mess. It is completely self-contained with nothing to be added.

Kluge Electronics, Inc., is the first to conceive, design and produce this remarkable contribution to modern radio. Among the special Kluge features designed into the CALIFORNIA KILOWATT are:

1. A California Kilowatt transmitter with an amazing new tube development—5 band operation with variable frequency control in each band—phone or CW at the throw of a switch—110 or 220 volt operation;
2. Provisions for your choice make of receiver;

3. Built-in speaker—(high fidelity remote speaker also available);

4. Built-in frequency monitor—all band crystal controlled;

5. Built-in world time clock;

6. Illuminated world map with cork backing;

7. Price—the complete CALIFORNIA KILOWATT Station costs far less than you would expect to pay for a transmitter alone.

Premiere showings of the Kluge CALIFORNIA KILOWATT will be held in key cities soon throughout the nation by America's leading wholesale distributors. For additional information about the CALIFORNIA KILOWATT write to Kluge Electronics, Inc., Dept. F1, 1031 N. Alvarado Street, Los Angeles 26, Calif.



The CALIFORNIA KILOWATT in closed position

KLUGE
ELECTRONICS INC.

A few territories are still available to qualified distributors. Write or wire Kluge Electronics, Inc.

... for years,
the advertised
and practiced
policy of the
TERMINAL
Radio Corporation
was

1. To maintain a complete stock of all standard, quality radio parts and equipment.
2. Anticipate the demand by being first with new products.
3. Fill and ship all orders the same day they're received.
4. Guarantee every item we sell despite its low price.

WE have always taken great personal pride in giving efficient service and seeing our customers happily satisfied.

Some of our customers who have ordered such critical items as test equipment, communications receivers and certain types of transformers and tubes often have had to wait weeks until we could fill their orders.

We want you to know that we are doing our best to fill all orders and hope that conditions will soon return to normal and permit us to again give you the fast-action service for which Terminal is famous.

About our catalog—we have decided to wait until we know more completely what's available and the cost. Just as soon as we start to receive an uninterrupted flow of radio equipment, our catalog will herald the great news. Why not drop us a card to be sure you're on our mailing list?

Meanwhile, we still say — IT'S **TERMINAL FOR BETTER BUYS AND TOP-NOTCH SERVICE!**

TERMINAL
Radio Corporation
85 CORTLANDT ST. N. Y. 7, N. Y.
Worth 2-4415

proach its normal operation. In other words information taken on these tests would either be subject to great error or entirely false. The only solution is to use instruments carefully at points where they will cause the least amount of disturbances or interaction. At high frequencies dielectric losses increase which demand use of insulating materials designed especially with low loss characteristics. Distributed capacity of circuit elements, sockets, and leads are important and require more rigorous design and manufacturing quality. For low radiation feeders coaxial cables are used, and in the set proper, shielded cabling is used extensively.

For emergency FM reception, an AM receiver may be used, providing the r.f. section can be tuned to the carrier. This is done by detuning an i.f. stage so that the FM signal when in the i.f. section is on the portion of the resonance curve which is fairly linear. A frequency deviation from this point will give an audio output proportional to frequency changes. Since AM stages are highly selective, very few of the FM side bands are amplified and consequently the output is quite distorted.

A brief attempt has been made to discuss the differences in AM and FM receivers and what problems will come up with regard to servicing them. Until there are many more sets in operation service data will not be abundant. Test equipment designed exclusively for FM equipment is in the engineering and development stage today. For the present, regular shop equipment can do the job satisfactorily until more specialized testers are available.

The future holds unlimited possibilities for the radio repairman. His services will be more and more in demand as improved and more complicated sets are produced for home and industry.

—30—

Captured German "Wurzburg" anti-aircraft fire-control radar being tested by the 15th Air Force in Italy. Tests proved that these radars which represented a billion dollar investment operated at only 25% of normal effectiveness as a result of Allied countermeasures, consisting of metal foil strips and jamming transmitters.

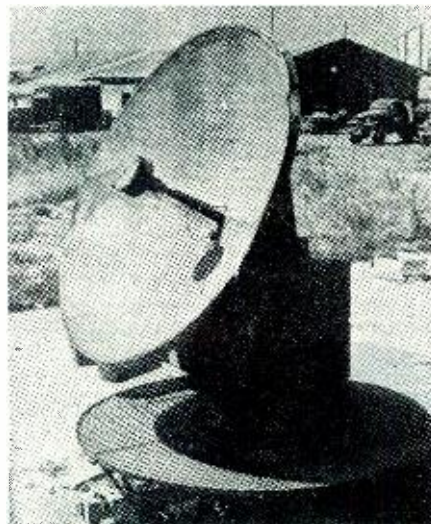

Practical Radio Course
(Continued from page 47)

dyne oscillator) at all frequencies except the particular one for which the temperature coefficient of the ceramic capacitor is chosen. The reason for this is as follows:

In a fixed-frequency circuit, the temperature coefficient of the ceramic trimmer capacitor across the main tuning capacitor may be chosen so as to compensate for the latter's temperature-induced change in capacitance, or the change in inductance of the tuning coil, (subject to the present limitations of available temperature coefficients of commercial ceramic capacitors, and the characteristic of the variation of main tuning capacitance or inductance with temperature that must be compensated). However, in a variable-frequency tuning circuit lumped changes in inductance or capacitance exert a varying compensating effect, over the frequency band covered by the circuit. Only at a single resonant frequency is it possible to compensate exactly for a change in lumped inductance by means of a single lumped capacitance. At all other frequencies the compensation effected will not be the exact amount required. The resulting drift will increase as the resonant frequency of the circuit is increased, as the percentage change in lumped inductance increases, or as the frequency changes from the corrected frequency. Thus, a circuit which has been capacitance-compensated at 500 kc. for a 0.1 percent change in inductance will have a frequency error of 0.15 percent at 1000 kc. True compensation of inductance changes at all frequencies is possible only by equivalent inductance changes rather than by capacitance changes. Only then will the correction characteristic be such that it follows up the undesired frequency shift at the same rate that it changes with temperature. Despite this, oscillator drift compensation by means of ceramic capacitors is widely used because it is simple, relatively inexpensive, and does help materially.

Some idea of what can be accomplished by tuning circuit refinements and the proper use of compensating capacitors in the tuned circuits of oscillators, can be gained from Fig. 1. Curve (A) represents the observed frequency drift (decrease) characteristic with time, of the oscillator in an early model all-wave superheterodyne receiver that exhibited annoying tuning drift characteristics on the high-frequency bands as the receiver warmed up. The measurement was made with the receiver tuned near the high-frequency end of the short-wave band which includes 15 and 18 megacycles. The frequency drift in kilocycles per second is plotted against elapsed time in minutes after the first measurement of the oscillator frequency, which was taken as soon as possible after the cold receiver was turned

YOUR FILTER PROBLEMS

SOLVED...

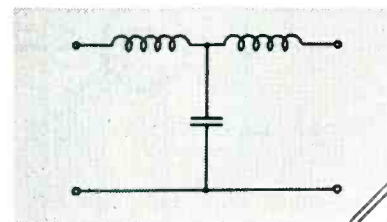
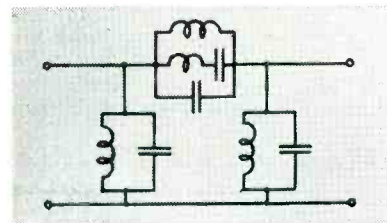
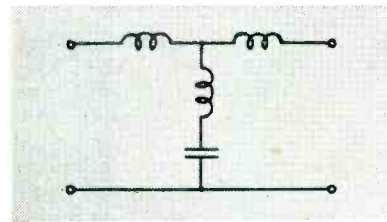
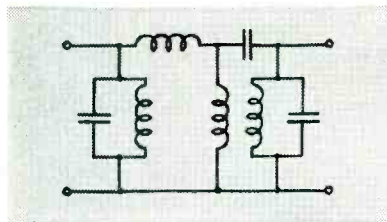
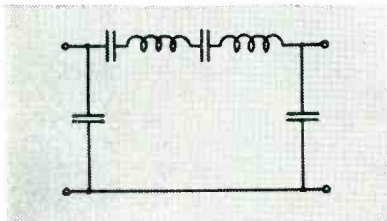
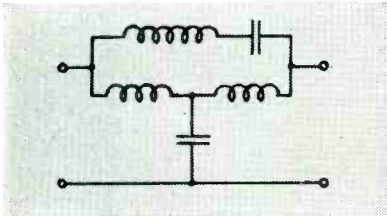

Our Specialties:
**ELECTRIC WAVE
 FILTERS**

**RESONANT CIRCUITS
 & TRANSFORMERS**



Kenyon's always progressive engineering staff has created a wide range of *Special Design Laminations* employing practical application of the very latest steel alloys. As a result, efficient, low cost and compact space saving equipment are all now available.

Because standard transformer cases are not usually suitably shaped for *Filter Components*, Kenyon's engineers have developed a wide range of special designs guaranteed to deliver maximum efficiency.

Diligent research has given Kenyon's engineers a vast and an intimate knowledge of filters and filter components. As your advisors, these experts can usually recommend minor changes in specifications that allow major saving in **COST, EFFICIENCY or SIZE** — or all three.

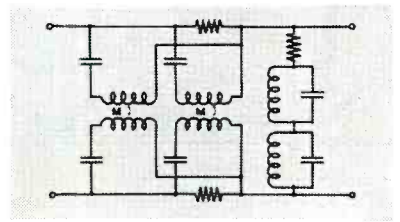

Inquiries Invited



THE MARK OF EXCELLENCE

KENYON TRANSFORMER CO., Inc. 840 BARRY STREET
 NEW YORK, U. S. A.



ARMY-NAVY
Official
HEAD PHONES
\$2.49



BURSTEIN-APPLEBEE
Made A Lucky Buy

Limited quantity of these fine brand new head phones. Highly sensitive, 8000 ohms impedance. Bi-polar magnets, bakelite shell and cap. Adjustable head band, leather covered spring steel. Cord connects from one side, out of the way. Molded sponge rubber ear cushions. Our price only \$2.49 per set plus 20c postage and packing charges. Retail value \$13.50. Order Number 17A37.



**MAIL THE COUPON
FREE CATALOG**

Latest developments in radio and electronic parts and devices, newest ham gear, gadgets, bargains, war surplus items . . . get this red hot bargain catalog FREE.

**18 YEARS
IN
RADIO**



BURSTEIN-APPLEBEE CO. Radio News
1012 McGee St., Kansas City 6, Mo.

Send me your new FREE Catalog.
Send me _____ pair of phones at \$2.49 per pair plus 20c pair postage. I enclose \$ _____ in payment.

NAME _____
ADDRESS _____
TOWN _____ STATE _____

on. This curve represents, of course, the most unfavorable condition of operation; the drift at lower frequencies on this same range, and on lower-frequency ranges would be much less than this. In fact, the drift in kilocycles on any frequency range is generally proportional to the cube of the oscillator frequency.

Curve (B) illustrates the reduction in oscillator frequency drift that was effected by the elimination of all high-loss dielectric materials (with their accompanying varying dielectric constants, etc.) from the coil form, wave-band switches, etc., in the oscillator circuits, and the use of a proper temperature-compensating capacitor in the tuned circuit. The drift occurring in one hour was reduced to about 15% of its original value. Still more marked is the reduction in drift, and its stabilization, after the first 15 minutes of operation. Retuning the receiver once at this point would suffice for many hours of operation.

Further improvement in speed of compensation could be obtained by any means which would cause the temperature of the compensating capacitor to rise more rapidly during the first few minutes of receiver operation. Location of this capacitor in a position of greater exposure so it would receive more heat directly from the oscillator tube would tend to produce this result.

Curve (C) in Fig. 1 illustrates what careful design and temperature compensation can accomplish in the way of virtual elimination of frequency drift almost from the time the receiver is switched on. It will be noticed that maximum frequency drift occurs within approximately 8 minutes of a cold start, and that further correction takes place thereafter with the result that the drift is almost completely eliminated within 30 to 40 minutes.

Available compensating capacitors are adequate to minimize the frequency drift of typical well-designed oscillator systems to a satisfactory degree, insofar as AM, FM and television services are concerned. For example, in one typical high-grade communica-

tions-type superheterodyne, the oscillator circuits are individually temperature compensated to hold frequency drift to within 0.004% per degree Centigrade.

Use of Compensating Capacitors in the Oscillator Tuning Circuit

A typical example of the method of applying a compensating type trimmer capacitor having a negative temperature coefficient to compensate the tendency toward frequency drift in the tuning circuit of a commercial, manually-tuned superheterodyne is illustrated in Fig. 3. Notice that it simply replaces the ordinary mica-compression type trimmer that would ordinarily be connected across the main oscillator tuning capacitor C_o .

In Fig. 2, a suitable compensating-type fixed capacitor, C_c , is employed to compensate the tendency toward frequency drift in the oscillator tuning circuit of a push-button tuned receiver. In this case, it also serves as the main tuning capacitor for the iron-core type oscillator tuning coils.

Use of Crystal-controlled Oscillator

At this writing it is reported that at least two manufacturers of push-button receivers for the standard broadcast band are interested in using a quartz crystal to accurately control and stabilize the oscillator frequency for each push button, now that quantity production of quartz crystals by improved methods has greatly reduced their cost.

One method of oscillator-frequency control and stabilization that has been proposed for push-button receivers is illustrated in Fig. 4. A quartz crystal of the proper frequency required for oscillator operation (within very close limits) to effect reception of the particular signal frequency assigned to the button is provided in the oscillator leg of each push-button circuit. In this particular circuit arrangement the series resonance of the crystal is used as the control factor for accurately controlling the frequency of the

Fig. 4. Crystal-controlled oscillator circuit for push-button tuned receiver.

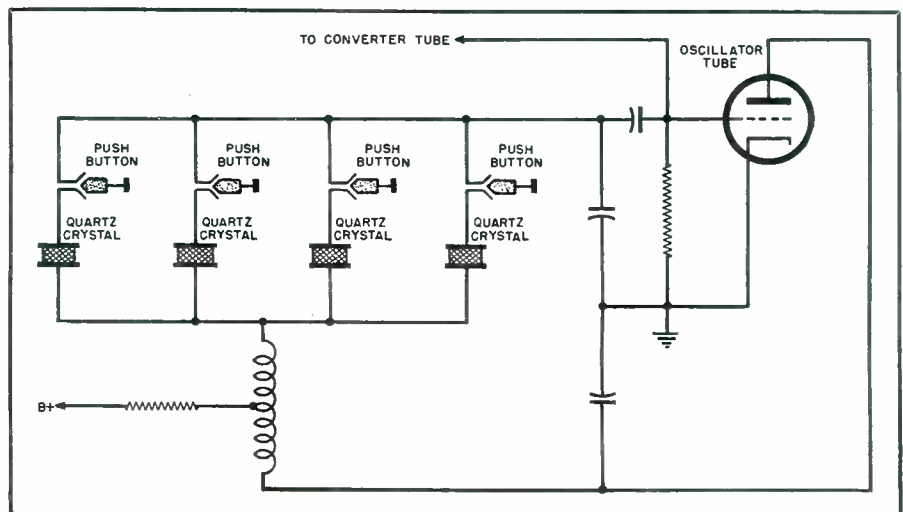

Quick Delivery

ON

**TIN and BARE COPPER
BRAIDED SHIELD TUBING**

Runzel has a stock of tin copper wire to start immediate production on any size Shield Tubing as illustrated.

Runzel
CORDS • WIRES • CABLES

State size
and quantity
required!

RUNZEL CORD & WIRE CO.
4723-31 MONTROSE AVENUE • CHICAGO 41



Crystalab KIT No. 1	Crystalab KIT No. 2
<ul style="list-style-type: none"> 15 blanks to precision tolerances 5 between 7005 and 7050 KC 5 between 7050 and 7220 KC 5 between 7220 and 7240 KC 10 Holders — CRL-16 10 Complete sets of springs, electrodes, covers, gaskets and screws 10 additional electrodes for slight freq changes 10 pieces of lintless cloth 1 box of fine abrasive for finishing 1 box of medium abrasive for rough lapping 1 piece of plate glass for lapping Blueprints of selector switch Photographs of selector switch 	<ul style="list-style-type: none"> 7 blanks to precision tolerances 2 between 7005 and 7050 KC 3 between 7050 and 7220 KC 2 between 7220 and 7240 KC 5 Holders — CRL-16 5 complete sets of springs, electrodes, covers, gaskets and screws 10 pieces of lintless cloth 1 box of fine abrasive for finishing 1 box of medium abrasive for rough lapping 1 piece of plate glass for lapping Blueprints of selector switch Photographs of selector switch
<p>INSTRUCTION BOOKLET giving complete details for selector switch, and complete instructions for lapping of your crystals.</p> <p>All components suitably boxed.</p>	<p>INSTRUCTION BOOKLET giving complete details for selector switch, and complete instructions for lapping of your crystals.</p> <p>All components suitably boxed.</p>

See your Local Radio Dealer

CRYSTAL RESEARCH LABORATORIES INC.
29 ALLYN ST., HARTFORD, 3, CONN., PHONE 7-3215

UTC
FOR HEARING AIDS
VEST POCKET RADIOS
AIR BORNE DEVICES

UTC SUB-OUNCER SERIES

UTC Sub-Ouncer units are 9/16" x 5/8" x 7/8" and weigh only 1/3 ounce. Through unique construction, however, these miniature units have performance and dependability characteristics far superior to any other comparable items. The coil is uniform layer wound of Formex wire . . . On a molded nylon bobbin . . . insulation is of cellulose acetate . . . leads mechanically anchored (no tape) . . . core material Hiperm-alloy . . . entire unit triple (waterproof) sealed. The frequency response of these standard items is + 3 DB from 200 to 5,000 cycles.

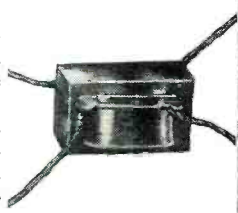

Type	Application	Level	Pri. Imp.	D.C. in Pri.	Sec. Imp.	List Price
SO-1	Inout	+ 4 V.U.	200 50	0	250,000 62,500	\$5.00
SO-2	Interstage/3:1	+ 4 V.U.	10,000	0	90,000	5.00
SO-3	Plate to Line	+ 23 V.U.	10,000 25,000	3 mil. 1.5 mil.	200 500	5.00
SO-4	Output	+ 20 V.U.	30,000	1.0 mil.	50	5.00
SO-5	Reactor 50 HY at 1 mil. D.C. 3000 ohms D.C. Res.					4.50



United Transformer Corp.
150 VARICK STREET NEW YORK 13, N. Y.
EXPORT DIVISION: 13 EAST 40th STREET, NEW YORK 16, N. Y., CABLES: "ARLAB"

oscillator circuit.³ No adjustment is required over a frequency range as great as 2 to 1.

It will be seen that one crystal, of the proper frequency rating, is required for each station selector push-button. Crystal-tuned FM receivers have been built, and crystals appear to offer encouraging possibilities along this line.

³ See PRACTICAL RADIO COURSE, Page 150, May 1945 issue RADIO NEWS.
(To be Continued)

Spotting Hurricanes (Continued from page 45)

hurricane struck the Florida peninsula with the suddenness and impact of an earthquake-like tremor. Although the 99-mile-per-hour-wind spent its fury about 172 miles south of the Orlo Vista radar-hurricane-detection outpost—and about 30 miles northwest of Miami—the fringe of the storm threatened to sweep away the radar sets, the canvas hut, and even the radar crew of Captain Jack Mataza. It seemed as if nature was putting on a show for the special benefit of weathermen and electronic crew stationed in the semi-tropical setting around Orlo Vista.

To plot the path of the hurricane, the radar equipment consisted of a 30-foot radar antenna mounted on a tower close by, and two electronic sets of the latest Army Air Forces design. One 'scope or screen on the radar apparatus—the same device employed on bombers for spotting enemy targets at night or in fog—was used as a height finder. Its pattern took the form of a wiggly line oscillating or moving to and fro from top to bottom of the radar 'scope. The other was a microwave, or finger-length radar outfit, with an electronic radius sweep of 220 miles and capable of affording advance warning of an approaching storm. It was a sort of early-bird-catch-the-worm device.

It was on the morning of September 15—and for 40 successive hours—when residents of Florida trembled in their sand-filled shoes, when despair was too mild a descriptive term, and when property owners could visualize their homes picked up as if they were feathers by that impetuous and devastating child of nature—the tropical hurricane. The weather in the vicinity of Orlo Vista—where the A.A.F. Center radar crew was huddled in their hut with the anxiety of depositors of a bank in a money panic—was cloudy but reasonably calm when the microwave radar set first intercepted returning impulses or echoes from southern Florida. Amidst a speckled blue light on the round, black radar 'scope, line squalls in concentric arcs were recorded as approaching northward in the peninsula. By 8 o'clock that night, the radar screen indicated that each succeeding concentric arc had a somewhat smaller radius of curvature and at exactly two minutes

Specified

BY AMERICA'S MOST CRITICAL SERVICE ENGINEERS

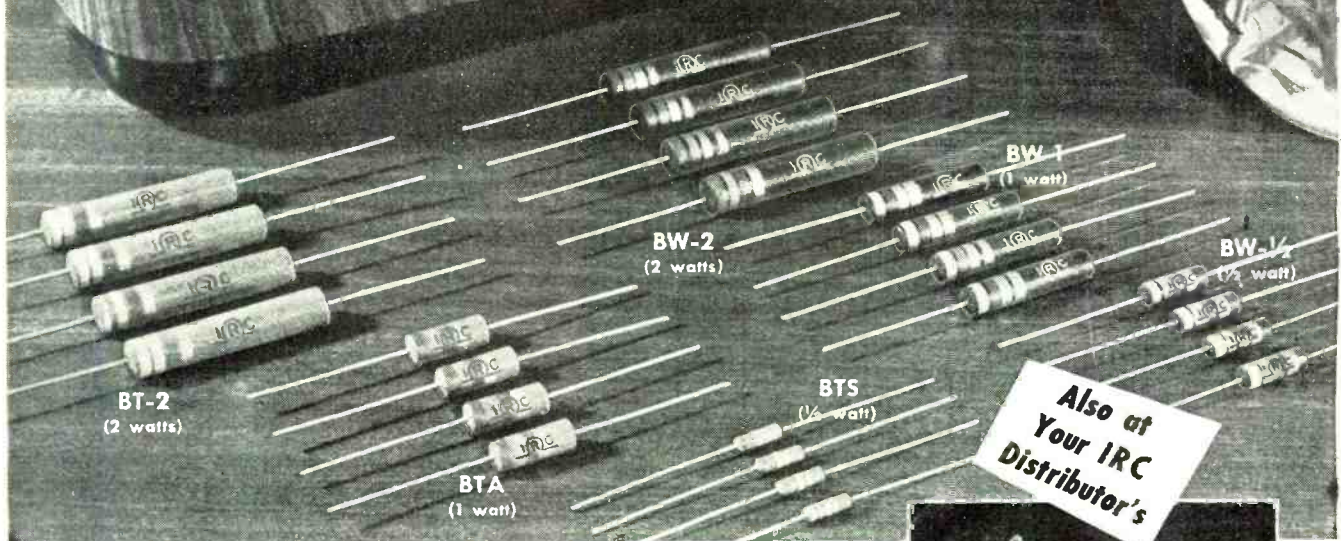

TYPE BT INSULATED Metallized RESISTORS TYPE BW INSULATED Wire Wound RESISTORS

... the perfect combination for speedy, dependable servicing!

Almost any piece of carbon is a "resistor". But a really good resistor, scientifically designed to meet every requirement of exacting radio and other electronic servicing, is something else again. For example, users of the famous Type BT have found that IRC's exclusive Metallized filament-type construction is a far cry from ordinary resistors. Since the beginning of Radio, this unique design principle has made possible far greater stability, more rugged construction and complete dependability in a very compact, low-cost unit.

Now, two new BT types, the BTS and BTA, are available. Designed to meet all the exacting requirements of modern servicing, they are conservatively rated at 1/2 watt and 1 watt, respectively, and incorporate all the excellent characteristics of older, larger types in a much smaller, more convenient size.

For greater stability and all-around efficiency in the lower ranges, the IRC Type BW Insulated Wire Wounds are recommended. A stock of these units and the Type BT in assorted ranges and wattages give you the ideal combination to solve almost any servicing problem... quickly and profitably.

The Resistor You Need . . . When You Need It!

Your local IRC Distributor now has quite complete stocks of BT's and BW's, in standard RMA ranges, ready for you. You'll find him a dependable source (and a very cooperative guy) for all of the IRC products shown on this page. He'll also be glad to give you your copy of IRC Service Catalog #50.

FOR BETTER-THAN-STANDARD QUALITY

Standardize on



INTERNATIONAL RESISTANCE CO.

Dept. 20-C 401 N. Broad Street, Phila. 8, Pa.

Makers of more types of resistance units, in more shapes, for more applications, than any other manufacturer in the world.

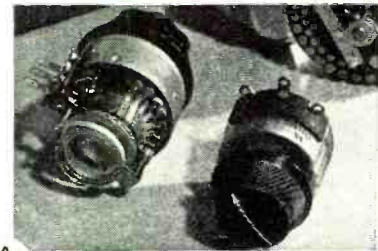
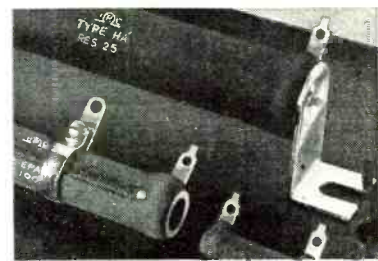
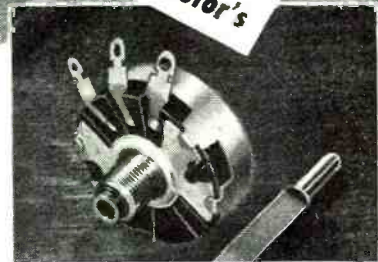

A VERSATILE TEST LABORATORY...IN ONE COMPACT UNIT!



Clippard ELECTRONIC VOLT-OHMMETER MODEL 406

NEW BRIDGE-TYPE CIRCUIT—fully balanced through 3 stages for maximum accuracy and stability. Tube complement: one 6X5GT rectifier, two 6SN7GT dual purpose tubes and 6AL5 dual diode in probe.

PEN-TYPE DUAL-DIODE PROBE—on detachable 36" shielded cable. High impedance, low capacity and convenient ground terminal assure accurate readings, A.F. thru U.H.F. ranges with minimum circuit disturbance.

EXTREME RANGE—full scale sensitivity of 0-1, 0-3, 0-10, 0-30, 0-100, 0-300 and 0-1000 volts A.C. and D.C. and 0-1,000 megohms in 7 ranges with ample overlap to eliminate guess-work. Decibel scale -20 to +51 in 3 ranges.

INCLINED METER—for easier, more accurate readings with less parallax.

HANDSOME APPEARANCE—Satin Chrome panel, etched black self-explanatory markings, convenient controls, quarter-sawn oak case, folding leather carrying handle. Overall size 10" x 8½" x 6½".

LABORATORY ACCURACY—calibrated to 2% accuracy at plant. 5% accuracy guaranteed in field. An instrument of laboratory quality and ruggedness priced within reach of all who want the best!

Write today for FREE bulletin
giving Complete Details!

Electro-Magnetic Windings

R. F. Coils

Sub-Assemblies



to 10 o'clock the center of the atmospheric disturbance was identified, beyond a peradventure, as 30 miles northwest of Miami.

Shifting their vigils—like war workers in a factory changing from day shift to night shift—Captain B. D. Douglas arrived at the wood-and-canvas hurricane-detection station to relieve Captain Mataza. Meanwhile two photographers augmented the radar and weathermen crew—the former operating cameras electrically as a means of *snapping* the pictures of each radar screen at regular intervals of 15 seconds. Then it was reckoned that the *heart* of the hurricane was traveling at nine miles an hour in a curve that would focus it immediately over the hurricane-detection station.

The next day newspapers reported the pattern of the storm on the radar sets as resembling the figure *six*. More in technical details, the A.A.F. crew reports that the general outline of the storm was unmistakably clear on the microwave set, the impulses or radar energy being reflected in a superb manner through the rain accompanying the hurricane. Its shape was that of the numeral six with clockwise tails having a spiral effect. At one o'clock on the morning of September 16, six distinct tails were visible, three of which were detached and traveling northward in advance of the storm's center. Supposedly, these tails were rain-carrying storm clouds, or line squalls, eight to ten miles in width and from three to five miles apart.

As the disturbance moved toward Orlo Vista, 6 miles from Orlando, the atmospheric conditions at the observation station grew in severity and the winds attained a velocity of 70 miles an hour—attended by pelting rain. The radar crew, huddled in the frail hut, ostensibly were worried about the tenacious quality of the radar an-

tenna tower to withstand the high wind and downpour of rain. As a precautionary measure, an anemometer had been installed near by so that if the radar antenna should topple, this wind-recording instrument could at least afford information as to how great a velocity of wind such an antenna could withstand.

At fifteen minutes to 4 o'clock, on September 16, the so-called *eye* of the storm was in juxtaposition of the hurricane-detection station, having detoured by it as far as ten miles to the west. This *eye*, the low-pressure area in its center, measured 12 miles in diameter. The absence of impulses or echoes on the radar screens indicated that there was no rainfall in the immediate vicinity of Orlo Vista. The height determining radar outfit disclosed that the thick cloud deck enveloping the *eye* of the storm extended to a height, on an average, of 18,000 feet. The fury of the storm had diminished appreciably due to its travel over land and subsequently the radar scopes intercepted telltales of the hurricane as it moved in a northeasterly direction, towards Jacksonville.

As previously indicated in this article, hurricane-detection by radio is at least 18 years old, and even radar was employed in August 1943 to detect storms. Prior to that, technicians of the U. S. Signal Corps had observed *impulses* or *echoes* on their relatively crude radar screens. However, such manifestations had not been observable as caused by thunderstorms. More recently, the A.A.F. Center meteorologists have employed radar to track storms, and to improve their technique of detection. But the range and fury of the September 15 hurricane (it subsequently gathered momentum and severely damaged Paris Island, S. C.) plus its close approach to the Orlo Vista radar station, added up fresh

A jeep-mounted mine detector set, the AN/VRS-1B, is designed to be operated with the vehicle traveling from 3 to 5 miles an hour, sweeping a path six feet wide in front of the jeep. The detector is designed to automatically stop the vehicle upon detection of a metallic anti-tank mine. The mine is then located within this six foot strip by lateral probing or by a portable mine detector. The detector consists of a search coil assembly, the electronic circuits and the automatic stop system. Electric power to operate the unit is supplied by the jeep's battery. This detector is essentially a 1000 cycle inductance bridge, with the search coils forming one side of the bridge. Upon passing near a metallic object, the bridge is unbalanced, the resulting signal is amplified and used to activate the automatic stop mechanism, which in turn stops the jeep. In order to increase the sensitivity, the electronic circuits are designed to operate on the change of signal strength and on a certain phase of the signal rather than magnitude of signal strength.

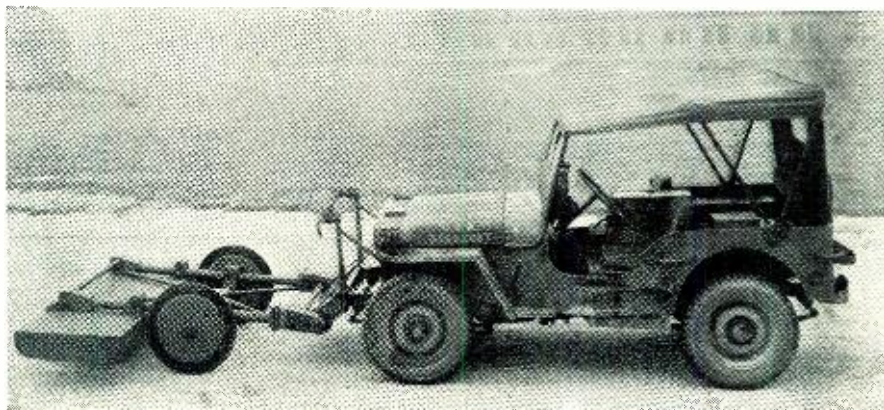

Liberty RADIO and PHONOGRAPH Kits...

6 Tube "Super Het" Radio Kit

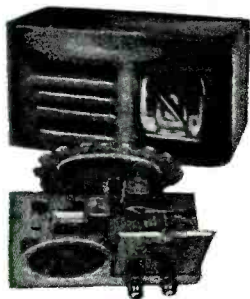

COMPLETE, INCLUDING ATTRACTIVE WALNUT CABINET — Diagram Furnished
All Parts Mounted
To assemble, all one needs is a soldering iron and 30 minutes of your time.
Uses 6SA7 — 6SQ7 — 6SK7 — 25L6 — 25XU or 12SK7 — 12SQ7 — 12SK7 — 35Z5 — 50L6
Your Cost — \$16.95
LESS TUBES

5 Tube "Super Het" Radio Kit

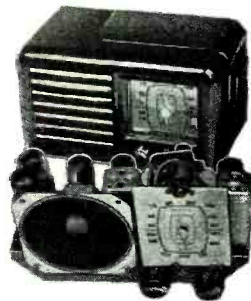

COMPLETE, INCLUDING ATTRACTIVE BROWN BAKELITE CABINET.
Diagram Furnished — All Parts Mounted
APP SIZE 9x5x6 Inches — Uses 6SJ7 — 6SQ7 — 6SJ7 — 6SK7 — 25L6 — 25Z6 or 12SJ7 — 12SK7 — 35Z5 — 35Z6
Your Cost — \$13.95
LESS TUBES

Portable Phonograph Kit



ATTRACTIVE ALLIGATOR COVERED CABINET
COMPLETE WITH MOTOR — PICK-UP — AMPLIFIER
SIZE: 14 x 7½ x 19
Uses 6C5 — 25L6 — 25Z6
TONE AND VOLUME CONTROLS
Your Cost — \$28.95
LESS TUBES

TERMS: 10% DEPOSIT WITH ORDER

Special Buys for the Amateurs and Industrials

SPECIAL HIGH VOLTAGE MICA CONDENSERS

C.D. MICA CONDENSERS .02 — 600 V. WKGU D.C. TEST 1000 V. D.C. — Your Cost .12 cts.
C.D. MICA CONDENSERS .0004 — 2500 V. WKGU D.C. TEST 5000 V. D.C. — Your Cost .19 cts.
C.D. MICA CONDENSERS .0001 — 600 V. WKGU D.C. TEST 1000 V. D.C. — Your Cost .12 cts.

GENERAL ELECTRIC PYRANOL BASE MOUNTING — 1 MFD. — 500 Volts WKG. — Your Cost \$.65
GENERAL ELECTRIC 2.0 MU-F — 600 V. D.C. BASE MOUNTING. — Your Cost 1.10
SPRAGUE — 4 MFD — 600 V. D.C. OIL UPRIGHT: Size (2½ x 1¼ x 4) BASE MOUNTING. — Your Cost 1.59
CORNELL DUBILIER — 8 MFD — 500 V. WORKING UPRIGHT ALUMINUM CAN. — Your Cost .95
CORNELL DUBILIER OIL — 10 MFD — 600 V. D.C. BASE MOUNTING. — Your Cost 2.10
CORNELL DUBILIER — 15 + 15 MFD — 450 V. W. TUBULAR — Your Cost 1.10
AEROVOX OIL COND. IN CAN — .5 MFD — (Size: 1½ x 1 x ¾") — Your Cost .29
CORNELL DUBILIER OIL COND. IN CAN — 10 MFD 50 W.V. (Size: 1¾ x ¾ x 1) — Your Cost .34
SWITCHES TOGGLE TYPE PUSH TO MAKE — Your Cost .14
SPECIAL CLOSE OUT G.E. METER MODEL 40ARB17 Reading 2.5 — 0 — 2.5 M.A. —
25° — 0 — 25 M.A. Two Readings — Your Cost 3.95

Attention: RADIO AMATEURS

SPECIAL VOLUME CONTROLS — NO SWITCH
2½ INCH SCHAFTS "STANDARD BRANDS"
1 meg — 200 M — 100 M — 500 M — 250 M — 60 M — 50 M
40 M — 20 M — 15 M — 10 M — 5 M — Your Cost .18 cts. ea.
DUAL VOLUME CONTROLS — NO SWITCH
10 M + 5 M / 100 M + 100 M / 10 M + 75 M / 20 M +
20 M / 80 + 1000 — Your Cost .28 cts. ea.

"SPECIAL" — OIL BATHTUB CONDENSERS
ALUMINUM CAN
.05 MFD — 600 V. — Your Cost .08 cts.
3 x .05 MFD — 300 V. D.C. — Your Cost .19 cts.
1.2 MFD — 600 V. — Your Cost .14 cts.
3 x 2.2 MFD — 600 V. — Your Cost .39 cts.
15 MFD — 35 VOLTS WORKING — Your Cost .16 cts.

SPECIAL — IMMEDIATE DELIVERY — "PORTABLE BATTERIES — "FARM PACKS"
Manufactured by Nationally Known Manufacturer — "FULLY GUARANTEED"

FARM "A B" BATTERY				
Stock No.	Voltage & Type	Size	List	Your Cost
782	1½ Volt "A", 90 Volt "B"	16x4½x6¾	6.25	4.35
PORTABLE "B" BATTERIES				
330	45 Volt "B"	4-1/16x2½x5½	1.50	1.05
430	45 Volt "B"	3-7/16x2¼x4½	1.50	1.05
530	45 Volt "B"	1¾x2¾x4½	1.60	1.10
830	45 Volt "B"	3½x1-11/16x5½	1.50	1.05
545	67½ Volt "B"	1¾x3½x6½	2.20	1.60

PORTABLE "A" BATTERIES				
Stock No.	Voltage & Type	Size	List	Your Cost
111	1½ Volt Unit Cell	2¾x1¼	.10	.06
114	1½ Volt "A"	2½x2½x3¾	.60	.42
116	1½ Volt "A"	3¾x2½x3¾	.85	.59
118	1½ Volt "A"	3-13/16x2½x5¼	1.00	.70
123	4½ Volt "A"	3¾x4-9/16x1¼	.55	.385
118L	1½ Volt "A"	10¾x3¾x1¾	1.10	.77
118SL	6 Volt "A"	10¾x3¾x1¾	1.10	.77
115S	7½ Volt "A"	3-3/16x1¾x7	.80	.57

10% WITH ORDER — BALANCE C. O. D.

LIBERTY SALES CO., INC.

115 WEST BROADWAY
NEW YORK 13, N. Y.
BARCLAY 7-6063

Smooth Power
BRINGS SMOOTH
PERFORMANCE



YOU CAN safely trust General Industries *Smooth Power* motors to deliver completely satisfactory performance in your phonographs, recorders and record-changers. They're compact, lightweight yet sturdily built. Their uniform speed and quiet operation make them smooth as velvet. Our comprehensive line gives you a wide selection for your planning and future requirements. *For smooth performance, standardize on Smooth Power motors.*



The General Industries Company
DEPT. M • ELYRIA, OHIO

findings as to the nature of violent storms.

"It exclusively established, for instance," reports the A.A.F. Center at Orlando, "that the forward right sector of a hurricane moving is the most violent, contains heaviest rainfall and squalls. Most important, however, was the fact that the entire progress of the hurricane, in its gradual curve up Florida, had accurately been plotted on a film. According to Colonel Lloyd A. Walker, staff weather officer for the A.A.F. Center and sponsor of the experiments of September 15th and 16th, high-frequency radar sets installed strategically throughout a hurricane area, such as Florida, might revolutionize methods of forecasting and plotting these most destructive of all natural phenomena."

The use of aircraft in tracking down hurricanes in the Miami area was already an accomplished fact before radar appeared upon the threshold. Now, however, this scientific ally of aviation—formerly flying out to sea and meeting the storm—means that stationary radar or television screen can survey the location, extent, intensity, velocity, and direction of thunderstorms and similar violent atmospheric disturbances in a radius of at least 200 miles.

Radar hurricane-detection sets, such as described in this article, will be employed to intercept storms 200 miles away and by indicating their velocity and course, enable operations' officers at airfields to schedule airplane take-offs and landings under auspicious weather conditions and to take precautionary measures to avert damage to aircraft on the ground. This was demonstrated at Maxwell Field, Alabama, about a year ago, when a radar crew detected a severe tropical disturbance speeding from the northwest at a velocity of 50 miles an hour. The storm was then only 48 miles removed from the air-base. Warnings were telephoned instantly to other airfields in the path of the oncoming hurricane. Visual devices detected nothing disturbing as to the weather outlook, but the far-seeing penetrating eye of radar gave cause for alarm and flying operations were suspended at the Tuskegee Field. The identical storm *SOS* was telephoned to the nearby Motion airfield but some inexplicable "crossing of the wires" of communication facilities caused a misunderstanding and flying schedules were not cancelled at this Army Field. On the forecasted schedule, the tropical disturbance struck with a vengeance. The Tuskegee Field suffered no damage; the Motion Field had 27 airplanes badly damaged and 13 members of the crew were injured.

Ferretting out the nature of hurricanes, as well as tornadoes, and the addition of other funds of information about weather—the universal *language*—are in the offing, due to the harnessing of the science of radar as an ally of the science of meteorology.

-30-

This Month's SPECIALS!

	Your Net
6 Volt 4 prong heavy duty vibrator, List \$3.95	\$1.89
10-12 tube power transformer 6.3 V. winding 100 Ma.	3.69
4" speaker case only for talk back or P.A. systems	.69
100 asst. 1 & ½ watt resistors up to 10% tolerance	2.45
New 6L6 metal tubes in original cartons	.89
New 6AG7 and 6AC7	.69
Headphones, Signal Corps, 8000 ohm, List \$10.00	2.95
Telegraph Keys with cutout switch 10 for	8.50
100' pushback wire	.59
I.F. transformers 456 K.C.	.49
2500 mfd. 3 volt F.P. condensers	.69
Volume controls with switch 1 meg for battery sets, ¾" shaft	.59
Toggle Switches S.P.S.T.	.22
Toggle Switches S.P.D.T.	.31
Toggle Switches D.P.D.T.	.42
.006 1600 W.V. buffer condensers	.15
8" black crackle speaker case, size: 12" x 12"	2.29
<i>plus shipping charges</i>	

Write for our illustrated literature featuring all types of radio parts.

Order from your jobber or write direct.

Dept. C

ARROW RADIO CO.

2205 W. Division St. Chicago 22, Ill.

Inside Facts About ROHME No. 7 PERMANENT MAGNET

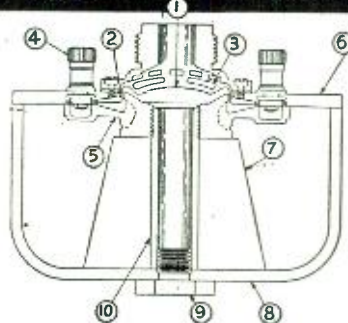

- 1—One-piece meta. diaphragm. Voice coil wound on diaphragm.
- 2—Horn mounting accurately centered.
- 3—Perforated die-cast palate.
- 4—Cadmium plated heavy-duty binding posts.
- 5—Flange molded to inner pole piece.
- 6—Outer pole piece of special alloy.
- 7—Heavy ALNICO permanent magnet.
- 8—Bowl of heavy gauge steel.
- 9—Brass assembly nut binds all parts.
- 10—Inner pole piece made of brass.

Write for circular RN-346 giving complete details.

ELECTRONICS DIVISION

ROHME Industries

3120 MONROE ST., TOLEDO 6, OHIO

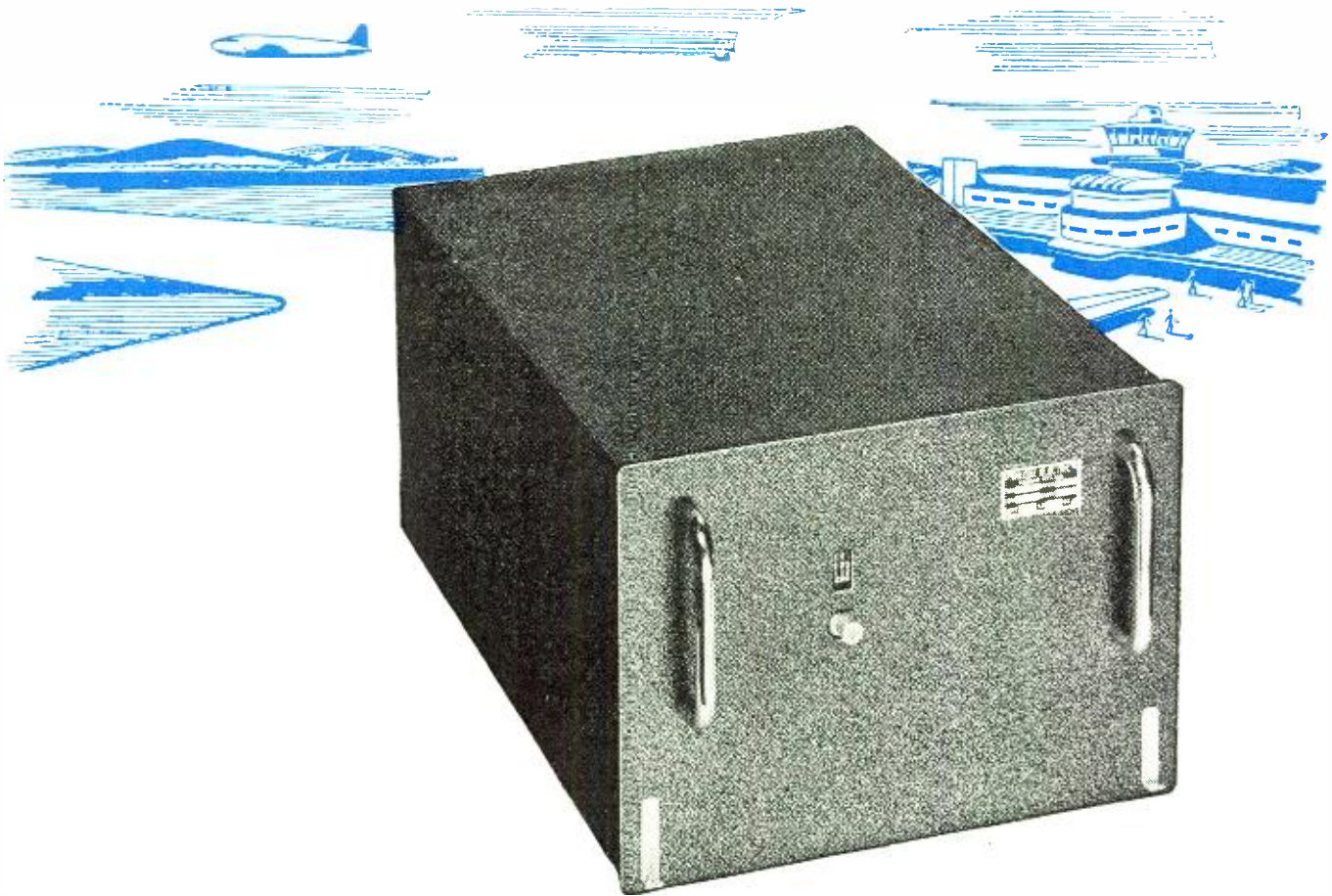

TYPE 308A V.H.F. RECEIVER

The Wilcox Electric Co. Type 308A Receiver is a tuneable super-heterodyne receiver for aircraft, covering the range of from 108 to 132 Mc. It is particularly useful in aircraft applications involving the reception of V. H. F. radio range, control tower, or company communication signals. A degree of performance, equal in every respect to that obtained with communication receivers operating in the medium-high frequencies, is obtained by virtue of a radically new approach to the problem of stability and amplification in tuneable V. H. F. receivers.

Dimensions: *One ATR Width and Height, 15½" Deep.*

Weight: *21 pounds.*

Connections: *Rear mounted plug.*

Input: *60 ohm Transmission Line.*

Output: *500 ohm Dual Audio Output.*

Output Power: *300 Milliwatts.*

Operating Voltage: *12 or 24 volts, D. C.*

Selectivity: *Designed for 100 Kc. Channel Separation.*

Spurious Freq. Rejection: *60 D. B. Below Desired Signal.*

A. V. C.: *Less than 9 D. B. Variation from Output at Rated Sensitivity.*

Sensitivity: *3 Microvolts for 300 Milliwatts Output.*

S/N Ratio: *4/1 in Voltage at Rated Sensitivity.*

Frequency Range: *108-132 Mc.*



WILCOX ELECTRIC COMPANY, INC.

Manufacturers of Radio Equipment

Fourteenth and Chestnut

Kansas City, Mo.

FOR EVERYTHING IN RADIO

WRITE

Leo, W9GFQ

For Fast Delivery!



Get Leo's own personal, sudden service on your radio and electronic needs. Quick delivery, lowest fee.ms. liberal trade-in allowances.

SERVICE DEALER NEEDS



WRL MULTITESTER
Steel case with 30-60° angle
Cat. No. 16-491
Less Leads .. **\$1875**

Handles AC DC Voltmeter, DO Milliammeter, high and low range Ohmmeter. 3" meter with sturdy D'Aronsva movement. Size 5½x8x3¼.

A complete stock of tools, replacement parts, test equipment, intercom and public address systems . . . everything for the progressive service dealer.

FOR EXPERIMENTERS

PHONO AMPLIFIER KITS

Complete with tubes, speaker, stamped chassis, and all resistors and condensers.

Cat. No. 7-271. \$9.50 ea. Lots of 3, ea. **\$915**



Crystal sets, Antenna Kits, Code Oscillator Kits, Transmitter Kits, and many other items for the experimenter and radio enthusiast.

HAM NEEDS

Transmitting tubes, condensers, mikes . . . everything for the Ham. One of the country's largest stocks of Ham equipment. Write Leo, W9GFQ, today, and be first with the latest. We invite inquiries for special equipment of all kinds.



TRANSMITTERS

For peak performance and more dollar for dollar value, get a WRL Transmitter Kit . . . designed in Leo's own laboratories . . . tested and proven. Available in 15, 35, 70, and 150 watt kits as well as kits custom built to your own specs. Write Leo today for complete details, prices and terms.

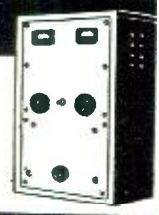

RECEIVERS

Here are just a few of the many well-known receivers offered by Leo:

- Hallcrafters SX-25 \$94.50
- Hallcrafters S-20R \$ 60.00
- Hallcrafters SX-28A \$223.00
- Echophone EC-1A \$ 29.50
- Hammarlund HQ-129X \$129.00
- National NC-9-40C \$225.00

Write for details of our trade-in plan and easy terms



Free!

NEW POST WAR 52 PAGE FLYER

52 pages packed with real buys in radio, electronic, and general merchandise. Write for your free copy today.

- Send for these exclusive items:
- Tube and Circuit Book 10¢
- Giant Radio Reference Map (size 3½"x4½") 15¢
- Handy Tube-Base Calculator 25¢

Dept. RN-3
COUNCIL BLUFFS, IA.

Wholesale RADIO LABORATORIES

Within the
INDUSTRY

J. C. FARLEY has been appointed controller of the Radio Tube Division of *Sylvania* with headquarters in Emporium, Pennsylvania.



Mr. Farley joined *Sylvania* in 1925 where he later held a position in the accounting department and was then promoted as radio tube division cost accountant. Mr. Farley has also held the position of manager of the Program Planning Department, and assistant to the general manager, Radio Division.

H. NORMAN MILLER, a member of the industrial sales staff of the *Westinghouse Electric Corporation* at Portland, Oregon for the past 19 years, has been appointed manager for the company in the Portland area.

Mr. Miller will succeed L. G. Fear, who will act as the company's special representative in both the Seattle and Portland areas. After serving in various sales posts at East Pittsburgh, South Philadelphia, Pa., and Mansfield, Ohio, Mr. Miller was transferred to Portland in 1926.

E. F. ERICKSON has been added to the executive staff of *Carter Motor Company* of Chicago. Mr. Erickson will serve as Purchasing Agent for the company.

Mr. Erickson has received his honorable discharge from the U.S. Army Paratroopers recently. He landed in France on D-Day and was later wounded. He received the Purple Heart for this action.

D. G. CALLANDER of *Callander-Lane Company*, Columbus, Ohio, has been appointed area distributor for *Stromberg-Carlson Company's* line of home radio and television receivers.



Mr. Callander has been associated with the major electrical appliance business in the Ohio area for the past eighteen years. The other partner, R. H. Lane, has also been associated with the appliance business in that area.

THE CANADIAN RESEARCH INSTITUTE has recently acquired the building formerly known as St. George House, at 46 St. George Street, Toronto 5, Ontario.

The new building supplies double the former laboratory space available

to the company. The electrical and instrument laboratories have been completely redesigned and streamlined in anticipation of a postwar increase in business. The company makes a line of radio service equipment.

EDWARD J. COHEN has just announced his resignation as vice-president and general manager of the *Insuline Corporation of America* in order to become an associate and co-partner of *J. J. Perlmuth & Associates* of Los Angeles, manufacturers' sales representatives.

Mr. Cohen has been associated with I.C.A. for twelve years. The Perlmuth organization represents I.C.A. on the West Coast.

E. J. DYKSTRA has been named district manager of the Chicago area for *Bendix Radio*, division of Bendix Aviation Corporation, according to an announcement by L. C. Truesdall.



Mr. Dykstra was formerly with *Farnsworth Television and Radio Corporation* as east-central division manager. As Chicago district manager, Mr. Dykstra will direct the sales of *Bendix Radio's* new line of AM-FM radios and radio-phonographs in northern Illinois, Wisconsin, and Minnesota.

PORTER TURNER has been named Field Engineer in the New York and Philadelphia territory representing the *Alliance Manufacturing Company* of Alliance, Ohio.

Mr. Turner was formerly a Sales Engineer with the company for eight years before taking a leave of absence to serve with the Merchant Marine.

Mr. Turner's office headquarters will be located at 401 Broadway, New York, New York. The company manufactures a line of miniature electric motors for remote control and actuation, in addition to a line of motors to drive turntables, record changers and radio tuning devices.

CYRUS T. READ, veteran radio amateur, was elected president of the *Hamfesters Radio Club, Inc.* of Chicago, the local affiliate of the American Radio Relay League.

Other officers elected include: Howard Hinman, vice-president; Clarence Zornes, recording secretary; Lawrence Gross, treasurer; Harry Gartzman, financial secretary; and Edward Costello, sergeant-at-arms. The retiring president, William S. Soich, becomes

THERE IS ONLY ONE RIGHT WAY TO TRAIN FOR TELEVISION

- First** See Television.
- Second** Learn television from engineers who work in the industry.
- Third** Train with real up-to-the-minute television broadcasting and receiving equipment. Be expert in servicing, operating, and engineering, so that you are capable of taking a job in the industry.
- Finish** By working with real television studio production experts with actual performances and with television manufacturing engineers in a large, up-to-date laboratory, so that you can become expert in the branch of television you are most capable of following. This is the right way to get into television and the way of

AMERICAN TELEVISION LABORATORIES, INC.
433 E. Erie St., Chicago 11, Illinois

Where there are day or evening classes, full or part time

A NATIONAL ORGANIZATION
APPROVED FOR GI TRAINING

AMERICAN TELEVISION INSTITUTE
Division of American Television Laboratories, Inc.
433 E. Erie Street
Chicago 11, Illinois

Please send me information regarding television training.

Name City

Address State

LAKE'S

RADIO CABINETS & PARTS

NOW AVAILABLE! Postwar 2 Post RECORD-CHANGER



In luxurious brown leatherette portable case, 15" L. x 15" W. x 10"

D. Latest electronic developments make this modern record-changer the finest on the market today!

List price \$49.95
Dealer's net 29.97

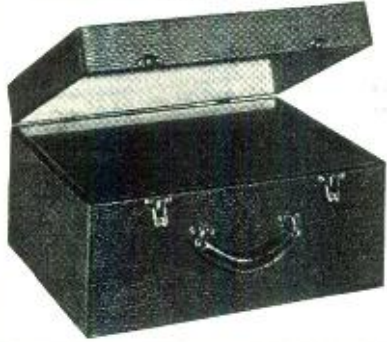

Portable Phonograph case, of sturdy durable plywood, in handsome brown leatherette finish. Inside dimensions 16 1/2" long, 14" wide, 9 1/2" high. Has blank motor board. As illustrated above, specially priced at

\$6.95



Portable Phonograph case in brown leatherette covering. Inside dimensions 17 1/2" long, 13" wide, 7 1/2" high. Has blank motor board and opening for speaker. As illustrated at left, specially priced at.....

\$7.95

Also blank table cabinets of walnut veneer in the following sizes, with speaker opening on left front side: (* Note: *7 has center speaker grill.)

#1	8 1/2"	L x 5 1/2"	H x 4"	D \$1.95
#2	10 1/4"	L x 6 3/8"	H x 5"	D \$2.75
#3	13 1/2"	L x 7 7/8"	H x 6 1/4"	D \$3.25
#7*	10 3/4"	L x 7"	H x 5 1/2"	D \$2.50
#8	17"	L x 9"	H x 9 3/4"	D \$4.50
#9	21"	L x 9 1/4"	H x 10 1/2"	D \$5.50

* Speaker Opening in center of front side. Cabinets available in Ivory color and Swedish Modern. Write for prices.

All types of radio cabinets and parts are available at Lake's Lower prices. A large stock is listed in our catalog.



SERVICEMEN—RETAILERS
Join our customer list today.

Dept. A

Write for our NEW, 12 page, illustrated, elaborate catalog!
Order from Lake!
You'll make no mistake!

Lake Radio Sales Co.
615 W. Randolph Street
Chicago 6, Ill.

chairman of the executive committee.

The Hamfesters is one of the largest amateur organizations in the country, with a pre-war membership approaching 500. Regular meetings were held throughout the war period when ham activities were at a virtual standstill.

* * *

H. F. YOTZ, formerly assigned to special work with *GECC* during the war period, has resumed his position as manager of the North-eastern District of the *General Electric Credit Corporation*. His headquarters are located at 30 Huntington Avenue, Boston, Mass.



Mr. Yotz joined the *General Electric Company* in 1922 as an electrical engineer and in 1934 became associated with the *GECC* in a promotional capacity at the general office in New York City. He was named manager of the Boston office in 1937.

* * *

TECHTMANN INDUSTRIES has announced the removal of their factory and offices from 828 North Broadway, Milwaukee 2, Wisconsin, to 714 West Wisconsin Avenue, Milwaukee 3, Wisconsin.

The new quarters will allow for a 500% increase in factory and office space.

* * *

HARRY B. SEEGER, formerly a representative for *American Phenolic Corporation*, passed away suddenly in Buffalo, New York.



Mr. Seeger represented *Jensen Radio Company* of Chicago, *International Resistance Company*, in addition to *Amphenol* in the Buffalo territory. He was born in Dorchester, Massachusetts, in 1902 and entered the radio field as Sales Manager and District Representative for the *National Union Radio Corporation*.

At the time of his death, Mr. Seeger conducted his own business as a Manufacturers' Representative, an organization which he founded in 1935.

* * *

JAMES M. BLACKLIDGE has been promoted to the post of General Sales Manager of the *Standard Transformer Corporation*.



For the past nine years, Mr. Blacklidge has been associated with *Stancor* in various capacities, including the post of Sales Manager of the Industrial Division.

Assisting Mr. Blacklidge in the Distributor Sales Division will be Earl T. Champion, who was formerly associated with *Centralab* of Milwaukee,

while Burt O. Anderson will continue to assist the new General Sales Manager in the Industrial Division.

* * *

EDWIN M. PERKINS has been named regional manager for *Admiral Corporation* of Chicago



Before joining *Admiral*, Mr. Perkins was manager of the Component Section of the Chicago Signal Corps Production Field Office. He has also been associated with the Clark Water Heater Division of McGraw Electric Company.

Mr. Perkins will be assigned a territory in the near future to cover the company's line of radios and accessories, Dual-Temp and conventional refrigerators, home freezers and electric ranges.

* * *

L. R. O'BRIEN is the new general sales manager of the Radio Receiving Tube Division of *Raytheon Manufacturing Company* of Newton, Massachusetts.



Mr. O'Brien joined *Ken-Rad Tube and Lamp Corporation* in 1925 and he held the post of director of sales for *Ken-Rad* until the company became a division of *General Electric*.

Mr. O'Brien has appointed Ernest Kohler and Curtis Hammond, both formerly with *Ken-Rad*, to assist him in sales engineering capacities at *Raytheon*.

* * *

C. EDWIN WILLIAMS has been appointed General Manager of the Cathode-Ray Oscillograph and Tube Division for the *Allen B. DuMont Laboratories, Inc.*

Mr. Williams, who comes to *DuMont* after completing three years' war service in Washington, D. C., as Chief, Transformer Unit, Radio and Radar Division of the *WPB*, will make his headquarters at the main offices of the company in Passaic, New Jersey.

* * *

F. PRICE MERRELS has been added to the staff of *The Harry P. Segel Company*, Manufacturers' Representatives, of Boston, Massachusetts.



Mr. Merrels attended Yale University and has recently been discharged from the U.S. Navy after 5 years of service. While in the service he specialized in radio and electronic applications.

He will be located at the Connecticut branch of the company, with offices at 179 Kenyon Street, Hartford. His territory will include Western Massachusetts, Connecticut, Vermont, and Eastern New York State.

-30-

rate them yourself, Doc...

the Stamford ⁶⁰

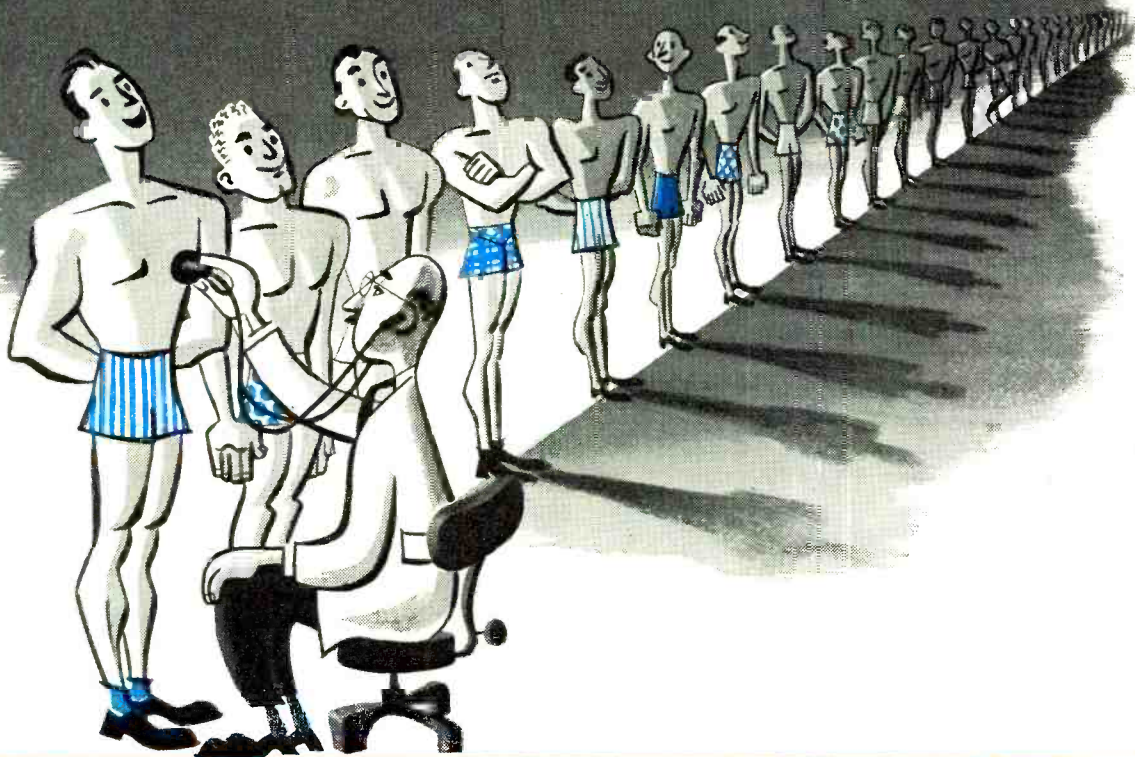

SIXTY Stamford Transformers—tested and terrific—are sitting on your jobber's shelf. Sixty transformer types that can "go places and do things" . . . go into any repair job and do a mechanic proud. But don't take our word as "gospel". Next time you need parts, make it a point to visit a Stamford "60"

jobber. Test one or ten or all sixty transformers . . . you will find them accurate as rated. Try them on your next replacement jobs . . . you'll find them reputation builders. For the address of your nearest Stamford "60" jobber, write: Stamford Electric Products Co., Inc., Stamford, Connecticut.

stamford

Transformers



THE STAMFORD DISPENSER

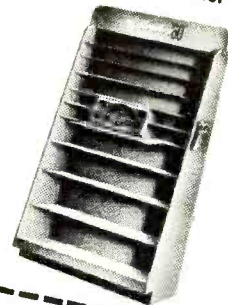

Copyright 1946, Stamford Electric Products Co., Inc.

ELECTRICITY

FOR RADIO AND
ELECTRONIC
APPLICATIONS



● ONAN ELECTRIC GENERATING PLANTS supply reliable, economical electric service for electronics applications as well as for scores of general uses.

Driven by Onan-built, 4-cycle gasoline engines, these power units are of single-unit, compact design and sturdy construction. Suitable for mobile, stationary or emergency service.

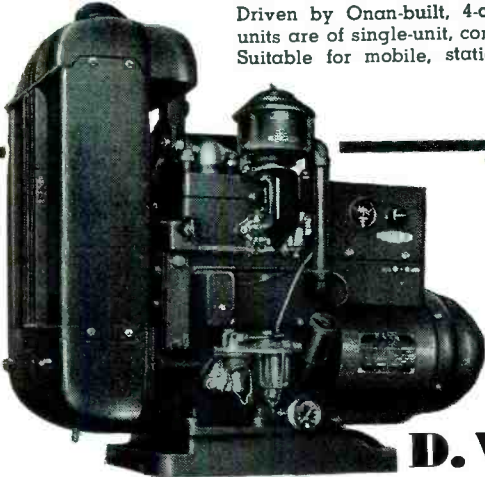

Models range from 350 to 35,000 watts. A.C. types from 115 to 660 volts; 50, 60, 180 cycles, single or three-phase; 400, 500 and 800 cycles, single phase; also special frequencies. D.C. types range from 6 to 4000 volts. Dual voltage types available. Write for engineering assistance or detailed literature.

Model shown is from W2C series, 2 and 3-KW, 60-cycle, 115 volt; powered by water-cooled 2-cylinder engine.

D. W. ONAN & SONS
MINNEAPOLIS 5, MINN.

2170 Royalston Avenue

International Short-Wave (Continued from page 44)

(NOTE: Regarding Radio Levant, frequencies are listed as 8.020, 8.030, and 8.035 by reliable sources, but the official schedules just received indicate a frequency of 8.110 (37 meters); this station has been operating with 3 kw. power, but hopes soon to increase its power to 10 kw., when it will operate in the 50-meter band, according to Swedish reports just received.)

NEWS FROM HCJB

From *Reuben E. Larson* of radio station HCJB, "The Pioneer Missionary Broadcaster," Quito, Ecuador, which station has been operated since 1931 by the World Radio Missionary Fellowship, Inc., comes word that "The Voice of the Andes" not only celebrated its 14th anniversary in December, but is now using 14 languages (the last to be added was German). HCJB has a tremendous worldwide audience.

Having received suggestions from listeners that they would like to help in making tests on the possibility of receiving the longwave and intermediate-wave transmission of HCJB, that station was on the air with music and special announcements, inviting all who wished an opportunity, to tune in to a special test program from 3 to 6 a.m. EST on February 3, on 308 m. (974 kcs.) and 73 m. (4.107). Those who sent in reports on this special transmission are to receive verification cards; HCJB verifies *all* correct reports.

By languages, Mr. Larson lists current schedules of HCJB as: Arabic—Saturday, 3-3:15 p.m. on 19-24-30 m.; Czech—Wednesday, 4:30-5 p.m. on 19-24-30 m.; Dutch—Sunday, 3-3:15 p.m. and Friday, 4:30-5 p.m. on 19-24-30 m.; French—Tuesday through Saturday, 4:15-4:30 p.m. on 19-24-30 m.; German—Sunday, 3:15-3:30 p.m. on 19-24-30 m.; Greek—Saturday, 3:15-3:30 p.m. on 19-24-30 m.; Italian—Saturday, 4:30-5 p.m. on 19-24-30 m.; Portuguese—Daily, 8:30-9 a.m. on 19-24-30 m.; and 8:30-9 p.m. on 24-30 m.; Quechua—Sunday, 8:30-9 a.m. on 73-308 m.; Saturday, 3:30-4 p.m. on 24-19-30 m.; Russian—Tuesday through Saturday, 4:00-4:15 p.m. on 19-24-30 m.; Sunday, 4-4:30 p.m. on 19-24-30 m.; Swedish—Sunday, Tuesday, Thursday, 4:30-5 p.m. on 19-24-30 m.; Yiddish—Sunday, 3:30-4 p.m. on 19-24-30 m.; English—Daily, 6:30-8 a.m. on 24-30 m.; additional on Sunday, 9-11 a.m. on 19-24-30 m.; daily, 5-6 p.m. on 19-24-30 m.; daily except Sunday, 9-10:30 p.m. on 24-30 m.; Sunday, 1:30-3 p.m. on 19-24-30 m. and 9-11 p.m. on 24-30 m.; Spanish—Daily, 6:30-8:30 a.m. on 19-73-308 m.; 6-8:30 p.m. on 24-30-48-73-308 m.; daily except Monday, 8:30-10:15 p.m. on 48-73-308 m.; Monday, 8:30-10 p.m. on 48-73-308 m.

English newscasts are scheduled daily for 5-5:05 p.m. (relayed from the

RADIO NEWS

WALSCO PRODUCTS

help the radioman

NEW LOW PRICED FLOCK FINISHING SET

Includes:

- Flock Spray Gun and Brush.
- 2 Colors of Flock, Undercoats, Thinner and Instructions.



Flock Gun and Flocking Material
Also Available Separately
For full information write Dept. RN



WALTER L. SCHOTT CO.
BEVERLY HILLS, CALIFORNIA • CHICAGO 5, ILLINOIS

HOPP Plastic RADIO DIALS

DIAL WINDOWS, NAME PLATES, SCALES, GAUGES, CHARTS, CALCULATORS, ETC.

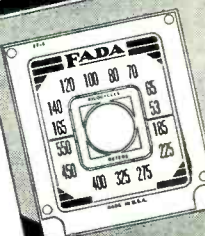

PLASTIC RADIO DIALS combine the beauty of radiant color with the utility of perfect light transmission. The possibilities of design, size, shape and color combination are limitless.

Whether your problem is dials, or any of hundreds of allied applications, let Hopp artists and engineers "sit in" on your designing problem.

Send us your blueprints or samples for quotation.

ESTABLISHED 1893
THE HOPP PRESS, INC.
460 W. 34th STREET, NEW YORK 1, N. Y.

United Network, San Francisco); and Spanish newscasts are (NBC) heard Sunday at 5 p.m.; daily at 7 p.m.; and daily except Sunday, 9 p.m. However, at 6 p.m. daily I have recently been hearing local news from the government of Ecuador read in *English* at 6 p.m. EST, also. (I have recently heard the 48-meter band transmitter around 10 p.m., some evenings in English, although it is scheduled in Spanish.)

Frequencies of HCJB transmitters were listed by Mr. Larson as: Local Longwave—308 m., 974 kc.; National Shortwave—73 m., 4,107 kc.; 48 m., 6,240 kc.; Continental Shortwave—30 m., 9,958 kc.; 19 m., 15,115 kc.; International Shortwave—24 m., 12,455 kc.

Mr. Larson pointed out that Quito Time is equivalent to EST.

* * *

SWEDISH SCHEDULES NOTED

From *Lennart Ekblom*, Stockholm, Sweden, comes the following schedules of the SW transmitters of The Swedish Broadcasting Corporation: Sundays—SBT, 15.155, 2:45-7:55 a.m.; 8:15 a.m.-2:15 p.m.; SBP, 11:705, 8-9 p.m.; 2:45-7:55 a.m.; 8:15-10 a.m.; SDB2, 10.780, 11 a.m.-5 p.m.; SBU, 9.535, 8-9 p.m.; 1:30-5 p.m.; Weekdays—SBT, 15.155, 6-6:50 a.m.; 10-11 a.m., 11:05 a.m.-1:15 p.m.; SBP, 11.705, 8-9 p.m.; 1:45-2:10 a.m.; 6-6:50 a.m.; SDB2, 10.780, 11:05 a.m.-5 p.m.; SBU, 9.535, 1:30-5 p.m.; 8-9 p.m.

Above schedules were as of December 8, 1945; it is reported in the East that SDB2 has been replaced by another transmitter, although frequency of this replacing transmitter was not reported.

Mr. Ekblom comments that The Swedish Broadcasting Corporation has not used QSL cards before, "but they will soon be ready to do so." He gives address as: *Sveriges Radio*, Stockholm, Sweden.

* * *

NEWS SCHEDULE OF "AIR"

Direct from All-India Radio, Delhi, we have received the following schedule of English newscasts: 5:30-6 p.m.—6.190, 7.210; 9:45-10 p.m.—6.190, 9.590, 7.275, 9.680; 10:30-10:45 p.m.—15.190, 15.160, 17.830, 15.350, 11.870; 12:30-1 a.m.—15.190, 15.350, 11.870; 1:30-1:45 a.m.—15.160, 17.830, 15.350, 11.870; 3-3:10 a.m.—7.290, 7.275, 15.290, 9.680; 4:30-4:45 a.m.—9.590, 7.290, 15.290, 15.350, 11.870; 6:30-7 a.m. (this period is titled "The Voice of Britain Calling the Far East" from Delhi)—9.950, 11.760, 15.160, 7.275, 15.350, 11.870. (Is heard well in most parts of the country on several of these frequencies.) 8-8:10 a.m.—4.960, 11.710, 7.275; 9:30-9:45 a.m.—7.290, 9.630; 10:50-11 a.m.—7.290, 6.190, 3.495, 6.100, 7.275, 7.240, 9.670; 11-11:10 a.m. (BBC news relay)—6.190, 7.210, 6.100, 7.240, 9.670.

According to *The Indian Listener*, official publication of "AIR," English newscasts are supplemented by news in Hindustani, Punjabi, Bengali, Tamil, Telugu, Malayalam, Marathi, Gujarati, French, Tonkinese, Cochinchina-

March, 1946

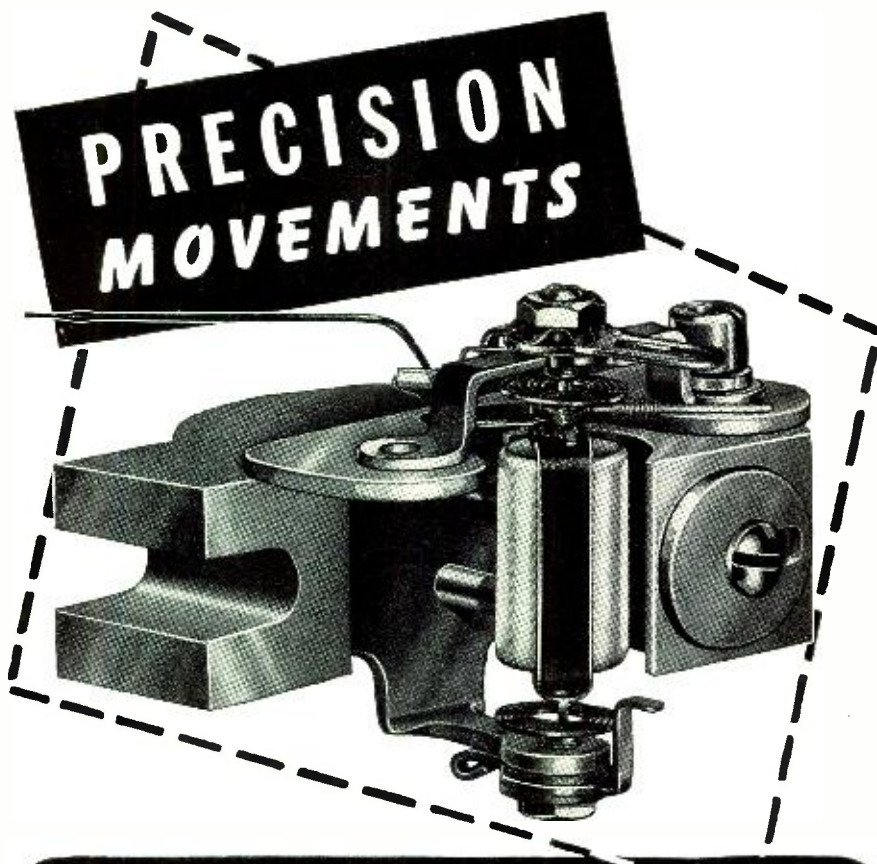

Burlington PANEL INSTRUMENTS



The heart of every Burlington Instrument — and the reason for its high degree of dependability — is the Burlington Precision Movement.

Design, material, and manufacturing processes are selected in such a manner that Burlington gives you a rugged instrument — which may be subjected to rough usage — and still retain its original calibration characteristics. All DC instruments employ Alnico magnets which are known to be more highly resistant to shock, heat, vibration, and stray fields than any other magnetic material.

All ranges AC & DC are available in 2½", 3½" and 4½" sizes, both square and round, flush mounting.

Engineering Service Furnished for Specialized Applications. No Obligation. Write Today for Further Information.

BURLINGTON INSTRUMENT CO.

903 FOURTH STREET BURLINGTON, IOWA

PANEL INSTRUMENTS • VOLTAGE REGULATORS • AUTOMATIC SYNCHRONIZERS • FREQUENCY REGULATORS



Something New... A Tube Cooler

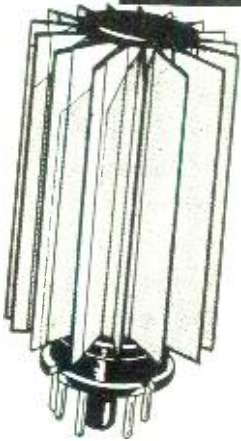

Here is a brand new idea in radio tube cooling. It is a high grade aluminum cooling device that is finned to operate much in the same manner as airplane engine cooling equipment.

Helps to reduce heat, increase efficiency and prolong life of tubes. Avoid hot spots. Available in standard radio tube sizes.

See it at your dealers now or write to **Terminal Radio**,
85 Cortland St., New York, or . . .

THE
Sharpnack Engineering Co.
Lincoln, Nebraska

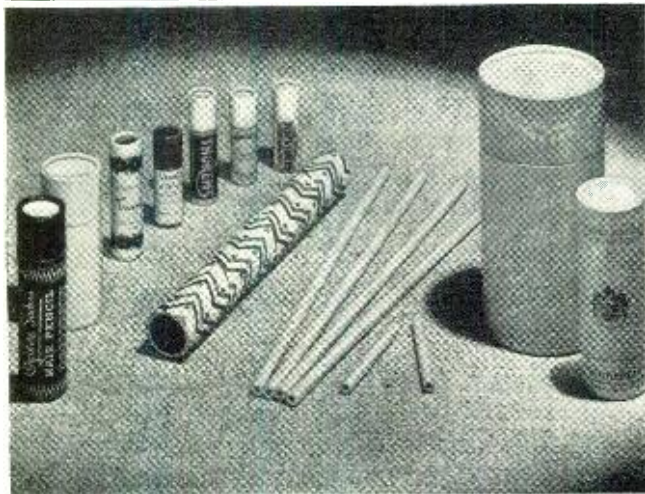

PAPER and TRANSPARENT TUBES for the RADIO and ELECTRICAL FIELD

Spiral wound—diameters 1/16" to 3". Exacting specification work in large quantity lots. Prompt delivery on Condenser Tubes, Socket Liners, Etc., Etc.

DIAMOND STRAW & MACHINE CO

114-116 East
New York



16th Street
N. Y.

nese, Burmese, Kuoyu, Amoy, Cantonese, Thai, Japanese, Italian, Pushtu, Persian, Afghan-Persian, Arabic.

CHINESE LIST

Ying Ong, Phoenix, Arizona, U.S. representative of the Central Chinese Broadcasting Administration (Chungking), has just sent us the following latest Chinese station list: XGOA, 5.918, Chungking, 7.5 kw., 7-8 p.m., with English news at 7:30 p.m.; 2-11:30 a.m.; XGOY, 11.900, Chungking, 35 kw., 7-8 p.m.; 5-6:30 a.m.; English news at 7:30 p.m. and 5 a.m.; XGOY, 7.153 and 6.128 (believed now to be changed to 6.134 or 6.135 to get out from under KRHO, Honolulu, on 6.120), Chungking, 35 kw., 6:35-10:30 a.m. in dual; the 6.128 (actually 6.135) transmitter continues to sign-off at 11:40 a.m.; XRRR, 10.260, 6.100, 7.380, Peiping, 10 kw. and 5 kw., no schedule given; XUPA, 9.695, Taiwan, 10 kw., 6-7:30 p.m.; 11 p.m.-12 midnight; 5-9:20 a.m.; XPSA, 6.990 (believed to be actually on 7.010), Kweiyang, 10 kw., 12:30-1:35 a.m.; 6:30-10 a.m.; XGOB, 9.540, Nanking, no schedule given; XORA, 11.780, Shanghai, 4 kw., 6:30-10 p.m.; 11 p.m.-10:30 a.m.; XGOL, 10.000 (reported to be actually on 9.997), Foochow, .2 kw., 11:30 p.m.-1 a.m.; 5-9 a.m.; XTPA, 11.650, Canton, 5 kw., 7-9:15 a.m.

English newscasts are listed for XGOY on 7.153 and 6.135 at 7:30 a.m. and 9 a.m. Other Chinese stations scheduled during the news period at 9 a.m. generally relay XGOY's English news at that time.

Mr. Ong listed BCB stations in China as XPRA, Kunming, 690 kc., 50 kw.; XMRA, Lanchou, 820 kc., 10 kw.; XGOB, Nanking, 680 kc., 10 kw.; XLPA, Changsha, 955 kc., 930 kc.; XLRA, Hankow; XKPA, Shansai; XOPB, Hangchow; XRPC, Tsingtao; XLPC, Nanchang, 1,080 kc., 3 kw.; Mukden, 1,080 kc., 100 kw.; and XGOG, Chengtu, 560 kc., 10 kw.

VPO DATA

From the engineer of Cable and Wireless (West Indies) Limited, B.M.L.A. Buildings, Beckwith Place, Bridgetown, Barbados, B.W.I., comes word that the VPO transmitters at Bridgetown are "occupied with telegraphy and inverted telephony" and "it is only when especially requested to broadcast that we do so, and then it usually takes the form of a programme transmission to the B.B.C."

VLA FREQUENCIES

Call-signs, wavelengths, and frequencies of the new VLA series of transmitters of Radio Australia now being used are: VLA, 41.21 m., 7.28; VLA4, 25.49 m., 11.77; and VLA6, 19.74 m., 15.20; location of these transmitters is Shepparton, near Melbourne, Victoria.

NEW

CKLO, 9.630 (31.15 m.), Sackville, N. B., is another station of the International Service of the CBC just added to the European Transmission, 3:15-7 p.m. EST; uses 50,000 watts power; news is at 4:45 and 6 p.m.; signals not too good due to interference. (Howe) The CBC's International Service is now sending out very attractive verification cards. (Gonder, Balbi)

Radio National Belge, Brussels, Belgium, 11.893 or 17.845 (heard lately on 17.845 *only*) has sent a verification; uses 5 kw. power, on 7-8 a.m., 11 a.m.-12 noon to Belgian Congo; studios and address for veris, Brussels. (Howe)

A number of new Chinese stations are now on the air; XGOL, listed as 10.000, Foochow, is reported heard on West Coast on an actual frequency of approximately 9.997. Changes in Chinese and Indian stations, in particular, are occurring almost daily. (Howe)

ZAA, 7.850, Tirana, Albania, is being heard to 3:20 p.m. and is in English, 3:10-3:20 p.m. (Howe)

Berlin, Germany, is being heard (since December 5), was on 6.080, but has moved to 6.030; Berlin is also reported on 6.220; both transmitters are believed to be in the Russian Zone of Occupation. (Howe)

NTH, Trondheim, Norway, 7,240, was on the air in December testing; may be heard again soon; operated by the Norwegian Technical University; verification card has been

received from this station. (Ekblom) Another Swedish report indicates this station has been testing, 8-8:30 a.m. and 5-5:30 p.m., asking for reports; also on 14.600, 8-8:30 a.m.; Swedish listeners report this station was also heard on 6.210 and that it announced as "Uksenderen N.T.H., Trondheim." (Howe, Skoog)

Call of Radio Congo Belge, Leopoldville, Belgian Congo, on 6.295, may be OTJ, heard weakly 11:30 p.m.-2 a.m. and 2-4 p.m.; OTM2 is the listed call of Leopoldville on 9.380; complete schedule of OTC, 9.745, also Leopoldville, is 1-4:30 and 5-11:45 p.m. with news in English at 7:15, 8:10, 9 and 11:30 p.m. (these last from the BBC). The correct call of the 17.770 channel of Leopoldville is OTC5, heard 5-9:30 a.m., 11:30 a.m.-1 p.m.; English news is heard at 8:30, 9:25, and 11:30 a.m.; fine signal here.

CE615, 6.152, Santiago, Chile, has returned to the air.

XGTA is the postwar call of Canton, China, on 11.650, not XGKO.

OLR3A, 9.550, Prague, Czechoslovakia, is reported with an evening transmission to North America, heard Thursdays *only*, 8-9 p.m. in Czech and English; comes on at 7:50 p.m. with "fish horn" identification. OLR4A, Prague, has irregular tests for the BBC, 9:30-9:45 a.m. on 11.840.

La Voce Dell' Italia, 6.025, Rome, is scheduled 6-8:15 a.m., 10:30 a.m.-1:30 p.m., 3-5 p.m.; heard well in East, coming on at 3:20 p.m. with bird chirping, quite good around 3:45 p.m.

The Tokyo transmitter on 6.015 (probably JLR) which has replaced JLG4, 7.550, relays WVTR with AFRN programs, 12 midnight-4 a.m.

CS2WI is the call of the Parede, Portugal, station on 12.400, according to a veri received by Swedish listener.

CHANGES

KRHO, 6.120, Honolulu, Hawaii, is now operating 5-10 a.m. (Howe)

The Paris Radio has made a number of changes recently; the North American Service is now being heard 8:55-10:35 or 10:45 p.m. on 11.845, 9.550 (new official frequency, this being the only schedule on this frequency), and 11.886. The 11.886 frequency is also heard to Latin America, irregularly, 6:30-8:40 p.m. and 5:30-6:15 a.m.; Paris is also heard on a new frequency of 11.705, 5:30-6:15 a.m. *Paris plans to install two new 100-kw. transmitters during 1946.* (Howe)

Cordoba, Spain, is being heard on 7.045, while Radio SEU, Madrid, is back on 7.107 from 7.135. (Howe)

XGOY, Chungking, China, which was buried under KRHO on 6.120 for awhile, returned to its old frequency of 6.135 on January 1, 1946. (Balbi)

CR6RC, Luanda, Angola, has moved to 11.002 from 11.735, heard 2-3:30 p.m. with 9.470.

LRX, 9.660, Buenos Aires, Argentina, signs off at 10 p.m. weekdays, heard going off at 10:40 p.m. on Saturdays with an English announcement followed by playing of a waltz.

March, 1946

Meet the Demand for Duotone's Duodiscs and Cutting Needles!



The mushrooming market in home-recording demands that all dealers be prepared to meet the needs of these enthusiasts. Give them the best—Duotone's Duodiscs for greater fidelity, longer wear and noiseless reproduction. Coated with nitrate on a base of aluminum, these Duodiscs will sell and then resell themselves. Follow up with Duotone Cutting Needles and you can't miss. Write now for specific prices and details.

RELATED PRODUCTS: *Duotone Hardening Fluid* which preserves the recording; the Duotone "Star" *Sapphire*; *Shadowgraphed Transcription Needles* for quality playbacks.

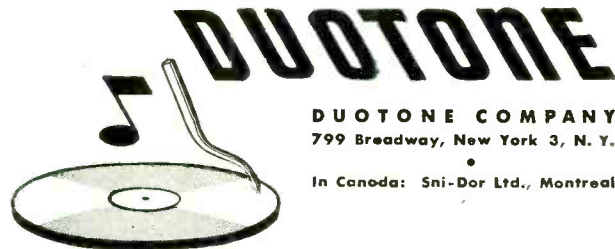

DUOTONE COMPANY
799 Broadway, New York 3, N. Y.

In Canada: Sni-Dor Ltd., Montreal

Latest schedule of Vienna, Austria, on 6.195, is reported as 12 noon-8 p.m.

COBQ, 9.250, Havana, Cuba, is on Sundays now to 2:05 a.m. when they sign off with "The Dance of the Hours." COCY, 11.740, Havana, was off during the evening for awhile—but is now heard again.

It is reported that TGX1, Guatemala, has moved from 6.188 to 7.012 on Saturdays only, 10 p.m.-2 a.m.

Latest frequency reported for CSW7, Lisbon, Portugal, is 9.730.

* * *

East Coast Report

Albert E. Bromley, Toronto, Ontario, Canada, reports ZOY, 7.050, Accra, Gold Coast, heard 2-3 p.m., weak; ZAA, 7.840, Tirana, Albania, heard

2:30-3 p.m., very weak; Sharq el Adna, 6.135, Jaffa, Palestine, 11 p.m.-12 midnight, fine signal; FXE, 8.020, Beirut, Lebanon, heard at 12:30 a.m., sign-off at 1:15 a.m. in French, good signal, also heard at 2:30 p.m. Douala, Cameroons, 11.525, heard once recently very weak at 2:50 p.m., blotted out by code at 3:05 p.m. Radio Rangoon, 6.040, Rangoon, Burma, heard at 6:50 a.m., off at 7:20 a.m., good signal. Radio Macau, 7.525, Portuguese China, heard with music at 7:25 a.m., soon was inaudible. ZBW, 9.470, Hongkong, Victoria, 8-8:45 a.m. in English, strong, English news heard at 8:35 a.m. VLW7, 9.520, Perth, Australia, 8:39-9 a.m., strong; VLA, 7.280, Melbourne, Australia, 9:15-9:47 a.m., fair; VLR,

9.580, Melbourne, Australia, heard at 6:15 a.m., fine signal. VLQ2, 7.215, Brisbane, Australia, nice signal at 6:33 a.m. PMH, 6.720, Bandoeng, Java, heard at 7:30 a.m. VUD6, 9.680, Delhi, India, heard at 7:53 a.m., excellent. ZRH, 6.028, Johannesburg, South Africa, heard 12 midnight-1:08 a.m., English at 12:15 a.m., weak. ZRK, 5.887, Capetown 3, South Africa, on at 11:45 p.m., much code interference. Ponta Arenas, Chile, 6.135, heard at 7:30 p.m. in Spanish, interference from Havana and is audible only when CHNX (Nova Scotia) is off the air. CR6RA, 9.470, Louanda, Angola, heard at 3:15 p.m., sign-off at 3:33 p.m., good signal.

Good DX reported by John J. Keran, Boston, Mass., includes Radio Eireann, 17.84, Eire, 12:40-1 p.m. with English news, sometimes clear; Radio Centre, 15.75, Moscow, 5:55-11:30 a.m. with English news at 6:40 a.m.; OLR2B, 6.037, Prague, Czechoslovakia, 2-5:15 p.m., with English news at 4:30-5 p.m.; HNU, 6.138, Baghdad, 9-11 a.m. in native language; FXE, 8.025, Beirut, Lebanon, 12:15-1:15 a.m., also heard at 11 a.m. with English news relayed from the BBC; Radio Macau, 7.525, Portuguese China, heard 4:30-9 a.m. on Thursdays and Saturdays, to 10 a.m. on Wednesdays and Fridays, with English news around 7:30-7:45 a.m. on Wednesdays and Fridays, clear at times but has had fade usually; TAP, 9.465, Ankara, Turkey, heard in Postbag Program Sundays at 4:30 p.m., and with English news daily at 12:45, 3:30 p.m.; EQC, 9.680, Iran, 2-3 p.m., with English news at 2 and 2:30 p.m., fair signal; Y15KG, 7.085, Baghdad, heard with English news from the BBC at 12 noon, getting better; SUZ, 13.825, Cairo, Egypt, heard 10:30-11:30 a.m. and with English news at 11:30 a.m., fair to good; VUD5, 11.79, Delhi, India, heard with English news at 7:30 a.m., good signal; CR7BE, 9.71, Lourenco Marques, Mozambique, very good this season, 1:30-3:30 p.m., has English news at 2:57 p.m.

Charles S. Sutton, Toledo, Ohio, sends tips on ZFY, 6.000, Georgetown, British Guiana, relays BBC news at 5:45 p.m.; PCJ, 15.220, Hilversum, Holland, heard 8-8:30 a.m. in Dutch with English program following to 9 or 9:30 a.m.; HVJ, 17.445, Vatican City, heard 10-10:35 a.m. on Tuesdays, English news, opens with chimes; CSW7, 9.730, Lisbon, Portugal, 7-8 p.m. in Portuguese; Radio France, 12.110, Algiers, heard well 12:30-1 p.m. in French, and later; VLC6, 9.615, Shepparton, Australia, 9-10 a.m. with English news at beginning and at 9:55 a.m.; Radio Saigon, 11.775, French Indo-China, heard 4:45 to 6 a.m. fade-out, has English news at 5:30-5:40 a.m.; ZPA5, 11.950, Encarnacion, Paraguay, heard 10-11 p.m., no English; Brussels, Belgium, 17.845, heard 11 a.m.-12 noon in French to Leopoldville; XEBR, 11.820, Hermosillo, Mexico, heard 10:30 a.m.-12 noon in Spanish; PZX5, 15.405, Paramaribo, Suriname, heard 11:30 a.m.-12 noon, no English, announce "Government

SPEED UP REPAIRS WITH THESE G-C AIDS!

Handle Dial Belt Replacements the Easy G-C Way!



1. To determine proper belt for any radio, G-C supplies a complete Belt Replacement Guide and Measuring Scale.
2. By using G-C Belt Guide, just check model number of the set to determine correct G-C Belt.
3. If you don't know model number or make of the set, use G-C Measuring Scale and simple instructions to measure belt.
4. Order belt by number from your radio parts distributor. Phone or mail your order to receive prompt service — no waiting.
5. Better still — have a complete G-C Belt Kit on hand. Belts are indexed in permanent steel box with slide-in drawer.

FREE TO ALL RADIO SERVICEMEN—68 page G-C No. 345 Belt Guide and Service Book and Measuring Scale. Ask for them at your Radio Parts Distributor.

Get "Smooth-Strong-Correct Fit" G-C Dial Belts from Your Radio Parts Distributor



GENERAL CEMENT MFG. CO.
ROCKFORD, ILLINOIS

UNIVERSAL
Model 501
RADIO TUBE TESTER

Advanced Styling — Finest Quality Materials and Workmanship.
Designed to give lasting service and priced to **SAVE YOU MONEY.**

WRITE TODAY for SPECIFICATIONS and PRICES.

Please rush me full details and specifications on UNIVERSAL Radio Service Instruments.

Name.....
Street.....
City.....

PRECISION ELECTRONIC INSTRUMENTS



UNIVERSAL INSTRUMENT CO.
306 E. McMILLAN STREET CINCINNATI 19, OHIO

Radio;" VUD5, 7.275, Delhi, India, heard in English and native, 9-10 p.m., with English news at 9:45 p.m.; Radio Tomario, ZYC8, 15.370, Rio de Janeiro, Brazil, heard 6-7 p.m. in Portuguese and Spanish; Radio Centre, 7.300, Moscow, heard with English news, 6:15-6:30 p.m. and later; Praia, 6.400, Cape Verde Islands, heard 4:30-5:30 p.m. in Portuguese *only*, with Portuguese news at 5:14 p.m., signs off with "Allo Bissau"; 1.U1M, 17.650, U.S.S. Iowa, heard 6:40-6:45 p.m. calling KU5Q for news relay.

Yves Dolbec, Montreal, Canada, reports HI1N, 6.245, Ciudad Trujillo, Dominican Republic, heard with news in Spanish at 10 p.m., good signal.

Glynn Moss, Preston, Ontario, Canada, reports that VONH, 5.970, St. John's, Newfoundland, with 300 watts power, sends out a very attractive veri, featuring a map of Newfoundland in blue; address is Broadcasting Corporation of Newfoundland, P. O. Box E5372, St. John's, Newfoundland. HI2A, Santiago de los Caballeros, Dominican Republic, which was on 7.085, moved to 6.80 in November; it mails its veri as a postal card which gives the station's frequency as 7.215; address is "Radiodifusora HI2A," "La Voz de la Reeleccion," Santiago de los Caballeros, Dominican Republic. HIT, Ciudad Trujillo, Dominican Republic, on 6.63 with 200 watts power, sent a "thank you" letter via airmail as a veri; address is Radiodifusora HIT, "El HIT del Aire," Apartado 1105. The Dutch-speaking station on 5.75 is PZH5, Paramaribo, Suriname, operating with 325 watts power; it sends out a veri with a picture of the Dutch flag and its transmitter building and aerials; address is "Governments Radio Dienst," Paramaribo. Mr. Moss comments, "I write all my reports to Spanish-speaking countries in Spanish and have always received prompt, courteous replies."

H. W. Hucker, North Bend, Ohio, reports VLG4, 11.84, Melbourne, Australia, signs off at 12:30 a.m.; FZI, 9.440, Brazzaville, French Equatorial Africa, heard well at 5:45 p.m.

REPORTS FROM ABROAD

Australia—*Rex Gillett*, DX Editor of "Radio Call," South Australia, reports a BBC news relay has been heard from Radio Singapore at 8 a.m. on 9.553 (31.40 m.), with good signal; a BBC news relay has been heard from Hongkong on 9.470 (31.68 m.) at 8 a.m. but with very poor signal strength. Jaffa, Palestine, was heard recently on 6.135 (48.90 m.) with what appeared to be a test transmission; between 2-3 p.m., a program of popular recordings was given, with lengthy English announcements each half hour; faded out at 3 p.m. Using Spanish, HVJ, Vatican City, has been heard on 5.968 (50.26 m.) to closing at 2:15 p.m.; this same channel was logged on another date reading English messages for Japan and China; this broadcast began at 2:15 p.m. Radio Belgrade, Yugoslavia, has been received about 7:45

March, 1946

Immediate Delivery!



AUTO-RADIO

Antennas

Insuline production has at last caught up with the first deluge of orders. Now you can expect—and receive—immediate delivery on your order for ICA Auto-Radio Antennas.

All of the new 1946 antennas are constructed of top-quality, chrome-plated admiralty brass which means they will remain rust-proof throughout their long lives. And because of the high standards of ICA engineering—developed over a period of almost a quarter of a century you are assured never-failing, rattle-proof performance.

So write, phone, or wire today for *immediate antenna delivery*. The Insuline Antenna Catalog and the 48-page Radio Parts Catalog are yours for the asking.

QUALITY PRODUCTS SINCE 1921

insuline



Insuline Corporation of America

INSULINE BUILDING • LONG ISLAND CITY, N.Y.



115

Highest Quality RADIO & ELECTRONIC TESTING EQUIPMENT

Immediate delivery from stock guaranteed

The New Model 447 AC-DC Multi- tester

Net Price **\$1795**



RANGES:

DC Voltmeter: 0-5-50-250-500-2500 volts
AC Voltmeter: 0-10-100-500-1000 volts
Output Voltmeter: 0-10-100-500-1000 volts
DC Milliammeter: 0-1-10-100-1000 milliamperes
DC Ammeter: 0-10 Amperes
Ohmmeter: 0-500-10000 Ohm, 1 Megohm
Decibel Meter: minus 8 to plus 55 Decibels

The New Model 448 Pocket Multitester

Net Price **\$2450**

RANGES:

DC Voltmeter: 0-5-50-250-1000 volts—first scale division —0.1 volt
AC Voltmeter: 0-5-50-250-1000 volts—first scale division —0.1 volt
Output Voltmeter: 0-5-50-250-1000 volts—first scale division —0.1 volt
DC Milliammeter: 0.5-10-100-1000 MA—first scale division —0.1 MA
Ohmmeter: 0/100, 0/10000, 0/1 meg, 0/1 meg.
Decibel Meter: —6 to 10—, —14 to plus 26, —23 to plus 40, —40 to plus 52DB



The New Model 705 Signal Gen- erator

Net Price **\$4950**

RANGES:

From 95 kc to 100 mc, continuously variable. Calibration accurate to 2% through broadcast bands, within 3% for high frequency bands. Planetary drive condenser, direct reading calibration, output modulated or unmodulated. Self-contained electronic modulation 400c sine wave available for external use. Special feature provided in having two degrees of modulation at both approx. 30% and 80%.



The New Model 802N Combina- tion Tube & Set Testers

Net Price **\$5950**

RANGES:

DC Voltmeter: 0/10/50/500/1000 at 1000 ohms per volt
Four Range AC Voltmeter: 0/10/50/500/1000
DC Milliammeter: 0/1/10/1000 DC Ammeter 0/10
D.B. Meter: —8/15/15 to 29/29/29 to 49/32 to 55 decibels
Four Range Output Meter—same as AC Volts



SUPERIOR Model CA-11 Signal Tracer.....\$18.75
SUPERIOR Model 1553 Volt Ohm Milliammeter..... 24.75
SUPERIOR Model PB-100 Volt Ohm Milliammeter..... 28.40
SUPERIOR Model PB-200 Multi Meter..... 35.75
SUPERIOR Model 450 Tube Tester..... 39.50
SUPERIOR Model 720 Multi Range AC Ammeter..... 49.50
SUPERIOR Model 400 Electronic Multi Tester McMurdo Silver Model 900 "VOMAX"..... 59.85
R.C.P. Model 315 Tube Tester..... 59.50
R.C.P. Model 488 Ultra-Sensitive Multitester..... 71.50
R.C.P. Model 805 Tube and Set Tester..... 89.50

Write for our new 12 page free catalog

Metropolitan

ELECTRONIC & INSTRUMENT CO.

Dept. R, 6 MURRAY STREET
NEW YORK 7, N. Y., U. S. A.
Phone: BARclay 7-5556

Cable Address: METRONICS

a.m. on 9.420 (31.85 m.) in a foreign language; station appeared to close at 8 a.m. Radio Omdurman, Anglo-Egyptian Sudan, is being heard in Australia at 12:30 p.m. announcing, "Good evening, everybody; this is Omdurman calling on 22.52 meters . . ." At this time (Thursday) a weekly ses-

Signal Shifter

(Continued from page 50)

With power applied and the cathode lead of the 6L6 opened, calibration of the unit should be checked. The band setting condenser C_1 should be used to fix the high frequency end of the band with the gang condenser at minimum capacity. Checking, by means of an accurately calibrated receiver, the bandspread should be approximately 80 degrees on the dial. With the 6L6 cathode connection closed, C_5 , and C_{15} should be adjusted so that the tuning of the two stages track.

A 25 watt lamp connected across the output of the two tip jacks which carry the r.f. from the link winding of the 6L6 should be lighted to almost full brilliancy. Output should be essentially constant over the entire range of the tuning condenser. In the event that the output falls off appreciably at any point it may be necessary to make some adjustments of the taps on the coils in the oscillator and buffer plate circuits.

If it is desired to use the 160 meter output of the unit, it will be necessary to neutralize the 6L6 buffer. This may be accomplished by removing the plate voltage from 6L6 and connecting a small flashlight lamp across the output terminals. C_{17} should be adjusted so that this lamp does not show any indication of output. If there is no need for 160 meter output, the neutralizing condenser C_{17} may be omitted. In the event that it is used, its adjustment is not critical and it will not be necessary to reset it for different frequencies.

When all the adjustments have been completed the unit should be allowed to thoroughly warm up and then checked for frequency drift. Stability should be attained in a maximum of 15 minutes. If the unit continues to drift after this time, some experimentation with C_5 , trying different temperature coefficient condensers in this position, may be necessary. When satisfactory stability has been attained, the oscillator should be calibrated.

If a frequency standard of some sort is available, this may be used in connection with an accurately calibrated receiver, zero beating the frequency standard and the oscillator.

Calibration marks may be made by means of a large darning needle inserted through the holes in the dial pointer. As many points as possible should be marked, and when completed, the paper scale removed and these various points inked in and

RADIO CHASSIS PUNCH



Saves hours of work cutting clean, accurate holes in radio chassis—for connectors and other receptacles. Simply insert cap screw in hole to be enlarged (drill small hole if necessary), turn with ordinary wrench to force punch through the metal. No reaming or filing—hole is smooth and clean. No distortion—die supports metal. Ten sizes from 3/4" to 2 1/4"; also up to 3 1/2" for meters. Write for free folder S-119 to Greenlee Tool Co., 1883 Columbia Ave., Rockford, Ill.

REGISTERED TOOLS
GREENLEE
FOR THE CRAFTSMAN

famous for

GREAT VALUES

Newly Released—A GREAT
"HAM SPECIAL"

We offer immediate delivery on—3000 V. Center-tapped plate Transformer, 350 Mills; Also 7 1/2 henry 400 mills choke. Both oil-filled; both made by Western Electric Co. to Signal Corps specifications.—

Both complete for **\$13.95**

F.O.B. New York City

Also a varied line of Test Equipment, Replacement Cabinets, Vibrators, Electrolytics, Tubes, Transformers, Soldering Irons, Radio Kits, Ham Supplies . . .

PLUS . . . hundreds of other items for every repair, maintenance, and experimental need. All items fully guaranteed . . . made right and priced right. We ship anywhere in the U.S.A.—promptly!

WRITE FOR OUR CATALOG NOW!

RADIO DEALERS SUPPLY COMPANY

135 LIBERTY ST., NEW YORK 6, N.Y.

marked with their respective frequencies. It is suggested that the lower frequency calibrations be placed on the outer scales with the high frequency ranges toward the center of the dial. In any event, band edges should be clearly marked, and preferably 100 kc. points indicated.

If rigidly constructed and accurately calibrated, the user will have a source of variable frequency output which compares favorably with the best units commercially available. Widespread adoption of this type of frequency control should do much to lessen QRM on the bands.

-30-

What's New

(Continued from page 64)

certain types of installations. The 3D23 may also be used as an oscillator or amplifier doubler.

Inquiries for further information on this tube should be addressed to *Lewis Electronics*, Los Gatos, California.

QUARTZ CRYSTAL

The development of a new midsize, shock-proof quartz crystal, known as the type HI5, has been announced by *The James Knights Company* of Sandwich, Illinois.

This new crystal, complete with phenolic holder and weighing less than 1/5 of an ounce, has tinned pig-tail connections which may be readily

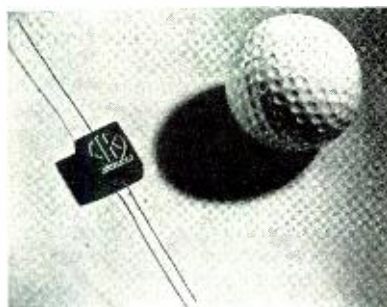

soldered into the circuit. Actual size of the unit is .600" x .725" x .350" and is dust-proof and moisture resistant.

Available frequency range is from 3000 kc. to 15,000 kc. to customers specifications. Frequency tolerance is .01% over a temperature range of 0° C. to 70° C.

POCKET MULTITESTER

Radio City Products Company is now offering a new model 448 pocket multitester featuring six testing instruments of high accuracy in one compact metal case.

A 3" square meter is used for easy reading with a movement of 200 microamperes and a sensitivity of 5000 ohms-per-volt. Ranges of multitester are: d.c. voltmeter 0-5-50-250-1000 volts, first scale division, 0.1 volt; a.c. voltmeter 0-5-50-250-1000 volts, first scale division, .1 volt; output voltmeter 0-5-50-250-1000 volts, first scale division, 0.1 volt; d.c. milliammeter

March, 1946

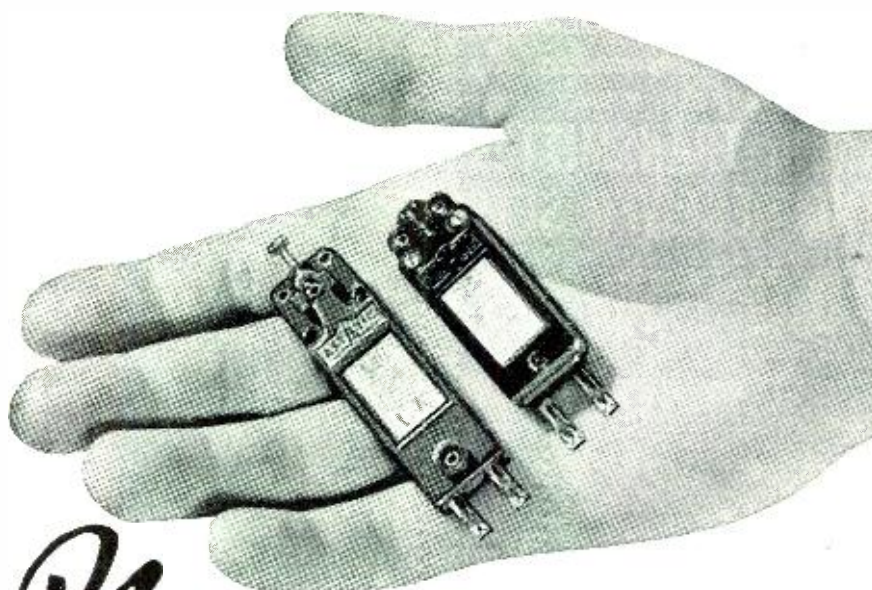

New Astatic Cartridges

Improve Phonograph Reproduction

INTENDED for use with both automatic record changers and manually operated equipment, these new Astatic Cartridges, in MLP and L-70 Series, assure a degree of fidelity heretofore unparalleled in the reproduction of recorded sound. All new Astatic Phonograph Pickup Arms will include these finer Cartridges.

L-70 Series Cartridges are of the replaceable needle type, are designed with streamlined housing, high output voltage and low needle pressure.

MLP Series Cartridges are of the permanent or fixed stylus type and are engineered to operate at one-ounce pressure, with increased vertical compliance, higher output voltage and reduced needle talk.

"You'll HEAR MORE
from Astatic"

• Astatic Crystal Devices
manufactured under Brush
Development Co. patents.

THE
Astatic
CORPORATION
CONNEAUT, OHIO

IN CANADA. CANADIAN ASTATIC LTD., TORONTO, ONTARIO

Available Immediately

PORTABLE, 2 WAY

RADIO TRANSMITTER AND RECEIVER SETS

No. SCR-583

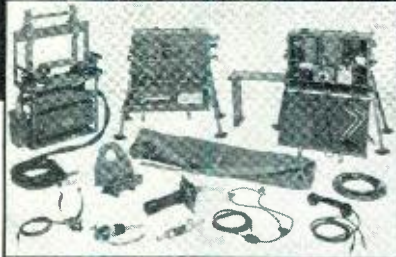

COMPLETE with War Dept. Manual and READY TO OPERATE ...

For pack, vehicular or ground operation. Entirely waterproofed; can be operated in driving rain. Power output up to 40 watts. Distance range to 80 miles. 12 Transmission Bands, Frequency range from 2.2 to 4.6 mc. Receiver 2.2 to 4.6 mc.

Government paid Approx. \$1775 for set ...
OUR PRICE while quantity lasts

\$215⁰⁰

Plus Crating
F. O. B. Chicago

EQUIPPED WITH

- Radio Transmitter and Receiver Set with Tubes
- Accessory Chest
- Antenna and Roll Bag
- Power Unit and Power Converter Unit
- Mast Bracket
- Head Sets
- Built-in Speaker
- Microphones
- Hand Sets
- Plugs
- Cables
- Code Key

ONLY 11 LEFT

LEONARD ASHBACH

Company

ELECTRONICS DISTRIBUTORS

Phone WHitehall 2065

152 W. HURON ST. • CHICAGO 10, ILL.

New Detector on Pocket Radio Developed



Advanced circuit with new Detector gives HIGHER EFFICIENCY. Sensational. ENERGY wasted by former circuits USED by Detector. Tremendous performance; plays BETTER than any batteryless radio in the world. Old-time radio men thrill to Detector's high efficiency. Ideal for experimenters, campers, shut-ins, auto cabins, etc. Complete. Send \$1 check or m.o. On arrival pay postman \$2.99, plus delivery fee for kit with instruction book. We assemble and wire for 99c additional. Address: Laboratory,

R. G. Middleton, 47-25 44th Street
Woodside, Long Island, New York

.5-10-100-1000 ma., first scale division. .01 ma; ohmmeter 0/1000, 0/10,000. 0/1 meg, 0/1 meg; decibel meter - 6 to + 10, - 14 to + 26, - 28 to + 40, - 40 to + 52 Db.

Db. range is calibrated for a line of 500 ohm impedance. For lines of other impedance, correction charts are supplied. The model 448 pocket multi-tester weighs only 1 1/4 lbs., and is complete with self-contained batteries, ready to operate in snap spring contact holders.

This instrument is the product of Radio City Products Company, 127 W. 26th Street, New York City.

DECI. POINT SLIDE RULE

Pickett & Eckel, Chicago, announce a revolutionary Deci. Point Slide Rule which places the decimal point "mechanically" for the result, as well as for the square root, cube root, and logarithm of the result, which are all obtained at the same time. The rule is further described as determining the precise location of the decimal point in involved expressions with results up to 19 places, giving 30-inch scale accuracy for cube-root, and 20-inch scale accuracy for square root.

The slide rule is manufactured of light-weight Dowmetal, which permits machining to very close tolerances and is unaffected by climatic conditions of heat, cold, or moisture, and will main-



tain its accuracy under difficult conditions. The Dowmetal core is surfaced with flat white plastic, on which the scales are placed by a special process to insure accuracy and legibility. The slide rule is 12 1/2" long and 2" wide.

An easy-to-understand manual provided with each slide rule covers all phases of slide rule operation, as well as decimal point location. In it, the mathematical theory of mechanical decimal point location is also covered for the benefit of advanced mathematicians.

Details of this instrument may be obtained from Pickett & Eckel, 53 West Jackson Boulevard, Chicago 4, Illinois.

RADIOTELEPHONES

Jefferson-Travis Corporation has announced its new postwar 1946 line of aircraft, marine, and mobile radio communications equipment.

Among the models announced is the new 25 watt postwar Coastal Model 252 Radiotelephone designed to meet the new requirements of pleasure yachtsmen and operators of commercial boats. All channels are crystal controlled and separate holders are used for both transmitting and its complementary receiving crystal. Me-

chanically interchangeable self-contained power supplies make possible use of the same set for either 12, 32 or 110 volt d.c. or 115 volt a.c. opera-

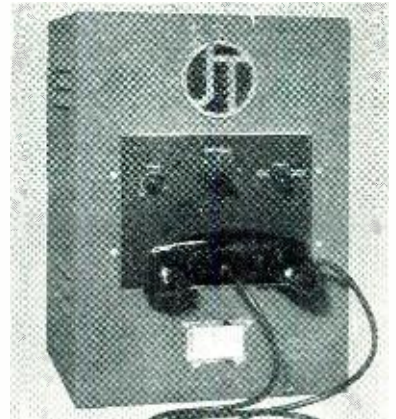

tion. Also scheduled for early production is the new 15 tube superheterodyne communications receiver covering the bands from 540 kc. to 32 mc. Other models include a four channel, 10 watt and a 10 channel, 75 watt set. A sturdy, compact combination marine direction finder and receiver and marine antennas complete this postwar line of marine radiotelephones.

Jefferson-Travis Corporation maintains a show room at its offices at 245 East 23rd Street, New York City.

SIGNAL TRACER

A new lightweight signal tracer which will give audible or visual indication of any signal at any point in a receiver from the antenna post to voice coil is being announced by Special Products Company.

Tradenamed "Speco Signal Tracer" this unit is simple to operate. The probe is a detector and sensitive r.f. and a.f. amplifier with a low capacity input and variable gain control. It is used in connection with an amplifier and obtains its power from that unit, utilizing the power tube and loudspeaker of the amplifier to make audible the signals coming from the radio being tested. Noise can also be detected in parts of a receiver not car-



rying the signal and noisy resistors, transformers, condensers or defective solder joints can be easily located.

The complete unit includes the amplifier with the tracer probe, although the tracer probe may be purchased separately. The complete unit is Model

RADIO NEWS

STAP, while the probe alone is Model STP.

For complete details of this unit with prices and delivery information, write *Special Products Company*, 9115 Brookville Road, Silver Spring, Maryland. P.O. Box 471.

TABLE MODEL RADIO

The first post-war radio off the production line at *Packard-Bell* is the 551 D which will be available in three different cabinet finishes: walnut, bleached wood and light leatherette, the latter two models with plastic trim.

The receiver is a five tube a.c. set equipped with a transformer. A five inch permanent magnet speaker is one of the features of this unit. A plastic handle is included for easy transportation of the receiver and conceals the tuning and station locator knobs.

Tubes are changed from the bottom without the necessity of removing a screw. The OPA approved price for



this receiver is \$34.90. The leatherette and bleached wood models are a dollar extra.

This receiver is manufactured by *Packard-Bell Company*, P.O. Box 3219, Terminal Annex, Los Angeles, 54, California.

-30-

350 Watt Transmitter

(Continued from page 43)

left to right, oscillator cathode switch, crystal selection switch, grid meter switch, plate meter switch, and keying jack. Placement of parts on the chassis is clearly indicated in the pictures. After the picture was taken, the 100-TH socket was mounted 1¼" below the chassis on pillars to reduce the length of the plate lead, but no improvement was noted, even on 28 megacycles. Short leads between the amplifier coil and condenser are assured by mounting the coil on the condenser with a pair of brackets cut from scrap aluminum, which make the connections as well as support the jack bar. The swinging link assembly mounts on the inner side of the coil on a piece of polystyrene bolted to the jack bar, with the center of the shaft about 1¼" from the center of the jack bar. This link assembly, as received from the manufacturer, consists of a 4" and a 2½" coil concentrically wound. They

March, 1946

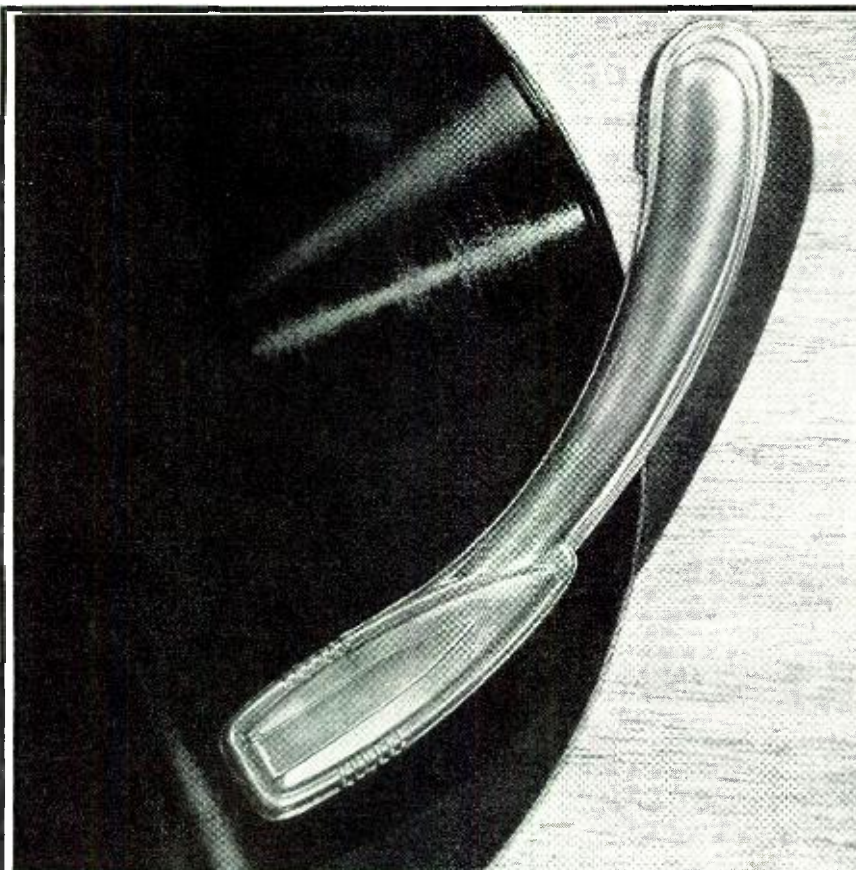

What you should know about the SHURE *Glider* Phonograph Pickup

<i>What is the "Glider" Pickup?</i>	The "Glider" Pickup is a lightweight, low mass Tone Arm with the new Shure Lever-Type Crystal Cartridge.
<i>How is low mass achieved?</i>	The arm is aluminum. It uses no counterweights or springs. It has a needle force of only 1½ ounces.
<i>What is meant by Lever-Type Cartridge?</i>	The Crystal is driven by a lever which improves the transmission of needle chuck torque into the Crystal. This results in higher output and greater lateral needle point compliance. It absorbs full impact of sudden jars to the Cartridge or needle, minimizing Crystal strain or breakage.
<i>What is its output voltage?</i>	The various types range from 1.6 volts to over 3 volts.
<i>What are its playing qualities?</i>	High needle point compliance affords faithful tracking which results in clearer, fuller tone qualities. Lightness means longer record life. The "Glider" is less susceptible to floor vibrations, improves playing of warped records and is especially suitable for Vinylite records.

MODEL 93A — \$5.50 LIST

Immediately Available at Shure Distributors Everywhere
Patented by Shure Brothers. Licensed under the Patents of the Brush Development Company

SHURE BROTHERS

Designers and Manufacturers of Microphones and Acoustic Devices

225 West Huron Street, Chicago 10, Illinois
Cable Address: SHUREMICRO



NOW—A REALLY HIGH-POWERED— Radio Engineering Library

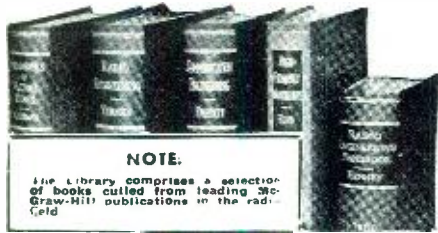

NOTE.

The Library comprises a selection of books culled from leading McGraw-Hill publications in the radio field.

- especially selected by radio specialists of McGraw-Hill publications
- to give most complete, dependable coverage of facts needed by all whose fields are grounded on radio fundamentals.
- available at a special price and terms

THESE books cover circuit phenomena, tube theory, networks, measurements, and other subjects—give specialized treatments of all fields of practical design and application. They are books of recognized position in the literature—books you will refer to and be referred to often. If you are a practical designer, researcher or engineer in any field based on radio, you want these books for the help they give in hundreds of problems throughout the whole field of radio engineering.

5 VOLUMES, \$559 PAGES, 2558 ILLUSTRATIONS

1. Eastman's FUNDAMENTALS OF VACUUM TUBES
2. Terman's RADIO ENGINEERING
3. Everitt's COMMUNICATION ENGINEERING
4. Hund's HIGH FREQUENCY MEASUREMENTS
5. Henney's RADIO ENGINEERING HANDBOOK

10 days' examination. Easy terms. Special price under this offer less than books bought separately. Add these standard works to your library now; pay small monthly installments, while you use the books.

10 DAYS' FREE EXAMINATION—SEND COUPON

McGRAW-HILL BOOK CO.,
330 W. 42nd Street, New York 18, N. Y.

Send me Radio Engineering Library, 5 vols., for 10 days' examination on approval. In 10 days I will send \$3.00 plus few cents postage, and \$3.00 monthly till \$24.00 is paid, or return books postpaid. (We pay postage on orders accompanied by remittance of first installment.)

Name

Address

City and State

Company

Position #N-3-45

ATTENTION! HAMS!

ECLIPSE PIONEER DYNAMOTORS

INPUT		OUTPUT	
E / I		E / I	
14 v.	3a	220 v.	.08a
14 v.	5a	345 v.	.135a
14 v.	8a	425 v.	.136a
14 v.	6.2a	330 v.	.170a
28 v.	3.1a	330 v.	.170a
28 v.	4a	420 v.	.163a

AVAILABLE AT
\$10.00 each

DAVID ELLIS, INC.
64 FULTON STREET, N. Y. 7, Dept. RNI

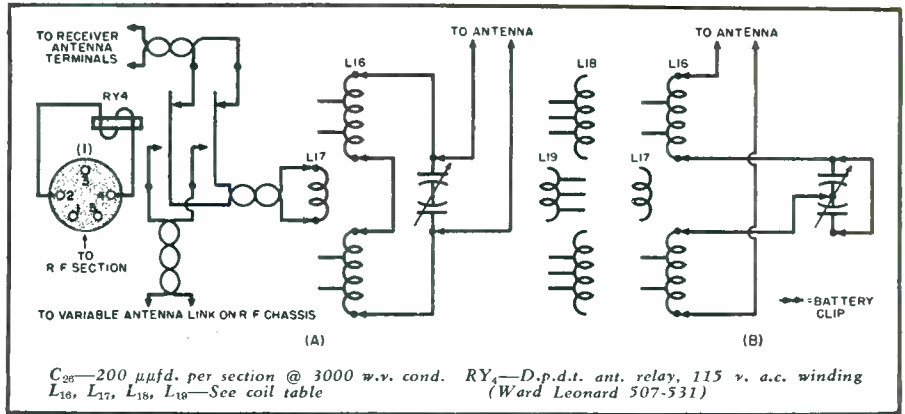

Fig. 4. Diagram of the antenna tuner. Socket #1 connects to socket #1 of the r.f. section, Fig. 3. A two wire cable is used, connecting these sockets.

are removed, and a three turn coil, 2½" in diameter substituted.

The 3.5 megacycle crystal is under the oscillator coil assembly, but no ill effects result, because when this crystal is used the coils are not.

Wiring is straight-forward. All leads that go through the chassis are protected from abrasion by rubber grommets. Each meter does double duty, being switched from one circuit to the other with a toggle switch. Putting them in the low voltage side of the lines eliminates the danger of getting a shock from the zero adjusting screws. Resistors across the switch terminals complete the circuit when the meter is in the other position, or if it should burn out. The oscillator is not metered, because its plate current never goes above a safe value, and it can be tuned by observing the grid current of the 807. Although very little deflection is obtained on the meter in this position, it is sufficient for proper adjustment of the oscillator.

Filaments of the 6V6 and 807 are heated from the filament winding of the bias transformer, which is wired so the 100-TH is biased at all times

the filaments are on. Allowing these filaments to float eliminates the possibility of cathode to filament breakdown when the key is up.

Building the antenna tuner on a flat metal sheet supported by chassis mounting brackets, 3½" up from the bottom of the 10½" panel allows more room to change the final amplifier coil than if a conventional chassis was used. As can be seen the condenser mounts in the center with a coil on each side. The antenna relay is directly over the tank coil underneath the metal sheet. Two pairs of feed-through insulators bring the link and receiver antenna leads to the top of the chassis. Heavy, flexible, high-voltage wire and copper battery clips are used for connections between the coils and other components.

The speech amplifier is built on a chassis, 3" x 3⅜" x 17" made by cutting a 3⅜" width from a deeper chassis, and mounting it by the lips of what was formerly the bottom of the 3½" panel. The power transformer is in the middle with the low level stages on one side, and the 6A3's and 5U4G on the other. All wiring, except to the

Antenna tuner chassis. Various tuning combinations are made by flexible leads.

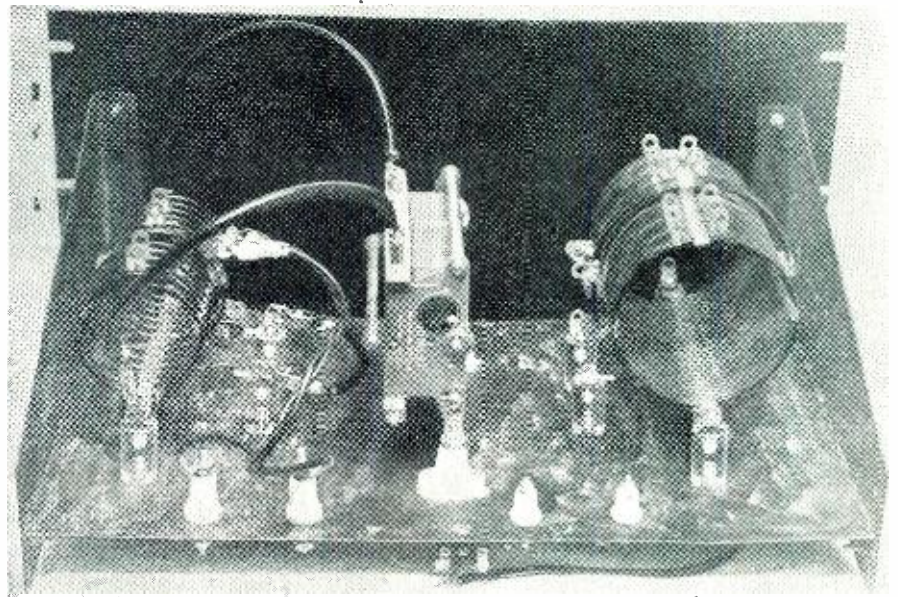

microphone connector, is completed before the panel is mounted. Great care should be taken to shield carefully the input circuit of the 6SJ7, including the r.f. choke and 50 μ fd. bypass condensers. A piece of copper slightly wider than the length of the choke was bent so it covered the choke and condensers, and was bolted to the chassis. The choke was wrapped with tape to prevent shorting. It is a good idea to shield the plate lead of the 6SJ7 and the grid leads of the 6K7 and 6SQ7; although they are not nearly as sensitive to hum and feed-back as the input leads.

The modulator is built on a 17" x 8" x 3" chassis, with a 12 $\frac{1}{4}$ " panel. The modulation transformer is mounted so the terminals protrude through the chassis. Choose taps to match an r.f. load of 9,000 ohms to the 16,000 ohms, plate-to-plate of the 811's. The shorting relay is mounted under the chassis, and the contacts connect directly across the output terminals. A step down ratio of five to one, primary to half the secondary, is used in the driver transformer. Once again the meter is placed in the B-negative lead, with a resistor across it for protection if the meter should burn out.

Careful layout is necessary to get all components for the r.f. power supplies on one chassis. They are built on a heavy duty chassis, 17" x 13" x 4". Parts are mounted to give maximum ventilation to the rectifiers and bleeder resistors. All filter chokes and filament transformers are mounted underneath the chassis. Relay, RY₁, is fastened to the chassis bracket above the filter condensers. The modulator supply is built on a 17" x 10" x 3" chassis. The relay in the center of the chassis is RY₂, which breaks the high voltage lead of the speech amplifier.

Power connections between chassis are by means of cables with plugs on each end.

Tuning is simple. For first adjustment the modulator and high voltage power supply should be off. Place a coil in the final amplifier. Remove the high voltage lead from the r.f. chassis. Set the slider of the oscillator dropping resistor to about three-quarters resistance. Turn the oscillator and buffer band switches and the crystal selection switch to the proper position.

TRANSMITTER CONTEST EXTENDED

THE closing date of the 1st Annual All Amateur Transmitter Contest has been extended to March 15, 1946, to permit additional entries from amateurs all over the country.

Two prizes, one in each of two classes (1 to 250 watts input power to the final amplifier, and 251 to 1000 watts input to the final amplifier) are to be awarded by Taylor Tubes, Inc. Each prize consists of the prize-winning transmitter built to the contestant's specifications, delivered to the contestant's home free of all charges.

Detail of the contest can be secured by writing Magazines, Incorporated, 188 West Randolph Street, Chicago, Illinois.

-50-

March, 1946



**IF IT'S ELECTRICAL
... AND IF IT ROTATES**

Check with **EICOR**

A roster of all Eicor products, in their various types and sizes, shows an astonishing number and diversity. But of special interest to users of rotary electrical equipment is our ability to produce units unusual in design or performance . . . and do it quickly, accurately, and at reasonable cost.

Serving in an endless list of special applications, these developments include . . . the smallest commercially produced dynamotor, for 10 watts continuous output, in a 2-5/16" diameter frame and weighing only 34 ounces . . . a motor rated 1/5 hp at 3800 rpm for intermittent duty, 2-5/16" in diameter, weight 38 ounces . . . an aircraft inverter to supply output of 100 va, 400 cycle, single or three phase, in a 3" frame and unit weight of 5 $\frac{3}{4}$ lbs. . . a .6 hp, 4000 rpm, intermittent duty motor, 4" in diameter and 9 $\frac{1}{2}$ lbs. weight . . . a dynamotor 4-1/16" in diameter which supplies 32 watts continuous output per pound weight . . . a 12 vdc motor rated $\frac{1}{4}$ hp at 1700 rpm with 150 in. lbs. lock torque in a 5 $\frac{1}{4}$ " frame.

These highlights are an indication of what EICOR has done in the past. In the days to come our creative engineering will solve similarly difficult problems involving motors, dynamotors, and generating equipment for industry. Your inquiry is invited.



EICOR, INC. 1501 W. Congress St., Chicago, U. S. A.
DYNAMOTORS • D. C. MOTORS • POWER PLANTS • CONVERTERS
Export: Ad Aurema, 89 Broad St., New York, U. S. A. Cable: Aurema, New York

CLARK PA-30 AMPLIFIER



With patented electronic equalization providing both bass and treble boost and attenuation over range of -12 db to +18 db.

Frequency Response— ± 2 db, 50-10,000 Cycles. Overall Distortion—Less than 5%. Hum—55 db Below Full Output. Finish—Metalized Bronze Gray.

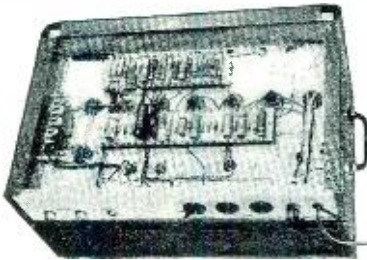

CLARK RADIO EQUIPMENT CORP.
4313 North Lincoln Avenue
Chicago 18, Illinois

SUPREME PUBLICATIONS

These are the practical radio manuals you need. Improve your radio knowledge. Speed up service work. Check manuals you want, write name below, and send this entire ad. as your order.

MOST-OFTEN-NEEDED DIAGRAM MANUALS



Use these diagram manuals to find all radio faults quickly. These large, inexpensive circuit manuals have the data for all popular sets.

- 1942 Manual, 192 pages.....\$2.00
- 1941 Size: 8½x11 inches..... 2.00
- 1940 Manual, 208 pages..... 2.00
- 1939 Manual, 192 pages..... 2.00
- 1926-1938 Manual, 240 pages. 2.50

OTHER TECHNICAL RADIO BOOKS



- Radio Servicing Course. 22 lessons. New edition. 224 pages, 8½x11"..... **\$2.50**
- Record Players & Recorders. All makes, diagrams, charts. 128 pages, 8½x11"..... **\$1.50**
- Practical Radio Mathematics. 25c
- Refrigeration Manual..... \$1.00
- Cyclopaedia of Television..... 40c
- Practical Radio & Electronics Course. 53 lessons.....\$3.95

- Radio Repairing with Substitute Parts.....25c
- How to Use Diagrams in Radio Service.....10c



- Simplified Radio Servicing by Comparison Method

New, revolutionary different method makes radio repairing twice as easy. Introductory treatise included. Simple picture suggestions tell you where to look for faults and how to make the repair. No testers needed for most jobs. With job-sheets, blue-prints, ideas, hints..... **\$1.50**

SUPREME PUBLICATIONS, 9 S. Kedzie, Chicago 12, ILL.

Check manuals wanted, send remittance with complete advertisement or write order in a letter. Books sent post-paid. Money back guarantee.

Name

Address

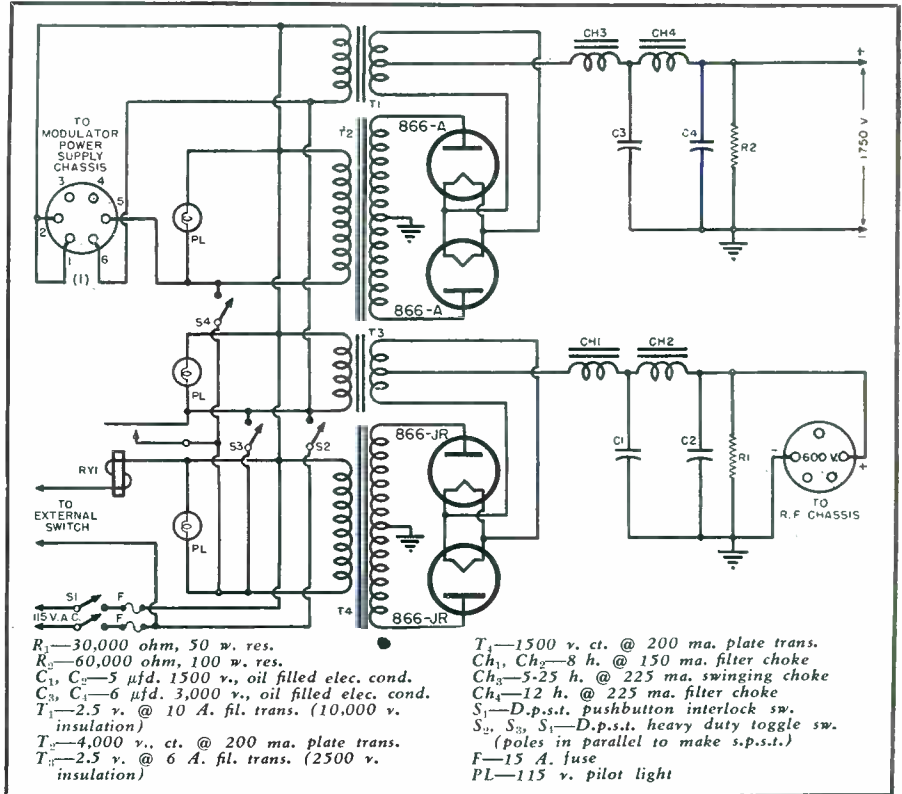

Fig. 5. Circuit diagram of the r.f. power supplies. Socket #1 connects to socket #1 of the modulator power supply, Fig. 6. The socket for the 600 volt output connects to socket #2 of the r.f. unit, Fig 3.

tions. Put the meters in the 807 plate and grid circuits. After allowing the filaments to warm up thoroughly, turn on the exciter power supply and resonate the plate circuit of the oscillator as indicated by maximum grid current on the 807. Then resonate the 807 plate circuit as indicated by a dip in its plate current as the condenser is tuned. Do not let the 807 operate any

longer than absolutely necessary with its plate circuit out of resonance, or the tube may be damaged. Flip the grid meter to the 100-TH, where it should go off scale if a 50 milliamperemeter is used. (Actual current should be 65 to 70 milliamperes.)

Unless the 100-TH should be accidentally neutralized, turning the final tank condenser should cause the grid

Rear view of modulator chassis. High voltage leads go to standoff insulators at left.



current to drop sharply at resonance. The oscillator plate condenser may be detuned slightly to bring the 100-TH grid current on scale. Adjust the neutralizing condenser in small steps until the deflection is eliminated. When this condition is reached the condenser may be locked. At this time remove the tubes from the exciter and from the bias supply, and connect the exciter supply temporarily to the 100-TH with the meters in the 100-TH plate and grid leads. No grid current should flow, nor should the plate current vary as the amplifier or buffer tuning condensers are turned. In the unlikely event that parasitics should be indicated, the trap shown in dashed lines should eliminate them.

Replace the tubes in the exciter and bias supply, but leave the low voltage supply connected to the amplifier as well as to the exciter. Connect a dummy load—a pair of 150 watt bulbs in series work well—to the antenna coupling link, and tune the amplifier to resonance. Coupling is adjusted until the stage draws about 65 milliamperes. Now connect the regular power supply. Assuming 1750 volts, the plate current will be approximately 200 milliamperes, and the output 250 watts. 100-TH grid current should be approximately 45 milliamperes, any value between 40 and 50 milliamperes being satisfactory. An input of 40 to 45 watts to the 807 will supply the required grid drive. No load minimum plate current of the 100-TH will vary between

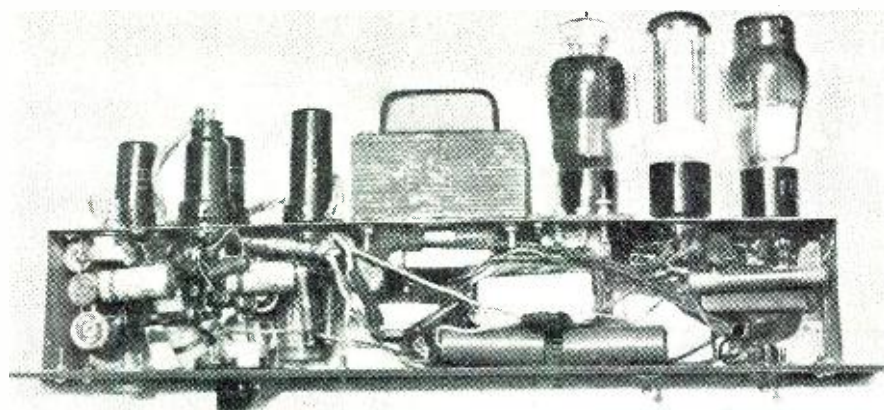

Under chassis view of speech amplifier. Schematic diagram is shown on page 41.

approximately 25 milliamperes on 3.5 megacycles and 75 to 80 milliamperes on 28 megacycles. At this time adjust the resistance of the oscillator dropping resistor so the 807 grid current is two or three milliamperes when tripling to 21 megacycles in the oscillator. The current is reduced to the optimum value on 7 and 14 megacycles by slightly detuning the oscillator.

With the dummy antenna still connected, turn on the modulator and speech amplifier. While listening to the signal in a monitor advance the gain control until modulation is 100%. Then turn on the compressor, and advance the compressor control until the modulation "blocks." Now carefully re-

tard the control until the modulation is clean, although at a lower level. Adjustment is completed by again advancing the gain control until modulation is 100% on peaks.

There are so many combinations possible with the antenna tuner that they can be better learned by experiment than by explanation; however, Figs. 4A and 4B show connections for feeding a balanced feed line with low-C parallel and high-C series tuning. Incidentally, the smaller coil may be used on all bands except 3.5 megacycles. The receiver can be used to familiarize one's self with the tuner; any combination that will peak received signals is correct for the trans-

Fahnestock Clips

RADIO'S GREATEST CONVENIENCE

FAHNESTOCK SPRING BINDING POST GRIPS THE WIRE BY THE ACTION OF A SPRING



No tools required to make the connection. Grips the wire with just the right pressure for good electrical contact. Simply press down, insert the wire and let go. Does not injure wire, hence connection can be made or opened as often as desired. Available in large variety of types and sizes to fit any radio purpose and any requirement as to position, space or method of attachment. You will find them in the better sets.

Positive contact; cannot jar loose. Brass or bronze—nonrusting.

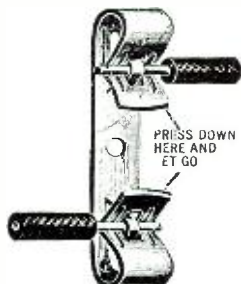
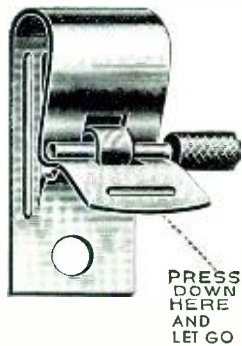

FAHNESTOCK ELECTRIC COMPANY, Inc.

46-44 ELEVENTH STREET
LONG ISLAND CITY 1, N. Y.

Please send us at once, Descriptive Literature, Prices and Delivery Schedule on

FAHNESTOCK CLIPS

For

Name

Address

City..... State.....

MORE SMASH BUYS at National Radio Distributors

IMMEDIATE DELIVERY

RMS REPLACEMENT CABINETS



PA-10 portable electric phono for 10-inch records and 5-inch speaker **\$7.75**
 PA-12 portable electric phono for 10-in. and 12-in. records and 6-inch speaker..... **\$9.95**
 PAC-100 portable automatic record changer (will accommodate any make)..... **\$8.95**

Replacement Cabinets to Suit Any Requirement.

WESTINGHOUSE EQUIPPED FLUORESCENT LIGHTS

2-light 20-watt kitchen unit ready to plug in **\$5.25** ea. In lots of 10..... **\$4.77**
 2-light 40-watt standard industrial fixture 48 inches long **\$11.95** each. In lots of 10..... **\$11.25**

Prices do not include lamps.

Also Fluorescent Desk and Bed Fixtures... **\$5.85** each (including lamps)

EXTRA SPECIAL!—CONDENSER KIT (By-Pass)

Consists of 100 Tubulars (all 600 Volt) in the following sizes: .001, .002, .006, .01, .02, .03, .05, .1 Mfd. Fully Guaranteed, Per Kit..... **\$5.95**

RADIO KNOB KIT

Contains 50 assorted styles set screw knobs for 1/4" shaft. A beautiful assortment of the most popular styles in present use. Per Kit..... **\$3.95**

INSULATED RESISTOR KIT

Contains 100 most popular sized DELUXE assortment of 1/4, 1/2 and 1 Watt, R.M.A. color coded, some Gold Band Per Kit..... **\$2.75**

AERIAL KITS (individually boxed) complete, including full instructions..... **75c**

RADIO KITS 4-tube TRF (including Tubes), SPECIAL..... **\$10.75**

5-tube SUPERHET (including Tubes)..... **\$17.95**

Please include at least 25% with all C.O.D. orders

Write for Our Latest Complete Catalog. Just Out!

National Radio Distributors

1029^a E. 163 St., New York 59, N.Y.

CAPACITORS —

OIL, PAPER and ELECTROLYTIC



Illinois
CONDENSER COMPANY
 1160 N. HOWE ST. • CHICAGO 10, ILL.

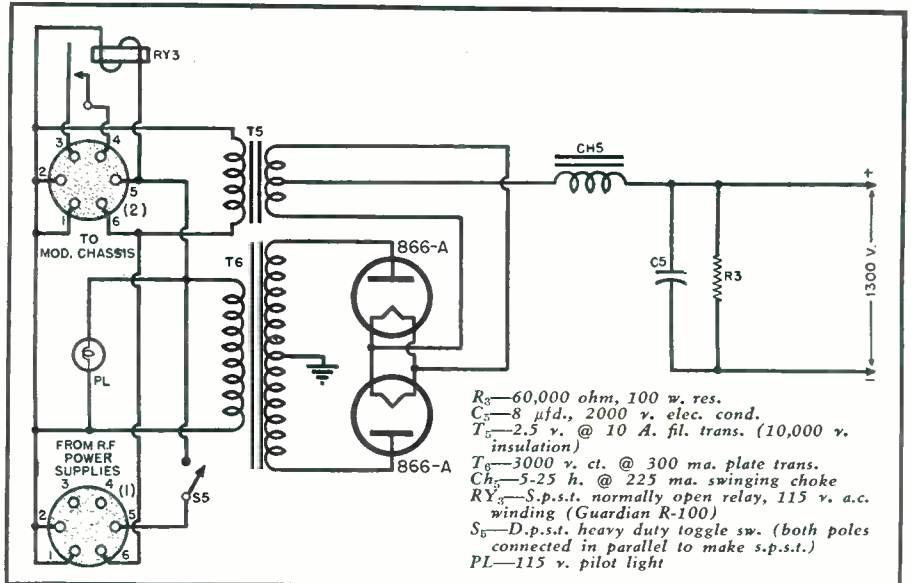

Fig. 6. Wiring diagram for the modulator power supply. Socket #1 connects to socket #1 of the r.f. power supply, Fig. 5. Socket #2 connects to socket #1 of the modulator, Fig. 2.

R_3 —60,000 ohm, 100 w. res.
 C_5 —8 μ d., 2000 v. elec. cond.
 T_5 —2.5 v. @ 10 A. fil. trans. (10,000 v. insulation)
 T_6 —3000 v. ct. @ 300 ma. plate trans.
 Ch_5 —5-25 h. @ 225 ma. swinging choke
 RY_3 —S.p.s.t. normally open relay, 115 v. a.c. winding (Guardian R-100)
 S_5 —D.p.s.t. heavy duty toggle sw. (both poles connected in parallel to make s.p.s.t.)
 PL —115 v. pilot light

mitter at the same frequency.

When using the external oscillator, it is possible to vary the frequency approximately ten kilocycles each side of resonance on 3.5 megacycles without retuning the transmitter. Proportionally great shifts are possible on the higher frequencies.

No pilot lights were used on this transmitter, because it was built for W9PBS, a blind amateur, and they would be useless to him. However, they may be installed as shown in the diagrams. Name plates were omitted for the same reason, but small paper tabs with names typed on them were glued near each control, primarily for the convenience of visitors.

It is suggested that a 12 1/4" panel be substituted for the 10 1/2" one on the r.f. chassis to give more room between the r.f. chassis and the antenna tuner, which will make it a little easier to change the amplifier coil. Either the height of the modulator or modulator power supply panel may be reduced to compensate for the change.

A standard 17" x 13" x 3" chassis may be cut in two pieces: 9 5/8" x 17", and 3 3/8" x 17". The smaller one can be used for the speech amplifier, and the larger for the antenna tuner.

A 2 1/2" diameter coil with the same number of turns may be substituted for the larger antenna coil, which was designed to cover the old 1.75 mega-

Rear view of r.f. power supply chassis. Two separate supplies, 1750 volt and 600 volt, are incorporated on a single chassis. Bleeder resistors are covered with wire mesh screening to prevent accidental contact with high voltage terminals.



cycle band. Most of the filament transformers are rewound units, but the commercial ones shown in the parts lists are satisfactory, and will fit the space available. Heavy duty casters are screwed directly to the bottom of the cabinet rather than using a dolly, which makes a slightly more finished job.

Undoubtedly band switching assemblies with a 21 megacycle coil instead of a 1.75 megacycle coil will soon be available, which will be more convenient to convert for use in a duplicate of this transmitter.

As the entire transmitter is completely enclosed, with an interlock switch that removes all primary voltages as soon as the door is opened, it was not thought necessary to use special insulated plate caps, etc., to make the transmitter safe. Nevertheless, it must always be remembered that the voltages used are positively lethal if not handled with respect.

This transmitter is in regular operation on 28,708 kilocycles under the call, W9PBS, as this is written, and will be used on other bands as they are released to the amateurs. Listen for it.

-30-

V.H.F. Frequency Meter

(Continued from page 34)

The audio amplifier, which also doubles as an audio oscillator for MCW, is a 6J6 dual triode. No grid bias is used in the two stage, resistance coupled amplifier. When a cathode resistor and capacitor was inserted in the common cathode circuit of this tube, low frequency oscillations always resulted. As a result, the cathode resistor was eliminated entirely. Although distortion results, this is of no consequence as far as the job of measuring frequency is concerned. (See Fig. 9.)

When the selector switch is thrown to "MCW," the audio amplifier becomes a multivibrator. At the same time the oscillator B+ lead is placed in series with the plate resistor of the last triode stage, resulting in a modulated r.f. output. Since the multivibrator output is not sinusoidal but

Fig. 6. Position of single slot rotor in relation to single slot stator for lowest possible frequency (A) and highest possible frequency (B).

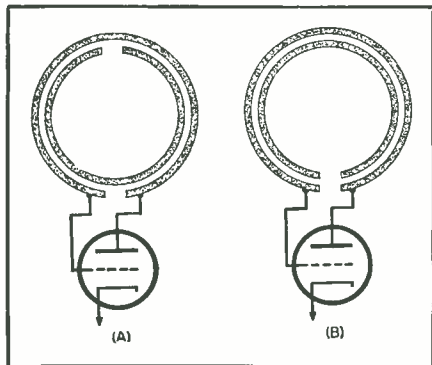

In this NEW WORLD OF ELECTRONICS

Will you go *Forward*—
or *Backward*?



**TO GET AHEAD YOU
MUST STUDY NOW**

NEW ELECTRONIC TECHNIQUES—War-born developments equivalent to 20 years of research are here. Your future demands that your technical knowledge be modernized to keep pace with these new developments.

THE EXACTING DEMANDS OF POST-WAR EMPLOYMENT require that you "deliver the goods." Employers can afford to be "choosy"—only the technically qualified can expect to pass the screening tests for the better jobs. "What do You Know"? will be the hurdle you will have to leap. Pulse shaping techniques—cavity resonators—pulse time modulation—single sideband multitone multiplex transmission—These are commonplace terms in this New World of Electronics. Do you know these or similar new techniques?

MORE THAN EVER BEFORE, a sound basic knowledge of up-to-date, fundamental engineering of radio-electronics is an essential to a better job—promotion—increase in pay.

LET CIRE TAKE OVER YOUR PERSONAL UP-GRADING PROBLEM! Qualified, competent instructors, ample, personalized instructional aids, orderly, progressively arranged study assignments in recognized, approved technical texts—these are only a few of the many superior advantages of CIRE'S plan of personalized spare-time home study training for professional self-improvement.

CIRE HOME STUDY COURSES COVER THE FIELD OF RADIO-ELECTRONICS—TELEVISION, ULTRA-HIGH FREQUENCY TECHNIQUES, AM AND FM BROADCASTING, COMMUNICATIONS ENGINEERING—from simple treatment of fundamentals, through preparation for FCC commercial radio operators' license examinations, up to and including complete high level quantitative treatment of advanced radio-electronics and communications engineering. Choose the course best suited to your needs, and start with the section you are qualified to enter. You pay for only the section or sections you need. Use the "Pay-as-you-go plan" patterned after ethical, educational practice. These features are unique with Cleveland Institute, and represent the best in the modern, post-war concept of home study training.

Many CIRE students of advanced engineering courses today are broadcast chief engineers. Graduates of CIRE courses are eligible for the top jobs in radio-electronics.



Write today for free, descriptive booklet—"THIS NEW WORLD OF ELECTRONICS HOLDS OPPORTUNITY FOR YOU."
No obligation—no salesmen.

CLEVELAND INSTITUTE OF RADIO ELECTRONICS

Successors to

NILSON RADIO SCHOOL,
Founded 1939

SMITH PRACTICAL RADIO INSTITUTE,
Founded 1934

RN-3 TERMINAL TOWER, CLEVELAND 13, OHIO

(Mail this Coupon)

Cleveland Institute of Radio Electronics, RN-3 Terminal Tower, Cleveland 13, Ohio.
Gentlemen: Please send information about your home study courses in Radio Electronics.

NAME	I desire training in.....
ADDRESS	I have had experience in broadcasting <input type="checkbox"/> servicing <input type="checkbox"/>
CITY	operating <input type="checkbox"/> mfg. <input type="checkbox"/> CAA <input type="checkbox"/> Army-Navy <input type="checkbox"/>
ZONE..... STATE.....	amateur <input type="checkbox"/> other..... I am a
	High School Grad. <input type="checkbox"/> College <input type="checkbox"/> I hold a.....
	degree in.....

For Soldering in
Tight Places...

DRAKE

No. 400 Soldering Iron

Smallest Industrial Iron
Ever Designed

60 Watts—1/4 in. Tip
Only 9 in. long—Wt. only 8 oz.

This mighty mite is backed by DRAKE'S 25 years of soldering iron manufacturing experience. The high quality and long service of DRAKE Soldering Irons have made them outstanding favorites with all types of radio men everywhere. The DRAKE No. 400 is an outstanding value at



Only \$4.50
LIS1

Drake Has an Iron
for Every Purpose.
Ask Your Radio
Parts Jobber.

DRAKE ELECTRIC WORKS, INC.

3656 LINCOLN AVE., CHICAGO 13, ILL.

**7 Days
Free Examination**

**PRACTICAL
RADIO
INFORMATION**

Including Frequency Modulation—Television, etc.

Inside Radio Information for all Servicemen—Aircraft Pilots, Students. AUDELS RADIO-MANS GUIDE contains 772 Pages, 400 Diagrams & Photos is complete—gives Authentic Principles & Practices in Construction, Operation, Service & Repairs. Covers clearly and concisely Radio fundamentals—Ohm's Law—Physics of sound as related to radio science—Measuring instruments—Power supply—Resistors—Inductors—Condensers—Transformers and examples—Broadcasting stations—Radio Telephony—Receivers—Diagrams—Construction—Control systems—Loud speakers—Antenna systems—Auto Radio—Phonograph pickups—Public Address Systems—Aircraft & Marine Radio—Radio Compass—Beacons—Automatic Radio Alarms—Short Wave—Coil Calculations—Testing—Cathode ray oscillographs—Static Elimination—Trouble Pointers—Underwriter's standards—Units and tables—Frequency Modulation—REVIEW QUESTIONS & ANSWERS. Ready Reference Index.

\$4 COMPLETE • PAY ONLY \$1 A MO.
Get this practical information in handy form for yourself—Fill in and MAIL COUPON TODAY

AUDEL Publishers, 49 W. 23rd St., N.Y.
Mail AUDELS NEW RADIO-MANS GUIDE for free examination. If O.K., I will send you \$1 in 7 days; then remit \$1 monthly until \$4 is paid. Otherwise I will return it.

Name _____
Address _____
Occupation _____
Reference _____ R.N.

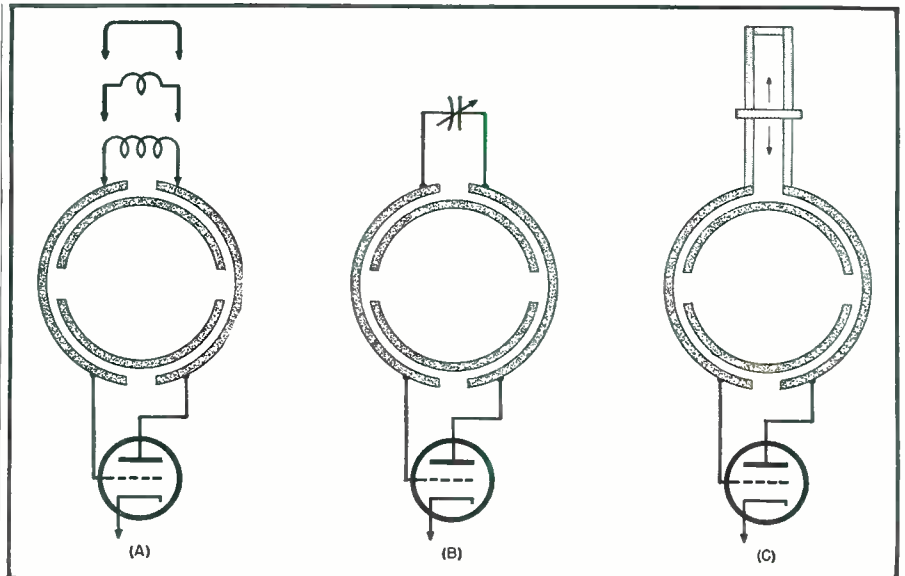

Fig. 7. Several methods that may be employed to increase the frequency range.

square, the r.f. output is very broad. This wide band r.f. is easy to locate.

Another useful output of the v.h.f. heterodyne frequency meter is video modulated r.f. In certain cases, such as radar and television, an r.f. output consisting of controlled, sharp pulses is necessary. This is easily obtained by turning the selector switch to "Video" and applying the pulses into the video jack via a coaxial cable. Positive pulses from 50 to 150 volts will fire the oscillator. Notice, in Fig. 9, that in the video position, the ordinary "B+"

is removed from the r.f. oscillator; the pulse positive peak supplies the necessary momentary plate voltage.

In the construction of the r.f. oscillator, care must be taken to provide a solid, stable base and rotor drive mechanism. A firm foundation, in this case, is furnished by rectangular brass tube stock, 1/8" thick, 1 1/2 x 3 inches in cross section and 9 inches long. The drive mechanism is a war surplus, precision 100:1 worm gear assembly, 50 vernier dial rotations being necessary to cover the entire frequency range.

Captured German radar equipment of the Mannheim type. This equipment was used to direct gun fire after the planes had reached the range of anti-aircraft fire. Signal Corps teams were assigned to the task of capturing enemy equipment intact in order that German radar could be analyzed and studied at Evans Signal Laboratories. According to the engineers who analyzed this and other units, German radar was good but not on a par with Allied equipment. The Signal Corps attributes this lag in German radar development to the fact that the Nazis relied heavily on their superior air force during the early stages of the war and failed to improve their radar equipment until it was too late to catch up with Allied developments.



The concentric tuner is fabricated from 1½" brass pipe and small pieces of ⅛" and ¼" acrylic (Plexiglass, Lucite, etc.) stock. A 4" length of the brass pipe, sawed in half lengthwise, became the stator. The rotor is made from the same stock except that the diameter, through bending, is reduced to 1.3". Like the stator, the rotor is sawed in half lengthwise. (See Fig. 8.) Although polystyrene would make for better high frequency insulation, the Plexiglass was the only workable plastic available. Since power is not a consideration, the slight loss does not matter as long as the oscillator functions throughout the entire frequency range. The circular plastic parts were cut out with a fly cutter. A lathe, however, would make a better and more precise job.

The rotor shafts are made from ¼" polished steel rod. Notice that the metal shaft does not extend throughout the entire length of the tuner but is broken in the middle by a fiber section. Higher values of circuit "Q" can be realized by minimizing unnecessary conductors in the tuner field.

Conveniently, the gear box slow speed shafts extend out both sides. One end is used to turn the tuner rotor through a flexible coupling while the other end supports and drives a 6" diameter, wooden calibration disc. Over 180° of this drum, 50 equally spaced divisions, numbered from 0 to 50, are placed. Each vernier dial rotation moves the disc one division. All graphs in this article are based on this method of calibration.

Filament chokes for the 955 are provided to keep the cathode above ground. The ceramic socket supports are wound with number 18 D.C.C. wire and become the forementioned chokes. Filament bypass capacitors are fabricated as shown in Fig. 10 and act as combination capacitors and feed-through insulators. The plate choke, wound on a ceramic pillar, is mounted on the opposite side of the tuner from the 955 tube.

The finished oscillator, complete with the rest of the circuits, is mounted inside an aluminum shield box. An external power supply is used to minimize internal heat. The knobs on the front panel from left to right are as follows: selector switch, volume control, vernier tuning knob. At the lower left are the r.f. jack, video input jack, and audio output jack.

By far the most difficult task is the calibration of the frequency meter when a frequency standard is not

NEW AMATEUR FREQUENCIES

The Federal Communications Commission has announced the opening of two additional frequency bands, 420-430 megacycles and 1215-1295 megacycles for amateur use. The frequencies between 420-430 may be assigned for amateur use provided that the peak antenna power of amateur stations is limited to 50 watts. Operation in these bands is effective immediately.

U. S. ARMY SIGNAL CORPS SURPLUS RADAR COMPONENTS AT PRICES WITHIN EVERYONE'S REACH!

U.H.F. RECEIVERS

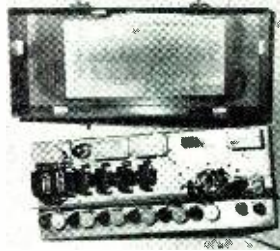

From SCR-268 Radar set, designed with view toward extreme efficiency on the ultra highs. Type 2-10406. Tunes from 201-210 megacycles. Has 15 tubes in superheterodyne circuit. Uses 6 acorn tubes (5-954, 1-955) in RF portion and 6SK7's in 4-L.F. stages that are designed for 20 megacycles with a 2 megacycle bandwidth. Each L. F. stage has a gain of 8.

Power supply (contained on same chassis) has husky Thordarson and Tohe transformer, chokes and filter condensers. Practically no hum whatsoever. Designed for 115 volt, 60 cycle operation.

Ideal for modification by amateurs or experimenters to "ham" or F.M. bands.

Chassis 25½" x 10½" x 8" —shipping wt. approx. 90 lbs.

ORDER NO. W-1421—

\$29⁹⁵

SHORT WAVE RECEIVERS



Signal Corps type BC-728C. Portable 7 tube receiver designed to operate on 2 volts. D.C. from self-contained battery and vibrator. Tunes four bands covering from 2 to 6 megacycles by push button tuning. One push button is used for each band, and any frequency in any band may be selected by finger tip tuning.

A 4" P.M. speaker is mounted in cabinet. Tube line-up as follows:

2-584 1-1S5 2-1T4 1-115 1T4

Operates well with 6 foot plug in antenna. All units are brand new. Complete with tubes, minus battery and antenna.

Ideal for most police, ship to shore, time signal and aircraft frequencies. 12" x 6¼" x 7".

Shipping Wt. 17 lbs.

ORDER NO. W-1422—

\$34⁵⁰

RADAR KEYING UNIT

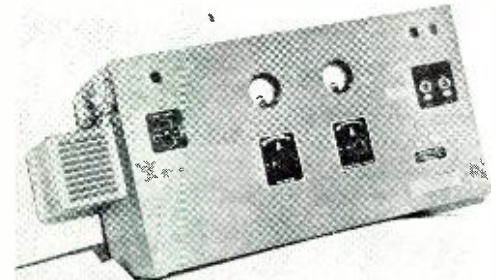

Signal Corps type BC-499 from SCR-268 Radar set. Designed for 115 volts AC 60 cycles. This unit developed the initial radar pulse and contains valuable component parts that valued individually would in sum, cost several times the selling price of this unit. Not fully used.

Following are a few of the items that make up the unit.

- 2—6L6 tubes
- 3—6S4 tubes
- 2—6P6 tubes
- 3—6S4 tubes
- 1—6C5 tubes
- 1—866 tubes

1—304TL (Eimac) triode transmitting type rated at 300 watts plate dissipation at high frequencies.

3—2 mfd. 4,000 V.V. GE Pyranol condensers.

1—7200 volt, 150 MA power transformer.

1—Variac 5 amps, General Radio type (RT 260).

1—5 volt, 26 AMP fil. transformer (for 304 TL).

1—2.5 volt, 10 Amp. fil. transformer (5000 volt. insulation).

1—1 mfd. 1,000 volt. GE Pyranol.

1—2 mfd. 1,000 volt. GE Pyranol.

1—2 to 4,000 volt, 27 volt. meters (0-1 mil. move). At least 50 other parts including

double blower.

Size 39" x 16" x 17½".

Shipping wt. 290 lbs.

Original Government cost over \$1,000. Complete units only.

ORDER NO. W-1414—

\$59⁵⁰

CONDENSERS

- GE Pyranol 8 mfd 600 V. W. \$1.85
- GE Pyranol 10 mfd 600 V. W. 1.95
- *GE Pyranol 2 mfd 4000 V. W. 8.95
- *Oil Filled 2 mfd 1000 V. W.65
- *Oil Filled 1 mfd 1000 V. W.55
- Bath Tub .5 600 V. W.34
- Bath Tub .1 600 V. W.18
- Bath Tub .05x2 600 V. W.28

POWER TRANSFORMERS

- ALL 115 V. 60 C. PRIM.
- 2000 V. C. T. 300 M.A. Oil \$13.50
- 3200 V. HALF W. 150 M.A. \$9.95
- 1000 V. C. T. 250 M.A. \$5.40

FILAMENT TRANSFORMERS

- 5 V.—26 Amp. Top Pri. \$2.75
- 2.5 V.—10 Amp. 10,000 V. Insul. \$3.95

FILTER CHOKES

- 7.7 Henries 320 M.A. 350 V. Ins. \$4.49

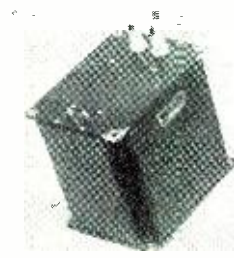

- Lip Mike Buttons (Gold Plated) \$2.00
- Throat Mike Buttons (Gold Plated) 1.80
- Telegraph Keys (Army-Navy) 1.00
- Telegraph Keys A. X. with base DeLux. 1.95
- Phantom Antenna comprises 2 12 ohm non-ind. res & 8 & 118-157 MMFD variable Cond. with .181 air-gap. 1.95
- Coaxial Cable—72 Ohms—List 85¢—pr. ft.18
- Coaxial Cable—500 feet—pr. ft.15

111 V. AC Relays DDPF Silver contacts 10 Amp. Rating \$2.40 In Hundred Lots. 2.00

Potentiometers — WIRT I.R.C. — CLARO. 750 Ohms. 23c In Hundred Lots. 20c

LIMITED SUPPLY. Brand New Plane Transmitters (Collins) B29 Type ART13 CW 266 Watts; Voice 125; Variable Tuning, 2 megs. at 18 megs.; complete with tubes. Crystal cal. ECD control with Dynamotor 28V D.C. Oper. **\$325⁰⁰**

Radio Modulator Type B C 423. Self-contained 115 V. Power Supply R.F. output 195 to 205 MC Mod. at approx. 5000 C. Complete with 5 tubes sold as is from Field Service. Can be used as H.F. Rec. Transceiver or Frequency Meter ... **\$20**

All merchandise guaranteed. Mail orders promptly filled. All prices F.O.B. New York City. Send Money Order or Check. Crating and shipping charges sent C.O.D.

COMMUNICATIONS EQUIPMENT CO.
131 LIBERTY ST., NEW YORK CITY 7, N. Y.
TELEPHONE WH 4-7658

FREE BOOK
SHOWS
SHORT CUT
TO
CODE SPEED

ENDORSED
BY CHAMPIONS

Skill, speed, accuracy free of nervous tension brings big pay.

The One and On'y Candler System

Nothing else like it. It is the course that has made code champions. Will help any sincere man gain greater speed, accuracy and skill. Learn the Candler way.

Fast, Efficient Operators Needed

If you need additional speed to be classed as an expert, try the Candler method. It is endorsed by champions. It has produced phenomenal results with a minimum of effort. Why not learn the faster and easier way. Get your copy of the Book of Facts for Code students, Telegraph and Radio Operators.

CANDLER SYSTEM CO.

P. O. Box 928, Dept. 2-., Denver (1), Colo.



**Champion Endorses
CANDLER SYSTEM**

T. R. McElroy, Official Champion Radiotelegraph Operator of the world with a speed of 75.2 w.p.m., claims his success is due to the Candler System.

TEST EQUIPMENT

A LIMITED QUANTITY
FOR IMMEDIATE DELIVERY

WESTON

No. 772 SET ANALYZER \$68.35

No. 697 VOLT-OHM-MILLIAMETER \$29.03

No. 663 VOLT-OHM-MILLIAMETER \$49.14

RCP

No. 488 MULTI-TESTER \$70.07

TRIPLETT

No. 2405 VOLT-OHM-MILLIAMETER \$44.10

Write for Free 1946 Parts Catalog



731 West Washington Boulevard
Dept. N CHICAGO 6, ILLINOIS

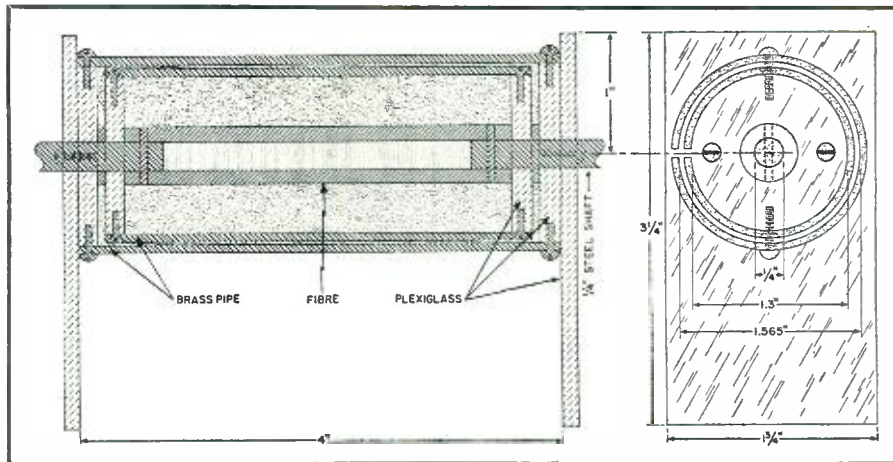

Fig. 8. Mechanical construction of the coaxial tank. Plexiglass end pieces are used.

available. Lecher wires are extremely helpful for finding rough frequency points. If a microammeter is inserted in series with the oscillator grid resistor, a decided deflection will occur as the Lecher wire shorting bar is moved through half-wave points. For more precise calibration, an accurate 5 or 10 mc. frequency source will allow check points by zero beating.

It is recommended that a graph, such as Fig. 5, be made showing the fundamental and all useful harmonics plotted against dial divisions. This graph is valuable for differentiating between harmonics when measurements are taken. When a powerful transmitter is being checked, spurious beats will be heard that may mislead the technician. Decreased pickup will eliminate this undesirable condition.

Lower frequencies than the fundamental may be measured by using the unknown frequency's harmonics. For example, if the transmitter under test is at 150 mc., its second harmonic will beat with the 300 mc. from the frequency meter. In all measurements, it is desirable to know the approximate (± 50 mc.) frequency of the unknown.

It was the author's intention, in building this heterodyne frequency me-

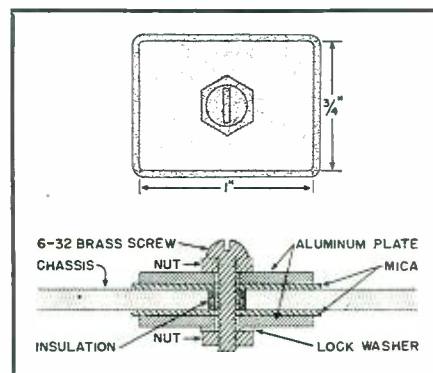
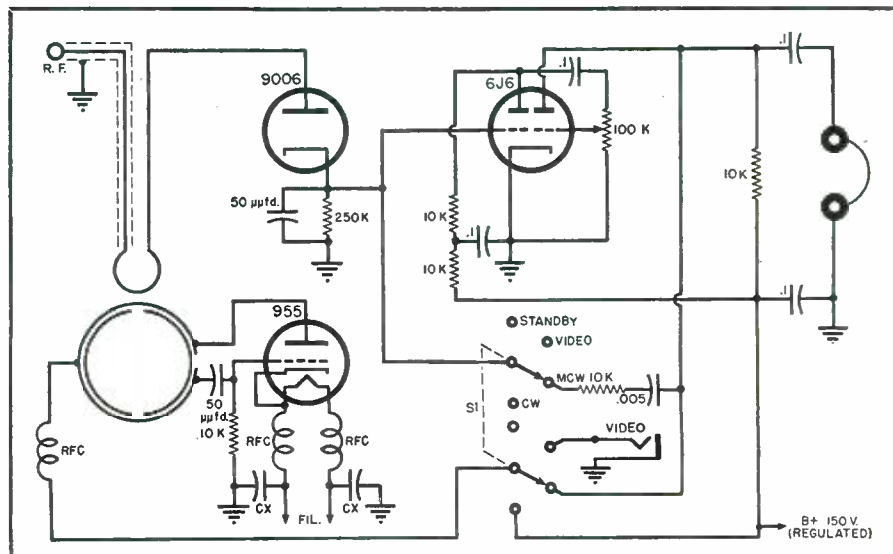

Fig. 10. Mechanical construction of the capacitor C_x shown in the schematic diagram, Fig. 9. There are two such units required, each having a capacity of approximately 100 μfd .

ter, to delve into the possibilities of the split concentric tuned oscillator. Results are gratifying in that the finished product works smoothly and well. The purpose of this article is not to provide detailed plans for building the frequency meter, but rather, to introduce the reader to another phase of microwave technique.

-30-

Fig. 9. Schematic diagram of v.h.f. frequency meter constructed by the author.



Spot Radio News
(Continued from page 14)

metropolitan district or a principal city, or the rural area surrounding a metropolitan area or principal city.

The FCC has listed 140 metropolitan districts for television stations. Stations in other metropolitan or city areas not listed in the table will *not* be assigned closer than 140 miles on the same channel or 75 miles on adjacent channels, except upon an adequate showing that public interest or necessity would be served.

Approaching the problem purely from an engineering point of view, the Radio Manufacturers Association receiver section committee has recommended the marking of FM receiver dials with wavelength or megacycle designations rather than FCC channel numbers. Chairman Dorman D. Israel explained that the RMA committee did not consider sales factors in its consideration of dial markings. A majority of the set manufacturers who have replied to an RMA poll have indicated they favor channel number marking. The FCC several months ago announced the adoption of a numbering system for FM channels, beginning with 201 for the first channel frequency, 88.1 mc., and so on.

AS A FURTHER STEP in its reorganization of the engineering department, FCC announces the following changes in personnel:

The field and research branch will be headed by Assistant Chief Engineer George E. Sterling and will consist of the following divisions: Field and monitoring, headed by George S. Turner; technical information, headed by Dr. Lynde P. Wheeler; laboratory, headed by Charles A. Ellert; allocation, headed by Paul D. Miles.

The safety and special services branch will be headed by William N. Krebs and will consist of three divisions: Marine and general mobile, Howard C. Looney acting chief; emergency and miscellaneous, headed by Glen E. Nielson; aviation, with George K. Rollins as acting chief pending the return of Edwin L. White.

As reported earlier, the broadcast branch, including the standard, FM and television divisions, has already been organized.

THE RMA SPRING MEETING of transmitters and transmitting tube manufacturers, comprising the transmitter section of the engineering department, is scheduled for April 29 and 30 at the Penn-Harris hotel in Harrisburg, Pa.

MELVIN E. KARNS, who resigned Nov. 1 as director of the WPB radio and radar division, has returned to an executive post with RCA. He is stationed at the RCA laboratories in Princeton, N. J., as administrative assistant to Dr. C. B. Jolliffe. —50—

March, 1946

**33 well overlapped
ranges . . .**

**plus long-life
dependability!**



WESTON

(Model 665 Type 1)

VOLT-OHM-MILLIAMETER

Its compactness, versatility and rugged dependability make Model 665 the ideal instrument for use in the field, or in the shop . . . whether servicing communications equipment, testing electrical components in production, or research or maintenance work. Provides 33 AC and DC voltage, DC current, and resistance ranges . . . with simplified switching arrangement for rapid operation. Built to WESTON standards to assure dependable measurement accuracy throughout the years. Full details on request. Weston Electrical Instrument Corporation, 658 Frelinghuysen Avenue, Newark 5, N. J.

WESTON Instruments

EXPORT

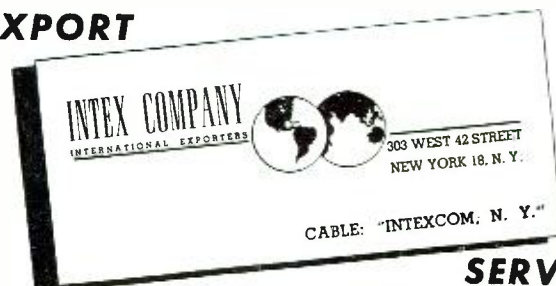

SERVICE

A complete export service for manufacturers including Financing, Sales Promotion, Foreign Correspondence, Permits, Shipping, and Export Packing.

Write us regarding your product for world wide distribution.

FOR IMMEDIATE DELIVERY!

RECORD PLAYERS

COMPLETE—SIMPLY INSTALL
YOUR OWN
MOTOR AND
TURNTABLE!



Record Player
Complete
without motor
& turntable
\$3250
per unit

PLAYER
CONTAINS:

All
Components
Mounted, Wired
and READY TO PLAY

- Large electro-dynamic speaker
- Tone Control • Volume Control
- A. C. Amplifier with power transformer, and connecting cords
- 3 tubes—1-6V6, 1-6CS, 1-5Y3
- Astatic pickup with arm rest
- Permanent needle—Knobs
- Acoustically-built cabinet
- All in a handsome, leatherette-covered, sturdily-constructed case, 14" wide, 7½" high, 16¾" long.

DEALERS—Write for quantity discounts!

UNION RADIO CORPORATION

1636 W. VAN BUREN ST., CHICAGO 12, ILL.

CAREER

Radio

FOUR INTENSIVE COURSES

Each one a chance for ambitious men and women to increase earning capacity and promote permanent employment.

1. RADIO TECHNICIAN. A general course including FM and Television. Students learn by constructing electronic and radio equipment under expert supervision.
2. RADIO COMMUNICATIONS. Prepare for FCC licenses. Includes telegraphy. Leads to position as merchant marine or flight radio officer.
3. AIRLINE COMMUNICATOR NON-TECHNICAL. Of special interest to YOUNG WOMEN. Prepares for employment in airport flight control offices.
4. RADIO & TELEVISION SERVICE. Employment as repairman on home-type equipment including standard broadcast and FM, as well as Television receivers.

MELVILLE RADIO INSTITUTE
"the radio school managed by radio men"



CLIP THIS COUPON

SEND ME FREE INFORMATION

NAME

ADDRESS

MELVILLE RADIO INSTITUTE

45 W. 45th St.
New York 19, N. Y.

Manufacturers' Literature

Readers are asked to write directly to the manufacturer for the literature. By mentioning RADIO NEWS, the issue and page, and enclosing the proper amount, when indicated, delay will be prevented.

PRODUCTION PARTS FOLDER

Ex-Cell-O Corporation is now offering an informative folder describing its facilities for manufacturing production parts and unit assemblies.

Of special interest are its graphic interior photographs of *Ex-Cell-O's* production departments showing the machinery used in parts output. *Ex-Cell-O Corporation's* services and facilities for making miscellaneous production parts were greatly expanded during the war and they are now available for mass production of accurate parts and sub-assemblies for peacetime products.

Copies of this "Production Parts" folder may be secured by writing *Ex-Cell-O Corporation*, 1200 Oakman Boulevard, Detroit 6, Michigan, and requesting Bulletin No. 36151.

PRODUCTION TOOL CATALOG

Acme Tool Company is now offering a new descriptive catalog illustrating precision production tools. This catalog, No. 45, features unusual production tools which have contributed to increased production wherever used.

Copies may be obtained upon request on company letterhead to *Acme Tool Company*, 200 Church Street, New York 13, N. Y.

CAPACITOR BULLETIN

Electrical Reactance Corporation has just released a new, illustrated bulletin describing in detail the characteristics of the company's line of Hi-Q Silver Electrode Ceramic Capacitors.

It is attractively printed in color and contains diagrams showing the construction of the capacitor and photographs illustrating the various steps of manufacture and tests applied to control quality during the manufacturing process. Complete specifications and capacitance values are included, together with type designations according to JAN specifications.

This bulletin covers the CI Type of capacitor with axial leads. Further information may be obtained by writing direct to *Electrical Reactance Corporation*, Franklinville, New York.

X-RAY DIFFRACTION BROCHURE

Of prime interest is the announcement by the *North American Philips Company, Inc.*, of its new illustrated brochure dealing with the basic theory, principles, and applications of x-ray diffraction.

F. G. Firth, Research Engineer, authored the text, which is divided in three parts and covers basic principles and theory of x-ray diffraction, the constitution of matter, and treats

many application problems at considerable length. The booklet explains in detail how x-rays are diffracted, the technique of powder identification, how various types of film-type equipment work, advantages of the new Geiger-counter x-ray Spectrometer, low-angle scattering, particle size, and orientation of matter, alloy formation, organic compounds, catalysts, studies of mineral substances, high polymer work, petroleum products, and heat exchanger problems.

For a copy of the 16-page booklet, address inquiry to the *North American Philips Company, Inc.*, Publicity Dept., 100 East 42 Street, New York 17, N. Y.

VIBRATION TEST PAMPHLET

L.A.B. Corporation presents literature covering vibration test equipment which has been found to expedite new design by the process of "shaking out" faults without protracted field tests. Faults in assemblies and components are thus exposed, hastening correction and avoiding expense, embarrassment, and the possible exposure of weaknesses which might show up after shipping or usage.

Three-dimensional vibration equipment, as well as test tables, are available for laboratory and production use and are illustrated and described in detail. Machines to special specifications may also be obtained.

Requests for literature may be addressed to the *L.A.B. Corporation*, P.O. Box 162, Summit, New Jersey.

ENGINEERING DATA

A pocket-size Library of Engineering Data has been completed by the *Manufacturers Screw Products Company* for all industrial users of screws and other fasteners.

Included on the four varicolored cards, which are enclosed in a durable, handy pocket envelope, are machine-screw weights and decimal equivalents of twist drills. The cards have ruled edges and provide a maximum amount of engineering information in a minimum amount of space.

In order to secure a set, write to *Manufacturers Screw Products*, 274 West Hubbard Street, Chicago 10, Illinois, on your organization letterhead, stating your position with the company.

JEFFERSON ELECTRIC CATALOG

In an interesting presentation, the major products of the *Jefferson Electric Company* are fully described in its colorful new 12-page catalog.

Pertinent data covers transformers for sixteen fields of application, in-

RADIO NEWS

cluding power circuit, mercury lamp, neon, signal, and street lighting. Numerous attractive illustrations add to the value of the brochure. In addition, descriptive information is supplied on ballasts, renewable and non-renewable fuses, fustats, plug fuses, and solenoids. For quick reference purposes, a listing of Jefferson sales engineers and their locations is also included.

A copy of this catalog, which is specified as No. 451-GB, will be furnished upon request made to the *Jefferson Electric Company*, Bellwood, Illinois.

ENCYCLOPEDIA OF FASTENERS

Manufacturers Screw Products, makers of stronghold fasteners, is now offering a catalog of their fasteners including many unusual features of interest to engineers, product designers, and purchasing agents.

This new book explains how screws are made and has many photographs of the various manufacturing operations showing the economical method of cold-forged manufacturing. For convenience, this helpful book is divided into twelve indexed divisions, including aviation products, machine screws, cap screws, set screws, sheet metal screws, bolts, studs and rods, nuts, washers, rivets, eyelets and pins, terminals and clips.

A copy of this 136-page Encyclopedia of Fasteners will be sent without charge to engineers, purchasing

agents, product designers, and others who specify or purchase fasteners. The request should be made on company letter-head, giving position, and sent to the attention of Mr. Hufe, *Manufacturers Screw Products*, 227 West Hubbard Street, Chicago 10, Illinois.

SPEAKER CATALOG

A new eight-page, with cover, catalog containing every type of reproducing unit and horn for sound reproduction has been published by *Racon Electric Company, Incorporated*.

This brochure features a new line of Super X Units, using the latest type of Alnico V magnets.

Further information regarding this descriptive catalog may be obtained by writing *Racon Electric Company, Inc.*, 52 East 19th Street, New York 3, N. Y.

BURGESS BATTERY GUIDE

To facilitate the replacement of all radio batteries, a new and more complete guide and products listing has been made available by the *Burgess Battery Company*.

A listing of the correct replacement batteries for portable and farm radios is combined in the new leaflet, which also includes a listing of private brand portables. Many new manufacturers are included and the number of the sets covered totals over 1000. Enabling quick identification of any stock number, a numerical and alphabetical

listing of all Burgess Battery products adds to the interest and value of this guide.

A copy will be furnished free of charge upon application to the *Burgess Battery Company*, Battery Division, Dept. RG, Freeport, Illinois.

HYDRIDE PROCESS BOOKLET

Titled, "The Hydride Process and Its Products," *Metal Hydrides Incorporated*, has issued a handy reference size booklet covering developments in the fields of metallurgy and chemistry.

Contents of the brochure deal with the hydride process, properties of metallic hydrides, titanium, titanizing, zirconium, titanium-copper alloys, method of addition of titanium to copper, zirconium-copper alloys, special metals, powdered alloys. Also included is a graph showing dissociation temperatures and volume of hydrogen held by commercial grade of metallic hydrides, as well as a list of hydrimet products.

Anyone interested in securing a copy of the booklet may do so by writing *Metal Hydrides Incorporated*, 22 Congress Street, Beverly, Massachusetts.

DIAL LEAFLET

Illustrated and described in an attractive, 4-page leaflet of the *American Dial Company, Inc.*, are representative precision instrument dials indicative of the great variety possible.

An interesting discussion covers pro-

SENSATIONAL SPECIALS ON POPULAR MERCHANDISE A FEW OF OUR TYPICAL BARGAINS

Write today for your copy of our latest price list

BALLAST TUBES, any type.....\$**.39** ea.
MICROPHONES: Gold-plated single button midgeet carbon mike—Waterproof and rugged—Built for Signal Corps. May be used as a lapel mike, concealed or secret pickup, for amplifiers, or may be attached to a home radio. **SUPER-SPECIAL—\$.95** ea. Bullet Crystal Mikes—\$**5.45**. Bullet Dynamic Mikes—\$**7.45**.
POWER TRANSFORMERS, half-shell type, 110V, 60 cycle. Specify either 6.3 or 2.5V when ordering.
For 4-5 tube sets: 650V, 40MA CT; 5V fil. and either 6.3 or 2.5 fil.....\$**1.40**
For 5-6 tube sets: 650V, 45MA CT; 5V fil. and either 6.3 or 2.5 fil.....\$**1.55**
For 6-7 tube sets: 675V, 50MA CT; 5V fil. and either 6.3 or 2.5 fil.....\$**1.70**
For 7-8 tube sets: 700V, 70MA CT; 5V fil. and either 6.3 or 2.5V fil.....\$**2.05**
For 9-11 tube sets: 700V, 100MA CT; 5V fil. and either 6.3 or 2.5 fil.....\$**2.75**
FILTER CHOKES: 2" mounting, cadmium plated straps; 200, 300, 400 or 500 ohms—Heavy-duty—\$**.89** ea. Midgeet type—\$**.49**. **AUDIO TRANSFORMERS**: 1 plate to single grid, 3:1—\$**.69**. 1 plate to PP grids—\$**.69**. Universal output, tapped for various impedances—\$**.79**. Mike transformers, single or double button—\$**.69**.
RELAYS: D.P.D.T. Heavy-duty construction, 50 ohms resistance; suitable for operation in tube plate circuit—\$**1.50**. Send for free relay sheet for full description of our stock of relays.
Midgeet Circuit Breakers, made for military use, 20 amp.—\$**1.25** ea. Heavy duty solid brass, screw type binding post—\$**.03** ea. 7 assorted IF transformers in aluminum cans—\$**1.98**. 5 assorted oscillator coils—\$**.69**. Test leads and prods, needle type, 50" wires, 5KV insulation, per pair, \$**.50**.
100 Watt Resistors: 100, 250, 3M, 10M, 11M, 20M ohms—\$**.35** ea. 10 Watt: 1, 10 ohms—\$**.10** ea. 300, 1M, 12M ohms—\$**.15** ea. 20 Watt: 18 ohm—\$**.10**. 50 Watt: 15M ohm—\$**.35** ea. 80 ohm, non-inductive—\$**.10** ea. 250 ohm CT—\$**.20** ea. All are ITC, Ohmite, Ward-Leonard or equivalent.
TUBULAR CONDENSERS, Guaranteed one year. Prices in lots of ten, either one type or assorted. 100 Mr. 25V—\$**.35**; 50 Mr. 150V—\$**.45**; 20-30 Mr. 150V—\$**.40**; 20-20 Mr. 150V—\$**.30**; 25 Mr. 25V—\$**.20**; 10-10 Mr. 450V—\$**.45**; 20 Mr. 150V—\$**.20**; 16 Mr. 450V—\$**.40**; 10 Mr. 450V—\$**.27**; 10 Mr. 50V—\$**.15**; 8 Mr. 450V—\$**.23**; 8-8 Mr. 450V—\$**.45**. Paper condensers, 600V: .25 Mr—\$**.20**; .1 Mr—\$**.10**; .05Mr—\$**.09**; .02Mr—\$**.08**; .01 Mr—\$**.08**; .008 Mr—\$**.05**; .005 and smaller—\$**.07**. **MICA CONDENSERS**, 1000V test, 600WV, any standard capacity—\$**.15**. **SPECIAL**—100 new, outdated condensers, no guarantee—\$**.90**—Average weight, 25 lbs.
3-Section Auto Antennas, complete with leads; 66"—\$**1.50**; 96"—\$**2.95**. High-grade Shure Crystal Pickups—\$**3.75**. Male AC plugs: Bakelite—\$**2.00** per 100; Heavy rubber, \$**5.95** per 100. Bakelite Cube Taps—\$**1.00** per doz.

EXCITING NEWS!!!

BRAND-NEW RADIO UNITS BUILT FOR ARMY TANKS AT A COST OF OVER \$900 NOW AVAILABLE FOR A TINY FRACTION OF THAT PRICE

Each is the product of an established leader in the field of radio manufacture, weighs only 41 lbs., and comes in a handsome, sturdy 17½x8¼x12½" metal cabinet. Each unit includes 2 separate transmitters, two separate receivers, and a 5.5 watt intercom amplifier. Each unit is complete with 15 up-to-date new tubes, and has passed the rigid government tests for the toughest service of all—use in a tank.

The 30 watt "A" transmitter uses an 807 final stage, a buffer stage, plus 4 other tubes, and covers from 2 to 8 MCs. continuously, by band-switching from the front of the panel. The "A" receiver is a superhet, covering the same bands, having an RF stage as well as 2 iron core IF stages, also a beat frequency oscillator.

The 5 watt "B" transmitter covers from 230 to 240 MC. (1.2 to 1.3 meters), as does the "B" receiver. By simple changes, these sets can be made to cover other bands if desired.

These sets all include a microammeter to read antenna current, signal strength (R meter), filament voltage, receiver or transmitter plate voltage, or transmitter current, all at the flip of a switch. By suitable connection to these sets, you can receive or transmit on "A" and "B" simultaneously, or you can act as a relay station by receiving on "A" and rebroadcasting on "B," or the reverse. You can even add your own conversation to the rebroadcast!

The best feature of all is the price. While our stock of this super-bargain lasts, your cost is only \$39.95. 10% deposit required with COD's. Complete instructions and circuit diagram included with each unit.

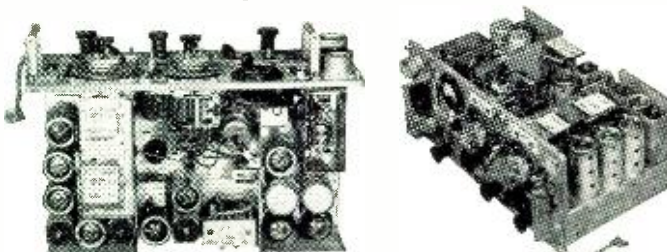

Power requirements for these units are 6 or 12-14, 275, and 500 Volts DC. They work very well on a 110 V, 60 cycle supply, which must be constructed, as it is not furnished. We can furnish complete power supply parts for a very reasonable additional sum.

BUFFALO RADIO SUPPLY 219-221 Genesee St., Buffalo 3, New York

Long, Satisfying Service



CERAMIC CAPACITORS



WIRE WOUND RESISTORS

CHOKE COILS



ELECTRICAL REACTANCE CORPORATION
FRANKLINVILLE, N. Y.

Roehr Distributing Company

St. Louis' Radio Mail Order House

ANTENNAS (Auto and Home)
CONDENSERS
RESISTORS
MICROPHONES
TUBES
PHONO MOTORS
BATTERIES
(All Types—
AB Packs)

PHONO NEEDLES
TRANSFORMERS (All Types)
VOLUME CONTROLS
(Complete Stock Carbon
and wire wound)

ALL R. M. S. CABINETS IN STOCK

Write for our list of tubes, catalog package, and information on how to secure a Speedex Tube Base Chart free of charge.

ST. LOUIS 3, MISSOURI

duction of these distinctive dials by means of an optically recording instrument which incorporates a combination of optical and electro-mechanical principles, achieving an amazing degree of accuracy. The special process used in the manufacture of the dials is described as resulting in uniform accuracy of line width and spacing, length of lines and their arrangement, whether uniform, logarithmic, or in accordance with special spacing requirements. Other production details and information on the wide range of styles and types of dials are also included.

For a free copy of this leaflet, written request should be made to the *American Dial Company, Inc.*, 450 West 45 Street, New York 19, N. Y.

-30-

R.F. Probe Design

(Continued from page 37)

6L6 tube is replaced and three of its pins are used as terminals for the probe output connections.

The probe is connected to the d.c. electronic voltmeter by means of a shielded, 2-conductor, rubber-covered cable. One end of this cable is fitted with an octal socket for connection to the probe while the other end of the cable is wired to a microphone-type chrome connector which plugs into a suitable socket on the d.c. electronic voltmeter. The latter socket is, of course, wired to the appropriate voltmeter circuits, as indicated in Figs. 4 and 5.

The shape of the probe permits ease in handling and allows it to be used in "hard to get at" places.

Capacitor C_1 is mounted inside the stand-off insulator while the 9006 tube, polystyrene tube socket, and resistor R_1 are located inside the metal shell of the reclaimed 6L6 tube. This shell may be painted a crinkle finish, if desired, to improve the over-all appearance of the finished instrument.

When constructing the probe, the first operation is to prepare the shell of the 6L6 tube. This is not difficult and is performed in a manner described as follows:

1. Carefully loosen the base of the tube by prying out the four metal tabs which hold it in place. Then pull the base from the shell and cut the wires which are connected from the pins to the tube elements. The base will then fall free of the shell.
2. Remove the metal disc on the lower inside of the shell. This disc contains the glass-to-metal seals through which the tube connections pass. The disc is most easily removed by drilling, but may also be removed by cutting and filing.
3. Remove all parts from within the shell and clean the inside thoroughly.
4. Drill a hole in the top of the shell through which capacitor C_1 can pass. This hole should be slightly

AMATEURS AND RADIO REPAIRMEN

We appreciate your bearing with us on the delay in deliveries, but hope you remember we accepted no orders for material we could not deliver.

Parts are coming in more freely now so the percentage of 100% filled orders is increasing. Thanks again.

EXCLUSIVE DISTRIBUTORS FOR STROMBERG-CARLSON AMPLIFIERS

Stanton Radio Supply

W9PSP W9JKE
521 State St. HAMMOND, INDIANA
Phone 2314

Amateur Radio WRITERS WANTED

To write articles on transmitters, receivers, antennas, test equipment, and any material of general interest to amateurs. Articles should be typewritten, between 2000 and 2500 words in length, accompanied by suitable diagrams, photos, and parts lists. Liberal payment made upon acceptance.

Address all communications to

Box 419

RADIO NEWS

185 North Wabash Avenue, Chicago 1, Illinois

RADIO NEWS

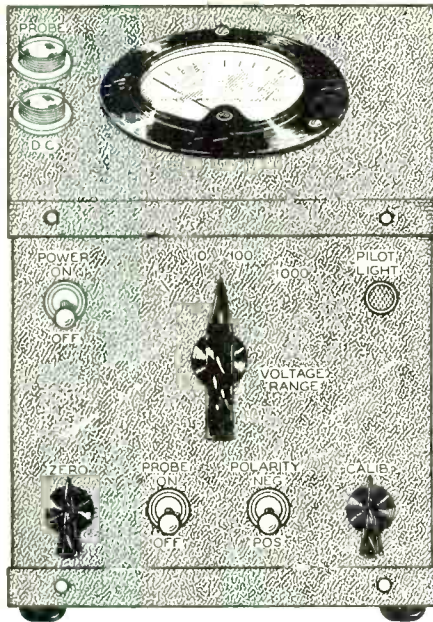

Fig. 7. Panel layout of a direct current electronic voltmeter.

larger than the inside diameter of the polystyrene stand-off insulator.

5. Drill a small hole on the side of, and near the top of the shell. This hole must accommodate the ground terminal.
6. Drill another small hole near the base of the shell to hold the screw used for connecting the metal shell to the ground pin of the base.
7. Drill and tap three or four holes, as necessary, in the top of the shell. These taps are used for gripping the screws which hold the stand-off insulator to the shell. The insulator should be the type which has a circular metal base, such as those made by the *James Millen Mfg. Co.*

After the shell has been prepared, the parts are next wired externally and the completed assembly slipped into the shell. All the wires should, of course, be kept as short as possible. A small tweezers will aid in the proper placement of parts.

After the internal parts are positioned, the stand-off insulator is mounted on top of the shell and over capacitor *C*. A small hole must be drilled into the side of the insulator through which the pigtail connector of the capacitor can pass. It is recommended that the end of this pigtail connector be wound around the metal prod and left unsoldered because the heat of a soldering iron may soften the polystyrene.

The final operation is to install the base on the shell. The three connecting leads of the probe are passed through three of the pins on the base and then soldered. After the soldering is completed, the base is placed in its original position and the four metal tabs pressed in to secure it in place.

NOTE: Be sure to write down the number of the pins to which the connections are made. This may be necessary for future reference.

If desired, a circular spring clip or

Heins & Bolet

68 CORTLANDT ST.

NEW YORK 7, N. Y.

ESTABLISHED 1921 • • • RECTOR 2-7600

In Stock—Immediate Delivery!

WEBSTER AUTOMATIC RECORD CHANGERS
STOPS AT LAST RECORD—Get Our Special Low Price

HAMMARLUND

HQ 129X RECEIVERS &

The New HAMMARLUND

SUPER PRO No. 400 SERIES



12" SPEAKER BAFFLES



OUR PRICE **\$2.95**

MICROPHONE FLOOR STANDS

10" Diameter, 9 lb. Base. All Chrome Pipe Section. Adjustable from 36" to 67". Positive Velvet Action Clutch.

\$5.25

20% DEPOSIT REQUIRED ON ALL C.O.D. ORDERS

WE CARRY A FULL LINE OF STANDARD RADIO PRODUCTS

Inquiries Invited on Products Not Advertised

WRITE FOR FREE LITERATURE ON STANDARD PRODUCTS

Where lasting appearance counts . . .

SNYDER

Antennas

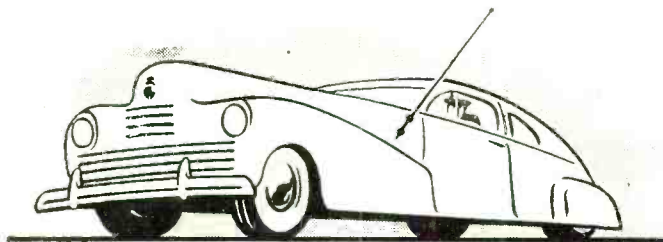

SNYDER
MANUFACTURING COMPANY

PHILADELPHIA

MANUFACTURERS . . . START TO FINISH



Alsam's REGENCY Striped Cases



Model RC-250 Portable Automatic Phonograph Record-Changer Case
Covered in attractive striped leatherette. Dimensions: 22 3/4" L x 15 1/4" W x 10 3/8" H. Takes record-changers with base plates up to 14 1/2" square. Mounting board also accommodates chassis and controls. Grilled front opening for 6" or 8" speakers; grilled opening in rear for acoustics and ventilation. Blank motor and insert boards included.

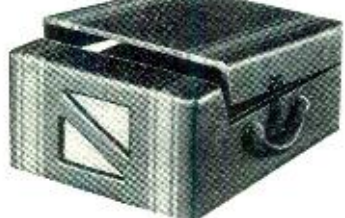

Model P-512 Portable Phonograph Case
Covered in attractively designed leatherette. Dimensions: 17" L x 14" W x 7 3/4" H. Will play 12" records with lid closed. Offset lid type. Grilled front opening for 5" or 6" speaker; grilled opening in rear for acoustics and ventilation. Blank motor and insert boards included.
Other cases and cabinets available for open face record-changers, portable phonographs, table model radios, open face record-players, wall baffles.
Write for illustrated literature and prices.
Order from your jobber.

ALSAM PRODUCTS COMPANY
805 MILWAUKEE AVENUE
CHICAGO 22, ILL.

WAR SURPLUS BARGAINS

BIG SAVINGS
Hundreds of specials
for RADIO SERVICEMEN

- CATHODE RAY TUBES
- POWER & TRANSMITTING TUBES
- HEADPHONES, etc.
- HARD-TO-FIND TEST METERS



7 LB. RADIO PARTS ASSORTMENT

A "gold mine" for the radio serviceman, handyman and repairman. Hundreds of valuable radio, radar and electronic parts, screw machine parts, bushings, sub assemblies, etc. More than your money's worth every time. An amazing value. Money-back guarantee.

K130R — FULL 7 POUNDS ONLY \$179

War Surplus Bargain Book
Page after page of war surplus and other bargains for the radio serviceman; also specials for home, shop and outdoors.
IT'S FREE! WRITE TO-DAY

FREE CATALOG

STARK'S Dept. RN34 509 So. STATE STREET CHICAGO 5, ILLINOIS

other suitable part may be mounted on the glass envelope of the diode tube in order to hold it permanently in position. This is not absolutely necessary, however, because the wiring within the shell holds the tube quite securely.

Any short length of wire will serve as a ground lead when connected to the ground terminal of the probe. A wire 8 to 10 inches long is suitable for low-frequency work while a short piece of bus bar approximately 2 inches long is better for high-frequency measurements.

D.C. Electronic Voltmeter

The probe may be quite easily connected to the d.c. electronic voltmeter. A suitable arrangement, as previously explained, is to install a socket on the voltmeter into which the connector on the probe's cable may be plugged. This allows the probe to be easily removed when not in use. Fig. 4 shows the writer's home-built d.c. electronic voltmeter with which the probe is used. Fig. 5 is a schematic diagram of this combination and illustrates the simplicity of attaching the probe.

Only three connections are usually necessary when connecting the probe to a d.c. electronic voltmeter.

1. A common ground connection between the probe and voltmeter. This connection also serves as one side of the 6.3 volt wiring for the heater of the diode tube. On some instruments, it may be found that neither side of the 6.3 volt source is connected to ground. If so, it will probably be necessary to run an extra lead to the probe and, in this case, a 3-conductor shielded cable will be required.
2. A conductor for connecting the voltmeter's 6.3 volt, a.c. source to the heater of the diode.
3. A conductor for delivering the d.c. output of the probe to the d.c. input of the voltmeter.

The probe's d.c. output voltage is negative and, for this reason, the voltmeter must be adjusted for negative d.c. measurements. A polarity-reversing switch is built into some d.c. electronic voltmeters while other models have separate input terminals for positive and negative voltages. If the instrument should, however, be designed for the measurement of positive d.c. voltages only, a switch to reverse the meter connections is not difficult to install. Such a switch is shown in Fig. 5.

For those who may be interested in building the d.c. electronic voltmeter illustrated, Fig. 7 is shown and the following information is included in this article.

The instrument has four d.c. voltage scales permitting a selection of either 1, 10, 100, or 1000 volts full-scale meter deflection.

No special meter scale is required. The normal 0-100 scale of the meter allows direct readings of the d.c. voltage being measured when the voltage range switch is at the 100 position. When the switch is at the 1, 10, or

RISCO

Servicemen's Special

SPEAKERS 4" & 5" PM..... \$1.45
4" & 5" 450 ohm.. 1.55

We carry all size speakers in stock.

SPRAGUE condensers, oil filled 4 mfd. 600 volt..... 1.95
Resistors, 10 watt, any size..... .20
I. C. A. Universal line cords..... .60
All other resistance cords..... .44
Antenna Coils, R.F. or Osc., pr..... .55
Aerial wire 7/22 copper tinned 100'.... .70
Micro Switches, all purpose..... .85
5 Tube superhet chassis..... .50

Special prices on knobs, resistors & condensers, asst. or kits.

3 TUBE AC-DC phonograph amplifier kits, including tubes and 5 inch speaker... **\$7.95**

5 TUBE AC-DC superheterodyne kit, including tubes and complete di-rections. **\$16.95**

Walnut cabinet for Superhet..... \$ 3.50
Pioneer remote control servos, pr... 6.00
For 110 volt A.C. 60 cycle use..... 10.00

All other radio parts available
Send for our latest catalogue

25% required with order
Balance C. O. D.

RISCO SALES CO.

RADIO & EXPERIMENTAL
PARTS AND SUPPLIES
224 East 65th St.

New York City 21

New York

JUKE BOX RECORDS

LATEST & HARD-TO-GET BACK NUMBERS

Some slightly used and some brand new—Victor, Bluebird, Columbia, Okeh, Decca, Capitol, etc. Such artists as Glenn Miller, Benny Goodman, Harry James, Bing Crosby, Frank Sinatra, Gene Autry, Duke Ellington, Fats Waller, Guy Lombardo, Andrews Sisters, Kate Smith, Ink Spots, Mills Bros., etc.

BIG PROFITS Your opportunity to cash in on this new field that is sweeping the country. Specify the type of music that sells best in your territory such as Swing, Sweet Music, Cow-boy, Hill-billy, Polkas, Blues, etc. Your price \$13.90 per 100 records, f.o.b. Chicago, 2% off for cash with order. All shipments made within 48 hours.

CHAS. HOODWIN CO.

4419 Broadway, K-15, Chicago 40, Illinois
World's Largest Dealers in Used Records

NEW TINY POCKET SIZE RADIO!
Slips in your pocket or purse—**WT. only 3 ozs.!** Complete **READY TO PLAY** as shown with self-contained phone for personal use. Beautiful black plastic case. Has a patented **fixed Crystal-Slide Tuning Dial!** **NO TUBES, BATTERIES, OR ELECTRIC PLUG-IN REQUIRED!** **USUALLY RECEIVES LOCAL BROADCASTS** without outside aerial wires.

GUARANTEED TO WORK when connected and used according to instructions. Can be used in homes, offices, hotels, cabins, in bed after hours, etc. (cash, money order, check) a o d pay postman \$2.99 plus delivery fees on arrival or send \$3.99 for postpaid delivery. **IDEAL GIFT FOR CHILDREN OR ADULTS ALIKE!** Get your **PA-KETTE RADIO NOW** for real enjoyment. Dealers in most cities.
PA-KETTE ELECTRIC CO., Dept. RN-3, Kearney, Nebr.

SEND ONLY \$1.00

1000 position, the voltage readings can be easily calculated by dividing or multiplying the reading obtained by a power of ten. For example, if an unknown voltage is being checked with the voltage range switch at 1 and the meter reading is 40, the correct voltage will be 40 divided by 100 (10^2), or 0.4 volts.

The accuracy is very nearly that of the meter itself. A bridge circuit is employed with large values of resistance in the cathode circuits of the tubes. This assures sufficient negative feedback to maintain the operating point of the tubes on the linear portion of their I_p-E_g characteristic curves. Such operation, in turn, allows the linear scale of the meter to be used without noticeable loss of accuracy.

The so-called "contact potential, gas current, or negative grid current" is negligible providing the bridge tubes are in normal operating condition. Some tubes, however, may prove to be better than others in this respect.

No special constructional precautions are necessary except that shielded wire should be used for all connections in the grid circuits of the tubes to prevent stray pickup.

The d.c. test leads (Fig. 6) are comprised of a shielded, single-conductor cable and a ground lead. A 5-megohm isolating resistor is built into the test prod to allow d.c. measurements to be made without interfering with the circuit under test. The test prod cover should be made of polystyrene or other high-resistivity material.

Both a zero adjustment and a calibration control are located on the front panel. A single 1.5 volt dry cell battery will serve for rough calibration purposes; when the d.c. test leads are connected to the battery and the voltage range switch is at the 10 volt position, the calibration control is rotated to the position which causes the meter to read 15 divisions on its 0-100 scale. The instrument is then ready for measurements on any voltage range without further adjustment. The accuracy for ranges other than the range on which the calibration operation is performed will depend entirely on the accuracy of the resistors used in the construction of the voltage-divider network.

The balanced nature of the circuit assures proper operation of the instrument even when the a.c. power source is undergoing slight fluctuations. A gas regulator tube is added to the rectifier, nevertheless, in order to insure stable operation if large changes in line voltage occur.

R.F. Voltage Measurement

After a d.c. electronic voltmeter has been properly adjusted for d.c. operation, the probe may be plugged in. At this time, a zero adjustment will be required if either the 1 or 10 volt range is to be used. The probe is then ready for comparison measurements of r.f. voltages. As previously stated, this type of measurement is all that is usu-

ally required for service work. If, however, it is desired to make accurate measurements of r.f. voltage, the instrument must be calibrated using known values of r.f. voltage having a frequency higher than 100 kc. It will be found that readings will be linear at levels higher than 1 volt. Thus, a single calibration will serve for all ranges except the lowest. On the latter range, a calibration chart will have to be made if accuracy is desired. The procedure for making up such a chart is generally known and can be found in most radio text books. For this reason, the procedure is not repeated in this article.

-50-

International Short-Wave

(Continued from page 116)

sion in English was presented; a program in Arabic was heard prior to 12:30 p.m.; the broadcast in English at 12:30 p.m. consisted of local news, this being preceded by the playing of the march, "Colonel Bogey"; the station signed off at 12:45 p.m. following station identification in English; operating frequency is 13.320.

"Headquarters Radio Southeast Asia Command broadcasting from Singapore" has been logged strongly at 3:15 a.m. with special programs for

Radio and Electronic

Components

All New Government Contract
Termination Material

For over two years we have been carefully selecting a wide variety of electronic parts and equipment. Today our stock is one of the largest and most complete in the country.

TRANSMITTER COMPONENTS: While we have practically any kind of radio component, we are particularly well supplied with transmitter equipment. Popular transmitting tube types manufactured by leading companies to Signal Corps specifications are available in quantity. All are new, first quality and in original cartons. High voltage transformers, chokes and filter capacitors, inductances, ceramic tube bases and coil forms, variable condensers for all frequencies and voltages, relays, by-passes and switches are just a few of the many transmitting parts now available.

RECEIVER COMPONENTS: For receivers, we can offer a wide variety of condensers (paper or mica), resistors, transformers and headphones. In addition, we have an excellent selection of meters, C-R tubes, sectional whip antennas, jewel-light assemblies, terminal strips and other items too numerous to list.

Every item is new, unused, and unconditionally guaranteed. We especially invite inquiries from manufacturers, jobbers, exporters and dealers. A wire, letter or personal visit to our display rooms may result in your getting just the items you need at once and at a substantial saving.

HANDY PORTABLE POWER OR LIGHT PLANT

Delivers 300 watts at 110 volts A.C. Extremely quiet. Runs 7½ hours on 1 gallon gasoline. Ideal for farms, trailers, boats, camps, etc. Built for Signal Corps. Weighs just 50 pounds. Priced at fraction of original cost. Complete with tools, spares, carrying case. **\$112.50**
F.O.B. Chicago.

WELLS SALES, INC.

4717 West Madison Street
Chicago 44, Illinois

USE COUPON BELOW FOR COMPLETE INFORMATION

WELLS SALES, INC., 4717 West Madison Street, Chicago 44, Illinois
We are interested in receiving information on the following items:

.....
.....
NAME.....FIRM.....
ADDRESS.....
CITY AND STATE.....

Electronics RADIO ENGINEERING

NEW COURSES FOR MODERN NEEDS

RADIONICS, the science of electronic applications, is widening its horizon hour by hour. There's a secure future in this field for YOU—provided you put OUR TRAINING ON YOUR must list NOW

Needed at once are specialists in Marine Radio, Police Radio, Aviation Radio, Broadcasting, Television, Frequency Modulation, High Frequency Broadcasting, and Commercial Radio Telegraph. That need will continue.

Our school is co-educational. It offers to women as well as men streamlined elementary and advanced courses for Radio Servicemen, Radio Engineering Assistants, Radio Test and Maintenance men. The work is thorough, practical, void of frills. The courses are approved by State Vocational Departments, Major Airlines, State Police Systems, Radio manufacturers, and hundreds of Broadcasting Stations.

Credit is given for Army Radio courses and experience toward any of our courses. High school graduation or its equivalent necessary for advanced courses. Tuition at pre-war levels. Send for catalog today.

MAIL THIS COUPON NOW!

VALPARAISO TECHNICAL INSTITUTE
Dept. R., VALPARAISO, Ind.

NAME

P. O. ADDRESS AGE

CITY and STATE
CATALOG REQUEST—RADIO NEWS

PUT THE RF IN THE ANTENNA WITH OUR Lo Loss SPREADERS

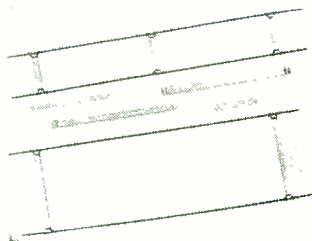

LIGHTWEIGHT—UNBREAKABLE

GIVE YOUR RIG THE BENEFIT OF
AN EFFICIENT FEED SYSTEM

USE OUR Lo Loss SPREADERS,
A SIZE FOR EVERY NEED.

2"	\$.15
4"20
6"25
Amateur Net Price	

WE PAY POSTAGE
In Continental U.S.A.,
on Spreader Orders
Over \$2.00, if Accom-
panied by Remittance.
(M.O. Preferred)

All Orders Filled Same Day as Received.

Watch for **BEAM ANTENNA** Next Month
—OR—

Write for Beam Antenna Literature.

Mail, Phone or Wire Your Orders to

RESEARCH MANUFACTURING CORPORATION
Box 757, Dept. N3
CHULA VISTA, CALIFORNIA

All-India Radio in Delhi, consisting of recordings and various foreign language commentaries; operates on 15.365 (19.51 m.). TAQ, 15.190 (19.75 m.), Ankara, Turkey, is heard with a fair signal with programs in a Balkan language at 12:30 a.m. VLN, 21.100, Sydney, Australia, has been heard on phone at 7:30 p.m.

Holland—His friends here will be glad to learn that *Peter Koelmans* (SWL.PA-L370), Boskoop, Holland, is safe and well after the German occupation of his homeland. In part, he writes to me: "From January till our liberation I stayed at home, as the Germans picked up all men from the street to work in Germany or to make defenses here in Holland. I was very glad they capitulated, as then I could be in the free air again. Last winter was a very bad one here in Holland. We had no food, no coal, no gas, no electricity. We hope that will never come back." Peter, who is 25, told an interesting story of how during the last months of the occupation, when it was not safe for him to be on the streets, his fiancée stayed at his home to help him hide from the Germans. He made a hiding place "in the portico of the sliding doors between the frontroom and backroom." At night when there was a ring at the doorbell, he went into this hiding place from his bed and then his YL closed the trapdoor, arranged the floor-covering, and *dipped* into his bed so that nobody could see that there was a young man in the house. At other times his YL slept with his little sister—"and in this manner there was never an empty bed in the home" to draw suspicion from the Germans. Peter was married to his YL on September 12, 1945. He was in high school to 1939, passed the examination and tried to join the Dutch Navy, but that year it was not possible and in the next year the Germans occupied Holland. Since February 1941, he has been employed in a coal office. First, he worked in Boskoop—but in December 1943, that office was discontinued and he was transferred to the Coal Committee in Gouda, about 6 miles from Boskoop. He says "each day I go on my bike with massive tires to my work. We distribute coal to factories, bakers, laundries, and the like. I am now assistant headclerk. . . . It is a pity I have no short-wave receiver yet, but I hope my U.S. friends will send me some parts and tubes when they can be sent, because there is nothing for sale here. When I get my set assembled and in good operating condition, I'll send you my logs." Peter's new QRA is Bootstraat 1a, Boskoop, Holland.

Ireland—*Osmond G. Dowling*, Radio Editor of the Evening Herald, Dublin, Ireland, has just sent us the names of four Irish short-wave DXers from whom we hope to get reports soon. Mr. Dowling is interested in receiving information concerning Irishmen in America broadcasting, U. S. radio people with Irish connec-

Calibrate your 'Scope to 1%
with **Voltascope**



PROVIDES three standard voltages—.1, 1.0 and 10.0 peak to peak volts. AC operated and adaptable for all make oscilloscopes. The magnitude of an unknown signal may be determined rapidly and accurately. No warm-up time makes the Voltascope ready for immediate use.

A self-contained instrument—no bigger than your hand. Fool-proof—no tubes. Easy to operate.
Net price, F.O.B. New York City

\$1500

POLARAD ELECTRONICS COMPANY
135 LIBERTY STREET • NEW YORK 6, N. Y.
Phone: REctor 2-0534

LOCATES TROUBLE INSTANTLY
IN ALL ELECTRICAL DEVICES



HANLAN APPLIANCE TESTER

In this single unit are combined all the necessary tests for examining every appliance. Checks thermostats under actual working conditions. Tells instant it opens or closes. Controls the heat on soldering irons—prevents overheating. Tests continuity, open circuits, etc. Checks automatic irons, vacuum cleaners, motors, shavers, bulbs, fuses, appliances with 3-way switches, etc. Great time, effort and money saver! Only \$9.50 complete. WRITE FOR CIRCULAR.

Pat. Pend.

HANLAN COMPANY

1419-R West Jefferson Los Angeles 7, Calif.
with each Tester. New, Complete, Practical
FREE Course in electrical appliance repairing.

LEs Correspondence Courses In
RADIO and ELECTRICAL ENGINEERING

ELECTRICAL ENGINEERING Get good grasp of wide electrical field. Prepare yourself at Low Cost, for secure future. Modern course. So simplified anyone can understand quickly.

RADIO ENGINEERING Extra fine course in radio, public address, photo-electric work. Trains you to be super-service man, real vacuum-tube technician. Servicemen needed badly. Diploma on completion.

WRITE Send postcard or letter for Free Copies of school catalogs, full details, all about deferred payment plan, etc. SEND NOW! **LOW \$25 Either AS Course**

LINCOLN ENGINEERING SCHOOL, Box 931-R87, Lincoln 2, Nebr.

FILMGRAPH PAT'D
Conference Recorders

UNINTERRUPTED Longtime (up to 12 hours) Conference & Telephone Recordings on Safety Film Models for Dictation "TALKIES"

ECONOMICAL PERMANENT INSTANTANEOUS PLAY-BACK

MILES REPRODUCER CO., Inc. 812 BROADWAY, N.Y.3 RN-3

Plastic Radio Cabinets
to Your Specifications

GOODCHILD PLASTICS CO.
1603 1/2 S. Western Ave.
LOS ANGELES 6, CALIF.



RCA Institutes, Inc.

Offer thorough training courses in all technical phases of Radio and Television

WEEKLY RATES **DAYS—EVENINGS**

VETERANS: RCA Institutes is approved under G. I. Bill of Rights

For Free Catalog write Dept. RN-46

RCA INSTITUTES, Inc.

A Service of Radio Corporation of America
75 Varick St., New York 13, N. Y.

tions. He says, "I am also very keen to get some 'dope' on the immediate future of television in the U. S. as well as the whole story of American sponsored programs." If anyone cares to write to Mr. Dowling his address is "St. Peter's," Whitehall Road, Rathfarnham, County Dublin, Eire.

New Zealand — William S. "Bill" Milne, Invercargill, sends us this report: ZOJ, 11.81, Colombo, Ceylon, English news at 5:30, 7:30 a.m. VLA6, 15.30 (this is listed as 15.20). Radio Australia, English news at 4 a.m. AES, 6.125, Milan, Italy, heard with English news at 2 p.m. PCJ, 9.59, Hilversum, Holland, heard testing to 3 p.m. He reports that recent tests over ZLN-4, 9.867, Wellington, at 2:15 p.m. have been "poor." JCKW, 7.22, Jerusalem, Palestine, heard at 3 p.m. VLW7, 9.52, Perth, Western Australia, is heard 5 p.m.-8:45 p.m. and 5:30-10:30 a.m. Verifications recently received are listed as from JCJC, 7.22, buff card; SUX, 7.869; VLG10; ZLN-4; Radio Levant, 8.035; HVJ, 16.538; HEK4, 11.96; HEO4, 10.342; and 24 OWI cards.

Sweden — This fine list of DX has come in from Lennart Ekblom, Stockholm, Sweden: HVJ, 9.66, Vatican City, 2-2:15 p.m. in French, weak; CR7BE, 9.71, Lorenzo Marques, Portuguese East Africa, 2:30 p.m. in Portuguese, good; Radio Belgrade, 6.15, Yugoslavia, 2:50 p.m. in French, strong; Warsaw, Poland, 6.09, with English news at 3-3:15 p.m., good; ZYC8, 9.61, Rio de Janeiro, Brazil, at 3:30 p.m. in Portuguese, strong; TAP, 9.465, Ankara, Turkey, English program, 4:30-4:40 p.m., good; Radio Brazzaville, 11.970, in English at 3:45 p.m., strong; PRI3, 6.000, Belo Horizonte, Brazil, 3:30 p.m. in Portuguese, weak; HEI2, 6.345, Bern, Switzerland, 3:50 p.m., strong; WNRI, 13.05, New York, at 9:15 a.m. in German, good; PCJ, 15.22, Hilversum, Holland, at 9:20 a.m. in English, and on 9.59, heard 8-9 p.m., good but on 9.59 has interference; Singapore Radio, 9.555, signing off at 10:30 a.m. in English, good; OIX1, 6.118, Lahti, Finland, at 10:40 a.m., excellent; ZNR, 6.76, Aden, Arabia, at 11:10 a.m., good; Y15KG, 7.085, Baghdad, Iraq, with English at 11:10 a.m.-12 noon, good; Radio Omdurman, 13.32, Egyptian Sudan, sign-off at 1 p.m.; has English program on Thursdays, 12:30-1 p.m., good. Mr. Ekblom comments that "this time (October-April) is a very bad time for DXing in Sweden. But the summer is very fine for DX results."

Moscow's evening transmission is heard on 15.23 and 11.75, fair, 6:20-7:30 p.m. to U. S.; has heard Moscow on 11.75 and 9.565 with Chinese programs, 9:30-10:30 p.m.

* * *

LAST MINUTE TIPS

The Victory Radio Club reports that LRY1, 6.088, Buenos Aires, Argentina, signs off at 9 p.m.; that VLQ2, 7.215, Brisbane, Australia, is being heard at 3 a.m.; that VUD5, 7.390, Delhi, India, March, 1946

R. C. & L. F. HALL

1015-17 Caroline St.
Telephone C-9731
Department N
Houston 2, Texas



R. C. (Dick) Hall
W5EIB



L. F. (Lillian) Hall
W5EUG

Receiver and transmitter deliveries are improving at such a rate as this is written (1-18-46) we now feel like we are safe in listing models and prices as we should have a very good stock by the time you read this (about March 1).

"THE HAM SHACK"

NATIONAL

NC-2-40C less speaker..... \$225.00
Speaker..... 15.00
1-10 less tubes, speaker & power supply..... 56.10
5886 power supply for 1-10..... 19.50
Tubes for 1-10 6Y4, 955, 6C5, 6F6..... 8.57
HRO-5TA; HRO-5RA

HAMMARLUND

HQ-129X less speaker..... \$129.00
Speaker..... 10.50

Super-pro

SPC-410-X (540 KC to 30 MC) cabinet model
SPC-110-SX (1250KC to 40MC) cabinet model
SH-410-X (540 KC to 30 MC) rack model
SPR-110-SX (1250KC to 40MC) rack model
PS-CW-10 10 inch PM speaker
(O.P.A. prices not determined at this time)

HALLICRAFTERS

S-41 Skyrider Jr. \$ 33.50
S-20R Sky Champion 60.00
S-22R Marine 74.50
S-39 Sky Ranger 110.00
X-25 Super Defiant 94.50
SX-28A Super Skyrider 223.00
S-37 (130-210MC) FMAM 591.75
S-36A (28-143MC) FMAM 412.00
Speaker for SX-25, SX-28, S-36, S-37 15.00
HT-9 transmitter (less coils, crystals, mike) 225.00

ECHOPHONE

EC-1A \$29.50

RME

RME-45 with crystal, meter & speaker \$166.00
DR-20 preselector 59.30
VHF-152 (2, 5, and 10 meter converter) 29.70
IF-90 (low freq. inverter) 29.70
Wire, write or phone your order. We will ship C.O.D. with a \$5.00 deposit. We also offer easy terms and trade-in allowances for used equipment.

"ACROSS THE OPERATING TABLE"
A postal card will place you on our mailing list to receive our amateur bulletin.

A FEW OF THE MANUFACTURERS WHOSE PRODUCTS WE DISTRIBUTE

Aerovox	Cinaudagraph	General Cement	Johnson	Milen	Radel	Thermador
Amphenol	Ciarostat	GE	Kaar	Mueller	RCA	Thordarson
Astatic	Drake	Hallcrafters	Keinor	National	RME	Trimmm
B&W	Dumont	Hammarlund	Leach	Ohmite	Sangamo	Triplett
Belden	Echophone	Hytron	Lectrohm	Poerless	Setchell-Carlson	Turner
Boley	Eimac	Instrucograph	Les Logan	Peterson	Silver	Vaco
Bud	Electronics Lab.	Insuline	Littelfuse	Pioneer	Speed-X	Waco
Centralab	Erie	Jensen	John Meck	Precision	Stancor	Walco
	Gammatron	JFD	Meissner	Premax	Taylor	Ward

"ACROSS THE SERVICE BENCH"

is the name of our dealer bulletin, which goes regularly to our service dealer customers. This bulletin keeps you in touch with the latest information on available equipment and supplies. A postal will place your name on this list and will also secure a "new customer tube allocation" if you request it.

SPECIAL ATTENTION
is being given to ex-servicemen entering business who need complete stocks. Such inquiries should be marked "for personal attention R. C. Hall."

SPECIALS

Resistor Kits

100 1/4, 1/2, 1 & 2 watt sizes, carbon \$2.95
25 10 watt and larger, wire wound 2.95
12 ast. volume controls 2.95

2 mfd. 2000 volt oil filled cond. \$2.95
Lewis Electronic 24G 3.75

TEST EQUIPMENT IN STOCK

Silver "Vomax" \$59.85

Ask for other brands and models, since we carry practically all of them and are getting shipments from time to time.

MARINE EQUIPMENT
We are able to give good delivery on marine radio telephones. Phone, write or wire for information.

POLICE, GEOPHYSICAL & MOBILE
radiotelephone equipment is available on good delivery. We welcome inquiries for your particular application.

INDUSTRIAL ACCOUNTS
are welcomed. Wire, write or phone. We have one of the largest electronic stocks in the Southwest.



PLASTIC KNOBS

for the Electronics Industry

IN the complete line of General Electric phenolic plastic knobs, you will find a wide variety of shapes and sizes to blend in with practically any type of equipment design.

Ruggedly constructed for the hard and constant use that knobs receive, these black phenolic plastic types will not only prove more than satisfactory but will also add a distinctive touch to the appearance of any unit. Write:

*Electronics Department
General Electric Company
Syracuse, N. Y.*



GENERAL ELECTRIC

100-52

ATTENTION!
STUDENTS • SERVICE MEN • HOSPITALS

Build Your Own
RADIO

It's Easy . . . We Show You How



We manufacture complete radio kits. Send for details.

Four tube T.R.F. Kit complete with tubes **\$10.95**
Six tube Superheterodyne Kit complete with tubes **\$17.95**

MULTI-TESTER

All the parts you need plus complete detailed instructions to enable you to build a multi-tester which parallels commercial meter construction **\$14.95**

Special for This Month
12" P.M. Speaker
(Heavy Slug) . . . \$4.95

Handy Volume Control Kits. Assorted Sizes
Condenser Kits & Resistor Kits
at Special Prices

We carry a complete stock of parts.
Export Inquiries Invited.

RADIO KITS COMPANY
Dept. K 120 Cedar St. New York 6, N. Y.



New MODEL 450
TUBE TESTER

Designed especially for the service man who wants to give better service. Speedy operation is assured by newly designed rotary selector switch which replaces the usual snap, toggle or lever action switches. Tests all tubes up to 117 volts including 4, 5, 6, 7L, Octals, Loctals, Magic Eye, Hearing Aid, Thyratrons, Single Ended, Floating Filament, Mercury Vapor Rectifiers, also Pilot Lights. Tests shorts and leakages up to 3 Megohms in all tubes. Tests both plates in rectifiers. Has many other new features and advantages that any good service man will appreciate after five minutes' use. Immediate Delivery.

Only **\$39.50**

Write for latest bulletin showing hundreds of other hard-to-get items at money-saving prices.

Lifetime
SOUND EQUIP. CO., Dept. 44
911-913 JEFFERSON AVE., TOLEDO 2, OHIO

was recently reported heard in Washington, D. C., from 6:30-7:15 p.m., in Chinese and French; and that LKJ, 9.540, Oslo, Norway, signs on at 2:58 a.m. with the Norwegian National Anthem, then has news in Norwegian to 3:25 a.m. sign-off. (Harris.)

Mail to Station ZAA, Tirana, Albania, is still being returned marked "Service Suspended"; check with your local post office before sending mail to Albania.

According to official schedules, Radio Nacional de Espana, 9.370, is listed in European transmission as follows: 3 p.m., English; 3:30 p.m., Arabic; 3:45 p.m., Spanish; 4 p.m., French; 4:30 p.m., Portuguese; 4:45 p.m., German; 4:52 p.m., Italian; and 5 p.m. sign-off. On Sundays these periods are reduced to six minutes each, the French moves ahead of the Arabic, and the extra time is taken up with music. A further transmission to America in Spanish, 6:30-9 p.m., is reported as best heard in this country, but at 3 p.m. I have been getting a nice signal in the English news period (read by a woman). For further information on this station address Subsecretaria de Educacion Popular, Direccion General de Radiodifusion, Madrid.

A hard-to-get station, Radio Omdurman, 13.320, is reported as heard in Florida, 3-4:03 p.m. in English, paralleling Khartoum, 9.220; signals weak, code interference. These stations are located in the Anglo-Egyptian Sudan.

A *Radio Congo Belge* transmitter listed as OTJ, Leopoldville, with 2 kw. power, is reported to be on an actual frequency of 6.295, heard 11:30 p.m.-2 a.m., and from fade-in at 3 p.m. to sign-off at 4 p.m., in parallel with 9.380.

Although the schedule of ZOY, Accra, Gold Coast, is not reported, we learn that it is operating on 7.295 with 5,000 watts power.

The station at Lourenco Marques, Mozambique, believed to have a call of CR7BG, is still heard 12 midnight-1 a.m. on approximately 15.370.

ZRK, 5.877 actually (listed as 5.885), Capetown 3; ZRH, 6.007, Johannesburg; and Pietermaritzburg, 4.880, are reported as audible in the East during the 11:45 p.m.-1:30 a.m. transmission. ZRK is the only one heard here in West Virginia recently. ZRL, 9.608, Capetown, was heard weakly in December at 6 a.m., with English identification, then went into Afrikaans program.

A Chinese station believed to be XGNC, Kalgan, is reported on about 6.175 to 4:45 p.m. when GRO, London, comes on the air and covers the Chinese signal.

Delhi's VUD2, 4.960, is reported on to 8:15 a.m. sign-off; comes back at 8:30 a.m. on 3.495 and continues there to 12:30 p.m. VUD7, 9.630, is reported signing on in French at 7:30 a.m.

Radio Saigon, 11.778, Indo-China, is being widely heard with English at 5:30-5:45 a.m. and 9-9:15 a.m. sign-off; on West Coast is also heard on

RADIO
Wholesale
REPAIR

THIS IS THE ANSWER
TO YOUR RADIO REPAIR TROUBLES!

Just SEND us the SET via Railway Express. We REPAIR and RETURN. You ADD MARK-UP AND DELIVER. That's all there is to it.

- Complete Stocks—We can fix 'em all
- 90 day guarantee
- Prompt service
- OUR LOW PRICES mean more Markup for you.

Send that set to

SHEFFIELD RADIO CO.
Dept. B 916 Belmont Ave., Chicago 14, Ill.



SALESMEN FOR CITY AND COUNTY
Nationally Known Manufacturer

Build up a business of your own with Nationally Advertised Products bearing Underwriters' label. Sell to schools, factories, service stations, warehouses, hotels, restaurants, public institutions, truck and bus companies, grain elevators, house trailers, autos, farms, homes, etc. Capable man can earn real money. Established in 1916. Write letter with details, age, experience, etc.

THE FYR-FYTER CO.,

Dept. 22-15 Dayton 1, Ohio

TEST EQUIPMENT

SHIPPED WHEN AVAILABLE!
(Subject to factory deliveries)

- SIMPSON 260-volt-ohm-milliammeter. \$33.25
- SIMPSON 305 tube tester. 39.50
- TRIPLETT 2413-tube tester. 45.00
- TRIPLETT 2432 signal generator. 49.75
- RADIO CITY 705-signal generator. 49.50
- RADIO CITY 802-N tube & set tester. 57.50
- RADIO CITY 448 pocket V.O.M. 24.50
- SUPERIOR 400-multimeter 52.50
- SUPERIOR CA-11-signal tracer. 18.75
- DuMONT 164-E-3' oscilloscope. 105.00

Also many, many others available.

WE ALSO STOCK AMPLIFIERS!

Amplifiers and complete sound systems available from \$29.99 up. Write to us on your specific needs. Orders shipped C.O.D. upon receipt of 25% deposit.

SCENIC RADIO & ELECTRONICS CO.
53 Park Place • New York 7, N. Y.

BUILD YOUR OWN FAST FREEZER

It's easy to build this household appliance and profitable to use. Save up to 75%. Operates on 110 or 220 volts. Plans show 5 sizes and are easy to follow. ENJOY MAKING ONE of these freezers from new or used parts. No expert knowledge needed. Mail \$1.00 bill or check for complete plans and catalog. 5 sizes 8 to 40 cu. ft.

LE JAY MFG. CO., 454 LeJay Bldg., Minneapolis 8, Minn.

RADIO ENGINEERING!

EX-SERVICE MEN can complete work here in shortest possible time. Special Prep. Dept'. Also Refresher Courses. Courses also in Civil, Electrical, Mechanical, Chemical, Aeronautical Engineering; Business Administration, Accounting, Secretarial, Science. Tuition, living costs low. 63rd year. Cosmopolitan student body. Enter Mar., June, Sept., Jan. Catalog. **TRI-STATE COLLEGE** 1636 College Ave. ANGOLA, INDIANA

Specify SAUERISEN
ACIDPROOF CEMENTS—COMPOUNDS

FOR
Tanks, Sewers, Stacks, Floors
Technical cements for all purposes.
Send sketches or samples
Sauerisen Cements Company • Pittsburgh 15, Penna.

Attention! HAMS
... FINISH YOUR OWN
CRYSTALS



NEW
Complete Crystal Finishing Kit

Meet F.C.C. regulations for frequency control with Quartz Crystals. Finish your own crystals to meet your individual requirements. It's fun—it's easy—it's economical. Kit contains four AT or BT low drift Quartz Crystals cut to U.S. Signal Corps wartime specification. Complete accessories including a holder with stainless steel hand lapped electrodes and special device for making limited frequency adjustments—flat glass grinding plates—coarse and fine special grinding abrasives—cleaning brush and syntax beads and complete instructions. Be sure to specify frequency desired so we can send blanks within easy grinding range.

ALL AT AMAZING LOW COST—
Send money order, check or cash for your kit today.

COMMERCIAL EQUIPMENT CO.
Dept. G
1416 McGee Street
Kansas City 6, Missouri

FREE INSTRUCTION

Unusual Buy
Cathode Ray Tubes



& Television Parts

New Factory Sealed Tubes for Television & Oscilloscopes

- RCA 5BP4, price..... \$18.00
- DUMONT 5BP1, price..... 15.00
- RCA Television switch with 5 Antennae RF transformers, price 5.60
- G.E. CR Power transformer 1700 V., 6.3 V., 2.5 V., price..... 9.90
- Cathode Ray tube Magnal socket 11 pole with H. Voltage wiring, price..... 2.40
- Cornell-Dubilier Oil Filter tubular Capacitor .1 mfd 3500 V., price..... 1.80
- .02 mfd 2500 V. Sprague tubular Capacitor, price..... .90

All types ceramic, mica and oil capacitors, trimmers, coaxial cable, etc.
Send 50c for complete catalog including diagrams for RCA, G.E., DUMONT and ANDREA Television Receivers, free with order \$5.00 and more.

RCA Parts and Equipment Distributors
World's First Specialized House in Television

ELECTRONICS SERVICE & SUPPLY
262 W. 40th Street, New York 18, N. Y.

March, 1946

4.810; reported on East Coast at 6:30 p.m. sign-on with French news. As far as can be ascertained, mail service to French Indo-China has not yet been resumed.

Y15KG, 7.085, Baghdad, Iraq, was reported heard recently in Arabic, 12-12:30 a.m., with weak signals; may have been a special broadcast.

JLG3, 11.705, Tokyo, is reported irregularly relaying the Japanese Home Service, 10 p.m. on; also JZJ, 11.800 from 4:30 to 6 p.m.; JZH4, 6.130 reported weak around 7 a.m. in Home Service; Tokyo on 3.790 has been heard paralleling JVV, 7.257, 5-8 a.m.

Sofia, Bulgaria, on 9.300 is reported heard at fade-in to sign-off at 3:30 p.m.

Milan, Italy, is reported with good strength afternoons, with frequencies varying from 9.628 to 9.635 and from 11.780 to 11.830, often creating interference.

PCQ, 18.215, Holland, has been heard contacting PJY, 16.350; there appears to be no regular schedule.

HVJ, 9.660, Vatican City, has been reported on West Coast Mondays at 10:15-10:25 a.m. in French; is probably on each Monday at 10 a.m. On 15.120, HVJ is reported Saturdays, 1-1:30 a.m. in Italian for Eritrea.

Radio Southeast Asia Command, 15.120, in Colombo, Ceylon, was reported recently at 5:30-7:30 a.m. with a program for the British Forces in Southeast Asia.

For those who have not yet logged All-India Radio in Delhi—and especially DXers in the East—it is suggested that they tune at 6:30-7 a.m. EST for the program called *The Voice of Britain Calling the Far East*, which has been picked up consistently on 9.590 and 11.870, and occasionally on 15.160; other frequencies used by All-India Radio for this English transmission are (announced) 7.275, 11.760, 15.350. An excellent signal from the 9.590 transmitter is heard here in West Virginia, and the 11.870 transmitter is usually also good.

AFRS, Tokyo, is reported to be operated by the Education and Information Detachment of the U. S. Army, Tokyo, according to announcement which is given only at sign-off, 9 a.m. It is believed the call WVTR is assigned to the block of medium-wave stations that relay JLP, 9.605, and WVTR, 6.020 to our troops. JLP and WVTR operate 4:30 p.m.-9 a.m. next day. JZK, 15.160, and JLS2, 17.845, are also reported as carrying the Tokyo AFRS program irregularly around 6:30-8:30 p.m., as does sometimes WVLC2, 18.530.

Before writing to Macau Radio, Macau, Portuguese, China, check at your post office; at last reports, mail addressed to Macau was being returned marked "Service Suspended."

The *Sharq el Adna* transmitter at Jaffa, Palestine, on 6.135, is now being heard signing on at 11:30 p.m. and off at 1 a.m.; is reported heard on West Coast around 9-10 a.m.

ZQI, 4.700, Kingston, Jamaica, is re-

HENRY RADIO

I am delivering these models:

- Skyrider Jr. 541 \$ 33.50
- Hallicrafters 520R 60.00
- Hallicrafters 522R 74.50
- Hallicrafters 539 110.00
- Hallicrafters SX-25 94.50
- Hallicrafters SX-28A 223.00
- Hallicrafters S36A 415.00
- Hallicrafters S37 591.75
- EC1A 29.50
- National N-2-40C 225.00
- National One-Ten 56.10
- National HRO Sr. 197.70
- RME-45 166.00
- Hammarlund HQ129X 129.00
- Hammarlund Super Pro 318.00
- HT-9 transmitter 225.00
- T350XM transmitter 850.00
- HT 4E BC-610 transmitter 695.00

DEMAND for some models exceeds supply. Some models I ship at once. You can trade in your receiver. You can order on my 6% terms. Write for information. I specialize in receivers and transmitters but also have crystals, transmitting tubes, microphones, test equipment, amateur parts, etc. Your inquiries welcomed.

BOB HENRY
49ARA

HENRY RADIO

BUTLER, MISSOURI AND
LOS ANGELES 25, CALIF.

"WORLD'S LARGEST DISTRIBUTORS OF SHORT WAVE RECEIVERS"

TELEVISION TECH CORRESPONDENCE COURSE

WANTED: Radiomen to take a specialized television course. Instructions begin and end with television. Course has been written for the Radio Serviceman who wishes to learn television repair, and the radio commercial operator who wishes to prepare for this new field. A knowledge of basic radio is assumed.

PREPARATION: The authors of a large portion of this course are Edward M. Noll and O. J. Jimerson. Mr. Noll is author of the present television series in Radio News and a former member of the television department of a major radio corporation; Mr. Jimerson, a former senior radar inspector and a former member of the same television staff.

ADDED FACILITIES: Widespread interest in this course has encouraged us to enlarge our facilities to handle more students.

TELEVISION TECH ENTERPRISES

BOX 94 HATBORO, PA.

Use these new books
to gain a **SURE** knowledge
of radio **EASILY** and at a
LOW COST

1. Introduction to

Practical Radio

Gives you *thorough* training in the groundwork for radio engineering and technical work. Fully explains all necessary math at the points where it is used. Shows in hundreds of examples how to apply theory correctly in the construction and repair of radio circuits. Written in plain, easy-to-understand English by *D. J. Tucker*, a "ham" of 24 years' experience, now chief radio engineer for 3 Dallas stations. Fully illustrated. \$3.

2. Principles of

Radio for Operators

Very clear, easy-to-understand explanations of the operating principles of every part of radio, with full material on antennas. Teaches all the fundamentals of the construction, servicing and operation of radio equipment. Includes much practical reference data in appendix. Nearly 500 illustrations and other visual aids developed for Navy and Signal Corps training.

By *Ralph Atherton* \$3.75

FREE EXAMINATION OFFER

The Macmillan Co., 60 Fifth Ave., N.Y. 11

Please send me the books checked by number below with the understanding that my bill will be cancelled if I return them in 7 days.

1 2

Signed _____

Address _____

RN

ported as heard well again in the East, daily from 4:30-6:32 p.m. sign-off; has headline news at 6:30 p.m.; this station verifies with a bright, colored card.

OAX6B, 6.038, Arequipa, Peru, is reported 6-7 p.m.

A New Zealand DXer (Art Cushen) reports a verification from the "Voice of America in North Africa," 6.040, 50,000 watts; his reception was verified by letter from Lt. Col. Preston W. Simms, Office of the Chief Signal Officer, Allied Force Headquarters; location is Algiers.

Radio Andorra, 5.997, is another European now reported around 5-6 p.m. again; on 9.330, Radio Andorra is scheduled 12 noon-5:30 p.m.

New Zealand Standard Time is 16½ hours ahead of EST, but they are not using it. They are actually 17 hours ahead of EST at the present time, which explains why ZLT7, 6.715, in its 4:30-4:45 a.m. EST radiation announces at closedown "until tomorrow at 9:30 p.m." Incidentally, ZLT7 is sending a good signal to West Virginia now. They will verify; address the Post & Telegraph Department, Wellington.

WSH, approximately 9.900, Ketchikan, Alaska, calls WZD, Seattle, irregularly, about 8 p.m.; early Australian broadcasts are coming in splendidly in the 9-megacycle band (mornings); London is good in the evening at several spots on the dial, particularly in the 9-megacycle band; the Cubans come in with powerful signals during the evenings in the 8-megacycle band; strangely enough, no strong Canadian is received—reports Otto Woolley, Colorado Springs, Colorado.

VUD5, 7.275, Delhi, India, was recently heard signing on at 8:59 p.m. and LRS, 9.317, Buenos Aires, Argentina, was heard with music at 8:42 p.m. (Harris.)

If you hear Chungking on 6.135 or 7.153 announcing as "XGOU," don't be surprised; *Paul Dilg* (California) writes that he recently heard this error in call; he comments, "Would like to get the right call of these Chinese if they know them!"

Other late tips from Mr. Dilg include Palestine, 6.135, heard on Sunday at 10 a.m., badly QRM'd by XGOY (believed on daily); the Palestine transmitter on 6.71 was definitely in dual with 6.135. Moscow on 7.56 was heard at 9:40 a.m., possibly in dual with 6.765 at that time. XGAP, 6.103, Peiping, China, has been drifting badly to close 6.100 where it jams India's VUD7, mornings. GRS, 7.075, London, has English news at 12 noon, which makes it difficult to pick up YI5KG, 7.085, Baghdad, which is reported to carry London's news at that time. (YI5KG is heard well in Sweden at that time, but Mr. Dilg says it fades out on West Coast shortly after 9:15 a.m.)

Mr. Dilg suggests that DXers in the East who might wish to log Korea's JODK, 2.510, should try for it just be-

EASY TO LEARN CODE

It is easy to learn or increase speed with an Instructograph Code Teacher. Affords the quickest and most practical method yet developed. For beginners or advanced students. Available to pass from beginner's alphabet to typical messages on all subjects. Speed range 5 to 40 WPM. Always ready—no QRM.



ENDORSED BY THOUSANDS!

The Instructograph Code Teacher literally takes the place of an operator-instructor and enables anyone to learn and master code without further assistance. Thousands of successful operators have "acquired the code" with the Instructograph System. Write today for convenient rental and purchase plans.

INSTRUCTOGRAPH COMPANY

4711 SHERIDAN ROAD CHICAGO 40, ILLINOIS

SPEAKERS RECONED!

4"—\$1.15 6"—\$1.35 10"—\$2.25
5"—\$1.25 8"—\$1.85 12"—\$2.50

Plus Transportation

Prompt Service—Expert Workmanship

York Radio

DISTRIBUTING COMPANY

Quality Parts for the Radio Profession

545 No. Water St. DECATUR 21, ILL.

RADIO COURSES

- RADIO OPERATING • CODE
- RADIO SERVICING — ELECTRONICS
- REFRIGERATION SERVICING

Personal Counselling Services for Veterans

Write for Latest Trade & Technical Catalog

Y.M.C.A. TRADE & TECHNICAL SCHOOLS

7 W. 64th Street New York City



Photo Electric Unit

For numerous control applications such as burglar alarms, industrial safety controls, automatic counters and in conjunction with a chime or bell to announce entrance of people in stores and offices. For AC.

Complete with all tubes and SPDT control relay. Net. \$9.45

ADSON RADIO CO.

221 FULTON ST., NEW YORK 7, N. Y.

PEN-OSCIL-LITE

Extremely convenient test oscillator for all radio servicing; alignment • Small as a pen • Self powered • Range from 700 cycles audio to over 600 megacycles u.f. • Output from zero to 125 v. • Used by Signal Corps • Write for information.

GENERAL TEST EQUIPMENT CO.

38 Argyle

Buffalo 9, N. Y.

CRABREE'S WHOLESALE RADIO

2608 Ross Ave.

DALLAS 1 TEXAS

ELECTRONICS

Choose your future in the world of radio-electronics on land—on sea—in the air. Communications experts in demand. Train now for these better-paying positions. Short day-night courses. Learn of unequalled opportunities through "Lifetime Careers in Radio Communications"—free booklet.

APPROVED FOR VETERANS
WESTERN RADIO COMMUNICATIONS INSTITUTE
Dept. Q, 106 West Third St., Los Angeles 13, Calif.

Ted McElroy

World's Largest Manufacturer of
Wireless Telegraphic Apparatus

COMPLETE CENTRAL OFFICE EQUIPMENT

McElroy Manufacturing Corp.

82 Brookline Avenue • Boston, Massachusetts

fore dawn; there is a great deal of static and QRM, but they pound through on the West Coast; heard as early as 5 a.m. weak but signal improves around dawn; early is heard in Native, later American recordings are used; might hear Coast Guard with weather reports—Seattle to Alaska—but they do not stay on long, are on the low side. (Note the proximity of this transmitter's frequency to WWV on 2.500, that frequency being a good check.) (Incidentally, have been following Paul's suggestion here in West Virginia, with no success, but am still trying; others in the East may be more fortunate!)

A late flash from Mr. Dilg indicates that the Chinese station heard on 7.50 is now believed to be Yen-an, Communist China; call lately sounds like XECR or XNCR or even XGCR, the first and last letters known to be right; heard 5-6 a.m., all Chinese talk by a woman. JWV, 7.26, is heard fair around 5 and after 8 a.m. Mr. Dilg also reports that apparently Radio Saigon is not using Standard Time which is 7 hours ahead of GMT, but is using a clock time 8 hours ahead of GMT. They announce news for "6:30 local time or 10:30 GMT" which would be 5:30 EST, and make their time 13 hours ahead of EST, assuming that the "6:30 local time" mentioned means "6:30 p.m. Saigon time."

PCJ, 15.22, Hilversum, Holland, weak at 9:30 a.m. on West Coast; the 11-megacycle band is now out for Far East reception there after 6 a.m.; BBC transmitters are all over the place from 21-megacycles to 9-megacycles after 9 a.m. (Balbi.)

PCJ is coming in here in West Virginia like a local on 15.22, 8-9:30 a.m. daily; in December their prewar announcer made a trip to London and secured a batch of new recordings which are now being widely used. On Sundays in particular, the signal is terrific, and usually there is English comment from 8:30 to 9:30 a.m. sign-off, including a short "Mailbag" period.

The Jaffa, Palestine, station on 6.790 has been coming through some mornings around 7:30-9 a.m.

A strong signal from the BBC is heard on approximately 18.75 at 8:30 a.m. with "English By Radio"; Canada's International Service on 15.190 has English news at 10:45 a.m.; Moscow's 11-11:30 a.m. broadcast in English to North America is announced as on 9.48, 11.83, 15.75, daily except Tuesday; the 15.75 frequency comes in well consistently, 9.48 and 11.83 are either poor or inaudible here. All-India Radio on 9.59 has been heard weak at 11 a.m., native. Nova Scotia's CHNX, 6.130, Halifax, and CJCX, 6.010, Sydney, are both heard well here mornings and evenings, sometimes around 12 noon. HEK5, 15.875 (announced), Bern, Switzerland, heard daily except Saturday with good signal, 2:20 (comes on with chimes and march) to 2:50 p.m. in "Short Edition"; official schedules recently

March, 1946

IT'S HERE!

A Truly 100% Vacuum Tube

VOLTMETER



5250

Immediate Delivery

SPECIFICATIONS:

D-C Electronic Voltmeter
6 ranges—0 to 3, 10, 30, 100, 300, 1000 volts
Input Resistance 11 megohms
Sensitivity—3 volt scale
—3,666,666 ohms per volt
A-C Electronic Voltmeter
6 ranges—0 to 3, 10, 30, 100, 300, 1000 volts
Input Impedance—10.5 megohms shunted by 5 micro-micro farads
Frequency response flat from 20 cycles to 2—K.C.
Electronic ohmmeter:
6 ranges—.01 ohm to 1000 meg. ohms

Meter:
200 micro amperes. D.C. of rugged construction
Accuracy—or —2% of full scale

TUBES:
1—6SN7, 1—6H6, 1—6X5

EQUIPMENT:
1—cable "D.C." shielded with connector and probe
1—cable "A.C." ohms with plug and probe
1—cable "common" with plug and clip

POWER SUPPLY:
105/120 volts, 60 cycle

96" AUTO ANTENNAS

1. Seamless Brass Tubing
2. High polished Chromium Plating
3. Stainless Steel "Snap Back" Top Rod
4. Heavily Insulated Shielded Loom Lead
5. 100% Low Loss Construction
6. Sturdy Quality Design and Workmanship

\$3.49 ea. 10 or more \$3.25 ea. Lots of 100 \$3.00 ea.

Complete line of Resistance Type Line Cords

Complete line of Resistance type line cords standard 3 terminal AC-DC resistance line cords. Prompt delivery. Flexible, sturdy cords, 3 terminal type with color coded timed leads. 45c each
135 - 160 - 180 - 200 - 220 - 250 - 10 or more
290 - 300 - 330 - 350 - 390 ohms 42c each

JUST RELEASED! FINEST BALLAST TUBES

L42B	K55B	165R4	39c Each
L42C	K55C	165R8	
K42B	L55B	185R	35c Each
K42C	L55C	185R4	
K49B	K80B	185R8	lots of 10 or more
K49C	K90B	250R	
L49B	K80C	100-77	
L49C	100-79	200R	
L49D	100-70		

We have the complete line of Alsam cabinets shown in this issue.

F. O. B. Chicago—Write Dept. N. for our latest catalogue. All foreign orders payable in U. S. funds.

RADIO PARTS COMPANY

612 W. Randolph
Chicago 6, Illinois



JFD
All Under One Roof
WE manufacture over 25 different lines for the Radio service trade and are prepared to ship

- JFD "SOCKETTE" RADIO TUBE ADAPTERS
- JFD EXACT DUPLICATE BALLAST TUBES
- JFD PHOSPHOR BRONZE DIAL CABLE
- JFD BATTERY ADAPTER HARNESSSES
- JFD ADJUSTABLE BALLAST TUBES
- JFD RESISTANCE CORD ADAPTERS
- JFD PHONO ADAPTER SWITCHES
- JFD MICROPHONE CONNECTORS
- JFD MIDGET JACKS & PLUGS
- JFD PHONOGRAPH NEEDLES
- JFD RESISTANCE CORDS
- JFD AC SERVICE CORDS
- JFD TOGGLE SWITCHES
- JFD AUTO CONDENSERS
- JFD SPEAKER CEMENT
- JFD ANTENNA LOOPS
- JFD AUTO ANTENNAS
- JFD BATTERY PLUGS
- JFD TUBE SHIELDS
- JFD RADIO WIRE
- JFD SUPPRESSORS
- JFD DIAL BELTS
- JFD DIAL CORD

WRITE FOR LITERATURE ON ANY OF THESE UNEXCELLED PRODUCTS

Serving the radio trade since 1929

J.F.D. MANUFACTURING CO. 4111 FT. HAMILTON PARKWAY
BROOKLYN 19, N. Y.

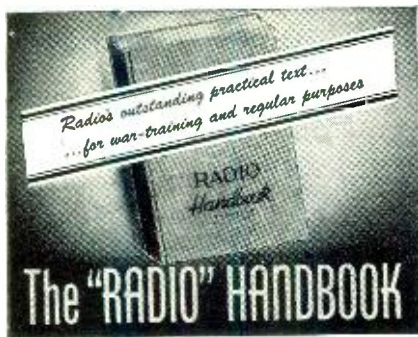

Basic electrical and radio theory in the simplest possible language, written especially for those without mathematical or technical training.

Dozens of complete how-to-build-it descriptions of many types of receiving, transmitting, and test equipment show practical applications. Hundreds of diagrams and large photographs.

Over 700 pages, durably clothbound, gold-stamped. From your favorite dealer, or from us, postpaid; please add any applicable taxes.

\$2.00 in Continental U.S.A. Elsewhere, \$2.25

RADIO AND ELECTRONICS BOOKS
Immediate Shipment on Mail Orders Anywhere

We stock nearly all radio and electronics books, and can furnish any other currently-published one on short notice. Send stamp for catalog. Currently popular books include:

- "U.H.F. Radio Simplified," Kiver.....\$3.25*
- "Practical Radio Communication," Nilson.....\$5.00
- "Principles of Radio," Henney.....3.50
- "Mathematics for Radiomen," Cooke.....4.00
- "Radio Physics Course," Ghirardi.....5.00
- "Radio Engineering Handbook," Henney.....5.00
- "Radio Engineers' Handbook," Terman.....6.00
- "Theory and Appl. of Vacuum Tubes," Reich.....5.00
- "Electronics," Millman and Seely.....5.00
- "Radio Engineering," Terman.....5.50
- "Microwave Transmission," Slater.....3.50
- "Basic Elec. for Communications," Timble.....2.80
- "Understanding Radio," Watson and others.....3.50
- "Prin. Aeronautical Rdo. Eng.," Sandretto.....3.50
- "Modern Radio Servicing," Ghirardi.....5.00
- "Hyper and U.H.F. Engineering," Sarbacher.....5.50
- "Standard Handbook for Elec. Engrs.,".....8.00
- "Cathode-Ray Tube at Work," Rider.....3.50
- "Frequency Modulation," Rider.....2.00
- "Radio Manual," Sterling.....6.00
- "Measurements in Radio Engineering," Terman.....4.00
- "U.H.F. Techniques," 4 authors.....4.50

* Add 4% for domestic postage (including A.P.O.'s); foreign, 10%; in Calif. add 2 1/2% sales tax.

EDITORS AND ENGINEERS

1420 North Highland Ave., Los Angeles 28, Calif.

RADOLEK

Radio-Electronic Service Parts

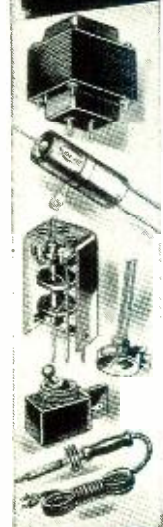

Large stocks assure the finest and most complete selections of all available items at lowest prevailing prices. Thousands of active buyers depend on us for their entire Radio repair and replacement requirements. Because we understand service problems, every order is expedited for delivery in double quick time. Everything we do is planned for convenience and satisfaction to our customers. You will find it profitable to make Radolek your buying headquarters.

FREE BUYING GUIDES

Because of existing conditions we keep our customers right up to the minute on available merchandise by releasing supplements frequently instead of sending our regular Big Profit Guide once a year. Send the coupon now to get these Free Buying Guide Supplements as they are issued.

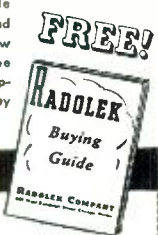

FAST SERVICE!

RADOLEK CO., Dept. B-112
 601 W. Randolph St., Chicago 6, Ill.
 Please send FREE Buying Guide Supplements

NAME _____
 ADDRESS _____

ORDER FROM RADOLEK

received direct from Bern indicate a Saturday transmission (?); the transmission of "Full Edition" on 9.185 and 7.380, 8:30-10 p.m., is heard with excellent signals on either frequency.

Radio Newsreel is heard in the African Service of the BBC at 2:30 p.m. on approximately 9.60, excellent signal; BBC's European Service heard on approximately 7.15 at 3:30 p.m., oftentimes relays "Voice of America" from New York; VLA, 7.28, Radio Australia, heard at 8:15 a.m. coming on with La Marseillaise, and calling French Indo-China, in French; ZRK, 5.885 (listed), Capetown 3, has good signal around 12 midnight when a clock strikes the hour, (7 a.m. in South Africa).

I recently heard Jaffa, Palestine's *Sharq el Adna* transmitter on 6.710 with excellent, clear signals at 12:15 a.m., appeared to be giving news in Arabic, played Near East music of unmistakable character; probably is in dual with 6.135, 11:30 p.m. to 1 a.m.

VLQ2, 7.215, Brisbane, Australia, sends a fine signal here, with English news at 8 a.m. JCKW, 7.220, Jerusalem, is still heard testing Saturday afternoons and early evenings to 8 p.m. sign-off; want reports and give address as A.W. 5, G.H.Q., M.E.F.; at 6:30 p.m. they sometimes "go over to the BBC" and relay London, among spots they carry being Radio Newsreel at 7:30 p.m. (note this is Saturday only). They announce a wavelength of 41.55 meters, frequency of 7.220.

VLC6, 9.615, Radio Australia, heard signing on at 11 a.m., R9-plus, to West Coast. RNB, 17.770, Belgian Congo, has excellent signals at 11:30 a.m. in English newscast. Radio Eireann, 17.84, heard signing off at 12:50 p.m., news is generally at 12:40 p.m., but time it starts varies slightly from day to day; still ask for reports from U.S. and Canadian listeners, with U. S. listeners being told to address Radio Eireann, Chrysler Building, New York City.

FXE, 8.025, heard 3:30-4:17 p.m. a recent Sunday when signed off with La Marseillaise; used Near East music and had French news at 4 p.m. (others report *English* news at 4 p.m., but I have not heard English from FXE at any time); incidentally, they never announce FXE and do not say Radio *Lebanon* or Radio *Beirut*—but invariably announce as Radio *Levant*. TAP, 9.465, Ankara, Turkey, is still coming through severe CWQRM Sundays at 4:30 p.m. with its *Postbag* program for 15 minutes; also is on to Britain same time on Mondays and Thursdays.

The Australian transmitter on 9.58 (VLG/VLR) relays ABC Domestic Program, English news at 8 a.m.; usually good here.

I recently picked up JZK, 15.16, Tokyo, talking to San Francisco's 18.025 transmitter; said were calling KQJ and mentioned JAG (approximately 17.84) as well as JZK so may have been in parallel on JAG; gave press dispatches at slow speed around

Classified

Rate 20c per word, Minimum, 10 words

RADIO ENGINEERING

RADIO Engineering, Broadcasting, Aviation and Police Radio, Servicing, Marine Operating and Electronics taught thoroughly. Expenses low. Write for catalog. Valparaiso Technical Institute, Dept. N, Valparaiso, Ind.

FOR SALE

RECTIFIERS—Halfwave, 5 Amperes, \$4.50, 2.2 Amperes, \$2.25; 1.5 Amperes, \$1.85. Fullwave. 1 Ampere, \$2.50; 5 Ampere, \$1.85. Maximum 18 volts input. List free. Milton Bursma, Route 5, Grand Rapids, Mich.

BUZZER Code Practice set complete with key, battery and instructions. Sends real wireless signals. Only \$1.65. Two sets \$3.00. Guaranteed. Rather Electric, Dept N, Cresco, Iowa.

LOWEST Prices. Radio Tubes, parts. Bargain lists 3c. Potter, 1314 McGee, Kansas City 6, Mo.

U.S. NAVY Aircraft Surplus Control Boxes. Two types, both for \$2.00 postpaid. Radio parts worth \$10.00. Van Sickle Radio Supply, Indianapolis 6, Indiana.

ALL new; Western Electric 19C audio oscillator 20-15,000 cycles. Has db meter. Output—4 to 6 db into 600 ohm line, \$150. Hewlett-Packard 325B Noise Distortion meter, \$330, F.O.B. N. Y. Westinghouse Meters. 2" bakelite case 0-5 amp. R.F., \$3.25. 0-1 ma movement, \$2.95. 3" square case 0-15 ma, \$3.25. C-D Dykanols 1 mfd 2000v —\$1.15, 4 mfd 1500v—\$2.00. Jack Krinsky, 4603 Church Ave., Brooklyn 3, N. Y.

JENSEN JHP-52 Speaker in cabinet, Record Player, Masco 17 watt Amplifier, all new Output transformer, tubes. Earl Swen, Gilby, N. Dak.

CATHODE Ray Tubes 5" new, \$8.60. Quantity discount. Electronic, 5832 Hegerman, Philadelphia, Pa.

SERVICEABLE Coast Guard Aircraft transceivers, 4 Model CGR 45 combination units, less meters, tubes and power supply, \$9.95 each, 3 HI frequency R-1 units with meters but no batteries or tubes, \$11.75 each. Made by G.E. and R.C.A. Lever, 7789 Spring Ave., Elkins Park 17, Pa.

CORRESPONDENCE COURSES

USED Correspondence Courses and Educational Books sold or rented. Inexpensive. Money-back guarantee. Write for Free Catalog listing 4000 bargains.—(Courses Bought.)—Lee Mountain, Pisgah, Ala.

CORRESPONDENCE Courses and self-instruction books, slightly used. Sold. Rented. Exchanged. All subjects. Satisfaction guaranteed. Cash paid for used courses. Complete information and 100-page illustrated bargain catalog FREE! Write Nelson Company, Dept. 2-59, Chicago 5.

USED Correspondence courses, Educational and Technical Books, bought, sold, rented. Catalog Free. Educational Exchange, Henagar, Ala.

AMATEUR radio licenses. Complete code and theory preparation for passing amateur radio examinations. Home study and resident courses. American Radio Institute, 101 West 63rd Street, New York City.

PATENT ATTORNEYS

RANDOLPH & Beavers: Registered Patent Attorneys, 231 E. Columbian Building, Washington, D. C. In order to protect your invention and reap the reward that should be yours, Patent your invention without delay, and at the same time have Rights to sell as Manufacturers convert to Civilian Production. Write for information and Record Form Today.

INVENTORS—Before disclosing your invention to anyone, send for Form "Evidence of Conception"; "Schedule of Government and Attorneys' Fees" and instructions. Sent free. Lancaster, Allwine & Rommel, 414 Bowen Building, Washington 5, D. C.

PATENTS SECURED Two valuable booklets sent free. Write immediately. Victor J. Evans & Co., 148-C Merlin Bldg., Washington 6, D. C.

WANTED

RADIO Circuit Man. Expert in designing and building high and low frequency oscillator circuits in quartz crystal industry. In reply give experience, references and salary expected. Box 426, c/o RADIO NEWS.

WANTED: A cheap and medium priced line of good Radios to distribute in North Carolina and South Carolina and the South East. L. B. Davis Sales Co., Box 431, Winston-Salem, N. C.

WANTED: Television Iconoscope Tube 1847. Box 1723, March Field, Calif.

RADIO NEWS

RADIO EQUIPMENT

RADIO Service men and experimenters send for our giant radio catalogue. Save dollars. United Radio Co. (1000M) Newark, N. J.

RADIO Tubes, parts. Write for bulletin. Henshaw, 3313 Delavan, Kansas City, Kan.

SURPLUS Radio and Electronic parts and equipment. New and used. Write for free list. Highbridge, 312 Canal St., New York 13, N. Y.

YOUR New Free Catalog is Ready! Radionic's Catalog lists hard-to-get radio parts and books. All available for immediate shipment. Send today to: Radionic Equipment Co., Dept. M3, 170 Nassau St., New York 7, N. Y.

MISCELLANEOUS

RADIO Servicemen—opening your first shop or expanding? Want to get capital without borrowing? Your customers are secured with our plan also. Send \$1 for copyrighted instructions to Radio Engineering, 480 Woodward Ave., New Haven, Conn.

BUSINESS OPPORTUNITIES

EXPERIENCED Radio Technician, veteran, 31 years old, 10 years successful business experience, would like partner with some experience in servicing or selling to open radio and appliance store. Only man with good character and some capital considered. I have capital, good credit and some equipment. Give complete information concerning self in letter of reply. Box 427, c/o RADIO NEWS.

NEW!
4-in-1
Job Card
Designed for Service Dealers

Provides: 1. Radio or Appliance Tag.
2. Customer Claim Check.
3. Guarantee.
4. 3x5 Filing Card.

SAMPLE AND PRICES ON REQUEST
Radio Press WORGANTOWN WEST VIRGINIA

ELECTRICAL TRAINING

8 months intensive residence course in fundamentals of industrial electrical engineering, including radio, electronics. Prepares for technician, engineering aides. Approved for veteran training. Classes begin July 8, and Oct. 21, 53rd year. Catalog.

BLISS ELECTRICAL SCHOOL
203 Takoma Ave., Wash. 12, D.C.

PLUG-IN TEST LAMP

Tests Everything Electrical
Speeds Up Trouble-Shooting



Used by Radio Men, Electricians, Mechanics and Experimenters. Tests continuity, open circuits, etc. ALWAYS READY! PLUGS INTO ANY OUTLET! Only \$1.50 Postpaid. FREE CIRCULAR. (Pat. Pend.). HANLAN CO., 1419-R, West Jefferson, Los Angeles 7, Calif.

Radio Servicemen: RADIO PARTS—TUBES

BARGAIN PRICES—NO PRIORITIES

PHONO MOTORS (9 Inch T.T.)	2.99
CRYSTAL PICKUPS 1 1/2 Oz.	2.79
FILTER COND., 20-20 Mfd. 150 V.	.39
BY PASS COND., .01, .02, .05, 1-600 V.	.07
LOOP ANTENNA (High Gain)	.59
ANT. & OSCIL. or ANT. and RF COIL SETS	.99
RESISTOR KIT—50 Ass'd. 1/8 to 1 Watt	.99

Write Today for Bargain Bulletin
RADIO DISTRIBUTING CO., Pasadena 18, Calif.

RADIO

RADIO Technician and Radio Communications courses. Register now for new classes starting first MONDAY of each month. Day and Evening Classes.

AMERICAN RADIO INSTITUTE

101 West 63d St., New York 23, N. Y.
Approved under GI Bill of Rights.

7:35 p.m. and either left the air abruptly or faded out around 7:45 p.m.

Radio National Francais, Paris, is still asking for reports and comments, and that they be sent direct to Paris. PRL8, 11.72, Rio de Janeiro, *The Voice of Brazil*, Radio National, also is still asking for reports (comments and criticisms).

Moscow on 11.63 heard at 6:45 a.m. in English, some mornings is poor on 15.75, fair on 11.83, very weak on 9.48; relay of Moscow's morning English transmission to North America comes in fair to good around 8 a.m. on 9.565 (Komsomolsk); in the evening, Radio Centre presents a *Moscow Newsreel* at 6:45 p.m. over several frequencies—only the 15.23 (Komsomolsk) frequency is heard well here.

BBC has news in General Forces Program at 11 p.m. nightly on approximately 7.32, and over other transmitters in the popular SW bands.

Some weeks ago a station was heard announcing as St. Martins, Netherlands West Indies, calling Curacao, in English, on 11.900, good signal.

Kiev, U.S.S.R., is reported as now heard on 6.020 with interference from XEUW, Vera Cruz, Mexico.

* * *

ACKNOWLEDGEMENTS

ARIZONA—Ying Ong. AUSTRALIA—Gillett, Maher. BARBADOS—Cable and Wireless (West Indies) Limited. CALIFORNIA—Balbi, Dilg, Curtiss, Boehnke. CANADA—Bromley, Ontario; Gauvreau, Quebec; CBC, Montreal; Moss, Ontario. COLORADO—Woolley. DISTRICT OF COLUMBIA—Havlana. ECUADOR—Lorson, HCJB. FLORIDA—Mohr. HOLLAND—Startz, PCJ, Koelmans. INDIANA—Green. ILLINOIS—Johnson, Gutter. KANSAS—Seckler. MASSACHUSETTS—Kernan, Harris. MICHIGAN—Johnson. NEW YORK—Australian News & Information Bureau; BBC; Bodgan; Bishop; Sink; Kentzel. NORTH CAROLINA—Sewell. OHIO—Sutton, Hacker. OREGON—Morris. PENNSYLVANIA—Smith. RHODE ISLAND—Underwood. SWEDEN—Ekblom, Skoog. TEXAS—Spoonts, Giles, Eckstein, Hatley. VIRGINIA—Howe, URDXC. WEST VIRGINIA—Gonder. WISCONSIN—Henriksen.

—30—

ERRATUM

It has been called to our attention that an error appeared in the schematic diagram, Fig. 3, page 36, January, 1946, issue. Resistor R₁ should be connected to the grid side of condenser C₁.

Photo Credits

Page	Credit
25Julian Krupa
26, 28U. S. Navy
38, 39Triplet Elec. Mfg. Co.
45, 52, 53Army Air Forces
46Belmont Radio Corporation
54RCA
68, 72Milwaukee Journal Photo
74ATSC
102, 126U.S. Signal Corps

Have You had the Chassis Touching JITTERS Lately? Here's how to speed and ease Service



115V. 0000 70-140V.

Big, husky 1/2 K.W.

ADJUST-A-VOLT

isolation transformer

This basic service tool:

- keeps AC-DC chassis neutral to ground.
- keeps AC-DC chassis neutral to grounded test equipment.
- will lower voltage to check intermittent oscillators.
- raises voltage to "pop" out stubborn intermittent parts.
- regulates voltage to service bench.
- boosts line voltage to portable P.A. systems.
- may be used as a speed control, or,
- an industrial voltage controller.

\$17.50 each, net f.o.b., Dayton, Ohio

TEAR OUT AND MAIL TO

SREPCO

STANDARD RADIO & ELECTRONIC PRODUCTS CO.
135 EAST SECOND STREET, DAYTON 2, OHIO

Please ship at once _____ Adjust-A-Volt transformers

Name _____

Address _____

City _____ State _____

ADVERTISER	AGENCY	PAGE	ADVERTISER	AGENCY	PAGE
Adeon Radio Co	Mitchell Advertising Agency	140	Marion Electrical Instrument Co	Shappe-Wilkes, Inc	13
Aerovox Corporation	Austin C. Lescarbours & Staff	145	Melville Radio Institute	Seidel Adv. & Publicity Agy	130
Aireon Manufacturing Corporation	Potts-Calkins & Holden	63	Metropolitan Electronic & Instrument Co	Mitchell Advertising Agency	116
Alliance Manufacturing Company	Foster & Davies, Inc	18	Middleton, R. G.		118
Allied Radio Corp	Henry H. Teplitz	9, 74	Miles Reproducer Co., Inc.	Altomari Advertising Agency	136
Alsam Products Company	Sander Rodkin Advertising Agy	134	Millen, James Mfg. Co., Inc.	James Millen, Inc	12
American Phenolic Corporation	Evans Associates	Fourth Cover	Murdock, Wm. J., Co.	John A. Smith & Staff	70
American Radio Institute	Sternfield-Godley, Inc	143	Murray Hill Books, Inc.	Harry P. Bridge	66, 67
American Television Institute	Turner Advertising Agency	107	McElroy Manufacturing Corp	Shappe-Wilkes, Inc	140
American Television & Radio Co	Firestone Advertising Agency	72	McGraw-Hill Book Co		120
Arrow Electronics Company	Mitchell Advertising Agency	76	McMurdo Silver Company	Stentor Company Advertising	61
Arrow Radio Co		104			
Ashbach, Leonard Company	Lieber Advertising Agency	118	National Company, Inc	Graydon Smith Advertising	23
Astatic Corporation, The	Wearstler Advertising Agency	117	National Radio Distributors	Burke & Wayburn	124
Audak Company	Hart Lehman Advertising	8	National Radio Institute	Van Sant Dugdale & Co., Inc.	3
Audel Publishers	Grant & Wadsworth, Inc.	126	National Schools	Mayers Company Advertising	21
			National Union Radio Corporation	Hutchins Advertising Agency	71
Bell Telephone Laboratories	N. W. Ayer & Son	17	Newark Electric Company	Charles Brunelle	79
Bliss Electrical School	N. W. Ayer & Son	143	Newcomb Audio Products Co.	Gail Hall Advertising	94
Bud Radio, Inc	Allied Advertising Agency	80			
Buffalo Radio Supply	International Advertising Agy	131	Ohmite Manufacturing Co	Henry H. Teplitz	57
Burlington Instrument Co	Weston-Barnett, Inc	111	Olson Radio Warehouse	Jessop Advertising Agency	84
Burstein-Applebe Co.	Frank E. Whalen Adv. Co.	98	Onan, D. W. & Sons	Graves & Associates	110
Candler System Co	Van de Mark Advertising	128	Pa-Kette Electric Co.	Arrow Advertising Agency	134
Capitol Radio Engineering Institute	Henry J. Kaufman Adv.	75	Polarad Electronics Co	Mitchell Advertising Agency	136
Centralab	Gustav Marx Advertising	122			
Clark Radio Equipment Corp.			RCA Institutes, Inc		136
Cleveland Institute of Radio Electronics	Kenneth H. Kolpein	125	R. C. & L. F. Hall		137
Clippard Instrument Laboratory	Savage & Talley	102	R-L Electronic Corp	R. S. Wittenberg Advertising	128
Collins Radio Company	McCann-Erickson, Inc	Second Cover	Radio Corporation of America	J. Walter Thompson Co	16, 65
	Abbott Kimball Co., Inc	139	Radio Dealers Supply Company	H. J. Gold Co	116
Commercial Equipment Co.	Borough Advertising Agency	127	Radio Distributing Co		143
Communications Equipment Co.	E. H. Brown Advertising Agy	58	Radio Kits Company	Edward Hamburger Adv. Co.	138
Concord Radio Corp.	McJunkin Advertising Agency	87	Radio Parts Company	Sidney S. Lovitt Advertising	141
Coyne Electrical School		140	Radio Press		143
Crabtree's Wholesale Radio	Post & Johnson, Inc	100	Radio Supply & Engineering Co., Inc.	Karl G. Behr Advertising	86
Croname, Incorporated		93	Radio Wire Television, Inc	S. T. Seidman Co	92
Crystal Research Laboratories Inc			Radolek Co.	Turner Advertising Agency	142
			Rauland Corporation, The	Roy D. Zeff & Associates	146
DeForest's Training, Inc	McDonald-Cook Company	15	Raytheon Manufacturing Company	Burton Browne Advertising	59
Diamond Straw & Machine Co	Halpern Advertising Agency	112	Research Manufacturing Corp		136
Drake Electric Works, Inc	William Hoffman & Associates	126	Rider, John F., Publisher Inc	Lansford F. King Advertising	19
Duotone Company	Maxon, Inc.	113	Risco Sales Co	Mitchell Advertising Agency	134
			Rohr Distributing Company		132
			Rowe Industries	Miller Advertising Agency	104
Editors & Engineers		142	Runzel Cord & Wire Company	Duane Wanamaker Advertising	99
Ecor, Inc	Henry H. Teplitz	121			
Electrical Reactance Corp	Scheel Advertising Agency	132	Sauereisen Cements Company	McCarty Company	138
Electronic Service & Supply	Burke & Wayburn Advertising	139	Scenic Radio & Electronics Co.		138
Electro-Voice, Inc	Henry H. Teplitz	81	Schott, Walter L. Co.	Barton A. Stebbins	110
Ellis, David Inc	Graphic Company	120	Sharpnack Engineering Co., The	Andrews Advertising, Inc	112
			Sheffield Radio Co	Sander Rodkin Advertising Agy	138
Fada Radio & Electric Co., Inc	Sternfield-Godley, Inc	6	Shure Brothers	Phil Gordon Agency	119
Fahnestock Electric Company, Inc		123	Snyder Manufacturing Co.	Abner J. Gelula & Associates	133
Fyr-Fyter Co., The	Van de Mark, Inc	138	Sound Equipment Corp. of Calif	Beaumont & Hohman, Inc	60
			Sprayberry Academy of Radio	Harry P. Bridge	7
General Cement Mfg. Co.	Turner Advertising Agency	114	Stamford Electric Products Co., Inc	Reiss Advertising Agency	109
General Electric Company	Maxon, Inc	137	Standard Radio & Electronic Products Company	Hutzler Advertising Agency	143
General Industries Company	Fuller & Smith & Ross, Inc	104	Standard Transformer Corporation	Burnet-Kuhn Advertising Co	64
General Test Equipment Co	Suzanne B. Hayman	140	Stanton Radio Supply		132
Goodchild Plastics Co.		136	Stark's	A. L. Addison Advertising	134
Greenlee Tool Co	Howard H. Monk & Associates	116	Stevens Walden, Inc	Howard Wessen Co	14
Guardian Electric	Kennedy & Co	85	Superior Instruments Co	Mitchell Advertising Agency	20
			Supreme Instruments Corp	O'Callaghan Advertising Agy	78
Hallcrafters Co., The	Burton Browne Advertising	5	Supreme Publications	Henry H. Teplitz	122
Hammarlund Mfg. Co., Inc. The	Roeding & Arnold, Inc	24			
Hanlan Co.		136, 143	Television Tech Enterprises	Mitchell Advertising Agency	140
Harvey Radio Company	Shappe-Wilkes, Inc	82	Terminal Radio Corporation		96
Heins & Bolet	Sternfield-Godley, Inc	133	Triplett Electrical Instrument Co	Western Advertising Agency	90, 91
Henry Radio	Burton Browne Advertising	139	Tri-State College	Clem J. Steigmeyer Advertising	138
Hexacon Electric Co.	George Homer Martin	94	Truetone Products Co.	Terrill Belknap Marsh	84
Hoodwin, Chas. Co.	J. L. Stewart Agency	134			
Hopp Press, Inc., The	Gallard Advertising Agency	110	Union Radio Corporation	Milton Mendelsohn Advertising	130
Hytron Radio & Electronics Corp	Henry A. Loudon Advertising	69	United Screw & Bolt Corporation	Fred Mellis Advertising	73
			United Transformer Corporation	Shappe-Wilkes, Inc	100
Illinois Condenser Company	Sander Rodkin Advertising Agy	124	Universal Instrument Co	B & M Printing Company	114
Instructograph Company	Turner Advertising Agency	140			
Insuline Corporation of America	S. R. Leon Co.	115	Valparaiso Technical Institute	Smith, Benson & McClure, Inc	136
International Resistance Co		101			
Intex Company	Terrill Belknap & Marsh Asso.	129	Ward Products Corporation, The	Burton Browne Advertising	78
			Welle, Mfg. Co	Beaumont, Heller & Sperling, Inc	88
J. F. D. Manufacturing Co	Mitchell Advertising Agency	141	Wells Sales, Inc.	Turner Advertising Agency	135
Jensen Radio Manufacturing Co	Burton Browne Advertising	22	Western Radio Communications Institute		140
Johnson, E. F. Company	David, Inc.	77	Western Sound & Electronic Labs, Inc.	Morrison Advertising Agency	88
			Weston Electrical Instrument Corporation	G. M. Basford Company	129
Kenyon Transformer Co., Inc	Jasper, Lynch & Fishel, Inc	97	Wholesale Radio Laboratories	Pfeiffer Advertising Agency	106
Kluge Electronics Inc	Wookey & Roman Adv. Agy	95	Wilcox Electric Co., Inc	R. J. Potts-Calkins & Holden	105
Kurz-Kasch, Inc.	Kircher, Helton & Collett	83			
			YMCA Trade & Technical Schools	Cecil & Presbrey, Inc	140
Lake Radio Sales Co	Sander Rodkin Advertising Agy	108	York Radio Distributing Company		140
LeJay Mfg. Co.	Frizzell Advertising Agency, Inc	138			
Liberty Sales Company Inc	Sternfield-Godley, Inc.	103			
Lifetime Sound Equipment Co.	Miller Advertising Agency	138			
Lincoln Engineering School	Buchanan Thomas Adv. Co.	136			
MacMillan Company	Atherton & Currier, Inc.	140			
Maguire Industries, Inc.	City Advertising Agency	10, 11			
Mallory, P. R. Co., Inc.	Aitkin-Kynett Co.	Third Cover			

STRAIGHT-LINE FEED

... Low Residual Inductance

... Higher Resonant Frequency

AEROVOX SERIES 1690

Mica Capacitors

● The brand new Aerovox Series 1690 molded-in-bakelite mica capacitor is intended specifically for circuits where inductance must be kept at a minimum. It is designed for least possible residual inductance, low r.f. losses and lower r.f. resistance and impedance. What's more, it provides increased KVA ratings for given capacitor sizes.

Such units can be advantageously applied as blocking capacitors in transmission lines; as tank capacitors for high-frequency oscillators; as by-pass capacitors for ultra-high-frequency currents; and as coupling or by-pass capacitors in induction-heating circuits.

Exceptional compactness for given KVA ratings; exceptionally-low-loss operation; ability to withstand constant duty and heavy overloads—for these and other reasons this latest Aerovox development marks a new performance standard for severe-service capacitors.



ACTUAL
SIZE

Featuring...

● Rounded hardware—round nuts tightened by spanner wrench supplied; round washers; spherical lock nuts. Elimination of sharp edges and corners that might cause corona loss.

● Body of XM or yellow low-loss bakelite molded about mica section for thorough sealing and extreme ruggedness.

● Mica section of carefully selected mica and foil. Designed for straight-line path for ultra-high-frequency currents.

● Several times the size of the well-known Series 1650 bakelite-molded transmitting capacitors. Dimensions: 2 3/8" w. x 2 1/8" d. x 1 3/8" h., and 4 3/4" overall between rounded terminal tips.

● Available in ratings up to 20,000 volts D.C. Test, or 10,000 volts operating. Capacitance values up to .001 mfd. at the highest voltage rating.

● Fine threads for terminal studs, insuring maximum contact and minimum resistance.

● Silver plating for all conducting members, minimizing skin resistance.

● Interested? Write for detailed information. Meanwhile, submit that capacitor problem for our engineering collaboration.



FOR RADIO-ELECTRONIC AND INDUSTRIAL APPLICATIONS

AEROVOX CORPORATION, NEW BEDFORD, MASS., U.S.A.

SALES OFFICES IN ALL PRINCIPAL CITIES • Export: 13 E. 40th St., NEW YORK 16, N. Y.

Cable: 'ARLAB' • In Canada: AEROVOX CANADA LTD., HAMILTON, ONT.

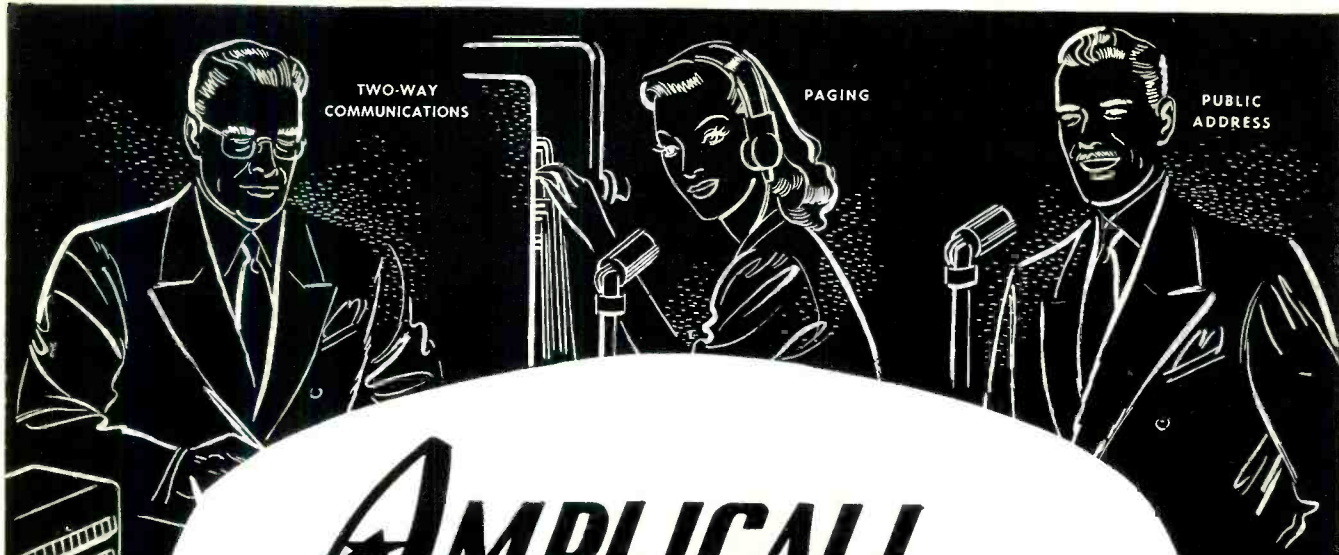

AMPLICALL

**Two-Way Communication,
Paging and Public Address Systems**

... Proved during the war!

When it was necessary to save not only hours but minutes and even seconds, *AMPLICALL* "came through." Its complete day-in-and-day-out dependability, multiple uses, flexible design, trouble-free operation and tone quality make it the preferred communications system. "*AMPLICALL*" is another way of saying "efficiency"... learn how it can bring about a greater efficiency for your business.



AMPLICALL
Intercommunication unit, available for two-way communication between multiple stations.



AMPLICALL
Weatherproof Speaker

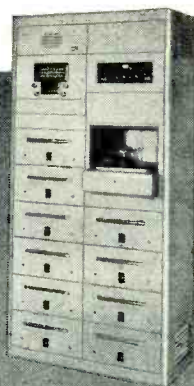

AMPLICALL
Paging Control Unit

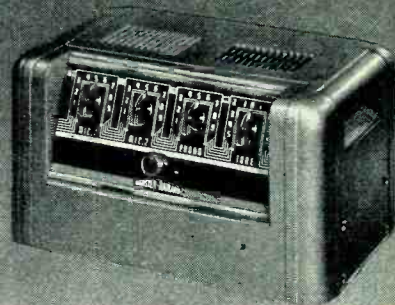

AMPLICALL
Audio Amplifier unit for laboratory, test equipment and general applications.

RADIO • RADAR • SOUND

Rauland

COMMUNICATIONS • TELEVISION

Electroneering is our business

THE RAULAND CORPORATION • CHICAGO 41, ILLINOIS

PRINTED IN U.S.A.

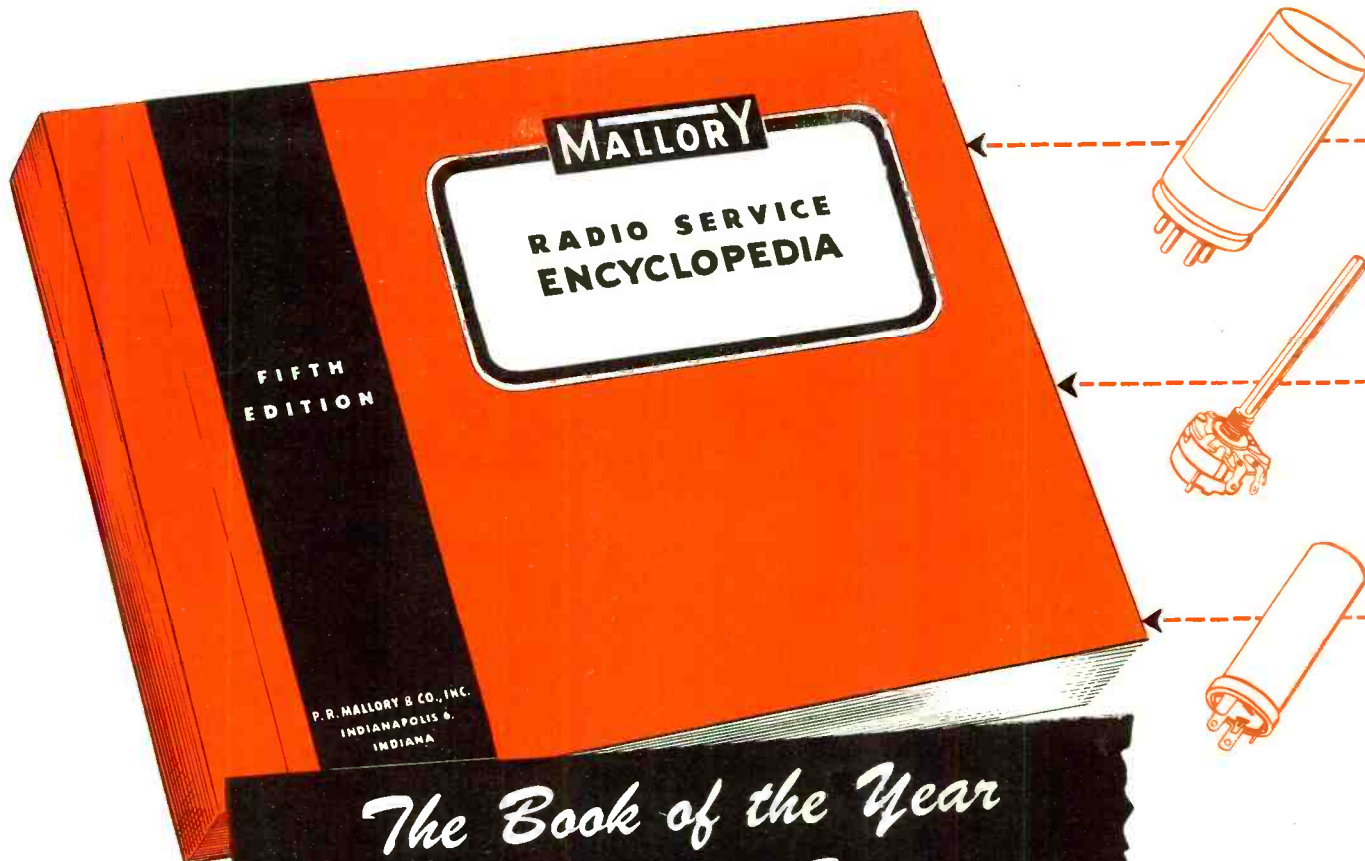

*The Book of the Year
for the Service Engineer*

AVAILABLE SOON!

MALLORY not only supplies you with the best replacement parts you can possibly buy—it backs them up with the finest available service information: literature that helps you in your daily work, gives you quick answers to every radio servicing problem.

A case in point is the forthcoming 1946 "Fifth" edition of the Mallory Radio Service Encyclopedia—a "must" for every radio service engineer. Here you get the *complete* story on servicing every pre-war radio—*4,000 more models than in any previous edition*—with circuit references, original part numbers, recommended replacements that you can get, tube complements and I.F. Peaks.

Here is a book that will pull you out of many a tight servicing spot. And a book that marks the end of an era—the *only* service encyclopedia dealing with *all* pre-war sets that are still in use. Order your copy today: the edition is limited. See your Mallory distributor. At your cost of \$1.25 net, it's the buy of the year.

**YOU EXPECT MORE—
AND YOU GET MORE
FROM MALLORY**

These typical Mallory "helps" are especially prepared to speed up your work, save valuable man hours, and others are on the way. If you don't have copies, see your Mallory distributor:

- 5th Edition Radio Service Encyclopedia
- Replacement Vibrator Guide
- Mallory Technical Manual
- Approved Precision Parts Catalog

P. R. MALLORY & CO., Inc.

MALLORY

VIBRATORS...VIBRAPACKS*...CAPACITORS...VOLUME CONTROLS
...SWITCHES...RESISTORS...FILTERS...RECTIFIERS...
POWER SUPPLIES. ALSO MALLORY TROPICAL* DRY BATTERIES,
ORIGINALLY DEVELOPED BY MALLORY FOR THE U. S. ARMY

*Reg. U. S. Pat. Off.

APPROVED PRECISION PRODUCTS

P. R. MALLORY & CO., Inc., INDIANAPOLIS 6, INDIANA

SYNTHETICS FOR ELECTRONICS

CONNECTORS

STEATITE SOCKETS

SYNTHETICS FOR ELECTRONICS

A-N FITTINGS

COAXIAL CABLES

**The Line That Reaches
'Round the World**

Depend upon

AMPHENOL

Quality

A-N CONNECTORS

CONNECTORS

PREFOCUSED LAMP RECEPTACLES

MICROPHONE CONNECTORS

With a proven background of honorable service on far-flung battlefronts around the world, Amphenol components — greatly improved by wartime experience and augmented in number, style and type — are now available to normal markets. Simplifying both buying and selling, this wider selection of high quality, tested items can be procured from one manufacturer. To know these popular Amphenol products better — write today for the new Condensed Catalog No. 72.

AMERICAN PHENOLIC CORPORATION
CHICAGO 50, ILLINOIS

In Canada • Amphenol Limited • Toronto

U. H. F. Cables and Connectors • Conduit • Cable Assemblies • Connectors (A-N, U. H. F., British) • Radio Parts • Plastics for Industry • Antennas