

See See What's New

# RADIO NEWS

★

OCT 22

OCTOBER  
1945

35c

In Canada 40c

ONLY MECK HAS THE COURAGE TO KEEP TELLING  
THIS STORY TO YOUR CUSTOMERS

"Buy Your New Radio  
from Your Radio Dealer"

EVERY MECK NATIONAL ADVERTISING DOLLAR  
SELLS THE PUBLIC  
ON THE INDEPENDENT RADIO DEALER



Every month every John Meck Industries advertisement in national magazines tells one important story—"Buy your New Radio from your Radio Dealer."

Meck puts all its efforts behind the Dealer—to help the Dealer fight postwar competition. Tie in with the Meck Preferential Dealer plan. See your Meck distributor for full details on this worthwhile franchise.

*John Meck*



**MECK RADIOS**

JOHN MECK INDUSTRIES, Inc., PLYMOUTH, IND., U. S. A.

AM • FM • TELEVISION • CONSOLE COMBINATIONS • PHONOGRAPHS

# I WILL TRAIN YOU TO START A SPARE TIME OR FULL TIME RADIO SERVICE BUSINESS WITHOUT CAPITAL

J. E. SMITH  
PRESIDENT  
National Radio  
Institute  
31st Year of  
Training Men  
for Success  
in Radio

## You Build These and Many Other Radio Circuits with 6 Kits of Parts I Supply

By the time you've conducted 60 sets of Experiments with Radio Parts I supply, made hundreds of measurements and adjustments, you'll have valuable PRACTICAL Radio experience for a good full or part-time Radio job!

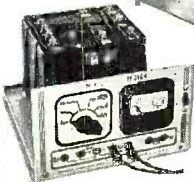
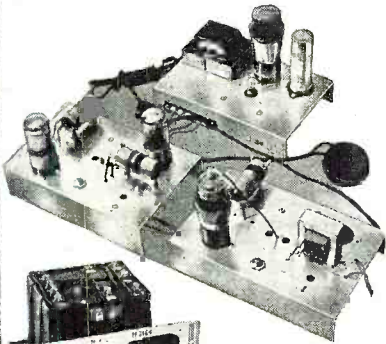

You build MEASURING INSTRUMENT above early in Course, useful for Radio work to pick up EXTRA spare time money. It is a vacuum tube multimeter, measures A.C., D.C., R.F. volts, D.C. currents, resistance, receiver output.

Building the A. M. SIGNAL GENERATOR at right will give you valuable experience. Provides amplitude-modulated signals for test and experimental purposes.

You build the SUPERHETERODYNE CIRCUIT above containing a preselector oscillator-mixer-first detector, i.f. stage, diode-detector-a.v.c. stage and audio stage. It will bring in local and distant stations. Get the thrill of learning at home evenings in spare time while you put the set through fascinating tests!



## SAMPLE LESSON FREE

I will send you a FREE Lesson, "Getting Acquainted with Receiver Servicing," to show you how practical it is to train for Radio at home in spare time. It's a valuable lesson. Study it—keep it—use it—without obligation! Tells how Superheterodyne Circuits work, gives hints on Receiver Servicing, Locating Defects, Repair of Loudspeaker, I.F. Transformer, Gang Tuning, Condenser, etc. 31 illustrations.



**My Radio Course Includes  
TELEVISION • ELECTRONICS  
FREQUENCY MODULATION**

The men at the right are just a few of many I have trained, at home in their spare time, to be Radio Technicians. They are now operating their own successful spare time or full time Radio businesses. Hundreds of other men I trained are holding good jobs in practically every branch of Radio, as Radio Technicians or Operators. Doesn't this PROVE that my "50-50 Method" of training can give you, in your spare time at home, BOTH a thorough knowledge of Radio principles and the PRACTICAL experience you need to help you make more money in the fast-growing Radio industry?

Let me send you facts about rich opportunities in the busy Radio field. See how knowing Radio can give you security, a prosperous future... lead to jobs coming in Television and Electronics. Send the coupon NOW for FREE 64-page illustrated book, "Win Rich Rewards in Radio." Read how N.R.I. trains you at home in spare time. Read how you practice building, testing, repairing Radios with SIX BIG KITS of Radio parts I send as part of your Course.

**Future for Trained Men Is Bright in Radio, Television, Electronics**  
The Radio Repair business is booming NOW. There is good money fixing Radios in your spare time or own full time business. And trained Radio Technicians also find wide-open opportunities in Police, Aviation and Marine Radio, in Broadcasting, Radio Manufacturing, Public Address work, etc. Send for free book which pictures your present and future opportunities.

Think of the boom coming now that new Radios can be made! Think of the backlog of business built up in all branches of Radio! And think of even greater opportunities when Television and Electronics are available to the public! Use only a few hours of your spare time each week to get into Radio NOW. You may never again see the time when it will be so easy and profitable to get started. Mail coupon for complete information.

**Many Beginners Soon Make \$5, \$10 a Week EXTRA in Spare Time**

The day you enroll I start sending EXTRA MONEY JOB SHEETS to help you make EXTRA money fixing Radios in spare time while learning. You LEARN Radio principles from my easy-to-grasp Lessons—PRACTICE what you learn by building real Radio Circuits with the six kits of Radio parts I send—USE your knowledge to make EXTRA money while getting ready for a good full time Radio job.

**Find Out What N.R.I. Can Do for YOU**  
MAIL THE COUPON for your FREE copy of my 64-page book. It's packed with facts about opportunities for you. Read the details about my Course. See the fascinating jobs Radio offers. See how you can train at home. Read letters from men I trained, telling what they are doing, earning. No obligation. Just MAIL COUPON in an envelope or paste it on a penny postal. J. E. Smith, President, Dept. 5KR, National Radio Institute, Pioneer Home Study Radio School, Washington 9, D. C.

### I Trained These Men

### SPARE TIME RADIO BUSINESS



"I have a spare time Radio and been very profitable, due to the efficient training I received from your Course. Last year I averaged over \$50 a month." —FRED H. GRIFFIE, Route 3, Newville, Pa.

"I am doing radio work in my spare time, and find it a profitable hobby. My extra earnings run about \$10 a week. I certainly am glad I took your N.R.I. Course." —FERDINAND ZIRBEL, Chaseley, North Dakota.



"About six months after I enrolled I started making extra money in radio, evenings and stormy days. That brought me a profit of \$600 in the last year." —BENNIE L. ARENDS, RFD 2, Alexander, Iowa.

### I Trained These Men

### FULL TIME RADIO BUSINESS



"Not long ago I was working 16 hours a day in a filling station at \$10 a week. Now I have my own radio business and average over \$60 a week. The N.R.I. course is fine." —ALBERT CHRISTENSEN, 1116—10th Avenue, Sidney, Neb.

"I am now operating a radio shop for myself and own all my equipment. Right now I only repair radios, because there are none to sell, but I average \$250 a month." —J. M. SCRIVENER, JR., Aberdeen, Miss.



"Am making over \$50 a week profit from my own shop. Have another N.R.I. graduate working for me. I like to hire N.R.I. men because they know radio." —NORMAN MILLER, Hebron, Neb.

## GOOD FOR BOTH 64 PAGE BOOK SAMPLE LESSON FREE

J. E. SMITH, President, Dept. 5KR  
National Radio Institute, Washington 9, D. C.

Without obligating me, mail your Sample Lesson and 64-page book FREE. I am particularly interested in the branch of Radio checked below. (No salesman will call. Please write plainly.)

- Radio Service Business of My Own
- Service Technicians for Radio Stores and Factories
- Spare Time Radio Servicing
- Government Civilian Radio
- Aviation Radio
- Operating Broadcasting Stations
- Army, Navy Radio Jobs
- Operating Police Radio Stations
- Operating Ship and Harbor Radio

(If you have not decided which branch you prefer—mail coupon for facts to help you decide.)

Name..... Age.....  
Address.....  
City..... Zone..... State..... 4PR



**AMATEUR**

The Oscilloscope Applied to Transmitter Checking ..... *Morris Eddy and Arthur Howard* 32  
 112 Mc. Crystal-Controlled Transmitter..... *L. G. Morey, W9KBO* 35  
 International Short-Wave ..... *Kenneth R. Boord* 47  
 Ultrasonic Communications..... *Robert G. Rowe* 48  
 Hamfesters Picnic ..... 52  
 The Road to Hamdom..... *S/Sgt. George Mobus, W9UAO* 54  
 QTC ..... *Carl Coleman* 56  
 Temperature Control in the Design of Stable Oscillators ..... *Lyle C. Tyler* 76  
 Captured 1000 Watt Jap Transmitter..... 96  
 4 Channel Mixer for Your Amplifier..... *David A. King* 110

**SERVICE**

New Type Signal Tracer..... *Shephard S. Litt, 2LCC* 31  
 Electrolytic Capacitor Checker..... *Rufus P. Turner* 38  
 Practical Radio Course..... *Alfred A. Chirardi* 50  
 Video Amplifiers..... *Edward M. Noll* 57  
 Reaching the Ruralist..... *John Latimer* 82

**RADAR**

Radar—The Silent Weapon of World War 2..... 25  
 Practical Radar ..... *Jordan McQuay* 44  
 Radar Plots the Invasion..... *Eugene Mason* 64

**GENERAL**

For the Record..... 8  
 Spot Radio News..... 12  
 Training with Visual Aids..... *Carl E. Winter* 41  
 Electronic Timers..... *Samuel A. Proctor* 53  
 What's New in Radio..... 68  
 Within the Industry..... 100  
 Tuning Fork Multivibrator..... *Cpl. Hayward L. Talley* 136  
 Manufacturers' Literature ..... 140  
 Letters from Our Readers..... 144

**COPYRIGHT, 1945 ZIFF-DAVIS PUBLISHING COMPANY**  
 185 N. Wabash Ave., Chicago 1, Ill.

BRANCH OFFICES: NEW YORK. WASHINGTON, LOS ANGELES, TORONTO



**WILLIAM B. ZIFF**  
*Publisher*

**B. G. DAVIS**  
*General Manager*

**C. R. TIGHE**  
*Ass't to the Publisher*

**GEORGE BERNER**  
*Advertising Director*

**HERMAN R. BOLLIN**  
*Art Director*

**H. G. STRONG**  
*Circulation Director*

**H. J. MORGANROTH**  
*Production Director*

**EDITORIAL**

**OLIVER READ, WSETI**  
*Editor*

**WM. A. STOCKLIN**  
*Ass't to the Editor*

**JOE MARTY, JR.**  
*Associate Editor*

**HAROLD S. RENNE**  
*Technical Editor*

**RAY FRANK, W9JU**  
*Amateur Radio*

**HAROLD BECKER**  
*Eastern Rep.*

**FRED HAMLIN**  
*Washington Editor*

**E. H. SEHNERT**  
*Chief Draftsman*

**ADVERTISING**

**S. L. CAHN**  
*Advertising Mgr.*

**L. L. OSTEN**  
*Midwest Adv. Mgr.*

**WM. L. PINNEY**  
*Western Adv. Mgr.*



**Cover Photo**  
 By Frank Ross

Engineers of Hytron devised this master tube tester to make a complete analysis of tube performance instantaneously. For complete details see October, 1944, issue of Radio News.

RADIO NEWS is published monthly by the Ziff-Davis Publishing Company, 185 N. Wabash Ave., Chicago 1, Ill. Subscription Rates: in U. S. \$3.00 (12 issues), single copy 35 cents; in Mexico, South and Central America, and U. S. Possessions, \$3.00 (12 issues); in Canada \$3.50 (12 issues), single copies 40 cents; in British Empire, \$4.00 (12 issues); all other foreign countries \$6.00 (12 issues). Subscribers should allow at least 2 weeks for change of address. All communications about subscriptions should be addressed to: Director of Circulation, 185 N. Wabash Ave., Chicago 1, Ill. Entered as second class matter March 9, 1938, at the Post Office, Chicago, Illinois, under the Act of March 3, 1879. Entered as second class matter at the Post Office Dept., Ottawa, Canada. Contributors should retain a copy of contributions and include return postage. Contributions will be handled with reasonable care but this magazine assumes no responsibility for their safety. Accepted material is subject to whatever revisions and by-line changes that are necessary. Payment, made at our current rates, covers all authors' contributors', or contestants' rights, title, and interest in and to accepted material, including photos and drawings.

Other Ziff-Davis Publications: Radio & Appliances, Radio-Electronic Engineering, Plastics Flying, Industrial Aviation, Popular Photography

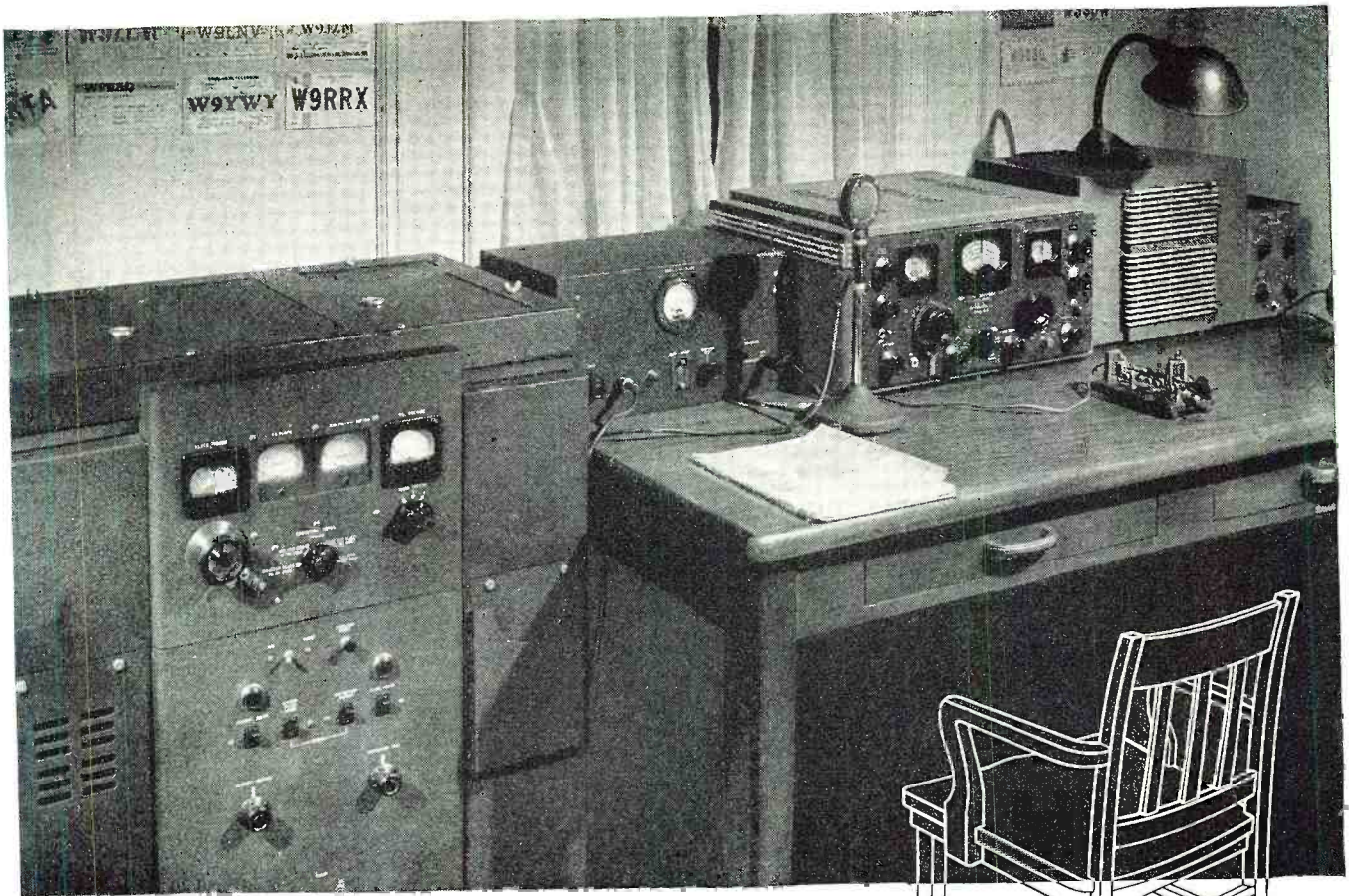

## Pull up a chair!

Get a ringside seat at the ideal ham shack of tomorrow. The above picture was made at Hallicrafters Ham Shack on the Boulevard, in Chicago. But no picture can represent, no artist can paint what Hallicrafters has in store for the amateurs when the demands of war production are relaxed. Rugged, dependable, sensitive high frequency transmitters and receivers — like the HT-4 which went to war as the famous mobile radio station SCR-299 and the SX-28A, the great communications receiver — belong in the postwar picture of your ideal ham shack. Hallicrafters

equipment has been constantly refined and developed under the fire of war. In peace it will come closer than ever to meeting the exacting requirements of the radio amateur who has played such a prominent part in the progress of all radio and who assumed such a valuable role in war communications.

Even now you can "pull up a chair" in your ideal ham shack by sending for Hallicrafters 1945 Catalog . . . a fascinating piece of ham literature . . . detailed specifications on more than 20 models that are helping to win the radio war. Specify Catalog S-36A.

COPYRIGHT 1945 THE HALL-CRAFTERS CO.

BUY A WAR BOND TODAY!



# hall-crafters RADIO

THE HALL-CRAFTERS CO., WORLD'S LARGEST EXCLUSIVE MANUFACTURERS OF SHORT WAVE RADIO COMMUNICATIONS EQUIPMENT, CHICAGO 16, U. S. A.

October, 1945

51

# Symbol

## OF A HAPPIER TOMORROW...

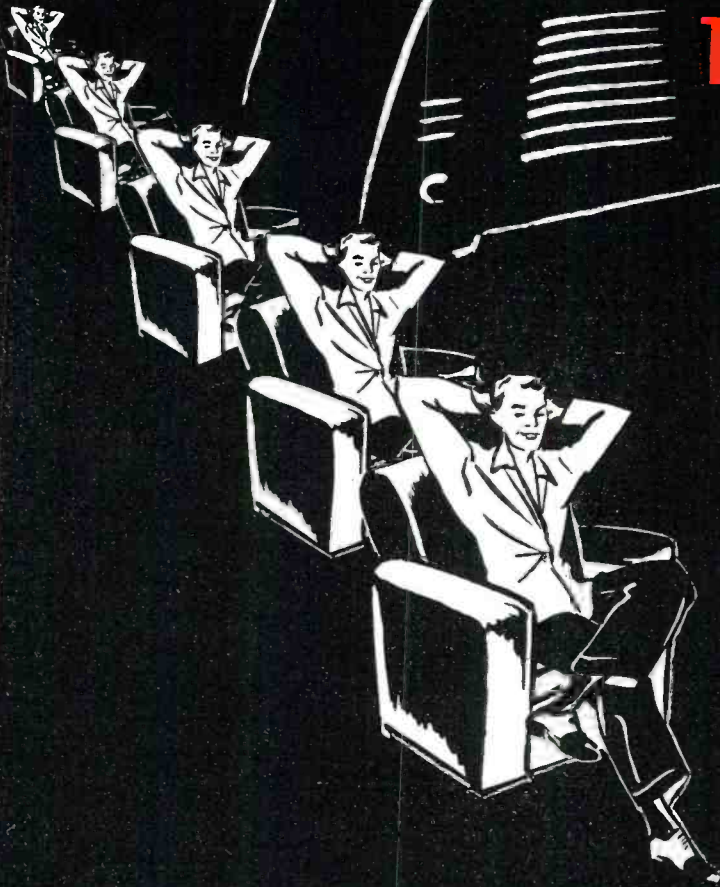

Radio has deepened our appreciation of the American way of life. Out of the crucible of war, it has forged a new and better understanding of the vital forces that shape our future. It brings promise of a happier tomorrow.

For many years, FADA has symbolized the best in radio engineering and development. And — as quickly as Government restrictions are modified, Fada's great manufacturing capacity will be concentrated on producing the finest radios for the civilian market.

There are some Fada dealer franchises still available. If you are not familiar with Fada's far-sighted profit-building merchandising plans, we suggest that you communicate with your jobber — or write to us directly.

PLACE YOUR FAITH IN THE

# FADA Radio

OF THE FUTURE

*Famous Since Broadcasting Began!*



FADA RADIO AND ELECTRIC COMPANY, INC., LONG ISLAND CITY, N. Y.

RADIO NEWS

**SPECIALISTS IN DESIGN  
AND MANUFACTURE OF  
FINE ACOUSTIC EQUIPMENT**

**NEW Jensen  
PRODUCTS -  
WATCH FOR COMING  
ANNOUNCEMENT**

FREE to the Armed  
Forces, Colleges,  
Technical Schools,  
Libraries.



**5 MONOGRAPHS AVAILABLE**

1. Loud Speaker Frequency - Response Measurements.
2. Impedance Matching and Power Distribution.
3. Frequency Range in Music Reproduction.
4. Effective Reproduction of Speech.
5. Horn Type Loud Speakers.

**25c** Each

PRODUCT NO. 1  
PRODUCT NO. 2  
PRODUCT NO. 3  
PRODUCT NO. 4  
PRODUCT NO. 5  
PRODUCT NO. 6

THROUGHOUT the war JENSEN remained true to a more than fifteen-year-old tradition of specialization in the design and manufacture of fine acoustic equipment. Very shortly now this persistent adherence to specialization will again bring forth new and improved JENSEN Loud Speakers and related products. Their quality and performance ability, in the JENSEN tradition, will suggest their use by all who want the best. Watch for further announcements.



**Jensen**  
SPEAKERS WITH

**ALNICO 5**

JENSEN RADIO MANUFACTURING COMPANY • 6617 SOUTH LARAMIE AVENUE, CHICAGO 38, ILLINOIS  
IN CANADA—COPPER WIRE PRODUCTS, LTD., 137 RONCESVALLES AVENUE, TORONTO

# AUDAX

RELAYED-FLUX  
Microdyne

## The Importance of SPECIALIZATION

Aside from outstanding and long-acknowledged technical skill—our “Specialization Formula” is probably as fully responsible for the world-renowned AUDAX quality as any other single factor.

We proudly concentrate all our energies and resources upon producing the BEST pick-ups and cutters. Because we are specialists in this field, much more is expected of us. Because the production of fine instruments like MICRODYNE is a full time job, it stands to reason that we could not afford to jeopardize our reputation—EVER—by making pick-ups a side-line.

After Victory, you may expect AUDAX improvements, refinements . . . master-touches to heighten the marvelous *fac simile* realism of AUDAX reproduction.

**AUDAX COMPANY**  
500-N Fifth Ave., New York 18, N. Y.

Creators of Fine Electronic-Acoustical Apparatus Since 1915

Send for complimentary copy of our informative

“PICK-UP FACTS”

★ BUY  
WAR BONDS

“The Standard by Which Others  
Are Judged and Valued”



# For the RECORD.

BY THE EDITOR

**T**HE Federal Communications Commission announced, on August 21st, that, effective at once, amateur radio operators in good standing who have been off the air since Pearl Harbor may operate until November 15, 1945, in the 112 to 115.5 megacycle band.

They will share this band with the War Emergency Radio Service, which was established as a temporary radio service for emergency communication in connection with national defense and conditions jeopardizing public safety. Many of the operators in this service were amateur volunteers. This WERS service will be terminated on November 15, 1945.

About 60,000 amateur operators were licensed at the time the Commission ordered them off the air after the outbreak of war. All of these, except those whose operator licenses were suspended or whose station licenses were revoked, will be eligible to operate in the 112 to 115.5 megacycle band thrown open by the Commission today.

Before the end of the provisional period announced today, the Commission will announce a further policy on future amateur operation. It is anticipated that other bands allocated to amateurs in the recent FCC frequency allocations will be made available to them as soon as they are vacated by present users. We predict more frequencies will be returned very soon.

**A**MERICAN radar, second only in effectiveness to the atomic bomb, now comes under the spotlight to reveal some of its technical magic. No one can deny the importance of radar as a contributing factor in winning both the European and Japanese war. The development of radar to its present high level of effectiveness has been the result of outstanding contributions made by American and English scientists.

We predicted many months ago that this would be, and it certainly has been, a radar war. Ever since Pearl Harbor the development of radar systems has progressed at a rapid rate. Many designs and changes have followed one another in rapid succession. Radar was not an old weapon. It was a new one especially adapted to global warfare on and over the earth and at sea.

Much has happened since RADIO NEWS presented the first story on the British radio locator. Many of you remember it. What has been accomplished is now history and the saving of thousands of lives can be attributed to the intelligent use of radar in the hands of Allied personnel thoroughly schooled to master the new technique employed.

Types of radar may be broadly classified in two categories. First comes the “search” type that sweeps distant and wide areas to detect the approximate position of a target. The second type is the “fire control” which employs a narrow beam to determine precisely the position of the target in order that shells can be aimed properly or that bombs can be released at the exact proper moment.

The search operation may be compared to the scanning of an entire scene with a naked eye. On the other hand, the fire control type of radar is comparable to focusing a telescope to “draw a bead” on the target.

Radar has not been developed by any one man or by any one manufacturer. Many firms pitched in with their full facilities in order to produce many types of radar in the quickest possible time. In fact, one large laboratory developed and produced designs for nearly 100 radars.

To illustrate the effective use of radar let us review quickly some typical “case histories.” American troops on the Anzio beachhead in Italy were taking a terrific pounding from Army night bombers. A new fire control radar was brought in and the following morning after its first night of action, the ground was strewn with Nazi planes. The night attacks stopped. The Nazis found out that they were losing too many aircraft. The same type of radar saw plenty of action in the Pacific by furnishing anti-aircraft protection on Saipan, Leyte, Okinawa, and on other Islands, especially during the early days of each invasion.

At sea in the battle of Santa Cruz Islands, the South Dakota was credited with shooting down thirty-two enemy planes during one engagement through the use of fire control radar. In the battle of Savo Islands, the same ship teamed up with the USS Washington to sink three Japanese cruisers plus one or two battleships with the aid of another fire control radar which supplied firing information to their main batteries. This engagement began at midnight and Japanese reaction to the amazing accuracy of U.S. Navy guns in pitch darkness at a great range is shown by the following authenticated story: It was a night battle near Guadalcanal; our warships had sunk a number of enemy ships before they could open fire. A Japanese officer, fished out of the water, asked immediately to see what he called “your six inch machine gun with the electric eye pointer.” This Jap was referring, of course, to our cruiser’s guns which had fired so fast and with such accuracy

(Continued on page 122)



# ORDER YOUR NEW Hallicrafters Communications Receiver NOW

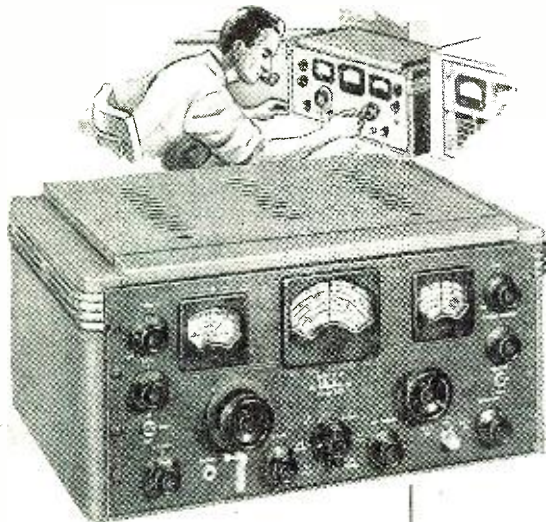

Available on Time Payments  
Trade-ins Accepted

**MODEL SX-28A**—This is the latest model of Hallicrafters famous *Super Sky-Rider* . . . the finest communications receiver built today! Has a frequency range of 550 kc. to 42 Mc. continuous in 6 bands. With crystal, less speaker, net . . . . . \$223.00

**MODEL SX-25**—The *Super-Defiant* . . . long-time favorite of amateurs who want fine performance at a moderate price. Has a frequency range of 545 kc. to 42 Mc. continuous in 4 bands. With crystal, less speaker, net . . . . . \$94.50



**MODEL 5-20R**—Popular *Sky-Champion* offers top performance in low cost field. Has a frequency range of 550 kc. to 43 Mc. continuous in 4 bands. With built-in speaker, net . . . . . \$60.00

**MODEL 5-39**—*Sky Ranger* portable . . . operates from its own self-contained batteries or 115 volts a.c. or d.c. Has frequency range of 540 kc. to 30.5 Mc. continuous in 4 bands. Net . . . . . \$110.00



**MODEL 5-36**—Covers both old and new FM bands. Operates on FM, AM, or CW. Outstanding for sensitivity, stability, high fidelity and versatility in the *very high frequencies*. Range from 27.8 Mc. to 143 Mc. continuous in 3 bands. Less speaker, net . . . . . \$307.50

**PM23 SPEAKER**—For SX-28A, SX-25 and S-36 above, net . . . . . \$15.00



**HALLICRAFTERS**

Honored for its Role in War Communications

On all fronts . . . on land, sea, in the air . . . in jungle, desert and arctic . . . Hallicrafters sets have performed gallantly for the Armed Forces of the United Nations. The fifth Army and Navy "E" award flies from Hallicrafters roof tops! Hallicrafters, you know, are *builders of the famous SCR-299.*



## ALLIED RADIO

833 W. Jackson Blvd. Chicago 7, U. S. A.

Over 20 Years of Service to the Nation

October, 1945

BE ONE OF THE FIRST to own and enjoy one of these celebrated receivers. Allied Radio is a leader in the distribution of communications receivers. **WE ARE NOW MAKING SHIPMENTS.** Orders are filled in turn. *Place your order now!*

Your new receiver will have vital war-proved features . . . *plus* latest engineering developments . . . to make it one of the finest values of the day. Choice of models cover world-wide short-wave, amateur and broadcast bands. All prices are net, F. O. B. Chicago.

## NEW ECHOPHONE EC-1A

Communications-Type Receiver

This short-wave and broadcast receiver *with its many new features* will be more popular than ever! You'll get performance you didn't think possible at such low cost. Covers entire tuning range from 550 Kc. to 30 Mc. (550 to 9.85 meters) in 3 bands. For 115-125 volts AC-DC. Automatic noise limiter. Built-in PM speaker. Compact and reliable. Complete with tubes. Net . . . . . \$29.50

*Subject to OPA approval*



*With one of these receivers, all the world's your neighbor. You'll feel proud to be among the first to have one . . . and glad you ordered yours now.*

If you prefer, convenient time payments can be arranged—or any communications receiver in good condition accepted for a liberal trade-in allowance.

SEND YOUR ORDER TODAY FOR EARLIEST DELIVERY

**ALLIED RADIO CORP.**

833 W. Jackson Blvd., Dept. 1-KK-5  
Chicago 7, Illinois

Date . . . . .

Please ship earliest moment . . . . . Model . . . . .

Enclosed \$ . . . . .  Full Payment  
 Part Payment (Balance C.O.D.)

Please send full information on Communications Receivers and Time Payment Plan, without obligation.

NAME . . . . .

ADDRESS . . . . .

CITY . . . . . ZONE . . . . . STATE . . . . .



**ALLIED RADIO**  
"Arsenal of Supply"

for Everything in Radio and Electronics

*Allied's complete service speeds vital needs to the Armed Forces and Industry. Concentrated here are the world's largest and most complete stocks of parts and equipment under one roof. And Allied has always been one of the leaders in the sale of communications receivers.*

NATIONAL RECEIVERS ARE THE EARS OF THE FLEET

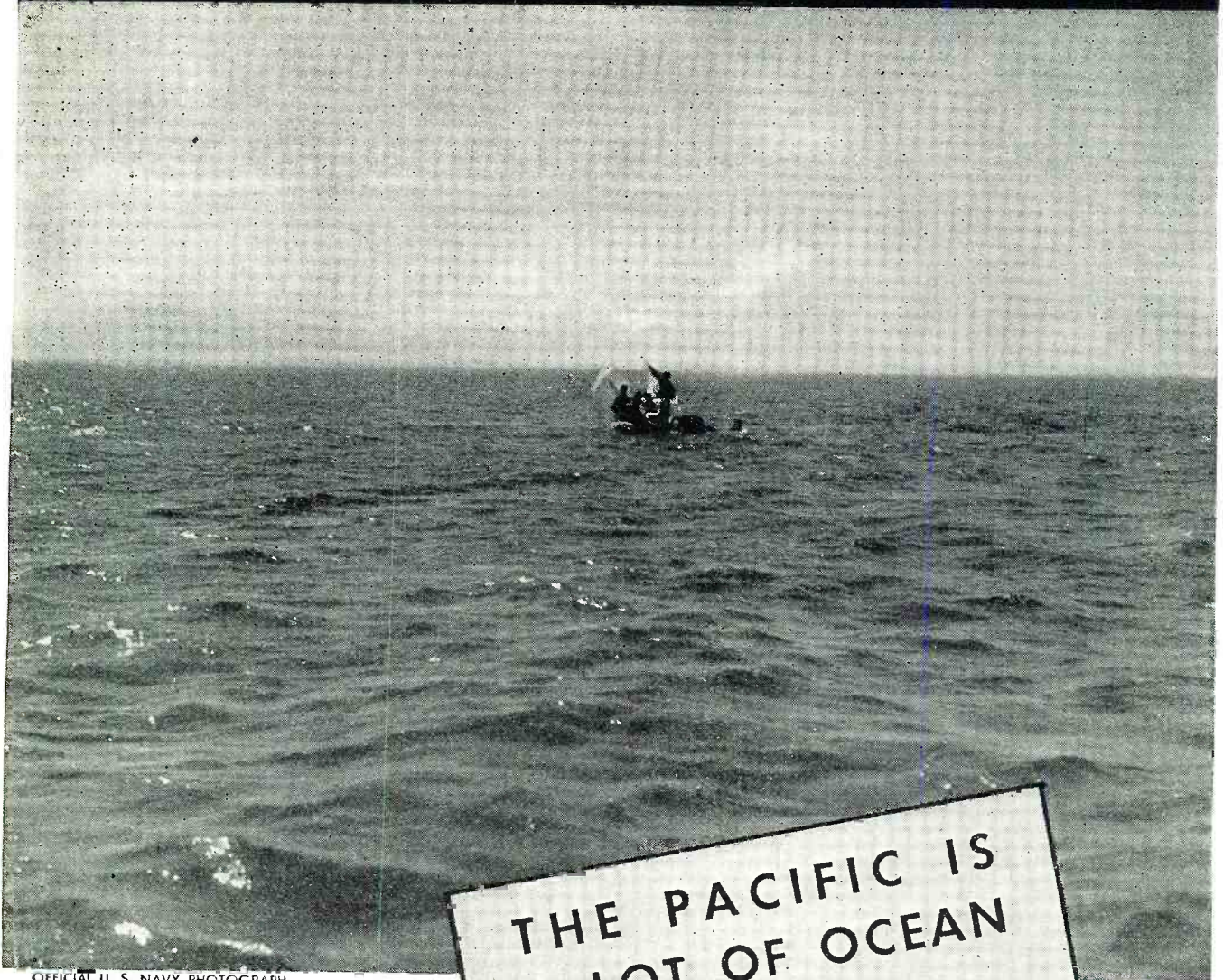

OFFICIAL U. S. NAVY PHOTOGRAPH

# THE PACIFIC IS A LOT OF OCEAN

It is a big place to get lost in. The ceaseless search by Navy PBM "Mariners" has saved the lives of many downed fliers. Sometimes the plane can make the rescue; often radio sends help on its way.

The Navy knows how important radio equipment is. 3 out of 4 of the Navy's ships — landing craft and larger — use receivers designed by National.

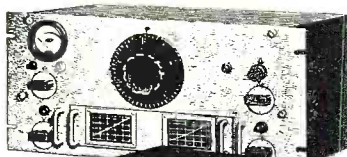

HRO

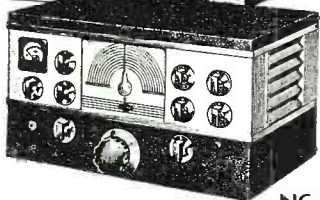

NC-200

## NATIONAL COMPANY

MALDEN  MASS, U. S. A.

NATIONAL RECEIVERS ARE IN SERVICE THROUGHOUT THE WORLD  
RADIO NEWS

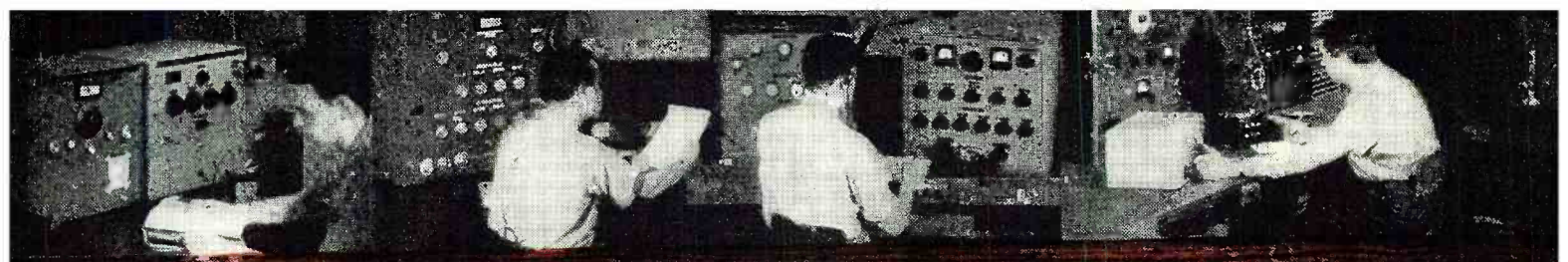

# WHY CHOOSE UTC?

## FOR WAR AND POSTWAR COMPONENTS

1. **UTC IS THE LARGEST** TRANSFORMER SUPPLIER TO THE COMMUNICATIONS INDUSTRY.
2. **THE SCOPE OF UTC PRODUCTS** IS THE WIDEST IN THE INDUSTRY.
3. **UTC ENGINEERING LEADERSHIP** IN THE INDUSTRY IS ACCEPTED . . . WE DESIGN TO YOUR NEEDS.
4. **THE QUALITY OF UTC PRODUCTS** IS HIGHER THAN EVER.
5. **THE DEPENDABILITY OF UTC PRODUCTS** IS BACKED BY MANY YEARS OF EXPERIENCE. UTC IS NOT A WAR BABY.
6. **UNEXCELLED PRODUCTION FACILITIES** MAKE UTC'S PRICES RIGHT AND DELIVERIES ON TIME.



*United Transformer Corp.*

150 VARICK STREET  
EXPORT DIVISION: 13 EAST 40th STREET,

NEW YORK 13, N. Y.  
NEW YORK 16, N. Y., CABLES: "ARLAB"



ALL PLANTS



Designed for



Application

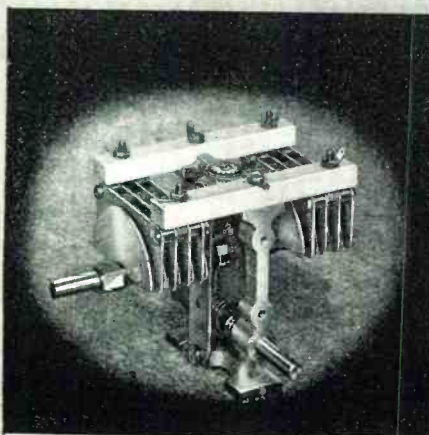

### The 11000 Series Transmitting Condensers

Another Millen exclusive "Designed for Application" product. Illustrated is the 11035 size. Permits more efficient use of newer tubes—more compact and symmetrical circuit arrangements and consequent better neutralization. Center fed rotors for better high frequency current distribution. Isolantite insulation; terminals in convenient places. Sturdy cast aluminum center frame with right angle drive, 16/1 ratio. Rounded polished heavy gauge aluminum plates. Extended rotor shaft for dial or indexing device.

**JAMES MILLEN  
MFG. CO., INC.**

MAIN OFFICE AND FACTORY  
**MALDEN  
MASSACHUSETTS**



## Spot Radio News

\* Presenting latest information on the Radio Industry.

By **F. D. WALKER**

Washington Reporter, RADIO NEWS

**HEARINGS BY THE FCC** on the engineering aspects of the new frequency allocations for FM continue to hold the spotlight in Washington. In line with the interest being shown by engineers throughout the country comes a communication from John Barron, Consulting Engineer of Washington, D. C., who comments as follows:

"The recently announced plan of allocation for FM stations by the FCC appears to be based upon what is termed "single market coverage", that is, any station (except 'rural') would be permitted to serve only a single market area and would not be permitted to serve two or more markets. This might be satisfactory in some cases, but it will not take care of all cases.

"For example, there are numerous AM stations now operating on low frequencies with medium power which permits them to render primary service to several metropolitan districts adjoining their trade area. If such a station obtained a 'rural' type FM assignment, it would be prohibited from placing a good city signal in these metropolitan districts. If it obtained a 'metropolitan' type assignment, it would presumably serve only the immediate trade area which accrued to the small city where its main studio is now located. If it obtained a 'community' type assignment, it would have a comparatively worthless coverage of a few miles, as such stations are proposed to be limited to 50 watts and generally low antenna heights and to be spaced so close together that their coverage will eventually be curtailed to approximately a six-mile radius. This coverage is based upon the assumption of the probable use of many receivers in such areas designed to sell at low prices and requiring a twenty-to-one ratio between desired and undesired signals.

"On the other hand, it should be kept in mind that, if something like a 'single market plan' is not adopted, some stations may be faced with the loss of national advertising and network affiliation as 50 kw. FM operation would permit some stations to serve cities and areas now covered by two or more AM stations which now carry the same network program. There is one school of thought which adheres to the idea of 'survival of the fittest' and which believes that there

should be no limit to the number of high-powered stations serving a given area, that the station serving the best program will get the listeners, and that the other stations can die off. It may be that more than four national networks could successfully program FM stations. The number of national networks is undoubtedly restricted at present by the limited number of AM stations having good coverage.

"It is pointed out that the proposed FM plan does not make provision for maintaining coverage of areas now served by AM stations so that some AM stations may find themselves having a greatly curtailed coverage area when they change to FM operation.

"The tentative plan of FM assignments provides for ten channels to be assigned to 'rural' type stations, fifty for 'metropolitan' type, and ten for 'community' type. It is difficult to estimate the exact total number of assignments this will provide, but obviously a great number will be permissible. Allowing for 'rural' stations to be spaced 300 miles apart, this would permit the assignment of about 24 for each frequency or a total of 240 stations. Allowing for 'metropolitan' stations to be spaced 200 miles apart, this would allow 60 of these for each frequency or a total of 3000 stations. Placing 'community' stations only 50 miles apart would permit the assignment of about 1000 on each frequency or a total of 10,000 of this class. This makes a grand total of 13,240 FM stations. Of course this does not take into account that it is not possible to use adjacent channels in the same area. (Every other channel can be used.) I would estimate that adjacent channel interference problems would reduce the number of potential assignments by 25% so that the estimate of the total number of stations is 9930. These figures are based upon the use of receivers which will operate well with a twenty-to-one ratio between desired and undesired signals on the same channel for 'community' stations and ten-to-one ratio for the other two classes of station.

"It seems doubtful to me whether the country can support or wants this many stations. The population of the continental United States in 1940 was 131,669,275. This would mean that there would be one FM station for every 13,250 persons.

"The number of cities in the U. S.

THE EYES  
HAVE IT

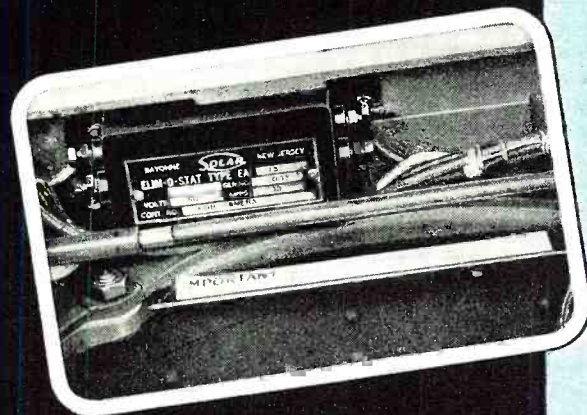

Quick as a wink the Fairchild Night Owl Camera records enemy movements intended to be hidden by darkness. Quick as a flash the radio of the photo-reconnaissance plane keeps touch with its base — and clearly — for Solar Elim-O-Stats are part of the electronic equipment of these highly perfected cameras. This is but one of many instances where Solar Elim-O-Stats are being used to absorb local interference and keep speech channels free. Let Solar advise you on radio-noise suppression.



WEST N. Y. BAYONNE PLANT  
A TOTAL OF NINE  
ARMY-NAVY EXCELLENCE AWARDS

**SOLAR MANUFACTURING CORP.**  
285 Madison Avenue • New York 17, N. Y.

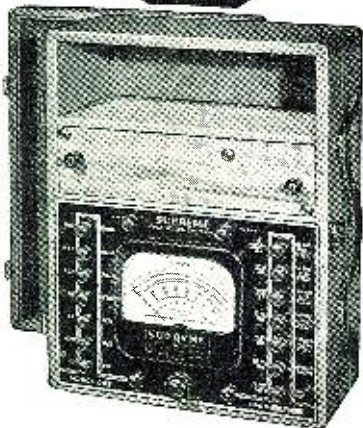

- ★ Design proven by over 5 years production
- ★ Dual D.C. Sensitivity—25,000 ohms per volt and 1000 ohms per volt.
- ★ Matched resistors of 1% accuracy
- ★ Push button operated—no roaming test leads
- ★ Open face—wide scale 4¼" meter. 40 microamperes sensitivity.
- ★ 1 Microampere first scale division.

### SPECIFICATIONS

- D.C. MICROAMPERES:  
0-70-700 microamperes
- D.C. MILLIAMMETER:  
0-7-35-140-350 milliamperes
- D.C. AMMETER  
0-1.4-14 amperes
- D.C. VOLTS, 25,000 OHMS PER VOLT:  
0-3.5-7-35-140-350-700-1400 volts
- D.C. VOLTS, 1000 OHMS PER VOLT:  
0-3.5-7-35-140-350-700-1400 volts
- A.C. VOLTS, 1000 OHMS PER VOLT:  
0-7-35-140-350-700-1400 volts
- OUTPUT VOLTMETER:  
0-7-35-140-350-700-1400 volts
- DECIBEL METER:  
0 db to plus 46 db
- OHMMETER:  
0-500-5000-50,000-500,000 OHMS  
0-5-50 MEGOHMS
- POWER SUPPLY  
Battery Operated

With the above specifications the Supreme Model 592 Speed Tester meets today's requirements for general laboratory use, assembly line tests and inspection, radio and other electronic repair and maintenance.

**SUPREME**  
TESTING INSTRUMENTS

SUPREME INSTRUMENTS CORP.  
Greenswood, Miss., U. S. A.

does not appear to justify a necessity for this number of stations. There were only 140 'metropolitan districts' classified in the 1940 census. These districts are those including and surrounding a central city of 50,000 population or more, generally extending out to an area where the population density falls below 150 persons per square mile.

"As to the actual cities, the 1940 census shows there were 3205 cities of 1000 to 2500; 1422 of 2500 to 5000; and 2042 above 5000. These total 6669. Incorporated places under 1000 were 10,083 which, added to the above, gives a grand total of 16,752. It would, therefore, appear that the FM plan anticipates establishment of many FM stations in towns of less than 1000 population. It is hard to believe that towns of less than 5000 can support a creditable FM station. Accordingly, I see no necessity for providing for so many small 'community' stations.

"The FM engineering standards provide that interference-free reception is to be provided out to the limit of anticipated usable signal (20 microvolts per meter) for 'rural' and 'metropolitan' stations but set up a greatly depreciated limit (approximately 1000 microvolts per meter) for 'community' stations. This means that the portion of the receiver dial used by 'community' stations will carry cross-talk interference in most areas. To me, it seems poor practice to require interference-free reception in two bands and then to permit high interference in the other band. The 'community' class of station will be similar to or worse than the present 'local' class of AM station, which stations interfere with each other severely at night. It seems as though greater power with lower interference would be desirable for many 'community' stations in view of the great number of possible assignments, even if these must be placed in communities of 5000 population or more. Under the FCC proposed plan, these 'community' stations could be placed in any community, such as a small city or suburb of a large city, or could even serve a part of a large city or metropolitan district. As there could be as many as five of these in each community, it is obvious that any 'metropolitan' station would be faced with competition from numerous 'community' stations spotted in and around its service area. It appears to be unnecessary regulation to limit arbitrarily 'community' stations to 50 watts, low antennas, and 50 miles separation.

"It is felt that the gap between the 'community' station classification and the 'metropolitan' classification is too large and that the proposed FCC plans will not accommodate the need in certain areas. I would suggest the addition of a fourth classification, to be known as a 'county' station. A county is a closely-knit entity and most small stations will need to serve their county

as well as the community which may be the population center of the county. It appears that any populous community would be capable of supporting one or more stations of three to ten kilowatts maximum power which should be sufficient to provide adequate rural coverage of approximately 50 to 60 miles. There were 3057 counties classified in the 1940 census (not including 26 independent cities not in counties). It is obvious, therefore, that there are sufficient frequencies to provide for an adequate number of 'county' stations, if this class is included.

"It is also believed that the 'rural' classification station should not be so severely restricted by regulation as to prohibit such stations from serving adjacent metropolitan districts. A more flexible arrangement, based upon the need in particular areas, appears preferable."

**THE OPINIONS OF OTHERS** who testified at the hearings vary widely, representing all degrees of acceptance or non-acceptance of the FCC proposals. Some few individuals, namely, John Morgan Davis, general counsel for the NAB and John W. Steen, attorney for *Westinghouse Radio Stations, Inc.*, stood pat on the brief as presented. Others rejected all of the proposals or recommended modifications of certain sections of the brief. Some of the Eastern networks asked that special consideration be given to the heavily populated New England area where AM has long been overcrowded and the FM band is filling in rapidly.

**THREE ELECTRONIC COMPANIES** have voted favorably on a proposed merger according to a recent announcement made public by the three companies. The *Utah Radio Products Company* of Chicago, *Universal Cooler Corporation* of Marion, Ohio, and *International Detrola Corporation* of Detroit, Michigan, have signified their intention to merge and throw their united resources into the postwar market, both domestic and foreign. *International Detrola* recently acquired controlling interest in *Rohr Aircraft Corporation* of California. Rohr has been granted permission to manufacture a limited number of domestic refrigerators and is seeking permission to build domestic washing machines. Thus, the combine will produce appliances as well as radio receivers and automatic record changers. The corporate setup has not been announced as yet.

**IN A RECENT ANNOUNCEMENT** the *Radio Manufacturers Association* has indicated that there might be some delay in the reconversion to civilian radio manufacture due to two major obstacles. The first of these is the shortage of critical components and the second is an uncertainty as to

Prepare Now for a Good-Pay Job in . .

# RADIO ELECTRONICS

Learn at Home with . .  
**DEFOREST'S A-B-C**  
*\* Syncro-Graphic*  
**TRAINING!**



**ONLY DEFOREST'S OFFERS  
YOU THE ADVANTAGE OF  
MOVIES**  
TO HELP YOU LEARN  
RADIO - ELECTRONICS  
**FASTER - EASIER**  
... AT HOME

**HERE'S WHAT DEFOREST'S  
A-B-C "SYNCR-O-GRAPHIC"  
TRAINING INCLUDES . . .**

**A "LEARN-BY-SEEING"  
MOVIES**

To help you master important Radio Fundamentals, you use the more interesting, easier-to-understand, VISUAL method of Movie Instruction . . . with a genuine DeVry Movie Projector and Training Films!

**B "LEARN-BY-DOING"  
EXPERIMENTS**

You make 133 Fascinating Experiments with 8 Big Kits of Radio Parts and Assemblies. You build modern Radio Receiving Circuits, Electric Eye Devices, an Aviation Band Circuit, Public Address System, Wireless Microphone, etc. . . . all in your spare time, in your own "Home Laboratory."

**C 90 "SYNCR-O-GRAPHIC"  
LESSON TEXTS**

Prepared under the supervision of Dr. Lee DeForest, the "Father of Radio," inventor of the Audion Tube, and holder of over 300 Radio-Electronic patents.

**EMPLOYMENT SERVICE**

DeFOREST'S also provides an *Effective Employment Service* which helps you get started in this *opportunity field of the future!*

DR. LEE DeFOREST supervised the preparation of DeFOREST'S Training

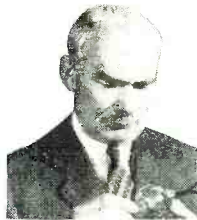

**"SYNCR-O-GRAPHIC"  
TRAINING**

Makes learning easier because all lesson diagrams and charts are printed on sheets that **fold out**—keeping illustrations constantly synchronized to text. Eliminates confusion from frequent flipping of pages to refer back or ahead to illustrations mentioned in text. An exclusive DeFOREST'S feature.

**DEFOREST'S TRAINING INCLUDES INSTRUCTION IN MOTION PICTURE SOUND EQUIPMENT, FM RADIO AND TELEVISION . . .**



E. B. DeVry, President  
DeFOREST'S TRAINING, INC.  
2535-41 North Ashland Avenue, Dept. RN-B10  
Chicago 14, Illinois, U.S.A.

Please send me your "VICTORY FOR YOU!"  
BOOK AND EQUIPMENT FOLDER

Name \_\_\_\_\_ Age \_\_\_\_\_

Address \_\_\_\_\_

City \_\_\_\_\_ Zone \_\_\_\_\_ State \_\_\_\_\_

If under 16, check here for special information.

If a veteran of World War II, check here.

Train *now* for the postwar Radio-Electronic job opportunities which wartime needs and experiences are developing! Use your *free time today* to store-up practical knowledge and experience for *good-pay* tomorrow! *Trained* men will be needed for the huge postwar requirements of Radio and Electronics, Broadcast Radio, Aviation Radio, Sound Picture Equipment, etc.—in manufacturing, merchandising, installing and servicing.

**EARN EXTRA MONEY—While You Learn**

When you learn Radio as DeFOREST'S teaches it, you can start a Business of Your Own—be your own boss, if you prefer! Even while learning, you may earn extra money doing Radio Servicing with your home as your "office." Get the facts about this fascinating home training in Radio-Electronics.

**SEND FOR FREE INFORMATION!**

Get "Victory for You!" book and Equipment folder. See how DeFOREST'S Training can help *you* towards good pay and a better job in a permanent industry. Also ask about DeFOREST'S *Residential Training* in the modern Chicago Laboratories shown at left. Mail coupon *today*.

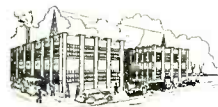

**DeFOREST'S TRAINING, INC.**  
CHICAGO 14, ILLINOIS

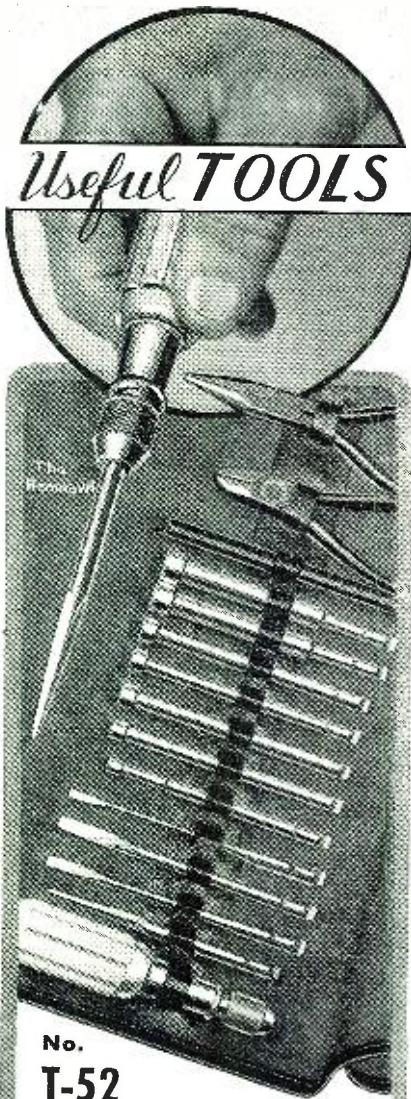

Useful **TOOLS**

No.

**T-52**

**SPINTITE SET.**

Chuck Type Handle with Reamawl, 3 Screw Drivers, 7 SPINTITES, Insulated Neutralizing Alignment Wrench, and 2 Pliers, all in a Leatherette Roll. . . .

**A Positive need in every RADIO, HOME and ELECTRICAL SHOP.**

**A Fascinating, Fast-Moving Item for thousands of stores. Your good jobber has it. . .**

Send for Catalog No. 141 picturing a full line of Automobile, Aircraft and Radio Tools

**WALDEN**  
WORCESTER  
WRENCHES

**STEVENS WALDEN, INC.**

468 SHREWSBURY STREET

**WORCESTER, MASSACHUSETTS**

what prices will be allowed by the OPA. Although many manufacturers have applied for "spot" authorizations to produce a limited quantity of radio receivers, WPB officials state that these authorizations will be limited to the component producing capacity of the industry, in excess of what is needed for war purposes.

The delay in announcing an industry-wide reconversion pricing formula is claimed by the RMA to be a deterrent to speedy reconversion. More than two months after Price Administrator Chester Bowles announced his reconversion pricing formula on May 11, only radio cabinets, out of all items going into a radio, have been given a price increase. Cabinet manufacturers were given an 18 per-cent rise of 1941 prices. Many parts manufacturers are unable to quote prices on deliveries set for 2 to 3 months hence.

Under the regulations announced in the middle of July by the OPA, radio set manufacturers have their choice of selling at their 1942 prices or applying for individual adjustments pending a determination of the industry-wide "increase factor." For this purpose a "profit factor" of 3 per-cent has been given radio and phonograph manufacturers to use, with allowable increases in basic wage rates and material costs in applying for higher prices.

**RADIO REPAIR SHOPS** should have an adequate supply of radio tubes for repair and maintenance shortly, according to WPB officials, as tube production has been stepped up to provide almost 4,000,000 tubes a month for this purpose. This is an increase of approximately a million tubes over previous months' output.

**THE NEW YORK CITY BOARD OF EDUCATION**

in cooperation with the Television Department of the National Broadcasting Company is launching an interesting educational experiment this fall. A comprehensive study is to be made into the field of the adaptation of television to classroom education. During the experiment, school officials and television experts will broadcast a weekly program over WNBT with a view to determining the type of television program most suitable for educational purposes. Pupils and teachers will evaluate these programs at the NBC studios. The first programs will be in the field of science and the initial broadcast will deal with the science of television itself. Experimentation in classroom use of these programs will begin at the junior high school level with pupils ranging from 13 to 15 years of age.

**THE OWI HAS ANNOUNCED** that more than 200 American technical experts drawn from various firms, universities, and government agencies have been sent to Europe to investigate Germany's technical industrial

war secrets. Among the developments which have already been discovered are new applications of radiation devices not explored so far in the United States, a new and improved x-ray tube for cancer therapy and industrial purposes, new flexible high tension cables that withstand double the voltage of American-made cables of the same size, and power circuit breakers with construction details unfamiliar to the U. S. American communications interests are represented by A. T. & T., Bell Labs., Federal Telephone and Radio Laboratories, RCA, and Western Electric.

**RESTRICTIONS ON THE PRODUCTION**

and sale of parts required for the manufacture and repair of electronic equipment, including radio sets, were removed by the WPB recently to aid reconversion in the radio industry. In addition, restrictions were removed from the sales of electronic equipment when produced under WPB authorization, according to the agency. The amendment to Limitation Order L-265 is responsible for the lifting of the controls.

**AN INCREASE IN THE AMOUNT**

of copper wire that a repairman may buy in a calendar quarter without WPB authorization has been increased from \$75 worth, or one-tenth of what was used in making repairs in 1941 (whichever is greater), to \$150 worth, or one-eighth of the 1941 repair usage. This new ruling affects refrigeration repairmen, domestic appliance repairmen, electricians, electrical contractors, and radio repairmen. The amended regulation also removes the prohibition against the use of new cord and other materials obtained under the regulation for certain types of maintenance and repair work.

**THE ESTABLISHMENT OF A**

National Research Foundation by Congress for the purpose of promoting a national policy for scientific research and education has been proposed by Dr. Vannevar Bush, director of the Office of Scientific Research and Development. In his proposal, forwarded to the White House, Dr. Bush recommended that the foundation be formed to develop scientific research, financially support basic research in non-profit organizations, encourage scientific talent in American youth by offering scholarships and fellowships, and promote long-range research on military matters. He further recommended that the foundation consist of nine members to be selected by the President and be responsible to him, these members to serve four years without compensation, and that the foundation have the following five divisions: Medical Research, Natural Science, National Defense, Scientific Personnel and Education, and Publications and Scientific Collaboration.

(Continued on page 148)

**RADIO NEWS**



# NO BUBBLE.

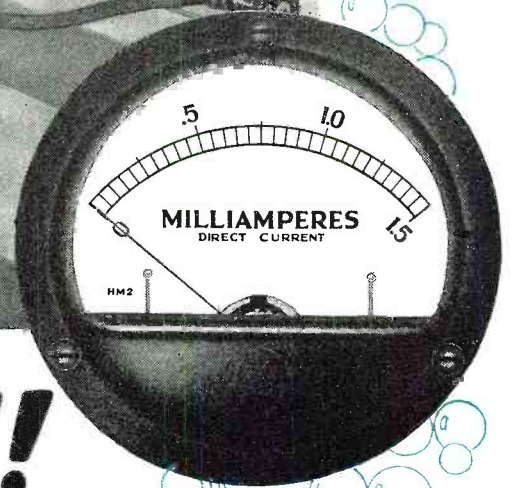

# NO TROUBLE!

**Production vacuum checking of Marion Glass-to-Metal Hermetically Sealed Electrical Indicating Instruments is no haphazard operation . . .** After sealing in our dehydrating rooms, the instruments are submerged in glass jars which are partially filled with alcohol. A vacuum of 25 inches is drawn in accordance with newest JAN-1-6 specifications. During the test we watch for air bubbles — no bubble means no trouble. Spot checks for a period of four hours are made in a 29 inch vacuum.

The testing apparatus, illustrated above, is a Marion development, and demonstrates our sincerity of purpose in producing hermetically sealed instruments. We take nothing for granted — we neither suppose nor assume. Because imperfectly sealed instruments entrap condensation, we make certain that every hermetic instrument bearing our name is — perfectly sealed.

## **Marion Glass-to-Metal Truly Hermetically Sealed 2½" and 3½" Electrical Indicating Instruments**

Write for our new, 12-page brochure. Manufacturers and users of radio and electronic equipment are invited to inquire into the advantages of Marion Glass-to-Metal Hermetically Sealed Instruments for postwar use.

 **MARION ELECTRICAL INSTRUMENT CO.**  
MANCHESTER, NEW HAMPSHIRE  
Jobber Sales Division: Electrical Instrument Distributing Co.  
458 BROADWAY NEW YORK, N. Y.

IF YOU WEIGH OVER 110 POUNDS, THE RED CROSS CAN USE A PINT OF YOUR BLOOD  
October, 1945

# JUST ONE

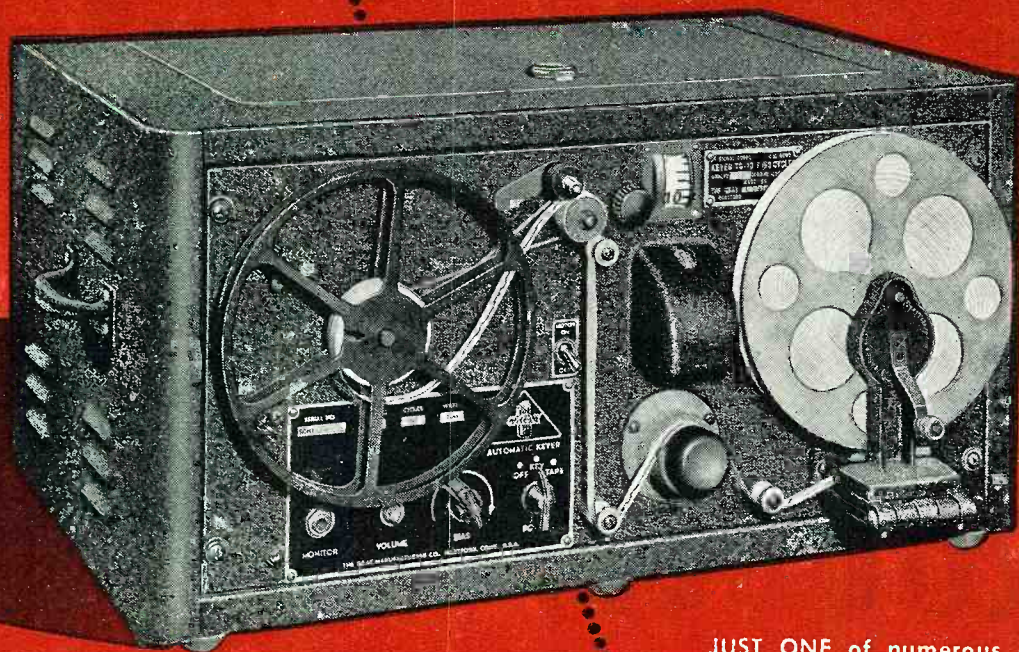

JUST ONE of numerous government radio and electronic items now available through the Hallicrafters Co., Chicago, agent for Reconstruction Finance Corporation.

This is a Keyer TG-10-F, an automatic unit for providing code practice signals from inked tape recordings. Excellent for group instruction, sufficient power to operate up to 300 pairs of head phones. Can be adapted as amplifier of 10 to 15 watts output for use with crystal mike or phono pick up. Completely checked and reconditioned by Hallicrafters engineers. Send coupon for further details and lists of other available items.

THESE VALUABLE ITEMS *Available Now*  
or very soon. Write, wire or phone for further information

- head phones • test equipment • component parts • marine transmitters and receivers • code practice equipment • sound detecting equipment • vehicular operation police and command sets • radio beacons and airborne landing equipment

## hallicrafters RADIO

HALLICRAFTERS CO., AGENT OF RFC UNDER CONTRACT SIA-3-24

WORLD'S LARGEST EXCLUSIVE MANUFACTURERS OF  
SHORT WAVE RADIO COMMUNICATIONS EQUIPMENT

**CLIP THIS COUPON NOW**

RFC DEPARTMENT 112, HALLICRAFTERS  
5025 West 65th Street • Chicago 38, Illinois

- Send further details and price on Keyer TG-10-F  
 Send listings of other available items

Especially interested in.....

NAME.....

ADDRESS.....

CITY.....ZONE.....

STATE.....

# I'LL SHOW YOU HOW TO SUCCEED IN RADIO

Here's the right training for Big Post-War Pay!



F. L. Sprayberry, one of the country's foremost Radio Teachers.

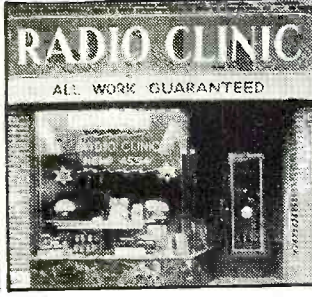

A RADIO SERVICE BUSINESS OF YOUR OWN

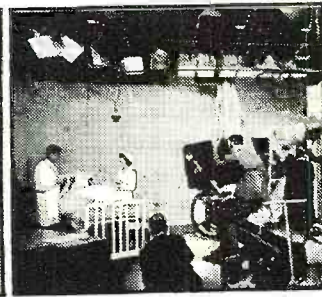

A GOOD JOB IN RADIO & TELEVISION BROADCASTING

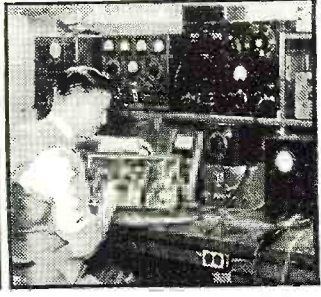

RADIO-ELECTRONIC SERVICE ENGINEER

# BE A RADIO ELECTRONICIAN

## NOW YOU CAN PREPARE AT HOME IN SPARE TIME FOR AMAZING OPPORTUNITIES AHEAD IN RADIO - ELECTRONICS - TELEVISION

The offer I make you here is the opportunity of a lifetime. It's your big chance to get ready for a wonderful future in the swiftly expanding field of Radio-Electronics INCLUDING Radio, Television, Frequency Modulation and Industrial Electronics. Be wise! NOW'S the time to start. Opportunities ahead are tremendous! No previous experience is necessary. The Sprayberry Course starts right at the beginning of Radio. You can't get lost. It gets the various subjects across in such a clear, simple way that you understand and remember. And, you can master my entire course in your

spare time. It will not interfere in any way with your present duties. Along with your Training, you will receive my famous **BUSINESS BUILDERS** which will show you how to make some nice profits while learning.

### Prepares You for a Business of Your Own or Good Radio Job

My training will give you the broad, fundamental principles so necessary as a background, no matter which branch of Radio you wish to specialize in. I make it easy for you to learn Radio Set Repair and Installation Work. I teach you how to install and repair Electronic Equipment. In fact, you'll be a fully qualified **RADIO-ELECTRONICIAN**, equipped with the skill and knowledge to perform efficiently and to make a wonderful success of yourself.



## SPRAYBERRY TRAINING GIVES YOU BOTH TECHNICAL KNOWLEDGE—SKILLED HANDS

There's only one right way to learn Radio Electronics. You must get it through simplified lesson study combined with actual "shop" practice under the personal guidance of a qualified Radio Teacher. It's exactly this way that Sprayberry trains you... supplying real Radio parts for learn-by-doing experience right at home. Thus, you learn faster, your understanding is clear-cut, you acquire the practical "know how" essential to a good-paying Radio job or a Radio business of your own.

### I'll Show You a New, Fast Way to Test Radio Sets Without Mfg. Equipment

The very same Radio Parts I supply with your Course for gaining pre-experience in Radio Repair work may be adapted through an exclusive Sprayberry wiring procedure to serve for complete, fast, accurate Radio Receiver trouble-shooting. Thus, under Sprayberry methods, you do not have one cent of outlay for manufactured Test Equipment which is not only expensive but scarce.

### Read What Graduate Says "One Job Nets About \$26.00"

"Since last week I fixed 7 radios, all good-paying jobs and right now I am working on an amplifier system. This job alone will net me about \$26.00. As long as my work keeps coming in this way, I have only one word to say and that is, 'Thanks to my Sprayberry training' and I am not afraid to boast about it."—ADRIEN BENJAMIN, North Grosvenordale, Conn.

### DON'T PUT IT OFF!

Get the facts about my training—now! Take the first important step toward the money-making future of your dreams. All features are fully explained in my big, illustrated FREE Catalog which comes to you along with another valuable FREE book you'll be glad to own. Mail Coupon AT ONCE!

## JUST OUT! FREE!

"How to Read Radio Diagrams and Symbols"  
... a valuable new book which explains in simple English how to read and understand any Radio Set Diagram. Provides the quick key to analyzing any Radio circuit. Includes translations of all Radio symbols. Send for this FREE book now, and along with it I will send you another big FREE book describing my Radio-Electronic training.

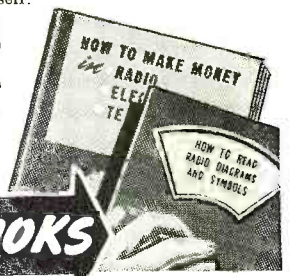

## GET FREE BOOKS

SPRAYBERRY ACADEMY OF RADIO  
F. L. Sprayberry, Pres.  
Room 25105  
Pueblo, Colorado

Please rush my FREE copies of "HOW TO MAKE MONEY IN RADIO, ELECTRONICS and TELEVISION," and "HOW TO READ RADIO DIAGRAMS and SYMBOLS."

Name ..... Age .....

Address .....

City ..... State .....

Tear off this coupon, mail in envelope or paste on penny postcard.

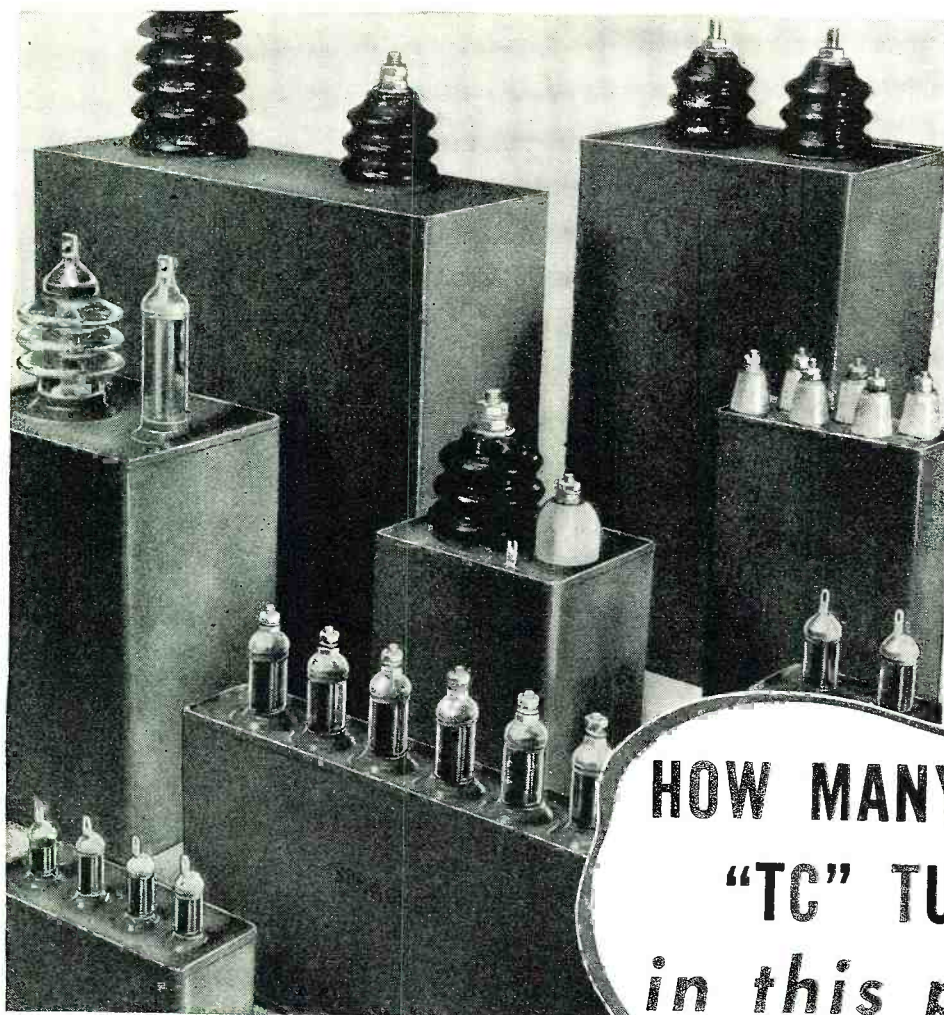

**HOW MANY SPRAGUE  
"TC" TUBULARS  
in this picture?**

**T**HESSE big energy storage capacitors are recent Sprague Electric Co. types developed for flash-photography, high-voltage networks, welding and other exacting wartime uses.

Consider thousands upon thousands of these giants in terms of the vast quantities of "TC" Tubular Capacitors and other service types that could have been made with the same investment of time and materials, and the Sprague wartime record looms even more impressive.

Every replacement type that has occasionally been missing from jobbers' stocks has been

more than accounted for by the FIVE separate Army-Navy "E" citations that Sprague has achieved. Moreover, a constant and steadily increasing supply of Sprague Atoms and "TC" Tubulars still makes it possible to match 9 out of 10 replacement requirements "on the nose!"

*As always — as long as the need exists — see Sprague TRADING POST on Page 93.*

**Sprague Products Company**  
North Adams, Mass.

*(Jobbing Sales Organization for Products of the Sprague Electric Co.)*

# SPRAGUE



**"NOT A FAILURE  
IN A MILLION!"**

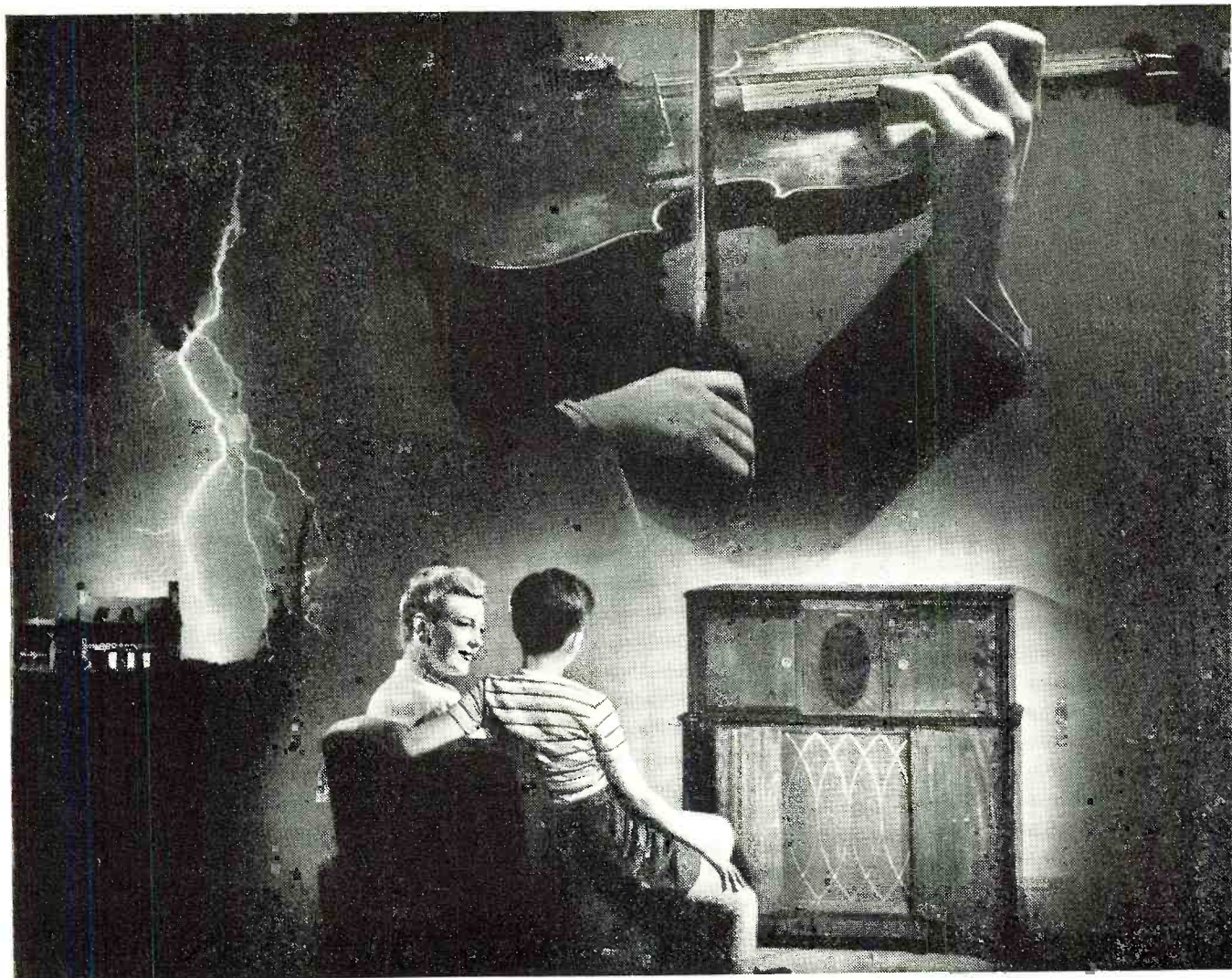

RCA Super-FM "soundproofs the air"... eliminates static and other interferences.

## ***RCA Super-FM...storms can be seen but not heard***

With RCA Super-FM radio, the most violent thunderstorm becomes a "polite little shower." It can be seen, but never interrupts broadcast reception.

The first time you hear Super-FM (Frequency Modulation) you'll hardly believe your ears! For all static, interference and other extraneous noises are miraculously eliminated.

During a thunderstorm you can listen to a delicate violin sonata—and think you're right in the broadcasting studio! Voices have a natural "in the same room with you" quality. You will agree that never before have your favorite symphonies, operas and popular tunes sounded so colorful, so pure, so full-ranged and so distinct on the radio!

Super-FM is another "modern miracle" developed by an RCA engineer. You'll owe it to yourself to hear RCA Super-FM before you buy.

The same kind of "let's do it better" research that perfected Super-FM goes into all RCA radio products. And when you buy an RCA Super-FM radio, or television set, or Victrola—made exclusively by RCA Victor—you will enjoy a unique pride of ownership in knowing that you possess one of the finest instruments of its kind that science has achieved.



George L. Beers, Assistant Director of Engineering for the RCA Victor Division, listens to the RCA Super-FM that he developed. Super-FM provides greater ease in tuning and a higher degree of selectivity as well as freedom from noise and interference.

## ***RADIO CORPORATION of AMERICA***

RCA BUILDING, RADIO CITY, NEW YORK 20



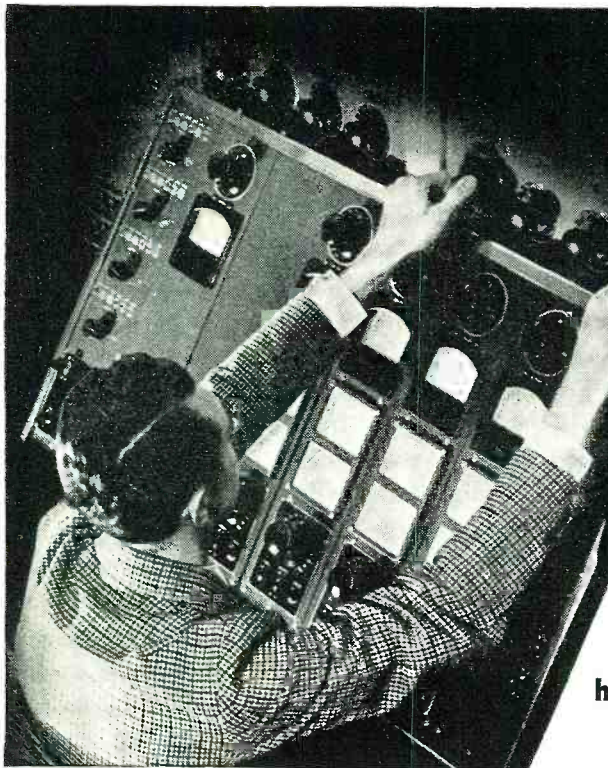

# Get Ready for POSTWAR RADIO ELECTRONICS AND TELEVISION NOW!

Great strides of progress have been made during the war. New equipment, methods, uses have been developed. Keep in the lead yourself with modern

## SHOP METHOD HOME TRAINING BY A GREAT ESTABLISHED RESIDENT SCHOOL



NATIONAL SCHOOLS HAS BEEN BRINGING OPPORTUNITY TO AMBITIOUS MEN FOR MORE THAN A THIRD OF A CENTURY. Above and to the right are two departments in this great school where modern developments are analyzed to provide National students with first-hand knowledge of short cuts and trade secrets. For full details fill out the coupon.

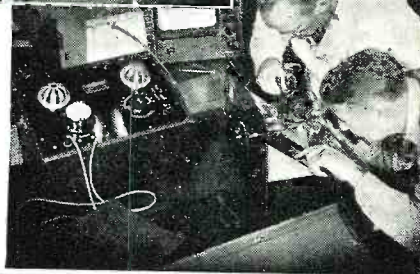

Take your place in the forefront of Radio, Television and Electronic progress. Get your share of the NEW business. War inventions and improvements—walkie-talkies, radar, aircraft control and communications—will quickly be adapted to civilian use. F.M. is winning almost universal acceptance and use.

Everywhere you turn new and important changes in the field of Radio are being put into operation every day. Television is rapidly being perfected. Electronics is being applied to industry and better living. The successful technician MUST KEEP UP WITH PROGRESS if he is going to be sure of his job—GET AHEAD IN BUSINESS.

National Schools presents a Radio and Electronic training system geared to the rapid advancement of the industry itself. Here is an exclusive home training system based on the shop methods as practiced in one of the World's foremost vocational education centers—the actual shops and experimental laboratories of this National institution. Send the coupon on the next page for complete details. Only National can bring you this type of training for only National has the shops, equipment and experimental laboratories for the development and extension of the system.

## Use This Modern Electronic Laboratory

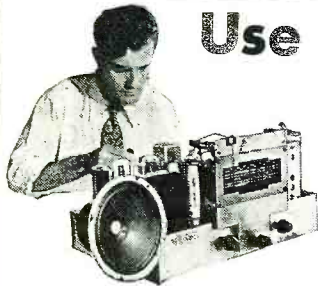

The very essence of National Shop Method Home Training is EXPERIENCE. You get to know Radio and Television circuits by building them yourself. You get

first-hand knowledge of how instruments work by a sound analysis and construction system.

You build a beautifully toned, high fidelity, long distance modern superheterodyne re-

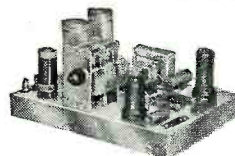
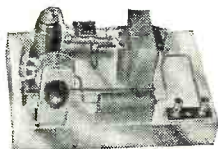

ceiver from the parts furnished with your course. In this way you have a thorough understanding of the superheterodyne principle.

You learn modulation, beat frequency and

signal generation by building yourself a small, operating radio transmitter with National parts. You get to know and understand the process of creating



audible signals by electronic means by conducting experiments with a National Audio Oscillator.

You conduct cathode ray experiments to gain a first-hand knowledge of the operation, repair and maintenance of Television equipment. Hundreds of experiments may be performed to gain first-hand experience with your National laboratory equipment.

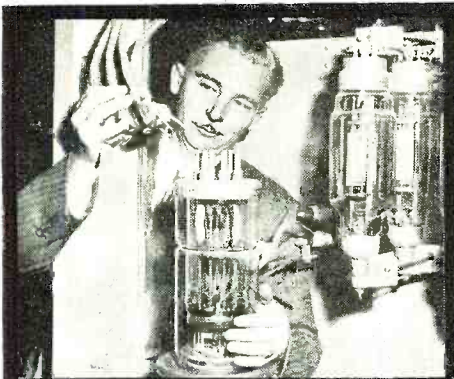

## New Fields

Electronics is already a most important factor in industry. Many manufacturing processes depend on electronic controls—employ electronic processes. In medicine and agriculture too, electronics is being used extensively. Are you ready to cash in on this development in a field that is so close to radio?

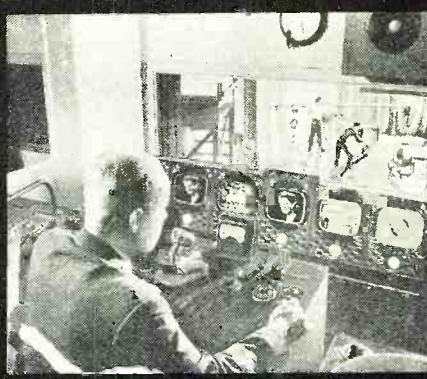

## New Equipment

Every day you learn of new types of radios and improved television—new electronic devices. Fac-simile, F.M., Radar, Sonar—all present new problems of manufacture, operation and maintenance that demand training and experience. Consider your advantages if you have the necessary preparation to tackle this work.

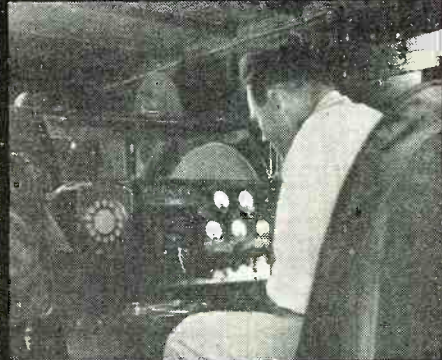

## New Hook-Ups

The relatively simple wiring of the radio receiver of a few years ago is as out-of-date today as one of the first automobiles. The new Radio and Television sets, and Electronic devices demand a thorough knowledge of new principles. National brings its students the results of continuous research and improved methods.

# NEW OPPORTUNITIES

Think what all this great progress in Radio, Electronic power and control and Television means to YOU PERSONALLY—you who are already in Radio or have a natural inclination toward it. The greatest opportunity of a lifetime is right within your grasp.

Compare the job you now have or expect to get when you are out of service or your present war job with the great future presented you by the broad field of Electronics.

Literally tens-of-thousands of technicians are needed in Radio and Television stations and communications companies all over the country—to operate, maintain and repair equipment. The man who **knows modern methods and equipment** is welcome almost at his own price.

Latest figures show that Radio represents a **5-billion dollar industry** and, in the opinion of experts, it is a **secure, well established, basic** type of business offering **steady employment**. Television, according to authorities, offers **half a million openings** right at the start. The man trained

in modern Electronics **CAN CHOOSE THE KIND OF INDUSTRY HE WANTS—THE PART OF THE COUNTRY HE PREFERENCES AND THE KIND OF POSITION MOST SUITABLE.**

### You Want Action

With this amazing speed-up training you can progress just as quickly as you wish—start taking advantage of your new found knowledge and experience in a very short time. Send the coupon below and learn the facts about this great educational development. Try out the **FREE SAMPLE LESSON** and see for yourself what you can accomplish so quickly and easily with the remarkable **SHOP METHOD HOME TRAINING.**

In a few months—perhaps only weeks—you may start making good money; maybe accept a **BIG PAY JOB** in industry—**GET INTO A PROFITABLE, LIFETIME BUSINESS OF YOUR OWN**, with little or no capital investment.

Take the first step now. Fill out and mail the coupon below.

# FREE LESSON

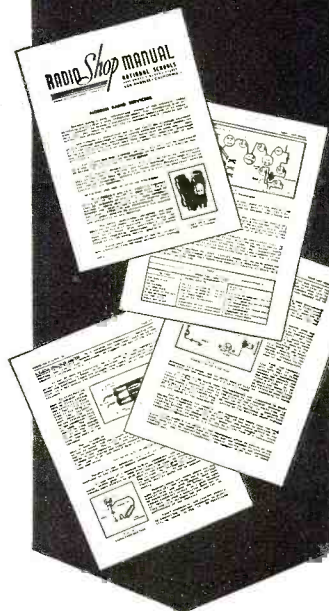

## Get this BOOK

Here is an interesting forecast of the future of Radio and the opportunities present for you in this, and allied fields right now. It is profusely illustrated and describes the jobs waiting for trained men everywhere. Send the coupon below for your copy.



## NATIONAL SCHOOLS

LOS ANGELES 37, CALIFORNIA EST. 1905

### MAIL OPPORTUNITY COUPON FOR QUICK ACTION

National Schools, Dept. 10-RN  
4000 South Figueroa Street, Los Angeles 17, California

(Mail in envelope or paste on penny post card)

Mail me FREE the two books mentioned in your ad including a sample lesson of your course. I understand no salesman will call on me.

NAME ..... AGE .....

ADDRESS .....

CITY ..... STATE .....

Include your zone number

## Here Are Some Samples of Success in Radio by National Graduates

National Shop Method Home Training wins good jobs, independence and security quickly. Take the word of National men who have established records in their favorite Radio, Television, or other branches of Electronics:



Joseph Grumien, Lake Hiawatha, New Jersey writes: "My latest offer was \$5,800.00 as Radio Photo Engineer, but I'm doing well where I am now engaged. I am deeply indebted to National."

Here's a statement from R. R. Wright, Blackfoot, Idaho: "Due to my training at National I was selected to instruct in the laboratory work of Navy and Marines."



From O. K. Ivey, Washington, D. C., comes this endorsement: "I believe National offers the best course to be had. Keep up the good work."



Robert Adamson, Kearney, Nebraska, National graduate, has two radio jobs—makes double pay as a radio instructor and as engineer at Station KGPW. He writes: "I am proud of my National training and appreciate the cooperative spirit."

Read what hundreds of other enthusiastic students have written about National Training. Send in your coupon today.

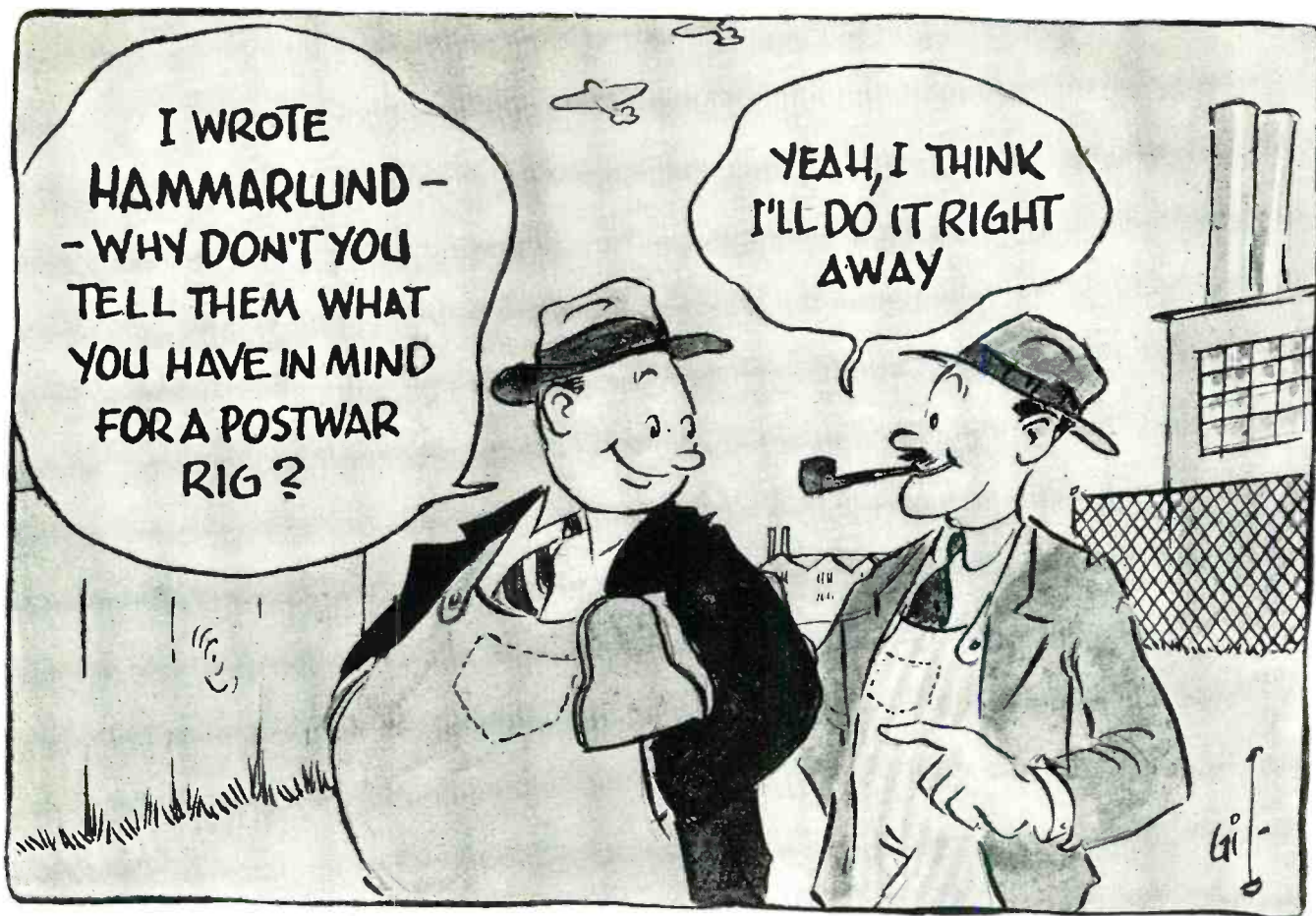

# WHAT DO YOU WANT?

YOU  
TELL  
US!

WRITE NOW! You've had four years to dream about a new transmitter or a new receiver. Tell us just what you think it should be and what it should do. We've had four additional years of engineering and research during which we have better equipped ourselves to bring you the finest in communications equipment.



ESTABLISHED 1910

Send your suggestions to "Postwar Development"  
DESK 12  
**HAMMARLUND**

THE HAMMARLUND MFG. CO., INC., 460 W. 34<sup>TH</sup> ST., N. Y. C.  
MANUFACTURERS OF PRECISION COMMUNICATIONS EQUIPMENT

RADIO NEWS



# Radar

*The Silent Weapon of World War 2*

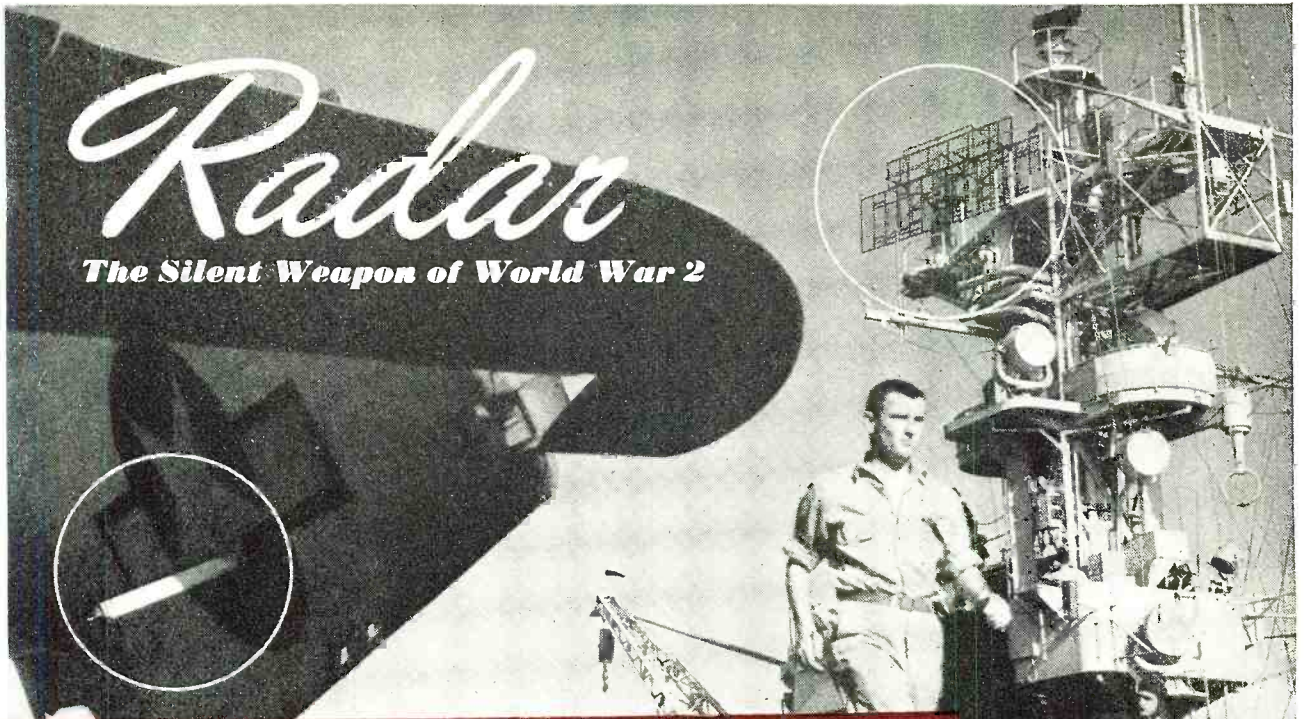

**A**N ELECTRONIC "eye" apparently developed independently by U.S., British, French, and German scientists in the 1930s, radar owes much of its rapid growth to the advent of war. First used in detection of surface objects in the near-distance under conditions of poor visibility, radar's range and versatility were quickly extended to provide long-range detection of air-borne, as well as surface objects, accuracy in fire-control, and identification of distant or unrecognizable planes and ships. To radar, the silent weapon of World War 2, goes much of the credit for England's doughty defense in the dark days of the "blitz", and also for "lighting the way" for our victories in the Pacific.

★ "Thinking cap" of the PT boats, the "radome" bulb, shown circled, houses the antenna of the radar set aboard the vessel. Invaluable to the hard-hitting PTs, because of their habitual tendency to operate under the cover of night, radar's electronic eye pierces the darkness, indicating the various targets and warning of immediate navigational dangers.

is in contrast to the small antenna on the wing of the General Motors Avenger torpedo-bomber shown in foreground. Close inspection of this plane installation will reveal the "teeth" of the antenna affixed to the terminal of the white strut. This installation is a Yagi-type antenna. The vessel is a Navy escort aircraft carrier, photographed while at sea.

★ Enlisted men in a radar unit listen to instruction during shakedown cruise of a Navy warship. Instructors are also enlisted men chosen for their aptitude and actual experience.

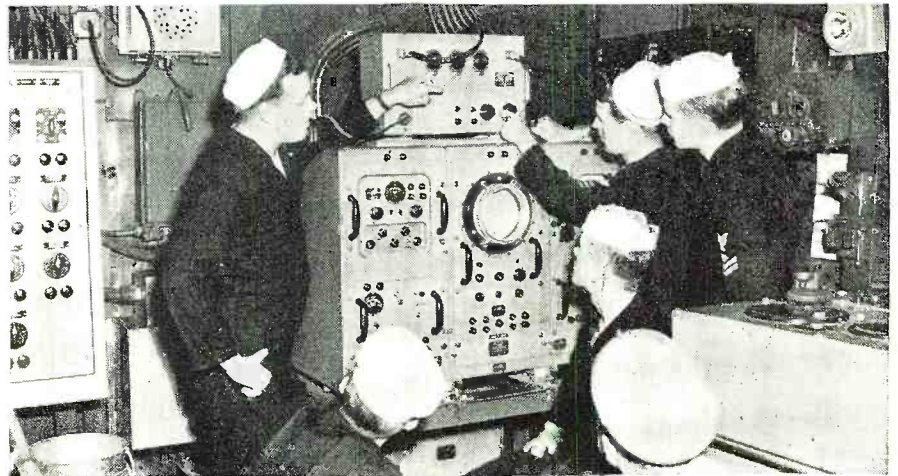

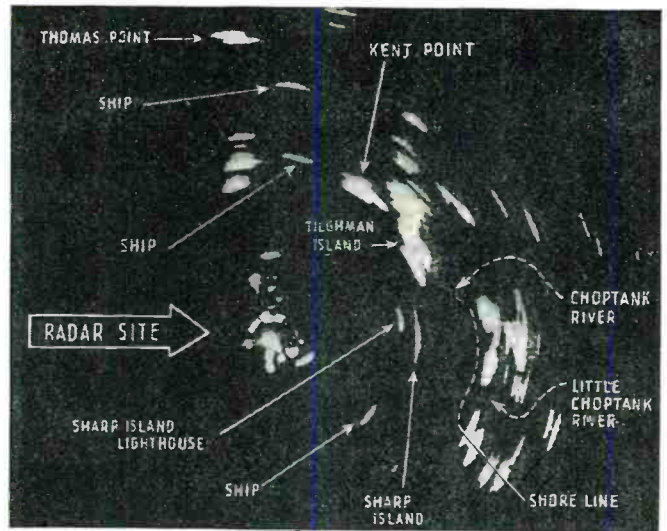
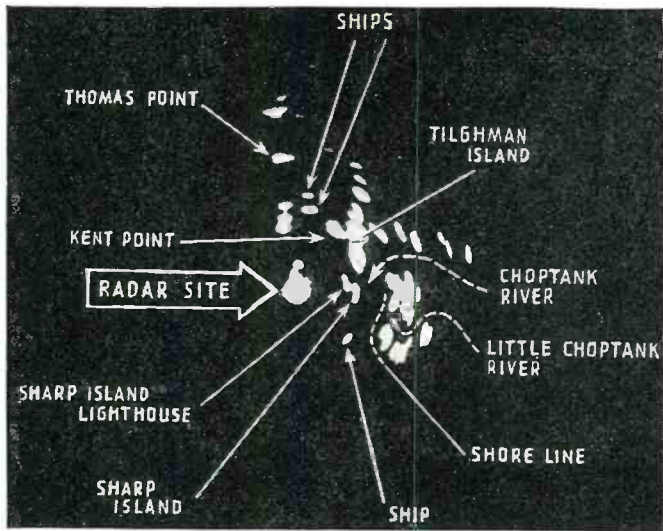

★ Radar equipment at the Naval Research Laboratory, Chesapeake Bay Annex, recently made this "search" of surrounding terrain. Lettered on the photographs of the PPI (Plan Position Indicator) scope are designations of points picked up by radar pulse. Compare the photograph (left) made with a considerably larger range with the photograph (right) made with a substantially lesser range, both of which represent scope of the same area. Notice how "pips" converge when the range is widened and diverge when the range is lessened.

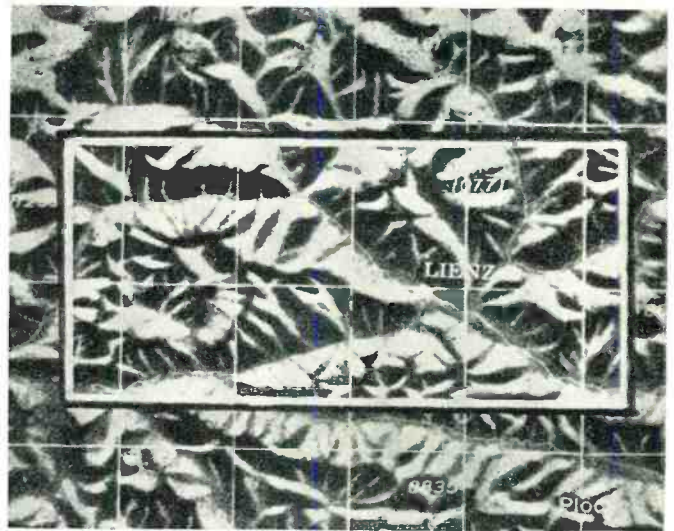
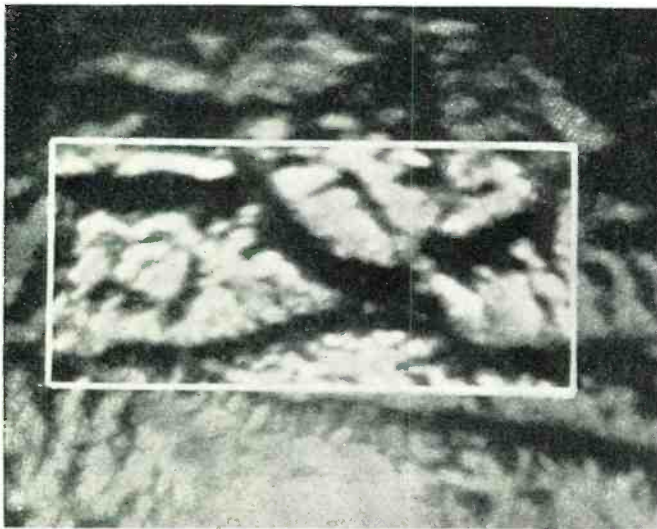

★ Radar takes a lot of the woe out of mountain flying. A navigator equipped with relief maps and scope pictures can determine his position without any trouble at any hour of the day or night, as the radar scope will show a pattern almost identical with his maps. Above photographs show scope picture (left) compared to same section on relief map (right).

★ Radar's directional characteristics are such that its results can be minimized by contour of terrain below. These two pictures of Innsbruck, Austria, illustrate what directional approach can do. Picture at left made on approach from south, shows city. Picture at right made on approach from north, spots general contour of valley, but fails to show the city proper.

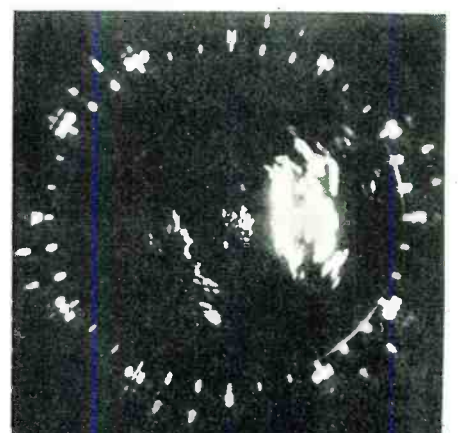
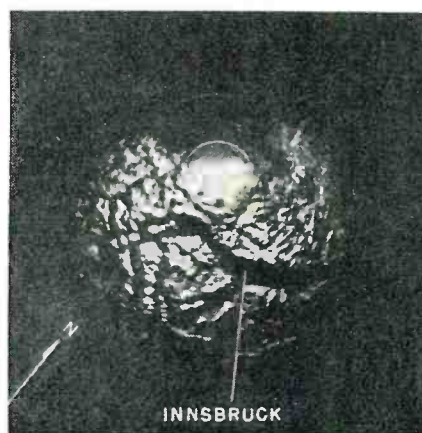
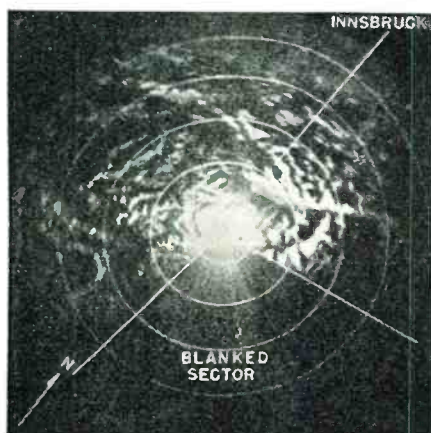

★ This photograph of a ship's PPI (Plan Position Indicator) scope was taken during the invasion of Lingayen on Luzon. The cluster of white dots shown in the photograph represents warships in the bombardment group; the large white mass, the coast, headlands, and highlands of the island; behind the attack flotilla, transports and the other ships composing the large invasion armada throw light pips on the radar scope.

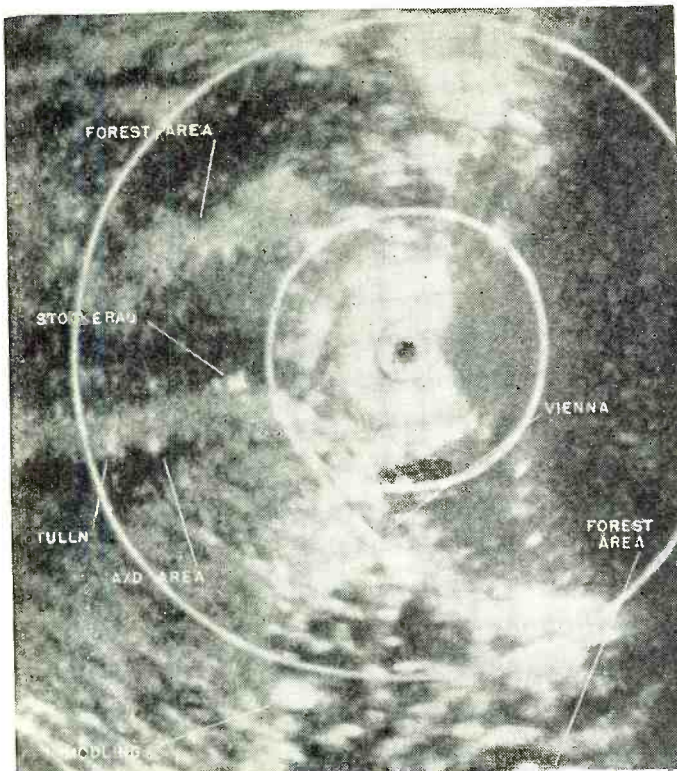

★ P-38 radar reconnaissance missions provide scope photographs for routes to and from the targets, as well as series of target runs, made from the cardinal points of the compass and from the logical axes of attack. The scope photographs made by reconnaissance planes are plotted on maps and reproduced for reference by Pathfinder operators during the actual bombing missions. In the photograph at left, forest areas around Vienna, Austria are resolved on scope in droopsnoot P-38. Returns are good enough to be used as check points in radar navigation. Map at right covers same area as shown on scope.

★ "Scope picture" of Oahu in the Hawaiian Islands made by a Navy plane on a radar test. Blob of light in center of the photograph marks the position of plane as shown on indicator of its radar; the island itself is the largest white area, with low points in the topography in black. The two "pips" between the inner and second circles are ships. →

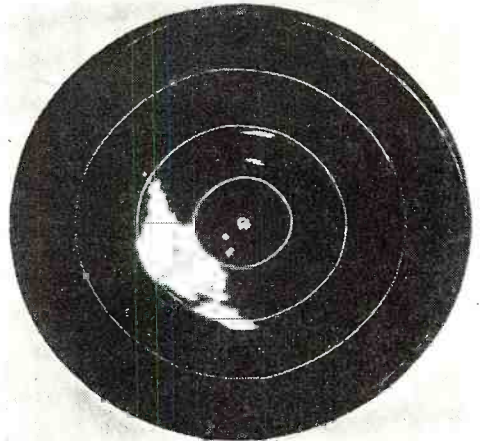

★ Radar repeater unit which repeats information from main SG type radar so operator in remote position may have indication exactly the same as main unit. Units of this type enable several positions to simultaneously monitor main radar unit, thus eliminating much delay in transmitting information to all locations at one time and affording multiple checks.

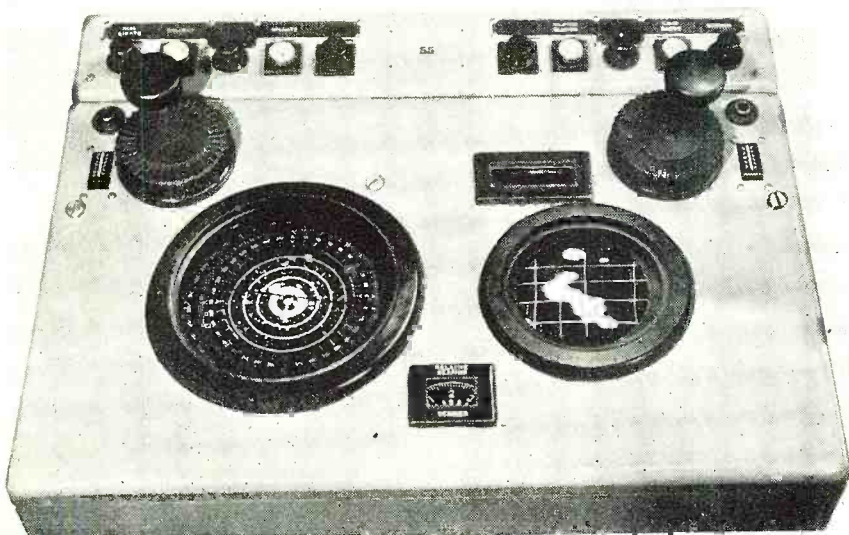

★ Radar photography experts consider this picture one of the best of its type. It was taken over the Munich area, with Munich proper shown as the light spot at the top.



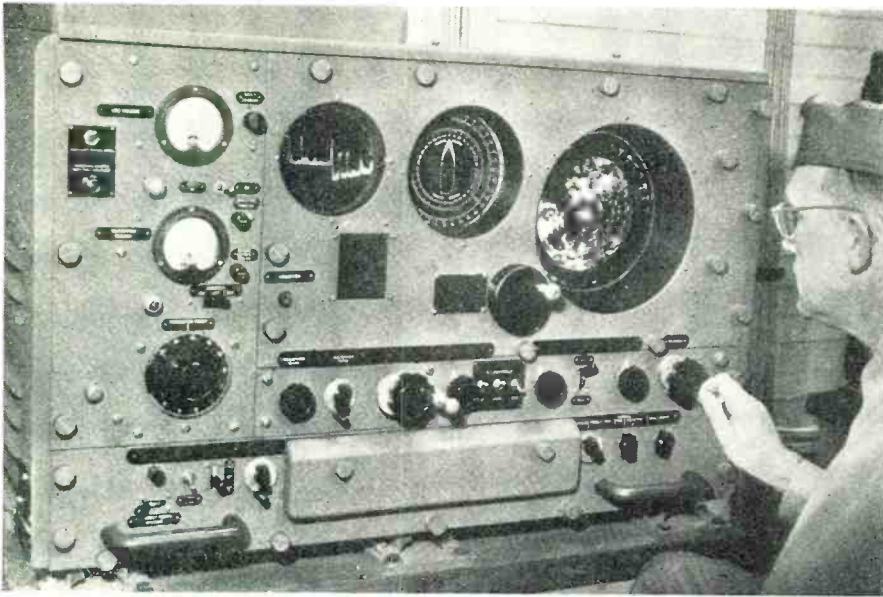

★ Operator using a type SG radar indicator to obtain the range and bearing of target. The relative bearing of operator's ship may be seen in center, just to the left of scope. Equipment of this nature is also used for plotting position of ship.



★ Closeup of a typical pattern as seen on an SG radar scope. A picture such as this affords the operator a complete picture of the territory in all directions from the ship, in spite of the fog or darkness, and may be quite readily compared with ordinary, conventional maps.

★ Study in black and white—radar training at a naval air station in U. S. Officers and men spend long hours, that will later pay dividends, studying intricacies of the "electronic eye" in simulated plot room.

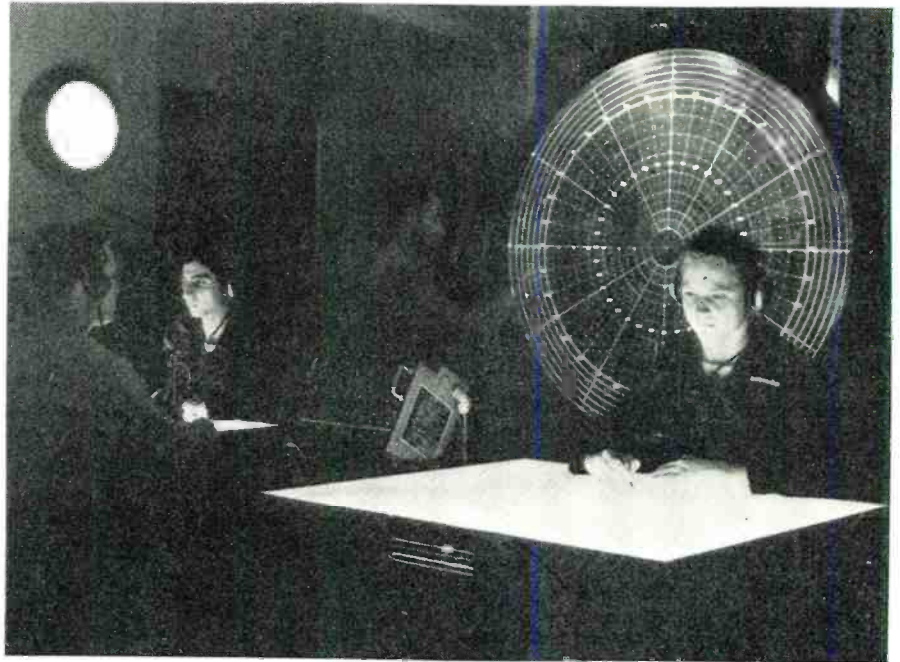

★ The slim and angular "elbows" of radar antennas are silhouetted atop folded wings of these Curtiss Helldivers spotted on flight deck of a Navy Essex-class carrier somewhere at sea. Adding this equipment to Navy planes gave the effect of applying telescopes to the "eyes of the Fleet," as aircraft are often known.

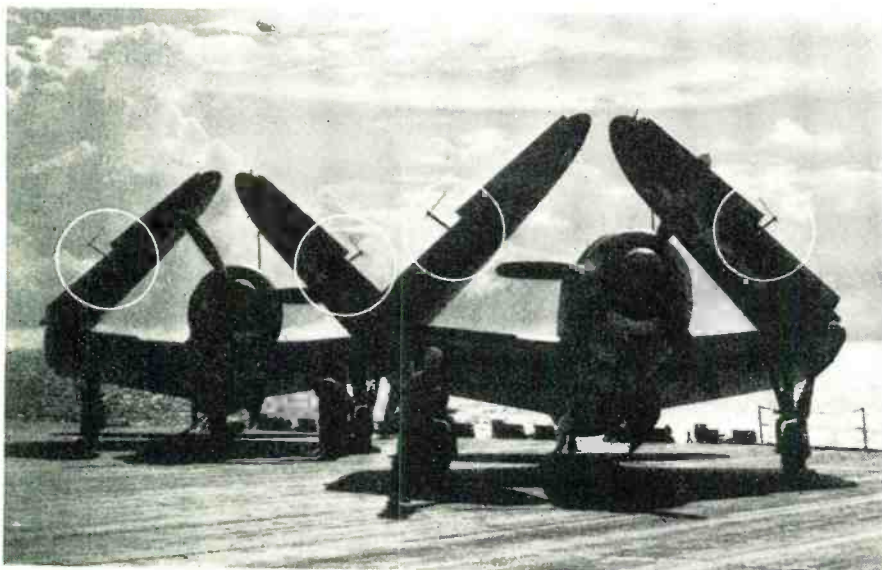

★ A typical parabolic antenna used with many types of radar equipment. By employing a parabolic antenna, very high gain and a highly directional beam are obtained.

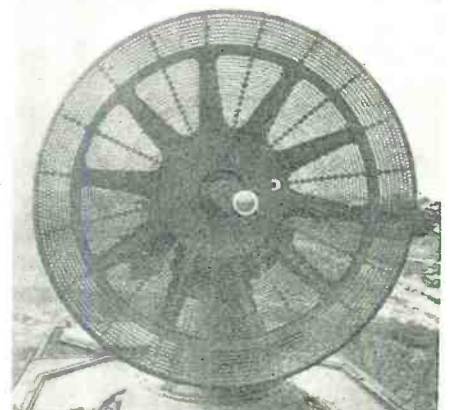

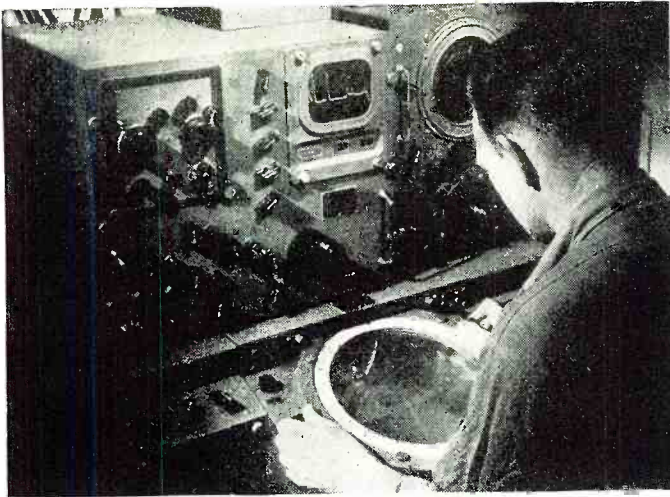

★ Through the electronic eye of radar, a Navy man determines distance and bearing of his "target" during experiments at the Naval Air Station, Anacostia, D. C. The indicator bearing the graph-like line in the center of the equipment is an A-scope; the large disc into which he is peering is a PPI scope—Plan Position Indicator.

★ Radar equipped P-38 "Lightning" reconnaissance plane, its "droop snoot" nose crammed with special electronic devices, readies for a take-off. Trips like these precede visits of giant bombers against enemy industrial targets. Intensive preliminary planning characterizes reconnaissance trips of this nature since the plane carries no armament and is under orders to avoid combat. Pilot and radar operator agree on final details of flight plan which will be followed.

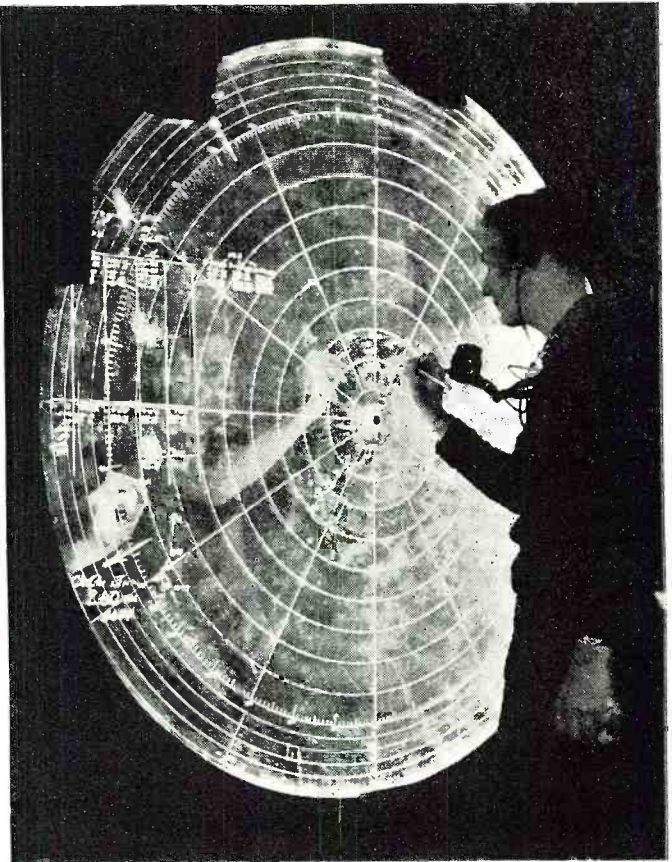

★ Information provided by radar's electronic eye is marked down on a vertical chart in the radar plot room of an Essex-class carrier during strikes against the Japs early in 1945. Behind the transparent expanse of the giant circle, other enlisted men can be seen working on various additional aspects of the incoming flow of information.

★ Pioneer workers in radar, Dr. A. Hoyt Taylor (right), Chief Consultant and Chief Coordinator of Electronics at Naval Research Laboratory, Anacostia, D. C., and his long-time associate, Leo C. Young, reminisce over the "scope" of radar's history beside the first radar set at the Research Laboratory. Few men know the history better. In 1922, while experimenting with communications equipment for the Navy, they made the initial discovery of distortion in radio reception caused by the intrusion of objects between transmitter and receiver. Working from this discovery, the two men and a number of associates and assistants made giant strides forward into the vast sphere of scientific fields covered by the word "radar" today. The equipment in the background, crude and elementary in comparison with the sets of today, was a breathtaking innovation when first used in 1937.



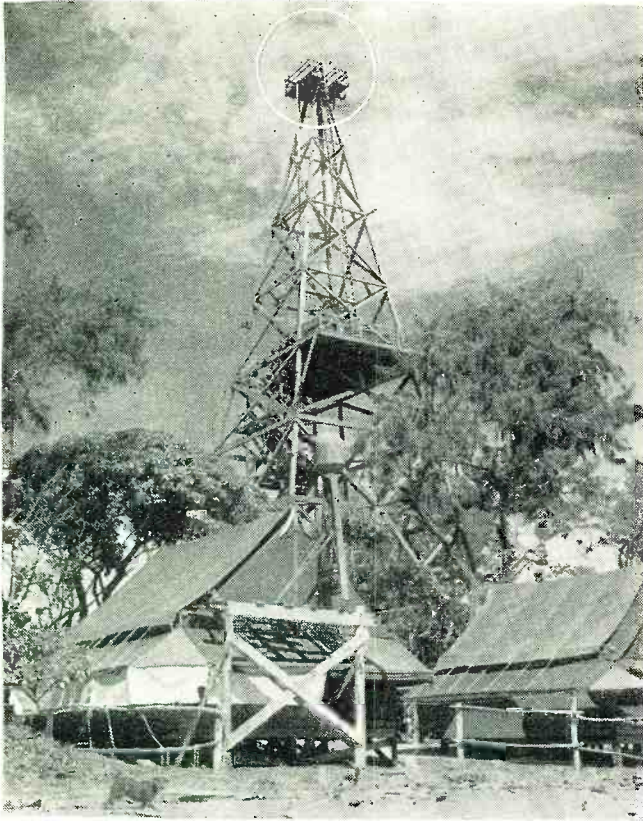

★ Instruction and improvements in radar are constant necessities in the Navy. At this station on Espiritu Santo, two types of radar antennas can be seen—one housed in a radome near the ground, the other installed on a towering "mast." By their use, Navy men on duty instruct or get instruction on latest in radar operations.

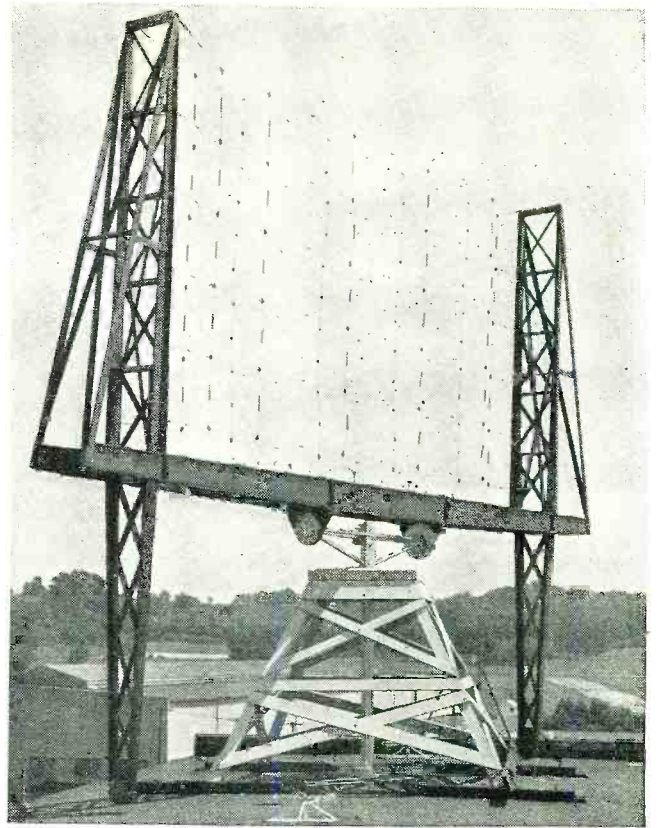

★ Close-up of the antenna of the first complete radar, installed "topside" of a building at Naval Research Laboratory in Anacostia, D.C. in the late 1930s. It is a "dirigible" antenna, meaning it is so mounted that it can be turned to allow for around the compass search. See photograph lower right for below-decks equipment.



★ Photograph of the first radar installation on a ship. Shown in the upper right-hand corner is a Yagi-type antenna mounted to a five-inch gun on the old USS Leary in 1937. The antenna was swung about by moving the gun. The photograph was taken during epochal tests in Chesapeake Bay, when equipment marked a monumental milestone in radar's history.

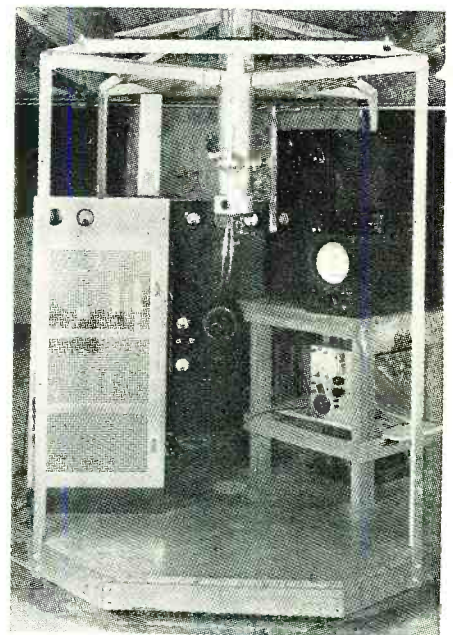
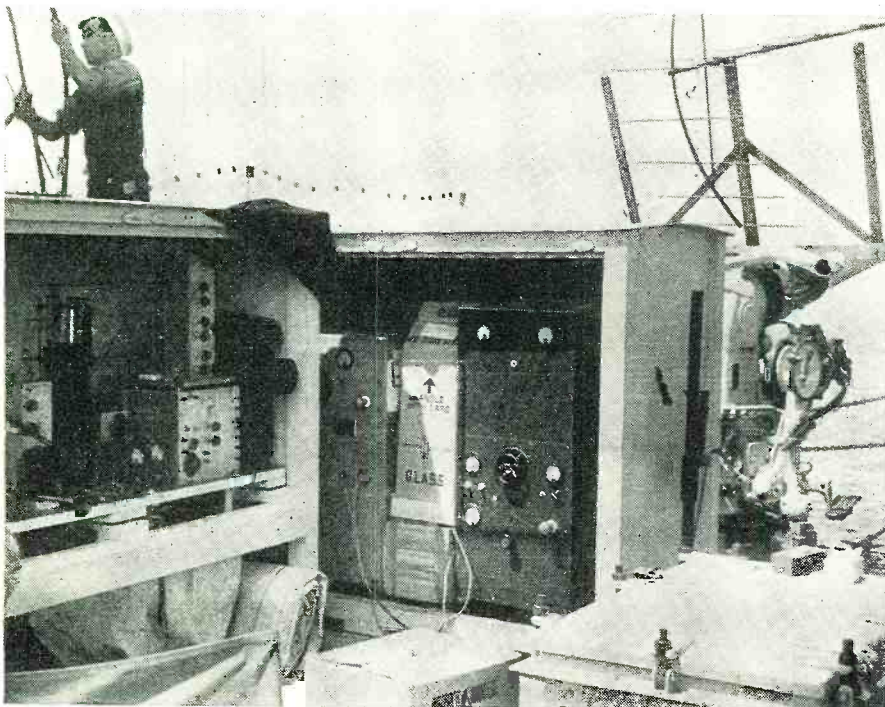

★ Below-decks view of the first complete radar set. The "dirigible" mast in the very center of the photograph pierces the ceiling and its upper extension bears the mattress antenna of the radar. Thus the operator below can turn the mast to cover the compass while making a search. The antenna can also be tilted, with the handle visible on the side of the mast. This equipment was so heavy, compared to present sets, that in order to tilt and turn it, two men had to do the job.

# New Type SIGNAL TRACER

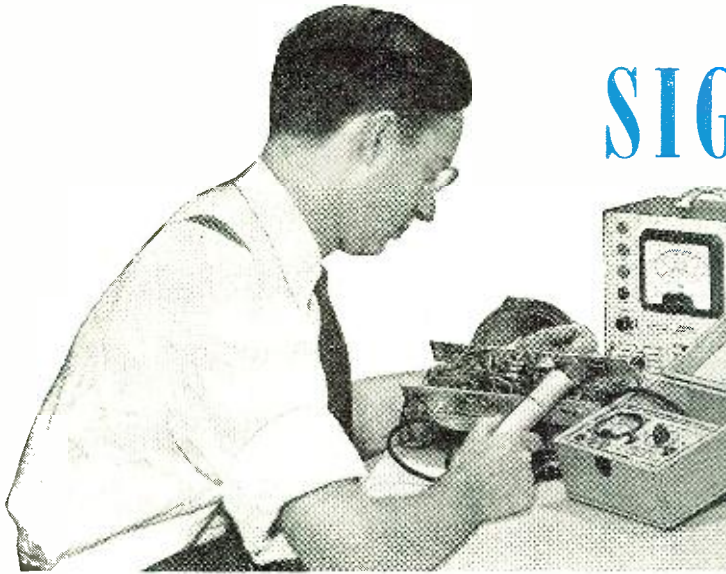

Serviceman employing the CA-11 signal tracer to check receiver.

By **SHEPARD S. LITT, 2LCC**  
Superior Instruments Co.

**Design of a highly sensitive and portable signal tracer. Simplicity of operation makes this tester ideal for home receiver repair—an important factor to servicemen.**

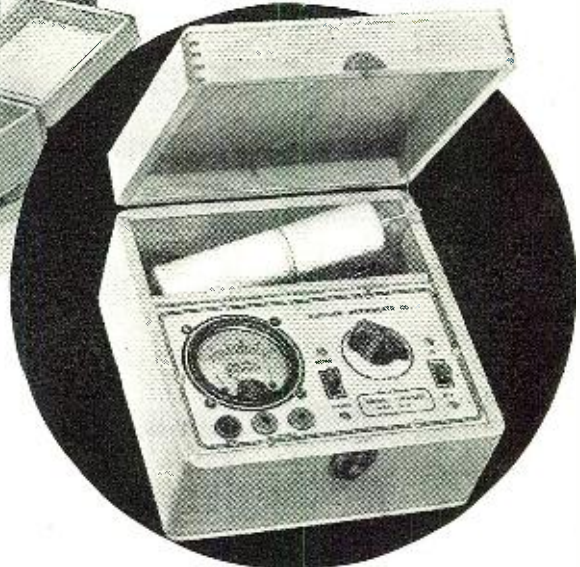

Commercially constructed unit.

**I**N THE design of an efficient signal tracer, several points must be borne in mind. It must be sensitive, small, portable if possible, and not load or detune a circuit. In the past, signal tracers consisted of diode-vacuum tube voltmeter combinations with additional amplifiers (often tuned for radio frequencies) that were quite efficient, but bulky. It would take almost as long to set up one of these signal tracers with its maze of special cables as it did to find the trouble in a receiver. Because of the tuned amplifiers, these signal tracers would also require tuning. While a tuned amplifier is very efficient, a slight shift in signal frequency would mean retuning and sometimes actually losing the signal. For these reasons, signal tracers never did enjoy the amount of popularity that they should have.

Most of the objections to the older type signal tracer are eliminated by the new model CA-11 signal tracer manufactured by the *Superior Instruments Co.* and described herein. No tuned circuits are used and there is only one connecting cable.

The circuit used is a 1T4 tube in a grid-leak vacuum tube voltmeter circuit, with provisions for insertion of phones.

The detector probe is composed of the 1T4 tube connected as a triode (screen grid and plate tied together)

and a .0003  $\mu$ fd. condenser and 20 megohm resistor. Both the .0003  $\mu$ fd. condenser and 20 megohm resistor serve a dual purpose. D.c. is prevented from being applied to the grid of the 1T4 tube by the capacitor, which acts as a blocking condenser, while the resistor acts as a grid return and bias resistor. The condenser-resistor combination also operates to attenuate the lower frequencies, those below approximately 300 cycles. This cut-off frequency was chosen for several reasons.

Should a large 60 cycle or 120 cycle

hum be superimposed on the signal, the low hum frequency would not mask the higher signal frequency. 400 cycles is also the usual modulating frequency of signal generators and it was, therefore, thought advisable to have the vacuum tube voltmeter pass this frequency. The graph (Fig. 3) shows the exact voltage required for full-scale deflection of the v.t.v.m. for the audio spectrum. It should be noted that the meter is not calibrated for voltage, but rather in relative signal value. V.t.v.m. sensi-

(Continued on page 132)

Fig. 1. Schematic diagram of the single-tube signal tracer. The unit is constructed in two separate parts, a detector probe and the battery and meter box.

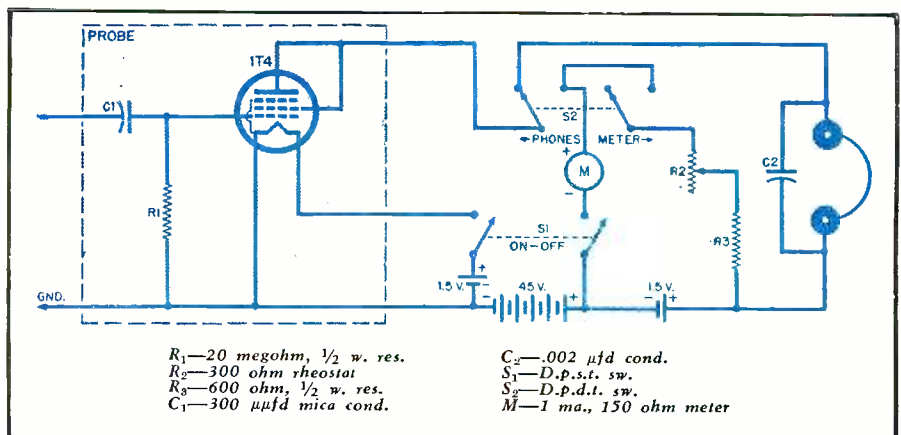

# The OSCILLOSCOPE Applied to Transmitter Checking

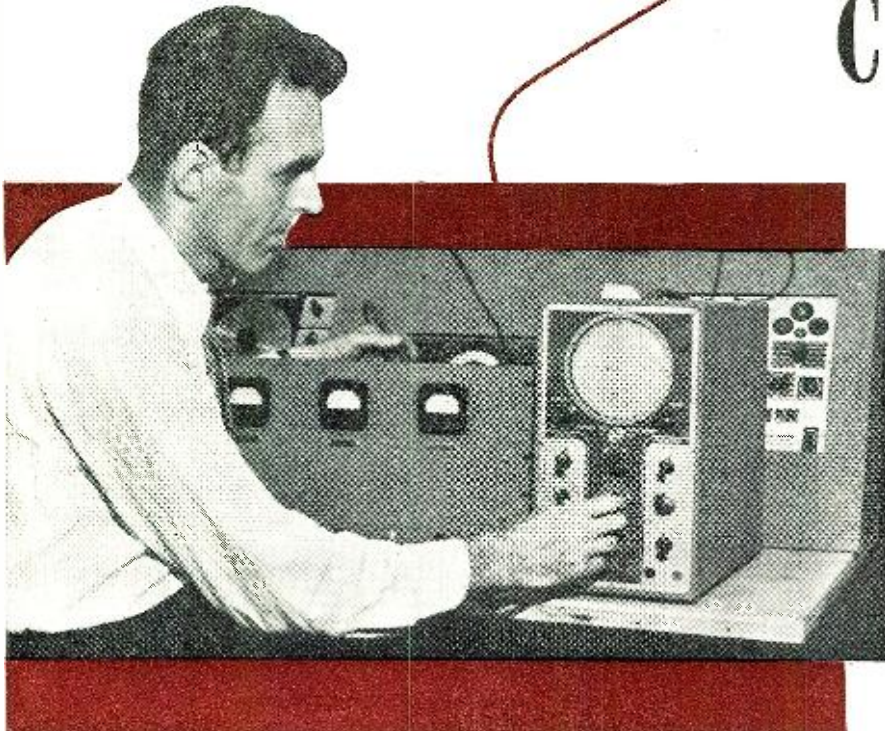

Radio technician applying the oscilloscope in checking transmitter.

*With permission to return to the air, amateurs should recheck their transmitting equipment. The oscilloscope is an ideal instrument for this purpose. Follow the procedure outlined herein*

By

**MORRIS EDDY**

and

**ARTHUR HOWARD**

IN A previous article, appearing in the September, 1944 issue of *RADIO NEWS*, we discussed the application of the oscilloscope to radio servicing. In this article, we will endeavor to demonstrate how the oscilloscope is used to check the operation of the transmitter.

The cathode-ray oscilloscope is the most valuable of all instruments in determining transmitter performance. It provides an instantaneous picture of what is actually happening inside the transmitter—thus, enabling the operator to determine the source of any possible defect in the apparatus. This versatile instrument is particularly suitable for r.f. or a.f. measurements, because it draws little or no power from the source. Where high

Fig. 1. When applying the oscilloscope to determine resonance of the tube circuit, the 'scope is loosely coupled as shown.

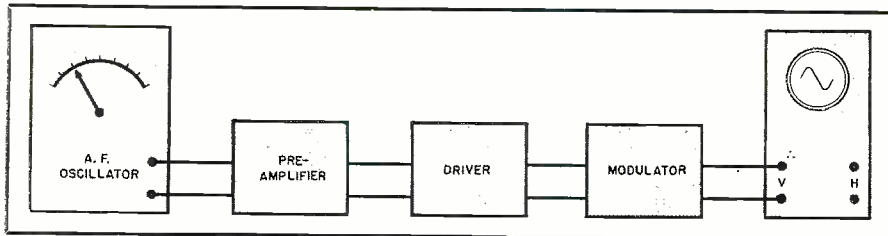
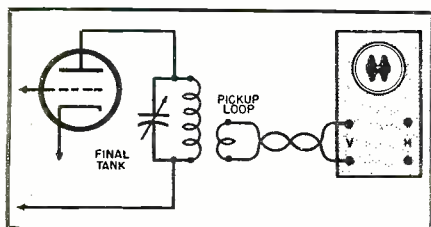

Fig. 2. Any defects in the speech-amplifier equipment can be easily checked by employing, along with the oscilloscope, an audio frequency oscillator, connected as shown

speed analysis of performance is required, such as on the assembly line, the merits of the oscilloscope are once again realized.

The following are some of the uses to which the oscilloscope can be put for determining the operation and securing maximum results from your transmitter.

Since it is possible for one to observe r.f. with an oscilloscope, it can thus be readily used as a resonance indicator. Should plate current meters be included in the transmitter, the use of the oscilloscope is not necessary. If meters are not included, the oscilloscope can be used as a temporary expedient.

To use it as an indicator for determining resonance, connect a coil of one or more turns of wire to the verti-

cal axis of the 'scope by means of a twisted pair line. Any sweep frequency can be utilized. Place the coil near the tank circuit of the stage being tested and a band should appear on the screen of the 'scope. The width of this band can be regulated by the number of turns of the coil and its distance from the tank. The load of the stage, such as the link coupling, grid coil of the next stage, or the antenna tuner is left on the resonant stage being tested, so that actual working conditions are observed. Your next step consists of rotating the tank condenser slowly, until maximum bandwidth is observed on the oscilloscope. When this condition is reached, the stage is at its desired resonance. Fig. 1 shows the necessary hookup.

In the above manner, all stages of



the transmitter can be aligned and faults existing in a stage of a transmitter can be traced to that particular stage.

### Neutralization Indicator

Because of the property of the oscilloscope of not drawing any appreciable power from a circuit, it makes a fairly sensitive neutralization indicator. In cases of emergency, it can be substituted for the regular indicating device.

To determine whether or not a stage is properly neutralized, turn on the filament of the chosen stage and apply excitation from the previous r.f. amplifier to its grid circuit. Be certain that the plate voltage is turned off. Use the same coil and twisted wire line as shown in Fig. 1. Hold this coil near the plate tank coil of the stage under test. Next, tune the condenser through resonance and, at resonance, no r.f. waves should appear on the screen, provided the stage is properly neutralized. If r.f. is present, adjust the neutralizing condenser with an insulated screwdriver until there is no r.f. remaining on the screen of the scope.

In push-pull circuits, both neutralizing condensers are adjusted simultaneously, i.e., step by step, until there is no r.f. present.

### Checking Modulation Equipment

Any defects in the speech amplifier equipment can be determined with the use of the oscilloscope. Faults indiscernible to the human ear are made apparent with this instrument.

First, connect an audio oscillator to the input of the speech amplifier equipment in place of the microphone. Take the output off the final stage of the modulator. Next, synchronize the sweep oscillator of the scope with the audio frequency. Refer to Fig. 2 for the diagram.

By comparing the original waveform of the a.f. oscillator with that of the output of the final stage, you can determine the quality of your modulating equipment. If distortion is present, it can be traced down to the individual stage causing this condition.

To localize the distortion to the stage causing it, proceed as follows:

Connect an a.f. oscillator to the input terminals of the speech amplifier. Then, connect the oscilloscope successively to the output stage of each of the tubes in the amplifier, starting with the preamplifier stage, and working toward the output stage.

As we proceed in this manner, the gain of the amplifier will increase. To compensate for this, decrease the amplifier gain control of the oscilloscope. This is necessary in order to prevent overloading the oscilloscope. Once the faulty stage is located, it should be serviced accordingly.

Another trouble frequently encountered by the operator is phase distortion. This condition occurs when the phase relationship of two or more factors in the amplifier circuit is altered. This condition can be usually rectified

## TYPICAL TRAPEZOIDAL PATTERNS SHOWING TRANSMITTER OPERATION

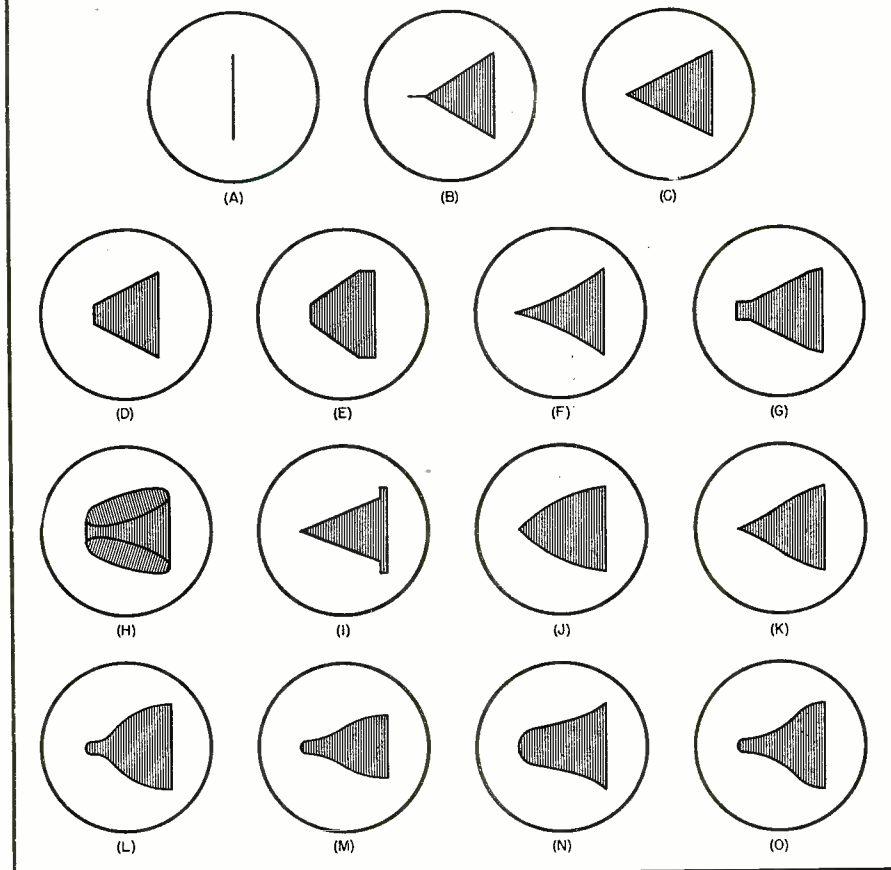

(A) Unmodulated carrier. (B) Over 100% modulation—distortionless wave. (C) Illustrating distortionless 100% modulated wave—ideal pattern. (D) Less than 100% modulation—wave contains no distortion. (E) Pattern illustrates two possible troubles. Insufficient r.f. grid excitation to modulated amplifier or lack of sufficient filament emission. (F) Pattern illustrates regeneration in class "C" stage, which is due to too much bias or improper neutralization. Note curved sides of pattern. (G) This trace is due to mismatched class "B" modulator to the class "C" load. (H) In this pattern we have a condition of phase shift. This is due to the fact that the audio voltages were not taken directly from the output of the modulator. (I) This pattern shows that parasites are present on the positive modulation peaks in the modulated amplifier. (J) Insufficient excitation or bias applied to a triode (plate modulated zero bias) will cause this trace. (K) Approximately 100% modulated (grid or cathode) wave. (L) Approximately 100% suppressor modulated wave. It uses separate r.f. driver. (M) This trace shows a poorly regulated r.f. driver or it can also be the result of excessive excitation. (N) Diagram of a grid modulated phone wave. It is not properly neutralized and also lacks proper reactive load. (O) A suppressor modulated wave. Circuit uses an 802 or 804 and has a crystal in the grid circuit.

by changing the circuit constant (RC values).

By using the above procedure, audio distortion, improper operation due to incorrect bias, phase distortion, etc., are readily detected. If desired, the over-all frequency response of the amplifier can be approximated by varying the audio oscillator frequency and noting the changes, if any, in the amplitude of the trace. It is essential that the output of the a.f. oscillator used be kept constant. For those wishing more accurate knowledge of the frequency response of the audio apparatus, a graph thereof should be made.

### Modulation in Radiotelephone Transmitter

Perhaps the most frequent use of

the oscilloscope is for observing modulation characteristics in radiotelephone transmitters. The oscilloscope can be utilized to disclose the modulation percentage, linearity, and power output available from the audio-modulator—without distortion.

Two types of patterns are regularly employed for checking the performance of radiotelephone transmitters. These are the wave-envelope and trapezoidal patterns. Each pattern tells much about the operation of the transmitter. For ordinary purposes, either one may be used. However, for a more exacting determination of performance, both types of patterns should be employed, thus getting a better delineation of the transmitter capabilities.

The wave-envelope pattern is the easiest to hook up and gives an over-

**TYPICAL WAVE-ENVELOPE PATTERNS  
SHOWING TRANSMITTER OPERATION**

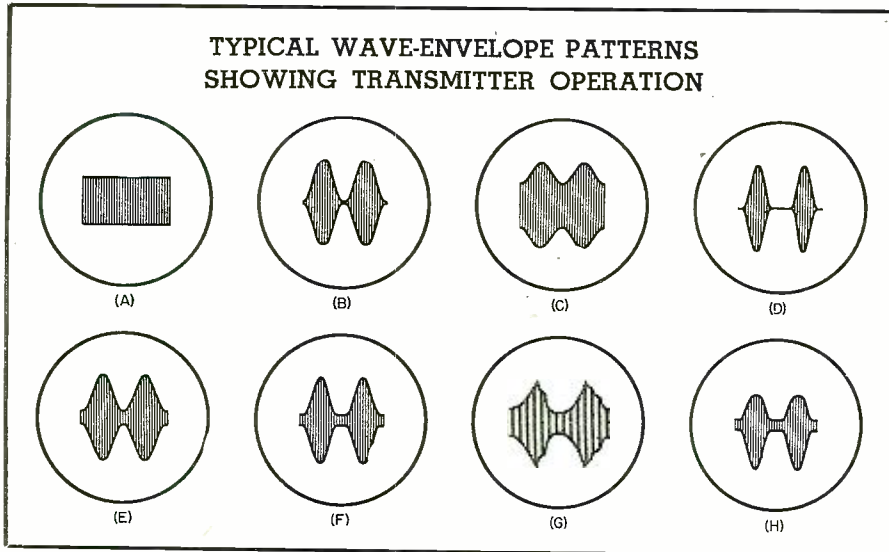

(A) Unmodulated carrier wave. (B) 100% modulation—ideal pattern to get. (C) Less than 100% wave. (D) Greater than 100% modulation (overmodulation). (E) This type of pattern is due to insufficient grid excitation to the final modulation stage. (F) This is a condition of overmodulation (greater than 100%) with the addition of audio distortion. (G) When the plate circuit of the modulated amplifier is not at the proper resonance, the trace, as shown, will be the result. (H) This type of pattern is due to overloading or rectification in the oscilloscope's amplifier.

all picture of the audio amplifier, modulator, and modulated amplifier. Any change in the waveform of the speech amplifier will produce a corresponding change in the wave pattern.

The waveform should be sinusoidal if the modulator is functioning correctly. A change in the audio frequency of the oscillator will necessitate a corresponding change in the sweep circuit.

In contrast, when observing a trapezoidal pattern, changes in audio frequency or waveform of the audio oscillator will not produce a change in the general shape of the pattern, provided the modulation percentage is constant. Thus, the trapezoidal pattern indicates only modulation percentage and linearity of the modulated r.f. amplifier.

Typical wave-form and trapezoidal patterns illustrating different modulating conditions, etc., are included. These should be referred to and studied. For critical examination, the proportions as shown on the typical characteristic sheets should correspond closely with the waveforms and trapezoidal patterns appearing on the screen.

The great advantage of the trapezoidal pattern over the wave-envelope pattern is that a microphone can be substituted for the audio oscillator and the effect of the operator's voice will be noted. The figure expands and contracts horizontally as the operator talks, completing the triangle as one hundred per-cent modulation is approached. Overmodulation is indicated by a dashed horizontal line extending from the vertex of the triangle.

If the same process as outlined above is carried out with the wave-envelope pattern, a meaningless jumble appears across the screen, because the sweep circuit is not synchronized with the speech. This effect can be counteracted to some extent by the following method. Apply a strong synchronizing voltage, taken from the pre-amplifier stage, to the synchronizing jacks of the sweep oscillator. This measure should make the trace more constant. Individual waveforms separated by short, bright dashes indicate overmodulation.

To determine the 60 or 120 cycle hum level of the transmitter in question, using the wave-envelope pattern, proceed as follows:

No a.f. signal is fed to the speech amplifier so that the figure appearing across the screen is a band (like an un-modulated carrier). Then, adjust the sweep circuit to a submultiple of the power line frequency, such as 20 or 30 c.p.s. If ripples or humps appear across the screen, extraneous modulation due to the power line is occurring. On the other hand, the trapezoidal pattern indicates immediately whether there is appreciable hum or noise modulation of the carrier.

**Methods of Connection**

The connections for the wave-en-  
(Continued on page 116)

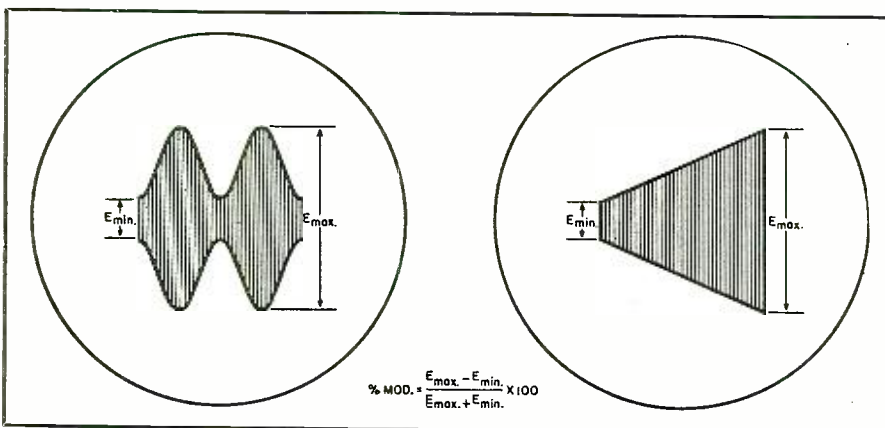

Method of determining modulation percentage of trapezoidal or wave-envelope patterns.



Fig. 3. Diagram showing oscilloscope connections for obtaining trapezoidal patterns when checking grid, suppressor, or screen modulated type transmitters.

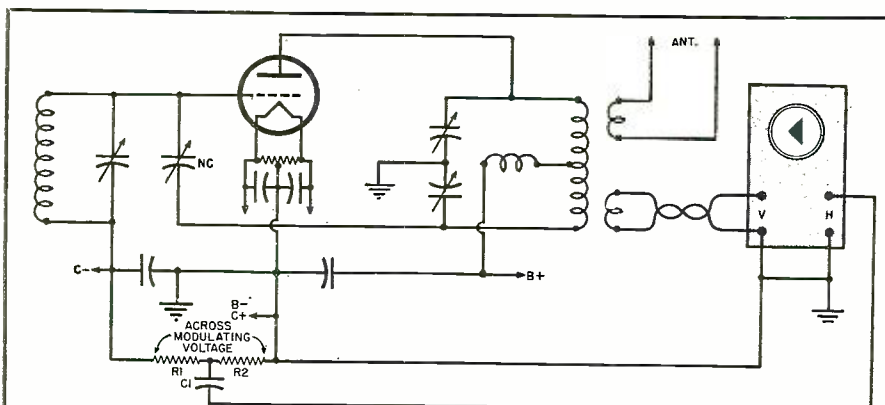

Values for voltage divider should be determined by trial, as they depend on the oscilloscope used.  
Usual values are:  
R<sub>1</sub>—5 megohm, 1 w. res.  
R<sub>2</sub>—50,000 ohm, 1 w. res. (low power)  
R<sub>2</sub>—10,000 ohm, 1 w. res. (high power)

For direct connection, R<sub>2</sub> is a potentiometer with C<sub>1</sub> attached to moving arm.  
R<sub>2</sub>—2 megohm pot. (high power)  
R<sub>2</sub>—5 megohm pot. (medium power)  
R<sub>2</sub>—5 megohm pot. (low power)  
(R<sub>1</sub> should be shorted when used on low power)

# 112 MC.

## Crystal-Controlled TRANSMITTER

By  
**L. G. MOREY, W9KBO**

*Employing "junk box" parts, this 25 watt input, fixed frequency transmitter is ideally suited for present operations.*

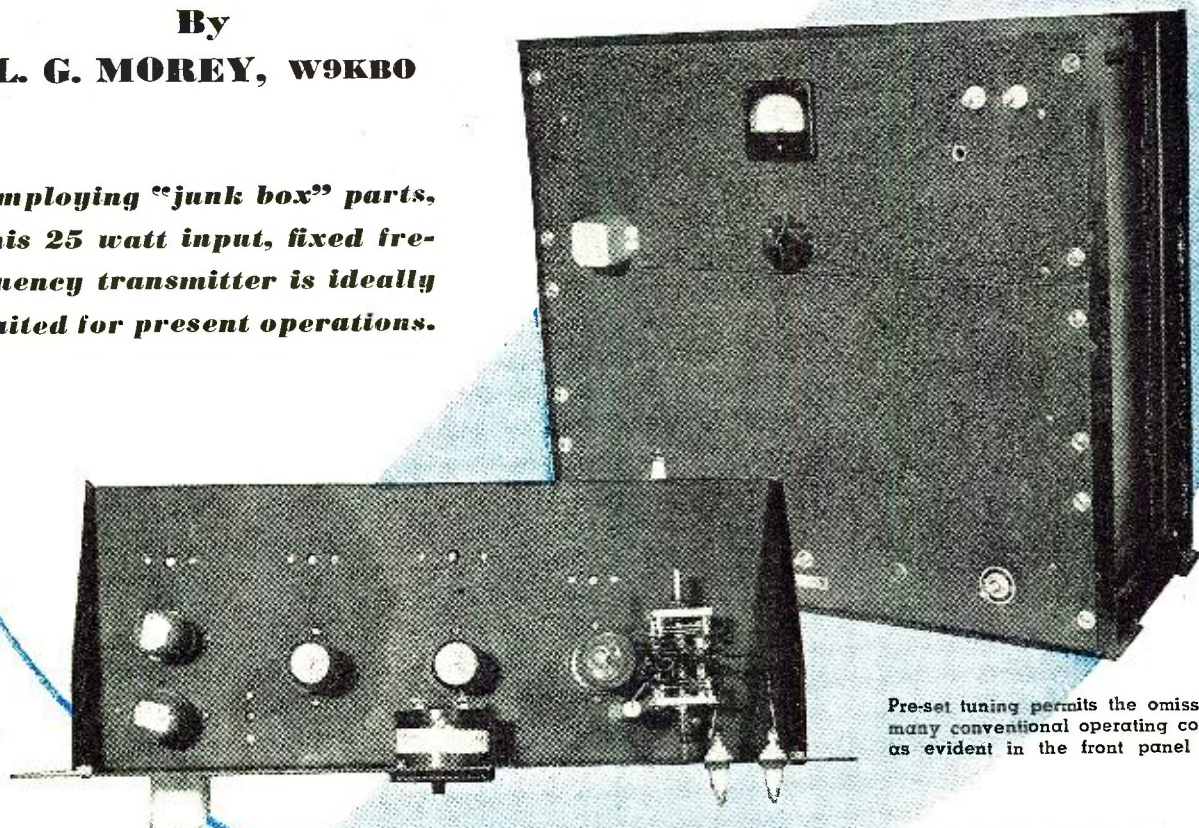

Pre-set tuning permits the omission of many conventional operating controls, as evident in the front panel view.

Top view of r.f. chassis showing the proper placement of component parts.

IN THE design of a station for WERS net control, some of the problems that beset the average amateur at present are rather easily surmounted by the large number of junk boxes available from which to choose parts. However, even with this large selection there must be many compromises. Seldom, if ever, is the final appearance the same as it would be if the standard catalog items were available.

The design and construction of the transmitter described was the result of the ingenuity of E. J. Stanley, W9DXU. Parts obtained from many amateurs and WERS operators were used in the final rig. Although there is little that is startlingly new in the completed unit, it is felt that it will serve as an indication of what can be done at the present time.

The power limitation of 25 watts imposed on WERS stations allows the choice of several tubes for the final stage. Among those available was an HK-24. This tube offered the advantages of low inter-electrode capacities, together with low grid driving requirements, with the possibility of using more plate voltage and so increasing the power at a later date. By experiment it was determined that a 6V6GT operated at 400 volts plate supply would furnish ample grid drive.

As this transmitter was to be used for net control, it was imperative that the frequency be stable, and this indicated either a very stable oscillator of the self excited type or the use of crystal control. Search of the available crystal indicated a large quantity of 7 mc. crystals in the hands of various members. The use of 7 mc. crys-

tals required that the frequency be multiplied sixteen times to arrive at the output frequency.

Experiment showed that sufficient drive for the final stage could be obtained by the use of a tri-tet oscillator using a 6V6GT on 7 mc. with the plate circuit tuned to the second harmonic, followed by three 6V6GT doublers, capacity coupled, and the third one in turn, link coupled to the final. With 300 volts on the plates of the oscillator and first two doublers, the 6V6GT third doubler is driven sufficiently hard to push the final to 10 ma. grid current under load.

The entire transmitter is constructed in two sections with standard rack and panel construction and mounts in a homemade rack, welded from 1 1/4" angle iron. Sides for the rack, made of thin sheet metal, are

welded in place to give the effect of a cabinet enclosure. The lower section is constructed on a 7" x 17" by 3" chassis and contains the speech and modulator system, together with both power supplies. The front panel for this unit is 10½" x 19" and is made of 16 gauge steel notched to standard panel dimensions. Controls along the lower edge of the front panel are, from left to right, microphone input, gain control, send-receive switch, pilot light, and power switch. Parts are located on the chassis where most convenient. A general idea of the layout in this particular model may

be obtained from the photograph of the lower portion.

The speech system consists of a crystal microphone, followed by a high-gain 6SJ7 which feeds the 6C5 driver for the class "B" modulator. A common power supply, consisting of a replacement type power transformer together with the 5Y3G rectifier and the filter circuit  $Ch_1$ ,  $C_{32}$  and  $C_{33}$ , furnishes the plate power for the audio system and the first three tubes of the r.f. section, along with the filament current of the audio section. The plate supply for the r.f. final and  $V_1$  driver is furnished by the transformer

$T_5$ . While this transformer has considerably more capacity than required, it was the only one available at the time this unit was constructed. If a 5R4GY rectifier is available it may be used to replace the pair of 866 Jr's used.

The switch  $S_3$  is used as a standby switch, cutting the plate voltage of both the final power supply and the low voltage power supply. When the switch is thrown to the send position, the voltage appearing across the primary of  $T_5$  is used to energize a normally closed relay mounted on the receiver. This relay is wired to the

Diagram showing the r.f. portion of the transmitter segregated by a dotted line from the modulator and power supplies.

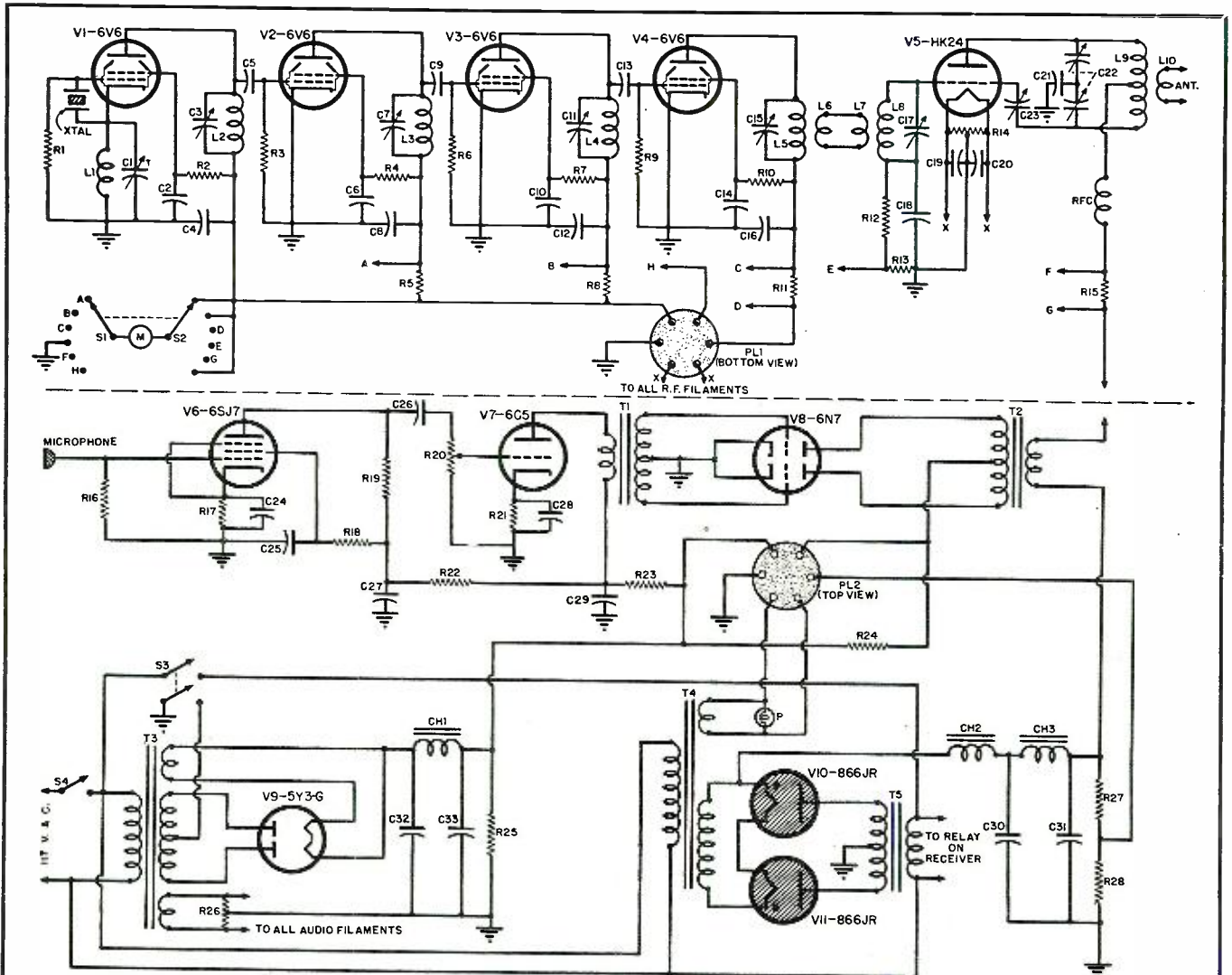

- $R_{11}, R_{12}, R_{13}$ —50,000 ohm, 1 watt res.
- $R_4, R_7, R_{10}, R_{22}$ —20,000 ohm, 2 watt res.
- $R_6, R_8, R_{11}, R_{13}, R_{15}, R_{24}$ —25 ohm, ½ watt res.
- $R_9, R_{10}$ —100,000 ohm, 1 watt res.
- $R_{12}$ —4000 ohm, 10 watt res.
- $R_{14}, R_{28}$ —50 ohm, C.T. wirewound res.
- $R_{16}$ —5 megohm, ½ watt res.
- $R_{17}$ —3000 ohm, ½ watt res.
- $R_{18}$ —2 megohm, ½ watt res.
- $R_{19}$ —250,000 ohm, ½ watt res.
- $R_{20}$ —500,000 ohm, gain control pot.
- $R_{21}$ —2000 ohm, ½ watt res.
- $R_{23}$ —10,000 ohm, 10 watt res.
- $R_{25}, R_{26}$ —20,000 ohm, 50 watt res.
- $R_{27}$ —2000 ohm, 25 watt res.
- $C_1$ —10-70  $\mu$ fd. mica padder cond.
- $C_2, C_4, C_6, C_8, C_{10}, C_{12}, C_{14}, C_{16}, C_{18}, C_{19}, C_{20}$ —0.05  $\mu$ fd. mica cond.
- $C_3$ —50  $\mu$ fd. midget variable cond.

- $C_5, C_9$ —100  $\mu$ fd. mica cond.
- $C_7, C_{11}, C_{15}, C_{17}$ —25  $\mu$ fd. midget variable cond.
- $C_{13}$ —50  $\mu$ fd. mica cond.
- $C_{21}$ —0.01  $\mu$ fd. 1000 v. mica cond.
- $C_{22}$ —15  $\mu$ fd. per section dual—.030" spacing variable cond.
- $C_{23}$ —Neutralizing condenser—National NC-600
- $C_{24}$ —5  $\mu$ fd. 25 v. elec. cond.
- $C_{26}$ —.05  $\mu$ fd. 400 v. cond.
- $C_{29}$ —.01  $\mu$ fd. 400 v. cond.
- $C_{27}, C_{28}$ —4  $\mu$ fd. 450 v. elec. cond.
- $C_{28}$ —10  $\mu$ fd. 25 v. elec. cond.
- $C_{30}, C_{31}$ —4  $\mu$ fd. 1500 v. oil filled filter cond.
- $C_{32}, C_{33}$ —8  $\mu$ fd. 450 v. elec. cond.
- $T_1$ —Driver transformer—Single plate to P.P. grids
- $T_2$ —Modulation transformer—8000 ohm primary to 10,000 ohm secondary

- $T_3$ —375-0-375 @ 150 ma., 5.0 v. @ 3.0 a., 6.3 v. @ 5.0 a. power trans.
- $T_4$ —5.0 v. @ 2.5 a., 6.3 v. @ 2.0 a. fil. trans.
- $T_5$ —600-0-600 v. @ 200 ma. plate trans.
- $Ch_1$ —150 ma. filter choke
- $Ch_2, Ch_3$ —150 ma. filter chokes
- $RFC$ —Ohmite type Z, r.f. choke
- $S_3, S_4$ —2 pole 6 position meter switch
- $S_5$ —D.p.s.t. toggle sw.
- $S_4$ —S.p.s.t. toggle sw.
- $V_1, V_2, V_3, V_4$ —6V6GT
- $V_6$ —HK24
- $V_6$ —6SJ7
- $V_7$ —6C5
- $V_8$ —6N7
- $V_9$ —5Y3G
- $V_{10}, V_{11}$ —866 Jr.
- $M$ —0-100 ma. meter
- $L_1$  to  $L_{10}$ —See coil table
- $P$ —6.3 v. pilot light

standby terminals of the receiver and disables the receiver when the transmitter is on. The additional socket mounted along the rear edge of the chassis is used as the terminal for this connection. All power connections from the power unit terminate in the six prong socket located near the center of the rear edge of the chassis. The standoff insulator mounted near the left hand side carries the plate lead for the final amplifier.

The upper deck contains the r.f. section mounted on a 7" x 17" by 3" chassis and uses a standard 7" by 19" front panel. To give more clearance for the tubes, the chassis is mounted so that it projects about one inch below the lower edge of the panel. The abbreviated shield can, at the left hand side of the panel, is used to cover the crystal holder to prevent "borrowing." A 0-100 ma. meter is mounted in the center of the panel with its meter switch below it. Antenna terminals are mounted in the upper right hand corner. The small hole located below these terminals is to allow screwdriver adjustment of the final tank condenser,  $C_{22}$ . While it is unusual to have a transmitter with no tuning controls on the panel, this unit was built to operate on a fixed frequency, and it was felt desirable to put the controls out of reach of the curious. In a transmitter for general use it would be preferable to bring the tuning controls out to the front panel.

In the top view of the r.f. section the holes allowing screwdriver adjustment of the tuning condensers may be seen near the front edge of the panel. R.f. coils in all cases are mounted directly on the tuning condensers, allowing the minimum of lead length. The neutralizing condenser,  $C_{23}$ , is of the type made for neutralizing 6L6's and is mounted above the chassis by means of its standoff insulator.

As meters are scarce items these days, only one meter was used in the entire transmitter and provision was made to switch it into the circuits it was desired to meter. This is accomplished by means of measuring the drop across the resistors located in the appropriate circuits. In the case of the doubler circuits this also includes the screen circuits, so this should be taken into account when measuring the plate current of these stages.

The power cable interconnecting the two units, as well as the lead carrying the modulated plate voltage for the final, are made of sufficient length to allow the units to be placed side by side on the bench for preliminary testing. If desired, they may be cut to the proper size when adjustments are completed.

When construction has been completed, the tubes should be placed in their proper sockets, leaving the plate lead to the final disconnected. After the tubes have had a chance to warm up, the plate voltage should be applied

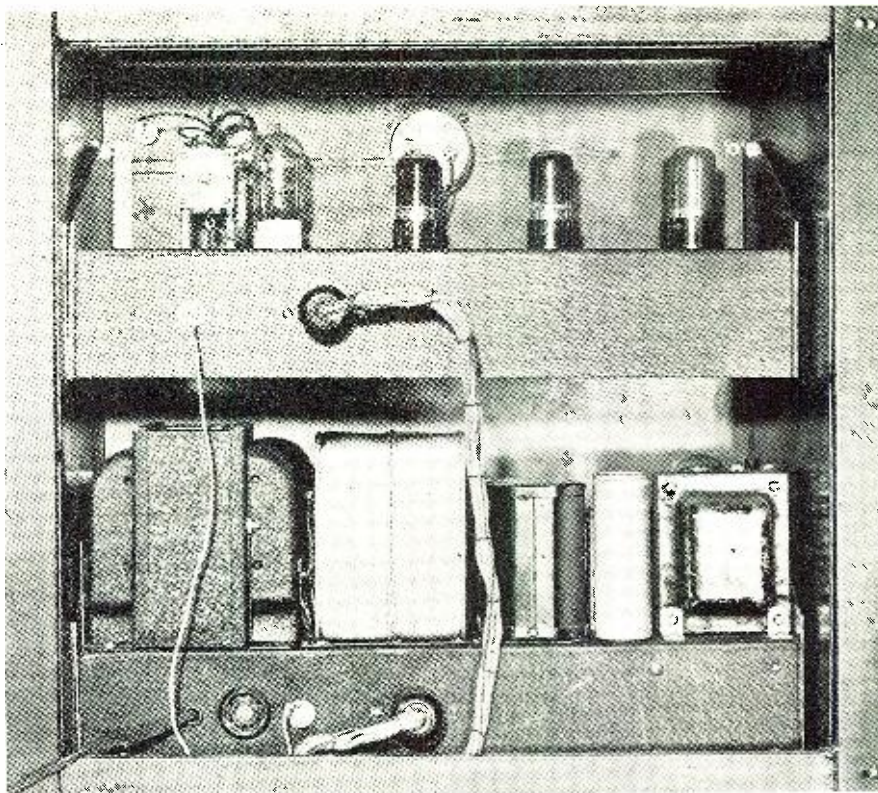

Employing standard rack and panel construction, this rear-view photo shows the r.f. chassis top and modulator and power supplies bottom.

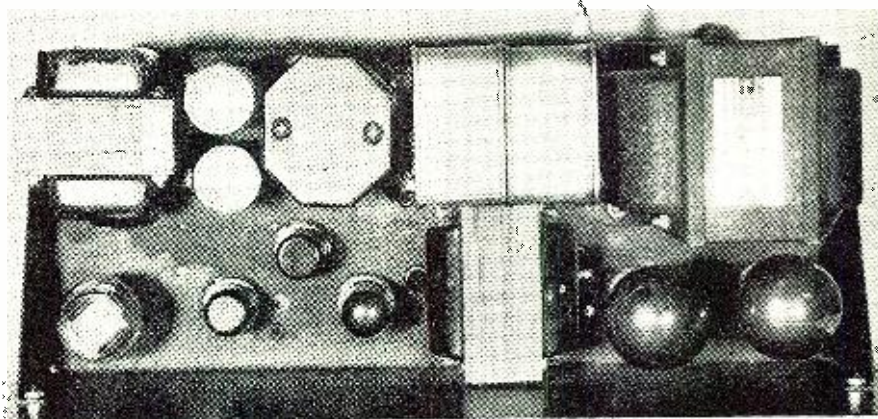

Top view of power supplies and modulator chassis. Transformers along with the other component parts are properly placed to prevent intercoupling.

and the stages tuned, starting with the cathode circuit of the crystal oscillator. The proper adjustment for this condenser is near minimum capacity. The plate condenser of the oscillator,  $C_1$ , should then be adjusted to give the maximum output on the second harmonic of the crystal. Varying the cathode condenser slightly should result in a position which will allow the plate condenser to be tuned through resonance with little effect on the crystal frequency. The optimum adjustment for the cathode condenser is that one which gives the desired output with as low a capacity setting as possible. This will result in low crystal current and consequently little heating and drift.

If an absorption type wavemeter is

available, it will prove very useful in locating the proper harmonics. Lacking this piece of equipment it will be rather difficult to determine which harmonic is actually being used.

The plate circuit of the first doubler should now be tuned to the 28 mc. band. Resonance is indicated by a dip in the plate current of this tube. The dip on the third harmonic will not be as pronounced so it will be fairly easy to determine the harmonic to which the circuit is tuned.

After the first doubler has been tuned to the proper frequency, the same procedure should be followed for the second doubler, tuning its plate circuit to the 56 mc. band. In this case also, resonance will be indicated by a

(Continued on page 106)

# ELECTROLYTIC CAPACITOR CHECKER

By  
**RUFUS P. TURNER**

Consulting Eng., RADIO NEWS

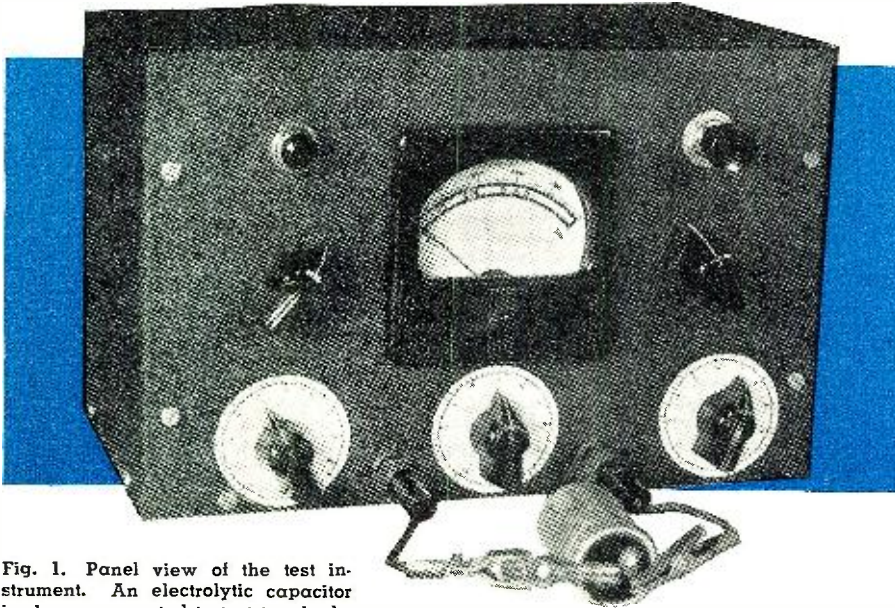

Fig. 1. Panel view of the test instrument. An electrolytic capacitor is shown connected to test terminals.

**The construction and operation of an easy to read electrolytic leakage tester. Its scale shows GOOD?-BAD similar to tube testers.**

A RESPECTABLE percentage of capacitor replacements in receiver servicing are electrolytic. Some servicemen report that they replace more electrolytic capacitors annually than wax or mica types combined.

In a receiver, the normal position of electrolytic capacitors is in the power supply filter, but one or more of these units may be found in bypass positions in the audio amplifier stages as well. In P. A. amplifiers, all of the by-pass and decoupling capacitors are apt to be electrolytic.

In all common by-pass and filter applications, capacitance values gen-

erally are not too important. Wide tolerances are permissible. Electrolytic capacitors so used often vary from one-half to twice their labelled capacitance without causing trouble in receivers or amplifiers. Capacitance measurements, whether alone or in combination with other tests, therefore, do little in themselves to satisfy the serviceman quickly as to the condition of an electrolytic capacitor.

On the other hand, a leakage test made at the rated d.c. working voltage of the capacitor is much more useful in radio servicing for revealing quickly the condition of a questionable electrolytic capacitor. But relatively few operators possess equipment for making such leakage tests, and the few satisfactory instruments to be found in service shops rarely ever are portable.

A handy electrolytic capacitor condition checker must be capable of indicating *directly* either the actual leakage current in milliamperes or the condition of the capacitor as good or bad. In order to be most useful in servicing, no calculations should be required. Adjustments and manipulations must be kept to the minimum. The capacitor must be tested at its rated d.c. working voltage which must

be supplied by the instrument and must be adjustable between 0 and 500 volts.

The instrument described in this article is a simple, but highly effective, leakage tester meeting the specifications just given. It supplies its own adjustable d.c. voltage in the range 0-500 and will accommodate all common sizes of capacitors between 2 and 100  $\mu$ fd. Leakage indications are given on an English scale reading GOOD and BAD like the scale of a tube tester. The working current range is 0 to 17.7 milliamperes.

First, we shall discuss the theory of the leakage test and the basic test circuit, and then will describe the constructional details of the actual instrument.

## How Capacitor is Tested

There is nothing complicated about a capacitor leakage test circuit. Nevertheless, it is a useful service tool. What is desired in such a set-up is to impress across the capacitor a d.c. voltage equal to the rated capacitor working voltage and to measure the resulting leakage current. This scheme is illustrated by Fig. 2A.

In order to accommodate the large number of electrolytic capacitors having different working voltages and different maximum permissible leakage currents, the test voltage may be made adjustable by means of a potentiometer in the output circuit of the d.c. power supply, and the range of the milliammeter may be made adjustable by means of a shunt rheostat. This arrangement is shown in Fig. 2B. The dial of the voltage control potentiometer may, if desired, be graduated in volts for direct reading without a voltmeter.

For use in these circuits, Chart 1 lists the maximum permissible leakage currents for various d.c. working voltages and rated capacitances. This table has been based upon recommendations by leading capacitor manufacturers for determining the maximum leakage values. These recommendations have been expressed as follows: Maximum leakage when the d.c. working voltage is between 0 to 99 volts should be .3 milliamperere plus .01 milliamperere per  $\mu$ fd.; for 100-199 v., .3 ma. plus .02 ma. per  $\mu$ fd.; 200-299 v., .3 ma. plus .03 ma. per  $\mu$ fd.; 300-399 v., .3 ma. plus .04

Fig. 2. Block diagram of basic circuit.

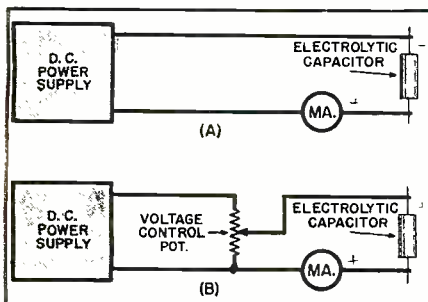

ma.  $\mu$ fd.; and 400 v. and higher, .3 ma. plus .05 ma. per  $\mu$ fd.

When making a leakage test it is important to keep the capacitor connected in the measuring circuit and to maintain the test voltage for a few minutes until the leakage current stabilizes. The current is high when the voltage first is applied, in a number of cases, but decreases slowly, finally reaching a steady value. If the voltage alters during this period of current decay, it must be readjusted to the rated working value of the capacitor. For best accuracy, one capacitor manufacturer recommends that before taking the final leakage reading the d.c. working voltage be applied for 5 minutes plus 1 minute for each month the capacitor has been stored prior to the test.

### Use of English Scale

Operation of the leakage tester in radio servicing and interpretation of its indications may be simplified by working out a series of special settings for the milliammeter shunt resistance. These selected settings will allow the circuit to be preadjusted so that each of the maximum permissible leakage values (Chart 1) always will be read at the same point on the meter scale. Thus, if an 8- $\mu$ fd., 450-v. capacitor is being checked, the shunt rheostat is set to such a value that .7 ma. will deflect the pointer to some previously selected position on the scale—and when working, say, with a 20- $\mu$ fd., 300-v. capacitor, the rheostat will be set so that this time 1.1 ma. will deflect the pointer to the same scale position.

The selected scale point may be labelled with a question mark. That portion of the scale between 0 and ? then may be labelled GOOD, and the portion between ? and full-scale, BAD. The leakage tester then may be read in the same manner as a tube tester.

In order to employ a simple 0-1 d.c. milliammeter as the indicating instrument without sacrificing any of the values given in Chart 1, the question mark must be placed at the .3-ma. point on the scale. The required range of the shunt rheostat then will be 6 to 1110 ohms. Photograph 1 shows the appearance of the special meter scale, and Chart 3 shows the precise manner in which it is marked off.

### Complete Circuit

The complete wiring diagram of the electrolytic capacitor checker is given in Fig. 3.

The d.c. test voltage is supplied by two 25Z5 or 25Z6-G tubes arranged in a voltage quadrupler circuit. The quadrupler saves the space that ordinarily would be required by a 500-volt power transformer. The no-load output voltage of this section is 4 times the peak value of the power-line voltage, or approximately 650 volts d.c. for an a.c. line voltage of 115. However, the loading effect of the voltage control potentiometer,  $R_1$ , reduces the maximum obtainable d.c. voltage to approximately 500. Ad-

D. C. WORKING VOLTAGE	2 $\mu$ fd.	4 $\mu$ fd.	5 $\mu$ fd.	8 $\mu$ fd.	10 $\mu$ fd.	16 $\mu$ fd.	20 $\mu$ fd.	30 $\mu$ fd.	40 $\mu$ fd.	50 $\mu$ fd.	100 $\mu$ fd.
0-99	.32	.34	.35	.38	.40	.46	.50	.60	.70	.80	1.3
100-199	.34	.38	.40	.46	.50	.62	.70	.90	1.1	1.3	2.3
200-299	.36	.42	.45	.54	.60	.78	.90	1.2	1.5	1.8	3.3
300-399	.38	.46	.50	.62	.70	.94	1.1	1.5	1.9	2.3	4.3
400 & HIGHER	.40	.50	.55	.70	.80	1.1	1.3	1.8	2.3	2.8	5.3

Chart 1. Maximum permissible leakage current (in milliamperes) of electrolytic capacitors between 2 and 100  $\mu$ fd. and a d.c. working voltage of 0 to over 400 v.

justment of  $R_1$  makes available a filtered d.c. test voltage which is continuously variable from 0 to 500.

The 25,000-ohm series resistor,  $R_2$ , limits the maximum current which may be drawn from the power supply to 20 milliamperes. This prevents damage to the tubes and to the voltage control potentiometer by short-circuited capacitors. The 0-1 d.c. milliammeter,  $M$ , is protected by a Type 4AG Littelfuse which will open at 1½ ma.

It has been stated already that the meter shunt rheostat must be adjustable from 6 to 1110 ohms. It is entirely possible to obtain this range in a single rheostat, but many of the resistance settings corresponding to the various maximum permissible leakage currents lie too close together to be set reliably on such a rheostat. For that reason, the shunt resistor has been separated into three series-connected rheostats,  $R_A$ ,  $R_B$ , and  $R_C$ , having maximum resistance values of 10, 100, and 1000 ohms respectively. Several shunt settings must be made between 6 and 10 ohms on rheostat  $R_A$ , and it is essential when these settings are made that  $R_B$  and  $R_C$  be set exactly to zero. However, true zero setting seldom is obtained with high-resist-

ance rheostats, so a switch,  $S_M$ , has been included in the circuit to short-circuit  $R_B$  and  $R_C$  when  $R_A$  alone is being used.

Working with the maximum permissible leakage current values given in Chart 1, a table of settings for the shunt rheostats,  $R_A$ ,  $R_B$ , and  $R_C$ , and the switch,  $S_M$ , has been worked out and is given in Chart 2. These settings of the shunt rheostats and switch will place at the .3-ma. point on the meter scale the maximum permissible leakage values for corresponding capacitances and working voltages, as given by Chart 1.

The pushbutton switch,  $S_2$ , when depressed, connects the milliammeter as a 0-500 d.c. voltmeter across the output of the variable power supply.  $S_2$  is a 2-pole, make-two, break-one, non-locking pushbutton. When reading the test voltage by this scheme, the shunt rheostats ( $R_A$ ,  $R_B$ , and  $R_C$ ) are cut out of the circuit automatically, while the milliammeter is connected to the test voltage points in series with resistors  $R_3$  and  $R_4$ , which act as multipliers. If a test capacitor happens to be connected to terminals X-X, it is left in the circuit undisturbed, so that the voltage may be checked under actual load condi-

Chart 2. Instrument settings for leakage test. All resistance ( $R$ ) values are given in ohms. These values are for use with a 0-1 d.c. milliammeter having an internal resistance of 100 ohms. For meters with movement resistances other than 100 ohms, divide the values given by 100/ $R_m$ , where  $R_m$  is the new meter resistance.

D. C. WORKING VOLTAGE	2 $\mu$ fd.	4 $\mu$ fd.	5 $\mu$ fd.	8 $\mu$ fd.	10 $\mu$ fd.	16 $\mu$ fd.	20 $\mu$ fd.	30 $\mu$ fd.	40 $\mu$ fd.	50 $\mu$ fd.	100 $\mu$ fd.
0-99	$R_A$	0	0	0	0	0	0	0	0	0	0
	$R_B$	0	0	0	0	0	0	0	75	60	30
	$R_C$	757	606	377	301	188	150	100	0	0	0
	$S_M$	open	open	open	open	open	open	open	open	open	open
100-199	$R_A$	0	0	0	0	0	0	0	0	0	0
	$R_B$	0	0	0	0	0	94	75	50	37	30
	$R_C$	757	377	301	188	150	0	0	0	0	0
	$S_M$	open	open	open	open	open	open	open	open	open	open
200-299	$R_A$	0	0	0	0	0	0	0	0	0	10
	$R_3$	0	0	0	0	0	63	50	33	25	20
	$R_C$	502	251	201	125	100	0	0	0	0	0
	$S_M$	open	open	open	open	open	open	open	open	open	closed
300-399	$R_A$	0	0	0	0	0	0	0	0	0	7.5
	$R_3$	0	0	0	94	75	47	37	25	19	15
	$R_C$	377	188	150	0	0	0	0	0	0	0
	$S_M$	open	open	open	open	open	open	open	open	open	closed
400 & HIGHER	$R_A$	0	0	0	0	0	0	0	0	0	6
	$R_B$	0	0	0	75	60	37	30	20	15	12
	$R_C$	301	150	120	0	0	0	0	0	0	0
	$S_M$	open	open	open	open	open	open	open	open	open	closed

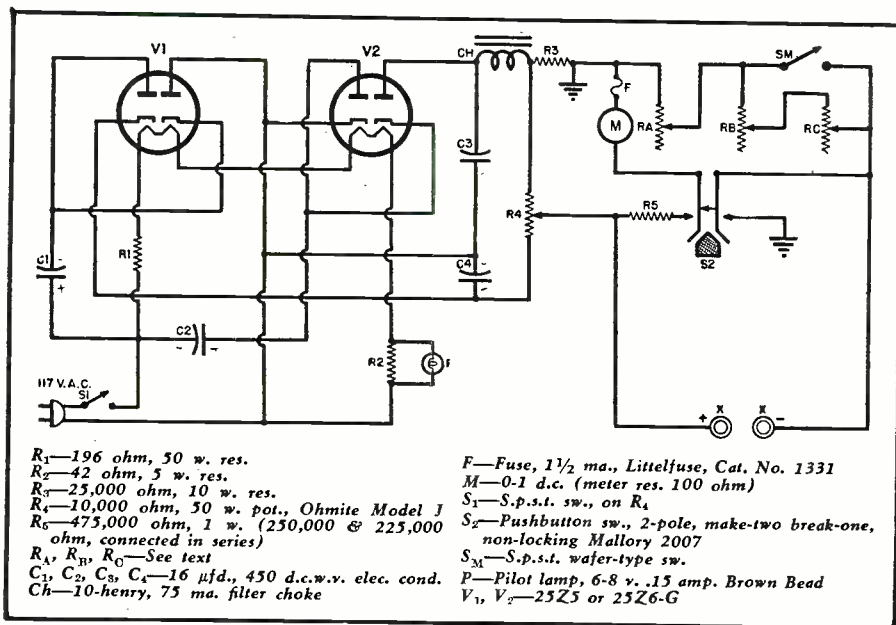

Fig. 3. Complete schematic diagram of the two-tube electrolytic leakage tester.

tions. The resistance values of  $R_3$  and  $R_5$  must be selected and checked closely so that these two resistors, acting together as the voltmeter multiplier, will show a total resistance value of 500,000 ohms. The top of the meter scale (See Fig. 1 and Chart 3) is graduated in volts.

The capacitor to be tested is connected to terminals X-X, the positive capacitor terminal to the positive instrument terminal. Since only a low value of limiting resistance is connected between the power supply and terminals X-X, the operator must exercise full caution to prevent touching the terminals, or the bare clips or prods of test leads connected to the terminals, while the instrument is switched on. The pilot light is a convenient, although not foolproof danger signal. The builder of the instrument should read closely the operating instructions given in the latter part of this article.

Heater voltage for the two tubes and the pilot light is supplied through the 196-ohm, 50-watt resistor,  $R_1$ , which may, if desired, be a line-cord resistor such as used in a.c.-d.c. receivers.

Only the necessary essentials have been included in this instrumental

Fig. 4. Panel layout showing proper position of meter and operating controls.

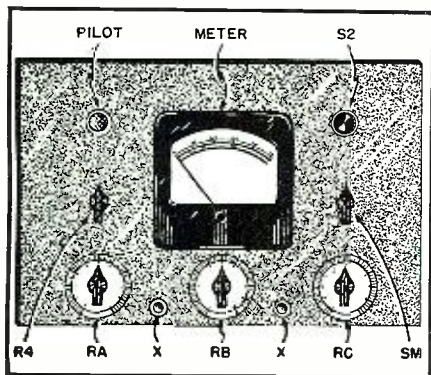

circuit. The checker has not been complicated by components and sub-circuits that would add little real advantage to its performance. The simple circuit arrangement and lack of critical combinations makes it possible to build the instrument into close quarters. The carefully worked-out table of settings (Chart 2) makes it possible for any builder to calibrate the few controls himself in the easiest possible manner and without additional complicated test gear.

#### Electrical Construction

Since the electrolytic capacitor checker is a d.c. instrument, the builder will not be concerned with coupling, hum fields, and similar considerations which complicate the assembly and wiring of a.f. and r.f. test instruments. For this reason, no set rules of arrangement and wiring need be followed. Shielding is not required, and the instrument may be built on a wooden panel and housed in a wooden case if metal is not available.

A heavy, flexible, insulated hookup wire may be used for wiring. Cabling the wire leads will enhance the appearance of the instrument's interior. Leads to and between rheostats  $R_A$ ,  $R_B$ , and  $R_C$  and switch  $S_M$  must be of heavy conductor—at least No. 14—and must be as short as practicable.

#### Mechanical Construction

Because of the small size of required parts, the electrolytic capacitor checker may be made compact. The author's version of this instrument, shown in the photograph and in the front panel layout drawing, Fig. 4, is built into a small steel cabinet, 9" long, 6" high, and 5" deep. The steel chassis is 3½" long, 4¼" wide, and 1½" high. The author used a steel cabinet and chassis simply because these parts were on hand. Other builders may favor the carrying case style common to tube testers and set analyzers.

Still others may prefer the store-counter type of construction.

Filter choke  $Ch$ , the fuse block for the meter fuse, and sockets for the tubes are mounted on the chassis. Capacitors  $C_1$  to  $C_4$  and resistors  $R_1$ ,  $R_2$ ,  $R_3$ , and  $R_5$  are mounted underneath the chassis. Indicating meter  $M$ , the pilot light bracket, voltage control potentiometer  $R_4$ , shunt rheostats  $R_A$ ,  $R_B$ , and  $R_C$ , pushbutton  $S_2$ , meter switch  $S_M$ , and capacitor terminals X-X are mounted on the front panel, as shown in the photograph and in Fig. 4.

Terminals X-X are the only panel-mounted parts which must be insulated from the panel. For this reason, they are protected by shoulder-type washers made of good-grade bakelite. It is convenient to employ plastic-top binding posts of different colors, such as red and black, for the positive and negative terminals.

The on-off switch,  $S_1$ , is mounted on the rear of the voltage control potentiometer,  $R_4$ , and is operated by the shaft of this potentiometer, the switch being opened when the potentiometer is in the zero voltage position.

Both the meter card and the scales for rheostats  $R_A$ ,  $R_B$ , and  $R_C$  are made by drawing on thin white Bristol board with black India ink. The meter card in the author's instrument has been graduated 0-500 volts, as well as GOOD-?-BAD, in accordance with the calibration scale given in Chart 3. In this instrument, the scales of  $R_A$ ,  $R_B$ , and  $R_C$  have been graduated (as may be seen from the photograph) in arbitrary units from 0 to 10, rather than in ohms. Settings of these dials and of switch  $S_M$  have been recorded on a chart cemented on the inside of the cabinet lid, all of the arbitrary dial figures having been listed to correspond to the resistance values in Chart 3.

Thus, when setting the instrument, a dial is turned to, say, 9, which means the same as a Chart 2 setting of 1000 ohms.

#### Calibration and Adjustment

The regular card of the milliammeter must be removed carefully from the instrument and a new one prepared according to Chart 3. This new card may be made from thin, white Bristol board if it is to be mounted by itself on the meter, or may be made of white paper if it is desired to cement it to the regular dial card. The regular card may be used as a template and pattern in preparing the special one.

After mounting the special card in the meter and mounting the meter on the front panel of the checker, resistors  $R_3$  and  $R_5$  are adjusted carefully to the exact values given in Fig. 3. For this purpose, employ a Wheatstone bridge or a good ohmmeter.

Setting of rheostat  $R_A$  every 1 ohm from 0 to 10 ohms, of  $R_B$  every 10 ohms from 0 to 100 ohms, and of  $R_C$  every 100 ohms from 50 to 1000 ohms also must be determined by means of the

(Continued on page 153)



# TRAINING *with Visual Aids*

By  
**CARL E. WINTER**

RADIO Chicago, the primary school of the U. S. Navy's Radio Technician Training Program, is doing a big and important job in the training of men to repair and maintain radar equipment, radio direction finders, u.h.f. equipment, and other such devices. When these men complete their radio technician training less than one year after entering the program, they are radio and radar technicians qualified to keep many types of the Navy's electronic equipment operating at top efficiency.

The thoroughness of the Navy training is, in itself, almost as great a scientific wonder as the marvelous equipment with which the students work. To assemble a conglomeration of men of all ages and backgrounds, possessing varying degrees of aptitude and general knowledge, put them through schooling comparable to some collegiate science courses, and within a year bring them to a mutual level of ability as highly skilled technicians in a field as abstractly theoretical as electronics, indeed requires a scientific approach. If any one method of instruction can claim credit for the rapid development of these potential radio technicians, that method would be the extensive visual aid program which is a vital adjunct to the teaching techniques used at these radio schools.

The training given radio technicians deals only with material associated with the theory and practice of radio and radar maintenance. This fact alone streamlines and differentiates the course from college engineering curricula, and the use of visual aids in presenting theory and practice to the student has been found to be of invaluable assistance in the transmission of new knowledge.

The results which have been achieved by means of visual aids in the field of adult education have aroused the interest of educators throughout the country.

The Radio Technician Training Program, as it is set up today, involves several educational helps which are of interest to the layman and educator alike. The first step in the program requires that the applicant for radio technician training successfully pass the special aptitude test which is designed to select only those best qualified and most likely to complete the

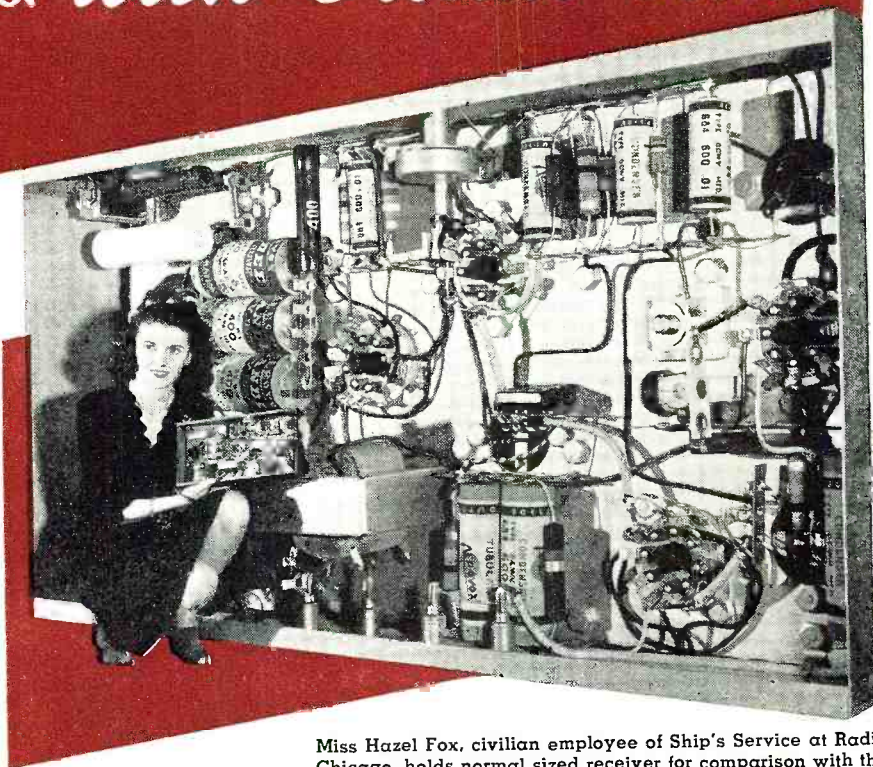

Miss Hazel Fox, civilian employee of Ship's Service at Radio Chicago, holds normal sized receiver for comparison with the giant instructional model made by Visual Aids Department.

## ***Instructional techniques used by the Navy to train their radio and radar repairmen can be used by civilian schools.***

prescribed course. This pre-selection of the students is accomplished by means of the well-known "Eddy Test". This test which was devised and developed by Captain William C. Eddy is not a measure of man's technical or mechanical background, but it does preclude a better-than-average working knowledge of high school mathematics and physics. While these two subjects receive the primary emphasis in the examination, it is also necessary

Lt. (j.g.) A. L. Rogers, W9OZE, Visual Aids Officer of Radio Chicago, holds a normal sized coil for comparison with the instructional coil made by visual aids.



for the applicant to understand certain phases of general science, shop practice, elementary electricity, and radio.

The "Eddy Test" is roughly divided into five categories covering approximately 80 questions on mathematics, physics, shop practice, electricity, and radio. In the field of mathematics, it is necessary for the applicant to be able to perform simple mathematical operations such as cancellations, division, multiplication, addition of algebraic fractions, square roots, percentages, equations and logarithms, etc. The part of the test covering physics requires a working knowledge of heat, light, magnetism, sound, and other phases of general science. Shop practice covers the use of various tools including micrometers, hand tools, the reading of shop drawings, the correct use of files, screws, bolts, soldering irons, etc. The requirements for electricity and radio cover Ohm's Law, direct current circuits, elements of alternating current theory, basic receiver principles, vacuum tubes, and circuit components.

The test breaks down into 40% mathematics, 20% basic physics, 15% basic electricity, 15% basic radio, and 10% shop practice. The grades received by the students in these tests



Over-all view of the Visual Aid Model Shop located at Radio Chicago, Chicago, Illinois. In this shop are built all of the visual aids used to teach radio trainees.

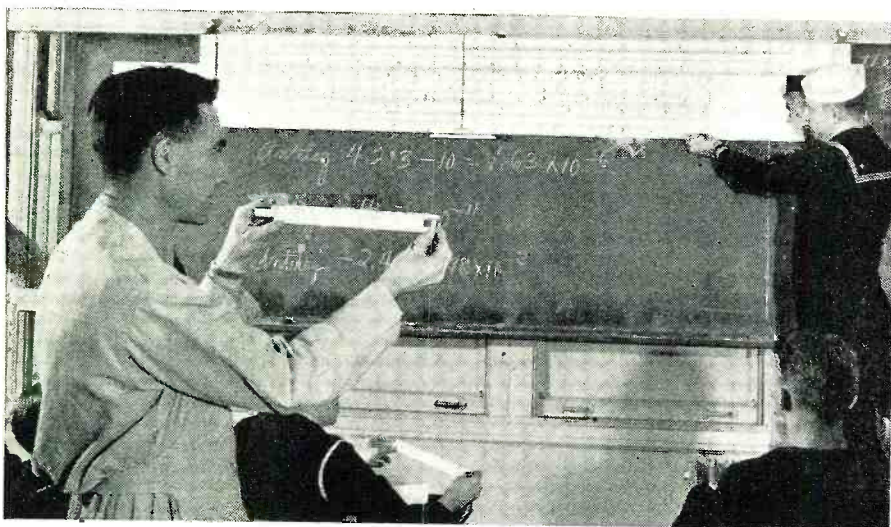

The principles of using the slide rule are taught by means of a giant model while students make computations on their individual rules. Chief Radio Technician E. J. Tripler of Montrose, Colorado, is instructing the class on the small slide rule while the model on the wall is being set by Charles Barrett, Specialist (X) 3/C. of DeLand, Florida, a member of the Visual Aids Department for Radio Chicago.



Laboratory where students are building five-tube superheterodynes as one of their projects before graduation. Note the large scale model of the receiver mounted on the wall for the guidance of the students in placing parts.



are entered as part of their Navy record and these records have resulted in a careful study of case histories and several revisions in the "Eddy Test", but basically the test remains about the same as it was at the time of its adoption in the early part of 1942.

Upon the successful completion of the "Eddy Test" and providing the candidate meets all of the physical and other requirements of the Navy, the student is sent to "boot" training where he must first of all become a sailor before he becomes a specialist. In boot training the student learns how to sling a hammock, how to tell port from starboard, and, in general, become a sailor. During this period, which lasts from five to twelve weeks, he can talk radio and dream radar to his heart's content but nary a radio tube or textbook does the candidate see.

Upon completion of "boot" training, the candidate enters pre-radio school, where during a month's course of intensive study he reviews high school algebra, learns the elements of electricity and the fundamentals of shop practices by means of lectures and laboratory classwork. In this school the student is first introduced to the visual aid method of instruction.

The use of the slide rule is taught by means of a giant nine-foot model of its familiar counterpart. This model is constructed to scale and is capable of being operated by the instructor. Problems worked by means of the slide rule are illustrated by the instructor, who makes the proper setting on the large scale model and the class then performs the proper operation on their individual rules.

In a similar manner, recognition of tools and the proper use of various shop equipment is taught. Sharpening of bits and twist drills becomes easier for the student because giant models of the grinding operation and cutting surfaces of the tools are available for comparison.

Thus, when the student completes his work at the pre-radio school, he is already familiar with many of the visual aids which he will meet time and again in primary and secondary schools.

In the primary schools, the student begins his work on radio equipment and associated test equipment in earnest. Each student, before his graduation from the primary school, is required to construct a complete five-tube superheterodyne receiver. The proper placement of parts and the general layout of the chassis are taught by means of a giant receiver which is exactly scaled to the original. The theory of radio operation is also taught by means of this gigantic receiver, which is large enough for a six-foot man to move around in comfortably.

In the courses in shop practice, the correct use of soldering irons, micrometers, and hand tools are continued at a high level by means of large scale models of each of these instruments. In specific instances, the use of visual

**RADIO NEWS**

aids has cut the training time in almost unbelievable amounts. In one experiment involving the installation of an octal tube socket in a chassis and the soldering of wire leads from a resistor network to certain socket prongs, fifty-five minutes were lopped off the instruction time by the use of a visual aid. Before the adoption of this instruction technique, it was the practice of the instructor to lecture to the students for a one-hour period on the correct practices involved in performing this operation. By means of the oversized model constructed by the Visual Aids Department, the lecture time was cut to a five minute preliminary outlining of the problem to be done.

In similarly dramatic fashion, the operation of the oscilloscope and correct interpretation of patterns on its screen is taught to the students by means of a 20" oscilloscope which is easily visible to the entire class during the instructor's lecture-demonstration. Since most of the features of the more readily portable units are incorporated on this demonstration 'scope, the class is thoroughly familiar with the operation of all the controls when he begins work on the oscilloscope projects.

The testing of meters, which has always been considered an extremely difficult subject to teach to groups because of the small size of most meter parts, has been facilitated by means of model meters which are built eight times normal size. Every detail down to the last coil turn is duplicated faithfully by the model makers.

In addition to individual pieces of equipment, the student becomes familiar with several other types of visual aids during his course of study. Circuits of various pieces of equipment are "blown up" and built onto a demonstration board. In some working models the operation of a re-

ceiver may be demonstrated and the signal traced through the circuit by means of electrically operated indicating devices. Various types of tubes, both receiving and transmitting become familiar to the student because actual tubes are mounted on demonstration panels for his inspection. In addition to this familiarization process, the Visual Aids Department builds giant stripped-down models of the internal construction of the tube showing all working parts, without the glass envelope in place.

Great care goes into the construction of each unit turned out by the visual aids group so that every feature of the model closely resembles or duplicates the characteristics of the original, including solder joints, etc.

The great majority of the visual aids in use at Radio Chicago have been the handiwork of the Visual Aids Department connected with the school. From a small beginning in November of 1942, when the first artist was assigned to the school, this department has expanded until today it is a full-fledged organization working full-time on the job of preparing training aids for the Navy.

The pioneer artist, upon whom rested the responsibility of organizing the work, was Chief Specialist (X) Brander, who is now a lieutenant stationed at the Bureau of Personnel, Training Division, in Washington, D.C. By January, 1943, this department had grown to three staff artists and model makers who devoted their entire time to producing training aids for the rapidly expanding radio school. Today this department keeps twelve Navy men busy full-time preparing the various material for class-room instruction. A completely equipped workshop permits independent operation of the department. Many types of materials are used in the construction of the models, including plastics,

wood, plywood, sheet steel, and non-priority material. The work of this department is now under the direction of Lt. (j.g.) A. L. Rogers, a peace-time radio amateur from Waukegan, Illinois.

In addition to the models used for training, the Navy is also a staunch champion of the efficacy of motion pictures and slide films in training operations. A Training Aids Library was set up at 1212 North Lake Shore Drive, Chicago, for the purpose of supplying films and projectors to supplement the visual aids.

By Navy contract, Burton Holmes Films, Inc. produced a 16 mm. sound movie in the laboratories of Radio Chicago entitled "Radio Technician Shop Practice". Upon completion of this standard 40 minute film, 3 more 16 mm. sound films and about 20 slide films (35 mm.) were produced in a similar manner under the supervision of Navy instructors at Radio Chicago.

Thus in several different forms, the Navy is making use of various time-saving visual aids in the instruction of their radio technicians.

It seems certain that in the postwar era, schools and colleges will be quick to take advantage of what the Navy has learned laboriously. When students from all walks of life are brought together to learn the intricacies of any science or abstract subject, new and disassociated ideas must be presented to them in a simplified, easily grasped manner if utmost speed of instruction and intelligent comprehension is to be obtained.

Visual aids have proved to be the ideal medium to achieve this end, for it is this method that has enabled Radio Chicago to prepare untrained naval personnel for the exacting task of maintaining the complex electronic equipment which is the voice, eyes, and ears of the U. S. Navy.

-30-

(Left) Jack Phillips, Specialist (X) 1/C of Long Island, New York, demonstrates the large sized micrometer used for instructional purposes. The normal sized unit is shown for comparison. (Center) Students are taught correct procedures for maintaining and servicing soldering irons from this giant model being supported by Francis Mair, Specialist (X) 1/C of Streatorville, Illinois. Mr. Mair is the head of the Visual Aids Department of Radio Chicago. (Right) The Du Mont twenty-inch oscilloscope is being used by Chief Ernest Sindelar, Chief Instructor of Radio Chicago, to instruct Charles O. Whitehead, Radio Technician 2/C. of Columbus, Mississippi, on correct operating procedure.

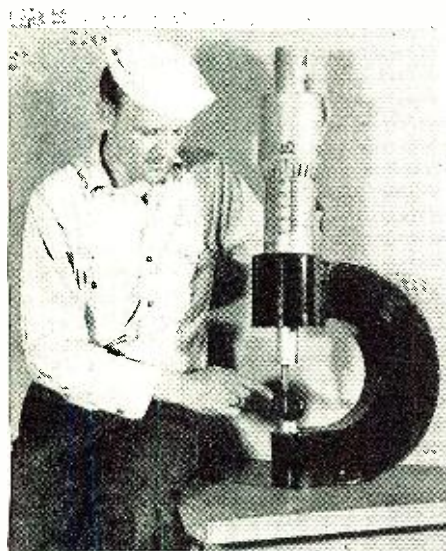

# Practical

# RADAR



Illustrated by  
Julian Krupa

By **JORDAN McQUAY**

**Part 5. The design of radar receivers capable of detecting weak echo signals. Conventional u.h.f. tubes, circuits, and design techniques are used throughout.**

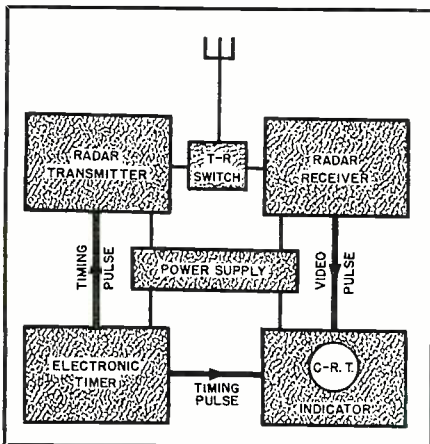

**A** CONSTANT barrage of r.f. pulses from a radar set scans the air and land and sea, searching for targets in light or darkness, in any kind of weather.

The pulses travel at the speed of light until they strike a target, when the r.f. energy is reflected or reradiated at equal speed in all directions from the surface of the target. Some of this reflected energy returns to the radar set in the form of *echoes* which are picked up by the radar receiving antenna.

The receiver takes every weak echo from the antenna, amplifies it, detects the echo envelope, and then feeds the

Fig. 1. Basic block diagram of a radar set.

rectified signal to the indicator unit of the radar set.

Once the echo signals are received from targets, determination of the ranges and directions of the targets are based on the facts that radio-frequency energy travels at a constant velocity (about 186,000 miles-per-second) and that the antenna set of a radar set is movable and highly directional.

The range or distance to a target can be found by multiplying the velocity by one-half the time a single pulse requires to complete a round-trip cycle, known as a radar cycle. This *time* is measured electronically by the cathode-ray oscilloscope and immediately translated into terms of *distance*—in yards or miles.

The physical position of the antenna system then gives us two angular measurements, the azimuth or bearing, and the elevation angle of the target.

Knowing the range or distance, azimuth, and angle of elevation, we can locate accurately the position of any object in space or on land or water.

The reception and detection of echoes from distant targets is an important job in the over-all function of a complete radar set (Fig. 1).

Because reflections from any target are scattered in random in all directions, the few echoes that return to the radar set are very weak. Yet these signals must be accepted by the receiver and amplified sufficiently so they can be observed as visual signals on the time base of a cathode-ray oscilloscope.

This ability of the receiver to detect and amplify extremely weak echo signals is a measure of the effectiveness of the radar equipment; the weaker the acceptable echo signal, the greater the workable range of the radar set.

Radar receivers employing, for the most part, conventional types of u.h.f. tubes and circuits require a fairly wide bandwidth input, at the same operating frequency as the radar transmitter. Except in this one respect, the radar receiver needn't differ greatly from other u.h.f. receivers. Therefore, much of the published and known theory of u.h.f. receiver operation is applicable to radar receivers.

### The Superheterodyne

A radar receiver must supply considerable amplification, with inherent stability and extreme sensitivity. For this purpose a superheterodyne circuit logically offers itself.

Special types of high-frequency tubes with low interelectrode capacitances are used in the r.f., local oscillator, and i.f. stages. And a large number of i.f. amplification stages may be expected in a radar receiver. These and other u.h.f. refinements give stability of operation at ultrahigh frequencies, as well as a high degree of sensitivity. Even when the receiver employs as many as six or eight stages of i.f. amplification, there is considerable stabilization.

The block diagram of a basic su-

perheterodyne receiver suitable for radar is shown in Fig 2.

It functions much in the conventional manner, with some important exceptions. The input to the receiver is broadly tuned with provisions for changing the input bandwidth; the intermediate frequency is measured in megacycles and the output of the receiver is a video signal containing a wide range of component frequencies.

A number of other circuit conditions must be considered in addition, if the radar receiver operates at ultra-high frequencies. High amplification by any one r.f. stage is seldom possible and there are considerable losses in the process of conversion to an intermediate frequency. The shortness of interconnecting leads becomes important. Interlocking of amplifier and local oscillator tuning becomes more difficult to avoid. All r.f. and i.f. circuit elements must be well shielded. Tuned sections of transmission lines are often used as "tank" circuits, and special types of u.h.f. tubes must be used in the r.f., local oscillator, and i.f. stages of the receiver.

In general, as the frequency of operation is increased, the physical structure and electrical design of radar superheterodyne circuits becomes more radically altered.

All of this is necessary to preserve the shape of the reflected echoes, while they are being detected and amplified.

It's a big job for the radar receiver. Often the simple diagram (Fig. 2) may become quite complicated, as shown in Fig. 4, where as many as 20 or 25 separate and distinct stages compose the complete receiver.

But regardless of the total number of stages in a radar superheterodyne, the receiver can be conveniently divided into five principal parts; the radio-frequency amplifier stages, the mixer or frequency conversion stage, the i.f. amplifier stages, the (second) detector stage, and the video amplifier stages.

### Problems of Noise

Like other u.h.f. receivers, the radar receiver is faced with the eternal problem of noise disturbances generated within the circuits of the receiver itself. If it were not for this problem, any number of amplification stages could be used to increase the amplitude of the echo signal, no matter how weak, by any desired amount.

These noise disturbances actually

## GLOSSARY OF RADAR TERMS

**Antenna array**—A symmetrical arrangement of dipoles with directional characteristics.

**Antenna reflector**—See reflector.

**Antenna switch**—See T-R switch.

**Azimuth**—Bearing or angular direction relative to true north.

**Beam width**—The width in azimuth of the pulsed r.f. energy beam.

**Bearing**—See Azimuth.

**Blocking oscillator**—Tuned-grid, tuned plate r.f. oscillator in which the grid circuit controls the pulse duration.

**Carrier frequency**—The ultra-high frequency at which a radar transmitter operates.

**Cathode follower**—Distortionless, impedance-matching, isolating stage.

**Charged line**—A pulse-shaping network which reflects a steep-sided rectangular pulse of a duration determined by the electrical constants of the line.

**Clamping circuit**—A circuit which holds either the positive or negative amplitude extreme of a wave form to a given reference level of voltage.

**Crystal mixer**—Mixing two frequencies by using the non-linear characteristics of a crystal.

**Cut-off limiting**—Limiting action of an amplifier when operated beyond the point of plate current cut-off.

**D.C. restorer**—See clamping circuit.

**Delay circuit**—Network or circuit which introduces a time or phase delay of a wave form.

**Differentiator circuit**—A short time constant (RC) circuit and amplifier which produces an output voltage with an amplitude proportional to the rate of change of the input voltage. A circuit used to sharpen a wave form. Sometimes called a peaking circuit.

**Dipole**—A half-wave, center-fed radiating element.

**Duty cycle**—The fraction of a complete radar cycle during which energy is transmitted.

**Echo**—That part of the r.f. pulse reflected back to the radar set by a target.

**Electronic timer**—The component of a radar set that originates the pulse recurrence frequency, and synchronizes the operation of other components with the radiation of r.f. pulses by the transmitter.

**Elevation angle**—The angle of the target with respect to the radar set and the horizontal plane of the earth.

**Envelope**—The general outline of a wave form.

**Gate**—A rectangular wave used to switch a circuit on or off electronically during certain portions of the radar operating cycle.

**Grass**—Static or noise appearing as intermittent, minute interruptions of the oscilloscope time base.

**Ground return**—That part of the r.f. pulse reflected by the ground surrounding the radar set.

(Continued on page 149)

are random, minute voltage variations due to any of several circuit conditions—usually associated with radio-frequency amplifier stages of the receiver.

The effect of these noise voltages depends not so much upon their individual amplitudes, but upon the power relation between the echo signal and the *collective* noise. If the amplitude of the noise voltages is not less than the amplitude of the echo signal, the echo cannot be recognized at the output of the receiver.

For this reason, the noise voltages must be kept as low as possible; *i.e.*, the signal-to-noise ratio must be kept high. The lower the noise level, the weaker the acceptable echoes—and the greater will be the working distance of the radar set. Thus, internal noise in the early stages of the receiver directly affects the useful range of the equipment.

There are three different kinds of noise disturbances in the r.f. section

of a receiver; noise due to thermal agitation, noise due to shot effect, and hum or induced noises.

Thermal agitation—the random motion of electrons in a conductor—is caused primarily by either high conductor resistance, or high operating temperature.

Shot effect—the irregular emission of electrons by the cathode of the r.f. amplifier tubes—is caused by low filament operating temperatures, resulting in a low space charge within the tube.

Stray electrostatic or electromagnetic fields often induce hum and other extraneous noises into a u.h.f. circuit. This is a form of modulation and generally exists when units of the r.f. stages are not properly shielded.

While it has not been possible to eliminate the noise disturbances caused by these three effects, most of them have been minimized by improved u.h.f. design and the use of special tubes.

Fig. 2. Basic block diagram of radar superheterodyne receiver.

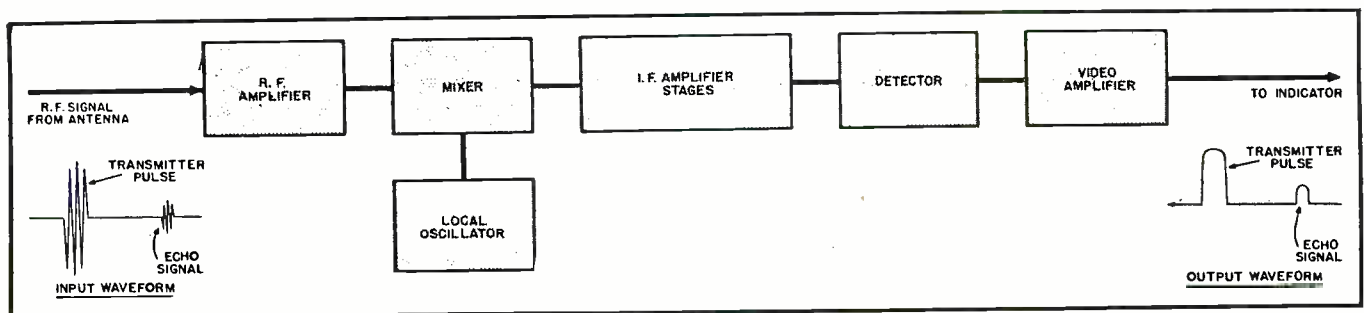

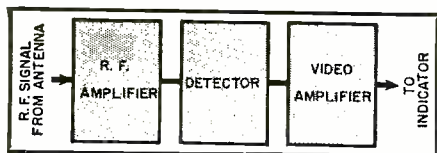

Fig. 3. Basic block diagram of superregenerative receiver.

Atmospheric "noise," or static, is another contributing factor to the sensitivity of the radar superheterodyne. A fairly wide input bandwidth would be required by most receivers, since the video output of the receiver must contain a wide range of frequencies, *i.e.*, be rich in harmonics, for faithful reproduction of the echo pulse. This wide bandwidth admits a greater amount of spurious external "noise" and atmospheric, which usually must be contended with unless some form of *variable* input bandwidth is used in the first r.f. stage of the receiver.

Considerable noise may be minimized or even eliminated by dividing the superheterodyne receiver *physically* so that the r.f. stages and mixer are located near the antenna system, and the i.f. and video stages are located elsewhere, near the main components of the radar equipment.

Parts of the receiver may often be distributed throughout the radar set so that their physical identity becomes lost. However, for purposes of our discussion we will assume the receiver to be a complete component, consisting of the r.f. amplifier, frequency conversion, i.f. amplifier, and video amplifier stages.

### R.F. Amplification

Probably most radar superheterodyne receivers use one or more stages of r.f. amplification, but at extremely high frequencies of operation this may be difficult.

However, we can assume that at least one stage of r.f. amplification is generally used—sometimes two or three stages—providing a considerable degree of pre-selection.

Because of noise disturbances, screen grid tubes are impracticable for r.f. amplification in radar superheterodynes. Inductive reactance of the cathode leads causes degeneration in the circuits associated with such tubes.

Grounded-grid triodes offer advantages as r.f. amplifiers at the lower frequencies of radar operation. If the input signal is applied to the cathode, the plate-to-grid capacitance of the tube then acts only as a plate load, instead of the conventional feedback circuit. This absence of plate-to-grid capacitance is due to the shielding action of the grounded grid.

At higher frequencies the Light-house tube has found considerable use as an efficient r.f. amplifier. But in the extremely high ranges, r.f. amplifier stages are seldom used in superheterodynes.

All of the u.h.f. circuit techniques discussed earlier in this series on "Practical Radar" can be applied to this stage of the receiver. Every piece of connecting wire, no matter how short, acts as some portion of a transmission line. Lumped inductance and capacitance are of far less importance than distributed inductance and capacitance, and coaxial cables or wave guides are used to transfer r.f. energy over any appreciable distance in the set.

Resonant circuits of the r.f. stages are of the fixed tuned type; that is, the stages are adjusted to a given frequency of operation, depending upon the carrier frequency of the radar transmitter. Tuning can be accomplished by variable condensers.

R.f. chokes used in the plate and filament leads of the r.f. amplifier tubes prevent leakage of the signal into the power supply. Because of the high operating frequencies involved, low values of inductance are required. The chokes may be formed from the interconnecting leads which supply voltages to the different tube elements, a few turns being sufficient for this purpose.

Every portion of the r.f. amplifier stage must be well shielded, and the complete stage also shielded from the rest of the superheterodyne.

These, and many other "trick" u.h.f. techniques, could be employed in radar receivers, in an effort to supply as much undistorted r.f. amplification as possible to the echo signal before it is passed to the frequency conversion stage of the radar superheterodyne.

### Frequency Conversion

Mixing or frequency conversion

could be accomplished in a radar receiver by means of a separate local oscillator in a somewhat conventional circuit. However, it should be noted that the output of this mixing stage, the intermediate frequency, needs to be considerably higher than in the usual u.h.f. superheterodynes.

At the lower operating frequencies of the r.f. spectrum, any of several types of high-frequency tubes can be used as the "mixer" with a stable local oscillator supplying the mixing frequency.

Link coupling between the mixer and local oscillator, and between the mixer and the first i.f. amplifier stage, would obtain the optimum degree of energy transfer between these stages. This method of coupling prevents interaction between the circuits due to heavy loading, such as would occur with other types of coupling.

Radio-frequency chokes would be as efficient in the power leads to the mixer stage as in the r.f. amplifier stages previously described.

The local oscillator might use any type of stable oscillatory circuit, and the tuning can be adjusted over a slight range of frequencies. The local-oscillator frequency may be slightly higher or lower than the r.f. signal, by an amount which represents the "difference" or intermediate frequency.

Frequency conversion at the higher operating frequencies of the u.h.f. spectrum becomes much more difficult and requires something of a new philosophy of "mixing."

One type of local oscillator capable of generating a high frequency for mixing purposes is known as the Klystron tube [Sperry] functioning in a very simple circuit. Also known as a reflex Klystron, this tube can generate radio waves of very short length.

The Klystron tube consists essentially of a cathode, a control grid, a repeller electrode, and a resonant cavity. The tube operates on the velocity-modulation principle, in which the transit time of electrons between the resonator and the repeller is utilized. Oscillations take place within the resonant cavity when properly phased electrons pass between the resonator grids. This phasing can be affected by the accelerating voltage

(Continued on page 151)

Fig. 4. Detailed block diagram of radar superheterodyne receiver.

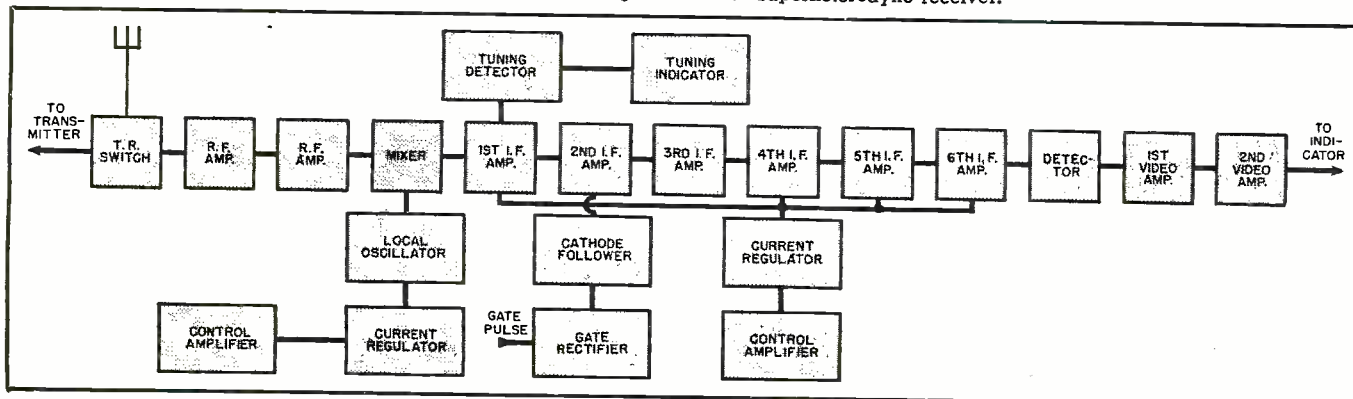



# International SHORT-WAVE

Compiled by **KENNETH R. BOORD**



## FIJI CALLS

From the far-away South Pacific, the Fiji Radio Service reports:

VPD2, 6.130, Suva, capital of Fiji, normally 10,000 watts, but now using only 500, takes its programs from local broadcast station ZJV (920 kc.). Actually, VPD2 is an extension of ZJV designed to cover outlying islands not served by ZJV. Hours of operation are restricted at present:

Daily, except Sunday, 4:15-5 p.m., news bulletins at dictation speed, followed by BBC news relay, 4:45 p.m.

Sunday, 2-6 a.m., special programs in Fijian and English; BBC news relay, 2 a.m.

Tuesday, 4-5 a.m., news bulletins and commentaries in Fijian; native music.

Radiations of VPD2 are omni-directional. When conditions become normal, VPD2 will revert to former schedules on high power with increased time on the air, and will provide a greater variety of service.

VPD2 is heard in various sections of America (recently reported heard in Ontario, North Carolina, West Virginia).

As an interesting sidelight, Paul M. Wilson, Ensign, USMS, Amateur Radio W4HHK, writes: "Early this year I had the pleasure of visiting Suva and seeing one of their radio stations, ZJV. The engineers were very courteous and showed me through the station. Before leaving I gave them one of my amateur QSL cards and in return received two from them—one bearing the call letters of the standard broadcast station, ZJV, and one from VPD2, short-wave. The cards are very attractive. My time ashore being limited, I was unable to visit VPD2, located outside Suva. VPD2's QSL card states there are three transmitters, frequencies used and times of operation not being given."

Communications should be addressed to Fiji Radio Service, Amalgamated Wireless (Australasia) Limited, Wireless Station, Suva, Fiji.

## NEW

New Zealand is about ready to begin regular short-wave overseas transmissions to the Pacific and the western coast of the United States. "This service will operate for several hours daily," says the National Broadcasting Service, operator of the new stations.

*(EDITOR'S NOTE: Since more than ever before the ears of the world are tuned to the Pacific and Asia, ISW this month is devoted primarily to broadcasts from Asia and Oceania. The rapid turn of events in the war will, no doubt, change the entire schedule of Japanese transmitters. It is difficult to predict as to how these many stations will be operated under Allied control. For this reason, all reference to these stations will be omitted until more detailed information is obtained. All reference of time may be assumed to be EWT unless otherwise indicated.)*

Tests have been made with two 10 kw. transmitters; eventual power is to be 100 kw. Calls and frequencies are expected to be:

ZL1, 6.080; ZL2, 9.540; ZL3, 11.780; and ZL4, 15.280.

Whether these transmissions will be heard in the East depends on a number of factors, but the reliability with which I have been picking up ZLT7, 6.715, Wellington 5 kw., here in West Virginia, leads me to believe the new 10 kw. transmitters will come through

satisfactorily. The 9.540 frequency is the best bet for the East, providing, of course, it is radiating at a time when Australia's VLC5 is off the air.

Inquiries should be addressed to James Shelley, Director, National Broadcasting Service, P. O. Box 3045, Wellington (C.1.), N. Z.

## CHANGES

Veteran monitors on the West Coast (Balbi, Dilg) report that, in general, Far East transmissions have been coming through somewhat erratically. There are reasons to believe that reception from that quarter will become even worse as winter comes on.

"Australia offers no problem; will be good all winter. VLC7, 11.84, will likely replace VLC4, 15.315, 9:55-10:45 p.m. to East Coast, and 1:10-1:45 a.m. to West Coast, beginning about October 1.

"Reception of Indian stations varies. Several are heard on East Coast that  
(Continued on page 84)

The short-wave listening post of D.R.D. Wadia, "Panorama", Malabar Hill, Bombay 6, India, one of the oldest members of the International Short-Wave Club and a VAC holder. Mr. Wadia has membership in the Heard All Continents Club and has collected verifications from throughout the world. He uses a National NC200.



# ULTRASONIC COMMUNICATIONS

*An analysis of the principal factors and equipment involved in conveying intelligence at ultrasonic frequencies through mediums such as liquids, gases, or solids.*

By **ROBERT G. ROWE**

**I**N ORDER to convey intelligence or to "communicate" through a medium, be it a liquid, gas, or solid, it is expedient first to establish in the medium, as a "carrier", some form of periodic wave motion which can be propagated to and detected at a remote point in the medium. Secondly, it is necessary to modify the existence or character of this wave motion in some pre-arranged, decipherable manner, or "modulate" the wave motion. Obviously, modifying the existence of the wave may be accomplished by alternately starting and stopping its generation; whereas, modifying its character may be accomplished by changing its amplitude, frequency, phase, or velocity. However, since the velocity of a wave in a homogeneous medium is fixed, the other aforementioned forms of modulation are relied upon.

In the art of radio communication, such "carrier" waves are electromagnetic in character, transmitted through the ether at a uniform velocity and modulated to carry intelligence by code or telephone.

In the art of sonic communication, such carrier waves are "compressional" in character, wherein the propagating medium suffers a sort of rectilinear deformation, which may be

transmitted through various liquids, gases, and solids at velocities determined by the characteristics of the medium, and modulated to carry intelligence. While electromagnetic and sound waves may be essentially different in character, they are alike in that they may each be propagated in suitable media. Quite obviously, the most universal form of sonic communication may be exemplified by a conversation between two or more people. The vocal cords, as well as the configurations and appurtenances of the oral cavity, cooperate to represent the compressional wave generator, which is both amplitude and frequency modulated. The air represents the gaseous medium through which such modified compressional waves are transmitted at a velocity of some 1100 feet-per-second. The human ear represents the receiver, which is capable of detecting and, perhaps, demodulating these compressional waves.

In the art of ultrasonic communication, so designated by virtue of the fact that the human ear will not respond to the higher frequencies, such waves still are compressional in character and may be transmitted through liquids, gases, and solids. It will be appreciated that ultrasonic communication, while not popularized, has

MEDIUM	FREQ. (k.c.)	DISTANCE (FT.)
WATER	10	1,312,400
WATER	100	13,124
WATER	500	525
WATER	1000	131
AIR	10	722
AIR	100	7.22
AIR	500	0.157
AIR	1000	0.072

Table 1. The distance sound travels before its intensity is reduced to one-half.

been known and used for many years. The early work of Langevin, Florsion, and others describes and discloses means and apparatus to communicate through a water medium via ultrasonic waves. Part of this work was directed toward submarine detection and signalling, as well as echo depth sounding, in which the principles involving the use of compressional water waves are truly the forerunners of the present-day principles involving the

Fig. 1. Two types of reproducers (loudspeakers) that can be used to communicate via a 20 kc. ultrasonic sound beam. (A) The magnetostriction reproducer and (B) the piezoelectric reproducer. Photographs of these units are shown in Figs. 2 and 4 respectively.

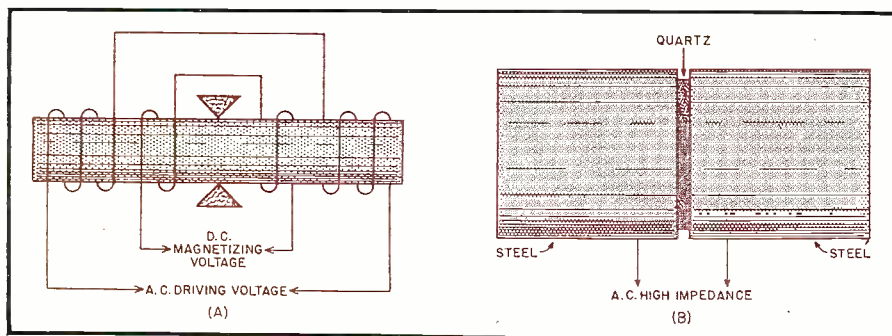
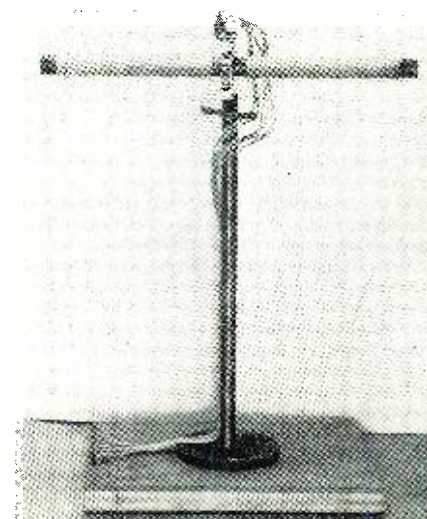

Fig. 2. The magnetostriction reproducer.





use of electromagnetic "ether" waves for radar. Early forms of "absolute altimeters" for aviation also employed sound waves, but their velocity was too low to render them practical for the vehicular velocities encountered in practice.

Compressional waves, in passing through any medium, are absorbed to an extent dependent upon the frequency of the waves, the nature of the medium, and the distance travelled. All mediums have a certain "compressibility" and "viscosity" whereby all of the compressional energy imparted to displace the medium is not returned to the wave but is partially transformed into heat. From Rayleigh<sup>1</sup>, the amplitude  $A$  of plane waves at a distance  $x$  from the generator, is:

$$A_x = A_o e^{-KN^2x} \dots \dots \dots (1)$$

where  $A_o$  is the original amplitude,  $e$  is the base of the natural logarithms (2.718),  $K$  is a coefficient depending upon the density, compressibility, and viscosity of the propagating medium, and  $N$  is the frequency of the wave motion. By inspection, the amplitude of the wave at a distance is inversely proportional to the square of the frequency, so that high frequency compressional waves fade out in much shorter distances than low frequency waves.

The factor  $K$  for a water medium has such a relatively low value that appreciable distances may be covered by compressional water waves at frequencies of from 20 to 50 kilocycles. The factor  $K$  for an air medium has a much higher value so that air distances must be measured in feet rather than in miles. The relative efficiency of the two mediums, as well as the effect of frequency, may be seen by examination of Table 1, which shows the approximate range at which the original sound intensity has been reduced to one half<sup>2</sup>.

A redeeming feature of ultrasonic sound waves, like high frequency electromagnetic waves, is that they are easily directed and formed into a cone or beam by conveniently small radiators. Provided that the vibrating surface producing the wave is moving like a piston with all surface elements in phase, the directivity of the reproducer may be roughly calculated from

$$\sin \theta = .61 \frac{\lambda}{r} \dots \dots \dots (2)$$

where  $\theta$  is the half-apex angle of the cone,  $\lambda$  is the wavelength and  $r$  is the piston radius<sup>3</sup>.

With the foregoing considerations in mind, various apparatus for communicating via a 20 kilocycle ultrasonic soundbeam has been constructed and employed. The frequency generator to produce the carrier wave consists of a commercial audio oscillator and ten-watt audio amplifier. In order to amplitude modulate the carrier wave, provision is made for plate modulating the output tubes of the ten-watt amplifier, in accordance with conventional AM radio transmitter practice.

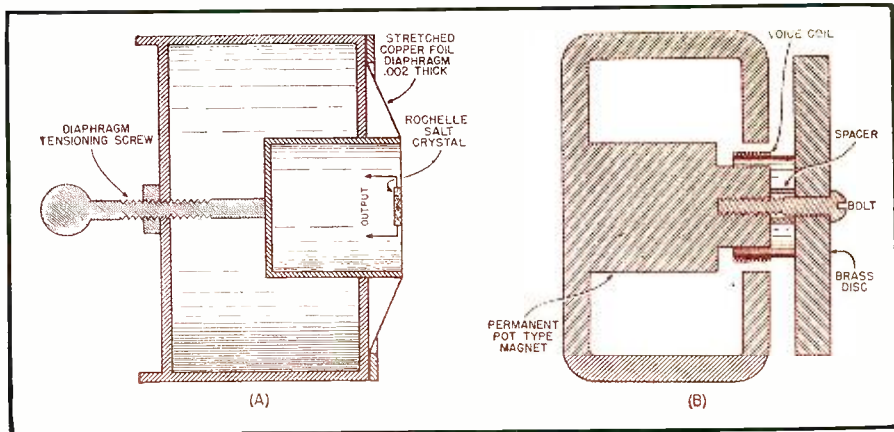

Fig. 3. (A) Mechanical arrangement of the mechanically resonant microphone. (B) Cross section view of the dynamic reproducer. Photographs shown in Figs. 6 and 5 respectively.

Three general types of reproducers or "loudspeakers," namely magnetostrictive, piezoelectric, and dynamic, have been used. With regard to these reproducers, magnetostriction refers to that phenomenon in which there is a change of length in a bar of ferromagnetic material attending magnetization. If the magnetic field is alternating (at 20 kilocycles in this case), the amplitude of longitudinal vibration in the bar will be maximum when the frequency of the applied field is equal to the fundamental elastic period of the bar. In accordance with the formula:

$$f = \frac{1}{2l} \sqrt{\frac{E}{d}} \dots \dots \dots (3)$$

where  $f$  is the frequency in cycles per second,  $l$  is the length of the bar in centimeters,  $E$  equals its modulus of elasticity in dynes per-square-centimeter and  $d$  its density in grams per-cubic-centimeter, the length of a bar for resonance at 20 kilocycles is approximately 5 inches. This reproducer is shown in Figs. 1A and 2, clamped for support at its nodal midpoint and strongly magnetized by an additional direct current magnetic field. In general this simple type of magnetostriction reproducer is unsatisfactory because of extreme eddy-current heating. Further, this particular bar, having an o.d. of one-half an inch, has a poor match with the air load. Better loading may be obtained with the addition of a larger diameter thick disc at one end.

The piezoelectric reproducer, illustrated in Figs. 1B and 4, consists in a 3.5 megacycle X-cut quartz plate cemented between two identically di-

(Continued on page 118)

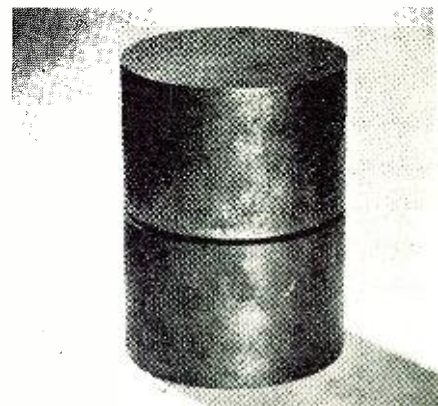

Fig. 4. The piezoelectric reproducer.

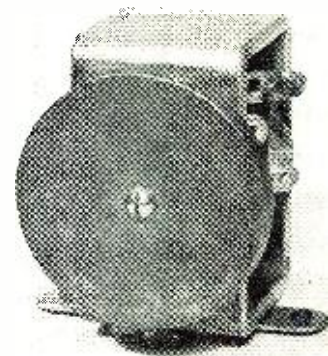
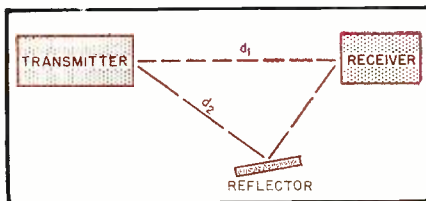

Fig. 5. Dynamic reproducer.

Fig. 6. Mechanically resonant microphone.



Fig. 7. When sound-waves along paths  $D_1$  and  $D_2$  arrive at the receiver out of phase, as can occur as shown in diagram, fading and phase distortion occur.



# Practical RADIO COURSE

By ALFRED A. GHIRARDI

## Part 38. Covering the special oscillator pre-selector tracking problems that exist in multi-band, manually-tuned receivers, and methods employed in solving them.

QUITE a variety of oscillator tuning and band-switching circuit arrangements have been developed and used in multi-band manually-tuned receivers. Unfortunately, space restrictions make it impossible to present all of them here. However, descriptions of two general arrangements that have been widely used (with only slight modifications) in the receivers of various manufacturers—one mostly in 2-band receivers and one in 3-band receivers—will serve to outline the general way in which the oscillator tracking and band-switching problems have been solved for each tuning band.

Fig. 1 illustrates a popular oscillator tuning coil, band-switching, and oscillator-preselector tracking arrangement that has been used in many 2-band receivers employing a tapped-coil system for multi-waveband coverage. For reception on the 540 to 1720 kc. broadcast-band tuning range provided in this particular receiver, the four band switches shown are thrown over to the "B" contact. This places

Fig. 1. Band-switching, tuning, high-frequency trimmers, and low-frequency padder arrangements employed in oscillator of a two band receiver using tapped coil system (Philco model 42-322).

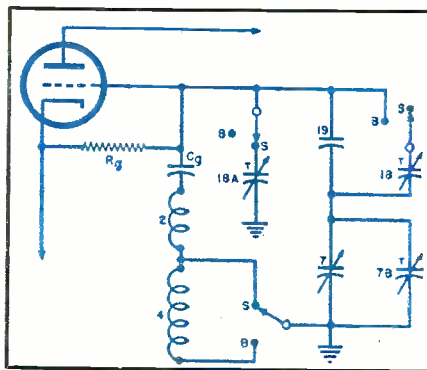
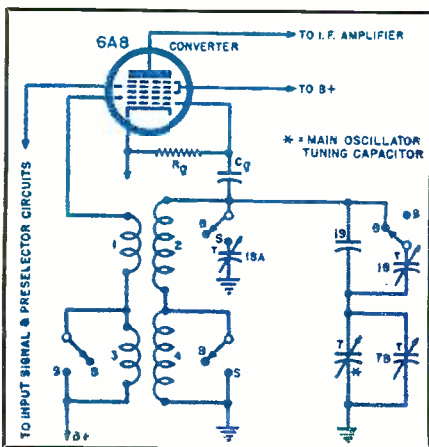

Fig. 2. Leaving portion 4 of the tuning coil open, as shown, when the short-wave band is being used has disadvantages over that of shorting the coil, illustrated in Fig. 1, as discussed in the text.

the full tickler winding (1 + 3) in the plate circuit (the second grid acts here as the plate of a triode oscillator), and the full secondary winding (2 + 4) in the tuning circuit. The full secondary is tuned by a combination made up of fixed low-frequency padder 19 shunted by adjustable broadcast-band padder 18, all in series with main oscillator tuning capacitor 7 shunted by its broadcast-band, high-frequency trimmer 7B. (Notice the similarity between this circuit arrangement and that of the fundamental "padder" circuit illustrated in Fig. 3 in the installment of this series that appeared in the September 1945 issue of RADIO NEWS.)

The manufacturer's aligning and tracking instructions specify that broadcast-band, high-frequency trimmer 7B and the similar one on the preselector tuning capacitor section (not shown) are to be adjusted to obtain correct oscillator-preselector tracking at the high-frequency end of the broadcast-band. The broadcast-band, low-frequency adjustable padder 18 must be adjusted at a preselector

frequency of 580 kc. in order to correctly tie down the oscillator tracking at the low-frequency end. Tracking will then be close and satisfactory all over the broadcast band.

For reception on the 8.7 to 15.5 mc. short-wave band provided in this receiver, the four band-switches shown are thrown over to the "S" contact. This shorts out portion 3 of the tickler coil and portion 4 of the secondary, leaving only portion 1 of the tickler and portion 2 of the secondary in the circuit. Padder 18 is now out of the circuit and adjustable short-wave high-frequency trimmer 18A is shunted across the tuning coil 2. Fixed series padder 19 still remains in series with the main tuning capacitor 7 that is shunted by its broadcast-band trimmer 7B. Short-wave high-frequency trimmer 18A, and a similar one across the short-wave preselector tuning coil (not shown), are to be adjusted for correct tracking at a preselector frequency of 15 mc. No means for adjustment of the padder capacitance is provided or necessary for the short-wave band.

A somewhat similar band-switching and oscillator tracking arrangement is used on many 3-band receivers that employ the tapped-coil system for multi-waveband coverage.

### Why Unused Portions of Tapped Tuning Coils are Shorted by Band-Switch

We will digress from our discussion of oscillator tracking for a moment, to consider an important detail in connection with the use of tapped tuning coils in multi-band receivers. It will be noticed that the lower portion, 3, of the full oscillator tuning coil is shorted out by the ganged waveband switch when it is set for short-wave operation, as is also the lower portion, 3, of the plate tickler coil. The tuning coil might have been tapped, of course, and its lower end left ungrounded; then the lower terminal of main tuning capacitor, 7, could have been arranged to be switched either to the lower end of tuning coil 4 for broadcast-band reception, or to the tap for short-wave reception, thus leaving the unused portion of the tuning coil open as shown in Fig. 2.

At first thought it would appear that leaving the unused portion of the tuning coil open would be better than shorting it, since experience has taught us that even one or two shorted turns in a tuning coil are undesirable. However, there is good reason for shorting coil 4, as we shall see. If an appreciable part of the coil is left open, the capacitance (both distributed and due to circuit wiring, shields, etc.) across this portion of the coil is likely to resonate it to a frequency in or near the desired short-wave band. If this occurred, it would greatly reduce both the sensitivity and selectivity over part of the short-wave band. In addition, coil 3 would most likely resonate at one frequency and coil 4 at a different frequency. This would throw the oscillator so badly out of track with the preselector circuits that it is doubtful if any signal at all would be received at certain frequencies. Spoiling the oscillator tracking is much more serious than spoiling the alignment of the preselector tuned circuits with each other. Another important thing to consider is that if the resonant frequency of the unused open portion of the oscillator coil happened to fall in the desired short-wave band, it is probable that the energy absorption would be so great that the oscillations would stop entirely. Now, if one unused turn of a coil is shorted it is very serious, for a comparatively large current will flow in the shorted turn and this will absorb power from the remainder of the coil and also seriously alter its effective resistance and inductance. If two unused turns are shorted, the effect is *less* serious because while the total voltage induced in the two turns is almost twice as great, the inductance of these two turns is *four* times as great as for one turn (inductance is nearly proportion-

al to the *square* of the number of turns). Consequently the inductive reactance and impedance will be proportionately greater, and the current flowing in the two shorted turns is only *half* what it was in one turn. Accordingly, when there are a large number of unused turns on a coil, the effect of shorting them, as was done in the circuit of Fig. 1, is usually negligible, so the band-switch circuit in multi-band receivers employing tapped coils is always designed to short *all* unused turns on the coils.

Fig. 3 illustrates the tapped-coil system employed in the preselector and oscillator of the 3-band *Stromberg-Carlson* 58 receiver. Note that the waveband switches are of the "shorting" type, designed to short out *all* unused coils when in either of the short-wave band positions,  $S_1$  or  $S_2$ .

### Oscillator Tracking and Band-Switching in Multi-Band Receivers Employing Separate Coils for Each Band

Most multi-band capacitor-tuned receivers, especially those designed to provide reception on 3 or more frequency bands, employ an individual preselector and oscillator tuning coil for each band, as illustrated in Fig. 4. In some of these, the secondary of each individual preselector and oscillator tuning coil is shunted with its own individual adjustable high-frequency trimmer capacitor, and the tuning circuit of each oscillator coil has, in addition, both a fixed and an adjustable low-frequency series padder (the adjustable padder is usually omitted from the tuning coil for the highest-frequency waveband). For each waveband, the circuits and ganged waveband switches are arranged to switch the proper preselector and oscillator tuning coils and individual trimmer

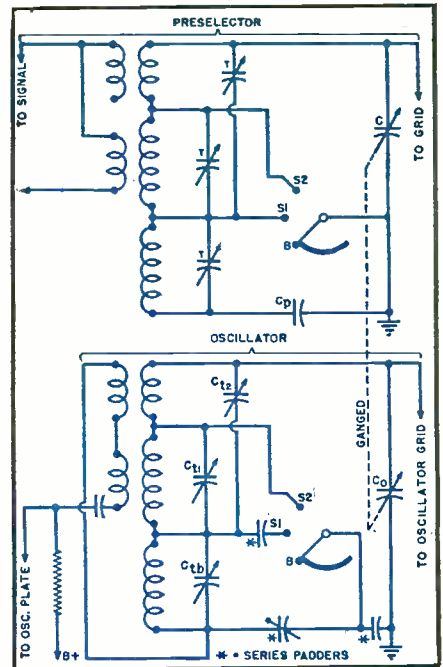

Fig. 3. Preselector and oscillator circuit arrangement employed in 3-band receiver, using tapped-coil system with coil-shortening type band switches (*Stromberg-Carlson* 58).

and padder capacitors into the circuits as units.

Fig. 4 illustrates a typical preselector and oscillator tuning and switching arrangement of this type, as used in the *Fada* model 290 series receivers which provide reception on the regular broadcast band and on two short-wave bands. Capacitors  $C_p$  and  $C_o$  are the main preselector and oscillator tuning capacitors, respectively, and are ganged together for single tuning control.

$B$  is the broadcast-band position of  
(Continued on page 158)

Fig. 4. Tracking arrangement provided in typical 3-band receiver (*Fada* model 290 series), employing individual tuning coils, high-frequency trimmers, and low-frequency padders for each of the three bands.

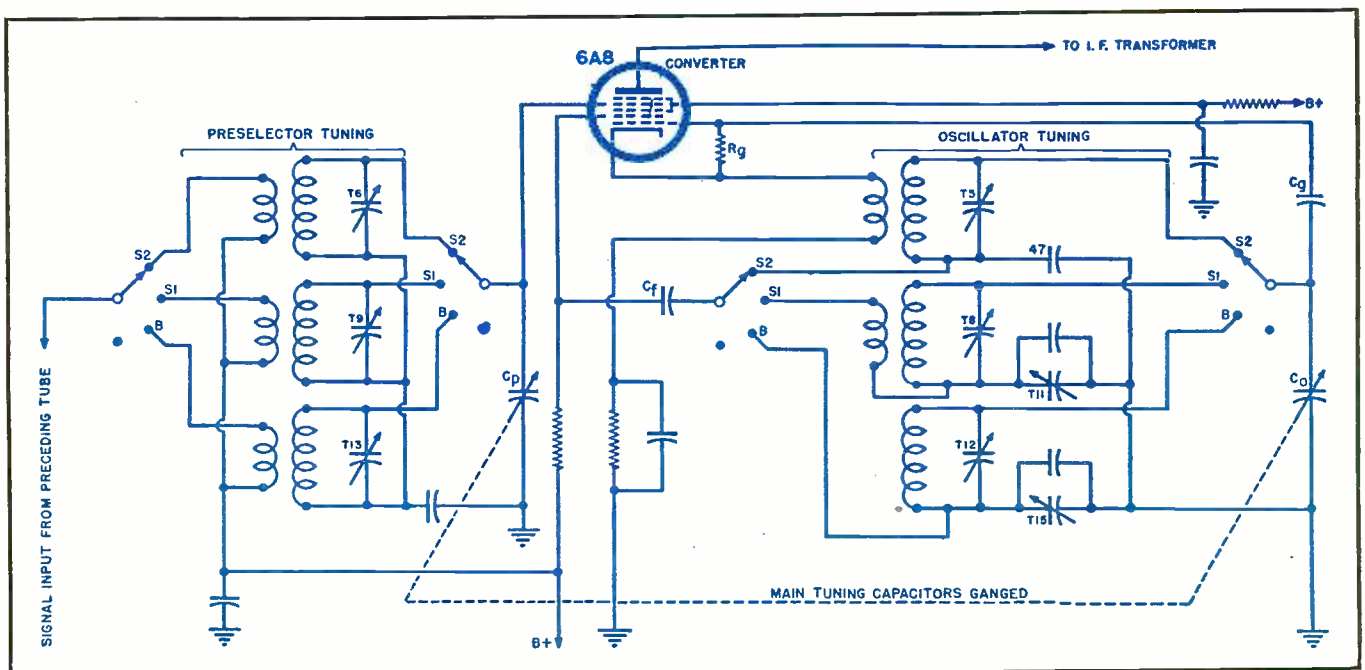



# Hamfesters Picnic

ON Sunday August 5, the Hamfesters Radio Club of Chicago held their 12th Annual Picnic at Dolton, Ill. In spite of wartime conditions and bad weather, the picnic was attended by over 500 persons. Demonstrations of WERS in connection with the CAP were held, using the 112 mc. band to contact planes flying overhead. As is traditional with the Hamfesters, a pie eating contest was held along with the usual games, races, softball game, and other events. Highlight of the day was the prize drawing in which several prizes were given to the lucky ticket holders. Copious quantities of the amber fluid along with many yards of hot dogs, cases of pop, and pounds of hamburger were consumed by the hungry crowd. Now that amateur operation is gradually being resumed it is felt that the club will soon be back to its prewar membership of 400 and arrangements have been made to hold meetings at the former clubrooms at Viking Temple. Plans are already under way to make the 1946 picnic the biggest amateur event ever held.



(1) Command Staff trailer used by the communications section of CAP. (2) The "thirsty" parked near the bar. (3) Most cars had 112 mc. mobile equipment like this typical set-up in W9KBO's car. (4) Major Al Knodell, WSTLQ, and Major Masterton, W9BYQ, of the CAP examine a "handie talkie". (5) Lt. Frank Ryan of CAP talks it over with W9HXW, Prexy of Hamfesters. (6) W9YQH and W9KBO discuss old times. (7) W9JRG holds a QSO. (8) The registration desk was set up to handle a large crowd. (9) "Doc" Kelly, W9MDO, and Higgins, W9AIO, compare notes. (10) W9LRM and W9GET quaff a few. (11) W9FWU gets a few pointers from W9LGU. (12) George Ashton, W9PNV, tries a "handie talkie." (13) Blueberry pie was the main course at event. (14) Hallicrafter's "299" was on display.



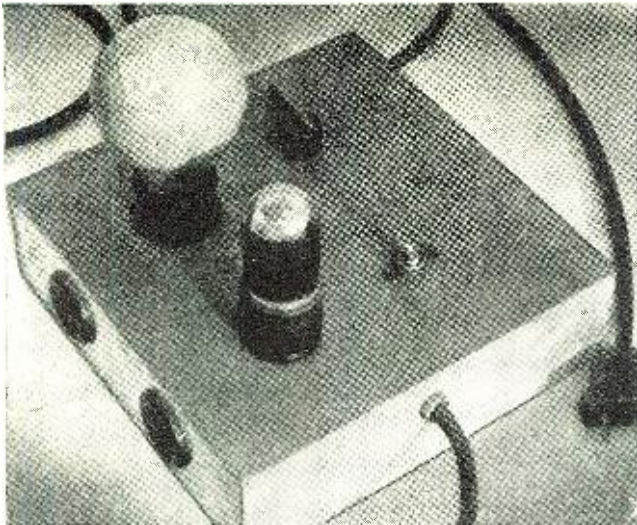

A 40-watt electric-light bulb is used for  $R_4$ . For better engineering practice, use a standard line-dropping resistor.

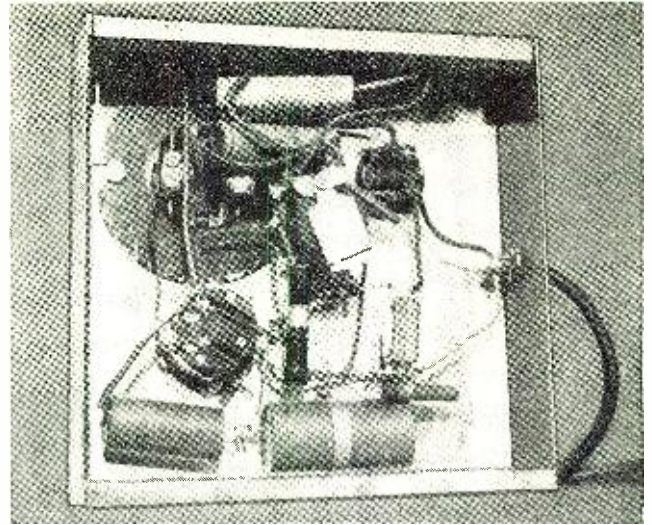

Bottom view of the one-tube electronic timer. A more compact unit may be obtained by employing a smaller chassis.

# ELECTRONIC TIMERS

By SAMUEL A. PROCTOR

*The design and construction of several electronic timers that provide time intervals from .1 second to several minutes.*

THIS device was conceived to meet the need of any operation requiring some simple, inexpensive, and reasonably accurate control of time intervals from .1 of a second to several minutes.

The controlling factors are so arranged that changes in applied voltage have opposing effects on the time interval which contributes to the high degree of accuracy, making it suitable for all operations similar to the timing of photographic prints.

## Operation

Closing  $Sw_2$  turns the instrument on (Fig. 1A). Normal position for  $Sw_1$  is at A, and when in this position, condenser  $C$  is charged by the rectified IR drop across the circuit composed of  $R_5$ ,  $R_4$ , and relay; current in this circuit energizes the relay, holding it closed and applying power to outlet-2. In this position, voltage on the control grid of the tube is low and its conductance is high.

Throwing  $Sw_1$  to position B, places condenser  $C$  in another circuit composed of  $C$ ,  $R_1$ , and  $R_2$ . This is a closed RC circuit and the condenser  $C$  begins to dissipate its charge through the associated resistors in the circuit. The IR drop thus developed is applied to the grid of the tube.

This voltage is negative with respect to tube's cathode and considerably higher than cutoff. In this condition the tube passes no current

and the relay releases its armature, which is the arm of a s.p.d.t. switch, energizing outlet-1. The relay remains in this position as long as the negative voltage on the grid is high enough to keep tube current below the required amount to close the relay. As a result of the condenser discharging through the resistor network, the grid voltage drops low enough to allow the tube to pass sufficient current to energize the relay, breaking circuit to

outlet-1 and making circuit to outlet-2. The length of time the tube is in a nonconducting condition is determined by the capacity of the condenser  $C$ , the resistance in the CR circuit, the quantity of charge in the condenser, and the characteristics of the tube. Only one of these factors is a variable, resistance  $R$ , a variable resistance of high ohmic value and the higher we make it the longer it will take  $C$  to

(Continued on page 66)

Fig. 1. Diagram of 1- and 2-tube electronic timers. 25L6, 35L6, or 50L6 tubes are all interchangeable in these circuits, providing the filament dropping resistor is changed.

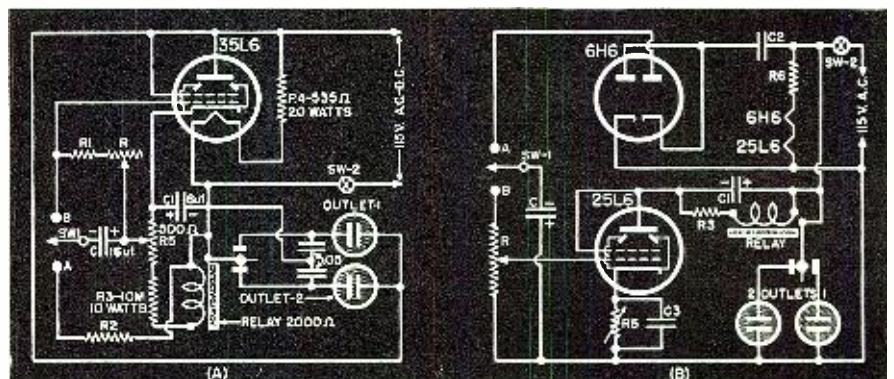

$C_1$ —16  $\mu$ fd. low-leakage type 150-v. elec. or paper cond.  
 $C_2$ —8  $\mu$ fd. @ 150-v. elec. cond.  
 $C_3$ —25  $\mu$ fd. @ 25-v. elec. cond.  
 $R_1$ —500,000-ohm pot.  
 $R_2$ —10,000-ohm, 1/4-w. res.

$R_3$ —10,000-ohm, 10-w. res.  
 $R_4$ —535-ohm, 20-w. res.  
 $R_5$ —500-ohm, screwdriver adjustable pot.  
 $R_6$ —280-ohm, 30-w. res.  
 $SW_1$ —S.p.d.t. toggle sw.  
 $SW_2$ —S.p.d.t. toggle sw. or mounted on pot.  
 $Relay$ —S.p.d.t. sw., 2000-ohm, 10-ma. max.

# THE ROAD TO HAMDOM

By

**S/Sgt. GEORGE  
MOBUS, W9UAO**

***Hams "to be" will find  
these valuable facts of  
the utmost importance.***

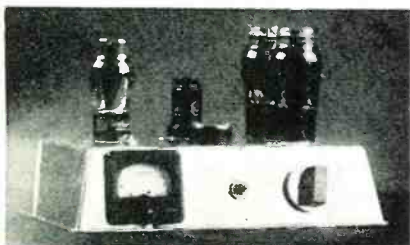

The use of a cake pan for the chassis offers the beginner a neat and attractive type of construction. Many an amateur can look back to his first assembly with pride.

**S**O YOU want to become a radio amateur—a ham! Well, that is a laudable ambition. It takes brains to be a ham operator! Skill is a prerequisite also and if you do not want to be a lid (that is, a ham who advertises his short-comings), you need plenty of ordinary common sense.

Perhaps you are a young fellow in school. More than likely you are one of the thousands of guys and gals who are wearing the uniforms of the armed services and have received training in some phase of military communications and your radio appetite has been whetted by the experiences you have had.

Regardless of who you are or what you are, you are possessed of one desire, that is to capture the thrill of communicating by radio—two way—through your own station.

There are a lot of thrills in this fast-moving, action-packed world of ours today. However, it is not necessary to go "a-roamin'" to find one of the greatest. The radio amateur has the world at his finger-tips. No need for him to stir out of his cozy "shack"! A switch thrown—a dial turned, and

Juan Valdivieso in Lima—Wang Lin in Canton—Tommy Atkins in London—all are with him. Distance and language are no barriers to the radio ham. Amateur radio is international. By the use of a few easily learned "Q" signals, standard throughout the world, an English speaking ham can converse intelligibly with a Chinese ham whose sole knowledge of the English language consists of the word *okay*.

This *kick* that a radio ham gets from communicating with far-away places is not the only benefit he derives from his hobby. A sense of accomplishment, to a large degree, is his if he has, with his own hands and with his own "know-how," planned and constructed his station.

Yes, there are hams and there are hams! I knew a fellow once, in school, who worked hard to get his code speed up, studied the question and answer book till he had it memorized and upon passing the exam received his class "B" ticket. His old man laid out the cash for a powerful, all-band xtal transmitter, a communications receiver as big as the kitchen stove, and an antenna system WLW would be proud to have in their back yard. This guy had a couple of pals, skilled in radio, who were kind enough to install and tune up the equipment and in no time flat he was sitting back and collecting QSL cards from all over the world.

There was another fellow who was bitten by the bug because he got too near a radio-parts catalog. This budding bane of the "BCL's" built himself a crystal set and in time, progressing through the one, two, and three tube stages, gradually increased his knowledge and desire to get on the air and set about doing so by building up a simple transmitter, a t.r.f. re-

Convenience of all operating controls with sufficient equipment to indicate performance, characterizes this deluxe ham station.

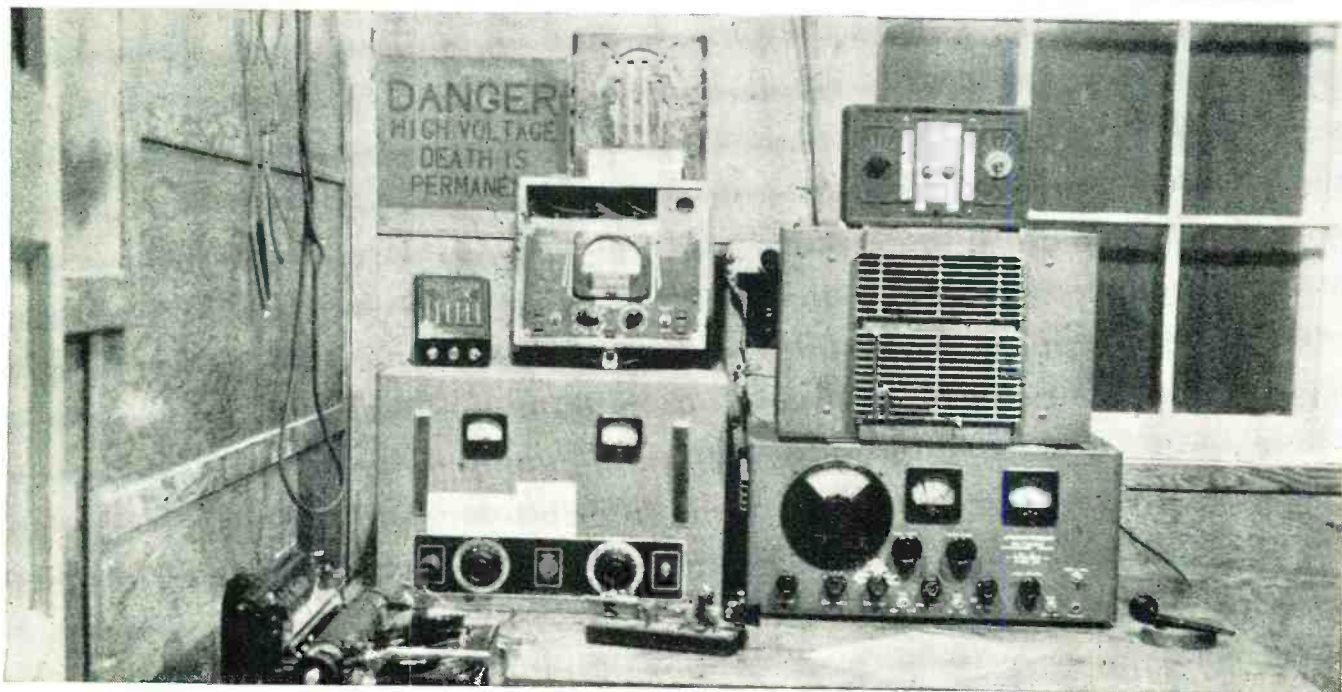



Neatness and a well planned layout characterize this medium powered ham station.

A receiver of the simple regenerative type, designed especially for the beginner.



ceiver, a monitor, and putting up a flat-top. This fellow had a good working knowledge of the gear he was intending to use and had no trouble passing the exam. When his license arrived he went on the air and words cannot describe the thrill that was his when he first heard his call being answered. He had taken a conglomerate mass of parts, panels, tubes, and wire and with his two hands and his personal "savvy" of radio, constructed a radio station of his own.

Which of these two men, do you think, felt the greatest sense of achievement and pride in his hobby?

Without hesitation, I would say that the ham with the home-grown rig had, to the greatest degree, that fine inner feeling of satisfaction which comes with the realization that he has really accomplished something remarkable. He feels, and rightly so, that he is a scientist and an engineer.

Insofar as radio being remarkable—I, personally, will never cease to marvel. When the mercury-vapor rectifier tube glows as the key is closed or the modulation meter swings over in response to my voice and I realize that someone, miles away, is listening to me I consider it a miracle. Not a miracle that the rig is in working order but rather a miracle that such a thing as radio transmission and reception is possible. I will always remember the pleased sensation I had when, with my first phone transmitter, I would throw the switch on to transmit and two "miraculous" things happened. The hall light, outside the room, went out and the porch light went on.

Not many hobbies pay off dividends as does amateur radio. The ranks of high-salaried radio engineers, designers, and operators are filled with men who have come up via the ham band route. The War and Navy Departments have given recognition to amateur radio by bestowing, in many cases, the higher ranks and grades to their radio-men whose records show ham experience.

How can a beginner in this hobby obtain the valuable knowledge and experience that will so much benefit him in the pursuit of pleasure and livelihood? Certainly not by regarding

his endeavors in amateur radio as pure play. He has been given the opportunity to use certain portions of the radio spectrum as his play-ground but in taking advantage of this opportunity he has assumed a responsibility. A part of this responsibility lies in his contributing to the advancement of the art. Surely all will agree that the man who has learned the whys and wherefores of radio transmission and reception by planning and building his own station will be more likely to fulfill his responsibilities than will the man who starts out with little knowledge and considers amateur radio only as a sport with which to while away a few hours each day.

There is much to be said for factory-built equipment. My mouth has watered many a time as I stood and gazed on those beautiful transmitters with their glossy panels and gleaming meter faces. And those wonderful receivers. What they won't do for a weak signal!

Yes, this type of equipment is fine to own and a joy to operate, but a ham should graduate to the stage of ownership of such gear. The beginner in the ranks of hamdom, the fellow who really wants to learn something, should start out by building up his own station—lock, stock, and barrel. Or, rather, transmitter, receiver, and antenna.

What does it take to go "on the air"? Not much. You can work wonders with a twenty-five watt transmitter. As for the receiver, I have seen three tube circuits that, when built up into a receiver, will do more than a number of the superhets of a few years ago. The power supplies are simple enough. You will need at least two—one of 500 to 600 volts output for the transmitter and another of about 250 volts for your receiver. A few dollars will buy the required amount of wire and insulators for both your transmitting and receiving antennas or, for that matter, you can use your transmitting antenna for both purposes.

You will need also a gadget known as a monitor. This piece of equipment will keep you informed at all times as to whether or not your signal is within the limits of the band of

frequencies allotted by the FCC for amateur communications. It will also allow you to hear your own signal and give you a constant check on its quality and the quality of your fist. Nothing elaborate is needed to fulfill the FCC requirements for keeping a continuous check on your frequency. FCC amateur regulation 12.135 reads as follows: "The licensee of an amateur station shall provide for measurement of the transmitter frequency and establish procedure for checking it regularly. The measurement of the transmitter frequency shall be made by means independent of the frequency control of the transmitter and shall be of sufficient accuracy to assure operation within the frequency band used."

Now, some ideas and advice on the construction of your equipment and the assembly of the station.

There is a trend among the more advanced amateurs toward the use of rack and panel assembly. This is good practice since it embraces compactness and neatness plus the desirable feature of short wiring. This type of design is a bit more difficult for the beginning constructor to achieve, however, and also is not so practical for the simple one-stage transmitter. A favorite among both newcomers and oldtimers in ham radio is the "breadboard". This style of design is time-tested. While it may not give you the compactness of rack and panel it more than makes up for this lack by the ready accessibility of all component parts and the simplicity in construction. Care must be taken in the placement of parts on the board since some degree of shielding is desired and also due to the fact that one or two points of high-voltage are bound to be exposed. It cannot be over-emphasized that a radio transmitter, even though it be comparatively low-powered, is a potential lethal machine. If it is found impossible to completely eliminate exposed high-voltage points it is advisable to at least make them as inaccessible as conditions will permit. In addition, the posting of a DANGER—HIGH VOLTAGE sign, lettered in red, near the equipment will successfully prevent strangers, unfa-

*(Continued on page 155)*



By **CARL COLEMAN**

**D.** H. OWENS shipped recently aboard a cargo vessel. . . . J. Telle and C. Wischmann were in at the big town a short while ago and visited their old pals before shipping again aboard their respective ships. . . . O. Halan has taken out a tanker assignment. . . . J. Verberg shipped out on a freighter. . . . Bob Alving called in at the Gulf recently and then re-shipped out aboard his old cargo craft. Bob must like that one. . . . A. Duval arrived from a rather extended voyage aboard his freighter and was in port for some time during the recent wet summer weather. . . . Fred Howe, ROU general secretary-treasurer, sends in a nice letter with some of the latest "dope" therein and reports that everything is going very well and that ROU now has over 3300 members with new men coming in every day. Says shipping is excellent and that they are assigning between sixty and seventy men each week and, from all indications, expect to continue to do so for some time to come. Fred says the shortage of radio officers is somewhat eased but that the experienced fellows are still in demand in the marine field. ROU also reports that good progress is being made in the airways—with agreements already in force with American Export Airlines and Northeast Airlines. At present negotiations are also under way with several other airline outfits. Fred comments that this will be a great field for radio officers now that the war is over and it should not be overlooked. It will provide high wages and excellent working conditions for the ambitious radio officer. Fred also reports new shipping agreements with Marine Transport and Barber Asphalt tankers with the new tanker pay scale having been

made retroactive to October 1944. New cargo agreements have already been signed with about fifteen outfits. Mr. Howe wishes us to call your attention to the new west coast office which was opened this last spring at 105 Market Street in San Francisco with representative Ralph D. Finch in charge. Mr. Finch was with ROU in New York for over a year. S. E. Douglass has been assigned to the Boston office which has been reopened after a long period of time. The office is at the same old stand at 170 Summer Street.

**U.** S. MARITIME COMMISSION reports that for the first time since November, 1942, the production of merchant ships from American shipyards fell below the 100 mark. . . . WSA reports that the November, 1942, output was eighty-nine ships; largest amount was during December, 1943, with a total of 219 ships, and 2,058,893 tons. With V-J day now here it looks as though the shipbuilding throughout the country will taper off somewhat slowly. However, it appears that for many months, if not at least several years, we will have good shipping. The nations overrun by the axis pow-

ers and the powers themselves are going to need a lot of food, building materials, etc., for a long time to come until they can get their own factories rebuilt and in operation again. From some of the reports it will take some time for this work to be completed. Of interest to us naturally, good shipping means more jobs for marine radio officers and, as a rule, the better the shipping is the better the pay. More good news for marine radio oprs. came recently with the Matson Navigation Company announcement that a greatly expanded fast freighter service between the mainland and Hawaii will be effected as soon as commercial shipping can be resumed. The new program will cost about twenty million dollars it was reported. All of the company's old freighters will be disposed of and faster equipment will be obtained in order to cut the travel time between the main ports of the west coast and the Hawaiian Islands.

**J.** LINE was in port a short time ago but made rather a quick turn around this trip. . . . Nice letter from Carl Amato up in the islands where he is with AACCS. R. Johansen took out a cargo assignment from the big town. . . . J. Bruglen also went out on a freighter. . . . Leif Hvidsten still reports from the South Pacific, the last jumping off point, but expects to return to these parts before long. . . . T. Tofer was recently assigned to a tanker.

Nice letter from Bill Chamberlain who is RM2C with the Navy in the Pacific and wants info regarding merchant marine. . . . Likewise, J. Watson who is also in the Pacific and looking for some dope on Gallups Is. radio school. . . .

Jack Watt, Roscommon, Mich., is looking for an active organization or union in his locality composed of Broadcast Station operators or engineers (maintenance) holding commercial tickets. Anyone with info regarding this point, kindly contact Jack, address as above. We have already notified a couple of organizations to get in touch with you, Jack.

**T**HE FM business seems to be picking up with still more applications to FCC for permits. Among the latest, Radio Projects of New York has requested authority for two new ones. one to be located in Queens and the other on Staten Island. Very little news from the boys in broadcast work.

**T**HE U. S. armed forces trained about 500,000 radiomen during the war, this includes some 5000 by WSA. Many of this group are operators but the majority (in the forces) are technicians. . . . Now that radar conditions have opened up, the boys are beginning to learn some of the details and the "how does it work" problems are being cleared up. Installations have already started aboard some of the merchant marine vessels and it is apparent that it will soon be aboard

(Continued on page 108)



"Aw shucks, there goes our broadcasting tower!"



# VII EC AMPLIFIERS

By EDWARD M. NOLL

Television Tech Enterprises

**Part 9. An analysis of the design of wide-band video amplifiers. Special tubes and circuit design are necessary for high definition television reception.**

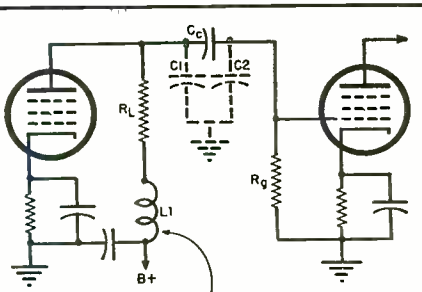

SHUNT PEAKING COIL BROADLY RESONANT WITH C1 & C2 TO EXTEND HIGH FREQUENCY RESPONSE

(A)

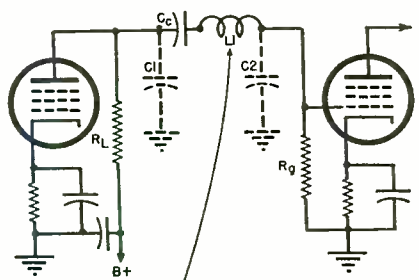

SERIES PEAKING COIL ISOLATES C1 & C2—PERMITS HIGHER RL AND LARGER SIGNAL ACROSS Rg AT HIGH FREQUENCIES

(B)

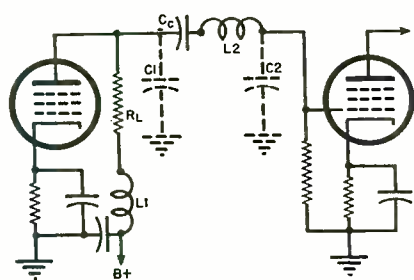

(C)

Fig. 1. High frequency compensation. (A) Shunt peaking. (B) Series peaking. (C) Combination of shunt and series peaking.

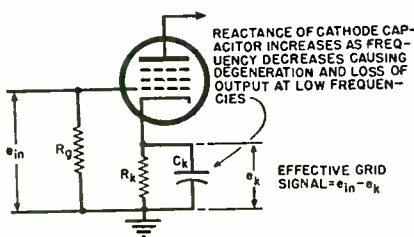
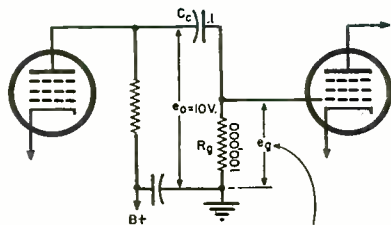

Fig. 2. The effect of the cathode capacitor on the output gain at low frequencies.

★ ★

Fig. 3. Loss of gain at low frequencies.



VOLTAGE ON GRID APPROXIMATELY EQUAL TO 10 VOLTS AT 1000 CYCLES BUT DECREASES AS REACTANCE OF COUPLING CAPACITOR INCREASES

**T**HE video amplifier is a resistance-coupled amplifier with necessary refinements to extend its frequency range. Video amplifiers used in critical television transmitter or test equipments have a linear response from almost zero cycles to as high as five or ten megacycles. The ordinary audio amplifier is lucky to have a linear response from one hundred cycles to six thousand cycles. A high-definition television receiver will have a linear response from 20 cycles to four megacycles; the smaller television receiver from 30 cycles to 2 or 2½ megacycles. A set with a large picture tube generally has a video amplifier with a broad response because the tube can more fully utilize the high-frequency components of the signal. In so doing, a sharp, well-defined picture appears on the fluorescent screen.

In the resistance-coupled amplifier and in the video amplifier, capacity limits both the high- and low-frequency characteristics. Low-frequency degeneration is caused by the increasing reactance of the series coupling capacitors; high-frequency degeneration, by the decreasing reactance of distributed shunt capacity (tube input and output capacities, wiring capacity, and parts capacity to ground). The video amplifier has the following features:

1. High mutual conductance tubes.
2. Tubes with low input and output capacities.
3. Low value plate load resistors.
4. Large value by-pass and coupling capacitors.
5. High-frequency compensating circuits.
6. Low-frequency compensating circuits.

7. An occasional direct-coupled stage (no interstage coupling capacitor).

8. Proper positioning of component parts to reduce distributed capacity.

The effects of capacity on the high- and low-frequency limits can best be demonstrated with simple mathematics. For example, the effects of shunt capacity on 1000 cycles and 1 megacycle can be clearly demonstrated by calculating the output voltage of a vacuum-tube circuit which has two milliamperes of alternating plate current. See Fig. 5. Output voltage, of course, is equal to the alternating component of plate current, times the load impedance. Consequently, in a plate circuit using a 100,000-ohm load resistor and having a total distributed capacity of 40 μμfd., the output voltage for a 1000-cycle, 2-ma., component of plate current is:

$$e_o = i_p \times Z_L$$

$$e_o = .002 \times \frac{R_L \times X_c}{\sqrt{R_L^2 + X_c^2}}$$

$$e_o = .002 \times \frac{10^5 \times 4 \times 10^6}{\sqrt{(10^5)^2 + (4 \times 10^6)^2}}$$

$$\therefore e_o = 200 \text{ volts approx.}$$

Output voltage for a 1-megacycle, 2-ma., component of plate current is:

$$e_o = i_p \times Z_L$$

$$= 8 \text{ volts approx.}$$

This represents a voltage differential of 192 volts, or the gain of the stage drops 96% at one megacycle in comparison with the gain at 1000 cycles. It is clear how little the shunt capacity affects the lower frequencies (output determined primarily by the

Fig. 4. Low frequency compensation.

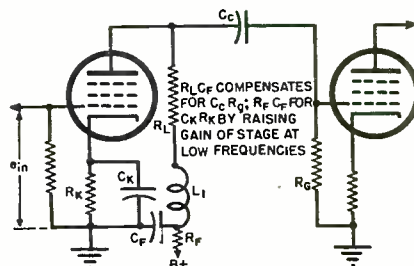
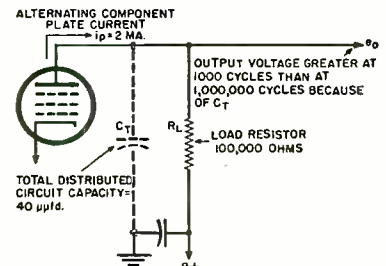
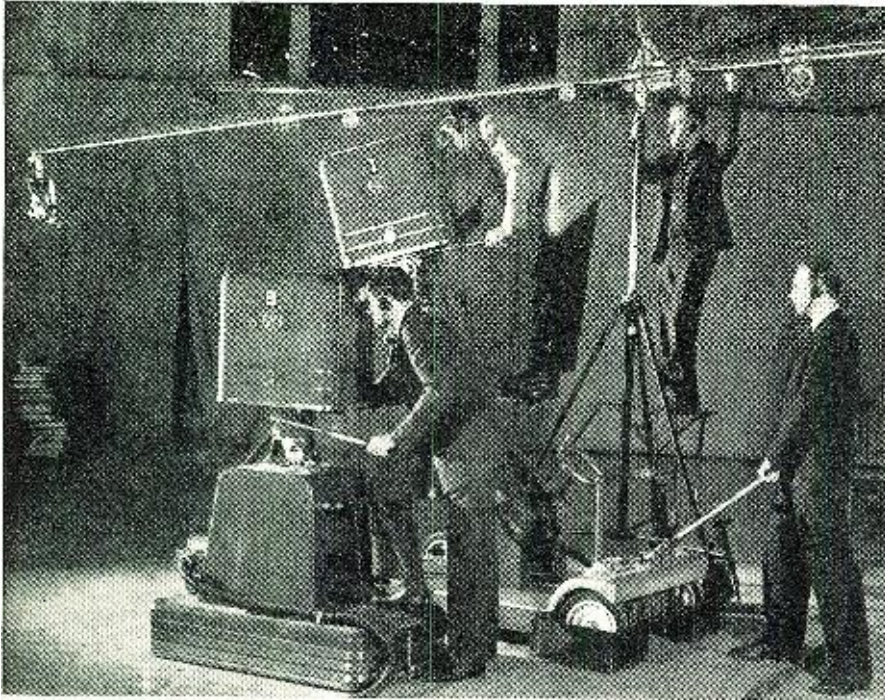

Fig. 5. Loss of gain at high frequencies.





Camera and boom at General Electric's television station WRGB at Schenectady, N. Y.

value of the resistor at these frequencies), but how dominant it becomes at the high frequencies.

If the value of the plate resistor is reduced to 4000 ohms, the effect of the shunt capacity is minimized. Now, under the same conditions, the output for a 1000-cycle component is:

$$e_o = i_p \times Z_L$$

$$e_o = \frac{.002 \times 4000 \times 4 \times 10^6}{\sqrt{4000^2 + (4 \times 10^6)^2}}$$

$$= 8 \text{ volts approx}$$

The output for a one-megacycle component is:

$$e_o = i_p \times Z_L$$

$$= \frac{.002 \times 4000 \times 4 \times 10^3}{\sqrt{4000^2 + (4 \times 10^3)^2}}$$

$$= 5.65 \text{ volts approx.}$$

This represents a voltage differential of 2.4 volts, or 30.3% drop in output voltage at one megacycle. Although the response has been leveled off, the gain is much less. Therefore,

a tube with a high mutual conductance (measure of how effective a tube is in converting a grid voltage variation to a plate current variation) is used to obtain the greatest possible variation in plate current. The greater the plate current variation, the greater will be the output voltage developed across the low plate resistor, which must be used, of necessity, to prevent high-frequency degeneration. Thus, response can be improved by keeping shunt capacity to a minimum and reducing the value of the load resistor. Gain can be increased by keeping shunt capacity to a minimum (permitting insertion of a higher load resistor), and by using a tube with a high mutual conductance.

A similar example can be used to demonstrate low-frequency degeneration by series coupling capacitors. See Fig. 3. In this circuit, the coupling capacitor has a value of .1  $\mu$ fd. and the grid resistor a value of 100,000 ohms. Now, at 1000 cycles, the reactance of the coupling capacitor is approximately 1600 ohms, and there is only a tiny voltage drop across the capacitor

of the series resistor-capacitor voltage divider, consisting of the coupling capacitor and grid resistor. Thus, if 10 volts appears in the output,  $e_o$ , of the preceding stage, this voltage, almost in its entirety, appears on the grid of the next tube. However, if the frequency of the 10-volt output signal is thirty c.p.s., the reactance of the coupling capacitor is approximately 53,000 ohms, which is more than one-half the resistance of the grid resistor. Consequently, a greater portion of the 10-volt output signal appears across the capacitor.

The low-frequency response can be improved in two ways; by increasing the value of the capacitor (increased capacity reduces reactance at all frequencies), or by increasing the value of the grid resistor so that a greater percentage of the total voltage applied to the series combination appears across the resistor even at low frequencies. These methods are subject to a number of limitations. For instance, the value of the grid resistor may not be increased beyond a certain safe value, set by the manufacturer, to prevent faulty operation caused by excessive gas currents. Another limitation is the fact that certain tubes in television circuits draw a limited amount of grid current. The excessively high grid resistor would develop too large a negative bias. Capacitor value can not be increased too much for the d.c. leakage increases, and the increased capacity to ground of the physically larger capacitor reduces the high-frequency response.

A second factor which causes low-frequency degeneration is the increasing reactance of the cathode by-pass capacitor as the frequency decreases. For example, if a 10  $\mu$ fd. by-pass capacitor shunts a 400-ohm cathode resistor, Fig. 2, the capacitor's reactance is 16 ohms at 1000 cycles, but, at 30 cycles, it jumps to 530 ohms. The cathode by-pass capacitor is actually a filter capacitor, as it levels off and fills in any audio frequency variations appearing across the cathode bias resistor. Now, to be an effective filter, the reactance of the capacitor at the prescribed frequency must not be greater than 1/5 the value of the resistor it shunts. In our example, this reactance is only 16 ohms at 1000 cycles and, consequently, it effectively filters any 1000-cycle variation attempting to appear across the cathode resistor. However, at 30 cycles, this reactance is even larger than the value of the cathode resistor, seriously reducing the effectiveness of the filter action. Thus, at 30 cycles, there is a considerable variation across the cathode resistor. Since the effective signal voltage appearing on the grid of the tube is measured from grid to cathode, this variation,  $e_k$ , across the cathode resistor, subtracts from the grid signal,  $e_{in}$ , reducing the effective grid signal to some value less than  $e_{in}$ . Consequently, less output appears in the plate circuit at 30 cycles than at 1000 cycles ( $e_{in}$  equal at both frequencies) at which freq.  $e_k$  is negligible.

Fig. 6. Schematic diagram of G.E. model 90 video amplifier. Frequency compensation is obtained by properly utilizing various inductors and capacitors.

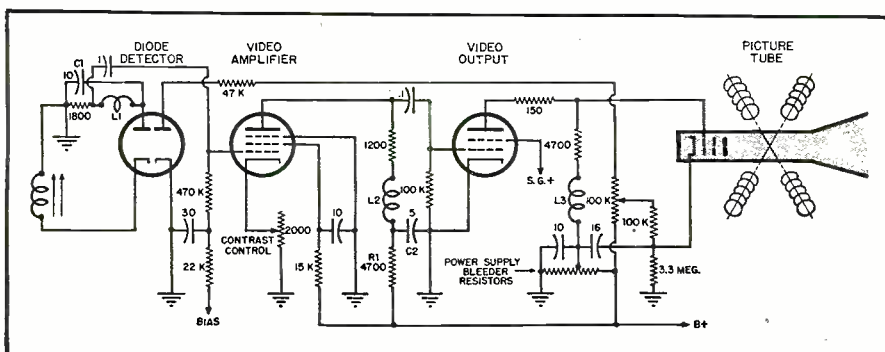

*Enduring Accuracy  
in Vital R.F. Applications*



# OHMITE RESISTORS & CHOKES

The unique characteristics of these Ohmite units have made them especially suitable for many r.f. applications. Proved by use before war came . . . they are performing vital functions today in the production and operation of critical equipment. Tomorrow—they will be more popular than ever!

**GLASS-SEALED NON-INDUCTIVE DUMMY ANTENNA RESISTORS**—for testing and measuring power output accurately. 100-watt and 250-watt sizes in variety of resistances.

**R. F. PLATE CHOKES**—single-layer wound on low power factor steatite cores, with moisture-proof coating. Built to carry 1000 M.A. 5 stock sizes from 2½ meters to 160 meters.

**PARASITIC SUPPRESSOR**—small, light, compact non-inductive resistor and choke, designed to prevent u.h.f. parasitic oscillations.

**NON-INDUCTIVE VITREOUS ENAMELED POWER-SIZE RESISTORS**—Useful in wide variety of radio frequency applications. 50-watt, 100-watt and 160-watt stock sizes in many resistances.

*Ohmite Engineers are glad to assist you on any resistance-control problem.*

**OHMITE MANUFACTURING CO.**  
4883 FLOURNOY STREET • CHICAGO 44, U. S. A.

**SEND FOR STOCK UNIT CATALOG 18**

*FREE—Helpful Catalog No. 18. Gives valuable data and information on stock resistors, rheostats, chokes, tap switches and other units. Write for your copy. Address Ohmite Mfg. Co., 4883 Flournoy St., Chicago 44, Ill.*

October, 1945

*Be Right with*  
**OHMITE**

**RHEOSTATS • RESISTORS • TAP SWITCHES**

*Available NOW!*

# VHF RECEIVER KIT with New FM Band



88.6 to 107.6 Mc

115 to 140 Mc

ACORN TUBES • SEPARATE TUNING UNIT

Ideal for Communications Work, Instruction, Training, etc.

A unique 10 tube Concord Kit for FM-AM and VHF reception with a separate tuning unit employing the new acorn tubes. Circuit design is straightforward and simple with no frills or unnecessary components. Extremely compact, sturdy and easily assembled. Has only two controls on the front panel—the tuning control and the volume control. There's a standard headphone jack for output, a switch for change-over from FM to AM, and a power switch in the AC line.

Comes complete with all necessary parts including holes punched and all tubes, wire, solder, hardware, and detailed instructions. Chassis is 10" x 12" x 3" black finish. Dull black panel is 6 1/4" x 12" wide. Two models—CRC-130—Range 88.6 to 107.6 Mc (for the new FM Band), and CRC-140—Range 115 to 140 Mc. Quantity limited—while they last—Use coupon below to order today or to ask for literature giving detailed information and specifications.

**\$54<sup>95</sup>**

Complete with Tubes

## CONCORD RADIO CORP.

LAFAYETTE RADIO CORPORATION

CHICAGO 7, ILL.

901 W. Jackson Blvd.

ATLANTA 3, GA.

265 Peachtree St.

CONCORD RADIO CORP.  
901 W. Jackson Blvd., Dept. E-105, Chicago 7, Ill.

Please ship at once the Concord VHF Receiver Kit—or special descriptive literature—as checked below.

CRC-130—VHF Kit Range 88.6 to 107.6 Mc     CRC-140—VHF Kit Range 115 to 140 Mc     Send literature giving details and specifications

Name.....

Address.....

City..... State.....

A high-frequency compensating circuit, Fig. 1, inserted in the plate circuit of a video amplifier, can be used to sustain stage gain at the same level that it is over the middle range of frequencies, in spite of the decreasing reactance of distributed shunt capacity. The presence of the inductor in the plate circuit, Fig. 1A, forms a low  $Q$  resonant circuit with the total distributed capacity and effectively equalizes the stage gain up to the desired top frequency for which the amplifier is designed. Another way of looking at the same so-called "shunt-peaking coil" system is that the increasing reactance of the inductor  $L_1$ , as frequency rises, balances the effects of the decreasing reactance of the total distributed capacity  $C_t$  ( $=C_1 + C_2$ ), maintaining, through a broadly resonant condition, the plate impedance essentially constant. Series peaking and combination series-shunt peaking, which perform similar tasks, are shown in Figs. 1B and 1C.

With series peaking, a greater gain is obtainable because, in calculating the value of the load resistor, only the plate circuit distributed capacity must be considered, the series inductor  $L_1$  effectively isolating the plate circuit distributed capacity  $C_1$  and the grid circuit distributed capacity  $C_2$ . Consequently, a higher value load resistor can be used without impairing high-frequency response, because the reactance of the distributed capacity does not become appreciable as quickly. The increase in load resistance causes an increase in stage gain. Furthermore, the inductor  $L_1$  and grid circuit distributed capacity  $C_2$  form a broadly resonant series circuit at the high-frequency limits, developing an appreciable voltage across  $C_2$  and  $R_{g1}$ , and therefore, on the grid of the tube.

In Fig. 1C, combination series-shunt peaking is used, effectively combining the advantages of both series and shunt peaking. A still larger value of load resistor can be used, increasing stage gain a bit more.

### How to Improve Low-Frequency Response

With low-frequency compensation, the actual gain of the stage is increased at lower frequencies to compensate for the loss of signal across a grid-coupling capacitor, or low-frequency degeneration caused by insufficient cathode filtering. A typical low-frequency compensated stage is shown in Fig. 4. Capacitor  $C_t$  has an increasing reactance as the frequency decreases and, in combination with load resistor  $R_L$ , causes the plate impedance and stage gain to be greater

Fig. 7. Equivalent output circuit at high frequencies.  $C_t$  is the deciding factor.

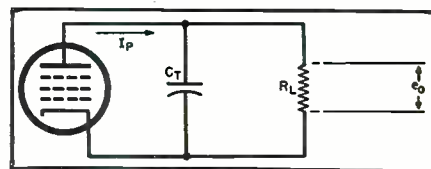

# MORE TUBES RELEASED SOON!

Get Your Share of RCA Tubes—*Order Now*



As the war ends, RCA is immediately ready to make larger and larger quantities of tubes for civilian requirements.

Since it will take some time to satisfy all new set requirements, your customers will have to depend on you to keep their old sets working.

Be sure to make the most of this opportunity by assuring yourself of a supply of RCA tubes. They have been, and will continue to be, *best sellers*—because they carry the *best-known name in tubes*.

Your RCA distributor will see that you get your share of any increased quantities of RCA tubes if he knows your requirements well in advance. You stand to gain a lot if you order your next 60 days' supply of RCA tubes from him *today*.

And remember, it's good business to do business with RCA. It pays to have the RCA name selling for you.

BUY WAR BONDS

Listen to  
"The RCA Victor Show,  
Sundays, 4:30 P. M.  
EWT, NBC Network



62-4626-06

In Metal, Miniature, or Glass,

THE FOUNTAINHEAD OF MODERN

TUBE DEVELOPMENT IS RCA

**RADIO CORPORATION OF AMERICA**

RCA VICTOR DIVISION • HARRISON, NEW JERSEY

LEADS THE WAY...In Radio...Television...Tubes  
Phonographs...Records...Electronics

October, 1945

61

IN TRANSFORMERS...

STANCOR Gives More!



- MORE ADAPTABILITY
- MORE ENGINEERING
- MORE BUILT-IN FEATURES
- MORE YEARS OF SERVICE

MORE than 80% of all radio transformer replacement requirements are met by the Stancor Uni-dapt Power Transformer line—"universally adaptable." The features wanted by radio service men, amateurs, and electronic engineers have been expertly engineered into this transformer line: (1) Ready interchangeability of mounting, assured by four auxiliary mounting brackets permits adaptation to a variety of mounting positions; (2) Heavy insulated leads, tinned for easy soldering; (3) Electrostatic shielding for minimum line interference; (4) Efficient core and coil design plus Stancor quality impregnation provide longer life and trouble-free service.

For transformer replacements, think first of Stancor. Write for details.

STANDARD TRANSFORMER CORPORATION

1500 NORTH HALSTED STREET CHICAGO 22, ILLINOIS



STANCOR UNI-DAPT  
UNIVERSALLY-ADAPTABLE  
REG. U. S. PAT. OFF. PMDG.

POWER TRANSFORMERS

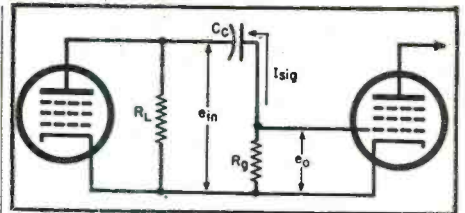

Fig. 8. Equivalent output circuit at low frequencies.  $C_c$  is the deciding factor.

at lower frequencies. Thus, the loss in signal across  $C_c$  at low frequencies is compensated for by a greater plate voltage signal, keeping an essentially constant signal across the grid resistor  $R_g$  with a decrease in frequency. Likewise, the combination of  $R_g$  and  $C_c$  perform the same task with respect to cathode degeneration by raising the plate impedance of the stage in proportion to the loss of signal through degeneration at low frequencies.

#### G.E. Model 90 Video Amplifier

The first frequency compensation encountered in the model 90 video amplifier (Fig. 6) is the diode peaking coil,  $L_1$ , which, in conjunction with the i.f. by-pass capacitor  $C_1$ , plus distributed capacities, forms a broadly tuned resonant circuit to keep the diode response essentially linear up to the high-frequency limit. Shunt peaking, inductors  $L_2$  and  $L_3$ , is used in the plate circuits of the video amplifier and video output stage. Capacitor  $C_2$  and resistor  $R_1$  form a low-frequency compensating combination in the plate circuit of the video amplifier. Low-frequency response is held up by the large coupling capacitors; high-frequency response, by the low-value plate resistors. Since there are no cathode bias resistor-capacitor combinations to cause degeneration in the video amplifier, no correction on this count is necessary.

#### Phase Distortion

Phase distortion in the audio amplifier is not noticeable unless it is severe; the same amount of distortion in a video amplifier seriously impairs its picture sharpness. The reason it is so noticeable is because the beam moves at such a high velocity across the screen that if one frequency component of a signal is delayed a number of microseconds with respect to another, the beam has already sped on an appreciable distance. Thus, if two different frequency components of a signal were originally transmitted with their peak amplitudes occurring at the same instant, phase distortion (referred to as non-linear phase delay) would cause one signal to reach peak amplitude before the other on the grid of the picture tube. Therefore, peak amplitude of one frequency component would be displaced with respect to the other on the picture-tube screen, causing the picture to blur.

Phase distortion can also alter the waveform of a rectangular pulse, for the pulse is composed of a fundamen-

(Continued on page 148)

RADIO NEWS



***In the Frigid Arctic...  
or the Steaming Tropics***

**T**HROUGHOUT our service to the Armed Forces, Eastern has always delivered every piece of equipment to the highest Government standards. Now Eastern's wartime "proving ground" is converted to simulate normal *peacetime conditions* in our laboratories, assuring you of

precision, quality and performance.

Every product bearing the Eastern trade mark will conform to the most exacting requirements. The Eastern Amplifier line will include standard items and many exceptional innovations. For complete details, write our Sales Manager, Department 10-E.

*Buy War Bonds*



U. S. Reg'n. Applied For

**EASTERN AMPLIFIER CORPORATION**  
794 EAST 140th STREET • NEW YORK 54, N. Y.

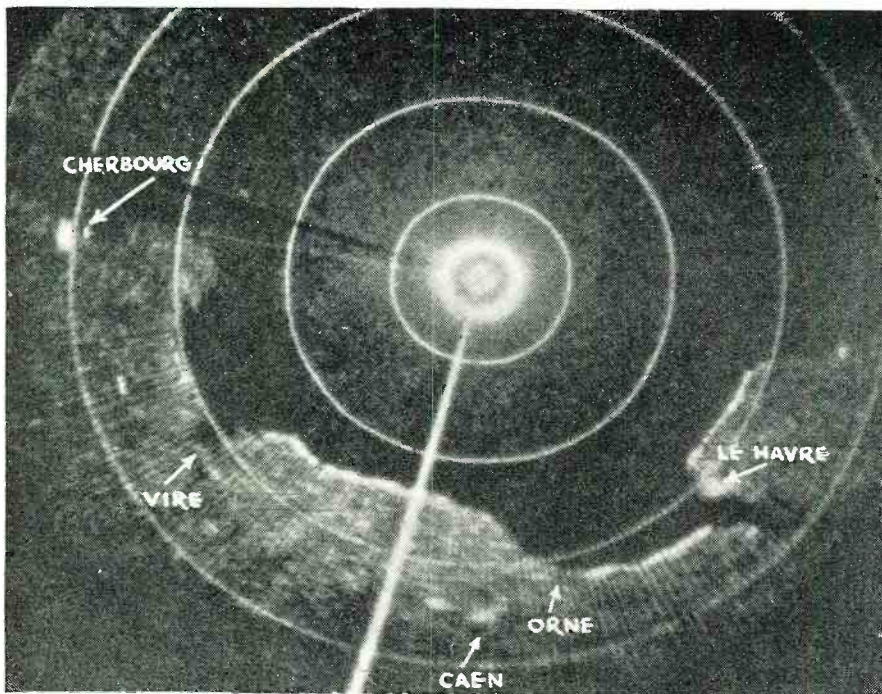

Fig. 1. Normandy beaches looked like this in the radar scopes of Eighth Air Force bombers during the pre-invasion reconnaissance flights. Despite solid clouds, coastline and built-up areas of the various towns showed up clearly.

# Radar Plots the Invasion

By EUGENE MASON

*Presenting for the first time historical radar photos of the Normandy beachhead invasion. Radar has proven to be the greatest technical development of this war.*

**R**ADAR'S most extensive use is to portray sea and ground formations far beneath high-altitude bombers and reconnaissance planes. Scanning the earth with its electronic beam, radar draws accurate maps of the land and sea beneath the plane—despite darkness, clouds, or rain. Shown here, for the first time, are actual pictures seen by radar operators in their oscilloscopes, miles above the French coast before and during the European invasion.

Every dot or blur of white has some significance in understanding a radar scope picture. Because each dot of white indicates an object on the ground reflecting the radar pulses. Thus large cities show up brighter than the surrounding countryside. White dots in the English Channel are boats, ships, or low-flying aircraft. Small dots visible inland usually indicate man-made structures. The brilliant white blotch in the center of these pictures shows the position of the plane when the photograph was taken. Concentric circles indicate the range from the plane.

The Normandy beaches looked quiet and peaceful (Fig. 1) during a pre-invasion reconnaissance flight. The cities of Le Havre and Cherbourg are clearly visible in the scope. And the characteristic French seacoast is strongly etched.

The same beaches on D-Day (Fig. 2) look much different. Every dot on the oscilloscope represents one or more invasion craft in the Channel. A few of the white blobs represent planes flying low over the water. Seen from a height of many miles, the radar-equipped plane was about 35 miles from the French coast, its position indicated by the brilliant center spot. Strong elements of the invasion fleet are massed just off shore. But in every direction can be seen the great mass of sea and air power thrown into the D-Day offensive.

The radar-equipped plane has passed over the invasion fleet (Fig. 3) and, at a lower altitude, is about to cross the coastline. The plane, on a

Fig. 2 (left). Same beaches on D-Day as those shown in Fig. 1. Plane has moved to within thirty-five miles of the coast, its position indicated by bright spot in center of scope. Invasion fleet (smaller blobs and grains) is clearly visible massed just off shore. Fig. 3 (center). Even though pilot and bombardier can see nothing, radar operators can tell them just where they are and when to drop their bombs. The photograph shows that the plane has just passed over the invasion fleet and is about to cross the coastline. Fig. 4 (right). Radar operator has turned a switch to obtain a magnified exact picture of a small part of the coastline.

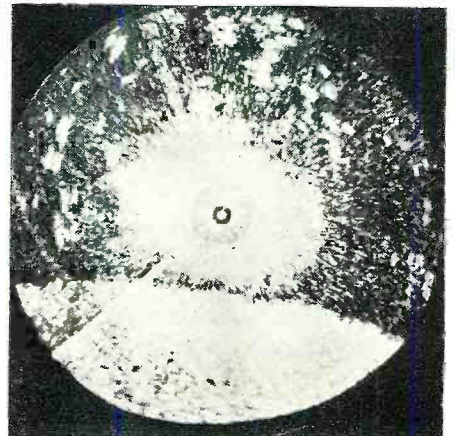
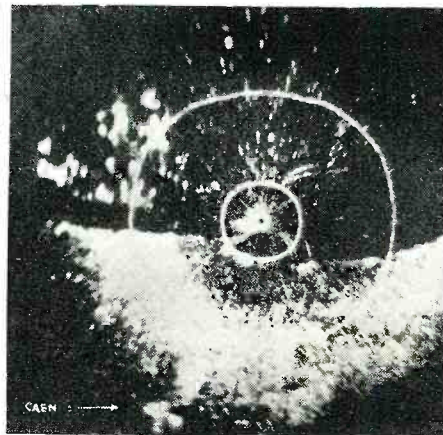
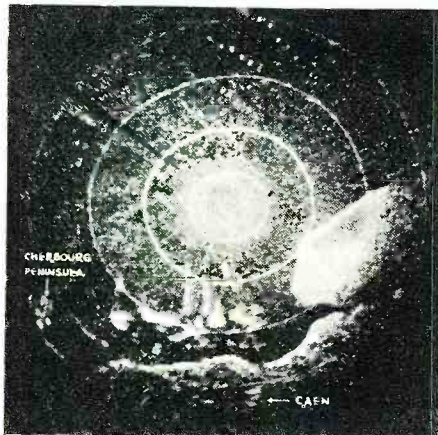



# FIRST AGAIN!

## CORNELL-DUBILIER THE TOP NAME IN CAPACITORS GIVES YOU THIS TIMELY SELLING TOOL

Your customers are tired of inferior merchandise. They certainly won't want shoddy, war-weary surplus. So get off to a good start in the competitive days ahead by sticking to the standard of quality in capacitors . . . Cornell-Dubilier. Put this card in your window, as a mark of reliable service and as proof that you stand by standards.

### FREE

See your C-D distributor today, he will give you one of these handsome, colorful 11x14 displays. If your distributor can't supply you, write to Cornell-Dubilier, New Bedford, Mass. Dep't A.

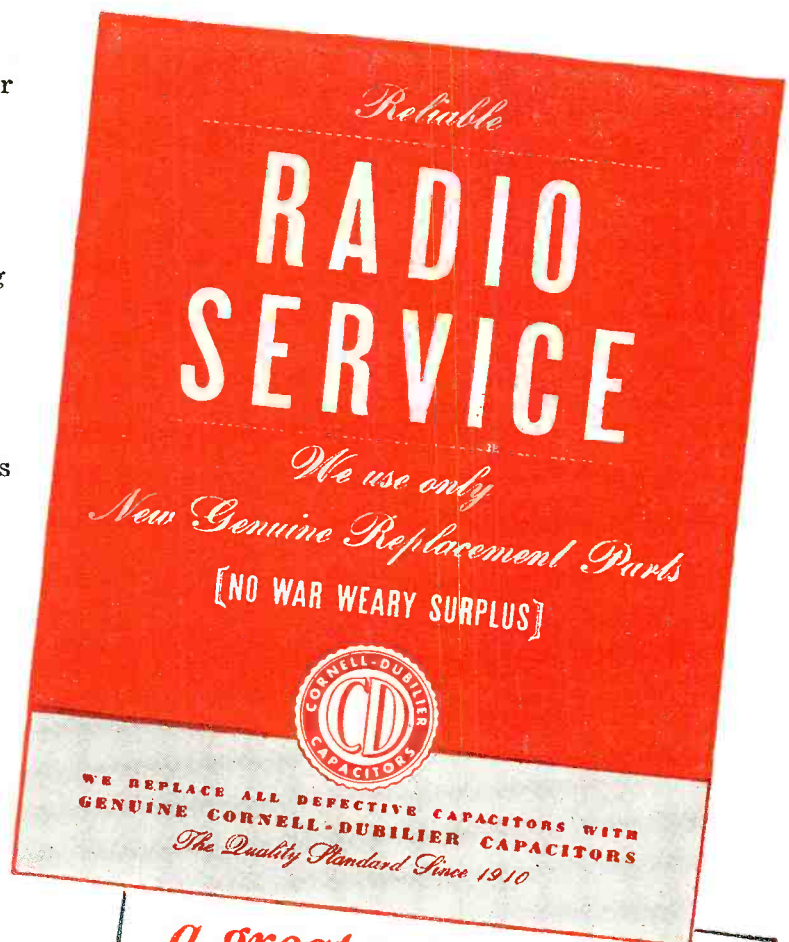

**CORNELL-DUBILIER  
IS READY WITH**

**ALL 3 COMPLETE LINE**

**NATIONAL ADVERTISING  
SALES HELPS**

*a great name in radio*  
**CORNELL  
DUBILIER**  
*the greatest name  
in capacitors*



**THOUSANDS OF  
RADIO OPERATORS  
SAY:**

*"I Can  
Really Hear  
NOW!"*

# MURDOCK

# RADIO PHONES

*"I never knew how much I was missing until I listened with my Murdock Radio Phones. I can really hear now!"*

Ever since 1904 when William J. Murdock patiently built his first radio phones, crystal-clear and reliable reception has been the goal of every MURDOCK craftsman. With MURDOCK equipment, long listening hours become a pleasure instead of a drain on vitality and nerves.

MURDOCK engineers have pioneered many major improvements since the birth of Radio.

The "solid-built" idea, head comfort design, trouble-free operation, and faithful reception are all memorable developments by MURDOCK men of vision. That's why you may be sure that in your choice of MURDOCK Radio Phones you possess the finest, clearest radio phones anywhere!

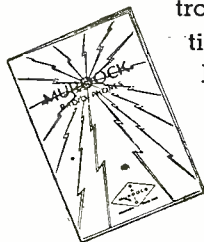

*Write for descriptive catalog today*

## SUB-CONTRACTS WELCOMED

Murdock manufacturing and assembling facilities are available to producers of Radio Phones and related parts. Murdock engineers and craftsmen can help you. Please send your inquiry to

**WM. J. MURDOCK CO.**  
174 Carter St., Chelsea 50, Mass.

bombing mission ahead of the newly established bridgehead, will use radar to locate strategic military objectives. Even though the pilot and bombardier can see nothing, the radar operator can tell them where they are.

Before crossing the coastline, the radar operator flips a switch on his set to obtain a greatly magnified picture (Fig. 4) of the actual bridgehead. The many white dots and blurs—though difficult to distinguish near the center of the scope—are clearly discernible as invasion barges, boats, and ships.

These are historic pictures—tiny white blobs of light on the face of an oscilloscope that attest to the night of Allied sea and air power.

-50-

### Electronic Timers

(Continued from page 53)

discharge to the point where the tube's conductance will allow sufficient current to flow to activate the relay. This feature provides stepless control over the length of time outlet-1 will be energized.

Accuracy of the instrument will be dependent, somewhat, on line voltage, but the nature of the circuit makes it self-compensating over a reasonable variation in line voltages, since the time interval is a function of both an RC circuit wherein

$$T = RC \log E \frac{1}{1 - e}$$

where  $E$  = initial voltage and  $e$  = voltage after the time interval  $T$ . Then to keep  $T$  constant for a given value of  $C$  and  $R$ ,  $e$  must increase or decrease with  $E$ . The other controlling factor is the conductance of the tube which varies inversely with  $E$ ; then to keep  $T$  constant, conductance must increase as  $E$  decreases, and since conductance of a vacuum tube is a function of grid voltage, which in turn is determined by  $Q$ , i.e. ( $e = Q/C$ ), this factor works out of phase with the CR circuit in its effect on the time interval. An increase of  $T$  in one factor is offset by a decrease of  $T$  in the other.

For purposes of calibration, compensation for changes in components, and wide variations in line voltages,  $R_2$  is in the circuit. It functions to control the point at which the tube conductance will allow sufficient current to flow to activate the relay, and when adjusted to maximum time interval of any particular instrument, all other time intervals will be as accurate as the original calibration.

The associated schematic gives all parts and their functions. Part values will be determined by requirements that any particular instrument is built to fulfill. If values shown in this schematic are used, the time interval can be anything between .1 of a second and 35 seconds.

-30-

# 2 NEW RELAYS

Here are two of the new types of Ward Leonard Relays that are being made available to the trade through Radio and Electronic Parts Distributors.

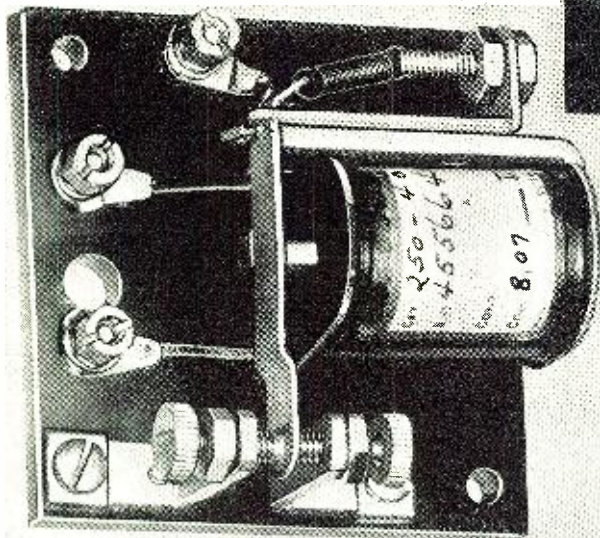
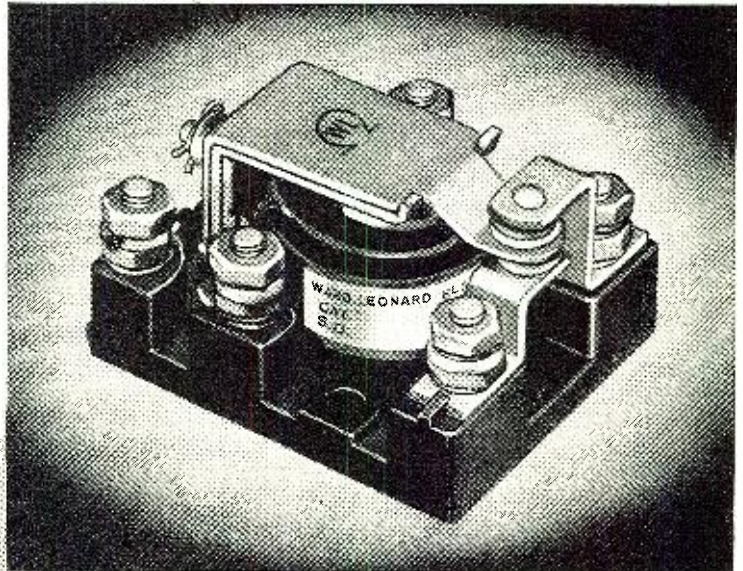

**BULLETIN 250 RELAY** will operate on minute fluctuations of current, and is easily adjustable to meet circuit or application requirements. It is available for operation on either A.C. or D.C.

**BULLETIN 105 RELAY** is useful for controlling small transmitters, public address systems, compressors, and similar devices.

Sturdily built on a molded phenolic base.

Compact in size, Single Pole unit measures  $1\frac{7}{8}$ " wide x  $1\frac{15}{32}$ " long x  $1\frac{1}{2}$ " high; Double Pole unit measures  $2\frac{1}{2}$ " wide x  $2\frac{3}{4}$ " long x  $1\frac{3}{4}$ " high.

Single Pole or Double Pole contacts.

Available for A.C. or D.C. operation.

*New catalogs giving complete data on Bulletin 250 Relays and Bulletin 105 Relays are available.*

*Write for your copy now.*

## WARD LEONARD ELECTRIC CO.

*Radio and Electronic Distributor Division*

**47 West Jackson Blvd., Chicago, Ill.**



**WARD LEONARD**  
ACCEPTED MEASURE OF QUALITY

**RESISTORS  
RHEOSTATS  
RELAYS**

# WHAT'S NEW IN RADIO

## New products for military and civilian use.

The products described herein are available, in most cases, only through high priority ratings. It is suggested that readers apply for further information on company letterheads, stating full details as to priorities available.

### HIGH VOLTAGE RECTIFIER

Chatham Electronics announces a new high voltage rectifier now available. This new rectifier incorporates many of the desirable features of both the mercury vapor and high vacuum types. Xenon gas fill and special features of construction make possible

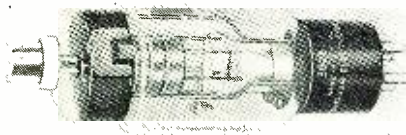

high peak inverse voltage rating, constant voltage drop, heavy current capacity, and a wide ambient temperature range.

The tube is particularly designed to withstand severe mechanical shock and vibration and may be operated in any position. It operates through an ambient temperature range of  $-75^{\circ}\text{C}$ . to  $90^{\circ}\text{C}$ . and the element structure is supported by three heavy gauge rods and additionally supported by contact, through shock absorbers, with the glass bulb.

Characteristics of the tube up to 150 c.p.s. include filament voltage 2.5 volts a.c., peak inverse voltage 10,000 volts, peak anode current 1.0 amp. at 10,000 volts, peak anode current 2.0 amp. at 6500 volts, average anode current 250 ma. at 10,000 volts, average anode current 500 ma. at 6500 volts. Characteristics of the tube up to 500 c.p.s. include peak inverse voltage 6500 volts, peak anode current 2.0 amps., average anode current 500 ma.

This tube is a product of Chatham Electronics, 475 Washington Street, Newark 2, New Jersey.

### SPINTITE TORQUE TOOL

A new tool featuring torque limiting action and torque settings calibrated in inch ounces is now being offered by Skyway Precision Tool Company. It is the Skyway Tork-Tite in a popular spintite style of convenient length, weight, and grip, incorporating a shaft contained in a light housing and floating in bearings.



This design makes possible torque tightening in sensitive inch ounce settings, for it is impossible to bind the

tool by improper use at an angle to the work and thus alter torque. The torque limiting action eliminates possibility of over tightening and guarantees accuracy.

This new spintite torque tool is presented in two models with either fixed or adjustable torque setting. The adjustable model is quickly set to a designed torque reading in the handle and secured with a positive locking device.

This tool is particularly adaptable in fields where sensitive and definite torque accuracy is required for assembly or laboratory work.

Details of this tool may be obtained from Skyway Precision Tool Company, 3217 Casitis Avenue, Los Angeles, California.

### WHEATSTONE BRIDGE

Industrial Instruments, Inc., is now offering a resistance limit bridge working to plus/minus .1%, known as model LB-3. This modified Wheatstone bridge uses a sensitive built-in galvanometer to provide for the high and low indication, respectively. The high and low limit dials cover a range of plus/minus 11% in .1% steps.

The zero on the galvanometer scale acts as a reference point when in nor-



mal operating position. Relays incorporated in the instrument provide for speedy test operation, either from a switch on the panel or one built into the test fixture. A receptacle on the panel provides connections between external switch and internal relays.

This new bridge may be used to check resistors between 1 ohm and 3 megohms. External resistance standards corresponding to the nominal values of the resistors under test are required. For most measurements the

galvanometer and internal 3 volts d.c. source will be found satisfactory. For measurement of resistors above several thousand ohms, and particularly when the resistance range is increased above 1 megohm, an external battery is recommended. For low resistance measurements particularly below 10 ohms, a more sensitive external galvanometer may be desirable, although most measurements between 1 and 10 ohms may be made satisfactorily by using an external  $1\frac{1}{2}$  volt battery.

This new modified Wheatstone bridge is manufactured by Industrial Instruments, Inc., 17 Pollock Ave., Jersey City 5, N. J.

### SOLDER FLUX

Battelle Memorial Institute, Columbus, Ohio, has developed a new solder flux which makes possible the easy soldering of many difficult-to-solder combinations of metals.

According to the institute, this new solder flux is more effective than common rosin fluxes and can be used safely in such applications as electrical equipment and can manufacturing. Although the raw flux has an acid reaction, complete neutralization takes place at soldering temperatures. Its residue is non-corrosive, non-conductive to electricity, soluble in water, and non-hygroscopic, making the flux adaptable to a wide variety of industrial soldering.

This flux may be used in soldering copper, steel, silver, brass, various alloys, and various electroplated parts, such as nickel-plate, silver-plate, and cadmium-plate.

### SELF TIMING INTERRUPTER

A new flasher-interrupter unit which incorporates distinctive design features is being manufactured by Electronic Testing Laboratories.

This new self timing interrupter comprises a miniature but heavy duty relay, an electro-thermal timing device and a non-inductive resistor unit. The unit is extremely compact and all components are incorporated in a single assembly which is light in weight (only 7 ounces). Four studs are provided for mounting on panel, bracket, shelf, etc., with elastic stop units assuring immunity to shock and vibration. The unit is expressly designed to withstand 10 G's in aircraft applications. The flasher-interrupter is normally furnished in open design.

Interruptions can be controlled through a range of from 60 to 80 per minute by varying the current through

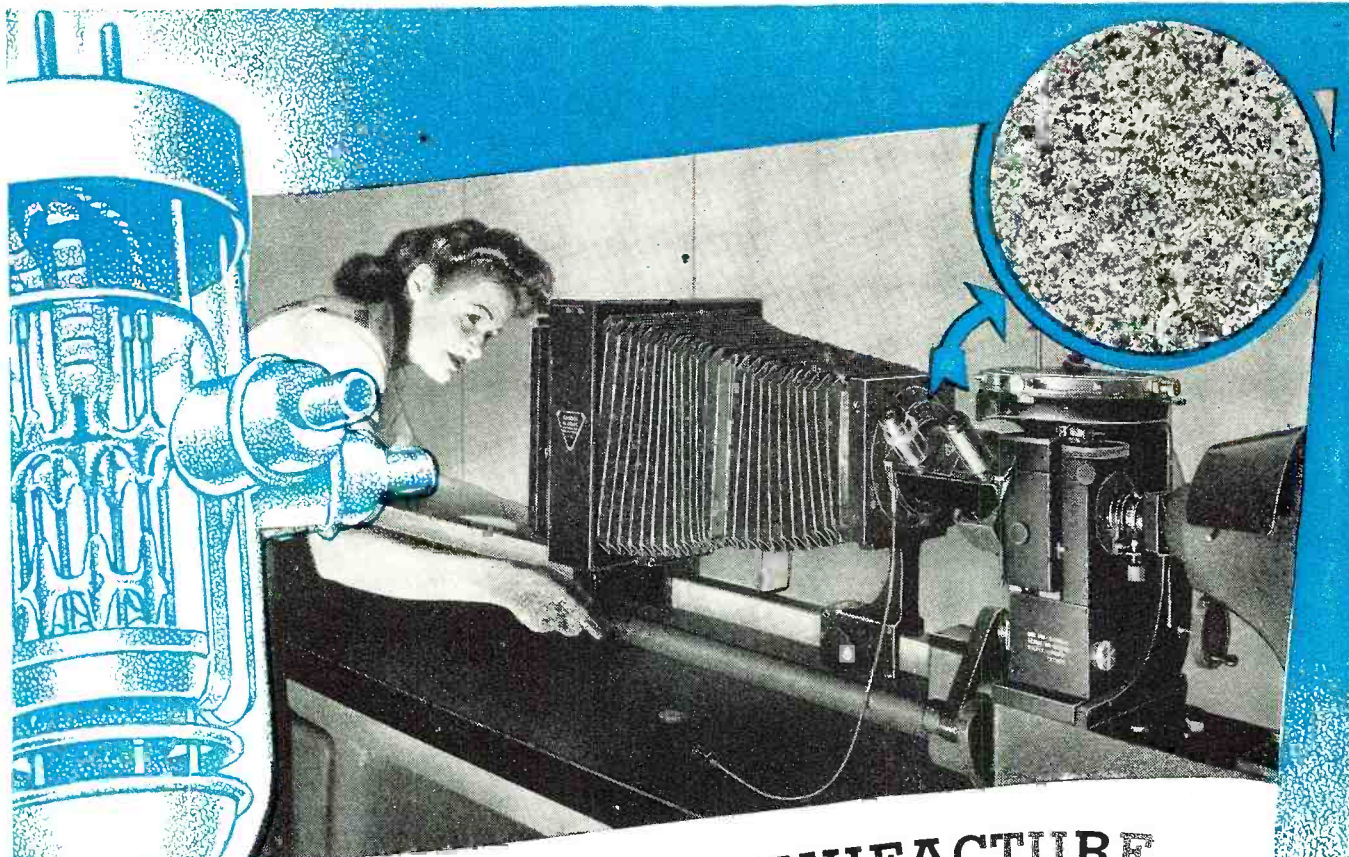

IN TUBE MANUFACTURE  
 ALL SMALL DETAILS ARE **LARGE**  
 TO *Federal*

From slender filament to anode block . . . *all* tube construction details, however small, are important to Federal. That is why this experienced and longtime manufacturer uses the illustrated high-magnification metallograph as part of its test equipment for checking raw material quality.

An example is the micro-photo inset. Here is shown oxide-free, high conductivity copper used for copper-to-glass seals . . . after the material has been reduced to a fine grain, non-porous structure through Federal's special metal-processing methods.

But whether copper, molybdenum or tungsten . . . they all are subjected to the same exclusive treatment and put through the same searching scrutiny . . . assurance that only the finest materials go to make up Federal tubes.

This exacting test is another good reason why Federal tubes are better tubes. Transmitting, rectifier, industrial power . . . they have a reputation that is deserved because they are *built to stay*.

Federal always *has* made better tubes.



*Federal Telephone and Radio Corporation*



Newark 1, N. J.

Send for This Valuable Self-trainer!

# SUCCESSFUL METHOD TO LEARN RADIO CODE

## Radio Operators' Code Manual

By  
WAYNE  
MILLER

THROUGH Wayne Miller's unique sound method, mastery of code transmission and reception can be gained easily and rapidly. This complete self-teaching system trains by means of character sounds and rhythm—develops proficiency in both sending and receiving. Step-by-step lessons are divided into convenient character groups and these are related to the L. C. Smith super-speed typewriter touch system, which the book also teaches. Contains F.C.C. rules and regulations and all other essential information. RADIO OPERATORS' CODE MANUAL is an essential book for every beginner as well as a valuable refresher course for the experienced operator.

- **Conquering the code with rhythm**
- **How to construct code practice equipment**
- **Character sound practice**
- **Sending and receiving practice groups**
- **Touch typing for radio operators**
- **Abbreviations used in radio communications**
- **F.C.C. rules and regulations**

**\$2.00**

USE COUPON BELOW TO  
ORDER BY MAIL



### ZIFF-DAVIS PUBLISHING COMPANY

185 North Wabash Avenue, Chicago 1, Illinois

I am enclosing ..... (check or money order) for which please send me ..... copy(ies) of RADIO OPERATORS' CODE MANUAL, priced at \$2.00 each.

Name .....

Address .....

City ..... Postal Zone .....

State .....

the thermal unit. Operating voltages include all standard a.c. and d.c. ranges and frequencies. Other voltages and frequencies supplied on special order. Normal actuating current is approximately 200 ma.

This unit is available in the follow-

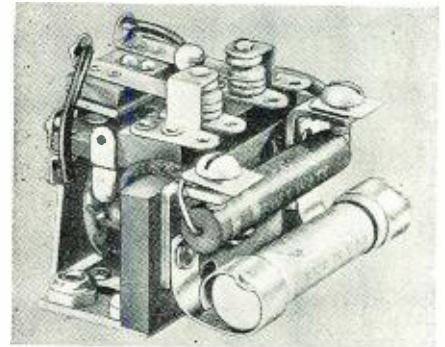

ing contacts: d.p.d.t. 15 amps. (non-inductive) at 32 volts d.c. or 115 volts a.c., or at 5 amps. (non-inductive) to 220 volts a.c.; s.p.d.t.d.b. 25 amps. (non-inductive) at 32 volts d.c. or 113 volts a.c., or at 7.5 amps. (non-inductive) to 220 volts a.c.

Applications for this flasher device include aircraft identification lighting, control circuit as well as marine, industrial, automotive, and railway signalling devices. Its use is suggested whenever a predetermined number of interruptions are desired in any electrical or electronic circuit.

Further information will be furnished upon request to *Electronic Testing Laboratories*, 44 Summer Avenue, Newark 4, N. J.

### WIRE-WOUND POTENTIOMETERS

Produced to Army and Navy specifications, new wire-wound potentiometers used in all major electronic equipment are announced for the first time by *Trefz Manufacturing Company*. This series of PWW-5 wire-wound potentiometers is fully approved under Bureau of Ships RE13A492C specifications, on basis of test performed.

The excellent linearity of both single and dual units makes them readily adaptable to applications using calibrated dials or in circuit arrangements where close series or parallel tracking is a requirement, according to the manufacturer.

Wattage rating is exceptionally high for a standard size unit. An electronically welded instrument spring maintains positive continuity between center terminal and wiping contact.

These potentiometers incorporate

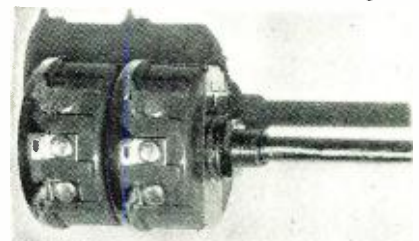

an approved phenolic case which is completely dust proof. When specified, a sealing washer can be furnished

**RADIO NEWS**

# WE HAVE YOU IN MIND, Mr. Radio Dealer

A Personal Message from  
the President of Templetone

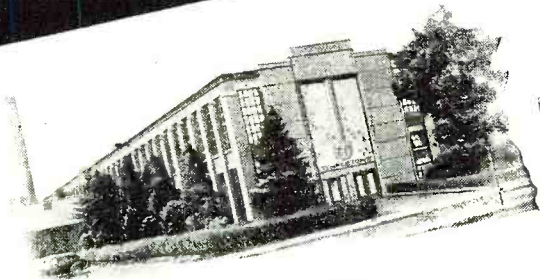

TEMPLE RADIO  
ELECTRONICS

  
**TEMPLETONE RADIO  
MFG. CORP.**

TEMPLETONE BUILDING  
NEW LONDON, CONN.

To you who have already joined the fast-growing circle of authorized Temple Dealers — and to the many other progressive merchants who will follow suit — greetings, and a hearty welcome into the Temple family.

To have earned the Temple Franchise evidences your high standing, integrity, experience and ability, and we at Templetone look forward with confidence to the major role you will play in the Temple picture.

Above all, you are our "front-line", our one and only actual contact with the public — the final judge and eventual purchaser of Temple Radios. To you is given the all-important role of completing the sale. To us is assigned the vital responsibility of providing invitingly-priced, top-value merchandise and sound, far-seeing promotional support that will multiply, over and over again, those completed sales — and multiply, over and over again, your profits. All this — at our command, all of our vast facilities, all of our forward thinking and planning have YOU, Mr. Retailer, foremost in mind.

Both Templetone and its Distributors look forward to serving you, confident that our association will lead to a long and mutually profitable relationship.

Sincerely,



Oscar Dane,  
President  
TEMPLETONE RADIO MFG. CORP.



Where FM will also  
mean Finest Made

between the case and the cover making a hermetically sealed potentiometer when used in conjunction with a water tight panel bushing.

These potentiometers are available with a resistance range of from 1 ohm to 150,000 ohms in both linear and tapered types and shafts can be supplied to the purchaser's specifications. They may also be supplied with switches and with an off position.

Full details of these units may be obtained from the *Trefz Manufacturing Company*, 38-11 Main Street, Flushing, N. Y.

#### VEST POCKET RADIO

An innovation in radio set convenience and utility is the new vest pocket radio planned for early production by the *Sentinel Radio Corporation*.

This new radio will be several times



smaller than the smallest camera or personal type radio sets heretofore manufactured and can be inconspicuously carried in vest pocket, shirt pocket, or handbag. It can easily be carried on the golf course, to ball games, on shopping tours, in fact anywhere and everywhere, and can be operated without disturbance to anyone.

The speaker of this new vest pocket radio will be of the approved hearing aid type. The complete unit includes radio, batteries, and tubes all within a compact case.

The vest pocket radio will be in production by the *Sentinel Radio Corporation*, Evanston, Illinois, as soon as existing production restrictions are lifted.

#### FM RECEIVER

*John Meck Industries, Inc.* has announced the development of an FM receiver which will provide reception on the new 90 to 106 megacycle band. This new set will also cover the present broadcast band of 42 to 50 megacycles as well as the band of 88 to 92 megacycles assigned for non-commercial educational uses.

Purchasers of this new FM receiver will have the advantages of a set ready for reception without changes or adjustments when stations are changed to the new band. This will eliminate costly conversions or the necessity of sending sets back to the factory or to the serviceman for adjustments to the new wave band.

This new FM receiver, which is expected to be in production at an early

date, is a product of *John Meck Industries, Inc.*, Plymouth, Indiana.

#### PLUG CONNECTOR

*Buchanan Research Laboratories, Inc.*, has developed a new type of plug connector with multiple-fingered spring inserts providing uniform pressure on long-wiping contacts.

This line, known as lok-plug connector, is available in from one through eighty circuits but practically any number of single or multiple circuit connections can be furnished, on special order, in any vertical or horizontal arrangement desired. Circuits are marked to denote single or multiple types.

Connectors in all sizes are furnished for surface or flush mounting and they are available for simple snap-on installation and ready removal without use of holding screws. Plugs accommodate all wire sizes from No. 26 through No. 12. Size ten wire uses larger plug bore. To facilitate circuit identification, insulation sleeves are available in six solid colors and in numerous color combinations. Butting against the molded receptacle, these sleeves make each connector a completely dead-front unit.

Further information may be obtained from *Buchanan Electrical Products Company, Inc.*, 2 West Jersey Street, Elizabeth, N. J., manufacturer and distributor of this new plug connector.

#### VACUUM-TUBE VOLTMETER

In keeping pace with the advances made in design of all types of electronic equipment, *Supreme Instruments Corporation* announces its Model 565 Vacuum-Tube Voltmeter.

For the first time, a probe designed for measurement of r.f. voltages has been built which is small enough to be held in the hand as a test lead. This probe contains a high frequency diode of the miniature type and can be used for the measurement, with negligible frequency error, over a frequency range of 50 cycles to 100 mc.

The design of the d.c. voltage measurement circuits is unusual in that



shielded leads are used, each of which has installed in it a 20 megohm isolating resistor which also acts as part of the multiplier resistors. A very high

## HOW TO TEST A RADIO IN 2 MI NUTES OR LESS!

Want to repair radios for neighbors and friends? Or, if you are a radio serviceman, do you want to learn how to diagnose radio troubles and fix sets TWICE AS FAST and TWICE AS PROFITABLY—without a lot of costly, hard-to-get test equipment?

Of course you do—and Ghirardi's RADIO TROUBLE-SHOOTER'S HANDBOOK is just the book that will make it possible for you to do it—for a total cost of only \$5. Send coupon on opposite page today.

## "IT'S THE BEST OUT OF 20" SAYS CHIEF ENGINEER

F. S. Bailey, Chief Engineer, Radio Operator's School, Brownsville, Texas, gives this endorsement of Radio-Electronic's greatest basic training book: "We find Ghirardi's RADIO PHYSICS COURSE the best of 20 or more books we have tried . . . both as a complete course in Radio Physics and for all other branches including broadcasting it is giving our students the VERY BEST FOR THEIR MONEY." Order now—use coupon on opposite page!



THE ONLY BOOK OF ITS KIND!

## All the Facts on A Little Known Subject NOW AVAILABLE!

Don't buy, specify, use, or replace Capacitors blindfolded! Save time, save money, and increase your service efficiency by really knowing all about this vital subject! Actually, no Radio-Electronic component is more important or less understood than the Electrolytic Capacitor. Postwar equipment will employ more of them—and in new, improved types. This new book, "The Electrolytic Capacitor" by Alexander M. Georgiev, for more than 15 years a leader in Capacitor research and development, at last explains the entire subject. Answers all the many questions servicemen, engineers, and designers have been asking about capacitors for years.

## ENDORSED BY A. A. GHIRARDI

"I heartily recommend The Electrolytic Capacitor as 'must' reading for the man who really wants to forge ahead in post-war Radio-Electronics," states A. A. Ghirardi, internationally famous technical author. "It tells what types to use and where, and how to use them to best advantage—explains the advantages and disadvantages of each—how to make emergency repairs and a host of other subjects invaluable to the man who KNOWS it pays to KNOW!"

Contains over 200 pages and 50 illustrations. Price only \$3 (\$3.25 foreign).

USE COUPON! in adjoining advertisement. MAIL TODAY!



# MAKE MONEY REPAIRING RADIOS AND OTHER ELECTRONIC EQUIPMENT

## GHIRARDI TELLS YOU EXACTLY WHAT TO DO ... EXACTLY HOW TO DO IT

If you like to repair radios at home in spare time, Ghirardi's **RADIO TROUBLESHOOTER'S HANDBOOK** offers you a new, fast way that makes the work easy—without a lot of previous experience or scarce, expensive test equipment. Or, if you are a professional radio man, it helps you repair two sets in less than the time you'd normally take for one. It is the ideal book for training new helpers, for substituting tubes and parts in these days of shortages, for repairing cheap sets quickly and profitably—in short, for repairing radios better, faster and more profitably than you may have thought possible.

### 4 LBS. OF FACTUAL, TIME-SAVING MONEY-MAKING SERVICE DATA

**RADIO TROUBLESHOOTER'S HANDBOOK** isn't a "study" book. It rolls up its sleeves and goes to work for you the minute you get it. It can easily pay for itself the first time you use it! Simply look up the make, model, and the trouble symptom of the Radio you want to repair... and go to work. No useless testing! No lost time or motion! The **HANDBOOK'S** clear instructions tell you exactly what the trouble is likely to be... and **EXACTLY** how to fix it. Actually, this big 4

pound, 744-page, manual size **HANDBOOK** brings you factual repair data for practically every radio in use today—over 4,800 individual makes and models!

In addition, there are hundreds of pages of helpful repair charts, tube charts, data on tuning alignment, transformer troubles, tube and parts substitutions, color codes, etc.—all for only \$5 (\$5.50 foreign) on an **ABSOLUTE 5-DAY MONEY-BACK GUARANTEE**.

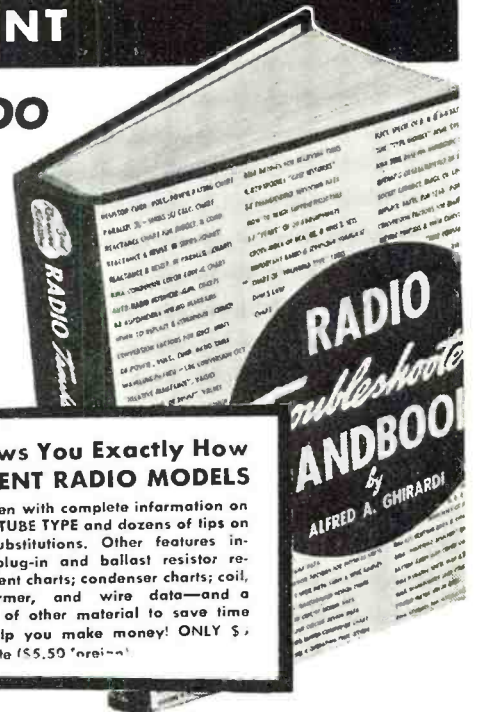

### This "Automatic Teacher" Shows You Exactly How to REPAIR OVER 4,800 DIFFERENT RADIO MODELS

Over 400 pages of the **RADIO TROUBLESHOOTER'S HANDBOOK** include specific common Trouble Symptoms, their Causes and Remedies for practically every Radio Receiver in use today. **IN ADDITION**, there are hundreds of pages including i-f alignment peaks for over 20,000 superhets; a big data section on i-f transformer troubles—and the most up-to-the-minute **TUBE CHART** you've

ever seen with complete information on **EVERY TUBE TYPE** and dozens of tips on tube substitutions. Other features include plug-in and ballast resistor replacement charts; condenser charts; coil, transformer, and wire data—and a wealth of other material to save time and help you make money! **ONLY \$5**, complete (\$5.50 foreign)

## COMPLETE BASIC RADIO-ELECTRONIC TRAINING

FOR BEGINNERS \$ **5**

All the Basic Science of Radio-Electronics in One Big 3 1/2 lb. Book—No Monthly lessons to wait for.

(\$5.50 foreign)

Train **NOW** for the most interesting of all postwar futures—**RADIO-ELECTRONICS!** Ghirardi's 972-page **RADIO PHYSICS COURSE BOOK** gives you all the basic training you need—at a price you can afford to pay! Actually, this big book has started more people in Radio-Electronics than any other book or course. It is more widely used for home study—and more widely used in U. S. Signal Corps and Navy Schools and in civilian schools and colleges than any other book of its kind!

### NO OTHER COURSE LIKE IT!

Ghirardi's **RADIO PHYSICS COURSE** book with its 500 illustrations and 856 self-testing review questions makes it surprisingly easy for you to learn at home without an instructor. Nothing is omitted, nothing condensed. Everything is made as easy as A-B-C. Ask any radio man! You'll be amazed how quickly you'll master the subjects that other courses and books make seem very complicated. Begin today. Examine this truly great book for 5 full days—and get every cent of your money back if you're not more than satisfied.

October, 1945

## LEARN PROFESSIONAL SERVICE WORK AT HOME WITHOUT AN INSTRUCTOR!

Study now for a good job as a professional Radio-Electronic Service Expert. It's easy to learn from Ghirardi's big 1300-page profusely illustrated **MODERN RADIO SERVICING**

book that costs you only \$5 complete. This one big book covers all phases of the work! Explains all necessary test instruments... even how to build your own if you prefer; how to troubleshoot all makes of radios, analyze electronic circuits, test components, make adjustments, repairs, etc., etc.—all step-by-step. Even explains how to start a successful Radio-Electronic Service Business of your own. Sold separately for \$5 (\$5.50 foreign), or see **MONEY-SAVING COMBINATION OFFER** in coupon.



### EVERY CONCEIVABLE SERVICE SUBJECT

Explains circuit and operation of all types of essential service instruments: How and when to use them; How to build your own; Preliminary trouble checks; Troubleshooting; Repairs; Obscure radio troubles; Aligning and neutralizing; Auto and Marine Radios; Interference reduction; AVC and QAVC circuits, etc., etc.

## 5-DAY MONEY BACK GUARANTEE

**Technical Division, MURRAY HILL BOOKS, Inc., Dept. RN-105, 232 Madison Ave., New York 16, N. Y.**

Enclosed find \$..... for books checked; or  send C.O.D. (in U. S. A. only) for this amount plus postage. If not fully satisfactory, I may return the books at the end of 5 days and receive my money back.

**RADIO TROUBLESHOOTER'S HANDBOOK \$5 (\$5.50 foreign)**       **RADIO PHYSICS COURSE \$5 (\$5.50 foreign)**

**MODERN RADIO SERVICING \$5 (\$5.50 foreign)**       **THE ELECTROLYTIC CAPACITOR (See advertisement in adjoining column) \$3. (\$3.25 foreign)**

**Special MONEY-SAVING COMBINATION:**  
Both Modern Radio Servicing and Troubleshooter's Handbook \$9.50 for the two (\$10.50 foreign).

Name.....  
Address.....  
City & Dist. No..... State.....  
(Please print or write plainly)

Here's a soldering iron with . . .

**HEAVY  
POWER**  
(225 WATTS)

**LIGHT  
WEIGHT**  
(14 OUNCES)

*made possible by*  
**KWIKHEAT'S  
BUILT-IN  
THERMOSTAT**

- ★ HEATS IN ONLY 90 SECONDS
- ★ MAINTAINS PROPER HEAT
- ★ CAN'T OVERHEAT
- ★ LESS RETINNING NEEDED
- ★ TIPS LAST LONGER
- ★ COOL, SAFE HANDLE
- ★ LIGHT WEIGHT

The Kwikheat Soldering Iron has ample reserve power for your soldering jobs—225 watts held in check by a thermostat built right into the iron\*—maintaining ideal temperature for perfect soldering—preventing overheating (which causes deterioration in other irons)—prolonging life of tips and eliminating the need for constant retinning. Besides these big advantages, the Kwikheat Iron is hot, ready to use only 90 seconds after plugging in. It is extremely light (14 ounces), well-balanced, and has a safe, cool handle. No wonder Kwikheat is a sensation wherever it is used. Ask your jobber. With choice of #0, 1, 2, or 3 tips. \$11.00

**6 INTERCHANGEABLE TIP STYLES**

- |   |    |   |    |   |    |   |    |   |    |   |    |
|---|----|---|----|---|----|---|----|---|----|---|----|
|  | #0 |  | #1 |  | #2 |  | #3 |  | #4 |  | #5 |
| \$1.25  |    | \$1.25  |    | \$1.25  |    | \$1.25  |    | \$1.75  |    | \$1.25  |    |

VANATTA



input impedance of 80 megohms on the 1 volt range and 40 megohms on the 500 volt range makes it possible to make voltage measurements, with negligible error, in circuits having extremely high impedance. In addition to these features the use of a balanced bridge type of circuit using nearly 100 per-cent degenerative feedback eliminates errors due to line voltage shift and grid current in the tube which operates the meter. The meter is completely isolated from the input circuit and any damage which might result from an accidental application of a high voltage to a low voltage range.

Voltage ranges of 0-1, 0-2.5, 0-10, 0-100, 0-250, and 0-500 d.c. and a.c. voltage ranges of 0-1, 0-2.5, 0-10, 0-100, and 0-250 are provided by means of push-button selection.

**AUTOMATIC BALL GAUGE**

Jack & Heintz, Inc., has developed a new electronic ball gauge to provide perfectly sized and perfectly matched balls for better and more accurate bearings, and to sort them faster.

When fed commercial balls, which have already been graded to a toler-

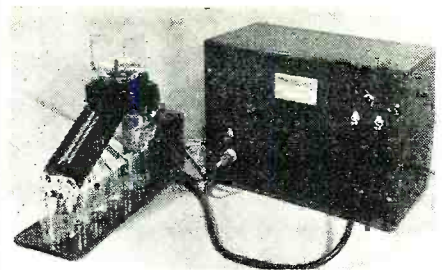

ance of 1/20,000 inch, this automatic machine sorts them into groups five times more accurate. As many as ten size selections can be made, each group being separated by only ten millionths of an inch.

Operation consists in filling the plexiglass hopper and removing the sorted balls. One operator can handle four machines easily and four machines sort more balls, more accurately, than thirty-two skilled operators using the conventional measuring equipment.

This automatic ball sorter is a development of Jack & Heintz, Inc., Cleveland, Ohio.

**FINGER TOOLS**

A new finger tool designed for all types of assembly work, especially adaptable for radio, automotive, electrical and aircraft, will soon make its appearance on the market, the Faso Manufacturing Company has announced.

This new Touch-n-Grip finger tool combines the advantage of the sense of touch with the grip ends of wrenches, screwdrivers, etc., in forming a small compact tool that enables the user to reach into snug, narrow, remote, or invisible working areas to touch and grip the work spot instantly, and simultaneously hold a nut, bolt, or screw in true fixed

(Continued on page 122)

**EACH UTAH VIBRATOR  
MAKES AND BREAKS MORE  
THAN A *billion* CONTACTS  
DURING ITS LIFETIME**

All of the well known Utah qualities of workmanship and design go into Utah vibrators, yet they cost no more than ordinary vibrators.

- ★ 70 vibrator replacement types.
- ★ 39 different hook-up diagrams.
- ★ Servicing 3651 different auto and farm radio models.
- ★ More than a million radio sets are equipped with Utah.



*There is a Utah vibrator for every replacement requirement!*

**UTAH RADIO PRODUCTS COMPANY • 820 ORLEANS STREET • CHICAGO 10, ILLINOIS**

Utah Electronics (Canada) Ltd., 300 Chambly Road, Longueuil, Montréal (23), P. Q. • Ucoa Radio, S. A., Misiones 48, Buenos Aires.

# TEMPERATURE CONTROL in the Design of Stable Oscillators

*The ideas presented herein may well apply to various types of self-excited u.h.f. and v.h.f. oscillators for frequency stabilization.*

By **LYLE C. TYLER**

Radio Engineer

ONE of the requirements in the design of a stable oscillator is close control of the temperature of the frequency determining elements of the circuit, whether that is a quartz plate or the LC tank of a variable frequency oscillator. In or-

der to attain a close control of temperature, considerable attention should be given the design of the controlled compartment.

Let us take, for example, a metal box lined with celotex or balsa wood within which is a heater and thermostat as in Fig. 1B. The thermostat is set to operate at a given temperature. The ambient temperature outside the box is somewhat lower. Now, if the ambient temperature is increased, the temperature inside the box will increase, not necessarily the same amount, even though the box is heat insulated and the thermostat is assumed to control the temperature. The temperature of various spaces within the box will probably not be uniform. Added insulation will not correct the fault, but only slow up the rate of change of temperature with a change of ambient temperature. The reason for the performance of this type oven is that the thermostat will control only the temperature immediately surrounding the controlling element of the thermostat. However, as will be explained later, the temperature of the controlling element can be adjusted to give the desired control provided the heater is correctly arranged and other design problems are properly considered.

If these components are rearranged, the heater and thermostat placed outside the box to be controlled, the heater distributed evenly on all sides of the box, and then all surrounded by an outer box as in Fig. 1A, a much greater amount of control can be attained for the reason that all sides of the box will be close to the same temperature as the controlling element of the thermostat. We can consider the box walls, the space between the box and the thermostat, the space between the thermostat and heater, and the space between the heater and ambient temperature as thermal impedances, Fig. 1C. By correct adjustment of these various thermal impedances, the temperature at *B* can be maintained very close to a constant value, even though the ambient temperature,  $T_A$  and the power in the heater varies within limits.

Fig. 1C illustrates how these im-

Fig. 1. The construction of temperature control enclosure. (A) Sectional rear view showing suggested type of construction and placement of components. Front and rear heater units not shown. (B) Type of arrangement which would give poor control. (C) Illustrating how spaces between components may be shown as thermal impedances.

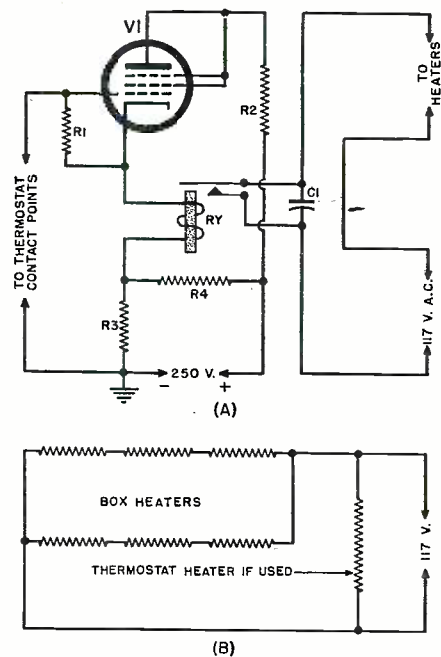
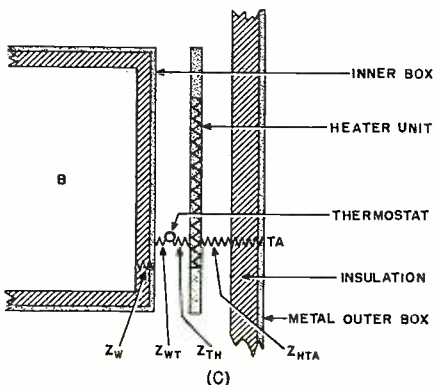
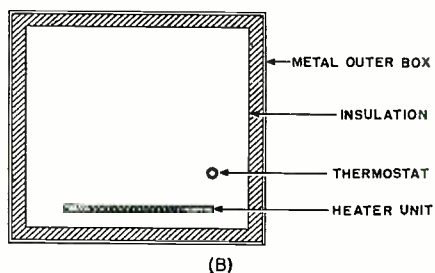
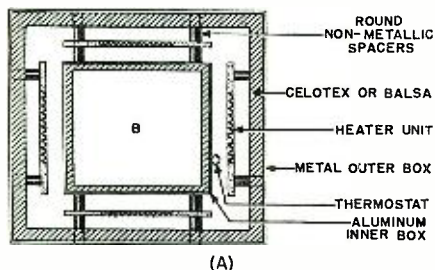

Fig. 2. (A) Relay circuit diagram for use with mercury thermostat. (B) Heater connections used in example described in text.

pedances are arranged. The impedance  $Z_W$  should be high enough to smooth out the heat cycles from the heater, which will cause the temperature at *B* to be maintained without fluctuations due to on and off periods of the heater.

The impedance  $Z_{WT}$  should be as low as possible, that is so the wall of the box will be maintained at the temperature of the thermostat, which will be approximately equal to the temperature inside the box. The type thermostat used determines how this is accomplished. This will be treated in more detail later.

The impedance  $Z_{TH}$  should also be as low as possible in order that the thermostat on-off cycles will be short.

The impedance  $Z_{HTA}$  should be as high as possible for economical reasons, that is, the better the insulation in the walls of the outer box, the shorter the "on" time of the heater will be, as less heat will be dissipated through the walls of the outer box.

In the design of an oven of this type, the first thing to consider is the size and material of the inner box, *B*. It should be made just large enough to conveniently hold the components to be temperature controlled. An aluminum box lined with balsa wood or celotex will provide an effective shield electrically. Aluminum, being a good thermal conductor, will equalize the temperature inside the box, while the



**MR. RADIOMAN: You Can Use These "Tools"  
To Build a Better Job and a Secure  
Career in RADIO-ELECTRONICS**

**CREI Home-Study Training in Practical Radio-Electronics Engineering  
Combined With Your Own Experience Assures You of Post-War Security and  
an Interesting, Profitable Career**

What's ahead for *you* in the field of Radio Electronics? One thing is certain. Now that Victory is won, Radio-Electronics will surge forth as one of America's foremost industries, offering promising careers for radiomen with modern technical training.

But, you won't be able to merely step into the job of your choice, for now it will be "the survival of the fittest." Employers will once again be "choosey." Only the best qualified men will be selected for the best jobs.

NOW is the time to take the time to prepare yourself for these important career jobs in radio-electronics engineering. CREI can show you the way by providing you with the "tools" to build a firm foundation of ability based on a planned program of technical training.

In our proved home-study course, you learn not only *how* . . . but *why*! Easy-to-read-and-understand lessons are provided well in advance, and each student has his personal instructor who corrects, criticizes and offers suggestions on each lesson examination. This is the successful CREI method of training for which more than 10,000 professional radiomen have enrolled since 1927.

Your ability to solve tough problems on paper and then follow-up with the necessary mechanical operation, is a true indication that you have the *confidence* born of *knowledge* . . . confidence in your ability to get and *hold* an important job with a secure, promising post-war future. These jobs are waiting today for radiomen with up-to-date CREI technical training. Investigate now the CREI home-study course best suited to your needs, and prepare for security and happiness in the coming New World of Electronics! *Write for all the facts now.*

**Servicemen—  
Discharged Veterans**

**CREI RESIDENCE TRAINING  
NOW AVAILABLE UNDER  
PROVISIONS OF "G.I." BILL**

CREI now offers Residence School courses in Radio-Electronics Engineering, Broadcast & Television Engineering and Broadcast & Television Servicing under the Serviceman's Readjustment Act of 1944 ("G.I." Bill). Classes now in session. Enter at any time. Write for details.

*Those interested in CREI residence school should write for information about the CREI Priority plan.*

**WRITE TODAY FOR FREE 36-PAGE BOOKLET  
"Your Opportunity in the New World of Electronics"**

TELL US ALL ABOUT YOURSELF, so that we can intelligently plan a course best suited to your needs. If you have had professional or amateur radio experience let us prove to you that we have something you need to qualify for a better radio job. To help us intelligently answer your inquiry—PLEASE STATE BRIEFLY YOUR BACKGROUND OF EXPERIENCE, EDUCATION AND PRESENT POSITION.



**CAPITOL RADIO Engineering Institute**

HOME STUDY COURSES IN PRACTICAL RADIO-ELECTRONICS  
ENGINEERING FOR PROFESSIONAL SELF-IMPROVEMENT

**Dept. RN-10, 3224—16th Street, N. W., Washington 10, D. C.**

Contractors to U. S. Navy—U. S. Coast Guard—Canadian Broadcasting Corp.  
Producers of Well-trained Technical Radiomen for Industry.

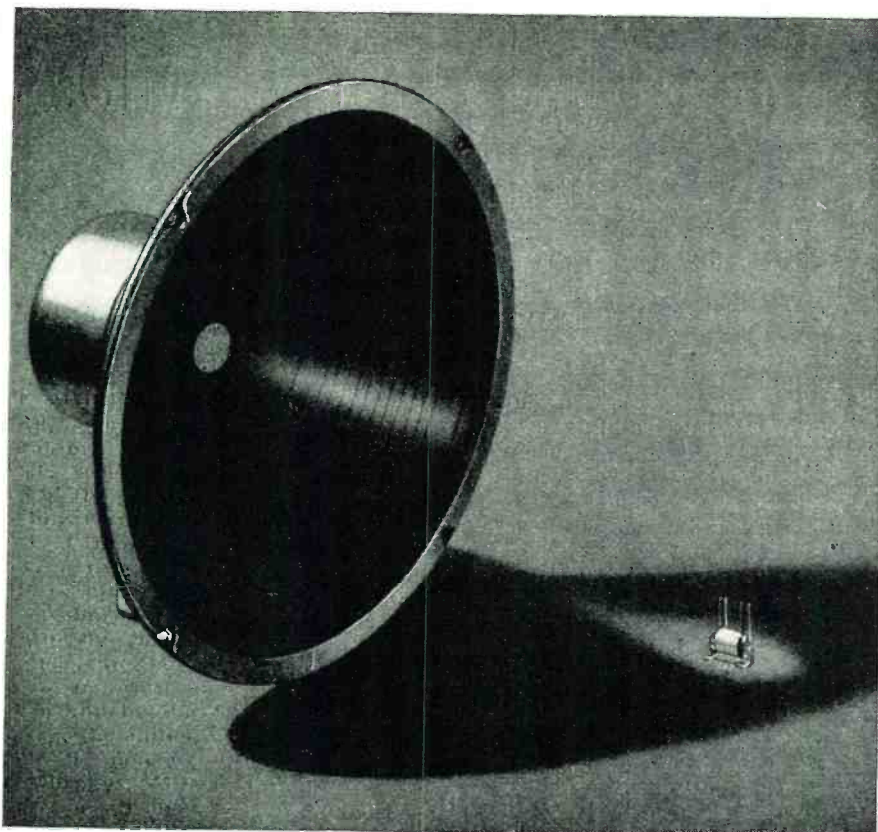

## Permoflux Speakers and Transformers Set New Standards of Comparison!

New Permoflux speakers in a complete range of true-dimensioned sizes from 2" to 15", with power handling capacities from 1 to 20 watts, provide the finest sound reproduction for every application.

Permoflux midget transformers, with their many practical circuit applications, have literally revolutionized efficiency concepts where size and weight are determining factors.

Advanced engineering designs, improved manufacturing methods and new materials have all contributed their share in the development of Permoflux speakers, transformers, microphones and headphones. You can count on Permoflux to provide an acoustic unit to suit your exacting requirements.

**BUY WAR BONDS FOR VICTORY!**

TRADE MARK  
**PERMOFLUX**

**PERMOFLUX CORPORATION**  
4900 WEST GRAND AVE., CHICAGO 39, ILL.



**PIONEER MANUFACTURERS OF PERMANENT MAGNET DYNAMIC TRANSDUCERS**

balsa or celotex will provide the necessary thermal filter. Necessary wire leads from the components should be brought out at a convenient place through as small an opening as possible.

The temperature at which the components are to be maintained is next considered. The highest ambient temperature at which the equipment will operate is determined. The temperature rise within the box caused by heat dissipation of the components mounted within is determined. This can be found by experiment as follows:

The inner box, *B*, is constructed and all component parts are mounted within it. The box is then subjected to a temperature equal to the highest ambient temperature,  $T_A$ , at which the equipment will operate. The components are then operated normally. After approximately one hour, measure the temperature within the box, *B*. Call this  $T_B$ . The temperature rise,  $T_R$ , will be  $T_B - T_A$  and the operating temperature,  $T_O = T_R + T_A + 2$ . If crystals only are to be temperature controlled and one crystal is to be operated at a time,  $T_R$  can be assumed to be 5 degrees centigrade. If all component parts of a variable frequency oscillator (except the tube) are to be controlled within the box then  $T_R$  should be 10 degrees centigrade. The operating temperature of the box,  $T_O$ , is then  $T_R + T_A$ . All temperatures are expressed in degrees centigrade. Note that the factor 2 is used only if  $T_R$  is determined experimentally. If  $T_R$  is assumed 5° C. or 10° C. in the specific cases as above, this factor is already considered.

Having determined the operating temperature of the box, the next step is to select the thermostat. The thermostat selected should have a small operating temperature differential. The mercury type is usually the best for this application, although it is usually more expensive than other types. It is fragile and must be handled with care. One type mercury thermostat has the thermometer scale engraved on the stem which, of course, would save the price of a separate thermometer. Other types of thermostats include the bimetallic and the snap-disc. These, as a general rule, will not operate on as small a temperature differential as the mercury type, but can be made to operate satisfactorily with special treatment, as will be explained later.

The operating point of the thermostat should be equal to or above the operating temperature of the box. If a mercury thermostat is used, a relay will have to be used to handle the heater current, as the contacts of this type thermostat will not handle any appreciable current. A suggested circuit for the relay is shown in Fig. 2A. The relay, *RY*, should have d.c. resistance of approximately 5000 ohms and operate on a current of from 2 to 4 ma. The contacts should be capable of handling the full heater current

**RADIO NEWS**

# A WISE TREND

A few years ago plugs and jacks were uncommon except for a few applications in radio and test equipment. Today the trend to greater use of plugs and jacks is fast becoming standard practice in radio and electronic industries.

Keeping up with this trend, Johnson has designed many new plugs to meet industries special requirements, as well as supplying standard plugs which are being used in an increasing number of new applications.

The use of plugs on components is growing more popular, speeding production, facilitating easy replacement and interchanging of parts.

Plug and jack assemblies make it possible to remove sections of equipment for repair and maintenance without disturbing the wiring, and in police, fire, railroad and similar installation, units which fail may be quickly replaced with little delay in operation.

Let Johnson, a pioneer in the manufacture of plugs and jacks, supply you with a plug and jack combination or assembly to meet your requirements.

Send us your problem.



Ask for catalog 968-Z



# JOHNSON

*a famous name in Radio*

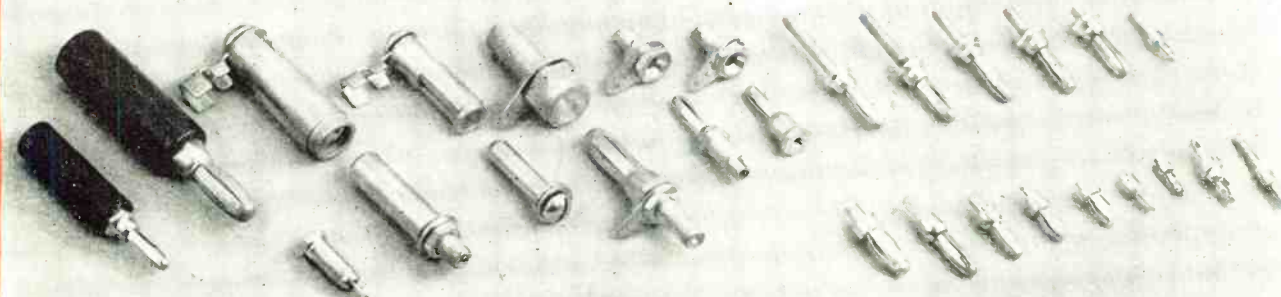

E. F. JOHNSON COMPANY • WASECA • MINNESOTA

# A Better Selection of

## RADIO CABINETS & PARTS

from

# LAKE!



Portable Phonograph case in brown leatherette covering. Inside dimensions 17" long, 14" wide, 8½" high. Has blank motor board and opening for speaker. As illustrated above, specially priced at . . .

**\$8.95**

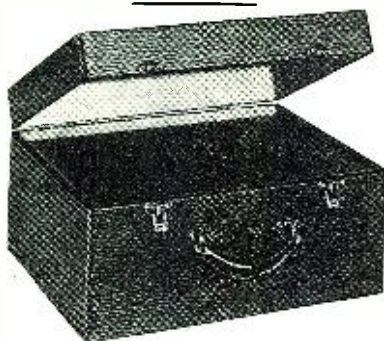

Portable Phonograph case, of sturdy durable plywood, in handsome brown leatherette finish. Inside dimensions 16½" long, 14" wide, 9½" high. Has blank motor board. As illustrated above, specially priced at . . .

**\$6.95**

Also blank table cabinets of walnut veneer in the following sizes, with speaker opening on left front side: (\*Note: \*7 has center speaker grill.)

#1	8¼"	L x 5½"	H x 4"	D \$1.95
#2	10¼"	L x 6¾"	H x 5"	D \$2.75
#3	13½"	L x 7¾"	H x 6¼"	D \$3.25
#7*	10¾"	L x 7"	H x 5½"	D \$2.50
#8	17"	L x 9"	H x 9¾"	D \$4.50
#9	21"	L x 9¼"	H x 10½"	D \$5.50

\*Speaker Opening in center of front side. Cabinets available in ivory color and Swedish Modern. Write for prices.

### POWER TRANSFORMERS

4, 5, or 6 Tube—6.3V at 2 amp. **\$2.45**

50 Mill Power Transformer. . . .

7, 8, or 9 Tube—6.3V at 3 amp. **\$2.65**

70 Mill Power Transformer. . . .

All types of radio cabinets and parts are available at Lake's Lower prices. A large stock is listed in our catalog.



**SERVICEMEN—RETAILERS**  
Join our customer list today.

Write for Our Free, New Illustrated Catalog!  
Dept. A

## Lake Radio Sales Co.

615 W. Randolph Street  
Chicago 6, Ill.

without arcing. Any bimetallic or snap-disc type thermostat used will handle the heater current without the aid of a relay. However, more attention will have to be given this type to keep the operating temperature differential at a minimum. This can be done with the use of a separate thermostat heater adjusted so the on and off periods will be short, and the temperature of the wall of the box *B* will remain as nearly constant as possible through the thermostat cycle. This will especially be necessary if the operating temperature of the thermostat is higher than the desired operating temperature of the box.

It should be noted that while Fig. 1A shows the correct *effective* placement of the thermostat with respect to the heaters and the box, it may be *physically* placed at any convenient location within the outer box provided the thermostat heater is adjusted so as to cause the thermostat to maintain the correct temperature at the wall of the box *B*.

All heaters used, including the thermostat heater, should be the open type with as little thermal storage capacity as possible. This is important if a non-fluctuating constant temperature is to be maintained. Heaters for the box should be the open "grill" or "card" type placed so that each unit will be parallel to and approximately one inch from its respective side. The heater unit area should be at least ¾ the area of the box side. The thermostat heater may be wound so as to surround or be adjacent to the controlling element. The size and power of the thermostat heater will have to be determined by experiment.

The total heating power of the box heaters should be considered next. The power used will depend partly on the amount of insulation used in the outer box. The heater power should be adjusted high enough to maintain the correct operating temperature of the box when operated at the lowest ambient temperature to be encountered, and low enough so "over-shooting" of operating temperature will not occur when operated at the highest ambient temperature. It will be found that the actual heating power is not critical if the thermostat heater is correctly adjusted. As a matter of fact, the heater power can vary or the ambient temperature can vary within reasonable limits and the correct operating temperature of the box can be maintained if the thermostat heater is correct.

Correct adjustment of the heater power and thermostat will be indicated by short "on" and "off" periods of the thermostat (complete thermostat cycle), no "over-shooting" of operating temperature during the warm-up period, and no "over-shooting" when the heater power or ambient temperature is increased within limits. With an increase in ambient temperature, the "off" time should remain constant and the "on" time should decrease. If the "off" time increases appreciably with an increase in ambient tempera-

ture, an effort should be made to reduce the thermal impedance between the thermostat heater and the thermostat controlling element. The shorter the thermostat cycle, the smaller the thermal smoothing impedance  $Z_w$  can be, that is, the insulation thickness of the inner box. For thermostat cycles of 1 minute or less, insulation may not be necessary in the inner box *B*, to maintain a non-fluctuating temperature within the box.

As an example of the performance that may be expected, we will assume an inner box, *B*, to be 5 inches outside dimension all sides, made of 1/16 inch aluminum, and lined with ¼ inch thick celotex. This box will contain one crystal. The outer box of metal will be 9 inches inside dimension, all sides lined with ½ inch thick celotex. See Fig. 1A for suggested type of construction. The inner box operating temperature is assumed to be 55°C. Six heater units of the open "grill" or "card" type will be used, each having a rating of approximately 50 watts. These will be connected series-parallel (Fig. 2B). Each unit will then dissipate approximately 5½ watts, making a total heater power of 6 x 5½ or approximately 33 watts.

A mercury thermostat which will make contact at 55°C. will be used. The mercury bulb is placed between the heater and the inner box wall as close to the wall as possible. If the thermostat is not also a thermometer, the thermometer bulb should be placed in the same effective location. At an ambient temperature of 25°C., the initial warm-up period when the thermostat will start operating will be approximately one to one and one-half hours and the temperature within the box will stabilize after four hours. The temperature at the thermostat bulb should not vary more than .2°C. over a complete thermostat cycle, approximately 1½ minutes, and the temperature within the box should remain constant through an ambient temperature range of from 10°C. to 50°C. A twenty per-cent line voltage change should not affect the inner box temperature, if the ambient is constant.

Due to the wide variety of applications, operating conditions, and requirements of an oven of this type, no rules or formulas can be set forth for use in its design and, therefore, a certain amount of "cut and try" will have to be used in each individual case. The methods and results as outlined herein are based on fundamental principles and actual experience of the author.

It should be noted that if any control shafts are used for components within the inner box, those shafts should be of non-metallic material such as bakelite or fiber. Any parts used that will be in contact with both the inner and outer box should be non-metallic, the reason being obvious in that a metallic part would furnish a low thermal impedance path between the inner box and the ambient temperature.

-50-

RADIO NEWS



# MPHENO offers

## WIDEST SELECTION OF APPROVED R-G CABLES



### *Immediate Delivery*

Amphenol's government approved "Coax" and "Twinax" R-G Cables today represent the maximum in types available from a single manufacturer—a definite advantage. There is usually a size for every normal requirement. But "special" needs too are promptly met. They embody the same widely experienced engineering, high quality materials and dependable production that have made Amphenol products famous the world over. And you can have immediate delivery on most Amphenol Cable types. So depend on Amphenol for any high frequency cable requirements. Catalog Section D brings you detailed technical data and helpful illustrations.

**AMERICAN PHENOLIC CORPORATION**

Chicago 50, Illinois

In Canada • Amphenol Limited • Toronto



U.H.F. Cables and Connectors • Conduit • Fittings • Connectors (A-N, U.H.F., British).  
Cable Assemblies • Radio Parts • Plastics for Industry

# Reaching the Ruralist

By JOHN LATIMER

*How a rural serviceman maintained a profitable enterprise regardless of wartime problems.*

AT MURPHY, Carthage, New York, goes after the rural inhabitants—rather than the city folks. It's true that he can't personally visit the farm house to service an offending farm radio, but he does the next best thing.

He has arranged with a nearby feed mill to allow farmers to leave radios needing service attention there. Murphy visits the mill once weekly, picks up the ailing sets, repairs them and returns them to the mill for pickup by the farmer. The farmer pays the miller who, in turn, turns over the money collected to radioman Murphy. Murphy pays the miller 5% on all money collected—not an unfair commission, nor an extravagant one. Murphy and the feed dealer have a cooperative advertising setup as well. On all postcards and direct mailing pieces the miller sends out—mention is always made of the fact that radio repair can be speedily arranged for at the mill.

Murphy uses a series of radio spots just before and after the daily noon-time farm program. In addition he parks his service-shop truck at the public market thrice weekly in the spring and summer. Farmers bringing produce to sell can lug along their radios for prompt service.

He is the first radioman in this section of the country to build up a wartime business in farm intercommunication sets. He has actually designed and constructed to meet individual farmhouse specifications over a score of such setups with outlets in farmhouses, barns, and other strategic farm points. Murphy sends each farmer a letter outlining the advantages of a "farm radio hookup" and follows up the letter with a personal visit to the farmhouse. He spends one full day a week in paying visits to farmers—the purpose of which is to persuade them to install an "intercommunication outfit" with all the trimmings. Also he has been an enthusiastic seller of "radio-ear" units, to place in the barn so that intruders would be spotted with ease. He secured a large number of such items just after the war broke out and consequently can still fill orders.

Murphy does provide credit for the farmer on all radio service. Half of the service bill must be paid when the set is returned, and the balance in 2 or 4 weekly installments, depending upon the amount outstanding. To date Murphy reports he has lost less than 5% due to poor credit risks. In many instances farmers place their radio service bill on their feed ac-

count. Under this plan the feed dealer pays Murphy spot cash and lets his rural customers pay him as they can.

Murphy finds that a "record rental library" works well for him. He rents a collection of 50 records to a farm family—2 weeks for \$1.50, 4 weeks for \$2.50. 100 records are loaned out—\$2.50 for a fortnight, \$4.00 for a full month. Murphy has several thousand records on hand which he purchased for a few pennies each in past years. Rental of these platters to ruralists assures him of a small and steady profit and at the same time provides him with an entry into their homesteads.

This radioman has a bulletin board in his shop on which are placed photographs of rural lads and lassies in the service. Farm folk come into the servicenter on Saturdays and weekends to leave photos of their loved ones for insertion on the board and also to inspect its contents.

He changes the board's photographic display every other week. He finds it a source of steady store traffic so far as rural patronage is concerned.

Each rural service patron is provided with an itemized list of all repairs made and the date of such repairs—stamped in so that no changes can be made. The farmer must bring or send in that invoice the next time the set refuses to play. If the cause for the set's defunct condition is traced to any item listed on a previous invoice and the interval between service calls is less than thirty days the second repair session is free. A 30-day period is all that Murphy can guarantee, what with the quality of replacements he's getting these days.

Murphy has an unusual sideline worth mentioning—the rental of 16-mm. motion projectors and accompanying films. Because his is a small town, there is no photographic dealer available. Murphy has a number of 16-mm. projectors and several sound outfits. Farmers can rent either silent or sound installations for a week at very reasonable rates. With country roads as they are, Murphy finds that farm families enjoy holding several brief, but entertaining shows on their premises during a "snowed-in" period. Also Murphy cooperates with the local Farm Bureau who will loan the farmer agricultural films while Murphy provides the visual sound apparatus.

He also makes sound movies of farms which can be shown later on and as a matter of record has made a dozen or more such epics during recent months. A number of farmers band together and finance such a "celluloid record" of the "farm front."

Summing it up, radioman Murphy makes his living from "down on the farm" and is doing nicely at it. Farmers need radios in tip-top operative condition so that they can keep up with news, weather, and crop reports. Murphy provides efficient radio service to meet this situation.

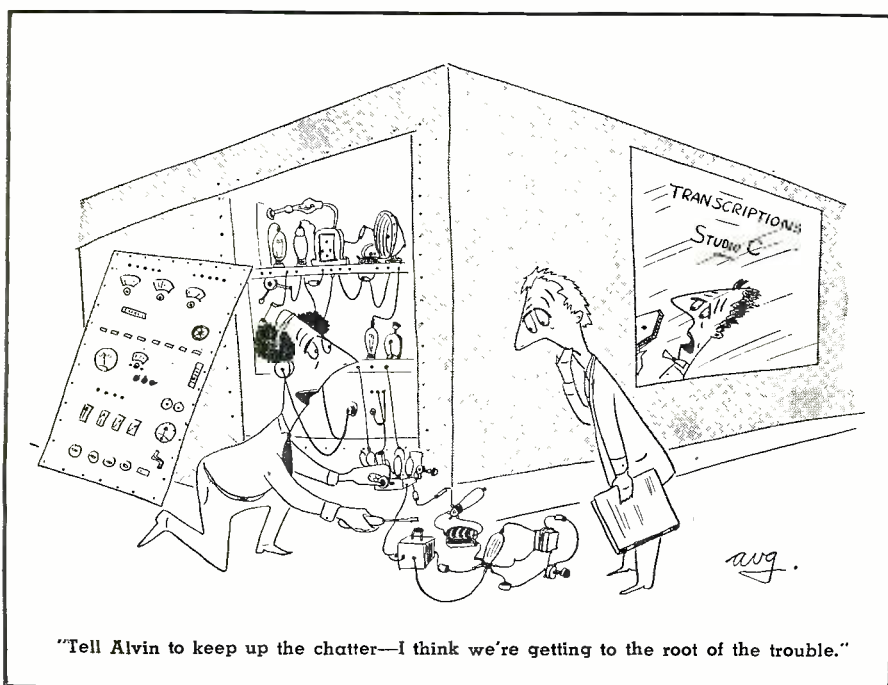

"Tell Alvin to keep up the chatter—I think we're getting to the root of the trouble."

There are two funny things  
about Wilmer



The first is Wilmer's getup.

The second is that he doesn't care if he *does* look like a castoff scarecrow.

Because Wilmer's a lot smarter than he looks. While he's making more than he's ever made before—he's doing right by his country. The dough he'd spend for a fancy wardrobe goes right smack into War Bonds . . . and for this Uncle Sam is mighty proud of him.

And Wilmer's doing right by *himself*, too. Because in a few short years he's going to be able to do something he's planned on. He's going to send Wilmer, Jr. to college—and in clothes that won't be any fugitives from a scarecrow, either.

He's going to be able to do it because Uncle Sam is going to give him back

a rich hundred bucks for every seventy-five Wilmer's *lending* now.

Naturally, you don't have to look like Wilmer . . . or tramp around in rags . . . to make your country proud of you, and your own future a whole lot more secure.

All you have to do is keep getting those War Bonds—and then forgetting them till they come due. Not bad—that four dollars for every three, and the safest investment in the world!

Why not get an *extra* War Bond today?

**BUY ALL THE BONDS YOU CAN  
KEEP ALL THE BONDS YOU BUY**



ZIFF-DAVIS PUBLISHING COMPANY

This is an official U. S. Treasury advertisement—prepared under auspices of Treasury Department and War Advertising Council  
October, 1945

**International Short-Wave**  
(Continued from page 47)

are inaudible or 'only weak' on West Coast. Frequencies and schedules change often. Best reception from India is during autumn and winter on the 7- and 6-megacycle bands; also on the 11-megacycle band some days (evenings).

Schedules for the two 100-kw. transmitters operated by *All India Radio* (Delhi) for October and November are:

TRANSMITTER 1—9-10 p.m., 7.300 (Oct.), 7.275 (Nov.), non-directional;

10:30-10:45 p.m., 11.760 (Oct.), 15.190 (Nov.), non-directional; 12 midnight-2 a.m., 15.190, North-East (Tokyo) Beam; 2:30-4 a.m., 7.275, non-directional; 5-5:45 a.m., 15.190 (Oct.), 11.760 (Nov.), North-East (Tokyo) Beam; 6-6:45 a.m., 15.190 (Oct.), 11.760 (Nov.), East (Burma) Beam; 7-10 a.m., 7.275, North-East (Tokyo) Beam; 10:15 a.m.-12 noon, 6.190 (Oct.), 6.150 (Nov.), non-directional; 12:15-2:15 p.m., 6.190 (Oct.), 7.275 (Nov.), West (Mid-East) Beam; 4-4:15 p.m., 6.190 (Oct.), 7.275 (Nov.), East (Burma) Beam; 6-6:45 p.m., 6.190 (Oct.), 7.275 (Nov.), East (Burma) Beam.

TRANSMITTER 2—8:30-10 p.m.,

6.190, non-directional; 10:30 p.m.-1:25 a.m., 15.160, East (Burma) Beam; 1:30-5:30 a.m., 15.160, East (Burma) Beam; 5:45-8 a.m., 11.790 (Oct.), 9.630 (Nov.), East (Burma) Beam; 8:30-10:25 a.m., 7.290 (Oct.), 7.300 (Nov.), East (Burma) Beam; 10:50 a.m.-12 noon, 6.150 (Oct.), 6.190 (Nov.), non-directional; 12:15-2:15 p.m., 7.290 (Oct.), 6.190 (Nov.), West (Mid-East) Beam; 3:30-4:15 p.m., 7.290 (Oct.), 6.190 (Nov.), West (Mid-East) Beam; 6-6:45 p.m., 7.290 (Oct.), 6.190 (Nov.), West (Mid-East) Beam.

**REPORT FROM INDIA**

D. R. D. Wadia, Bombay, India, writes he is one of the oldest members of the International Short-Wave Club and also a VAC holder. Using a National NC200, during the last two years he has logged Rome, KGWI, KWID, KGEI, WNBI, WBOS, and other U. S. stations; PRL8, Switzerland, YV5RM, OPM, FZI, ABSIE, AFHQ (Africa), British Mediterranean Radio, British Army Test Stations, Leopoldville, Ceylon, H. Q. Southeast Asia Command, Cairo, the BBC, German, and Japanese stations. These transmitters were picked up on the loudspeaker, signal strength varying from R-3 to R-9, Mr. Wadia reports.

**REPORT FROM AUSTRALIA**

From Adelaide, South Australia, Rex G. Gillett, DX Editor, the South Australian Radio Call, writes that an average of 120 square inches of space is devoted to DX notes per issue, with a circulation averaging 30,000. "All the leading DXers in Australia and New Zealand subscribe to Radio Call, and according to reports received, it is a very popular publication."

"Verifications from stations have only been sought for the last two years," he continues, "and consequently, only 150 have been received so far. Countries verified are Cuba, Ceylon, India, Java, New Zealand, New Caledonia, Ecuador, Canada, Costa Rica, Guatemala, Mexico, Chile, Mozambique, French Equatorial Africa, U. S. A., Fiji, Gold Coast, Switzerland, Syria, Senegal, Hawaii, Haiti, and, of course, Australia. In addition to being DX editor of Radio Call, I send regular reports to Radio and Hobbies, and Australasian Radio World in Sydney, Tune In in New Zealand, and not so regularly to Listener In in Melbourne."

Gillett is a member of the New Zealand DX Radio Association, Australian DX Radio Club (Melbourne and Adelaide branches), All Wave All World DX Club, New Zealand Radio and Hobbies Club, Universal Radio DX Club, and Victory Radio Club (U. S. A.).

Gillett uses a "standard 5-valve commercial receiver".

**BEST BETS FOR BEGINNERS**

AUSTRALIA—VLC5, 9.54, Shepparton, 8-8:45 a.m. to East Coast, news at 8, 8:35 a.m.; believed strongest year-round SW signal from abroad. VLG4

**PORTABLE POWER PROBLEMS**

THIS MONTH—ILG MOTOR TEMPERATURE TEST

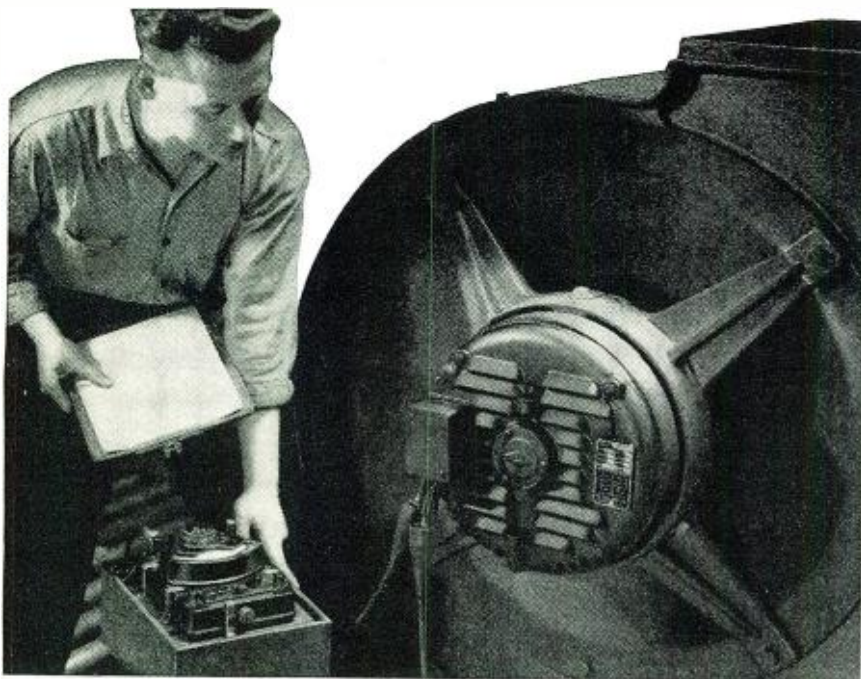

**BURGESS INDUSTRIAL BATTERIES** power ohmmeters to determine temperature rise in fan motors manufactured by Ilg Electric Ventilating Company. Thousands of industries using test and control equipment rely on Burgess Batteries for dependable service. Your local Burgess distributor can fill your needs from the line designed to meet industrial requirements. For full information on the *complete line* of dry batteries write for the name and address of your nearest Burgess distributor.

**2 OUT OF 3 SELECTED BURGESS BATTERIES** as their *first choice* in a recent nation-wide survey of manufacturer electronic engineers. If you require a special battery for a new application, Burgess engineers can solve your problem with the right battery type.

*Burgess Battery Company, Freeport, Illinois*



LOOSE TALK IS STILL DANGEROUS!



**BURGESS BATTERIES**

VOTED FIRST BY ENGINEERS IN NATION-WIDE INDUSTRIAL BATTERY SURVEY

# To Save Life

## RAYTHEON TUBES ARE USED IN NEW ELECTRONIC STETHOSCOPE

The conventional "acoustic stethoscope," used by doctors since the horse-and-buggy days, now gives way to a revolutionary electronic stethoscope called the "Stethetron."

Human lives are saved by making diagnosis easier and more accurate with the "Stethetron" made by The Maico Company, Inc. Of particular interest to you is that miniature Raytheon High Fidelity Tubes are used in this remarkable device because of their complete dependability and precision performance.

This is just one more example of the superiority of Raytheon Tubes—the line that you should feature to give your customers the best possible service.

Feature Raytheon Tubes now—for greater profits—and watch for the Raytheon merchandising program designed especially for established radio service dealers who want to lead the field in postwar volume in their communities.

*Increased turnover and profits, plus easier stock control, are benefits which you may enjoy as a result of the Raytheon standardized tube type program, which is part of our continued planning for the future.*

**Raytheon Manufacturing Company**

RADIO RECEIVING TUBE DIVISION

NEWTON, MASSACHUSETTS • LOS ANGELES • NEW YORK • CHICAGO • ATLANTA



# RAYTHEON

*Radio Tubes*

ALL FOUR DIVISIONS HAVE  
BEEN AWARDED ARMY-NAVY  
"E" WITH STARS

*Devoted to Research  
and the Manufacture of Tubes for the New Era of Electronics*

*Listen to*  
"MEET YOUR NAVY"  
AMERICAN BROADCASTING CO.  
Every Monday Night  
Coast to Coast  
181 Stations

October, 1945

85

(or VLC7), 11.84, Shepparton, 9:55-10:45 p.m. to East Coast, news at 10:30 p.m.; also 1:10-1:45 a.m. to West Coast, news at 1:15 a.m.; first of these transmissions heard best on West Coast, last heard well in East, also. VLC4, 15.315, scheduled same as VLG4; both transmissions on 15.315 heard well both West and East. VLC6, 9.615, Shepparton, 11-11:45 a.m. to West Coast, news at 11, 11:30 a.m.; excellent in West, generally, good signal in East.

CHINA—XGOY, 9.805 (announced, but actually heard on 9.810), Chungking, dual 7.153, 6:35 a.m.-noon or 12:45 p.m., news at 6:35, 9, 11:10 a.m.; some mornings 9.805 (actually, 9.810)

is heard in East the first hour or so of transmission. (See "Changes.")

INDIA—VUD7, 6.19 (also reported as 6.15), Delhi, 10:50 a.m.-12 noon, news at 10:50 and BBC news relay at 11 a.m.; relays General Forces Program from BBC, 9-11 p.m., news at 9 p.m. VUD5, 7.275, Delhi, 9-11 p.m., news at 9:30 p.m. VUD8, 15.350, Delhi, scheduled 8:30-10 p.m., news at 9:45 or 9:50 p.m.; heard almost nightly in East with good signal.

#### OTHER IMPORTANT TRANSMISSIONS FROM ASIA AND OCEANIA

(\*Indicates stations heard almost daily in the U. S.)

AUSTRALIA—\*VLW6, 9.68, Perth, 6:30-11:30 a.m., news at 7, 9, 11 a.m.

\*VLC6, 9.615, Shepparton, 5-6 a.m. to Philippines (English); 9-10:15, 10:35-10:45 a.m. to Asia, news at 10, 10:35 a.m.; good in East.

\*VLG4, 11.84, Melbourne, dual \*VLC6, 11-11:45 a.m., news at 11, 11:35 a.m.; only fair in East.

\*VLG3, 11.71, Melbourne, dual \*VLC4, 15.315, Shepparton, 11 p.m.-1 a.m. to Australian National Forces; play recordings, news generally at 12 midnight; VLC4 sends excellent signal to East.

VLG3, 11.71, Melbourne, dual VLC7, 11.84, Shepparton, 2-2:40 a.m. to Tahiti (French only).

\*VLG3, 11.71, Melbourne, 2:55-3:25 a.m. to Britain; fair in East.

VLG10, 11.760, Melbourne, 5-6:15 a.m. to Asia (English).

VLG4, 11.84, Melbourne, 5:30-6:15 a.m. to Forces in Southwest Pacific (English); heard some days in U. S.

\*VLG, 9.58, Melbourne, 10:35-10:45 a.m. to Forces in India (English); heard some mornings in East.

VLG5, 15.23, Melbourne, dual VLC2, 9.68, Shepparton, 12:15-12:45 p.m. to Britain; heard occasionally in the U. S.

CEYLON—\*ZOJ, 11.81, Colombo, 7:30-10:45 a.m., news at 8:30, 10:30 a.m.; heard on West Coast, only occasionally in East; letter verifications are being received.

ZOJ, 15.275, Colombo, opens at 11 p.m. with news; news also at 12:30 a.m.

ZOH, 4.900, "Colombo Radio," Colombo, relays long-wave, 5:55 a.m.-12:20 p.m., news at 9, 11 a.m.

CHINA—\*XGOA, 9.730 (actually heard on 9.725), Chungking, 12:30-1:45 a.m., 5:30-10:15 a.m., news at 10 a.m.

XGOA, 5.918 (actually heard on 5.910), Chungking, 10:15 a.m.-12:45 p.m.

XGOY, 11.900 (actually heard on 11.905), dual 7.153, Chungking, 7-8 p.m., news at 7:30 p.m.; formerly heard in East but not recently; XGOY, 11.900, also scheduled 5-6:30 a.m.

XPSA, 6.990, Kweichow, 12:30-2:10 a.m., 6-11 a.m.

XGCA, 9.625, Kalgan, 7-8:45 a.m.; fair signal to West Coast only.

FIJIAN ISLANDS—\*VPD2, 6.130, Suva, daily, except Sunday, 4:15-5 p.m., news bulletins at dictation speed, followed by BBC news relay, 4:45 p.m.; Sunday, 2-6 a.m., special programs in Fijian and English; BBC news relay, 2 a.m.; Tuesday, 4-5 a.m., news bulletins and commentaries in Fijian; native music. Good signal to East Sunday mornings, 2-6 a.m.

GUAM—\*KU5Q, 17.82, 15.90, 3-11 p.m. to networks, irregularly. On 12.25, 9.67, 9.33, 3-8 a.m. to networks; heard with powerful signal in East on 12.25; good signal in West on 12.25 and 9.67.

HAWAII—\*KRHO, 17.80, Honolulu, 7:30 p.m.-3 a.m., news on the hour; heard well in East.

\*KRHO, 9.65, Honolulu, 12 noon-2:45 or 3 p.m., news on the hour.

\*KRHO, 6.120, Honolulu, reported schedule, 3:15-11:45 a.m.

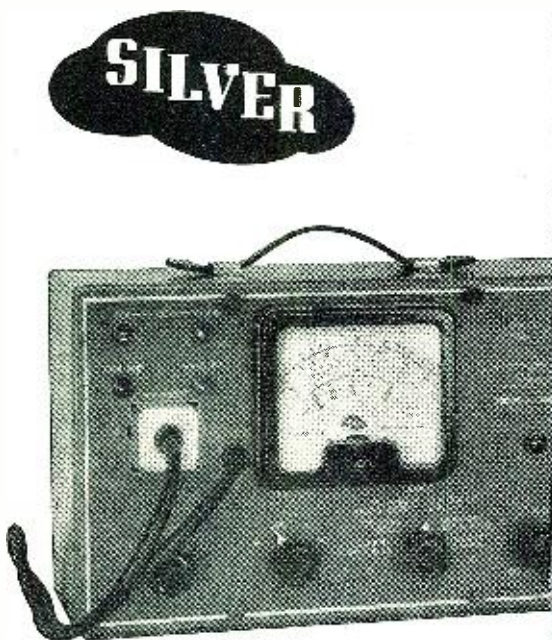

1. Brand new post-war design . . . positively not a "warmed-over" pre-war model.
2. More than an "electronic" voltmeter, **VOMAX** is a true vacuum tube voltmeter in every voltage/resistance/db. function.
3. Complete signal tracing from 20 cycles through over 100 megacycles by withdrawable r.f. diode probe.
4. 3 through 1200 volts d.c. full scale in 6 ranges at 50, and in 6 added ranges to 3000 volts at 125 megohms input resistance.
5. 3 through 1200 volts a.c. full scale in 6 ranges at honest effective circuit loading of 6.6 megohms and 8 mmfd.
6. 0.2 through 2000 megohms in six easily read ranges.
7. -10 through +50 db. (0 db. = 1 mw. in 600 ohms) in 3 ranges.
8. 1.2 ma through 12 amperes full scale in 6 d.c. ranges.
9. **Absolutely stable**—one zero adjustment sets all ranges. No probe shorting to set a meaningless zero which shifts as soon as probes are separated. Grid current errors completely eliminated.
10. Honest, factual accuracy:  $\pm 3\%$  on d.c.;  $\pm 5\%$  on a.c.; 200 through 100 megacycles;  $\pm 2\%$  of full scale,  $\pm 1\%$  of indicated resistance value.
11. Only five color-differentiated scales on 4 $\frac{1}{2}$ " D'Arsonval meter for 51 ranges (including d.c. volts polarity reversal) eliminate confusion.
12. Meter 100% protected against overload burnout on volts/ohms/db.
13. Substantial leather carrying handle. Size only 12 $\frac{1}{2}$ " x 7 $\frac{1}{2}$ " x 5 $\frac{1}{2}$ ".

SEND FOR FREE CATALOG

OVER 34 YEARS OF RADIO ENGINEERING ACHIEVEMENT

**McMurdo Silver Company**  
1240 MAIN STREET, HARTFORD 3, CONNECTICUT

## "VOMAX"

### THE KEY TO POST-WAR PROFITS

Created by a world-famous receiver design engineer specifically for post-war receiver servicing . . . that's why "VOMAX" will do more for you . . . make you the boss, not the victim, in servicing complex post-war receivers.

It's one thing to design test equipment by theory . . . but it's quite another thing when new and original theory is harnessed to over thirty-four years of outstanding experience in radio receiver design and service. Created out of such experience to satisfy the rigorous demands of serious research and service technicians, the new "VOMAX" is a volt-ohm-db.-ma.-meter and dynamic signal tracer without equal. Born out of an intimate daily knowledge of your job and problems . . . it solves them as you've always hoped they would someday be solved.

Imagine the added profits earned . . . the time saved . . . the immense improvement in your work . . . if you had an instrument with which you could measure every voltage in old, modern and complex post-war receivers. Imagine the benefits of being able to trace and measure r.f., i.f., a.f., a.v.c., a.f.c. signals right through every circuit . . . d.c. and any frequency from 20 cycles through over 100 megacycles. Imagine all measurements . . . d.c., a.c., r.f., i.f., a.f.; made with such astronomically high meter resistance as not to upset the circuit being measured. Add resistance measurements by modern v.t. method . . . even power input in watts, a wide range of capacitances by a couple of external resistors. Then imagine complete stability and dependability . . . result: made possible by new inventions obtainable only in "VOMAX."

It's no wonder "VOMAX" is sold out for 1945 on advance jobber orders. But though the factory is sold out, jobbers still have a few left. May we suggest that you follow the lead of America's top-flight service organizations . . . manufacturers . . . engineering laboratories . . . and place your order immediately? Service-station-originated AA-5 priority does the job. But only fast action will bring you "VOMAX", the key to post-war service profits, this year.

NET PRICE

\$59.85

# A POSTWAR PROJECT FOR YOU...

## SUPERSTANDARD RECEIVING TUBES

**SUPERSTANDARD**—above standard; a term coined by Hytron for a standard receiving tube completely redesigned to give improved performance in special electronic applications

Receiving tube design is often a compromise. Ruggedness, dependability, long life—the very qualities most desirable in industrial electronics and aviation—have often been sacrificed for reduced cost and power consumption in broadcast receivers. Low filament current may be poor economy in an industrial tube. A standard 6SJ7GT may be objectionably microphonic in sound equipment. Vibration, jars, shocks, and inadequate maintenance in the factory may play hob with a standard receiving tube.

### STANDARD — SPECIALLY SELECTED — NOW HYTRON PROPOSES SUPERSTANDARD

**HYTRON IS CONVINCED:** Standard receiving tubes are not right for special electronic applications. Special selection of standard tubes leads to embarrassing replacement problems—does not guarantee permanence of characteristics specially tested, long life, or suitability for operation at not-too-conservative maximum ratings. Hytron prewar ceramic-based low-loss GTX

tubes were but a step in the right direction. The Navy “ruggedized” tube program points the way. Complete redesign of many receiving tubes is mandatory. A tube listing at a dollar in electronic equipment costing thousands and controlling huge production lines is false economy which has already dealt industrial electronics many an unnecessary black eye.

### MAY WE HAVE YOUR OPINION?

- 1 Do you agree that special selection merely results in replacement problems?
- 2 How many thousands of hours of life should **SUPERSTANDARD** tubes have?
- 3 What degree of vibration and shock should **SUPERSTANDARD** tubes be capable of withstanding?
- 4 For what characteristics not now tested should **SUPERSTANDARD** tubes be production tested?
- 5 Would you be willing to pay a premium price for **SUPERSTANDARD** tubes to attain trouble-free operation?
- 6 Should Hytron concentrate on developing **SUPERSTANDARD** tubes usable for many special purposes, and avoid trick and highly specialized tubes?
- 7 How closely should a **SUPERSTANDARD** tube adhere to fundamental characteristics of a standard receiving tube it supersedes?
- 8 Do you believe **SUPERSTANDARD** tubes should have special bases to avoid replacement by inferior standard receiving tubes?
- 9 Should **SUPERSTANDARD** tubes have new type numbers, or the old standard type numbers with a special suffix (e.g., 6SJ7GTS)?\*
- 10 Have we omitted pertinent questions you believe important?

*\*NEMA and RMA are now working on type designation systems.*

The Hytron **SUPERSTANDARD** tube is as yet an idea—a postwar project for YOU. You who use the tubes can spark the program—can make it come to life. Hytron will put its postwar engineering drive behind the **SUPERSTANDARD** tube, if you will help. Let us know the improvements of specific characteristics your experience has proved desirable. Drop a line today to our Commercial Engineering Department.

OLDEST MANUFACTURER SPECIALIZING IN RADIO RECEIVING TUBES

# HYTRON

**RADIO AND ELECTRONICS CORP.**



MAIN OFFICE: SALEM, MASSACHUSETTS  
PLANTS: SALEM, NEWBURYPORT, BEVERLY & LAWRENCE



INDIA—VU7MC, 6.065, Akash Vani, Mysore, scheduled 3:30-4:30, 7:30-11:45 a.m., 9:30-10:30 p.m. In the future other autonomous native states such as Hyderabad and Baroda may have their own SW services. Baroda's proposed transmitter has not yet been installed due to the war.

\*VUD4, 9.59, Delhi, 8-11:30 a.m., news at 9:30, 11 a.m.

\*VUD5, 7.275, Delhi, 8 a.m.-12 noon; news at 9:30, 10:50, 11 a.m.; also heard 9-10:30 p.m., news at 9:30 p.m.

\*VUD6, 9.635, Delhi, 10:50 a.m.-12:30 p.m., news at 10:50, BBC news relay, 11 a.m. QRM'd by CBFX, Montreal, but sometimes gets through to East; heard well in West.

VUB2, 6.150, Bombay, 8:55 a.m.-12:30 p.m.; fair signal to West Coast.

VUC2, 9:530, Calcutta, reported schedule is 3-6 a.m., with fair signal on West Coast.

IRAN—EQC, 9.680, Teheran, reported from Australia as heard 6-7 p.m., closing with clock chimes, a foreign language announcement, and a brisk piece of music. An English language talk concludes at 6:15 p.m., after which bright recordings are played. Seldom heard in U. S.

IRAQ—Y15KG, 7.090 (also reported as 7.085), Baghdad, scheduled 9 a.m.-4:10 p.m.; heard occasionally in U. S., with popular recordings at 12:15 p.m. Reported heard "weak" on West Coast, 10-11:30 a.m.

NEW ZEALAND — \*ZLT7, 6.715, Wellington, special National Broad-

casting Service news summary for Pacific troops, 5:30-5:40 a.m. Can be heard most mornings in East now; better in West. Operated by Post & Telegraph Department, with 5-kw. power.

PHILIPPINES—WVLC, 7.795, Manila, reported heard after midnight and at 5 a.m. Has been heard calling San Francisco on 8.890 at 9 a.m. Reported heard on 9.792, 6-7 a.m., with the "Philippine Hour." An alternate frequency reported is 18.560.

PY, Press Wireless, 9.305, reported heard 12:30 a.m. and 5-6 a.m.

AHITI—FP8AA, Papeete, 12 midnight-1 a.m., Tuesdays and Fridays; reported good in West, audible some mornings in East.

U.S.S.R. (Asiatic) — RW15, 5.94, Khabarovsk, 2-10 a.m., Home Service only.

Khabarovsk, 13.190, reported heard irregularly, 6:55-7:15, 9-10 p.m.

Komsomolsk, \*9.565, dual 8.81, 3-10 a.m. and 11 p.m.-1 a.m., news at 7:40 a.m. on 9.565 only; the 9.565 transmitter reaches the East with a good signal most mornings.

Komsomolsk, \*15.230, relays Radio Centre, Moscow, some days, 7:40-8:45 a.m. and 6:47-7:25 p.m., news usually at 7:40 a.m., 7 p.m. Heard both in West and East.

Komsomolsk, 15.110, relays Radio Centre, Moscow, irregularly.

Komsomolsk, 11.885, relays Radio Centre, Moscow, 7:40-8:45 a.m., 6:47-7:25 p.m., news usually at 7:40, 8

a.m., 7 p.m. Heard in East occasionally.

Petropavlovsk, 6.07, relays Radio Centre, Moscow, 7:40-8:45 a.m., news at 7:40 a.m.; also heard irregularly at other times. Fair signal reported in both East and West, irregularly.

#### ACKNOWLEDGEMENTS

This month our thanks go to:

ARIZONA—Ying Ong; CALIFORNIA—Balbi, Dilg, Gould, Noyes, Foster, Curtiss; COLORADO—Wooley; DISTRICT OF COLUMBIA—Government of India Information Services, Chinese Embassy, Legation of Switzerland, Information Bulletin, Embassy of the U.S.S.R., Royal Norwegian Information Service, Netherlands Information Bureau, Royal Egyptian Legation; ILLINOIS—Hester, Gutter; MASSACHUSETTS—Harris, Florentine, Cotter; NEW JERSEY—Simpson. NEW YORK—Leo T. McCauley (Consul General) Consulate General of Ireland, American-Swedish News Exchange, Inc., Belgian Government Information Center, BBC, Australian News and Information Service, Kulze, Richards; OHIO—Hoiermann; OKLAHOMA—Brewer; PENNSYLVANIA—Bornholdt; RHODE ISLAND—Underwood; TEXAS—Freund; VIRGINIA—Howe, URDXC; WASHINGTON—Hanson; WEST VIRGINIA—Gonder; AUSTRALIA—Gillett, Suffolk, Radio Call; BAFFIN ISLAND (Arctic Circle)—Bettelon; BRITISH GUIANA—de Freitas, ZFY; CANADA—CBC

# FIX ANY RADIO

## Amazing New Invention

Simplified  
Radio  
Servicing  
by  
Comparison  
Method

Find radio faults with a new simplified method. Repair radios in minutes instead of hours. Revolutionary, different Comparison technique permits you to do expert work almost immediately. Most repairs can be made without test equipment. Simple point-to-point, cross-reference, circuit suggestions locate faults quickly and easily.

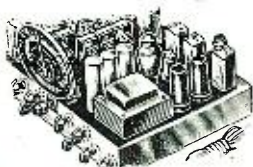

New 1945 Edition

REPAIR ANY RADIO  
IN MINUTES—NO TESTERS NEEDED

Learn how to locate the source of trouble in any radio without equipment. Make needed tests, measure voltage, trace the signal, by using only a resistor, small condenser, and a crystal detector. Inject signals without any signal generator. Test parts by the new Comparison method. Test tubes without equipment. Repair any radio expertly following illustrated simplified plans. Improve your radio servicing ability. Examine and apply the plan for 10 days without obligation or risk. Send coupon today.

COMPLETE  
**\$1.50**  
ONLY  
SPECIAL OFFER  
READ THE DETAILS

Learn trouble-shooting short-cuts; find any radio fault with ease. Follow the tests shown on 24 large circuit blueprints. Over 1,000 practical repair hints. Hundreds of simplified tests using a 5¢ resistor and any filter condenser. Introductory material for beginners and to serve as review for experienced radio men. Several chapters on test equipment. Complete plan in large manual form, 64 practical job-sheets, size: 8½ x 11 inches. Sold on no risk trial. Money-back guarantee. Send coupon today.

NO RISK TRIAL ORDER COUPON

**SUPREME PUBLICATIONS**

9 S. Kedzie Ave.

Chicago 12, Illinois

Ship postpaid the new complete Simplified Radio Servicing by Comparison Method manual for 10 days' examination. I am enclosing \$1.50 full price. I must be entirely satisfied or you will refund my total remittance.

NAME: .....RNO

ADDRESS: .....



**"ECHOPHONE'S GADGETS  
ON THE CITIZENS'  
RADIOPHONE BAND  
WILL BRING US  
CLOSER TOGETHER  
THAN EVER"\***

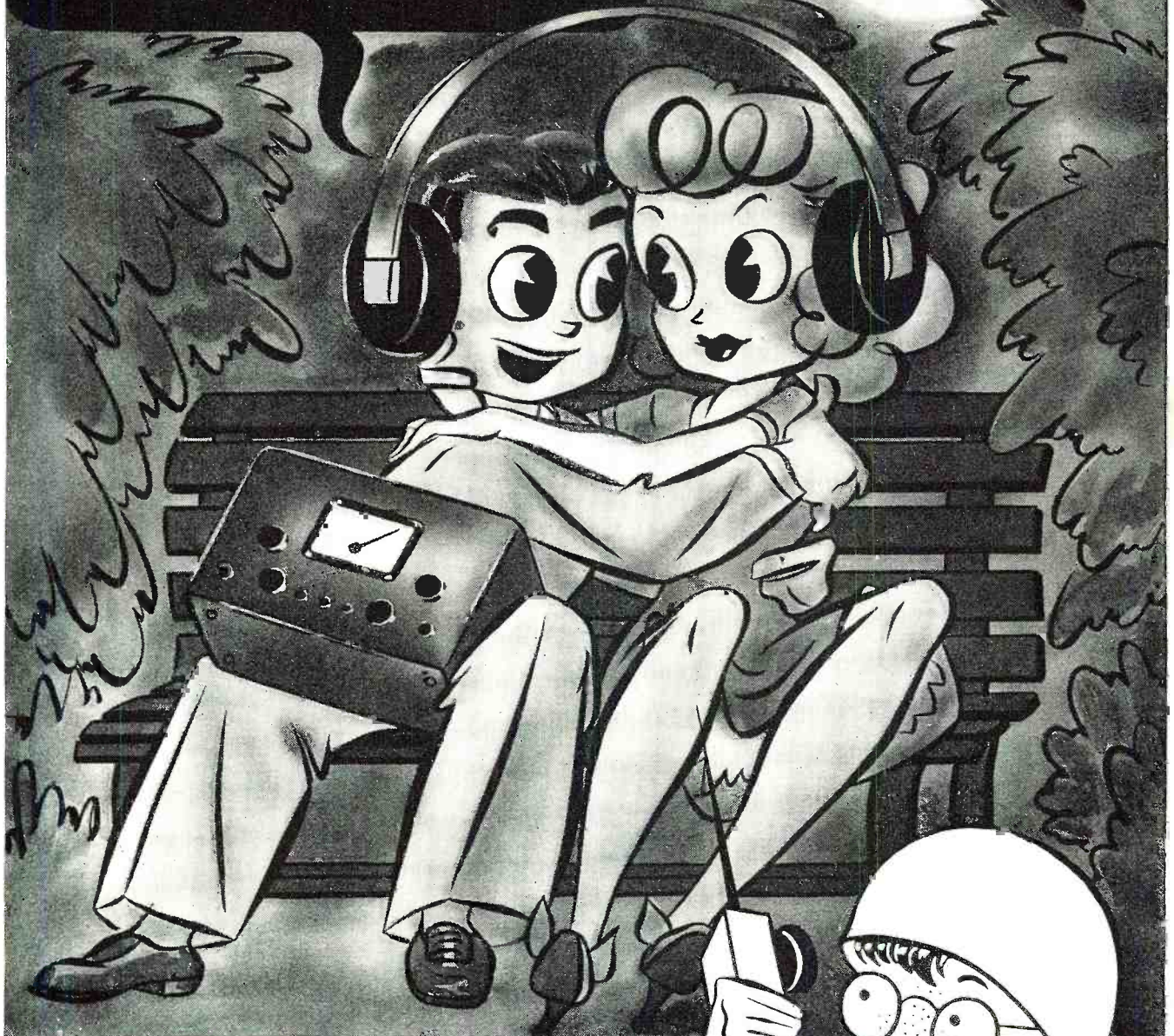

**HOGARTH'S PLANS ARE WELL IN HAND**

Hogarth's well aware of the future new possibilities for Echophone. There will be Echophone equipment for use on the citizens' radio communications service band. It is certain to be low in price, high in performance and completely dependable. The present EC-1 covers from 550 kc. to 30 Mc. on three bands... electrical bandsread on all bands... self-contained speaker... 115-125 volts AC or DC.

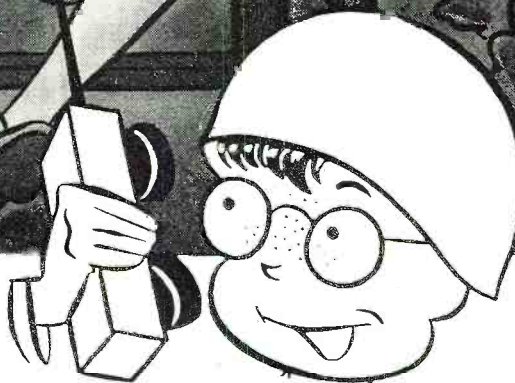

**ECHOPHONE**  
*"The Ears of the World"*

\*Citizen's radio communications service band, 460-470 Mc., recently proposed by the F.C.C.

**ECHOPHONE RADIO CO., 540 NORTH MICHIGAN AVE., CHICAGO 11, ILLINOIS  
October, 1945**

# Announcing Batteries by RCA

- **RADIO-ENGINEERED  
FOR EXTRA LISTENING HOURS**
- **PREFERRED-TYPE LINE  
FOR BETTER PROFITS....**

**RADIO-ENGINEERED  
BATTERIES**



**RADIO CORPORATION OF AMERICA**

RCA VICTOR DIVISION • CAMDEN, NEW JERSEY

LEADS THE WAY... In Radio... Television... Tubes...  
Phonographs... Records... Electronics

**WHY! —**

● RCA batteries offer you something *new*... batteries engineered specifically for *radio* under the trademark of RCA—one of the leading radio manufacturers... the best-known name in radio!

A *Preferred-Type* line, similar to the famous RCA *Preferred-Type* tube program, will simplify your battery stocks... will bring you faster turnover for a smaller investment... will require less stocking space... will ensure fresher batteries at the time of sale.

The top quality and peak performance that you and your customers expect from any RCA product will give them longer listening... and in the long run you will do more business with satisfied customers.

RCA Radio-Engineered Batteries for All Types of Sets... and a Complete Line of RCA Dry Batteries



**WHEN! —**

RCA Radio-Engineered batteries will come to you as soon as civilian radio batteries are released in quantity... and as soon as possible after you order them.

That day may be just around the corner. *Now* is the time to get ready.

Listen to "THE RCA VICTOR SHOW,"  
Sundays, 4:30 P.M., EWT, NBC Network

**WHAT TO DO ABOUT IT**

Mail this coupon to your tube distributor today. It's your reservation for a personal preview of RCA's battery plans for you. He will send you a complete explanation, telling just what to do to get set for big profits from RCA batteries.

**WHERE! —**

You'll be able to order RCA *Radio-Engineered* batteries, as well as tubes, from your tube distributor. RCA batteries will be sold *only* through authorized tube distributors.

**MAIL THIS RESERVATION TODAY!**

62-6736-103

DEAR MR. TUBE DISTRIBUTOR:

I'm interested in increasing my battery profits, and I should like information concerning the new line of RCA *Radio-Engineered* batteries. Please mail me all details of the RCA battery plan as soon as possible.

Name.....

Company.....

Address.....

.....

Who is a major supplier of critical radio and electronic equipment to industry, war agencies, service men, schools, etc.?



**HARVEY!**

Who can locate hard-to-find parts, or recommend effective substitutes, for the harassed purchasing agent?



**HARVEY!**

Who has up-to-the-minute information on latest developments in the field for present or postwar use?



**HARVEY!**

Who takes every possible means to deliver the goods promptly, to give you extra-special service without extra cost?



**HARVEY!**

HARVEY has been in the business for a dozen and a half years. We stock lines of leading radio and electronic manufacturers. And we back them up with our own specialized experiences which, in turn, can save you time, trouble and money.

Telephone Orders to LO. 3-1800

**HARVEY**  
**RADIO COMPANY**  
**HARVEY**

103 WEST 43rd ST., NEW YORK 18, N. Y.

(Montreal, Quebec), Bromley, Pimbert (Toronto Ontario), Harrison, British Columbia; CHINA—T. Y. Penn, Deputy Director General, Central Broadcasting Company; INDIA—The Indian Listener, Wadia; NEW ZEALAND—National Broadcasting Service; TURKEY—Radio Branch, Turkish Press Dept., Ankara.

\* \* \*

**LAST MINUTE TIPS**

VQF2, 6.985, Kuching, Sarawak (in Borneo), recently heard 12:30-1:45 a.m., music, talks in English; signed off with "God Save the King." Was Jap-controlled, but sign-off indicates it is again in Allied hands. CJA2, Montreal, Canada, heard at 8 p.m. calling GDB, London, approximately 13.760. SPW, 13.635, Warsaw, Poland, heard twice recently, 9-10:15 p.m. ZOY, 7.050, Accra, Gold Coast, 2-3 p.m., news at 2 p.m. New USSR station heard in Russian, 11-11:15 p.m. on approximately 13.450. (Sutton, Ohio). Probably an Asiatic Russian.

ICD, approximately 16.50, Rome, Italy, heard with good signal early in August; messages; said they were "using new transmitter and new studios," and that speech-inverting equipment was expected by August 15. Radio France, 9.520, dual 9.613, 9-10:45 p.m., news 9:30 p.m., asks for "comments and criticisms," address: Radio France, French National News Service, 501 Madison Ave., New York 22. (Gonder, W. Va.)

OIX2, 9.500, Lahti, Finland, heard

signing off in English (woman announcer) at 4:50 p.m. Said they were on "exactly 9 and one-half megacycles."

KIO, 11.680, Kahuhu, Hawaii, heard at 8:50 a.m. relaying Manila.

LRA5, 17.720, Buenos Aires, Argentina, heard in English, 5-5:15 p.m., then in Spanish or Portuguese, 5:15-5:27 p.m. sign-off, a recent Friday.

HEF4, 9.185, Bern, has replaced HER3, 6.165, to North America, 9:30-11 p.m., dual 7.380, news at 9:45 p.m. A new Bern frequency of 15.875 has replaced HEO4, 10.342, 3:20-3:50 p.m., news at 3:30 p.m. All Swiss signals are good. (In mid-August, HEF4 was drifting to approximately 9.52.)

VLQ2, 7.215, Brisbane, Australia, heard 3:30-9:30 a.m., news at 4, 7, 9 a.m.; good signal in East. VLC6, 9.615, Shepparton, has news and sports results at dictation speed, 5:45 a.m.; good, copyable signal in East.

CFCX, 6.005, Montreal, Quebec, has CBC news at 7 a.m. Announcement heard of current schedules of the CBC International Service from the powerful (50,000-watt) Sackville, N.B., short-wave transmitters, is now confirmed by a press release from Montreal. These transmitters put Canada on the air 12 hours daily, 7 a.m.-7 p.m. (noon to midnight in the United Kingdom and Western Europe, recently reverted to ordinary summer time after having been on double summer time during the European war); many new entertainment programs in Eng-

This picture was taken in the battery factory of the Central Electric Works near Kweilin, China, before the Jap forces occupied the city. The photograph shows the rather crude method employed in the manufacture of radio tubes. Similar to American industries, girls do the intricate assembly work. The city of Kweilin was recently retaken by the Chinese forces. However, there is considerable doubt as to whether production at this plant has been resumed. The radio industry in China has always been rather crude. Chinese officials aware of this fact have recently made plans to adopt American production methods to facilitate expanding the radio industry in China. Provisions have been made to send a group of engineers to this country to study our production methods.



# SPRAGUE TRADING POST

A FREE Buy-Exchange-Sell Service for Radio Men



Five times cited  
for distinguished  
wartime service.

## ... NOW, in Peace

you can count on Sprague—just as  
the nation counted on Sprague in war!

**FOR SALE**—Riders 1 to 7 \$35. Want pocket portable radio. Pvt. A. Ismal, 2333 Grand ave., Bronx 53, N. Y.

**FOR SALE OR TRADE**—Library of 18 radio and electronic books. Cash or will trade for camera, photo eqpt. or Christy & Pacific appliance course. Sgt. James Stern, 408 S. Tejon st., Colorado Springs, Colo.

**URGENTLY NEEDED**—Original test sheet or copy for 'O' Radioteknik laboratory tube tester. Theodore Vanderwonde, Box 531, Randolph, Wis.

**WILL TRADE**—Chicago Industrial Instrument #431 V-O-M complete for small table radio a-c or ac-dc. Edward Schuman, 65 E. 53rd st., Brooklyn 3, N. Y.

**FOR SALE**—Triplet #677 d-c voltmeter, #675 d-c milliammeter; 673 a-c voltmeter; #678 ohmmeter \$15 ea.; sig. gen. #3; Jensen 15" speaker with power supply and Philco record player. Elizabeth Beebe, Vivian st., R.F.D. #2, New London, Conn.

**FOR SALE**—American 2-button carbon mike; Shure crystal; Turner 999 Dynamic mike; Leiktrphone contact mike with built-in volume control and amphenol plug; Signal electric drill, etc. John Archibald, 1722 Melville st., Bronx 60, N. Y.

**WANTED**—Complete set Riders, new or used. Donald McClish, Box 87, Mesick, Mich.

**WILL TRADE**—2 ac-dc radios, need slight repairs. Want 3 or 4-tube set with short-wave plug-in-coils. T. Prince, Box 871, Uniontown, Pa.

**FOR SALE**—Philco all-wave sig. gen. \$20; Supreme tube tester with adapters \$25; Green Flyer phono motor \$15; power transformers and other parts and tubes. Clarks Radio Shop, Corinna, Me.

**WANTED**—Signal generator. Will pay cash. Edward Dowse, 329 Reed ave., Salt Lake City, Utah.

**FOR SALE**—Over 100 new tubes at 40% off ceiling. Send for list. G. H. Doty, 1036 S. Broadway, Dayton 8, Ohio.

**WILL TRADE**—6F6-G, 6L7, 6U5, 6C5, 12SK7, 12SA7, 50L6 and 6SC7GYG tubes for Riders 12, 13 or 14. Shiseo Akada, 3307-A, Newell, Calif.

**FOR SALE**—N. R. I. tester, parts for 10w amplifier, and 16mm movie camera. Want 35mm camera. Pvt. S. W. Reed 3rd, PIAT Co. X, 55 S.A.W., A.A.B., Santa Ana, Calif.

**WANTED**—1st class serviceman, real opportunity for right man. Southern Radio Service, Thomasville, Ga.

**FOR SALE**—Bogan 70-watt amplifier with built-in phono; 2 Turner 33D mikes; 4 Utah 12" speakers; 3 outdoor all steel baffles; 2 indoor baffles; all slightly used \$200. Carl L. Ding, 213 W. Emerson st., Princeton, Ind.

**FOR SALE**—Tubes at wholesale prices. Write for list. Will pay cash for Riders #2. J. T. Matthews, 1000 Decker st., Mononkabela, Pa.

**WANTED**—Motorola Wireless record player, WR3. Will sell Weston R.F. ammeter CV382, \$6. M. Kelly, 708 Newington ave., Baltimore, Md.

**URGENTLY NEEDED**—Any kind radio and technical radio books. P.F.C. Joseph Geviado, 913077 U.S.M.C., M.N.-P.O.T.D.—O.T.U. 2—N.A.A.S., Kingsville, Texas.

**FOR SALE**—Clough-Brenkle CRO 3" scope; Jensen M-10 AC 14" auditorium speaker; RCA 2M1V 57-B oscillator and PA audio and power transformers. J. J. Bressler, 25 Donsan Place, New York 34, N. Y.

**WANTED**—10" & 12" record changer. Cash or will trade Univex Mercury 13.5, carrying case, tripod, range finder and extension meter. Jack Ferdin, 1247 Grant ave., Bronx 56, N. Y.

**FOR SALE**—Sprayberry radio servicing course; Olympian C melody saxophone. Pioneer peno-motor; Jewell set analyzer and Philco #38 console with tubes. Want Riders 2, 6 and 8. Clifford Lessig, 24 Eighth st., Frenchtown, N. J.

**WILL TRADE**—Astronomical telescope; midget radio, electroscope for testing radium, etc. Want portable typewriter. F. Madlinger, 1704 Palmetto st., Brooklyn 27, N. Y.

**WANTED**—New or used 1-crystal pickup replacement cartridge, 3-hole mount, and crystal pickup. Monroe Hill, Apt. 2, 1909 N. E. 6th st., Oklahoma City, Okla.

**FOR SALE**—Triplet professional all-purpose tester #1175-B, with test leads and instruction book. Want late Hickok traceometer or Rider chanalyst. Robert F. Young, 729 W. Dominick st., Rome, N. Y.

**URGENTLY NEEDED**—1½ and 1½ watt Neon test bulbs. J. T. Necklem, Colonel, c/o G.S.C. I.N.P.—EB, 2105 Axton road, Mansfield, Ohio.

**FOR SALE**—Sensitive d-c relays, coil resistance 8000 ohms, single pole, double throw, 2 amps. at 115v. a-c \$1 ea. Joseph F. McDonald, P. O. Box 123, New Hyde Park, N. Y.

**WILL TRADE**—17-jewel Gruen watch for set analyzer or multimeter in good condition. W. H. Elkins, 389 Cambridge ave., Memphis 5, Tenn.

**WANTED**—25Z5 rectifier tube. Don Beckery, Wolf Point, Mont.

**FOR SALE**—Instrucograph code transmitter 5 to 40 w.p.m. with basic tapes, three advanced tapes, headphone, tube oscillator and key. \$25. Pfc. Don E. Calkins, Hq. & Serv. Co. TAS, Fort Knox, Ky.

**URGENTLY NEEDED**—1A7, 1N5, 1H5, 1T5, 6G6, 117Z6, 1A5 tubes and Rider's Leo-Bovee Radio Service, Rt. 4, Anoka, Minn.

**SELL OR TRADE**—Stock of tubes to trade for 1S4, 6A7, 25D8, 25Z6, 35Z5 tubes or will pay cash. Roger F. Cain, Savannah, Mo.

**FOR SALE**—Capacitor analyzer, \$20 and 6B5, 45, 12SA7, 1N5GT, 6V6, 12SQ7 tubes. Leyden Radio Sales & Service, 9651 Franklin ave., Franklin Park, Ill.

**WANTED**—Two 25Z5 tubes. Cash or will trade. Ray Jay, 207 Brown st., Milton, Ore.

**FOR SALE**—Clough Brenkle sig. gen. with built-in motor-driven condenser "Wobulator" 100KC to 30MC on fundamentals & higher on harmonics; recalibrated and with circuit diagram \$40 or will exchange for Riders 10, 11, 13 and 14. Philip P. Goldstein, 288 ave. F., Brooklyn 4, N. Y.

**FOR SALE**—Superior condenser tester BR-44 and 1 ea. 25L6, OZ4, 12SK7, 32L6, 6J7, 6U7, 6L6; two 24, 78; three 6K7, 80, 25Z5, 43 and four 27. Tubes \$14. Walter Socha, 8 Tomasin ave., Schenectady 8, N. Y.

**WANTED**—Signal Generator 120 KC to 260 MC. David's Radio Service, 319 Los Angeles st., Bellflower, Calif.

**WILL TRADE**—Slightly used Remington shaver. Want V-O-M or what have you. Cpl. W. A. Seeger, c/o Postmaster, San Francisco.

**FOR SALE**—Janette rotary converter 110v d-c to 110 a-c, 500 watts. Wilbur Gastonquay, Box 345, Tobonga, Calif.

**URGENTLY NEEDED**—V.T.C.: LS-22, LS-21 or LS-19 interstage audio transformer. James G. E. DuBois, 1081 Jackson ave., St. Louis 5, Mo.

**WILL TRADE**—Used Webster recorder and phono changer; transmitter tubes and parts, receiving tubes; Meissner P.M. converter; 30-watt amplifier and Kainer horn. Want Hickok 510X-530 tube tester and 592 Supreme analyzer. R. Voigt, 4365 Miller road, Flint, Mich.

**WANTED**—Set tester, tube tester or combination; also sig. gen. What have you? P. M. Millington, 1519 W. Compton Blvd., Clearwater, Calif.

**FOR SALE**—500w transmitter with receiver. Tony Zucco, 3rd st., Cresson, Pa.

**WANTED**—Hickok sig. gen. #188x and late tube tester, S. Marsh, 1308 Rosedale ave., Chicago 40, Ill.

**WILL TRADE**—RCA auto radio #67M3. Want phono-recorder unit or amplifier. Robert F. Bullock, P. O. Box 132, Branch, Ark.

### YOUR OWN AD RUN FREE!

For three wartime years, the Sprague Trading Post helped radio men sell, trade or buy needed materials. Now, with the advent of Peace, this free advertising service will continue as long as the need exists.

We'll gladly run your ad free in the first available issue of one of the 5 magazines in which the Trading Post appears. All we ask is that it be written clearly and concisely, that it be confined to radio materials, and that it fit in with the spirit of this service.

**As always we know we can count on you to use Sprague Condensers and Koolohm Resistors—and to ask for them by name!**

**HARRY KALKER, Sales Manager**

Dept. RN-105, SPRAGUE PRODUCTS CO., North Adams, Mass.  
Jobbing distributing organization for products of the Sprague Electric Co.



# SPRAGUE CONDENSERS KOOLOHM RESISTORS

TM. REGISTERED U. S. PATENT OFFICE

Obviously, Sprague cannot assume any responsibility, or guarantee goods, services, etc., which might be exchanged through the above advertisements.

lish and French to Canadian occupation forces have been inaugurated, with broadcasts to United Kingdom, France, Czechoslovakia, Holland, and Germany, being increased. Schedule: CHTA, 15.22, 7 a.m.-4:30 p.m.; CHOL, 11.72, 4:45-7 p.m.

A letter from Brazzaville indicates that FZI is due to "take a back seat" in favor of Radio France, Paris. On 9.440, Brazzaville is still heard with excellent signal throughout the U.S., news in English at 2:45, 4:45, 6:15, 7:25 p.m. The last two are also heard on 11.97.

ZFY, 6.000, Georgetown, British Guiana, sends a good signal to East, 3:45-8:15 p.m. ZFY's studios and offices were burned in February; modern, air conditioned, sound-proofed, better-

equipped studios are to be built. In the meantime, ZFY has been using a temporary studio set up in a Masonic lodge room. (de Freitas, ZFY.)

RNB, Leopoldville, Belgian Congo, is now heard on 9.750, instead of former 9.783, news at 8:15 p.m. Still relays BBC, 9:15 p.m.-12:45 a.m. A letter from the Belgian Government Information Center, New York City, states there are no short-wave stations in Belgium at present, and that Leopoldville will shortly discontinue its independent programs and only relay Brussels. Brussels has been reported from time to time recently as on the air, however, on 11.925, fair until 3:30 p.m., announcing as "Radio National Belge." Also reported on 11.930 and 17.845.

The Royal Norwegian Information Service, Washington, reports the Je-loey short-wave broadcaster is in operation on experimental wavelengths only and has no regular service. Details from Oslo are promised shortly.

Most BBC frequencies come through from London with excellent signal strength. The 31-meter band is alive with London transmitters at night. Tuning across the 31-meter band after midnight and before 1:30 a.m., the General Forces Program and Pacific Service transmitters are all over—9.51, 9.60, 9.64, 9.69. Have word of a SW station at Lusaka, Northern Rhodesia, on 7.22, around 1 p.m.; identifies in English; uses several native languages, woman announcer. Moscow is heard well in Chicago at 12 noon EWT on 15.75 and also irregularly in evenings on same frequencies; sometimes is very strong.

As many may know, "Deutcher Kerzwellen Sender Atlantik" ("Radio Atlantic") was operated from England; this was revealed after V-E day. (Gutter, Illinois.)

CKRO, 6.150, Winnipeg, Manitoba, scheduled 10 p.m.-1 or 1:05 a.m. (Hester, Illinois.)

As of August 1, English language transmissions from Radio Centre, Moscow, were listed by the USSR Embassy, Washington, as: 7-7:40 a.m., 11.83, 15.75; 7:40-8:20 a.m., 6.07, 9.56, 10.44, 11.63; 8:20-8:45 a.m., 11.83, 15.75; 12 noon-12:30 p.m., 11.83, 15.75; 6:47-7:25 p.m., 7.03, 11.83, 15.75; 8-10 p.m., 7.03, 9.46, 11.95. Reception in the East is erratic, best bets being 15.75 and 9.565, mornings, and 15.23, 6:47-7:25 p.m. (although not listed by the Embassy, have been hearing this one almost daily).

AFN, 6.080, Paris, new 100-kw station operated by Armed Forces Network in the European Theatre, now scheduled midnight-8:05 p.m., when has twenty minutes of operational notes at dictation speed. Sign-off at 8:05 p.m. is with National Anthem. Excellent signal here in East, some QRM.

VLW6, 9.680, Perth, Australia, heard with excellent signals in East, mornings, world news at 7 a.m. followed by ABC news. Announces this is the "nightly ABC Service."

ZNR, 12.115, Aden, heard again, 12:15-1:15 p.m. "Omdurman Radio," 13.200, Anglo-Egyptian Sudan, heard 12 noon-2 p.m. Vienna has been heard recently on 7.140 at 4:30 p.m. The summer schedule of Ponta Delgada, Azores, 4.040, is 4-6 p.m. CP5, LaPaz, Bolivia, reported back on 6.205. HJAG, Barranquilla, Colombia, is back on 4.975. PRJ4, 4.825, Parnaiba, Piaui, Brazil, has returned to this frequency from 9.205. HI3X, 12.105, Ciudad Trujillo, Dominican Republic, has returned to this frequency from 11.850, heard 6:10-10:40 p.m. HC1AC, 7.200, Quito, Ecuador, "La Voz de la Democracia," is heard with strong signals until 12:15 a.m.; HC1BS, 9.355, Quito, is heard 9 a.m.-midnight, HC2RL, 6.635, Guayaquil, is reported returned to the air.

(Continued on page 130)

**RADIO NEWS**

# ANTENNAS

EST.



1906

*For every radio purpose*

**BRACH ANTENNAS**

*since the beginning of radio broadcasting  
have been pace-makers in their field*

IN WAR

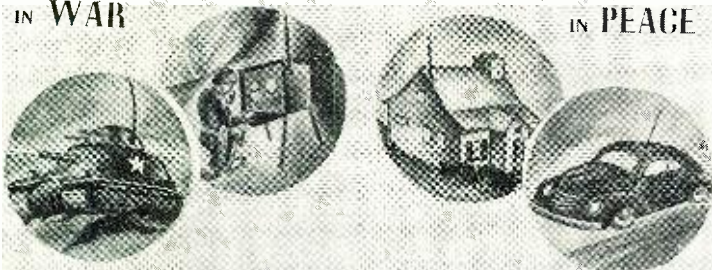

IN PEACE

BRACH Antennas, tested and perfected to meet Army and Navy standards, are doing their part for victory on land, on sea, and in the air.

After the war, BRACH Puratone\* Antennas will again resume their established leadership for Home and Auto Radios, Television, Marine, F.M. and other services.

TODAY AND IN THE FUTURE

... FOR *antennas* REMEMBER

\*Reg. Patent Trade Mark

L. S. BRACH MFG. CORP.

**BRACH**

NEWARK 4, N. J.

*World's Oldest and Largest Manufacturers  
of Radio Antennas and Accessories*

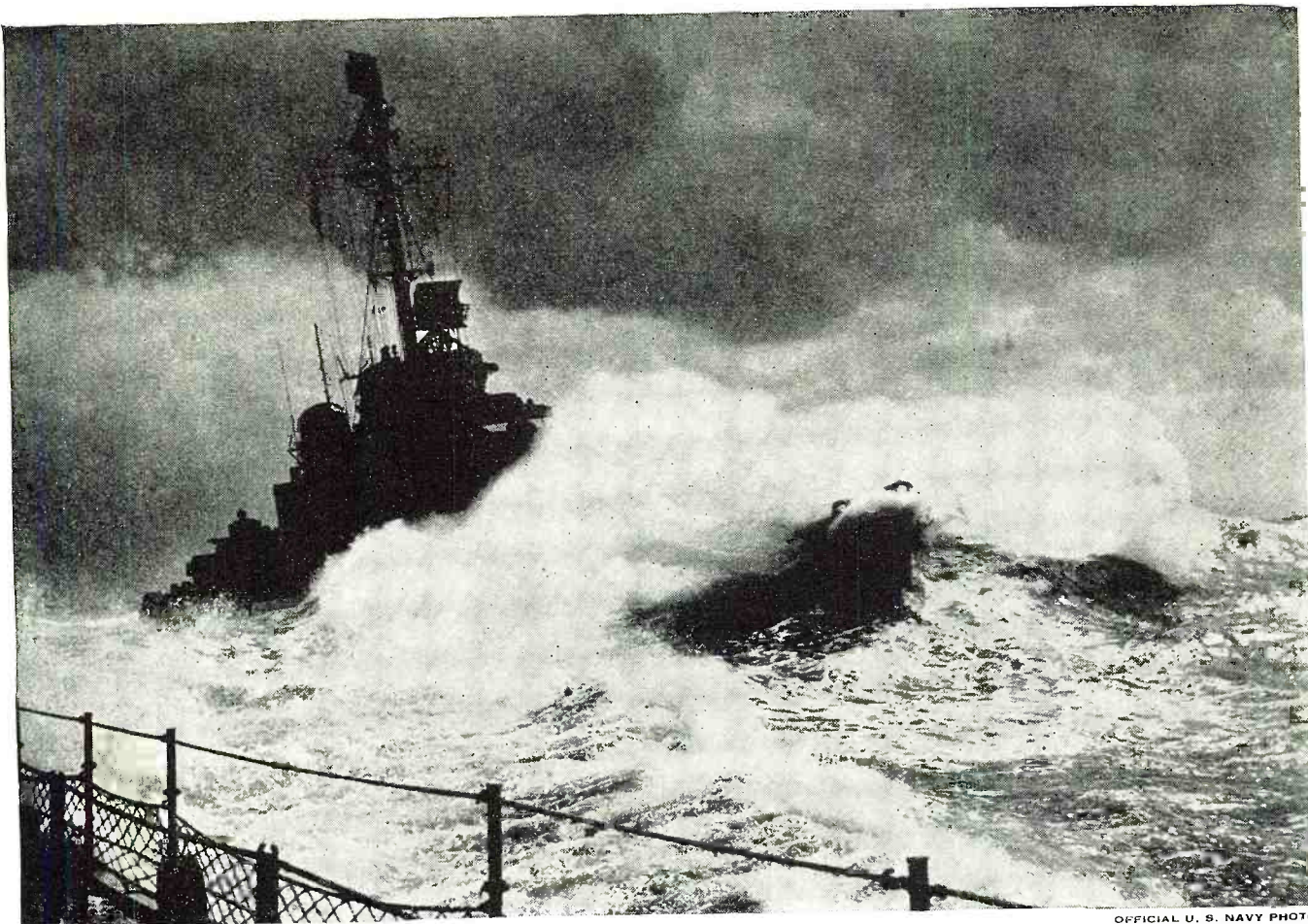

OFFICIAL U. S. NAVY PHOTO

## Any port in a storm ... but there are no ports

More than one sailor has said, "It's a helluva place to fight a war!"

That's a miracle of understatement when you know the Pacific as well as the U. S. Navy knows it.

They know how many thousands of miles you have to go before you reach the fighting fronts.

They know there's almost continual rain and bad weather to hamper operations after you get there.

*And they know there are no good ports!*

Think of the thousands of ships, and the millions of tons of supplies it takes to keep our fighting forces moving toward Japan.

Imagine, if you can, the problem of handling those ships and supplies with no port facilities.

There are no giant cargo cranes...no miles of docks and warehouses...nothing but beaches, and human backs, and a refusal to call any job impossible.

Remember, too:

**It takes 3 ships to do the supply job in the Pacific that 1 ship can do in the Atlantic.**

**It takes 6 to 11 tons of supplies to put a man on the Pacific battleline, and another ton per month to keep him supplied.**

**It takes a supply vessel, under ideal**

**conditions, half a year to make one round trip.**

Add up those facts, multiply by the number of sailors, soldiers, and marines for whom the Navy is responsible.

Maybe you'll begin to realize what "no ports" can mean in the rough, tough waters of the Pacific.

Maybe you'll see that we have *two* reasons to be proud of the U. S. Navy. *First*, the way they've sunk the enemy's ships.

*Second*, the way they sail *your* ships... taking the worst the Pacific can hand them...but keeping the supply lines open...keeping the attack *on schedule!*

**SPERRY GYROSCOPE COMPANY, INC.** GREAT NECK, N. Y.



*Division of the Sperry Corporation*

★  
LOS ANGELES • SAN FRANCISCO • SEATTLE • NEW ORLEANS  
CLEVELAND • BROOKLYN • HONOLULU

MAKERS OF PRECISION INSTRUMENTS FOR THE ARMED FORCES

**PARTS?**  
ORDER TODAY FROM...

**R. W. T.**  
**WORLD'S LARGEST**  
Radio Supply House • Founded 1922

For Industrial Organizations  
Laboratories • Purchasing Agents  
Radio Dealers & Service Men  
Training Schools • Expeditors  
Amateur Operators and Experimenters

**10,000 PARTS**  
Immediately available. (Some no longer  
need priorities.) Selected and shipped  
same day your order is received.

**Radio Wire  
Television Inc.**  
100 SIXTH AVE. (DEPT. R10) NEW YORK 13  
BOSTON, MASS. NEWARK, N. J.

Originators of the  
**Lafayette Radio**  
soon in production again

96

# CAPTURED 1000 Watt JAP TRANSMITTER

*This transmitter, like all radio equipment produced by the Japs, has the appearance of being copied direct from American models.*

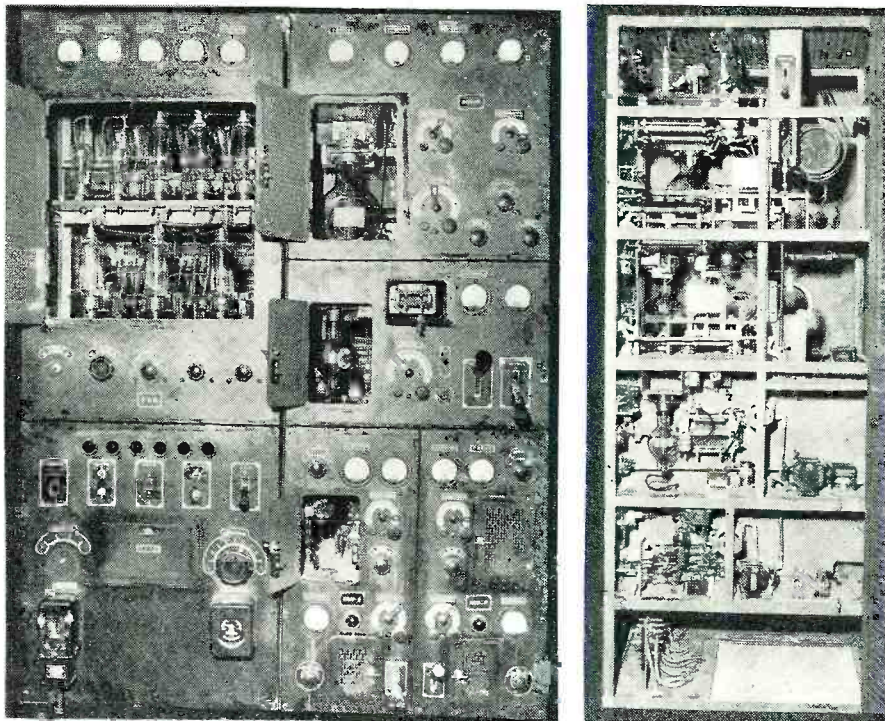

Front panel view of Jap 1 kw. transmitter shows power supply racks toward the left and r.f. section on the right. Side view shows r.f. section of transmitter. From top to bottom, antenna tuning, power amplifier, driver, buffer doubler, and oscillator.

**S**HERMAN to the contrary, war sometimes has advantages, at least for former civilian radio-men in the signal corps. T/5 John M. Young, of Springfield, Missouri, for example, found that it gave him the opportunity every ham dreams about, to have a one-kilowatt transmitter put in his lap with the privilege of playing around with it all he pleases, finding out what makes it tick, and making it tick some more.

The set was a Japanese 1000-watt CW transmitter captured on Luzon by the U. S. Army Signal Corps. It was, by far, not the best or largest we had captured, but it was the only one of its kind we had found.

From the front panel, it looked like a transmitter that might have been designed in America about ten or twelve years ago. It came in two separate cabinets about six feet high and four feet wide, the r.f. section and the power supply. It was a conventional exciter, buffer-doubler, driver and power amplifier, all single-ended and capacitively coupled with

a link coupling from the final stage to a pi-network antenna matching arrangement.

The interior revealed coils, resistors, condensers, and potentiometers of a design also about ten years old. The use of heavy aluminum castings, glass stand-offs, and connecting shafts from the front panel, was evident throughout. Each of the multitude of doors on the front and side was protected by an efficient interlock of a wedge-contact type. It had no forced air or water cooling arrangement. Flat discs mounted on wooden coil forms and heavy variable condensers served their purpose. The heavy construction of the condensers, especially in the driver and power amplifier stages, could take a fair amount of arcing.

All tube filaments had voltage regulators on the primary side of the transformers. They were variable resistors, a sliding arm over resistance wire wound on a wooden form, somewhat similar to the laboratory type variable resistor.

Of its six meters, five were Japanese

**RADIO NEWS**



**Because Accuracy Hangs in the Balance**

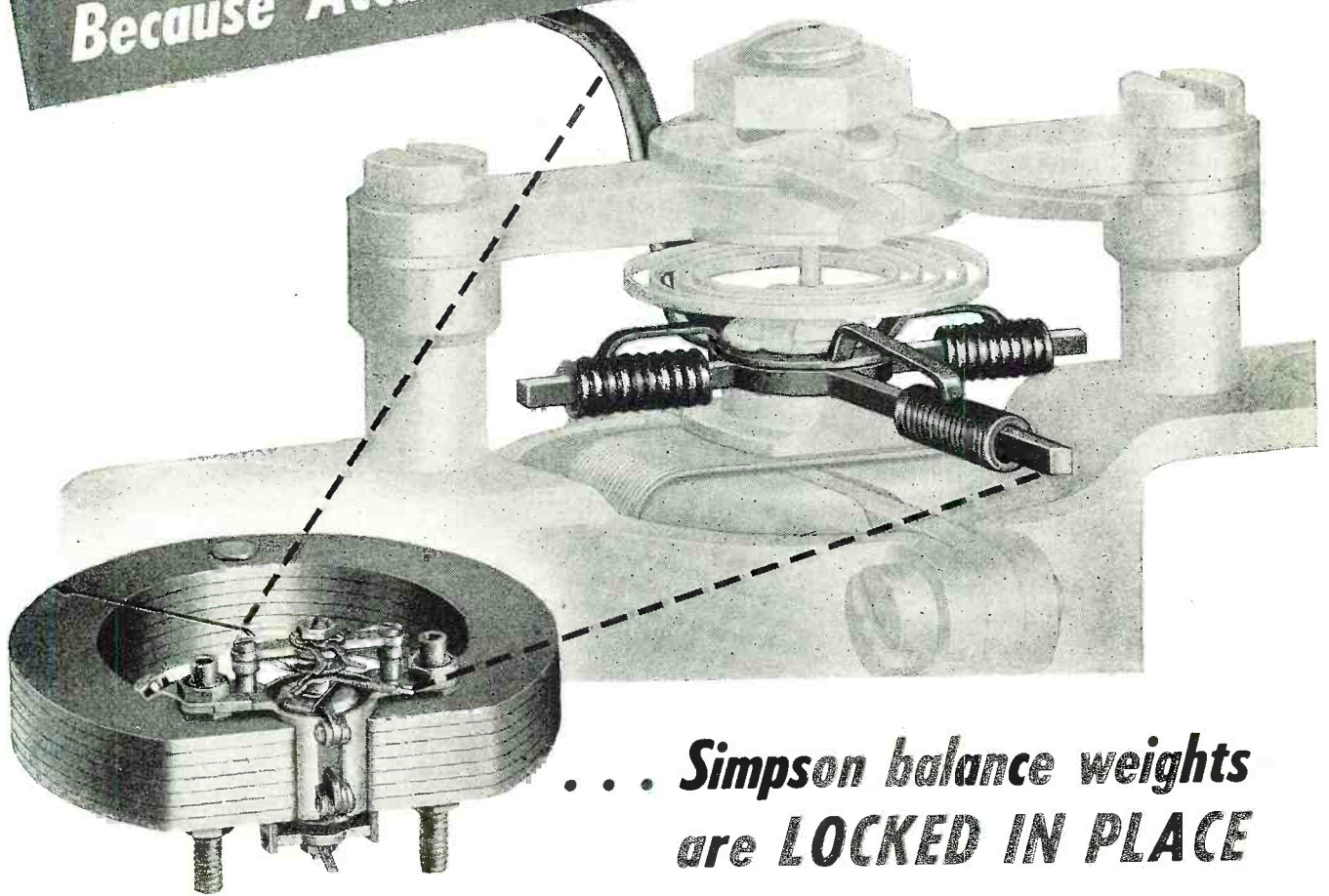

**... Simpson balance weights are LOCKED IN PLACE**

PERHAPS it's the smaller details, like these balance weights, that best illustrate the value of Simpson's 35 years of experience.

Though only tiny coils of wire, these balance weights have an important function—to offset the weight of the pointer so the moving assembly will swing in perfect balance. If the instrument is to stay accurate, they must stay in place.

So Simpson has devised a method of locking these balance weights in position. This construction not only defeats vibration and shock, it per-

mits even greater initial accuracy and makes possible faster, more efficient production.

Such refinements come from a greater knowledge of the problems of instrument manufacture, and a greater fund of practical experience which can be applied to their solution. This is the simple reason Simpson Instruments are writing such an outstanding service record in posts of vital responsibility. This, too, is your guarantee of the ablest translation of today's advances in tomorrow's instruments.

SIMPSON ELECTRIC COMPANY  
5200-5218 Kinzie St., Chicago 44, Illinois

# Simpson

INSTRUMENTS THAT STAY ACCURATE

Buy War Bonds and Stamps for Victory

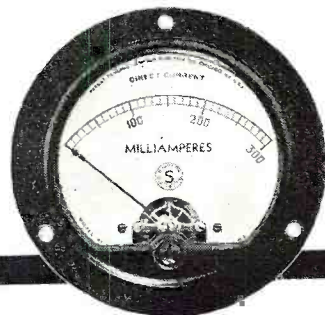

and one, the driver and power amplifier filament voltages, was a *Weston*, model 476, 0 to 15 a.c. voltmeter, manufactured in America.

The exciter provided for either crystal control or master oscillator operation. It was divided into two electrically separate sections, low and high frequency. Choice was made with a heavy-handled knife switch that resembled a high power switch. It incorporated four crystal sockets for each section, but there appeared a peculiarity. Two of the sockets were of the double pronged, plug-in variety while the other two had circular bases. Evidently the lack of standardization in Japanese crystal manufacture necessitated designing

the transmitter to utilize existing crystals. It had no insulation or temperature control in the crystal compartment. Only a temperature compensating resistor circuit gave it any semblance of stability. The tube was the equivalent of a 47, but its workmanship and results were below American standards.

The buffer-doubler employed an American type 860 tube. Its circuit design was conventional and matched the rest of the rig in being out-moded. The only peculiarity of this stage was two knife switches on the front panel that shorted out fixed coils and condensers. The handles were large and again similar to a power switch.

The driver also used an American

type 860 with the same features found in such a single-ended stage a decade ago. Keying of the screen grid of this circuit left the oscillator and buffer-doubler constantly excited. The keying relay was sluggish but ruggedly built. It could key up to about 150 words a minute.

The power amplifier, with its American-type 861 tube, was elementary with a crude feedback circuit for neutralization.

The power supply was a three-phase, 220-volt bridge rectifier using six 820 type, mercury vapor rectifiers for the plate power and bias supply from two 866's in full wave, single-phase rectification. Wire wound bleeder resistors, in banks, looked serviceable, but showed sign of sweating. Transformers and filter condensers appeared adequate. The transformers had a lot of iron in them, and the workmanship of the winding was passable.

An overload relay of the magnetic coil variety was reset by a toggle switch. The time delay was a clock arrangement, which could be set for any desired time. Fuses were cartridge type.

The potentiometers and switches were heavy and sluggish.

The Japanese had made this transmitter work for them, so why not make it work for us? That, again, was the job of signal corps technician, John Young. With typical ingenuity, he cannibalized a power transformer from another captured set, and wound some copper tubing to replace the driver and power amplifier coils that were missing. Tubes, found separately, were put to use. Young tried hit-and-miss methods with the foreign dials and the meters began to respond. Reflected impedance kept knocking the exciter off frequency. It was a touchy job, since no provisions had been made to lower the plate power during tuning. 861's were hard to get, at that stage of the operation, and the current carrying capacity of the Jap counter-part was uncertain. The danger of drawing too much current and burning out the tube was considerable.

Finally, after tuning each stage and constantly retuning the preceding stages, the transmitter was ready to go on the air. The link coupling to the antenna proved inadequate, so Young tapped into the power amplifier tank directly. It worked.

Our own superior equipment was being installed by then, and though the Jap transmitter's frequency was unstable and its design outmoded, it was employed as a stand-by.

This set does not typify Japanese signal equipment. Although the Japs haven't surpassed us, the U. S. Army Signal Corps today is using a good deal of captured equipment to supplement its own supply. A high degree of skill and constant training on the part of signal corps personnel has made this equipment serve the vast Southwest Pacific communications system.

**PEAK PERFORMANCE**  
*on the "Highs"*

with the new  
**RME 45**

*Features*

- Streamlined two-tone cabinet
- Acoustically designed speaker housing
- Relay rack mounting panel
- Six bands, 550 to 33,000 KC
- Automatic noise limiter
- Relay control and break-in terminals
- Signal level meter
- Variable crystal filter
- Bandspread—equivalent to 75 linear inches for every 180 degree sweep of main pointer

**NOW ON SALE**

SINCE 1933

**RME** FINE COMMUNICATIONS EQUIPMENT  
**RADIO MFG. ENGINEERS, INC.**  
Peoria 6, Illinois U. S. A.

With the new RME 45 you'll have peak performance on the high as well as the low frequencies. There's no secret about how it was done—even though some of the experience has been gained while producing for the Armed Forces.

It was accomplished by the use of loctal tubes . . . shorter leads . . . reduced distributed capacity . . . temperature compensating paddlers . . . and a score of additional refinements—each making its individual contribution to increased efficiency.

The RME 45 combines careful workmanship with ease of operation, sound engineering and brilliant performance.

Literature Describing the RME 45 will be sent on request

# DUALS

*with Lugs*

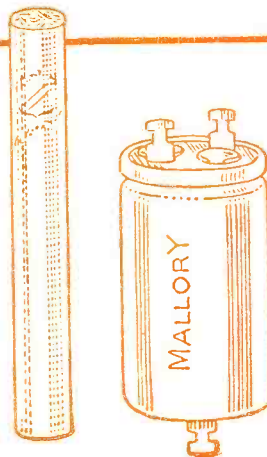

**They're GOOD and SMALL**

Smaller than a cigarette—*smaller, in fact, than some of the smallest cardboard capacitors made!* But aluminum-cased, hermetically sealed! Long-lived, dependable! That's the story of the new Mallory Duals.

Notice those lugs at top and bottom! They eliminate broken leads, difficult skinning operations . . . make handy anchors for other wiring.

Notice especially the bottom capacitor in the upper left-hand picture. That's the Mallory "TCS," each section of which is independent of the other. It will replace units of common negative, common positive or separate section construction—yet it's the *smallest* separate section unit ever made!

These Mallory Dual Capacitors are part of a *complete new line*, including pint-sized single units too. Get acquainted with the entire family! See them—buy them at your nearest Mallory distributor.

**P. R. MALLORY & CO., Inc.**  
INDIANAPOLIS 6, INDIANA



*More than ever—  
ALWAYS  
INSIST ON*

P. R. MALLORY & CO. Inc.  
**MALLORY**  
APPROVED  
PRECISION PRODUCTS

VIBRATORS • VIBRAPACKS\* • CONDENSERS  
VOLUME CONTROLS • SWITCHES • RESISTORS  
FILTERS • RECTIFIERS • POWER SUPPLIES

ALSO MALLORY "TROPICAL" DRY BATTERIES, ORIGINALLY DEVELOPED BY MALLORY FOR THE U. S. ARMY SIGNAL CORPS, NOT PRESENTLY AVAILABLE FOR CIVILIAN USE.

\*Trademarks

"I'M SURE OF FASTEST SERVICE FROM ALLIED"



**LARGEST and most complete STOCKS**

Everything in **RADIO and ELECTRONICS**

**FREE Helpful BUYING GUIDE**



**RADIO PARTS AVAILABLE without priority**

Over 10,000 items from all leading manufacturers . . . ready for rush delivery.

**NEW! Parallel Resistance & Series Capacitance**

**CALCULATOR**  
Solves Every-day Problems—Quickly!  
No. X37-960  
Postpaid... 25c



**R. F. Resonance and Coil Winding CALCULATOR**  
No. 37-955  
Postpaid ..... 25c

**6 Radio Books for 75c**

- Dictionary of Radio Terms. No. 37-751 10c
  - Radio Data Handbook. No. 37-754 25c
  - Radio Circuit Handbook. No. 37-753 10c
  - Radio Builders Handbook. No. 37-750 10c
  - Radio Formulas & Data Book. No. 37-752 10c
  - Simplified Radio Servicing. No. 37-755 10c
  - All Six Books No. 37-799 ..... 75c
- Write for Quantity Prices

**ALLIED RADIO CORP., Dept. 1-K-5**  
833 W. Jackson Blvd., Chicago 7, Ill.

Please send following (..... enclosed)

- FREE Guide
- Calculator 37-955
- Calculator X37-960
- 37-750
- 37-751
- No. 37-799 (All 6 Books)
- 37-752
- 37-753
- 37-754
- 37-755

Name.....  
Address.....  
City.....State.....

**ALLIED RADIO**

*Within the*  
**INDUSTRY**

**DON R. CANNON** has been named sales manager of *The Radio Craftsmen*, of Chicago, manufacturers of radio and electronic equipment.

Mr. Cannon joined the company after serving for more than two years as the production supervisor for the Dayton Signal Corps Procurement District at Dayton, Ohio.

Prior to his service with the Signal Corps, Mr. Cannon was the midwest manager for the *Electric Auto-lite Company*, Storage Battery Division.

At the same time, Byron L. Friend, partner of the company, announced the appointment of Edward E. Schultz, Jr., formerly of *Press Wireless*, to the post of chief engineer for the company.

\* \* \*

**W. G. H. FINCH**, formerly assistant chief engineer of the *Federal Communications Commission*, has been promoted to Captain. Captain Finch had been a Lt. Commander in the Naval Reserve for some time before the outbreak of war and was made a Commander in 1942.

Captain Finch relinquished his post as president of *Finch Laboratories*, which he founded in 1935, to volunteer for active duty with the United States Navy. He is now on the staff of Commodore J. B. Dow, U.S.N., in the research and design branch of the electronics division of the Bureau of Ships.

\* \* \*

**ELWOOD R. BERKELEY** has been appointed divisional manager in charge of radios and major appliances of *American Wholesalers*, distributors for *The Crosley Corporation*.

Mr. Berkeley previously served as sales promotion manager of the *Premier* division of the *Electric Vacuum Cleaner Company* of Cleveland. Prior to his association with *Premier*, Mr. Berkeley spent approximately two years with the *Nash-Kelvinator Corporation* and before that time, served for six years in the merchandising of major household appliances for the *Hecht Company* of Washington, D. C.

\* \* \*

**RADIO PARTS AND ELECTRONIC EQUIPMENT SHOWS, INC.**, a newly formed corporation, is sponsored by Radio Manufacturers Association (Parts Division), Association of Electronic Parts and Equipment Manufacturers, Sales Managers Club, East-

ern Division, and National Electronic Distributors Association.

The purpose of this new corporation is to conduct postwar national and regional exhibitions or conferences for the benefit of member exhibitors in the radio and electronic industry.

At the initial meeting of the Board of Directors held at the Stevens Hotel in Chicago, the following officers were elected: president, H. W. Clough, *Belden Manufacturing Company*; vice-president, Charles Golenpaul, *Aerovox Corporation*; secretary, Jerome J. Kahn, *Standard Transformer Corporation*, and treasurer, Sam Poncher, *Newark Electric Company*. J. Arthur Kealy, of the law firm of Ungaro & Sherwood, Chicago, corporation attorney and active in the radio industry, was appointed general counsel.

The corporation has planned to hold an industry show as soon as practicable following the lifting of travel and other restrictions. Present plans also include the appointment of a show manager on a full-time basis to handle the direction and manifold details in connection with the conduct of the type of shows planned.

\* \* \*

**OSCAR HAMMARLUND**, founder of *Hammarlund Manufacturing Company, Inc.*, and a communications pioneer, died August 25 at his home in Brooklyn at the age of 83. Mr. Hammarlund was born in Stockholm, Sweden and came to the United States in



1882 to accept a position with the *Elgin Watch Company*. In 1886 he joined *Western Electric Company* as superintendent of their Chicago plant. He subsequently worked for *Gray National Tel-autograph Company* where he was closely associated with Elisha Gray, co-inventor of the telephone, in the development of the technique of transmitting actual writing over wires. He founded the *Hammarlund Company* in 1910. The company manufactures radio apparatus and components which have been used by the Armed Forces in World War II.

\* \* \*

**BENDIX AVIATION CORPORATION** has formed a new division known as *Bendix International* to handle their foreign trade program. With the exception of the United States and Canada, they will handle, throughout the world, the products of the seventeen divisions of the corporation.

Charles T. Zaoral, who joined the corporation in January as coordinator of foreign affairs, will be general manager of this new division. Other ap-

Another  
"First"!



▶ We repeat: 25,000 volts accelerating potential on a cathode-ray tube! That's front-page electronic news. Likewise cathode-ray history in the making.

The DuMont Multi-Band Tube (Type 5RP) permits recording at writing rates in excess of 2500 km/sec (using a 35 mm camera with f:1.9 lens) corresponding to sine wave transients at 40 megacycles!

This is a hot-cathode, permanently-sealed, high-vacuum tube. Subdivision of the intensifier element provides a controlled gradient allowing a total accelerating potential of 25,000 volts to be employed, with only slightly reduced deflection sensitivity. Greatly increased brightness with small spot size results in a writing rate far exceeding that heretofore obtainable.

Yes, DuMont pioneering continues.

▶ Literature on request.

© ALLEN B. DUMONT LABORATORIES, INC.

Cylindrical flat-face tube. Approximately the size of conventional 5-inch tubes. Deflection-plate leads brought out through neck instead of base. Shunt input capacities and cross-coupling effects reduced to minimum. Second anode and intensifier leads brought out through envelope to facilitate high-voltage operation.

**DUMONT** Precision Electronics & Television

ALLEN B. DUMONT LABORATORIES, INC., PASSAIC, NEW JERSEY • CABLE ADDRESS: WESPEXLIN, NEW YORK

# ALLIANCE "Even-Speed" Phono-motors

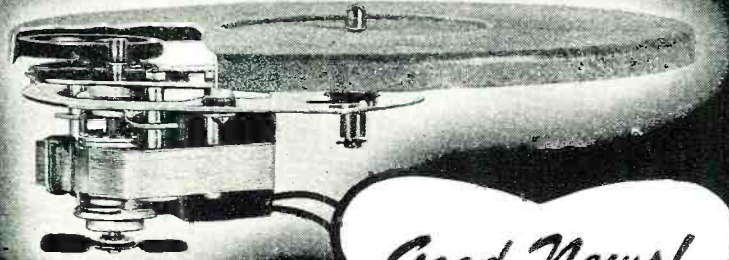

Good News!

## ALLIANCE RESUMES PRODUCTION on One Standard Model

• We are now able to return to production of one standard variation of Alliance Model 80 Phono-motor, according to the following definite specifications and on the production plan explained below.

**STANDARD SPECIFICATION No. 811**—Turntable No. Y-278-S2; 110 Volt, 60 cycle, 9" Model 80 Production must be on the following practical basis under present conditions where there are no large volume priority orders—namely, by accumulating a sufficient quantity of small orders with necessary priority and making periodical single production runs at such time as the quantity of accumulated orders is enough to make this practical. Priority orders (currently only orders of AA-3 or higher, with GOVERNMENT CONTRACT NUMBER and MILITARY END USE, or where certified to be used in Sound Systems, Intercommunications or Paging Systems, as exempted from under M-9-C) must allow delivery time required to obtain a minimum practical production run; to procure material for all orders in hand, and make one production run of the one type standard unit only, for shipment on the various accumulated orders. • Check the above against your requirements, and if you have proper priority, communicate with us.

**REMEMBER ALLIANCE—Your Ally in War as in Peace!**

AFTER THE WAR IS WON, WE WILL TELL YOU ABOUT SOME NEW AND STARTLING IDEAS IN PHONO-MOTORS

**ALLIANCE MANUFACTURING COMPANY**  
ALLIANCE, OHIO

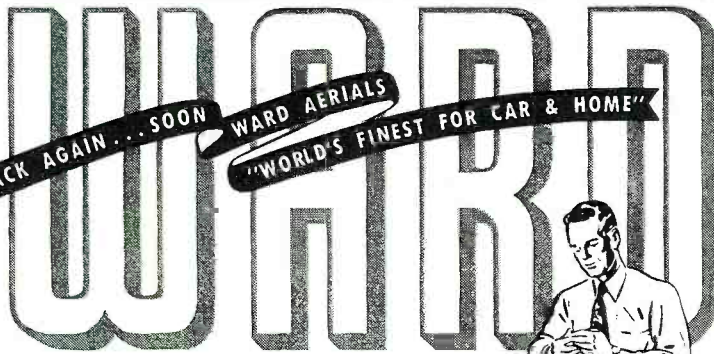

First Choice . . .

**OF AMERICA'S AUTO MAKERS**

Utmost efficiency, finest quality, precision workmanship and vital war-time developments are four important reasons why Ward Antennas are first choice of America's auto makers today, as they were before the war.

For top performance and dependability, together with maximum profits and customer satisfaction, look to Ward for the world's finest antennas for car and home!

**WARD**

Antennas

THE WARD PRODUCTS CORPORATION  
1523 EAST 45TH STREET • CLEVELAND 3, OHIO

pointments to this new division include: F. A. Stanton, foreign patent counsel, who represented Bendix in Paris for many years; L. B. Coates, division comptroller, formerly of the central staff; Paul Moss, sales manager; Harold McEnness, assistant sales manager. Fernando Jose Cardenas, formerly with *Westinghouse*, *General Electric*, and *Sylvania*, is manager of central and South American territories.

*Bendix International* has established headquarters at the corporation's New York office, 30 Rockefeller Plaza.

\* \* \*

**HARRY E. FOSTER** of *Foster Agencies* was elected president at the annual meeting of the *Radio Executives Club of Toronto*. He succeeds C. W. Wright, founder of the club and president for the past two years.

Mr. Foster is supported by Vice-President Walter Elliott, *Elliott-Haynes Ltd.*, Secretary Art Benson, *Canadian Broadcaster*, and Treasurer Walter Enger, *McKim Advertising Ltd.*

\* \* \*

**JAMES T. WATSON** has been elected vice-president of *Maguire Industries, Inc.*



Mr. Watson was president of the *Meissner Manufacturing Company* which has been purchased by *Maguire Industries, Inc.* The *Meissner* company will operate

as a *Maguire* division under the management of Mr. Watson.

The *Meissner Manufacturing Company*, founded in Chicago in 1922, became a part of *Maguire Industries, Inc.*, New York, late in June of this year. The firm was started by James T. Watson and its early business consisted entirely of the manufacture of coils which were sold to radio set manufacturers and servicemen. In 1936, the plant and executive offices were moved to Mt. Carmel, Illinois.

\* \* \*

**JAMES KNIGHTS COMPANY** of Sandwich, Illinois, has announced the opening of a Chicago sales office, headed by E. H. Aberdeen, located at 175 West Jackson Boulevard.

Mr. Aberdeen has been active in the *James Knights* sales department for some time. He is now working with radio-electronic manufacturers in the development of improved postwar applications for *James Knights* crystals and other products manufactured by this company.

\* \* \*

**ELECTRONIC LABORATORIES, INC.** of Indianapolis through its Board of Directors has announced the election of new officers and several promotions in the company.

The new chairman of the Board of Directors is Norman R. Kevers, formerly president of the company. William W. Garstang has been elected president. He was formerly vice-president and general manager. Three

**RADIO NEWS**

# PRECISION is a hobby in MT. CARMEL, ILL.

Yes, precision is the hobby of the men and women who make up Meissner's famed "*precision-el.*" The high quality electronic equipment that their skilled fingers produce each day is proof enough that they enjoy the work as thoroughly as they enjoy their after-hours hobbies. You'll find more proof in the photographs on this page.

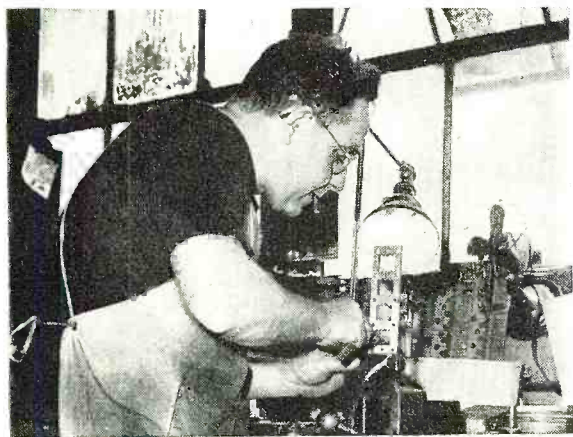

This "*precisioneer*" takes the same interest in his work at Meissner as he does in his home. He proves it with a smile that is typical of *precision-el* — as typical as the precision quality of Meissner products.



Here's a member of Meissner's *precision-el* whose smile is contagious. Delicate adjustments properly made are the reason. Higher quality in Meissner electronic equipment is the result!

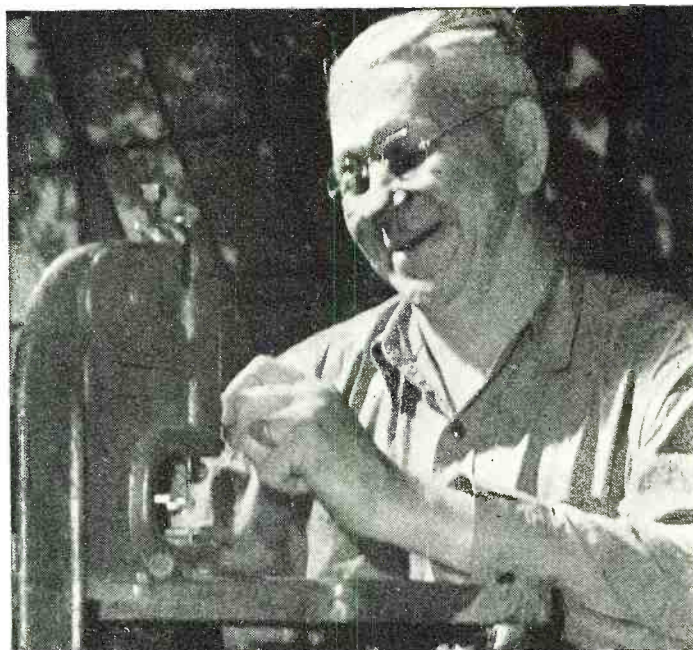

It could be a new grandson or a 3-pound bass that brings a smile like this, but it's not! It's pride in a precision electronic job well done. It's a reason for higher quality in Meissner products.



Baseball broadcast? Not on your life. But it's a "homer" for this member of Meissner's laboratory staff. The satisfied smile means that the instrument he's testing is "on the Meissner quality beam."

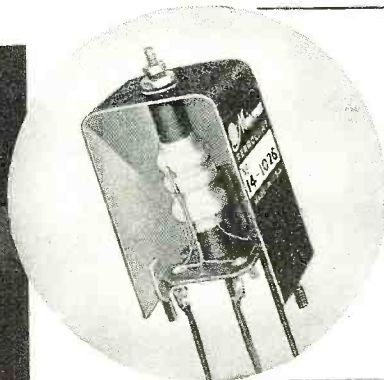

### Replace Broadcast Band Coils Easily

These Adjustable-Inductance Ferrocort (iron core) coils will replace Antenna, R.F. or Oscillator coils without the trouble of locating "exact duplicates" because they are continuously variable in inductance over a wide range. The inductance of the old coil is easily matched by simple screwdriver adjustment. Ferrocort iron cores add gain and selectivity to the receiver. Available shielded or unshielded, shipped with complete instructions. Order by number. 14-1026 Univ. Ant. Coil; 14-1027 Univ. R.F. Coil; 14-1028 Univ. Osc. Coil. Price \$1.50 each.



# MEISSNER

MANUFACTURING COMPANY • MT. CARMEL, ILL.

**ADVANCED ELECTRONIC RESEARCH AND MANUFACTURE**

Export Division: 25 Warren St., New York; Cable: Simontrica

**LEO'S SPECIAL!**

**Immediate Delivery**

Money Back Guarantee on this all-purpose

**Multitester**

Handles AC and DC Voltmeter, DC Milliammeter, High and Low range Ohmmeter. Size 5½x8x3¾. 3" meter with sturdy D'Aronsvall movement. Write for priority information.

**EVERYTHING IN TEST EQUIPMENT** We have it or can get it. Preferred delivery, quick service on all makes, all types. Hundreds of new items on order. Buy from Leo, W9GFQ.

**See Leo for WRL Radio Kits** priority required



Model WRL 300 ONLY \$18.75 Less Leads



**Phono Amplifier Kits** Complete with tubes, instructions \$9.50 No. 1059...



**Code Oscillator Kits** Complete with tube. Size 3"x6" No. 66-200 \$4.95

**PLACE YOUR ORDER NOW!** Leo is making delivery now on **HALLICRAFTERS** For preferred delivery, easy terms, and liberal trade-in allowance, write Leo, W9GFQ.

**EXCLUSIVE AT LEO'S!**

- 44 Page Parts Flyer... **FREE**
- Packed with hard-to-get items. Immediate delivery to radio repairmen. Usual priorities. Experimenters write Leo, W9GFQ, on how to get radio repair parts.
- Tube and Circuit Reference Book .....10c
- Handy Tube-Base Calculator .....25c
- Giant Radio Reference Map, Size 3½x4½ ft 15c



**MAIL TODAY**

Wholesale Radio Laboratories RN-10  
744 West Broadway  
Council Bluffs, Iowa

Please rush Multitester No. 300, \$18.75 is enclosed, or Enclosed is \$\_\_\_\_\_, Balance C.O.D.

Here's 10c, Send "Tubes and Circuits" Book.

I want a Tube-Base calculator. 25c enclosed.

Ship me your radio map. 15c enclosed.

Send me your free flyer of hard-to-get radio parts.

Name \_\_\_\_\_

Address \_\_\_\_\_

Town \_\_\_\_\_ State \_\_\_\_\_

I am  an amateur;  experimenter;  service man.

**QUICK SERVICE**

Your order will receive my own personal attention. You'll get "same day" delivery service from the heart of the nation on anything in radio.



*Sincerely,*  
Leo W9GFQ  
**Wholesale RADIO LABORATORIES**

vice-presidents were named, Walter E. Peek, sales manager; Paul H. Frye, chief engineer; and Harry C. May, works production manager. Thomas D. Scheidler, treasurer, and William J. Lochhead, secretary, were previously elected.

**EDGAR N. GREENEBAUM, JR.**, has been appointed manager of the newly acquired Chicago office of *Emerson Radio and Phonograph Corporation*.



Mr. Greenebaum formerly served three and one-half years as assistant to the commanding officer of the Wright

Field Corps Procurement District. Prior to his work at the signal corps, Mr. Greenebaum represented *John Plain and Company* of Chicago as buyer and merchandise manager for five years, in addition to serving as merchandising consultant on phonograph records for *Sears, Roebuck and Company* headquarters.

The new office of *Emerson Radio and Phonograph Corporation* is located in the American Furniture Mart, 666 Lake Shore Drive.

**ADMIRAL CORPORATION** has appointed *R. U. Lynch, Inc.*, as distributor of the company's radios, refrigerators, home freezers, and electric ranges for the Rhode Island territory, according to an announcement by Wallace C. Johnson, manager of field activities.

**JOHN MECK INDUSTRIES, INC.**, has announced the formation of *Audar, Inc.* This separate corporation will manufacture and sell public address systems and audio amplifiers as an affiliate of *John Meck Industries, Inc.*

John S. Meck is president of this new corporation, E. W. Applebaum, treasurer and general manager, and Russell G. Eggo, secretary.

Sound equipment, formerly manufactured by the *Meck Company*, will now be produced by *Audar, Inc.*

**J. B. ELLIOTT** has been named general manager of the *RCA Victor Home Instruments Division* of the *Radio Corporation of America*.



Mr. Elliott entered the radio field in 1926 as a branch manager for the *Brunswick Radio Corporation*. He joined *RCA Victor*

in 1935 and a year later was appointed district manager for the New England area. In 1939 he was appointed assistant field sales manager at the company's headquarters in Camden, and a year later became sales manager of the radio, phonograph, and television department. Mr. Elliott now returns to *RCA Victor* from *Schick, Inc.*, where he was vice-president in charge of sales and advertising.

In his new capacity, Mr. Elliott will

be located at the *RCA Victor Division's* headquarters in Camden and will direct all activities connected with the design, engineering, production, distribution, and sales of *RCA Victor* radios, television home receivers, and Victrola phonographs.

**BENJAMIN SEUTTER**, night traffic superintendent of *Press Wireless* and one of the most widely known veteran wireless telegraph operators in America, died recently after an illness of several weeks. He was 51 years old.

Mr. Seutter had been with *Press Wireless* since 1931. He was a holder of world's records for rapid radio reception, had served with the United States Navy, and was the first operator to receive a radio S.O.S. from an airplane. At one time he was on the staff of a transatlantic radio receiving station of the *New York Times*.

**HARADEN PRATT**, vice president and chief engineer of the *American Cable and Radio Corporation*, has been elected chairman of the Radio Technical Planning Board. He will take office October 1 and succeeds Dr. W. G. R. Baker, vice-president, *General Electric Company*, who has been chairman since the RTPB was organized in September, 1943.



Mr. Pratt is also vice-president and chief engineer of *Mackay Radio and Telegraph Company*, *All America Cables & Radio, Inc.*, *The Commercial Cable Company*; vice-president, *Federal Telephone and Radio Corporation*, and is Fellow, director, secretary, and past president of Institute of Radio Engineers.

At the time of his selection to the chairmanship of the RTPB, Mr. Pratt was delegate of the Institute of Radio Engineers to the RTPB and chairman of the Panel on Radio Communications of that group.

**RADEL MANUFACTURING COMPANY**, Cleveland, has recently been organized by Sidney Ludwig, formerly chief engineer of *Ward Products*. This new company will manufacture a complete line of automobile radio aerials, and radio parts and equipment.

**E. S. GOEBEL** has been appointed acting director of field sales in the Communications and Electronics Division of *Galvin Manufacturing Corporation*. Mr. Goebel will be in direct charge of the activities of all field salesmen.

Norman Wunderlich resigned as sales manager on July 1.

**HENRY F. DEVER** has been elected president of the *Brown Instrument Company*, a wholly-owned subsidiary of the *Minneapolis-Honeywell Regulator Company*. He succeeds Charles B. Sweatt.

Mr. Dever, who has been serving as vice-president in charge of engineer-



*“Metal Rectifiers  
are more dependable . . .  
have longer life”* ★



*Henry Hulick, Chief Engineer, WPTF,  
Raleigh, N. C.*

Mr. Hulick has ample proof that surgeproof metal rectifiers increase the dependability of transmitter operation. For a Westinghouse 50 HG transmitter has been in service at WPTF since June, 1941

These efficient rectifiers are an exclusive Westinghouse feature . . . used in the 50 HG unit as bias rectifiers for speech, input stages, power amplifier and modulator and plate rectifier in the exciter. Their life is virtually unlimited. Tube replacement cost is completely eliminated and the threat of unpredictable rectifier tube failure is erased. No complicated relaying

is required; they can be connected to the power circuit instantly.

Metal rectifiers are just one of many outstanding Westinghouse developments in modern transmitter design that feature extra dependability and uninterrupted performance. Ask your nearest Westinghouse office for the complete story of Westinghouse transmitters . . . 5, 10 and 50 kw AM, 1, 3, 10 and 50 kw FM. Westinghouse Electric Corporation, P. O. Box 868, Pittsburgh 30, Pa. J-08119

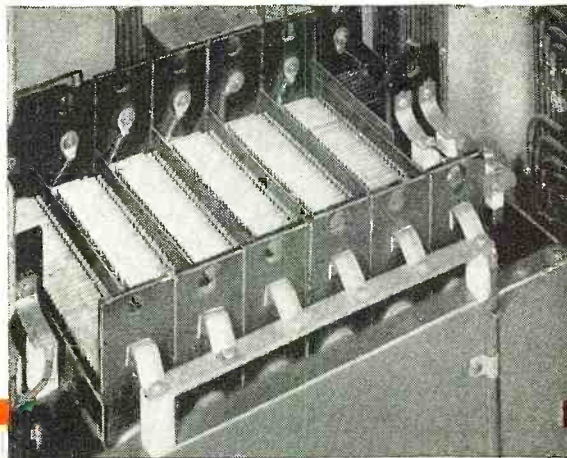

★ *“I prefer metal rectifiers in all practical positions. They are more dependable, require less servicing, are not as erratic and have longer life.”*

*(Signed) Henry Hulick*

**Westinghouse**  
PLANTS IN 25 CITIES . . . OFFICES EVERYWHERE

*Electronics at Work*



XXV RADIO'S 25th ANNIVERSARY KDKA

**IMMEDIATE DELIVERY FROM STOCK**

**TRIPLETT**

Volt-Ohm-Milliammeters

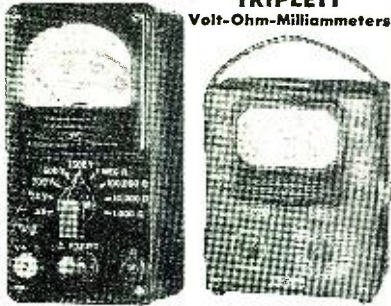

TRIPLETT 666 ..... 15.25  
 TRIPLETT 666-H ..... 14.00  
 TRIPLETT 1200-S ..... 34.67  
 Servicemen's Priority

**MASCO AMPLIFIERS**



Complete with tubes.  
 17 Watt ..... 30.30  
 25 Watt ..... 42.60  
 35 Watt ..... 54.60  
 50 Watt ..... 70.50  
 17 Watt with Phono-top ..... 42.30  
 25 Watt with Phono-top ..... 52.20  
 35 Watt with Record-changer ..... 89.10

**TURNER MICROPHONES**

Model	Type	Cord	Level	Each
BX	Crystal	7'	-55	\$5.85
22X	Crystal	7'	-52	10.88
33X	Crystal	20'	-52	13.23
BD	Dynamic	7'	-52	8.53
33D	Dynam.	20'	-54	14.70



**SPEAKER BUYS!**

4" PM square	.....	\$1.35
4" 450 ohm, square	.....	1.40
5" PM 2 watt	.....	1.25
5" 450 ohm	.....	1.50
10" PM 11 watt	.....	7.20
12" PM 16 watt	.....	10.14
12" PM 17 watt	.....	14.25

**SPRAGUE - CORNELL DUBILIER AEROVOX CONDENSERS**

8 mfd 450v Upright can .76¢  
 16 mfd 450v Upright can 1.12  
 20 mfd 450v Upright can 1.23  
 8 mfd 450v Tubular .44¢  
 16 mfd 450v Tubular .65¢  
 20 mfd 150v Tubular .44¢  
 20-20 mfd 150v Tubular .76¢  
 40-20 mfd 150v Tubular .82¢  
 30-30 mfd 150v Tubular .79¢  
 50-30 mfd 150v Tubular .94¢



**RADIART VIBRATORS**

Type	Equal	Each
S-1	4-4	\$1.35
5300	294	2.09
5326P	509P	1.76
5334	868	2.09
5341M	901M	1.76
5400	248	3.50
5426	716	3.50

ORDER OTHERS BY MAKE AND SET MODEL

CRYSTALS ..... M22 2.94 L40 2.35 LP6 4.70  
 PICKUPS ..... 2.97, 3.30, 3.90  
 MOTORS ..... 3.17, 3.33

**PHILCO BEAM OF LIGHT**

Selenium Cell only, no holder ..... 1.80

20% deposit required on all C.O.D. orders. 2% transportation allowance on orders of \$25.00 or more accompanied by payment in full.

Write for FREE CATALOG

**RADIO SUPPLY & ENGINEERING CO., Inc.**  
 129 SELDEN AVE. DETROIT 1, MICH.

ing for *Minneapolis-Honeywell*, will also assume the responsibilities of E. B. Evleth, general manager of *Brown Instrument*, who has requested that he be relieved of his duties because of ill health.

\* \* \*

**COLBY H. KNAPP** has been named supply sales manager for *Stromberg-Carlson Company's* telephone division according to an announcement by Lloyd L. Spencer, vice-president in charge of sales.



Mr. Knapp joined the company in 1927 and has served as assistant Chicago supply manager, Chicago supply manager, radio and telephone representative in the states of Illinois and Iowa, telephone sales representative in Indiana and Wisconsin, and Chicago office manager and cashier. During the war period he was a member of the priorities department at the main office in Rochester, N. Y.

Mr. Knapp will continue to make his headquarters at the company's Chicago branch office located at 564 West Adams Street.

\* \* \*

**EDWARD H. FRANK** has been named office manager for the *Westinghouse* lamp division's northwestern district headquarters in Chicago.

Mr. Frank joined *Westinghouse* in 1916 in the St. Louis office of the lamp for the central district office in Pittsburgh since 1940. He succeeds George A. Olsen, who has joined the *Westinghouse Electric Supply Company* in Milwaukee, Wisconsin.

-50-

**112 Mc. Transmitter**

(Continued from page 37)

dip in the plate current although it will not be so pronounced due to the greater circuit losses.

The tuning of the third doubler is similar, although in this stage the dip

in plate current will be very slight. This plate circuit should be tuned to the 112 mc. band in this case. This will complete the preliminary tuning of the exciter stages.

The meter should now be switched to read the grid current of the final, and the tuning of the final grid circuit adjusted to give the maximum reading. It will probably be necessary to re-adjust the tuning of the third doubler slightly as the final grid is varied. If sufficient drive is not obtained the links around both the third doubler tank and final grid should be adjusted.

The final amplifier is now ready for neutralizing. The plate circuit of the final should be tuned through resonance, at the same time watching the grid current. Proper neutralizing is obtained when the final can be tuned through resonance without affecting the grid current. It will probably be necessary to retune the grid circuit as the neutralizing condenser is adjusted. When neutralizing is perfect, all stages should be retuned for maximum output.

Plate voltage should now be applied to the final by connecting the lead from the modulator. With no antenna connected, the plate current of the final at resonance should dip to about 10 to 15 ma. A 25 watt bulb should now be connected across the antenna terminals and the loading adjusted to give maximum output by varying the coupling of the output link. As the legal limit of input power for WERS work is 25 watts and the plate voltage is 500 volts, the maximum plate current will have to be kept below 50 ma.

A microphone can be connected to the input, and the gain control adjusted for proper level. The lamp bulb should increase in brilliancy as the microphone is spoken into, 100% modulation being indicated by a nominal increase in brilliancy. If operation appears satisfactory, the output frequency should be checked by means of a reliable wavemeter or well shielded receiver. The antenna may now be connected and the output link again adjusted for proper loading, and the transmitter is ready for use.

Table I. Coil data providing necessary electrical and mechanical requirements.

COIL	FREQ	TURNS	WIRE SIZE	DIAM.	LENGTH
L <sub>1</sub>	7 mc.	8	#20 p.e.	3/4"	Close wound
L <sub>2</sub>	14 mc.	11	#20 p.e.	1"	1/2"
L <sub>2</sub>	28 mc.	7	#12 tinned	7/8"	3/4"
L <sub>4</sub>	56 mc.	4 1/8	#12 tinned	5/8"	5/8"
L <sub>5</sub>	112 mc.	2	#12 tinned	5/8"	1/2"
L <sub>6</sub>	Link	2	#20 push-back	5/8"	At "cold" end of L <sub>5</sub>
L <sub>7</sub>	Link	2	#20 push-back	5/8"	At "cold" end of L <sub>5</sub>
L <sub>8</sub>	112 mc.	2	#12 tinned	5/8"	1/2"
L <sub>8</sub>	112 mc.	4	#12 tinned	1"	1 1/8"
L <sub>10</sub>	Output	2	#20 push-back	7/8"	At center of L <sub>9</sub>

# SYLVANIA NEWS

## RADIO SERVICE EDITION

October Published by SYLVANIA ELECTRIC PRODUCTS INC., Emporium, Pa. 1945



Radio servicemen looking for a simplified explanation of the science of electronics are urged to add to their reading list *A Primer of Electronics* by Don P. Caverly.

### Simplified Language

It gives you, without formulas or much mathematics, just what you want to know about electronic principles and how they are applied in working devices.

Here is an especially clear and simple explanation of electronics and electronic tubes and circuits, written by a Sylvania engineer for all concerned with the application, servicing, operation, or manufacture of industrial or household devices based on this science. Basic enough for beginners, yet technically authoritative and complete.

### Has Many Illustrations

Containing 235 pages of concise, easily understood language, the book is further clarified by having 125 specially prepared drawings and photographs. It is published by McGraw-Hill and is available for \$2.00 from your Sylvania distributor or, as a Sylvania service, directly from us.

## RADIO SERVICEMEN CAN NOW OBTAIN FORMER GOVERNMENT TUBES

*(Sylvania Tested and Guaranteed)*

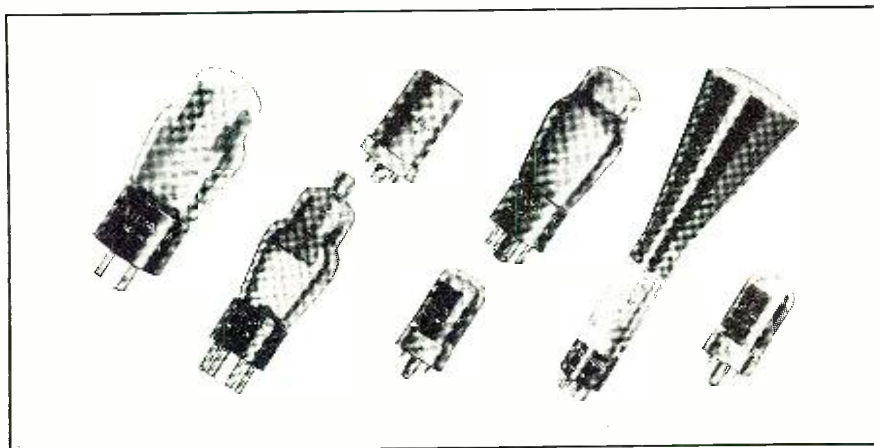

Sylvania Electric announces the following tube types available to radio servicemen.

Several of the types released are of particular interest to amateurs and experimenters. With this market in mind, Sylvania has inserted similar announcements in representative "ham" publications.

The current list is as follows:

- 38—Well known standard output pentode.
- 39/44—Well known standard R.F. Amplifier.
- 2X2/879—The standard high voltage, low current rectifier for oscilloscope use.
- 7C4/1203A—A small lock-in diode rectifier suitable for use in vacuum tube voltmeter probes. 6/3 volt 150 ma. heater.
- 7E5/1201—A lock-in triode for use as a low power oscillator or amplifier up to 750 mc. 6.3 volt 150 ma. heater.
- 46—Standard power amplifier. Suitable for Class B or C amplifiers and used in many amateur transmitters.
- OD3/VR150—Radio servicemen recognize this well known voltage regulator.

EF-50—A 9 pin completely shielded R.F. Amplifier somewhat similar to Type 7W7. Heater rating 6.3 volts at 300 ma.

1626—A transmitting triode requiring 12.6 volts, 250 ma. heater supply. Four watts output at 250 volts plate (max.).

1629—Same characteristics as Type 6E5 except for octal base and heater rating of 12.6 volts, 150 ma.

38142 (VT-52)—Similar to Type 45 except for its filament rating of 7.0 volts, 1.18 amperes.

5BP1—Well known 5" cathode ray tube with the usual green trace. Makes a good scope with 1500 to 2000 volt anode supply.

5BP4—Same as 5BP1 except for the screen which gives a white trace.

VT-25A—This is the same as the regular Type 10 but has a low loss base. This item should be interesting to amateurs.

All tubes are available under the familiar L-265, or on rated orders, through Sylvania distributors.

# SYLVANIA ELECTRIC

Emporium, Pa.

MAKERS OF RADIO TUBES; CATHODE RAY TUBES; ELECTRONIC DEVICES; FLUORESCENT LAMPS, FIXTURES, WIRING DEVICES; ELECTRIC LIGHT BULBS

October, 1945

107

# Here, Mr. Radio Service Man Is a Natural for You

Descriptive Literature Sent on Request



## SPEED IRON

PATENT PENDING

THE SUCCESSOR TO THE ELECTRIC SOLDERING IRON

115 Volt, 60 Cycle, 100 Watt

### IT'S REALLY FAST!

Soldering heat in 5 seconds after pressing the trigger!

You don't wait for the SPEED IRON to heat. It waits on your bench, cold, for you. When you pick it up and press the trigger it goes to work with a surge of power and speed that is amazing.

SPEED IRONS have been tested and used in hundreds of war plant applications over a four year period and are now available to radio repairmen.

**IF YOUR RADIO PARTS DISTRIBUTOR DOES NOT YET HAVE SPEED IRONS IN STOCK WRITE**

**WELLER MANUFACTURING CO., DEPT. N, EASTON, PA.**

This transmitter has been in use three times a week for the past two years with no adjustments whatsoever and has maintained consistent communication with stations located in a radius of twenty miles. Signal strength has been reliably good and the quality of speech reported excellent. Just an example of what can be done with a little ingenuity combined with several junk boxes.

Now that FCC has announced the resumption of amateur operation on the 112 to 115.5 mc. band, a transmitter of this type will be necessary for the crowded conditions of the near future.

-30-

### Q. T. C.

(Continued from page 56)

most of them. It certainly will be a big help in shipping circles when a vessel can safely be brought into port or navigated in bad weather when visibility is low. Under the old system it was often necessary to anchor or proceed under very slow speed during such time. This equipment will eliminate the present uncertainty of navigating in narrow or crowded shipping channels and the dangers of fog and darkness when visibility is poor.

**C**ONGRATULATIONS to the U. S. Coast Guard which, in late July, celebrated its 155th anniversary.

**A** NEW engineering and research building for the manufacturing division of Press Wireless is being constructed at Long Island City, the company recently announced. . . . PW has plants and operations at Hicksville, Baldwin, Little Neck, Long Island, and Chicago. PW did a nice job in communications during the war and expects postwar business to be good.

**L**AST SPRING General MacArthur paid a tribute to the merchant seamen of the United States which I am sure will be of interest to all of you. This note possibly did not come to your attention. It reads, "With us they have shared the heaviest fire. . . . On these islands I have ordered them off their ships and into foxholes when their ships became untenable targets of attack. At our side they have suffered bloodshed and death. They have contributed tremendously to our success. I hold no branch in higher esteem than the merchant marine service." Like most of the General's statements, it is short, to the point, and shows appreciation for a job well done. Ran across many of the gang who had not seen that item and thought it worth while repeating for those of you who missed it. . . . What became of A. Vandenberg? Has anyone seen L. Bye around? Some of the gang seem to stay away for long periods of time every now and then . . . or maybe "no shore leave," or longer trips than usual. . . . 73

# Tone...

*Always a Deciding Factor*

In the selection of any musical instrument, tone is of vital importance. Cinaudagraph Speaker Engineers have kept pace with every tone advancement — pioneered many new developments. That's why you'll want tomorrow's, better than ever, Cinaudagraph Speakers in every fine receiver — every quality sound unit.

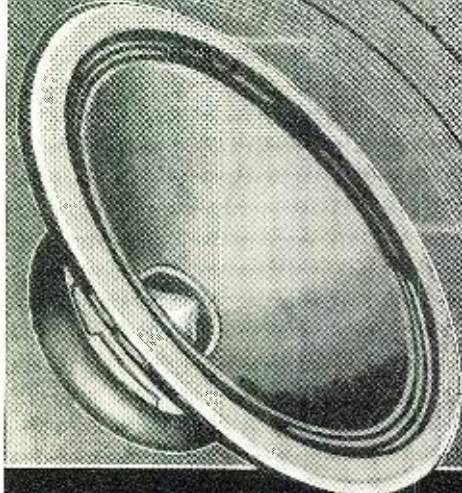

**Cinaudagraph Speakers, Inc.**

3911 S. Michigan Ave., Chicago  
Export Div., 13 E. 40th St., New York 16, N. Y.

*"No Finer Speaker in all the World"*



**ON THE  
SERVICE  
SIDE  
OF RADIO ROW**

**THROUGH THE N. U. EQUIPMENT PLAN SERVICE DEALERS  
RECEIVED 60,000 PIECES OF FINE TEST EQUIPMENT**



Since 1930, National Union has been the only radio tube and parts manufacturer whose entire merchandising program has been designed 100% to support the "service side of radio row" exclusively!

You know how the N. U. Equipment Plan brought 60,000 pieces of the finest test equipment to radio service dealers — free! You know how N. U. national and cooperative advertising, promotions, literature, displays and other business-builders helped dealers and jobbers prosper.

**AFTER THE WAR . . .  
MORE THAN BEFORE!**

Count on National Union for even more help . . . a wider selection of tubes and parts, even better equipment deals, powerful new merchandising plans, more technical service information . . . to make business prosperous for all "on the service side of radio row"!



**NATIONAL UNION  
RADIO AND ELECTRON TUBES**

*Transmitting, Cathode Ray, Receiving, Special Purpose Tubes • Condensers • Volume Controls • Photo Electric Cells • Panel Lamps • Flashlight Bulbs*

# FREE! NEW 11th EDITION RADIO'S MASTER

The only official  
Radio and Electronic  
equipment source-book

## Tells you:

### WHAT

the product does, its specifications, comparable and competing items . . . Thousands of illustrations . . . Data covers 90% of all products in the industry, each item indexed and cross indexed.

### WHO

makes it. Directory of manufacturers alphabetically listed, with page numbers for instant reference.

### HOW MUCH

Prices on thousands of items, all clearly catalogued for easy buying.

### WHERE

you can get it. Your nearest sources that can supply your radio and electronic requirements. Saves time . . . Eliminates bulky files.

**IMPORTANT**

Distributors from coast to coast have just bought quantities of this 800 Page, hard-covered encyclopedia ready for free distribution.



If you are an Engineer or Purchasing Agent WRITE FOR FREE COPY NOW.  
★ Write us on your company letterhead and we'll put you in touch with the jobber nearest you who has your FREE Copy. No obligations.

Address Dept. FEP 1

**UNITED CATALOG PUBLISHERS, INC.**  
110 Lafayette St., New York 13, N. Y.

# 4 CHANNEL MIXER for Your Amplifier

By DAVID A. KING

**T**HERE are many amplifiers in use today, both of professional and home constructed types, that have been designed with a single input terminal. These amplifiers are entirely adequate for any purpose where it is desired to amplify sound from only one source at a time. For those who desire to make more elaborate sound pick-ups for such purposes as moving picture sound-tracks and other home recording ventures, the electronic mixing panel described herein will prove of real value.

In designing this mixer it was proposed to develop a unit which, while retaining all or most of the advantages enjoyed by expensive professional equipment, still used standard receiver parts. Many of these parts, as in the case of the amplifier, can well be salvaged from discarded radio receivers.

Many volume controls designed for use in home radio sets are somewhat noisy when used ahead of a high-gain instrument where even minute variations in voltage are amplified to the point where they will produce annoying volumes of sound in the loudspeaker.

This fault has been eliminated in the present design by removing the volume controls from the low-level input to the grid circuit of the mixer tube. This means the addition of one extra tube for each low-level channel but, in the opinion of the writer, this extra tube is more than justified by the quieter operation gained through its use.

Through the use of standard electronic mixer tubes, the use of ex-

Through the use of standard electronic mixer tubes, the use of ex-

Schematic diagram of four-tube mixer. Each input has its individual volume control.

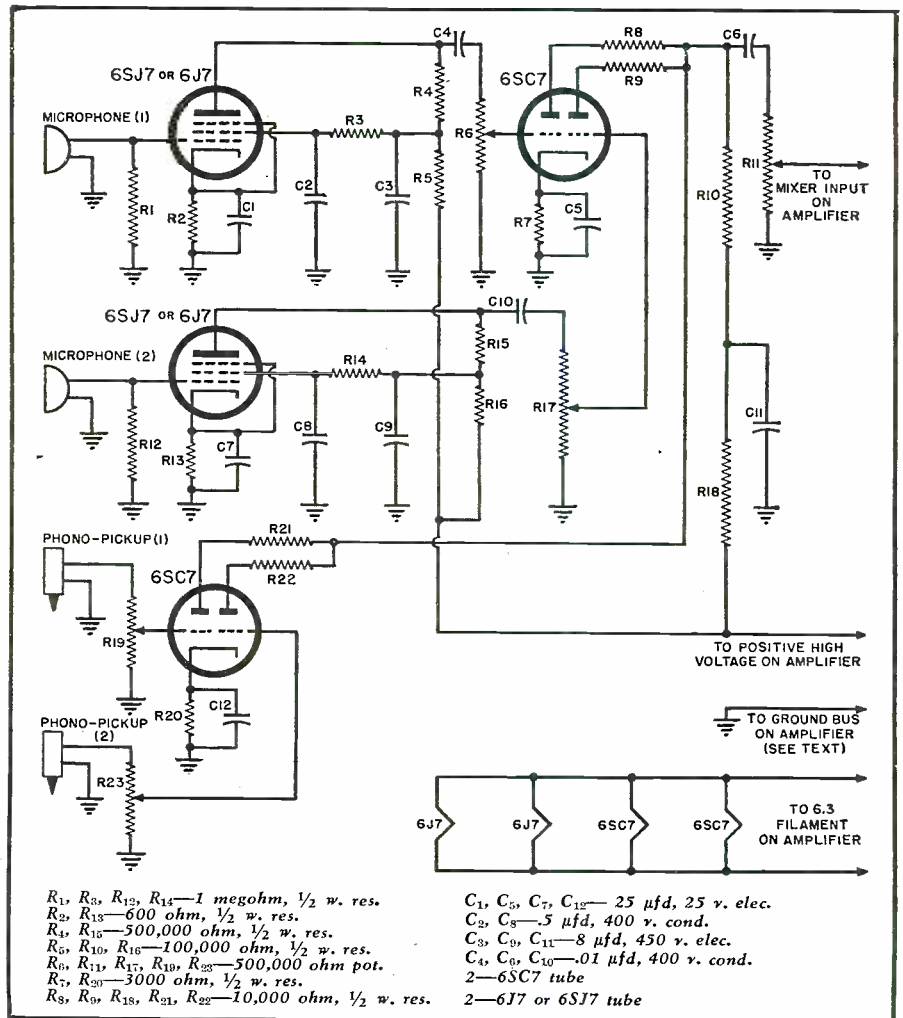



**CONFIDENTIALLY,  
WE'RE JUST A  
BUNCH OF  
HAMS AT  
HEART!**

**F**rankly, the magic of Radio is still a lot of fun to us! We here at GATES—every one of us, right up to the top man—put the enthusiastic imagination of the youngest amateur into our products.

That enthusiasm, supported by a background of continuous experience since 1922—and backed up by engineering ability and real precision workmanship—is what gives GATES Products their dependable quality.

For good Transmitting Equipment—reasonably priced—for your needs today, tomorrow, or whenever—call on GATES! The GATES RADIO CO., Quincy, Ill., U.S.A.

**Write for Details About the GATES Priority System for Prompt Post-War Delivery**



**QUINCY, ILLINOIS**

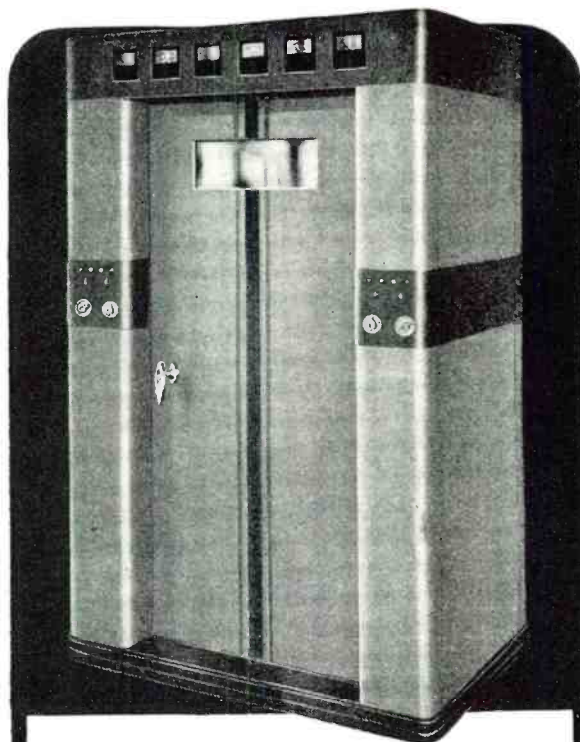

**GATES ONE KILOWATT  
BROADCAST TRANSMITTER**

This GATES Transmitter embodies the latest in engineering developments—modernized and streamlined to bring efficiency *plus* good looks to the Post-War Broadcasting Station.

All parts are conveniently, accessibly located for simple operation; and the pressure-type cabinet assures dustless, cool performance. A Transmitter of extremely high fidelity.

**Detailed Bulletin on the New GATES 1  
KW Transmitter Will Soon Be Available**

**PROGRESS REPORT**

*GATES is now in full production on civilian equipment and can make prompt delivery on many popular items.*

**EXCLUSIVE MANUFACTURERS OF RADIO TRANSMITTING EQUIPMENT SINCE 1922**

# Lifetime SAVES YOU MONEY ON RADIO PARTS and SUPPLIES



## BALLAST TUBES

J.F.D. Ballast Tubes—  
K49B, K49C, K55B, K55C,  
L49B, L49C, L55B, L55C  
.....48¢  
100-77, 100-70 .....58¢  
NEW TYPE Aircooled  
Ballast Tubes .....88¢

## TUBES WITH ADAPTERS

Use these combinations to replace tubes that can't be bought now.

To Replace	Use Tube & Adapter	List Price	Your Cost Tube & Adapter
1A5	1T4 & Adapter.....	\$3.10	\$1.51
1N5	1T4 & Adapter.....	3.10	1.51
1H5	1S5 & Adapter.....	3.10	1.51
3Q5	3S4 & Adapter.....	3.10	1.51
1Q5	3S4 & Adapter.....	3.10	1.51
1T5	1T4 & Adapter.....	3.10	1.51
45	3A4 & Adapter.....	2.95	1.43
47	3A4 & Adapter.....	2.95	1.43

## RESISTORS—24c

10 Watt Wire Wound Resistors, all values..24c

## AC-DC RESISTANCE CORDS

135-160-180-220-250-290-300-330-350-390 OHM  
Each .....48c 10 for .....\$4.50  
ICA Universal 22-330 ohm.....73c  
560 ohm for 3-way portable.....73c

## SPEAKER BARGAINS

4" Electro Dynamic Speakers,  
450 ohm .....\$1.68  
5" Electro Dynamic Speakers,  
450 ohm .....1.86  
6" Electro Dynamic Speakers,  
450 ohm .....2.58  
5" 6-Volt Auto Speakers.....1.68  
7" 6-Volt Auto Speakers.....1.59  
8" 6-Volt Auto Speakers.....1.59  
6" x 9" 6-Volt Oval Auto  
Speakers .....1.59



## CONDENSERS 37c EACH

20-Mfd 150 V Tubular condensers.....37c  
20-20 Mfd 150 V Tubular condensers.....60c  
20-30 Mfd 150 V Tubular condensers.....69c



## SAVE ON WIRES & CABLES

Hookup Wire—short lengths.....lb. 69c

Hookup and Push-Back Wire—assorted colors—  
rubber, cotton and plastic cover—89c per 100'  
—10 assorted 100' rolls.....\$7.80

Single conductor shielded rubber-covered micro-  
phone cable—6 to 40 ft. lengths....per ft. 6c

Two conductor shielded rubber-covered micro-  
phone cable—short lengths—6 to 40 ft....per ft. 10c

WRITE for latest bulletin listing hundreds of  
items available for immediate shipment.

**Lifetime Sound Equipment Co.**  
1101-1103 ADAMS STREET TOLEDO 2, OHIO Dept. 39

actual size

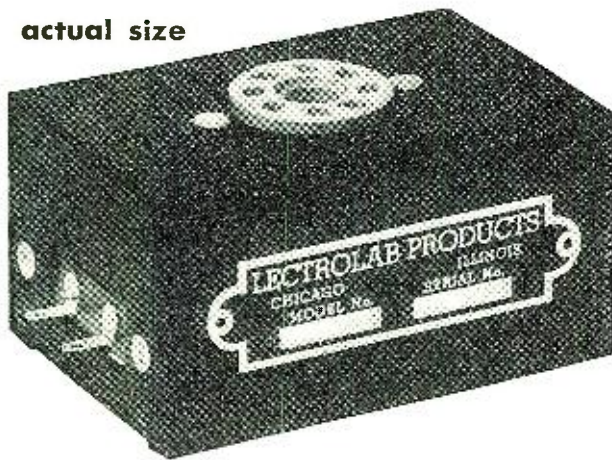

## Phono-Amplifier

A compact phonograph amplifier—ONLY one tube,  
but comparable to most 3-tube amplifiers. Built into  
sturdy metal chassis.

The amazing efficiency of this small amplifier will  
pleasantly surprise and satisfy you.

We also manufacture all types of coils and pick-ups. Send  
your specifications and we will gladly quote prices.

# LECTROLAB PRODUCTS

Manufacturers and Designers of Electronic Devices

2806-10 W. HARRISON STREET • CHICAGO 12, ILLINOIS

pensive pads has been eliminated and a mixer has been provided where each channel can be set to its own level without inter-acting with any of the other channels.

The tube line-up shown is perfectly satisfactory with the circuit constants shown. The reader is referred to any standard hand-book of resistance-coupled amplifier design for constants for tubes other than those shown. The only exception to this is the variation shown in the schematic where it is noted that 6J7 tubes may be substituted for the 6SJ7 tubes used by the writer. Since these tubes differ only in a few minor respects insofar as audio frequency applications are concerned, the same circuit constants may be used with either tube. One added precaution to be used with the 6J7 tube, though, is to be sure to use a shielded lead to the grid-cap and to use one of the little cap shields over the grid-cap. In the case of a "G" tube, of either type, it will be found that a close-fitting metal shield will give a huge reduction in noise pick-up.

In planning your mixer panel layout remember that the usual construction rules prevail; keep all leads as short as possible and parts well spaced to prevent intercoupling. All circuits are so routed as to prevent coupling from output to input through any path whatsoever. To this end, the output of the mixer panel should be well separated physically and the associated wiring so routed as to prevent capacitance or inductive coupling between these circuits. It will be noted that de-coupling nets have been introduced into the plate-circuit of each tube. These nets were found to be absolutely indispensable in the prevention of motor-boating and other forms of instability.

As indicated in the schematic, a ground bus interconnected with that on the amplifier will be found to reduce hum and other forms of disturbances to a minimum. Carry this ground bus on mounting lugs which are carefully insulated from the chassis and do not connect this bus to the mixer chassis at any point. Bond the mixer chassis to the amplifier chassis to prevent the formation of static charges between these units. It may be found that a good connection to earth ground will reduce noise level and it will certainly prevent any chance of shock due to any stray voltage between chassis and ground.

In wiring this unit, bear in mind that the low-level input circuits (those marked "mic. 1 and mic. 2" on the schematic) are carrying voltages which are amplified some 7000 to 10,000 times before they are reproduced in the loud-speaker. For that reason, noise voltages which would ordinarily be negligible assume proportions comparable to program level. This latter is true since the output of high-quality microphones is so minute as to be comparable in value to the noise voltage in a carelessly laid-out circuit.

This is mentioned, not as an attempt



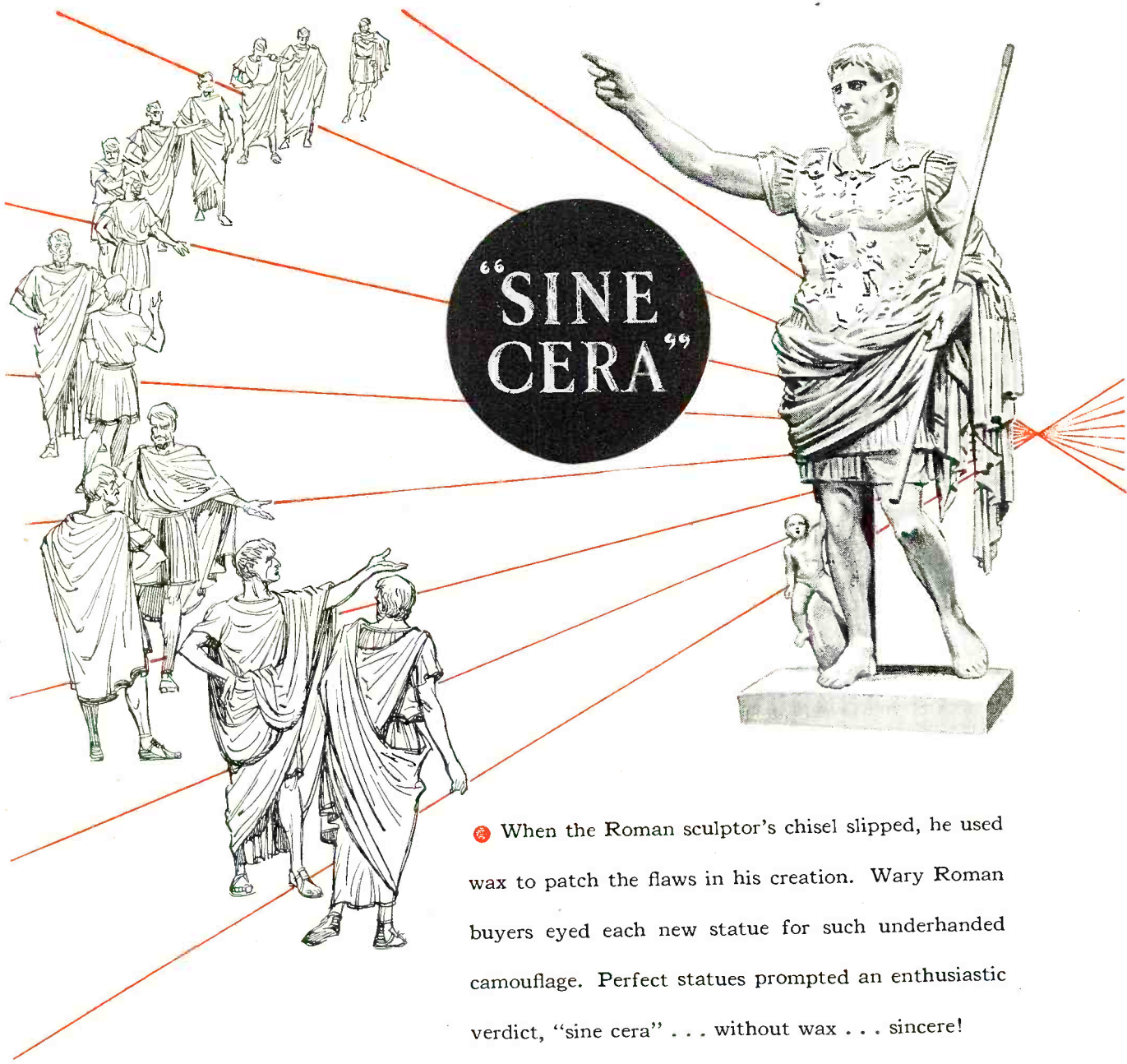

• When the Roman sculptor's chisel slipped, he used wax to patch the flaws in his creation. Wary Roman buyers eyed each new statue for such underhanded camouflage. Perfect statues prompted an enthusiastic verdict, "sine cera" . . . without wax . . . sincere!

Sincerity produces perfection in the Detrola radio receivers, automatic record changers and other electronic instruments expressly created for the world's foremost merchants and their customers.

DIVISION OF INTERNATIONAL DETROLA CORPORATION  DETROIT 9, MICHIGAN

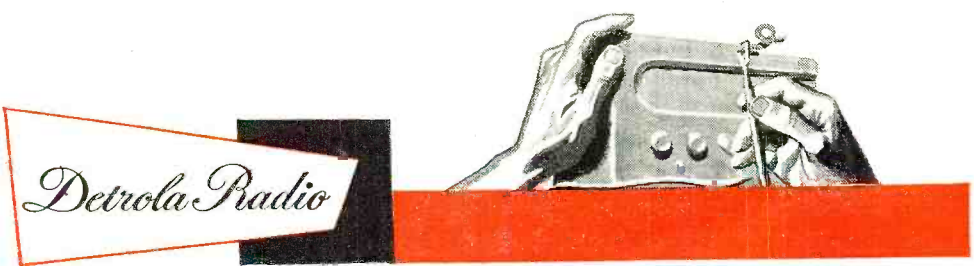

# RADIO PARTS FOR IMMEDIATE DELIVERY

We carry a complete supply of all types of radio parts and electronic equipment.

## Extra Special! SPEAKERS

10" PM 12 Watts Output

Extra Heavy Slug \$5.35 ea.

in lots of ten or more; \$4.50 ea.

12" PM 15 WATTS OUTPUT

Extra Heavy Slug \$7.50 ea.

in lots of ten or more; \$6.50 ea.



### OSCILLATOR COILS

Center tapped oscillator coils 456 KC.  
Standard oscillator coils 456 KC.

35c ea.

### 2 BURNER ELECTRIC HOT PLATE THREE HEAT

High quality materials used throughout.

\$6.50 each



### SPECIAL!

Output Transformers for 50L6-35L6-43-25L6, etc. .... 59c ea.

## CHASSIS

Blank

8" x 5" x 1 1/2"  
With Four Holes  
8" x 4" x 1 1/2"  
8" x 5" x 1 1/2"  
With Five Holes  
9" x 6" x 1 1/2"  
10" x 5" x 1 1/2"  
9" x 4" x 1 1/2"

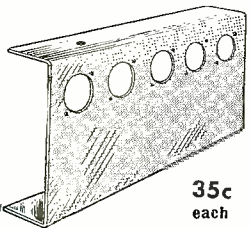

35c each

### CONDUCTOR CORDS

#18-2 Conductor Rubber Zipp cord.

Price \$18.00 per thousand

Quantity 5000 or more. \$15.00 per thousand

#18-2 Conductor Rayon Lamp Cord

Price \$18.00 per thousand

Quantity 5000 or more. \$15.00 per thousand

### RESISTANCE LINE CORDS

135 ohm	180 ohm	220 ohm	290 ohm
160 ohm	200 ohm	250 ohm	330 ohm
Each	.....48c	In Lots of 10..	45c ea.
535 ohm	Each. 65c	In lots of 10.	62 1/2c ea.
560 ohm			

FOB Chicago

WRITE FOR OUR LATEST CATALOGUE  
All foreign orders payable in U.S. funds.

# RADIO PARTS COMPANY

612 W. RANDOLPH ST.  
CHICAGO 6, ILLINOIS

to scare the reader, but to save him from the rather disappointing experience of finding that his mixer is a source of noise rather than a means of amplifying the speech and music it is designed to handle.

These voltages can be reduced to the point where they can be neglected by a few simple precautions. First, keep all low-level signal leads as short as possible and run them entirely in shielded wire. This applies to the grid leads of the low-level or microphone input tubes. Bond these shields carefully to the ground bus, but insulate them carefully where they pass through the chassis. Second, use some type of shielded input jack. An ordinary single circuit radio jack will do if it isn't too large physically. If a large jack is unavoidable, enclose it in its own shield to avoid pick-up. A still better input jack for the "mikes" is the regular amphenol button-contact jack. This latter may be hard to obtain, however. Third, never try to use ordinary wire to connect a high-quality microphone to any amplifier. Use regular microphone cable which is carefully shielded. Even when using cable of this type, carefully avoid cable runs longer than those recommended by the manufacturer of your microphone. This is usually about 50 feet for most makes of high-impedance instruments.

If longer cable runs are necessary, obtain a microphone with a line transformer in its case and provide a line-to-grid transformer for each microphone channel. This latter, if carefully shielded, will provide somewhat better over-all response for the microphone placed at some distance from the mixer.

One more excellent precaution, which will pay off in reduced hum level, is to make sure that all wires carrying raw a.c. (such as filament leads) are carried through the circuit as twisted pairs and pushed as far into a corner of the chassis as possible.

It will be remembered that the filament circuit of the amplifier was grounded on one side to avoid hum pick-up. It would be an excellent idea to ground the mixer filament lead, as well. However, an obvious precaution would be to make sure that the same lead is grounded in both amplifier and mixer to avoid any chance of a short circuit.

The panel lay-out is left up to the reader's taste with these few notes. First, if obtainable, select a panel of some metallic material such as iron or aluminum. This may, of course, be finished to suit. Second, lay out the channel controls in logical sequence across the top of the panel and place the master control below them or, if preferred, place the master control near the top of the panel and line the other controls up along the bottom. This is for the sake of avoiding confusion in operation. If practicable, make all microphone and phono connections to the back of the mixer cabinet and keep the low-level tubes as far away from the panel as the size of the chassis permits. This latter is not of too much importance, however, provided shielding has been carried out as suggested.

The wiring complete, connect the mixer to the power amplifier as indicated in the schematic. Before placing tubes in the sockets, check voltages on the tube sockets with a good voltmeter if one is available. Failing this, at least check the filament terminals with a neon bulb to be sure that plate and heater leads haven't been crossed. This could cause considerable damage to the amplifier's power pack even though a tube were not burned out.

Now place the tubes in position. Place a finger on the input circuit of one of the low-level inputs and slowly advance the corresponding mixer control. The result should be a loud humming sound in the loudspeaker. Now turn this mixer control to zero and try the other low-level channel

Eight elements for test equipment are soldered at one time, in a few seconds, by this new, ingenious electronic power heating set-up in the Camden plant, RCA Victor Division, Radio Corporation of America. Elements are assembled with a pre-formed ring of solder in position at juncture to be sealed, then secured in a fixture. Operator lowers them through holes in work surface, into alternating magnetic field of an induction coil, then applies high-frequency power to coil by pressing a button. Induced currents generate heat in the elements and flow solder uniformly and almost instantly. A 15-kilowatt electronic power generator supplies the power.



The New Model 400

# ELECTRONIC MULTI-METER

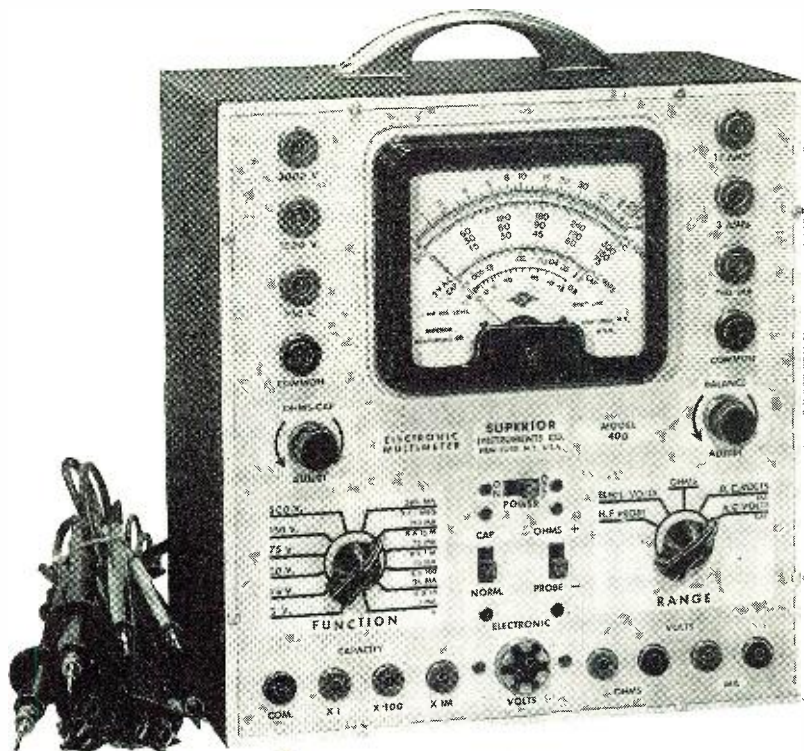

A COMBINATION  
VACUUM-TUBE  
VOLTMETER  
AND  
VOLT-OHM  
MILLIAMMETER  
PLUS  
CAPACITY  
INDUCTANCE  
REACTANCE  
AND  
DECIBEL

*Measurements*

## Specifications:

### D.C. ELECTRONIC VOLTS:

(At 11 Megohms input resistance)  
0 to 3/15/30/75/150/300/750/1500/3000 Volts.

### D.C. VOLTS:

(At 1,000 Ohms Per Volt)  
0 to 3/15/30/75/150/300/750/1500/3000 Volts.

### A.C. VOLTS:

(At 1,000 Ohms Per Volt)  
0 to 3/15/30/75/150/300/750/1500/3000 Volts.

### D.C. CURRENT:

0 to 3/15/30/75/150/300/750 Ma.—0 to 3/15 Amperes

### RESISTANCE:

0 to 1,000/10,000/100,000 Ohms—  
0 to 1/10/1,000 Megohms

### CAPACITY: (In Mfd.)

.0005—.2 .05—20 .5—200

### REACTANCE:

10 to 5M (Ohms) 100—50M (Ohms)  
.01—5 (Megohms)

### INDUCTANCE: (In Henries)

.035—14 .35—140 35—14,000

### DECIBELS:

—10 to +18 +10 to +38 +30 to +58

The Model 400 comes housed in a rugged crackle-finish steel cabinet complete with batteries, two sets of test leads, one set of V.T.V.M. probes and instructions. Size 5 1/2" x 9 1/2" x 10". Net.....

**\$52<sup>50</sup>**

**SUPERIOR INSTRUMENTS COMPANY**

**DEPT. R. N., 227 FULTON STREET, NEW YORK 7, NEW YORK**

Give  
generously to



## YOUR COMMUNITY WAR FUND

### Representing the NATIONAL WAR FUND

The money you gave last year helped give the boys the tonic of entertainment . . . personal appearances by the world's leading radio and motion picture stars—talented men . . . and by lovely women in remote places where just the sight of a feminine face is enough to make up for weeks and months of loneliness and isolation.

Your dollars made possible the U.S.O.—in addition to many other great services at home and abroad—2,500 U.S.O. clubs and U.S.O. Camp Shows.

The job is bigger this year . . . much bigger. Won't you be bigger than ever this year, too, and give generously?

the same way. Now feed in sound from either a microphone or some other source of equal level and check the amplifier and mixer for quality. If instruments are at hand, an audio oscillator may be used to drive the amplifier and mixer and the over-all frequency response determined for each channel in turn.

In operation, connect each input channel of the mixer to an appropriate sound source, *i.e.*, one or two microphones for spoken commentary and sound-effects and two phono pickups for "canned" sound-effects or musical backgrounds (or both!). If possible arrange to have the microphones placed in rooms away from that used for the mixer panel. This latter is to provide an opportunity to use a loudspeaker to "monitor" the mixing results and adjust each separate channel to its proper level. Failing this, a pair of headphones may be connected into the circuit.

Nothing, in the writer's opinion, can give any person any greater satisfaction than to achieve fine results with apparatus built by his own hands. If those results are a well-planned soundtrack for a home movie film or a well-recorded sound-drama, a person has an artistic achievement as well as a scientific one to "point to with pride".

-30-

### Transmitter Checking

(Continued from page 34)



## The QUICKEST way to locate personnel is with BELL VOICE-PAGING EQUIPMENT

BELL Voice-Paging Equipment locates individuals in the quickest time possible . . . cuts "hold-the-phone" delays to the minimum . . . provides for plant-wide broadcasting of announcements, instructions, time signals and alarms—and also permits plant-wide broadcasting of recorded music! Its widely adjustable, precision-built, standard units—specially designed for industrial use—can be grouped to fit any need. Also designed for quick, easy expansion or rearrangement. Get details on this new BELL Industrial Sound Equipment.



**BELL SOUND SYSTEM, Inc.**

1200 Essex Ave.,

Columbus 3, Ohio

Export Office: 4900 Euclid Ave., Cleveland 3, Ohio



velope pattern, as stated above, are much simpler than those of the trapezoidal pattern. The method consists of feeding some of the output of the modulated amplifier to the vertical axis. This is done with a coil of one or more turns of wire fed to the input terminals by means of a twisted pair. On high frequencies (100 kc. and above) direct connection should be made to the vertical deflector plates of the scope. This measure is necessary because the amplifier contained in the instrument is not capable of handling high frequencies.

The sweep circuit is synchronized with the audio oscillator that is fed to the input of the speech amplifier equipment. To do this, feed the audio output from the oscillator to the synchronization terminals through a .01  $\mu$ fd. condenser. The height of the pattern is varied by changing the number of turns of the coil or its distance from the output tank. The load, antenna, or antenna tuner is left connected to observe performance under actual working conditions. With the sweep circuit properly synchronized and at a multiple of the audio oscillator frequency, an image appears with several sine waves. By increasing the audio oscillator output, the percentage of modulation is correspondingly increased. By this method, all types of modulation may be observed including plate, grid, screen, and suppressor modulation. Fig. 1 shows the necessary hookup.

# Announcing...

## NEWLY DESIGNED **RADIART AERIALS**



WITH FEATURES AND  
ADVANTAGES THAT MAKE  
THEM THE

*Sensation of 1945!*

This new RADIART Line is complete — 3 and 4 Section Models — to fit all cars — all angles — cowl, fender and under hood types — with waterproofed leads of new design featuring lowest capacity — high efficiency construction — with combination pin and bayonet fittings.

All models are made with only highest quality Admiralty brass tubing and stainless steel top section — thereby providing the maximum in

elastic load limit consistent with the utmost in strength and rigidity.

Newly designed method of mounting provides simplest form of one man installation — Mounting is completely waterproofed and impossible to short to the body.

And including those well known RADIART Features of the "Static" muffler magic ring and the permanent all-metal anti-rattler.

★ Check these RADIART advantages and features against all other aerial specifications and you will understand why RADIART AERIALS HAVE ALWAYS BEEN THE STANDARD OF COMPARISON.

*Ask your distributor about deliveries of these new models.*

MANUFACTURED BY THE MAKERS OF RADIART EXACT DUPLICATE VIBRATORS



### Radiart Corporation

3571 W. 62nd STREET

Export Division  
25 Warren St., New York 7, N.Y.

• CLEVELAND 2, OHIO

Canadian Office  
455 Craig St., W., Montreal, Canada

**RADIOMEN'S  
HEADQUARTERS  
BUFFALO  
RADIO SUPPLY  
219-221 Genesee Street  
Dept. N  
BUFFALO 3, N. Y.**

!!! ALL TYPES OF RADIO TUBES IN STOCK ALMOST ALL THE TIME !!! MAIL IN YOUR ORDERS FOR ALL TYPES NEEDED! NOT JUST THE CRITICAL NUMBERS, AND WE'LL TRY TO FILL THEM COMPLETELY. WE ALSO HAVE ALL KINDS OF BALLAST TUBES IN STOCK. Perfect 25Z5 and 25Z6 replacements in stock listing for \$2.80. No resistors, no rewiring, cost you **\$1.00** each! Silvertone 1A2 ballasts or RCA UX200 (replace. 71A), in cartons—**\$0.10** each. All adaptors, including resistor type—**\$0.60** or **10** for **\$5.50**. Unwired adaptors, octal or loctal to octal—**\$0.20**. While they last, the foll wing tubes with list prices as indicated, cost you only **\$0.49**: 12SF5—**\$1.10**; 6SC7—**\$1.30**; 2B7—**\$1.30**; 6C8G—**\$1.60**; 6B8G (replaces 6Q7)—**\$1.30**; 6SN7—**\$1.30**; 39/44—**\$1.00**; 6SD7 (repl. 6SK7, 6SJ7)—**\$1.30**; 6L6G—**\$1.95**

92" triple chrome plate! best quality standard car aerials with low-loss lead and connector. **\$5.95** list, costs you **\$2.95**.

Replace broken radio plugs with new bakelite plugs or caps, **100** for **\$2.00**. Replace frayed or worn electric cords with new parallel conductor, rubber covered zipcord (POSJ). The kind you've waited for. **250** ft.—**\$4.50**.

Send for our new alignment tool catalog. FREE. The most complete in the industry. 6" long fiber ¼" hexagon aligning wrenches cost you only **\$0.12**.

Resistor Assortments: 50—2 Watt—**\$1.95**; 200—½ Watt Carbon—**\$4.50**; 200—½ Watt Insulated—**\$5.00**. We also have a 10 Watt Wire Wound, 525 ohm tapped at 250. Can be used as a 125 ohm by paralleling, or a 250 or 275 ohm. Perfect for tube substitutions, **\$0.10** each.

Assorted rubber grommet kits. All sizes. Average 125 pieces. **\$1.25** each. Pushbutton Tuning Trimmer Strips. 6 to 10 trimmers each. Per Strip **\$0.10**. All kinds of relays at tremendous bargains. Send for our relay sheet. 10,800 ohm, 100 watt Cand-ohm replacement voltage dividers, 5 Tape **\$0.30** each.

Latest Amateur's Handbooks with all tubes listed. Postage free **\$0.98**. Send for our free catalog sheet on latest service manuals and books.

All purpose Neon Pocket Testers, 60V to 550V **\$0.35**. These testers indicate the kind of current, AC, DC, or RF, and come complete with a handy instruction booklet outlining various tests on radio sets, including the locating of fading, dead stages, and making screen grid and plate circuit tests.

Special on Permanent Magnet Dynamics: 2½"—**\$1.75**; 4"—**\$1.75**; 5"—**\$1.75**; 6"—**\$1.95**; 8"—**\$4.25**; 10"—**\$6.00**; 12" (21 oz. magnet)—**\$8.00**.

Guaranteed Tubular Condensers: 8 Mfd, 450V—**\$0.35**; 10 Mfd, 450V—**\$0.35**; 20/20 Mfd, 150V—**\$0.35**; 20 Mfd, 150V—**\$0.25**; 10 Mfd, 150V—**\$0.18**; 25 Mfd, 600V—**\$0.20**. 1 Mfd, 600V—**\$0.10**. All smaller capacities in 600V rating cost you **10c** each.

"Bullet" Crystal Microphones with 7' Shielded Lead—**\$5.45**; "Bullet" Dynamic Microphones with 7' Shielded Lead—**\$7.45**; Double Phone or Mike Plugs, Red or Black Barrels—**\$0.27**; First Grade Needle Point Test Prods—**\$0.45** per pair.

Free Stroboscope with each order while supply lasts.

**LOWEST PRICES, COMPLETE STOCKS, FAST SERVICE STANDARD MERCHANDISE**

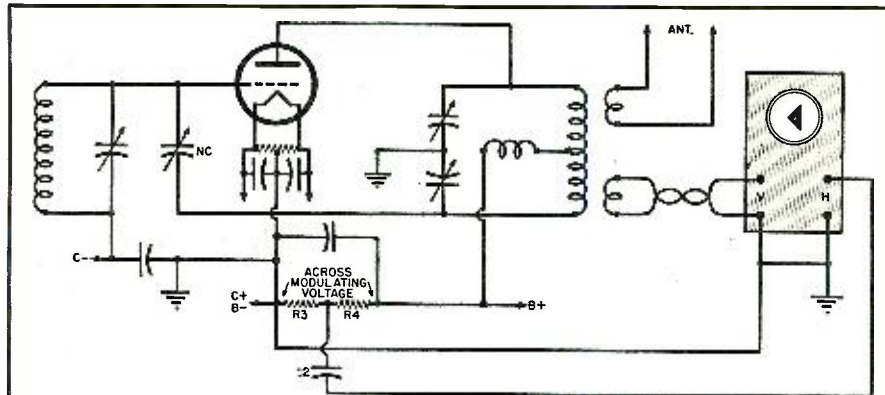

Values for  $R_3$  should be determined experimentally. Usual values are as follows:  
 $R_3$ —25,000 ohm, 1 w. res. (low power)  
 $R_3$ —10,000 ohm, 1 w. res. (medium power)  
 $R_3$ —3000 ohm, 1 w. res. (high power)  
 When direct connection is used,  $R_3$  should be a pot. (.5 meg., .1 meg., 50,000 ohm respec-

tively for low, medium, and high power transmitters).  $C_2$  is placed on variable tap of pot. For low power transmitter,  $R_4$  should be a .5 megohm, 1 w. res. For high power transmitter, several .5 megohm, 1 w. res. are connected in series, one for every 500 v. of d. c. applied to modulated amplifiers.

Fig. 4. Method of obtaining trapezoidal patterns in checking plate modulated transmitter.

If low level modulation is used, the r.f. pickup should be from the final stage as this is the criterion of performance.

If a trapezoidal pattern is to be obtained, the same connections as above are used except for the horizontal axis. Here, some of the audio voltage used to modulate the final amplifier is connected to the horizontal axis. This a.f. voltage must be in the proper phase relationship with the r.f. output in order to obtain the correct pattern.

The requisite voltage is obtained from a voltage divider across the modulating voltage (see Figs. 3 and 4). Connect it to the horizontal amplifier in the 'scope which then makes possible the regulation of the width of the image. Values of the voltage divider are given in the diagram.

**Difficulties in Obtaining Patterns**

If the proper care is exercised in making connections and instructions are followed carefully, no trouble should be had in obtaining patterns. Otherwise, the operator may believe that the trouble originates in the transmitter itself and search thereof will be made there, while it is due (in most cases) to maladjustment of the oscilloscope. Some of the faults usually encountered and their interpretations are given below.

One of the most common faults that the beginner experiences when the wave-envelope pattern is used is non-sinusoidality. This may be due to the compression of too many waveforms on the screen. The effect can be explained by the fact that the spot diameter of the trace causes the outer edge of the image to appear brighter than the central areas. This is a result of the decreased speed at the edges. It causes the crests to be broader and the troughs of the wave to be narrower. The condition is alleviated if the image occupies a generous portion of the screen and only two or three cycles are observed.

Another fault is leaning of pattern. This results from coupling between

the horizontal and vertical circuits of the oscilloscope. It is most common with high-frequency carriers.

Phase shift in the trapezoidal pattern occurs when the horizontal axis is connected to a.f. voltage in the pre-amplifier instead of the modulating voltage.

In conclusion, as the operator becomes more familiar with the oscilloscope as applied to checking transmitter operation, he will become more expert in interpreting the various patterns encountered.

**REFERENCES**

Rider, John F.—"The Cathode-Ray Tube at Work." John F. Rider Pub. Co., New York, 1935.  
 A.R.R.L.—"The Radio Amateur's Handbook," Pub. by American Radio Relay League, 1944.  
 Jones, etc.—"Radio Handbook," Pub. by Editors and Engineers, Los Angeles, Calif., 1943.  
 Howard, A., & Eddy, M.—"The Oscilloscope Applied to Radio Servicing," RADIO NEWS, Sept. 1944

—50—

**Ultrasonic Communications**  
(Continued from page 49)

mentioned sections of steel rod. In order to determine the resonant frequency, the required over-all length of this steel-quartz-steel "sandwich" may be approximated from the previously mentioned formula, because the velocity of sound in quartz and steel is about the same. This unit has an inherently high impedance requiring a high driving voltage and necessitating the incorporation of a special matching transformer as used with piezoelectric instantaneous record cutting heads. The high voltage appearing across the quartz engenders difficulties in mounting the reproducer.

The dynamic reproducer, illustrated in Figs. 3B and 5, consists essentially of a small permanent magnet loudspeaker with the cone replaced by a resonant brass disc one-quarter inch thick and two inches in diameter, pinned at its center to the central pole piece of the permanent magnet, and

# Federal... **KNOWS** H-F Cable

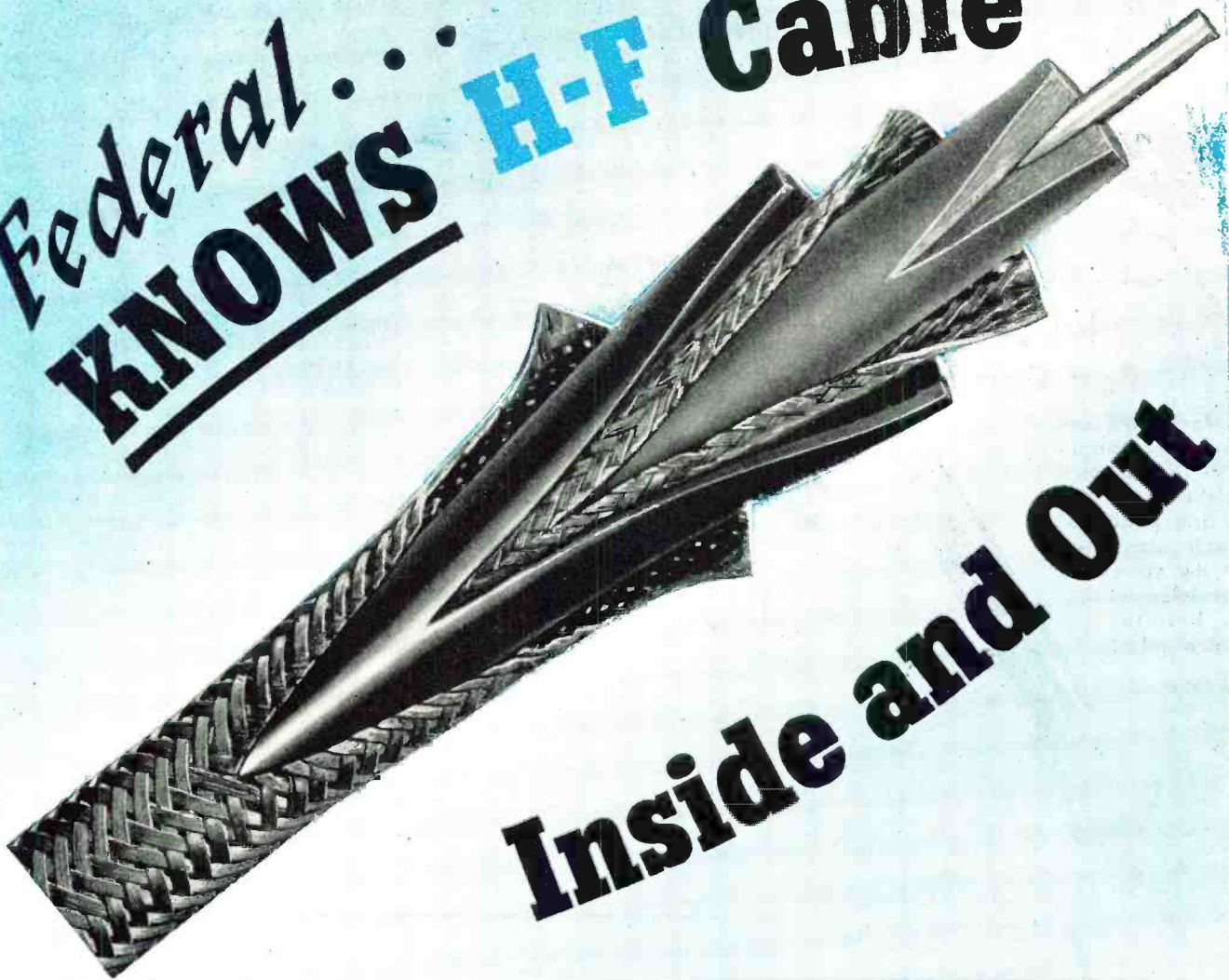

## Inside and Out

From inner conductor to outer covering : : : Federal really knows high-frequency transmission lines.

And this knowledge was not easily won. As the pioneer in the field Federal not only developed over 80% of all h-f cable types in use today . . . but developed most of the equipment needed to test them.

Attenuation, high-voltage, dielectric and balance testing equipment, velocity of propagation, braid-resistance and electri-

cal length meters : : : were all Federal-engineered to fit specific requirements.

That's why it's logical to turn to the acknowledged leader in the field for the finest in h-f cables, specialty-engineered harnesses and cable assemblies.

Where requirements are critical . . . for transmission lines with special characteristics . . . for custom-built and engineered harnesses and cable assemblies . . . take your high-frequency transmission problems to Federal.



## Federal Telephone and Radio Corporation

Newark 1, N. J.





**...here's a  
TIP  
for You!**

In fact there are four interchangeable tips adapted to the Ungar Soldering pencil... each designed to do speedy precision work on hard-to-reach jobs!

No. 537 Pencil Tip, made from Elkaloy A, Tip 1/8" dia.

Ruggedly built, the Ungar Soldering tool weighs only 3.6 ozs., is perfectly balanced and handles like a fountain pen. Heats in 90 seconds. Draws only 17 watts. Unit complete with any one tip sells at less than \$2. Please order from your Electronics distributor.

No. 538 Chisel Tip, made from Elkaloy A, Tip 1/8" dia.

No. 536 Standard Tip, made from Hard Drawn Copper

No. 539 Extra Hot, made from Tellurium

**Ungar**  
Electric Tools, Inc.  
Formerly Harry A. Ungar, Inc.  
LOS ANGELES 54, CALIF.

carrying the voice coil. This unit has given excellent service in practice with relatively high output.

Various receivers for receiving the 20 kilocycle sound waves have been employed, all of them requiring some type of microphone, a carrier amplifier, a demodulator, a carrier filter, and an audio system, as in conventional radio receivers. Two different microphones have been successfully used, both being the Rochelle salt crystal type. The first unit is an unmodified commercial crystal microphone (As-tatic WR-20) having dual crystals and diaphragms, having good response in the 20 kilocycle region. The second unit, shown in Figs. 3A and 6, employs a stretched foil diaphragm with a small Rochelle salt crystal cemented directly to the inside face. Provision is made, as illustrated, for varying the tension on the diaphragm to permit adjustment for some mode of mechanical resonance at 20 kilocycles. This mechanically "tunable" microphone has considerably higher output on equivalent sound intensities than the standard commercial unit, with the added feature of tending to reject lower, non-resonant frequencies.

Two types of receivers, one rather unusual in design, have been employed. The first type consists of several stages of tuned audio amplification, followed by a diode detector, carrier filter, and audio amplifier. As an interesting experiment, in an effort to improve sub-harmonic rejection, improve selectivity, and eliminate the necessity for a 20 kilocycle carrier filter, another receiver was designed in which the output from the microphone is successively doubled to 160 kilo-

cycles, amplified with a two-stage 160 kilocycle r.f. amplifier, demodulated, and passed to the conventional audio system. As expected, in this particular arrangement, rather severe audio distortion is caused by the carrier doublers if a high percentage of modulation is used. In subsequent experiments it is proposed to use either push-push doublers or full-wave rectification to elevate the carrier to the higher frequency. With the frequency raised to around 160 kilocycles, standard 175 kilocycle i.f. transformers provide conveniently packaged, high-Q tuned circuits for amplification.

Up to the present time, out-of-door tests with the disclosed equipment have not been made, but experiments which have been performed are of great interest. The 20 kilocycle carrier has been modulated with both tone and phonograph signals and received exceedingly well over distances of some thirty to fifty feet. Modulation does not render the carrier audible to the ear. However, with the unmodulated carrier directed toward the receiver, speaking into the carrier microphone produces audible signals in the receiver audio output system. With the carrier removed, the audible signal disappears.

Remarkably pertinent effects may be produced by reflecting a second carrier wave path, in addition to the original path, from reproducer to microphone, as shown in Fig. 7. Fading and phase distortion, such as encountered in standard radio reception, may be produced realistically in the ultrasonic receiver by varying the position of the reflector, the motion of the reflector being somewhat analogous to

Transmitters mounted in airplanes flying six miles above the earth hold the key to Stratovision—a new system of nationwide television and FM radio announced August 10th, by the Westinghouse Electric Corporation. Programs for the system, a joint development of Westinghouse and the Glenn L. Martin Company, would be originated in ground studios and "beamed" (solid lines), in much the manner of military radar, to planes for broadcast. Similarly "beamed" plane-to-plane connections (dotted lines) would form a nationwide network. Each plane would receive and broadcast nine simultaneously available programs throughout a 103,000 square-mile area within its 442 mile line-of-sight diameter (shaded circles). Broadcast locations shown would provide coverage for 78 per-cent of the nation's population; 100 per-cent coverage merely would require more airplanes.

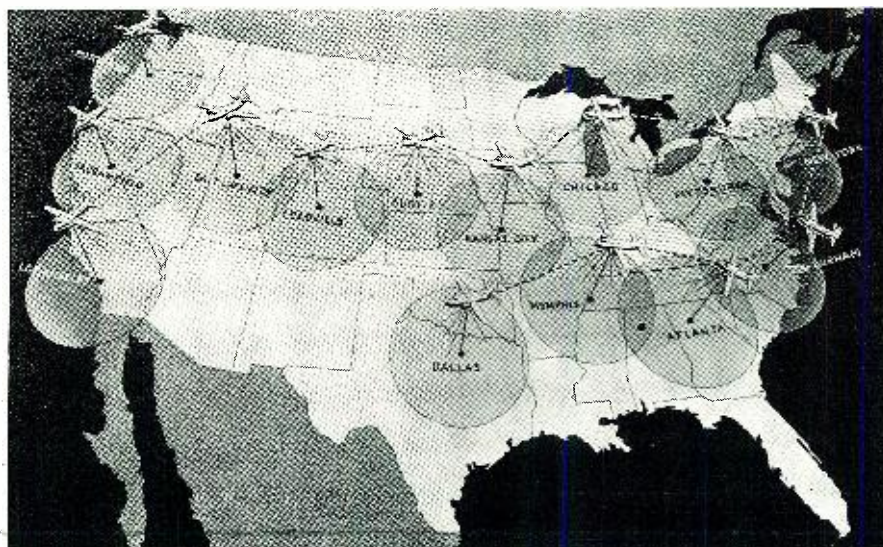



# UP TO 42 Mc

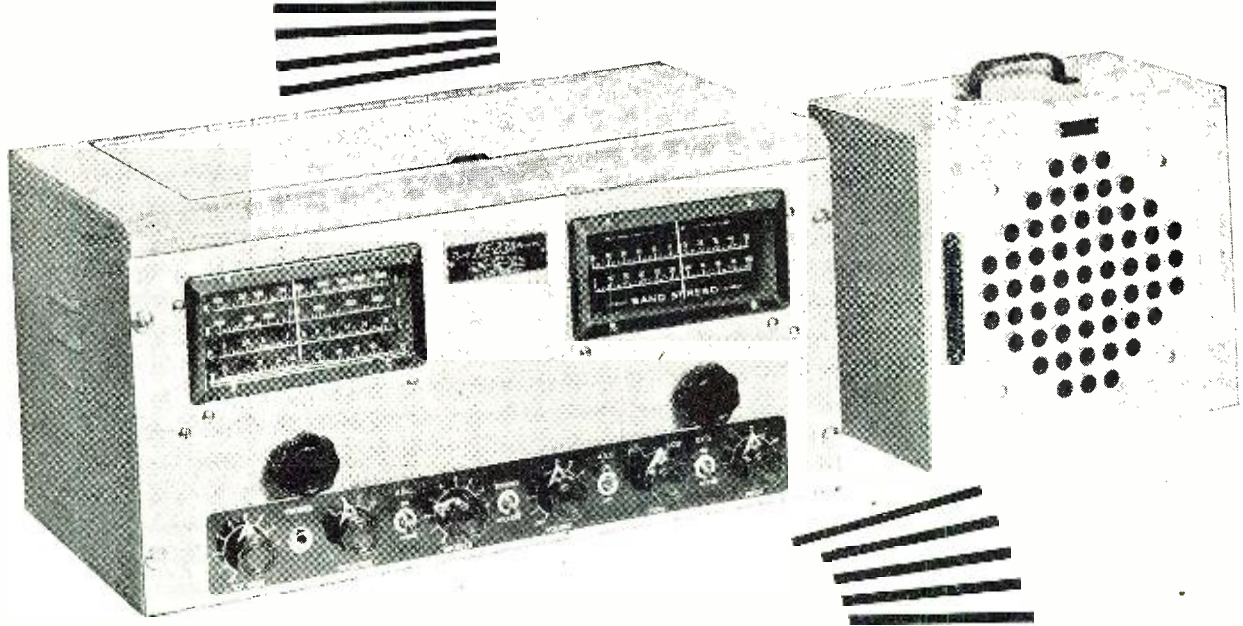

# DOWN TO 500 Kc

## No-signal squelch circuit makes this general purpose KAAR RECEIVER IDEAL FOR STANDBY!

The KAAR KE-23A general purpose receiver has a wider than customary range, covering all of the radio communication bands from 500 Kc to 42 Mc. Unsurpassed for most types of emergency, commercial, and amateur operation, it is especially favored as a standby receiver.

A *no-signal squelch circuit*—normally not available in a general purpose receiver—automatically silences the speaker except

when a call or message is being received, thus eliminating background noise during standby periods. A threshold control on the panel determines the amount of carrier required to operate the receiver, or cuts out the squelch circuit when desired.

This nine tube receiver has a high degree of stability and its selectivity and sensitivity insure reception under the most difficult conditions.

The KE-23A, designed for 117 volt 60 cycle AC operation, is instantly converted to 6 volt DC by plugging in a KAAR 647X power pack at the back. Write today for additional information about this versatile KAAR receiver.

**KAAR**   
**ENGINEERING CO.**  
PALO ALTO, CALIFORNIA

Export Agents: FRAZAR & HANSEN  
301 Clay Street • San Francisco, California

**FM TRANSMITTERS**—50 and 100 watt mobile FM transmitters with instant-heating tubes for lower battery drain.



**CRYSTALS**—Low-drift quartz plates. Fundamental and harmonic types available in various holders.



**AM TRANSMITTERS**—Mobile, marine, and central station transmitters for medium and high frequencies. Instant heating, quickly serviced.

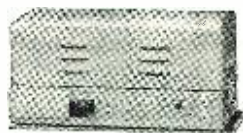

**MICROPHONES**—Type 4-C single button carbon. Superb voice quality, high output, moisture proof.



**CONDENSERS**—Many types of small variable air condensers available for tank circuit and antenna tuning.



the motion of the Heaviside layer. The movement of people within range of the apparatus produces like results and indicates the potential utility of ultrasonics for intrusion or passage detection in air mediums, using the beam-of-sound rather than the beam-of-light principle.

In the near future it is proposed to conduct out-of-door tests in an effort to empirically determine the range of such apparatus.

**REFERENCES**

1. Lord Rayleigh, "Theory of Sound."
2. Dr. L. Bergmann, "Ultrasonics," P. 195.
3. Ibid. (2), P. 194.

-30-

**For the Record**  
(Continued from page 8)

that he thought they were huge machine guns.

These are only a fraction of the many case histories where radar has been used in combating our enemies. Radar, like a tree, has grown from many roots. It has been developed through years of research and experiment. In fact, during all stages of the development of radar, the techniques of the communications art have been

drawn upon by the engineers and scientists. In giving due credit to the development of radar we must recognize radar as being a "joint development." Now that we have reached a happy conclusion in our war effort, let us recognize the effective results that may be obtained only by carefully planned and extended team work on the part of nations fighting side by side to attain the common objective. Let us be careful in giving our credit to any one individual and, finally, let us be thankful that both American and foreign scientists rolled up their sleeves and pitched in to develop the potent weapon that is radar.

We are devoting considerable space in this issue to a review of some of the radar equipment used during the war. Space does not permit a complete resume. As time goes on and restrictions are lifted we will bring you later units.

Postwar applications for radar are many. To fly a plane in dense fog or to sail a ship on the high seas without fear has always been the dream of the pilot and navigator. Today it is a reality.

Yes—science moves on. We know now that the electronic tube is playing a vital role in the development of the atomic bomb. Let no one underestimate the vast use to which electronic tubes will continue to perform in the postwar era . . . . . O.R.

**ELECTRICITY**  
FOR RADIO AND ELECTRONIC APPLICATIONS

● ONAN ELECTRIC GENERATING PLANTS supply reliable, economical electric service for electronics applications as well as for scores of general uses.

Driven by Onan-built, 4-cycle gasoline engines, these power units are of single-unit, compact design and sturdy construction. Suitable for mobile, stationary or emergency service.

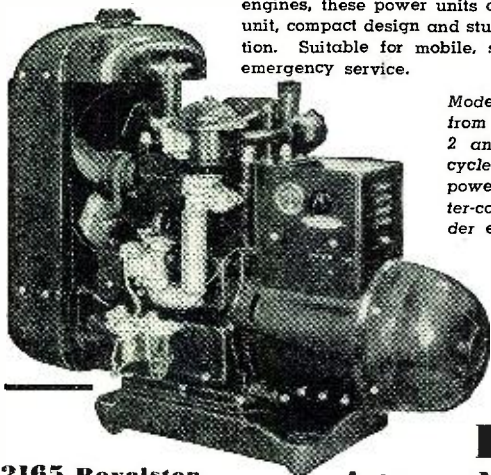

Model shown is from W2C series, 2 and 3-KW, 60-cycle, 115 volt; powered by water-cooled 2-cylinder engine.

Models range from 350 to 35,000 watts. A.C. types from 115 to 660 volts; 50, 60, 180 cycles, single or three-phase; 400, 500 and 800 cycles, single phase; also special frequencies. D.C. types range from 6 to 4000 volts. Dual voltage types available. Write for engineering assistance or detailed literature.

2165 Royalston Avenue, **D.W. ONAN & SONS** MINNEAPOLIS 5, MINN.

**What's New**

(Continued from page 74)

position for assembly or disassembly. Since this tool is always "on hand—at the finger tips", it will be found useful for general mass production operations where the constant use of a wrench, screwdriver, etc., is part of a job detail. It eliminates the repetitive action of laying aside and picking up tools.

The Touch-n-Grip is worn like a

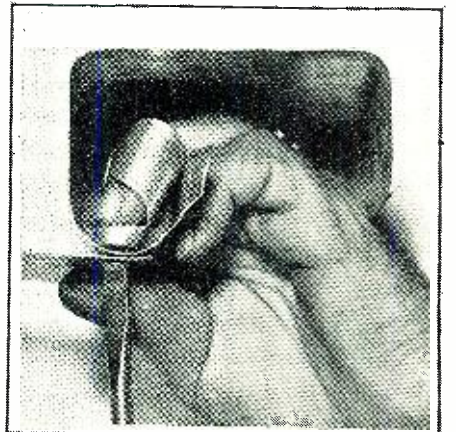

ring without restricting the free motion of the hands or fingers. When not in actual use, it can be turned around the finger and out of the way to leave the hands free for using other tools or work details.

Additional details of this unit will be furnished those requesting them from

**RADIO NEWS**

**SPEED UP REPAIRS WITH THESE G-C AIDS!**



FREE STEEL CABINET

Get This New **FREE Dial Belt — Drive Cable and Cabinet Repair Guide!**

**G-C Dial Belt Kits**  
Exact replacement woven fabric belts. Easy to install — no stretching — no adjustments — a perfect fit every time. Kits come with 25, 50, 100, 200 or 300 belts.

Pocket size 68 page book contains thousands of listings, specifications — time saving service instructions. Invaluable to every radio man. Get a copy from your jobber. If he cannot supply you, write us.



**Immediate delivery on all G-C Products**

Order From Your Radio Parts Jobber  
**ALWAYS ASK FOR G-C PRODUCTS**



**GENERAL CEMENT MFG. CO.**  
ROCKFORD, ILLINOIS

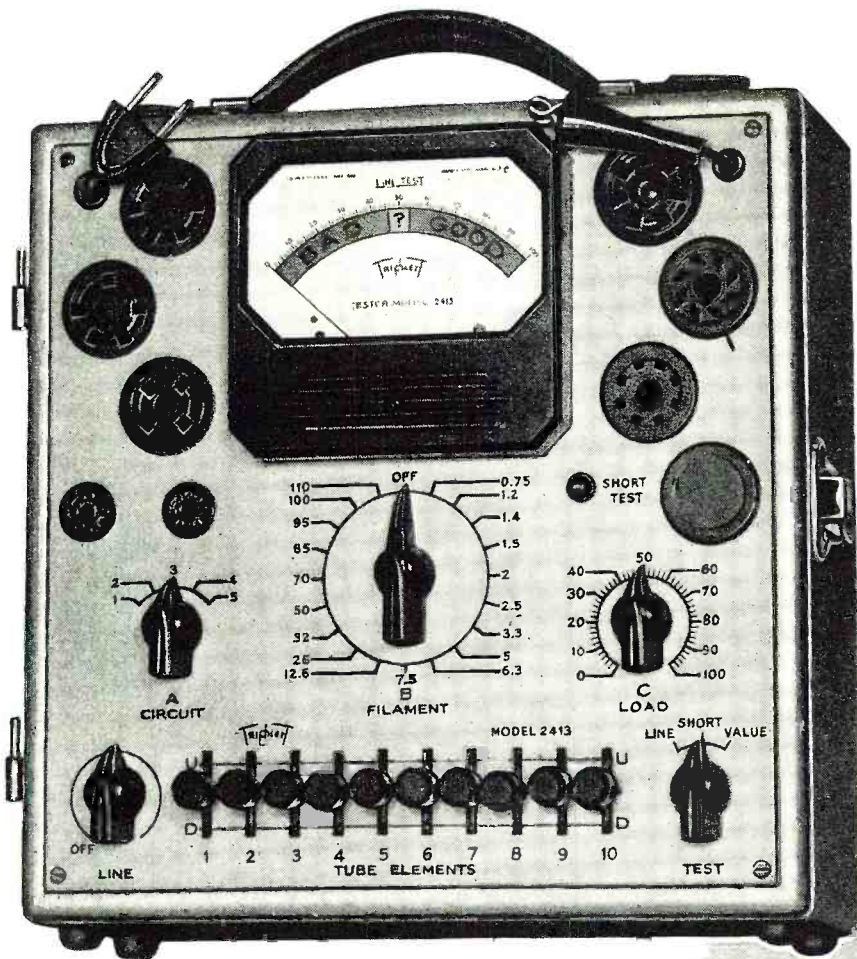

**MODEL  
2413**



is another  
member of the  
**NEW TRIPLETT  
Square Line**



# The New Speed-Chek Tube Tester

**MORE FLEXIBLE • FAR FASTER • MORE ACCURATE**

Three-position lever switching makes this sensational new model one of the most flexible and speediest of all tube testers. Its multi-purpose test circuit provides for standardized VALUE test; SHORT AND OPEN element test and TRANSCONDUCTANCE comparison test. Large 4" square RED•DOT life-time guaranteed meter.

Simplicity of operation provides for the fastest settings ever developed for practical tube testing. Gives individual control of each tube element.

New SQUARE LINE series metal case 10" x 10" x 5½", striking two-tone hammered baked-on enamel finish. Detachable cover. Tube chart 8" x 9" with the simple settings marked in large easy to read type. Attractively priced. Write for details.

## Additional Features

- Authoritative tests for tube value; shorts, open elements, and transconductance (mutual conductance) comparison for matching tubes.
- Flexible lever-switching gives individual control for each tube element; provides for roaming elements, dual cathode structures, multi-purpose tubes, etc.
- Line voltage adjustment control.
- Filament Voltages, 0.75 to 110 volts, through 19 steps.
- Sockets: One only each kind required socket plus one spare.
- Distinctive appearance with 4" meter makes impressive counter tester — also suitable for portable use.



# Triplett

**ELECTRICAL INSTRUMENT CO. BLUFFTON, OHIO**



**Now...  
DIRECT TO YOU!**

**A Great  
THERAPEUTIC INVENTION!**

**Sun-Kraft**

**COLD QUARTZ ULTRA VIOLET  
RAY THERAPY  
LAMP**

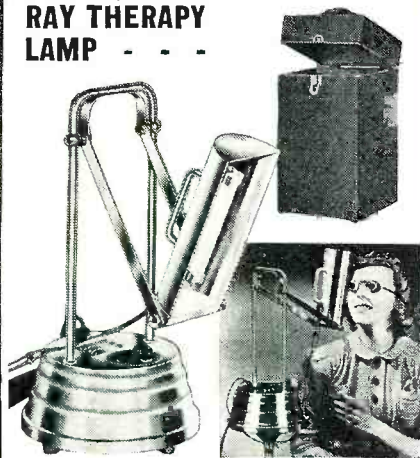

**LOTS OF 3  
OR MORE**

**\$64.50 LIST**

**\$38.70 EA. } YOUR PROFIT \$25.80**

**20% DEPOSIT REQUIRED WITH EACH ORDER**

- 95% Pure Cold Ultraviolet Radiation!
- Induces Vitamin D!
- Powerful Germicidal Agent and Sterilizer!
- Portable . . . Compact . . . Remarkably Flexible!
- Carries Manufacturer's Guarantee!

*Place Your Order Now!*  
**IMMEDIATE DELIVERY**

**LEONARD ASHBACH**

*Company*

**ELECTRONICS DISTRIBUTORS**

Phone Whitehall 2065

152 W. HURON ST. • CHICAGO 10, ILL.



**GENERAL ELECTRIC  
TYPE 211 TUBES**

**BRAND NEW  
IN ORIGINAL CARTONS**

Regular Price . . . \$10.00  
**YOUR COST . . . 3.95**

Also all types of Radio  
and Electronic Equipment

**McGEE RADIO & ELEC. CO.**  
Dept. N, 1330 Broadway, Denver, Colorado

*Paso Manufacturing Company, 41-27  
Bell Boulevard, Bayside, Long Island.*

**TELECHRON MOTOR**

The *Paragon Electric Company* has announced an improvement in the *Paragon 300 Series Time Switches*. It is the *Telechron Motor*, an industrial type, self-starting synchronous motor which adds years to the life of the time switch. Complete, self-oiling lubrication by means of a patented capillary oiling system, practically instantaneous self-starting at full rated load, gear reduction fully sealed to exclude dust and dirt, and low power consumption are among the many operating advantages of this motor, according to the manufacturer.

The 300 Series is light in weight,

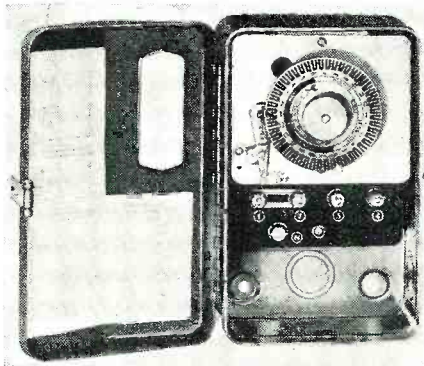

small and compact in design, and is constructed to give efficient performance. It has switch capacity of 3000 watts per pole with easily mounted-accessible terminals, skip-trip feature, knockouts on both sides, back and bottom, and two bearing plate construction.

These time switches, which may now be purchased without a priority rat-

ing, are widely used for controlling signs, commercial lights, attic fans, stokers, oil burners, blowers, pumps, valves, motors, etc.

Further information is available from *Paragon Electric Company, 37 West Van Buren Street, Chicago 5, Illinois.*

**MARINE RADIO TELEPHONES**

*Hudson American Corporation*, a subsidiary of *Reeves-Ely Laboratories, Inc.*, has announced four new models of marine radio telephones designed to meet communications requirements in the yachting and coastal harbor services.

The complete line covers ship-to-ship, ship-to-shore, and ship-to-Coast Guard (emergency) marine radio telephones ranging from 5 watts to 75 watts and operating on frequencies between 2100 kc. and 2800 kc.

Exclusive with all four models, which will have identifying trade names, are several unique features. No variable condensers are used in these sets, therefore precluding the danger of inefficient operation due to their use. Completely individual adjustment of each channel is provided to assure greater transmitting and receiving efficiency. The transmitter and receiver have complete crystal control and the new transmitter-output coupling system is designed to give greater efficiency of operation and to minimize both interference with other communications and harmonic radiation.

One model is built especially for small craft. A single-channel unit, with a capability of approximately 5 watts of transmitter power output, it can provide two-way communication over a normal distance of approximately 25 to 50 miles under favorable conditions.

Here is the tube that made possible RCA's first practical demonstration of experimental television on the new enlarged screen, approximately three-by-four feet. Before the members of the Society of Motion Picture Engineers, a full hour's program from the NBC television studio was shown in exceptional clarity through this Kinescope projection tube, photographed in profile with the cover laid back to reveal the inside construction. The images appeared on a motion picture screen.

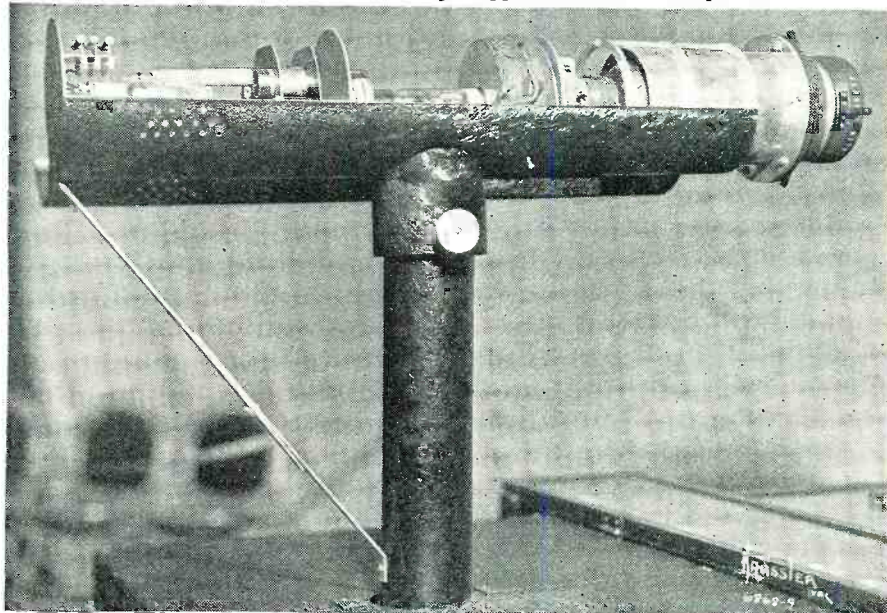

Since there's nothing finer than a Stromberg-Carlson

for the Main Radio

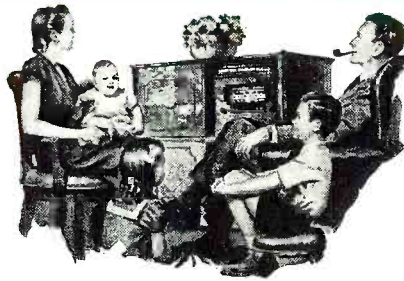

in any home

There's nothing finer than a Stromberg-Carlson

for the Main Radio Line in your showroom!

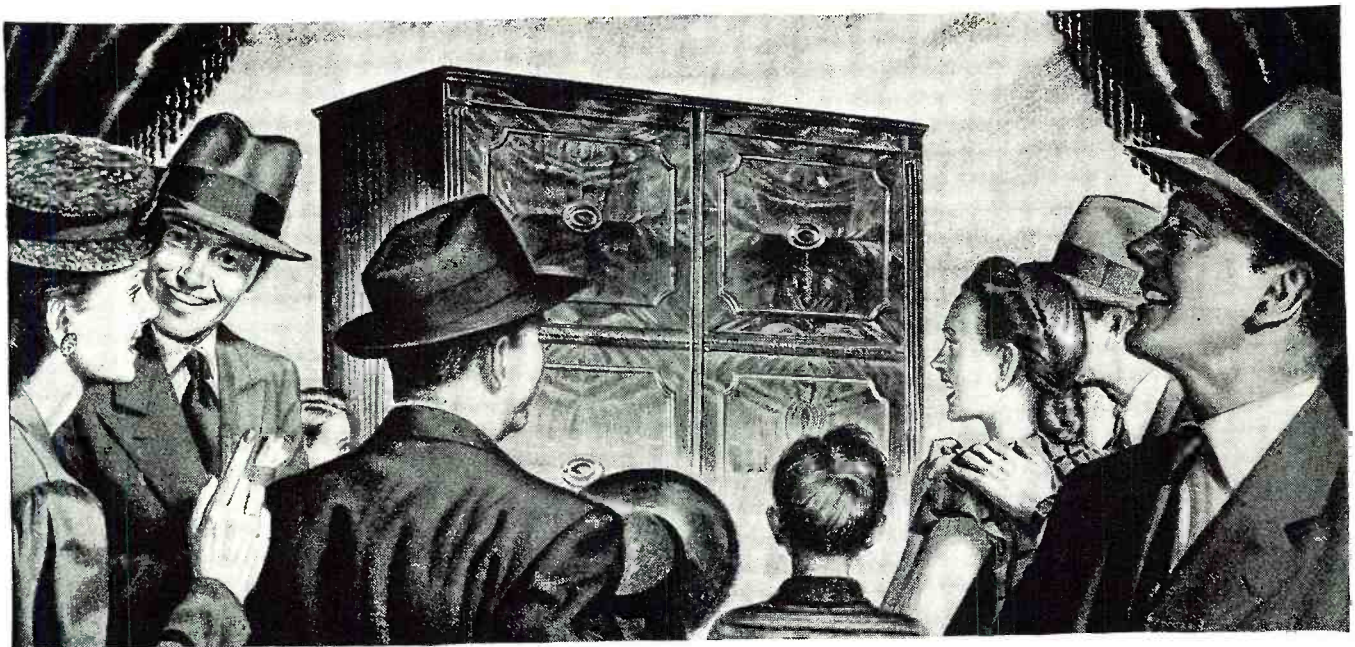

**THESE SEVEN WORDS**, "There's nothing finer than a Stromberg-Carlson" have aptly summed up Stromberg-Carlson leadership for 51 years. Today, by the millions, America is swiftly swinging to the conviction that the *main* radio in any man's home should be as fine a musical instrument as its owner can possibly buy.

Stromberg-Carlson is the main choice for the *main* radio in whatever price range — whether table model, console, or radio-phonograph combination. And its superiority as a musical instrument is carried to the public through vigorous national advertising with some 475,000,000 impressions in thirteen leading magazines during 1945.

Ask your Stromberg-Carlson distributor for details  
**October, 1945**

of the very favorable Franchise Agreement now being offered, or write us directly. For Stromberg-Carlson is:

- *the important radio unit*
- *the radio unit carrying real profit opportunity*
- *the radio unit with easy-selling public acceptance.*

Become an Authorized Dealer now, and organize your postwar business around the Stromberg-Carlson *main radio* — a consistent profit maker whether in an outstanding table model, console, or radio-phonograph combination.

**STROMBERG-CARLSON**

ROCHESTER 3, NEW YORK

RADIOS . . . RADIO PHONOGRAPHS . . . AND TELEVISION

125

Another model is nominally rated at 10 watts of transmitter power output, with 5 channels available, and has a communication radius of approximately 75 to 100 miles under favorable conditions. Channels 1 and 2 are set up for ship-to-ship communication. Channel 3 allows for emergency communication with the Coast Guard. Channels 4 and 5 will be made available for any of the ship-to-shore radio telephone channels in the vicinity of the vessel on which the equipment is installed.

Another model, the Hudson 25-watt, 6-channel marine radio telephone set has a communication radius of approximately 250 to 400 miles under

favorable conditions. The 75-watt, 10-channel ship-to-shore radio telephone is designed for ocean-going vessels in the coastal services and offers a normal communication radius of approximately 500 to 1000 miles under favorable conditions.

These four marine radio telephones can be manufactured now for commercial use with the necessary priorities and are the product of *Hudson American Corporation*, New York City.

#### PLASTIC PIPE SEALS

*American Molded Products Company* has announced plastic pipe seals and thread protectors in countersunk pattern. Due to the demand for the

countersunk type, this addition to the line now gives users a choice, as the squarehead patterns pioneered by this company are still available.

The strength and lightness, as well as the toughness, of plastic make it

#### NEW! Plastic Pipe Seals and Thread Protectors COUNTERSUNK PATTERN



PIPE SIZE	LENGTH IN. OF THREADS	OD IN.	WID. IN.	WIDENESS IN.
1/8"	.350"	2/16	1/32"	.070"
1/4"	.500"	3/16	1/32"	.090"
3/8"	.625"	3/16	1/32"	.110"
1/2"	.750"	3/8"	1/32"	.130"
5/8"	.875"	1/2"	1/32"	.150"
1"	1.000"	5/8"	1/32"	.170"

*American Molded Products Company*  
1644 N. HONORE STREET • CHICAGO 22, ILLINOIS

## ANTENNAS

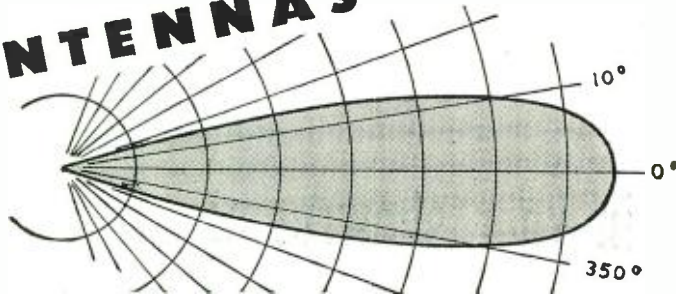

### HIGH GAIN END-FIRE ARRAYS

The pattern of the 18 element, high gain, end-fire array (illustrated above) will convey more than words, the capabilities of the Workshop for manufacturing antennas to fill your requirements. Due to our exceptional electronic test equipment for measuring gain, pattern and impedance match we can readily meet the most exacting specifications for all types of antennas suitable for use in the high frequency spectrum — from 30 mc up.

If you have an antenna problem in the VHF, UHF, or SHF bands we can help you — write or phone the details.

**The WORKSHOP ASSOCIATES**  
*Antenna Manufacturers* FOR THE ELECTRONIC INDUSTRY  
64 NEEDHAM STREET, NEWTON HIGHLANDS 61, MASSACHUSETTS



suitable for pipe seals and thread protectors. Plastic takes accurate and durable threading, is non-corrosive, dielectric, and most efficiently excludes moisture, oil, dirt, and grit.

The square sockets of this new countersunk pattern are made in dimensions to fit commercial square bars of standard sizes. Dimensions are the same as the maximum size of cold rolled square steel bars given in A.S.T.M. specifications. Sizes available are: 1/8", 1/4", 3/8", 1/2", 3/4", and 1".

Further information on these new plastic pipe seals and thread protectors may be secured by writing to *American Molded Products Company*, 1644 N. Honore Street, Chicago 22, Illinois.

#### ISOLATION TYPE VARI-FORMER

A new type W Vari-Former which is double, or isolation, wound for laboratory and industrial use has been introduced by the *Gulow Corporation*.

This unit has a primary wound for



115 volt input and a variable secondary wound for an output of 0-130 volts. Separate terminals are provided for both primary and secondary windings for full flexibility. It is possible to connect these units as auto transformers making several different voltage combinations possible.

**RADIO NEWS**

## Precision Electronic Equipment

**FOR**  
**RADIO SERVICE**  
**AUTOMOTIVE SERVICE**  
**INDUSTRIAL SERVICE**  
**EDUCATIONAL SERVICE**

**UNIVERSAL INSTRUMENT CO.**  
**P. O. BOX 85 CINCINNATI 11, OHIO**

**UNIVERSAL INSTRUMENT CO., P. O. Box 85, Cincinnati 11, O.**

Please send me at once, Descriptive Literature, Prices and Delivery Schedule on

Name.....  
Address.....  
City..... State.....

*Hear them pass the word along*

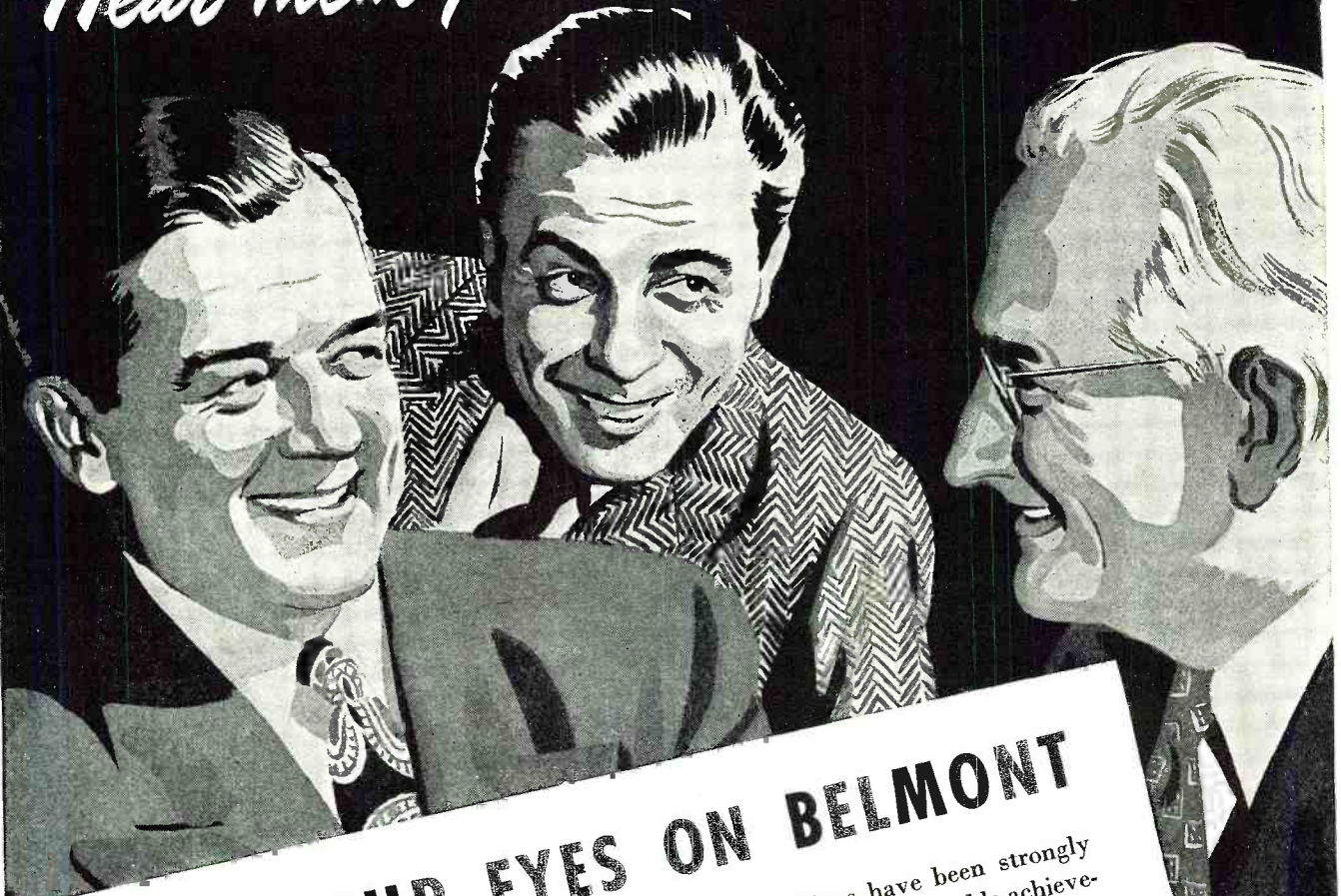

## KEEP YOUR EYES ON BELMONT

• When people talk about the post-war radios and television sets they are planning to buy, you hear more and more of them speak of Belmont.

There are good reasons for this keen and growing interest in Belmont's products of tomorrow.

Millions of future buyers are looking to Belmont with confidence because of the outstanding performance of Belmont-made radios in their own homes.

Additional millions have been strongly impressed by Belmont's notable achievements in the field of wartime electronics. And through a program of consistent national advertising, people everywhere are learning of Belmont's plans to play a dominant part in the post-war radio and television world.

Keep your eyes on Belmont! Belmont Radio Corporation, 5929 West Dickens Avenue, Chicago 39, Illinois.

# Belmont Radio

RADAR ★ TELEVISION ★ F.M. ★ ELECTRONICS



**150 DIAGRAMS and HOW TO READ THEM**  
**150 DIAGRAM BOOK FREE**  
 For Examining My  
**EL CTRICITY**

HERE'S a valuable book of 150 Electrical and Radio wiring diagrams with charts and instructions. Practical information you need to win security and promotion. It's yours FREE merely for examining my 7-Volume Set on **Applied Practical Electricity** on 7-day's free trial. This 7-Volume Set COVERS EVERYTHING ELECTRICAL FROM HOUSE WIRING TO ADVANCED AC-DC MOTORS and EQUIPMENT. Thousands of diagrams and photos... written so both "beginners" and "old-timers" can easily understand.

**7-DAY'S FREE TRIAL** I want to send you the 7-volume set AT MY RISK, postpaid, for 7-day's FREE examination. I'll also send you the FREE book of 150 Shop Prints which you are to keep as my gift regardless of whether or not you return the 7-book set. (No salesman will call.)  
**Offer Limited—Send Coupon Now!**



**FREE COUPON** NOT AN ORDER—JUST A REQUEST TO SEE BOOKS

H. C. Lewis, Pres., Coyne Electrical School, Dept. 75-T3, 500 S. PAULINA STREET, CHICAGO 12, ILLINOIS

Send me the new 7-volume set "Practical Electricity." Also send the book of 150 Shop Prints which is a FREE gift to me regardless of whether or not I keep the 7-volume set. I'll either return the 7-book set in 7 days and keep the 150 Shop Prints book as a gift from you and owe you nothing, or pay \$3 within 7 days and \$3 a month until I am paid, or I'll pay the cash price of \$19.75. One year FREE Consultation Service and Technical Bulletins included.

NAME \_\_\_\_\_ Age \_\_\_\_\_  
 ADDRESS \_\_\_\_\_  
 TOWN \_\_\_\_\_ Zone \_\_\_\_\_ STATE \_\_\_\_\_  
 Check here if you want to save \$1.25 by paying the postman the cash price of \$19.75 on delivery. Same 7-day's examination and Money-Back Guarantee.

**Now for EVERY WORK SHOP!**  
**NEW Invention Electroplaters by BRUSH**

**Easy to Plate CHROMIUM GOLD, SILVER, NICKEL, COPPER**  
 For Pleasure and Profit!

If you have a workshop—at home or in business—you need this new Warner Electroplater. At the stroke of an electrified brush, you can electroplate models and projects—you can replate worn articles, faucets, tools, fixtures, silverware, etc with a durable, sparkling coat of metal. Gold, Silver, Chromium, Nickel, Copper or Cadmium. Method is easy, simple, quick. Everything furnished—equipment complete, ready for use. *By doing a bit of work for others, your machine can pay for itself within a week.* So make your shop complete by getting a Warner Electroplater right away. Send today for FREE SAMPLE and illustrated literature. ACT AT ONCE!

WARNER ELECTRIC CO., Dept. D-51, 663 N. Wells St., Chicago 10, Ill.

**FREE Details & Sample!**

WARNER ELECTRIC CO., 663 N. Wells St., Chicago 10, D-51  
 Gentlemen: Send Free Sample and Details to:  
 Name \_\_\_\_\_  
 Address \_\_\_\_\_  
 City \_\_\_\_\_ State \_\_\_\_\_

**TITAN SLIDE RULE**  
 6" diameter. Easily read, clearly marked single index scales. Gives logarithms, reciprocals, squares, square roots, sines, and tangents. Continuous circular calibrations cannot go "off-scale." Invaluable in multiplication, division, proportion, conversion, all mathematical problems. Made of durable heavy pure white Vynlite. Complete with instructions, \$2.95. Leatherette case 75c additional. Money-back guarantee.  
 PRECISION INSTRUMENT CO.  
 Box 654, Dept. BB, Church St. Annex, New York 7, N.Y.

Inputs of 115 or 220 volts can be applied and output ranges of 0-65 or 65-130 are obtainable with increments of .3 volts. Likewise output ranges of 0-130 or 115-245 with increments of .6 are possible.

The separate primary and variable secondary windings are wound on the same core which results in close regulation and obviates the necessity of using two transformers to obtain an isolated variable voltage supply. For critical electronic testing and special applications, an electro-static shield has been imposed between the primary and secondary, grounded to the core and brought out to a separate terminal.

This new unit has the same high overload capacity as the type "C" (auto-transformer) Vari-Former. Units with capacities of 500 va. to 2000 va. are available. The 500 va. measures 7" x 9" x 4½" deep, weight 20 lbs. The 2000 va. measures 10" x 10" x 8" deep, weight 50 lbs. Custom designs are also available to meet unusual requirements, both electrical and mechanical.

This unit is being manufactured by the *Gulow Corporation*, 26 Waverly Place, New York 3, N. Y.

**TELEPHONE BATTERY CHARGERS**  
 The manufacture of fully automatic telephone battery chargers for operation over a wide range of power line voltages and load requirements is announced by *Federal Telephone and Radio Corporation*, associate of *International Telephone and Telegraph Corporation*.

These regulated and filtered chargers are designed to maintain telephone batteries in a fully charged condition, ready for any emergency. They are ideally suited for use in manual central offices, in automatic exchanges, and in both private and rural, manual or automatic branch exchanges.

The battery chargers utilize the

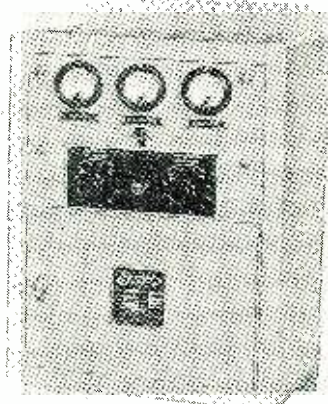

*Federal Selenium Rectifier* in operation from single-phase, 60 cycle power lines of 110, 130, 200, 220, and 250 volts, selected units providing direct current outputs ranging from 2.4 to 16 amperes for from 12 to 60 cells.

Battery potentials are automatically maintained within selected limits by a voltage control relay circuit which

varies the charge between high and trickle rates, both of which are adjustable. The unit is designed to operate without automatic regulation if necessary, permitting the rate of charge to be adjusted manually when desired.

The d.c. output circuit is filtered to prevent the introduction of noise on telephone lines, the a.c. ripple component being guaranteed not to exceed 40 millivolts at full load. An alarm circuit is provided to indicate failure of charger or battery circuits, both of which are equipped with fuse protection and overload switches. A voltmeter on the front panel indicates battery voltage.

Further information may be obtained from *Federal Telephone and Radio Corporation*, 67 Broad Street, New York 4, N. Y.

**DYNAMIC MICROPHONE**  
 The prewar KD dynamic microphone for recording, industrial call, and public address systems, manufactured by *Universal Microphone Company*, Inglewood, California, has been reissued.

Various changes have been made technically and in the casing styling to bring the instrument up to the moment. Frequency response is 50-7500 cycles-per-second; output level 63 db. below one volt per bar; and impedance 40,000 ohms. The KD is finished in deep bronze plating, includes a 10 ft. rubber covered cable, uses spring steel cable strain relief at the housing, and uses standard coupling ⅝th inch 27 thread.

The KD weighs under 2 lbs. for shipping. It is 3¼ inches in diameter with a depth of 2⅝ inches. It will be marketed through the 16 factory representatives, the Canadian and export divisions, and the usual jobbing channels.

**ALLOY SPRAYER**  
 The exclusive manufacturing and selling right to the Forrester Alloy Sprayer and parts, formerly sold as the Alloy Sprayer, has been acquired by *Stewart Tool Manufacturing Company*.

The Forrester Alloy Sprayer is an electrically heated portable gun for spraying low temperature alloy metals. The complete unit consists of the gun with trigger handle, electric cord, 10 ft. air hose, air filter, pressure gauge, and pressure regulator. It is light weight, easy to handle and a complete unit which can be plugged into any 110 volt circuit and attached to an airline. It heats quickly and metal melts in approximately 2 to 10 minutes, depending on the alloy used.

The spraying is done by pressing the trigger on the pistol grip handle. The spray can be regulated to suit each type of work being done by a thumb controlled valve which is located above the pistol grip handle. The Forrester Alloy Sprayer can be adjusted so it will spray low temperature alloy metals from 100 to 600 degrees F. by simply adjusting the thermo switch to the desired temperature.



*"Ceilings" are saving you money*



It's a far longer and more expensive war than the last one—but this time the cost of living hasn't been allowed to get out of hand. If you're ever tempted to grumble at price-and-wage controls, look at these charts—and DON'T. They're one reason to bless ceiling prices...and to check 'em whenever you shop. (They're posted for your protection!)

*Rationing gives all a fair share*



The Millionbucks get no more points than the poorest folks in town. Necessities are rationed to see that each gets his share. And rationing also keeps prices down: without it the fellow with the biggest wad of dough would have a terrific edge. Share and play square ... pay points for everything you buy. (And shun black markets like the enemy they are!)

## —and the money you DON'T SPEND helps hold living costs down

**The plain bread-and-butter fact is this:** there's about \$1.50 in people's pockets for every dollar's worth of goods in the stores.

Splurge—buy anything you don't actually need—and you put the heat on everything to rise all along the line.

Save—deny yourself something you want but can get along without—and you help yourself a little today and a lot tomorrow.

Squeeze that budget. Squeeze a little more money into your savings account. Squeeze a little more into insurance. Squeeze yourself into buying another War Bond today... and every month from now on in.

Wise enough to harness your money for your own safety?

ONLY YOU CAN DO IT.



**ZIFF-DAVIS PUBLISHING COMPANY**

A United States War Message prepared by the War Advertising Council, approved by the Office of War Information; and contributed by this magazine in cooperation with the Magazine Publishers of America.

The proper pressure for spraying is controlled by the pressure regulator and pressure gauge. This should be between 30 and 60 lbs. for average work. If a permanent coating is desired the heavier spray at higher pressure will be used. If for reproduction, or temporary protection, a thin coat-



ing which can be easily removed will require a lower pressure.

Suggested uses of the Forrester Al-loy Sprayer in the electrical and radio fields includes tinning carbon brushes, spraying ceramics for radio, spraying iron-selenium plates for rectifiers and metal spraying glass surfaces and porcelain.

Complete details and price list will be furnished upon request to *Stewart Tool Manufacturing Company*, 5742 Lakewood Avenue, Detroit 13, Michigan.

-50-

## International Short-Wave

(Continued from page 94)

CNR, 16.666, Rabat, French Morocco, is scheduled 7:8:45 a.m. TGNA, 7.170, Guatemala, has good signals, 8-10:15 p.m. Swedish sources report EQC, 9.680, Teheran, Iran, is scheduled 1-3:30 p.m., and report EPB, 15.120 (not 15.100), is scheduled 3:45-5 a.m. Radio Luxembourg, 7.265, reported 12 midnight-3 a.m. Frequencies of Lusaka, Northern Rhodesia, are 3.915, 4.900, 7.220. OAX4X, 9.510, OAX4Q, 6.010, Lima, Peru, are heard in parallel, 7 p.m.-12:30 a.m. JCTA, 7.190, Cairo, is scheduled 11:30 p.m.-1:30 a.m., 3 a.m.-4 p.m. with news at 3:30, 6:30 a.m., 12:30 and 3 pm. JCKW, 7.220, Cairo, same schedule, but news at 12:30, 7, 11 a.m., 1, 3 p.m. FXE, 8.110, Beirut, Lebanon, scheduled 5:25-5:30 and 11-11:45 a.m. to the Forces, news at 5:25, 11 a.m. (URDXC.)

Okinawa on 10.630 has been heard evenings, good signals, when calling KU5Q, Guam, with dispatches at 8-8:10 p.m. EWT, HE12, 6.345, Bern, Switzerland, heard from about 5:30 p.m. for a short time. "The British Forces' Program from New Delhi" (India) is heard at good volume until closing at 12:30 p.m. on 9.680. Although VLW6, Perth, operates on same frequency, the Australian is usually drowned by the Indian station. At 12:45 p.m. this Delhi station opens

with programs in Hindustani. (Gillett, Australia.)

SPW, 13.635, Warsaw, Poland, is on the air irregularly in early evenings, heard closing at 7:30 p.m. Only foreign language, presumably Polish, is used. Does not seem to have regular schedule, sometimes signing off at 8 p.m. HE15, 11.715, Bern, Switzerland, heard from 2:30-4 p.m. with programs in French, German, and Italian. (Suffolk, Australia.)

OLR4A, 11.840, Prague, Czechoslovakia, heard at 4:34 p.m. in English; signs at 5:05 p.m. CXA10, 11.900, Montevideo, Uruguay, heard with good signal, 7:50-10:13 p.m. JANS, 18.135, Batavia, Java, recently heard very weak at 10 p.m. WVLC, 7-

795, Manila, Philippines, heard at 12:23 a.m. WHX, Ketchikan, Alaska, 9.920, heard at 9:35 p.m. (inverted speech). "Polskie Radio," 6.115, Lublin, Poland, heard at 9:20 p.m.

SDB2, 10.780, Stockholm, Sweden, heard at 3:45 p.m. in Swedish. TAP, 9.465, Ankara, Turkey, heard most days in English, 4:27-4:45 p.m. A Spanish station on 9.860 (EAQ?), Madrid, was heard recently at 6:30 p.m. in Spanish. SBT, 15.155 (or 15.160), Stockholm, Sweden, heard in Swedish at 7:30 a.m. VUD3, 15.290, Delhi, India, heard in native language at 8 a.m.; signs at 8:10 a.m. KRHO, 6.120, Honolulu, Hawaii, heard mornings in Japanese and English, news in English at 8 a.m. Algiers on 11.765, relaying "Voice of America" programs was heard to sign-off recently at 7:47 a.m. ZFY, 6.000, Georgetown, British Guiana, heard with a religious program at 8:30 a.m. Sundays. Tananarive, Madagascar, 12.135, heard 8:40 in French, either left air or faded out at 9:40 a.m. (Bromley, Ontario.)

"Radio Dakar," 11.715, Dakar, French West Africa, was recently heard signing on at 3:15 with "Ici Dakar," followed by news in French; believe regular schedule is 8:15-8:45 a.m.

HCJB, 15.100 (or 15.115), heard with good signal, 6-10 a.m. Has excellent signals mornings and evenings on 12.455 and 9.958; English news at 6 p.m. (Gonder, W.Va., Freund, Texas.)

PRL8, 11.72, Rio de Janeiro, Brazil, has excellent signals evenings to 11 p.m. JLT2, 9.645, Tokyo, heard 5:30-8:15 a.m. XEWW, 9.500, Mexico City, pounds in, 9 a.m.-1 a.m. next day. JLG2, 9.505, Tokyo, heard mornings, very poor. (Freund, Texas.)

SBT, 15.155, Stockholm, Sweden, heard with good signal at 11 a.m. Dublin, Eire, heard on 17.840 at 1:45 p.m. with news. The 5:10-5:30 p.m. transmission of "Radio Eirann" on 9.595 is erratic. (Harris, Mass.)

All broadcasting from Holland is on medium or long wavelengths, three stations being in operation—The Hague, Lopik, and Hilversum. These broadcasts are heard in England; except for the English lessons, they are in Dutch, consisting of news, press reviews, messages and answers, and cultural talks. In the event short-wave broadcasts are resumed, frequencies used by Hilversum prior to the war will likely be employed again, but the economic situation in Holland is such that it is difficult to make any prediction as to when this will occur. (Netherlands Information Bureau, Washington.) Many DXers will remember the welcomed, powerful voice of pre-war PHL.

Alma-Ata, U.S.S.R. (Siberia), 8.815, heard in parallel with 9.565 at midnight excellent signal on West Coast. (Harrison, British Columbia.)

CSW6, 11.040, Lisbon, Portugal, musical program at 3:30 p.m., fades. (Kulze, New York.)

HJCT, 6.26, Bogota, Colombia, signs off at 12:15 a.m. (Brewer, Okla.)

-50-



## Sun-Kraft Ultra-Violet Ray Therapy LAMP

- PORTABLE
- CONVENIENT
- COMPACT

*An ideal item for*

## RADIOMEN TO SELL

Here is a product which will be a good seller with your other electrical appliances. You undoubtedly will keep one for your own use too, because this lamp promotes radiant health, eases muscular aches, and gives sun tan. Produces 95% ultra-violet rays. Quartz tube never burns out. Attractively finished in satin chrome and complete with goggles, leatherette carrying case and built-in automatic timer. Carries the manufacturer's complete guarantee.

O.P.A. Approved Retail  
Price .....\$64.50

Dealers' Price

**\$38.70** EACH  
(lots of 3)

**\$43.00** EACH  
(lesser quantity)

ORDER YOUR LAMPS TODAY!

**CHICAGO NOVELTY COMPANY, INC.**

1348 Newport Avenue

Chicago 13, Illinois

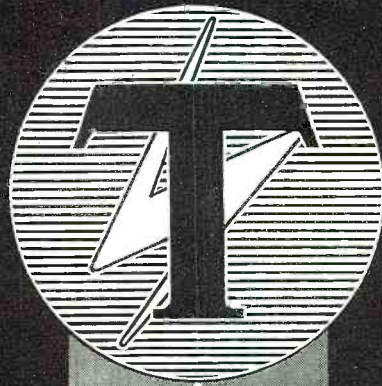

SINCE

1895



## Transformer Specialists . . .

*Thordarson's* tradition of quality provides the underlying reason for its past half-century of progressive leadership in the specialized manufacture of dependable transformers, components and other electronic devices. This same tradition, upheld through every phase of *Thordarson* design, engineering and manufacturing is

your guarantee of the finest transformers for requirements of Tomorrow . . . and years to come. With confidence . . . gained by this ability to produce quality merchandise and coupled with novel sales policies . . . *Thordarson* looks forward to supplying the expanding demands of the radio and electronic industries.

500 WEST HURON ST., CHICAGO, ILL.

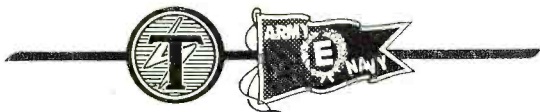

ORIGINATORS OF TRUE-FIDELITY AMPLIFIERS

**THORDARSON**  
 ELECTRIC MANUFACTURING DIVISION  
 MAGUIRE INDUSTRIES, INCORPORATED

# NOW—A REALLY HIGH-POWERED— Radio Engineering Library

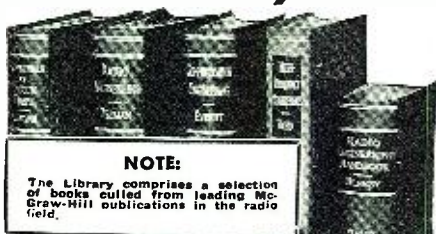

### NOTE:

The Library comprises a selection of books culled from leading McGraw-Hill publications in the radio field.

- especially selected by radio specialists of McGraw-Hill publications
- to give most complete, dependable coverage of facts needed by all whose fields are rounded on radio fundamentals.
- available at a special price and terms

THESE books cover circuit phenomena, tube theory, networks, measurements, and other subjects—give specialized treatments of all fields of practical design and application. They are books of recognized position in the literature—books you will refer to and be referred to often. If you are a practical designer, researcher or engineer in any field based on radio, you want these books for the help they give in hundreds of problems throughout the whole field of radio engineering.

**5 VOLUMES, 3559 PAGES, 2558 ILLUSTRATIONS**

1. Eastman's FUNDAMENTALS OF VACUUM TUBES
2. Terman's RADIO ENGINEERING
3. Everitt's COMMUNICATION ENGINEERING
4. Hund's HIGH FREQUENCY MEASUREMENTS
5. Henney's RADIO ENGINEERING HANDBOOK

10 days' examination. Easy terms. Special price under this offer less than books bought separately. Add these standard works to your library now; pay small monthly installments, while you use the books.

**10 DAYS' FREE EXAMINATION—SEND COUPON**

**McGRAW-HILL BOOK CO.**

330 W. 42nd Street, New York 18, N. Y.

Send me Radio Engineering Library, 5 vols., for 10 days' examination on approval. In 10 days I will send \$3.00 plus few cents postage, and \$3.00 monthly till \$24.00 is paid, or return books postpaid. (We pay postage on orders accompanied by remittance of first installment.)

Name .....

Address .....

City and State .....

Company .....

Position .....

RS 10-48

## Learn RADIO-ELECTRONICS-TELEVISION

### 12 WEEKS TRAINING IN COYNE SHOPS WHERE YOU "LEARN-BY-DOING"

Trained Radio-Electronics men needed now. They will be needed too when the war is over. Tremendous expansion in Radio, Electronics, Frequency Modulation and Television predicted—a world of new opportunities. Get Radio Training in the Coyne Shops in Chicago now, and BE READY.

*Ill Finance Your Training*

If you are short of money, you can start now and pay most of your tuition after you graduate. Many earn while learning. Free Lifetime Employment Service to graduates. EXTRA training in INDUSTRIAL ELECTRONICS and Electric Refrigeration—no extra cost.

**FREE BOOK**  
Whether you're 16 or up to 40, get the facts. Big illustrated book tells about your future in Radio-Electronics-Television. Mail coupon today. We also have facilities for men with physical disabilities whether due to war or other causes. Check coupon for details.

**VETERAN'S**  
Coyne is equipped to train those who qualify for training under the G. I. Bill of Rights. Check coupon.

**H. C. LEWIS, Pres., RADIO-ELECTRONICS DIVISION**  
COYNE ELECTRICAL SCHOOL  
500 S. Paulina St., Dept. 75-1K, Chicago 12, Illinois

Send me FREE BOOK on COYNE RADIO-ELECTRONICS TRAINING and details of "Pay-After-Graduation" Plan.  Send physical disability details.  Send special G. I. Bulletin.

NAME .....

ADDRESS .....

CITY .....

STATE .....

## New Type Signal Tracer

(Continued from page 31)

tivity is 1.8 volts full scale from 250 c.p.s. to well past the aural range of 10,000 c.p.s. Below 250 cycles, the sensitivity of the voltmeter is reduced because of the high-pass filter, the sensitivity at 120 cycles being 2.2 volts full scale and dropping to 5.4 volts at 60 cycles. The sensitivity at 40 cycles is even less and although it doesn't appear on the graph, the voltage required for full-scale deflection at this frequency is in the vicinity of 15 volts.

Sensitivity of the probe at the radio frequencies is shown in Fig. 2. It should be noted that the frequency response is flat to 10 mc. Above this point, resonance takes place in the tube and

associated parts tending to increase the sensitivity at 15 mc. The sensitivity then takes a decided drop past 20 mc. At 40 mc., the probe requires 1.3 volts to obtain one scale deflection on the meter. Although the probe is essentially flat to 10 mc., the loading on the circuit increases as the frequency is increased. The useful range is to approximately 10 mc. Above 10 mc., loading is excessive due to the material used in the probe.

The remainder of the instrument consists of the battery box, meter, and balancing control. A 45 volt battery is used to supply plate voltage for the 1T4, with a 1½ volt cell taking care of the filament voltage. One of the characteristics of this type of v.t.v.m. is the large idling current. This is caused by the lack of grid bias. When a signal is applied to the

## NEW INDUSTRY ON PACIFIC COAST

THE hottest word in the Pacific Coast war effort not long ago was tropicalization. This is the term used for the bitter campaign against fungus, the invisible round-the-clock foe in the battle of the South Pacific. Out of this condition comes a new industry for the Pacific Coast.

Fungi have caused standard signal corps equipment to break down in six hours after it reaches jungle theaters. Arcing, crosstalk, and flashovers, as the result of fungi, have played hob with Army, Navy, and Marine communications at critical stages of our land and sea operations.

There are 5000 different kinds of fungi in the tropics and the vegetable growth, which luxuriates in the heat and moisture of fox-holes, attacks transmitters, receivers, amplifiers and remote control, power supply, and test instruments. Once unpackaged, instruments are seldom dry again in the South Pacific.

Fibre, laminated plastics, cotton,

Photo shows tropicalization process in coating equipment at the Communications Equipment Corp., Pasadena, Calif.



linen paper, and celluloid derivatives, wood, leather, wax, and even glass and metal provide veritable green-houses for the growth of fungus.

"Due to the extreme weather and combat conditions of this war, moisture and fungus growth are shortening the life of signal corps equipment at a startling rate, even to the point of completely destroying its usefulness," says Major General W. H. Harrison, Chief of the Army Procurement and Distribution services.

Signal corps radio experts who can sharp-shoot the ether with an accuracy that has cost the Japs plenty have themselves been disarmed and rendered impotent by fungus.

Now, in the shadow of the California Institute of Technology, tropicalization of all U. S. Signal Corps equipment en route to the South Pacific is going on at a whirlwind pace. Signal corps officers say that this treatment increases the life of some equipment as much as 240 times.

"Lacquers and varnishes containing fungicidal ingredients are the answer," declares Bert Barron of the engineering staff of the Signal Corps job. "From the handy-talkie and so called 'breakie-backie' (which weighs more than 100 pounds) to the self-contained 50-watt radio stations which are landed quickly in the wake of all island invasions, every vulnerable part of the equipment is treated.

"If contact portions of the equipment cannot be treated because of the danger of insulation, these parts are masked.

"Cables, coils, electric inductors, transformers, phenolic parts, terminal boards, switches, and hook-up wires are among the parts treated. These are baked for six hours in a pre-heated oven at a temperature of 140 degrees Fahrenheit before spraying. Equipment is then reassembled and tested before final packaging."

Communications Equipment Corporation has built a dehydrating and spraying plant on their grounds in East Colorado Street. With the expansion of postwar trade in the South Pacific it is believed by company officials that tropicalization will constitute a permanent and specialized Pacific Coast industry.

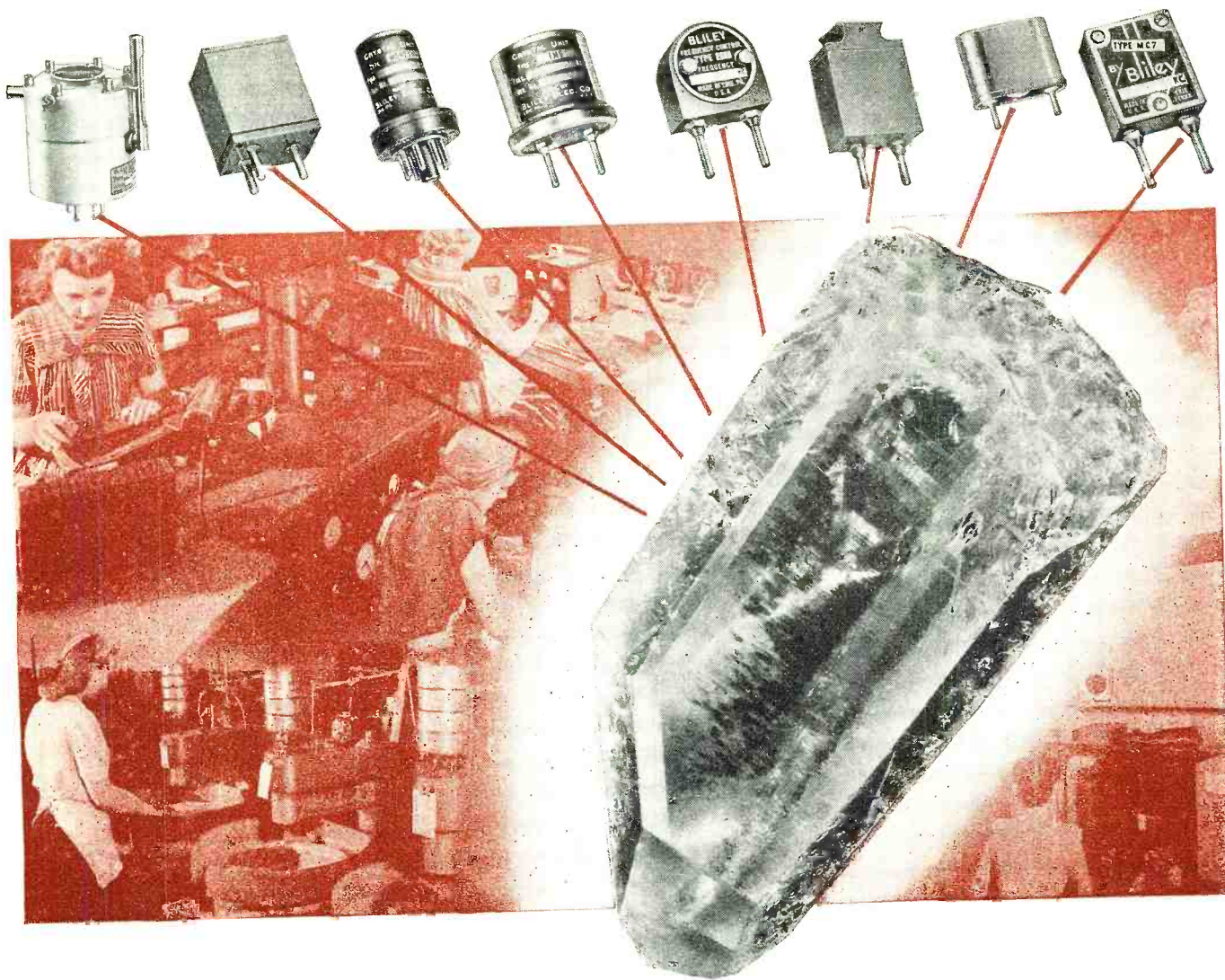

*You name the application . . .*

## **BLILEY** has the crystals

Post VJ Day production of Bliley acid etched\* crystals for FM receivers, Aircraft and Marine radios, Railroad communications equipment and many other applications is proceeding with the same skill and efficiency that marked our wartime operations.

Substantial quantities of these crystals are in the hands of foresighted manufacturers who planned in advance with Bliley engineers for frequency stabilization in their post-war models.

Now, more than ever before, you

need the versatile experience of Bliley engineers and craftsmen gained through more than 15 years of quartz crystal engineering exclusively. Whether your requirements are one crystal or a million, you can be sure of top quality—top design—and top performance—in Bliley crystals.

+ + +

*\*Acid etching quartz crystals to frequency is a patented Bliley process.*

Radio Engineers —  
write for temporary  
Bulletin RN-26



*Another star has been added. Our 5th citation for outstanding achievement in producing materials essential to the war effort.*

# **Bliley** CRYSTALS

**BLILEY ELECTRIC COMPANY • UNION STATION BUILDING, ERIE, PENNSYLVANIA**  
October, 1945 133

# 110-VOLTS AC from DIRECT CURRENT

with KATO KONVERTERS. Furnish standard 110-volt AC from 32, 110, or 220-volts DC. Good deliveries on sizes 350 through 1500 watts.

PIONEERS IN THE BUILDING OF SMALL ROTARY CONVERTERS

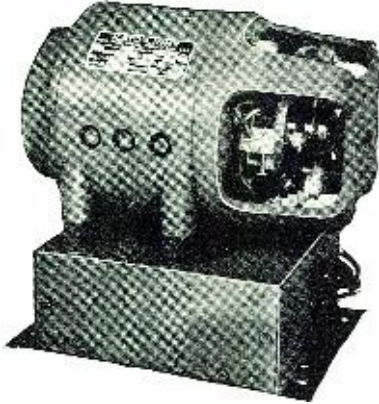

Katolight Rotary Konverter, 225 Watt

Good deliveries on 5, 7½, 15 and 25 KW AC generators. Mfr.'s DC generators, motor generators, frequency changers, high frequency generators.

Special motors and generators 25 to 800 cycles.

KATO ENGINEERING CO.  
120 Rock Street Mankato, Minnesota

## 7 Days

## Free Examination

# PRACTICAL RADIO INFORMATION

Including Frequency Modulation—Television, etc.

Inside Radio Information for all Servicemen—Aircraft Pilots, Students. AUDELS RADIO-MANS GUIDE contains 772 Pages, 400 Diagrams & Photos is complete—gives Authentic Principles & Practices in Construction, Operation, Service & Repairs. Covers clearly and concisely Radio fundamentals—Ohm's Law—Physics of sound as related to radio science—Measuring instruments—Power supply—Resistors—Inductors—Condensers—Transformers and examples—Broadcasting stations—Radio Telephony—Receivers—Diagrams—Construction—Control systems—Loud speakers—Antenna systems—Auto Radio—Phonograph pickups—Public Address Systems—Aircraft & Marine Radio—Radio Compass—Beacons—Automatic Radio Alarms—Short Wave—Coil Calculations—Testing—Cathode ray oscillographs—Static Elimination—Trouble Pointers—Underwriter's standards—Units and tables—Frequency Modulation—REVIEW QUESTIONS & ANSWERS, Ready Reference Index.

**\$4 COMPLETE • PAY ONLY \$1 A MO.** Get this practical information in handy form for yourself—Fill in and MAIL COUPON TODAY

AUDEL Publishers, 49 W. 23rd St., N.Y. Mail AUDELS NEW RADIOMANS GUIDE for free examination. If O. K., I will send you \$1 in 7 days; then remit \$1 monthly until \$4 is paid. Otherwise I will return it.

Name \_\_\_\_\_  
Address \_\_\_\_\_  
Occupation \_\_\_\_\_  
Reference \_\_\_\_\_ R.N.

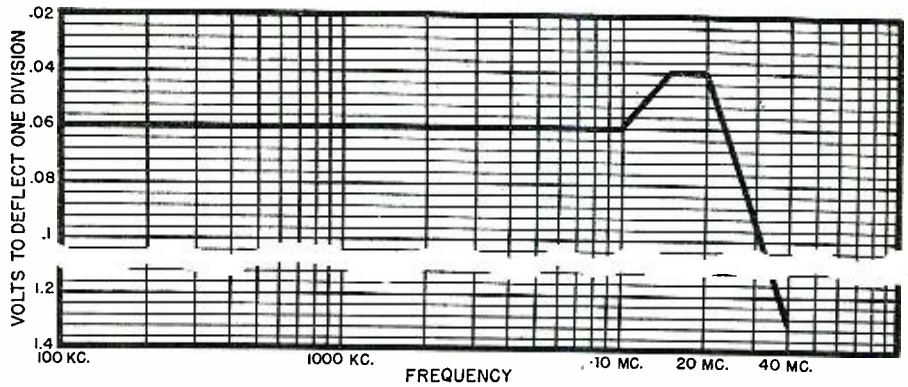

Fig. 2. Curve shows the sensitivity of the probe at radio frequency.

grid, rectification takes place and the grid current flowing through the grid resistor biases the tube, causing the plate current to drop. Ordinarily, this would cause the meter to read backwards. In this unit, however, the meter is connected backwards—the plus terminal being connected to the plate and the minus terminal connected to "B+." A bucking voltage is applied across the meter so that the meter reads zero with no signal applied. When a signal is applied, the meter reads up scale in the conventional manner.

As an example of how this signal tracer could be used to locate trouble in a receiver, the following illustration is given. A typical a.c.-d.c. receiver with a loop antenna and the following tubes, 12SA7, 12SK7, 12SQ7, 50L6, 35Z5, has intermittent operation and a very distorted signal.

With the receiver set to receive a station, take readings at the control grid and plate of each tube, starting with the 12SA7 control grid and working toward the 50L6 plate. As the probe is moved from grid to plate of each stage, the reading of the v.t.v.m. should increase. Failure of the meter to increase indicates a defective stage. The above, of course, can only be done while the receiver is in the inoperative condition. If when we touch the control grid pin of the 12SK7, we get a reading of 20 on the meter and the plate shows no signal, the trouble is obviously due to a defective 12SK7 stage.

This can be caused by a defective tube, open i.f. transformer, or open cathode resistor. The exact cause can

be found with a tube-tester, or any standard volt-ohm-milliammeter.

The distortion can then be detected the same way. When using the v.t.v.m. to detect audio, the needle will fluctuate with the modulation. A steady deflection indicates hum. If it is desired to listen to the distortion, phones are plugged into the jacks provided, and the meter disconnected by means of a switch on the panel. The probe can then be touched to the grid and plate of each tube until the received signal is distortionless. If when connected to the grid of the 50L6, no distortion is noticed and, when connected to the plate, it shows considerable distortion, the trouble is then in the 50L6 and its associated circuits. The cathode can be shorted to one side of the filament, or a high resistance leak can occur between the grid and the cathode or filament. Distortion or hum throughout the receiver can be caused by a defective 35Z5, the filter condenser, or a.c. that is in the power supply.

Although only two instances are shown above, the signal tracer can be used for various other purposes. The oscillator for example can be checked for oscillation by simply holding the probe near the coil or tuning condenser. If oscillation ceases when the condenser is rotated, the plates of the variable condenser may be shorted or the tube may be defective.

Thus, it becomes readily apparent that "bugs" may be found quickly and under innumerable conditions with the simple expediency of a model CA-11 signal tracer.

—30—

Fig. 3. The voltage required for full-scale deflection of the v.t.v.m.

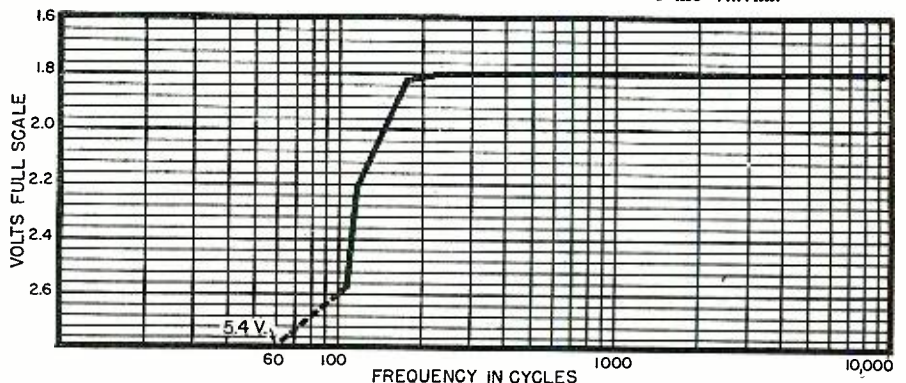

# FARNSWORTH

**EXTENDS COMMUNICATION ACTIVITIES**

**BY ACQUIRING**

## **THE HALSTEAD**

## **TRAFFIC COMMUNICATIONS CORPORATION**



WILLIAM S. HALSTEAD, president of the Halstead Company, joins the Farnsworth organization as consultant on radio communications equipment and traffic control, as well as on other phases of Farnsworth's broad electronic developments.



JOHN A. CURTIS, vice president of the Halstead Company and chairman of its management committee, joins the Farnsworth organization as manager of the mobile communications division.

To EXTEND its broad communications activities into the rapidly expanding field of mobile railway and highway communications and control, Farnsworth has acquired the assets of the Halstead Traffic Communications Corporation, including its developments, designs and patents. Key personnel, including William S. Halstead, president, and John A. Curtis, vice president, have joined the Farnsworth staff.

The Halstead organization is a recognized pioneer in this relatively new field of radio communications. It has invented, developed and produced field-tested equipment to provide railroads with modern, unfailing radio communications. It gave the world its first successful highway radio service, including the centralized control of busses, trucks and passenger vehicles.

The Halstead technical staff will establish new headquarters at the Fort Wayne Farnsworth laboratories. The organization will be merged and coordinated with more than two hundred Farnsworth research and development engineering personnel—a staff of scientists and technicians recognized as one of the country's leading technical organizations in the development of television; broadcast transmitters and receivers; radio-phonographs, and the most complicated types of radio and radar equipment for the Armed Forces.

Farnsworth resources, plus its seventeen years of electronic pioneering, its extensive engineering staff, and specialized manufacturing facilities, will strongly augment the outstanding position of the Halstead developments in this field.

## **FARNSWORTH TELEVISION & RADIO CORPORATION**

**FORT WAYNE 1, INDIANA**

Farnsworth Radio and Television Receivers and Transmitters • Aircraft Radio Equipment • Farnsworth Television Tubes • Halstead Mobile Communications and Control Systems for Rail and Highway • the Farnsworth Phonograph-Radio • the Capehart • the Capehart-Panamuse

For Soldering in  
Tight Places . . .

**DRAKE**

No. 400 Soldering Iron

Smallest Industrial Iron  
Ever Designed

60 Watts— $\frac{1}{4}$  in. Tip

Only 9 in. long—Wt. only 8 oz

This mighty mite is backed by DRAKE'S 25 years of soldering iron manufacturing experience. The high quality and long service of DRAKE Soldering Irons have made them outstanding favorites with all types of radio men everywhere. The DRAKE No. 400 is an outstanding value at



Only \$4<sup>50</sup>  
List

Drake Has an Iron  
for Every Purpose.  
Ask Your Radio  
Parts Jobber.



**DRAKE ELECTRIC WORKS, INC.**  
3656 LINCOLN AVE., CHICAGO 13, ILL.

LOOK! 250-FT. COIL

Wire

Stranded  
No. 20  
Vinylite  
Insulated



AVAILABLE  
from



Flexible, waterproof and oilproof Wire. Use it for hookup, ground, lead-in, etc. Insulation strips off easily. Our price is only a fraction of the actual value of this high quality Wire, obtained through a manufacturer's cancellation. ACT NOW!

(Send for our Free Monthly Catalog)

**Olson Radio Warehouse**  
73-A MILL STREET, AKRON, OHIO

Please send me \_\_\_\_\_ 250-ft. Coils of No. 20 Wire  
at \$1 per Coil. I enclose \$ \_\_\_\_\_

NAME \_\_\_\_\_

ADDRESS \_\_\_\_\_

# TUNING FORK MULTIVIBRATOR

By **CPL. HAYWARD L. TALLEY**

Instructor, Signal Corps Schools

**T**HE control of oscillator frequencies has long been of primary importance in the electronics field. In the case of radio-frequency oscillators the question of frequency control was largely solved with the advent of the quartz crystal oscillator.

The use of quartz crystals is far from practical in the case of audio oscillators however. The thickness of a crystal is inversely proportional to frequency, and the thickness of a crystal for the audio range would therefore exceed all practical limits. The thickness of a 1000 cycle crystal would be between 66 and 112.6 inches depending upon the cut used. Accordingly another system of oscillation control must be used for the audio frequency range.

One such system is the tuning fork multivibrator. The fork long has had a record of faithful service. Today, with its application in oscillator control circuits, its scope of usefulness has been multiplied.

The multivibrator is well known today for its part in radio frequency measurements. When operated as an independent oscillator, the multivibrator may be designed to generate frequencies ranging from as low as one cycle-per-minute to frequencies in excess of 100,000 cycles-per-second.

Uncontrolled, the multivibrator is notoriously unstable. Its frequency is altered abruptly by shifts in operating voltages or circuit values. However, the device has another noteworthy property. It may be stabilized readily, and in the controlled state the stability and frequency accuracy of the multivibrator reach the same order as those properties of the controlling device.

A simple fork-controlled multivi-

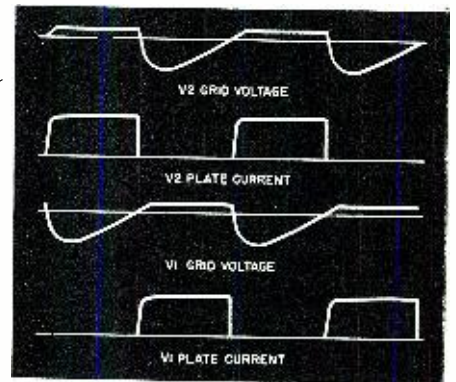
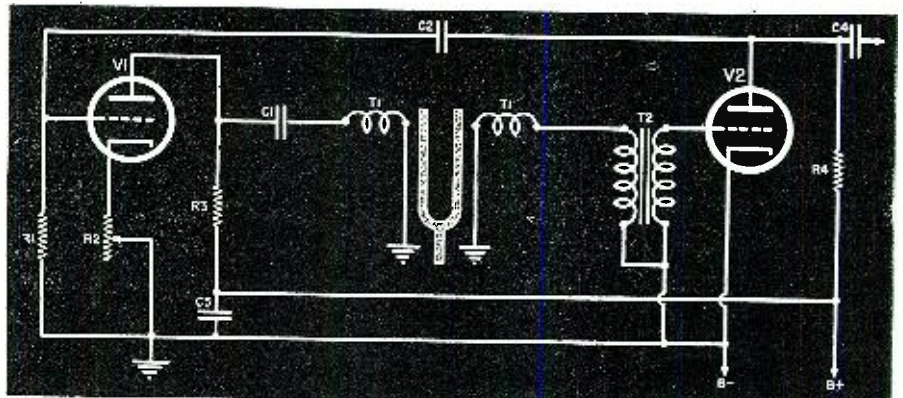

Fig. 2. Oscillograms show wave form at various points of the circuit. The multivibrator, as an independent oscillator, can generate frequencies from one to one hundred thousand cycles-per-sec.

brator is shown in Fig. 1. It is seen to be essentially a two-stage triode resistance-coupled amplifier with the exception that the output is coupled back to the input through the feedback condenser  $C_2$ .  $C_1$  is the interstage coupling condenser,  $C_3$  the plate circuit by-pass condenser usually encountered in RC amplifier circuits.  $T_1$  compensates for the phase change encountered in the tuning fork transformer  $T_1$ , thus maintaining the conditions for positive feedback. The tubes are identical in type, often the two sections of a twin triode such as the 6N7.

The precision tuning fork is of bimetallic construction giving it a low temperature coefficient of frequency and permitting a large mass for a given frequency. In the best laboratory units where the maximum amount of precision is desired, the fork itself is held at constant tem-

Fig. 1. Diagram of tuning fork controlled multivibrator.





*. . . this is the single unit\* construction of*  
**SHURE Super-Cardioid**  
**Dynamic Microphones**

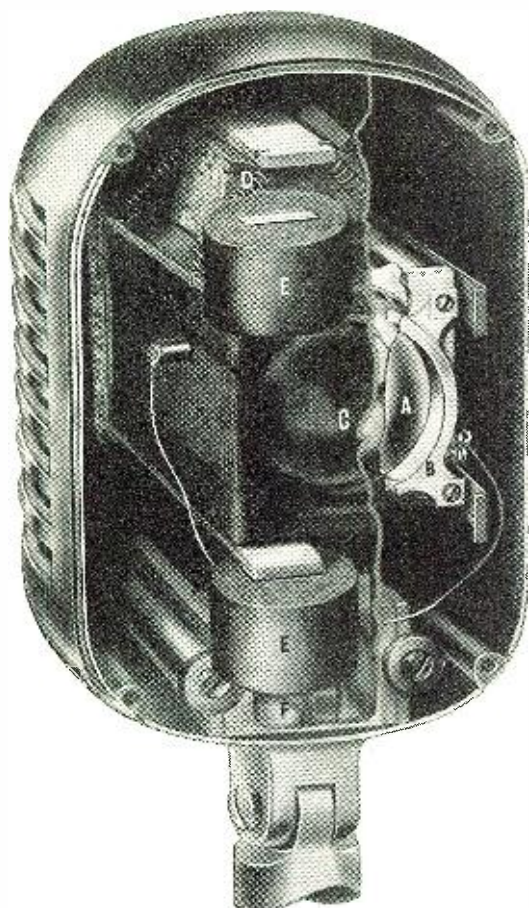

- (A) Single moving coil diaphragm.
- (B) Rugged 4 point moving coil suspension.
- (C) First wind and dust screen.
- (D) Spring mounted mechanism.
- (E) Shock absorbers.
- (F) High fidelity transformer.

\* Using the "Uniphase" principle, an exclusive patented Shure development, this single unit construction is possible in a unidirectional Microphone. This eliminates the problems of matching two dissimilar units and results in compactness and ruggedness. Because only one unit is employed, all these advantages are available at less cost to you.



List Prices . . . Shure Super-Cardioid  
 Dynamic Microphones

*Models "556" Broadcast . . . . \$75*

*Models "55" Unidyne . . . . . \$47 to \$49.50*

**SHURE BROTHERS**

*Designers and Manufacturers of Microphones and Acoustic Devices*

**225 West Huron Street, Chicago 10, Illinois • Cable Address: SHUREMICRO**

## HEAVY DUTY SOLDERING IRON 115 WATTS

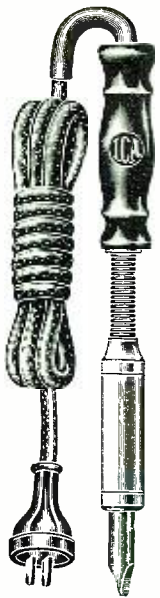

Especially designed for the serviceman. Heats up to operating temperature in 3 minutes and can be left on all day. Adjustable tip assures proper heat at soldering point. Thoroughly insulated. Cannot be come grounded. Equipped with 7/16" diameter heavy duty tip.

Specially Priced  
Net Each  
**\$4.41**

Write for Free Illustrated Flyer.



731 W. Washington Boulevard  
Chicago 6, Illinois

perature in an oven similar to those employed in quartz crystal stabilization. Such a control may be satisfactory when incorporated in any oscillator not requiring closer original frequency adjustment than about .005 per-cent or smaller frequency drift than approximately .01 per-cent. Such applications include the synchronization of facsimile scanning drums, timepiece and power alternator rating, and certain a.c. bridge measurements.

The operation of the multivibrator may be understood by reference to the oscillograms of Fig. 2. Oscillation begins as a result of a surge of electrons in one of the tubes (say tube  $V_2$ ) as plate voltage is applied. This causes the plate voltage of tube  $V_2$  to decrease, and likewise the grid of tube  $V_1$ . As plate current in tube  $V_1$  decreases the plate becomes more positive. The positive pulse passes through condenser  $C_1$  (Fig. 1), the tuning fork transformer  $T_1$ , and transformer  $T_2$  to the grid of tube  $V_2$ . In this way the current in tube  $V_2$  increases and that in tube  $V_1$  decreases until tube  $V_1$  cuts off. Tube  $V_1$  cannot remain cut off however for  $C_2$  will slowly discharge through  $R_1$  allowing the grid of tube  $V_1$  to lose its negative potential. As tube  $V_1$  begins to conduct, the grid of tube  $V_2$  becomes more negative so that the initial action is reversed. This is clearly shown in Fig. 2.

The characteristic frequency of the uncontrolled multivibrator is determined primarily by the grid-leak resistance and the grid condenser capacity. This characteristic frequency is duplicated by the natural frequency of the tuning fork.

The fork is set into vibration by the initial pulse from  $T_1$ . As long as the amplitude of the driving pulses remains constant the multivibrator is held rigidly to a fixed frequency, due to the switch-like action of the fork as it varies the coupling between the primary and secondary of  $T_1$ . A vernier frequency adjustment is provided by a potentiometer in the cathode circuit of tube  $V_1$  which allows a slight variation in the amplitude of the driving pulses. If the amplitude of vibration is sufficiently high this range of control may be extended to allow the fork to be manually set to frequency through a wide temperature change. A more accurate method, however, is to temperature control the fork in the manner described earlier. In this case the amplitude of vibration of the fork may be reduced greatly and the vernier range of control becomes very small. A low amplitude of vibration makes the fork far more accurate.

### Design Data

Usually it is desirable to make  $C_1$  equal to  $C_2$  and  $R_1$  equal to the impedance of the secondary of  $T_2$  at the frequency under consideration. In some cases it may become necessary to add a resistor in series with the secondary of  $T_2$  to ground. An approximation of the necessary values

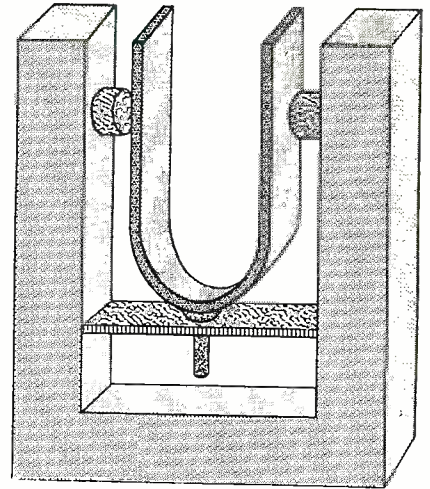

Fig. 3. Tuning fork transformer assembly.

may be obtained by the use of the formula

$$F = \frac{1,000,000}{R_1 C_2 Z C_1}$$

where

$F$  = frequency in cycles

$C$  = capacitance in microfarads

$R$  = resistance in ohms

$Z$  = total impedance of  $T_2$  secondary and any series resistance used.

Typical operating values for a 1000 cycle frequency are as follows:

$C_1$  = .01 microfarads

$C_2$  = .01 microfarads

$R_1$  = 50,000 ohms

$Z$  = 50,000 ohms

For the most reliable operation,  $C_1$  and  $C_2$  should be first grade mica condensers whenever the capacitance permits. They should be mounted below the instrument chassis away from the heat of tubes and close to their points of connection. As far as practicable the triodes should be matched in characteristics, particularly inter-electrode capacitances. The resistors should be of not less than 2 watt ratings for any of the receiving type triodes operated at less than 250 volts on the plate.

The fork and transformer assembly (see Fig. 3) is composed of a tuning fork of an alloy having a suitable temperature coefficient of frequency as previously described, a non-magnetic framework, preferably of cast aluminum, and a clamp of the same material for holding the tuning fork fast within the frame. A coil is fastened to each side of the upper portion of the frame; together these coils compose  $T_1$ .

Obviously, care must be taken to assure that sufficient clearance is allowed between the fork and these transformer coils to eliminate any possibility of the coils impeding the movement of the tines of the fork as the fork is driven by an impulse of reasonable amplitude. It is often desirable to mount the entire assembly within a can covered with a blanket of rock wool or other insulating material to reduce the effect of radical changes in temperature.

# FREE

# TO YOU



## COLOR CODE and OHMS LAW CALCULATOR

### Great Time Saver

Burstein-Applebee of Kansas City offers you this great convenience FREE. Easy to work. Solves many problems in a jiffy. FREE to Radio men, electronic engineers and others in the business. Attach coupon to your letterhead.

MAIL COUPON NOW



BURSTEIN-APPLEBEE CO.  
1012 MCGEE ST.  
KANSAS CITY 6, MO.

Send me FREE Color Code and Ohms Law Calculator along with latest catalog.

I am \_\_\_\_\_  
STATE CONNECTION IN INDUSTRY

NAME \_\_\_\_\_

ADDRESS \_\_\_\_\_

TOWN \_\_\_\_\_ STATE \_\_\_\_\_

# No e he Sad Resemblance ?

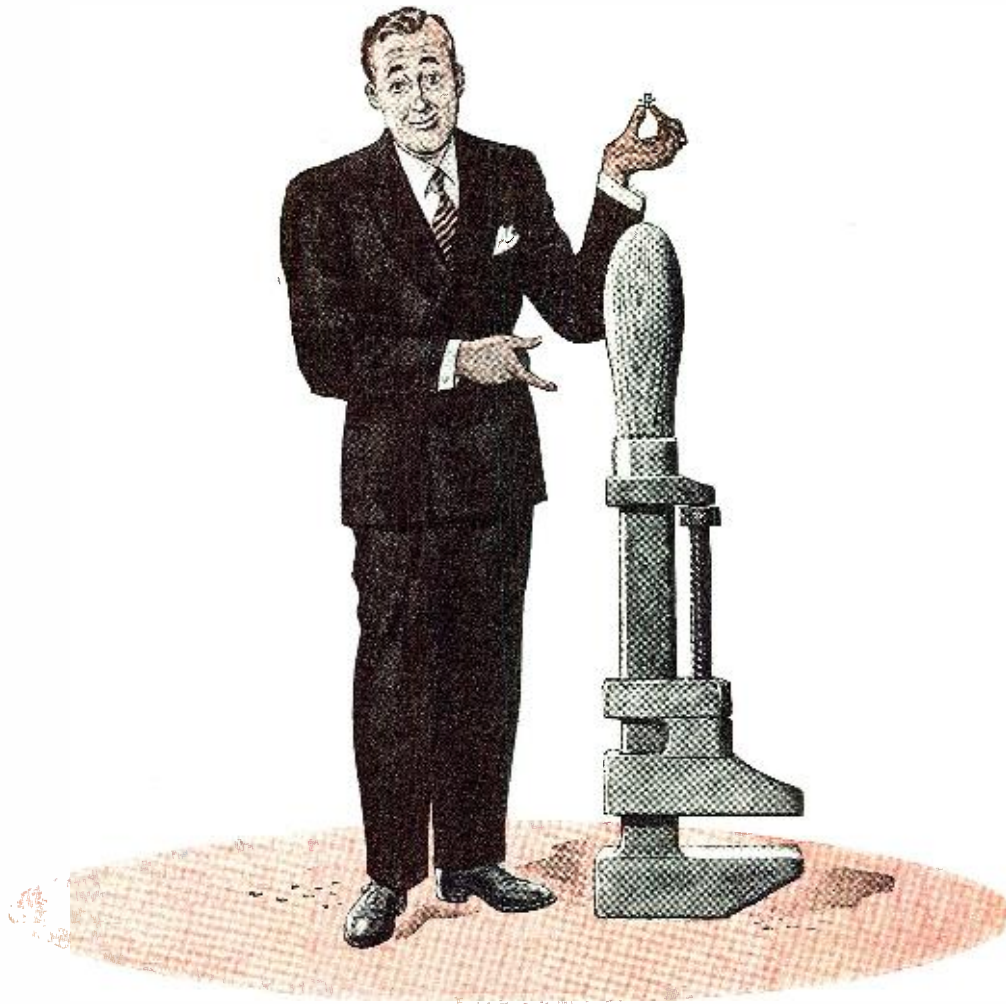

**THE LITTLE GADGET** is a metal insert—for *your* plastic part, perhaps. It's likewise the monkey wrench in the works of many a molding and delivery schedule. But not to us and *our* customers!

We produce inserts right in our plant. And we cut out snarls in shipping—misunderstandings about materials, methods, dimensions or tolerances—and difficulties in meshing insert and molding schedules. In fact, that resemblance we mentioned

doesn't even exist here at Kurz-Kasch.

This is another evidence of our policy of shouldering *complete* responsibility for your plastics molding job—and that goes for every step from design to delivery. We offer, too, one of the largest, best-equipped custom molding plants in the country—plus one of the oldest and most respected records in the industry for furnishing plastic parts to American industry.

Our front door is open, and we're interested in what business we can fit

in. If you have an interest in plastic parts molded by compression or transfer, let's talk it over.

### "A Businessman's Guide to the Molding of Plastics"

Send for your free copy of this illustrated brochure. Just write to Dept. 7 on your letterhead and we'll send it with our compliments.



**THE WAR BONDS YOU KEEP ARE THE BONDS THAT COUNT**

# Kurz-Kasch

*For over 28 years Planners and Molders in Plastics*

Kurz-Kasch, Inc. 1429 South Broadway, Dayton 1, Ohio. Branch Sales Offices: New York • Chicago • Detroit Indianapolis • Los Angeles • Dallas • St. Louis • Toronto, Canada. Export Offices: 89 Broad Street, New York City

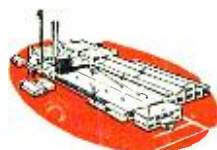

October, 1945

139

# CUT HOLES

3/4" TO 3 1/2"



## in radio chassis

Punch cuts through chassis, die supports metal to prevent distortion, cap screw is turned with wrench to cut clean, accurate holes for sockets, plugs, and other receptacles. Saves hours of work — no reaming, filing or drilling! 3/4" to 3 1/2" sizes. Get complete data now from Greenlee Tool Co., 1890 Columbia Ave., Rockford, Illinois.

WRITE FOR FREE FOLDER S-119 ▶



## Capacitors of Time-Tested Quality

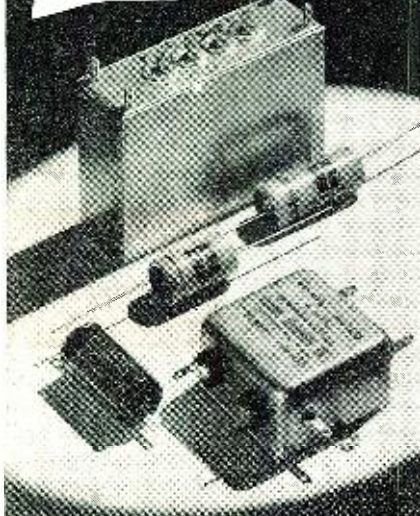

**Illinois  
CONDENSER COMPANY**  
1160 N. HOWE ST. • CHICAGO 10, ILL.  
Manufacturers of Oil, Paper  
and Electrolytic Capacitors

# Manufacturers' Literature

Readers are asked to write directly to the manufacturer for the literature. By mentioning RADIO NEWS, the issue and page, and enclosing the proper amount, when indicated, delay will be prevented.

In view of the present paper shortage, a limited number of copies of the booklets described herein are printed. Manufacturers will endeavor to comply with all requests; however, if your copy is not received after proper request has been made, it most likely will indicate that the supply is exhausted.

### GROUND RESISTANCE

A bulletin covering several models of the *Associated Research, Inc.*, line of ground resistance test equipment has been released for distribution.

Details of ground resistance testing procedures are included along with data on earth conditions, specifications, and prices of the Vibroground line of instruments.

A copy of this bulletin, Catalogue 104, will be sent to those requesting it from *Associated Research, Inc.*, 221V S. Green Street, Chicago 7, Illinois.

### FM TRANSMITTERS

*Federal Telephone and Radio Corporation* has announced that their line of FM transmitters covering the new 88 to 106 mc. band are available.

Details of this line of transmitters, which include 1 kw., 3 kw., 10 kw., and 50 kw. units, are contained in the booklet which the company now has available for distribution to engineers and station managers in the FM field.

A copy of the bulletin will be forwarded upon request to *Federal Telephone and Radio Corporation*, 200 Mt. Pleasant Avenue, Newark 1, New York.

### CONDENSED CATALOGUE

A description of the most frequently demanded rotary power equipment has been condensed into a four-page bulletin, issued by *Carter Motor Company*, which is now available for distribution.

Included in the bulletin are various genemotors, magmotors, and other rotary equipment, along with complete information and pictures. A number of the newly developed units of the line have been added to the listing.

A copy of Bulletin No. 445 will be sent to engineers and radio amateurs who make their request to the company on letterheads. Requests may be made to *Carter Motor Company*, 1608 Milwaukee Avenue, Chicago, Illinois. Copies are also available from radio parts distributors.

### INSTRUMENT BOOKLET

*The Triplett Electrical Instrument Company* has issued a four-page booklet covering their recently announced line of hermetically sealed instruments.

Included in the booklet are engineering details of the 1 1/2", 2 1/2", and 3 1/2" meters which are adapted for flush mounting on instrument panels.

The line of instruments includes a.c. voltmeters, ammeters, and milliammeters; r.f. ammeters and milliammeters; and d.c. voltmeters, ammeters, milliammeters, and microammeters.

A copy of the booklet will be furnished to those requesting it from *The Triplett Electrical Instrument Company*, Bluffton, Ohio.

### TUBE CHART

A tube interchangeability chart, for the convenience of engineers and purchasers of electronic tubes, is now being offered by *Amperex Electronic Corporation*.

Approximately 300 transmitting tube type numbers and their equivalent designation in Amperex tubes are included in the chart. The listing is printed on an 8 1/2 x 11 1/2 inch card which is punched for convenient wall mounting.

One of these cards will be forwarded upon request to *Amperex Electronic Corporation*, 25 Washington Street, Brooklyn 1, New York.

### SPEAKER DATA

The *Altec Lansing Corporation* has recently released a 12-page brochure covering their line of two-way, multi-cellular speakers.

In addition to describing various models of the multi-cellular speaker, the booklet includes response curves and other pertinent data of value to the engineer and the serviceman. According to the company, this new line of speakers provides a frequency coverage of from 40 to 15,000 cycles plus.

A copy of this brochure will be forwarded to those requesting it from *Altec Lansing Corporation*, 1210 Taft Building, Hollywood 28, California.

### PARTS CATALOGUE

A complete listing of radio cements, chemicals, hardware, cabinet repair kits, repair parts, tools, and other service accessories are included in a new catalogue now being offered by *General Cement Manufacturing Company* of Rockford.

This catalogue, No. 146, will be forwarded upon request to the company at 919 Taylor Avenue, Rockford, Illinois, or may be secured from any *General Cement* jobber.

### COMMERCIAL VIDEO

The *General Electric Company* has recently released a 16-page publica-

1920



A. G. HOFFMAN  
PRESIDENT

1945



E. F. HOFFMAN  
VICE-PRESIDENT

# MIDWEST RADIO CORPORATION

## CELEBRATES ITS

# *25th Anniversary Year*

The year 1945 completes a quarter-century of pioneering, of progress, of achievement, of leadership in the field of radio for the Midwest Radio Corporation. Very few radio manufacturers can match the unbroken record of continuous manufacture and of faithful adherence to high quality standards which MIDWEST RADIO has established and maintained during the past twenty-five years.

Since its establishment in 1920, Midwest Radio Corporation has figured prominently in the pioneering of many outstanding radio developments. Among them: Single dial, 3-gang condenser battery sets . . . all electric radios . . . superheterodyne . . . screen grid . . . amplified and resonant AVC . . . dual speakers . . . 2400 meters band . . . shielded switching . . . noise-reducing antenna system . . . push button tuning . . . ceramic porcelain insulation . . .

reinforced capacitors . . . pre-balanced coil assembly . . . acoustisonic louvres . . . 9-Band dial . . . and others too many to mention.

• Today—although still engaged exclusively in the production of electronic and radio instruments for our Armed forces—Midwest is planning new and finer radios for the post-war period.

### PLAN TO BUY YOUR POSTWAR RADIO DIRECT FROM THE MIDWEST FACTORY

That's how thousands of Midwest Radio owners, for 25 years, have enjoyed the finest in radio . . . and at SAVINGS UP TO 50%. Midwest's Factory-to-You plan of distribution has been amazingly popular because it enables you to buy better radios for less, and because the Midwest organization is directly responsible to you.

### WRITE FOR CATALOG NOW!

There is already a heavy advance demand for the Midwest Radio Catalog to be issued after Victory. To be sure that you will receive one of the first copies, send the coupon below requesting that your name be placed on the preferred list. The print order will be limited, so act now!

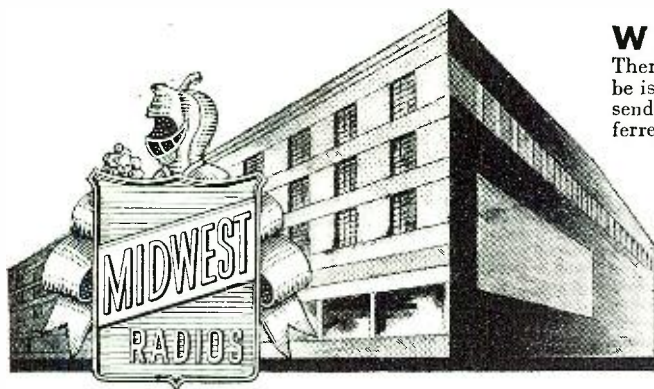

Send this coupon TODAY!

Mr. A. G. Hoffman, President  
Midwest Radio Corporation  
Dept. 11-AA, 909 Broadway  
Cincinnati 2, Ohio

Gentlemen: Please place my name on your list to receive the first post-war catalog of MIDWEST RADIOS.

Name.....

Address.....

City..... Zone..... State.....

# MIDWEST RADIO CORPORATION

DEPT. 11-AA . . . 909 BROADWAY . . . CINCINNATI 2, OHIO  
October, 1945 1-11

**Available at Once!!**  
**RECEIVERS, TRANSMITTERS,**  
**TEST EQUIPMENT**  
**OF ALL TYPES**  
**U. S. GOVT. SURPLUS**  
**At Bargain Prices!**

☆ ☆ ☆  
*Build Your Own*  
**MULTI-TESTER**  
*It's Easy—We Show You How!*

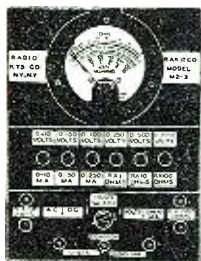

All the parts you need plus complete detailed instructions!

Parallels commercial meter construction  
 Efficient push button operation

- Sturdy all-metal case
- 6 Voltage ranges
- 3 Current ranges
- 4 Resistance ranges including extra high
- 6 Output ranges

Specially priced

**\$14.95**

Send for Details at Once!

☆ ☆ ☆  
*Build Your Own Radio!*

All parts in complete kits

**\$10.95 to \$17.95**

WRITE TODAY FOR FULL DETAILS ON ALL ITEMS

**RADIO KITS COMPANY**

Dept. K 120 Cedar St. New York 6, N. Y.

**NO PRIORITY**  
**For Harco Radio MASTS & TOWERS**

Revocation of Order M-126 permits manufacturing from surplus inventories. We have adequate surplus stocks to make...

**IMMEDIATE SHIPMENTS**

**HARCO CO. INC.**  
 ELIZABETH 4, NEW JERSEY  
 Catalog mailed on request

tion entitled "Intra-Tel Systems" which describes, in detail, a television system for use by department stores.

Complete information on installation costs, yearly operating budget, and other data for a typical system is included. The booklet is illustrated by charts, drawings, and scenes from recent merchandising presentations over station WRGB in Schenectady.

Copies of the brochure may be secured free of charge from the Electronics Department, *General Electric Company*, Schenectady 5, New York. Please specify brochure EBT-28-A when making your request.

**HEADER DATA**

For the information of engineers and designers, *Electrical Industries, Inc.*, has issued a new booklet covering data and specifications on E-I multiple headers and sealed leads.

Various items of essential information and dimensions are included to facilitate the selection of proper headers and leads for the job.

A copy of this data sheet will be forwarded upon request to *Electrical Industries, Inc.*, 42 Summer Avenue, Newark 5, New Jersey.

**INDUSTRIAL BROCHURES**

A series of brochures which list various types of industrial equipment are being offered by *Walker-Jimieson, Inc.*, of Chicago.

These brochures are designed to acquaint industrialists with various types of equipment available for production, inspection, and research applications. Among the titles available are booklets on voltage supply equipment, lighting equipment, shop tools and equipment, sound equipment, electrical maintenance equipment, and test and inspection equipment.

The brochures will be sent free of charge to engineers and purchasing agents who write on company letterhead to *Walker-Jimieson, Inc.*, 311 S. Western Avenue, Chicago 12, Illinois.

**MECK PRESS BOOK**

The *John Meck Industries* of Plymouth, Indiana, has announced that they are mailing a completely prepared press book to all of their jobbers.

This book has been prepared to enable local jobbers to provide publicity stories for the local newspapers and other publications, as well as material and suggestions on short talks for business groups and a radio script. The booklet also contains suggestions for tying-in the first local showing of new merchandising with new stories.

The booklet also contains a list of photographs which will be sent to the jobber on request and completely prepared stories for the press.

**MOLDING MANUAL**

A new eight-page manual covering various applications of molded plastics, including electronics, has been issued by *Mack Molding Company, Inc.*, 180 Main Street, Wayne, New Jersey.

According to the manual, the com-

pany is prepared to mold plastics to include any property or combination of properties.

A copy of this publication will be forwarded upon request to the company.

**AMPLIFIERS**

The *Eastern Amplifier Corporation* has announced that a new postwar catalogue covering the company's complete line of amplifiers will be available for distribution in the near future.

All requests to receive this catalogue should be addressed to *Eastern Amplifier Corporation*, Bruckner Blvd. and 140th Street, New York 54, New York.

**LAYMAN'S ELECTRONICS**

A specially prepared booklet, "The Amazing Electron", is now available for distribution to educators, consumer organizations, farm groups, labor unions, and the general public, according to the announcement made by *Electronic Corporation of America*.

This booklet is profusely illustrated with cartoons and is written in a simple non-technical manner which provides basic information on electronics for the layman. A brief description of the development of various pieces of electrical equipment is included.

Copies of this booklet can be obtained from *Electronic Corporation of America*, 45 West 18th Street, New York 11, New York, free of charge to individuals, and in quantities of 20 or more, for a five-cent handling charge.

**INDUSTRIAL TUBES**

The *General Electric Company's* tube division has announced the compilation of a new 412-page technical manual covering electronic tubes for industrial applications. The book is designed for engineers, designers, and other tube users as a guide in selection of tubes for industrial applications.

The manual is profusely illustrated with photographs, outline drawings, and performance curves. Tabbed dividers facilitate the locating of tube data, and the looseleaf binding permits the addition of new data sheets as they are released.

The manual is available at a cost of \$2.00 per copy and new data sheet service is \$1.00. Orders for the manual should be addressed to Electronics Department, 267-122, *General Electric Company*, Schenectady, New York.

**HIGH FREQUENCY FM**

In a booklet prepared for the public, the *Hallcrafters Company* of Chicago has outlined some of the advantages which may be expected from the shift to higher frequencies for FM.

The booklet, which was written by Cyrus T. Read, director of sales engineering for the company, is entitled "The New FM Frequencies and What They Offer to You". The distribution of this booklet will be made to the public through *Hallcrafters'* distributors and representatives.

# Microphones Engineered by *Electro-Voice* Answer Everyday Sound Problems



### Maximum Intelligibility Under Extreme Noise

Hand-Held, close-talking single button carbon \*DIFFERENTIAL microphone for all speech transmission in any noisy, windy, wet or extremely hot or cold locations. Cancels out background noise. Articulation is at least 97% under quiet conditions, and 88% under a 115 db noise field.

Model 205-S. List Price . . . . . \$25  
\*Patent No. 2,350,010



### Higher Articulation with Less Fatigue

Moving coil, hand-held Dynamic microphone for high fidelity speech transmission. Uniform response, free from peaks, in the useful frequencies gives higher articulation, provides more usable power level, and is less fatiguing to the listener. For outdoor or indoor use.

Model 600-D. Dynamic. List. \$27.50  
Model 210-S. Carbon. List. \$17.50



### Poly-Directional with Adjustable Polar Pattern

The versatile high fidelity Cardak is readily adjustable to reduce any combination of reflected sound. Cuts reverberation or random noise pick-up . . . minimizes acoustic feedback. For broadcasting, recording, public address, communications.

Model 725—Cardak I. List . . . \$55  
Model 730—Cardak II. List . . . \$75



### General-Purpose Dynamic for Voice and Music

Widely used because of its dependable all-around performance. Excellent frequency response for both indoor and outdoor speech and music pick-up. Rugged, small size, light weight. High output. Suitable for public address, dispatching, paging, recording and remote broadcast.

Model 630-C. List Price . . . . . \$30



### Velocity High Fidelity Bi-Directional Sound Pick-Up

Wide, flat frequency response, bi-directional polar pattern, high fidelity characteristics, wide-angle front pick-up, and pick-up range make it ideal for solo, orchestra, or chorus, for single speaker or groups. For indoor P.A., broadcasting, recording.

Model V-1-C. List Price . . . . . \$30  
Model V-2. List Price . . . . . \$37.50  
Model V-3. List Price . . . . . \$50

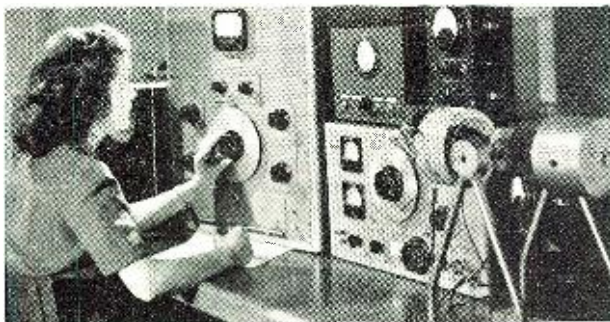

### Corner of E-V "Lab"

One of our Quality-Control units used in testing close-talking microphones. Harmonic distortion, frequency response, positional response (for carbons) level, etc., are carefully analyzed. Calibration is effected by Bell Laboratory standards and our own reciprocity checks.



### SEND FOR COMPLETE CATALOG

Gives valuable data on Electro-Voice Microphones for communications, public address, broadcasting and recording. Includes helpful Reference Level Conversion Chart.

Authorized Distributors Everywhere



No finer choice than

# Electro-Voice

## M I C R O P H O N E S

### GUARANTEE

The E-V models shown here are guaranteed forever against defects in workmanship and material.

FOR *Better Performance!*

Rowe No. 7  
Permanent  
Magnetic  
Driver Unit



**7 OUTSTANDING ADVANTAGES**

- (1) Designed for high peak amplifier output. 18 to 20 watts continuous duty.
- (2) Central cone-shaped magnet of ALNICO. Does not deteriorate in strength through shocks or ageing.
- (3) Flux strength of 12,000 gauss in the magnetic gap
- (4) One-piece metal diaphragm especially processed to eliminate internal strains and stresses.
- (5) Voice coil wound directly on diaphragm. No loose wires.
- (6) After complete assembly the unit is charged with a force of 10,000 ampere turns per inch.
- (7) Long life. free from breakdowns and trouble

Write for illustrated circular giving complete details. Address

**ELECTRONICS DIVISION, Dept. RN-10**

**Rowe Industries**  
3120 MONROE ST., TOLEDO 6, OHIO

**KELNOR**  
REG. U. S. PAT. OFF.  
*electric SOLDERING IRONS*

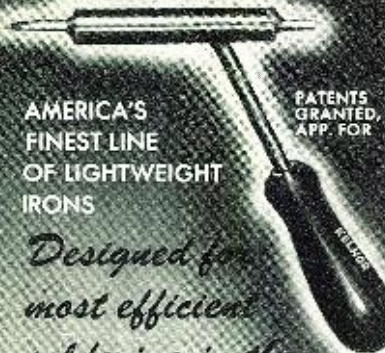

AMERICA'S  
FINEST LINE  
OF LIGHTWEIGHT  
IRONS

PATENTS  
GRANTED,  
APP. FOR

*Designed for most efficient soldering in the*  
**ELECTRONIC,  
RADIO AND  
INSTRUMENT  
manufacturing and  
repairing fields**

Easily solders hard-to-reach connections. Cuts down fatigue, increases accuracy. Illustration above about one-third actual size; weighs 9 ounces. Order from your retailer or jobber.

**KELNOR MANUFACTURING COMPANY**  
GENERAL OFFICES: CENTRAL TOWER, SAN FRANCISCO 3, CALIF.

..... **LETTERS** .....  
**FROM OUR READERS**

**IDENTIFICATION**

**I** WISH to compliment Mr. Thomas H. Bell of North Attleboro, Mass., for his letter to you on practical suggestions for manufacturers of radios who make a Chinese puzzle of their sets for underpaid servicemen to unscramble.

"The suggestion of listing the model number so it can be referred to is great and I hope they stop making upside down jammed-in pancake receivers. Let's all get behind this and run a series of protests each month so the radio manufacturers will take note and really build a set they can be proud of from a serviceman's standpoint also."

S. J. Rust  
South Bend, Indiana

\* \* \*

**Y**OUR editorial in the August issue of RADIO NEWS about Westbrook Pegler was very timely. In my opinion he is a screwball of the highest order.

"Many men have tried to slander the radio industry before and I think it's about time we did something about it. . . ."

Carl C. Seidler  
Brooklyn, N. Y.

\* \* \*

**HAZARD!!**

From one of our most prominent authors comes the following notice which appears in a St. Paul hotel:

**WARNING!!**

**ELECTRIC CURRENT**

Please use care with electric appliances.

The current varies from a.c. to d.c. without warning.

For information call Extension 55.

The Management

"We found the attached in our room in this hotel. I consider this the last word in hazards.

"Scares me! Tho't you (et al) would be amused."

John D. Goodell  
St. Paul, Minn.

\* \* \*

**I** HAVE just received my August issue of RADIO NEWS and happened to turn to an article on page 28 entitled, 'QRM—A Threat to Amateur Radio', written by T/Sgt. George Mabus, W9UAO.

"This not only is an interesting article, but the pictures drawn are also quite an item of surprise as this is my

station W9CVU. I am enclosing a picture of my station for your comparison. . . ."

"I am quite proud of the record of this station for 40 watts. On 75 meter phone I have worked all districts in the U. S., Hawaii, Mexico, Alaska, Puerto Rico, and have a three-hour confirmation of my phone on 75 meters from New Zealand. On 20 and 10 I have worked all over the world. I use a 20 meter and 10 meter 8 JK antenna and a full wave antenna for 75 meters. I have been on the air since 1913 and all transmissions have been from one address, 1949 1st Ave.,



East. Was Official Observer for the ARRL before the war. Have 30 w.p.m. code proficiency award from ARRL.

"The transmitter is a Collins 32G and the receiver is a National 101X."  
Chas. W. Boeger, Jr.  
Cedar Rapids, Iowa

*Congratulations W9CVU! We selected this photograph as an outstanding looking ham station for our artist to use in making his illustrations.*

\* \* \*

**T**HE many letters published by you regarding the licensing of radio servicemen have been most interesting, but they seem to present mainly the radio servicemen's side of the question.

"As a customer who never intends to be a serviceman, I see no necessity of a licensing system, nor any advantages therein for others than the organizers. Many charlatans and incompetents are found in all of the trades and professions, both licensed and unlicensed, and a license is no guarantee of their exclusion.

"The theory of licensing sounds well, but unfortunately the licensing systems do not seem to keep pace with technical advances. Consequently, the soon-obsolete entrance requirements allow the licensing of sub-caliber personnel, those already licensed tend to rest on their laurels instead of keeping up to date on the latest developments, and both the industry and its customers suffer.

"In the selection of a man to service my own radios, I avoid two classes: those professing to service all makes, and those with a cluttered-up shop



full of junk, I shall continue to select the man who has specialized on my brand of radio and who has sufficient modern equipment for the servicing of it. And, after the war, additional preference will be given to the radio man who has been trained in one of the Army or Navy schools, as I have learned from observation that he has been trained in repairing to a high standard of quality rather than down to a price.

"It does not appear that the returning graduates of our service schools need worry any about being able to pass the stiffest license examinations that can be cooked up. However, our American plan of free enterprise and competition is not based on the payment of a fee or tribute to a system or organization in order to earn an honest living.

"Let's keep it that way."

Major Ed. M. Hoskinson  
Chicago, Illinois

**I** HAVE been a fan of RADIO NEWS for a good number of years.

"Prior to my army career, I had also been a serviceman in the radio field. I went through the depression days working in that field. While in the service of Uncle Sam of around three years or so, I have become acquainted with other prewar servicemen, also in the service, and my comments are on practically the same thought as the others I have had the honor to meet.

"I have been following the articles in the news—pro and con. My supposition is that servicemen who have not been in the armed services in this war era do not relish competition. Also, some of the ones who are howling so loud, as I imagine it, have been doing a very lucrative business while others are in the armed services for their good.

"While here in the U. S. I had been in three camps, all of which are very near large cities. During my army career in those three camps, I had, at times, contacted the service shops and had become fairly acquainted with each of them personally, and to their efficiency and also their service charges. All but one was waxing fat on the public in regards to the actual troubles with each radio serviced. I realize that is a broad statement, but true. I also realize a number of the ones who howl fairly loud do not relish competition, which is natural.

"I believe what I am about to say would stop some of the servicemen who are making most of the noise in regards to discharged veterans getting into the field.

"Since FM and AM and television are practically a reality and will enter the serviceman's shop in the near future, if not sooner, why not have a universal examination covered by all the states in the U. S. A. covering theory on FM and AM and some on theory on television as we will have them coming into our shops soon. Also, some questions on oscilloscopes (theory) as that is in conjunction with

October, 1945

# RMS

# CABINETS



**P. A. SPEAKERS**  
PSD-12 Dual  
also PS-12 Single

**Your JOBBER**  
is adding these NEW  
Fast Moving  
**LEATHERETTE**  
**PORTABLES**  
to the popular  
  
profit-pulling line

Here is a new group of timely items, you will certainly want to have.

It has the same eye appeal, solid construction and right-pricing that has made all RMS products a quick success with dealers and service men from coast to coast.

If you want to see action, ask your JOBBER to take your orders now for early deliveries.

**LEATHERETTE PORTABLES**  
and CASES for PHONOS,  
AMPLIFIERS & INTERCOMS  
and many other cabinet requirements.

*Of course you know about the RMS line of Exact Replacement Cabinets for all makes of Radios*

*\* Write to your Jobber for new catalog of complete RMS line.*



**PHONO-AMPLIFIER**  
PA-12  
10" and 12" records



**PC-16 TRANSCRIPTION CASE**  
for 16" Records



**SPEAKER BAFFLES**  
5 sizes 5" to 12"  
same in Walnut



**BLANKS**  
6 sizes to take  
4 to 10 Tube sets



**RECORD PLAYERS**  
LRP-25



**LRP-5**  
LRP-15 front grill



**Walnut Veneer**  
RP-200 Blank  
RP-100 Cut-out  
RPA-300



# RADIO MERCHANDISE SALES

550 WESTCHESTER AVE., NEW YORK 55, N. Y.

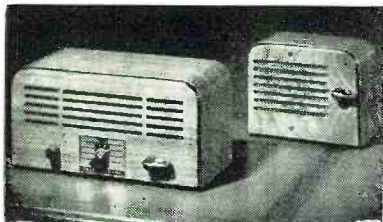

**GET A HEAD START WITH INTER-COMM THAT**

*"Has Everything"*

Boom days are here for Inter-Communication! Don't let any grass grow under your feet! Identify yourself immediately with

**Talk-A-Phone**

the world's most advanced and complete line of Inter-Communication.

Get a head start and stay in the lead with Inter-Communication that "Has Everything"! Extensively advertised. Well and favorably known. Easy to install, sure to satisfy. Good deliveries now.

**See Your Jobber AT ONCE!**

**Talk-A-Phone Mfg. Co.**

1512 S. Pulaski Road Chicago, Ill.

*For Radio as you want it!*

We're still up to our ears in critical war work but when the war's won we will again be ready

**.. To DESIGN, DEVELOP and MANUFACTURE ..**

Radio Receivers and Transmitters  
Industrial Electronic Equipment  
Airport Radio Control Equipment  
Marine Radio Telephone Equipment

Your inquiries will receive immediate action

**ISLIP RADIO MFG. CORPORATION**

ISLIP, L. I., NEW YORK

television. Then, I do believe, some of the old timers or new timers who are doing some of the most howling will howl because they also have to pass the examinations as they have been servicing a number of years. This article should shut a lot of the howlers up. Personally, I'm for just such an examination. How about the howlers. Why not make the examination a tough one.

Sgt. H. Bronwell  
El Paso, Texas

\* \* \*

I AM duly in receipt of your July issue which altogether is a very interesting number but am still at a loss to see why something cannot be done to put Radio and Electronics on a materially physical basis. It would surely simplify the whole subject and greatly facilitate developments.

"It requires a radical change in our concepts of matter and motion but could anything be more absurd than the accepted atomic theory. Matter is not a force measurable by weight, matter is an indestructible volumetric substance which of itself develops no weight. The atoms and elements are volumetrically proportionate and are

not in any remote way gravimetrically proportionate. It is the size, shape and condition of motion of the atoms which determines the physical character of the elements.

"It is assumed that the force of gravity is a magnetic force and in spite of every evidence to the contrary, it is again assumed that all matter is equally magnetic and that equal weights of the elements are equal quantities of matter, hence the atomic weights. The weights of the atoms are entirely dependent on the intensity of the electronic force impressed on them and nothing could be more variable. Sixteen pounds of oxygen combined with 2 pounds of hydrogen do not make 18 pounds of water. There is perhaps no compound which has the same weight as the combined weights of its component atoms. Weight is a force produced by the vibratory motion of the electronic atmosphere and has two main variables viz., the intensity of the vibratory force of the electronic atmosphere and the atomic size, shape, and intensity of the vibratory motion of the matter weighed both of which are continually changing.

"But what has all this got to do

Men who developed the "Meissner" electronic radio phonograph listen to a symphony record at the first official showing of the instrument held recently at their sales' headquarters in Chicago. Left to right: E. J. Stanmyre, chief engineer; James T. Watson, vice-president in charge of plant; and G. J. Rockey, vice-president in charge of sales. The Meissner Manufacturing Company, along with the Thordarson Electric Manufacturing Company of Chicago, recently became a part of Maguire Industries, Inc., New York. This organization was created in the years since 1939 by Russell Maguire, from a forgotten arms manufacturing company and the production of \$130,000,000 of the famous "Tommy guns" for the United Nations. Its present products include radio and electronic equipment, powder metallurgy items, oil, and a mixture for asphalt paving.

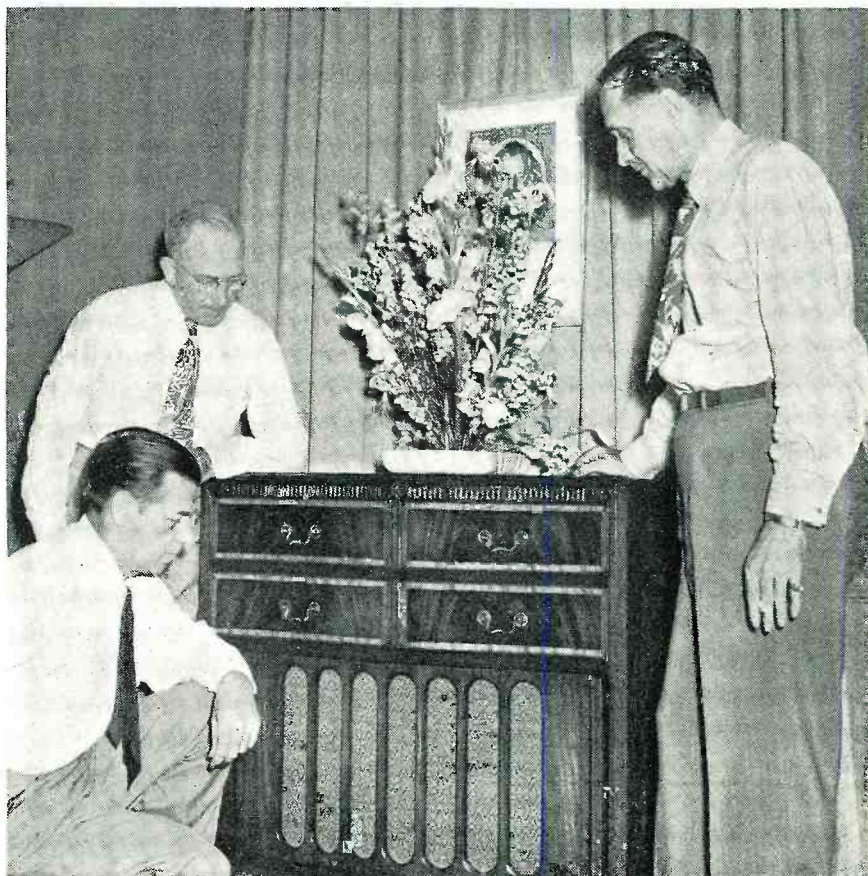

with Radio and Electronics? It has everything to do with the subject if we would deal with it in a material physical way.

"Atomic Matter is an indestructible volumetric substance which of itself develops no weight but is built up from matter in a primary state of subdivision being in what we may call electricity. This electronic matter still consists of pieces of matter of many sizes and shapes and different sized atoms are built up of different kinds of electrons under different conditions.

"The density of the universal electronic atmosphere is very great. Under some conditions it is perhaps denser than any of the elements, atomically, but when perfectly fluid it is not perceived by us except through the forces which it develops such as light, radio, electric currents, etc. These are transitory vibratory motions which are super-imposed on the static vibrating medium of transmission. The fluidity and vibratory intensity of the electronic atmosphere is indicated by the velocity of light, etc.

"Due to the extreme fluidity and very high frequency of the electronic atmosphere, its energized condition is not perceived by us as temperature but as voltage, but it is readily convertible into temperature by atomic resistance as in a lamp filament. It is not compressible in the ordinary mechanical way, but it can be compressed by induction as in an electric generator and it can be expanded by education through an electric motor. This applies only to certain kinds of electric currents. There must be as many kinds of electric currents as there are different kinds of light or different kinds of sound or other vibratory systems.

"The primary motion of the particles of matter is rotative motion, a secondary motion is orbital motion. These in combination develop a helical motion and this is what we call rotatively vibratory motion. There is no such thing as positive and negative electricity except in the positive and negative rotation of the systems. Pieces of iron in a magnetic field of force do not attract or repel each other. They are pushed or pulled around by the helical forces of the electronic atmosphere.

"From the foregoing, it should be evident that all the phenomena in connection with electronics is purely mechanical, based on matter and motion. The universe is a very dense ocean of electronic matter energized beyond anything we can conceive of as temperature. The earth and the other bodies we see floating around are waste dumps of the de-energized electronic matter, their motions being controlled by the atmosphere in which they float. The basic energy of the universe resides in the electronic ocean or just where we should expect to find it, with its vibratory velocity of about 186,000 miles-per-second."

John Roger, N.Y.

-30-

## Headquarters for Aluminum Base Recording Blanks

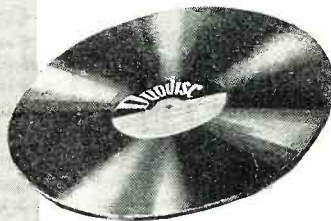

Retailers are invited to avail themselves of this new, improved, high-quality aluminum base, nitrate coated recording blank! Duotone's mass production facilities place us in the position of accommodating your requirements without delay. Write today for specific prices and literature. Immediate deliveries.

**RELATED PRODUCTS:** *Duotone Cutting Needles for better cutting quality; Duotone Hardening Fluid which preserves the recording; the Duotone "Star" Sapphire; Shadowgraphed Transcription Needles for quality playbacks.*

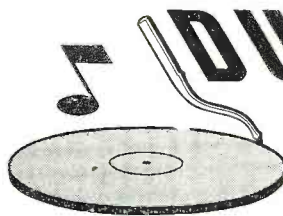

**DUOTONE COMPANY**  
799 Broadway, New York 3, N. Y.

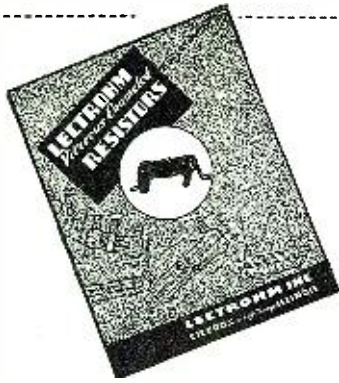

## IMPORTANT RESISTOR DATA

These 12 pages of valuable resistor information are important to you! Here is complete data on Lectrohms wide selection of Vitreous Enamelled Resistors; including fixed, adjustable, "Rib-on-edge" and ferrule terminal types—power line and R. F. chokes, brackets, bushings, solder pots, etc., with illustrations and complete description. If you do not have a copy—write for it!



5131 West 25th Street, Cicero, Illinois  
Division of the National Lock Washer Company,  
Newark, N. J.

## TELEVISION TECH CORRESPONDENCE COURSE

**WANTED:** A limited number of radio-men to enroll in a specialized television course. Instructions begin and end with television. Course has been written for the radio serviceman who wishes to learn television repair, and the radio commercial operator or radio amateur who wishes to prepare for this new field. A knowledge of basic radio is assumed.

**PERSONAL INSTRUCTOR:** The instructor assigned to those who answer this ad promptly (no obligation) will be Edward M. Noll or O. J. Jimerson. Mr. Noll is the author of the present television series in Radio News and a former member of the television department of a major radio corporation; Mr. Jimerson, a senior radar inspector and a former member of the same television staff.

## TELEVISION TECH ENTERPRISES

Box 94, Dept. B, Hatboro, Pa.

## Video Amplifiers

(Continued from page 62)

tal frequency and a series of harmonics. Now, if phase distortion is present, the higher harmonic components may lead or lag the fundamental and lower harmonics, which rounds off or distorts the pulse, causing delay in triggering or instability. Fortunately, if a linear frequency response is maintained stage by stage, the phase distortion or non-linear time delay is not serious; however, in systems in which there is lumped frequency compensation, there can be serious phase distortion which must be corrected by a phase network or some form of phase compensation in each stage.

In a parallel resistor-capacitor combination, a prescribed length of time is required for the voltage to build up across the combination after the plate current variation has passed through it. The actual delay time is proportional to the decreasing reactance-resistance ratio. When the reactance decreases, with an increase in frequency, to a value approaching the value of the resistance, the delay time or lagging angle increases. If the resistance is very small in comparison to the reactance of the distributed capacity (Fig. 7) over the middle range of frequencies, there is no appreciable lag, plate current variations and output voltage  $e_o$  being essentially in phase. However, at the high frequencies, where the reactance of the distributed capacity approaches the value of the resistor, the time delay is constant for all frequencies (equal angles of lag); there is no phase distortion. This example is comparable to the usual 180-degree phase shift in a vacuum tube. However, if some frequencies, in this case the high frequencies, are delayed with respect to other frequencies as far as phase angle is concerned, it means that they are also delayed with respect to each other as far as time is concerned. Thus, it will take a higher frequency longer to build up across the combination than a lower frequency, producing phase distortion.

Likewise, the interstage coupling capacitor introduces phase distortion because it causes the lower frequencies, as they appear across the grid resistor, to lead the middle range frequencies. At frequencies where the reactance of the coupling capacitor is negligible in comparison with the grid resistance, the grid voltage is essentially in phase (no phase lag) with the signal current flowing through the series coupling-capacitor and grid-resistor combination. However, at low frequencies where the reactance of the coupling capacitor has increased to a value approaching the value of the grid resistor, the signal current begins to lead the voltage  $e_{in}$  applied to the series combination. Since the voltage across the grid resistor is in phase with this current, it effectively leads similar voltages of the middle range of

frequencies, which also appear across the grid resistor and which, supposedly, are to reach peak amplitude at the same instant.

Next month's installment treats the video amplifier in detail, demonstrating how it fits into the over-all theory of operation. It explains, among other things, signal polarity, necessity for direct coupling, d.c. reinsertion, contrast control, picture-tube bias, etc. In preparation for this article, the reader should review installments 2, 3, and 4, to refresh and reinforce his knowledge of the general over-all operation of the television system.

(To be continued)

## Spot Radio News

(Continued from page 16)

### Personals

**Aric Vernes** has been appointed executive vice president and general manager of *Philips Export Corporation*. He will also continue his post as Secretary of the organization. . . . **William E. Snodgrass**, formerly executive v. p. of the *Dictograph Products Company* has joined *Western Electric* as general manager of the hearing aid division. . . . **Haraden Pratt** has been elected Chairman of the Radio Technical Planning Board, succeeding **Dr. W. R. G. Baker**. Mr. Pratt is vice president and chief engineer of *American Cable and Radio Corporation*, an I. T. & T. subsidiary. . . . In preparation for a postwar expansion of the phonograph record business, *RCA Victor* has announced the return of **Eli Oberstein**, to the Popular Artists Relations and Repertoire post he left in 1939. . . . **Lloyd L. Spencer**, vice president in charge

One of the first to announce a television receiver out of the luxury class, the *Viewtone Co* of New York City, recently demonstrated its new set which they claim is designed for low cost mass production. The set retailing for about \$100 is a small table-model. It uses a 7-inch viewing tube which affords sharp, clear-cut images and surprisingly comfortable viewing with a minimum of eye-strain.

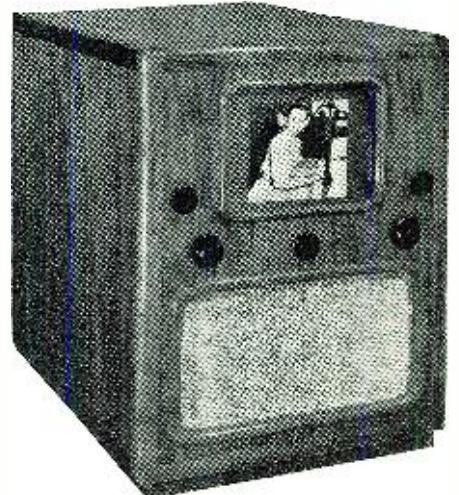

RADIO NEWS

of sales for *Stromberg-Carlson* has announced the appointment of **Colby H. Knapp** as supply sales manager for the telephone division. . . . **Crosley Corporation's** peace-time products will be handled in Cuba by **Gustavo Madrazo**, president of the *Independent Electric Company of Cuba*, according to the announcement made by **John W. Delind, Jr.**, director of exports for the company. . . . **Paul A. Ryan**, founder and first editor of the *Crosley* house organ *News and Views*, has been named first vice president of the American Association of Industrial Editors, Inc. . . . **Reeves-Ely Laboratories, Inc.**, has announced several organizational changes including the appointment of **E. L. Wayman, Jr.**, as General Administrative Head, **P. E. Bowen** as Sales Manager for the *Hulson American Corporation*, **F. F. Sylvester** as Technical Director in charge of research and engineering for both the parent organization and affiliated companies. . . . **Harold C. Vance** has been appointed Manager of the Direct Sales Department for the *RCA Tube Division*. . . . **Herbert H. Kronen** has been named Vice President and General Manager of *RCA Victor's* Brazilian subsidiary with headquarters in Rio de Janeiro.

—50—

### Radar Terms

(Continued from page 45)

**Indicator**—Any of several types of cathode ray oscilloscopes.

**Indicator gate**—See Gate.

**Isolating circuit**—A stage which passes signals in only one direction through a circuit.

**Klystron**—A velocity modulated tube used to produce low-power u.h.f. oscillations.

**Lighthouse tube**—A high-frequency triode of special design used to produce u.h.f. oscillations of medium power.

**Limiter**—A circuit which limits, clips, or removes either (or both) the positive or negative extremities of a wave form.

**Listening period**—The time during which a radar transmitter is quiescent or not radiating energy.

**Magnetron**—A high-frequency magnetic-field diode of special design used to produce u.h.f. oscillations of very high power.

**Main pulse**—See Transmitter pulse.

**Master oscillator**—A source of timing oscillations which control or affect all other radar circuits.

**Microsecond**—One millionth of a second.

**Modulator**—A circuit which directly controls or triggers the radar transmitter.

**Multivibrator**—A relaxation oscillator which oscillates of its own accord (a free-running multivibrator), or which oscillates only when triggered by an external voltage.

**Overdriven amplifier**—Amplifier circuit in which the combination of cut-off limiting and saturation limiting of a sine wave produce a rectangular voltage wave.

**Peaking circuit**—A differentiator circuit used to sharpen a wave form.

**Peak power**—The maximum output power of an r.f. pulse at the transmitter.

**Presentation**—The form in which radar echoes appear visually on an oscilloscope.

**Pulse**—A sudden change of voltage (or current) of brief duration.

# CARE "Custom-Built" Mounting Bases Simplify Assembly and Maintenance

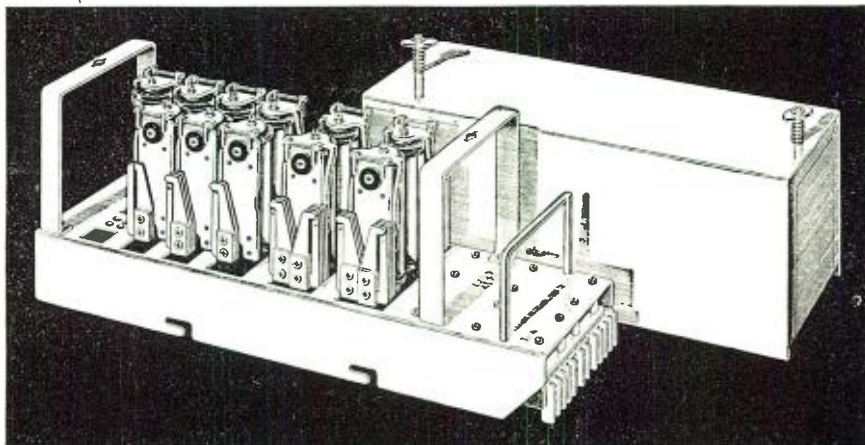

Pictured here is a typical Clare Relay Mounting Base with built-in connector strips. This method of mounting relay components provides greatly simplified maintenance, permits a complete bank of relays to be removed at any time for easy readjustment or replacement.

Under side of the mounting base, shown below, illustrates the wiring and three 24 point base connectors. The bayonet slots shown on the side of the base are locked into protruding frame pins, allowing the base connectors to be aligned with the frame connectors. This also provides a mechanical mounting of the assembly and relieves any stress on the connectors.

The 24 point jacks shown are made of nickel silver and make a firm friction contact with the frame jack. Insulation between jacks is linen base bakelite which provides good mechanical and electrical characteristics.

In keeping with the Clare principle of "custom-building", various sizes of mounting bases are available and special bases are easily provided. Standard jacks are: 12, 16, 20, 24 and 32 point sizes.

Call on Clare engineers to assist you with standard or special mountings in keeping with the requirements of your design. Address C. P. Clare & Co., 4719 West Sunny-side Avenue, Chicago 30, Illinois. Sales engineers in principal cities. Cable address: CLARELAY.

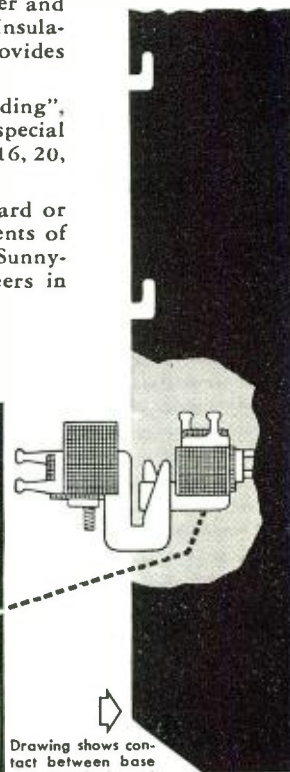
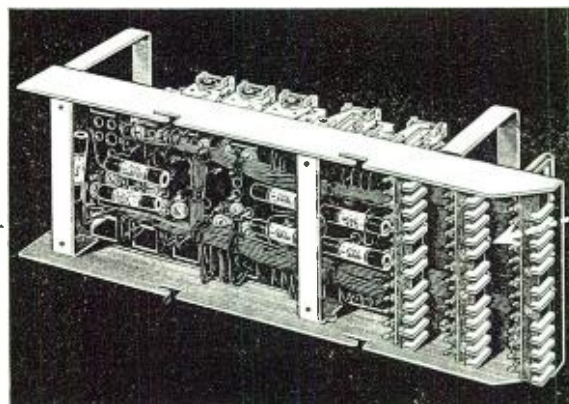

Drawing shows contact between base mounting jack and frame jack.

# CARE RELAYS

"CUSTOM-BUILT" Multiple Contact Relays for Electrical, Electronic and Industrial Use

## FOR SALE:

**TRANSMITTER**,  $\frac{1}{2}$  KW Phone, 1 KW CW Amateur type, 5 bands, completely enclosed in steel rack and panel. Simpson meter complement . . . dual power supplies, automatic starting equipment. Panel 6' x 26" x 22". Ready to operate with a minimum of overhauling, less tubes. Price for quick sale \$400 F.O.B. Chicago.

**Microphone cable**, shielded No. 18 rubber covered. .07c per ft.

**Record blanks**, black acetate, no label  $6\frac{1}{2}$ " dia., ea. .05c.

**Male AC plugs**, pre-war variety (NOT Victory type) 10c ea.

**Jacks UTAH "IMP"** (Signal Corps Type) No. IJ-110. ea. 21c.

**AC Line Cords** . . . dual conductor rubber covered special 10 ft. lengths with pre-war male plug 25c.

**Wall Baffle speaker cabinets** . . . fits 12" speakers leatherette covered, heavy construction \$4.95.

**Replacement cabinets** for radio receivers, mahogany finished, inside dimensions  $9\frac{1}{2}$ " long 7" high,  $5\frac{3}{4}$ " deep, takes most midget chassis. \$2.75 ea.

Miscellaneous job lots on standard resistors, condensers and parts. Write for prices and technical data.

**Battery chargers**, heavy duty . . . 12 Volt, 6 amp. and 6 Volt, 6 amp., trickle switch, dry disc type rectified. Made for Signal Corp. . . . \$22.50 with connectors.

**UNION RADIO CORPORATION**  
1636 W. VAN BUREN STREET  
CHICAGO 12, ILLINOIS

Here it is . . .

## The NEW FIFTH EDITION of PRINCIPLES of RADIO

By KEITH HENNEY

Editor, ELECTRONICS

So popular has this book become that it has now gone into a FIFTH EDITION. This textbook is designed for those with or without technical training in radio who want a working knowledge of the basic principles of radio communications. In simple, non-technical language, "Henney" starts with the fundamental principles of electricity, and gradually develops the subject of radio practice. Practical applications of theories are simplified by the specific examples, experiments, and problems, together with drawings, diagrams and photographs of actual apparatus.

1945 534 Pages  
Illustrated \$3.50



### ON APPROVAL COUPON

JOHN WILEY & SONS, INC.,  
440 Fourth Ave., New York 16, N. Y.

Please send me on ten days' approval a copy of Henney's PRINCIPLES OF RADIO. At the end of that time, if I decide to keep the book, I will remit \$3.50 plus postage; otherwise I will return the book postpaid.

Name.....

Address.....

City and State.....

Employed by.....

RN-10-45

**Pulse duration**—The time duration of a pulse.

**Pulse generator**—See Electronic timer.

**Pulse rate**—See Pulse recurrence frequency.

**Pulse recurrence frequency or p.r.f.**—The timing rate of radar pulses, originating in the electronic timer.

**Pulse recurrence time**—The reciprocal of pulse recurrence frequency.

**Pulse width**—See pulse duration.

**Quiescent period**—See Listening period.

**R.F. oscillator**—Output stage of the radar transmitter in which u.h.f. oscillations are generated.

**Range**—The direct-line distance between a radar set and a target.

**Receiver**—The component of a radar set which receives, detects, and amplifies echoes reflected from targets.

**Receiver gate**—See Gate.

**Recurrence rate**—See Pulse recurrence frequency.

**Reflector**—A metallic object or surface behind a radiating dipole to reinforce radiation in a desired direction.

**Reflex Klystron**—See Klystron.

**Repetition rate**—See Pulse recurrence frequency.

**Ring oscillator**—Any number of pairs of high-frequency triodes operated as an r.f. oscillator in a tuned-grid tuned-plate circuit.

**Rotary spark gap**—A pulse-protruding device in which circularly arranged electrodes are rotated past a fixed electrode producing periodic high-voltage arc discharges.

**Saturation limiting**—Limiting action of an amplifier when operated beyond the point where grid current flows.

**Scanning**—The direction of pulsed r.f. energy over or across a given region or area.

**Sea return**—That part of the r.f. pulse reflected by water surrounding a sea-borne radar set.

**Spark gap**—An arrangement of two fixed electrodes between which a high-voltage arc discharge takes place.

**Squaring amplifier**—See Overdriven amplifier.

**Squegging oscillator**—An extreme form of grid blocking in an r.f. tuned-grid tuned-plate circuit.

**Synchronism**—The relationship between two or more periodic or recurrent wave forms, when the phase difference between them is zero.

**Synchronizer**—See Electronic timer.

**T-R switch**—A device which switches a radar antenna between the radar transmitter and receiver, preventing transmitted energy from reaching and damaging the receiver.

**Tail**—Attenuated decay of an r.f. pulse.

**Target**—Any object which produces a radar echo.

**Time base**—The trace produced on the screen of a cathode ray tube by horizontal deflection of the electron beam.

**Time constant**—An indication of the speed with which a circuit can be charged or discharged.

**Timer**—See Electronic timer.

**Transmitter pulse**—Burst of r.f. energy radiated by the radar transmitter. The pulse appears as a strong signal at the left end of the oscilloscope time base.

**Unidirectional**—In one direction only.

**Video amplifier**—A circuit amplifying a very wide range of frequencies which includes and exceeds the audio range.

**Wave guide**—A hollow pipe or tube, having a circular or rectangular cross-section, used to transmit r.f. energy.

## better to KNOW than to guess

The man who "knows his theory cold" is the man who goes further faster in radio.

For a complete mastery of the essentials of radio and electricity needed for all practical radio work, and for a useful reference on those essentials, use



D. J. Tucker's

## INTRODUCTION TO PRACTICAL RADIO

Written by the chief engineer of 3 Dallas stations, this new book covers all the basic theory and shows how to use it in the construction and operation of radio. It explains fully the mathematics needed in connection with each principle and its applications.

It teaches the principles of radio so clearly and thoroughly that the reader will be able to use them with complete accuracy and assurance. Get this book now for your reference shelf. It will help you train your new workers and it will help you in the solution of many radio problems.

322 pp. Fully illus. \$3.00

Order from your bookstore or from

**THE MACMILLAN COMPANY**  
60 Fifth Ave. New York 11

## Unusual Buy Cathode-Ray Tubes



New. Factory sealed, for  
**TELEVISION & OSCILLOSCOPES**

RCA 5BP4 price.....\$18.00

N-U 3AP1 price.....\$ 9.00

Other CR Tubes 3" to 12"

**Amphenol Coaxial Cables**

Polystyrene beaded & Polyethylene solid dielectric, for low losses and freedom from interference.

Type 21B-290-7/26-XXV, 72 Ohm., List price .085, your price \$0.25 p. ft. Many other types. Ask for list.

### TELEVISION PARTS

RCA Deflection yokes compl. with hardware & cable.....\$19.50

RCA High and Low Voltage complete in one unit Television power supplies, oversize unit.....\$90.00

AEROVOX Type 3009 Capacitor .5 MFD. 3000 Volt Working.....\$ 2.40

G.E. Pyranol Capacitor 2 x .1 MFD, 7000 Volt Working.....\$ 9.00

All types of ceramic, mica and oil Capacitors. Many other television parts, ask for complete catalogue.

RCA Parts and Equipment Distributors

WORLD'S FIRST SPECIALIZED HOUSE IN TELEVISION

**ELECTRONICS SERVICE & SUPPLY**  
262 West 40th Street, New York 18, N. Y.

RADIO NEWS

**Practical Radar**  
(Continued from page 46)

of the electrons, the voltage of the reflector, or the resonant frequency of the cavity. Thus, any one of these interrelated variables can be used to tune and adjust the Klystron for operation at any desired local-oscillator frequency.

**I.F. Amplification**

The large amount of gain required in a radar receiver is obtained by considerable amplification of the intermediate frequency, thus requiring a large number of i.f. amplifier stages.

The intermediate frequency may be quite high, while some radar receivers function with a considerably lower i.f. signal. An important factor governing the choice of intermediate frequency is the bandwidth of the circuits.

The width of the frequency channel passed by the i.f. amplifier is determined by the spectrum range of the returning echo signal. Since reception of the signal is of the double-sideband variety, this region allows for sufficient uniform amplification of all video frequencies.

The frequency bandwidth must be fairly wide to pass all of the component frequencies contained in the received r.f. signal. To fix the bandwidth within acceptable limits, "damping" resistors could be used in the i.f. circuits.

The sensitivity as well as the selectivity of the entire set will suffer if the bandwidth of the i.f. amplifier is too wide. Losses in the i.f. amplifier stages can be made almost negligible by using very close coupling between the primary and secondary windings of i.f. transformers.

In order to vary this coupling, the physical location of the primary winding can be changed with respect to the secondary winding. This coupling adjustment is particularly critical in the first stage of i.f. amplification.

The first i.f. stage should be operated with the lowest possible noise level, in an effort to obtain as high a signal-to-noise ratio as possible.

Following stages of i.f. amplification may be primarily straight i.f. amplifiers, operating under similar but not so exacting conditions as the first stages. All i.f. stages are double-tuned.

Since gain values as high as 100 db. can be expected from the combined stages of i.f. amplification, tendencies toward regeneration must be carefully controlled by filters and proper shielding.

Lead shielding and filters can also prevent the receiver from being over-sensitive to strong external r.f. and a.f. fields.

Although the radar receiver is protected by the T-R switch (Fig. 1) from transmitter power surges, a small signal is permitted to "leak through" the receiver in order to register as a

# SOUND VALUES at TERMINAL RADIO

**DE LUXE  
20 WATT AMPLIFIERS  
No. 6419**

- 2—HIZ MIKE INPUTS
- 2—PHONO INPUTS with Fader Controls
- 1—Master Gain Control
- DUAL TONE CONTROL for Bass and Treble
- Illuminated Panel
- 4-8 or 500 OHM OUTPUT
- 2—65Q7
- 1—6SJ7
- 1—6SC7
- 2—666G
- 1—523

NET PRICE WITH TUBES  
**\$43<sup>59</sup>**  
F.O.B. N.Y.

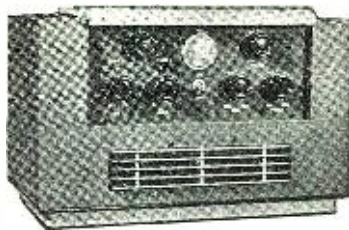

**WALNUT FINISH  
WALL BAFFLES  
REINFORCED  
CONSTRUCTION**



- SPECIAL PRICES:**
- For 5" Speaker..\$1.74
  - For 6" Speaker.. 2.45
  - For 8" Speaker.. 3.01
  - For 10" Speaker.. 3.48
  - For 12" Speaker.. 4.53

NO PRIORITY REQUIRED

**UTAH PUBLIC ADDRESS  
SPEAKERS**

Model	Watts	Diam.	
8P	7	8"	\$3.38
10P	9	10"	5.43
12P	10	12"	6.61
E12P	13	12"	9.40
G12P	17	12"	14.25
GS12P	20	12"	20.43
H12P	22	12"	25.28

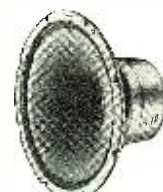

NO PRIORITY REQUIRED  
OTHER SIZES AND MODELS IN STOCK

**STEEL UTILITY CABINET**

Size 19x12x10" for 8 3/4x19" Panel



- Top door with Snap lock
- Heavy duty construction
- Black crackle finish
- Special Price while they last only \$3.98
- Steel Panel ..... .88
- Steel Chassis 11x17x2..... 1.35

NO PRIORITY REQUIRED.

**HEAVY DUTY POWER CONTROLS  
STANDARD BRANDS—NEW STOCK**

- 50 WATT } ANY SIZE } \$1.82
- 16 Ohms
- 32 Ohms
- 50 Ohms
- 150 Ohms
- 250 Ohms
- 300 Ohms
- 25 WATT } ANY SIZE } \$1.63
- 6 Ohms
- 100 Ohms
- 250 Ohms
- 5000 Ohms } 1.92



NO PRIORITY REQUIRED

**DE JUR MICROAMP METERS  
BRAND NEW STOCK**

- 0-200 Micro-Amp
- 3 Inch Diameter
- No Priority Required

PRICE ONLY  
**\$7<sup>95</sup>**  
R.N. 10



## Terminal Radio Corporation

85 CORTLANDT STREET, NEW YORK 7, N. Y. Telephone WOrth 2-4415

**WAR SURPLUS BARGAINS!**

**WAR SURPLUS BARGAINS**

**BIG SAVINGS**  
Hundreds of specials for RADIO SERVICEMEN

- CATHODE RAY TUBES
- POWER & TRANSMITTING TUBES
- HEADPHONES, etc.
- HARD-TO-FIND TEST METERS



**7 LB. RADIO PARTS ASSORTMENT**

A "gold mine" for the radio serviceman. Hundreds of valuable radio parts, including rivets, soldering irons, sockets, coils, resistors, condensers, switches, transformers, etc. An amazing value. Money-back guarantee.

**K130R — FULL 7 POUNDS ONLY \$179**

**War Surplus Bargain Book**

Page after page of war surplus and other bargains for the radio serviceman; a l.s.o. specials for home, shop and outdoors.

**IT'S FREE! WRITE TO-DAY**



**STARK'S** Dept. 509 So. STATE STREET CHICAGO 5, ILLINOIS

For the Finest in Sound Equipment Watch...

**NEWCOMB**

... the sound of quality

Announcements of special interest to discriminating buyers of sound equipment may be expected in the near future. Send us your address to receive these mailings as they become available.

*Newcomb*

**AUDIO PRODUCTS CO.**  
Manufacturers Since 1938  
2815 So. Hill Street, Dept. F  
Los Angeles 7, California

strong pulse—or "transmitter" pulse—at the beginning of the time base of the indicator oscilloscope. This r.f. signal directly from the radar transmitter may have a blocking effect each time the pulse passes through the receiver. To counteract this possibility, a gate pulse could be applied to the second i.f. amplifier stage.

The gate pulse consists of a rectangular voltage wave controlled by the electronic timer. The wave would be applied to one or more of the i.f. stages and could either bias the tube(s) to cut-off, or completely remove the plate voltage during the time the transmitter is pulsing. This, in effect, is a protective device to prevent the i.f. stages from overloading due to the extremely powerful input pulses from the transmitter.

After the desired degree of amplification has been obtained by the i.f. stages of the radar receiver, the signal is detected—probably by means of a conventional diode—and the rectified output is then applied to the video stages of amplification.

**Video Amplification**

An energizing voltage of from 50 to 200 volts peak with a bandwidth of about three megacycles is required by most cathode-ray tube circuits. It is the purpose of the video stages of amplification to supply this wide range of frequencies at the desired voltage amplitudes.

Video-frequency amplifiers are usually resistance-coupled with a characteristically almost-flat gain response over the entire range of frequency operation, about three megacycles.

Video-frequency amplifiers have been developed which supply from 30 db. to 50 db. of gain per stage with bandwidths as great as two megacycles. Use of the same circuits for bandwidths of about three megacycles, lowers the amount of stage gain to about 25-35 db.

Some means of limiting the amplitude of the video output may be provided, to prevent defocusing of the cathode-ray tube due to strong signals. The output signal from the video amplifier is usually a negative-going pulse, applied to the grid of the cathode-ray tube. A positive-going pulse would be applied to the cathode of the indicator tube.

The type of cathode ray oscilloscope used by the radar set would not normally influence the nature of the output from the video amplifier stage or stages.

**Superregenerative Receiver**

Another type of receiver offering radar possibilities is the superregenerative receiver (Fig. 3).

A superregenerative oscillator forms the basis of this type of receiver. Superregeneration takes place when oscillations are started and stopped at an r.f. rate which is low in comparison with the frequency of the generated voltage. This is accomplished by means of a quench oscillator.

**12 WEEKS SHOP TRAINING**

**TRAIN FOR YOUR PLACE IN ELECTRICITY**

*All Finance Your Training*

**EXTRA 4 WEEKS COURSE IN INDUSTRIAL ELECTRONICS INCLUDED!**

At Coyne you "Learn by Doing" on real machinery and equipment. Trained Electrical men needed now. Electricity offers you opportunities for the best jobs today, and a real peace-time future. Don't let the opportunities of peace-time catch you unprepared. Get your electrical training now.

**EARN WHILE LEARNING, JOB HELP AFTER GRADUATION**

The place to get your electrical training is at Coyne. We have been training men and young men for 46 years — by the famous "Learn by Doing" method in the great Chicago shops.

Many do part time work to help out with expenses. Free lifetime employment service when you graduate.

Right now I'm including extra training in Industrial Electronics and Electric Refrigeration at no extra cost. Send coupon now for Free Book and details. No obligation; no salesman will call. I send facts — then you decide. Mail coupon today. We also have facilities for men with physical disabilities whether due to war or other causes.

-----

H. C. LEWIS, President  
COYNE ELECTRICAL SCHOOL  
500 S. Paulina St., Dept. 75-81, Chicago, 12, Ill.  
Send me your Free Electrical Book and details.  
 Send G. I. Bulletin  Physical disability.

Name .....

Address .....

City .....

State .....

**IF YOUR SPEED IS LESS THAN 50 W.P.M. SEND TODAY FOR THIS 52 PAGE FREE BOOK — FOR AMATEURS AND COMMERCIAL RADIO OPERATORS**

**CANDLER SYSTEM BOOK & FACTS**

It shows that "crack" operators rely on something besides practice to develop their high speed and proficiency; it explains the "knack" of sound-sense and sound-consciousness — the secret of speedy sending and receiving. Once you acquire these mental processes, reading code becomes almost second nature to you, just as the rhythm of a dance band becomes automatic to musician and dancer.

Champions endorse the Candler System. It is used in training Commercial Operators, Amateurs, and Radiotelegraph Specialists in Signal Corps, Airlines, Broadcast Studios, Police Inter-City Communications. Wherever the fastest, most efficient operators are found, there you will find Candler trained men.

If you want s-p-e-e-d, if you have any difficulties in operating technique, if 40-50, and more, wpm seem fantastic speeds to you—send for this revealing 52 page Book now. It's yours without cost or obligation. Simply send your name and address to—

**CANDLER SYSTEM COMPANY**  
Dept. 2-L, Box 928, DENVER, COLO., U.S.A.  
And at 121 Kingsway, London, W. C. 2, England

**BUILD YOUR OWN!**

**FAST-FREEZER** PLANS \$1.00

Every amateur will be proud to build this household necessity which requires no expert knowledge. Operates on 32 or 110 volts. There's fun in building and profit in using this handy freezer. Saves up to 75%.

**PLANS ARE SIMPLE**

These 8 to 40 cubic foot sizes can be built new or used parts. Mail \$1 bill or check for complete plans and catalog

**LEJAY MFG., 454 LeJay Bldg., Minneapolis 8, Minn.**



The incoming r.f. signal from the antenna is applied to the grid of the superregenerative stage. Since the tube is operated in a highly regenerative state, there will be very high amplification of the signal *during periods of oscillation*.

Because of the limiting action of the circuit, the video output doesn't depend on the strength of the input r.f. signal.

Although the sensitivity of a superregenerative receiver is very high, its lack of stability, and other disadvantages, prevents wide use in radar applications.

(To be continued)

### Capacitor Checker

(Continued from page 40)

bridge or good ohmmeter. These settings are inscribed upon the rheostat scales. If arbitrary dial divisions are employed, locate each resistance setting listed in Chart 2 and make a list of the corresponding dial settings rather than ohmic values.

To check the power supply, voltage control potentiometer, and d.c. voltmeter circuit, (1) with  $S_1$  switched off, insert power plug into line receptacle and (2) while holding pushbutton  $S_2$  depressed, close  $S_1$  and advance  $R_1$  slowly, noting readings on voltmeter scale of meter  $M$ . If it is desired to compare meter  $M$  readings with those of a standard d.c. voltmeter, connect latter between positive  $X$  terminal and junction of  $Ch$  and  $R_1$ . If the milliammeter is of good quality and calibration and if the voltage scale has been drawn carefully and the resistors  $R_2$  and  $R_3$  critically adjusted, the voltage scale of meter  $M$  will be found to agree closely with a standard d.c. voltmeter.

If desired, the voltage control potentiometer may be provided with a scale or dial graduated directly in volts. This will obviate taking voltage readings with the meter. However, such a scale is not recommended unreservedly, since its readings will not be true for all load conditions.

If rheostats  $R_A$ ,  $R_B$ , and  $R_C$  are calibrated meticulously, no further adjustment or calibration of the instrument will be required.

#### How to Operate the Instrument

The method of using the capacitor checker is always the same, regardless of the type and characteristics of electrolytic units tested. Only the settings of the controls will differ for various capacitances and working voltages. The routine manipulations may be mastered in a short time by the busy serviceman.

The following procedure must be observed in checking the condition of electrolytic capacitors: (1) With line plug inserted into power outlet and  $S_1$  switched off, connect electrolytic capacitor to terminals  $X-X$ , positive capacitor terminal to positive instrument terminal. (2) Set rheostats  $R_A$ ,

$R_B$ , and  $R_C$  and switch  $S_1$  to positions given in Chart 2. (3) Switch on  $S_1$  and advance voltage control potentiometer  $R_1$  slowly from zero voltage, a short distance, noting meter  $M$  reading. (4) At this point, check operating voltage simply by depressing pushbutton  $S_2$  and reading voltage scale of meter  $M$ . If voltage is not up to rated working value for capacitor under test,

release  $S_2$  and advance  $R_1$  slightly higher. Re-check voltage by depressing  $S_2$ . As capacitor charges, or as it forms (if it has been shelved for a considerable period), voltage may be observed to fall very slowly. In this case, continue adjustments over period of several minutes until voltage stabilizes at the working value. (5) When voltage is stabilized, release pushbutton

**A COMPLETE WORKSHOP TO THE RADIO INDUSTRY**

**DIALS**

**TRANSPARENT PLASTIC DIAL WINDOW FACES**

**FABRICATING PLASTIC PARTS FOR ALL TYPES OF RADIOS**

**PRECISION MACHINED PARTS**

**INSULATING COVERS**

**METAL & PLASTIC NAME PLATES**

**FACILITIES • EXPERIENCE**

available for large or small runs:      adapts the most suitable plastic to your operation:

PRINTING	LUMARITH
STAMPING	CELLULOID
ENGRAVING	VINYLITE
EMBOSSING	BAKELITE
MACHINING	PYRALIN
DIE CUTTING	PLASTACELE
POLISHING	LUCITE
FORMING	PLEXIGLAS
MOLDING	VULCANIZED FIBRE
LAMINATING, ETC.	and all other plastics

Send us your Blueprints and Specifications

**N. G. SLATER CORP**

Manufacturers of Plastic and Metal Products

3 WEST 29th STREET, NEW YORK 1, N. Y.

In the Rocky Mountain Region  
it's  
**RADIO & TELEVISION SUPPLY CO.**  
810 EUCLID AVE., PUEBLO, COLO.

"If we don't have it, we'll get it—  
or it can't be had! Phone 5729"

### THE BEST VIBRATOR

A small vibrator with a great future!  
**QUIET! COMPACT! EFFICIENT!**  
A revolution in Postwar VIBRATOR design. Till materials are more plentiful, we will continue to rebuild old vibrators at \$1.00 each. Include return postage. Send vibrators to

**BEST VIBRATOR CO.**  
BOX 5802 CLEVELAND 1, OHIO

**Export for Profit**

Roburn Agencies, Inc. have represented leading manufacturers of radio and electrical equipment, parts and accessories, in world-wide markets since 1935. Extensive facilities relieve you of all export headaches — correspondence, advertising, sales, finance, packing and shipping. A few additional clients seeking experienced, reliable representation are invited. Write for information on Profits Through Exports.

**Roburn Agencies, Inc.**  
115W Fulton Street New York 7, N. Y.

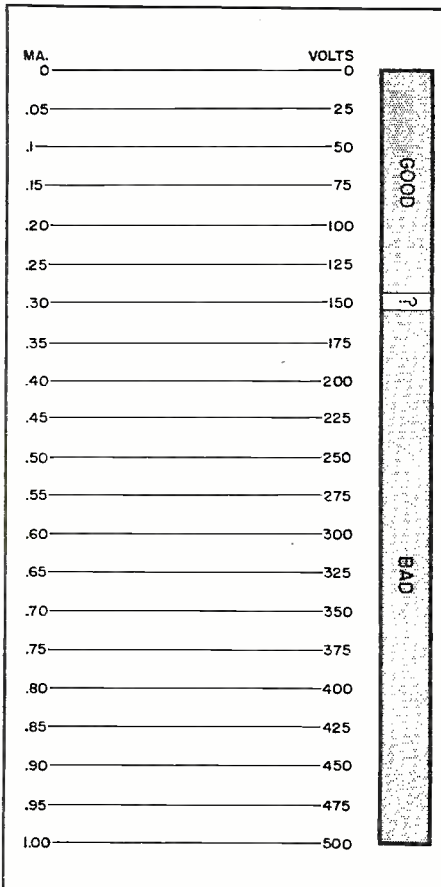

Chart 3. Dial calibrations.

$S_2$  and read capacitor condition on English portion of meter scale. (6) If meter pointer reaches BAD portion of scale (with  $S_2$  released) before voltage reaches rated working value for capacitor, and does not fall slowly back toward zero, capacitor has excessive leakage and is probably shorted if the pointer climbs to the upper limit of the BAD region. (7) When meter reading (with  $S_2$  released) is at the question mark on the meter scale, capacitor leakage is at the maximum permissible value for the unit being tested.

Always discharge the capacitor after it has been tested, otherwise a severe shock may be received. Keep switch  $S_1$  off when an actual test is not being made, and turn it off again before disconnecting the capacitor from the instrument. Keep a good pilot lamp in the socket to warn you when the power is on. Never attempt to disconnect the capacitor from the instrument until the pointer of the meter (instrument in the leakage test, not voltage, position) has fallen all the way back to zero, indicating complete discharge of the capacitor. If the pointer seems too slow in falling to zero, the capacitor may be discharged more quickly by short-circuiting its terminals or the X-X instrument terminals to which it is connected. For this purpose, use a short length of insulated wire with the two ends bared, but be sure to touch only the insulated portion when discharging the capacitor.

**Hi-Q**

**CERAMIC CAPACITORS**

**WIRE WOUND RESISTORS**

**CHOKE COILS**

**ELECTRICAL REACTANCE CORPORATION**  
FRANKLINVILLE, N. Y.

**PHONO CABINET** Model PA-12

Beautiful aeroplane-luggage covered. Size: 14" W.. 7½" H.. 19" L. Complete with lock and key.

Your net price **\$9.95**

Distributors: Write for quantity price. We can also supply all types of radio and electronic equipment.

**McGEE RADIO & ELEC. CO.**  
1330 Broadway, Denver, Colorado

Correspondence Courses in **RADIO and ELECTRICAL ENGINEERING**

**ELECTRICAL ENGINEERING** Get good grasp of wide electrical field. Prepare yourself at Low Cost, for secure future. Modern course. So simplified anyone can understand quickly.

**RADIO ENGINEERING** Extra fine course in radio, public address, photo-electric work, trains needed badly. Diploma on completion.

**WRITE** Send postcard or letter for Free Catalogue. Details, all about deferred payment plan, etc. **SEND NOW!** **LOW \$25** Either **AS** Course

**LINCOLN ENGINEERING SCHOOL.** Box 931R-82 Lincoln 2, Nebr.

**FILMGRAPH**

**ALL-PURPOSE SOUND ON FILM CONTINUOUS RECORDER**

Instantaneous playback—no studio or processing required. Records for as low as 12½¢ per hr.! Few demonstration models now available if you act at once. Write for free descriptive circulars.

**MILES REPRODUCER CO., Inc.**  
812 Broadway (Dept. RN-9) New York 3

**PATENTS and TRADE MARKS**

Protect and profit by your ideas. Full information on request. Prompt expert service. 30 years' experience.

**LESTER L. SARGENT**  
Registered Patent Lawyer  
Post Office Box 3156  
1115 K. St., N. W., Washington, D. C.

**PEN-OSCIL-LITE**

Extremely convenient test oscillator for all radio servicing; alignment • Small as a pen • Self powered • Range from 700 cycles audio to over 600 megacycles u.h.f. • Output from zero to 125 v. • Used by Signal Corps • Write for information.

**GENERAL TEST EQUIPMENT CO.**  
38 Argyle Buffalo 9, N. Y.

**Ted McElroy**

World's Largest Manufacturer of Wireless Telegraphic Apparatus

COMPLETE CENTRAL OFFICE EQUIPMENT

**McElroy Manufacturing Corp.**  
82 Brookline Avenue • Boston, Massachusetts

## The Road to Hamdom

(Continued from page 55)

miliar with the gear, from suffering possible injury or worse.

In wiring the transmitter it is good practice to have the various parts arranged so that the leads, particularly in the tank sections, are as short as possible. By tank sections we refer to the resonant or tuning circuits of the transmitter which include, usually, a variable condenser and a coil. It is extremely important that the power supply unit and the power leads be kept out of the "inductive field" of these r.f. circuits if the emitted signal of the transmitter is to be free of hum or other modulation. Toward this end, it is also desirable that the wires bringing power to the filaments of the tubes be twisted. This effectively prevents the building up of an a.c. field in the vicinity of the r.f. sections.

Fasten all component parts of your transmitter securely to the breadboard or chassis. While the use of a crystal-controlled oscillator will anchor your signal pretty well to one frequency, you can still be troubled to a great extent with a wobbly signal if any of the parts in the transmitter are subject to vibration or other movement.

The construction of your receiver will probably offer more headaches than any other piece of equipment or part of your station. The quantity of aspirin tablets consumed will be decreased considerably, however, if a few simple rules are observed.

Shielding is important. Therefore, it is advisable that, instead of a breadboard being used, the receiver be built on a metal chassis with a metal panel. It is even more desirable to build it on a metal chassis that will slide into a metal cabinet since this method of construction will give you over-all shielding. As with the transmitter, the receiver parts must be securely fastened down for, in high-frequency reception, stability of the signal is of prime importance.

Unless the circuit of the receiver is of a fairly advanced design and you have been very careful in laying out the parts, it is wiser not to build the power supply on the same chassis and enclosed in the same cabinet with the receiver. The regenerative type receiver is very sensitive to inductive hum and in order to bring in the weaker signals and to bring in any signal with a clear CW note it is necessary that your receiver be absolutely free of such hum.

Your power supplies will be comparatively simple to build. However, as with any of the equipment, careful planning and construction will pay off with trouble-free operation. As stated earlier, two units will be needed. It is possible to use just one but such practice will entail the use of a rather complicated switching arrangement and a system of dividing and dropping the voltage output. Any

power supplies that you build at this time will find a place in later and more advanced stages of your work in amateur radio.

The two general types of rectifier tubes in common use with power supplies for low-powered work are high-vacuum and mercury-vapor. Either of these types may be used in the receiver supply but the mercury-vapor is recommended for the transmitter power. The mercury-vapor rectifier tube has the advantage of better voltage regulation over the tubes of a high-vacuum type. This is extremely important if the power supply is to be used with a CW transmitter since the variation in load on the supply when

the transmitter is keyed will cause a "chirpy" signal. Even better regulation may be obtained by the use of a "bleeder" resistor across the power output of the supply. The type-83 mercury-vapor tube is ideal for such purpose since one of these tubes can safely handle power sufficient to deliver 600 volts output with plenty of filter and enough current to supply your transmitter input-power requirements with a safe margin. A choke-input filter should be used with these mercury-vapor rectifiers. The filament voltage should be applied before turning on the plate power.

A monitor is nothing more than a very simple regenerative receiver. The

## RIDER VOLUME XIV COVERS 1941-42 RECEIVERS

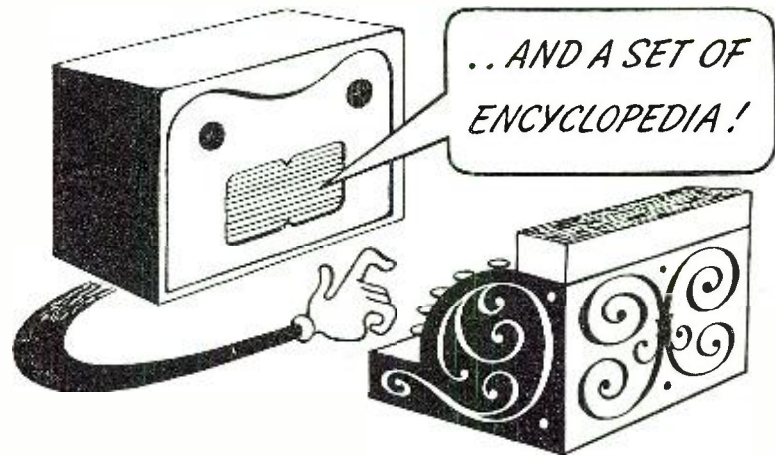

Even back in '41, when I was brand new, "Information Please" was giving sets of Encyclopedia Britannica to people who submitted questions that stumped the program's "experts."

If the "Information Please" people ever want to get hundreds of servicemen to stay up nights thinking of questions they can offer a "set of Rider Manuals," recognized as the most valuable piece of equipment in any shop.

That's why there's such a tremendous demand for Vol. XIV right now. It contains the vital servicing data needed to quickly diagnose and cure the ills of radios of my age; the last generation born before the stoppage of civilian set manufacture.

We have been worked hard because of the war. For the same reason paper is scarce and WPB limitations on paper may cause your jobber to be out of a Rider Manual. Thanks for being patient.

### RIDER MANUALS (14 VOLUMES)

Volumes XIV to VII . . . 12.50 each volume

Volume VI . . . 9.50

Abridged Manuals I to V (1 vol.) 15.00

Automatic Record Changers

and Recorders . . . . . 7.50

### OTHER RIDER BOOKS YOU NEED

The Cathode Ray Tube at Work

Accepted authority on subject . . . . . 4.00

Frequency Modulation

Gives principles of FM radio . . . . . 2.00

Servicing by Signal Tracing

Basic Method of radio servicing . . . . . 4.00

Servicing Superheterodynes . . . . . 2.00

### The Meter at Work

An elementary text on meters . . . . . 2.00

### The Oscillator at Work

How to use, test and repair . . . . . 2.50

### Vacuum Tube Voltmeters

Both theory and practice . . . . . 2.50

### Automatic Frequency Control Systems

—also automatic tuning systems . . . . . 1.75

### A-C Calculation Charts

Two to five times as fast as slide rule . . . . . 7.50

### Hour-A-Day-with-Rider Series—

On "Alternating Currents in Radio Receivers"—

On "Resonance & Alignment"—

On "Automatic Volume Control"—

On "D-C Voltage Distribution" . . . . . 1.25 each

**JOHN F. RIDER PUBLISHER, INC. 404 FOURTH AVE., N.Y. 16, N.Y.**

Export Division: Rocke-International Corp. 13 E. 40th Street New York City

Cable: ARLAB

**RIDER MANUALS** *are complete*  
**IN 14 VOLUMES**

# RADIO TUBES

We have radio tubes combined with adaptors, sold as complete units, for the following critical numbers:

1A5	1C5	1H5
1N5	3Q5	6A7
6A8	6SC7	6R7
6Q7	6SQ7	
1T5	1Q5	75
84-6Z4	80	6X5

\$1.05 each—no orders accepted under \$10.00. 5% discount on all orders of 50 or more.

### Regular tubes—not substitutes

7T7	.....\$ .60 each
6SN7	..... .50 each
1T4	..... .50 each
354	..... .50 each
155	..... .50 each

No orders accepted under \$10.00. 5% discount on all orders of 50 or more.

Signed supplier's certificate No. L-265 must accompany all tube orders.

**Manor**  
**Electric & Appliance Co.**  
 3238 Southport Ave., Chicago 13, Ill.



RCP Volt Ohm Milliammeter	
420 S.P. ....	\$27.50
(0-400 Microampere basic meter)	
Shure Crystal pickup No. 550....	3.30
Masco 17 Watt Amplifier with tubes .....	30.30
RCA Service Notes 1923-37 and 1938-1942 .....	each 5.94
5BP1 Cathode Ray Tubes.....	17.95

... and when they're Federated Purchaser, you know they ARE specials. Watch more where these came from. Watch our future ads!

**federated purchaser, inc.**  
 NATIONAL DISTRIBUTORS OF ELECTRONIC PARTS  
 80 Park Place New York 7, N.Y.

unit, with its required batteries, should be enclosed in a metal container. It can be built small enough to carry around the room since only a small 22½ volt "B" battery and a flash-light cell will furnish enough power for its operation if a low-drain tube is used. A type-30 tube is recommended for this unit.

If your transmitter is of the "self-excited" type, the monitor may be used to adjust the transmitter to any desired frequency. This is done by first using the monitor as a miniature transmitter. The receiver is tuned to the frequency you want to use and the monitor, set near-by, is tuned until the beat-note from it is heard in the receiver. This indicates that the monitor is tuned to the same frequency as the receiver. Now the monitor is used as a receiver. The headset is plugged into the monitor and the transmitter is tuned until the signal is heard. Since the monitor is tuned to the frequency you desire and the transmitter is tuned to the monitor therefore the transmitter is tuned to the right spot. QED!

Due to the fact that space conditions vary so much with each station location, no particular transmitting antenna type will be discussed. Generally speaking, where space permits, a half-wave or full-wave antenna will give maximum results. If the transmitter is to be operated on the lower frequencies of the ham-bands, it is very likely that a full-wave antenna will be found impractical. The antenna should be erected as high as possible and away from obstructions such as buildings and trees. Low-loss insulators (and spacer-bars, in the case of Zepp feeders) should be used. Pyrex, steatite, or glazed porcelain, to mention only a few, are excellent for this purpose. A switch, at your operating position, will enable you to use the one antenna for both transmitter and receiver.

Well, we seem to have given a rather general coverage of the fundamental pieces of equipment for your station. This article is not intended to be technical. Detail can come later. Obviously you cannot build up your station at this time since Uncle Sam has nixed general amateur operating for the duration. The word *priorities* rears its ugly head also. But—now is the time for planning and firing the imagination and *brother*—is my imagination fired! Oh, to dive once again into the QRM on forty. Oh, to hear again the melodious voices of the gang on seventy-five telling me my "modulation" is perfect.

What does it matter that the Jr. Op, expected momentarily at 9UAO, will need a new pair of booties about the time the OM needs a new plate transformer. Or, does it matter if the XYL hankers for that "perfectly divine" dress just when the boss (?) decides to broaden his scope with a new xtal. Now! I can always take up woodcarving.

## BEAUTIFUL WALNUT CABINETS

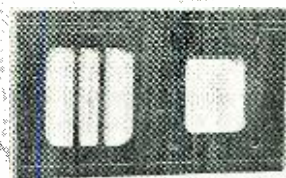

### Model M-1 CUT TO FIT MEISSNER

6 TUBE KIT #10-1199.	YOUR COST..	\$3.95
Model C —13" L 7½" H 7½" D	Blank	3.95
Model B —12" L 7½" H 6½" D	Blank	3.75
Model A —11" L 7½" H 6" D	Blank	3.25
Model AA —10" L 7" H 5½" D	Blank	2.85
Model AAA —9" L 6" H 4½" D	Blank	2.45
Model V-Phono 12x11x4"	Blank.....	3.25

We can also furnish all types of Radio and electronic equipment.

**MC GEE RADIO & ELECTRIC CO.**  
 1330 Broadway DENVER, COLORADO

## YOUR NEW FREE CATALOG IS READY FOR YOU!

Radionic's Catalog No. 26 lists hard-to-get radio parts! Helps you fill your radio and electronic needs. All parts are available for immediate shipment. All are highest quality. All are exceptional values.

SEND TODAY FOR YOUR FREE COPY TO  
 Dept 10-B

**RADIONIC EQUIPMENT CO.,**  
 "CHANCELLOR" PRODUCTS  
 170 NASSAU STREET, NEW YORK 7, N. Y.

## LOCATES TROUBLE INSTANTLY IN ALL ELECTRICAL DEVICES



### HANLAN APPLIANCE TESTER

In this single unit are combined all the necessary tests for examining the true condition of every appliance. Ideal for checking temperature regulating thermostats. Tells instant if opens or closes. Tests continuity of open circuits, etc. Tests on 110 V. Highly efficient for testing vacuum cleaners, motors, field coils, shavers, radio tube filaments, flash light bulbs, lamps, appliances with 3-way switches, etc. Provides maximum protection! Speeds up the operation! Always ready! Great time, effort and money saver! Guaranteed! Only \$9.50 complete with instructions. Free Circular. **HANLAN COMPANY, 1419-R West Jefferson Blvd., Los Angeles 7, Calif.**

## CRABTREE'S WHOLESALE RADIO

2608 Ross Ave.

DALLAS 1 TEXAS

## RADIO

RADIO Technician and Radio Communications courses. Register now for new classes starting first MONDAY of each month. Day and Evening Classes.

### AMERICAN RADIO INSTITUTE

101 West 63d St., New York 23, N. Y.  
 Approved under GI Bill of Rights.

★ **INDUSTRIAL** ★  
**MAN-POWER BUREAU**

# ELECTRONIC ENGINEERS!

**War-Winners Today, Post-War Builders Tomorrow!**

Leaders in NATIONAL UNION RADIO CORPORATION'S staff of engineers, scientists and technicians have brought us far out in front in the electronic industry. We have a research laboratory and two manufacturing plants in Newark, N. J., and a manufacturing plant near Philadelphia, Pa. We invite you to consider your opportunities with us for professional advancement, stimulating, friendly associations, and a future with promise.

## NATIONAL UNION NEEDS:

**SENIOR TUBE ENGINEERS:** These men **MUST** have actual experience with radio tube manufacture. The pay and opportunities are commensurate with your ability.

**COMMERCIAL ENGINEERS:** Engineers interested in developing electronic tube applications, who may represent us among radio manufacturers upon occasion.

**QUALITY CONTROL MEN AND WOMEN:** Here you need an interest in the practical application of statistical and/or engineering procedures to many factory processes.

**TEST EQUIPMENT ENGINEERS:** Men experienced with meters or electronic test equipment to work either as **TEST EQUIPMENT DESIGN ENGINEERS** or as **MEASUREMENT LABORATORY ENGINEERS**.

**JUNIOR ENGINEERS—MEN AND WOMEN:** Do you have a college degree in Physics, Electrical Engineering, Chemical Engineering, Mechanical Engineering, Mathematics or Chemistry? This company offers an opportunity for young, ambitious graduates to assume responsibilities and to exercise initiative.

## WOMEN!

*We have a number of fine young women engineers with us now. We need more. If you have a degree in Electrical Engineering, Chemical Engineering, Mechanical Engineering, Physics, Chemistry or Mathematics and are seeking career opportunities, investigate.*

If you have thorough training in your field, as evidenced by job experience in radio or allied industries, or by a college degree—if you have ambition, initiative and resourcefulness—if you have the ability to inspire your co-workers, then . . .

*Phone or Write*

**DR. L. GRANT HECTOR**  
*Director of Engineering*

## NATIONAL UNION RADIO CORPORATION

Plane St. at Raymond Blvd.

Newark 2, New Jersey

WMC RULES OBSERVED



Give generously to  
**YOUR COMMUNITY WAR FUND**

Representing the NATIONAL WAR FUND

# OPENINGS FOR **RADIO ENGINEERS ELECTRICAL ENGINEERS MECHANICAL ENGINEERS**

In the development and production of all types of radio receiving and low-power transmitting tubes. Excellent post-war opportunities with an established company in a field having unlimited post-war possibilities.

Apply in person or in writing to:

*Personnel Manager*

**RAYTHEON  
MANUFACTURING CO.**  
**Radio Receiving Tube Div.**  
**55 Chapel St., Newton, Mass.**

## Technical Writers Wanted!

Engineers and physicists who have had experience in (spare time) writing technical manuscripts on electronic design or applications including radio, television, facsimile, etc.

Reply Box 310, c/o RADIO NEWS  
185 N. Wabash Ave., Chicago 1, Ill.

**INDUSTRIAL**  
**MAN-POWER BUREAU**

Continued

**ENGINEERS**  
**FOR DESIGN WORK**  
**ON RADIO RECEIVERS,**  
**AUDIO AMPLIFIERS,**  
**TELEVISION**

Men with substantial experience wanted, preferably those having Degrees in Electrical or Communications Engineering. Write, giving details of experience and salary expected, to:

**FREED RADIO CORPORATION**

Makers of the Famous Freed-Eisemann Radio-Phonograph

200 Hudson Street  
New York 13, N. Y.

**RADIO ENGINEERS DRAFTSMEN WANTED**

For development and design of marine radio telephone, telegraph and navigational equipment.

Permanent positions available with pioneer company.

write

**Mackay Radio and Telegraph Co., Inc.**  
MARINE DIVISION

111 Eighth Avenue New York 11, N. Y.

**RADIO MECHANICS**

We have a number of openings for skilled mechanics, particularly with A & E licenses. We have a smaller number of openings for unlicensed mechanics, radio operators, skilled aviation personnel of all types. These are excellent paying positions. Contact us shortly before you are discharged giving both Army and Civilian addresses, giving full information. Main Office: AIR PERSONNEL & SALES, INC. First National Bank Building, Urbana, Illinois. Branch Office: P.O. Box 1895, Pittsburgh, Pa.

**Practical Radio Course**

(Continued from page 51)

each band switch. Capacitors  $T_{12}$  and  $T_{13}$  are the broadcast-band preselector and oscillator high-frequency trimmers respectively, which are to be adjusted for proper high-frequency tracking at a preselector frequency of 1500 kc. Capacitor  $T_{15}$  is the adjustable unit of the broadcast-band low-frequency padder, and is to be adjusted for proper low-frequency tracking at 600 kc.

$S_1$  is the first short-wave band position of each band switch. Capacitors  $T_6$  and  $T_7$  are the high-frequency trimmers for this band, and are to be adjusted for correct high-frequency tracking at a preselector frequency of 4.5 mc. Capacitor  $T_{11}$  is the low-frequency padder for this band, and is to be adjusted for proper low-frequency tracking at a preselector frequency of 1.8 mc.

$S_2$  is the higher-frequency short-wave band position of each band switch. Capacitors  $T_8$  and  $T_9$  are the high-frequency trimmers for this band, and are to be adjusted for correct high-frequency tracking at a preselector frequency of 15 mc. No low-frequency adjustable padder is provided for this band—the fixed low-frequency padder  $\lambda_7$  sufficing for correct tracking here.

To insure perfect tracking the ganged main oscillator tuning capacitor should be "rocked" while adjusting the low-frequency padders, so that the maximum signal output will be followed.

**Interlocking Trimmers**

Inspection of the separate-coil multi-band oscillator circuit in Fig. 4 reveals that a separate coil and oscillator high-frequency trimmer is used for each band. The trimmer is connected across the coil for that particular band and utilized only when that coil is in the circuit. Hence, the adjustment of a trimmer on one band is entirely independent of the trimmer adjustments on any other band so it does not matter which band is first adjusted for correct high-frequency tracking.

Many multi-band receivers that use a tapped-coil tuning system instead, employ trimmers that are in the circuit on more than one band. For example, for the broadcast band in the oscillator of the *Stromberg-Carlson* 58 receiver (see Fig. 3), all three trimmers are in series across the full tuning coil. Therefore, the oscillator tracking at the high-frequency end of the bands must be adjusted on the highest-frequency band first, when the lower two portions of the tuning coil, and their trimmers, are shorted out by the waveband switch. Then the adjustment is made on the medium-frequency band, and finally the broadcast-band. If the tracking adjustment were made on the broadcast-band first, the subsequent tracking adjustments made on the other two bands would

**Classified**

Rate 20c per word, Minimum, 10 words

**WANTED**

RADIO Tubes 2B6 wanted. Jarvis, 27 Boulevard, New Rochelle, N. Y.

ENGINEERS interested in becoming associated with national engineering organization as Consultants. Write United Engineers, Box 1065-D, Los Angeles 28, Calif.

**RADIO ENGINEERING**

INTENSIVE radio operator courses (Marine, Broadcast, Aviation) prepare for FCC examinations. Co-ed. Days—evenings. Western Radio Communications Institute, Dept. "R," 106 West Third St., Los Angeles 13, Calif.

RADIO Engineering, Broadcasting, Aviation and Police Radio, Servicing, Marine Operating and Electronics taught thoroughly. Expenses low. Write for catalog. Valparaiso Technical Institute, Dept. N, Valparaiso, Ind.

**RADIO EQUIPMENT**

RADIO Service men and experimenters send for our giant radio catalogue. Save dollars. United Radio Co., (1000M) Newark, N. J.

**CORRESPONDENCE COURSES**

USED Correspondence courses, Educational and Technical Books, bought, sold, rented. Catalog Free. Educational Exchange, Henagar, Ala.

USED Correspondence Courses and Educational Books sold or rented. Inexpensive. Money-back guarantee. Write for Free Catalog listing 4000 bargains.—(Courses Bought.)—Lee Mountain, Pisgah, Ala.

CORRESPONDENCE Courses and self-instruction books, slightly used. Sold. Rented. Exchanged. All subjects. Satisfaction guaranteed. Cash paid for used courses. Complete information and 92-page illustrated bargain catalog FREE. Write Nelson Company, Dept. 2-59, Chicago 4.

**FOR SALE**

BARGAINS—Tubes, Parts, etc. Write—J. C. Thimijan, Lake City, Minn.

SELSYNS, Autosyns, Synchro-Units—war surplus aircraft type instruments for indicating position of remotely located rotary antenna. Applicable in remote control circuits. \$15.00 pair without priority. Wiring instructions included. Discount to dealers. D. O'Connor, 7 Winthrop Terrace, East Orange, N. J.

GET LIST. Surplus tubes, capacitors, meters, electronic instruments. Fraction original cost. Quest, 395, Great Neck 3, N. Y.

RECTIFIERS—Halfwave, 5 Amperes, \$4.50; 2.2 Amperes, \$2.25; 1.5 Amperes, \$1.85. Fullwave, 1 Ampere, \$2.50; .5 Ampere, \$1.85. Maximum 18 volts input. List free. Milton Bursma, Route 5, Grand Rapids, Mich.

BUZZER Code Practice set complete with key, battery and instructions. Sends real wireless signals. Only \$1.65. Two sets \$3.00. Guaranteed. Rathert Electric, Dent N. Cresco, Iowa.

HOOK-UP Wire: Rubber and Aircraft Covering. 3 lbs., \$1.00. Postpaid 1000 miles; over 25c. Satisfaction guaranteed. Coaxial and multi-conductor available. Aldred Salvage Supply, 2515 Boulevard, Jacksonville 6, Florida.

LEADING radio retailers, buy our hobby, sporting, toy, game, other fast-selling merchandise. Boost radio business. Riolen, Riolen Bldg., New Rochelle, N. Y.

BUILD radio complete with tubes \$10.95, details. Radio, 9418a Avenue "A", Brooklyn, N. Y.

LOWEST Prices. Radio Tubes, parts. Bargain lists 3c. Potter, 1314 McGee, Kansas City 6, Mo.

**MISCELLANEOUS**

AIRCRAFT Radio-Army radio transmitters and receivers converted. All types aircraft radio serviced and installed. Work done by FCC licensed mechanics. Prompt service-satisfaction guaranteed. Backed by 15 years experience. Airway Radio-Sales and Service, 10636 S. Spaulding Ave., Chicago 43, Ill.

ADMINISTRATIVE—Returning Veterans with Navy Radio Technician training and experience, also 20 years of Banking and Accounting experience, including 7 years as a Bank Examiner before entering the service. Looking for a permanent administrative position, preferably Treasurer or Comptroller, with a Broadcasting System or Radio and Electronic Manufacturer. Wallace T. Miller, 1322-32 St., Des Moines 11, Iowa.

I AM SEEKING a line of Radio, etc. I can offer intelligent representation as distributor or agent. Clifford, 7 Irvington St., Boston.

LEARN radio easier—faster! "The Mystery of Radio (How it Works)" illustrates, explains radio principles, wiring circuits, connections, etc. in easy-to-understand terms. Only 50c. Details free. Scientific Radio Service, Box 1285, Sioux City 7, Iowa.

RADIO Books—We have hundreds of the best Radio and Television books. Send for free book lists. Vaughan's, 4524 Spruce St., Philadelphia, Pa.

### PATENT ATTORNEYS

INVENTORS—Before disclosing your invention to anyone, send for Form "Evidence of Conception"; "Schedule of Government and Attorneys' Fees"; and instructions. Sent free. Lancaster, Allwine & Rommel, 414 Bowen Building, Washington 5, D. C.

RANDOLPH & Beavers: Registered Patent Attorneys, 231-E Columbian Building, Washington, D. C. In order to protect your invention and reap the reward that should be yours, Patent your invention without delay, and at the same time have Rights to sell as Manufacturers convert to Civilian Production. Write for Information and Record Form Today.

PATENTS SECURED. Two valuable booklets sent free. Write immediately. Victor J. Evans & Co., 948-K Merlin Bldg., Washington 6, D. C.

## ELECTRICIANS! RADIO MEN!

Earn More Money!

Get this new GIANT SIZE

**ELECTRICAL and RADIO TROUBLE SHOOTING MANUAL**  
GUARANTEED BY COYNE

Yours 10 Days Free

OVER 500 Large Size Electrical and Radio Shop Prints - How to read and use them

Needed by war workers, maintenance men, old timers! Nothing else like it. Saves time, helps boost your pay... 4 GREAT BOOKS IN ONE!  
1. New Step-by-Step Trouble Shooting Course. 2. 500 Shop Prints. 3. Elec-Radio Dictionary. 4. Spare Time Jobs.  
**FREE!** 1 yr. Technical Counsel by mail from COYNE staff, on trouble-shooting problems.  
**SEND NO MONEY!** See offer below. Satisfaction guaranteed by famous COYNE "Learn-by-Doing" Electrical School. Rush coupon now!

H. C. LEWIS, President, Dept. 75-72  
COYNE ELECTRICAL SCHOOL, 500 S. Paulina St., Chicago 12, Ill.  
Send, with all shipping charges paid, your new COYNE Electrical and Radio Trouble Shooting Manual. Within 10 days after getting it I'll either return it or send \$3, then \$3 monthly until total of \$3.95 is paid. Cash price \$8.00—you save over 10%. Same 10-day free trial and return privilege.

NAME \_\_\_\_\_ Age \_\_\_\_\_  
ADDRESS \_\_\_\_\_  
CITY \_\_\_\_\_ Zone \_\_\_\_\_ STATE \_\_\_\_\_



### Learn modern watch and clock repairing

At home, spare time. Good field now... security and contentment in future. Start part-time business and earn while you learn. HOROLOGY is precision instrument work... a great and growing field, sensational opportunities. Easy self-instruction course. Low price. Money-back guarantee. Write now for Free Success Catalog. NELSON CO., 321 S. Wabash Ave., Dept. 8K9, Chicago 4, Illinois



### RCA Institutes, Inc.

Offer thorough training courses in all technical phases of Radio and Television

WEEKLY RATES 7 DAYS—EVENINGS  
VETERANS: RCA Institutes is approved under G. I. Bill of Rights  
For Free Catalog write Dept. RN-45  
RCA INSTITUTES, Inc.  
A Service of Radio Corporation of America  
75 Varick St., New York 13, N. Y.

Specify SAUERISEN  
ACIDPROOF CEMENTS—COMPOUNDS  
FOR  
Tanks, Sewers, Stacks, Floors  
Technical cements for all purposes.  
Send sketches or samples  
Sauereisen Cements Company • Pittsburgh 15, Penna.

nullify the settings on the broadcast-band because the trimmer capacitors for the two short-wave bands also have a tuning effect on the full tuning coil when it is used for broadcast-band reception. Similarly, adjustment of trimmer  $C_{12}$  affects the tuning of the portion of the coil used for the medium-frequency band, so, unless the highest frequency band is tracked before the medium-frequency band, it will nullify the settings on the latter.

### Fixed Tracking Padders

In the oscillators of some multi-band receivers there is only an adjustable type series-padding capacitor for the broadcast-band, the series padder for the medium- and short-wave bands being in the form of fixed capacitors (see Fig. 3). In others, all bands but the highest-frequency band are provided with adjustable padders, the latter requiring only a fixed padder of the proper capacitance value (see Figs. 1 and 4).

It is interesting to note that if the receiver is designed to have the oscillator operating at a lower frequency than the signal, the low-frequency pad or pads are placed in the preselector tuning circuits instead of the oscillator tuning circuits. Using a "low side" oscillator is advantageous in ultra-high frequency receivers, since the oscillator has greater output and stability when operating at a lower frequency. Let us see the reason for this. The difference between "low side" (or lower-frequency) oscillator operation and "high side" (or higher-frequency) oscillator operation amounts to twice the intermediate frequency. Therefore, in a standard broadcast-band receiver employing the usual 455 kc. i.f., the frequency advantage gained by low-side oscillator operation would be only  $455 \times 2 = 910$  kc. The benefits of such operation would be negligible! The difference in efficiency also would be negligible. On the other hand, in a u.h.f. receiver employing a much higher i.f., say 5 megacycles, the difference of  $5 \times 2 = 10$  mc. between the two methods of oscillator operation could result in a considerable improvement in oscillator performance if the "low-side" mode of operation is employed.

The special oscillator-preselector tracking problems encountered in receivers that employ push-button station selection will be explained in the next article of this series.

(To be continued)

### Photo Credits

Page	Credit
25, 26 (top, bottom right), 27 (center), 28 (center, bottom left), 29 (top, bottom right), 30... U. S. Navy	
26 (center, bottom left and center), 27 (top, bottom), 29 (bottom left)	U. S. Army Air Forces
31	Supreme Instruments Co.
41, 42, 43	G. Haug
58	General Electric Co.
92	Paul Guilmette, Inc. (CNS)
96	U. S. Army Signal Corps
114	RCA Victor Division, RCA
120	Westinghouse Electric Corp.
146	Maguire Industries, Inc.

# RADOLEK

## Radio-Electronic Service Parts



Large stocks assure the finest and most complete selections of all available items at lowest prevailing prices. Thousands of active buyers depend on us for their entire Radio repair and replacement requirements. Because we understand service problems, every order is expedited for delivery in double quick time. Everything we do is planned for convenience and satisfaction to our customers. You will find it profitable to make Radolek your buying headquarters.

### FREE BUYING GUIDES

Because of existing conditions we keep our customers right up to the minute on available merchandise by releasing supplements frequently instead of sending our regular Big Profit Guide once a year. Send the coupon now to get these Free Buying Guide Supplements as they are issued.

FREE!



### FAST SERVICE!

RADOLEK CO., Dept. B-107  
601 W. Randolph St., Chicago 6, Ill.

Please send FREE Buying Guide Supplements

NAME \_\_\_\_\_  
ADDRESS \_\_\_\_\_

### ORDER FROM RADOLEK

## THIS MULTITESTER IN STOCK IMMEDIATE DELIVERY

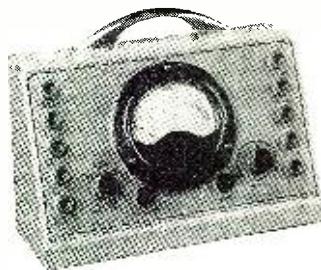

YOUR COST ONLY

\$18.75

Less Test Leads

Model No. MT 100

### UNCONDITIONALLY GUARANTEED SATISFACTION OR MONEY BACK

Latest meter design in all metal case; compact-rugged; the answer to your need for an all purpose, accurate Multitester. Case measures 3 1/2" x 8" x 5". Complete with self-contained batteries.

## RADIO REPAIR MEN ORDER THIS TESTER TODAY

OMAHA RADIO PRODUCTS CO.  
300 Saunders-Kennedy Bldg.  
Omaha, Nebraska

Enclosed is full remittance of \$18.75, or my Deposit of \$..... and ship Multitester #MT 100 C.O.D. for balance.

NAME \_\_\_\_\_

ADDRESS \_\_\_\_\_

CITY \_\_\_\_\_ STATE \_\_\_\_\_

# INDEX OF

# Advertisers

Oct.  
1945

ADVERTISER	AGENCY	PAGE	ADVERTISER	AGENCY	PAGE
Aerovox Corporation	Austin C. Lescarboursa & Staff	161	Murdock, Wm. J. Company	John A. Smith & Staff	86
Air Personnel & Sales, Inc.		153	McElroy Manufacturing Corp.	Shappe-Wilkes, Inc.	154
Alliance Manufacturing Company	Foster & Davies, Inc.	102	McGee Radio & Elec. Co.		124, 154, 155
Allied Radio Corporation	Henry H. Teplitz	9, 100	McGraw-Hill Book Company		132
American Phenolic Corporation	Evans Associates, Inc.	81	McMurdo Silver Company	Stentor Company Adv. Agy	86
American Radio Institute	Sternfield-Godley, Inc.	156			
Ashbach, Leonard Company	Lieber Advertising Company	124			
Audak Company	Hart Lehman	8			
Audel Publishers	Grant & Wadsworth, Inc.	134			
			National Company	Graydon Smith Advertising	10
Bell Sound System, Inc.	Wheeler, Kight & Gainey, Inc.	116	National Radio Institute	Van Sant, Dugdale & Co.	3
Bell Telephone Laboratories	Ayer, N. W. & Sons, Inc.	162	National Schools	Mayers Company, The	22, 23
Belmont Radio Corporation	Leaumont & Hohman, Inc.	127	National Union Radio Corporation	Hutchins Adv. Agy	109, 157
Best Vibrator Co.		153	Nelson Company	A. N. Baker Advertising Agy	153
Bliley Electric Company	Hardy Advertising	133	Newcomb Audio Products Co.	Gail Hall Advertising	152
Brach, L. S. Mfg. Corporation	United Advertising Agency	94			
Buffalo Radio Supply	International Advertising Agy	118	Ohmite Manufacturing Co.	Henry H. Teplitz	59
Eurgess Battery Company	Howard H. Monk & Associates	84	Olson Radio Warehouse	Jessop Advertising Agency	136
Burstien-Applebee Company	Whalen, Frank E. Adv. Co.	138	Ornaha Radio Products Company		159
			Onan, D. W. & Sons	Graves & Associates	122
Candler System Company	Van De Mark Advertising	152	Permoflux Corporation	Turner Advertising Agency	78
Capitol Radio Engineering Institute	Henry J. Kaufman Associates	77	Precision Instrument Co.	Reuben Barrow Advertising	123
Chicago Novelty Company, Inc.	Sander Rodkin Adv. Agency	130			
Cinaudagraph Speakers, Inc.	Michael F. Mayger	108			
Clare, C. P. & Co.	Hamilton Advertising Agy, Inc.	149	RCA Institutes, Inc.		159
Concord Radio Corporation	E. H. Brown Advertising Agy	60	R-L Electronic Corporation	R. S. Wittenberg Advertising	133
Cornell-Dubilier Electric Corp.	Reiss Advertising	65	Radiart Corporation	Kenneth H. Kolpien	117
Coyne Electrical School	McJunkin Advertising Co.	132, 152	Radio Corporation of America		
Coyne Electrical School	Phil Gordon Agency, The	128, 159	Victor Division	Kenyon & Eckhardt, Inc.	21, 90, 91, Back Cover
Crabtree's Wholesale Radio		156	Radio Corporation of America	J. Walter Thompson Co.	61
			Radio Kits Company	Edward Hamburger	142
DeForest's Training, Inc.	MacDonald-Cook Company	15	Radio Mfg. Engineers, Inc.	Rudolph Bartz Advertising	98
Drake Electric Works, Inc.	William Hoffman & Associates	136	Radio Merchandise Sales	Daniel de Koven Advertising	145
DuMont, Allen B., Laboratories, Inc.	Austin C. Lescarboursa & Staff	101	Radio Parts Company	Sidney S. Lovitt	114
Duotone Company	Maxon, Inc.	147	Radio Supply & Engineering Co., Inc.	Karl G. Behr	106
			Radio & Television Supply Co.		153
Eastern Amplifier Corporation	Roberts & Reimers, Inc.	63	Radio Wire Television, Inc.	Diamond Seidman Co.	96
Echophone Radio Company	Burton Browne Advertising	89	Radionic Equipment Company	Hirshon-Garfield, Inc.	156
Electrical Reactance Corporation	Scheel Advertising Agency	154	Radolek Company	Turner Advertising Agency	153
Electronic Laboratories, Inc.	Burton Browne Adv. Third Cover		Raytheon Manufacturing Company	Burton Browne Advertising	85
Electronic Service & Supply	Burke & Wayburn Adv. Co.	150	Raytheon Manufacturing Company		157
Electro-Voice Corporation	Henry H. Teplitz	143	Rider, John F. Publisher, Inc.	Lansford F. King	155
			Roburn Agencies, Inc.	Reiss Advertising	154
Fada Radio & Electric Co., Inc.	Sternfield-Godley, Inc.	6	Rowe Industries	Miller Agency Company, The	144
Farnsworth Television & Radio Corporation	Ayer, N. W. & Sons, Inc.	135			
Federal Telephone & Radio Corp.	Marschalk & Pratt Co.	69, 119	Sargent, Lester L.		154
Federated Purchaser, Inc.	Burke & Wayburn Adv. Co.	156	Sauereisen Cements Company	McCarty Company	159
Freed Radio Corporation	Lawrence Fertig & Co., Inc.	158	Shure Brothers	Phil Gordon Agency, The	137
			Simpson Electric Company	Kreicker & Meloan, Inc.	97
Gates Radio Co.	The Ridgeway Company	111	Slater, N. G. Corp.	Kermin-Thall	153
General Cement Mfg. Co.	Turner Advertising Agency	122	Solar Manufacturing Corp.	O. S. Tyson & Company, Inc.	13
General Test Equipment Co.	Suzanne B. Hayman	154	Sound Equipment Corp. of Calif.	Beaumont & Hohman, Inc.	74
Greenlee Tool Company	Howard H. Monk & Associates	140	Sperry Gyroscope Co., Inc.	Young & Rubicam, Inc.	95
			Sprague Products Company	Harry P. Bridge Co., The	20, 93
Hallicrafters Company, The	Burton Browne Advertising	5, 18	Sprayberry Academy of Radio	Harry P. Bridge Co., The	19
Hammarlund Mfg. Co., Inc., The	Roeding & Arnold, Inc.	24	Standard Transformer Corp.	Burnet-Kuhn Advertising	62
Hanlan Company		156	Stark's	A. L. Addison Adv. Counsel	152
Harco Co., Inc.	Lewis Advertising Agency	142	Stevens Walden, Incorporate	Howard-Wesson Co.	16
Harvey Radio Company	Shappe-Wilkes, Inc.	92	Stromberg-Carlson	McCann-Erickson, Inc.	125
Hytron Radio & Electronics Corp.	Henry A. Loudon Advertising	87	Superior Instruments Company	Loewy Advertising Agency	115
			Supreme Instruments Corporation	O'Callaghan Advertising Agy	14
Illinois Condenser Company	Sander Rodkin Adv. Agy	140	Supreme Publications	Henry H. Teplitz	88
International Detrola Corporation	Zimmer-Keller, Inc.	113	Sylvania Electric Products, Inc.	Newell-Emmett Company	107
Islip Radio Mfg. Corporation	Kotula Company	148			
			Talk-A-Phone Mfg. Company	Dwight M. Blish	146
Jensen Radio Manufacturing Co.	Burton Browne Advertising	7	Technical Division Murray Hill Books, Incorporated	Harry P. Bridge Co., The	72, 73
Johnson, E. F. Company	David, Inc.	79	Television Tech Enterprises		150
			Templetone Radio Mfg. Corp.	Peck Advertising Agency	71
Kaar Engineering Co.	Conner Company, The	121	Terminal Radio Corporation	Sternfield-Godley, Inc.	151
Kato Engineering Co.		134	Thordarson Electric Manufacturing Division Maguire Industries, Inc.	Park City Advertising Agency	131
Kelnor Manufacturing Company	Kelso Norman Advertising	144	Triplett Electrical Instrument Co.	Western Advertising Agency	123
Kurz-Kasch, Inc.	Kircher, Lytle, Helton & Collett	139			
			United Radio Corporation		150
Lake Radio Sales Co.	Sander Rodkin Advertising Agy	80	United Catalog Publishers, Inc.	Daniel de Koven Advertising	110
Lecrohm, Incorporated	Merchandising Advertiser	148	United Transformer Corp.	Shappe-Wilkes, Inc.	11
Lectrolab Products	Sander Rodkin Advertising Agy	112	Universal Instrument Company		126
Levay Mfg.	Frizzell Advertising Agy, Inc.	152	Ungar Electric Tools, Inc.	Milton Weinberg Adv. Co.	120
Lifetime Sound Equipment Co.	Miller Agency Company, The	112	Utah Radio Products Company	Abbott Kimball Co., Inc.	75
Lincoln Engineering School	Buchanan Thomas Adv. Co.	154			
			Ward Leonard Electric Co.	E. M. Freystadt Associates, Inc.	67
Mackay Radio & Telegraph Co., Inc.	Marshall & Pratt Co.	153	Ward Products Corporation, The	Burton Browne Advertising	102
MacMillan Company, The	Atherton & Currier, Inc.	150	Warner Electric Company	Mason Warner Co.	128
Mallory, P. R. & Co., Inc.	Aitkin-Kynett Co.	99	Weller Manufacturing Company		108
Manor Electric & Appliance Co.	Sander Rodkin Adv. Agy	158	Westinghouse Electric Corporation	Fuller & Smith & Ross, Inc.	105
Marion Electrical Instrument Co.	Shappe-Wilkes, Inc.	17	Wholesale Radio Laboratories	Pfeiffer Advertising Agency	104
Meck, John Industries	Fensholt Co., The	Second Cover	Wiley, John & Sons, Inc.	Ray-Hirsch & Waterston	150
Meissner Manufacturing Co.	Gardner Advertising Co.	103	Workshop Associates	Larcom Randall	126
Midwest Radio Corporation	Savage & Talley	141			
Miles Reproducer Co., Inc.	Altomari Advertising Agency	154			
Millen, James Mfg. Co., Inc.	Millen, James, Inc.	12			



# AERVOX "Know-How"

Aerovox "Know-How" in action: Chief Engineer Stanley Green (center) with Joseph L. Collins (Electrolytics), Louis Kahn (Assistant Chief Engineer) and Samuel Heyman (Production Manager) working out the capacitance problem of a customer from the application blueprints.



## ... can save you untold time, expense, trouble

• Ingenuity, imagination, versatility, adaptability, coupled with sound engineering practice, add up to Aerovox "Know-How."

Of course Aerovox has an outstanding line of standard capacitors—paper, oil, electrolytic, mica and low-loss ultra-high-frequency types. A wide range of requirements are met with such a variety of listings. But Aerovox can also meet most extraordinary needs with special types that do not have to be billed at usual special prices. Here's why:

A tremendous variety of cans, terminals, insulators, mountings and production processes at the disposal of Aerovox engineers enables Aerovox to make up special types quickly, readily, inexpensively. So:

Bear in mind Aerovox "Know-How"—and save untold time, expense, trouble.

• Try us on that capacitance problem.

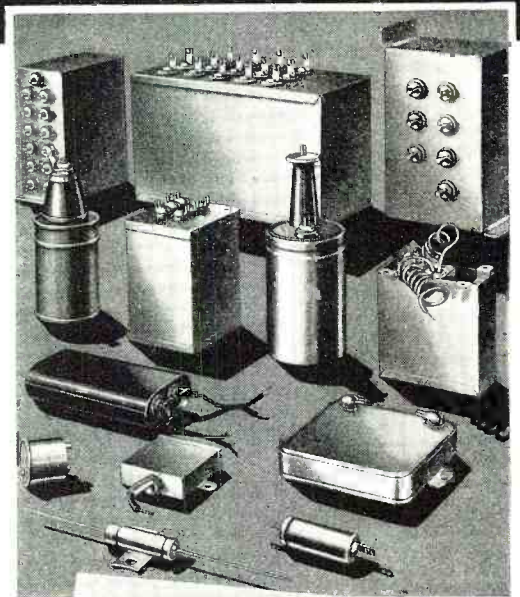

Typical "special" capacitors assembled from standard Aerovox parts, indicating the wide variety of cans, terminals, insulators and mountings.



# Capacitors

INDIVIDUALLY TESTED

AEROVOX CORPORATION, NEW BEDFORD, MASS., U. S. A.

SALES OFFICES IN ALL PRINCIPAL CITIES

Export: 13 E. 40 St. NEW YORK 16, N. Y. • Cable: 'ARLAB' • In Canada: AEROVOX CANADA LTD., HAMILTON, ONT.

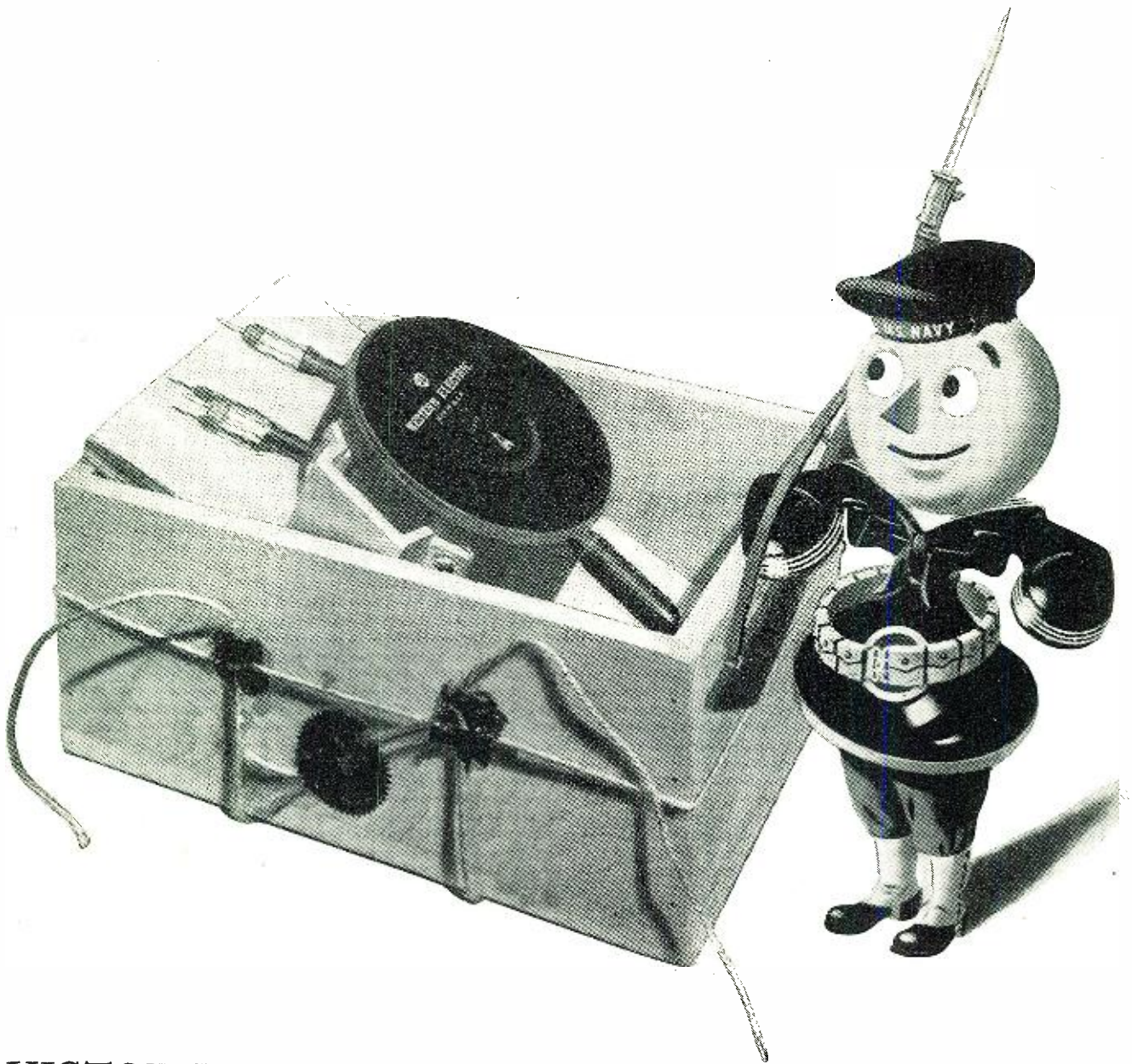

## VICTORY REVEALS A MYSTERY

More than two years ago, an engineer of the Laboratories visited *U.S.S. Boise*, returned with a mysterious box which went into the Laboratories' vault. Now, victory opens the box and discloses a special kind of electron tube called a magnetron. It was part of a Radar which furnished data to aim *U.S.S. Boise's* guns during the night action off Savo Island on October 11-12, 1942. Because of the high frequency generated by this magnetron, the Radar was not detected by the enemy and the action was a complete surprise. Six Japanese warships were sent to the bottom of the sea.

This magnetron is a symbol of the Laboratories' enormous war program. Half of it was devoted

to Radar, the other half gave birth to radio transmitters and receivers, sonar apparatus for the Navy, loudspeaker systems for ships and beach-heads, fire-control apparatus for anti-aircraft artillery. Coming months will unfold the story of these and many other contributions of the Laboratories to the victory of our arms.

Bell Telephone Laboratories' war work began before the war; until now, it claimed practically all our attention. With victory, we will go back to our regular job—helping to bring you the world's finest telephone service.

**BELL TELEPHONE LABORATORIES**



Exploring and inventing, devising and perfecting, for continued improvements and economies in telephone service.

Printed in U. S. A.

**RADIO NEWS**

# WHY CARRY LARGE VIBRATOR STOCKS?



... when **4** E-L Vibrators Meet 95%  
of All Auto Radio Replacement Needs!



**Y**ES, it's true! You need stock only *four* models of E-L Vibrators to serve the 1,122 auto-radio models comprising 95% of the replacement demand! Result: much smaller inventory, faster turnover, and greater profits for dealers and distributors.

**Standardization with Higher Quality**—This unique E-L Vibrator standardization plan is the product of exhaustive research into auto-radio requirements . . . and of adapting to those requirements E-L models whose design and exclusive features have been perfected and proved in the toughest military applications.

These E-L Vibrators are of the balanced resonance type, with 8 contacts instead of 4—*twice* as many as other makes.

Tests show they provide 33% *longer vibrator life*, with output and starting voltages held virtually constant at all times.

**See Your E-L Distributor**—Your E-L distributor will fill your orders as soon as possible, considering the fact that his stocks are limited due to military demands.

With your order, you'll receive your copy of the new E-L Auto-Radio Vibrator Replacement Guide. Designed to hang on your wall, it will tell you instantly which E-L Vibrator to use for most auto-radios as far back as 1936. See your E-L distributor!



**Electronic**  
LABORATORIES, INC.  
INDIANAPOLIS



# The **RCA** 155-C – A Versatile OSCILLOSCOPE

WHEREVER a general-purpose oscilloscope is required, the RCA 155-C is the choice. Designed for simple operation, faithful reproduction, accurate comparisons, and quick results, this oscilloscope is fast becoming standard equipment in laboratories and service shops.

The 155-C is different from other 3" oscilloscopes because it includes a built-in light shield, removable graph screen, direct deflector connection, binding jacks (a combination binding-post and pin jack), a 6-volt AC terminal, and an improved-timing axis oscillator.

Completely portable and attractively cased, this instrument is priced within the reach of owners of small shops and laboratories.



MAIL THE COUPON FOR FURTHER TECHNICAL DETAILS

Test and Measuring Equipment Section  
Radio Corporation of America  
Camden, N. J.

Please send me information about the RCA 155-C Oscilloscope.

Name .....

Street Address .....

City and State .....

155-BB



**RADIO CORPORATION  
OF AMERICA**

RCA VICTOR DIVISION • CAMDEN, N. J.

In Canada, RCA VICTOR COMPANY, LIMITED, Montreal