

RADIO NEWS

NSE

APRIL
1941
25c
In Canada 30c



Testing Vibrators
in the Factory

beginning

The 1941 Super Superheterodyne

MIDGET HAM STATION FROM SPARE PARTS

CRYSTAL-CONTROLLED AMATEUR FM TRANSMITTER

AN AUDIO CYCLE COUNTER ★ BUILD A CONDENSER ANALYZER

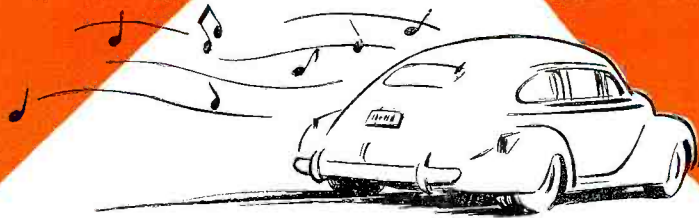

*Send Them Away Happy...
and Keep Them Happy...with*

P. R. MALLORY & CO. Inc. **MALLORY VIBRATORS**

It's easy to send customers away happy when you have corrected a vibrator failure with the exact Mallory Vibrator required. But the important fact is that the long life and dependable performance of Mallory Vibrators is sure to keep your customer happy . . . and make you his first thought when his home receiver needs service.

Mallory has simplified vibrator replacement to its greatest practical extent. As the makers of vibrators for the great majority of all auto radios, Mallory has standardized vibrator application wherever possible. On the other hand . . . circuits requiring special design have not been ignored. The result is the most practical balance possible between the variety of types and the requirements of exact replacement.

Depend on Mallory for every vibrator replacement in auto radios or battery operated receivers. They cost no more!

P. R. MALLORY & CO., Inc.
INDIANAPOLIS, INDIANA
Cable Address—PELMALLO



It's FREE
Only a few copies left. See your distributor now for your 1941 Vibrator Guide.

*More than ever
—INSIST ON*

P. R. MALLORY & CO. Inc.
MALLORY
APPROVED
PRECISION PRODUCTS

**VIBRATORS • VIBRAPACKS • CONDENSERS •
VOLUME CONTROLS • ROTARY SWITCHES •
SINGLE AND MULTIPLE PUSH BUTTON SWITCHES
• RESISTORS • RADIO HARDWARE**

Yours AT NO EXTRA COST.... A complete full-length Book on Photographic Exposure!

PROFUSELY ILLUSTRATED with pictures, charts, tables, diagrams, etc.!



	4	8	16	32	64	128	256
0.4	0.24	0.36	0.48	0.60	0.72	0.84	0.96
0.5	0.30	0.45	0.60	0.75	0.90	1.05	1.20
0.6	0.36	0.54	0.72	0.90	1.08	1.26	1.44
0.7	0.42	0.63	0.84	1.05	1.26	1.47	1.68
0.8	0.48	0.72	0.96	1.20	1.44	1.68	1.92
0.9	0.54	0.81	1.08	1.36	1.62	1.89	2.16
1.0	0.60	0.90	1.20	1.50	1.80	2.10	2.40
1.1	0.66	0.99	1.32	1.65	1.98	2.31	2.64
1.2	0.72	1.08	1.44	1.80	2.16	2.52	2.88
1.3	0.78	1.17	1.56	1.95	2.34	2.73	3.12

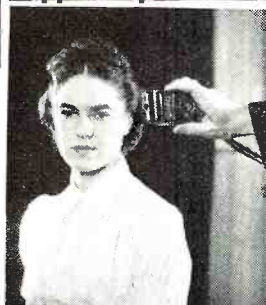

COLOR	BRIGHTNESS	BEST FRAME	EXPOSURE	SPEED
RED	100	37	1/50 Sec	63
ORANGE	250	40	1/50 Sec	9
YELLOW	320	36	1/50 Sec	5.6
GREEN	250	40	1/50 Sec	9
BLUE	320	44	1/50 Sec	14
OVERALL	100	35	1/50 Sec	5

HERE'S A PARTIAL LIST OF CONTENTS:

- Camera Settings Simplified
- Consider the Film's Problem
- What Is Incorrect Exposure?
- Substitute Measurements for Judgment
- What is an Electric Eye?
- Measuring Illumination and Brightness
- How to Hold an Exposure Meter
- Making Uniform Negatives With a Movie Camera
- The Science of Exposure
- Make Your Meter Direct Reading
- Improving Negative Sharpness
- Measuring Film Densities
- Negative Range Measurement
- Reading the Negative
- Lighting for Color Filters
- Scene Brightness Range Exposure
- Texture Scenes
- Portraits
- Night Photography in Color
- Projection Data
- Emulsion Speed Values for Various Colors
- The Art of Exposure
- Photographic Quality
- Controlling Scene Lighting
- Fitting the Scene to the Paper
- Special Photographic Effects
- Color Separation Negatives
- Differences Between Color and Black-and-White Exposure Technique
- Emulsion Speed Values
- Light in Photography
- Brightness versus Illumination

THIS BIG, SPECIAL BOOK INSERT COMES AS AN ADDED FEATURE OF THE APRIL POPULAR PHOTOGRAPHY AT NO EXTRA COST TO YOU!

Do you want to learn how to take better pictures? Do you want to avoid unnecessary work, costly mistakes, and disappointments with your camera? Let the *Manual of Correct Exposure for Film and Paper*, by H. P. Rockwell, Jr., guide you to good pictures twelve months of the year. Here, in one complete volume, is more practical, reliable information on photographic exposure than in any other book ever published. The convenient detailed table of contents enables you to get, immediately, the exact information you need about exposure indoors and outdoors, still or movie, black-and-white or color!

IT'S NEW FROM COVER TO COVER!

Now you can stop searching for reliable directions through dozens of incomplete books. This new and informative volume, authored by H. P. Rockwell, Jr., B. S., M. E., tells you all you need to know for correct exposure under any conditions. Everything explained minutely; made even clearer by a profusion of pictures, charts, diagrams, tables, etc.

MAKE SURE OF YOUR COPY NOW!

Imagine! This valuable full-length book, bringing you all the answers to every photographic exposure problem, simply, clearly, thoroughly, is yours at no extra cost! Yes, this big, special 35,000-word insert comes as part of the April issue of POPULAR PHOTOGRAPHY . . . a bonus unprecedented in photographic magazine history. Don't fail to take advantage of this spectacular value!

AT ONLY 25c for both the magazine and the special book insert, this is one of the greatest bargains ever offered to camera owners. The print order of this gigantic bonus issue is limited, so act promptly! Go to your newsstand or camera store and get your copy at once!

APRIL ISSUE

Popular Photography

NOW ON SALE AT ALL NEWSSTANDS AND CAMERA STORES! 25c



BY THE EDITOR

COMPLETING a 2200 mile visit through the East, we were more than happy to discover conditions in the radio industry improving by leaps and bounds. Of course, this is not the first time in the short history of the trade that it has taken a tremendous upswing. Howsoever, we were happy to find it in the condition of a lustily bawling brat, replete with growing pains, squawks, and all the signs of good health. One of the surest exhibits of prosperity was the griping we encountered from factory production managers complaining of a lack of raw materials with which to complete orders. Closer questioning elicited the information, however, that government orders, at least, were all being completed on time and that raw material was forthcoming whenever it was actually needed.

Some factories are operating entirely on "priorities," and no material is being furnished for civilian use. Other factories are operating strictly for National Defense purposes, only, but are able to keep up their civilian contracts by working their help late and paying them over-time. Throughout the note was extremely optimistic, and we were greeted with smiles; and a general feeling of well-being seems to permeate the field.

* * *

EVERYWHERE on our trip, manufacturers told us that they had acquired a silent but nevertheless highly potent partner. This was the *F. B. I.* whose agents appear in every factory operating on National Defense orders. In some cases, the names and the personnel of the *F. B. I.* were known to the manufacturer and, in other cases, their presence was known but the actual persons were not. *F. B. I.* men in factories are engaged in ferretting out sabotage (if any), subversive activity between the workers and, most especially, in preventing unwanted people from viewing the work being done. Some radio factories require identification buttons, although this practice has not extended to the remoter areas. Fingerprinting, in general, has not taken place in the industry although several large firms have reported that some of their employees have been required to file their prints. All employees must be citizens of the United States and a questionnaire is filled out which is duly forwarded to the *Federal Bureau of Investigation.*

* * *

SO great a demand for radio personnel of even limited technical ability has made itself felt in the industry, that jobbers are discovering it increasingly difficult to obtain men to wait on customers, only. Salaries have increased in some cases proportionately, although the figures for the average

(Continued on page 49)



Trade-Mark Registered

Including Articles on POPULAR TELEVISION

The Magazine for the radio amateur experimenter, serviceman & dealer

VOL. 25, NO. 4

Contents for April, 1941

FEATURES

- RADIO NEWS Super Superheterodyne, Part 1** **6**
 Karl A. Kopetzky, W9QEA & Oliver Read, W9ETI
 Constructing a receiver which literally has "everything."
- As I See It!** **10**
 John F. Rider
 Serviceman subjects discussed in the author's usual terse manner.
- Condenser Analyzer** **11**
 M. J. Butkiewicz
 Testing a capacitor for power factor and leakage while in the circuit.
- High Fidelity Pre-Amplifier** **12**
 C. G. Sims & C. B. Lester, W9ECN
 A neat unit for the broadcaster, amateur or recordist.
- Midget Transmitter-Receiver from Spare Parts and Tubes**
 **15**
 William D. Hayes, W6MNU
 Instead of swapping those spare parts, build a ham station with them.
- An Experimental Crystal-Controlled Amateur F.M. Transmitter**
 **17**
 Karl A. Kopetzky, W9QEA
 An experimental rig which is at once crystal-controlled, yet is F.M.
- Build Your Own Recording Studio, Part 4** **20**
 Oliver Read, W9ETI
 Concerning the mysteries of constant amplitude vs. constant velocity recording.
- An Audio Cycle Counter** **28**
 Rufus P. Turner, W1AY
 An unusual unit which does away with listening for null points.
- Communications and Electronic Maintenance, Part 6** **36**
 W. H. Bohlke
 How to use the completed service bench to best advantage.

Cover Picture: Courtesy of P. R. Mallory & Co., Inc.
Testing vibrators in the factory.

DEPARTMENTS

- | | | |
|--|---------------------------------------|---------------------------------------|
| Book Review 40 | QRD? 35 | Police Radio 26 |
| What's New in Radio . . . 24 | Bench Notes 27 | Serviceman's Experiences 19 |
| Radio Physics Course . . . 53 | Manufacturer's Literature 40 | Serviceman's Cases . . . 66 |
| Hamchatter 32 | Aviation Radio 23 | The Video Reporter . . . 23 |
| Serviceman's Legal Advice 31 | Washington Communication 14 | Ringling the Bell 38 |

Copyright 1941,
 ZIFF-DAVIS PUBLISHING COMPANY
 Member of the Audit Bureau of Circulations

RADIO NEWS is published monthly by the Ziff-Davis Publishing Company at 608 S. Dearborn St., Chicago, Ill., William B. Ziff, Publisher; B. G. Davis, Editor; J. Fred Henry, Business Manager; Karl A. Kopetzky, W9QEA, Managing Editor; Oliver Read, W9ETI, Technical Editor; Raymond Frank, W9JLJ, Laboratory Technician; Herman R. Bollin, Art Director; S. L. Cahn, Advertising Manager. New York Office, 381 Fourth Ave. Subscription \$2.50 per year; single copies, 25 cents; foreign postage \$1.00 per year additional, Canada 50c additional. Subscribers should allow at least 2 weeks for change of address. All communications about subscriptions should be addressed to: Director of Circulation, 608 S. Dearborn St., Chicago, Ill. Entered as second class matter March 9, 1938, at the Post Office, Chicago, Illinois, under the Act of March 3, 1879. Contributors should retain a copy of contributions. All submitted material must contain return postage. Contributions will be handled with reasonable care, but this magazine assumes no responsibility for their safety. Accepted material is subject to whatever adaptations, and revisions, including "by-line" changes, necessary to meet requirements. Payment will be made at our current rates upon acceptance and, unless otherwise specified by contributor, all photographs and drawings will be considered as constituting a part of the manuscript in making payment.

DAVEGA AMATEUR RADIO—63 CORTLANDT ST., N.Y., N.Y.
(DIVISION OF DAVEGA CITY RADIO—WORLD'S LARGEST RADIO DEALER)

NEVER BEFORE!

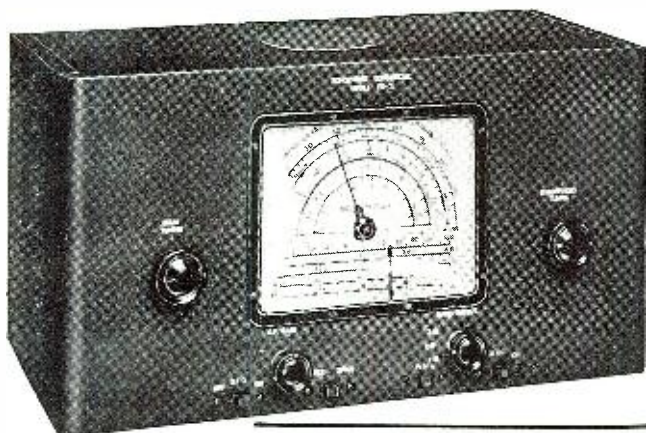

- Crystal filter (four-position variable selectivity).
 - Calibrated bandspread.
 - Automatic noise limiter.
 - Preselection all bands
 - Two stage IF amplifier.
 - Fly-wheel tuning
 - Separate 6-inch PM speaker.
 - CW Monitor.
- 49.95

ECHOPHONE Commercial

- Preselection on all bands
- Calibrated bandspread
- Automatic noise limiter

8 Tubes, 3 bands, covers 545 to 2100 kc.—2.1 to 8.1 mc.—7.9 to 30.5 mc. 5" PM dynamic speaker mounted in cabinet. Calibrated bandspread scale on 80/40/20/10 meter amateur bands. Electrical bandspread at all frequencies in the tuning range. Operates on 115 volts alternate current or direct current. Available also for operation on higher voltages with resistance cord.

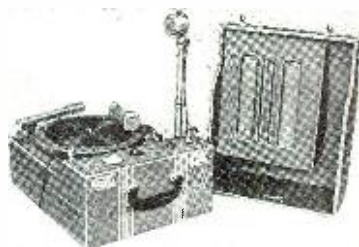

**PRESTO
MODEL K RECORDER**
 World's Most Complete Stock
 Send to DAVEGA for free
 catalog

- Other Recorders
- FEDERAL
 - ORPHEON
- 16" & 12" Turntables

HALLICRAFTERS NEW FM/AM



Tunes to 165 mc. ★ Covers FM Relay Frequencies. Model S-27B operates on 3 bands; 36 to 60 mc; 56 to 94 mc; 92 to 165 mc; Switch changing from FM to AM reception. R.F. Amplifier 1st detector and oscillator are high frequency, 15 tubes.

FINEST McMURDO CHASSIS EVER BUILT!

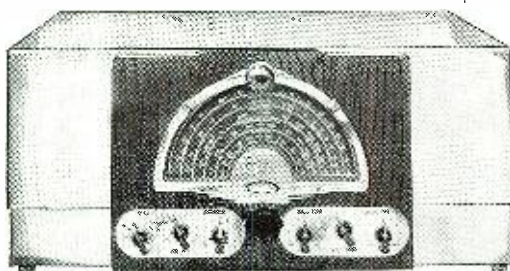

Two R.F. Stages
 Variable Selectivity
 Giant Jensen 18" Speaker
 Finest Shielding
 34 Watts Undistorted
 Built to Sell for \$350.00
\$189.50
 Complete including
 18" Speaker made by
 Jensen

A Really Wonderful Value!

- Ten independent ranges—Six general, four amateur band-spread
- Full vision velvet vernier dial—ratio 30 to 1
- Sensitivity—better than one microvolt
- Signal to noise ratio better than 30 db. at ten meters
- Stability—3 parts in 100,000 with a 20 volt line fluctuation
- Wide range crystal filter with rejection ratios as high as 10,000 to 1
- Low drift temperature compensation
- Series valve noise limiter
- Crystal clear tone with 8 watts undistorted output
- Amateur net price with speaker in cabinet—\$147.50



AMATEUR DIVISION, 63 Cortlandt St., N. Y., N. Y.
World's Largest Radio Dealer

DAVEGA

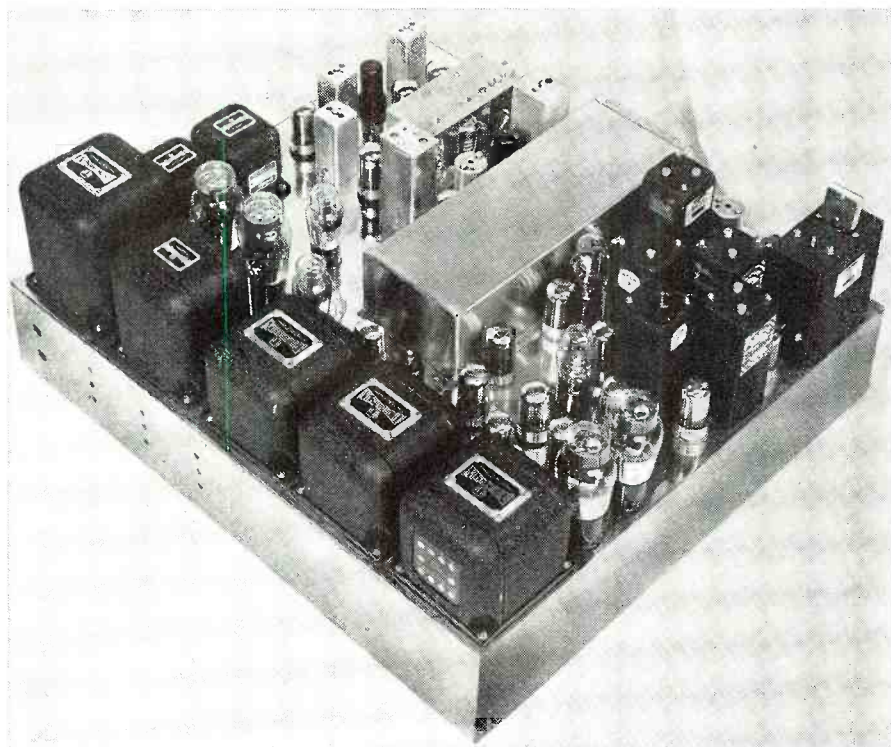

The chassis is of brass, reinforced. The units are all designed for overloads. All tubes are laid out for the shortest possible leads.

ble-shooting, should any develop, can reasonably be handled with the usual test instruments, and either "signal-tracing" or "H & F" (Hunt & Find) systems may be used.

Parts are not made to do double-duty, and most tubes are operated at their lowest ratings, the preference being towards *more* tubes, rather than overloaded ones.

Actually the receiver is the result of a long series of conferences between the authors and engineers, factory production, and manufacturers. Each of these has contributed a little to the unit. Nor have contemporary magazines been neglected, and due credit must be given to "RADIO," "QST," "ELECTRONICS," "RCA REVIEW" and "IRE PROCEEDINGS" to mention just a few. While on the subject of credits, one would have also to mention the *Radio Manufacturing Engineers* of Peoria, Illinois; *The National Company* of Malden, Mass., and *The Hallicrafter's, Inc.*, of Chicago, Illinois, all of whom contributed much to make the receiver a success. Thanks should also go to those of the Parts Manufacturers who generously contributed some of the component parts appearing in the various parts lists, and to the *Par-Metal Co.*, of Long Island City, N. Y., who made up the special cabinet.

There are many features of the receiver which will be discussed as the articles proceed, but the outstanding 23 are here given below:

(1) *Band coverage divided in six bands.* In the a.m. spectrum: 540 kcs. to 1580 kcs., 1500 kcs. to 4500 kcs., 4100 kcs. to 12200 kcs., 7300 kcs. to 18800 kcs. and 11200 kcs. to 31600 kcs. In the f.m. band: 50 to 42 megacycles. It will be noted that coverage in the a.m. spectrum overlaps one band with another, and creates sufficient spread in each band adequately to cover that band. The

f.m. spectrum is covered for the present f.m. assignment.

(2) *Two stages of r.f. amplification* are included ahead of the first detector. These two stages will afford excellent selectivity and will give a signal to image ratio equal to the best available commercial receiver.

(3) *Regeneration is included in the i.f. transformer stages*, thoroughly controllable. That, we felt, coupled with the two stages of r.f., should afford the razor-sharp selectivity so necessary for reception in the congested amateur bands of today.

(4) *Variable i.f. band width.* The i.f. transformers which are used in the "Super Superheterodyne" are of the variable band width type, controlled by a panel switch. Three widths, conveniently termed "broad," "medium," and "sharp," are available. In the "broad" position, music is best received, while the "sharp" position is for communication work on c.w.

(5) *An "R," meter* has been provided to read the signal strength of the received signals. This is a convenience familiar to many amateurs and also to the professional radio man. With a slight change, the input "R" meter can be calibrated so as to read the signal in microvolts. The calibration, however, was not attempted in the laboratory unit because of a lack of facilities.

(6) *To match the "R" meter*, is a *d.b.-v.u. meter* to read the output of the audio frequency amplifier channel. This meter is convenient for the recording of broadcasts, or to indicate the level into a telephone line. Its greatest use, however, will be for recording. (A minor point, perhaps, but nevertheless one which we

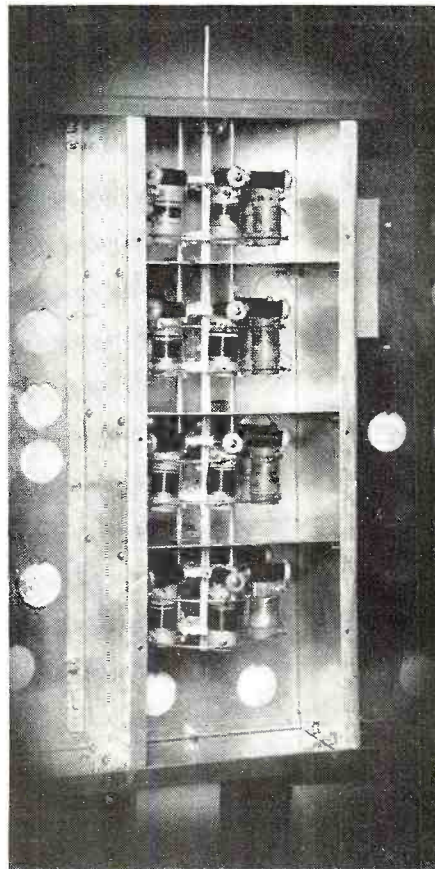

The coil compartment is built of sheet brass and reinforces chassis.

The coil compartment with its cover in place. Holes are to tune padders.

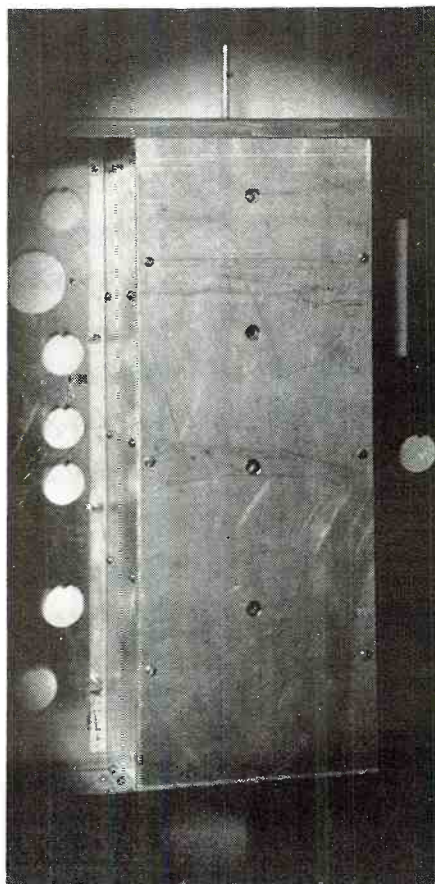

thought should be included in any "dream" receiver.)

(7) A variable automatic volume control has been included. This is a tap switch selecting capacities which vary the time lag of the a.v.c. circuit. The advisability of such a control for the reception of extremely weak varying signals is apparent and obvious. Personally, we have always felt that it was not enough to have an a.v.c. "on and off" switch (which also is included) but that a certain amount of intermediary control over the a.v.c. circuit itself should be afforded. It was with this purpose in mind that the variable a.v.c. control was included.

(8) Following the best commercial example, an automatic squelch is included. It is true that few amateurs are familiar with, nor are there many amateurs using, the squelch circuit. We believe that it will become more popular in the future. Its greatest use is in communications work, especially where the receiver is "standing by," the operator waiting for a carrier of known frequency to come on the air. During the period that the receiver is "standing by" and the carrier of the distant station is not on the air, the receiver is automatically silenced. The transmitted carrier trips the squelch circuit and makes the receiver

operative. Especially is the squelch circuit useful when operating near the owner's transmitter frequency, since it will automatically "kill" the receiver during transmission. Those operators who are accustomed to listening in on the airplane or marine stations will find the squelch circuit invaluable to them as a saver of nerves.

(9) In order to take fullest advantage of the audio channel, an automatic volume expansion circuit has been included with suitable controls. It is a well-known fact that broadcast stations in general use modulation compressors so as to stay within the 100 per cent modulation limits im-

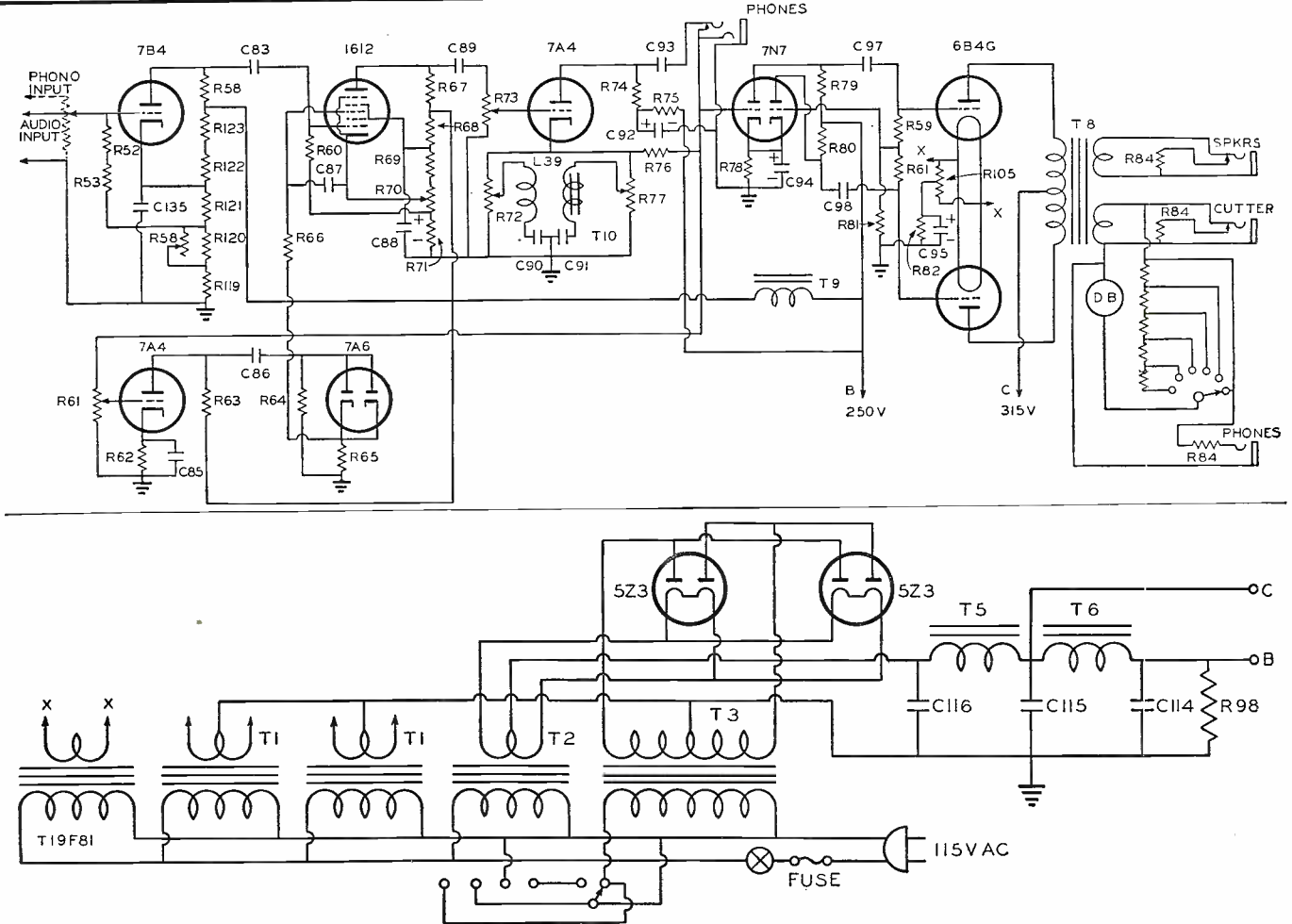

Top: Audio Amplifier circuit. Bottom: Power supply circuit diagram.

- R₆₁—500,000 ohm pot. Mallory
- R₆₂—1 megohm, 1/2 w. Aerovox
- R₆₃—150,000 ohms, 1/2 w. Aerovox
- R₆₄—5,000 ohms pot. Mallory
- R₆₅—20,000 ohms, 1/2 w. Mallory
- R₆₆—250,000 ohms, 1/2 w. Aerovox
- R₆₇—1 megohm, 1/2 w. Aerovox
- R₆₈—250,000 ohms, 1/2 w. Aerovox
- R₆₉—10,000 ohms, 1 w. Aerovox
- R₇₀—100,000 ohms, 1/2 w. Aerovox
- R₇₁—100,000 ohms, 1/2 w. Aerovox
- R₇₂—250,000 ohms, 1/2 w. Aerovox
- R₇₃—500,000 ohms, 1/2 w. Aerovox
- R₇₄—100,000 ohms, 1 w. Aerovox
- R₇₅—10,000 ohms, 1 w. Aerovox
- R₇₆—10,000 ohms, 1 w. Aerovox
- R₇₇—800 ohms pot. Mallory
- R₇₈—200 ohms, 1 w. Aerovox
- R₇₉—25,000 ohms pot. Mallory
- R₈₀—500,000 ohms pot. Mallory
- R₈₁—20,000 ohms, 1 w. Aerovox
- R₈₂—50,000 ohms, 1 w. Aerovox
- R₈₃—250,000, 1/2 w. Aerovox
- R₈₄—25,000 ohms pot. Mallory
- R₈₅—1500 ohms, 1 w. Aerovox
- R₈₆—100,000 ohms, 1 w. Aerovox

- R₈₀—100,000 ohms, 1 w. Aerovox
- R₈₁—100,000 ohms, 1 w. Aerovox
- R₈₂—700 ohms, 10 w. Mallory
- R₈₃—DB meter multiplier Triplett
- R₈₄—500 ohms, 10 w. Mallory
- R₈₅—100,000 ohms, 50 w. Mallory
- R₈₆—100 ohms center tapped
- R₁₀₅—2000 ohms, 1 w. Aerovox
- R₁₂₀—8000 ohms, 1/2 w. Aerovox
- R₁₂₁—150 ohms, 1 w. Aerovox
- R₁₂₂—20,000 ohms, 1 w. Aerovox
- R₁₂₃—30,000 ohms, 1 w. Aerovox
- C₈₃—.01 mfd. 400 v. Mallory
- C₈₄—16 mfd. 450 v. electro. Mallory
- C₈₅—.5 mfd. 200 v. Mallory
- C₈₆—.1 mfd. 400 v. Mallory
- C₈₇—.5 mfd. 200 v. Mallory
- C₈₈—8 mfd. 450 v. electro. Mallory
- C₈₉—.1 mfd. 400 v. Mallory
- C₉₀—.02 mfd. 400 v. Mallory
- C₉₁—.5 mfd. 200 v. Mallory
- C₉₂—8 mfd. 450 v. Mallory
- C₉₃—.02 mfd. 400 v. Mallory
- C₉₄—20 mfd. 25 v. Mallory
- C₉₅—20 mfd. 100 v. Mallory
- C₉₇—.01 mfd. 600 v. Mallory

- C₉₈—.01 mfd. 600 v. Mallory
- C₁₀₀—See Text
- C₁₁₄—16 mfd. 450 v. Mallory
- C₁₁₅—8 mfd. 450 v. Mallory
- C₁₁₆—8 mfd. 450 v. Mallory
- T₁—6.3 v. @ 5 A. Thordarson T11F60
- T₂—6.3 v. @ 5 A. Thordarson T11F60
- T₃—375-0-375 v. @ 250MA Thord. T15R07
- T₅—250 ma. filter choke Thord. 15C55
- T₆—250 ma. filter choke Thord. 15C55
- T₈—Output trans. Thord. T15S90
- T₉—Filter choke Thord. T68C08
- T₁₀—Audio filter Thord. T14C61
- L₃₀—30 mhy. choke Millen
- Panel—1/8" Aluminum, 17" x 26", Par-Metal
- Cabinet—Custom-built, Par-Metal
- Chassis—24" x 22" x 4 1/4"—1/16" brass
- Sockets—Amphenol
- Knobs—Millen (with dots)
- Tubes—7B4, 1612, 7A4, 7N7, 6B4G, 7A6, 5Z3
- Hytron
- Meters—Model 323 —10 +6 db. "level indicator" Triplett
- Dial—Browning, 5 1/2" "Bandspread"
- Dials—Crown, "Band tuning" aircraft type
- Gears—American Stock Gear Co.

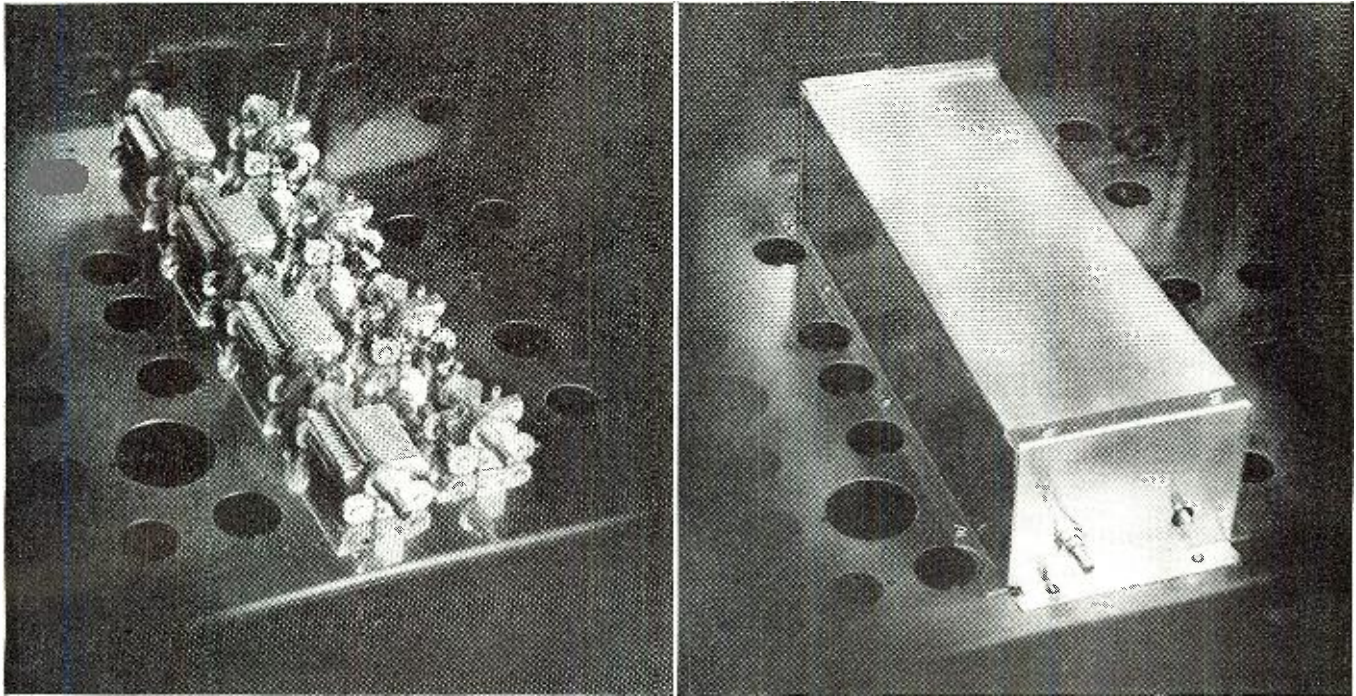

The A.M. condensers uncovered (left) and with the dust cover in place (right).

posed by law. With the automatic volume expansion at the receiving end, so much as is lost from the music by the compression used at the transmitter is reinstated by the expander in the receiver. Of particular advantage is the a.v.e. circuit for reproduction of phono records, and the resultant brilliance, because of the expansion, will be appreciated.

(10) A new *treble and bass equalizer* circuit has been added in the audio channel. A full explanation of this circuit is included in this issue. Of course, tone controls on receivers are not new, but treble and bass equalizers which can *attenuate* or *boost* either the treble or bass are comparatively rare. Once the operator has become familiar with the operation of the control and becomes used to treble and bass equalizers, he will find it difficult to understand how he ever got along without them.

(11) For beauty of reproduction, especially in the matter of music, the audio amplifier channel terminates in a strict *Class*

"A" *output circuit*. Low mu tubes, the octal equivalent of a 2A3's are used. The advantage of these tubes is discussed in the text.

(12) In order that the finest reproduction aurally could be had, a *special dual Jensen speaker system* has been adapted to this receiver. A full discussion of this dual system is included in this article. It was decided that insofar as no effort had been spared to make the audio channel as near professional in quality and perfection as possible, that dual speakers should be used in preference to the usual single loud speaker with its limitations.

(13) *Recording facilities* have been included in the unit, it being only necessary to plug a cutting head of proper impedance into the jack provided. Monitoring of the recording as it is being made, can be done with earphones.

(14) As part of the monitoring services with which this receiver is equipped, a 2" C-R tube was included in the now-familiar *modulation monitoring circuit*. With this Cathode Ray tube and its con-

trols integral with the receiver, it is possible to monitor any transmission for modulation percentage. While the results as viewed on the screen of the tube are somewhat approximate, they are nevertheless sufficiently accurate to advise when over-modulation is taking place. A complete description of the percentage modulator cathode ray tube will be described in the text of the second part of this series.

(15) A *noise limiter* has been included since its use in communication sets has more or less become general practice throughout the trade. The noise limiter is of the *Lamb* type and was found to be quite satisfactory. Its operation on c.w. signals has never been very good, but for phone work it seems excellent. It should be possible to adjust the noise limiter, together with the antenna phase system, so as to eliminate a large part of extraneous noises from reception.

(16) Wherever possible, *loktal tubes* have been used. There are (Continued on page 41)

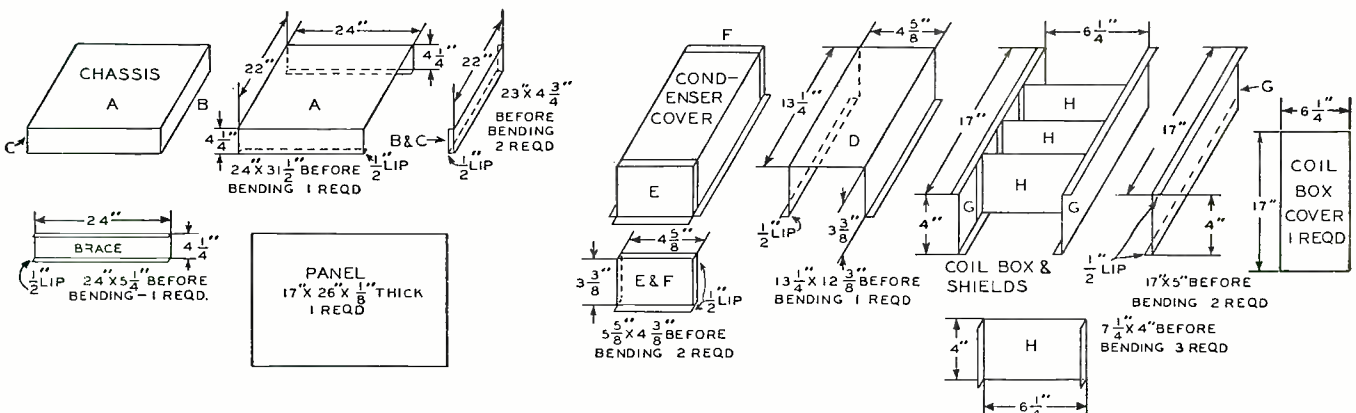

Constructional details of the metal work.

A S . . . S E E . . .

by **JOHN F. RIDER**

Dean of the Servicemen

Frequency Modulation

This frequency modulation business is moving ahead at a rapid rate. A number of stations in different parts of the country already have received licenses and about two dozen more are pending. This was so about four weeks ago. Maybe by this time the number has increased.

From what is evident upon the surface, those manufacturers who are producing f.m. receivers (and more than likely others in the future will follow the same policy), are manufacturing a combination receiver embracing f.m. and a.m. types of transmission, wherein separate r.f., mixer, i.f. and demodulator systems are provided for the two types of transmission and a common audio amplifying system is used for both types of receivers. Also they are producing a separate and distinct f.m. receiver embracing the usual r.f., mixer, i.f., demodulator and audio system.

The idea of using a separate f.m. channel of r.f., mixer, i.f. and demodulator feeding into the common audio system no doubt will lead to the sale of separate f.m. converters which will be used with the audio system now in use in the a.m. receiver possessed by the customer. The frequency bands used in the f.m. receivers now in production range between 40 and 44 mc. for the carriers and between 2 and 3 mc. for the i.f.

Speaking in generalities and recog-

nizing the advantages of frequency modulation, we still feel that many years will elapse before the conventional a.m. type of receiver will become obsolete and be replaced by the f.m. type of receiver. Operating upon the high frequencies, f.m. type of transmission is still subject to the vagaries and limitations of such transmission, hence in those sections of the country where the reception of stations several hundred miles distant is the required thing for radio broadcast operation, a.m. types of transmitters will be in use for a long time. And there are many places in these United States where transmitters are more than 100 miles from receiving centers.

Under the circumstances, it seems to us that the frequency modulation form of transmission is another one of those developments which the service industry must take in its stride without feeling any alarm that it will inject new requirements of radical nature into the testing procedure, cause revolutionary changes in the design of test equipment, etc. Incidentally the signal-tracing process of servicing takes frequency modulated receivers right in stride, for after all, it is just another type of receiver which operates upon a signal, a signal which is different than an a.m. signal, *but a signal just the same*. In fact, the f.m. receiver does not differ so very radically from the conventional a.m. type of receiver. If you were to glance at

two schematics, one of a f.m. receiver and another of an a.m. receiver, you would not notice a great number of differences.

True, the demodulator in the f.m. receiver is of the discriminator variety utilized in a.f.c. receivers, but we have seen such discriminators used in a.f.c. receivers, hence the tube circuit structure is not a radical departure. It is also true that a carrier voltage limiter is used in the f.m. receiver so as to maintain the carrier amplitude fed into the demodulator at a constant level, but once again we saw a similar arrangement used in one commercial type of a.f.c. double superheterodyne. Hence this tube circuit is not absolutely new.

We hear about the broad band pass used in the f.m. type of receiver, but upon closer analysis we find that the band



John F. Rider

pass used in the i.f. system, for example, in a f.m. type of receiver, is not so very much greater in proportion to the peak frequency than the normal band pass used in the conventional superheterodyne operated at say 465 kc. For example 7.5-kc. sideband in a 465-kc. amplifier amounts to a band pass of about 4 percent of the peak frequency. In a f.m. receiver with 2-mc. i.f. peak, side bands of from 75-kc. to about 100-kc. each side, amount to a total band pass of about 7 to 10 percent of the peak, so that what appears to be a very wide band pass actually is in line with, and would be expected considering the basic frequency and the type of circuit.

More Work and Less Effort

A number of years ago, we read an article about service shops and one thought remained with us. Frankly, we do not know why, but it seemed quite sensible. Maybe that is why it stuck.

Every so often we see suggestions about how to build the ideal service shop. One thing that we miss in the requirements set up for such a shop are a few insignificant items, yet such things eventually can prove to be very annoying and actually impair the efficiency of operation. No, we're not interested in assuming the role of an efficiency expert, but neither do we like to finish a job of checking a receiver and then find it difficult to straighten out.

What we have in mind is the height of the stool used at the bench; the height of the bench and the placement of the light, and last but by far not the least, the height of the man working at the bench. Be honest, have you given any thought to your height, the stool you sit on and the height of the bench where you are working? If you're like the rest of us, the answer is more than likely in the negative. Yet it means a great deal. It means getting out more work with less effort—less of that tired feeling after the day is over and more uniform efficiency during the day. Comfort is necessary for good work. Forgetting radio work for the moment, we know that comfort is essential to a good typing job.

We don't intend specifying how high

(Continued on page 57)

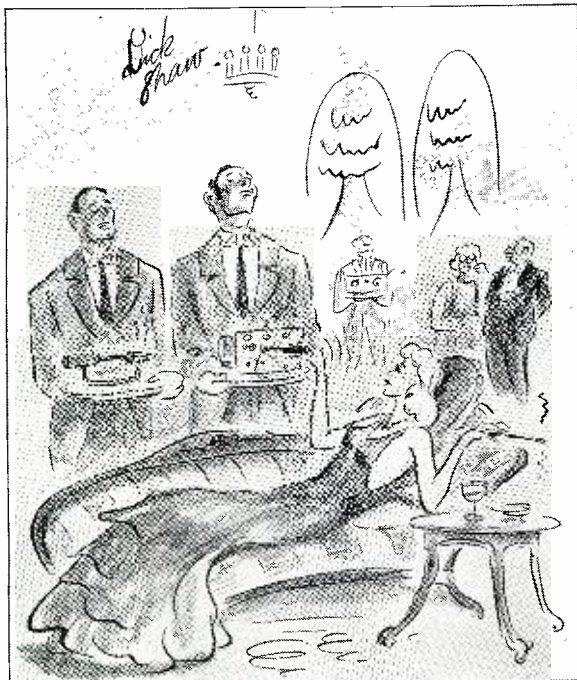

"Maybe daughter told the truth when she said that new repairman was teaching her soldering 'till 4 A.M."

CONDENSER ANALYZER

by
M. J. Butkiewicz
Mt. Carmel, Pennsylvania

An excellent instrument for the serviceman to construct and to use in his everyday repair jobs.

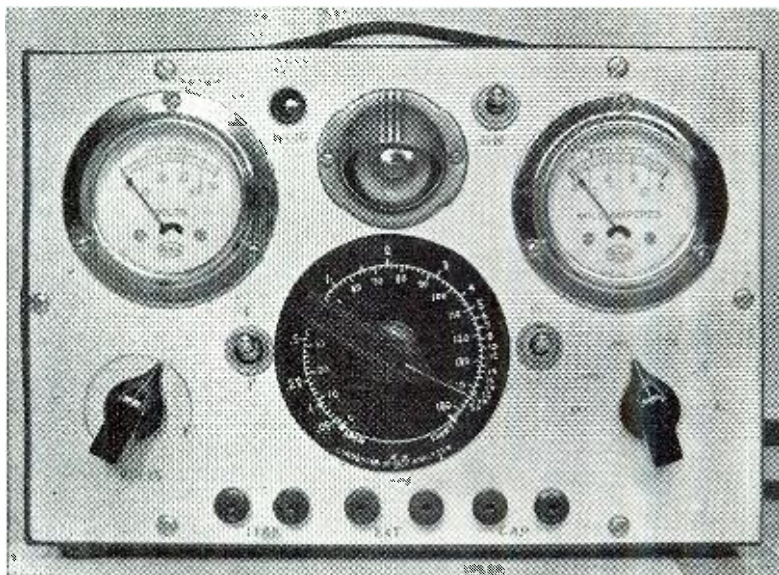

The unit is compact and is easy-reading.

MOST servicemen associate a bridge with some sort of laboratory equipment which is used only to make certain precision measurements which they are not concerned with and therefore do not appreciate the value of this instrument; but they are only fooling themselves.

If they would take the time and trouble to build up a simple bridge such as the one described here, they would not only find that some of the time consumed in testing condensers would be cut in half but that the final condition will be accurately known, and the sets they send home will not bounce back with a bum filter that has just gone "west."

Some fellows think that all is needed is a simple leakage test to determine the condition of the condenser. This is a very mistaken idea. Leakage is but one of three tests that are required to find out the accurate condition of a condenser, the other two being "Capacity" and "Power Factor." The reason for this is that in testing for leakage it is assumed that the capacity of the condenser is what it is marked which actually is not always the case, as condensers have been found to test several microfarads higher or lower than marked.

Take for example a set with dried up filters: A leakage test will disclose no leakage and we jump to the conclusion that the condenser is good, but a test of capacity will show us that there is none or very little, so therefore there is no filtering action. Now the condenser might show the right capacity but still there can be no filtering action if the power factor is high, therefore for a complete

check of the condition of the condenser, the above three tests must be made.

The condenser analyzer to be described here is of the "Wien Bridge" type, and it tests for capacity and power factor without disconnecting the condenser from the circuit. Of course, for leakage tests, the condenser must be disconnected to put a milliammeter in series with it.

As can be seen from a study of the diagram this analyzer has a variable voltage supply and can be adjusted to the working voltage of the condenser under test. This is an important feature of this instrument as will be noted in testing electrolytics for leakage. Erroneous results will be obtained if the condenser is not tested at the working voltage, since the maximum leakage occurs at the rated voltage. With this analyzer condensers can be tested at voltages up to 500 volts.

By reference to the circuit diagram

it can be seen that the power supply voltage is indicated on the voltmeter. This is a 0-50 voltmeter with a series resistor to increase the range up to 500 volts.

As voltmeters with a 500 volt range are rather expensive, a 0-50 voltmeter was used, thereby keeping down the cost of the instrument. The circuit incorporates a pair of tip jacks for external standards which make the unit a very versatile one as a resistance, inductance or impedance bridge as well.

Headphones could have been used for the null indicator but it was decided to favor the 6E5 tuning eye since it is also used as a power factor indicator. In testing for capacity the null point is reached at the maximum opening of the eye. In testing condensers that have high power factor, the eye will not open all the way and the difference between the amount that the eye will open, and the maxi-

(Continued on page 54)

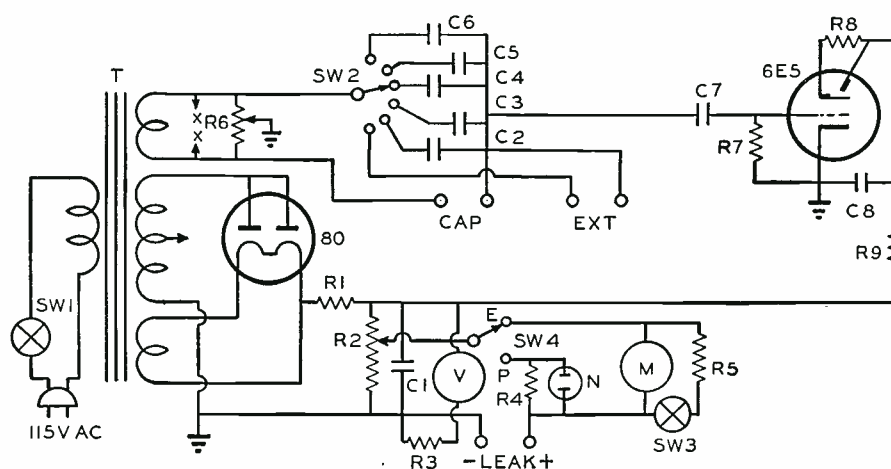

C₁—16 mfd. 450 v. electro. Sprague
C₂—.0005 mfd. mica Sprague
C₃—.005 mfd. mica Sprague
C₄—.05 mfd. paper Sprague
C₅—5 mfd. 200 v. paper Sprague
C₆—5 mfd. 200 v. paper Sprague
C₇—.01 mfd. 400 v. Sprague
C₈—.1 mfd. 400 v. Sprague
R₁—See Text
R₂—50,000 ohms, pot. Mallory
R₃—Value depends on meter used
R₄—500,000 ohms, 1 w. IRC

R₅—Meter shunt. (depends on meter res.)
R₆—10,000 ohms, pot. Mallory
R₇—10 megohms, 1/2 w. IRC
R₈—1 megohm, 1/2 w. IRC
R₉—50,000 ohms, 1 w. IRC
SW₁—SPST toggle
SW₂—S P 6 pos. sw. Mallory
SW₃—SPST toggle
SW₄—SPDT toggle
M—0-15 DCMA Triplett
V—0-50 DCV Triplett
N—1/4 w. neon lamp

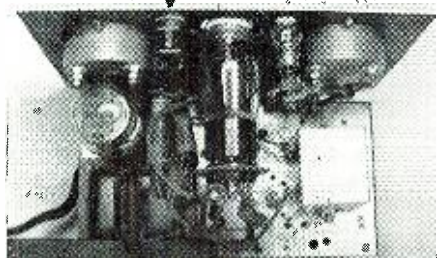

Behind the panel of the analyzer.

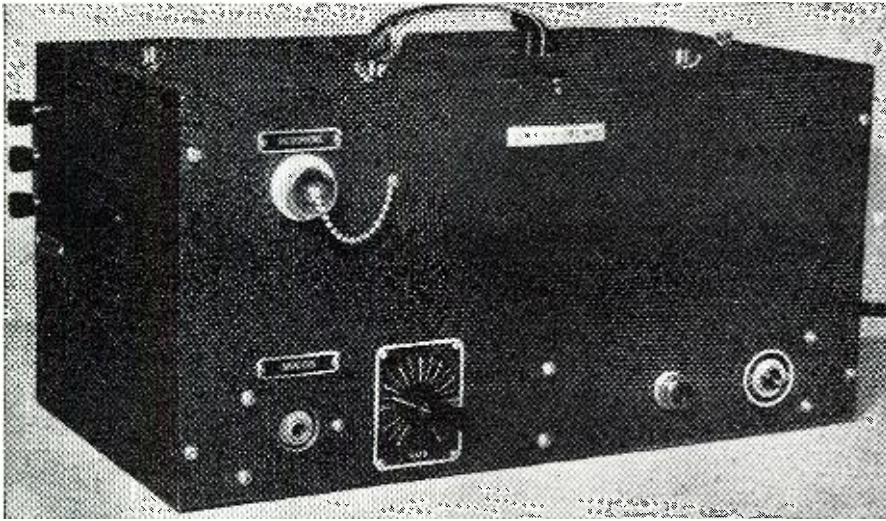

An extremely rugged, yet well-built portable pre-amplifier.

A HIGH FIDELITY PRE-AMPLIFIER

by **C. G. SIMS, C. E. and C. B. LESTER, W9ECN**
Paducah, Kentucky

*There are many uses for this unit; but most
of all, the recordist will desire to own it.*

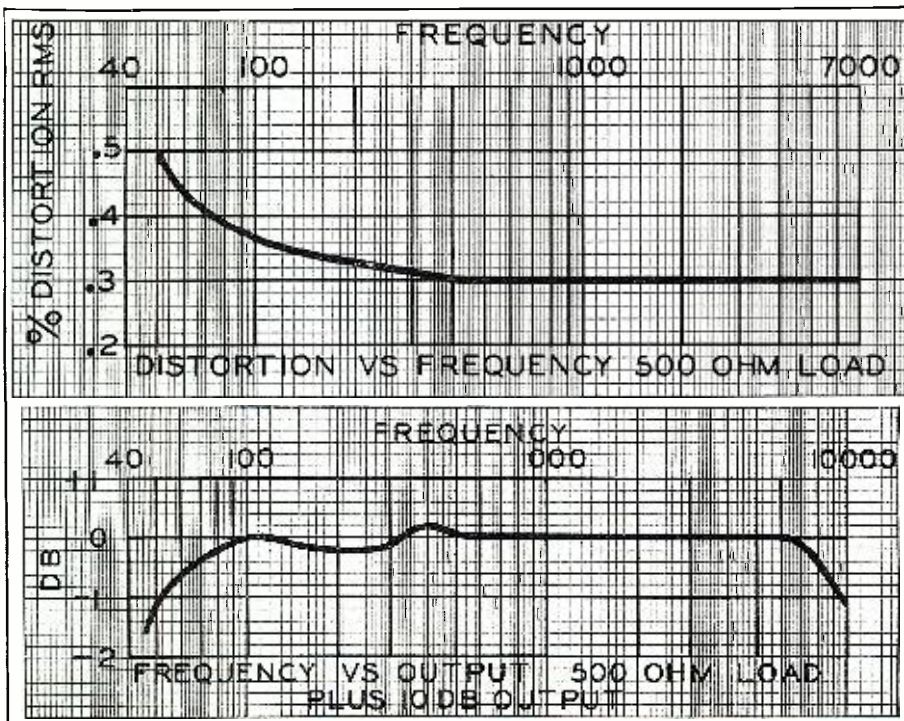

FIRST we want to explain a few things. One; this amplifier was designed first and always as a remote amplifier in a broadcast station, and 17 of them are now in use at WPAD and WHOP. Second; we don't make any extraordinary claims for this unit. We just believe that you can, by following the parts list and instructions given herein, construct an amplifier that will duplicate ours in every way. Third; even though we explain it in the sense that it is being used as a remote amplifier, the thought must be kept in mind that it cannot be beat for quality and flexibility, and it may be used in any application requiring a small, high-fidelity amplifier. It can also be used as a fine quality pre-amplifier. In fact it has many uses.

First in designing this amplifier was the quality. To match the rest of our equipment, it had to have a frequency response essentially flat from 50 to 8,000 cps to carry dance bands and other music, such as church organs and the like. We beat this considerably, the curve running within $1\frac{1}{2}$ db from 45 to 11,000 cps. Then came distortion. Our distortion runs less than 0.5% at plus 10 db output, and less than that at lower output levels. We must have no hum—and our level is 68 db down from maximum output. You can't hear it with the gain fully open and the mike plug open. Gain was almost a secondary factor since that must be incorporated in almost any pre-amplifier. We ended up with a measured gain of 89 db working out of a -60 db input from a diaphragm type crystal mike.

The circuit is basic in design, and entirely conventional, but some queer things are inserted here and there. To keep the high end of the response curve up, we used triodes throughout. Our input tube is a 6F5 with a gain of over 100 with a 5 megohm grid resistor. Then comes the 6C5 second stage with a Centralab N-103 500,000 ohm pot. for a gain control. This, in turn, is coupled to a 6F6 class "A" triode for an output stage. And that just about covers it.

However, there are several peculiarities that aid in obtaining our goal of flat frequency response and low noise level. First, the de-coupling net in the plate of the 6F5. Since the gain is so high and almost no current is drawn, the d.c. voltage must be absolutely pure and free from ripple. The power supply already has two chokes and 36 mfd. of filter and it may seem unreasonable to use more filter in any plate lead, but in view of the fact that the condenser-choke combination also acts as a de-coupling circuit, it is undoubtedly worth while. We use an 8 hy. 40 ma. Thordarson T13C26 choke and a Solar XC-62 2 mfd. oil filled condenser for this. And be sure that it is oil filled.

After having several 8 mfd. electrolytics go "out" while on duty, this oil filled job has been inserted in all our amplifiers and we have had no further trouble from this source.

Next, to keep the low frequency response up, we used inverse feedback around the 6C5. A very simple but effective arrangement is shown in the diagram. A 500,000 ohm 1 watt resistor and a .01 mfd. mica condenser (Solar XB-1-11) are in series around the plate and grid. The 180° phase shift through the tube takes care of

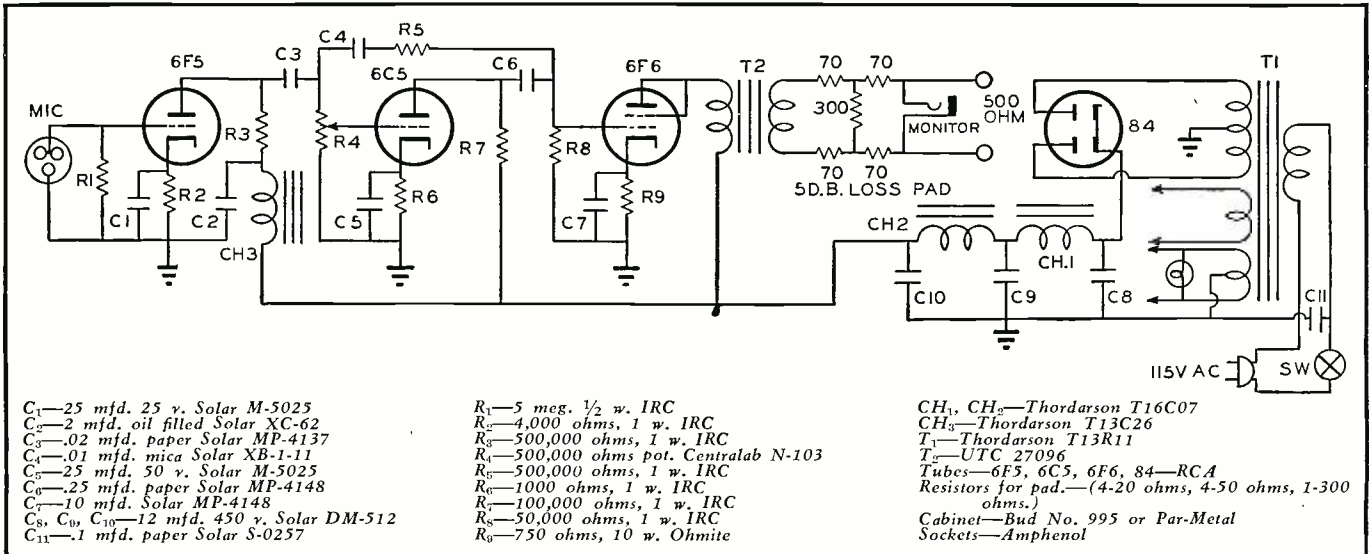

the degeneration, the condenser and resistor being used only to control the proper amount to be used and still not cut into the gain of the stage too deeply.

The 6F6 is working in a very commonly used circuit, so we won't dwell on it too much. It simply is a pentode connected as a class "A" triode with the screen tied to the plate. It might be mentioned here that the 10 watt Ohmite Brown Devil resistor in the cathode is the only resistor above 1 watt in the entire unit. The output transformer is made by UTC (27096) and has taps for 500-200-50 ohm output. Their use, in conjunction with the 5 db pad will be explained later.

The power supply is a little unorthodox inasmuch as we use a tube with a 6 volt filament on the usual 5 volt rectifier winding. This doesn't mean anything except possibly to obtain a little longer tube life and less hum from the rectifier. There are two chokes, Thordarson T16C07, and three condensers, Solar DM-512 12 mfd. in the double section filter and they very effectively smooth out all fluctuations. So far as we have been able to determine by ordinary tests, the output from this is pure d.c. with no ripple. The on-off switch is in the a.c. lead, and the pilot light is across the 6.3 filament winding.

Further to lower the hum level, we by-passed the a.c. line with a .25 mfd. paper condenser. Since one side of

the line is always grounded, when the line plug is in the proper relationship with the socket the chassis is very effectively grounded and thus we rid ourselves of using an external ground connection. The proper method for finding the right plug position is to leave the microphone jack open and open the gain control wide open, leaving the headphones in the monitor jack. When the plug is in the wrong position, and a.c. voltage is placed on the chassis proper, and a very definite hum may be heard, but when in the right position, no hum will be heard whatsoever, and only a slight hissing sound will indicate that the amplifier is turned on.

All cathodes are heavily by-passed to keep the low end up as high as possible. The first two stages use 25 mfd. 50 volt Solar M-5025 electrolytics, and the 6F6 uses a 10 mfd. 50 volt Solar M-5010. Also, be sure to use the low voltage types of electrolytic condensers if any changes in types are made. The high voltage 8 and 16 mfd. types won't hold their calibration with such a small potential applied across them.

Now—about construction. The cabinet is a Bud No. 995 and is a stock size $7\frac{1}{2}$ "x14"x7"; and the chassis was made for us on special order by Par-Metal. It is made of aluminum and measures 13 "x $7\frac{1}{4}$ "x2". We might mention here that aluminum *must* be used if all hum is to be eliminated.

At first we used steel chassis, but these have recently been rebuilt on aluminum. The complete elimination of hum is worthy of the small difference in cost between the steel and aluminum types.

The microphone input jack is an Amphenol female connector type PC3F and the phone monitoring jack is a Yaxley Jr. open circuit type No. 701. The a.c. switch is an H & H toggle spst, and the dial light assembly is made by American Hdwe. Co. The three name plates marked "Microphone"—"Monitor"—"500 Ohm Output" are made by Bud and the "Off-On" switch plate is a Crowe No. 272. Amphenol Clip-tite sockets type S8. are used for the three octal tubes and an S5 is used for the 84. All socket holes are punched with a special socket punch that cuts the locking pin for the Amphenol sockets.

The output is run into the Eby type 21-T triple binding post on the side of the cabinet, but just two of the terminals are used,—the "Ground" post being left open. All power supply wiring is cabled, but the rest of the amplifier is hung in on terminals or simply supported by their own pig-tails. Our last 12 amplifiers have been exact duplicates of the unit described.

For amateur applications the monitoring jack and 5 db pad may be left out with consequent simplification and lowering of cost. The ham can

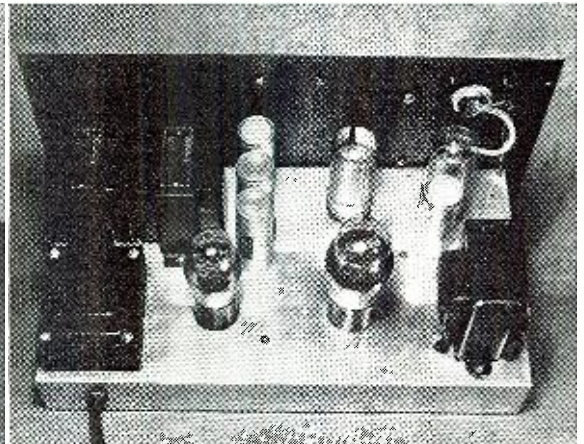
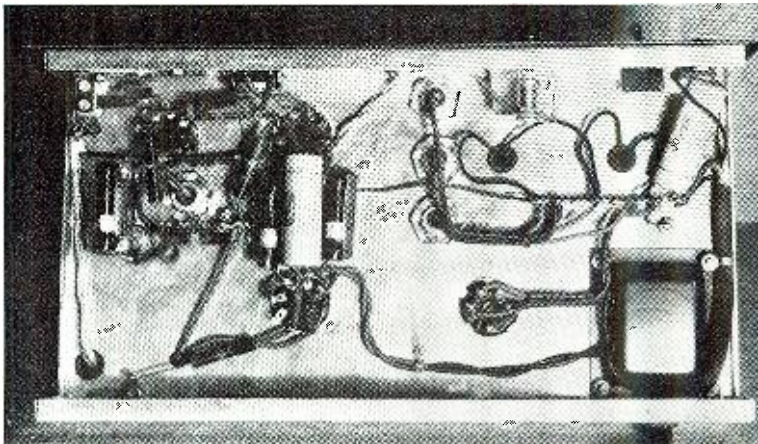

• Constructional and wiring details are clearly shown here. Note simplicity of layout.

use the unit in his modulator, for instance to drive the grids out of a pair of 2A3's in class "A", which in turn will drive almost any ham class "B" tube.

And here's an idea—the government requires that all hams have some means of seeing that they don't over modulate.

This amplifier won't keep you from overmodulating; but by the addition of an a.c. voltmeter you can keep your modulation up to the 100% mark all the time, regardless of the input level.

First, place a 0-10 a.c. voltmeter across the 500 ohm line. Then, with the pre-amp gain at half scale, set the transmitter gain so that the modulation hits 100% on peaks, noting where the voltmeter swings. This will be your "0 db" point. From now on, until the main transmitter speech gain is shifted, when your needle is kicking to that point, you will be modulating 100%. Thus you can change input levels, swap mikes, or talk just any way you want to and still hold your modulation up to 100% and keep the rig delivering its maximum output at all times, which is a distinct advantage.

In commercial applications, operation is different. Since the *A T & T* standard level is 1.73 volts in a 500 ohm line, (corresponding to 0 db as referred to .006 mw.), you may readily see that not nearly all of the amplifiers power is used. For short hauls we just barely crack the fader to about one-fourth of the full open position and throw plenty of sock into the station console.

And here's how the 5 db pad comes in. We heartily recommend that this pad be incorporated in all commercial uses. This pad is designed to attenuate the output signal 5 db and is made up from *IRC type BT* stock value resistors. Since there are no 70 ohm values in their regular stock, this value is obtained by putting a 50 ohm resistor and a 20 ohm 1 watt resistor in series. This makes the pad consist of nine resistors whose total cost is entirely overbalanced by the advantages they lend to the amplifier.

Take, for instance, the case where you're pulling a signal over a 40 mile line. Our output transformer is designed to reflect the proper plate load on the 6F6 when working into 500 ohms, but the impedance of the line may be anything but that. They vary from 100 to 850-900 in different cases, depending upon the length and condition of the line. Saying that the impedance of the line is 700 ohms, and that the impedance varies as the squares of the turns ratio in the transformer, then the load on the plate of the 6F6 will be far from its proper value, putting humps and double humps in the frequency response curve of the amplifier. However, with the pad inserted between the line and the output transformer, the transformer is working into the pad, and not the line. If the pad is designed with an input-output impedance of 500 ohms, then the proper load will be reflected onto the plate of the 6F6 and conditions will be the same as if the amplifier were working into the proper terminating impedance. The pad knocks out 5 db of the amplifier output, but that doesn't really matter.

Now another thing. When working
(Continued on page 55)



by **ALFRED TOOMBS**
Special Washington Correspondent for RADIO NEWS

FCC Hits Pay Dirt in Subversive Radio

THE Federal Communications Commission's air detectives, who are patrolling the radio waves 24 hours a day in their search for activities inimical to United States defense, definitely are hitting pay dirt.

The work of the Defense Operations unit of the FCC is one of the closest guarded secrets in Washington. Since the unit, fortified with an appropriation of a million and a half dollars, started its large scale monitoring nearly a year ago, there has been no word from official sources about its activities. Neither directly nor indirectly would any FCC official give any idea as to the extent of the defense work nor as to results obtained.

At a recent press conference, however, Chairman Fly of the FCC—and of the *Defense Communications Board*—let the cat out of the bag. Reporters, irked because they could find out nothing about the defense operations, began to needle Mr. Fly. The FCC Chairman at length admitted that a "substantial amount of equipment" had been seized as a result of the Defense Operations unit's activities.

This was a startling admission, since there had been no official announcement of the impounding of any equipment. The statement caught other members of the Defense board off base, too. They went to great pains later to explain that Mr. Fly, when he said that equipment had been seized, did not really mean that equipment had been seized.

Fact is, that radio equipment has been seized as a result of the unit's work. No later than last month, a United States Marshal in West Virginia, acting in cooperation with FCC agents, moved in and grabbed the elaborate rig being used by an operator in that state.

This operator, who had no license, was arrested and is now facing trial. The full details of his activities will probably never be made public, but if they are, there will be a sensation.

From an unimpeachable source, we have learned that this case is but one among many involving a menace to defense which the FCC operatives have run down. No less than 1,200 investigations of suspected radio stations have been made since the defense unit began large scale operations.

The *Defense Operations* section, it is explained, is "trying to understand" the meaning of this subversive radio activity. They are trying to find out who the secret operators are, where their stations are located, to whom they are talking and what they are talking about. There are 450 men now working in the defense unit and officials are confident that they have the situation well in hand.

High officials, asked if there was any evidence that licensed amateur operators were involved in any subversive activity, would not say yes—and they would not say no. They said that there had been no particular trouble with the hams and they gave great credit to the ARRL for its monitoring work. In fact, it was a ham who broke the case in West Virginia. But the defense unit officials left the impression that there might be a couple of bad apples in the barrel. In substantiation of this bad news, we have learned that the F. B. I. has been probing several of the returns made by licensed operators when all were registered and fingerprinted last fall. Something is stirring.

Spy Hunt Extends to S. A.

THE Chief of the *Defense Operations Section* of the FCC, hard-driving George Sterling, has just returned from a trip to the south which was loaded with some interesting implications. The purpose of his trip

was to supervise the setting up of monitoring stations in Puerto Rico and the southern United States.

This spotlights a problem about which little has been said in Washington—the possibility of the operation, by agents of European governments, of high-powered stations in remote sections of countries to the south of us. The effectiveness of the radio patrol in this country makes the operation of a hidden transmitter in the United States an uncertain proposition.

Canada, likewise, maintains an active patrol of the air. If foreign agents hope to have a dependable means of communication by radio between North America and Europe, therefore, their best bet is to set up stations in the Caribbean and Central American countries.

Last month, we revealed the reports of the establishment of hidden stations in Santo Domingo, in the colony of German refugees there. A further report has reached Washington that a powerful transmitter is operating out of Haiti. Two Germans already are in jail there, it was reported, for illegally operating a short-wave station from Pationville, center of a large Nazi colony.

American military observers have reported that on a German-owned plantation in Haiti, there stand the components of a transmitting station, ready to be set up at any time, which cost not less than \$100,000. These are just examples of what is going on.

That the United States intends to expand its radio patrol to include the Caribbean area, there can be no doubt. The station in Puerto Rico and those on the southern border will patrol Latin-American airplanes, as well as our own. The bearings obtained on illegal stations and reports on the activities of these stations will be forwarded to the Governments in whose territory the stations are operating. Plans have already been completed, we have learned, to have the State Department handle this delicate matter.

A.A.R.S. Code Test

THE Army amateur system's annual Code Proficiency Contest on February 10 attracted about 1,000 returns—including one which Major David Talley was showing around the War Department to prove what a determined gang of hams there are in the system.

This return, accompanied by a letter, came from W. B. Hollis, W5FDR/WLJR, Houston, Tex. He was offering an "alibi" for not making a better showing. He was in bed with the flu and a strep infection—but got up to take the speed test anyway. He did all right when the test started—at the commercial speed of 20 words per minute and got along as it increased to 25, then 30 words. But the signal began to fade and he discovered that his antenna had shorted out to the ground. By the time he got it fixed, the transmission was going at the rate of 55 words per minute. He got that, went up to 60 and then to 65 words per minute—and there aren't many in the country who can get that high. So he wrote to Major Talley to "alibi" for missing part of the test.

A typical ham—neither fire, nor flood nor flu can stop him.

Note: The text for the speed test was taken from a romantic love story appearing in the December issue of "Telephone Review," published by the New York phone company, and detailed the tribulations of poor Joan Rose Ann.

Another Investigation Asked

THE printers' union, at its Florida convention, passed a resolution calling for an investigation of the radio industry. In
(Continued on page 51)

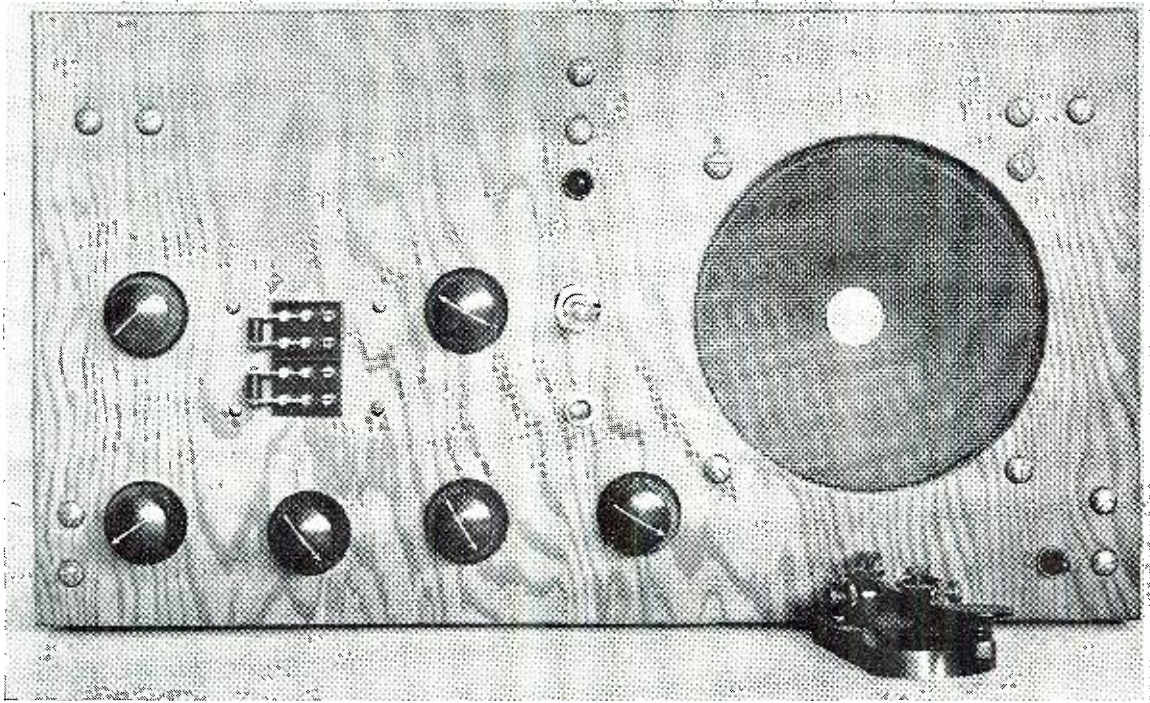

Sufficiently well-built to be proud of, is this little rig.

MIDGET TRANSMITTER-RECEIVER from SPARE PARTS and TUBES

by **WILLIAM D. HAYES, W6MNU**
Oakland, California

***What to do with the spares which clutter up every ham's shack
has been neatly solved by the author. Beats swapping them, too.***

THE art of radio is in a state of continual flux—familiar words but none the less true. A piece of equipment that was considered the last word two or three years ago is now looked upon as practically an antique. The design of standard parts is being constantly improved, and new tubes and circuits appear in such rapid succession that it is no easy task to keep even vaguely posted on the latest developments.

Because of this condition, it is almost inevitable that anyone who builds his own equipment and likes to keep it up to date should gradually accumulate a considerable stock of spare parts. These parts have been retired from active duty not because of unsatisfactory operation but merely to make way for new and improved design. How to put these unemployed parts back to work is something of a problem. The little outfit

described in this article was built entirely of spare parts of the type that most hams have around the shack. The only new material was the plywood for the cabinet and some hardware. It fills the need for a portable transmitter-receiver that can be used wherever 110 volt a.c. is available, and is very well suited for use in the summer cabin, or even at home when the main rig is being overhauled.

The Receiver

The receiver consists of a '27 regenerative detector transformer coupled to a '47 output stage, and it is recommended that a good quality audio transformer be used. The output stage feeds an eight inch dynamic speaker. The receiver covers 70 to 550 meters in two bands, the broadcast band being desirable in case the unit is used for portable work while on vacation for instance. It is surprising what satisfactory broad-

cast reception is obtainable from a simple receiver of this type.

The coils are wound on plug-in forms and are mounted horizontally behind the front panel. Data for the plug-in coils can be found in any handbook and in numerous magazine articles, and will not be needlessly repeated here. Most hams have a set of four-prong coils lying around somewhere anyhow. Band-switching is accomplished by means of two midget DPDT knife switches. The receiving antenna is coupled to the detector through a 100 mfd. variable condenser which is convenient in compensating for the wide variation in antenna length which is apt to be encountered in portable operation. No special dial was used for the bandspread condenser because with the main tuning condenser almost all the way open, the bandspread condenser just covered the eighty meter band

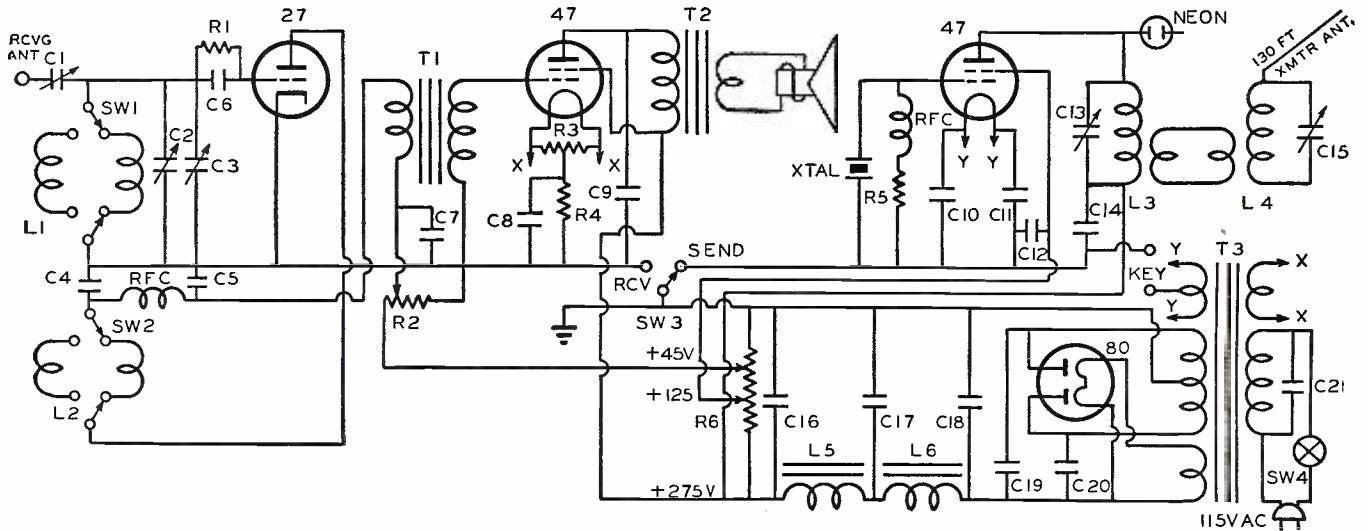

- C₁—100 mmf. variable. Cardwell Trim-Air
- C₂—260 mmf. broadcast condenser
- C₃—25 mmf. variable. Cardwell Trim-Air
- C₄—100 mmf. mica. Aerovox
- C₅—100 mmf. mica. Aerovox
- C₆—100 mmf. mica. Aerovox
- C₇—1 mf. paper. Aerovox
- C₈—25 mf. 25 volts. Aerovox Dandee
- C₉—0.1 mf. 400 volts paper. Aerovox
- C₁₀, C₁₁, C₁₂, C₁₃, C₂₁—0.01 mf. 400 volts paper. Aerovox
- C₁₄—140 mmf. variable. ICA
- C₁₅—140 mmf. Variable. Hammarlund Star

- T₂—Power transformer. Stancor P-2859
700 volts c.t. at 70 ma.
2.5 volts c.t. @ 3.5 amps.
2.5 volts @ 7.5 amps.
5 volts at 3 amps.
- X—80 meter crystal. Hipower
- N—1/4 watt neon bulb.
- B—2.5 volt pilot bulb.
- SW₁, SW₂—DPDT knife switches.
- SW₃—SPDT toggle switch.
- SW₄—SPST toggle switch.
- Tubes: RCA
Jeweled pilot light. Yaxley

- R₁—1 meg. 1/2 watt. IRC
- R₂—50,000 pot. Centralab
- R₃—20 ohms center-tapped. Mallory
- R₄—450 ohms, 10 watts. Ohmite "Brown Devil"
- R₅—25,000 ohms, 1 watt. IRC
- R₆—20,000 ohm bleeder, 75 watt. Ohmite
- L₁, L₂—Plug-in coils. See text
- L₃, L₄—Transmitter coils. See text
- L₅—30 hy. 75 ma. Stancor C-1002
- L₆—Speaker field.
- RFC—2.5 mh. Miller
- T₁—1.3 audio transformer. National A-100
- T₂—Output transformer on speaker.
- Speaker: Wright De Coster Model 630.

C₁₆, C₁₇, C₁₈—8 mf. 500 v. Aerovox

C₁₉, C₂₀—0.02 mf. mica 500 v. Aerovox

comfortably, and the position of the arrow gave a sufficient indication of the section of the band being received. Of course if the set is to be used for a good deal of operation at the home station, or if logging of stations is desired, a vernier dial could easily be installed. However for portable operation using the eighty meter band, the simple arrow knobs have proven adequate. What's more, they don't get out of order.

The Transmitter

The transmitter employs a '47 crystal oscillator on eighty meters

with link coupling to the antenna tank. By using the same type of tube in both transmitter and receiver, the number of spare tubes that needs to be carried along on portable operation is reduced to three, a '27, a '47, and an '80. The windings of the transmitter coils are placed near the lower end of the two forms so that there is space for adjustment of the link at the upper ends. This provides a very nice control of antenna coupling. As in the case of the receiver no coil data will be presented here because it is adequately covered in the vari-

ous handbooks. Not only that, but the number of turns will be dependent on the diameter of the coil-forms and wire which you happen to have.

One terminal of a 1/4 watt neon bulb is connected to the hot side of the oscillator tank to indicate resonance. The oscillator tank should be tuned for maximum brilliancy of the neon bulb, and the antenna circuit for minimum brilliancy. The antenna coupling should be such that the neon bulb is almost extinguished when both circuits are in resonance. After the tuning procedure has been carried out as described, the capacity in the oscillator tank should be reduced very slightly. This will prevent keying chirps, and will insure that the oscillator starts right off every time the key is closed. Center-tap keying is employed, and the two .01 mfd. condensers connected from each side of the '47 filament to ground help to minimize key clicks.

A separate filament winding is used for the oscillator, so that changing from receive to transmit merely consists of throwing SW2. This disconnects the negative lead from the receiver and connects it to the transmitter, permitting very rapid change-over.

The Power Supply

A glance at the power supply circuit will show that it is revolutionary in design, really startling. It actually uses an 80 (a rare type of rectifier tube). The speaker field is used as the first choke, followed by a thirty henry Stancor job, and the output of the power supply is 99 & 44/100 per cent pure. The two plate-filament condensers on the 80 were found necessary in order to eliminate tunable hum in the receiver.

Construction

The use of 1/4 inch plywood makes (Please QSY to page 58)

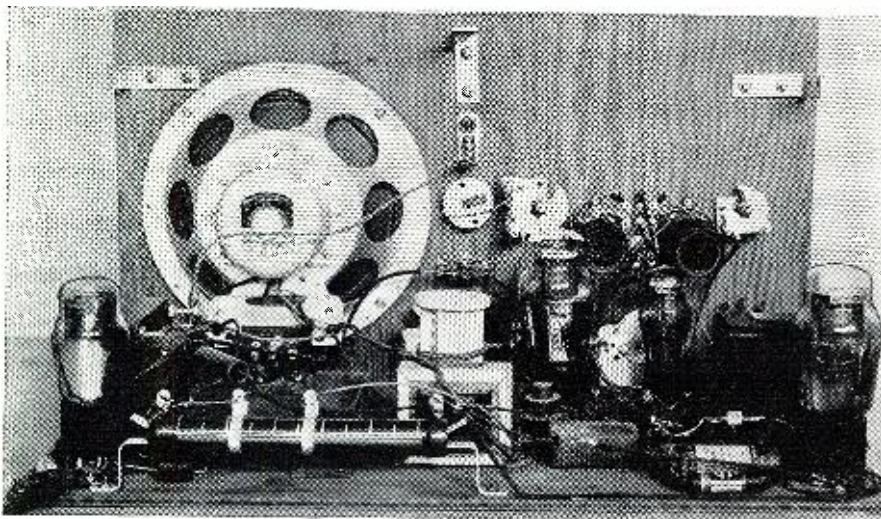

The wiring here is not quite as "haywire" as it seems, and that is due to the fact there is no chassis under which it can be run. The chassis is a piece of wood. A single buss wire will have to be run as a common ground connection, and all "grounds" soldered to it. Use the most direct wiring possible, but be sure to keep the grid and plate circuits well separated. Number 18 wire will do for all circuits except the 115 v. line input which should be run with regular rubber-covered "parallel" pair commercial wire.

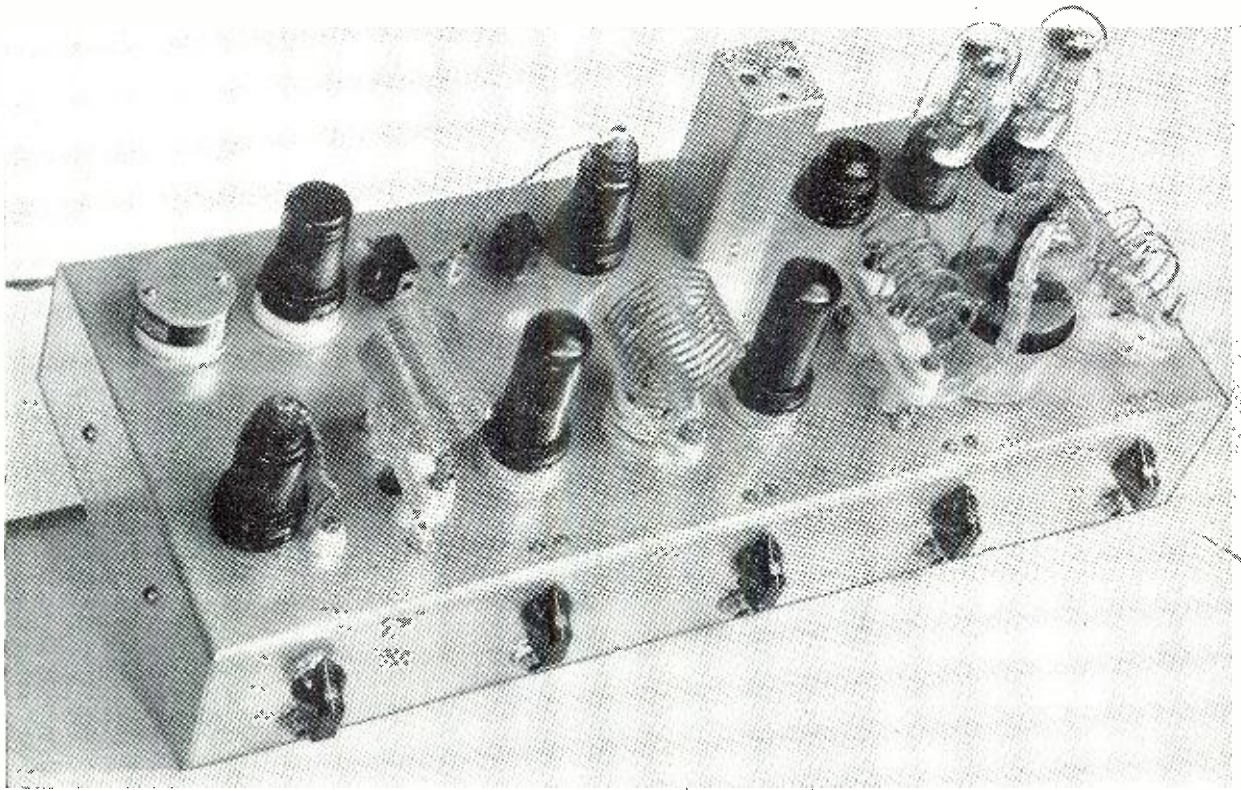

No power supply is included in the experimental crystal-controlled F.M. transmitter.

An Experimental Crystal-Controlled Amateur F.M. Transmitter

by **KARL A. KOPETZKY, W9QEA**

Managing Editor, RADIO NEWS

A simple, easy-to-adjust, crystal-controlled 56 megacycle, 50-watt input F.M. transmitter.

WITH the interest in F.M. increasing at a rapid pace, many amateurs have been experimenting with 5 meter transmitters of this category. The fundamental interest in F.M. work lies in the fact that not too much in the way of circuit data is available. This situation presents to the amateur the ideal condition wherein he may experiment to his heart's content and, also, there is always the chance that he may stumble upon something unusual or outstanding just as he did many years ago when he discovered the effectiveness of the Ultra High Frequencies.

Heretofore, a number of circuits have appeared, not only in this publication, but others, serving the amateur fraternity, showing how simple it is to put together a frequency modulated 5 meter transmitter. The fundamental difference between the amateur transmitter and those of his professional brothers lies in the fact that the amateur has consistently continued to use a reactance type modulator, mainly for the sake of simplicity.

This type of frequency modulation has, however, many draw-backs. Not the least of these is the fact that there is not any way in which the carrier

can be returned to normal or "resting" position when no modulation is present on the carrier. A great many amateurs experimenting with the reactance modulation type of F.M. transmitter have experienced difficulty in keeping their carrier somewhere close to the "original" setting so as to be able to make contact, it being one of the by-words in the fraternity that the most contacts are made by maintaining a fixed frequency upon which other amateurs may look for you.

In view of the above, we decided that the only solution would be in perfecting a simple crystal-controlled rig. Between that decision and the ultimate experimental model herein illustrated and described was a long and tedious process of research trial and error coupled with arguments in and around amateur engineering circles. Finally, we found that we would

have to go back to articles written by Armstrong himself and study these for the purpose of understanding them completely before we would be even able to consider the assembly of the experimental job.

The basic results of our experiment station and research is a transmitter which seems to work exceedingly well. Using the now-conventional ECO oscillator and tripling until the 5 meter band is reached, a reactance modulator and a crystal-controlled i.f. discriminator voltage control system, we found this to be about as simple a transmitter as could be assembled which, at the same time, would give the amateur a staple, terminal frequency upon which his station could be "fixed" and to which frequency he would reasonably assume the carrier would return whenever modulation was not being used. In addition to

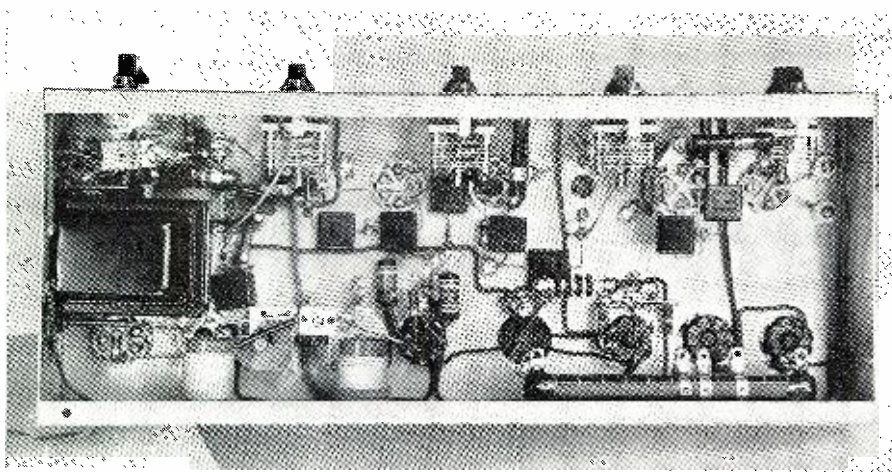

Note the simplicity in the wiring of the F.M. transmitter.

that, the circuit as used provides for a guard against overmodulation or modulation assuming such characteristics as would cause the carrier to swing too far from the "resting" frequency.

No tests have yet been made to determine just at which point amplitude modulation exceeds frequency modulation is receivability, but it would be a simple task to combine with this transmitter high level class B modulation applied to the final r.f. amplifier in the normal *amplitude modulated* manner by throwing a switch. Then the amateur could switch easily from F.M. to A.M. and back, affording a large number of field tests to determine the relative values of the two types of transmission.

We discovered in checking down the

circuit that the greatest amount of engineering explanation would be involved in the description of the operation of the discriminator part of the transmitter. It looked very simple on paper, but to explain it completely, it would have taken many more pages than the constructor would care to read. Throughout this article there are a number of technical explanations which may be skipped by the constructor in the event he is not interested in knowing the theory behind the operation. All component parts' values are given. The construction is not difficult and if the details herein set down are followed, an excellent little F.M. transmitter should result.

Theory of Operation

In order to understand the theory of operation of the amateur F.M.

transmitter, one must immediately discard the notion that crystal-control is by harnessing the r.f. frequency of the crystal oscillator directly to the output tank although processing it on the way and amplifying its power. Crystal control, as applied to this F.M. transmitter, is actually a d.c. voltage proposition. In other words, the crystal is used to generate an r.f. frequency, and this r.f. is subsequently converted into a d.c. potential which is applied in its proper polarity to the control grid of the 6L7 reactance modulator tube across the ECO oscillator, and prevents the 6L7 from swinging the ECO oscillator too far from "resting" frequency. The only time that the crystal oscillator is called upon to do any work on the carrier frequency is when, by virtue of one condition or another, the reactance modulator causes the ECO to vary its frequency. At "resting" frequency, and with no audio present, the crystal oscillator-discriminator unit does not develop any voltage.

Paraphrasing this statement and possibly to clarify it, one might say that so long as the carrier remains constant, the crystal-oscillator-discriminator section of the transmitter is not called into play, but should the frequency vary, then the crystal oscillator and discriminator section takes hold to control the swing. In addition to that, should conditions arise whereby the carrier is left off "resting" frequency without modulation, the crystal oscillator and discriminator circuits tend to return the ECO oscillator to the "resting" or "normal" operating frequency.

(Continued on page 46)

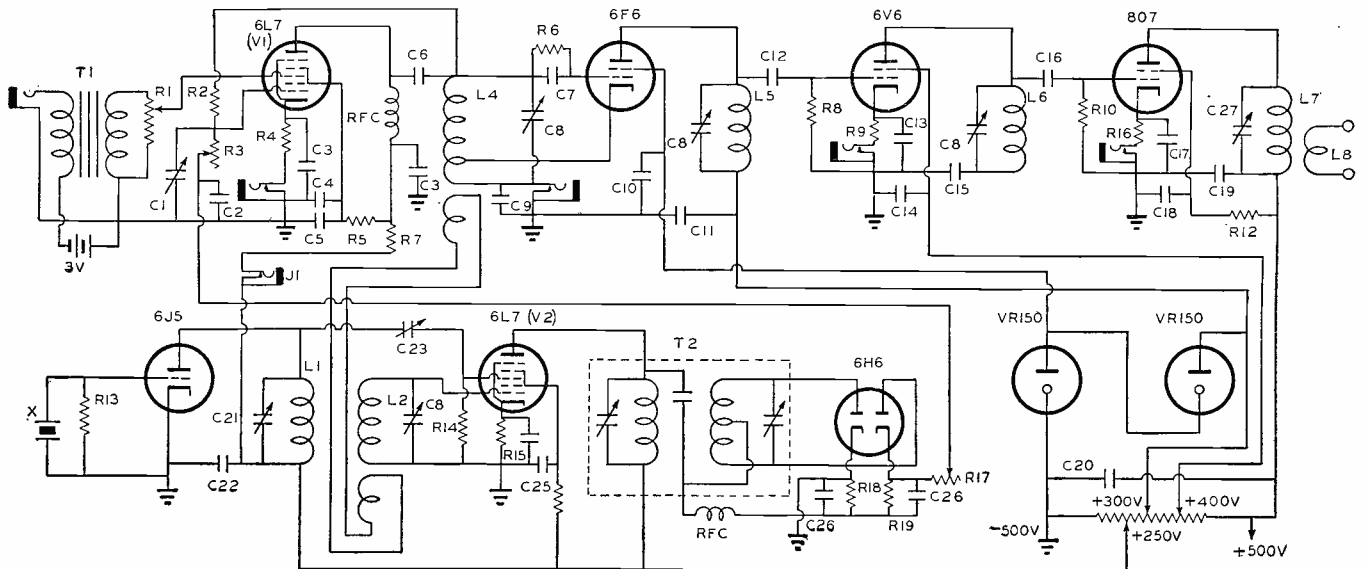

- R₁—1 megohm pot. Centralab
- R₂—40,000 ohm 1/2 w. IRC
- R₃—500,000 ohms, Centralab
- R₄—350 ohms, 1 w. IRC
- R₅—25,000 ohms, 1 w. IRC
- R₆—50,000 ohms, 1/2 w. IRC
- R₇—10,000—25,000 ohms, 1 w. IRC
- R₈—40,000 ohms, 1 w. IRC
- R₉—400 ohms, 10 w. Ohmite
- R₁₀—40,000 ohms, 1 w. IRC
- R₁₁—450 ohms, 1 w. Ohmite
- R₁₂—25,000 ohms, 10 w. Ohmite
- R₁₃—20,000 ohms, 1 w. IRC
- R₁₄—40,000 ohms, 1 w. IRC
- R₁₅—350 ohms, 1 w. IRC
- R₁₆—250 ohms, 10 w. Ohmite
- R₁₇—5-1.0 megohms, Centralab
- R₁₈₋₁₉—25,000 ohms, 1/2 w. IRC
- C₁—3-30 mmf. padder Hammarlund

- C₂—0.0005 mf. mica Aerovox
- C₃—.01 mfd. 400 paper Aerovox
- C₄—8 mf. 250 v. electro. Aerovox
- C₅—.01 mfd. 400 v. paper Aerovox
- C₆—.00025 mfd. mica Aerovox
- C₇—.00015 mfd. mica Aerovox
- C₈—75 mmf. var. Cardwell ZR75AS
- C₉—.005 mfd. mica Aerovox
- C₁₀—.005 mfd. mica Aerovox
- C₁₁—.005 mfd. mica Aerovox
- C₁₂—.00015 mfd. mica Aerovox
- C₁₃—.005 mfd. mica Aerovox
- C₁₄—.005 mfd. mica Aerovox
- C₁₅—.005 mfd. mica Aerovox
- C₁₆—.00015 mfd. mica Aerovox
- C₁₇—.005 mfd. mica Aerovox
- C₁₈—.005 mfd. mica Aerovox
- C₁₉—.005 mfd. 1000 v. mica Aerovox
- C₂₀—8 mfd. 450 v. electro. Aerovox

- C₂₁—75 mmf. var. Cardwell ZR75AS
- C₂₂—.005 mfd. mica Aerovox
- C₂₃—3-30 mmf. padder Hammarlund
- C₂₄—.01 mfd. paper Aerovox
- C₂₅—.01 mfd. paper Aerovox
- C₂₆—.0002 mfd. mica Aerovox
- C₂₇—25 mmf. var. Cardwell ZU25AS
- T₁—Mike-to-grid Thordarson T5738
- T₂—465-456 kc. Discriminator Carron
- L₁—29 t. No. 24 DCC—1" dia. form.
- L₂—3 t. No. 24 DCC over cold end of L₁
- L₃—National 40E tap at 7th turn. Take off 4 T.
- L₄—Bud OEL 20 m. coil (less 1 turn)
- L₅—3 T, No. 10, 1/2" Dia., 2" long
- L₆—Bud OEL-5 (less 1 turn)
- Chassis—Bud or Par-Metal 7"x17"x3"
- Sockets—Millen & Amphenol
- Tubes—RC A
- RFC—2.5 mhy. Millen

Serviceman's Experiences

by LEE SHELDON

Chicago, Illinois

Don't inject yourself into your customer's arguments!

WF had been getting plenty of calls lately, but for some reason, I had been muffing them. The customers, as far as I could tell, were the same sort we had always had, and the sets had the same things wrong with them; but when I gave a price—blooey!—about fifty percent of them wouldn't let me take the sets to the shop.

Al pointed out that such calls were not only a waste of time, but also were actually harmful to our reputation; every incompleting contact we made, whether money changed hands or not, resulted in hard feelings, and was evidence of something wrong with our professional machinery.

I countered by telling him there were bound to be periods of void in anyone's career. Willie Hoppe, for instance, after running six points in a three-cushion match, followed his minor miracle by eight innings during which he scored nothing—but he was Champion, none the less. Authors experience barren periods, during which—no matter how hard the Muse is mauled—they produce nothing. In the lull, they are often forced to fill in with some real work. Even the sun is sometimes eclipsed.

Although I had Bronx-cheered Al's ideas of my defection, I was privately worried. As I drove to Johnson's house to repair their *Atwater Kent*, I determined to get the job, no matter what means I had to employ.

Two women—Mrs. Johnson and her sister-in-law—showed me to the living-room and sat in opposite corners while I examined the set. I noticed with satisfaction that all the tubes were lit, and as I was unbolting the chassis, Mrs. Johnson asked

"What's wrong with it?"

"I don't know yet," I replied, stalling for time. I wanted to know just how the ground lay before I committed myself.

In about three minutes Mrs. Johnson turned to the other woman and asked, coldly

"Well, Eileen—why don't you ask him?"

Eileen cleared her throat nervously and spoke to me. I welcomed the interruption because it gave me time to think.

"Does it hurt," she asked, nervously, "to plug a vacuum cleaner into the same outlet the set is connected to?"

So that was it! The rig had broken down while she was cleaning the room, and the other was blaming her for the trouble! Well, I thought to myself, here's where I cinch the job by throwing a scare into them.

"It's not good practice," I replied, "although the set is not *always* damaged as a result. Tell me—was the set *playing* while you used the cleaner?"

I stared at her intently, and she dropped her head.

"Yes," she admitted.

"Oh-oh!" I said. "Well, that's too bad. It's a sad state of affairs when a dealer can't warn you about such things when you buy a set!"

Eileen swallowed a couple of times, but did not raise her head. I turned to Mrs. Johnson, who was sitting there, burning quietly.

"Filter condensers are probably shot," I told her. "Cost you around seven fifty."

"I certainly won't pay for it," she said, daggering Eileen with her eyes.

"Isn't it your set?" I asked, sensing trouble.

"Of course it is," she replied, "but why should I pay when *she* caused the damage?"

Eileen spoke as if she was about to cry.

"I'm sorry," she said, "but I haven't got seven dollars and fifty cents—you *know* I haven't, Mary."

"I know I've stood about as much of your foolishness in this house as I am able," Mrs. Johnson snapped. "Just you wait until I tell Henry about this tonight!"

Neither paid any attention to me. I stood by, waiting for them to get their dirty linen in off the line.

"Now, Mary," Eileen pleaded, with a breaking voice, "you know I try very hard to fit into the family as usefully as possible. It's only till I get a job that I must live with you—"

"Only?" screamed Mrs. Johnson, jumping up from her chair. "Eighteen months," she said to me, "and she calls it *only*!" She strode to the door. "If I've got anything to say in this house, you'll be out of it by tomorrow night. I'm going to tell Henry about that trip to Chinatown, too!" she added, slamming the door.

Eileen pushed her face into a handkerchief and cried with everything she had.

How the hell did I get into a thing like this? I wondered. Eileen was broke, so there was no use to try to do business with her—even if I waited until after the storm; and Mrs. Johnson—who, judging from the upstairs sounds, was rearranging the bedroom furniture with her foot—was a poor prospect, at best. I replaced the chassis and left the house without even finding out what happened in Chinatown.

Al, of course, knew exactly where I'd made my mistake, and wasn't a bit bashful about telling me so.

"Listen, Dracula," he said, using that annoying tone he affects when he begins to shake a finger at me, "you shouldn't have started the argument by blaming anyone for the breakdown. When a serviceman enters a house, he is somewhat like a doctor—"

"Comparisons are odorous," I interrupted.

"If the doctors can stand them, so can you," he continued. "Both servicemen and doctors are called into homes to restore happiness and health—not to make people miserable. Those who pay your living trust in your ability to help; and—since they do, is it unreasonable that you should respect their feelings? Why are you staring at me like that?"

"I've never noticed it before," I replied, "but your ears stand out at right angles to your head when you get mad. Have you—"

"It was entirely your fault you lost that job," my partner persisted. "Instead of pretending a customer is at fault, it would be better to stretch your ethics a bit and play down the customer who really was to blame. Don't forget you're in his house to help, no harass!"

When Al gets going on a train of thought, he's like a locomotive; I can't stop him, but sometimes I am able to switch him so that he runs out of steam on another line. I knew he was wrong, but I got him talking about something else before the argument

(Continued on page 58)

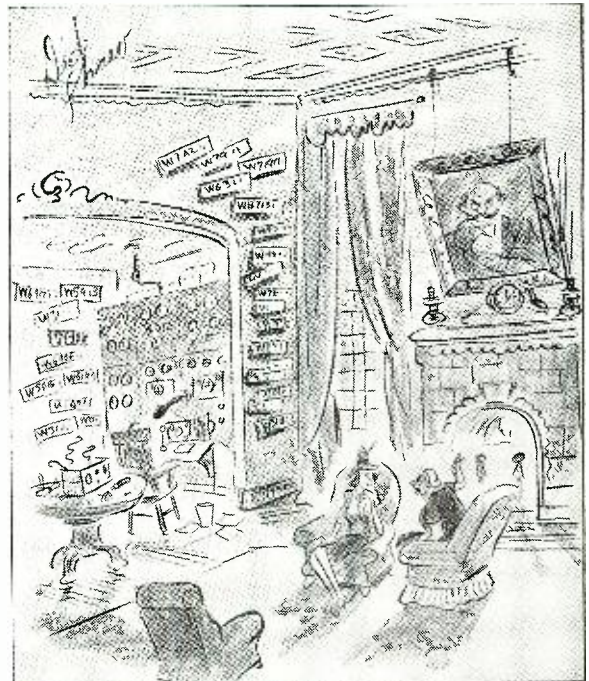

"Walter built it in 1920, but he has not yet got his license to work it."

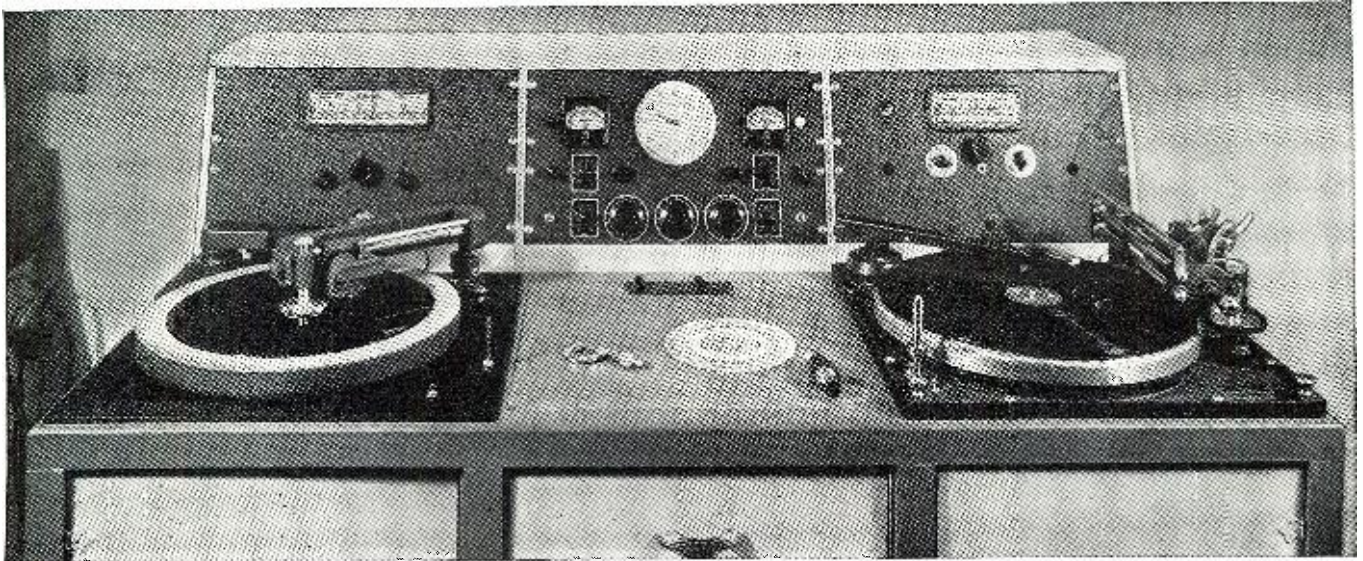

The laboratory set-up which the author used throughout his experiments.

Build Your Own RECORDING STUDIO

Constant Amplitude vs. Constant Velocity Recording

by OLIVER READ, W9ETI

Technical Editor, RADIO NEWS

Covering a subject concerning which there has always been some mystery, but which every recordist should understand.

Part 4.

WE have taken the reader through various necessary stages dealing with the art of recording so that he may become familiar with the problems which he will have to meet. We have stressed the importance for using high grade equipment when good recordings are to be made.

Unfortunately, there is no substitute for precision made equipment. This includes the turn-table, amplifier, cutter, speaker and, in fact, any and all parts of the complete assembly. There is no one of these parts which does not require a certain amount of study in order to ascertain whether or not it will be suited to the purpose.

We promised to give the reader a comparison between commercial "constant velocity" and "constant amplitude" recording procedure. It might be well to point out that in the case of commercial records turned out by the various manufacturers that these are cut with a method known as "constant velocity." This means that for a given sound source input voltage that the actual swing of the cutting stylus,

properly termed "stylus displacement," will vary for different frequencies. A typical curve of a record cut by this method is illustrated in *Figure 1*.

A considerable amount of noise reduction may be had through the other method known as "constant amplitude" recording by using crystal cutters for both the recording and play-back. These devices permit a considerable degree of noise reduction and they require no equalization in either the recording or play-back circuits. In defining "Constant amplitude" recording, we find that a constant sound pressure for all frequencies at the microphone will be represented by the same amplitude or stylus displacement of the cutting device. Fig 3. In other words, the side-to-side motion of the stylus will reach a *definite limit* for all frequencies. From this, we see that it is possible to use, generally, a much higher cutting level, and the danger of cutting in to the next groove will be minimized. We can, therefore, cut many more grooves-per-inch on the disc.

The usual method, "constant veloc-

ity," recording, is represented by the same vibrational velocity, i. e. — the amplitude of the undulations cut in the record is inversely proportional to the frequency. The amplitude is the velocity divided by the frequency, but since the velocity is constant, amplitude is the constant divided by the frequency.

In *Figure 3*, we find various wave patterns shown which represent groove undulations for both types of recording. These patterns were prepared by the *Brush Development Company* and illustrate clearly the comparisons of both methods used in recording. Note that in the pattern which represents "constant amplitude" recording, that the amplitude of the groove undulations is constant *regardless of the frequencies*. In the pattern which represents "constant velocity" recording, it will be noted that the amplitude of the groove undulations decreases as the frequency increases in such a manner that a frequency of 10,000 c.p.s. has but $\frac{1}{100}$ th the amplitude of 100 c.p.s.

Since this latter method would

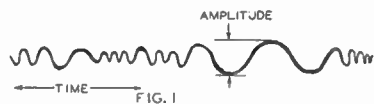

necessitate excessive amplitudes at the lower frequencies to obtain sufficient amplitudes at the higher frequencies for satisfactory reproduction, commercial "constant velocity" records are usually cut "constant amplitude" from the lowest frequencies up to, approximately, 500 c.p.s. as indicated. This is also done to permit more grooves to be recorded without danger of "cross-over" or, "echo."

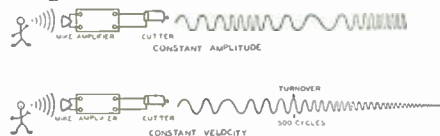

C.A. vs. C.V. Recording

The "cross-over" effect is that condition in which one groove cuts completely over into an adjacent groove, (see Fig. 2) while "echo" effect is that condition in which one groove deforms the wall of an adjacent groove. (See Fig. 4.) Assuming that for average recording, the amplitude for a frequency of 1,000 cycles will be the same for "constant velocity" and "constant amplitude" recording, then the amplitude for a frequency of 5,000 c.p.s. for "constant velocity" recording will be only $\frac{1}{5}$ th the amplitude for "constant amplitude" recording. However, this



takes into consideration that the cutters used in both methods of recording have a uniform characteristic at least up to 5,000 c.p.s.

We may now see that "constant amplitude" recording has an advantage over "constant velocity" recording, since the cutter automatically provides the higher amplitudes at the higher frequencies required for noise reduction during reproduction.

The crystal cutter (such as the *Brush Models RC-1* and *RC-20*) is best suited for "constant amplitude" recording, since its stylus displacement (amplitude) is proportional to the input voltages over its useful frequency range. Furthermore, due to the inherent stiffness of the crystal element, the amplitude and frequency response are practically unaffected by depth of cut or variations in hardness of recording materials. When these crystal units are used to reproduce "constant amplitude" records, the relationship of the higher and lower frequencies at the input of the cutter is maintained since the output of the pick-up is proportional to the stylus displacement over its frequency range.

Considerable noise reduction takes place in reproduction, since the output voltages, as generated by the higher frequency sound modulations in the record, are considerably greater than the output voltages generated by the tiny irregularities in or on the record material (surface noise). While it might appear that these higher amplitudes may interfere with the reproduc-

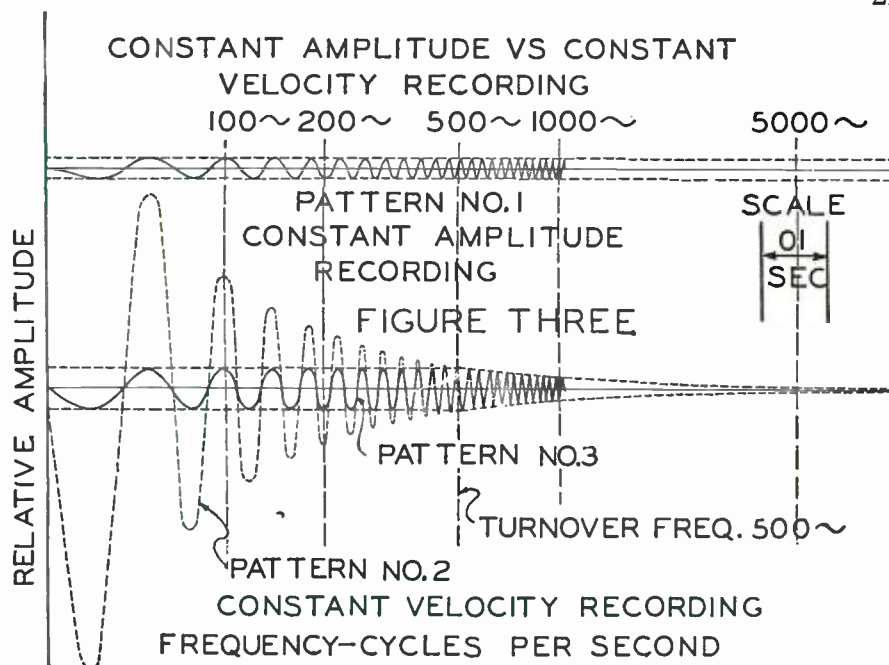

ing stylus tracking the grooves at these higher frequencies, this defect can be practically disregarded, considering the fact that both speech and musical sounds contain much less energy for the higher frequencies than they do for the lower frequencies. Furthermore, "high fidelity" crystal pick-ups, such as the *Brush PL-20* used on this equipment, are available with low inertia vibratory systems and styli of small radii of curvature which are capable of tracking high frequency undulations of rather high amplitude.

Surface noise has always been a problem to the listener as the resulting scratch in many cases tends to "mask" the higher audio frequencies. "Constant amplitude" recording offers a definite improvement for this condition and a noise reduction of from 6 to 10 d.b. may be had over the usual "constant velocity" recording, using the same type of recording material. Actually, this noise reduction appears even greater due to the irritating nature of the surface noise. Recent years have brought out a more satisfactory possible audio range, which may be recorded. This is due to a combination of factors among which are, the improvement in the design of mechanical equipment, the use of better recording materials, the sapphire stylus, and the new low pressure crystal pick-ups, not to mention several others. By carefully choosing our equipment, we may rest assured that we will enjoy comparable results. The cost of both crystal and magnetic cutters of good quality is now lower than ever. This is due to the "boom" in home recording which occurred in early 1940. Many of the inexpensive units are capable of cutting up to frequencies as high as 8,000 cycles when used with proper equipment and in intelligent application. Let us now consider what we may do in conjunction with our own recording studios.

First, we must select discs which have an even layer of coated material. These discs must be free from dust or impurities. They should be of fresh stock and should be obtained from reputable distributors. Second, we must select the finest type of cutting stylus which may be used.

Sapphires are available from three dollars to ten dollars, and the use of this type is recommended. We have already discussed the requirements for the recording amplifier, and we may sum up these requirements as follows: the maximum undistorted output should be approximately 60 d.b. above the noise level of the amplifier. The frequency response should be flat from 50 to at least 8,000 c.p.s. within plus or minus 2 d.b. Next, the amplifier should have a low harmonic content at full-rated output, and this harmonic distortion should be less than 5%. The full rated output of the amplifier should be ten times as great as that actually used during the process of recording or in reproduction so as to be able to handle the peaks. The overall gain of the amplifier should be sufficient to meet all requirements. It must have sufficient gain so that practically any type of microphone may be used under various conditions. If magnetic cutters are used, they will require an amplifier equipped with an output transformer to properly match the impedance. Crystal cutters, in some cases, also require the use of a transformer. The cutter must be selected from those which are free from peaks anywhere within the audio range. In the better grade of cutters these peaks are suppressed or removed by proper "damping." The overall volume range of the cutter must also be considered. This should be approximately 50 d.b. above the noise level created by the record material.

Both the crystal and the magnetic cutter have come in for their share of argument as to which is the better type to use. We have used many in conjunction with our own recording set-up, and have found that each possesses definite merit in its own right. For example, some of the advantages of a crystal cutter are as follows: Because of its inherent stiffness, the amplitude and frequency response are almost completely unaffected by depth of cut in variations from hardness of the record material; two, if these records are cut "constant amplitude" the usual form of equalization may be dispensed with, which will provide a wider frequency range with a consequent reduction of surface noise.

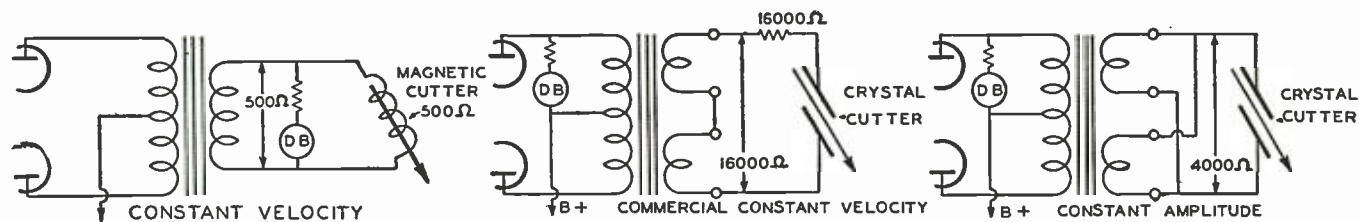

Figure 6. Constant amplitude vs. constant velocity recording circuits.

They may also be cut "constant velocity" with simple equalizing networks.

Groove Speeds

One must consider the *speed* of the record as it travels under the stylus when high fidelity cutting is to take place. There are two speeds generally used—namely, 78 r.p.m. and $33\frac{1}{3}$ r.p.m. The former speed permits the higher frequencies to be recorded with greater precision than would the slower speed of $33\frac{1}{3}$ r.p.m. A certain amount of velocity is required in order to eliminate crowding effects within the groove of the record which would make proper tracking of the playback pick-up more difficult. In the last installment of this series, we illustrated several light patterns that were made from discs cut at slow speed. The minimum diameter used was six inches. The velocity of the record below this diameter is too slow for proper modulation of the groove. As the diameter increases, the velocity increases for a given turn-table speed, and the recording of the higher frequencies becomes more accurate. For example, if we increase the speed to 78 r.p.m. at a six inch diameter, we would be able to record the higher notes more satisfactorily than we would at the slow speeds.

Whenever one is to use slow speed recording, he must consider the *diameter* of the disc with respect to the frequencies which are likely to be encountered during the process of recording. In many cases, the operator will know what type of selection is to be recorded. If it contains an abundance of stringed instruments, or others which produce high overtones, it will be well to begin the record at as large a minimum diameter as possible by timing the selection beforehand and by using as much of the outside of the disc as possible. We have mentioned "equalization" before in this series and this refers to the treatment of various frequencies so that they may be either increased in volume or decreased according to the needs. It is necessary to boost the high notes when recording at small diameters at slow speed. This applies particularly to recordings which are made with magnetic cutters, which we have discussed. Units are available so that this equalization may be done automatically. As the diameter increases, we may reduce this high frequency boost gradually so that when the record is played back the high notes will not be lost under the surface noise.

In some installations, the bass frequencies are increased at small diameters in order to create certain effects or to take care of some frequency discrimination that may be present somewhere within the recording equipment.

In order to determine whether or not equalization is required, it is only necessary to make a series of test

records such as those illustrated in our last installment and to play them back for observation. The ear is a satisfactory medium for judging the final results, particularly if one is trained in music. If, upon listening to a recording, the high notes appear rather weak, another test may be conducted with the high notes further boosted, and these may be checked for comparison. One may soon learn the peculiarities of his own equipment by such comparative checks. It is not necessary to have elaborate laboratory equipment if one is able to appreciate the difference between ordinary and excellent results.

Unfortunately, checks are frequently required where equipment is subject to temperature change. An adjustment which works satisfactorily during the warm summer months will usually be far from correct when recording during cooler weather. Not only will the disc material vary in texture, in most cases, but various adjustments will also shift and will have to be compensated for. For that reason, comparative checks should be made at regular intervals in order to determine the status of the combined recording set-up. One should never attempt to record at slow speeds until they are capable of turning out consistently high quality records made at 78 r.p.m.

Off-the-Air Recording

We have already described the type of tuner needed for high quality work. The recent introduction of *Frequency Modulation* has opened up a new field for the serious minded recordist. Unfortunately, this type of transmission is not available except in certain communities. For several months past we have engaged in recording, using a high grade F.M. tuner in conjunction with our recording studio. The quality of the discs produced indicate that the day will soon come when we may consistently record audio frequencies as high as 15,000 c.p.s. This will require great precision of the parts and the use of a tuner capable of passing frequencies which will extend to that range. Most of the lines used for transmitting audio pulses to the transmitter are, as yet, not able to include 15,000 c.p.s., as the requirements of the amplitude modulated transmitter are such that they do not actually need anything above 5,000 c.p.s. Recently, we have been able to enjoy the extended range provided by the modern F.M. stations. Now, in order to record these frequencies, it is necessary to select a cutter which will respond to those pulses. Our experiments were carried out utilizing the *Brush RC-1* crystal cutter and which was illustrated in the last article of this series.

It is imperative that some form of indicator be provided on the F.M. tuner for proper tuning of the station if full advantage is to be taken of the extended frequency range. The prob-

lem of matching the tuner to the amplifier is important, and the best type of network to use will depend upon the particular equipment selected. Some tuners are provided with a "tone control" which should be omitted when used for recording purposes. It is far better to use the equalizers included within the recording amplifier for this purpose.

In no case should the reader attempt to cut high fidelity records where turntable rumble is present. When played back, this rumble will appear along with the music and will completely ruin the effect of the transcription. This furthers the argument against the use of flimsy recording turntables and inexpensive parts which are not capable of giving the desired results. The table rumble should not be audible when the amplifier is used at full rated output.

If an audio oscillator is available, it should be used for the initial adjustments before any attempt is made to include all of the frequencies available from the F.M. transmitter. In this way, one may insure himself against the waste of discs, which are rather expensive to purchase.

The recording of standard a.m. transmissions does not present any great difficulty and, in fact, the requirements are not as great as those needed for the recording of F.M. signals. Any good grade of cutter may be used which will record all frequencies from 50 cycles to 5,000 cycles without distorting them. The a.m. tuner should also be provided with a tuning indicator in order that the station be tuned accurately. Some of these tuners are capable of rather broad band width characteristics. In some cases, a 10 kc. beat-note will be heard. It may be effectively removed by inserting a suitable filter tuned to that frequency at the output of the tuner.

The monitoring of the program is extremely important and one should be equipped with a high fidelity loud speaker which may be run at comfortable volume levels while the recording is being made. By so doing, the user will have a true picture of the reception as it comes in.

Conclusion

We have received many letters requesting information on recording procedure from many standpoints. We shall attempt to cover as much as possible, all of these topics in future installments. The whole study of semi-professional recording is one which cannot be undertaken in a short period of time. One must first acquire the "knack" of his own particular equipment and certain rules set forth for one may not suffice for another user. In other words, the operator must become familiar with his own setup and must use a certain amount of common sense in applying the

(Continued on page 52)

THE VIDEO REPORTER

by Samuel Kaufman

WITH W2XBS back on the air in the New York area, the station is saving live talent expenditures by using outdoor and indoor sports pickups—professional football and hockey, for example—and moving pictures.

Once again, we must report that the sports pickups make excellent program fare, but the feature-length movies are worse than the average second picture at double-feature theatres on Bingo night.

IN line with the efforts of the *National Television Systems Committee*, NBC recently announced that frequency modulation will be alternated with amplitude modulation to carry the sound portions of the present experimental series of television transmissions.

The *NTSC*, incidentally, is showing signs of progress. The course it is following seems to call for slow traveling. But the lads seem sure-footed and it really seems as if the committee's work will wind up with "everybody happy." There still are some very tough hurdles ahead and it is known that some representatives on the panels will be tough babies to handle when it comes to yielding on any pet theory. But



Cleaning out video tube blanks.

there's a general spirit of harmony in the desire to get things started and there's a chance that "things will start" shortly after this reaches print.

HOLLYWOOD, land of make-believe, has somewhat startled New York television men with the spontaneity and forcefulness of its entrance into the video field. And there's nothing that's make-believe about the Los Angeles television endeavors. There's so much money involved in the numerous West Coast sight-and-sound transmitting units, that the Celluloid City shows signs of immediately recruiting engineers and talent on a large scale.

Los Angeles television participants figuring in the news recently include *CBS*, *Television Productions*, *May Department Stores*, *Leroy's Jewelers* and the *Hughes Tool Company*. The latter firm, it is said, has \$2,000,000 available for video stations in Los Angeles and San Francisco.

IT is interesting to note that prominent department stores and various types of specialty shops are among applicants for television stations in various parts of the country. This action implies that alert retailers are quick to recognize the potential importance of television advertising to local audiences.

At the start of commercial telecasting, most sponsored programs will be local in nature, both in entertainment content as well as advertising blurb. It will take a

(Continued on page 59)

AVIATION RADIO

by CHARLES J. SCHAUERS

A LETTER from E. J. Allen, of New York, requests information relative to the proper procedure in obtaining the necessary licenses for an aircraft radio transmitter installation.

Every radio transmitter must be licensed by the Federal Communications Commission, and each person operating a transmitter must have a radio operator's license.

The class of license necessary to operate any transmitter is dependent upon the type of service for which the transmitter is used; size of the transmitter (governed by application), and duties performed while transmitter is in operation.

We are only concerned here with an aircraft radio transmitter installation and its operation. Therefore, we will not go into detail involving other classes of service.

In the Continental United States, a radio operator operating aboard an aircraft must have at least a "restricted radio-telephone" license (old "third class license") and having such a license cannot operate a *radiotelegraph* station unless a code test has been passed and code endorsement received.

A speed of 15 words per minute is necessary in order to obtain the code endorsement.

After a few hours study, one may pass the "restricted phone" examination, and a license will be issued authorizing the operation of the usual low power transmitter found in most private planes, using type A-3 transmission.

After obtaining the radio operator's license, it will be necessary to obtain the station license.

Form #04, obtained from the Federal Communications Commission, must be filled out and executed. This form in its entirety covers a technical description of the transmitter which will be used.

If a transmitter is purchased from any one of the leading aircraft radio manufacturers, a duplicate of the form is usually filled out for the purchaser.

Upon completing the form it is mailed to the Commission who will take immediate action and provide the applicant either with a license for the installation, or request further information which concerns the proper licensing of his equipment.

No license is required for a receiver installation alone, but with the addition of a transmitter, safety is greatly increased; especially when flying in the vicinity of airports where traffic is heavy.

A TYPICAL receiver installation is shown in next column. This installation requires that the installation technician exercise care and technical tact; because, even if the down-lead to the "under belly" an-

tenna were off center to an appreciable degree, directivity would predominate. This is but one of the minor considerations, but a

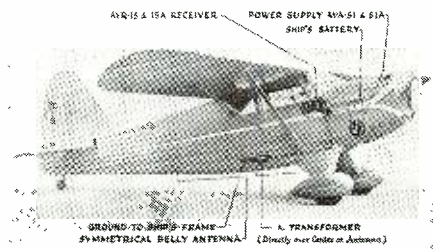

large one when maximum efficiency is desired.

Antennae installation on modern aircraft has always been a major problem, but due to progressive advancement, installations are being simplified more and more every day.

If one were to notice the new, large aircraft, they would see, instead of a "mass" of wires, maybe two or three vertical whip antennae.

These antennae, if properly matched by suitable coupling transformers and tuning elements, seem to be very efficient. However, for transmitting purposes, they are used only at extreme high frequencies.

IN figure below is an internal view of RCA's loop antenna. Due to outer shell construction, wind resistance is held at a

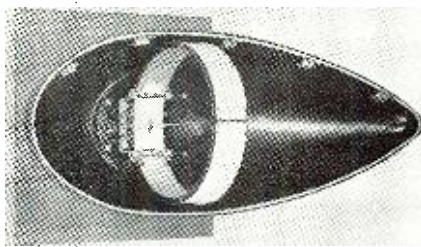

minimum, and the simplicity of installation is apparent when looked at from a bottom view.

The holding plate may be drilled and
(Continued on page 65)



Many plane accessory factories are conducting classes for employees. Here P. H. Nelson of Lear Avia is instructing the boys of the shop in whyfor's & wherefor's of radio . . .



A new directional loop developed by RCA for the private flyer is here shown installed on a Stinson plane.

★ What's NEW in Radio ★

The Hallcrafters Model S-31 FM/AM Tuner offers special advantages to those who already possess high-fidelity audio equipment, providing full facilities for FM, and for broadcast reception of unusual quality, without the necessity for duplication of audio equipment. Its undistorted output of 130 milliwatts is ample for any standard amplifier, including those in existing broadcast receivers.

The S-31 provides a dual i.f. system, the 4.3 mc. FM channel utilizing 1852 and 1853 tubes in its two 4.3 mc. stages, a 6SJ7 limiter and 6H6 discriminator. The 455 kc. AM channel includes a single 6SK7 with special band-pass input circuit, and a 6SR7 which serves as detector and a.v.c. and its triode section as the output stage for both AM and FM channels and also for phono. A 6SK7 t.r.f. stage and 6SA7 converter provide the r.f. input to both channels.



The two tuning ranges are 540 to 1,650 kc. and 40 to 51 mc. These are selected by a panel switch which also automatically selects the appropriate i.f. channel. Terminals are provided for standard and doublet antennas, and for phono input. The two scales on the "slide-rule" dial are fully calibrated in kc. and mc. Other controls include a radio-phono switch, a.f. gain, tone control, and "S"-meter adjustment. This meter, mounted on the panel beside the tuning dial, serves as a conventional tuning and signal strength meter for AM reception and as a carrier-centering indicator for FM tuning.

Outputs of 500 and 5,000 ohms are provided, plus a headphone jack for monitoring purposes. The panel is the standard rack-mounting type, 19"x8 3/4" and suitable for rack or cabinet mounting.

Knight-Bruno Dual-Speed Recorder. The new Knight-Bruno Recorder is a complete professional-type recorder, phonograph and public address sound system. This unit includes, in addition to the Bruno Model BR-12 recorder, a complete Knight 20-watt Recording and P.A. system of special design. This system is an excellent combination for use in recording studios and by sound specialists for high-quality precision work.

The recorder cuts from outside-in at 100 lines to the inch at both 33 1/3 and 78 R.P.M. Records on all types of discs, from 6" to 12". Constant speed motor drives turntable through special idler. Recorder is equipped with magnetic cutter head and high-impedance pickup. Recorder and sound system are each housed in durable compact, Fabrikoid cases.



The amplifier delivers 20 watts of usable power (26 watts peak). Hum is inaudible. Tapped output—4, 6, 8 and 500 ohm impedance. Supplied with Volume Indicator Meter, tone control, and volume control. Microphone gain is 127 db. Frequency response is 50 to 10,000 C.P.S. A Jensen 12" PM12C speaker with 30-foot cord and plug is supplied, mounted in one of the carrying cases which also houses the amplifier. A high-quality crystal microphone is also supplied with 25-foot cable and floor stand. For 110 volts, 60 cycle operation.

A product of Allied Radio Corporation, 833 West Jackson Boulevard, Chicago, Illinois.

Walter L. Schott Co., Los Angeles, makers of Walsco Products, announces a new product for reconditioning of phonograph records and treating of transcriptions and recordings.

This new product is called **Walsco Recordene** and has the following features: On commercial records, it will first remove all dirt, dust, or grease that has accumulated in the grooves; then it will leave a plastic film which will reduce surface noise and friction, and therefore prolong the life of the record. Measurements have proven that this treatment does in no way affect the sound reproduction.



On recordings and transcriptions the liquid is recommended for use after the blanks are cut and before they are played back, to prolong their life.

This product is put up in an attractive 2 ounce bottle, the cap of which has a built in special wool-felt dauber, which makes it extremely easy to apply by pressing the saturated dauber on the revolving record.

Walsco Recordene is available to dealers in an attractive display carton holding one dozen 2 ounce bottles. List price is 35c per bottle.

Presto 11-A Recording Motor. The fast growing interest in recording and high quality reproduction of records and transcriptions in the home has created an insistent demand on sound equipment distributors for a higher quality recording and record playing turntable.

To meet this demand, Presto Recording Corporation has just released as a separate unit the dual-speed 12" turntable formerly sold only as part of their model K commercial recorder.

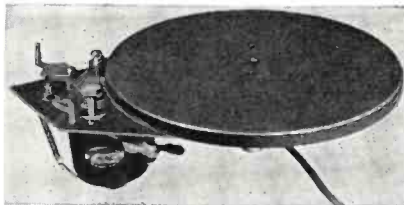

Radically different in design from any other table on the market, the new Presto 11-A employs a cast aluminum turntable precision machined to dynamic balance. The table revolves on a single ball-bearing at the base of a bronze shaft with. A heavy, live rubber tire is fitted to the rim of the table. A metal pulley on the motor shaft drives directly against the tire eliminating idler wheels, rubber tired pulleys and other parts which wear rapidly. A slip-over pulley is removed to change speed from 78 to 33 1/3 RPM. The motor and turntable are mounted on a steel base ready for installation in portable or console phonograph record and 16" transcription players.

Each part of the Presto 11-A table is hand-fitted and finished resulting in these excellent performance characteristics . . . speed accuracy .4% . . . speed regulation .2% noise due to mechanical vibration 45 db below zero (.000 W).

The 11-A is recommended for use in school reproducing systems, sound effects equipment used in radio stations, recording and motion picture studios and for the highest quality home recording and recording playing combinations.

Motorola "Playboy." Claiming to be the first in their field to offer purchasers of a personal portable that will play where other personal portables fail or their money will be refunded, the Galvin Mfg. Corporation has just introduced the Motorola "Playboy" . . . a radio that is as "small as a pocketbook" and as "easy to carry as a brownie camera."

The factory claims this confidence is warranted by the fact that the "Playboy" has been completely tested and proved and embodies the same engineering skill that has helped make Motorola America's Biggest selling auto radio. They say that this radio will play mostly anywhere and

will get as many stations as will most big portables.

The set is only 6 1/4" long, 4 1/4" high and 3 1/2" deep and weighs 4 1/2 lbs. It starts playing automatically when the lid which contains the aerial is snapped open. And it stops when it is shut.

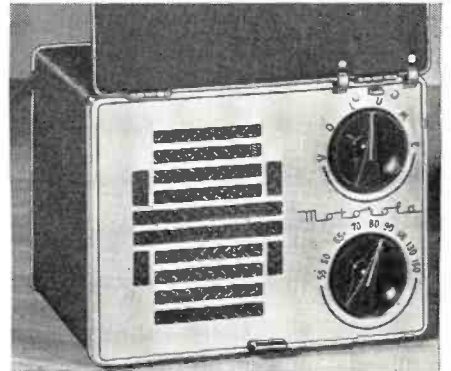

The superheterodyne "Playboy" has four latest type miniature tubes and is encased in a crackle finish metal case of modern design with shimmering chrome trim and a front cover of Polystyrene, the new plastic.

Plug-In Electrolytics now standard items. Originally made to order for military, aircraft, police radio, sound system, and other users of continuous-service equipment, the Aerovox plug-in electrolytics are now listed in the latest catalog and made available as standard jobber items.

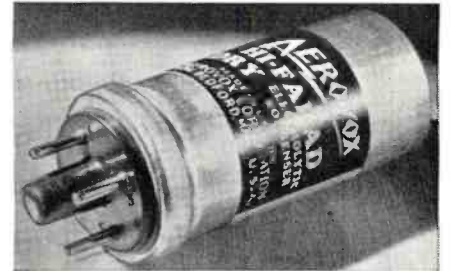

These unique plug-in condensers, developed and manufactured by Aerovox Corporation of New Bedford, Mass., are provided with a specially-constructed octal base which fits into the standard octal socket. Such units are readily removable for substitution testing and checking and replacement, in much the same manner and ease as regular radio tubes. This feature is vitally important in continuous-service equipment, wherein electrolytic condensers must be instantly replaceable when necessary. Auto radio sets and other assemblies are beginning to come through with plug-in condensers, hence the need for such replacements as standard items.

Aerovox plug-in electrolytics are now available in the 525 v. surge 450 v. D.C.W. rating, and in 10 to 80 mfd. single-section, 10-10 and 20-20 double-section, 10-10-10 triple-section, and the 10 x 10 x 450 + 20 x 25 combination.

Ohmite Generator Field Rheostats. Smooth, close, gradual control of generator voltage is provided by Generator Field Control Rheostats

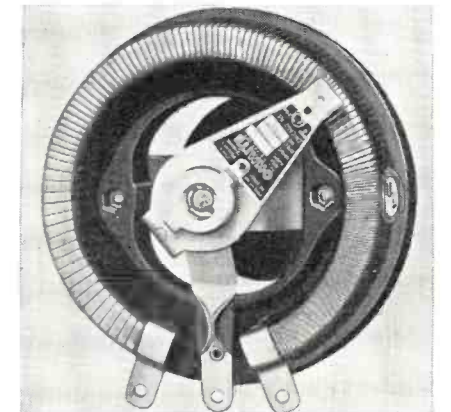

produced by the Ohmite Manufacturing Company, Chicago.

Ohmite compact, vitreous enameled construc-

tion insures permanently smooth operation and exact control—and simplified design problems for generator and switchboard designers. By providing practically continuous variation of resistance in even the smallest sizes, they effect considerable saving in control-panel space. This economy in space and weight makes them particularly useful on portable equipment, such as welding generators, home lighting plant generators, etc., also on shipboard, on trains, airplanes, and automotive equipment.

Ohmite Field Rheostats are tapered or uniformly wound, as required, designed to provide control for separately or self-excited generators. They are available in a series of ten wattage sizes, from 25 to 1,000 watts. Thus, there is an Ohmite Field Rheostat suitable for every size generator—from the smallest to units of several kilowatts. By connecting Rheostats in tandem, this range can be extended further.

Hundreds of standard size units are listed in Ohmite Catalog 40 according to the field voltage, and cover the range from 24-32 volts to 320-400 volts. Rheostat ohms, maximum and minimum amperes, minimum field ohms and rheostat size are all given so that the proper unit for the desired amount of control can easily be selected.

Ohmite Engineers will design individual Field Rheostats to fit each generator field condition. Write to Ohmite Manufacturing Company, 4835 Ploumroy Street, Chicago, Illinois.

Mercury Midget Switch. An extremely small mercury switch measuring only $\frac{7}{16}$ " long by $\frac{3}{8}$ " diameter has recently been announced by Littelfuse, Inc., 4748 N. Ravenswood Avenue, Chicago, Illinois. This switch is designed for use in low voltage circuits up to 25 volts A.C. or D.C., and currents up to 10 amperes at 6 volts and 3 amperes at 25 volts. There is no friction or wear in operation, and no maintenance of attention is required. The durable metal and bakelite body contains the mercury. A newly designed baffle device assures positive "make or break" operation, with no opportunity for a flickering action when equipment is jolted. This switch is designed to fill the need for an inexpensive, reliable switch for thermostat circuits, pin game machines, automobile glove compartments, trunks and hood lights, radio door lights, telephone circuits, indicator circuits, etc. List price is 15c. Further information and specific recommendations can be obtained by writing the manufacturer direct.

New Deluxe RCA Victrola Home Recorder announced. A deluxe RCA Victrola incorporating home recording facilities, housed in an 18th Century design cabinet in Chippendale style, has been announced by Allan B. Mills, Manager of Phonograph Sales.



The deluxe instrument, Mr. Mills said, is substantially the DeLuxe RCA Victrola V-301, with the addition of home recording facilities. It has the same handsome cabinet and the same outstanding operating features.

The new instrument provides a truly deluxe home recording instrument at a price well within the reach of the average buyer," he said. "In addition to conventional home recording, this model also provides for re-recording, for mixing music or speech with either radio programs or recorded music, or it may be used as a public address system."

The new instrument is identified as Model VHR-307 and may be had in either mahogany or walnut.

The new table model, V-101, illustrated, is a 5 tube (plus rectifier tube and ballast) instrument delivering 5 watts of power through an audio system especially designed for record reproduction. Its distinctive cabinet, which allows for playing 10- and 12-inch records with the lid closed, is of birch veneer, with contrasting heart walnut and maple veneers for decorative purposes.

It has the newest type of molded tone arm and an efficient crystal pickup. Two-point tone control and a highly efficient 6-inch loudspeaker are among its many other features. Convenient radio reception is provided by a built-in loop antenna, while provision is made for connecting an outside antenna for distant reception. Its selective superheterodyne circuit has magnetic core I-F transformer for increased sensitivity.

Precision Series "J." The Precision Apparatus Company announces a new, rugged, accurate

and reliable, popularly priced multi-range A.C. Ammeter, designed for many fields of application, such as radio service, electrical appliance repairs, refrigeration, air-conditioning, motor repair, machine shop, transmitting, etc. Can be used on all line frequencies from 25 to 60 cycles; 300 milliamperes full scale to 60 amperes; 8 A.C. current ranges; special red correction scale for direct reading on 25 cycle service; $\frac{1}{4}$ " inch square type meter, accurately balanced and pivoted A.C. movement with specially constructed damping chamber. Meter accuracy 2%. When used with either the Precision Series 844, 854 or 862 multi-range testers, the "J" provides a complete all-purpose AC-DC industrial type circuit analyzer. Available in 3 models. Literature from manufacturer, Precision Apparatus Company, 647 Kent Avenue, Brooklyn, New York.

The F. W. Sickles Company, of Chicopee, Mass., announces a new product, the "Check-A-Loop," an efficient service instrument for checking loop antenna alignment.

By its ability to raise or lower the inductance of a loop, it quickly shows whether trimming capacity should be increased or decreased. Not just another trick or gadget, made to sell, it is an indispensable tool for the design engineer, for radio production set alignment, and for the radio service man.

The F. W. Sickles Co., 165 Front Street, Chicopee, Massachusetts.

A new Hickok Radio Testing Instrument has been improved by the addition of a self-contained Speaker internally connected for monitoring either R-F, I-F, or A-F. Channels.

Model 155, with its five Hickok Meters gives continuous, accurate measurement of voltages and traces the signal in any five circuits at one time—without interfering with the performance of the set. Vacuum Tube Voltmeter circuits so arranged that accidental overvoltage cannot damage meters.

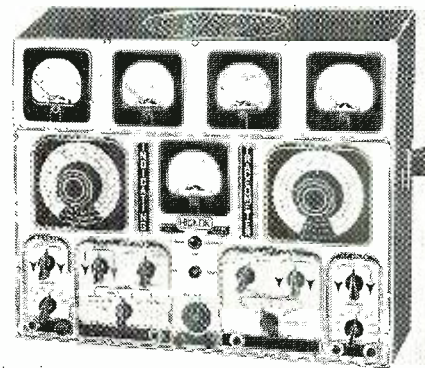

Here are the various measurements possible with this accurate instrument: Signal measurement in microvolts at any point of the entire R-F-I-F section; measurement of actual oscillator voltage throughout its entire range; measurement of all D.C. Voltage, A.V.C., A.F.C., Power Supply, etc.; measurement of A.F. and A.C. Voltage in any circuit; measurement of actual wattage consumption of any A.C. system to 300 watts. All measurements being made without disturbing normal operation of circuit under test.

Model 155 Traceometer is unequalled for rapid servicing of Frequency Modulated, Amplitude Modulated and Television Receivers.

For more complete data write The Hickok Electrical Instrument Co., 10301 Dupont Ave., Cleveland, Ohio.

New Amerperit Automatic Relay for AC-DC Battery Sets. The new Amerperit automatic relay automatically changes the battery sets to AC-DC operation. All that is necessary is to plug the regular cord into an AC-DC line and turn on the set switch.

With the Amerperit automatic relay instantaneous operation is obtained on AC-DC—it is not necessary to wait for the rectifier tube to heat up. When the switch is turned on, the set operates immediately on battery for approximately 25 seconds—the time it takes for the rectifier to heat up—and then switches off automatically to AC-DC operation. There is no break in the program.

The relay consists of two single pole contacts which are placed in the minus A and minus B battery lead. As soon as AC or DC is passed through the set the relay automatically starts its operation.

With the Amerperit automatic relay it is impossible to forget to switch or change the set to AC-DC operation. With manual changeover, forgetting to change the set to AC-DC operation—operates the set needlessly on batteries—resulting in short battery life and increased expense.

Attachment Plugs Given New "Hold Tight" Virtues. General Electric has built an "anchor" into attachment plugs to promote closer relations between convenience outlets and cords. A new "Anchor Loop" contact prong, with all the virtues the name implies, has been announced by the G-E construction materials division in Bridgeport, Conn. It's designed to increase holding power in both old and new convenience out-

lets without distortion of outlet contacts. "Hold tight" is its motto.

The new prongs can be supplied on several types and sizes of General Electric molded-on, all-rubber attachment plugs. The prongs are designed to eliminate excessive stress on outlet contacts, and tests indicate that outlets retain their original ability to hold standard solid prongs after long use of plug caps with new "Anchor Loop" contacts.

New Sprague IL-2 Interference Locator announced. The Sprague Model IL-2 Interference Locator is an entirely new device, designed in cooperation with outstanding public utility engineers and radio interference specialists to provide an inexpensive, highly sensitive and rugged portable device for the location and isolation of radio interference elimination. It is equally useful in the hands of the radio serviceman who is interested only in noise complaints arising from electrical devices attached to power lines, or to the public utility engineer whose job it is to eliminate radio noise sources from the power or distribution line itself. In addition, the Locator is ideally adapted for locating underground pipes, providing an excellent combination device which will soon earn its cost for municipal water and light departments.

The Locator operates either from self-contained batteries for portable operation, or directly from 115 volt AC or DC lines. It is equipped with directional loop antenna mounted on top of the cabinet when in use, or carried within a cover recess when carried. An extendible pole antenna is also provided as standard equipment, a special input circuit for the latter providing sensitivity of a high order.

Master Radiotician's Cabinet. Although it contains only 18 Type D IRC All-Purpose Volume Controls along with six switches and five special, extra Tap-in Shafts, the new IRC Master Radiotician's Volume Control Cabinet paves the way for prompt, efficient service on from 60% to 75% of all control replacements! It is a real time saver for the busy serviceman, eliminating the need for ordering controls individually for individual jobs. It simplifies installations because IRC Type D All-Purpose Controls with their special Tap-in Shafts are easy to install, and may be used universally to replace midget-size or larger, old-style controls. It permits replacements to be made immediately from the serviceman's stock on well over two-thirds of all the jobs he is likely to set.

The Cabinet is supplied at no extra cost. Servicemen pay only the standard net price for the controls, switches and shafts. The Cabinet is included in the deal. It is one solid, all-metal construction and is attractively decorated to improve the appearance of the service shop. It is 14½" long, 7¾" high, 4¼" deep, and weighs approximately 6 lbs. complete.

Recording Disc Display. The Howard Recording Discs are constructed from a soft steel base, coated with a special lacquer developed by the Howard Radio Laboratories. This coating, known as Type "C," has practically eliminated tearing, permitting the needle to make clean even grooves, resulting in recordings that are without surface noise. Due to the steel base the records lie absolutely flat on the recording turntable which prevents "Wows."



The discs are hardness processed for longer life and better reproduction of the higher frequencies. The coating is of even liberal thickness (not in layers) and does not deteriorate with age. They are available in 6½", 8" and 10" sizes. Illustrated is the display which Howard supplies to its jobbers and dealers.

New UTC "Steady-Volt." UTC announces a new type of voltage regulator for maintaining constant voltage for laboratory apparatus, production testing and heating equipment, electronic instruments, and the various other applications where a constant voltage unit is essential.

The input voltage may vary from 95 to 130 volts. The output voltage is maintained within one per cent accuracy. There is a negligible variation in output voltage from no load to full load, permitting the use of the device at any rating up to its maximum value. In addition, a triple output receptacle is provided affording 110, 115 or 120 volts output. The efficiency and power factor are high and the distortion relatively low for a unit of this type.

The operation of the regulator is entirely new.

It involves no moving parts, being based on a magnetic principle which assures instantaneous response, to correct either transient or chronic line voltage fluctuations.

Stromberg-Carlson introduces new Plastic Personal Radio. New addition to the Stromberg-Carlson line is a streamlined plastic table radio available in a choice of Ivory finish or a rich brown color with horizontal white stripes. Not a midget, but a big small-radio, it measures 13½ by 8¾ inches, by 8¾ inches deep.

It offers AC-DC operation on the Standard Broadcast Range from 550 to 1,600 kc. Features include five tuned circuits, Tone Control, Automatic Volume Control, 5½-inch Dynamic Speaker, and a Built-in Loop with connection for outside aerial if desired. A new easy-to-read Stromberg-Carlson Airplane-Type Pointer Dial is used.

This new personal radio, the No. 600-H, in brown finish, carries an eastern list price of \$24.95; in ivory finish, of \$26.95.

New Emerson Table Radio. There is no danger of wear or peeling marring the satiny surface of this new Emerson table cabinet. It is molded of Resinox, Monsanto phenolic plastic, and the color and finish are inherent in the material. Resinox is tough and strong, too, and the cabinets stand long usage without harm. With this plastic, intricate parts such as the Emerson grille, are readily molded integrally with the cabinet, giving wide freedom of design.

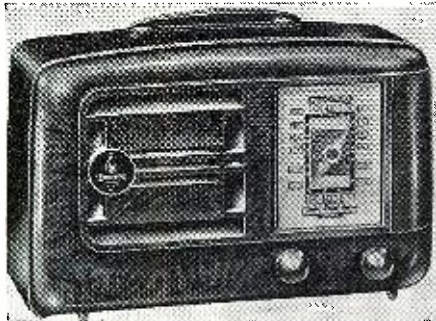

Associated Attleboro Manufacturers Inc., Attleboro, Mass., mold the cabinet for Emerson Radio & Phonograph Corporation, New York City. Plastics Division, Monsanto Chemical Company supplies the material.

An important addition to the CLARION line of Sound Equipment is the new 51 watt booster amplifier.

The A-77K 51 watt booster amplifier was especially designed for use where wide coverage is desired. This booster converts low power systems to any desired output, making it the perfect unit for covering large areas with speakers at remote points. The unit is ideal for use in airports, arenas, athletic fields, civic centers, etc.



Any high power desired can be had by linking up these booster stages. Pull output available with an input driver voltage of only .15 volt. Circuit utilizes 2-6SK7, 1-83 and 4-6L6G tubes in push-pull parallel with inverse feedback. Gain of high impedance input, 65 db. Frequency response, 40 to 12,000 CPS. Rated output, 51 watts. Peak output, 75 watts. Hum level below zero level, minus 22 db. Output impedance, 2, 4, 8, 16, 500 ohms. External pre-amplifier power available from amplifier. For operation on 110-125 volts, 50 cycles A.C.

This unit is available in three models, for table mounting, rack mounting and in cabinet. Cabinet model pictured, lists at \$102.25. Further information and catalogue may be obtained by writing to the Transformer Corporation of America, 69 Wooster Street, New York, N. Y.

DAVEGA OPENS NEW STORE

A. Davega, Vice-President of the Davega-City Radio Stores, today officiated at the opening of their new Bronx Unit, 2860 Third Avenue and 149th Street, which is known as the Hearn block.

(Continued on page 56)



by **WILBERT T. PETERSON**

Illinois State Police Dept.

Secondary Frequency Standard

A UNIQUE arrangement of a secondary standard for measuring the frequencies of the Illinois State Police transmitters has been devised by Virgil O. Lehman, chief construction engineer for the system.

The frequency measuring rack contains a *Hammerlund Super-Pro* receiver, a *General Radio* electronic frequency meter, and a home made 100 kc. temperature controlled crystal oscillator, 10 kc. multi-vibrator and heterodyne frequency meter with its stabilized power supplies, and a loud speaker.

By zero beating the 100 kc. oscillator with standard transmissions from *WWV*, the apparatus is very accurate for police frequency tolerances.

A signal may be measured by beating it directly in the antenna circuit of the receiver with a 100 kc. bar or multi-vibrator. The receiver then amplifies and detects the signal and the result read directly on the *General Radio* frequency meter. By use of the direction push button on the 100 kc. oscillator, the frequency can be interpolated from the receiver dial, which acts as a marker for the 10 kc. multi-vibrator, plus or minus the frequency meter reading.

A fleeting c. w. signal may also be measured by first beating the c. w. signal with the heterodyne frequency meter. The antenna circuit is then opened, and by zero beating the heterodyne frequency meter again with the 100 kc. bar and multi-vibrator, the frequency is then determined in the same manner.

Co-axial Tank

THE problem of bringing down a co-axial transmission line from an UHF antenna installation on top of a vertical radiator used for lower frequencies is handled very easily by a simple filter made up at the bottom of the tower.

The filter consists merely of winding a coil with the co-axial line itself and shunting it with a variable capacitor enabling the circuit to resonate at the frequency being radiated by the tower.

The bottom end of the "co-axial" tank circuit is then grounded, and the inner conductor is available for attaching to UHF receivers.

This little trick works out very well for police stations transmitting on the lower frequency bands, but receiving on the UHF band. The UHF antenna can be placed at the top of the tower, and the feedline secured to the tower and brought down to the base. These filters are available commercially from the *Victor J. Andrew Co.* of Chicago.

Frequency Problems

DUE to the increasing number of police radio stations operating now on radio telegraph, the need for more frequencies is becoming more and more apparent.

On November 1, 1940, three frequencies 2036, 2040 and 2044 were taken away from the police service and given to the amateurs. The police were given three higher frequencies 7480, 7805, and 7935, however the interzone c. w. stations must now use the 5195, 5140, and 5135 band for work at night, and the zone stations operate on 2804, 2808, and 2812.

This 5100 band serves well at night for distances more than 200 or 300 miles, but for shorter distances, skip plays an active part, and communication is almost impossible. Stations in adjoining states literally jump over each others heads.

In order to clear their traffic, these inter-

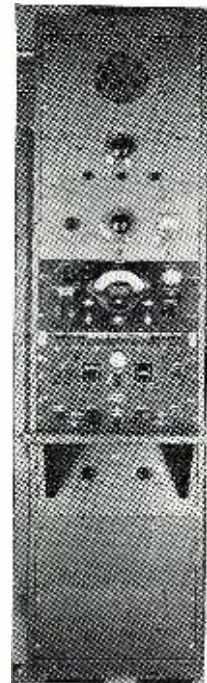

Secondary Frequency Standard of I S P.

zone stations must relay unnecessarily, or switch down to the zone band.

With some 64 zone police stations already crowding these three frequencies, the result is generally a bedlam of signals, and may the best man win!

Another frequency in the municipal police medium high frequency band also has been lost as of the FCC ruling in December, 1940, deleting 2350 kc from the police service.

Two additional state police channels have been made available however, 1722 and 1730 kc. The municipal and state police frequency of 1712 kc. has been changed to 1714 kc.

The *Associated Police Communication Officer's Inc.* and the *International Association of Chiefs of Police* have done a marvelous job in their fight to retain and increase our police channels.

Capt. Donald S. Leonard, first vice president of the *IACP*, together with Maurice O'Neill of the *New Orleans Police* and E. C. Denstaedt of the *Detroit, Mich., Police* are amongst the leaders in this work. They deserve the praise of everyone engaged in police radio work.

Police Ham Nets

MANY police operators with ham tickets are setting their rigs on 3980 kc., which they have adopted as their phone net frequency, and communicating with each other during their leisure moments when not on duty.

This new net has been termed the "POP" net, and it is a subsidiary to their QPO c. w. net on 3715 kc. These two nets enable the boys to chew the rag before or after working hours, and affords a closer association between the ops of the various departments.

Every fellow who is associated with police radio is heartily invited to get a rock or set his ECO on these frequencies and become acquainted with some of the other police ops.

Shortage of Trained Men

THE shortage of trained radio men is now readily seen in the police field, as various departments are losing men right and left to the government.

Many Naval Reserve and National Guard

(Continued on page 62)



by **ROBERT KENDALL**

Service Manager, Indianapolis, Indiana

The Galloping Gibbon

NE of the more disconcerting aspects of writing for publication is the fact that by the time the author has hammered out a few choice generalities on any subject, one of the many possible exceptions always arises to confound him for the moment. In this case a few thoughts had been more or less assembled on the question of "Service in the Home vs Service in the Shop" with some bias toward the shop, when the inevitable exception appeared on scene. Since this department is quite willing to consider *any* side of *any* question, and hopes particularly to avoid that dogmatic air of being the *Voice of Omniscience*, so peculiar to some news broadcasters, we will put a damper on our own angle of the question, for the time being, and present the exception as exemplified by Mr. Quincy Gibbon, of Rolling Fork, Mississippi.

Mr. Gibbon, we learn from other sources, is an outstanding exponent of that school of servicemen who "fixes 'em where he finds 'em," and pursues the elusive radio job to the customer's home, grappling with its bugs then and there. Now unless Mr.



The Galloping Gibbon himself.

Gibbon is a Hindu *Yogi*, which we doubt, we do not believe he enjoys squatting on the floor over the up-turned chassis any more than we do, and so there must be a better reason for his flitting about from job to job. It isn't hard to discover, as those who investigate will find that Rolling Fork had at the last census a population of 1320 persons, that is, when Mr. Gibbon is home, which apparently is not often.

Since we are reliably informed that Mr. Gibbon is doing something better than staying two jumps ahead of the sheriff, it is fairly certain that with this limited number of prospects in his home town, he cannot indulge successfully in that practice—so popular with many small business men—of parking on his canetta and waiting for business to come to him. Mr. Gibbon simply enlarges his territory by employing that handy vehicle,

the automobile; and with three large suitcases full of parts and tubes, covers all the small towns that can be conveniently reached from his headquarters.

The accompanying snapshot shows Mr. Gibbon with most of the test instruments found necessary for the fast, sure service essential for successful house to house work. The businesslike figure on the left is, of course, Mr. Gibbon, and the instrument on the tool chest is a *Rimco* signal tracer, which Mr. Gibbon *does* take with him on every job. Next is an up-to-date tube checker accompanied by one of the latest volt-ohmmeters, employing one of those eye-saving "giant" meters. Although Mr. Gibbon is an "old-timer" in the radio business, it is apparent that he does not consider it as a reflection on his experience and ability to take advantage of the convenience of up-to-date equipment.

It is also apparent that Mr. Gibbon gets around as he says in a recent letter:

"I've been north of Memphis a couple of times (in '39 I barnstormed 43 states, Canada, Mexico, and both World Fairs at New York and Frisco) and I know you boys above the snow line have your troubles and problems too."

And speaking of troubles in the Cotton Belt, Mr. Gibbon says:

"And then on the second trip that same customer with that same 5-tube stump-jumper wouldn't approve the installation of a new filter condenser because she could still play it as it was, provided she did not open up the volume control those last two notches. She says she has been noticing for quite a while now that when she would open it up those last two notches that it would quit 'singing' and go to 'whistling.' Then if we make the sad mistake of asking her exactly when did she first notice it, she comes back with the good news that it has been doing that ever since she paid us to fix it the first time!"

For Mr. Gibbon's consolation it may be said that this is only one variation of a common theme song, that has a familiar ring to the ears of all servicemen; and likewise proves that all corny customers are not necessarily confined to the Corn Belt.

Block That Kick

THAT cautious air and slight crouch habitual to many servicemen is not due to a suspicion that his immediate neighbor might be a pick-pocket, but is more likely to be caused by getting ready to duck when the tube manufacturers start talking about "standardizing" again. In the past "standardizing" has generally re-

sulted in a 50% increase in tubes types; and a good kick in the pants for the serviceman, in the vicinity of his pocketbook.

The Life of Trade—'Tis Said

MANY years ago, the then popular Gelett Burgess rhymed about the Purple Cow somewhat as follows:

*"I've never seen a purple cow
I never hope to see one,
But I can tell you anyhow
I'd rather see, than be one."*

We feel much the same way about elevator operators. In our occasional excursions to the lairs of commerce in the downtown office buildings we cannot fail to note that the elevator men on the whole seem to be a gloomy lot, inclined to a morose taciturnity. Since it is not likely that this is one of the requirements for their job, we conclude it is a condition produced by the job, and a logical explanation of the situation is not difficult. Close confinement in a cage for a large part of each day can hardly be considered as stimulating to speech or thought, and the shortlived contact with transient customers does not permit much discussion of the *quantum theory*, or the chances of the *Yanks* this year.

It would be a strong mind indeed that could maintain a constant amiability in the face of those secretive individuals who stubbornly refuse to respond to the operator's pleadings of "Floor, please," and then shout "Nine" just as the car pulls up to the tenth floor. But this aggravation is small compared to the hourly dread of that individual, who at the first opportunity says brightly, "Well, you boys certainly have your ups and downs—heh, heh," with the pleased air of having uttered an original epigram. How the operator refrains from committing mayhem on these occasions is hard to see, and must be taken as evidence of the possibilities of self-control.

The dullness of this frowsy aporphism however, does not mitigate the painful truth, in its application to all lines of human endeavor, and most certainly the radio business. However, after more years of experience than we care to count, we find that each extra-good business week is often followed by a poor one, and as long as the average stays up to a reasonably satisfactory figure, conclude that some of this week's business was merely picked up ahead of time, and proceed to enjoy our idle time while it lasts.

During one of these off days, when we should have been going through our customer-card file, we sat goggling out the window of *Super-Snappy Sales & Service* idly watching the traf-

(Continued on page 55)

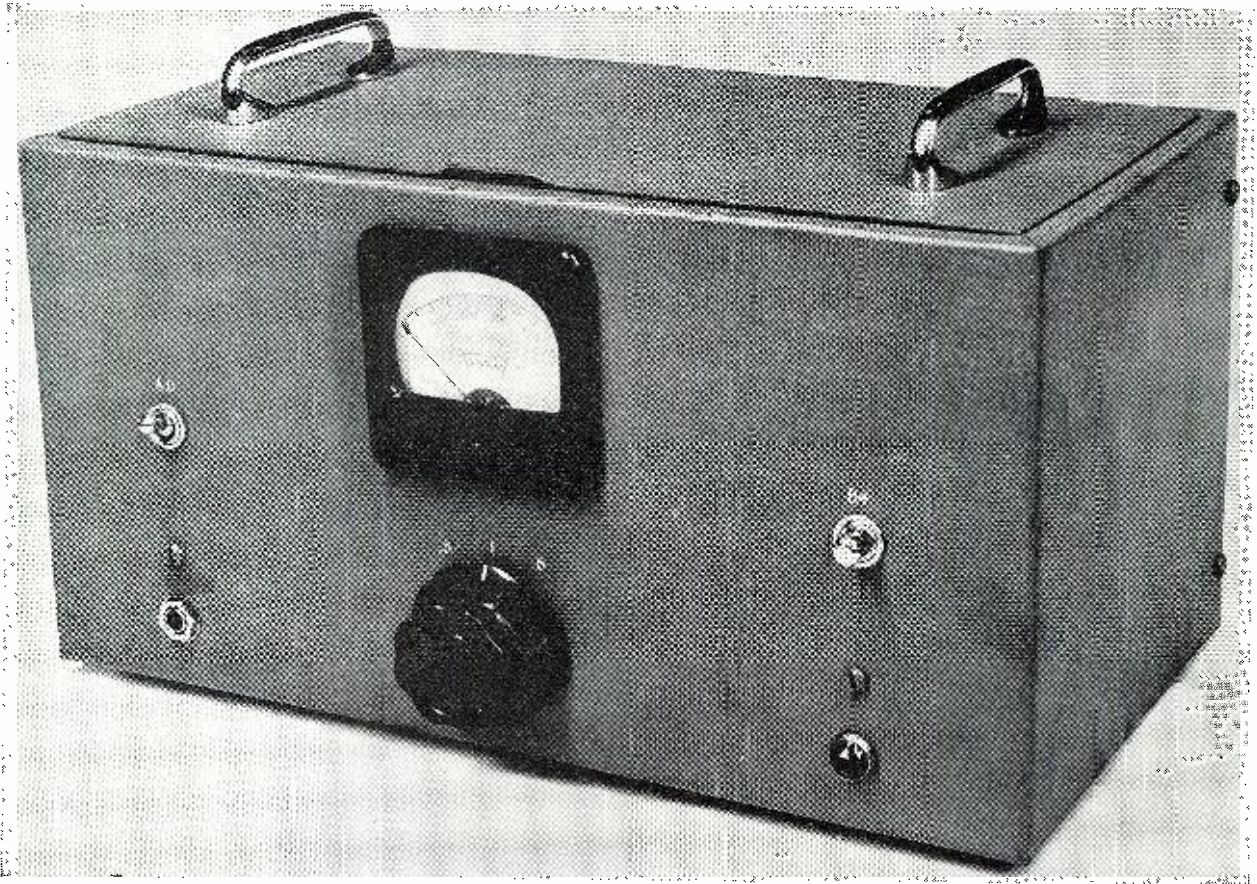

Portable, simple to construct, easy to operate,—that's the Cycle Counter.

A DIRECT READING A. F. CYCLE COUNTER

by RUFUS P. TURNER, W1AY

Cambridge, Massachusetts

**No more listening for null points, no more balancing a bridge;
just plug in audio source and read the frequency from a meter.**

IN the January 1941 issue of RADIO NEWS, the author outlined construction of a simple *Wien* bridge audio-frequency meter equipped with a null dial, reading directly in cycles per second. Subsequent mail response has indicated that a number of readers representing a good cross section of the radio and electronic industry have duplicated that instrument with no difficulty. Some of these builders state that they have already employed the bridge-type meter profitably to determine the frequency of modulated code signals, set the pitch of home-made single frequency audio oscillators, and to study r.f. oscillator drift by measuring beat notes between oscillator and standard-frequency signals. There have been only two criti-

SIMPLY feed an unknown tone or unknown audio voltage into this electronic cycle counter and read the exact frequency—in cycles per second—on its standard meter scale. The operator does not have to adjust anything! The signal may be large, small, or fading, of good or bad waveform, but there will be no change whatever in the indicated frequency as long as the signal voltage does not fall lower than 1 volt or rise higher than 175 volts. It is inexpensive, easy to build, and may be calibrated by anyone able to pick up WWV.—The Editors.

cisms, and these have been universal: that a certain amount of skill is still required, (except under most ideal conditions), to set the frequency dial

to true null; and that the operation, while not necessarily a slow one, requires some time for its successful execution. There has arisen, as a consequence, a real demand for a fool-proof meter that needs no such adjustment but which gives a reading automatically at the instant an unknown frequency is fed into it.

The demand presented a man-sized aspect at first; because it seemed ideal that such a meter would preferably make use of a standard *d'Arsonval* current or voltage type that some means be provided to divorce its frequency readings from the amplitude of the signal, that some standard linear scale be used to preclude any necessity for special markings or reference to charts, and that

it be capable of easy and "homey" calibration, since most amateurs and experimenters do not have access to precision audio test oscillators or similar standards. At once, the immediate prospects were in the direction of complicated multi-tube circuits with various automatic gain—and frequency-controlling subcircuits, to say nothing of some non-existent movable-coil meter.

But the writer recalled that Dr. F. V. Hunt of Harvard University's *Cruft Laboratory* published a paper in the February 1935 issue of *Review of Scientific Instruments* in which was described a basic circuit for such direct-reading frequency meters. And, proceeding along the lines prescribed in that paper, it has been possible to design such an instrument for amateur duplication. That instrument is described in this article.

This month's audio-frequency meter is almost amazing in its performance. It is truly an electronic *cycle counter* which, superior to the bridge-type meter, requires no manipulation by the operator, save the selection of the appropriate frequency range. There is no dial for the user to set closely to null and no inaccuracies arising from varying signal levels or differences in waveform. Since the response of the device is linear, frequency indications are made directly on the regular scale of a standard microammeter; and, also because of this linearity, it becomes necessary to calibrate only one point in each range.

From the illustration it will be seen that the indicating meter employed in the instrument is a 0-500 d.c. microammeter. In conjunction with the vacuum-tube circuit utilized, this instrument provides frequency ranges of 0-500, 0-1000, and 0-5000 cycles per second. Because the circuit response is no longer linear above 5000 cycles, the range was not extended beyond that frequency.

Use of the "cycle counter" is the acme of simplicity. The operator simply applies the unknown signal voltage to the input circuit of the instrument by making appropriate connections between the signal source and the small jack in the lower left-hand corner of the front panel. Immediately, he sees the frequency indicated directly in cycles per second by the microammeter. If the reading is only part of the way up the meter scale, he may turn the range switch (see knob under the meter) down to the next lowest range for a closer reading.

Particularly novel features of the A. F. Meter are:

(1) The frequency reading is independent of the amplitude of the applied signal voltage over a usefully wide range. By actual test, no change whatever can be found in the indicated frequency as the signal voltage is varied between 1 volt and 175 volts RMS. This means that the a.f. signal under investigation may be either weak, strong, or fading and still be measured with accuracy and steadiness of reading.

(2) The frequency reading is likewise independent of the waveform of the applied signal over a wide range, an advantage which permits checking the frequency of such devices as buzzers, saw-tooth-wave sweep-circuit oscillators, multivibrators, etc., with the ease characteristic of usual sine-wave operations.

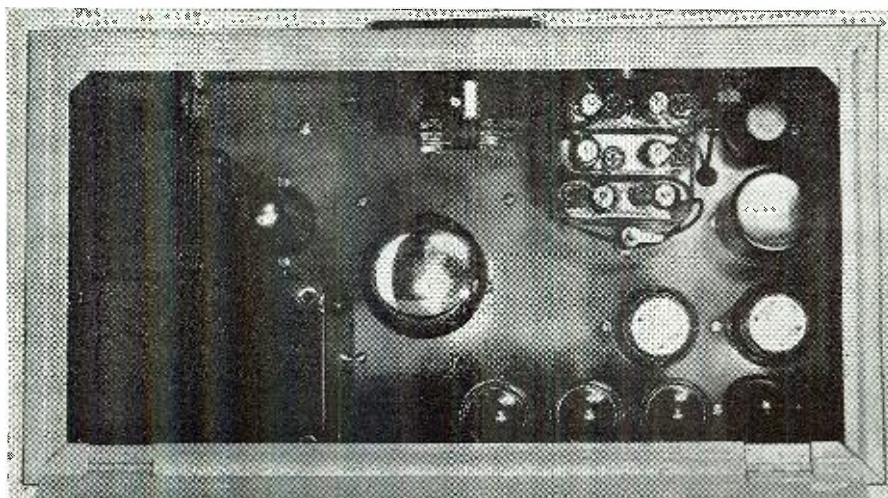

Top chassis, inside cabinet view of the Cycle Counter.

(3) The input circuit (see circuit diagram) presents a high impedance to the signal source; which means, among other advantages, that negligible loading is occasioned the signal source. The A. F. Meter may be connected at will to the output circuit of a radio receiver, audio-frequency oscillator, beat-note detector, or audio amplifier without disturbing the normal operation of those, or similar devices.

(4) The pitch of actual sounds may be determined easily with the A. F. Meter by providing a suitable microphone pickup. For example, a simple carbon microphone might be connected externally in its own battery and transformer circuit and the latter connected directly to the input jack of the instrument. Or, if it is desired to employ a low-level crystal, velocity, or dynamic microphone, the speech amplifier associated with that type of pickup might have its output circuit connected directly to the A. F. Meter input circuit. With such arrangements, the pitch of musical instruments, horns, bells, and the like may be determined quickly by sounding them into the microphone, or the frequency of machine noises measured.

(5) A good quality blocking condenser, C1, is employed in the input circuit of the A. F. Meter to permit

direct connection of the instrument to points where a d.c. component is present together with the a.f. signal.

(6) The signal applied does not need be composed always of pulses or cycles evenly spaced along the time axis. Because of this feature, the A. F. Meter will find application in counting operations where pulses may occur a few milliseconds apart.

(7) Elaborate filtration of the power supply is unnecessary; and even with the simple filtration of meter and amplifier circuits as shown, measurements are made at the power-line frequency and thereabouts with no difficulty. Voltage regulation of the plate power supply is required, but this is accomplished simply by means of a gaseous voltage regulator tube, as will be observed.

Theory of Operation

It is axiomatic that if a series of spaced pulses of identical voltage be applied to a d.c. current-indicating meter through a suitable multiplier resistor to prevent off-scale deflection, the average reading of the meter will depend only upon the number of identical current pulses passing through it in a single second and will be directly proportional to that number. The meter will accordingly indicate the frequency of the pulsating signal voltage if the pulse amplitudes are

Under chassis view of the unit. Note resistor rack.

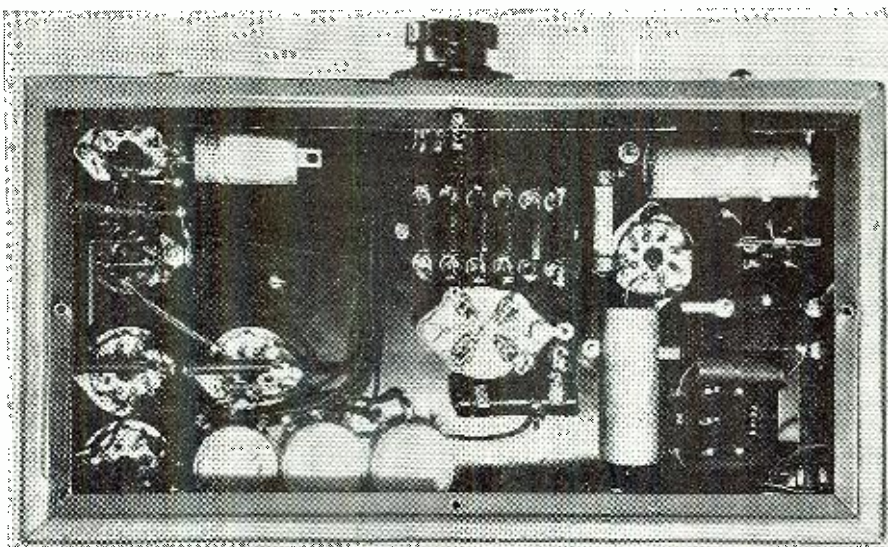

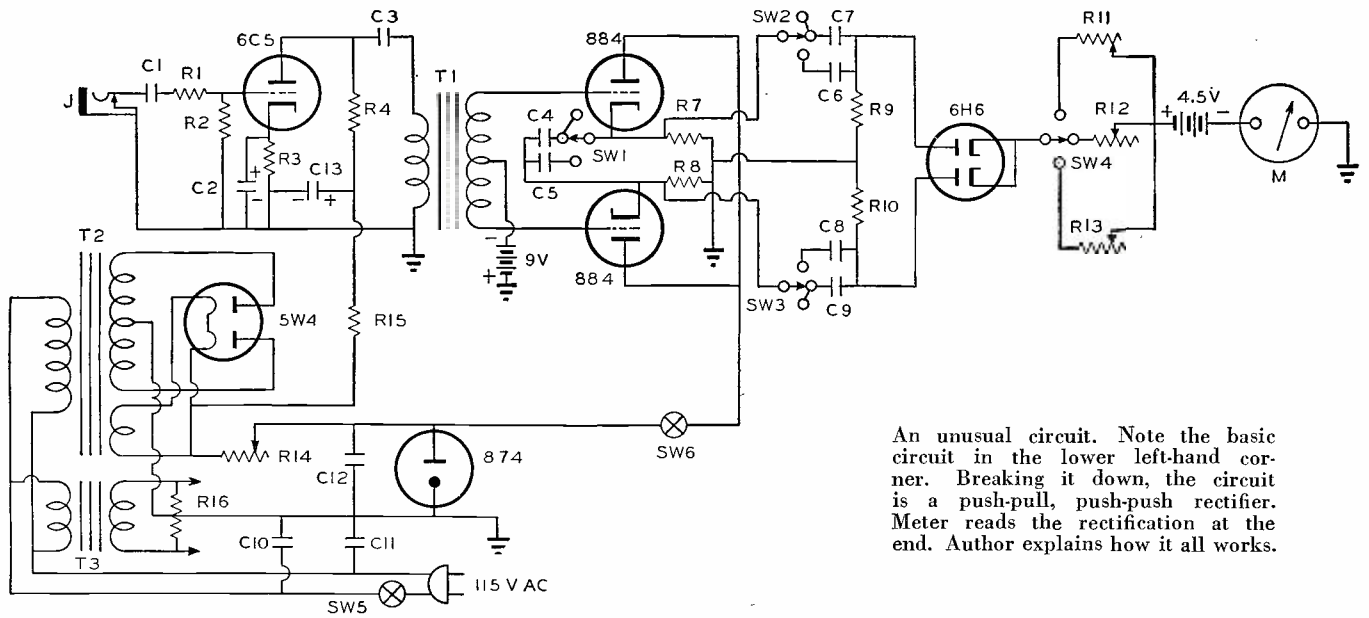

An unusual circuit. Note the basic circuit in the lower left-hand corner. Breaking it down, the circuit is a push-pull, push-push rectifier. Meter reads the rectification at the end. Author explains how it all works.

- C₁—0.01 mfd. mica. Aerovox 1467
- C₂—10-mfd., 50 w. v. midjet tubular electrolytic. Aerovox PRS-50
- C₃—0.1 mfd., 400-volt tubular. Aerovox 484
- C₄—0.01 mfd. mica. Aerovox 1467
- C₅—0.002 mfd. mica. Aerovox 1467
- C₆—0.001 mfd. mica. Aerovox 1467
- C₇—0.01 mfd. mica. Aerovox 1467
- C₈—0.001 mfd. mica. Aerovox 1467
- C₉—0.01 mfd. mica. Aerovox 1467
- C₁₀—0.1 mfd., 200-volt tubular. Aerovox 284
- C₁₁—0.1 mfd., 200-volt tubular. Aerovox 284
- C₁₂—16-mfd., 450 w. v. midjet tubular electrolytic. Aerovox PRS-450
- C₁₃—16-mfd., 450 w. v. midjet tubular electrolytic. Aerovox PRS-450
- J—Midjet closed-circuit jack. Carter type 2A
- M—0.500 D. C. Microammeter. Triplett 327-A
- PL—6.8-volt, 0.15-A pilot light
- R₁—0.25 megohm, 1/2 watt. I. R. C. BT¹/₂
- R₂—0.25 megohm, 1/2 watt. I. R. C. BT¹/₂

- R₃—2000 ohms, 1/2 watt. I. R. C. BT¹/₂
- R₄—60,000 ohms, 1 watt. I. R. C. BT¹/₂
- R₅—150,000 ohms, 2 watts. I. R. C. BT²
- R₆—150,000 ohms, 2 watts. I. R. C. BT²
- R₇—3000 ohms, 2 watts. I. R. C. BT²
- R₈—3000 ohms, 2 watts. I. R. C. BT²
- R₉—3000 ohms, 2 watts. I. R. C. BT²
- R₁₀—3000 ohms, 2 watts. I. R. C. BT²
- R₁₁—300-ohm midjet wirewound potentiometer. I. R. C. W-300
- R₁₂—4000-ohm midjet wirewound potentiometer. I. R. C. W-4000
- R₁₃—3000-ohm midjet wirewound potentiometer. I. R. C. W-3000
- R₁₄—1000 ohms, 25 watts, semi-variable. I. R. C. DHA-25
- R₁₅—2500 ohms, 10 watts. I. R. C. type AB
- R₁₆—64 ohms, center-tapped. Mallory-Yaxley 864C
- S₁, S₂, S₃, S₄—Sections of a 4-pole, 3-position non-shorting, rotary selector switch. Yaxley

- 3243-J
- S₅—s. p. s. t. a. c. toggle switch. H & H
- S₆—Circuit-breaking, s. p. s. t. pushbutton switch. H & H
- T₁—Miniature interstage audio transformer. Kenyon A-31
- T₂—Power transformer. 125-0-125 v. c. t. at 200 m. a.; 5 v., 3 A. Kenyon T-220
- T₃—Heater transformer. 6.3 volts, 3 amp. Kenyon T-388
- Cabinet—National HWR
- Sockets—5 octal. National CIR-8
- 1 standard 4-pin. National XC4
- Pilot-light bracket and jewel. Mallory-Yaxley B-310
- A.C. plug and receptacle. Amphenol 61-M10 and 61-F10
- Knobs for R₁₁, R₁₂, and R₁₃
- Tubes: 1—RCA 6C5, 1—RCA 874, 1—RCA 6H6, 1—RCA 5W4, 2—RCA 884
- Bias Batteries—3, 4 1/2-volt. Burgess 5360

maintained at a constant value. By appropriate adjustment of the series multiplier resistor, a known pulse frequency may be made to coincide with a convenient meter scale graduation, whereupon the pulse frequency, in pulses (or cycles) per second will be indicated directly on the regular current scale of the meter. For example: the multiplier resistor may be set such that a known pulse frequency of 500 per second will cause a convenient deflection of 500 microamperes, whereupon frequencies of 400, 300, 200, 100, etc., will cause deflections of 400, 300, 200, 100, etc., microamperes along the regular meter scale.

The absolute necessity for maintaining the amplitudes of successive pulses constant is readily appreciated by considering that the meter reading is normally also directly proportional to the magnitude of pulse voltage. And if the pulses are not of unipotential

nature, the same frequency indication will result from a low-frequency, high-voltage pulse as from one of high frequency and low voltage. Excursions of amplitude would, therefore, seriously impair the accuracy of the instrument.

An audio-frequency voltage is simply an alternating voltage. Rather than a collection of pulses, it is a succession of complete cycles, each representing reversal of polarity, uniform increase, and uniform decrease of amplitude from and to the zero axis. It remains only to convert an audio-frequency voltage into a series of periodic equipotential pulses to adapt the arrangement just described to common frequency measurements.

To accomplish this purpose, Dr. Hunt has recommended the use of a modified *Thyratron* inverter. The thyratron tube is a triode which characteristically maintains a constant voltage drop across itself once its discharge has been triggered off by a suitable grid voltage. Unlike other triodes; it is, after ignition, no longer subject to grid control until the discharge has been extinguished. The circuit employed in the a.f. meter is so arranged that the unknown a.f. signal voltage is applied 180° out of phase to the grids of two thyratrons. The tube whose grid receives the positive half of the a.f. cycle is "triggered off" and normal plate current flows through its plate circuit back to the negative line of the plate-power supply. When the signal polarity reverses on the following half-

cycle, the arc discharge in the first thyratron is extinguished, the second thyratron grid is made positive, the arc discharge is initiated in that tube, and normal plate current flows in its plate circuit. Because the thyratrons maintain a constant voltage drop across themselves, a pulse of uniform voltage is delivered by their circuit to a d.c. current-indicating meter each time the polarity of the applied signal voltage reverses. The thyratron plate voltage is regulated to insure equipotential pulses.

The basic circuit for accomplishing the action just described is shown. The signal voltage of unknown frequency is applied to the primary terminals, F-F, of the simple step-up audio transformer, T. The secondary winding of this transformer is center tapped, the outside terminals being connected to the grids of the type 884 gas triodes, V1 and V2. The indicating meter, M, is a d.c. microammeter connected in the cathode circuit of the double diode 6H6 (V3) together with the multiplier resistor, R5, and the small battery, B2, which regulate the magnitude of current flowing through the meter.

Both plates of the 6H6 are raised momentarily to a positive potential by the circuit embracing V1, V2, C1, R1, R2, R3, R4, C2, and C3 each time the polarity of the input signal voltage reverses, and a single pulse is delivered to meter, M. The direct plate voltage applied to the 884's is 90 volts, and this must be regulated by means of a type 874 gaseous regu-

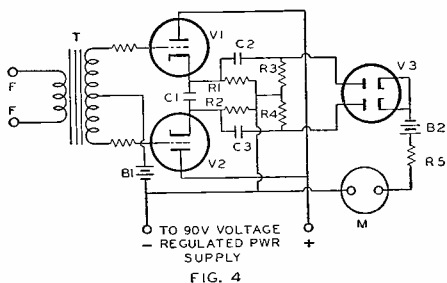

Basic circuit of the Cycle Counter.

lator tube, since the popular "VR" types do not have sufficient current-handling capabilities.

The setting of R5 will determine at which point on the meter scale a certain frequency will be indicated. Thus, if M is a 0-500 d.c. microammeter, R5 may be so adjusted that the pointer rests on 500 microamperes when a known signal of 500 cycles per second frequency is applied to the input terminals, f.f. It is evident, then that R5 is actually the calibration control of the a.f. meter and that this resistor should be made variable to take care of the initial calibration and subsequent readjustment necessitated by aging of tubes and components.

The frequency range over which the instrument is capable of operating is determined by the values of C1, C2, C3, and R5. Because of this fact, each one of these four components must be switched to new values when the range is increased or decreased. If M is a 0-500 d.c. microammeter, C1 0.002 mfd., C2 and C3 each 0.001 mfd., and R5 a 3,000-ohm volume-control type rheostat, the meter will be capable of reading 0-5000 cycles per second. To decrease this frequency range; C1, C2, and C3 must be lowered in capacitance, and the resistance of R5 correspondingly lowered. The battery, B1 delivers 9 volts; B2, 4½ volts.

Since the frequency readings afforded by the meter, M, may thus be made to correspond to the regular micro-ampere graduations of its scale, and since operation of the instrument up to 5 kc. is linear, a suitable point in any range may be set by means of a known audio-frequency input, whereupon all other points on the scale will automatically be in calibration. For example, R5 may be so adjusted, with a known 1000-cycle input signal, to bring the pointer to 100 on the meter scale. Or, if the operator has available only a 400-cycle signal (such as might be obtained from his r.f. test oscillator), R5 may be adjusted to bring the pointer to 40 microamperes, which point, it is seen, is read as 400 cycles when using the 0-5000-cycle range. If the values of components previously referred to be altered to change the instrument range to 0-500 cycles per second, then 400 cycles would, of course, be made to coincide exactly with the 400-micro-ampere graduation of the meter scale.

Complete Circuit

The addition of a simple, one-stage amplifier to the circuit of figure 4 will provide the a.f. meter with a high-impedance input circuit as well as increasing its sensitivity to small signal voltages. This refinement, together with an arrangement for suitably switching the components C1, C2, C3, and R5, and a self-contained voltage-regulated 90-volt power supply affords a complete multi-range a.f. meter of such accuracy, completeness, and flexibility as to satisfy the requirements of the most exacting electronicist.

Such a complete circuit is shown. Note that a 6C5 resistance-coupled amplifier stage has been added to the basic circuit, and that a mica blocking condenser, C1, has been inserted into the input circuit to permit direct measurement of frequency in circuits where a d.c. component is present. Going back to the basic

(Continued on page 59)

SERVICEMEN'S LEGAL ADVICE



THIS month, we continue with our discussion of leases.

Sometimes, a lessee may assign his lease to another. Where this is done, the other, known as a sub-lessee, stands in the shoes of his assignor and is liable for the rent while in possession. However, the mere assignment does not relieve the lessee from his obligation. If the sub-lessee should fail to pay his rent, the lessee would nevertheless be liable and in effect the lessee is a surety of the sub-lessee. In other words, the lessee may not evade his responsibility under the lease by assigning it to another.

In *Zinwell vs. Adams*, 144 N.Y. Supp. 815, an action was brought for two months rent under a written lease. The undisputed facts were that the landlord entered into a lease with one Ponzoni for a term of three years at a yearly rental of \$1,350 per year payable in equally monthly installments, which rent Ponzoni covenanted and agreed to pay. Later, with the landlord's consent, Ponzoni assigned the lease to the defendants. At the time of the assignment, the defendants wrote and signed the following agreement:

"For and in consideration of one (\$1) dollar and other valuable considerations and the consent to the assignment of the within lease to us, we do hereby jointly and severally, for ourselves, our heirs, executors, and administrators, assume and agree to observe and perform each and every one of the covenants contained in the said lease, and which on the part and behalf of the lessee therein named are to be observed and performed."

The defendants entered into possession under the assignment, and the landlord accepted rent from them. Subsequently the defendants assigned the lease to Adams, who went into possession and the landlord accepted rent from Adams. Subsequently, they assigned to Andrew, who went into possession and the landlord accepted rent from him. Adams and Andrew executed an assumption agreement similar to that executed by the defendants.

From the foregoing facts, the Court held that by the assignment of the lease, together with the agreement on the part of the assignee to assume all the covenants of the lease, not alone did the assignee become obligated to pay the rent by reason of privity of estate, but also by privity of contract with the lessor. When the assignee, therefore, in turn assigned the lease and his assignee went into possession, the privity of estate was broken; but the . . . contract was not thereby destroyed, and the defendants remained liable upon their contract for the rent that might subsequently accrue up to the end of the term.

The Court further held that no surrender of the lease was occasioned by the acceptance of rent from the defendant's assignee, even though the assignment was made with the landlord's consent. The Court held that the defendants were not thereby discharged; there was no new lease made, nor was any act done which was inconsistent with the original lease. The Court held that it was nothing more than accepting payment through the hands of another of the rent reserved in the original lease and in accordance with its terms and conditions.

In *Murray vs. Harway* 56 N.Y. 337, a lease contained a covenant on the part of the lessee not to assign the lease. It contained a condition that if default should be made in the keeping of that covenant, it should be lawful for the landlord to re-enter and dispossess the tenant. In violation of this covenant, the tenant assigned the lease to another. Thus, there was a breach of the condition and a forfeiture of the lease and the right to re-enter became operative, but the exercise of the right to re-enter was entirely in the option of the landlord. The landlord there had the right to re-enter or else waive

that right. The Court held that any act done by the landlord after the forfeiture of the lease, which recognizes the continuance of the tenancy is an election between the right to hold the tenant to the lease subject to all of the duties of possession and of all his rights thereunder and the right to re-enter and dispossess him. The acceptance of rent is ordinarily the recognition of the continuance of the tenancy; but when it is made after the act or forfeiture by the tenant and with the knowledge of the landlord in that act, it is a waiver of the forfeiture. The Court in that case found that the landlord or the landlord's successors in interest had accepted the rent of the premises from the assignee and that they did it with the knowledge of the assignment of the lease and by so doing, the landlord did waive his right to dispossess the tenant. *A condition against assignment, once dispensed with is dispensed with forever.*

In *McGregor vs. Board of Education of the City of New York*, 107 N.Y. 512, an action was brought by the landlord upon covenants contained in leases. The plaintiff rented the premises to the defendant to be used for the purpose of a public school. Alterations in the interior to accommodate for use were contemplated by the lessor and to be made by the lessee and were alike contemplated by each when the contract was made. A printed form of lease was used and contained an expressed agreement from which the clause forbidding alterations was stricken out before execution. There was also an expressed covenant that the lessee should make all requisite alterations, and a further lease on its part to surrender the premises at the expiration of the lease "in the same condition as they were at the execution of the lease, reasonable use thereof as a public school and damages by the elements excepted." The lessee changed the dwelling house into school rooms, removing partitions and making alterations necessary for the new use. This lease was followed by three others in similar form, each executed before the termination of its predecessor. The complaint set out in the lease a continued occupation and alleged a breach of the covenant for restoration averring that "the premises were left in a condition utterly unsuitable for a dwelling-house" and "uninhabitable for any purpose," and that water taxes had been left unpaid and settled by the lessor. A witness testified that when the lessee removed from possession the walls were broken, the floors were broken and basement was used for refuse and that the sidewalk was broken by the dumping of coal upon it.

At the close of the plaintiff's case, the defendant moved to dismiss the complaint on the ground that no violation of the covenant had been shown since the lease contemplated alterations in the premises and that they were to be used as a school. The Court held that this ground was not sufficient to justify a dismissal of the complaint. Granting that the defendant was not bound to restore the premises in their former condition as a dwelling house, it is still true that damages to the premises were not an effect of the alterations. Whether these injuries did or did not flow from the reasonable use of the premises for school purposes was a question of fact to be decided upon by the jury. The defendant further contended that no violation of the covenant of the last lease had been shown and that there was a waiver of such violation of the covenants in the prior leases.

The Court held that the complaint relates to a continuous possession under all of the leases and while the plaintiff did not show the separate damages at the close of each

(Continued on page 59)

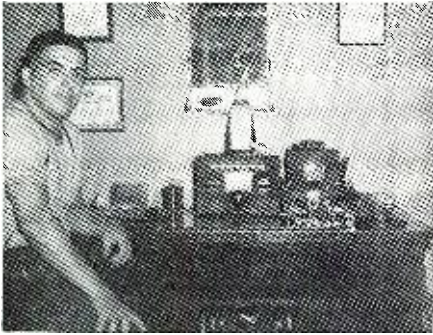

Hamop & station wIgej.



Hamrig of hamop w9nma.



From Omaha, Neb., comes w9vuu.



Rolfe, Iowa, boasts hamop w9mqx.

HAM CHATTER

NOTICE TO HAMS

WATSA matter with youse guys? Don't you want any do-re-me? Can't you use a new tube or a condenser, or a set? Well . . . why not send in some dope for this column. We pay real honest to goodness money for this column's contents. Plus a buck for each picture we use. Come one, come all . . . we got lotsa money to give out. Get yours while the getting is hot!!! We expect to buy all we can run. Send in pictures of your best XYL or the YL, too. They look good to you, why not let us see them? And cartoons! We will pay up to a fin for each used. So . . . get busy. Prosperity is here . . . Yes sir, right in this column. Address Ham-chatter Editor, RADIO NEWS, 608 S. Dearborn Street, Chicago.

THE YLRL-OM'S controversy which we expected to fill our mail box with letters, both PRO and CON, failed to materialize! Watsmatta with youse guys? Are you interested, or are you not? Or are you-all suthern gemmen, and don't wanta insult the gals. Anyway we are going to hold the Contest open one more month, and then give the prizes.

Meanwhile to even everything out, we hereby offer two prizes of \$5 each for the best letter from YL or XYL ops, PRO & CON, respectively, on whether this column should run the YLRL news to the extent we had been doing in the past. Letters must be in within 30 days after this issue hits the newsstands.

Well, you gals, here is the opportunity you have been seeking! Let us have your views. Don't spare the horses if you want to vent your spleens on the OM ops, here is your chance. Only remember, girls—be ladies!

The HC Editor.

JOE W9BZT FARNETI, writing about "One Sissie," says:

The months of January and February were both outstanding in the amount of dx and noise. Daytime reception revealed Ia., Michigan, Ohio, Ky., and a few other states. Late afternoons and evenings were particularly fine, in spite of congested conditions of the 160 meter band, to the extent that all districts excepting the 6th and 7th were heard very nicely.

A two way contact between W4 FGR, Bessemer, Ala., and W9BZT, Highwood, Ill., using 80 and 35 watts respectively and which was heard by W8RFT, Nellis, West Virginia, 100 per cent during one afternoon from 5 to 5:30 p. m., was one of the more unusual examples of band conditions.

Other low power stations were heard doing very well. W6's and W7's were heard profusely during early morning hours, some of whom have written in to tell us when and where they will be on and are here listed.

W7HEY, Midwest, Wyoming: 1905 each Tuesday morning.

W6TCC, Provo, Utah: 1898 each Monday morning.

W6PDV, Reno, Nevada: 1880 on Wednesday morning.

W6PST, Reno, Nevada: ECO Always listening and ready to call.

F7FWC, Malin, Washington: 1894 Monday mornings.

W6RPG, Genoa, Nevada: ECO Monday mornings.

W6ESH, San Mateo, Cal.: 1915 nearly every morning.

W5HHT, New Orleans, La.: 2017 Not regular as yet.

W6PHW, Salt Lake City, Utah: 1888 Wednesday morning.

Additional DX: W5IZA, South Coffeyville, Okla., wid 3 watts coming in Q4 R7; W5BUZ, Texas really rolling in; W6NOY, Arizona, on 1890, Q3 R8 in very heavy QRM; W1MLT Q5 R9 and sounding like a local; W6OXG, Cal., on 1885; W4EXR, Tenn., 12 watts Q4 R9; W5GG, Miss., very good; W7ILR, Bellingham, Washington, nice and strong; W4CPG, Florida



Hamop & station wIcib.

5-9: W5ESN Shreveport, La. (1892 k.c.) 5-9: W5ZS same town also coming fine.

Interesting note: Kenosha, Wisconsin comes to the fore with a very active radio club but more important is the fact that an entire family, namely, Mr. and Mrs. Bert Nelson and son Harold are all licensed Hams, Bert being W9BOM, Ella being W9RCM and Harold being W9LAB. Each of the three have their own rig and operate under their own call. Ella is out after W.A.S. using 100 watts. Bert is mainly out for rag chewing but doesn't pass up any DX, and Harold just "messes around" Hi.

W3GGT, Walt, Lancaster, Pa., contacted W6PHW during his third night on 160, as did W2NOB, Ed, Seacliff, Long Island, New York, another new comer to this band but one from whom a lot will be heard.

W9QFO is inquiring about rates for haunting houses, how come Johnny?

W9NAI, Elgin; W9BOM, Kenosha; W9NIP, Columbia; es W9UEW, Omaha: turn out to be Movie Op's.

HARRY D. MILLEN furnishes the following 1st Dist. News:

W1WV is a lieutenant in the local Home Guard Unit.

W1AJA sez ti if they nd a gd general his services are available, hi hi.

Both W1LDR & W1JJG r operating portable frm Camp Hulen in Tex., where most of boys frm this area r stationed.

W1JG is being operated by W1JLH. Both stations operate on 10 fone. Due to the eagerness of locals to cooperate, many skeds hve bn arranged between the soldiers and families, & it is practically impossible to get contacts other than skeds.

W1FH of 14 meg fame is giving 75 fone a try. The rig is the same rig it is used on 20 fone.

W1EMU usta be in the radio mfging biz. W1DTJ is in the law biz.

W1FGM of Berlin, N. H. on 10 fone. Fred recently changed QTH.

W1MGQ biding an E.C.O. as per W1GFW's design.

W1KWD got a nw *Hallcrafters* 5 & 10 and thinks its the berries.

W1MMH also got a nw *Skyrider* 5 & 10 in place of his homemade *Jones* rcvr.

W1NBT the "New Born Transmitter" (which is really a new born rig) is a nw ham in Jamaica Plain. U probably hve hrd Eddie many times frm W1PA's microphone. The transmitter was bit by W1ANR & operates on 10 fone. Eddie got his call on his birthday, which is quite a gift frm the 'ke cops.'

W1UCH who has been off the air fr sum time wl be active agrn on the amateur bnads, we hr frm a vy reliable source.

W1IAP planning to increase pwr to 400 wts shortly.

W1MSS got a nw *Hallcrafters* HT-6. Got it fer a Xmas present.

W1KZT is a member of the Brookline police.

W1MDY is the station of the Burroughs News-boy's Amateur Radio Association. At present the station is operated by W1MRS on 10 fone. Joe informs us that the 112th Div. of recruits want to contact N.E. (we hve no info on wat sta they r operating from at present.) The clubs sta also operates on "one sissie."

First again: W1GOU wrked Canton Isle on 10 fone.

With summer cuming, everyone arnd these parts r starting in wid picking up old gears, pulling down the electric conduit from the house system & starting to hand out cigars to the next door neighbors. Its beam planning time! Sum of the gang in this group arnd town r: DSN, GDY, LGC, MBC, MMH, KSA, BDM, NBM & urs truly. While on the subject of beams, not to criticise, but 2 of the local 10 meter boys hve bn tuning their beams for more than one full yr nw. Wow, 'ats wat we call tuning.

Wonder who's wielding MIG's xyl's rolling pin & vases these days. Bucla, Nick's better half, broke her arm. Nick's whispering "it's a ill wind it blows no gd."

W1MME wrked Maine one nite during short

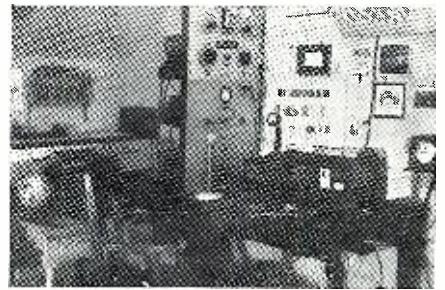

Hamstation of w7hnt.

skip up on 10 fone. Ruddy nw has a signal shifter, along with his beam, it really beams. He has almost full control of the band locally.

W1JOU on 10 fone. W1IMP of Terryville, Conn. on 75 fone.

WINJ of Braintree is on 80 fone at present. Rig uses 809 in fil wid abt 65 wts input. Vic is on 20 fone and 40 cw. Kcwr is a Super Defiant 25 Halcyon's job.

W1GYZ a school teacher by profession. Ken is on 10 meters, grid modulating to a pr of 812's in the final.

KB4HBX of the Virgin Isles is putting in a fairly gd on 28 megs.

Is this a record (or something)? W1JUZ, on one nite when short skip was coming thru on 10 meters made 42 contacts frm 11:15 pm to 2:25 am. And besides, listen to these reports. Thirty eight r-9 plus, one r-9, one r-8 and two r-7s, all in 3 hrs & 10 minutes, in case u haven't figured it out by this time.

W1EKG wuz first pres of the Parkway Radio Club.

W1MX contacted W1MMH one minute after 12 on New Years nite. But the unusual part of it wuz th they didn't roll up the contact until 7:17 am on January 1st. (Boy, wat windbags.)

W1HUG teaches at Northeastern Univ. in Boston. He sez as a rule the hams in his classes r not quite up to snuff. This is no doubt due to the large amount of the time they spend skooting arnd the ham bands when they should be doing their homework.

A new ham and the bands is W1LCY. Altho he has had the ticket for almost three yrs, he only got on the air 3 months before the ticket ran out. The rig he is using is W1DLR's creation.

W1NBT planning to buy W1KAL's 2 1/2 meter rig.

Sry to hr tt W1MJK has left the old 10 meter bud, as he sez for gd, to go up on 20 fone.

W1NDH is a nw ham in the Boston area. We were vly glad to pick up this info becz us truly usta go to school wid the op. Simon Geller, who at the time was a SWL & became interested in ham radio. At the present time Simon is on 160 meter fone & wrking out swell.

W1KXU of Dorchester wrked 195 stations in the Nat. QSO Party.

Frm W1GOU we learn tt we r sn to hve a N.E. Net on 10 fone. This net wl meet at 6:45 pm. W1CIB wl contact the boys on 160 and by this method try to bring stations frm other prts of N.E. into the net.

W1GVO is on 160 fone. At present Ralph is blding a 250 watt mod using a pr of 100TLE's to modulate the rig class B.

W1LOX is back at Newport frm the Cape. Fred is on 160 fone.

W1MRV who at present is on 40 cw, wl shortly try out 160 fone wid a *Stancor* "20." Good luck Johnny.

W1JWC is a cop! (Better watch out fellas)

W1LYH wrked N.H. on 10 fone. Guy is nw up on 20 meters, is putting out a swell wallop, even in the thick of the QRM.

We hr frm reliable sources th the local 5 meter activity has increased quite a bit in the past few months. The dx has n reported to be vly gd & as rule stations in N.H. and Conn & the surrounding area cn be wrked without much trouble. Most of the rigs r fairly hi pwred & as a result the sigs r vly strong. Sum of the more active of the gg r: W1EKT, BJB, TZ, AKD, SI, JDD, and KS.

Sum of the 10 fone DX coming thru these days r: K6PLZ, K6MYY, KB4HBX, K7DBR, KA1CM, KA1GM, K6PTW, KF6GEJ, KA1GC, K6SYM and K6BKZ.

By the time this item reaches the cd's desk W1AHD of Boston wl be in beautiful Hawaii. Al left Boston in early Feb. Al is in the govt's service as a dentist. He wl be stationed there for 3 yrs. Al took along wid him his Harvey UHX-10 & also his nw NC-200. If he got abt I mo ago Al plans to set up his ham gear at the post and try to get into Boston to wrk the gg and his family. We all wish u the best of luck in ur nw position Al, & we'll keep a sharp lookout fer ur sig on 10.

W9VHQ of Deeprive, Ia. is sporting a new *Sky* Champion, and new rig with T40 in final running 70 watts of fb sig.

W9FZF surprised me very nicely with a call, to let me know he was back on the old qrm band. Nice sig there Deke.

W9DRT is looking for a car cushion? What happened Wayne?

W9OTA and W9OFD are new hams on 160 meters, both have a very fine sig. for their first.

W9EFI finally ended up with that fb HRO Sr. receiver. Conk is really enjoying his radio now.

W9QGY has just built up a fb eco, so leonard is everywhere on the bands now.

Was very much surprised to hear my old friend W9WJU calling me last week and Doc sure has fb sig.

W9YFB and YAS of Garner Ia spent several days with me in person last week, we had a very fine visit. W9YAS graduates as a male nurse from a New York hospital next month.

W5GCE is sure working the Dx with that fb rig he has on 160. Happy is a swell contact any time.

W5LLK sounds mighty fine when Francis is on the mike. We Northerners sure like that Southern accent the YL's down in Texas have.

W9WPB is playing around with only 6 watts on 160 meters and working Dx with it too. Nice going there Ed.

W9LFH helped me get an important death message into Minneapolis when all communications here were down. Thanks a lot pal.

W9URW and IID were coming in fine here the other night, call us again fellows we like to work Colorado way out here in Missouri.

W5IWW always has a fb sig up here from Okla. He has one of those Eco's too and squats all over the band.

Yours truly is spending February in Hot Springs Ark so this wont bore you fellows next month Hi. But I will be listening so dont talk about me. So Long from the *King of Happiness*.

DON LIVELY of Ojai, Calif., dishes up the following:

Dear Ed:

Here is a bit of dirt about the W6 boys and gals.

W60YV of Beverly Hills has finally succumbed to the lure of the "snake in the grass." Lath is sporting a nice new eco.

Dud, W6TDW got his discharge from the *Marine Corps* after being called back into active duty, and is now spinning knobs on the Breakfast Club show again.

Dick, W6MZC (The man who made 40 meter off center fed Hertz's and Breting 14s famous) now has a pair of Gammy 54s taking over for the old 100th's, cant tell any diff between former 600 watts and 350 now here in LA.

W6TAC, is heeding his country's call. Ed is now a sailor boy and in training at the new armory.

The mayor of *Rattlesnake Gulch* has rebuilt and as is the usual case Bill has more than his share of bugs in the new rig. I wonder if that is the reason that the melodious voice of W6OZ has not filled the air of the southwest of late?

John W6QVS Powers, the golden voiced, legal mind of Southwest LA has moved to the high hills, where John threatens to put up rhombics and such for ten and one sixty, sure hope he skips over me.

Doc, W6TEY has given up sawboning temporarily for his first love. Doc is assembling aircraft radio equipment for one of the big aviation accessory plants.

Had a swell ragchew with W6SBL the other evening. Milt has just joined the family of Mother Bell, pretty swell old gal to work for eh Milt; she's the one that hatches all of those F1s.

Brownie, W6PPW has a new gadget that has all the boys watching the old gain control, it is a modulation indicator that not only checks the outgoing sigs but those received.

Our old pal, Larry W6RNK has really splurged the last few months, in the order named he has acquired a third harmonic, an NC101X, signal shifter, and rebuilt the rig.

If you lugs would like to hear some real AMC, take a listen to Kay W6CSC, between press skeds; Kay is modulating his 809 exciter running 50 watts input with 250 watts of audio from pp 811s, and I cant hear any splatter a half mile away.

Here is a little story that should give a few of the brethren a laugh. It seems that a couple of the gang in Southwest LA had a bit of a feud on with another of the boys in the same section who was running considerably higher power on the same freq; and of course they couldnt copy each other at all when he was on.

So they decided that a small *blitzkrieg* would be in order, and both proceeded to get on the air and soon after the rag-chew started, the other gent as expected comes on testing and calling CQ, but to no avail, they comment on every thing in each others transmissions, just as if there wasnt another signal on the band. This goes on for some two hours and the boys sign after a very fb QSO leaving the other guy just about nuts, because he knows they couldnt possibly copy each other thru him and to this day I dont believe that he know that this contact was carried on by means of land line, the boys simply kicking on their rigs and then talking over the fone without the least bit of QRM.

Ran into Don W6LCD the other day, he is designing ultra high freq aircraft radio equipment for Air Associates, his latest is a 50 watt output job working on 120 mc and is abt the size of the average communications recvr, complete with power and speech not bad?

Bob, W6MDK is temporarily off the air, too much bcl trouble, ye gods why dont they draft those damn midsets for the scrap heap, they might make fairly good shrapnel.

Believe it or not Harold W6RVE of Ojai (the station without a transmitter) finally got some QSLs printed now all he needs is a rig to go with them. Hi!!

W6NUR of San Francisco has also lowered himself to the level of the rest of us Doc now has a signal shifter and can be found most any place these days.

The KAs have been pounding in very nicely in the early morning of late on forty, bet the dx situation would be plenty ok if it werent for that stuff over there.

Talked to W6QNH the other morning and Glen had on the new rig he finally retired the



Toledo's pride (hi!) w8tlc.



Pe-war Zedder, z12 sx.

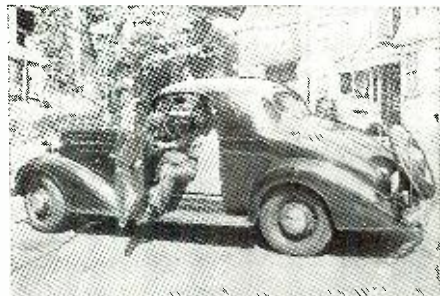

Portable-mobile w1bgw.

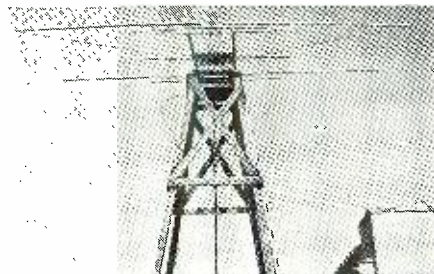

Hamop's twent' rotary w5fnv.



Hamop & station w5mct.

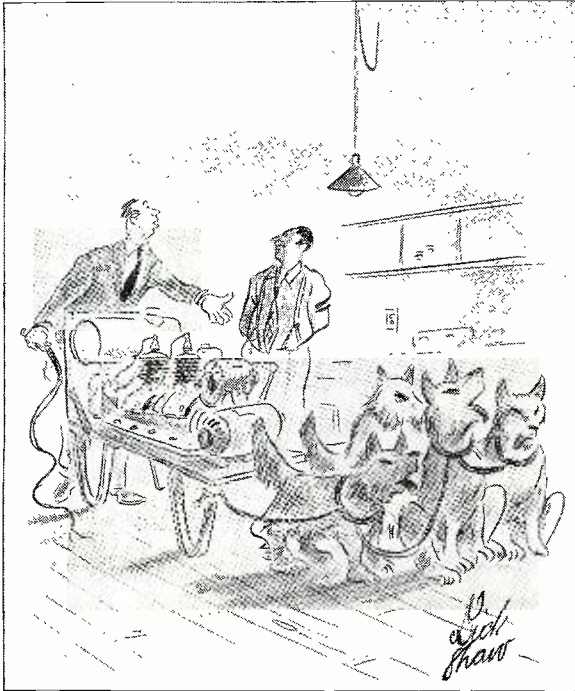

"That ham from Fairbanks, Alaska, ordered mobile equipment, didn't he?"

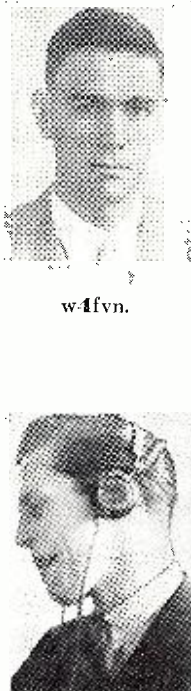

w4fvn.



w1lot.



"40,000 volts or not, I'm not going to waste any gas on hash for your ham-friends!"

mighty two and a half watter and is now running 30 watts to an 807.

Wonder if any of you guys have ever compared the construction of a 6L6G to that of an 807. If not take a look sometime and see if maybe you can't see why 6L6s perform so nicely at supposedly high overloads.

Ted W6QVY has been much more active on one sixty since ten has been so screwy this year, and has been doing a darn nice job as assistant AEC coordinator, Ted has district Three and Four.

The Boys finally caught up with a certain BL that had been working just about every body on the band, they introduced him to the rightful owner of the call which just about floored the poor guy, too bad he had to pull such a stunt he was really a swell ragchewer. No foolin a guy is really a dope to bootleg these days and it only serves them right to get it in the neck.

Id sure have a hard time proving I was a ham right now my ticket has been away for over four months for modification and not a word from it yet, wonder what's holding up the procession? Gotta go now, so 73 and dont work furriners.

W3CDY tells the gang that: W3DPK is rebuilding his entire layout consisting of xmitter, ant. & recvr. Tt is why he is being missed on 75.

W3FYQ is back on 75 with a new rig running abt a kw to a low ant. The rpts are fb though.

W3GJX is building a mod to get back on 75. He got a 2nd class phone ticket lately.

W3IEG is having great success on 75 with a pr hp T20's cathode mod. With a few more QSLs he will have WAS.

W3HCF is commander of American Legion Post at Myerstown Pa. Tt shows true spirit, Harry.

W3GEM has enlisted & is stationed at Middletown Pa. Air Depot. He is doing his turn operating.

W3HZK is working for *Western Electric*. We'll miss you on 40 Lyn. exW3FYG, exW5HQT, K6TEB is working for

KGMB Hawaii as technician, Congrats John. W3IGO is in training for one year with the National Guard Unit the 213 C.A. (aa) encamped at Virginia Beach Va.

W3ILB has a 6L6G working eco coupled to a 66 ft. ant & has loads of success on 40.

W3GJA is a radio op in the 6th Pursuit Squadron Hawaii.

W3HHE is attending Lebanon Valley College in spite of a visual handicap. Here are best wishes for success, Sam.

W3FSD who is well known on 20 fone has a low pwr rig on 75.

W3IGP passed the exam for class A & is racking his brain for a suitable mod circuit to give fone a trial. Hal needs only a few more QSL for WAS.

NEWS from LA by W51KP:

W5's: hqe is working 10 meters these days, hmp dan are both plumbers, isf has that new antenna up and wrking DX agn.

imu's meters work backwards (Hi).

jkw is new N.O.La. ham (Congrats OM).

mo has new power Co. hopes to have IIOV. now.

ewv changed qra to Norco (Lotsa luck OM), izl cannot get out on 160 meters, gdw is known as Grandpappy on 160.

hht's 160 rig really gets out fd.

hvd hci int are all really FB ragchewers. (keep it up fellows).

gnc works portable from Louisiana State University.

Well thats all this time from La. and I leave with this thought "let's have less 160 meter harmonics in the 80 meter band."

W5IEF is now xmitting from Independence.

W5TNE's XYL studying for her license.

W5UBC is ex-W5CC's XYL.

W5DS wants to sell one of his fone rigs. Says he expects to settle in Toledo soon.

W5PWY's hobby of photography keeping him busy.

W5GW also a camera enthusiast.

W5TLQ has been grinding a mirror for a new

telescope so he'll be sure to see that comet tail.

W5MMZ now has title of Chief Radioman and is "vacationing."

W9PJF blasts in wid: W9emh has recd his class "a" es seems to hve ferotten the ol one-sissie band.

The other morning w9mbu wrked fum coast to coast with 5 watts. Party gud Walter.

W9gwp wrked k-tel a few weeks ago on 160 es Edd only runs 50 watts.

There are 3 hams hr in W. Frankfort nw. w9nvy-Bob, w9bda-Bill, es w9pjf-yours turly, Paul.

W9slu has left 160 es is nw on 40.

W9fek is nw back on 160 after being off fer sum time due to fact tt he was rebuilding, ur rig sounds swell over this way Elmer.

W9zya has moved to Metropolis. Wunder if we will hve a hamfest at Dam 53 this year Slinny?

W9evw has been wrking ever thing he can hear on 20 cw with 2 watts.

W9mbu is gona go to radio school. We'll sure miss u Walter.

W9dvi has got hisself a new Howard revr es he says it really pulls 'im in.

W9yry has rebuilt his final es nw has a t40 there.

W9pkj is a new ham in Duquoin es he wrks out fb. Hi Pete.

W9nvy, a new ham hr in W. Frankfort, has been on 40 es has wrked 16 states so fer. Not bad Bob.

W9pbl went up fer commercial ticket the other day. We're all rooting for u Ernie.

W9yhr is rebuilding the whole rig in a new rack 'n everything.

W9esb has been experimenting with a ton loaded vertical on 160 es says it wrks fb when properly adjusted.

W9wed is nw running abt 600 watts to his big broadcast bottle.

LE W9BDO (Babies DO) Crawford, pride of Seneca, Nebr. hits the trail wid:

W9LXI, Lloyd, lately of C.A.A. emergency landing field op is nw "at" not "in" Ft. Leaveuworth, Kan as he "joined" Unk's army.

Wyoming has bn qsyd into 7th Corps Area of AARS. W7AGG the hubbie of the muchly-called gal "Betty" W7IDO, is gab control in the wide open spaces thr.

Every Razzberry is now a member of 160 F AARS net. W9HRR belongs up in S Dakoty—Fred's YF not up 2 par is in Calif es reports R tt she is feeling btr which is FB Josie.

W9SQT is on'ing for CAA at Sidney, Nebr. Ben argues for his beluvvd 40CW but he argues on 160F.HI.

W9ISJ tuk a fling at 40 cuppla daze ago es cum back up 2 160F dissusted tt outa duzzen QSOs he onl got 1 rag-chaw! Hi Bill! Bill is relief agent for U.P.R.R located at Miller, Nebr at moment.

W90ZC another Morse man still is modulating fm Thayer tho expects 2 b qsyd sum place else on RR snr or later if not b4! Leonard is also considering a job in Arizona so mayb he may yet help sum of U WAS addicts out on tt state.

W9WRV's sigs sound "all wet" 2 U. tt will be OK as Wes has his ant hung on the 135 town water tank. Hi. Hi. High enuf anway.

W9TRK Jerry at Scott Field at time of writ-

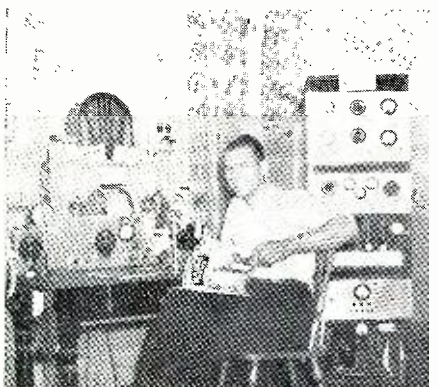

He reads R.N., does w1bdm.

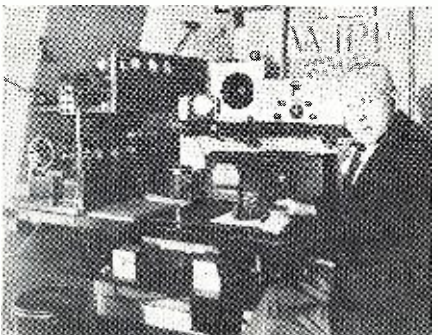

Boston's famous hamop w1pi.

ing this, expects to be sent back to Chanute to get sum finishing touches. Jerry was home for Xmas vacation and W9's AMY, MJY es PDH driv dwn es gave Unk's newpew the twice-over.

W9CCR—Completely crazy radio—Percy acquired himself a brand new infant es is he a proud poppa!

7th CA AARS 3995 ke net is nw under tutelage of W9NNK, Stan.

Many hv bn asking me abt W9ADJ—I simply hv not bn hearing Clyde on es think he is rather inactive, or off 75 anyway.

W9HDB "Lee" es W9EYN both of the Mile High City join noon round tables on 75.

W9HAF es W9HNG meandered twn to RI's in Denver last yr es in due time cum home with "A" tickets. Claude had nvr wrkd CW on ani band but old Rose loves to twiddle a bug. Both R welcome additions to mi 3995 ke AARS net in 2nd dist 7th CA.

W9NNK—7 is op'ing for United Airlines at Cheyenne nw. W9IQZ same but at North Platte—Buffalo Bill's old home town. W9GTG is nw at Grand Island wid a new YF Ruth but hvng rec'd a promotion in CAA expects to be oscillating fm Cheyenne sn.

A certain "brunette-blonde" sparked a sparkler out of one of Unk's nephews late last yr—wunder if she hadda get dwn on her knees to do the askin' as the OB had sed she must! Hi.

W9YUM cud afford a bit of ice nw 4 sum gal if ani wud ask him real nicely as Forrest just rec'd a promotion es darned gud increase in pay-check which he intends to invest in a new auto insted of a YL out at March Field but he likely will be in Ariz sn.

W9IDO Don is stationed on St. Looie side of the accumulated collection of many-raindrops known as Old Man River—sorry I didn't get a personal visit Don when U were home on furlough.

W9YXR Don near Potter is new sec'y of Western Neb: Radio Club.

Wid increased monitoring force sum of the boys hv bn acquiring "pink" valentines, it seems. Make us btr ops.

Sigs hv bn rather erratic lately on lo-freq bands. Am hearing East-South-and-West coasts on 75F 1-2 hrs after sun-up; es other morn W9PO Greeley, Colo wrks K60QE Harold abt 2 hrs after sun-up which is a bit "unusual" for 75! K60QE with his rhombic sure puts in a good sig on 75 es apparently also enables him to hear us fine there on the Mountain near Honolulu! He duz FB on 20, also.

K4FAY es K6LEJ were opposite ends of a large round table of around 30 stns on 75F one morn. So far, no QSL fm either so no particular due on either. We bn hearing K4DTH on CW on lo-freq end of 4 me but Jose wudnt answer us fone men so I went out on 3870 es got him after 3rd try of fist wiggling.

Wrkd K7DWH Fred in "salmon cannin'" town agn on his usual 3996 kes es Fred sez bn quite inactive last yr or 2. Also hrd a W6 luzzable K7 at Yakitat, Alaska on 75F but he wuz rather weak hr, but wrking west coast stns OK. W9MZY managed to cliche wid K7DWH cuppla caze after I did. Ken's new 812 put a hole out thru the glass when he had it on 10 M as gettler-plate was up agnst glass es acced to a frame gud. They gave him a new bottle.

W5JL ECO's around on 75 es represents Ark on my net for us.

W9WRS spends a lot of his operating time on high freq end of 160F—too bad Earl lo-freq end isn't open to gab, too—es still experiments wid ants, etc. in true ham fashion.

W9BZI Pete of Wagner, S Dak is hrd regularly wid gud sig on 160CW es bi-rosh in the CW end of the band, too!!! Most of the 160CW is cracked out in fone portion it hears to me like.

RELIABLE Dow (W9KOH) Summers of Mo., reports:

January month of sleet, snow, has been very hard on ham antenna equipment, but a lot of very important traffic has been handled in spite of the weather. The public is beginning to realize what Ham radio can do in emergencies.

We are forming a Missouri net work, and will include the Iowa boys if they want to join us. We will hold sessions on 160 meter phone every Sunday at 11 A.M. So far we have W9IIS, IPR, OTA, OFD, AEZ, BYM, IXR, JEB, and KOH. Any one interested in joining this net please drop me W9KOH a card, all are welcome.

W9APY and VZQ have a contest on to see who gets WAS on 40 meter first. They are having a very close race.

W9VDC of Lansing Mich is very interested in Jitterbugs, dont blame you very much Paul, but I wudnt sit at home and kid them via radio.

W1ERX was laying an R9 sig out here at 6 pm on 160 meters last eve. Called you Frank but no answer.

W9JZA has up a new Zepp thats sure doing a swell job about 1865ke.

W9LEE is a new NYA station located at Chariton Iowa, operated by W9QGL. They have a fine lot of equipment.

Radio Whispers: 'Tis said that the boys of the NCR are just about the finest that have ever turned out for our government. Many have been called to the colors; and all are doing a bang-up job. Our hats are off to the NCR lads. Nor are the AARS fellows slouches. They, too, have been given signal (hi) honors. Guess the good old cw crowd can crow plenty about what's what these days. Maj. Dave Talley down at station WARL says his only kick is that there are not enough men in the AARS. How's about joining up? Meet nothing but the best people, got grand experience, and have a lotta fun. It's patriotic, too!

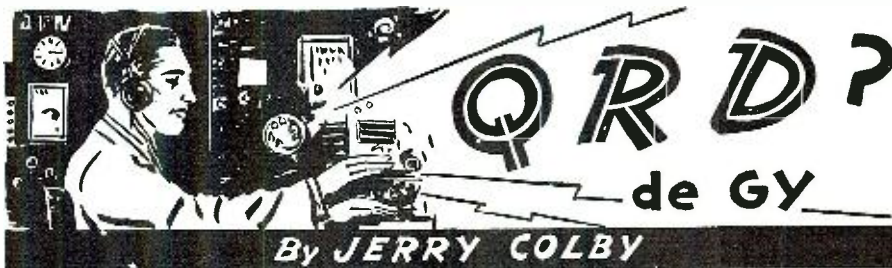

FOR the past few months our continuous calls to Brother Leroy Bremmer's home met with no response, so imagine our surprise and relief when we received a post card from him postmarked Manila, Philippines. Bremmer, who is secretary of the VWOA, Los Angeles group, is an oldtimer with service to his credit since about 1914. So this little vacation must have been taken just to keep his hand in. Really not a bad idea. Kinda gives us a thought, eh? Well, how's it feel to be pounding brass again, Roy?

AND speaking of oldtimers, Izzy Emanuel, veteran Chief Op of the SS Mt. McKinley, can certainly stack up to the title. Emanuel pounded brass when the prefix "K" to our call letters was not even thought of and when Morse was the only dot and dash system used. That was way back in 1910. He recently broke into headlines when he volunteered to transport planes across the Atlantic. But he was turned down because "too old." Although he has turned the corner of 47, Izzy is just a kid, especially when he hits Seattle and rents a plane. He has more than 1000 hours to his credit and at one time held a transport pilot's license, which he lost because of lack of service. He has answered many an SOS call during his 30 odd years of time shipping out of Northwest ports and has seen a few of his billets go down into watery graves: the SS Governor, Umatill, Alameda and the Alaskan. It's oldtimers like Izzy who have made the American radiop spirit the envy of the world. We should have more like him.

THEN there's Brownie, you remember old FB, the Pres. Roosevelt, PanAmerica, American Legion, etc. back in '17, '21, '23? But he has gone commercial. Yousah, Brother Brownie has himself a store in Hollywood which sells everything from a phonograph needle to a recording unit. And it's quite a large store, too. But he occasionally pines for the salt spray, especially when a few old ops get together over a cup of jamoch. That's one time Brownie will hop outta his store to set 'em up at the corner eaterie. Yeah, you can see the old dreamy look come over his pan when they start reminiscing. Ah, for the good ol' days.

"WHAT goes on?" should be the title of this paragraph. "Or are we trying to act naive?" you may well ask. But from the mass of material which has been brought to our attention it would seem that Hell's about to pop loose in the American communications field. In the December issue of *Cosmopolitan* there appeared an article showing that the Nazi setup was deliberately intending to seize the merchant marine in case of war with our government. The article goes on to say that through Communist control of seamen and communication organizations this can be accomplished. Previous to this we find that Honorable Fred Bradley of Michigan in the House of Representatives made statements to the effect that there is a trojan horse in the Merchant Marine. He called Mervyn Rathborne,

former president of the ACA, a communist and the go-between of the marine and communication fields. We now note that in the ACA publication *MSG* a deliberate attempt is being made to push the Radio Officers of the ACA into the seamen's union, the *NMU*. We have also noted that in recent months many top ranking officials of the ACA have resigned from their posts. We find that Paul Rothman, one of the charter members of the *ARTA* (ACA), has just added another name to the others who have resigned from ACA. "What goes on?" we again ask.

IN a recent mimeographed circular mailed to all members of the ACA by H. F. LaCoste, Secretary of *Local 8 ACA*, a most eloquent plea was made to keep the *ACA-Mardiv* intact. Not to, under any circumstances, affiliate with *NMU*. Its clear, concise phraseology was poetic in its effort to show the ACA membership that by affiliation with the *NMU*, its identity would be completely lost. As LaCoste states, "I say this, and perhaps it's political suicide" and we are wondering whether Brother LaCoste knows more than his mimeographed article shows.

THEN we published Fred Howe's letter requesting affidavits from various officials of the ACA to deny their affiliation with communist or subversive groups. But nary an affidavit or comment came from these officials. And to cap the whole matter, when Representative Isacs of California put up his bill, *H.R. 10446*, which would deny or nullify a license to any radiop who could be proven to be or to have been a member of any subversive organization, *ACA'S* publication *MSG* "went to town" trying to get members to write to their congressmen to kill the bill. "What goes on?" We won't believe, we can't believe, that American radiops who have lived and worked under the American

(Continued on page 57)

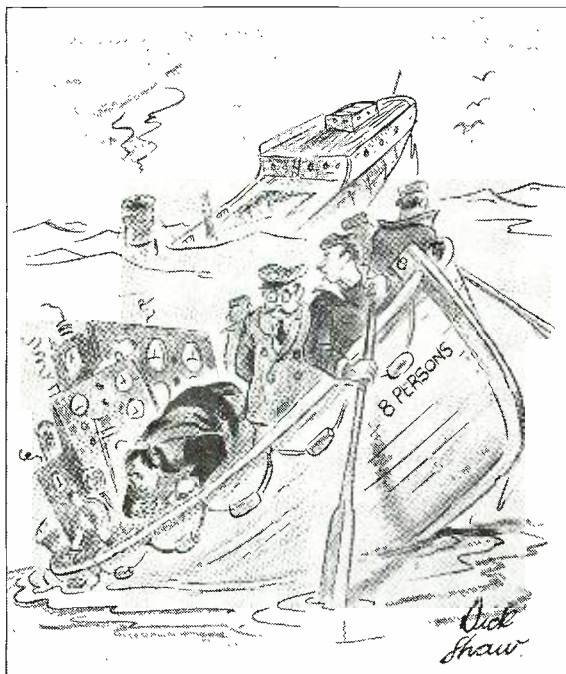

"How are you gonna run that, Sparks; from my flashlight battery?"

COMMUNICATION & ELECTRONIC MAINTENANCE

by **W. H. BOHLKE**

Director of Test Equipment Merchandising, R.C.A. Mfg. Co., Camden, N. J.

Having assembled the service bench, the author takes up the subject of how to use the instruments for best dollar returns.

Part 6.

NOW that we have established the major units for this typical test bench of the future, we feel free to devote one such article to a general discussion of the supplementary units; those units which have not been considered as basic and shown as a part of the test bench. Also details relating to actual servicing technique. In fact, because of the diversity of opinion, the latter will be dealt with before the former.

We know from experience and investigation of the servicing activities of the personnel in the various fields of activity mentioned in this series, that in general three methods of locating trouble are employed. They are voltage measurement, so called point to point resistance measurement and signal tracing. In some cases, the signal generator may be used to feed a signal into certain circuits for test purposes. This method, which unlike signal tracing, is by no means a departure from conventional methods of trouble finding.

Granting that signal tracing is increasing in popularity by leaps and bounds and fast supplanting all other methods as a primary system of trouble localization, it is nevertheless true that there are servicemen who are still using voltage and resistance measurement methods. Consequently, the service shop intended as one suitable for universal application, must contain such apparatus as lends itself to any and all forms of trouble shooting, so as to comply with the wishes of the operator as well as with the information which the receiver or transmitter manufacturer supplies in his service data.

As one can readily understand, we lean definitely towards signal tracing and sincerely feel that more and more receiver and transmitter manufacturers will feel likewise in the future and will furnish that data which is of value in connection with signal tracing. This is shown by the fact that when *Rider* first introduced signal tracing to the servicing industry, but one manufacturer, namely *Motorola*, published data (microvolt sensitivity) which could be used in such testing. Today *RCA*, *General Electric*, *Farnsworth*, *Zenith* and *Motorola* furnish signal tracing information in complete detail; a few other manufacturers furnish some information and many more are making their plans to incorporate the full data necessary for proper application of this type of trouble diagnosis. As we have said earlier in this series, the one basic method is signal tracing and voltage and resistance measurements are definitely secondary

or supplementary methods of operation which follow up on the findings of signal tracing.

Be that as it may, and concur or disagree with us, as you see fit, the basic units selected for the electronic and communication service shop will enable you to work with whichever system you prefer. You may feel that since you prefer voltage and resistance measurement, you have no use for signal tracing apparatus. We say that you will find to the contrary, even if you apply signal tracing only to those jobs where you have exhausted your patience trying to locate the fault in the system by your preferred method. This fact is beyond contradiction and we have no hesitancy going out on a limb to make that statement. It will withstand the most rigorous analysis by the most experienced voltage and resistance measurement serviceman.

Feeling that what we say has been proved in the broadcast servicing field, we feel many times more confident in the other fields where operation is carried out on the higher frequency ranges up into the ultra-high. And since this shop is being projected into the future, to add to that which is being accomplished today, it is imperative that the equipment suggested be such as to fulfill the needs of the future as we think they will be. So, by providing apparatus which gives each man the opportunity to employ whatever testing method he chooses and by providing for the future, we feel that a fair and dispassionate selection of instrument types has been made. In fact, we are fortified in that belief by the very fact that the types of test apparatus suggested to the reader are of such character as expands upon the operating capabilities of his own systems, even if they are not signal tracing. An example of this is the suggestion that the voltmeter be of the electronic type, rather than of the conventional variety, because it provides the operator with the means of making his voltage measurements with the system under test in actual operation, thus greatly expediting determinations of existing conditions and facilitating conclusions. Also the ability to make measurements of control voltages during operation. So much for the present about servicing techniques.

Assembly of Apparatus

Of significant importance in the selection of the basic apparatus for this ideal service shop, is the ability to assemble the apparatus for simultaneous observation of conditions at different points in a system being tested. With the exception of the process of resist-

ance measurement (the resistance measuring section of the electronic volt-ohmmeter), every other unit in the group can be combined with every other for application to a unit being tested, while the unit is in operation. The reasons behind this arrangement are not associated with the location of intermittent defects. Such work can be done with ease, but of far greater importance is the ability to localize defects with extreme speed and facility by simultaneous observations of operating, control and signal voltages, in different parts of a system. Also the ability to note the effect of variations in any one of these values upon the other.

The importance of such operating ability in every day radio service work is very important, but in those fields where the receivers are subject to more critical requirements—where the repair of a receiver must be made in the shortest possible time so as to minimize the period of inactivity of that system—the ability to do these things is of tremendous importance. All of this is made possible only because the type of apparatus selected is of such character that the input impedance is very high and interaction between the different units is a minimum. Granting that the final reasoning power is within the brain of the operator, those facts which become the basis for reasoning, are developed by the apparatus and the more that can be established at the same time, the more readily can the conclusion be made by the operator with minimum hazard of error or mistake. Of equal importance is the fact that when servicing procedure is of such character that the final result must be of a certain definite, prescribed quality, as for example a certain sensitivity and a certain order of selectivity in the case of a receiver, the type of apparatus outlined can be combined to provide such testing facilities as will permit identification of, and adjustment to, the prescribed conditions.

The man who is interested in such a service shop must appreciate that many of his operations will be carried out upon systems which, while resembling those utilized in the everyday commercial broadcast field, are nevertheless different, in that the multiplicity of controls is greater and the operation of every one of the controls requires definite checking. Naturally the income from such operation is greater than that from everyday service work. In fact, it is just as readily applicable to everyday service work, without necessarily increasing the cost of operation to a degree which would

call for a prohibitive charge. The very fact that the proper type of equipment is available whereby all the required facts can be established in rapid order, is a means of reducing, rather than increasing operating expense. In this respect the service shop is no different than a manufacturing organization. The greater the efficiency of operation the lower the actual operating expense per job; the more work it is possible to handle and the *better* the actual output.

One of the weaknesses of many service establishments is the belief that it is sufficient to have one piece of a kind of equipment. To a certain extent we can appreciate this kind of thought, particularly when the apparatus is expensive. But there are innumerable instances when the lack of duplication in inexpensive equipment causes much loss of time. No one piece of test apparatus can be guaranteed against failure. All that can be guaranteed is that *if* it does fail within a certain period after purchase, it will be repaired gratis. Naturally every responsible manufacturer tries to get the longest operating life into every piece of equipment he produces, but what happens if that much undesired condition, failure of the unit, develops? Unless some other apparatus in the shop is available so that work continues, work must stop, or the process of operation must be changed to suit the limited capabilities and the consequences can prove expensive in more ways than one. Yet we would hesitate for a number of reasons to suggest that two a.c.-d.c. volt-ohm-meters be a part of the test bench; that a less expensive signal source also be available to supplement the signal generator.

In the basic equipment we have shown in this test bench certain duplications exist and are essential. The voltmeter in the *Chanalyst* can do in place of the d.c. voltmeter in the *Jr. Voltohmyst*—at least over a certain part of the range of the instrument. The a.f. channel in the signal tracing unit can serve as an approximate indicator of alternating voltage in place of the a.c. voltmeter in the *Jr. Voltohmyst*. The a.f. oscillator can serve as a modulator voltage source in place of the internal modulation source in the *Signalyst*. The oscillograph also is an emergency a.c. voltmeter. The calibrator is an emergency signal source in place of the signal generator.

The tuned circuits and rectifier in the signal tracing system can serve as an emergency receiver and with the oscillograph can be used to check the mode of operation of the signal generator. With the converter feeding the *Chanalyst*, almost the entire range of the signal generator can be checked. For sensitivity measurements both the signal tracing and signal generator units are suitable, hence one is a check upon the other or a means of establishing conditions if one fails.

The modulator unit in the signal generator is a temporary substitute for the audio oscillator. By simple calibration, the r.f. and a.f. channels of the signal tracing unit can be employed as percentage modulation indicator to check the signal source. The calibrator is of course a means of checking frequency. The heterodyne detector in the signal generator as well as the *Chanalyst* can serve in conjunction with a signal input to

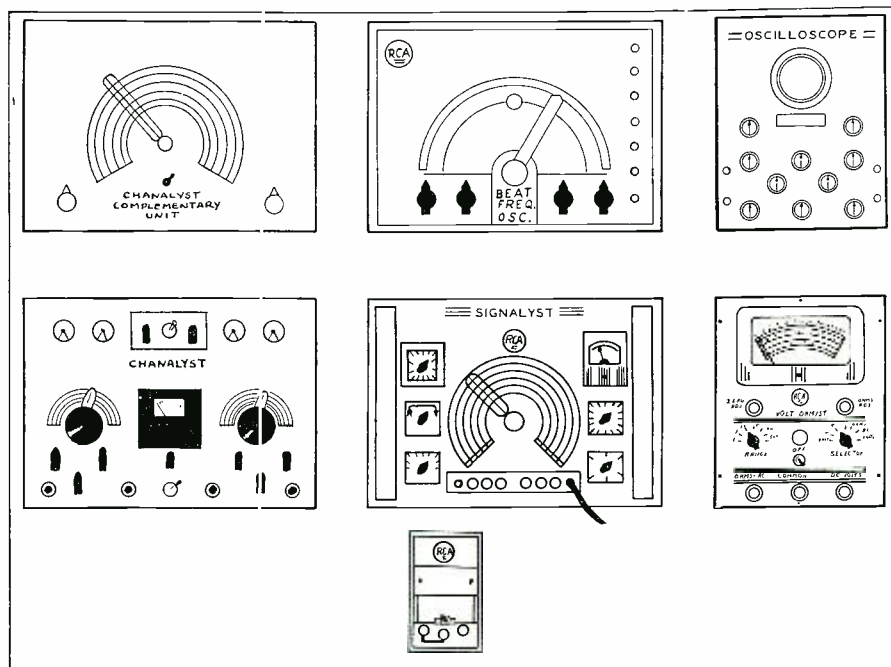

What the complete communication and electronic service bench should contain.

check frequency calibrations. All of the things we are mentioning here are not actually service operations, but are important from the viewpoint of being able to maintain service operations if a unit fails, or as a means of identifying the condition of the respective servicing units. More than one receiver was incorrectly adjusted because of some discrepancy in the signal source and more than one system being serviced proved a tremendously irksome job, until the discovery was made that in addition to the actual defect in the system, the test equipment made its contribution of confusion because of improper operation.

But let this suffice as an illustration of possible applications of these units in the event of equipment failure. If we attempted at this time to list all of the possible service applications of the individual units and their capabilities when acting collectively, it would take up more space than the editors of *RADIO NEWS* could sensibly allot to us. Furthermore, we have something to say about some of the devices, which we feel sure you are acquainted with, yet do not see upon this test bench. That does not mean that we are omitting them. We intend including them, but feel that certain qualifying statements must accompany their selection. Sometime before this series is concluded, we shall dwell upon applications of the complete assembly.

Frequency Modulator

Getting back to devices which you normally would expect to see in this set-up, yet miss in the bench we show, one of them is a frequency modulator device. We are fully aware of the varieties which exist in the field today; the fixed and variable frequency oscillators used with a separate oscillograph or the so-called oscilloscope. Then there are the various motor driven varieties of frequency modulators. Many of these are out in the field and all we can say to the owners of these units is, if you have one use it. As far as this electronic and commu-

nication service shop is concerned, we shall wait until a frequency modulator—or modulators—possessed of all frequency requirements which now exist and seem evident in the future is available. Except where band width conditions are important and the use of visual alignment for observance of regeneration, etc., we believe most present day applications can be performed with the standard amplitude modulated signal generator. If we had a frequency modulator in the shop, we would not cast it out—we would use it. However, since present day units are intended to operate over the i.f. bands used in broadcast receivers and f.m. receivers require frequency modulation over a 2 to 4 megacycle band and television receivers require frequency modulation over a band several times as great as that of *fm*, rather than recommend something that is very limited in operating range with respect to actual requirements, we prefer to wait until something that meets the present and future needs, at least for the next few years is available.

Speaking about frequency modulator units, we would like to make a forecast. Just as there is need for visual alignment of i.f. systems, so will there develop a need for an instantaneous picture of the response curve of an a.f. system. In other words an audio frequency, frequency modulator, which when used with an oscillograph, will provide an overall a.f. response characteristic. Such a unit will be of inestimable value in connection with public address and sound reinforcement systems, in fact with any and all a.f. operations.

Tube Checkers

The tube checker is a device which belongs in the service shop, but since it is not that type of device which belongs mounted upon a bench panel we prefer to speak about it separately as if it were a supplementary device. Each shop requires two types of checkers. One which can be classified

(Continued on page 56)

Ring the Bell

How to tell a customer his set is obsolete and what to do with accumulated units.

by SAMUEL C. MILBOURNE

Serviceman, Greenwood, Miss.

WE visit few radio repair shops that do not have their walls lined with an odd assortment of old radios which have accumulated because their original owners fail to un-hock them. Often these radios lie de-gutted in dark corners, with their innards brazenly displayed to the world and the holes in their empty cabinets resembling smirking skulls.

The problem of how to dispose of them is an ever-growing one. We give you the results of our experience for what ever help it may be.

First, we don't let them accumulate. So many servicemen will not return radio receivers to their owners until the irate fellows threaten to "have the law" on them. It makes no difference whether the repair has been made, or an estimate has been turned down and the serviceman must return the set un-repaired. The primary rule to which every serviceman should subscribe is GET THAT SET IN AND OUT OF YOUR SHOP AS FAST AS POSSIBLE. If a repair is authorized, no money can be collected until the set has been returned. If the decision is hanging in the air, you can't make the repair until you get the green light. If its a "return unrepaired" job, the sooner you get the set out of your shop the better. If you have a fire, or accidently damage it, you are liable.

There are many cases where, because of one thing or another, the set can't be returned. The customer moves away, or he tells the serviceman he can keep the old set, or the customer disappears and does not return to claim the set. In such cases, we suggest that you look up the law pertaining to your responsibility for the set. In some states you can sell the set in 30, 60 or 90 days if it is not claimed, provided you have a sign to that effect in your shop. In any case, once you



How not to show your customer that his set is obsolete. Use some tact!

have a legal right to dispose of the set, we suggest that it be examined and a cost estimate made to determine whether it can be repaired at a reasonable cost to you. If so, repair it and sell it for the normal repair charge you would have received on it plus any advertising or selling cost you might incur. If not, deposit it gently in the ash can and forget it.

In this locality, the sale of second-hand sets to the poorer people is a profitable side-line. Get a down payment of one or two dollars and arrange weekly payments of 50c or \$1.00. If you can get about a dozen of these weekly accounts on your books, they provide some welcome additional pin-money. Often you can gradually build a customer up through a series of trades from a small receiver to a console model. Here is where so-called Yankee trading blood will tell.

By returning sets promptly and legally moving to possess and re-sell "orphaned" radios, you will keep your floor and shelf space clean and pave your cash register with a continuous flow of silver.

When Is a Set Obsolete?

Being of part Irish ancestry, and possessed of a normally sunny disposition, we do not intentionally pick fights—either verbal or otherwise—but we do not dodge them when the occasion demands. Thus, when a good customer of ours asks the question, "is my set obsolete?" we hitch up our britches and tell him the truth. While our method of arriving at an answer to this question may not suit the most discriminating, it satisfies us.

We look at the set, get down the manuals, if in doubt, and look for an avc circuit. Finding none, we turn our left thumb outward and downward, while delicately holding our nose between right thumb and first finger. The customer usually gets the point at once, but often not without further discussion. We gently explain to him that his kitchen cabinet was built previous to 1930 and while it set him back two years financially, it has paid for its costs time and again in educational and entertainment value. We further wise-up our customer to the fact that a set without avc is like a car without brakes and, using this as a starting point, we soar into a snap-explanation of avc action which leaves us both slug-happy. We also slyly introduce the idea that a repair of his set will be fairly expensive and make a mental note to add \$5 to the bill. If this is to no avail, we give him an estimate which clinches the argument.

As you can no doubt see, we do not like to repair old sets. We have reasons. Aside from the pleasant facts

that they are easier to repair and command a better repair bill, we have found ample reasons to shy clear of them. First, and foremost, they often refuse to stay fixed for any length of time. They are like the one-horse shay which, when it finally fell apart, did a good job of it. Second, the correct replacement parts are often hard to obtain. Third, when a set of this vintage is finally fixed, the owner still hasn't anything which even faintly resembles a modern radio. Fourth, an honest repair (not a patch-up) calls for a bill, the payment of which would go quite a ways toward the purchase of a new radio. Fifth, we don't like to see people throw away money without a reasonable return. Sixth, we don't like the idea of, as one serviceman phrased it, "being married" to a flock of super-annuated radios.

There are those intrepid souls who suggest messing around inside the set and adding avc, tuning indicators and a set of two-toned horns. There are also those who recommend jerking out the old set and replacing it with a new chassis. Personally, we always suggest to our customers the delightful and soul-satisfying idea of using the cabinet sans chassis as a living room bar. A local cabinet maker specializes in this cabinet wizardry and the lining can also be obtained despite Mississippi's loyalty to the cause of prohibition. Thus, we send our customers on their way rejoicing with the name of a dealer who will sell them, for a consideration, a real radio—and who is

(Continued on page 52)



Turn your accumulated sets into a silver mine. These sets have value.

BUY DIRECT FROM THE MANUFACTURER AND SAVE

WE KNOW OUR PRICES ARE VERY LOW and expect a certain amount of skepticism from servicemen who have never purchased the SUPERIOR way, but five years of sticking to our way of doing business has convinced us and many thousands of servicemen who have purchased from us that it is a practical and mutually profitable way of doing business. We know that the average income of the Radio Serviceman prohibits his purchasing high-priced equipment, and yet the very nature of his work makes it necessary for him to use accurate, dependable and up-to-date equipment. We know we have solved the problem for him and our continually expanding business proves that servicemen recognize this claim to be true.

BESIDES THE THOUSANDS OF SERVICEMEN AND TECHNICIANS, THE FOLLOWING WELL-KNOWN NAMES ARE LISTED AMONG SUPERIOR INSTRUMENT PURCHASERS: Standard Oil Company of New Jersey; U. S. Dept. of Agriculture; U. S. Dept. of Commerce; U. S. War Department; C.C.C. Camps; National Youth Administration; Goodyear Tire and Rubber Co.; E. I. duPont de Nemours & Co.; University of Nebraska; Leland Stanford Junior University; Westminster College; Oberlin College; University of Michigan; Boston College; Pomona College; Board of Education, Remus, Michigan; Board of Education, City of New York; Board of Vocational Education, State of Illinois; City of Bartow, Florida; Florida State Dept. of Education; Educational Dept., Custer, North Dakota.



The New Model 1220
POCKET LABORATORY

- ★ WEIGHS ONLY 28 OUNCES!!
- ★ USES A 2% ACCURATE 0-200 MICROAMMETER—ENABLING MEASUREMENTS AT

5000 OHMS PER VOLT

SPECIFICATIONS

- ★ 6 D.C. Voltage Ranges: 0-3-10-50-250-500-5,000 volts.
 - ★ 3 A.C. Voltage Ranges: 0-15-150-1500 volts.
 - ★ 4 Resistance Ranges: 0-3000 ohms, with 15 ohm center, direct reading to 0.2 ohm; foregoing base range multiplied by 10, by 100 and by 1,000, to read up to 3 Meg. with self-contained 3 V. flashlight battery.
 - ★ D.C. Current Ranges: 0-200 microamperes; 0.2-20-200 Milliampères, using wire-wound shunts.
 - ★ 3 Output Meter Ranges: Same as A.C. Voltage Ranges.
 - ★ 3 Decibel Ranges: From -2 to +58 D.B., based on .006 watt in 500 ohms.
- Model 1220 comes complete with cover, self-contained battery, test leads and instructions. **ONLY \$10⁴⁵**

The New Model 1240 TUBE TESTER

Instantaneous snap switches reduce actual testing time to absolute minimum. Tests all tubes 1.4 to 117 volts.

Sockets for all tubes—No adapters.

SPECIFICATIONS:

- ★ Tests all tubes, 1.4 to 117 volts, including 4, 5, 6, 7, 7L, octals, octals, Bantam, Jr., Peanut, single ended, floating filament, Mercury Vapor Rectifiers, the new S series, in fact every tube designed to date.
- ★ Spare socket included on front panel for any future tubes.
- ★ Tests by the well-established emission method for tube quality, directly read on the GOOD ? BAD scale of the meter.
- ★ Jewel protected neon.
- ★ Tests shorts and leakages up to 2 megohms in all tubes.
- ★ Tests leakages and shorts in all elements AGAINST all elements in all tubes.
- ★ Tests BOTH plates in rectifiers.
- ★ Tests individual sections such as diodes, triodes, pentodes, etc., in multi-purpose tubes.
- ★ Latest type voltage regulator.
- ★ Features an attractive etched aluminum panel.
- ★ Works on 90 to 125 volts 60 cycles A.C.

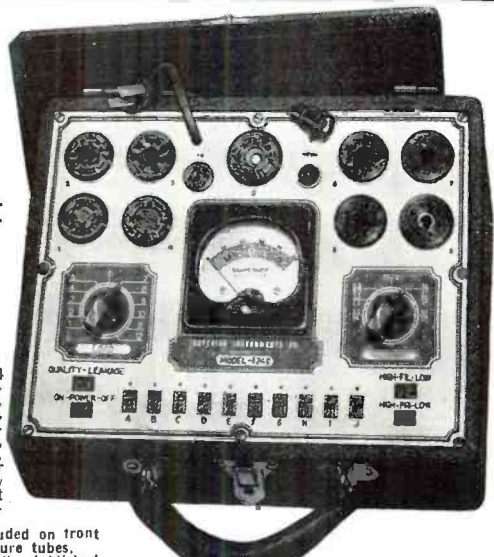

Model 1240 comes complete with instructions and tabular data for every known type of receiving tube. Shipping weight 12 pounds. Size 6" x 7 1/2" x 10 3/4". **\$11⁸⁵**
Our Net Price. PORTABLE COVER \$1.00 ADDITIONAL

THE NEW CHANNEL-ANALYZER

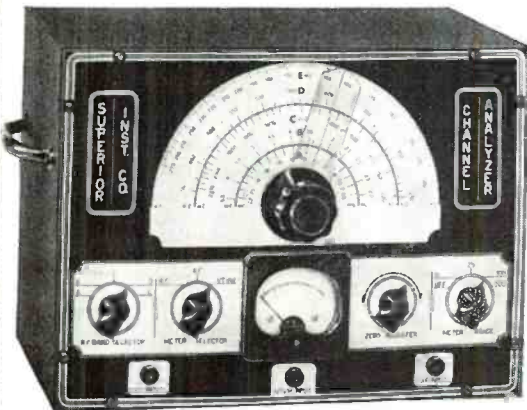

FOLLOWS THE SIGNAL FROM ANTENNA TO SPEAKER OF ANY SET

The well-established and authentic SIGNAL TRACING METHOD of locating the very circuit in which there is trouble, and the very component that causes the trouble, is now for the first time available at a price any radio serviceman can afford.

THE CHANNEL-ANALYZER WILL

- ★ Follow the signal from antenna to speaker through all stages of any receiver ever made.
- ★ Instantly track down exact cause of intermittent operation.
- ★ Measure both Automatic-Volume-Control and Automatic-Frequency-Control, voltages and circuits without appreciably loading the circuit, using built-in highly sensitive Vacuum-Tube Voltmeter.
- ★ Check exact gain of every individual stage in receiver.
- ★ Track down and locate cause of distortion in R.F., I.F., and A.F. amplifier.
- ★ Check exact operating voltage of each tube.
- ★ Locate leaky condensers and all high-resistance shorts, also show opens.
- ★ Measure exact frequencies, amount of drift and comparative output of oscillators in superhets.
- ★ Track down exact cause of noise.

The Superior Channel-Analyzer comes housed in shielded cabinet and features an attractive etched aluminum panel. Supplied complete with tubes, three specially engineered shielded input cables, each identified as to its purpose. Also full operating instructions. Size 13" x 10" x 6". Shipping weight 19 pounds. Only... **\$19⁷⁵**

MODEL 1230 SIGNAL GENERATOR



WITH FIVE STEPS OF SINE-WAVE AUDIO

SPECIFICATIONS:

1. Combination R.F. and A.F. Signal Generator, R.F.—100 K.C. to 90 Megacycles, A.F.—200 to 7500 cycles; Sine-wave—WITH OUTPUT OF OVER 1 VOLT. All direct reading, all by front panel switch manipulation.
2. R.F. and A.F. output independently obtainable, alone or with A.F. (any frequency) modulating R.F.
3. Latest design full-range attenuator used for controlling either the pure or modulated R.F.
4. Accuracy is within 1% on I.F. and broadcast bands; 2% on higher frequencies.
5. Giant dial etched directly on front panel, using a new mechanically perfected drive for perfect vernier control.
6. Operates on 90 to 130 V. A.C. or D.C. (any frequency).

The Model 1230 comes complete with tubes, shielded cables, molded carrying handle and instructions. Size 14" x 6" x 11". Shipping weight 15 pounds. Only... **\$12⁸⁵**

SUPERIOR INSTRUMENTS CO. 136 Liberty St., Dept. RN4 New York, N. Y.

TECHNICAL BOOK & BULLETIN REVIEW

THE MYSTERIES OF TELEVISION, by Arthur Van Dyke, published by *The House of Little Books*, 156-5th Avenue, New York City, price \$1.00, 55 pp. It is the object of this book to describe the latest developments in communication by television and to explain the mysteries which it has for the layman. No single book can cover completely each of the many aspects of Television. It is attempted here to describe most of them, in general terms, for the interest of those who desire to obtain an understanding of its fundamentals, either for general information, or as preparation for later more detailed study. For those who wish to study Television more deeply, a bibliography is included, and some helpful hints on further study are given. Chapters include the "Start of Television," "The Transmitter," "The Iconoscope," "The Receiver," "The Kinescope," and many other subjects.

THE RADIO CONTROL INSTRUCTIONAL MANUAL, published by *Radio Control Headquarters, Inc.*, Grandy, Conn., U. S. A., price 10c. This little booklet describes in detail units which are especially made for the control of model aircraft by means of radio. The hobby of radio-control of models is rapidly growing in importance and national interest and is one of the most fascinating of all hobbies. At the model airplane meet at Chicago last July, there was a record entry of radio-controlled airplanes, and there is every indication that from now on the radio-control event will steal the show at all meets. This booklet will be a valuable aid to those seeking information on the subject of radio-control for model planes. Price 10c.

1940-1941 ASTM STANDARDS ON ELECTRICAL INSULATING MATERIALS. The 1940-1941 edition of this publication which is of service to all those concerned with electrical insulation and related materials includes twelve specifications and tests covering flexible varnished tubing, varnished cloth tape (black bias-cut), phenolic laminated sheet, friction and rubber insulating tape, rubber gloves for electrical workers, rubber matting, asbestos yarns and tape, asbestos roving, and cotton tape for electrical purposes. Five standards cover molded insulating materials, and five pertain to plates, tubes, and rods. There are procedures for testing electrical insulating oils including saponification number, and three other tests pertain to glass including pin-type lime glass insulators, glass spools, and electrical porcelain. Also included are the proposed specifications for rubber insulating blankets for use around electrical apparatus or circuits.

Copies of this 340-page publication can be obtained from A.S.T.M. Headquarters, 260 S. Broad St., Philadelphia, Pa., at \$2.00 per copy in heavy paper cover.

"HOW TO CHOOSE A SLIDE RULE" by Don Herold. Published by *Keuffel & Esser Co.*, Hoboken, N. J. (Continued on page 63)

MANUFACTURERS' LITERATURE

Our readers are asked to write directly to the manufacturer for this literature. By mentioning RADIO NEWS and the issue and page, we are sure the reader will get fine service. Enclose the proper sum requested when it is indicated.

PHOTOTUBES, Bulletin from RCA. Complete information on phototubes and their applications is being distributed to engineers, servicemen, amateurs, students and experimenters throughout the country by RCA transmitting tube distributors. The material, in simplified form, is presented interestingly in a 16-page booklet prepared by the *RCA Manufacturing Company*.

The phototube's usefulness in light-operated relays, color discriminating devices, automatic counters, for light measuring, and for film sound reproduction, is explained in detail. The easy-to-understand discussion of phototube theory is backed up by numerous circuits and descriptive material, characteristic curves, and charted data on the complete RCA phototube line.

RCA phototubes are of two principal groups, gas types and vacuum types. Most of the gas types are designed primarily for sound reproduction, but their high sensitivity makes them suitable for many relay applications as well. Included in this group are the 868, a tube long used for sound reproduction; the 918, similar to the 868 but having the improved sensitivity; the 923, similar to the 918 in a short bulb; the 927, especially designed for 16 mm equipment; and the 920, a twin tube for use in push-pull sound reproduction from a double sound track.

Other gas types more especially designed for relay applications are the 921, a compact cartridge-type tube; the 924, a small end-on type with cathode facing the end of the bulb; and the 928, with the cathode arranged to respond to light from many directions.

The vacuum-phototube group is of primary interest to the designer of light-operated relays and light-measuring equipment. The 926 has the spectral response closest to that of the eye, and is therefore of particular interest in colorimetric work. The 929 has an exceptionally high response to blue and blue-green radiation, and so is important for flame-control applications where it is desired that the tube respond to the flame and not to the heated objects in it.

The other vacuum types differ chiefly in structural details. They include the 917 and 919, two exceptionally low-leakage types which are alike except that the anode is brought out to a top cap in the 917, and the cathode to the top cap in the 919; the 922, a compact cartridge type, and the 925, a tube with short bulb. RCA Manufacturing Co., Camden, N. J.

SNAPSHOTS IN SOUND, a new colorful brochure issued by *The RecordDisc Corp.* of 395 Broadway, New York, N. Y., manufacturers of home recording blanks. Literature lists 3 grades, the Semi-professional, the Economical and the Amateur lines, in both nitrate and non-inflammable coatings. Accessories include playback needles, cutting styli and mailing envelopes, together with valuable hints on recorder operation. Available at your local distributor or direct from The RecordDisc Corp., 395 Broadway, New York, N. Y.

RADIO INTERFERENCE ELIMINATION, a new bulletin prepared for Servicemen who have made it a point to study radio interference elimination as a means to increased profits in this rapidly growing phase of the business has just been issued by *Sprague Products Company* of North Adams, Mass.

This includes a complete description of the causes and cures of radio interference on power transmission and distribution lines as developed by Sprague engineers in more than three years of field and laboratory work. Although it is written primarily from the angle of the public utility company and deals with problems relating directly to public utility power lines, the booklet should prove helpful to servicemen who specialize in interference elimination work. Not only will it help round out their knowledge, but will serve as a guide in helping them diagnose radio noise complaints to tell whether the interference is coming from some appliance or electrical equipment connected to the line or from the line itself. In many cities Public Utility Companies work with trained radio interference specialists.

A copy will be sent free upon request to bona fide radio servicemen. This manual will help you in your training. Sprague Products Co., No. Adams Mass.

RCA RADIO and TELEVISION TEST EQUIPMENT. The most complete showing of RCA test equipment ever compiled is presented in the 1941 edition of the *RCA Radio and Television Test Equipment Catalog* (No. 105), according to L. A. Goodwin, Jr., in charge of Test Equipment and Accessories Sales. Several outstanding new radio and television test equipments, and phonograph modernization assemblies, are included.

The catalog of 28 pages—printed in (Continued on page 63)

Super-Superheterodyne*(Continued from page 9)*

two reasons for this move; first, the tube elements terminate directly at the socket connections without any pins being introduced between the socket connections and the tube element leads. And, secondly, all loktal tubes contain their own internal shields, making other shielding unnecessary. A third, but not so important advantage presents itself in the fact that loktal tubes are rigidly held in their sockets due to the type construction used.

(17) An antenna noise phasing system has been included. Not very much work has been done on antenna phasing systems; however, Jones, in his handbook a number of years ago, indicated that these antenna phasing systems can be used advantageously if most of the work is done on a fixed band or frequency. In communication work this is almost always true. Provision is made for two antennae. These antennae are then tuned 180° out of phase by the phasing network, so as to cancel out antenna "noise." A more technical description of this antenna phasing system will follow, but it was felt that no "dream" receiver would be complete without it.

(18) Naturally, a crystal filter was included. This crystal filter is standard in every respect, containing the usual crystal phasing and crystal sensitivity controls.

(19) Variable beat frequency oscillator for c.w. reception is part and parcel of the receiver. No communications receiver could very well operate without it. The panel control varies the pitch of the b.f.o., being of such character as to do it either side of "zero beat." The effectiveness of such a control lies in its ability to appear to give single-signal reception of c.w. signals without the use of the crystal filter. The b.f.o. can be used independent of all other controls, such as the a.v.c., a.v.e., crystal filter, r.f. gain, etc., a feature found in few units. The use of the b.f.o. to approximate single-signal c.w. reception will be discussed later in the series.

(20) An r.f. gain control has been included. This gain is most valuable in operating on extremely powerful signals in a noisy location and affords complete control of the i.f. and r.f. stages. It was felt that no modern communications receiver should be constructed without the inclusion of this control.

(21) Continuous electrical band-spread has been arranged for any part of the sets' five-band coverage. For this reason the band-spread has not been calibrated. The spread is adequate and will be discussed later.

(22) In the f.m. circuit an f. m. resonance indicator of the double magic-eye type has been added. This will enable a correct and accurate alignment with the re-

For Perfect F-M Reception ON YOUR PRESENT RECEIVER



use this new Meissner F-M RECEPTOR

*A highly efficient, 8-tube Converter for
any receiver—entirely self-powered!*

Here's the practical answer to the demand for immediate F-M reception when F-M comes to your community! If it hasn't already arrived, it will very soon. All the unbelievable magic of true "high-fidelity," static-less, noise-free and interference-free reproduction may then be yours—simply by adding this inexpensive converter to your set!

Your present receiver was probably purchased with the idea of getting the best that you could obtain for the money—modern frequency coverage, well-styled cabinet, reliable brand—all these things were carefully considered. Most of all, however, you insisted on good tone quality—and got it! Receiver manufacturers have given commendable attention to this important feature in recent years. This means that your receiver has a good audio system and reproducer. It is still limited, however, to the regular "amplitude-modulation" system of broadcast reception—painfully affected at times by noise, static and interference that often spoils otherwise excellent reproduction.

This new Receptor uses the audio system only of your present receiver; contains a complete "front end," from antenna to audio input, specially designed for Frequency Modulation reception. Includes high-gain R-F stage, mixer-oscillator, two-stage I-F channel, limiter, discriminator and second detector. Output connects to "Phono" terminals at audio input of regular receiver. Available in two models, for 110-volt, 50-60 cycle operation or for 110 volts DC; with or without cabinet. See your Meissner distributor at once or write for further details!

Write Today for Free Meissner Complete Catalog!

ADDRESS DEPT. N-4

Meissner
"PRECISION-BUILT PRODUCTS"

MT. CARMEL
ILLINOIS

A SHORT, SHORT STORY

**CABINETS
CHASSIS
RACKS
PANELS
BY PAR-METAL**

"It's the line of Beauty"

—and that's all there is because when you've said that—you've said about everything. Of course Par-Metal suggests so much more—like modern streamlined design; handsome appearances; accurate machining for easy assembly and a wide variety from which to choose. The Par-Metal catalog No. 40 gives all the technical data that you may need. It's free at your jobbers or direct from us.



PAR-METAL PRODUCTS CORP.

3262 49th St., Long Island City, N. Y.
Export Dept.; 100 Varick St., New York, N. Y.

SAVE MONEY

WITH THIS

Free Book

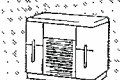

RADIOS



PARTS



P.A. EQPT.



HAM EQPT.

What a book to have! Just open it to the section you are interested in—there's your radio, sound system, your choice of nationally advertised parts. Everything in radio is here. But that's only the start of the story! Lafayette prices are the lowest—saving you money on everything you buy. Send for your FREE copy of this great buying guide today. Just tear out and mail the coupon.

Lafayette Radio

100 SIXTH AVENUE, NEW YORK, N. Y.
CHICAGO • ATLANTA • BOSTON
NEWARK • BRONX, N. Y. • JAMAICA, L. I.

LA FAYETTE RADIO CORP.
DEPT. 2D1,—100 SIXTH AVE., NEW YORK, N. Y.
Rush FREE Catalog No. 82

NAME.....
ADDRESS.....
CITY..... STATE.....

ceived f.m. signal.

(23) *The component parts used throughout the construction of the 1941 Super Superheterodyne are of such a character as to permit severe overloading without structural or electrical failure. This is an important point in a communications receiver of the magnitude of this one. Where one is operating 35 tubes in their intricate and inter-woven circuits, it is extremely necessary that the component parts be of such construction internally, that there not be a break-down, since its tracing through such a maze of wiring becomes at once a herculean task.*

These twenty-three points in effect are the outstanding features of the "dream" receiver. They represent hours of thought and careful planning and while they may not represent all of the features which any one reader might desire to have included in his receiver, the authors believe that it represent at least 99 per cent of all of the features which the majority could want.

A word about the appearance of the unit. As can be seen from the illustration, it is massive, measuring 26" across by 24" high. That is a lot of receiver, but it will be noted that there is no crowding of parts and the comfort of operation has been taken into consideration in the symmetrical layout of the panel.

One comment that will be made is that there are an interminable amount of knobs. Such is not the case, since when once the receiver has been adjusted to its operating position, the amount of controls actually in use vary between four and six. That is not an unusual number and certainly not a greater number than those which must be used to operate almost every commercial communications receiver presently on the market.

The criticism has been that the receiver is too bulky for the average operating table. That may be true; however, in the actual use of this receiver, it is believed a special operating position would be made available. If the receiver has all of the points indicated above, and if these points indicate necessary and valuable adjuncts to communication operation, then we believe it would be fitting to make a special table or operating position to accommodate this receiver. In fact, with the trend toward rack and panel mounted transmitters, and since the transmitter is easily controlled from the receiver by means of remote relays already included in the receiver, there is not any reason to have anything but the receiver, a frequency monitor, a key, microphone, paper and pencil on the operating desk.

If the operator limits himself to these utensils and apparatus, he will find his operating table less cluttered than is usual with other receivers. This is true because the receiver includes within itself a number of different and independent circuits obviating the necessity for additional equipment, such as Cathode Ray oscilloscopes, modulation indicators, f.m. receivers and the like.

It is not expected that any great numbers of readers will want to construct this unit in the home. In the first place, the component parts are not of the inexpensive variety and, in the second place, a great many of the

For those who want the best!

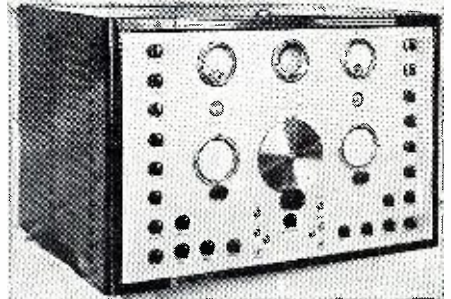

Of course HYTRON Tubes were used by Radio News Editors in the new R.N. Super Super Het Receiver!

Whether Receiving or Transmitting Tubes—you can always depend upon Hytron for outstanding quality and performance.

1941 Our 21st Year

HYTRONIC LABORATORIES

76 Lafayette St., Salem, Mass.

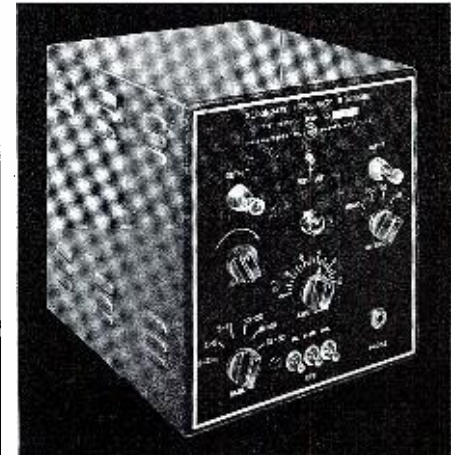

A NEW Precision Crystal Secondary Frequency Standard

THAT HAS BEEN

"Designed for Application"

A precision frequency standard capable of being adjusted to WWV or some other primary standard and putting out uniformly accurate calibrating signals with 10, 100, 1000 KC intervals. Uses the new GENERAL ELECTRIC No. 18A 1000 KC crystal having a frequency temperature coefficient of less than one cycle /Mc/C°. The crystal is sealed in Helium in a standard metal tube envelope.

The self-contained AC power supply has VR150-30 voltage regulator tube.

In addition to oscillator, multivibrators, and harmonic amplifier, a built-in mixer with phone jack and gain control on panel is incorporated.

Catalogue Upon Request

JAMES MILLEN MFG. CO. INC.
150 EXCHANGE ST. MALDEN, MASS.

readers, both professional and amateur, already have communications receivers. In order to assist those readers just mentioned, we have broken down the construction of this receiver into small component parts and units which may be added to existing receivers or may be built as special and separate units.

Naturally, if one takes advantage of the independent parts and does not wish to include them in the whole, the chassis measurements will not be the same and, hence, all chassis measurements, excepting outside ones, have been omitted. It was found that the construction of the super heterodyne was an assembly of a number of composite parts. In the design of these composite parts, the fact was taken into consideration that each part should be able to operate by itself and independently. So the reader may have no hesitancy in building, for instance, the amplifier channel, or the power supply, or the modulator, or the output meter section, or the squelch circuit, or the antenna phasing network, or, in fact,

any of the vast number of small electrical units which make up the whole of this receiver.

Construction Details

The chassis is constructed from heavy sheet brass. The overall dimensions are 24"x22"x4¼". The use of brass is highly recommended wherever obtainable. It provides an easily-worked material that has excellent shielding properties. Furthermore—the electrical conductivity is better than that of steel or other commonly used materials. It takes on a high lustre when buffed, and this adds to the professional appearance of the completed unit. After all of the drilling has been done, the buffing is completed. Then a coating of clear lacquer is applied to prevent tarnishing.

Great care is required in laying-out the chassis due to its weight. The three main pieces are marked off to proper dimensions and then taken to a metal shop for bending on a brake. The large piece is turned down at the front and at the rear of the assembly. The two sides are held in place by flowing solder in the four corners. The

use of a torch is recommended for this operation as the heat dissipation on the chassis is great. After all pieces are assembled, the high spots are filed down to a smooth surface. All of the sharp outside edges of the chassis are also filed round. This is required to prevent tearing of the buffer when it is applied to the surfaces. *Note: the metal work should not be attempted by any but an experienced mechanic or experimenter with adequate tools.*

The shielded box—seen on top of the chassis—is used as a dust cover for the two condenser gangs of the AM tuner. This can extend very close to the tube sockets so that short leads may be used. It was necessary to cut away part of the turned-out edges of the can to clear them. Both front and back pieces of the can are removable. These are held in place by self-tapping screws.

Actual layout dimensions will not be given in this series of articles as there are too many variables. For example—the reader may have some particular portion of the complete receiver on hand from other equipment. If this is

HERE'S THE NEW **Jensen** "Speech Master" **REPRODUCER**

FOR DESK, WALL OR PANEL MOUNTING

ATTRACTIVE streamlined appearance, versatile utility, and exceptional acoustic performance are capably combined in the new JENSEN "Speech Master"—designed especially for highly effective speech reproduction at moderate levels. Efficient, fully-enclosed PM structure. Rugged moving system. Internal provision for transformer mounting.

Desk Type . . . complete with base . . . "tilt" adjustment . . . for desk or wall mounting . . . List Price \$9.95.
Panel Type . . . for rack or cabinet assemblies . . . List Price \$8.10.

Bulletin 106 gives complete details.

Especially Designed for
Radiophone Communication
 Airline—Police
 Aviation—Commercial
Intercommunication
 One-Way & Talk-Back
Paging Systems
 Low-Level Stations
Public Address
 Low-Level Extensions

Jensen
 6601 SOUTH LARAMIE AVENUE - CHICAGO
 CABLE ADDRESS: JERAD, CHICAGO
 REPRODUCERS



★ Add pep and efficiency with these dependable Ohmite parts. They're proved right on the toughest jobs in every climate. Get them at your Jobber.

Dividohm Resistors — easily adjusted to resistance you need. **Brown Devils** — 10 and 20 watt resistors for voltage dropping, bias units, bleeders, etc. **R. F. Plate Chokes** — 4 stock sizes for 5 to 160 meter bands. Rated at 1000 MA. **Parasitic Suppressor** — to prevent u.h.f. parasitic oscillations. **Center-Tapped Resistors**—used across tube filaments to provide an electrical center for the grid and plate returns.

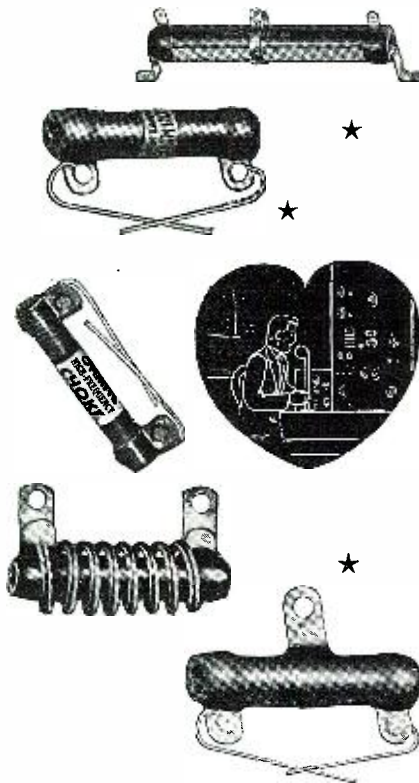

Send 10c in coin for handy new Ohmite Ohm's Law Calculator—Figures, ohms, watts, volts, amperes. Easy to use!

OHMITE MANUFACTURING CO.
4883 Flornoy Street, Chicago, Ill.

10c in coin enclosed. Send Ohm's Law Calculator

Name.....
Address.....
City.....State.....
Occupation.....
Radio News—April

OHMITE
RHEOSTATS RESISTORS TAP SWITCHES

suitable, it may be used providing, of course, that it meets the technical requirements of the circuit.

First and of greatest importance, is the actual construction of the chassis. This must be done accurately when so many parts are involved. The illustrations will indicate the proper positions for most of the parts, at least the important ones, and may be followed conveniently. The chassis is constructed from three pieces of metal and the bottom edges are turned over for 1/2" to strengthen the alignment.

Three long baffles are constructed from the same gauge brass as that of the chassis and these are formed to fit as indicated on the illustration. Each section of the main coil assembly is shielded from adjacent sections. This is highly important for proper operation of the set. The long partition shield is used mainly to support the heavy weight of the transformers that mount directly above. Holes are cut into the shield so that cables, which connect to the transformers, may be kept together for neatness.

We found that much effort could be spared by using one of the "screw type" socket hole punches instead of the conventional "punch" type. The thickness of the metal seems to best be cut by this method. All of the pieces are assembled and held together with 3/32 machine screws and nuts. All brass pieces are individually buffed before they are finally installed. Some of the parts must be assembled before the baffles may be put in place. One of these is the AM coil-switch assembly. The actual construction of this unit will be discussed in later installments.

The liberal use of lockwashers is required to prevent any loosening of the assembly after the receiver is placed in service. A little attention to this important detail may prevent a structural failure later on.

A gear drive was purchased for the band-spread assembly. This includes a 6-1 gear which is driven by the tuning shaft directly above the band-switch. Other gears are used at a 1-1 ratio to drive the large *Browning* dial at the same speed as that of the band-spread condensers. The power is thus applied to the condenser gang, and the dial itself is not called upon to deliver any power for tuning purposes. The main band-set condenser gang is driven by a pulley and belt arrangement. This permits a symmetrical layout to be maintained without locating the condenser assembly too far removed from its associated circuits.

The most logical place to start is to build the power supply. This consists of one unit which furnishes plate voltage to the main circuits, and another for the oscilloscope. Three filament transformers are required to supply the heavy drain of the 32 tubes. The circuit should be wired so that the current is divided between the two main transformers. The third is used exclusively for the filaments of the 6B4G's. Heavy push-back wire must be used for the filament circuits so that no voltage drop will develop.

The Audio Amplifier

Several features have been incorporated in the design of the audio equipment so that a wide choice of application is afforded. For instance, a recording amplifier of professional capabilities is included for those who

wish to benefit from high-fidelity response. The circuits include full bass and treble compensation facilities so that equalizing is available for recording at slow speeds properly. Application of this subject is covered in the series of articles "How to build a Recording Studio in RADIO NEWS."

The lineup for the audio amplifier is as follows: A 7B4 first audio and squelch tube, 16L2 (6L7) mixer-expander, 7A4 audio and degenerative tone control tube, 7N7 phase inverter, 6B4G class "A" power amplifiers, 7A4 expander amplifier, and 7A6 rectifier for the audio expander. The over-all gain of this section is more than sufficient for any type of phono-pickup, or detected signal.

The audio-expander circuit is entirely conventional. The amount of expansion is controlled by the 1 megohm potentiometer at the input to the 7A4 amplifier tube. The rectification of the audio takes place in the 7A6 duo-diode. The rectified signal, now appearing as a bias to the injector grid or the 1612 tube, controls the amount of gain at that stage. The cathode of the 1612 returns to the voltage-divider network at a potentiometer so that the proper point of operation may be set. This can best be done after the unit is in operation. The normal voltage will be approximately 14V. Different settings of this potentiometer will effect the operation of the gain within the stage. There is quite a variation in tubes of the 1612 or 6L7 type so each one must be adjusted separately.

Tone Control Circuit

The tone control circuit is rather

FIRST!!
WITH THE
LATEST!

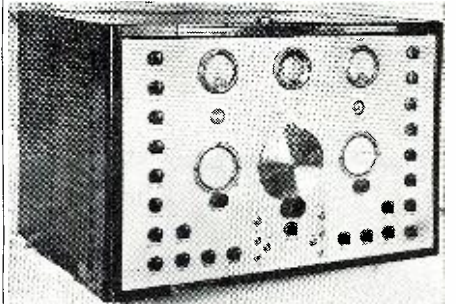

As soon as full diagrams are available from the staff of RADIO NEWS, we will be able to furnish all parts for the

1941 RADIO NEWS Super Superheterodyne



Also we have a full line of all ham parts.

4-hour service on all orders.
Send for our latest catalog! It's free.



NEWARK ELECTRIC COMPANY
DEPT. RN 4

323 West Madison Street
Chicago, Illinois

Telephone: Dearborn 0083

novel in its design. It was first developed by one of the authors some years ago in conjunction with a recording amplifier at W9ETI with very satisfactory success. It may be used with practically any triode tube in conventional amplifier equipment. Part of the audio output is fed back from the plate circuit to the cathode circuit of the tube where it terminates into the LC circuits in such a manner that a variable reactance will either aid or oppose the normal response of either the high or low frequencies, depending on settings.

The audio (bass) choke is one normally from an inexpensive AC-DC receiver. The exact value of its inductance is not critical. The best seems to be around 7 henrys. The current carrying capacity of the choke need not be considered, as the actual applied current is practically nil. For best performance, this choke could be shielded in a cast-iron or steel case. All of the wiring within this circuit must be done carefully to avoid any residual hum from appearing.

The treble section is made up from a standard 30 mhy. r.f. choke. This should also be placed within a metal can to afford complete shielding.

The circuit is very effective in compensating for various types of music. It is capable of actually *boosting* the treble or bass frequencies, or *attenuating* them. Standard potentiometers are used. Each of these are 25,000 ohms and are connected with shielded wire to prevent hum pickup. The treble portion consists of a 30 mhy. choke in series with a .02 mfd. condenser. The bass circuit has been described.

Output Tubes

The choice of output tubes which are best suited for recording purposes is rather limited. The best is the type 2A3 (6A3), or its equivalent 6B4G. The plate resistance of these tubes is very low which makes them ideally suited when working into either a magnetic or crystal type cutter. The output transformer is designed to work into two 500 ohm lines, one for the dual *Jensen* speakers, and the other for a cutter. The output transformer must be capable of passing the entire range of frequencies at little or no distortion. A *Thordarson* type T15S90 is one of the units which meets this requirement.

Some form of volume indicator must be used to indicate proper cutting level when recording. By adopting 500 ohms for our output, we can use a standard DB meter which is calibrated for this impedance. A jack is provided so that a regular phone plug can be used to the unit. When this plug is removed a 500 ohm resistor cuts in to the circuit so as to maintain proper loading to the transformer. This permits the DB meter to be used as an output indicator when in regular service. Range multipliers must be used when it is necessary to increase the audio output. These are available from *Triplet*—manufacturer of the meter. Note that the DB meter is also calibrated in VU's for the accommodation of those familiar with this type of level indicator.

A second jack is provided to accommodate a pair of headphones. These are used when microphone recording is taking place, instead of the speakers, for monitoring purposes. A series re-

sistor should be included to cut down the volume appearing at the phones. The exact value must be determined by experiment as this will depend upon the sensitivity of the phones. Another jack is used for output connections to the dual speakers. The plug is removed when microphone recording is used to prevent any feedback from spoiling the record. A resistor is cut in to load the output when this is done. It should have a rating of at least 10 watts.

Microphone input may be at the phono jack. There will be sufficient gain for most types. The resistance of 500,000 ohms across the microphone will have an effect on the high-frequencies. If better response is wanted, this potentiometer may be increased to 1 or even 2 megohms.

It is necessary to know the impedance of the cutter before any decision can be reached as to the best method to use for proper coupling to the output of the amplifier. Crystal cutters require a secondary impedance of from 4,000 ohms to 16,000 ohms, depending upon what type of recording technique is used. It is best to stick to a standard at the receiver (500 ohms) so that matching transformers may be used where needed for crystal cutters, etc.

The dual-speaker system is designed around a new *Jensen* unit. One of these operate most efficiently at the lower frequencies, while the small unit performs best in the higher frequency spectrum. By using a special network—it is possible to limit the response of each speaker to that range where greatest efficiency will be obtained.

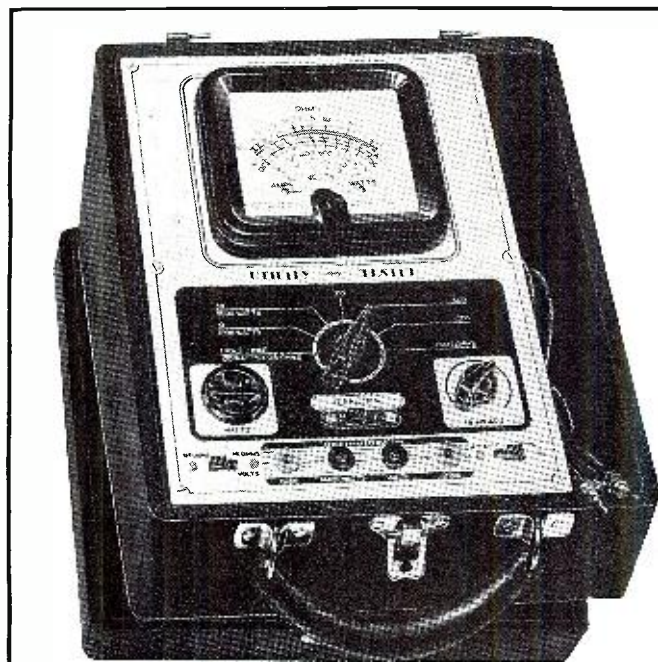

GREAT NEWS!!—THE NEW UTILITY TESTER

The Utility Tester is a new kind of instrument for testing all electrical appliances—WASHERS, IRONERS, REFRIGERATORS, RANGES, VACUUM-CLEANERS, TOASTERS, PERCOLATORS, HEATERS, SUN LAMPS, AIR-CONDITIONING, MOTORS, etc. The Utility Tester enables every possible measurement necessary to service any electrical appliance.

Mr. Radio Serviceman, here is a new source of revenue for you. The UTILITY TESTER will enable you to accept and economically service electrical and industrial jobs you have been compelled to pass up in the past. You already possess the fundamental electrical knowledge necessary to service electrical and industrial utilities, and now you can have the instrument which will enable you to apply this knowledge to a new and lucrative source of extra income.

SPECIFICATIONS:

3 WATTAGE RANGES: A.C. AND D.C.

0-100 Watts 0-1000 Watts 0-5000 Watts.

The UTILITY TESTER reads the wattage consumption (subject to power factor correction) of any appliance, motor, etc., while it is in operation. Thus you can actually prove to the layman the actual consumption of any appliance and compute the actual cost per hour operation, basing your calculation on the local current cost. This is a feature never before obtainable in any instrument selling for less than \$50.

6 VOLTAGE RANGES: A.C. AND D.C.
0-1 Volt 0-10 Volts 0-50 Volts 0-100 Volts 0-500 Volts 0-1000 Volts.

4 CURRENT RANGES: A.C. AND D.C.
0-1 Ampere 0-10 Amperes 0-50 Amperes 0-100 Amperes.

As far as we know no instrument selling for less than \$50.00 has ever enabled current measurements up to 100 Amperes. The UTILITY TESTER provides this service on both A.C. and D.C.

2 RESISTANCE RANGES:
0-300 Ohms 0-3000 Ohms.

The UTILITY TESTER reads all resistances commonly used in electrical appliances and in addition reads extremely low resistances. For instance, 1½ ohms appears on the center of the low ohms scale and resistances as low as 1/50th of an ohm are easily read. This is a feature never before obtainable in an instrument selling for less than \$50.

The Utility Tester comes complete with portable cover, self-contained battery, test leads, and all necessary instructions. Shipping Weight 11 lbs.

ONLY
\$11.85

SUPERIOR INSTRUMENT CO., 136 Liberty St., Dept. N4, New York, N. Y.

There is no point in using a speaker system that is not capable of reproducing the full range of this audio system and we recommend that the builder adhere to specifications as close as possible.

The adoption of 500 ohms as a standard permits the output of the amplifier to terminate into regular broadcast lines. In this application, means for reducing the output of the amplifier must be considered. The most satisfactory would be to utilize a fixed loss-pad at the output to the line. Inasmuch as the normal undistorted output is approximately +32 db, we may incorporate a pad which will reduce the output to somewhere near zero level or slightly above. A variable pad might also be used to some advantage where a line of unknown capabilities is encountered. However, the BC engineer has the proper knowledge of this subject and further data is not required by the experimenter or amateur operator.

The entire audio portion of the receiver may be tested by conventional means. Phono test records are available for checking frequency response of the entire audio. These may be used to good advantage, as it will then be possible to make a complete examination of the overall capabilities of the system.

Next month we will discuss the two complete r.f. tuners, one for the reception of standard AM transmissions (5 bands), and the other for the FM stations. By using separate tuners, we are able to attain a high degree of performance. These tuners are designed to include several features not found in commercially-available sets, and we feel that much of the information contained may be applied to existing receivers, or that portions may be selected to be added as a refinement to many sets. It would be quite impossible to include full constructional data in any one installment. It has been our sole purpose to engineer a receiver to include as many features as possible. —50—

Experimental F.M. Xmtr

(Continued from page 18)

A full description of the action of a discriminator is contained in the well-known book, "Automatic Frequency Control Systems," by John F. Rider, and it will pay the amateur to read the pages 20 through and including 52. From a reading of the book it will be seen that when the carrier frequency is exactly tuned on the nose and no modulation is present, the voltage produced at the discriminator terminus is zero. Since bias is already present at the control grid of the reactance tube, the reactance tube is caused to act as capacitance across the grid circuit of the ECO, fixing its frequency. As the carrier varies, plus or minus, and within limits predetermined, the voltage rises and falls due to the operation of the discriminator. This voltage change is applied to the control grid of the reactance tube and causes that tube to vary as a capacitance. The extent to which the reactance of the modulator tube affects the grid of the ECO is dependent mutually upon the amount of modulation and upon the voltage supplied both from the discriminator and resistors R3, R17.

It can readily be seen therefore that should the carrier shift or should the reactance tube present a capacitance characteristic to the grid circuit of the ECO in that "quiescent" period which shifts the carrier from "resting," a voltage will be present at the discriminator tube terminus resistors R18 and R19. This voltage will be applied in proper polarity to the control grid of the 6L7 reactance tube and cause the capacitance to change and the carrier to return to "resting." The operation of a discriminator, therefore, is that of a voltage control element. In order for the discriminator to operate in this manner, it is necessary to mix the output from the crystal oscillator and the output of the ECO. These combined r.f. frequencies are joined in the 6L7 mixer tube V2 and result in an i.f. frequency of 465 kilo-

cycles. The amount of the swing which the discriminator is capable of handling will depend upon how broadly the discriminator transformer T2 primary and secondary are tuned. To go into the full relationship of the primary and secondary tuning elements of this discriminator transformer, T2, would be to take up more space than is justified in a construction type article. It suffices to say, therefore, that the discriminator action and the control grid characteristic of the reactance tubes are both standard in their respective applications.

To recapitulate, therefore, we have the ECO generating a fixed r.f. frequency which is amplified in power and tripled twice in two stages to result in the desired 56 megacycle output carrier. Coupled to the ECO oscillator, we have the reactance modulator 6L7 (V1) tube, which, in turn, carries a certain amount of fixed bias through Resistor R3 to maintain its characteristics as a capacitance across the ECO grid circuit. By coupling the output of the ECO to the output of the crystal oscillator, we can cause a resultant i.f. frequency of 465 Kcs. to be generated in the output of the 6L7, (V2) tube. This exact i.f. frequency is only generated when the ECO is in "rest" position. As the carrier moves up and down in frequency in response to the reactance modulation tube V1 a resultant i.f. frequency carrier is generated at the output of tube V2 which is plus or minus that number of kilocycles which is represented by the swing from "rest" position and 465 Kcs., the i.f. frequency. The differential thus developed is caused to become a voltage potential at the output of the discriminator tube across resistors R18 and R19. This voltage is applied in proper polarity to the control grid of the reactance tube through Resistor R17 and R3 causing it to vary its capacitance across the grid of the ECO. The variation in capacitance if in the right "direction," causes the ECO oscillator to become stabilized in the "rest" position.

Construction

The entire experimental model is built upon a *Bud* or *Par Metal* 7 x 17

THIS YEAR YOUR PROFITS DEPEND UPON YOUR SPEED

THIS year your biggest problem lies—not in getting sufficient work—but in getting your jobs out faster. The Rider Books shown here are designed to increase your speed in trouble-shooting—*increase your profits per hour.*

CHECK THIS LIST

Automatic Frequency Control Systems, 144 pages, hard covers, \$1.00.
The Cathode Ray Tube at Work, 336 pages, over 450 illustrations, \$2.50.
Hour-A-Day-with-Rider Books on Resonance and Alignment—on Automatic Volume Control—on D-C Voltage Distribution in Radio Receivers—on Alternating Currents in Radio Receivers. Sciff covers—only 60c each.

SERVICING BY SIGNAL TRACING

Book explains this fundamental method of servicing that is free from every limiting factor heretofore encountered. 360 pages, 188 illus., \$2.00.

FREQUENCY MODULATION

Frequency Modulation is here! This book explains transmission of F-M signals as well as discussing the new F-M sets. 136 pages, illustrated, \$1.00.

THE OSCILLATOR

Protect your investment in oscillator equipment. Make any future investment in the light of the knowledge this book gives you. 256 pgs., 167 ill., \$1.50.

VACUUM TUBE VOLTMETERS

Explains practical aspects as well as principles underlying functioning of various classifications of v-t voltmeters. 160 pages, \$1.50.

METER AT WORK

If you want to get the most from your present meter or want to buy the proper one for your needs, you should have this informative book. Only \$1.25.

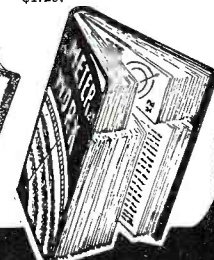
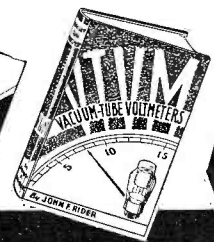
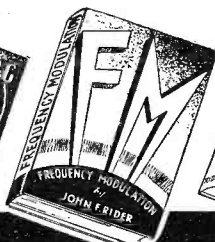
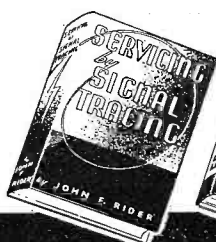

JOHN F. RIDER Publisher, Inc., 404 Fourth Ave., New York City

Export Division: Rocke—International Elec. Corp., 100 Varick St., N.Y.C. • Cable: ARLAB

x 3 inch chassis, cadmium plated. The layout of the parts follows conventional procedure and shielding problems are minimized by the use of metal tubes and by keeping the various r.f. stages in position where they may be wired with short lead lengths. The microphone transformer is mounted below the chassis and the bottom lugs are prevented from shorting to the chassis by inserting a piece of fibre board, or heavy cardboard, between the chassis and the bottom of the transformer.

All of the variable condensers used to tune the various r.f. stages are mounted by means of special U brackets supplied by the manufacturer of the condensers. Half-inch holes are drilled so that the condenser shafts will have plenty of clearance and will not come in direct contact with the metal. These condensers must be entirely insulated from the chassis.

The two condensers used for the tuning of *L1* and *L2* are mounted below the chassis and may be seen by referring to the underside view, directly above the two coils. These two coils are hand-wound and coil data will be found on the parts list. The forms are 1 inch in diameter and are made by *James Millen Mfg. Co.* They are supplied with a mounting hole on one end so that they may be bolted directly to the chassis.

The small trimmer condenser mounted between *L1* and *L2* is a 3-30 mmfd. ceramic type unit which may be adjusted for proper coupling between the two circuits.

The link coil, *L3*, consists of three turns of push-back wire wound around the bottom end of *L2*. These leads should be of ample length so that the

twisted pair may extend to the bottom of *L4* where they will terminate to the link winding of the coil.

The other trimmer condenser, *C1*, may be seen alongside of the microphone transformer and directly under the 6L7 socket. The set screw is removed from the trimmer so that the approximate capacity will remain at about 3 mmfd.

The proper location for the various by-pass and mica coupling condensers may be seen on the illustration. With the exception of the plate by-pass condenser to the 807 stage, they may be of the 500 volt type.

All of the sockets used for the stages having radio frequency application are of the ceramic type while those in the remaining circuits are of bakelite. Likewise, a 4-prong bakelite socket is used as a receptacle to receive the plug from the power supply. The bleeder resistor, *R18*, is mounted alongside of this socket. Three variable taps are provided so that proper voltage points may be selected to provide for correct operation of the unit. These are indicated on the schematic diagram.

The transformer, *T2*, is a standard replacement discriminator transformer designed for 465 Kc. operation and is made by the *Carron Mfg. Co.* Any replacement unit may be used in this circuit.

The output of the 6H6 discriminator tube is fed to the grid of the 6L7 through resistors *R3* and *R17*. The value of the latter must be determined from experiment but best operation will be found with a value of approximately 500,000 ohms.

In order to add stability to the control circuits, we included suitable volt-

age regulator tubes. These are *RCA VR-150-30* and are wired in series as indicated. The maximum voltage appearing across the two tubes will be limited to 300 volts and, even though the current from the power supply varies considerably, they will maintain a constant voltage to the 6F6 plate. The screen supply voltage is taken from the junction point between the two voltage regulator tubes. Inasmuch as the screen draws less than the current flowing through these tubes, they will act as a voltage divider. In this case, a potential of 150 volts will be applied to the 6F6 screen.

The other remaining parts visible on the illustration are the audio gain control, and the microphone jack. Two flexible leads are brought out from the chassis and these are connected to a 3 volt "C" battery. The design of this unit is such that a microphone of high gain must be used. This means that a single button carbon mike will be most satisfactory in application. Other jacks are provided, which may be seen mounted below each tank condenser and they are wired into the cathode circuits in order that the presence of high voltage will not be encountered when plugging in a milliammeter.

The illustration of the top of the chassis shows clearly the proper placement for all of the coils used in the experimental model. It was necessary to remove one turn from the 20 meter coil in order that it be capable of resonating at approximately 19.5 to 20 megacycles. A link winding is illustrated on *L6*. This may be eliminated, or left in place and not used because it is not required. The two stand-off insulators mounted alongside *L7* and

RADIO SERVICE MEN! HAMS! SOUND MEN!

GET THESE BIG CATALOGS **FREE!**

Because there's a Sears Mail Order House right near you, you make big savings on transportation costs by buying from Sears

Our catalog of Amateur and Service Supplies contains a most complete selection . . . everything you could possibly want! By ordering from your nearest Sears Mail Order House you save real money on transportation costs. As a rule, orders are filled same day received. Everything money-back guaranteed . . . and Sears Easy Payment plan is an easy way to buy! Write for this book today . . . A postal card will do . . . ask for Catalog RN717A.

SEARS, ROEBUCK and CO.

Chicago, Philadelphia, Boston, Kansas City, Minneapolis, Atlanta, Memphis, Dallas, Seattle, Los Angeles

L8 are for connection to either an antenna coupler or to a twisted pair feeder system, or any low impedance line.

The crystal is a standard 40 meter *Bliley Type BC3* amateur unit. The frequency of the one in this particular model is 7120 Kc.

The tuning of the unit is extremely simple. The 6J5 oscillator circuit may be checked by conventional means and r.f. may be indicated on a neon lamp. The output is coupled to the injector grid of the 6L7 (V2) mixer tube. Likewise, the other signal from the oscillator coil of the 6F6 will be fed into the grid circuit of the mixer tube through the link circuit terminating at L3. The resultant frequency of 465 Kc. will be passed to the discriminator primary of transformer T2.

The plate circuit of the 6F6 ECO oscillator is tuned to three times the frequency selected by L4 and C8. Tripling takes place within the oscillator stage. This signal is fed to the 6V6 grid and again the following plate circuit is tuned to three times the incoming frequency. Now we have tripled twice and have output within the 5 meter band on that portion set aside for the transmission of F.M. signals.

The 807 amplifier operates straight-through on fundamental frequency and the usual precautions must be taken to prevent parasitic oscillations. Complete shielding is recommended and we have made use of an aluminum can which is cut down so that the top edge will be directly in line with the bottom of the tube plate. This cutting was necessary as the 807 socket was underslung beneath the chassis in order to reduce the length of the plate lead.

Transmitter Adjustment

Adjustment of the r.f. section, including that of the ECO will not be discussed in this article since it is entirely normal in every respect and almost every amateur who has done anything at all with the construction of transmitters should be able to put the r.f. carrier on the air. For those

who would like further information on this subject, any one of the handbooks presently available gives this in full.—Ed.

Assuming that the r.f. section is working, the next step is to get the crystal oscillator going. This is done in a normal fashion and the output of the crystal oscillator is checked with a neon tube, wave meter, or thermogalvanometer. The next stage is to fire up the ECO, the crystal oscillator, and the mixer 6L7 (V2) and adjust the coupling links between the oscillator output and the output of the ECO so as to obtain a transfer of energy from the ECO to L2 of V2. Next adjust ECO grid so that the resultant frequency difference between it and the crystal oscillator output is 465 Kc. By coupling the output of the plate of V2 through a .00005 mfd. condenser to the antenna post of a 465 Kc. i.f. broadcast receiver; check the resultant i.f. frequency.

Next step is to adjust the discriminator transformer, T2. This is best done with a 465 signal generator. However, if one is not available, a V.T.V.M. can be used across resistors R18 and R19, in the following manner:

Disconnect the arm of the potentiometer R1. Insert a 1.5 volt battery between the arm and ground applying the positive potential to the injector grid of the 6L7 (V1). Tune the discriminator transformer until maximum voltage is obtained across resistors R18 and R19. Reverse polarity of the battery, and determine that the same voltage is obtained at resistors R18 and R19.

Another method is to insert a milliammeter in jack J1. Make the tests with the battery as above indicated. A change in current should be indicated on the meter upon insertion of the battery. The change should be identical regardless of whether the voltage is positive or negative.

A final check may be made by noting grid condenser C8 setting, and then slightly detuning. A change in current reading on the meter inserted in jack J1, or voltage on the V.T.V.M. if

used, should be noted. Returning C8 to the "original" position should cause the meter also to return to its original reading, or the V.T.V.M. should read zero.

Shifting the ECO frequency slightly shifts the resultant frequency plus or minus from 456 Kcs. It is this shift which results in a voltage at the terminus of the discriminator tube. Having tuned the discriminator transformer to get the maximum voltage across the load resistors, you are now ready to try the transmitter.

Disconnecting the crystal oscillator the mixer (V2) and the discriminator tubes by pulling them from their sockets, adjust the resistor, R3, in the control grid of the reactance modulator until frequency modulation is obtained. There are a great number of ways to check this, the simplest, but least accurate, being to try it out on an AM receiver. If frequency modulation is present, a hash on the carrier will result. The most accurate method of checking, however, is by means of the oscilloscope or V.T.V.M., which should accurately show frequency modulation taking place. Once the transmitter is operating as a frequency modulated transmitter, insert the crystal oscillator mixer and the discriminator tubes in their sockets and adjust the resistors R3 and R17 so that the voltage applied from the discriminator terminus causes the final terminal frequency of the 5 meter transmitter to remain constant. This is largely a matter of experimentation. Oscillographs may again be called into play, since they are the most accurate instruments with which the frequency shift may be checked; however, a receiver capable of receiving 5 meter signals, amplitude modulated, may be used. A number of tests should be made to see that the carrier remains constant. Resistors R3 and R17 should be varied until no matter how heavy the audio signal input, the carrier does not shift beyond that point which has been predetermined by the experimenter. This may be anything up to 25 Kcs. each side of "resting."

If the unit as a whole is functioning properly, the voltage built up from the discriminator will act to hold the carrier within the limits above described and will cause it always to return to its original "resting" position. This also can best be determined by experimentation in the shop of the amateur and by contact on the air.

From the standpoint of clarity of speech and tone, the discriminator crystal oscillator should neither add nor detract anything. It may be found, however, that the speech is somewhat muffled. This will be normally due to the fact that the discriminator transformer is too broadly tuned and is causing the frequency modulation to be broad in swing. Slight detuning of the secondary should correct it. As we said at the outset, the frequency modulated transmitter is an entirely experimental proposition and should be treated with that thought in mind. There are great gaping holes in which sufficient explanation of the technical properties of the transmitter are left unsaid, mainly because not much is known about them and it is believed that should the amateur build this unit and experiment with it he will learn "by doing" much more rapidly than in any other manner.

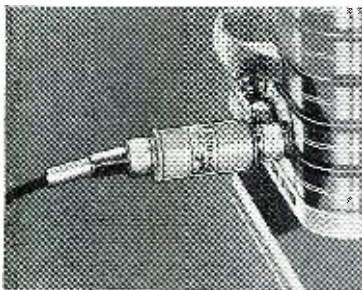

You Can Use a LOW IMPEDANCE MIKE With a HIGH IMPEDANCE AMPLIFIER

MICROPHONE CABLE TRANSFORMERS



ADAPT your amplifier for use with low impedance mikes. Use a Thordarson Microphone Cable Transformer. Two types available: T-14A75, 30-50 ohm for voice coil connection of dynamic mikes; T-14A76, 200-250 ohm for mikes with self-contained output transformers. \$14.50 LIST each.

30 WATT AMPLIFIER WITH FIVE INPUT CIRCUITS

IDEAL for those installations requiring extreme flexibility and undistorted power output. Five input circuits—three for microphones and two for phono pickups. Can be supplied either wired for high impedance mikes. Independent bass and treble controls. Provides greater undistorted output, more gain, less hum, and extended frequency response. Model T-30W30 Amplifier . . . \$122.50 LIST.

Other models range from 8 to 55 watts including AC-DC mobile types. A preamplifier and two boosters are also available. Ask for Catalog 600—FREE.

THORDARSON

ELEC. MFG. CO., CHICAGO
TRANSFORMER SPECIALISTS SINCE 1895

For the Record
(Continued from page 4)

salaries for the month of December, 1940, just released, indicate a lower wage by a few cents per hour than for the similar time period of 1939. Some schools are reporting that students are leaving in the middle of classes as soon as they are able to do minor radio work, such as wiring nominal sheet metal work. These men are being snapped up right and left and are earning good money. Proselyting by big firms among electrical engineering students is almost a national pastime if one judges by the "raids" being conducted by the larger firms.

Radio operators are scarcer than the proverbial "hens teeth." High speed operators are being sought by the Government to fill much needed Defense positions. Few operators of this category seem to be available although the salary offered is attractive. Everywhere in radio, the pinch of insufficient technical labor is being felt and a great many factories were found to be training their own personnel, finding it easier to train than to hire already-trained.

* * *

FROM the reading of the above paragraphs it would seem that practically every radio man worth his salt would have a job. Peculiar condition, however, is that such is not the case, and letters continue to pour into various Governmental agencies and into radio magazines indicating that there are still a great many radio men who are unemployed. The most common reason stated for non-employment is that the prospective employee is located in a geographical position far removed from the center of the manufacturing zones of the radio industry. Naturally, radio manufacturers are not willing to pay traveling expenses and hire men "sight unseen." Whether or not the condition will become sufficiently severe to cause a reversal of policy on the part of the manufacturers and permit these operators and servicemen and radio men to obtain jobs is problematical.

Uncle Sam himself is

looking for radio operators; for instance, for a unit stationed in Washington, D. C. He has exhausted all those in that neighborhood but Government red-tape prohibits our Government enlisting a man from some remote place in the United States and shipping him to Washington for the purpose of joining him to that unit. Accordingly, great efforts are being made to induce radio operators and men in the outlying districts to come to the manufacturing zones



Amazing New "WALSCO" STAPLE DRIVER

for radio men, electricians, or anyone doing stapling. Makes wire and cable installations twice as easy—much neater—saves half the time. Wires can be stapled in corners, behind pipes, into moldings—places never accessible with a hammer and ordinary staples. Drives staples even into walls, brick, mortar, etc. Magazine works automatically and holds strips of staples which come in several colors. Ask your jobber for demonstration and catalogue 41-C of all WALSCO PRODUCTS

or write **WALTER L. SCHOTT CO.**
5264 W. Pico Boulevard, Los Angeles, California

LATEST DEFENSE NEWS APPEARS IN RADIO NEWS



Super Pro

SERIES 200

for the Tough jobs!

THE illustration above shows "Bob" and "Mabel" Beebe operating W7HXU, one of their two fine amateur stations. "Bob" has his own station, W7IGM, at his place of business. Both stations use "Super-Pro" receivers. Here is what "Bob" writes: "We have, beyond doubt, the world's worst receiving location, bar none, including three 26,000 volt transmission lines exactly 35 feet from the transmitter, and when the old-timers saw what we were blundering into, we were assured that 'It could not be done,' and actually were out looking for a new home with suitable reception when someone suggested Hammarlund 'Super-Pro.' The 'Super-Pro' changed the situation completely and when the band is open, Mabel works 'em."

YES—for the tough jobs you'll find the "Super-Pro" can't be beat. It is built for 24-hour a day service under practically all conditions. To enjoy really fine reception, use a "Super-Pro." Your local jobber will be glad to arrange a demonstration. See him today. For complete technical information including curves and diagrams, mail coupon below.

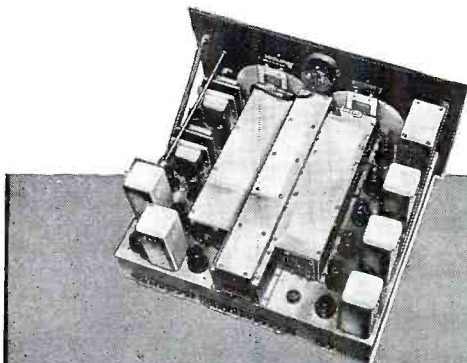

RN-4

HAMMARLUND MFG. CO., Inc.
424 West 33rd St., New York City

Please send 16-page "SP" booklet.

Name.....
Address..... State.....
City.....

HAMMARLUND

EXPORT OFFICE: 100 VARICK STREET, NEW YORK CITY

CABLE ARLAB

and to the Government units locations at their own expense. While it is true that this forces the prospective operator and radio man to gamble on obtaining employment on his own money, spent for traveling expenses, we know of relatively few cases where such operators have not been able to make connections, if they have taken the trouble to write beforehand explaining their full qualifications and have been asked to present themselves in person. * * *

THE one question confronting industry which has everyone puzzled, and to which no answer at present seems available, is "What will happen after the National Defense situation is over?" This is a serious problem involving thousands of people and the question of employment, the buying power in the industry and the fear of overstocking one's shelves. It is expected that, in the near future, meetings will be held by representative associations looking toward an advance solution. * * *

COMMENCING with this issue, we finally bring to the light of day the Super Superheterodyne which has successively gone through the stages of the engineers' design papers, the drafting board, the construction bench, and finally, the testing table. It is virtually a "dream" receiver come true; and we were amazed to find a great number of manufacturers interested not only in the performance of the receiver, but its construction.

In order that our readers may get the maximum benefit from this series of articles, which commences with this issue, the construction of the receiver

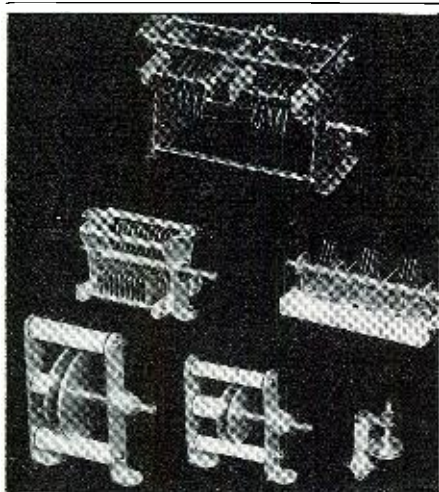

BUD Condensers insure "peak performance"

BUD Condensers are designed to enable you to secure the utmost efficiency from your equipment. They are constructed with close-fitted brass bearings, Alsimag 196 insulation, electro-soldered assemblies on all midgets and juniors, center-rotor contacts on all dual units and insulated tie-rods on all high frequency types. These features have established BUD Condensers as the outstanding "performance leaders."

BUD
BUD RADIO, Inc.
CLEVELAND, OHIO

has been broken up into component parts, each of which is complete in itself and which may be adapted to an existing receiver or may be used for other purposes. In the final installment component parts will be joined together to indicate the final and completed unit. While we know now in advance all the parts included in this receiver, it would be spoiling it for our readers to advise them in advance. Accordingly, we will take advantage of an editor's prerogative and reveal performance data and component parts as we go along. * * *

A REMARKABLE fellow is Rufus Turner, ace technical writer. We saw Rufus while we were in Cambridge, and we expressed to him our gratification for his having chosen RADIO NEWS as a medium to publicize some of his extremely valuable, intricate, and novel servicemen's units. He told us how the "Cycle Counter," explained fully in this issue, came into being.

It seems that Rufus has his home laboratory located in a place where there is considerable external noise and he was engaged in making a series of tests with an audio bridge. Using the usual null—earphones system—Rufus discovered that the external noise was so great that he could not accurately calibrate when he had reached the null point. This bothered him, and he sat down and decided then and there that something ought to be done about it. The result of his annoyance is the unique instrument called "the Cycle Counter." To servicemen who have been accustomed to testing audio signals by means of a null point, this instrument will be a godsend. All one has to do is to plug the audio sine wave signal into the input and read the frequency from the meter. No listening, no using a magic eye, no adjustments, etc. So different was this instrument from the usual type of servicemen's home-built unit that we mentioned it to a number of prominent engineers, and found that none of them had even given consideration to such a design. Since we wish to play fair with Rufus, we did not divulge in advance his extremely simple circuit and interesting solution. May we recommend to these engineers as well as our servicemen that they follow the articles appearing in RADIO NEWS wherein they will see how one serviceman-engineer can solve a problem and do the entire trade a great favor. * * *

BROWSING through amateur radio publications, we noticed a complete lack of crystal-controlled F.M. jobs for the ham. Discussing it in open forum in our technical staff here, our first thought was to use a crystal oscillator and modulate it in the good old-fashioned manner. It took no time at all to assemble a small crystal oscillator; and, in modulating it, we found instead of frequency modulation that varied in accordance with the audio input, something that was as wild as the Chicago Fire. Obviously, this was not what we wanted.

Starting from that point we worked backwards until we got to the original Armstrong patent papers and then we started to work forward. The result of this research is the experimental crystal-controlled 50 watt 56 megacycle F.M. transmitter which appears

in this issue. It is not, by any means, perfect, nor is it a substitute for a commercial broadcast F.M. transmitter. It is, however, an attempt at F.M. crystal-control for the amateur.

Its key-note is simplicity and its operation, while limited to voice frequencies, will be found extremely stable. The most difficult part about the whole situation was to change the inborn ideas of crystal control. It seems that in frequency modulation a crystal control is used to provide a fixed bias and not a fixed r.f. train. Once we had this point firmly imbedded in our mind, the rest was somewhat easier. A cursory examination of the circuit will show even the rank-est beginner that it is an ECO oscillator successively tripled to reach the proper terminal frequency. The oscillator is a reactance modulated type using a single tube modulator and a carbon microphone. Nothing is new about that either. The crystal control comes in the discriminator stage by mixing the output of the ECO oscillator and the output of the crystal oscillator to obtain an i.f. differential of 465 kcs. This frequency differential is translated into a voltage bias which is applied to the reactance modulated tube, holding it stable, steady and within bounds.

There are some among our readers who will complain that this is not what they thought to be "crystal control" but if they will take the trouble to examine commercial crystal control in F.M. transmitter circuits, they will find that stripped down to the barest essentials, our ham job closely parallels the commercial engineer's idea.

Since one of the reasons for the ham's existence is his insatiable desire to experiment, we thought the little F.M. transmitter would give him the outlet into something new, something different and, at the same time, something "so satisfying" as to make it worth his while to go into the somewhat above nominal expense involved. It would be interesting for the amateur to obtain both a crystal controlled F.M. transmitter and a crystal controlled A.M. transmitter on the identical frequency and request some other amateur at considerable distance, say one hundred to three hundred miles (when the band is open), to inform him as to the difference at the receiving end in regard to the received signals. RCA has made numerous tests to determine the place in frequency swing where A.M. surpasses F.M. in readability. Since the amateur's transmitter would have a nominal swing of not more than 25 kc. in either direction, and since this swing is easily controlled by applying more or less bias via the crystal controlled stage route, it will be relatively easy for the amateur to discover for himself at just which point in frequency modulation differential the A.M. signal has a greater power than the F.M. signal over a given distance and a given set of conditions. * * *

AND that about winds up the column for the month. While the National Radio Parts Manufacturer's Show is still quite a way off, the industry is pointing gradually to it with new developments, and is busy preparing . . . that is, when it gets a "breather" from National Defense work.

And so are we. KAK.

Washington Communication

(Continued from page 14)

Congress, this was echoed by Senator Wheeler, a veteran conductor of investigations.

The resolution introduced by Senator Tobey, calling for such a probe, is stalled behind the mass of defense legislation. Those who want to investigate hope to slip a bill through in the closing days of the present session, when more pressing matters have been disposed of.

Army Plots Ham Station Equipment

THE first complete census ever made of this nation's reservoir of radio equipment and abilities in the ham field is now under way.

At the direction of the War Department, questionnaires are being mailed to licensed hams, asking about such things as the type of equipment, fitness and willingness for military service or civilian defense service, etc.

This questionnaire was prepared some months ago by the Army but the answers probably will be used as the basis for plans of the Amateur sub-committee of the Defense Communications Board. When the answers are received, punch cards will be made for each ham and will be filed away. These will record the age and availability of the man, his knowledge of radio, his experience, his location, the power input of his rig and whether he is dependent on commercial power.

Thus, if the defense board should wish to call upon the hams of New England, for instance, to cooperate in the formation of an aircraft warning net, they will merely have to run off the cards. Within a few minutes, they will have the names, locations and specifications of all hams in the area.

Of course, there is nothing compulsory about it. The Army cannot and will not force any one to serve who does not want to. The purpose of the questionnaire is to determine the extent of our amateur radio resources. The defense group is anxious to get the answers as promptly as possible.

D.C.B. Labor Trouble

THE Defense Communications Board is having "labor trouble." We reported earlier the sub-surface row which broke out when the CIO demanded representation on the Amateur sub-committee. This row has now spread and the labor organizations are demanding representation on all of the defense board sub-groups.

The effort to take over the Amateur committee has been abandoned for the time being at least, while the CIOmen work for more adequate representation on the committees which are preparing regulations to govern the broadcasting industry, shipping, etc. They have threatened to quit the defense board entirely unless their demands are met.

On other fronts of defense-radio, there's trouble brewing for the union men.

We revealed some months ago that the Navy was concerned over the possibility that some operators on our merchant marine boats may be disloyal. First public utterance on this subject—which foreshadows the taking over of merchant marine wireless rooms by the Navy—was made before a Congressional Committee recently by Rear Admiral S. C. Hooper, Navy chief of communications officer.

Telling the House Committee on the Merchant Marine that the Navy was worried about radicalism in the radio unions—the A.C.A. had been under discussion—the Admiral said:

"The radio operator is in a better position than anyone other than the master of the ship to cause trouble. The radio operator can communicate with the enemy and nobody knows what he is sending out. An operator with subversive ideas could divulge the position of the fleet.

"It might even be a matter between victory or defeat. The operator can communicate with the enemy and tell them anything he wants."

You can mark it in your little black book as inevitable: the Navy will take over the wireless operators on American vessels and allow no one to touch a key who is not absolutely trustworthy.

Note: The bill on which Admiral Hooper was testifying would shorten the six months' period now required for training radio operators by the Maritime Commission. He said that unless the training period was shortened, there would not be enough operators. The AFL favored the measure, the CIO opposed it. Best bet: it will pass.

The CIO United Electrical Radio and Machine Workers are asking a 10 cents an hour increase for the 100,000 members of that union who work for General Electric and Westinghouse. These demands are part of a carefully synchronized campaign by CIO unions in key industries.

President James Carey of the radio workers' union told leaders of locals at a conference in February that defense orders had increased G. E. and Westinghouse profits by 60 per cent in 1940 over 1939. The 10 cents an hour increase would boost the companies' payrolls by nearly \$25,000,000 a year.

These two firms are strongholds of the union and if the wage demands aren't met, there is the threat of strike. This is the first move in increased union activity in the radio industry. There will probably be trouble before it's all over. Watch it.

Television Hearings

THE Television hearings at the FCC on March 20 feature some new faces in the field. One of the most conspicuous of these is that of Howard Hughes, the flyer and movie producer.

When the FCC upset the video appellation last year and decided to start all over on new standards, the Commissioners hoped that someone other than the big chain broadcasters would come forward to build the new industry. The fact that RCA had a stranglehold on television was probably the biggest factor in causing the Commission to halt commercialization.

Last year, Chairman Fly visited Hollywood. When he came back, he told of his hopes that the movies and television would get together. Hughes, who has budgeted \$2,000,000 for television experimentation, looks like the boy who will bring the movie influence to television.

Allen DuMont and Hughes will be in a strong position before the FCC to put over their ideas—as opposed to David Sarnoff's—on what should be done in the field.

The Television Systems Committee, made up of engineers from the Radio Manufacturers' Association and from the FCC, recommended, by the way, that FM be used in connection with television. Watch for Howard Armstrong, the FM discoverer, to spring a surprise one of these days in the television field.

Good Neighbor Broadcasts

THOSE who are planning our big offensive in the radio field in South America are awaiting the return of Don Francisco, advertising expert who is working with the Nelson Rockefeller committee to improve Pan-American relations.

Francisco has been traveling through South America, making a survey of the radio situation. Upon his recommendations will rest largely the plans for increasing the extent of our Good Neighbor broadcasts. These broadcasts shortly will dwarf anything the Europeans have ever tried.

Nazis Trying to Contact Agents Here?

UNLIKE the rest of the country, Washington did not giggle at that radio stunt of the German short-wave last month. They suspect there was something more than German stupidity at the bottom of that insult-Hitler-at-his-own-expense request.

The Ameradio, which is the German short-wave propaganda broadcast for this country, asked our citizens to send them cables telling the Nazis what they thought of the broadcasts directed here. The cables were to go collect—although, of course, they weren't cables. The messages went by RCA radio, which is the direct connection with Germany.

Thousands of citizens responded—Germans saying they got 5,000 replies. Most of the messages gave Hitler the raspberry. Citizens requested the Ameradio to broadcast everything from eye-witness accounts of the bombing of Berlin to news of the suicide of Hitler, Goering, et al. But everyone—even those who sent the gag messages just to use up a little of Hitler's money—had to sign

COMPLETE

RADIO COURSE

\$1.95

POSTPAID

HOW 9,348 RADIOMEN OBTAINED THEIR TRAINING



HELPS YOU GET A RADIO JOB

"The radio training course is the finest, up to date, easy to understand course... This course outlines practical work. We are using this course in our Topeka High School. It is wonderful." Henry Ward, Jr., Topeka, Kansas.



"You should get more money for the R.T.I. Course. The first week I studied it, I made \$10.00 repairing sets. I built my own test outfit from details given in this course. I have repaired 100 radios to date..." Robert C. Hammel, Davenport, Iowa.



"I am very satisfied with the course. When I was at the twelfth lesson I started to repair radios. It took me two months to master your course." Roger Lanzlois, Montreal, Canada.



"I have found since taking your course how modern and up to date it really is. There is not one page in the whole course which anyone interested in radio can afford to miss. Your course started me on the road to a well paid job and has repaid me many times." Charles A. Schuch, Reading, Pa.

You may also get exact reprint of the regular \$39.00 Radio Technical Institute course for only \$1.95, the full price. The course is complete in every way and exactly the same as higher priced original lessons.

AMAZING REDUCED PRICE

Learn to repair all radio sets expertly. From the very start you are introduced to practical equipment and methods. A single time-saving hint will more than pay for the special \$1.95 price for the complete course and all supplementary material. Tells you how to become a first class radio serviceman with easy to follow lessons.

PREPARED FOR HOME-STUDY

Get ahead in Radio with this complete training. No special education or previous experience required. The streamlined lessons are clear, interesting, easy to understand and use. A final examination and diploma available after course is finished. Special \$1.95 price for the entire radio course can be earned the first hour of radio work.

NEW LESSONS

Every phase of radio including television, PA, troubleshooting, short-cuts in servicing, essential theory, practical construction, and all other important branches.

EVERYTHING ABOUT RADIO

Reprinted in 1940, with added facts on signal tracing, P. A., television, photocells, and every other important development. Forty-three radio manufacturers helped to prepare this course. This training will give you data you need on the job. Limited quantity of courses printed. Look the lessons over in your home without any risk.

10 DAYS' FREE EXAMINATION

SUPREME PUBLICATIONS, Room 734, 3727 W. 13th St., Chicago, Ill.

Ship the complete course on approval without any obligation to buy. I may keep the course for 10 days. If, for any reason, I am not pleased, you guarantee to refund my money.

I will pay \$1.95 and 15c postage to the mailman.

I am sending \$1.95, the full price, ship postpaid.

Name: _____
Address: _____

their name and address.

This was the thing that disturbed official Washington. The FCC and the FBI undertook quiet checks on the stunt. They saw the possibility of (1.) a Nazi effort to contact spies here, (2.) the possibility of an effort to complete a list of potential Fifth Columnists.

The foreign propaganda broadcasts have been a kind of minor headache to defense officers. Few Americans listen to them. The best weapon against such broadcasts, Washington has decided, is ridicule. The *Chicago Times*, for instance, takes the propaganda broadcasts apart regularly and with great glee. [The column referred to in the *Chicago Times* is by Lucas. Ed.]

It is interesting to make one note in connection with the activity of Berlin's *Ameradio*. While the Nazis were able to dig up an Englishman to be their Lord Haw-Haw, they apparently could find no American to do their radio job. The *Ameradio* features an "American" with an Oxford accent.

FCC Favors "Wire-Tapping"

THE FCC has been giving quiet support to the *Hobbs Bill*, which will allow Federal law enforcement agencies to tap wires and radio messages in cases where they believe a felony is being committed. This bill was introduced after the Supreme Court threw out a case in which evidence had been obtained by wire tapping.

The FBI has given its support, claiming that wire-tapping is essential in counter-espionage. And the FCC has given its approval to the measure for the same reason. At present, the *Defense Operations* unit is allowed by law to listen to radio messages and to intercept them. But it cannot use these messages as evidence. Thus, even if the monitors of the air should intercept an espionage message, they could not bring this message into court as evidence to convict the station operator of spying.

The *Hobbs Bill* tosses out all legal provisions for the sanctity of radio messages. It says: "Notwithstanding any other provision of law, whenever the head of any executive department of the United States has reason-

able ground for believing that a felony may have been committed, any investigational agency may . . . intercept, listen in on, or record, telegraph, radio and any other similar messages or communications."

J. Edgar Hoover of the FBI has been behind the bill and President Roosevelt gave his endorsement to it. There's not much doubt: it will pass.

Defense Purchases

The War Department budget for radio purchases for the fiscal year which begins in July will be in the neighborhood of \$50,000,000, this column has learned. The Budget hearings are not yet over, but the Army is asking for—and probably will get—an appropriation for that amount for radio equipment.

The following are the latest contracts cleared for defense radio equipment: The Hallicrafters, Inc., Chicago, \$9,078 for components for radio sets; Cook Electric Co., Chicago, \$35,278, for jacks; Kellogg Switchboard and Supply Co., Chicago, \$505,358, for microphones and jacks; Rauland Corp., Chicago, \$74,735, for radio parts; RCA, Camden and Harrison, \$888,500, for tubes and radio sets; General Ceramics, Keasby, N. J., \$25,325, for insulators; Widin Metal Goods Co., Garwood, N. J., \$18,020, for mast sections and radio sets; General Electric, Schenectady, N. Y., \$8,667, for transmitting equipment and instruction books; Universal Microphone Co., Inglewood, Calif., \$122,000, for microphones; Froiland Mfg. Co., Springfield, Mass., \$10,866, control units and coupling; Lundquist Tool and Manufacturing Co., Worcester, Mass., \$106,388, for parts for ground and hand radio; Federal Telegraph Co., Newark, \$59,531, for transmitting equipment; Western Electric Co., Kearny, N. J., \$295,018, for coils, crystal units and cases; Telephonics Corp., N. Y. C., \$16,350, microphones; Western Electric, Kearny, N. J., \$109,068 (for Coast Guard).

Wise Men Are Betting:

THAT zinc and brass will follow the course recently taken by aluminum in being barred to all but priority orders, with the civilian customers squawking to beat all hell.

THAT recording disks will no longer be "backed" with near "gold," aluminum. Paper and plastic will be used. Some dealers have hoarded the aluminum disks and will make a killing.

THAT the *Trauman Bill* to investigate Defense Contracts will cause a headache in high official sources, and a furor in the press. It concerns the \$ a year men. Watch here for details next month.

THAT the unions will be still stronger as *National Defense* continues, and will be too strong to be unseated after the *Situation Is Over*.

THAT the electronics trade is on the verge of being shoved up into second place as a national industry, with the motors first.

THAT non-strike legislation will eventually be enacted.

THAT radio engineers may soon have to take state examinations and be licensed the same as lawyers, doctors, etc.

THAT in spite of denials, the U. S. Army is deeper into FM than it cares to admit. Specially in regard to tanks.

THAT television is to be used in *National Defense*, and will get newer and longer wavelengths.

THAT FM will never supplant AM.

THAT radio jobbers' business will equal and perhaps surpass last year's dollar value business not counting the *National Defense Orders*.

THAT Congress will investigate why most defense radio orders have been placed in the East and Middle West, the far West getting the bye-bye.

Ringling the Bell
(Continued from page 38)

our very dear friend.

A Plea for Standard Radio Terms and

Spelling

One of the "little" things which "gripe" this writer is the non-standard radio terminology and spelling.

For instance. Take the term used to describe the poor but honest toiler in a radio repair shop. Omitting some of the terms affectionately (?) bestowed upon him by irate customers, we have *serviceman, service man, radioman, radio man, radio mechanic, radio-trician, radio engineer, radio specialist*, etc. There are probably a few others, but we forget them for the present.

Then there is the perennial battle of the *oscilloscopes* and the *oscillographs*. Which term is the more correct? Getting further into test instrument terminology, we find *set tester, analyzer, multimeter* and a variety of terms using "plug-in" or "plug-and-cable" to describe multi-range meters. Sometimes it is hard to determine whether the instrument has or does not have a "harness" attachment for plugging into radio sockets.

Going into the matter of "meters," we find that the manufacturers of "meters" call them *indicating instruments* not *meters*, because a "meter" to them is an indicating device with some method of recording, such as a light meter which is employed to record current consumed by a user.

Is the little device which "isn't a firecracker in a carload" a *condenser* or a *capacitor*?

Coming to those radio items which are made up mostly of wire, we find that they are called *inductors, coils, chokes* or *transformers*, depending to a small extent upon their use, but to a larger extent upon individual terminology. When we study the various forms of terms used to describe the lowly *intermediate-frequency transformer*, we run into a welter of differences in the abbreviation of the adjectives. *IF, if, i.f., I.F., I-F, i-f*, give you just a few samples. The same applies to the words "radio frequency" and "audio frequency" when they are used as adjectives.

Then there are the same differences when "direct current" or "alternating current" are abbreviated. *D.C., d.c., D-C, d-c*, etc. The same variation for a.c. The prize, to our way of thinking is the term "A.C. Current"—which, when un-abbreviated, reads "Alternating Current Current." We aren't too happy about "A.C. Volts" and "D.C. Volts" which, when expanded read "Alternating Current Volts" and "Direct Current Volts."

The above are merely a few of the variations and inconsistencies which keep us awake at nights. No effort will be made to prolong this diatribe (we really do not mean it as such) by kicking around some of the terms for parts (such as *tube, battery, condenser*, etc.) which have no descriptive meaning. Our thought in presenting this to you was to point out that simplification and standardization always is profitable, whether it be in the manufacture of radios, or the terms used by the radio industry. It looks to us as if the RMA and the IRE could spend some profitable time in standardizing the use of radio terms—to a greater extent

ONE Mike Does 3 Jobs
for P. A. Men
Recorders
and Amateurs
TURNER HAN-D



Whatever the job, Turner Han-D is there ready to fill the bill! Specially engineered for voice and music, it works equally well indoors or out. You can hold it, hang it by suspension hook, or mount it on floor or desk stand. Rich brushed chrome finish. Equipped with positive contact slide switch. Write for full details. 9X Crystal Han-D, List \$22.50. 9D Dynamic Han-D, List \$25.00.

TURNER 22X Crystal
Puts Pep into Your Equipment

If you want clear, crisp performance, with low feedbacks, see and try 22X. Rich satin chrome finish in a streamlined model you'll appreciate. Tilted head adds to utility of unit. With 7 ft. cable set, and protective mike pouch. List. \$16.50 Dynamic model, 22D, List \$25.

Write for Free Information to The Turner Co., 908 17th St. N.E., Cedar Rapids, Iowa.
Crystals Licensed Under patents of The Brush Development Co.

TIME TO TURN TO TURNER

TURNER MICROPHONES 99
TURNER VIBRATORS 22

PUSH-PULL VIBRATORS

The hit of the year! Features 10 engineering advances. Send for full free information.

Recording Studio
(Continued from page 22)

fundamental principles to his equipment. We have also received many requests for actual studio layouts, the placement of microphones and recording equipment, and the treatment of the studio to meet various acoustic conditions. These subjects will be dealt with as space permits

than heretofore.

A Strange Message

In twiddling the dials, we ran across something which seemed rather queer. It happened at the end of the news broadcast in English from 2RO in Italy, at 7.10 C.S.T. on the night of Dec. 23d. The woman news broadcaster called "Garabali in New York" and proceeded to tell him that the frequency of 2RO-18 had been changed slightly to "avoid interference" and for him to "send them more reports" as the last they had received were dated Nov. 12th.

The message itself was quite harmless sounding, but the thing which struck us as peculiar was that it was given *very slowly* and repeated at a tempo which could have only been used for the purpose of assuring the reception of every word in its correct order. Or, it might be for the purpose of allowing the receptor to write down the message. Why so slow and why the repeat? The *apparent* context of the message would have been easily understood and remembered if given in a normal speaking tempo, and without repetition. Could it be that "Garabali" could not speak good English? Then why not give it in Italian? Had the message another meaning? . . . Probably not, probably it was a straight message . . . we wonder.

The Use of Glass Bottles for Small Parts

In our two decades of radio experimenting, servicing, designing and writing, we have from time to time hunted for certain small parts in many a box, drawer, jar, case, can, pile of dirt, etc. A fellow who has been a constant Nimrod of the Nuts for that length of time gets pretty fixed ideas about what he thinks is the proper method of storing small parts so that a crystal ball and a bath towel is unnecessary to find a 6-32 screw.

Our personal preference at the moment is glass jars, properly labeled, and set side by side on special shallow shelves.

These jars may be pint mason jars, fruit jars, mayonnaise jars or any other kind of glass jar which allows a practiced if slightly watery eye to run up and down the length of the shelves for that elusive part. Small labels on each have a time-saving effect where for instance several values of small capacitors are kept in separate jars.

The shelves should be 5- or 6-inches deep and spaced so that a 1/2-inch clearance is allowed between the jar top and the bottom of the immediate upper shelf. Narrow shelves are a necessity—yards of them—so that one jar isn't stacked in front of another. Several sized jars require different shelf heights. Along the floor (for the first 18 inches) build bins for wire, rags, and such odds and ends which are always cluttering up the shop. An 8-or 10'-wide board, set on end, will act as the front part of the bin, allowing plenty of space into which can be thrown all those stray articles which are not adaptable for shelf placement.

Another important point for the glass jar idea is that when you take your periodic inventory (or do you?) it becomes considerably easier a task. Of course, parts which are boxed by the manufacturer should be stacked on the shelf *in the original boxes*. Like peanuts, don't shell them until you are ready to use them.

RADIO PHYSICS COURSE

by Alfred A. Ghirardi

(Continued from last month)

In order to obtain the amount of amplification necessary for satisfactory loud speaker volume, it is usually necessary to employ more than one amplifier tube. Modern amplifiers employ a number of stages of amplification, the signal being fed to the grid circuit of the first tube. The output voltages appearing across the load in the plate circuit of this tube are fed to the grid circuit of the next tube, etc. It is not at all uncommon to use 5 or more high-gain stages of amplification ahead of the detector. The problem of tuning can of course be solved by using as many resonant circuits as are necessary to reduce the strength of the signal-voltage variations of the unwanted stations down to a value where they do not cause interference with those of the station being received. The degree of selectivity required for this purpose depends both on the signal strength of the stations it is desired to receive and that of the unwanted stations whose fields affect the receiving antenna simultaneously.

In spite of all the changes which have taken place in radio receiver design, there has been very little change in the fundamental principles involved in amplifier design, although certain new principles have been added and the constants of most circuits have been revised to suit the newer types of vacuum tubes. Of course the mechanical construction of the parts have been continually changed in order to reduce the cost of raw materials necessary, greatly simplify and cheapen the manufacturing processes, and reduce the overall dimensions of the entire receiver.

To add a stage of t-r-f amplification to a detector, it is only necessary to couple the antenna circuit to the grid circuit of the amplifier tube by some device, such as an r-f transformer, and to couple the output or plate circuit of the r-f amplifier tube to the input or grid circuit of the detector tube. If the transformers are used for coupling, this means connecting the primary of the first transformer into the antenna circuit, and the secondary in the grid circuit of the amplifier tube. The secondary of each transformer is tuned by means of the variable tuning condenser as shown, to form a series of resonant circuit.

Since a single r-f amplifier stage would hardly provide sufficient selectivity or amplification for satisfactory reception, more similar stages may be added to it. Theoretically, any number of amplifier stages (an amplifier stage consists of the amplifier tube together with its coupling device), could be added, but in practice, the number is determined by the total amplification desired, the amplification produced by each tube and coupling device, and in many cases the selectivity desired, since this determines the number of tuned circuits to be employed. The simple five tube t-r-f receiver, popular for several years employed two stages of r-f amplification, detector, and two stages of audio amplification. The successive amplifier tubes in radio frequency amplifier stages can be coupled by resistances

HOW TO SAVE ON EVERYTHING IN RADIO

SEND FOR ALLIED'S NEW CATALOG

Free!

180 PAGES SHOWING EVERYTHING NEW IN RADIO

A GREAT BOOK OF RADIO VALUES

Just off the press! ALLIED'S new Spring Catalog—cramped with smashing values from cover to cover! ALLIED offers you everything new in Radio, real savings and fast service. Dealer, Serviceman, Soundman, Builder, or Amateur—whatever your interest in Radio, you'll find the new ALLIED Catalog a necessity! Send for your FREE copy today.

NEW RADIO SETS VALUES IN P. A.

Every one a Champion—new "Personal" three-way Portables; latest Recorders; Phone-Combinations; Plastic Sets; World-wide Models; new FM-AM receivers; Auto and Farm Radios; Amateur Sets—all at lowest prices that spell Savings and Profits!

25 New Sound Systems! For every Public Address application—7 to 75 watts. Widest selection; finest features; Easy Payment Plan and 15 Day Trial. Dollar for dollar, you get more when you buy 1941 KNIGHT Sound Equipment.

FOR THE BUILDER 15,000 RADIO PARTS

Count on ALLIED for the latest low-cost kits and for help in building any type of radio circuit. Complete listings of the latest builders' and experimenters' supplies. New diagrams. ALLIED is Headquarters for Radio Builders!

The biggest selection of quality parts in all radio. Every leading make—complete listings for every radio building and servicing requirement. You need this reliable Guide to Everything in Radio at the lowest prices!

ALLIED RADIO

833 W. Jackson Blvd., Dept. 1-D-1
Chicago, Illinois

Send me your FREE 180 Page 1941 Spring Catalog.

Name.....

Address.....

City..... State.....

FREE

Are You Playing

"BLIND MAN'S BUFF"

with Your Future?



Are you, like so many other professional radiomen, aimlessly groping for the door to opportunity? Thousands of ambitious radiomen have been set on the right course with the help of CREI advanced technical training. The well-written text plus the personalized training provides a proven formula for more rapid advancement.

Our records show that CREI graduates as a group are among the highest paid in radio—and that 69% (by actual survey) enjoy salary increases during or immediately after their training! Year after year we constantly strive to improve our courses and the results they enable you to enjoy.

Why not investigate what CREI training in Practical Radio Engineering can do for you?

Write for Facts Today—

Let us send you our interesting booklet, together with personal recommendations for your advancement in radio. To help us intelligently answer your inquiry, please state briefly your education, radio experience and present position; also whether interested in home study or residence training.



Free Booklet
Sent

CAPITOL RADIO ENGINEERING INSTITUTE

Dept. RN-4, 3224-16TH ST. N. W., WASH., D. C.

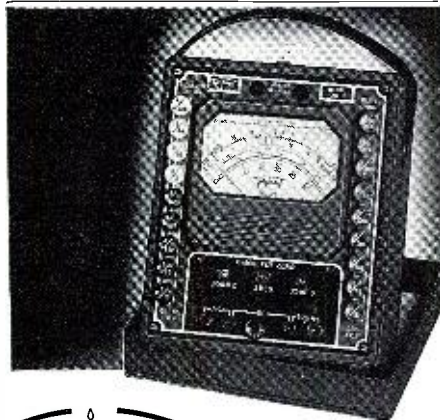

TRIPLET

Model 1200-F
Push-Button Type

Dealer Net Price
\$27.84

Push-button switching by a new, simpler way makes the Model 1200-F an entirely automatic Volt-Ohm-Milliammeter with maximum speed and minimum switching. Only one button need be pressed for any range and test setting. Ranges: DC 0-10-50-250-500-1000 at 25,000 ohms per volt . . . AC 0-10-50-250-500-1000 at 1000 ohms per volt. DC Milliamperes 0-1-10-50-250. . . 0-50 DC Microamperes. . . Resistance 0-1000 Low Ohms, shunt type circuit; 0-300,000 ohms; 0-3 and 0-30 Meg-ohms, series type circuit. Self-contained batteries for all ranges. RED • DOT Lifetime Guaranteed instrument, rectifier type. Attractive metal case with rich brown suede enamel finish. Panel with new three-tone finish. Dealer Net Price. **\$27.84**

Write for Catalog—Section 154 Harmon Avenue

THE TRIPLET ELECTRICAL INSTRUMENT CO.
Bluffton, Ohio

Condenser Analyzer

(Continued from page 11)

imum amount it *should* open if the condenser were good, determines the amount of power factor present.

The original unit was built in a 6"x9"x5" cabinet with a sub-panel made of aluminum. The steel panel furnished with the cabinet was discarded in favor of aluminum which is much easier to work. The 9-watt potentiometer in the "B" plus circuit must be insulated from the panel or it will burn out due to the shorting of the "B" supply.

Be careful about leads in the bridge section. Have short leads and allow plenty of space between them so as not to introduce too much capacity in the circuit, otherwise the bridge will not read low capacity. If trouble is encountered with very low capacity tests be sure to touch one of the test leads with your finger while balancing for the null point, or the reading will not be accurate. Try either lead until you get a change in null point with your finger on it, this is the right one to touch.

Calibration

Anyone of several methods can be used to calibrate this instrument, but the one to be described here is we believe the most accurate as well as a very economical method of obtaining precision results without going to the expense of buying precision standards.

Now all condensers have reactance; and the formula for the reactance of a condenser is $\frac{1,000,000}{2 \times \text{PI} \times \text{F} \times \text{C}}$ where F

is the frequency in cycles per second, C the capacity in mfd.

For example: To find the reactance of a condenser of 5 mfd. at 60 cycles, figure $\frac{1,000,000}{6.3 \times 60 \times 5}$

which solves at 529 ohms.

Now to calibrate the capacity tester for five mfd., a variable resistor is connected to the external tip jacks and the sw2 is turned to external position. An ohmmeter is temporarily connected across the resistor in the external jacks and this variable resistor is set to the value of the formula above (529 ohms). The ohmmeter is removed and this resistor of 529 ohms is then the standard for this scale. **THIS RESISTOR IS NOT CHANGED DURING THE ENTIRE CALIBRATION FOR THIS SCALE.**

Another variable resistor is connected across the test leads and set to the same value or 529 ohms. The null indicator is then adjusted by potentiometer R6 for balance, and this is the electrical center of the 5 mfd. scale, and should be marked 5 mfd. on the scale. For calibration of other values use the formula, or use the chart supplied for the value of ohms to which the resistor across the test leads should be set.

Balance out with null indicator for each value of resistance given to correspond with the value of mfd. and mark the bridge scale in mfd. according to the chart. For other scales lower in capacity use scale just calibrated and divide by 10 or 100 or

1000 corresponding to whatever internal standard is used.

Now a word about operation of the instrument as a whole. Connect instrument and set R2 to working voltage of condenser to be tested. For paper condensers throw sw4 to position "P" and insert test leads in jacks marked "leak," and connect to condenser under test. If neon flashes once and remains out the condenser is good, if it continues to flash at frequent intervals, the condenser is leaky, and if it remains lighted the condenser is shorted and should be replaced.

For the leakage test on electrolytic condensers throw sw4 to "E" position and close sw3. This places the 15 milliamperere movement of the series milliammeter in the 150 milliamperere position and should the condenser be shorted it will not burn out the meter. It also allows the condenser to form, and, while it is forming, a high leakage current may be noticed.

If however the leakage does not come down to a safe value very shortly, the condenser should be discarded. If the current falls to a low value then sw3 can be opened and the correct leakage read on the 15 mill scale. This reading should be noted, for when a capacity test is made later on, the leakage should be applied against the actual capacity which the condenser has and *not the value marked* on it. If the leakage is satisfactory, shift the test leads to "Cap" jacks and throw sw2 to the proper range of the internal standard and adjust the null indicator R6 for maximum opening of the eye. The capacity can be read directly on the scale. If the eye will not open all the way, there is an amount of power factor present which causes series resistance in the circuit and the condenser will not give maximum filtering action. If there is too much of a shadow in the eye (representing the power factor) discard the condenser. This test can be made on filter condensers without disconnecting them from the circuit in the set.

In conclusion let us state that once the bridge type of analyzer is used, you will wonder how you ever got along without it. It is fast, accurate and easy to operate and will save you many a headache on "Call-Backs."

Inductance or resistance matching can be made with this instrument by placing the part to be checked in the external jacks and throwing sw4 to external position. Apply test leads to parts to be matched. If the null point is at the center the two are equal. For this test the test leads must be in jacks marked "Cap."

The accuracy claimed for this instrument is more than sufficient for service work, and the over-all range in capacity is approx. 10 mmf. to 100 mfd.

In the illustration you will notice the dial is calibrated from .05 to 50 mfd., indicating a 2 mfd. standard was used, but in a later model a 5 mfd. standard was used to make it possible to have each range a decimal of 10, 100, or 1000 times. This gives us a larger range from 10 mmfd. to 100 mfd. To read very low capacities use very short test leads.

-30-

Hi-Fi Pre-Amplifier

(Continued from page 14)

into a long haul, the by-passing effect of the line must be taken into account. This by-passing effect shunts out the higher audio frequencies, and throws a hump in the bass end of the response curve at the receiving end of the signal, making the signal sound "boomy" and without highs. This effect varies with the length of the line, gradually becoming worse until, at distances of over 100 miles, the amplifier cannot be used without some sort of equalization.

We overcome this by a very simple operation. You'll notice that the output transformer has a 200 and a 50 ohm tap on the output winding. It is the characteristic of impedance matching that when working a low impedance output into a high impedance input, the lows are attenuated—having the effect of increasing the highs.

This is what we want. The line attenuates the highs, and the mismatch knocks out the lows, smoothing out the response curve until it is again essentially flat. This may not be the flat curve that the transformer manufacturers talk about; within 1/2 db from 30 to 15,000 cps., but it will be within 3 db from 50 to 8,000, and that's better than the average radio receiver will pass. And don't worry about the mismatch. An impedance mismatch of 10 to 1 is only a loss of a little over 4 db and that's not much. So, on a long haul, just switch out the pad and hook onto the 20 ohm tap. A switching arrangement might be used, but here at WPAD we have 13 of these units in use,—some with and some without the pad. Therefore we don't have to use such an arrangement, but it can be done.

We have pulled over 230 miles with one of these amplifiers,—from Louisville, Ky. to Paducah without any complaints of "bassiness," and still with plenty of signal for the program amplifier. This was on a class "E" line—unequalized and with no repeaters on the line. —50—

Bench Notes

(Continued from page 27)

fic around a fairly busy corner. Ignoring the passengers cars, since they were going by our place, we noted the varieties of business represented by the delivery trucks and cars, which were roughly as follows: Four dry cleaners, three beverage distributors, five groceries, two department stores, four laundries, and several others. This observation inevitably led to the obvious fact there is plenty of competition in any line of business, and from there to thoughts of competition in the radio business.

When three or more radio men meet and engage in any discussion of business conditions, sooner or later the talk swings around to "competition," especially that obnoxious to the speaker, with most of the condemnation falling on the heads of those low cut-price scoundrels, and the part-time man or beginner. There are generally frequent references to the "legitimate" serviceman, which ap-

parently means one who is conducting his business in a manner approved of by the speaker, usually far removed from the speaker's area of trade; or it may be, we have often suspected, merely a round-about method of implying an opinion of his competitors in general.

This department has no intention whatever of questioning the sincerity of these proponents of the rights of the so-called "legitimate" serviceman, but on the other hand we are not at all sure that the most frequently condemned men constitute a class deserving the sound and fury raised against them. For example, let's investigate the case of *Cuthbert the Cutthroat*, whose newspaper ads of "50c service calls" so frequently arouse the ire of others. Taking a quiet snoop around his shop, Cuthbert will often be found busily engaged at the bench, which bears four or five repair jobs and an adequate number of test instruments—some of which are the latest model—and exhibits other small signs of being solvent. It is apparent to any experienced man that the 50c fee for service calls is not sufficient to do much more than pay the rent, let alone buy new test instruments; therefore it can only be concluded that Cuthbert is getting something more than 50c out of each job, which is exactly what he is doing. A peek at the totals on the job cards attached to the completed jobs, generally shows that Cuthbert is getting as much for his work as any of his competitors in that neighborhood, if not a little more. Cuthbert has merely learned that his class of trade, which is largely Mr. & Mrs. Average Customer, has for some time been inclined to view the customary "\$1.50 Service Call" as an arbitrary fee in addition to the cost of actual repairs. Strictly speaking, the 50-cent service call is merely a "loss-leader" for the wary customer, and assists materially in solving the important primary problem of actually getting the first call from a prospective new customer. Once Cuthbert gets that call, and makes an inspection at the customer's house, he is a poor salesman if he doesn't come away nine times out of ten with a job that is going to net him something considerably more than 50c or \$1.50 either for that matter.

In spite of the fact that in many communities service men are finding that a charge for a "service call" cannot even be mentioned if they are to get a chance at the job, many service men are clinging to the old \$1.50-for-a-service-call idea as though it were an inalienable right, in the face of the fact they may be losing business daily on account of it. It is a losing game to insist on maintaining a minimum charge, if a man's customers will not pay it. There may be some satisfaction in announcing, "We charge so much for a service call;" but there is no profit in hearing the click of a hastily hung-up phone at the other end of the line.

When a service man begins to lose business, there is small profit in shouting "chiseler and cutthroat" at his competitors, but it is high time for the serviceman to pay more attention to his own business methods, and find out if he has been merely coasting along from the easy money days

YOU'RE THE DOCTOR

... and you can prove it!



HERE IS Sylvania's latest sales-builder . . . a radio chassis chart that will discourage the most optimistic home tinkerer.

More clearly than any other promotion piece we've ever seen, "What Is Wrong with Your Radio" convinces your customer that only an expert can make radio repairs . . . and **YOU'RE THE EXPERT.**

Write Hygrade Sylvania Corp., Dept. RC31, Emporium, Pa., for a free copy of this mailing piece . . . and for full information on the 25 other silent salesmen Sylvania offers you either free, or at substantial savings.

Sylvania's Silent Salesmen

- | | |
|---|--|
| 1. Window Displays, dummy tube cartons, timely window streamers, etc. | 16. Technical manual |
| 2. Counter displays | 17. Tube base charts |
| 3. Electric Clock signs | 18. Price cards |
| 4. Electric Window signs | 19. Sylvania News |
| 5. Outdoor metal signs | 20. Characteristics Sheets |
| 6. Window cards | 21. Interchangeable tube charts |
| 7. Personalized postal cards | 22. Tube complement books |
| 8. Imprinted match books | 23. Floor model cabinet |
| 9. Imprinted tube stickers | 24. Large and small service carrying kits |
| 10. Business cards | 25. Customer card index files |
| 11. Doorknob hangers | 26. Service Garments |
| 12. Newspaper mats | 27. 3-in-1 business forms |
| 13. Store stationery | 28. Job record cards (with customer receipt) |
| 14. Billheads | |
| 15. Service hints booklets | |

SYLVANIA

SET-TESTED RADIO TUBES

Also makers of Hygrade Lamp Bulbs, Hygrade Fluorescent Lamps, and Miralume Fluorescent Light Fixtures.

before Mr. Hoover's pretty soap-bubble exploded from an excess of hot air. That there is a certain amount of price cutting is probably true, but that is not sufficient reason for a man to feel that every job his nearest competitor gets must be on account of cut-prices. We feel certain that the amount of price-cutting done on radio service is grossly over-estimated, as few provable cases have been actually encountered over a number of years. In fact our experience has been quite to the contrary, in that most of the evidence obtained from customers indicates strongly that the majority of service men are more inclined to over-charge for mediocre service.

Before bawling "Price-cutter" at that fellow down the street who seems to be getting the business, it might be a good idea to ask, "How do you *know* he does?" After all it may be, that he is simply a better business man.

Electronic Maintenance

(Continued from page 37)

as a portable unit and one which can be classified as a counter unit. All of us understand the varieties of tube checkers available upon the open market. Essentially they are of the mutual conductance type and the emission type. Comparing these two kinds shows a tremendous superiority in favor of the G_m variety, even though it is virtually impossible to make a real

mutual conductance meter, from the viewpoint of tube engineers to sell within the price range limits of the servicing industry. Nevertheless, the so called G_m meter is superior to the emission type.

Granting this to be true, it does not cast the emission type of meter entirely into the discard. In fact, if we recognize how much information can be gleaned by the process of signal tracing concerning the condition of the tube in a receiving or amplifying system, the emission check is sufficient to substantiate or disprove the conclusions made concerning the tube in the receiver. Again we reiterate that we are not placing the emission check upon a higher plane than the mutual conductance test. All we are saying is that while the mutual conductance test is better, the emission tester is definitely not in the discard. In fact, it seems after close analysis, that every inexpensive tube checker must be of the emission variety, for it seems impossible to produce an inexpensive tube checker which is built along mutual conductance test lines. This however should not be construed as a final and definite conclusion, for no one knows what the future holds in store.

Considering the problem of tube checkers, we recognize the need of existing types in a shop such as we have outlined, but we must add that further thought is imperative, so as to embrace those tube types which find application in industrial apparatus and low powered transmitters, as well as receiving tubes. Knowing how things are done in the radio industry, we venture the statement that not many moons will pass before we see tube checkers of wider field of application than those which have gone before. Also that some time in the near future, there will appear a tube checker of a variety which will have less obsolescence than those that have gone before. Just what it will be, we have an idea, but cannot say very much about it. So, concluding for the present, the subject of tube checkers, you are your own boss in deciding what you want. As to possible obsolescence in what you may select, well, the industry has become accustomed to such things in the life of those units, so that changes made necessary by the developments of tube types do not cause much alarm or much surprise.

Speaking about obsolescence and tube types, the recent suggestion by RCA to the tube industry to try to select preference type tubes may eventually simplify the tube checker problem. The preference tube type program as it applies to new tubes sold to manufacturers cannot help but be of aid, for it greatly reduces the number of types of tubes introduced during a year.

Photo-electric Cells

It is not far fetched to speak about means of testing photo-electric cells, as one kind of apparatus required in such a modern service shop. This is tube checking, but not of the common variety. It may call for a standard amplifier, a standard light source and measurement of the electrical output. As yet we don't know of any specific units being built upon a commercial scale to do this work, but as this industrial market grows, there will be such devices.

Microphones

The testing of microphones is an-

other future problem for the service shop. This technique has been well developed in laboratories, but unless we are very badly informed, tests upon microphones are made by the manufacturers and the "mikes" must be returned to them. From the service viewpoint, this does not make sense. If the amplifier is checked in a service shop, all parts of that amplifier should be within the province of the shop. And as far as mike testing is concerned, our experience has been that it takes a little more than just calling 1, 2, 3 and 4 into the microphone and whistling a few times.

In line with microphones are record pick-ups. Proper testing calls for the proper type of sound sources, such as constant frequency recordings of known amplitude and frequency and characteristics. Playing an ordinary record is not sufficient, although it is true that this has been the usual procedure.

From all of this it would seem that our electronic and communication service shop will require a few standard amplifiers of various varieties to be used with special purpose tubes, microphones and pick-ups. Speaking about amplifiers, and we mean the most complicated there are, we just want to drop a hint that there will be signal tracing applied to such units, just as to radio receiving systems.

It is possible for us to continue in this way for page after page, listing the various kinds of apparatus which can very readily appear in such a shop to do all kinds of work. Unfortunately space does not permit it, for we are trying to speak within limited space about the activities of an industry and to encompass a scope never attempted before. Therefore if you miss a few things that you have thought about, don't feel that we are forgetting them. You will see just what we mean in the last installment of this article when we shall list the possible equipment in such a shop and the work that can be done with it.

We can readily understand that many men do not possess the required finances to enable them to go out and buy not only the kind of equipment shown upon the basic test bench, but all of the other units which will be included, some of which have been mentioned. They can be acquired piece by piece and as each new unit is purchased, the field of activity increases.

What's New in Radio

(Continued from page 26)

This new branch, located in the hub of the Bronx shopping centre, with entrances on both streets, is Davega's largest store in that borough.

It comprises two floors with more than 8000 square feet of space devoted to the display and sale of Sports Apparel, Sports Equipment, Radios and Electric Refrigerators and Appliances. The store is completely modern in design and equipment. Fluorescent lighting is used thruout its interior and display windows. An air-conditioning plant has been installed, ready for use next summer.

In this new location, the company has instituted a new idea in radio retailing. Four rooms have been decorated and finished in four different and distinctive color harmonies. The prospective buyer will thus be able to make a better choice of a radio cabinet that will harmonize with the decorative scheme of his own home.

-30-

SAVE UP TO 50%
30 DAYS TRIAL
15-TUBE MIDWEST RADIO
FACTORY-TO-YOU
PUT THIS CHASSIS IN YOUR PRESENT CABINET
PUSH-BUTTON TUNING
FOREIGN RECEPTION DIRECT
Liberal trade-in allowance on many new models shown in FREE catalog—from 6 to 18 tubes—up to 5 bands—including automatic recording radio phones Home Recorder, etc. (User-Agents Wanted)
UP TO \$25.00 TRADE-IN ALLOWANCE
EASY TERMS
COMPLETE CHASSIS WITH TUBES AND SPEAKER
MIDWEST RADIO CORPORATION
DEPT. 11-HH CINCINNATI, OHIO

RECORDING ACCESSORIES

All rec. acc. from one source of supply. Four types of rec. blanks in usual sizes. Cutting and playback needles, etc. News QSL rec. blank for amateurs. 1941 cat. just off the press. Everything for professional, home or experimental recording.

National Recording Supply Co.

1065 Vine St.

Hollywood, Cal.

POWER AND LIGHT

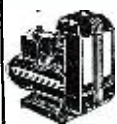

ONAN A.C. ELECTRIC PLANTS supply current for Radios, Transmitters and Receivers, P. A. Systems, Movie Projectors, Sound Truck Apparatus, Tools, Lights, All Appliances, Urethane Standby Equipment in Schools, Hospitals, Theaters and Public Buildings in case of Power Line Failure due to Storms, Floods, etc. Available in 110 or 220 Volt A.C.—12, 32 and 110 Volt D.C.—Also Dual Voltage A.C.-D.C. Types, Manual, Full-Automatic & Self-Starting. \$99 and up. Shipped. Ready to Run.

D. W. ONAN & SONS

1454 Royalston Avenue, Minneapolis, Minn.

RADIO ENGINEERING DEGREE IN 2 YEARS

Intensive, specialized course, including strong basis in mathematics and electrical engineering, advanced Radio Theory and Design. Modern laboratory. Low tuition. Self-help opportunities. Also 2-year courses in Aeronautical, Chemical, Civil, Electrical and Mechanical Engineering. Participation in Civilian Pilot Training Program. Enter June, September, December, March. Catalog.

INDIANA TECHNICAL COLLEGE

741 E. Washington Blvd.,

Fort Wayne, Ind.

QRD? de Gy
(Continued from page 35)

flag, who have gained a living standard second to none in the world, would directly or indirectly try to undermine this government. If radiops were stay-at-homes and had never been in any other country outside of these United States, there could possibly be some excuse. But world travelers that they are, there can be no reason for any sane and sensible radiop working with subversive elements. It is our fervent hope that all American radiops will be courageous enough to aid our government's Intelligence forces to ferret out any rats in the communication field. This is a most serious matter, gentlemen, and we're not crying "Wolf," believe us.

COMING in from Vladivostok, Russia, the opr on the *Socony-Vacuum* tanker, *Aurora*, decided he had seen enough of the Red Utopia, so he ups and quits before there might be a return trip involved. *CTU* was called to furnish a replacement and after much scurrying around Jack Hakim was given the billet. Because of Hakim's anti-red views, he may even try to convert the Vladivostokians to American ideals.

FINAL "30": Many old time friends of Brother Betterton, formerly of the *SS West Kyska*, will miss him since he has passed on to his just reward. Betterton died at sea on a trip from the East Coast to Frisco. Old timer Vernal C. Dean, formerly of the *Amer. President Lines*, and more recently on the tanker *Derco* out of 'Pedro, was assigned to take the *West Kyska*.

CTU-MARDIV'S fly-about, snappy west coast representative haunted our shack the other day trying to find a qualified op or two for a billet or two which was going begging. He finally filled the berths, but is now on the lookout for radiops with tickets having 6 months service to fill the jobs to be available when *Alcoa's* new ships, now being completed in the Frisco area, will be placed in operation. Any of youse guys interested in this announcement please contact A. B. Anderson, 1065 N. Vine St., Hollywood, Calif. It is understood that the *SS Alcoa Pioneer* which was put in commission in November is paying \$165 per. plus 25% extra when ship is in Canadian waters. There are six more vessels due to come down the ways.

OUR Mobile sleuth-hound, Brother Underwood, manager, operator and janitor of *WLO*, sez: Brother Wasserzieher was quite agitated tother day when he was offered the berth on a Greek ship which is to load in Canada for England. A \$250 bonus each way was thrown in as a come-on, but Wassie wouldn't fall. He was more worried about losing his American citizenship. Which is smart work, OM. An American citizenship is worth more than gold can buy and a lot of guys have tried that, too.

Incidentally, one operating practice that is becoming increasingly prevalent is the practice of sending anonymous calls. Many ops will, when wishing to raise a coast station, merely call the station without signing their own call. And some of them will keep this up until the *CS* answers, even tho that might be some time later because the *CS* is listening on some other freq. This is strictly against regs and I believe it should be stopped. I can't help but feel it's like saying "Hey, you!"

OUR aviation pal, Charlie Bolvin, must still be up in the air 'cuz we hain't heard nary a word from outta Akron. Melbe he's like the cub reporter who called up his chief and cracked, "Couldn't get any story on the wedding you sent me to cover because the bridegroom was killed on his way to the ceremony, the bride was shot by a former suitor and the church burned down so there was no wedding. . . . and no story. Nothing happened, chief." So cheerio and please remember that America, with all its faults, still has free speech, free press and freedom of worship. So with best 73 . . . ge . . . GY.

As I See It!
(Continued from page 10)

a bench should be, but if you look into the design of the things that are used in the home kitchen over which the cook or housewife bends, you'll find that the manufacturers devote much attention to creating the most comfortable working conditions. Naturally a graduated bench is out of the question, but an optimum height is still possible. Many a man has kneeled down in front of a bench in order to work upon some portion of a chassis and after being in that position for five or ten minutes found himself with a kink in his thigh or calf. A stool of the proper height should be available for that work, just as it is for the normal operations. Sounds funny, but it makes sense.

A kink in the back right now, is the reason for writing this squib.

THE Halstead micro-wave traffic control system, wherein traffic lights speak to the man in the car, telling him where to go and how to go, is being tried out. We once saw this thing work in our lab where *March of Time* pictures were made.

Why should there be traffic horns to annoy everybody and be a means of getting a ticket for causing public disturbance, when it is possible to send out super-sonic waves from one car to the next and thus tell the driver ahead of you that you want to pass and hope that he'll let you get by.

Here and there you hear about the possibility of using electron multipliers in place of the conventional audio amplifying system; the same thing in the r-f system and the same thing in the i-f system. Most certainly such a tube, and it can conceivably be a single tube, would eliminate a lot of present day headaches in attaining the required fidelity.

And people are talking, very quietly of course, about the development of output tubes which would have such a low impedance as to work right into the voice coil without any output transformer; thereby making some use of the power now being lost in the output transformer. Don't ask us what that tube will look like, because we do not know. All we said was that some people are talking about them.

What good is the heat that is developed in the modern day radio cabinet during the operation of the receiver? Nothing, you say. All right, how can we do away with it? Putting a fan in there is no good; it's not practical. But what about cold cathode tubes? It's old stuff, we know, but not hopeless. If this ever comes to pass, we'll be able to pull a tube out of a socket without roasting our fingers.

Service Charges

SOME time ago we mentioned that we felt it possible to establish a series of service charges based upon a mathematical equation. Work has been going on in this direction and it looks like we are on the right track. Much more has to be done and it will take several more months, but in the end, we think that it will make sense.

Legal Advice

FOR some time past we have been reading a feature in *RADIO NEWS* titled "Serviceman's Legal Advice."

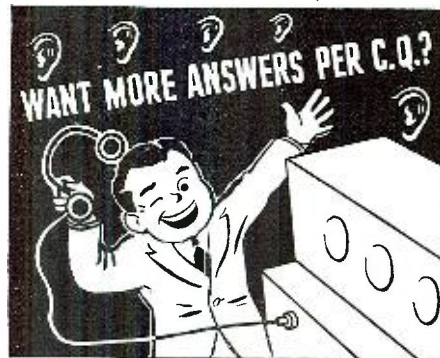

Lead in Your District With A FULLY AUTOMATIC Rig!

★ Why fumble around with just any old contraption, when it costs so little to have a new, snappy, fully automatic rig that can rate the best in your district?

It's easy . . . simple . . . costs less using low-priced Relays by Guardian. Model A-100 Antenna Relays by Guardian are unsurpassed for AM-FM change-over . . . break-in . . . heavy-duty keying in the primary with contacts in parallel . . . grid controlled rectifier keying and many other double pole, double throw uses.

Radio News' new "Super-Super" is Guardian equipped. And there's a thousand other ways in which Guardian controls can be used.

RELAYS BY GUARDIAN

LOW-PRICED. Famous The World Over for Sturdy Construction and Dependable Operation.

Modern straight-line production methods and volume sales to thousands of radio amateurs enable you to get precision engineered Relays by Guardian at extremely low prices listed below.

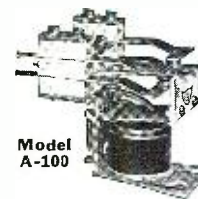

Model A-100 Antenna Relay

Model A-100 — Double Pole—Double Throw. AlSiMag insulated. Same rating as A-100-C. For single wire fed antenna installations, two A-100-C's in place of an A-100 will avoid possible mismatch caused by distorting two-wire systems to provide for single relay installation.

AMATEUR LIST PRICES

Standard A-100, A-100-C, Antenna Relays AlSiMag Insulated. Operate on 110 V.—50 to 60 cycles A.C.

A-100 Double Pole—Double Throw **\$5.95**

A-100-C Single Pole—Double Throw **\$3.30**

R-100 Relays AlSiMag Insulated Same Rating as the A-100 Relays:

R-100-C Single Pole—Double Throw **\$3.30**

R-100 Single Pole—Single Throw **\$2.75**

R-100-G Triple X Insulated **\$5.00**

FREE CIRCUIT DIAGRAMS

See your jobber today or write for specifications and full details.

ASK FOR BULLETIN "N"



GUARDIAN ELECTRIC

1630 W. WALNUT ST. CHICAGO, ILL.

RECORD CHANGER

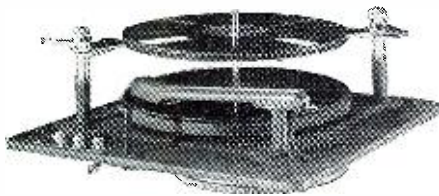

Plays 10 12" or 12 10" records. 14" by 14" by 5" high. Crystal pickup. Handles warped records. Will not chip or crack records. Reject switch—automatic or manual change—2 point record suspension. 115 V. 60 cycles. Only 7 seconds to change records.

\$1295

F.O.B.

UNCUT CONSOLE CABINETS

Send for latest folder

LAKE RADIO SALES CO.

618 W. RANDOLPH ST. CHICAGO

FASTEST WAY TO LEARN CODE

Easy, Fascinating, LEARN by EAR To Be a GOOD OP.

The New All Electric Master Telex Code Teaching Machine is exactly what thousands are looking for. No experience needed. Ideal for beginners—steps up WPM for ALL Ops. There is no guess work with Master Telex, because it records your sending in visible dots and dashes. You SEE and HEAR exactly how you are making your signals. You learn code the way you'll be using it—by SOUND. That's why practically every school teaching code uses TELEPLEX. Complete course included at no extra charge. Used by many schools for teaching code. Low cost; easy terms. MONEY BACK GUARANTEE. Send now for booklet RN4, no obligation. Postcard will do.

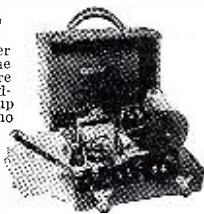

TELEPLEX CO., 107 Hudson St., Jersey City, N. J.

In Canada write:

CANADIAN ELECTRONIC INST., TORONTO, ONT.

Simplest WAY TO REPLACE BALLASTS

4 STANDARD TYPES of Amperite Regulators replace over 200 types of AC-DC Ballast Tubes now in use. . . Has patented automatic starting resistor. List \$1.00

WRITE FOR REPLACEMENT CHART "S" Amperite Co. 561 Broadway, N. Y. C.

AMPERITE

OTHER MEN have read and profited by our free books "Patent Protection" and "Selling Invention." Fully explain many interesting points to inventors and illustrate important mechanical principles. With books we also send free "Evidence of Invention" form. Reasonable fees, deferred payments, forty-three years' experience. Write to: Victor J. Evans & Co., Registered Patent Attorneys, 428-D, Victor Building, Washington, D. C.

PATENT YOUR IDEA

SOLAR RED-CAPS

Smaller Diameter Dry Electrolytics

SPEED Servicing

Write for Catalog

SOLAR MFG. CORP. Bayonne, New Jersey

We have read the contents of each of the issues and to say the least have found them very enlightening from the viewpoint of what the legal pitfalls are in the servicing business. It is also true that it was dry reading, as is all such legal material unless it involves some sensational murder case or when one man runs away with another man's wife and explains the complete conversation that ensued before and after the act and all of the acts involved.

Be that as it may, the fact remains that this legal advice is very valuable material, but being of a curious nature, we queried a number of servicemen about what knowledge they had gained from the facts submitted in the various issues. Lo and behold, we picked on men who had never been sued, hence felt that they needed no legal advice, consequently had never read Mr. Healy's column.

Frankly, this is typical of many men in the servicing business. Never having had a fire there was no occasion for fire insurance. Never having been sued, there was no occasion to read anything which might sometime in the future be of value. If you examine the records of court cases, every day will show some wherein a serviceman is an active participant, either as the defendant or as the plaintiff. Now this column, if we understand it correctly, is not intended to make a serviceman his own counsel in case he becomes involved in some legal entanglement, but rather it is intended to keep him out of such difficulties as much as possible.

Such being the case, it should at least be read. When we say this we are not going to bat for Mr. Healy as an individual, or in any way casting any reflection upon his column by saying that many servicemen do not read it. We, in our humble opinion, think that it is a damn good feature of the magazine and should be continued, if it is read by only 5 percent of the readers of the paper.

Xmtr. from Spare Parts

(Continued from page 16)

construction very inexpensive and extremely easy. After working on a steel chassis for a while, plywood feels like butter. The brackets that are used for fastening the pieces of plywood together are obtainable from most five and ten cent stores. Since the dimensions of the cabinet are dependent on the size of the components used, such as the diameter of the speaker, the individual constructor should adapt the cabinet size to the parts on hand. If all connections are carefully soldered, and the plywood cabinet is built substantially, it will take a lot of banging around and still come up for more. The only vulnerable spot is the neon bulb on the front panel, and this can be easily removed while in transit. The speaker is protected by a piece of ordinary window screening; so that you can leave the set on the floor without worrying about some jitterbug putting his foot through the cone.

Since the whole point in building the outfit is to utilize spare parts, each individual will of course want to make use of whatever equipment he has available, and there is no use in attempting to duplicate the set

exactly. For instance, if you have a suitable rotary band switch on hand, by all means use it; similarly, if you happen to have a six inch speaker instead of an eight, use the six, etc.

Performance

The set has been operated quite a good deal from a cabin in the Santa Cruz mountains here in California, and using a transmitting antenna 130 feet long and only ten feet high, satisfactory QSO's have been completed with stations in Washington, Oregon, Idaho, and Nevada, as well as with a multitude of stations all over California. With a good antenna who knows what would be possible?

All in all the set should provide considerable pleasure for the constructor, and it will take those spare parts out of the class of frozen assets and put them back to work where they belong.

Serviceman's Experiences

(Continued from page 19)

got really serious. I knew that, sooner or later, I'd come across a job that would prove me right beyond fear of contradiction.

The following evening I worked on a set that I decided to use in proving my point. The job was a *General Electric* super-het; its owner and his wife sat reading their papers as I examined it.

The original fault was a gassy '80, as was obvious from its color. To make sure nothing else was wrong in the voltage supply, I replaced it with a good one—with the volume control turned 'way down, so the music wouldn't blare out—and everything was okay.

The beautiful part of the job was that someone had obviously been fooling with the set after the '80 went west. The trimmers were all bent, and the threads had been stripped by whoever tried to get fancy with a screwdriver. There was a nice long rip in the speaker cone—fresh, and man-made; and I wrung my hands and smiled an evil smile (mentally, of course) as I stood up to break the sad news. *Someone* in the family had a guilty conscience, and—believe me—they were going to pay for it!

Just when I was about to break the news, a 14-year-old boy came in. When he saw me, he stopped, looked frightened, and sat on the edge of a straight-backed chair. *There* was my victim!

Knowing I held all the cards, I cleared my throat and announced confidently

"Mr. Haley, your set is in a deplorable condition. It will cost thirteen dollars to repair it!"

The man lowered his paper and looked at his wife. She gave him some sort of signal, and he replied:

"Sorry, but we can't afford it. What makes it so expensive?"

Well, he was *asking* for it. I glanced at the boy; he was actually pale. A person couldn't help feeling sorry for him, thinking of what his parents would do after I'd sold him down the river.

"The original—" I replied, glancing at the boy again, who was so filled with fright it began to spill from his eyes.

"The—er—that is, it needs an overhaul," I stammered. "Yes, that's it—

an overhaul. Some small tuning condensers have worn out; a couple of tubes should be replaced; and the speaker cone has—uh—warped sorta."

"Do such things occur by themselves?" the woman asked, looking at the boy suspiciously.

"Surely," I lied. "All old sets should be overhauled. It stands to reason, like." I felt the job slipping further away.

"Mother!" the boy interrupted, "If you and Dad each pay five dollars, I'll chip in three from the money I'm saving for my bike. I think we should have the set repaired—we'd miss it a lot if we didn't!"

"Well, I'll be damned!" the man said, admiringly, and glanced at his wife.

The boy held the front door open while I carried the set out to the truck.

"Thank you, my boy," I said, with the warmth that comes only from a completed contract.

"Thank you, sir," he replied happily. "When you come back, I'll take you over to my uncle's house—something's wrong with his set, too. I know, because I was visiting there yesterday."

He winked, and began a beautiful friendship. I'm giving him a set of tools for his birthday.

-30-

Video Reporter

(Continued from page 23)

considerable time to stir up participation by a sizable number of national advertisers.

The very propaganda of pioneer television firms to the effect that the signals were limited to localized service areas caused many national advertisers to shelve the idea of participation for a long time to come.

But locality advertisers—particularly department stores—view television as an ideal medium to announce sales and display their wares. But, incidentally, they will have to provide entertainment, too. And, regarding obtaining national advertisers on the stations they own, just watch them attempt wielding a big stick on manufacturers of lines they themselves carry!

It is understood that both NBC and CBS have their eyes on the establishment of television networks. NBC has a bit of edge towards this goal insofar as its own contemplated stations are concerned. But the guess is that CBS will concentrate on the linking of affiliated rather than owned video stations. And while we're in a guessing mood, we'll wager an old Indian penny that the FCC will be inclined to approve the latter course sooner than the former.

Servicemen's Legal Advice

(Continued from page 31)

term, and so prove four distinct causes of action, the plaintiff did prove a breach of covenant referable to some one or more or all of the leases. The Court further held that each new lease involved the surrender to the landlord of the lessee's possession under the prior lease, though they all ran to their termination, and there was no surrender of the lease themselves. But such surrender, at the expiration of each term, instead of being actual was implied from the presumed intention of the parties and devised to give consistency to the new lease. The Court further held that the surrender of the lease during the term, and the acceptance of a new lease by the landlord does not extinguish rights of action already accrued, and while, at the close of a term, there is surrender of possession by the tenant in such condition as to violate a covenant in the lease, and an acceptance of possession by the landlord, the two things occurring at the same time, there is one unbroken and continuous term.

Audio Cycle Counter

(Continued from page 31)

circuit of figure 4, it is interesting to note that the same values of C1, C2, and C3 will afford frequency ranges of 0-500 and 0-1000 cycles per second. Hence, only R5 need be switched for these two ranges. Consequently, it will be noted that the range switches, S1, S2, and S3 (figure 5) are so wired that the same capacitances are used for both ranges, 0-500 and 0-1000 cycles. The switch S4 selects different calibration rheostats for these two ranges, however.

To render the range-changing operation simple, the switches S1, S2, S3, and S4 are components of a 4-pole, 3-position rotary selector switch. It is this switch that is controlled by the finger-grip knob visible just below the meter in figure 1.

The 90-volt power supply is comprised by the plate-rectifier-filament transformer, T2; the 6.3-volt transformer, T3, which supplies heater voltage to the amplifier, gas triode, and double diode tubes; the filament-type rectifier, 5W4; voltage regulator, 874; 874 current-limiting resistor, R14; amplifier filter resistor, R15; and filter condensers, C12 and C13.

Electrical and Mechanical Features

The instrument might have been made as large as a communications receiver; but excessive spreading of the components is not required in this device, so its physical proportions were kept as small as practicable. However, the good practice was observed in keeping the power supply components on one side of the chassis and the input circuits on the opposite side.

The mounting of parts on the chassis is shown. Reading from left to right along the rear of the chassis, we have the 6H6 tube, and the knobs of the three calibration resistors, R11, R12, and R13. It will be noted that the shafts of these volume-control-type rheostats were not cut down. This places the three knobs high above chassis and within easy reach when the cabinet lid is lifted. In the second row from the rear of the chassis, appear the two type 884 gas triodes. Directly below the left-hand 884 is the input transformer, T1. For space saving, a midget transformer which plugs into an octal-sized tube socket was chosen. This transformer, Kenyon type A-31, is only a bit under an inch and a half in diameter and stands about 2 3/8 inches above chassis. Directly below this transformer will be seen the 6C5 input amplifier tube and to the right of this tube, the three small Burgess 5360 4 1/2-volt C-batteries which make up the 9-volt gas triode grid battery and the 4 1/2-volt 6H6 battery. To the right of the batteries is the Triplett Model 327-A three-inch square 0-500 d.c. microammeter, and almost directly behind the meter is the RCA 874 gaseous voltage regulator tube. Since this tube is rather long, being housed in one of the now antiquated envelopes, its socket had to be mounted below chassis and a large circular hole cut to pass the tube base, in order to close the lid of the cabinet. The power transformer, Kenyon T-220, fills the left hand rear corner of the chassis; and the filament transformer, Kenyon T-388, is mounted to

I'll Send My FIRST LESSON FREE



It Shows How I Train You at Home for GOOD RADIO JOBS

J. E. SMITH, Pres. National Radio Institute

Get my sample lesson Free. Examine it, read it—see how clear it is, how easy to understand. Find out how I train you at home in spare time to be a Radio Technician. Do it now. Mail the coupon.

Many Radio Technicians Make \$30, \$40, \$50 a Week

Radio Broadcasting stations employ operators, technicians, Radio manufacturers employ testers, inspectors, servicemen in food-pay jobs, Radio jobbers and dealers employ installers and servicemen. Many Radio Technicians open their own Radio sales and repair businesses and make \$30, \$40, \$50 a week. Others hold their regular jobs and make \$5 to \$10 a week fixing Radios in spare time. Automobile, Police, Aviation, Commercial Radio, Loudspeaker systems, Electronic Devices are other fields offering opportunities for which N. R. I. gives the required knowledge of Radio. Television promises to open good jobs soon.

Beginners Make \$5 to \$10 a Week Extra in Spare Time While Learning

The day you enroll I start sending Extra Money Job Sheets, start showing you how to do Radio repair jobs. Throughout your course, I send plans and directions that have helped many make \$5 to \$10 a week in spare time while learning. I send you special Radio equipment to conduct experiments and build circuits. This 50-50 method of training makes learning at home interesting, fascinating, practical. YOU ALSO GET A MODERN, PROFESSIONAL ALL-WAVE SET SERVICING INSTRUMENT to help you make money fixing Radios while learning, and equip you for full time work after you become a Radio Technician.

Find Out What Radio and Television Offer You

Act Today. Mail the coupon now for sample lesson and 64-page book. They point out Radio's spare time and full time opportunities and those coming in Television; tell about my training in Radio and Television; show more than 100 letters from men I trained, telling what they are doing and earning. Find out what Radio, Television offer YOU! MAIL COUPON in an envelope, or paste on a postcard—NOW!

J. E. SMITH, President Dept. IDR, National Radio Institute Washington, D. C.

Good for Both 64 PAGE BOOK SAMPLE LESSON FREE. RICH REWARDS IN RADIO. Mr. J. E. SMITH, President Dept. IDR National Radio Institute Washington, D. C. Mail me FREE, without obligation, your Sample Lesson and 64-page book, "Rich Rewards in Radio." (No Salesmen will call. Please write plainly.) Age..... Name..... Address..... City..... State..... 2FR

the front. Near these two transformers the 5W4 rectifier tube is mounted.

The entire unit is housed in a *National HWR* cabinet which has the following dimensions—13½" wide, 7" high, and 7¼" deep. This cabinet, which is supplied completely assembled and with a wrinkle baked lacquer finish, is fitted with a tray type of chassis of the same heavy steel of which the cabinet is fabricated and secured by self-tapping screws approximately two inches up from the bottom of the cabinet. A steel bottom plate, provided with table feet, is held

to the bottom of the cabinet by self-tapping screws. The handles seen on the top lid in figure 1 are not supplied with the cabinet, but were added by the writer. They are chromium-plated, modernistic drawer handles obtainable for about fifty cents each at any hardware supply house.

Note the arrangement of parts and wiring under the tray-chassis. A square hole has been cut in the chassis at center-front to clear the range switch. Incidentally, the range switch is quite clever as a factory item. It embodies four poles which may be switched into three positions, yet has only one deck and is just a bit more than an inch in diameter. It embraces the separate sections listed as S1, S2, S3, and S4 in figure 5, and may be obtained by calling for *Yaxley* non-shorting selector switch type 3243-J. Directly to the rear of the switch is a thin bakelite terminal board holding C4, C5, C6, C7, C8, and C9. These are the condensers that determine the frequency ranges of the instrument and must be of good-grade mica construction. Those used were the *Aerovox* type 1467.

It was stated earlier that the cycle-counting portion of the circuit does not require excessive filtration in its plate power supply. Therefore, it will be noticed that the 884 plate circuit is returned directly to the 874 voltage regulator, receiving filtration by action of the regulator circuit and the tubular electrolytic condenser, C12. The resistor, R15, together with C12 and C13, serves to filter the plate power delivered to the 6C5 amplifier and seems to do this job very effectively.

The switch, S6 is a pushbutton type (seen in the upper righthand portion of the front panel), which interrupts the B-plus line to the 884 circuit when it is depressed. This switch has been included to break the B-plus line and permit the 884's to deionize when their steady ionization throws the instrument out of operation. This might occur when switching from one range to the other, or when the instrument is placed into operation with the input signal being fed in at the same time. The gas triodes become ionized and the indicating meter will then give no reading. Restoration of proper operation is then obtained simply by depressing S6 quickly, then releasing it.

An input jack of the midget circuit-closing type, seen in the lower left-hand corner of the front panel (figure 1) admits the signal under inspection. This feature was included in order that a metal plug and shielded line might be used between the A. F. Meter and the signal source. For reasons of good shielding and rapid connection, this jack and plug input system is a decided advantage.

The pilot-light jewel is seen in the lowermost right-hand corner of the front panel in figure 1; the off-on line switch, S5 directly above the input jack.

All of the rules of good construction apply without any additional emphasis to the building of the A. F. Meter. This instrument presents no peculiar constructional and operational difficulties. This is a very fortunate fact when the almost amazing performance it gives is considered. One of the writer's associates correctly remarked that it is indeed amazing

how difficult it is to make the instrument *fail* to operate!

In order to do away with a trailing line cord when the instrument is transported, the line has been made plug-in. Directly to the rear of the power transformer, and through a circular hole cut in the back of the cabinet, is installed an *Amphenol* motortype receptacle, type 61-F10 into which is inserted the companion *Amphenol* plug, type 61-M10 to which is connected the a.c. line cord and standard plug.

Calibration

Before the instrument is placed into operation, the voltage regulator must be adjusted in the following manner. Insert a d.c. milliammeter in the lead from R14 to the 874 plate. Depress the switch S6 or remove the lead from the junction of R14 and the 874 plate, so that the 884 plate circuit will be permanently disconnected from the power supply. Turn on the instrument and after the tube heaters have come up to operating temperature, adjust the slider on R14 until the milliammeter indicates a current of 42 milliamperes through the 874. The slider is securely fastened in this position. The lead to S6 may then be restored (or the pushbutton switch released).

The simple method of calibrating the A. F. Meter has been the cause of the most surprise on the part of observers of the instrument. Generally, audio-frequency equipment offers a particular headache to amateurs, experimenters, and servicemen, since the inevitable—seldom accessible—precision audio oscillator is called for. The single-frequency calibration, already explained earlier in the article, eliminates this cause of worry in the case of the A. F. Meter. Any radio man has access to some one or two dependable audio frequencies, and these may be used to calibrate the instrument, as it will presently be shown.

Method 1. The 400-cycle modulating signal in most r.f. test-alignment oscillators and signal generators may be depended upon to be more than reasonably close to that stated frequency. This first method of calibration will, therefore, employ that source.

Turn on the test oscillator and the A. F. Meter and allow them to come up to operating condition. Set the A. F. Meter range switch to 5000 cycles.

If the 400-cycle modulating voltage is externally available at terminals on the oscillator panel, run connections between these terminals and the Meter input jack. A deflection of the microammeter should now occur; and if it does not, depress the deionization switch, S6 momentarily. Adjust R13 slowly until the pointer of the microammeter rests on the 400-cycle point of the scale (which in this case amounts to 40 microamperes). The 0-5000-cycle range is now in calibration, and the accuracy of other frequency readings will depend upon the accuracy of the 400-cycle signal.

Turn the range switch down to the 0-1000-cycle scale and, following the same procedure as above, set the pointer to the 400-cycle position of the scale (which in this case would be 200 microamperes) by slowly adjusting the rheostat, R12.

Now, turn the range switch down

ASSURED STABILITY

WITH
BLILEY CRYSTAL UNITS

**10-20-40-80-160
METER BANDS**

TYPE B5 —This highly active crystal unit for the 40 meter band has less than 4 cycles/mc/°C drift. Price \$4.80.

TYPE LD2 —An efficient and powerful low drift crystal unit for the 80 or 160 meter band. Price \$4.80.

TYPE HF2 —Simplifies the construction of 5- 10- and 20-meter transmitters. Drift, 20 meters, 20 C/mc/°C; 10 meters, 43 C/mc/°C. Price, 10 or 20 meters, \$5.75.

TYPE BC3 —A moderately priced mounted crystal with unusual activity and power output. Drift 23 C/mc/°C. Price, 40, 80 or 160 meters, \$3.35.

BLILEY ELECTRIC CO. • ERIE, PA.

EVERYTHING IN RADIO

HAS IT?

This big book serves your entire needs. It includes sets, parts and supplies, public address, amateur equipment, testers, kits, fluorescent lighting. Nationally known favorites at lowest possible prices. Write today for your copy of this

BIG FREE CATALOG

BURSTEIN-APPLEBEE COMPANY

1012-14 McGEЕ STREET, KANSAS CITY, MISSOURI

EASY TO LEARN CODE

It is easy to learn or increase speed with an Instructograph Code Teacher. Affords the quickest and most practical method yet developed. Available tapes from beginner's alphabet to typical messages on all subjects. Speed range 5 to 40 WPM. Always ready—no QRM.

MACHINES FOR RENT OR SALE

The Instructograph Code Teacher literally takes the place of an operator-instructor and enables anyone to learn and master code without further assistance. Thousands have used and endorse the Instructograph System. Write today for full particulars and convenient payment and rental plans.

INSTRUCTOGRAPH COMPANY

Dept. NR, 4701 Sheridan Rd., Chicago, Ill.

Representatives for Canada
Radio College of Canada, 54 Bloor St. West., Toronto.

CANADIAN SERVICEMEN

can now purchase SUPERIOR Test Equipment direct from *Radio Parts Supply Co., RN4, 962 Bleury St., Montreal, Canada.* They stock our complete line. See pages 39 and 45 in this issue.

SUPERIOR INSTRUMENTS CO.

to the 0-500-cycle range and, as above, set the meter pointer to exactly 400 cycles on the scale (this time corresponding directly to 400 microamperes) by slowly adjusting the rheostat, R11. It is possible on this 0-500-cycle range to obtain a decidedly wide-open reading of 60 cycles by feeding the power-line frequency into the A. F. Meter from the secondary winding of a filament transformer. Indeed, the line voltage frequency might be used to calibrate the 0-500 and 0-1000-cycle ranges if the operator had no other standard available.

If the 400-cycle modulating voltage is not made available externally in the test oscillator, set the latter to any appropriate frequency and couple it to a radio receiver. Tune in the modulated oscillator signal carefully "on the nose" with the receiver. Cut the attenuator down to prevent overloading of the receiver; then connect the A. F. Meter input across the speaker terminals (transformer or voice coil—it makes no difference), whereupon the 400-cycle calibration signal will be available and all of the foregoing calibration procedure may be followed.

Method 2. The standard-frequency broadcasts emanating from the National Bureau of Standards station, WWV are modulated at 440 cycles per second and 1000 cycles per second with audio frequencies of extreme accuracy derived from crystal standards. The normal 5000-kc. broadcast is modulated at 440 cycles per second; and, by preannounced schedule, the 10,000- and 20,000-kc. broadcasts are modulated at 1000 cycles per second.

To utilize these precise audio frequencies for setting the three range calibrations of the A. F. Meter, it is only necessary to be able to tune in these WWV broadcasts. The A. F. Meter is connected across the speaker terminals, as just previously described, after the desired WWV signal has been carefully tuned in. The 440-cycle modulation is used to set the 0-500-cycle range of the meter; and this can be done very accurately, as 440 cycles can be read closely—directly on the 440-microampere graduation of the meter. The 1000-cycle modulation is used to set the 0-1000 and 0-5000-cycle scales; and this adjustment may likewise be made with great accuracy; since on the 0-1000-cycle scale, 1000 cycles per second represents exact full-scale deflection of the meter, and the 100-microampere line on the 0-5000-cycle range.

When using this method, great care must be exercised to keep the background noise of the receiver as low as possible, since the A. F. Meter will tend to indicate the predominant frequency present in the background noise components. In this respect, the tuned-RF receiver might prove much more satisfactory than the superheterodyne if the operator can pick up sufficient signal from WWV in his own locality with that type of set. Fading of the signal will introduce no difficulty, as the reading of the A. F. Meter is constant, as previously pointed out, over a very wide voltage range. In some localities, fading of the WWV signal is accompanied by a type of audio distortion which presumably raises the frequency of modulation up to the second harmonic. The writer has on occasion noticed this effect, when the 440-cycle note

would suddenly ascend to the 880-cycle region. However the picked-up signal was usually stable for a sufficiently long time to permit complete setting of the microammeter pointer before the next tone excursion.

Method 3. Those experimenters who have available, or have access to a precision audio-frequency oscillator of any type might, of course, use that instrument for the direct calibration of each range of the A. F. Meter. Suitable frequencies might be chosen to give easits reading of the meter scale. Other points along the range might also be checked after the initial calibration, although it will be apparent at once to the operator that this procedure is unnecessary, since the entire scale will be in calibration if any one point has been set carefully.

Other Methods. In general, any standard audio-frequency available to the operator may be utilized for calibration purposes. Its voltage and waveform are not important. If the voltage is lower than 1, the signal may be applied to a simple amplifier and the A. F. Meter connected to the amplifier output circuit. Or, if the available signal voltage exceeds 175, it may be reduced to a suitable value with a simple potentiometer. In some cities, the telephone company will supply a standard audio frequency over the 'phone if a certain number is dialed. This tone might be utilized by connecting the A. F. Meter in the output circuit of an appropriate amplifier, connecting a microphone to the amplifier input and placing it near the telephone receiver. The actual "dial tone" of the telephone might likewise be used if the operator can find out from the telephone company what the frequency in his location happens to be. Other methods will be at once evident to those builders who have available single audio frequencies of reliable accuracy.

Should the meter fail to leave zero during any of these adjustments or subsequent attempts to use the instrument, and the power is turned on (as evidenced by glowing of the pilot light), simply depress the deionization switch, S6 momentarily to restore operation.

Uses of the A. F. Meter

The foremost reason for the existence of the direct-reading audio-frequency meter is the rapid indication of frequencies within its range. The utility of electronic instruments is, however, often astounding, applications usually being readily made in fields totally unrelated to communications. Paramount among the applications of interest to our readers will, nevertheless, be those which enable radio-frequency investigations by the direct measurement of heterodyne beat note frequencies.

The A. F. Meter has thus been applied commercially to measure deviation of radio frequencies. An unknown radio frequency is caused to beat with a nearby standard-frequency point and the A. F. Meter used to measure that beat frequency and therefore the cycles (or fractional kc.) deviation from the standard frequency. For example, suppose that a certain unknown radio frequency, picked up on the radio station monitor along with 10-kc. points from a frequency standard, is noted by separate observation of the two signals to lie slightly higher than the 10-kc. point corresponding to

SPRAYBERRY TRAINS YOU
for
GOOD PAY!
STEADY WORK!
ADVANCEMENT!
in
RADIO and TELEVISION



DON'T WAIT! START NOW!

You Can Make Money Almost At Once! You'll be quickly shown how to get and do neighborhood Radio Service jobs for practice and profits. You easily learn Television, Frequency Modulation, Signal Tracing, Mobile Radio (Auto-Tank), Aviation Radio, Electronics, Facsimile Radio, Radio Set Repair and Installation Work. I'll Prepare You Quickly In Spare Time

At Home Or At Camp
SPRAYBERRY Training does not interfere with your present work. You will receive personal coaching service all the way. You'll be fitted to hold down a good paying job in Radio or to have a Radio business of your own.
You Get Professional Test Equipment
... Plus Experimental Outfits
... includes 148 RADIO PARTS (to build complete Radio Receiver), RADIO TOOLS and a TESTER-ANALYZER. MY EXPERIMENTAL OUTFITS enable you to conduct actual experiments with your own hands.

NO EXPERIENCE NEEDED
It makes no difference what your education has been. I can fit you to become a real RADIO TECHNICIAN. Your success is my full responsibility.

THE SPRAYBERRY COURSE IS SOLD UNDER MONEY-BACK AGREEMENT

RUSH COUPON for BIG FREE BOOK

SPRAYBERRY ACADEMY OF RADIO
F. L. Sprayberry, President
425-D University Place, N. W.
Washington, D. C.

Please rush my FREE copy of "HOW TO MAKE MONEY IN RADIO."

Name..... Age.....

Address.....

City..... State.....
(Mail in envelope or paste coupon on penny postcard)

RADIO DIAGRAMS
MOST - OFTEN - NEEDED

MOST OFTEN-NEEDED RADIO DIAGRAMS
ALL MAKES 1926-1938
In this one low-priced manual you have all the circuits you really need. 427 diagrams of most-often serviced radios is the help you want for easier, faster, and better repairs. You will find 4 out of 5 diagrams needed in this manual. 244 pages, large 8½x11 in. size. Special price... **\$1.95**

4 OUT OF 5 CIRCUITS YOU NEED
HOW TO SAVE TIME
Service hints, diagrams, alignment data, test charts, and parts lists included will prove time-savers and money-makers for you. Get these handy "on the job" handbooks. No need to work blind-folded. The time saved in two days will more than pay for these manuals.

MOST POPULAR 1940 RADIO DIAGRAMS
1939-1940 DIAGRAMS
This single manual will give you over 80% of all 1939-40 circuits ever needed, acquaint you with recent radio developments, and teach you how to service quickly millions of sets sold last year. Models of 43 manufacturers. 212 large pages, 8½x11 inches. **\$1.50**
Limited quantity at.....
FREE EXAMINATION

SUPREME PUBLICATIONS, Room 744
3727 W. 13th St., Chicago, Illinois
Ship the manuals checked. I must be satisfied or you will refund my money in full.
 Most Often-Needed Diagrams, 1926-1938 @ \$1.95
 Most Popular 1940 Radio Diagrams @ \$1.50
 I am enclosing \$....., send postpaid.
 Send C.O.D. I will pay the mailman.
NAME.....
(Write address below and send this corner).....

WHY NOT START NOW!

Waiting and wishing will never prepare you for a promising career in the Army, Navy or Commercial communications field. Find out today how you can easily learn RADIO CODE with the Candler System without leaving your own home. Expert radio operators are in demand. The Communications Reserve of the U. S. Navy is enlisting 5400 radio operators. The Candler System is a SPECIALIZED TRAINING backed by over quarter century of success. Candler System was selected by the U. S. Naval Reserve in the ninth district for training radio operators.

Get All the Facts!



Write today for the New Candler Book of Facts. It's FREE! It tells you the whole interesting story of how you can build a career. Send for it today. A postal will do, and there's no obligation.

CANDLER SYSTEM CO.
Dept. N-4,
ASHEVILLE, N. C., U. S. A.

RADIO ENGINEERING

DEGREE IN 2 1/2 YEARS

• Complete Radio Engineering Course in 2 1/2 years. Bachelor of Science Degree. Radio (television, talking pictures and the vast electronic field) offers unusual opportunities for trained radio engineers. Courses also in Civil, Electrical, Mechanical, Chemical, Aeronautical Engineering; Business Administration and Accounting. Tuition, living costs low. World famous for technical 2 1/2-year courses. Special preparatory department for those who lack required high school work. Students from all parts of the world. 58th year. Enter June, Sept., Jan., March. Write for catalog. 1641 COLLEGE AVE. ANGOLA, IND.



TRI-STATE COLLEGE

RADIO

ENGINEERING,

broadcasting, aviation and police radio, servicing, marine radio telephony and telephony, Morse telegraphy and railway accounting taught thoroughly - 48 weeks' Engineering course equivalent to 3 years of college radio work. All expenses low. Catalog free. School established 1874. Dodge's Institute, Oak St., Valparaiso, Ind.

RADIO TECHNOLOGY

RCA Institutes offer an intensive course of high standard embracing all phases of Radio and Television. Practical training with modern equipment at New York and Chicago schools. Also specialized courses in Aviation Communications, Radio Servicing and Commercial Operating. Catalog Dept. RN-41.

RCA INSTITUTES, Inc.
A Radio Corporation of America Service
75 Varick St., New York 1154 Merchandise Mart, Chicago

LES Correspondence Courses in **RADIO and ELECTRICAL ENGINEERING**
ELECTRICAL ENGINEERING Get good electrical field. Prepare yourself at Low Cost, for secure future. Modern course. So simplified anyone can understand quickly.

RADIO ENGINEERING Extra fine course in radio, public address, photo-electric work. Trains you to be super-service man, real vacuum-tube technician. Experimental kits furnished. Diploma on completion.

LOWAS' \$25 Either course, only \$25. Deferred payment plan available. Write for free copies of school catalogs, student magazines, full details. **SEND NO MONEY!**
LINCOLN ENGINEERING SCHOOL, Box 331-R 28, LINCOLN, Neb.

RADIO-TELEVISION

Oldest, largest Radio-Television school in West trains you for good pay job. Complete instruction including Radio Construction and Service, Broadcast Operating, Sound, Talking Pictures, Television, Public Address, etc. Flexible plan to meet specific needs of those with or without jobs. Transportation allowed to L. A. Exam room and board while learning. Request Free Catalog.

NATIONAL SCHOOLS Dept. 4-RN
Los Angeles

RADIO NEWS —
first with the latest news.

3990 kc. A beat note is set up, as a result, with the 3990-kc. standard-frequency point. If the A. F. Meter is connected to the output circuit of the monitor, it reads, let us say, 4000 cycles, which means that the unknown transmitter or oscillator frequency is exactly 4000 cycles (4 kc.) higher than 3990 kilocycles—or its exact value is 3994 kc. If the beat note, as indicated by the Meter had, on the other hand, been 50 cycles (0.05 kc.), the exact frequency of the signal would be 3990.05 kc., a very close figure, but not the closest possible with the meter.

In making rapid checks against a frequency standard in crystal grinding operations, the A. F. Meter is particularly useful. It is of equal value in checking the progress of grinding—as when approaching a certain frequency in steps of a few kilocycles—as in actually finishing crystals off to a fraction of a kilocycle. An example would be the grinding of a crystal to such a fractional frequency as the experimental-station frequency, 3492.5 kc. Using a 100-kc. oscillator-10-kc. multivibrator type of r.f. standard, the point 3490 can easily be located on a satisfactory monitor or radio receiver. The crystal is then ground until the signal from the oscillator in which it is being tested zero beats the frequency 3490. It is then ground further until the beat note between its own frequency and the standard 3490-kc. point (as indicated by the A. F. Meter) becomes 2500 cycles (2.5 kc.) corresponding to 3490 plus 2.5 kc., or 3492.5 kc.

Actual sound pitches may be checked directly and quickly by picking them up with a microphone, feeding them into an amplifier, and operating the A. F. Meter in the output of the amplifier. In this manner, musical instruments might be tuned very accurately by knowledge of the exact note frequencies, the pitch of horns, bells, chimes, and the like adjusted (provided these were of single-frequency or predominant-frequency characteristics), industrial noises arising from machinery and other sources might be classified as to frequency and suitable steps then taken for their elimination, etc. The instrument is fast enough to follow the frequency fluctuations of the voice, but within the input limits mentioned earlier will not be influenced by the degree of loudness of speaking or singing.

The A. F. Meter has already been used extensively as a deviation meter in radio stations to indicate the extent of movement from the assigned carrier frequency. Two methods may be applied. One employs a precise crystal oscillator on the station's exact assigned frequency. The actual carrier of the station is caused to beat with this crystal frequency, and the result noted with the A. F. Meter. When the station is operating exactly on its assigned frequency, the Meter will read zero. As the carrier frequency deviates from the assigned frequency, however, the meter will begin to read the exact number of cycles (or kilocycles) deviation.

When the a.f. meter is employed as a carrier-frequency deviation meter, as in the foregoing description, it is not capable of showing whether the deviation is higher or lower than the

assigned frequency. Another application takes care of this more refined indication. The "monitoring" crystal is ground on a frequency slightly different from that of the assigned frequency: say, for illustration, 1 kc. higher in frequency. When the station is operating exactly on its assigned frequency, a beat note of 1000 cycles will then be set up with the monitoring crystal. The a.f. meter recording this beat note can be set to read 1000 cycles at mid-scale, on a 0-2000-cycle range, whereupon the reading will decrease when the carrier frequency deviation is in the negative direction, or increase when deviation is in the positive direction.

There are multitudinous other applications of the A. F. Meter. We do not pretend to have even skated close to them all. A separate paper might easily be written on each possible application. Many such uses will occur to any owner of this useful electronic instrument—many jobs will be made easier and their solutions more quickly arrived at by the meter.

We believe that if the reader just thinks through a few of the profitable applications of the instrument, he will, upon being duly surprised at its low cost and easy calibration, set right out to duplicate the one we have shown. He might even provide himself with more frequency ranges than the three we have shown.

Police Radio

(Continued from page 26)

operators are being called into active service all over the country.

Others are leaving for the civilian jobs the FCC and other government agencies are making available, such as monitoring officers, teaching positions in the Army, NYA, etc.

It is with deep regret that the police field must give these men up, however we realize they are taking part in our National Defense program, and we wish them all the luck in the world in their new venture.

VWOA Police Ops

THE fact that a surprisingly large percentage of police radio ops are eligible for a VWOA membership was shown at a meeting of the VWOA on Tuesday, Feb. 11, at the Lake Shore Athletic Club in Chicago.

Bill Halligan of *Hallifrafter* fame was the host and chairman of the meeting assisted by George Martin of *RCAI*. Halligan was also awarded a life membership in the organization. Some of the vet police ops attending were Jack Dodman, Harvey Kohnitz and Gilbert Matthews of the *Illinois State Police*, Lou Baer, John Schultes, Pete Rice and Elmer Webster of the *Chicago Police*.

Notes of Interest

WE'VE noticed in several UHF municipal installations that the signal strength of the station house transmitter was great enough in the area which it covered to eliminate one of the IF stages in the patrol car receivers. This of course will decrease the sensitivity of the receiver, however noise pulses will not be as bothersome, and the available signal strength overcomes this loss in amplification. Variable r.f. gain controls also would be welcome additions to UHF receivers in most cases.

Many police installations still using all wave receivers set on one frequency often experience oscillator frequency drift. This drift may be compensated for by installing a new Centralab negative temperature coefficient condenser across the oscillator coil, and readjusting the oscillator trimmer.

The squelch circuit on the model AR 5013 RCA police receivers can be made more sensitive by replacing the 85 second detector

RADIO made EASY

LEARN AT HOME - IN SPARE TIME!

36 VOLUMES in 1 Big Book!

1. Broadcasting System
2. Sound, Speech, Music
3. Electronic Theory: Electric Current
4. Elec. Units; Ohm's Law
5. Electric Circuits
6. Magnetism
7. Electromagnetism
8. Electromag-Induction
9. Inductance
10. Capacitance; Condensers
11. A.C. Circuits
12. Filters
13. Measuring Instruments
14. Radio Waves
15. Broadcasting
16. Receiving
17. Vacuum Tube Principles
18. V. T. Characteristics
19. Vacuum Tube Construction
20. V. T. Detector and Amplifier Action
21. Radio Frequency A.M. Application
22. "Superhets."
23. R.F. Amplifiers; Tuning Coils
24. Audio Amplifiers
25. Loudspeakers
26. Battery Receivers
27. Power-Supply Units
28. Electric Receivers
29. Auto and Aircraft Radio
30. Photo Pick-up: Public Address
31. Short-Waves
32. Photoelectric Cells; Cathode-Ray
33. Television
34. Antennas and Grounds
35. Testing; Servicing
36. Sound Pictures

Ghirardi's COMPLETE Course will train you QUICKLY

Here's your **BIG CHANCE** to get a thorough training in basic RADIO FUNDAMENTALS—quickly, easily, without previous experience or study. Today there are **HIG OPPORTUNITIES** and lots more jobs for men with radio training—in radio factories, in radio service shops—and in all branches of the Army and Navy.

RADIO, SOUND, TELEVISION —MADE EASY AS A. B. C.

Ghirardi's famous **RADIO PHYSICS COURSE** is the quickest short-cut radio training you can find. The most complete and most economical too! His clear explanations, graphic illustrations, and 856 self-testing Review Questions make it as easy to understand as a primer. Thousands of successful radio men got their start with this book, and it's used by more radio technicians and students than any other radio text in the world! Get this whole 972-page course today for only \$4—and get started on your own radio career!

Use it 5 Days —OUR RISK!

Your money back if not fully satisfied. Don't delay—get started now—mail this coupon at once!

972 Pages 508 Illus.

\$4

Only 4

RUSH COUPON TODAY!

Radio & Tech. Publ. Co., Dept. RN-41, 45 Astor Pl., N. Y.

Enclosed find payment for my: MODERN RADIO TROUBLE SHOOTER'S BOTH books at \$6.50 Special Combination Price

RADIO PHYSICS COURSE, with your 5-day Money-Back Guarantee.

Name

Address

City

State

Send me free literature.

and squelch control tube with a 75. A quarter megohm resistor should be inserted in series with the plate of this tube.

Story of the Month

THE prize true story of the month happened at one of our large State Police stations. It seemed the transmission line went out, and the radio supervisor strung up a wire on the roof of the building to act as an emergency antenna.

As the kilowatt was applied to the antenna, the police clerk sitting at the telephone switchboard nearly jumped out of his chair as he noticed all the lights on the board go on at once. Thinking it was a blockage brewing, he immediately grabbed for all the plugs he could get his hands on and plugged up the lines. At this moment the carrier happened to be turned off, and the lights in the board went out. The clerk then began to answer the lines he had plugged up one at a time, but to his dismay all he could get was the local operator with the familiar "Number, please?"

After a logical explanation by the supervisor of the induction of r.f. currents into the telephone lines, he finally settled down, but with very disgusting thoughts about radio operators in general.

-30-

Technical Review

(Continued from page 40)

Contains 24 pages—26 illustrations—2 colors. This humorous publication explains for the first time the difference between the various types of slide rules available, in straightforward, salty language. Although written primarily for students in engineering colleges, this booklet contains slide rule information of interest to the entire engineering profession. Free upon request. *Keuffel & Esser Co., Hoboken, N. J.*

PHOTO RELAYS.

Their Theory and Application, by F. H. Shepard, Jr., published by *Manville Press, Inc.*, New York City. 26 pp. with diagrams and illustrations. Price 25 cents. The photo relay, or light operated relay has been used for many years. It is a device which lends itself to the imagination and has been, perhaps, too often used because of its appeal as a "spectacular" and "mysterious" device. For this reason, it has been used in places where it had no justification; where the results could have been obtained satisfactorily by simpler, more straightforward means. It is the desire of the author to point out that when used conservatively and with the same "factors of safety" that are generally used in other electrical and mechanical equipment, the degree of reliability of photoelectric equipment should equal and even surpass that expected of other electrical and mechanical equipment. The following chapters are included: Photoelectric Phenomena—Amplifiers—Glow Discharge Tubes—Light Sources—and Applications. Price 25 cents. *Manville Press, Inc.*, New York City.

-30-

Manufacturers' Literature

(Continued from page 40)

two colors on heavy coated paper—opens with a presentation of the popular *RCA Dynamic Demonstrator*, which dramatizes radio circuit theory and action to show how complicated circuits operate. It concludes with another new feature—a listing of transmitting and special purpose

Learn RADIO SERVICE WORK with these 2 BIG Ghirardi BOOKS

MODERN Radio SERVICING

Learn HOW with this!

Here's the world's most highly praised course in practical radio service work—all for you in this one handsome 1300-page home-study book. First, a big 420-page section explains all types of servicing test instruments—how they work, how constructed, how to build, how to use them. Then, 900 more pages give you a thorough, step-by-step procedure course in trouble-shooting, testing, adjusting and repairing all makes of radio sets and other electronic devices by latest scientific "factory methods" that fix sets quicker. Learn how to do radio servicing this quick, easy, economical way right in your own home! Learn WHAT to do and HOW to do it. Send for your copy today. **\$4**

1300 pp. 708 illus. 720 review questions

RADIO Trouble-Shooter's HANDBOOK

Save TIME with this!

Time is money... Save it!

Here's real help for servicemen—518 big manual-size pages of valuable, time-saving, factory-checked servicing data right at your finger tips to help you do every servicing job quickly and accurately. Its 52 BIG SECTIONS contain 275 jumbo pages of time-saving "Case Histories" on over 3,500 receivers... Alignment data for over 15,000 superhets... Servicing and installation data for all Auto Radios, Intercommunicators and Sound Recorders... Trouble-Shooting Charts... RMA Codes... Trade Directories... Wire, Tube, Resistor and Condenser Charts. **52 BIG SECTIONS** in all! Speed your service work with all the vital servicing data this big book contains. Send for YOUR copy today. **\$3**

518 pp. 134 illus. 8 1/2 x 11 size. Fabricoid.

MAIL COUPON TODAY!

Radio & Tech. Publ. Co. Check here for FREE circulars.

45 Astor Pl., New York, Dept. RN-41

Enclosed find payment for my:

MODERN RADIO TROUBLE SHOOTER'S BOTH books at \$6.50 Special Combination Price

RADIO SERVICING HANDBOOK

NAME

ADDRESS

CITY

STATE

MONEY-BACK IF NOT SATISFIED!

Are Army Air Corps Standards Too Strict?

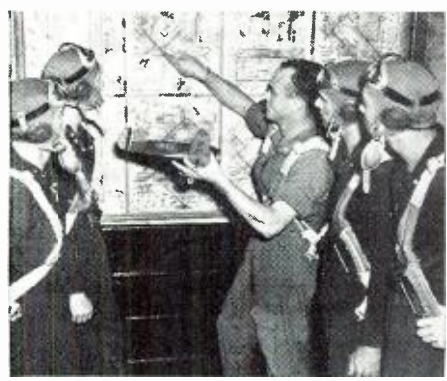

Do the Air Corps Schools deliberately "wash out" a predetermined percentage of students? Are eliminations arbitrary, sudden and final? Should young men who "flunk" because of "an inherent inability to fly" be given a second chance? The startling answers to these and many other highly controversial questions on Air Corps standards can be found in two authoritative and timely articles in the April *FLYING* and *Popular Aviation*. By all means don't miss this "debate" in the

APRIL ISSUE

FLYING AND POPULAR AVIATION

NOW ON SALE AT ALL NEWSSTANDS—25¢

RADIO OPERATORS WANTED

The National Defense Program is creating innumerable openings for Commercial Radio Operators—Now is the time to capitalize on your radio training and experience by obtaining a commercial operator's license and taking advantage of the many opportunities presented—The "RADIO OPERATORS' LICENSE GUIDE" has been especially prepared as a study and reference manual for those radiomen having considerable training and experience who are unfamiliar with the exact requirements for a commercial radio operator's license—Containing over 1,250 questions and answers to the new type examinations it will aid you to pass the tests—Only three dollars postpaid or purchase from your local parts distributor.

WAYNE MILLER

The Engineering Building • Chicago, Ill.



LEARN RADIO

**SERVICING COURSE—8 WEEKS
OPERATING INCLUDES SERVICING—5 MONTHS**

H. C. Lewis
I'LL FINANCE YOUR TRAINING

Mail coupon today for free book showing how you can learn Radio Operating, Servicing, Sound and Television in a few short weeks in Coyne Shops and also how you can pay tuition in easy monthly payments after graduation.

LEARN BY DOING

On real Radio receiving and transmitting equipment at Coyne. Simple, easy method of practical shop training. You don't need previous experience. Prepare for Radio Operators' Government license Exam. and for good jobs in Broadcast, Police Radio, Aircraft Radio, Ships, Commercial Radio stations, or in service shops and radio factories. "Learn by doing", the quick, modern way, at Coyne Shops in Chicago.

EARN WHILE LEARNING
Job Help After Graduation

We assist you in getting part-time work to help pay living expenses and give you real employment service after you graduate.

**H. C. LEWIS, Pres., COYNE RADIO SCHOOL,
500 So. Paulina St., Dept. 41-31, Chicago, Ill.**

Please send me your free book and details of easy Pay-After-Graduation Plan.

NAME _____
ADDRESS _____
CITY _____ STATE _____

**SEND
COUPON
TODAY**

WASHINGTON COVERAGE! READ RADIO NEWS

Classified

Rate 15c per word. Minimum, 10 words.

CORRESPONDENCE COURSES

AMATEUR Radio licenses, training in code and theory. Resident and home study courses. Hundreds of licensed students. American Radio Institute, 1123 Broadway, New York.

USED Correspondence Courses and Educational Books sold or rented. Inexpensive. Money-back guarantee. Write for Free Catalog listing 4000 bargains. (Courses Bought.) Lee Mountain, Pisgah, Alabama.

CORRESPONDENCE courses and educational books, slightly used. Sold. Rented. Exchanged. All subjects. Satisfaction guaranteed. Cash paid for used courses. Complete details and bargain catalog free. Nelson Company, 500 Sherman, Dept. D-237, Chicago.

PATENT ATTORNEYS

PATENTS—Advice and booklet free. Highest references. Best results. Promptness assured. Watson E. Coleman. Patent Lawyer, 724 9th Street, Washington, D. C.

PATENT your idea—Simple inventions often valuable. Two advisory books—free. Victor J. Evans & Co., 429-D Victor Building, Washington, D. C.

INVENTORS—Before disclosing your invention to any one send for Form "Evidence of Conception"; "Schedule of Government and Attorneys' Fees" and instructions. Sent free. Lancaster, Allwine & Rommel, 414 Bowen Building, Washington, D. C.

PHONOGRAPH RECORDS

PHONOGRAPH Records 10c. Catalogue. Paramount, FE-358 East Market, Wilkes-Barre, Pennsylvania.

PHOTO FINISHING

ROLLS DEVELOPED, two prints each and two free enlargement coupons, 25c. reprints, 2c each; 100 or more, 1c. Summers Studio, Unionville, Mo.

PHOTOGRAPHIC COPYING

LICENSES, wiring diagrams, etc., photographically copied. Enlarged or reduced. Sample 5x7 print, 10c. William D. Hayes, Box 1433-R, Oakland, California.

RADIO ENGINEERING

RADIO Engineering, broadcasting, aviation and police radio, servicing, marine and Morse telegraphy taught thoroughly. All expenses low. Catalog free. Dodge's Institute, Elm St., Valparaiso, Ind.

tubes. The new test equipment items include the Junior VoltOhmmyst, low-cost electronic voltmeter-ohmmeter; a Deluxe Tube Tester and Pre-heater; the newly-styled 3-inch Cathode-Ray Oscillograph, No. 155; and the A-C Test Oscillator, No. 167.

Another new feature is the inclusion of a complete series of transmitting-tube sockets, coinciding with the announcement of substantially lower prices on six popular types.

Most notable addition to the pages devoted to parts and accessories is a home recorder and automatic record player unit designed for phonograph modernization. In addition, RCA's popular replacement parts guide, included in the 1940 catalog, has been brought up to date.

The catalog also shows microphones, radio, FM, and television antennas, radio and television parts and accessories, and devotes a full page to the new AR-77 Communication Receiver, which marks an important advance in receiver design for amateur and general communication services. Free.

NATIONAL RECORDING SUPPLY CO., Hollywood, Cal., in February issued its 1941 catalog, highly illustrated in colors, for recording machines and its complete line of recording accessories.

The firm has just announced a line of four types of recording blanks, coated on paper, bond base, aluminum and heavy alloy base in various sizes. Long wearing, durable, economical, with low surface noise, the discs are manufactured for professional or home use.

Newest single item in the *National* catalog is a small coated blank made especially for amateurs in the form of a patented *National* QSL disc. Recent developments indicate that many amateurs now possess recording equipment and, instead of the old-time postcard, now use a disc to record other amateurs' talks and send them through the mails.

The Hollywood company, the staff of which represents many years of recording sales and service, has specialized in grouping complete recording accessory lines under one roof where it is available to dealers from the one source.

Playback and cutting needles, in various types of material, has been assembled for dealer trade in varying quantities, and ranging from the highest degree of perfection to what the trade knows as "competitive items," packaged as *National* brand, or for private brand use by individual dealers. Other accessories include albums, crystals, pickups, marking ink, mailing envelopes, etc.

PRECISION BOBBINS. *Precision Paper Tube Company*, 2033 West Charleston Street, Chicago, Illinois, have just issued a new Bulletin, with bobbin data sheet, illustrating and describing their line of dielectric paper coil bobbins.

Where space becomes an important factor, a comparison between layer

and bobbin wound coils is given and illustrated, showing the advantages of using Precision Bobbins.

Manufacturers of coils, relays, solenoids, small motors, photo-electric devices and other electrical actuated equipment using coils, will find this bulletin most interesting. A copy may be secured by writing.

RADIO INSPECTION SERVICE CO. CATALOG. As one of the leading jobbers in Connecticut, *Radio Inspection Service Company* has released their latest catalogs to the trade. A veritable encyclopedia of radio parts and equipment with almost 300 pages of description, specifications and prices of their entire line. It is an extremely useful book to have on your desk, so drop a line to *Radio Inspection Service Company*, 227 Asylum Street, Hartford, Conn., and get your copy. Free.

1941 EDITION OF SPRAGUE INTERFERENCE MANUAL. Servicemen who recognize the fast-growing business possibilities in radio interference elimination will find much of interest and help in the new, 1941 edition of the famous *Sprague Manual* of Radio Interference Elimination, just issued by the *Sprague Products Company*, North Adams, Mass., makers of *Sprague* Condensers, Test Equipment and Koolohm Resistors. It is available, either direct or through *Sprague* jobbers at a net price of 25c.

Fully revised to cover important new developments including interference elimination from fluorescent lighting, use of the new Model IL-2 Interference Locator and various new filter procedures for modern requirements, the Manual should prove indispensable to the serviceman who makes a point of keeping abreast of developments in this rapidly expanding phase of his business.

From a study of noise-reducing antennas, to locating and remedying all types of man-made radio noises, the Manual is a complete guide. Throughout, it is based on practical rather than theoretical experience, as gained by *Sprague* engineers in more than three years of intensive field research with public utility and interference elimination specialists. Price 25c. *Sprague Products Co.*, North Adams, Mass.

TURNER VIBRATOR MANUAL. *The Turner Company*, of Cedar Rapids, Iowa, U.S.A., are distributing a new catalog, 1-41, to the trade. The new Turner Vibrator, which works on the push-pull principle, has been made available as replacement units for all makes of receivers. Included within the pages of the catalog is a complete vibrator index, showing the proper type to use for all applications. Furthermore, valuable technical data is included as an aid to the engineer and serviceman. Unlike the ordinary vibrator, these new units work on an entirely new principle and, the manufacturers claim, improved perform-

ance may be had by using them for all replacements. Copies are available from the *Turner Company*, Cedar Rapids, Iowa.

PHILCO. Parts, Accessories, Tubes and Batteries. *Philco Radio & Television Corporation*, Philadelphia, Pa., have published a new catalog with reference listing of parts for all models of *Philco* radios, tubes for 1941, 1940, 1939, 1938 *Philco* radios, and a complete line of batteries for all farm radios and portables. The list prices of all parts are shown on page 49, which is a valuable aid to the serviceman in basing his estimates covering materials to be used on a repair job. The accessory folder is intended for use as an envelope stuffer in mailings made by dealers and servicemen. The 1941-Parts Catalog includes valuable reference information in the form of listings, according to model numbers, of the parts, tubes, and batteries required for replacement purposes in the 15 million *Philco* radios. Authorized servicemen may obtain a copy by writing to the *Philco Radio & Television Corporation*, Philadelphia, Pa.

RCA RECEIVING TUBE CHARACTERISTICS CHART (1275-B) This new chart, which now covers three hundred and nine types of receiving tubes, retains the convenient booklet form of the preceding edition. Included are data on all *RCA* glass and metal receiving tube types arranged in numerical-alphabetical order. The first two pages show a classification of the types according to their cathode voltages and their functions. Types having similar electrical characteristic are grouped in parentheses. This classification will assist the tube user in identifying type numbers and in choosing a tube type for an application. The last two pages show socket connections with *RMA* designations. Our readers may obtain a copy of the chart from the Commercial Engineering Section, *RCA Manufacturing Co., Inc.*, Harrison, N. J.

CINAUDAGRAPH SPEAKERS 1941 CATALOG. A new printing describing the latest *Cinaudagraph* speakers. Included are radio and P. A. speakers, air column sound projectors, linear standard speakers, and woofer-tweeter units. Copies are available from *Cinaudagraph Speakers, Inc.*, 2 Selleck Street, Stamford, Conn.

AEROVOX TRANSMITTING CAPACITOR CATALOG. Capacitors for the design, construction, testing and maintenance of radio transmitters, electronic devices, laboratory apparatus, fine instruments and similar work are described in this new catalog No. 1780. This *Aerovox* Transmitting Capacitor Catalog contains not only a listing of such standard types as are deemed most desirable for transmitting and other critical applications, but also a compila-

tion of essential technical data dealing with dimensions, terminals, mountings, electrical characteristics, and, in the case of the mica capacitors, radio-frequency current-carrying capacity, etc. They believe that this is the first time that such extensive data has been made generally available to the designing engineers. For further information as to obtaining a copy, write to the *Aerovox Corporation*, New Bedford, Massachusetts.

AEROVOX MOTOR-STARTING CAPACITOR MANUAL. Replete with practical application data, in addition to handy listings of electrolytic and oil motor-starting capacitors, the new 1941 edition of the *Aerovox* Industrial Capacitors Manual should be in the working library of every man engaged in servicing refrigerators and fractional horsepower motors utilizing capacitors. For the first time this edition introduces a numerical cross-section of *Aerovox* types with such data as A.C. voltage, actual range, nominal range, dimensions, illustrations, list price, and corresponding parts numbers of motor manufacturers. The alphabetical listings of motor types and their capacitor requirements, are more extensive than ever before. To simplify inventories and the handling of rush servicing jobs, there are listed certain standard *Aerovox* capacitors which serve a plurality of motor types, as so-called universal replacements, as well as the exact-duplicate replacements. A copy of the manual is obtainable from the local jobber, or from *Aerovox Corporation*, New Bedford, Mass., on request.

HOWARD announces three new free catalogs. Included is the 490 Technical Manual. In addition to full charts and schematics on the *Howard* 14-Tube Professional Receiver, several pages are devoted to the art of receiver measurements. A good technical book for amateurs, servicemen and sound engineers. The other catalogs are Folder 103, containing recording discs and needles; and Folder 104, complete line of Communication Receivers and Accessories. Free. *Howard Radio Co.*, 1731 Belmont Ave., Chicago, Ill. -30-

Aviation Radio
(Continued from page 23)

tapped, and mounted either underneath the belly of an aircraft or on top of the aircraft at the center junction of the wings. Methods of installation are dependent on the construction of the aircraft and the availability of space for the compass receiver.

IMPROVEMENTS to existing equipment which aids blind flying and over-cloud navigation, are being made every day. The *Harvey Machine Company* of Los Angeles seems to have the answer to the "automatic pilot-radio compass" aid to flying. This device enables the aircraft to fly directly to a station; with angular drift being compensated for by an intricate system of circuits in the radio receiver combination. This new aid to navigation will fly the airplane on a straight course, regardless of side-winds, to a predetermined destination.

FREE!
RADOLEK'S
NEW 1941
RADIO
PROFIT
GUIDE



**Bargains /
Galore Like These.**
**PORTABLE RECORDER
and Play Back
Combination \$19⁷⁵**

A complete self-contained Portable Recorder and Electric Phonograph. Nothing else to buy. Consists of combination record cutter and playback pickup, constant speed 78 RPM motor with weighted turntable, built in 3 tube amplifier complete with tubes, volume control, PM dynamic speaker, crystal microphone and desk stand. Entire unit housed in alligator grain bakeloid covered case, size 13" x 13" x 7". Uses standard acetate discs and needles. For 110 volt 60 cycle AC operation.



**BASIC RECORDER
\$7²⁵**

Same combination recording and playback chassis as used in above unit. For build-your-own recorders or for use in conjunction with radio receiver. Includes combination cutting head and playback pickup with feed mechanism, constant speed 78 RPM motor with 8 1/2" weighted turntable and needle cup installed on 3/8" leatherette covered mounting board ready to use with your own microphone and recording amplifier. Mounting space required 12 1/2" x 12 1/2" depth, 3" below board and 3 1/2" above board. For 110 volt 60 cycle AC operation.



**PROFESSIONAL TYPE
10" RECORDING DISCS
only 19¢**

Made by foremost manufacturer. Proven equal or superior to any discs of this type regardless of cost. These blanks have very slight imperfections but guaranteed to make perfect recordings or your money back. Coated on both sides - heavy metal base - non-inflammable. Big savings! 6" Discs - 10c; 8" - 14c; 10" - 19c; 1c less in 25 lots. Send no money - shipped C.O.D. plus postage.



**EVERYTHING NEW IN RADIO
AT BARGAIN PRICES!**

Shows hundreds and hundreds of up-to-the-minute radio parts, sets, accessories, ham gear, electric appliances and supplies. Indispensable to every amateur, experimenter, set builder, sound engineer and service man. Keep up with radio and all its phases - send for the big FREE Radolek Profit Guide now! DON'T WAIT - SAVE MONEY AT RADOLEK.

SEND TODAY! PASTE ON A POST CARD

**RADOLEK CO., Dept. B-53
601 W. Randolph St., Chicago, Ill.**

Send FREE Catalog.
 Ship PORTABLE RECORDER C.O.D. \$19.75 Plus Postage.
 Ship BASIC RECORDER C.O.D. \$7.25 Plus Postage.
 Ship _____ Discs; Size _____ inches, C.O.D. Plus Postage.

Name _____
Address _____



*"Let's look
at the record"*

● We hear a lot these days about this oil and that oil used in oil-filled condensers. Almost sounds like a barber shop with its confusing array of hair tonics, each one with a high-falutin' name and with claims that exhaust the dictionary of superlatives.



But in the final analysis it's the performance that counts. That's why Aerovox hasn't entered the battle of superlatives. Rather, Aerovox rests its case strictly on the performance of its Hyvol Transmitting Condensers out in the field. Tens of thousands are in daily use. They tell the story better than we can. And so, borrowing the phrase, we simply say, "Let's look at the record."



Ask Your Jobber...

He'll gladly show you the Aerovox Hyvol Transmitting Condensers available in several types, many sizes, and in all popular capacities and working voltages up to 7500 D.C.W. Ask for new 1941 catalog—or write us direct.



Due to the directive qualities of the radio compass, this phenomena is put to practical usage by tuning in a station on "rear course" or "front course" or by using both stations, front and rear. The latter method makes for greater navigational accuracy.

Further tests on this new device are being made every day, and apparently it seems to be the center of attention at one of the largest air fields in the United States.

General

A FEW letters have come to the attention of the writer concerning the combined dynamotor (power unit) tester and signal tracing oscillator, mentioned in December's issue.

In answer to those inquiries, let it be said that a construction article is being prepared, which will give full data; taking into consideration, parts used; how operated; and the different applications of this instrument.

Many pilots do not realize the importance of reeling out their trailing antenna (used for transmitting) to the exact length. Having ten feet too much, or too little wire reeled out, will cause a tremendous drop in the efficiency of the entire system, and may even cut the transmission range in half. Furthermore, most aircraft anti-noise type microphones which are damped highly, used with aircraft transmitters, are of the close-talking type, and to get the best results from the transmitter, it is necessary to hold the microphone in a near-vertical position very close to, or actually touching the lip. When holding the mike in this manner, it will usually be found that it is only necessary to talk in a normal tone of voice, and it will be much easier for the person listening in, on the ground, to understand the pilot.

The above, passed along to pilots by the radio technician and serviceman will prove helpful, and will be appreciated in any event.

Thanks to D. K. Warner, engineer of RCA's Aviation Radio Sales for his assistance in solving a few problems which satisfactorily pleased a few of our readers by way of photograph references.

Those radio operator-pilots owning "dry" battery operated receivers, are cautioned not to depend upon them if they are not certain as to the condition of the installed batteries before take-off. If an aircraft radio manufacturer or portable set manufacturer tells you that the set will operate efficiently for 125 hours without changing batteries; change them when the service time has reached 100 hours. (This is no reflection on manufacturers but is a safe-guard promulgated for one reason, SAFETY!)

If possible, a battery "time-log" should be kept by the set owner if the set is to be depended upon for instrument flying. (Radio navigation)

Hint of the Month

TYPEWRITER oil has many uses around aircraft radio equipment, and equipment "cabineted" in crackle finished metal. Because a small amount will go a long way, it is quite economical.

A few drops on tuning gears in both direct and remote control mechanisms will provide the correct amount of lubrication necessary. However, some mechanisms are grease filled, and typewriter oil has no place in these. Another use, apply a small amount on a good dry cloth, and go over the outsides of transmitter, receiver, and control cases; then wipe the surplus dry. A shiny luster appears as if by "magic" and reflects the thoughtfulness of the technician.

New Radio Loop

A NEW loop antenna, (AVA-56-A) manufactured by RCA, is used to enable aural null direction finding in aircraft when used with receivers which will match the adapter kits. This new loop is remotely operated by means of a flexible cable and tuning mechanism, and enables the pilot or radio operator to take bearings for "position fix" while in flight.

The outstanding feature that the writer sees in this new loop is that of remote control which allows the compass receiver to be placed anywhere in the plane; the distance from the tuning mechanism being controlled by the length of the control cable, which is 12 feet long.

SERVICEMAN'S CASE HISTORIES

Reprinted with permission, from **RADIO Trouble Shooters Handbook**. Copyright, 1939, Radio & Technical Publishing Co. Copyright in Canada and Great Britain, and all countries subscribing to the Berne Convention, by Radio & Technical Publishing Co. All rights reserved.

GOLDENTONE

Case Histories are listed under "Fordson"

GOODYEAR-WINGS Receivers

See Case History listings under Belmont

GRAYBAR RECEIVERS

GRAYBAR GB-4

(Uses same chassis as RCA R-5 receiver.) See the Case Histories listed for the RCA R-5 receiver

GRAYBAR GT-7

(Uses same chassis as RCA R-4 receiver.) See the Case Histories listed for the RCA R-4 receiver

GRAYBAR GB-8

(Uses same chassis as RCA R-7 receiver.) See the Case Histories listed for the RCA R-7 receiver

GRAYBAR GT-8

(Uses same chassis as RCA R-8 receiver.) See the Case Histories listed for the RCA R-8 receiver

GRAYBAR GB-8A

(Uses same chassis as RCA R-7A receiver.) See the Case Histories listed for the RCA R-7A receiver

GRAYBAR GB-9

(Uses same chassis as RCA R-11 receiver.) See the Case Histories listed for the RCA R-11 receiver

GRAYBAR GC-13

(Uses same chassis as RCA R-6 receiver.) See the Case Histories listed for the RCA R-6 receiver

GRAYBAR GC-14

(Uses same chassis as RCA R-12 receiver.) See the Case Histories listed for the RCA R-12 receiver

GRAYBAR GT 8-56

(Uses same chassis as RCA R-71 receiver.) See the Case Histories listed for the RCA R-71 receiver

GRAYBAR GT 8-69

(Uses same chassis as RCA R-72 receiver.) See the Case Histories listed for the RCA R-72 receiver

GRAYBAR GT10-69

(Uses same chassis as RCA R-74 receiver.) See the Case Histories listed for the RCA R-74 receiver

GRAYBAR GT10-88

(Uses same chassis as RCA R-76 receiver.) See the Case Histories listed for the RCA R-76 receiver

GRAYBAR GT10-99

(Uses same chassis as RCA R-77 receiver.) See the Case Histories listed for the RCA R-77 receiver

GRAYBAR GB-100

(Uses same chassis as RCA R-55 receiver.) See the Case Histories listed for the RCA R-55 receiver

GRAYBAR GB-310

(Uses same chassis as RCA Radiola 18 receiver.) See the Case Histories listed for the RCA Radiola 18 receiver

GRAYBAR GB-311

(Uses same chassis as RCA Radiola 33 receiver.) See the Case Histories listed for the RCA Radiola 33 receiver

GRAYBAR GB-320

(Uses same chassis as RCA Radiola 51 receiver.) See the Case Histories listed for the RCA Radiola 51 receiver

GRAYBAR GB-330

(Uses same chassis as RCA Radiola 60 receiver.) See the Case Histories listed for the RCA Radiola 60 receiver

HALLICRAFTERS

on Easy Terms!

See
**ALLIED'S
FREE**
New 1941
**SPRING
CATALOG**



Compare These 1941 Features of The Hallicrafters SX-28

15 tubes—two stages preselection—calibrated bandspread inertia controlled—micrometer scale tuning inertia controlled—tone and AC on-off—beat frequency oscillator—AF gain—RF gain—crystal phasing—adjustable noise limiter—send-receive switch—AVC-BFO switch—bass boost switch—phono jack—80, 40, 20 and 10 meter amateur bands cali-

brated—wide angle "S" meter—band pass audio filter—improved signal to image and noise ratio—push-pull high fidelity, audio output—6 step wide range variable selectivity—improved head-phone output.

Amateur Net, Less Speaker, \$159.50
\$15.95 Down, \$12.68 Monthly for 12 Months

**THE
SKY
BUDDY
MODEL
S-19R**



The Sky Buddy covers everything on the air from 44 mc. to 545 kc. including the 10, 20, 40, 80 and 160 meter amateur bands. Employs the same electrical bandspread system used in higher priced Hallicrafters Models. Controls are arranged for maximum performance with minimum effort.

Amateur Net, \$29.50
\$4.43 Down, \$4.43 Monthly for 6 Months

**THE
SKY
CHAMPION
MODEL
S-20R**



The best value ever offered in the communications field. 9 tubes—4 bands—tunes from 540 kc. to 44 mc.—has all the essential controls for good amateur reception—built-in speaker—provision for operation from batteries or vibrapac.

Amateur Net, \$49.50
\$4.95 Down, \$5.90 Monthly for 8 Months

ALLIED RADIO

Send for this
**NEW 1941 RADIO
CATALOG FREE**
180 pages

Just off the press. Find out how Allied's Time Payment Plan saves you time and money. There's no red tape at Allied! Send for the Catalog Today!



Dept. I-HD-1, 833 W. Jackson Blvd.
Chicago, Ill.

Send me your FREE 1941 Spring Catalog on everything in Radio.

NAME

ADDRESS

CITY STATE

RCA-813

BEAM POWER AMPLIFIER

360 Watts Input with
Less Than 1 Watt
Driving Power!

Amateur Net **\$22.00**
(Reduced from \$28.50,
April 1, 1940)

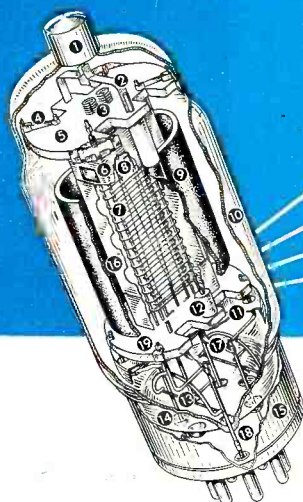

BIG-TIME MAGICIAN OF THE BEAM TUBE LINE!

Note These Features

1. Medium Metal Cap
2. Short Ribbon Plate Connector
3. Filament Support Springs
4. Mount Support
5. Top Ceramic Mount Support
6. Top Shield
7. Aligned-Turn Control and Screen Grids
8. Heavy-Duty Thoriated-Tungsten Filament
9. Large Sturdy Graphite Plate
10. Hard Glass Bulb with Mount-Aligning Dome
11. Bottom Shield Disc
12. Ceramic Plate-Support Spacer
13. Directive-Type Getter Container
14. Dish Type of Stem
15. Ceramic-Insert Giant Base
16. Beam-Forming Plate
17. Filament Connector
18. Tungsten-to-Glass Seal
19. Bottom Ceramic Mount Support



For high-power transmitters requiring exceptional overall efficiency—for ultra-modern rigs that need no neutralizing adjustments, rigs that can switch bands in a flash—for high-power gear with few tuning controls, requiring a minimum of driver equipment—use the RCA-813. It's the largest of the amateur "beams", big-brother magician of the famous RCA-807. It can handle a greater variety of big-time jobs than any other tube of its size or class.

As a final in c-w service RCA-813 takes 360 watts (CCS) with less than a watt of drive. As a final in plate-modulated service, it takes 240 watts with only 1.2 watts of drive. Moreover, it doubles, triples and quadruples with unusually high efficiency

and high harmonic output. It can be operated at full ratings up to 30 Mc—at reduced ratings up to 60 Mc. Power sensitivity of the RCA-813 is extremely high. Screen current requirements are very low.

In brief, the RCA-813 gives you *real power—real circuit simplification—real economy*. And it makes possible a flexible, high-power rig at a cost comparable with that of equipment using ordinary tube combinations.

Typical (Class "C" Telegraphy) CCS (Continuous Commercial Service) Ratings

Filament voltage, 10 volts (a.c. or d.c.); filament current, 5 a.; D-C plate volts, 2,000; D-C screen volts, 400; D-C grid volts, -90; D-C plate current, 180 ma.; D-C screen current, 15 ma.; driving power, 0.5 watt; power output, 260 watts.

COMPLETE DOPE ON THE NEW RCA-866-A/866 RECTIFIER...

... is contained in the January, 1941 issue of RCA HAM TIPS. Full technical details, typical circuit applications, etc. Ask your RCA Amateur Equipment Distributor for a copy.



Transmitting Tubes



RCA MANUFACTURING CO., INC., CAMDEN, N. J. • A Service of The Radio Corporation of America
In Canada: RCA Victor Company Limited, Montreal