

SPECIAL TELEVISION NUMBER

RADIO NEWS

AND

SHORT WAVE RADIO

SHORT
WAVE
TIME
TABLE

MAY 31

25¢
U. S. AND
CANADA



BUILD THIS "DON LEE"
TELEVISION
RECEIVER

HENRY
HOOD
PICKER

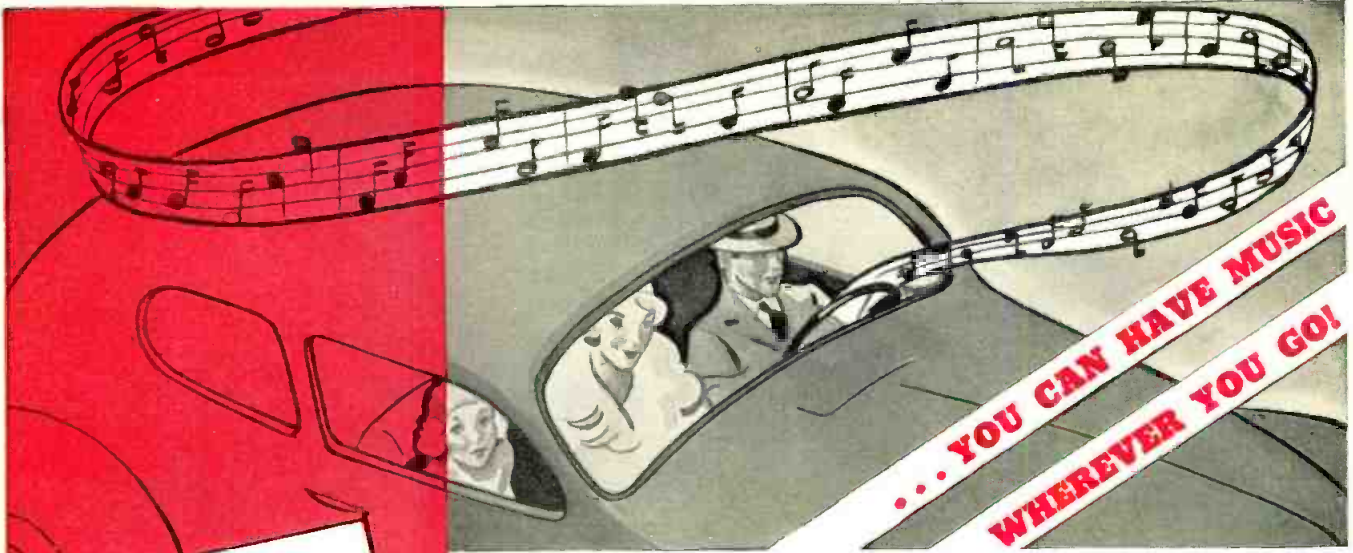

WITH
Safety Tuning

See the new sensational Automatic Frequency Control Model that instantly tunes in stations at the flick of the dial. It's a real contribution to the DRIVE SAFELY Campaign.

- 8 Metal Tubes—6 1/2-inch Speaker—
- 7 Watts Output—3-point Tone Control
- Antenna Circuit Matching System—
- and a parade of other outstanding features



GENERAL  ELECTRIC
AUTO RADIO

ENJOY all the thrills of radio while driving in the city or along countryside highways.

General Electric offers motorists a choice of three 1937 AUTO RADIO MODELS. There's a deluxe set (Model FA-80) with a new kind of SAFETY TUNING . . . permitting you to concentrate your eyes on the road, while you instantly tune in a station for perfect Focused Tone reception. This is the only auto radio of its kind!

THE new G-E Super-Six (Model FA-61) brings you a quality of leadership in radio performance that makes it the greatest auto radio value in the medium-price field. Then, there's the sensational new Six-tube (Model FA-60) that in performance, looks, name and excellence gives remarkable value for its low price.

Arrange through your nearest G-E Auto Radio dealer to have a GENERAL ELECTRIC AUTO RADIO installed in your car.

 TWO
Additional
POPULAR
MODELS



There are 2 six-tube G-E Auto Radio models to choose from.



"CUSTOM-BUILT"
INSTRUMENT PANEL
CONTROLS FOR ALL
MAKES OF CARS

They harmonize correctly with interior decorations

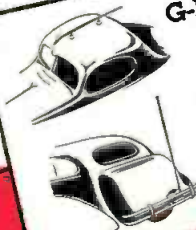

G-E AUTO ANTENNAS
FOR HOME-LIKE
RECEPTION

Four new Auto Antennas specially designed for car operation. Easy and quick to install on all cars. Ask for a demonstration.

GENERAL  ELECTRIC
AUTO RADIO

APPLIANCE AND MERCHANDISE DEPARTMENT, GENERAL ELECTRIC COMPANY, BRIDGEPORT, CONNECTICUT



J. E. SMITH, President, National Radio Institute
The man who has directed the home study training of more men for the Radio Industry than any other man in America.

Be a Radio Expert

Many make **\$30 \$50 \$75** a week

I will train you at home for many Good Spare Time and Full Time Radio Jobs

Do you want to make more money? Radio offers you many opportunities for well-paying spare time and full time jobs. And you don't have to give up your present job or leave home and spend a lot of money to become a Radio Expert.

I start sending you Extra Money Job Sheets. They show you how to do Radio repair jobs that you can cash in on quickly! Throughout your training I send you plans that made good spare time money—\$200 to \$500 a year—for hundreds of fellows. My Training is famous as "the Course that pays for itself."



Set Servicing
Spare time set servicing pays many \$5, \$10, \$15 a week extra while learning. Full time servicing pays as much as \$30, \$50, \$75 a week.

Many Radio Experts Make \$30, \$50, \$75 a Week

Radio broadcasting stations employ engineers, operators, station managers and pay up to \$5,000 a year. Spare time Radio set servicing pays as much as \$200 to \$500 a year—full time jobs with Radio jobbers, manufacturers and dealers as much as \$30, \$50, \$75 a week. Many Radio Experts operate their own full time or part time Radio sales and service businesses. Radio manufacturers and jobbers employ testers, inspectors, foremen, engineers, servicemen, paying up to \$6,000 a year. Radio operators on ships get good pay and see the world besides. Automobile, police, aviation, commercial Radio, and loud speaker systems are newer fields offering good opportunities now and for the future. Television promises to open many good jobs soon. Men I have trained are holding good jobs in these branches of Radio. Read their statements. Mail the coupon.

I Give You Practical Experience

My Course is not all book training. I send you special Radio equipment and show you how to conduct experiments and build circuits which illustrate important principles used in modern Radio receivers, broadcast stations and loud speaker installations. I show you how to build testing apparatus for use in spare time work from this equipment. This 50-50 method of training makes learning at home interesting, fascinating, practical.

Broadcasting Stations
Employ managers, engineers, operators, installation and maintenance men for fascinating jobs and pay up to \$5,000 a year.



You Get a Money-Back Agreement

I am so sure that I can train you successfully that I agree in writing to refund every penny you pay me if you are not satisfied with my Lessons and Instruction Service when you finish. I'll send you a copy of this agreement with my Free Book.



Loud Speaker Systems
Building, installing, servicing and operating public address systems is another growing field for men well trained in Radio.

There's a Real Future in Radio for Well-Trained Men

Radio already gives good jobs to more than 300,000 people. And in 1936, Radio enjoyed one of its most prosperous years. More than \$500,000,000 worth of sets, tubes and parts were sold—an increase of more than 60% over 1935. Over a million Auto Radios were sold, a big increase over 1935. 24,000,000 homes now have one or more Radio sets, and more than 4,000,000 autos are Radio equipped. Every year millions of these sets go out of date and are replaced with newer models. More millions need servicing, new tubes, repairs, etc. A few hundred \$30, \$50, \$75 a week jobs have grown to thousands in 20 years. And Radio is still a new industry—growing fast!

Find Out What Radio Offers You

Act Today. Mail the coupon now for "Rich Rewards in Radio." It's free to any fellow over 16 years old. It describes Radio's spare time and full time opportunities and those coming in Television; tells about my training in Radio and Television; shows you actual letters from men I have trained, telling what they are doing and earning. Find out what Radio offers YOU! MAIL THE COUPON in an envelope, or paste on a postcard—NOW!

HERE'S PROOF THAT MY TRAINING PAYS



\$80 Monthly in Spare Time
"I work on Radio Part time, still holding my regular job. Since enrolling five years ago, I have averaged around \$80 every month." JOHN H. MORRISSETTE, 773 Silver Street, Manchester, N. H.



Makes \$50 to \$60 a Week

"I am making between \$50 and \$60 a week after all expenses are paid, and I am getting all the Radio work I can take care of, thanks to N.R.I." R. H. ROAD, R. 136, City Hall, Los Angeles, Calif.



Operates Public Address System

"I have a position with the Los Angeles Civil Service operating the Public Address System in the City Hall Council. My salary is \$153 a month." R. H. ROAD, R. 136, City Hall, Los Angeles, Calif.

Many Make \$5, \$10, \$15, a Week Extra in Spare Time While Learning

Practically every neighborhood needs a good spare time serviceman. The day you enroll

**J. E. SMITH, President,
National Radio Institute
Dept. 7ER, Washington, D. C.**

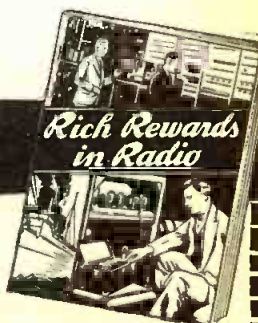

This Coupon is Good for One FREE Copy of My Book

**J. E. SMITH, President, Dept. 7ER,
National Radio Institute, Washington, D. C.**

Dear Mr. Smith: Without obligation, send me the Sample Lesson and your free book about spare time and full time Radio opportunities and how I can train for them at home in spare time. (Please write plainly.)

NAME..... AGE.....
STREET ADDRESS.....
CITY..... STATE..... 8FR3
Do you have a friend who is also interested in Radio? Do him a favor. Write his name and address below. We will send him our book and won't mention your name unless you ask us to.
NAME.....
STREET ADDRESS.....
CITY..... STATE..... 7ERA

GET MY FREE LESSON ON "TYPES OF RADIO TUBES"

Do you want proof that my training gives you facts you must know to master Radio? Then get my Lesson "Types of Radio and Electronic Tubes; How They Operate." It tells how and why Tubes work, explains cathodes, grids, plates, extra grids, etc. Describes operation of all types of Radio and Television tubes including duplex, cathode ray, acorn and new "beam" tubes—prong-numbering system—new R. M. A. tube numbering system, etc. More than 60 illustrations, including special photos showing assembly of metal and glass tubes and cut-away drawings showing details of various glass and metal tubes. Get this Lesson FREE. No obligation. JUST MAIL COUPON.



Edited by LAURENCE MARSHAM COCKADAY

S. GORDON TAYLOR Managing Editor WILLIAM C. DORF Associate Editor

JOHN M. BORST Technical Editor JOHN H. POTTS Assoc. Tech. Editor

WESLEY G. HILLS Art Editor

Vol. XVIII May, 1937

No. 11

Reading Guide to this Issue—

- AMATEURS—3, 4, 5, 6, 11, 12, 13, 14, 15, 18, 21, 22, 23, 24, 25
BROADCAST FANS—2, 3, 5, 6, 17, 25
DEALERS—1, 4, 5, 6, 7, 8, 10, 20, 23, 25
DESIGNERS—4, 9, 11, 12, 15, 22, 23
DX FANS—16, 17, 23, 25
ENGINEERS—4, 5, 6, 8, 9, 11, 12, 15, 22, 23, 25
EXPERIMENTERS—4, 5, 6, 8, 9, 10, 11, 12, 15, 18, 22, 23, 25
MANUFACTURERS—5, 8, 9, 10, 12
OPERATORS—5, 12, 15, 21, 22, 23, 25
SERVICEMEN—1, 4, 5, 7, 8, 9, 10, 11, 12, 18, 22, 23, 25
SET BUILDERS—4, 5, 8, 9, 10, 11, 12, 15, 18, 22, 23, 25
SHORT-WAVE FANS—4, 5, 6, 12, 15, 19, 20, 23, 25
STUDENTS—1, 2, 3, 4, 5, 6, 7, 8, 9, 10, 11, 12, 15, 18, 21, 22, 23, 25
TECHNICIANS—4, 5, 6, 7, 8, 9, 10, 11, 12, 18, 22, 23, 25

1 Serviceman's Diary... Anonymous 644
2 Radio Facts and Oddities... H. T. Elmo 646
3 Do You Want to Become a "Ham"?... 647
4 Building a Television Receiver... Don Lee Television Staff 649
5 Television Ready But "Under Wraps"... S. Gordon Taylor 652
6 New Farnsworth Television Station... The Television Reporter 654
7 The Service Bench... Zeh Bouck 656
8 Oscillographs As Money Makers... 657
9 Calibrating the R. N. "Capatron" Oscillator... John H. Potts 658
10 Growing Dollars in the P.A. Field... 659
11 No "Bugs" in This D.C. Amplifier... Gerard J. Kelley 660
12 Thoughts on 10-Meter Receivers... 661
13 The Amateur's Part in Flood Relief... Everett M. Walker 662
14 The "Ham" Shack (10-Meter Antennas)... 664
15 How to Build a 10-Meter Converter... Raymond P. Adams 666
16 The DX Corner for the Broadcast Band... 668
17 Station List (Central and South Americas)... John M. Borst 670
18 The Radio Workshop... 671
19 The DX Corner for Short Waves... Laurence M. Cockaday 672
20 World Short-Wave Time-Table... 674
21 Q R D?... By GY 680
22 The Technical Review... The Technical Editor 682
23 Free Booklet Service... 683
24 Coil Data for Crystal U.H.F. Transmitter... Frank Lester 689
25 What's New in Radio... William C. Dorf 696

Coming Next Month

Special Short-Wave Number

THE June issue will be the Annual Short-Wave Number, with many features including Charts, Maps, Tables, which will appeal especially to the Short-Wave DX enthusiast. Also there will be plenty of informative articles for Servicemen. Amateurs and Experimenters.

Published Monthly by Teck Publications, Inc., Washington and South Avenues, Dunellen, N. J.

Lee Ellmaker President and Treas.

B. Holepl Secretary

H. D. Crippen W. P. Jeffery Advertising Management
Virgil Malcher
205 W. Wacker Dr., Chicago Western Representative

EDITORIAL AND EXECUTIVE OFFICES

461 EIGHTH AVENUE, NEW YORK CITY, N. Y.

Entered as second class matter at the Post Office at Dunellen, N. J., under the act of March 3, 1879. Copyright, 1937, by Teck Publications, Inc., in U. S. and Canada. All rights reserved. Registration of title of this publication as a trade mark applied for in United States Patent Office. Printed in the United States of America. The contents of this magazine must not be reproduced without permission. We cannot be responsible for lost manuscripts, although every care is taken for their safety.

25c a copy. Subscriptions, \$2.50 a year, \$4.00 for two years; in Canada and Foreign Countries \$3.00 a year, \$5.00 for two years. Subscribers are notified that change of address must reach us five weeks in advance of the next date of issue.

GIVEN FREE

To Those Subscribing for Radio News NOW!

THE 1937 RADIO DATA BOOK is crammed from cover to cover with hard-to-get information of use to every radio enthusiast—no matter what his connection with radio! It has articles of interest to everyone, written in a simple, easy-to-understand, concise manner.

It tells you how to build all kinds of radio apparatus, how to get best results in short-wave reception, includes useful experimental data, and has many charts of vital interest to every radio man.

There are over 160 illustrations, charts, hook-ups and diagrams, over 70 different items and articles, covering all phases of radio! See the list of contents below for a complete picture of the wealth of information included in this book. Then, mail the coupon today, while our limited supply lasts!

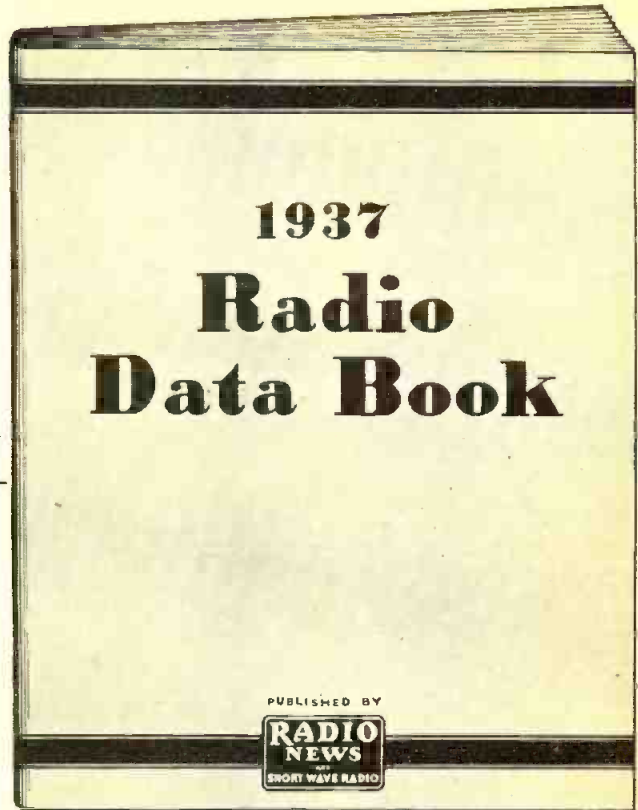

Actual Size 8" by 11"

Over 160 Illustrations

The 1937 RADIO DATA BOOK is not for sale at any price—it was published solely for use as a gift to RADIO NEWS subscribers. You can get a copy, absolutely free, by taking advantage of our special subscription offer of 5 issues of RADIO NEWS for \$1. (Canada & Foreign \$1.25). Present subscribers may obtain copies by extending their present subscriptions for five months. Take advantage of this special offer now!

List Of Contents

Television

Gives a complete picture of the present status of television, and tells what we may expect in the near future.

Characteristics Of Receiving Tubes

Complete data on receiving tubes, assembled in one handy chart, broken down as follows: Detector and Amplifier Tubes—Rectifier Tubes—Special Tubes—Base Connections—Comparison Charts—and Socket Connections.

Radio Receiver Construction

Construction details for: A Portable 10-Tube A.C.-D.C. Receiver—a 2½-555 Meter Receiver—a Low Current Farm Receiver—a New Converter with Metal Tubes—an All-Wave Pre-Selector—and a Communication Receiver.

Mail This Coupon Today!

Radio News, Dept. 375
461 Eighth Avenue, New York, N. Y.

Enclosed find \$1. (Canada & Foreign \$1.25). Send me the next five issues of RADIO NEWS and rush a copy of the 1937 RADIO DATA BOOK to me without charge. (If renewal, check here)

Name

Address

City State

If you are a serviceman, please check here .

All-Wave Reception Aids

Includes: DX Tips—a World Time-Conversion Chart—Data on Antennas and Grounds—Verifying Short-Wave Calls—a U. S. and World-Wide Mileage Chart—International Call Letters—How To Learn the Morse Code—and Wavelength-Frequency Conversion Data.

Amateur Radio

Description of 5-Meter Receivers, Transmitters and Antennas—How To Build a 5-Meter M.O.P.A. Transmitter and a Two-Way Auto Radio—Circuit diagrams for 10-Meter Apparatus—Complete transmitting tube chart—and Constructional Data on an All-Band Transmitter.

Experimental Radio Data

Making Your Own Relays—Compact 5-Watt P. A. Amplifier—Plug-In Coil Shields—Non-Slip Dial Cables—Building a Multi-Point Switch—Lamp for Photo-Cell use—Adding A.V.C. to the "All-Star" Receiver—Pilot Light for Soldering Iron—A Simple Stroboscope—A Handy Tool—Two Soldering Kinks—Overcoming Refrigerator Interference—Identifying Replacement Connections—Simple V. T. Voltmeter—Useful Wooden Rack—Relay from Old Audio Transformer—New Uses for Condensers—A Resonance Indicator—Concrete Foundation for Antenna Mast—Improving the Browning 35—and An Electronic Interrupter.

Servicing

And Engineering Notes

Constructional details for: An All-Wave Frequency Meter—a Simple Beat Frequency Audio Oscillator—a Crystal-Controlled Calibrating Oscillator—and a Resonance Tester.

Sound Equipment

Constructional details for: The Radio News 20-Watt Amplifier—the Radio News A. C. Pre-Amplifier—and a 15-Watt High-Gain Amplifier.

Station Lists

U. S. Broadcasting Stations—World's Leading Short-Wave Stations.

Special Beginner's Supplement

By popular request, we have included as a special supplement, the installments of the "Radio Beginner" which appeared in the May to September, 1936, issues of RADIO NEWS. These lessons include: Radio Waves, How a Radio Station Works, Detection, Constructing a Simple Diode (or Crystal) Receiver, Operation of Vacuum Tubes, A Simple Triode Vacuum Tube Receiver, R.F. and Audio Amplification, Tube Versatility, A One-Stage Audio Amplifier, How a Power Supply Unit Works, How An Amplifier Works, Discussion On Tone Controls, and An Audio-Frequency Amplifier and Power Unit.

RADIO NEWS

461 Eighth Ave., New York, N. Y.

Pages From A Serviceman's DIARY

WEDNESDAY—A service truck equipped with running water might seem a most desirable vehicle, but when this feature is present under only certain disagreeable conditions when it is least wanted, it is something less than pleasant. In very hot weather, the radiator boils over. In very cold weather, the same thing happens. In rainy weather, the broken drop window on the right-hand side admits an intermittent torrent. And today it is pouring. When business gets better, maybe we'll get a new truck. (Maybe!)

Started off the day with a trip to the island. This is a private island, with a private road leading to the bridge. A large ornamental iron gate, guarded by a special cop, keeps people out who are not residents unless they can show reason why they should be admitted. Pulled up alongside the guardhouse and gave the horn button a wallop. It refused to toot, a new ailment. Turned up my collar and climbed out of the car. Opened the guardhouse door and found the cop reading a newspaper and smoking a pipe.

"Would you mind swinging wide the Golden Gate?" I asked him. Might as well be cheerful even under bad conditions.

"Where do you want to go?" he said, without cracking a smile.

"To Heaven," I told him. "Got a date with these angels." Showed him my call tickets.

He looked at me. "I think you got the wrong place. You want the nut-house down the road."

"No," I told him, "I was there yesterday."

"They let you out a few years too soon," he said. But he opened the gate.

Saving a Converter

Drove down the winding road and over the bridge, stopping at the gardener's cottage on a large estate at the extreme end of the island. He has always been a good customer, buying a Stromberg 14 and just lately adding a short-wave converter. After each call he has a habit of smuggling out a dozen nice, warm eggs, fresh from the hens, for prompt service. So I go here first. He looked mournful today.

"What trouble are you having?" I asked him.

"Nothing wrong with the radio," he said, "but the folks are kicking." He motioned toward the big house. "They say I'm using too much electricity, staying up nights playing the set. I've got to have a special meter installed or have you fix the set so it won't draw so much juice."

"You won't need anything of the kind," I told him. "The converter draws only 65 watts and you can get a thousand watts for an hour for a nickel."

"You better go up and talk to them," he told me. "They got some big bills."

Went up to the house, taking the converter along. Stopped at the kitchen first and inquired if they had bought any extra electric irons, toasters, etc. The cook remembered that they had bought a big electric refrigerator a few months ago. Went upstairs and showed the converter to

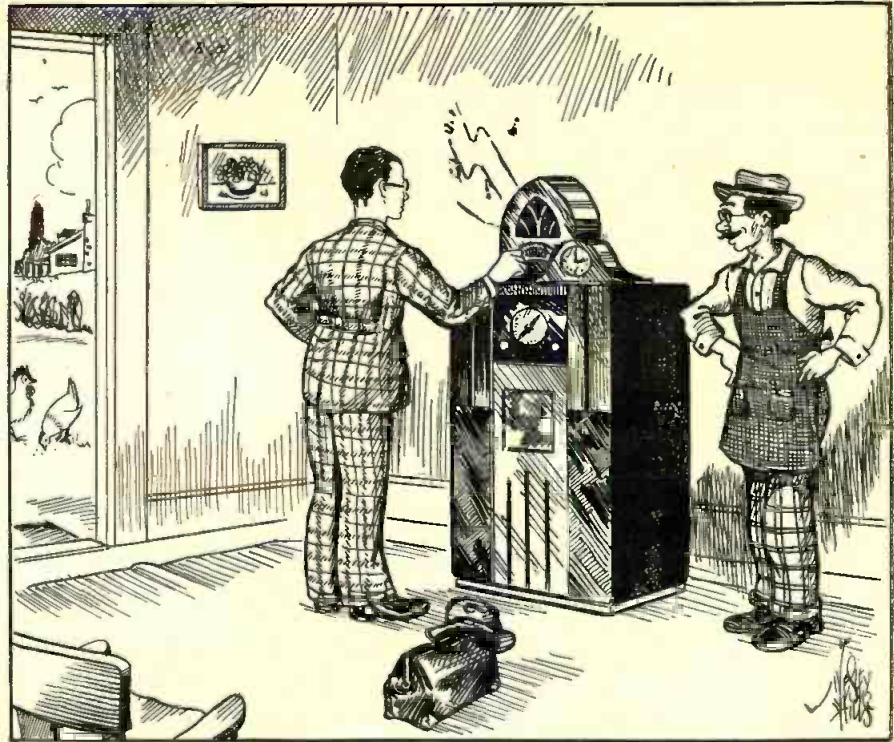

MONEY DOESN'T ALWAYS INDICATE THE BEST CUSTOMER

Some of the most worthwhile clients that radio servicemen have are not over-abundantly supplied with that material wealth often thought of as the basis of success. They are in general more appreciative of honest effort, more appreciative of the benefits that radio can bring and more willing to acknowledge that the serviceman too is working to make a living.

the mistress, explaining that it cost very little to operate. Then went over the electric bills with her and showed her that the big increase started the month they got the refrigerator, before the converter was installed. Pointed out that it would be much cheaper for her to have a power meter installed for the appliances. Got permission for the gardener to keep his converter going and for our electrician to come and figure on the rewiring. Inquired about their own radio and found, believe it or not, that this big, wealthy family had only an antique Echophone midget. (Oh, yes, very well satisfied with it. Couldn't wish for anything better.) Didn't want to wear out my welcome, so refrained from any further sales talk. Returned the converter to the gardener, who was so happy that he ordered a Telechron clock with Westminster chimes, which he had been yearning for. Sold it to him on installments, but he will pay on the dot; he always does. Got my dozen eggs and moved on.

"Arresting" a Headache

"You just overhauled this radio, we had a new aerial put up and now it's worse than ever." The lady was indignant.

THESSE records from an anonymous serviceman's diary should be of decided interest to veteran servicemen, as well as to those whose experience in the service field is more limited. Written by a man who "knows his stuff," and shot with an occasional outcropping of humor, these items provide many hints not found in text books. More of these pages will appear from time to time.

"If something has gone wrong, we'll make it right," I reassured her.

No matter how careful we are, there are times when work does not pan out right. Here was a fine Philco 16-X, carefully realigned, all tubes fresh, neatly installed, yet the job was unsatisfactory.

The Trouble Located

Tuned in one local station and found, in the background, another station. Moved over one degree on the dial and both stations disappeared. Tried another local channel. Same trouble. It hadn't done this at the shop. Checked over the house wiring, thinking hard meanwhile. Finally, it came to mind . . . cross-modulation. They had previously used a short, indoor aerial with no trouble of this nature. Therefore, something in the new antenna system must be affecting it. Disconnected the ground. Trouble still present. Checked over the lead-in. All apparently in good order. Looked over the lightning arrester. Connections tight. Recalled, though, that sometimes these act as rectifiers, so disconnected it and tried the set again. Glory be, now okay! A lucky break for me, since the lady anxiously watched every move and was now convinced that the set had not been mishandled.

Well, it's all in a day's work. If we didn't get a headache once in a while the game would lose its charm.

New Mike Stand Features Easy Operation

The new Bruno model B22 microphone stand is so designed and constructed that with a slight pressure of the finger on a button, conveniently placed below the microphone, it can be easily and noiselessly raised or lowered with one hand. The stand is finished in durable lacquered gunmetal, its maximum height 59 inches, the minimum 42 inches and weight 14 pounds.

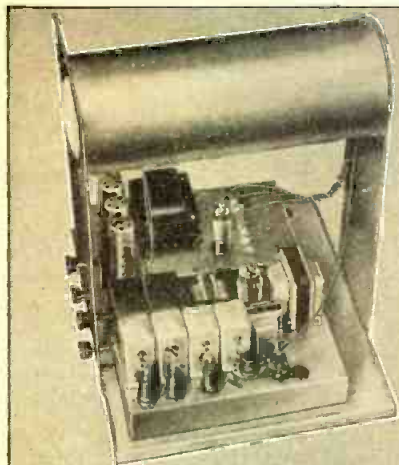

W.R.S.CO. FIRST AGAIN - NOW IT'S TELEVISION!

A SCOOP OF WORLD-WIDE IMPORTANCE

- AVAILABLE IN KIT FORM
- BUY ALL NECESSARY PARTS AT WHOLESALE RADIO SERVICE CO.
- EASY TO BUILD AND OPERATE
- EXCELLENT IN PERFORMANCE
- PARTS AND PRICE LIST SENT FREE

YOU TOO, like most of us, have probably despaired of ever actually seeing practical Television—but it's here at last! The new Don Lee Television Receiver, available in kit form, more than fulfills the hopes and expectancies of those who have desired excellent image reception. You'll be amazed by the clear reception this kit affords. And as usual, **WHOLESALE RADIO SERVICE COMPANY** can supply every component necessary in the construction of the receiver at the Lowest **WHOLESALE** Prices. Write today for a **FREE** copy of the complete parts and price list. Use coupon below.



RADIOS

5 TUBE AUTO RADIO

Simplicity of mounting! Excellence of performance! Beauty of appearance! Three phrases that give you a word-picture of this powerful, sensitive word-picture defies competition.

\$15⁹⁵
COMPLETE

And, it's offered at a price that defies competition. Among the outstanding features are: Five modern tubes, used in superhet circuit; built-in electro-dynamic speaker; noise suppressor circuit that eliminates the need for external spark plug suppressors. Once installation is made, there is no further need for experimenting with noise eliminators. Enclosed in welded weatherproof case. Only antenna and battery connection necessary. No dangling cords, or protruding chassis. Tubes can be changed without dismantling receiver. Take a tip—try this set in your car—you'll be convinced. Complete with tubes, Model AJA-1—\$15.95.

DUAL RADIO



TWO RADIOS FOR THE PRICE OF ONE

\$32⁵⁰
COMPLETE

Trailer Set

TRULY THE MOST SENSATIONAL RADIO DEVELOPMENT OF THE YEAR! A dual purpose radio that does an equally good job at receiving, whether you have it in a **BOAT—CAR—TRAILER** or **YOUR OWN HOME!** Get this **LAFAYETTE** miracle radio and when the "gypsy in you" wins out, you'll be all set for splendid reception—roaming the roads in a trailer, stepping along in your car or cruising in your boat. It operates on 110 volts A.C. or on a 6-volt Storage Battery **WITHOUT CHANGES OF ANY KIND.** Don't start on that trip without it. The enjoyment it will give you will be worth the cost many times over. Check these outstanding features—see if you can duplicate this buy elsewhere:

Operates from a 6-volt battery or 110 volts A.C. Covers short wave, and broadcast bands (18.4-52 meters) and (193-555 meters). Automatic Volume Control. Full Tone Control. Adaptable for Trailer, Home, Boat or Car. Fully guaranteed! Complete with tubes, nothing else to buy—\$32.50.

SOUND



Lafayette 20 WATT PORTABLE SOUND SYSTEM!

The most sensational amplifier ever offered—extremely versatile, it can be put to a multitude of uses. Can be used with two microphones simultaneously. Ideal for the band leader, orchestra, floor show, window demonstrators, lecturers or musicians.

A few of the features that make this equipment the "tops" in the sound field are: New "neo dials" (Neon-like lighting facilitates operation in dark rooms); "reverse feedback" circuit makes possible crystal clear reproduction with minimum distortion; automatic equalization; all metal tubes; 4 input channels and airplane luggage type cases. And most important—**LAFAYETTE** Co-ordinated Sound Systems eliminate all guess work! All components of the system are scientifically grouped to obtain the finest possible fidelity of reproduction. Mail coupon for complete descriptive catalog.

Model A367-P 20 watt Co-ordinated Sound System, less tubes and mike—**\$59⁷⁵**
Model A860-P 20 watt Co-ordinated Sound System, complete, ready to operate, nothing else to buy—**\$83.50**

FREE CATALOG

GET YOUR COPY OF THE NEW SPRING CATALOG—MORE BARGAINS THAN YOU EVER DREAMED OF



WHOLESALE RADIO SERVICE CO., Inc.
100 SIXTH AVENUE, NEW YORK, N. Y.

- Rush FREE information on DON LEE TELEVISION KIT.
- Rush new 116-page FREE catalog No. 68-2E7.
- Enclosed please find money order
- check for Trailer Set AD-32
- Auto set AJA-1

Name _____
Address _____
City _____ State _____



RUSH THIS COUPON

WHOLESALE RADIO SERVICE CO. INC.
NEW YORK, N. Y. • CHICAGO, ILL. • ATLANTA, GA.
100 SIXTH AVENUE 901 W. JACKSON BLVD. 430 W. PEACHTREE ST., N. W.
BRONX, N. Y. NEWARK, N. J. JAMAICA, L. I.
542 E. FORDHAM RD. • 219 CENTRAL AVE. • 90-08 166th STREET
(MERRICK ROAD)

RADIO FACTS and ODDITIES

(Send in your Radio Oddities to "Elmo" and see them illustrated)



THE EMPEROR NAPOLEON

CONFERRED UPON ALESSANDRO VOLTA, THE ORDER OF THE **LEGION OF HONOR**, IN RECOGNITION OF HIS INVENTION OF THE **PRIMARY CELL !!!**



HOWARD SQUEAKS
SELLS RADIOS IN
WELLINGTON, NEW ZEALAND.



IN MANY FARMS AND ORCHARDS IN GERMANY, **INSECT PESTS** ARE EXTERMINATED BY MEANS OF **RADIO WAVES!!**



THERE IS **NO** RADIO TRANSMISSION FROM BROADCASTING STUDIOS !!! THE PROGRAM IS REALLY CARRIED BY **TELEPHONE LINE** TO THE ACTUAL TRANSMITTING STATION AND THERE TRANSFORMED INTO RADIO WAVES !!!

Becoming An Amateur

MANY short-wave listeners have written letters to the editors of RADIO NEWS within the last year asking for information on how to become an amateur. They ask such questions as: Is it necessary to take a course to own and operate an amateur station? Is there a charge for the license and where are examinations held? What does a transmitter cost? etc. Typical of these is a letter received from J. Donovan, a short-wave listener of Marquette, Mich. Mr. Donovan lists four questions which cover quite well any questions that might occur to the prospective amateur. The four questions and answers follow:

1—Q. Is it necessary to take a course in radio to be able to own and operate an amateur station?

A. No, it is not necessary to take a course in radio to become a radio amateur, although it is necessary to have a basic knowledge of both transmitting and receiving equipment. This may be obtained from numerous books.

2—Q. Is there any charge for the license and where are the examinations held? Must these examinations be taken every so often or are they for an unlimited time? Where would one get the information asked for in the examinations?

A. There is no charge for an amateur license other than a notary fee of 25c for attesting to the validity of answers on a station and operator's application blank. Licenses are issued by the Federal Communications Commission, which has branch offices in the principal cities of the country. Licenses are issued for a period of three years. After an examination is taken and passed, no further examination is necessary providing the station is kept in operation. Lack of activity after a license expires makes it necessary to take a new examination unless it can be shown to the satisfaction of the examining authority that the failure to apply for renewal was due to something beyond the control of the applicant. Information contained in examinations is available in several "handbooks" published for the amateur. Most radio stores keep these in stock.

3—Q. What is the very cheapest station one would be able to build and which would be able to compete with other amateurs? Do these stations operate on 60-cycle a.c. current? What is the cost of upkeep per hour? Must one operate them daily or may they use them only about three times weekly?

A. The cost of an amateur station varies tremendously. However, it should be possible to construct an efficient telegraph transmitter for between twenty and thirty dollars. Telephone equipment costs considerably more as expensive speech equipment is necessary to supplement the apparatus normally used for telegraph transmission. Practically all amateur stations are operated from 60 cycle alternating current, as this type of power is available in more than 90 per cent of the homes in the United States. Some sections of the country have 25 and 40 cycle a.c. and direct current, which it is possible to use providing the apparatus is designed for such mains. An amateur may operate his station at any time he chooses. There are no operating requirements other than the station must have had communication with at least three other amateur stations within ninety days before the expiration of term of license in order to qualify for renewal of license at the end of the three-year period without having to take another examination.

4—Q. About how much space is needed for an amateur station? Are two separate units necessary; one for sending and one for receiving?

A. Space needed for an amateur transmitter is governed entirely by the facilities available and the operator who constructs it. It is possible to mount a complete station in a secretary type of desk with a transmitter consuming no more space than the average size receiving set. On the other hand some amateurs have a whole room for their radio equipment. A separate unit is necessary for transmitting as a transmitter always functions independent of the receiving set. Any receiving set that is capable of tuning the amateur frequencies may be used. Practically all all-wave sets fulfill this requirement. Amateur frequencies are: 1715 to 2000 kc.; 3500 to 4000 kc.; 7000 to 7300; 14000 to 14400 kc., and in addition channels in the vicinity of 28000 kc., 56000 kilocycles and other higher frequencies. For frequencies above 14000 it is necessary to use a specially designed receiver, designed for ultra-high frequencies.

YOU CANNOT SERVICE New 1937 Receivers Without Modern Instruments

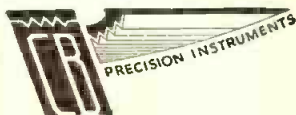

When your automobile needs adjustment of the electrical system, where do you go? Auto maintenance men learned long ago that the "well equipped shop gets the business." You, too, will find that the addition of modern equipment speeds work, increases profit and customer prestige.

These Instruments Will Modernize Your Shop



"Wobbled" Oscillator

MODEL OMA range 100 kc to 30 mc with "wobble" calibrated to exactly 20 kc at every test frequency, making possible direct reading selectivity curves. "Inductor-sweep," an exclusive C-B feature, provides both single and double trace curves. Net cash, \$64.50. Only \$7.00 down.

DeLuxe Oscillograph

MODEL CRA complete oscillograph using 3-inch tube with extreme high sensitivity horizontal and vertical amplifiers, linear sweep, etched aluminum front panel, dual power supply, etc. Net cash, \$92.50. Only \$10.00 down.

Beat Audio Oscillator

MODEL 79-B combines with the oscillograph and "wobbled" oscillator for complete analysis of high fidelity and afc receivers. Pure sine-wave output from 20 to 15,000 cycles. High output, 25 volts, linear within 2 db. Net cash, \$56.50. Only \$6.50 down.

Separate "Wobbler"

MODEL 81-A connects in 15 sec. to any r-f oscillator. No alterations or loss of calibration. Calibrated 20 kc sweep. Net cash, \$34.50. Only \$4.00 down.



MODEL 105 Oscillograph Only \$5.50 down

A duplicate of the deluxe oscillograph, using the new type 913 tube. Has dual wide range amplifiers linear to 100,000 cycles, extended sweep frequency range (30,000), lock-in control, and everything needed for all Cathode-ray laboratory and service tests.

The MODELS OMA or 81-A may be plugged directly into this instrument to eliminate all complicated connections. Net cash, \$48.90.

NEW—Quick Action C-B Time Payment Plan

The CLOUGH-BREngle Co.

2813 W. 19th St., Chicago, U. S. A.

Send full information on the new low priced C-B Cathode-Ray Equipment and QUICK ACTION Time Payment Order Blank.

Name.....

Address.....

No need for long delays in credit approvals. See your jobber today or mail the coupon.



There's no question about it!

MALLORY-YAXLEY

Precision Radio Replacement Parts Cost No More Than Ordinary Products

Seeing's believing! Check the prices of Mallory Condensers, Mallory Vibrators and Yaxley Volume Controls against ordinary products. See for yourself that Mallory-Yaxley products cost no more than ordinary replacement parts which you may have believed were cheaper.

Can products rated as *tops* throughout the radio service field be priced on a really competitive basis? *A check-up answers that question!*

Can a company that's done more for the service man be content to charge no more? Mallory-Yaxley price lists say "YES" to this one.

Perhaps you've thought that a company big enough and progressive enough to publish a book like the Mallory-Yaxley Radio Service Encyclopedia might feel entitled to a little edge in the matter of price. If so you're mistaken. For there's no question about it — Mallory-Yaxley products cost no more.

And — after you've used these precision replacement parts a while you'll find that the good will and good business they build make Mallory-Yaxley products *actually cost less in the long run!*

There's no question about that, either!



Put Servicing On An Easier, More Profitable Basis with the MALLORY-YAXLEY RADIO SERVICE ENCYCLOPEDIA

which gives complete, authoritative information on all repairing of all sets. Ask the Mallory-Yaxley distributor about your copy — now!



Use
P. R. MALLORY & CO. Inc.
MALLORY
 REPLACEMENT
 CONDENSERS...VIBRATORS

P. R. MALLORY & CO., Inc.
 INDIANAPOLIS INDIANA
 CABLE ADDRESS — PELMALLO

Use
YAXLEY
 REPLACEMENT
 VOLUME CONTROLS

Radio News

May, 1937

Build This
DON LEE

TELEVISION *Receiving Set*

Here is the first chance presented to the television experimenter and amateur to build a really modern cathode-ray television receiver from a carefully tested and authorized design and from plans that are complete, so that the builder can make one and know that it is actually workable

By the Don Lee Television Staff

IN common with all high-definition television transmissions, a receiver for displaying the images must tune very broadly as compared to the usual communications type receiver used for receiving voice and music transmissions. A high intermediate frequency must be employed in a television receiver and band-pass transformers used to provide sufficient band width. In the "audio" section of the television receiver, abnormally low values of plate resistors must be used and great care exercised to keep the stray capacitance of wiring and components to a minimum.

Circuits Given

The diagram of the Don Lee receiver described here in detail is shown in Figure 1. It is of the television superheterodyne type embracing the design features set forth above. The antenna is indicated by the tubing at the upper left, separated in the center and connected to L1. The separate lengths of the tubing should be 63 inches long and $\frac{1}{4}$ inch or more in diameter. They should be joined mechanically by an insulator 2 or 3 inches long. The leads running from the antenna to L1 indicate

a length of 70-ohm cable, known as "EO1," or the rubber-covered parallel pair feeders known as the Lynch "Giant Killer" Cable. It is desirable that the feeder should extend perpendicularly from the antenna for 5 feet or more. The antenna end of the feeder is fanned out for 6 inches and one conductor attached to each 63-inch length of the antenna. The receiver end is brought in through insulating bushings to the 1 to 2-turn coil, L-1.

MOVIE STAR "KNOWS HIS PICTURES"

Robert Montgomery, the popular screen star, said, when he and Mrs. Montgomery witnessed the television demonstration as the guests of Harry R. Lubeke, director of television for the Don Lee Broadcasting System, "I am surprised at the results. . . . The present exhibition is a great advance over one I attended a few years ago."

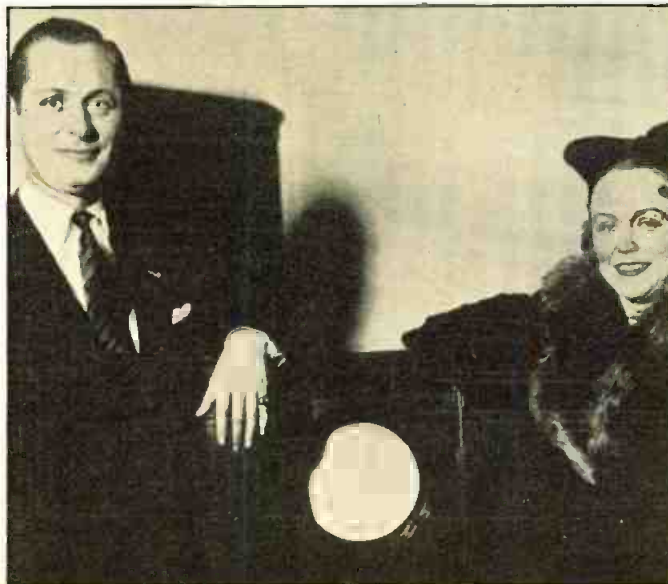

The first resonant circuit, L2, C1, should be of "high-loss" construction; that is, no effort should be made, as is usually done, to keep the coil away from shielding, or use the best quality variable condenser. The radio-frequency resistance of this circuit *must be considerable* to insure that the high-frequency components of the wide image sideband will not be attenuated. This can be accomplished by using components of ordinary quality or by shunting a fixed resistor across the circuit. The components should be mechanically excellent, but the use of bakelite coil forms, bakelite pieces for coil support, and condenser end plates, is definitely allowable. This circuit, with vacuum tube VT1, com-

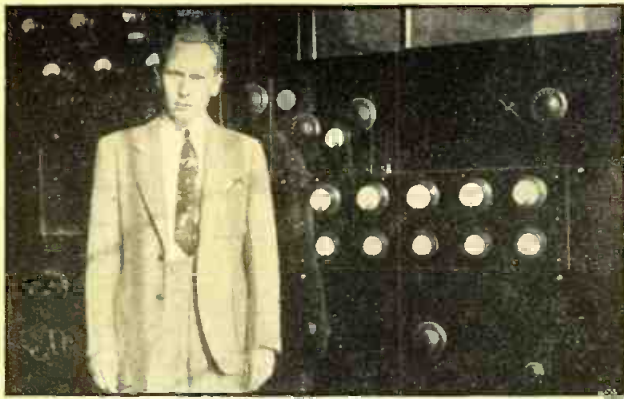

THE TELEVISION TRANSMITTER AT W6XAO

Harry R. Lubcke is shown standing in front of the W6XAO television transmitter that operates on 45 megacycles (6 $\frac{2}{3}$ meters) which transmits high-definition images daily in Los Angeles, California.

prises the superheterodyne first detector or converter. This is housed in the front left dark shield can shown in the front left of Figure 3. The porcelain lead-through insulator at the left supports coil L1 and provides external binding posts for the incoming feeders. The upper of the two knobs is the tuning control and comprises the shaft and variable condenser C1. This is one of the front-panel knobs. The knob directly below it is the volume control, comprising resistor C7 in the circuit of Figure 1. Behind the first shield is the oscillator shield, and condenser C15 of this circuit is ganged with condenser C1. This is accomplished by an ordinary shaft coupling.

These two shields are preferably made of copper, with as few joints as possible to give good shielding at ultra-

high frequencies. They may be chromium, but not cadmium plated, if desirable. Cadmium plating is satisfactory for the chassis in general and aluminum shield cans may be used elsewhere. Copper shield cans with chromium plating are an extra refinement. The remainder of the circuits of the converter VT1 and oscillator VT7 are more or less standard. Oscillator coil L2 is placed over (surrounding) the grounded end of coil L11. No difficulty should be encountered in

AN "ACTUAL" PHOTOGRAPH

Unretouched photo of the television image received 3 $\frac{3}{4}$ miles away from the transmitter under home receiving conditions. The picture was taken with an ordinary Eastman folding pocket Kodak with a comparatively slow lens of F6.8. The subject is a member of the American Legion and a few folds of the American flag show in the background.

securing ultra-high-frequency oscillation with this circuit.

Coil condenser combinations C3, L3 and C4, L4 complete the band-pass intermediate-frequency transformers. These should also be of "high-loss" construction. Bakelite coil forms and small wire are specified, while the condensers may have bakelite end insulators, and may be of the mica compression type. The

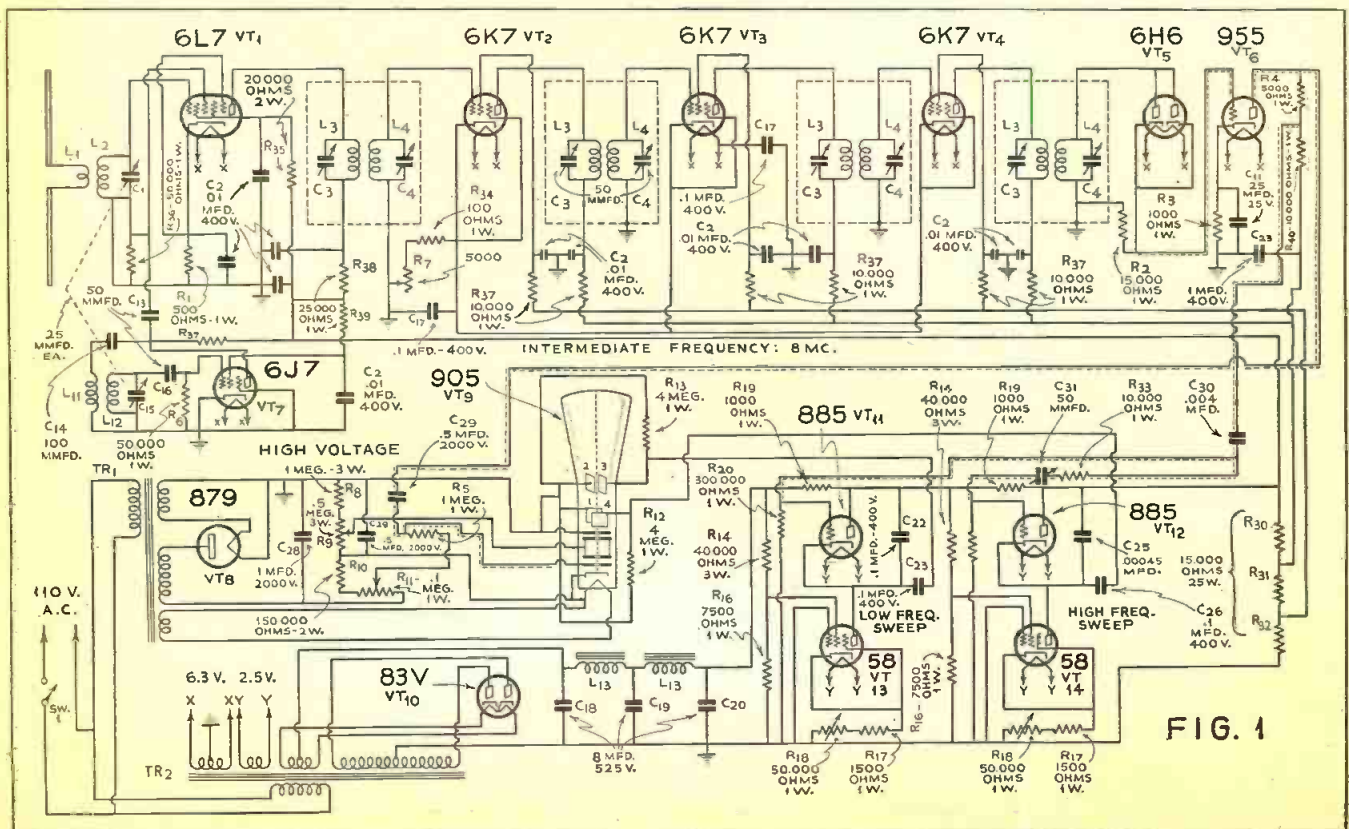

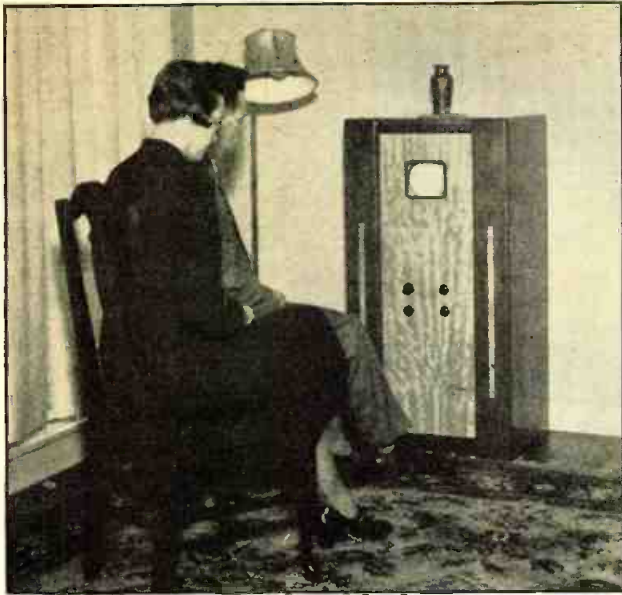

THE COMPLETED "SIGHT" RECEIVER

An exclusive photograph of the Don Lee receiver, described in this issue, shown in use in a private residence and used for checking transmitted air programs.

intermediate-frequency transformers are shown as the row of rectangular shield cans down the center of the chassis in Figure 3. The three 6K7 intermediate-frequency vacuum tubes are shown to the right of the several stages. It is not necessary that the arrangement shown be strictly adhered to. Increasing the space between shield cans and placing a tube between each one, or a staggered arrangement of shield cans and tubes is satisfactory. The diagram shows three stages of intermediate-frequency amplification, indicated by tubes VT2, VT3 and VT4, with the associated equip-

THE SWEEP CIRCUITS

Figure 4. The chassis for the sweep circuits and high-voltage power supply are contained on this chassis. The cathode-ray tube adjustments are located on the rear.

ment. This amount of amplification is satisfactory where a moderate or strong signal is available, such as a hillside or unobstructed line of sight location on level ground, using an antenna 25 or more feet above surrounding objects. Where these conditions cannot be met, an additional stage of intermediate-frequency amplification is recommended. The addition is accomplished by merely constructing and installing another tube, VT3, another intermediate-frequency transformer, C3-L3, C4-L4; a socket, shield can, two isolating resistors, R37, and two by-pass condensers, C2. The adjustment of the several condensers, C3-C4, of each stage should be available from the outside, and they should be

adjusted to give the best detail while looking at the image.

VT5 is a diode second detector, the output of which appears at the right-hand end of resistor R2. It will be noted that this (Turn to page 694)

THE RECEIVER PROPER

Figure 3. The superheterodyne receiver and low-frequency power supply. The high-frequency circuits are housed in the two darker copper shields and the intermediate-frequency circuits in the four bright cans.

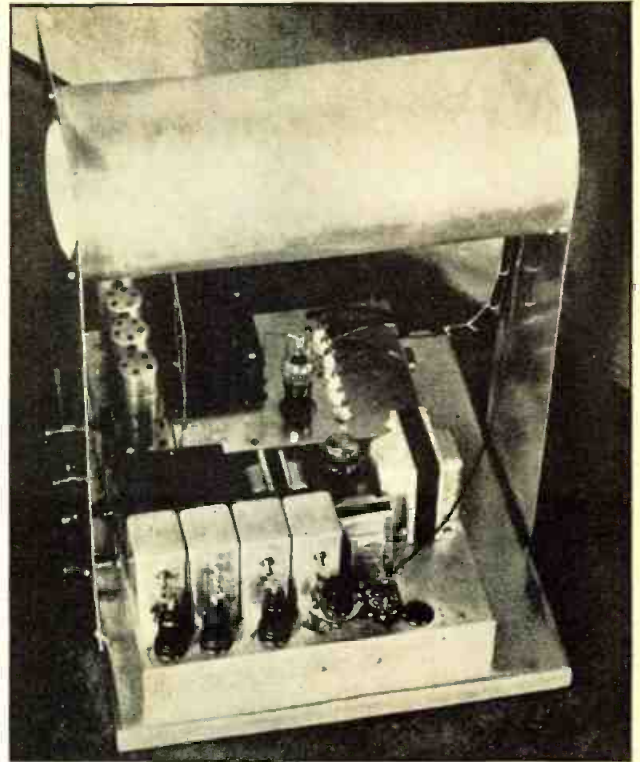

THE COMPLETED CHASSIS

Figure 2. The superheterodyne and low-voltage power supply are shown in the foreground, the sweep circuits and high-voltage power supply are in the background with the shielded cathode-ray tube above.

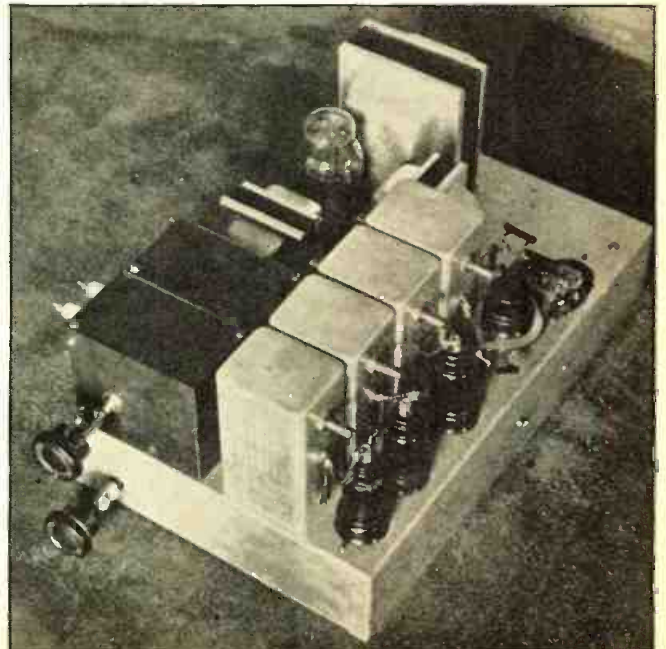
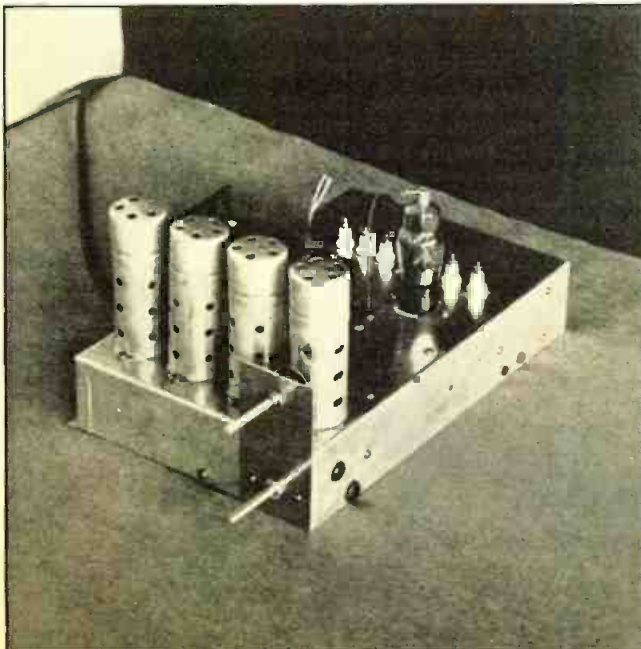

TELEVISION

But Kept

Another demonstration provides is ready for the home so far as

By S. Gordon



LEE ELLMAKER CHATS WITH OFFICIALS



ABOVE: THE PICK-UP. BELOW: RECEIVER



THE demonstration of its latest television developments by Philco provided, for this author, a peculiar combination of pleasure and disappointment. Pleasure because the television reproduction was really good—but disappointment because of the relatively small improvement over the demonstration of six months ago by the same company.

The latest demonstration took place at the Germantown Cricket Club, located in a suburb of Philadelphia. Here were arranged several consoles similar in appearance to present-day radio-phonograph combinations. These were the combination sight-and-sound receivers, and in front of each were grouped about 40 chairs. Each console had its built-in loudspeaker equipment and the television scenes appeared in a mirror mounted in the partly opened cover of the console, in such a position that the scenes on the horizontal screen of the cathode-ray tube within the console were reflected in the mirror so that anyone in front of the console could view the pictures.

Demonstrates Distinctly Acceptable Quality

The transmitter was located at the Philco factory, about three miles distant, air line, and the sight-and-sound program was transmitted via the air; the sight on a frequency of 54 megacycles and the sound on 49 megacycles (about 6 meters).

The televised program consisted of a variety of subjects, including an orchestra, a vocalist, a parade of mannequins in a fashion show, a news reel and some outdoor scenes on the roof of the factory. In addition, various small objects were shown to demonstrate the degree of detail that could be reproduced.

It can be said without hesitation that television as demonstrated here would be considered highly satisfactory for the home. With the family seated anywhere within 10 feet of the front of the console, the images on the screen would be distinctly visible in black and white. Close-up views of persons and objects were particularly good. When a dollar bill was placed before the camera, for instance, it was possible to read the serial number; and when an ordinary pocket watch was shown it was possible to even see the moving second hand and the marking on the portion of the dial over which it moved.

Television versus Home Movies

It has been the common practice to compare television with home movies, with due allowance for the fact that the television screen is much smaller than a movie screen, of course. So far as close-ups are concerned, it is believed that this television demonstration did equal good home movies. In the case of more distant "shots" however, the home movies have the edge. Larger objects and persons at a distance from the camera can be clearly seen, but, beyond a few feet, facial features become vague. Thus a person who is clearly identified in a close-up can be recognized when 10 or 15 feet distant from the camera only by the clothes or general appearance.

The news-reel reproduction suffered for this reason. The various scenes were clear enough to be interesting. Close-up views of persons, and some close-up shots of the rushing torrents of the Ohio during the showing of flood scenes were really excellent. But a motorboat passing up one of the flooded

PHILCO TELEVISION EQUIPMENT

Top: The receiver, and grouped around it, left to right, James M. Skinner, President, Philco Battery Co.; Lee Ellmaker, Publisher of RADIO NEWS; Sayre M. Ramsdell and Larry E. Gubb, Vice-President and President, Philco Radio & Television Co. Center: The new Philco Television Camera. At left: * Close-up of the latest type of sight-and-sound receiver.

Now Ready "Under Wraps"

convincing evidence that television technical development is concerned

Taylor

streets, perhaps 50 feet from the camera, was barely distinguishable, requiring several glances to definitely identify it as a boat. It should be pointed out here by way of explanation, however, that the light conditions were evidently poor at the time this scene was made, due to cloudiness and perhaps even a light rain.

A scene, directly televised, showing Connie Mack being interviewed by Boake Carter, left nothing to be desired. With these two well-known gentlemen seated at a table, as shown in one of the photographs on these pages, every feature and facial expression was absolutely distinct.

These observations lead to the conclusion, mentioned before, that television reproduction has developed to a point where it would be accepted with open arms by Mr. and Mrs. Average Man. True, landscapes and other such scenes would be lost and baseball or football games would not lend themselves to "televising" in the present state of the art. But radio artists, speakers, prize-fights and anything else with persons, objects or action within a reasonable distance of the camera would constitute enjoyable and worth-while material for television in the home.

What is Perfection in Television?

The disappointing phase of this demonstration is found in the fact that, although the television interests are withholding television until it is "perfected," the progress made during the past months is very slight. Just what is meant by "perfected" television? Do they mean to hold up its release until they are able to provide television on a large screen such as those used for movies? Do they hope to be able to show clear detail 50 or 100 feet from the camera? If these are the things for which they are waiting it will likely be years before we have television, judging from the minor progress shown in the past year or so.

If it is standardization of scanning they are waiting for, the wait should not be long. All indications are that the 441 lines, 30 frames per second employed in the Philco demonstration have proven highly satisfactory and acceptable. These figures represent the standard proposed by the Radio Manufacturers Association. If this association is agreed, and if those who have witnessed programs using this standard are likewise agreed as to its suitability, why delay further?

And Still We Have to Wait!

One of the important causes for delay to date is found in the failure to decide what frequencies are to be employed for transmission. The Radio Manufacturers Association has recommended the range extending from 42 to 90 megacycles, but it appears that the Federal Communications Commission is loath to grant this request and there are many radio authorities who agree that this is not a logical selection. In this RADIO NEWS heartily concurs.

Entirely aside from the fact that the amateurs were years ago assigned the range extending from 56 to 60 megacycles, and that the R. M. A. would like to see this range taken from the amateurs so as to make their own proposed range continuous from 42 to 90 megacycles, there is another (Turn to page 692)

FASHION SHOWS OF FUTURE

Right: Another one of the scenes shot, as part of a fashion review, during the demonstration. This fashion review indicates a type of program which is bound to be popular when television enters the home—the ladies—the sponsors—and possibly even the men!



TELEVISIONING A "SET"

This scene, showing Boake Carter interviewing Connie Mack, was viewed from 3 miles distant, via television, during the Philadelphia demonstration, and was as clear as the printed reproduction shown here.



THE TRANSMITTING ANTENNAS



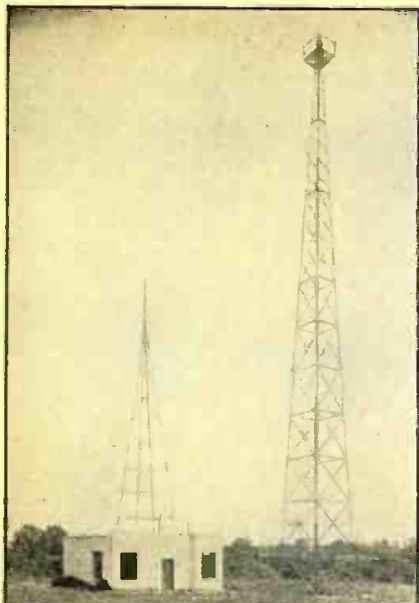

TELEVISION ANTENNAS

The transmitting station of the Farnsworth system, showing the two steel antenna towers.



SCENE DURING REHEARSAL IN MAIN TELEVISION STUDIO

This is a view that greeted your reporter's eyes on the recent demonstration of experimental television at Wyndmoor.



TAPS AND GYRATIONS

The tap dancer is bound to be a favorite to television audiences in the future. Scene shows rehearsal of such a feature.

A New Kind of Program

WITH the inception of television broadcasting will come a totally new kind of radio program over the air. To show how close this era is, the pictures on this page indicate the pains an outstanding television authority and his staff are taking to be ready with studio staffs and trained personnel for the very special art of television presentations.

MINIATURE BACKGROUNDS

It is predicted that "dwarf" set-ups may be used for backdrops in future television productions. Picture shows a BBC midget model of the Coronation Procession.

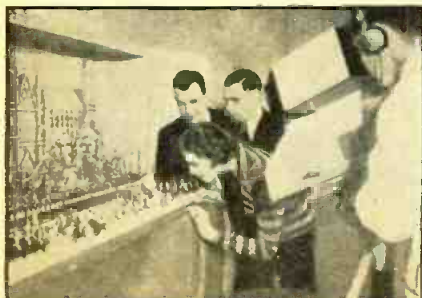

New Studios And A New Transmitter **FARNSWORTH**

By The **RADIO NEWS**

UPON my return from Wyndmoor, Pennsylvania, I am still more convinced that the television era is closer than many persons in the radio industrial and legislative circles of the nation care to admit. Maybe you never heard of Wyndmoor. But you're going to hear about it and may even see a part of it in the very near future. This small town, a suburb of Philadelphia, already holds, within its limited bounds, one of the most complete and technically advanced television stations in the world. Designed and erected by Farnsworth Television, Inc., of Philadelphia, the sight-and-sound unit should be on the air experimentally by the time this article reaches print.

More than a year had passed since my earlier visit to the Farnsworth laboratories and the strides noticeable in that period were gigantic. The number of image lines is now 441, as are also the new Philco and RCA-NBC standards. This is the recommended standard of the Radio Manufacturers Association. A sharper image is now available and the apparatus has been considerably refined, one of the most notable improvements being in the design of a shorter receiving tube which, by a new

STUDIOS JUST COMPLETED

An early photograph of the new Farnsworth studios before the surrounding grounds were landscaped.



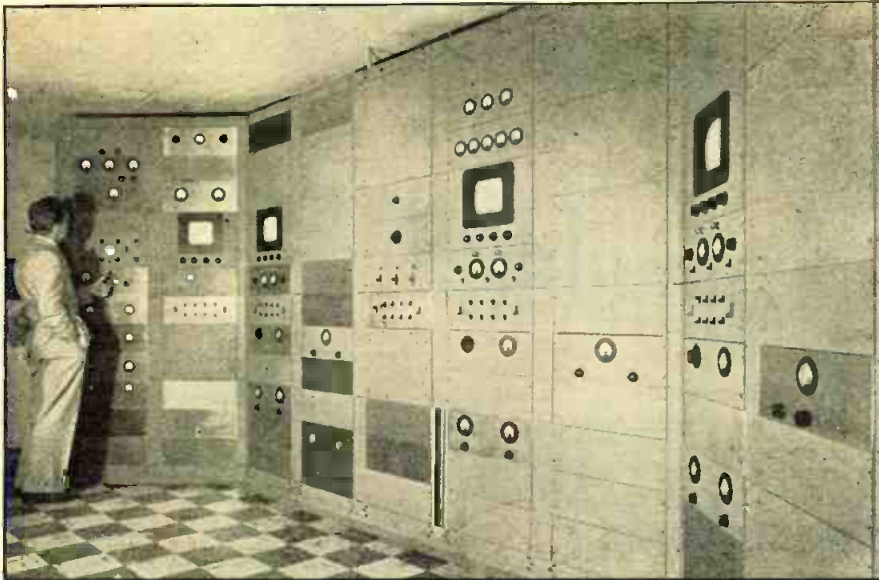

THE GREAT NEW TRANSMITTER FOR SIGHT AND SOUND
 Here is a view of the new panels containing the transmitting apparatus installed in the transmitter house at Wyndmoor, Pa.



TELEVISION CAMERA

The above words aptly describe the appearance of the Farnsworth television pick-up, which looks simpler and is smaller than those used by other systems.

Employing 441 Lines Announced By TELEVISION

Television Reporter

means of deflection, yields as large a picture as the older and very long type of valve.

Television demonstrations to the press are now a commonplace. There are bracketed periods every year when all commercial contenders for American and world television leadership get up a show and invite radio and science editors to look at a laboratory test, usually

with makeshift, improvised studios. Oftimes the demonstrations reveal the progress made technically with little thought to the program and production end. But, at Wyndmoor, where I visited the Farnsworth plant for a special demonstration, I discovered an elaborate Hollywood-like studio. Programs were in rehearsal. Scenic paraphernalia, lighting equipment and the television cameras arranged in the large studio revealed that polished, well-rounded programs can go on the air on short notice.

Although Wyndmoor is just past the Philadelphia (Turn to page 679)



MAKE-UP IMPORTANT

As RADIO NEWS has pointed out before, new technique must be developed for television make-up. Photo shows a cosmetics expert actually testing the effects of different styles of make-up in determining one most successful for this new art.

Everyone Wants Television

THERE is no doubt in people's minds as to whether or not they would like to have an efficient television receiver in their homes.

FOR YOUR HOME?

Every American may soon be enjoying a television receiver such as that pictured below, which is one of the models developed by Farnsworth. It contains a vision screen at eye level.



TELEVISION SCHEMATIC
 Below is the fundamental circuit employed in the latest receiver types developed by Farnsworth.

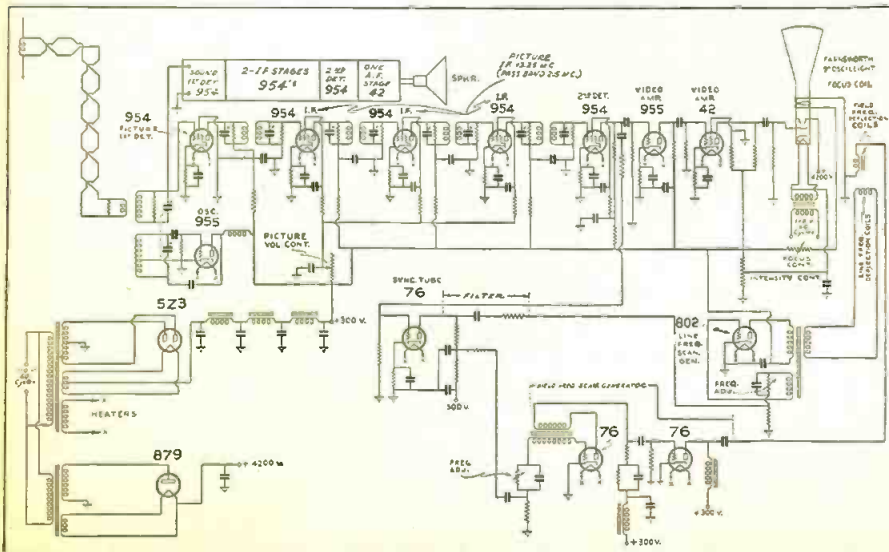



A SERVICE SHOP FROM THE ANTIPODES
Two prominent American instruments on an Australian bench.

THE SERVICE BENCH

Free Inspection . . . Service Kinks . . . **SERVICING: RCA-Victor . . . Belmont**
. . . Atwater-Kent . . . Majestic . . . Philco . . . Kennedy . . . Macy . . . General
Electric . . . Brunswick . . . Meissner I.F. Units . . . Service Shop . . . RCA
Meetings . . . Book Review

Conducted by Zeh Bouck, Service Editor

PUTTING PROFITS INTO FREE INSPECTION

FREE inspections and free tube tests continue to be highly controversial matters between individual servicemen and factions of servicemen. One group argues that free inspections do not bring in money and therefore represent a direct loss to the business—and, anyway, a laborer should be worthy of his hire. The other side maintains, with equal heat, that free inspection and testing are a sort of advertising, an excellent selling and publicity-getting point, and are justified from this point-of-view. They also point out that most free inspections result in service jobs directly—a tube replacement as well as more involved and profitable repairs.

The rebuttal, of course, is to the effect that such service work is not profitable if you charge only for the time consumed in making the repair and throw in the free inspection time. On the other hand, if you figure in the "free inspection" on your cost card, it ceases to be free inspection, and the serviceman is not playing fair with his client. It is also pointed out that free inspection often necessitates transportation, which is a direct expense against the business. The proponent will then reply that in any well regulated business the matter of transportation is taken care of in overhead, and the increase due to free inspection will be negligible. Finally it will be declared that no one has much faith in anything they get for nothing.

Both Views Correct

As in most controversial matters, both sides are right. Free inspection is fundamentally a form of advertising—and as such it must necessarily be paid for by the business, the same as any other form of advertising. Provision should therefore be made in the allotment set aside for advertising—which budget forms a part of the overhead which must be considered in

computing the cost of every service job. (See the *Service Bench*, April, 1937.) Estimate the number of hours devoted to free inspection every month—quite apart from the time utilized in actual servicing and repairing. Allow one dollar per hour for such free services, and add the total to the regular advertising budget. The cost of free inspection, etc., will then be absorbed, as it should be, on a pro-rata basis for every service job.

Many servicemen find free inspection of definite sales promotional value, and it is sound business when financed as described above. The American public is something-for-nothing conscious and free inspection falls in line with "free air," "free parking," "free crank-case service," etc., etc.

THE DAY'S WORK

Frank Bentley, Jr., of Missouri Valley, Iowa, who photographs as he services, sends us the kink illustrated in Figure 1. The picture tells its own story. Save the prongs from the usual 115-volt plug when the composition cap breaks. Screw these down in various convenient spots—on the side of the service bench, on the shop walls, inside of drawers, on the walls of the

FIGURE 1

How to keep plugs where you can find them—simple and sensible.



service truck—and slip the female plug over them. Plugs always come in handy, and it is just when they are needed most that they disappear into the farthest recesses of the junk box.

From the service case-book of Harry Schmidt, Richmond Hill, L. I., New York, who specializes in radio service, public-address systems and hearing aids, comes the following data on—

Victor R-15

"The complaint was fluctuating volume accompanied with noise. A new volume control cured the fluctuating part of the trouble, but the noise persisted. Thorough inspection indicated that the noise was from a cause exterior to the set, and it was finally located in a 3-way plug which accommodated several floor lamps. Watch these plugs—they have four ways of getting loose and noisy!

Belmont 525

"Another complaint of noise. In this instance it was caused by a condenser lead resting against a carbon resistor. Vibration of the speaker created an intermittent contact. Pushing the wire away from the resistor cured the trouble.

Atwater Kent 37

"There are still plenty of the old reliable AK-37s in existence. Weak signals and distortion is a logical enough complaint with these sets. This will usually be caused by a dirty volume control and a partially short-circuited speaker filter condenser. Clean the volume control and replace the condenser with a 1 mfd. 600-volt unit.

Majestic 70

"Another of the old reliables. This receiver was noisy when tuning. The locknut on the condenser had loosened, permitting the rotor to shift and occasionally to make contact with the stators. Also clean the hum balancer.

Philco 20

"The same old complaint—noise and intermittent reception. In this case it was caused by a lump of solder hanging on to a wire and shorting occasionally when it touched the chassis. It will happen in the best of sets.

Atwater Kent 55

"Noise. Clean the contacts of the 'Lo-Dis' switch and the speaker plug.

Belmont 100

"Fading and noise were corrected in this receiver by the simple expedient of replacing the volume control. Use a one megohm unit.

Kennedy 20

"Long interval fading. Replacing a weak 27 failed to remedy matters. A thorough test and much profanity were no more effective. Finally, all connections were given the hot iron treatment—which worked as it often does. Probably an intermittent high-resistance contact.

Macy M.B.-9 Twin Speaker

"Plenty dead, and the power transformer was completely burned up about it! The cause was a short-circuited field in the larger speaker. When the field coil was removed for examination, it was discovered that the inside terminal wire had short-circuited to the core. The coil itself was undamaged. A new lead, some mica insulation and sealing wax took care of the speaker, and a new power transformer restored the set to operation. Use a husky transformer on these jobs.

"On these models the dial is located about eighteen inches from the chassis, (Turn to page 678)

Modern CATHODE-RAY Oscillograph

(Money-Making Applications)

By John H. Potts



A COMPACT AND EFFECTIVE SHOP TOOL
The oscillograph described in this article is here shown during one of the numerous tests to which it was subjected in the R. N. Lab.

THE truth of the old Chinese proverb, "A picture is worth a thousand words," is demonstrated in the tremendous interest caused by the introduction of the cathode-ray oscillograph among servicemen, experimenters and amateurs. "Seeing is believing" and the oscillograph gives us a picture, clear and truthful, of electrical waves.

THE high cost of cathode-ray apparatus employing the larger tubes has deterred many from acquiring such equipment. Since the introduction of the new type 913 miniature tube, however, it is now possible to obtain an excellent complete cathode-ray oscillograph at a price well within the means of a great number of servicemen, experimenters and amateurs. It should be remembered, though, that good instruments of this type can never be extremely low in cost. While the 913 tube effects a big saving in original and replacement cost and is more economical in voltage and space requirements, the same care must be given the design of the associated sweep circuits and other features as for any of the larger instruments if equivalent results are to be obtained. These points have received careful consideration in the new Clough-Brengle model 105 oscillograph shown herewith, which has just been tested in the Radio News laboratory.

Well Designed Job

This new instrument is provided with a high-grade linear sweep circuit utilizing the type 885 gaseous triode tube, the frequency range extending to 30,000 cycles. It has vertical and horizontal amplifiers, beam centering controls and

THE "WORKS"

This is the way it looks with the case removed.

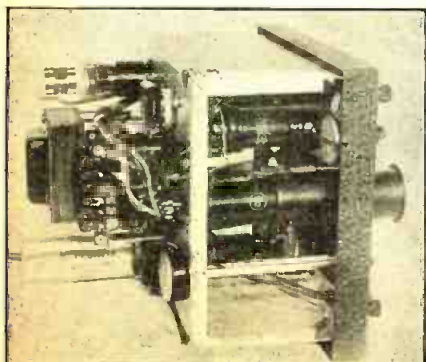

a synchronizing circuit. A sliding tube shield acting as a shadow box enables the images to be viewed easily in a brightly lighted room without applying excessive voltages or causing eye-strain. The vertical amplifier has high gain and is rated linear to 100 kc.

The complete schematic diagram is given in Figure 1. The instrument is light, compact and easily handled; features which enable it to be conveniently employed when, as is usually the case, bench space is limited.

On the right-hand side of the case there is a port-hole which permits the user to open a link and make direct connection to the vertical plates. This is a particularly advantageous arrangement for high-frequency testing. The writer found it possible to make observations and tests at 25 megacycles by this means.

Aligning Sets

The application of the cathode-ray oscillograph to receiver alignment have been heavily stressed by practically all writers, yet many "old-timers" among servicemen still feel that they can align intermediates accurately by the old "point-to-point" methods and have therefore hesitated to add an oscillograph to their equipment. While the older type receivers, with sharply peaked

i.f. transformers, are amenable to this procedure, modern receivers of better fidelity are often equipped with over-coupled transformers to give a flat-topped curve. When aligning such circuits, the adjustment of the primary reacts on the secondary and vice versa. The whole operation then becomes a hit-or-miss procedure with little possibility of optimum results.

Other Applications

Even with the older type superhets, alignment is made an easier and more precise operation. In adjusting the padder, for instance, it is necessary to rock the gang condenser back and forth to make certain that the proper adjustment for the i.f. beat is also the point of r.f. resonance. Using the oscillograph rocking is unnecessary since the complete overall curve will reveal any misalignment.

Receiver modernization is an idea which many servicemen have played with, usually with little success. Often the difficulties encountered could be greatly simplified if the proper equipment were at hand. The older type sharply peaked i.f. transformers, for instance, may be staggered to give far better fidelity. To (Turn to page 693)

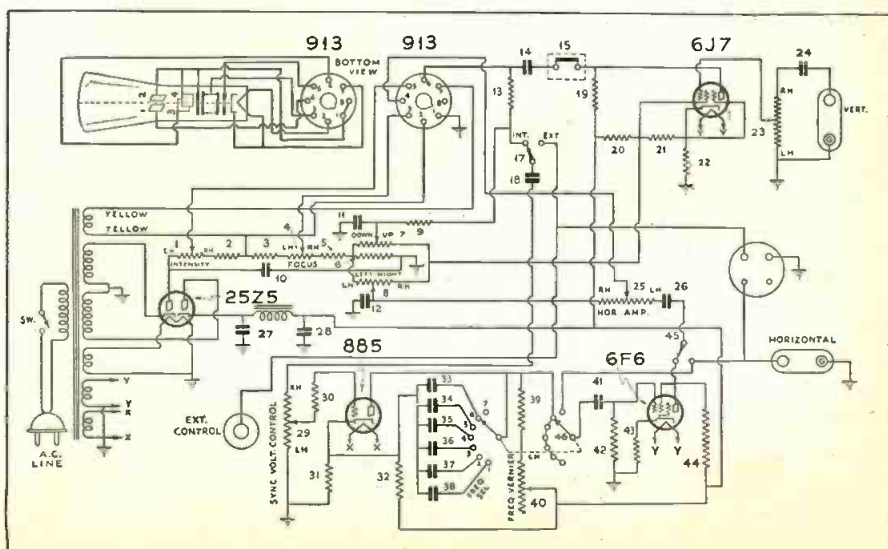

Suggestions for Calibrating the R. N.

"CAPATRON"

Signal Generator

By John H. Potts

A SOMEWHAT simpler method of installing the dial assembly has been found suitable and is illustrated in Figure 1. The variable condenser shaft is coupled to a 5/16th inch bakelite rod which passes through an eccentric hub mounted on the panel in the manner shown. This hub fits within the inner section of the dial assembly and is necessary to enable the dial numbers to change during rotation. The eccentric hub is a standard part available from the National Company. The mounting details should be clear from the diagram, but it should be emphasized again that the bakelite shaft must be perfectly aligned so that the dial will not bind. The 5/16th bakelite rod is rather difficult to obtain since it is not a stock size, but it is handled by some houses and can be procured on special order by others.

The Tube Voltmeter

The built-in vacuum-tube voltmeter was calibrated at radio frequency against a laboratory standard in accordance with the curve shown in Figure 2. Actually this curve shows the input voltage to the attenuator for a given reading of the tube voltmeter, since this is what we are primarily interested in. Leads should be kept as short as possible when making such calibrations. As mentioned last month, when the r.f. control is at minimum setting and the attenuator shorted out, the tube voltmeter connects to the signal generator output terminal through the .001 blocking condenser.

The Attenuator

A calibration point may be selected and checked at any future time at 60 cycles through the output terminals without taking the instrument apart. This provides a convenient means of getting an immediate check on the tube voltmeter whenever desired. There will be a slight discrepancy between the r.f. calibration and that at 60 cycles due to the small size of the blocking and bypass condensers, but this can be allowed for in making the check.

The attenuator is calibrated in decibels according to the scale given in Figure 3. This scale is reproduced full size and may be used for a template or cut-out and glued to the attenuator sliding

strip. A thin piece of celluloid placed over the scale will serve to keep it clean and protect it from damage. The bakelite knob on the sliding strip was taken from a surplus anti-capacity key switch.

The screws mounting the stationary copper disc on its bakelite support at the end of the attenuator tube are arranged to project through the support so the movable disc will contact them and short out the attenuator when the sliding strip is pushed all the way in. The total output voltage of the oscillator as indicated on the tube voltmeter, will then be applied to the output terminals of the signal generator. This high voltage will be found a great convenience in checking detector and i.f. circuits and in preliminary aligning when installing a replacement i.f. transformer.

The Zero Level

When the movable disc is withdrawn until it just fails to touch the short-circuiting screws, attenuation is introduced equal to the ratio of the capacity between the two copper discs and the output capacitance, assuming that the latter is very large. In this model, using an output capacitance composed

of a 14-inch shielded cable, the attenuation ratio was 20 to 1. The shield braid had an outside diameter of 3/8ths inch over ignition cable. This means that a 2-volt signal at the input to the attenuator gives .1 volt across the output terminals at minimum attenuation. This, then, is our zero level. If we reduce this level 20 db., we decrease the voltage to 1/10th the zero level, or .01 volt. At -40 db., the voltage output is .001, etc.

Checking Calibration

The first 30 db. attenuation should be calibrated with a receiver; the balance may be done mathematically.

To check the calibration against a receiver, an all-wave type with a.v.c. and a tuning meter or "magic eye" may be conveniently employed. The signal generator is connected to the receiver in the usual manner. A piece of card or white paper is placed under the knob of the receiver sensitivity control. The signal generator tube voltmeter is set at 1 volt and the attenuator set for maximum output. The receiver sensitivity control is then adjusted until a small reading is obtained on the tuning meter or magic eye and the sensitivity control setting is marked on the white paper. Let us call this mark "A". Now leaving everything set, increase the signal generator tube voltmeter reading to 2 volts.

Completing the Scale

Adjust the receiver sensitivity control until the same reading is obtained on the tuning indicator as was formerly obtained with the control set at "A" and 1 volt. Mark the sensitivity control setting again, calling the new mark "B." We now know that moving the receiver sensitivity control from "A" to "B" makes a two-to-one change in sensitivity. Let us once again return the sensitivity control to point "A" but with 2 volts instead of 1 volt indicated on the signal generator tube voltmeter. Now instead of backing off the sensitivity control to point "B," let us pull out the attenuator slider until the reading of the receiver tuning meter is the same as was previously determined for point "B." Since changing the sensitivity control from point A to point B indicated a 2-to-1 voltage change (6 db.),

THE R.F. UNIT AND SCALE

An internal view of the r.f. unit, showing the layout of the various parts and tubes, and (below) Figure 3, a full-size calibrated scale for the attenuator.

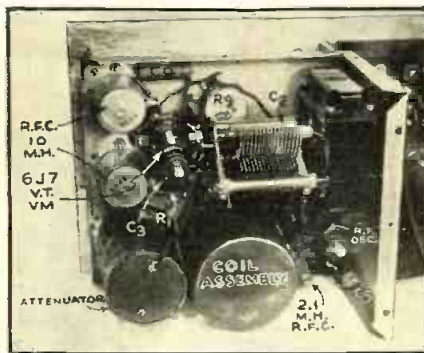

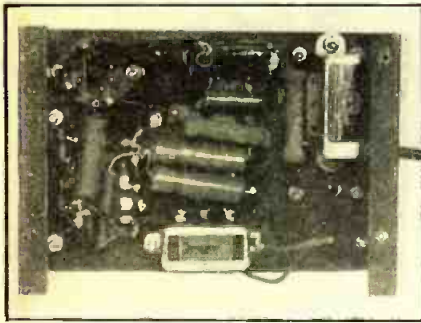

BENEATH THE CHASSIS

The layout of parts on the under side of the power supply and a.f. oscillator chassis.

the attenuator has now been adjusted to effect a 2-to-1 voltage change. Other points may be secured in like manner.

Frequency calibration of test oscillators has been described so often that it is perhaps unnecessary to go into any great detail on the subject. The best and most convenient method is to do the job with a special crystal oscillator giving 100 kc. and 1000 kc. beats, supplemented by checks against broadcast stations of known frequency. Since the variable condenser employed in this instrument is of the straight-line frequency type, the calibration is much simpler than with other types of tuning condensers, even though the coils used do not permit precise s.f. results.

Frequency Calibration

Tune in a broadcast station on the standard broadcast band, using a short piece of wire as an antenna so that a sharp tuning point is secured. Bring to exact resonance as indicated by a slight deflection on the tuning meter or magic eye. Now tune in the signal generator to the same frequency, using an unmodulated signal, until a squeal is heard in the speaker. Bring this squeal down to a very low pitch by careful adjustment of the signal generator tuning condenser. The point where the pitch becomes inaudibly low is zero beat at the precise frequency of the broadcast station. This operation is repeated for all stations of known frequency and a curve is plotted, covering the standard broadcast band.

Now proceed to the lower frequency

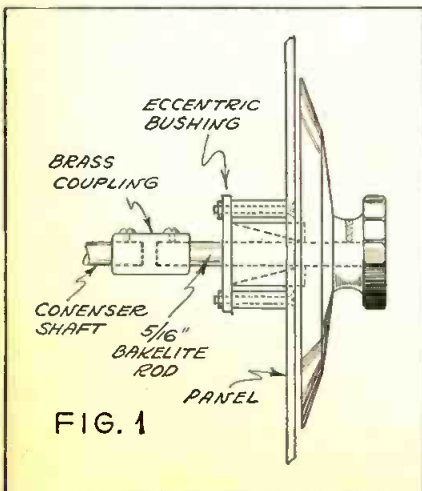
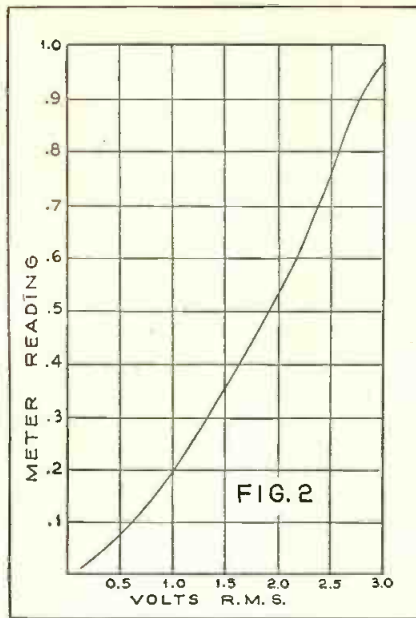
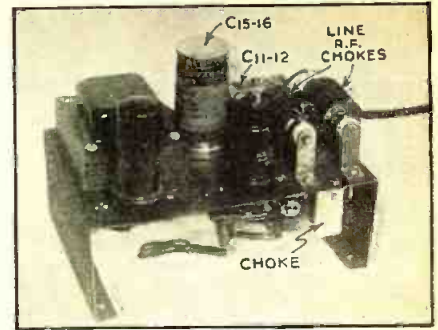

FIG. 1



bands. Having determined where 600 kc., for instance, comes in, tune the receiver to this frequency and adjust the signal generator on the 200-400 kc. band, starting with the tuning condenser unmeshed, gradually increase the tuning capacity until the signal is heard in the speaker. Modulation should be used if there is no broadcast station at this point. Again tune the oscillator to exact resonance as indicated by the tuning meter. This should then be 300 kc. To make doubly sure, tune the receiver to 900 kc., leaving the oscillator adjusted at 300 kc. Another signal should appear



TOP VIEW OF CHASSIS

Another view of the power supply chassis, showing the line chokes, tube arrangement and other details.

at this point. Return the receiver to the 600 kc. point and pick up the 200 kc. signal from the test oscillator. Recheck this point by adjusting the receiver to 800 kc. and make certain that the signal appears at this point. This operation may be repeated for 150 kc., rechecking at 750 kc., and so on.

High-Frequency Points

High-frequency points may be obtained by setting the test oscillator at 1000 kc. and calibrating the receiver with its harmonics at 2000, 3000, 4000, etc. The signal generator may now be switched over to the bands including these fundamental frequencies and the calibration points determined. Points so determined will not be as accurate as those given directly beating against broadcast stations, since there may be some slight error due to frequency drift during the (Turn to page 700)

Growing
DOLLARS
in the
P. A. Field

FEW realize the tremendously wide field that has opened up for public-address installation during recent years. To emphasize this point the following list, recently compiled by the Webster Company, showing the variety of places in which P.A. systems are now in use, is passed along to readers. It should prove suggestive, not only to dealers and P.A. prospects, but to owners of many enterprises in which such installations can be used to advantage.

Airports, Railroad Stations, Bus Terminals—For announcement of arrivals and departures, special announcements, call systems, etc.

Amusement Parks, Baseball Parks, Band Stands, Football Fields, Stadiums, Race Tracks—For announcements, speeches, music, control and handling of crowds, etc. Besides voice and music amplification, a P.A. system permits picking up activities at any point. Individuals can talk from any point without necessity of moving, and speech can be provided with a musical

background, with aid of musical recordings, etc.

Auditoriums, Sports Arenas, Skating Rinks, Ballrooms, Lodges, Commercial Clubs, Convention Halls—For announcements, scoring, call system, paging, music entertainment, rebroadcasting, to carry auditorium programs to adjoining rooms, entrance ballyhoo, car calling, etc.

Cemeteries—For supplying or amplifying music in grounds, for supplying chimes from recordings, for cemetery chapel services, for portable use on various occasions.

Churches—For public-address in main room and adjoining rooms, for supplying chimes in lieu of bells, for recording sermons, events, etc., for music rebroadcasts, etc.

Exhibitions, Carnivals, Fairs, Side Shows, Circuses, Tent Shows—For general announcement and ballyhoo at entrance and in grounds, for supplying music, judging events, portable systems for side shows, music system for special acts, etc.

Restaurants, Road Houses, Barbecue Stands, Cook Houses, Concessionaires—For music, announcements, ballyhoo, calling orders, instructions, etc.

Factories, Department Stores, Brokerage Offices, Large Business Offices—General announcements, paging, rebroadcasts, call system, etc.

Hotels—For radio in guest rooms, amplification in main rooms, music in dining rooms, paging, for use of speakers at conventions, etc.

Hospitals—Radio for patients, paging system, radio for nurses' home, amplification (Turn to page 700)

No "Bugs" in This D. C. AMPLIFIER

Although simple to construct and adjust, this little amplifier will provide perfect tone with ample volume for home use.

By Gerard J. Kelley



WHEN direct-coupled amplifiers were announced by Loftin and White several years ago, they were accepted as the ideal amplifier from the standpoint of fidelity. It is probably due to economic considerations, as well as due to the critical adjustment of voltages that the system lost favor.

THEORETICALLY, the direct-coupled amplifier permits the lowest amplitude, frequency or harmonic distortion with the widest frequency range. This writer has spent a long time in the study and development of this form of amplification. The result of this study is a new type of direct-coupled amplifier which does not require critical adjustment of voltages or circuit constants, yet offers the same advantages as the old direct coupled amplifiers. Hum bucking circuits are no longer necessary either. Designs have been made for several amplifiers, including push-pull circuits, but this article describes a two-stage amplifier employing a pentode voltage amplifier stage and a 2A3 or 6A3 output tube.

The Compensating Circuit

It will be appreciated that any variation in the potentials of the first tube may result in an amplified change in the grid-bias of the last tube, with possible distortion. Such variations may be caused by ageing of tubes, heating, tolerance of parts, etc. Therefore, it is necessary to counteract the effect of these changes by a compensating circuit

which works on d.c. only. This is accomplished by supplying the screen of the pentode tube from the cathode of the output tube. (See Figure 1.) If for any reason the circuit constants have changed so as to result in too high a plate current in the 2A3, the voltage of the screen will be raised, resulting in more current in the pentode, more voltage drop in its load and increased bias on the 2A3. In this way the plate current always returns to approximately the same value. Due to the resistance capacity filter in the screen circuit, the compensation does not work on a.c. signals.

High-Frequency Response

The high-frequency response, like in all other amplifier systems, depends on the capacity shunting the coupling device. This capacity consists of the output capacity of the first tube, the input capacity of the next tube and the capacity of the wiring connected to the coupling device. Since the direct-coupled amplifier uses less parts or coupling units, the capacity is lower.

The condenser across the diode load of a detector may be responsible for considerable loss in high frequencies. Therefore, it is recommended to omit this condenser and employ a small condenser (C8) in the output across a low impedance. Considerably better high frequency response is obtained in this way. There is enough capacity in the first tube to prevent instability.

Low-Frequency Response

Good regulation in the power supply is necessary for low-frequency response. The rectifier and the filter should have low resistance. The 83V has been found better than a mercury vapor tube because the latter would require filtering and shielding. The choke should have low resistance and high inductance. The output condenser should be at least 8 mfd., and may be an electrolytic. The input condenser must be a paper type because of the high voltage. A suitable condenser from 3 to 5 mfd. capacity is made by Cornell-Dubilier (Type PE-B6808).

Resonating the output by means of a shunt feed circuit is another way of bringing up the lows. The circuit of Figure 1 shows two output connections. If shunt feed is used, the blocking condenser (C9, C10) might be an 8 mfd. electrolytic and 2 mfd. paper in parallel to provide the odd total of 10 mfd. required. C3 can then be 1 mfd. paper and the choke is 30 henries. When series feed is employed, C3 should be increased to 8 mfd. (electrolytic). The shunt feed connection boosts low notes considerably more than the series connection.

The most convenient way of biasing the first tube is by means of a flashlight cell in the cathode circuit. The plate current of the tube charges up the battery and it needs to be changed only when the tube is changed.

The best quality is obtained by direct coupling of the amplifier to the diode detector, as shown to the left of the dotted line. In some locations, a single tuned circuit coupled to a tuned antenna will bring in the local stations.

The wire-wound resistor (R3) in the filament circuit may be replaced by a speaker field of equivalent resistance value. Suitable power transformers are manufactured by Thordarson (type 7021) and U.T.C. (type 14552). They may be used without any change in constants.

This amplifier with a 57 and 2A3 or 6C6 and 6A3 is rated conservatively at 3 watts output. Its response curve into a resistive load is flat within 1 db. from 30 to 10,000 cycles. Although the output may seem low, it is ample for use in the average living room. The writer has found that a Philco U7 speaker provides excellent quality.

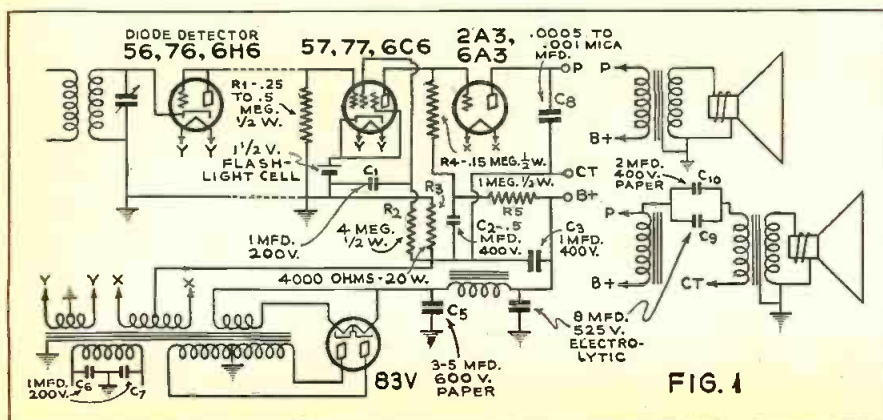
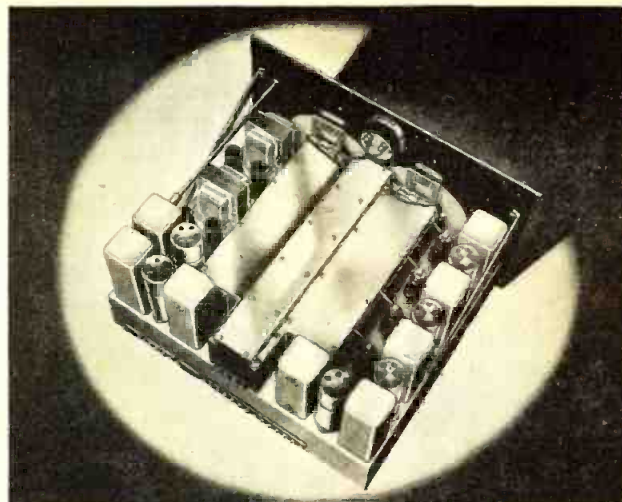

FIG. 1

Thoughts On Receivers for 10 Meters

By S. Gordon Taylor



THE 1.2-40 MEGACYCLE SUPER-PRO

A PREVALENT impression among amateurs who are not thoroughly familiar with 10-meter conditions, is summed up in a comment recently heard: "When the 10-meter band is open, any receiver is good enough but when the band shuts down, no receiver is any good."

Unfortunately, the idea voiced above has been widely accepted due to the fact that it is frequently possible to hear practically all of the world on even a poor receiver when this 28-30 megacycle amateur band "opens up." The important fact that is lost sight of, however, is that a good deal of the time the band is neither wide open nor tight shut and it is particularly during this "in between" condition that the advantages of a good receiver are important.

Good Receiver—Real Asset

It is not uncommon to hear comments, such as the one quoted above, over the air and later on in the QSO to hear this same "ham" report to the one at the other end of the contact that part of the previous transmission was "lost due to a bad fade." A signal that fades, let us say, from an R7 to an R2 when using a poor receiver, might very likely be termed an R9-plus signal fading perhaps only to an R7 were this same station using a good 10-meter receiver.

The fact of the matter is that re-

MANY mistaken ideas have been circulated concerning the 10-meter band and equipment for use thereon, probably because of the widespread interest that has developed in it almost overnight. The author, in this article, points out the weakness of some of these generally accepted beliefs, insofar as they involve practical receiving equipment for use in this range.

Receiver requirements for 10 meters are just as stringent as for operation on 20 meters or any of the other lower frequency bands. On 10 meters the variations in conditions come more rapidly and are perhaps somewhat more radical than on the other bands but that is the primary difference.

High Efficiency Possible

A good receiver means more 100% QSO's and that, after all, is what counts.

Another supposition which has been given too much credence is that due to the complications of design introduced by the higher frequency, one cannot hope to obtain receiver efficiency equal to that obtained at the lower frequencies. This thought had undoubtedly been encouraged by a number of the communication and all-wave receivers on the market which are much less efficient on this band. In fact, there have been such receivers which were just about useless in the 10-meter range due in most cases to the fact that the addition of this range was pretty much of an afterthought. There are certain technical complications involved in circuits used at these very high frequencies, but the obstacles are by no means insurmountable even in receivers that employ band-switching and which cover from the broadcast band all the way up to 40 megacycles or thereabouts.

To definitely check this latter thought, it was decided to run a series of measurements on a multi-band receiver. It happens that the newest

Hammarlund Super-Pro, a model identical with the standard model except that instead of covering the range of 540 to 20,000 kc., it covers from 1250 to 40,000 kc., was available, so it was used as the subject of the tests. Not only were these measurements quantitative, but every measurement made was repeated on both the 10- and the 20-meter bands to provide a direct comparison and therefore a double check. It was considered worthwhile to undertake these measurements inasmuch as there has been very little published concerning actual receiver measurements at these high frequencies.

In a superheterodyne such as the one measured, there are certain characteristics which are a function of the i.f. amplifier and would therefore be alike for all bands. Included among these are selectivity, a.v.c. action and fidelity.

Laboratory Tests

Measurements of these features were therefore only sufficiently thorough to indicate that the new model is at least equal to the standard model Super-Pro, measurement data of which was given on page 474 of the February issue of RADIO NEWS.

The characteristics which are determined very largely, if not entirely, by the r.f. circuits were given special attention in the measurements. These include overall sensitivity, image selectivity and band-spread. (Turn to page 699)

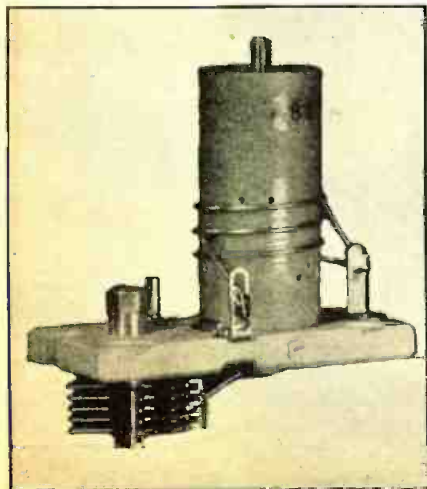

10-METER OSCILLATOR COIL
Designed for rigidity and stability. Note, at left, the air trimmer below the base, and the screw on top by means of which a copper disc is adjusted to provide exact inductance for perfect alignment. At right, Figure 1.

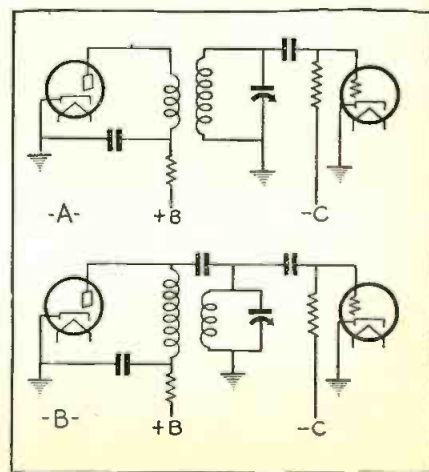



NAVAL COMMUNICATION RESERVE DOES ITS PART

Officers and personnel of the Naval Communication Reserve, consisting of amateurs receiving training in radio procedure, served both in their homes and at control stations, as pictured above, in handling radio relief messages to the stricken zones.



RUSHING BURNED OUT PART

Everyone lends a hand to load a new generator and transmitting tubes on plane bound for broadcasting station WAVE at Louisville. Below: Even wives of amateurs helped out, as Mrs. Frase, Jr., is shown assisting in clerical work during flood.



AMATEURS *for* FLOOD

Amateur radio again came to the record in supplying emergency floods that swept down the Ohio Mississippi

By Everett

THE work of no one amateur can be singled out in this flood disaster. Every amateur operator in the country operating on the 160- and 80-meter bands, which were set aside for emergency traffic, did his part by keeping silent unless he had some important traffic that had to do with the saving of lives or rushing medical supplies.

Amateurs Organize Aid

Amateurs in the flood area quickly organized as soon as word of the pending disaster began to spread—even before the raging flood waters swept over the high levees along the Ohio that had been constructed after the 1913 disaster. Amateurs of the United States Naval Reserve, of the Army Amateur Net as well as those unattached, quickly swung into action. They co-operated with the Red Cross, the United States Coast Guard, the United States Army Engineering Corps, state and city authorities and broadcasting stations, in

EVERYONE GIVES SERVICE

Musicians in overcoats and mufflers keep up community spirit by playing in a "frozen" studio at WLW, Cincinnati. At right, below: E. R. McCarthy, of the U. S. Forest Service, operating his portable transmitter, WSEM, contacting the U. S. S. Yokoma on rescue duty in the flooded area.

answering frantic calls for help and organizing and directing relief where it was most needed.

Radio Minute Men

Amateurs often have been described as the "minute men of radio." Short-wave listeners who had occasion to listen in on either the 75- or 160-meter band during the flood heard them living up to this tradition. The story that was unfolded by their brief, cryptic messages gave the listener a true picture of the disaster—far more vivid than it is possible to describe it in words. These aural messages were only a part of the traffic handled by the amateurs; there were hundreds of others attached to Navy and Army networks handling emergency traffic in telegraph code. In addition there were many more operating on the ultra-high-frequency band of 5 meters handling local traffic between Red Cross unit headquarters, on boats cruising about to pick up stranded refugees and between other relief stations.

Directing Relief

Listeners heard many messages like these:

"... Urgent, call for assistance, urgent: two expectant mothers and one who has just given birth are in need of a doctor."

"... The river at 5 p.m. stands at 59 feet. . . . It is rising at the rate of a



SWING INTO ACTION RELIEF

rescue and turned in a marvelous communication during the disastrous River valley and thence to the in January

M. Walker

tenth of a foot every four hours. . . ."
" . . . Send boats, send boats, Third and Breckenridge Streets, seven persons clinging to an overturned boat . . . this is the third call. . . ."

Fire Alarms Too

" . . . Fire has broken out for the second time today in the varnish factory at Twelfth and Broadway . . . urgent . . . send all boats available to remove residents in nearby houses. . . ."

" . . . The Weather Bureau reports the river now is stationery at 59.9 feet. . . ."
" . . . Urgent . . . attention all boats . . . proceed to the Louisville Plate Glass Factory . . . there are thirty refugees there . . . this is the fire zone. . . ."

And so continued for almost two weeks, when more than fifty mid-western cities along the rivers were without water, light, power and necessary supplies.

W8YB Outstanding

One of the principal amateur stations in the quickly organized flood network was that of the University of Cincinnati, W8YB. This station was on the air continuously during the flood and maintained contact with other amateur stations along the Ohio River, advising these sections. It was through this station that other amateurs operating east and west of the flood zone first learned of the emergency. They were quick to relay the information and it was not

long after high water descended on the Ohio as a result of almost sixteen days of constant rain wherein over twelve inches fell in the fertile valley, that a portion of the 75-meter 'phone band was cleared for action. All frequencies between 3950 and 4000 kilocycles were set aside for emergency work.

F. C. C. Intervenes

The task of handling the emergency traffic became constantly more difficult as the disaster area spread. More stations in the network were needed, and it was necessary to cover longer distances for the transmission of the emergency messages.

At the request of these amateurs, the Federal Communications Commission intervened to restrict all amateur operation in the 160- and 75- meter bands to flood relief traffic messages.

"The Federal Communications Commission has been advised that the only contact with many flooded areas is by amateur radio," said the commission's order, "and since it is of vital importance that communications with flooded areas be handled expeditiously, it is ordered that no transmissions except those relating to relief work be made within any of the authorized amateur bands below 4000 kilocycles until the commission determines that the present emergency no longer (Turn to page 701)



WINGING MESSAGES OF MERCY SKYWARD

All through the night amateurs stuck to their posts and handled official communications for the American Red Cross, U. S. Engineers, U. S. Naval Reserve, the Coast Guard and other organizations. Picture above shows E. C. Frase, Jr., owner and operator of station W4FK at Memphis, still going strong at 4:15 a.m., as indicated by the clock.



FROM VANTAGE POINTS

Amateurs and broadcasting engineers of W4AS don boots and radio sets strapped to their backs to send news of isolated families in the flood area.

5-METER SETS IMPORTANT

Rowboats with ultra-short-wave transmitters were pressed into service as NBC men helped out at Portsmouth, Ohio. Lower right: Emergency messages streaming through the control room of WMC.





The "HAM" Shack

Conducted by
Everett M. Walker
Editor for Amateur Activities

A REAL PRINCE
Meet Prince Vinh San, owner and operator of Short-Wave Station FR8VX, whose home is in St. Denis, Reunion Island. He is on 10 and 20-meter phone and 80-meter c.w.

More Dope on 10-METER Antennas

TEN-METER operation is here to stay. The last year brought an increase in activity on the band that will insure it continued popularity. Two years ago there was only a handful of experimenters enjoying the unique conditions the band offers; today there are thousands.

THE increase in 10-meter activity has done much in the way of bringing to light many of the unknown quantities of operation in the 28-megacycle region. While there still is much to be gleaned about ultra-short-wave phenomena, much has been learned through the persistent activity of both pioneer experimenters and those who have followed on the band.

All one has to do to find out how 10 meters has caught on is to listen in on a Sunday when conditions are good. Ten meters as both a local and a distance band seems destined to become even more popular in the future. Already one hears complaints of QRM. But many of those who are just becoming acquainted with 10 meters are finding it difficult to obtain good results. There seems to be small difficulty on the average amateur's part in making a transmitter perform according to Hoyle, but many complain of not getting good results.

Research has proved that, like on most of the high-frequency bands (and all bands for that matter), the most important item of success is: Antennas! There still is much to be learned about antenna phenomena, but there are many known quantities that at least insure reasonable success on a first try.

It has been demonstrated by those who have had comparatively good success on the band that the antenna is even more important than power. Low power seems to be equally effective at 28 megacycles as high power, providing the "signal squirter" is good.

One of the main features of 28 megacycles is the problem of erecting a good antenna is comparatively simple, even for the amateur who is handicapped by lack of space for lower frequency operation. Small space is required. Furthermore, because of the size, amateurs who hitherto have been handicapped find they can experiment at 28 megacycles to their heart's desire with almost every conceivable type of radiator from a simple half-wave affair to a diamond or rhombic antenna.

Directive Antennas

Experience of those who have operated consistently on the band over a period of years is that some form of directive antenna is almost essential to good success. These range from simple half-wave antenna with a reflector to the more complicated multi-element arrays. For the most part the half-wave radiator is the least effective. But for those who find this is the only type of antenna adaptable to their locations, there are a number of simple rules that may be followed to obtain the most from it.

The Feeders

The first and most important consideration is how to feed it. This of course, applies to all types of antennas, but more particularly to the half-wave radiator where every amount of radiated power will help shove a signal out beyond the backyard. The most efficient method of feeding such an antenna is some form of matched impedance line system. This may be a 400-ohm line matched to a "Y" antenna, a Johnson "Q" or a "J" antenna, or, if the distance between the antenna and the transmitter is less than thirty feet, a

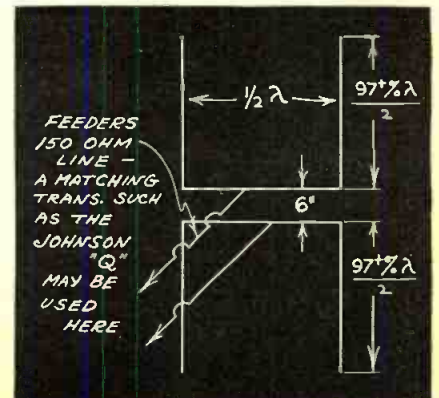
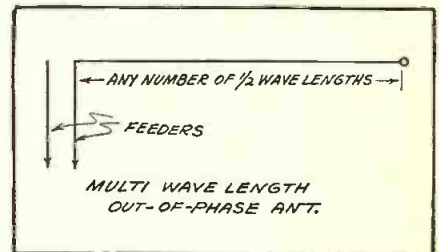
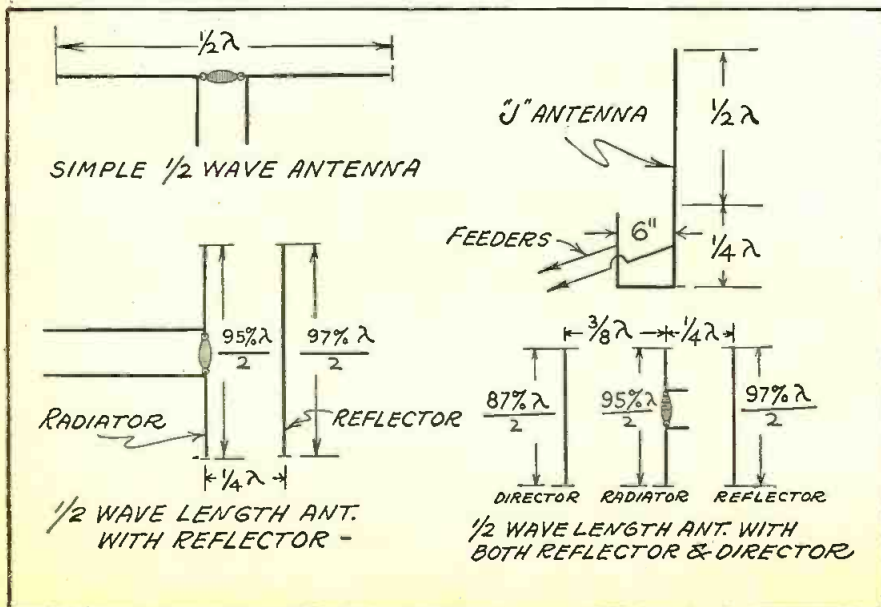

A Department for the amateur operator to help him keep up-to-date

good transmission twisted pair. Another excellent feeder is a concentric line.

Choosing the method of feeding will depend largely on location and the size of the pocketbook. The most practical is the spaced pair having an impedance of about 400 ohms.

One of the most important factors to consider is the height above ground and whether the antenna should be in a vertical or horizontal plane. For the most part the simple half-wave radiator will perform best in a vertical plane simply because at 28 megacycles a low ground angle of radiation is desirable. This angle, of course, will vary with the height; the higher the antenna, the lower the angle of radiation. A vertical antenna will be non-directional and will be found effective on local work as well as DX. Under practical tests it was found that the vertical antenna will perform quite well up to about two wavelengths above ground, whereas the horizontal antenna begins to get erratic when over a quarter wavelength above ground. In tests actually conducted at one location it gave the best results at sixteen feet above the earth. However, this rather handicaps the amateur who is not fortunate in being at the top of a hill or mountain.

The "J" Antenna

Location and the make up of the soil directly under the antenna also play an important part in the effectiveness of the antenna as a radiator. It is because of these conditions that some form of directional antenna has proved more effective in most locations than the simpler form.

For the amateur who finds it necessary to employ a half-wave radiator, one of the simplest and most effective arrangements is the "J" antenna. A typical arrangement is shown elsewhere in this department. One of its advantages is that it may be hoisted up a mast easily.

One of the problems in stringing a directional antenna is deciding what is the most

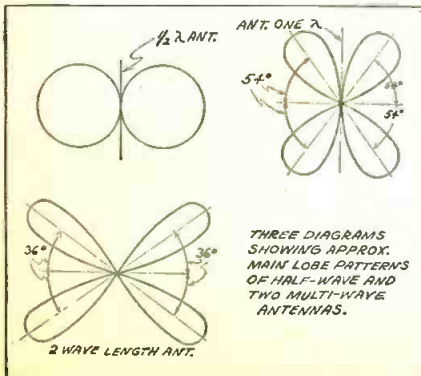
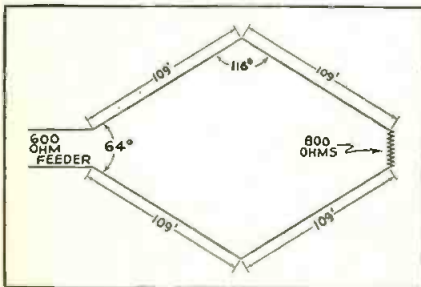

INDIAN STATION VU7FY

The first amateur radio station in India, owned by O. G. Spindlie, Kolar Gold Field, Coromandel P. O., South India, is pictured above. He is reputed to be, with K4SA, the first amateur station in the world to work all continents two-way phone outside of the United States.

desirable direction to direct a signal in a given location. One way of getting around this is to use some sort of a rotating arrangement or erect several antennas that may be selected at will for directing a signal in a desired direction. For laying the plans of any type of directive ultra-high-frequency antenna a good compass, a protractor and a globe are essential tools. One gets in the habit of looking so frequently at flat maps that the sense of direction frequently is far from accurate. If you do not believe this, which city is farther west, Reno, Nevada, or Los Angeles? Believe it or not, Reno is! Then take a look at the Panama Canal. It runs north and south, not east and west! These are only a few of the distorted ideas one gets from associating directions with a flat map.

Use of Reflectors

Therefore it is desirable to plot the position of an antenna rather carefully, particularly if it is one of the more directional types. Now to review some of the simple and more complicated types of arrays that have been tried by many 10-meter operators and found to give good results.

The simplest is the half-wave antenna and reflector placed 1/4 wavelength from the radiator itself. This type antenna seems to perform best in a horizontal plane although it has been used at 28 megacycles in a vertical position with some success by a number of operators. Because of its comparative simplicity, it is possible to construct it so it may be rotated with comparative ease. By devising an arrangement of ropes and pulleys, it is possible

to control its rotation (thus its direction) from within the shack.

A simple arrangement of this type antenna may be constructed with an old wagon wheel mounted horizontally atop a mast or peak of the house. In most locations free rotation over 180 degrees will be ample, although amateurs in the South and outside the United States will find it desirable to swing the radiator over a greater arc. The principal problem is designing the feeders so they will rotate freely and without entanglement. If the feeding distance is comparatively short, a twisted pair line will simplify the problem. Sliding contacts may be used, but it is advisable to avoid this practice, as it is almost impossible to design anything that will stand up under all kinds of weather conditions.

This type of antenna radiates in a direction away from the reflector. If properly designed it will radiate a signal twice as strong in the direction of the beam as a simple half-wave radiator without a reflector. The reason for this is: due to the spacing between the radiator and reflector being 1/4 wavelength, the signal or wave

(Turn to page 684)

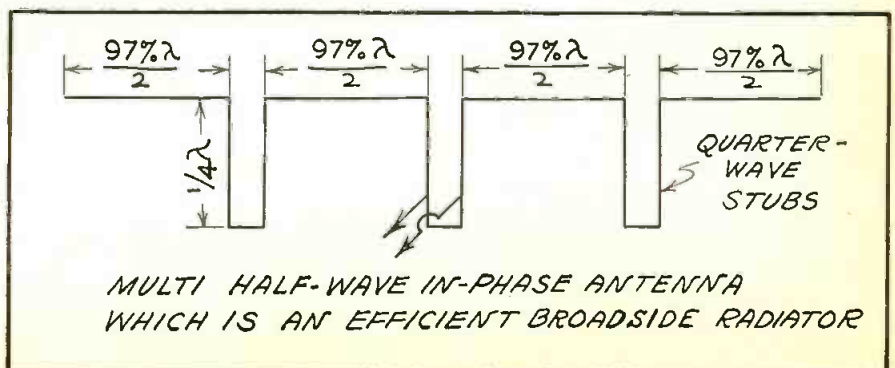

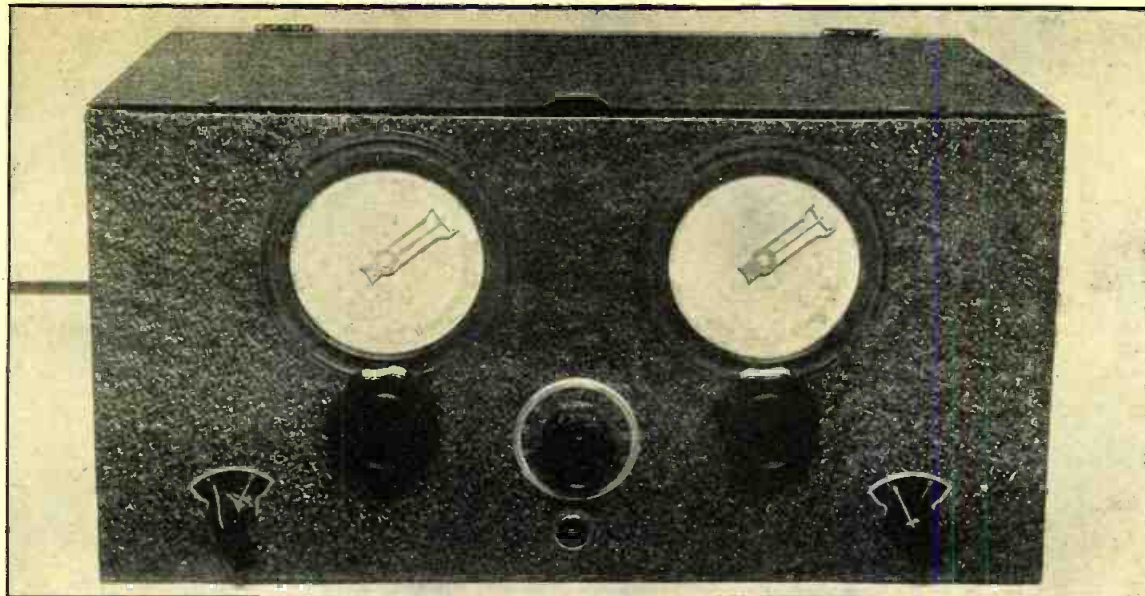

THE ADAMS CONVERTER—ALL SET TO GO PLACES

Neat in appearance and both effective and simple in operation. The 2-dial tuning is made easy by the fact that the gang r.f. control (right) is relatively broad. The band-spread system used in the oscillator circuit spreads the 10-meter band over the entire 270-degree scale if desired, leaving this control sharp but not critical.

Build This 10-Meter Converter And Hear The World

If your regular receiver will tune anywhere around 1500 to 1800 kc. you can use this converter ahead of it to obtain 10-meter reception, or by altering the coil sizes it may be used for receiving signals on other ultra-high-frequency bands

By Raymond P. Adams

A LARGE number of the switched-coil superhets do not lend themselves readily to range extension. Then, too, many efficient, well-made, plug-in coil receivers remain similarly limited because their design is such as to prohibit effective operation with new coils wound for the ultra-highs. As a result, the amateur with such limited equipment, if he desires to listen on 10 meters, must add either a separate 10-meter receiver or a practical converter which, used in conjunction with "on hand" apparatus, will provide coverage of this band. Of the two alternatives, the converter is by far the most economical.

A 10-meter converter for amateur service should have adequate band-spread, contain all the tried and tested low-loss features of modern ultra-high-frequency apparatus, be complete with an r.f. stage and self-contained power supply, have a high order of gain, sensitivity, and signal selectivity and be adaptable to a reasonably wide range of intermediate frequencies. The writer

WITH increasing amateur activity around 28 megacycles (the 10-meter band) there is a real need for accessory equipment which will extend the range of present receiving apparatus up to these frequencies.

has designed, and presents in this article, an instrument which is believed to fully meet these requirements.

The converter was built to meet certain broad but rigid specifications as set forth by the editors of RADIO NEWS and determined by 10-meter operating requirements in general. It has two tuning controls, one for the oscillator and one for the ganged preselector and mixer circuit, both with micrometer pointers for precise logging. A potentiometer governs detector regeneration and thus effective gain, sensitivity and, to a certain extent, selectivity. Switches for the a.c. line and antenna change-over from converter to receiver operation are provided. The conveniently sized (14-by 7- by 8-inch) metal cabinet houses the complete instrument with its self-

contained power supply equipment.

Metal tubes are used throughout. All coils are of No. 14 tinned solid copper wire, self-supported on the midjet tuning condensers. All tuning condenser shafts are insulated from each other and from the dial hubs by flexible couplings to eliminate metal-to-metal bearing noises and to secure maximum isolation of circuits.

The general layout as shown in the photographs represents the most satisfactory of several experimental set-ups. Humless, stable, and very effective performance feature this final model.

The oscillator employs a 6C5 in a Hartley circuit with plate voltage of approximately 100. Higher voltages or a cathode tap too high up on the grid coil produce unnecessarily strong oscillation and sometimes queer, tunable hums calling for far more r.f. by-passing.

Detector (mixer) screen voltage is obtained from a 10,000-ohm potentiometer bridging a portion of the B supply divider, and its variation controls regeneration. The detector coil is cathode-

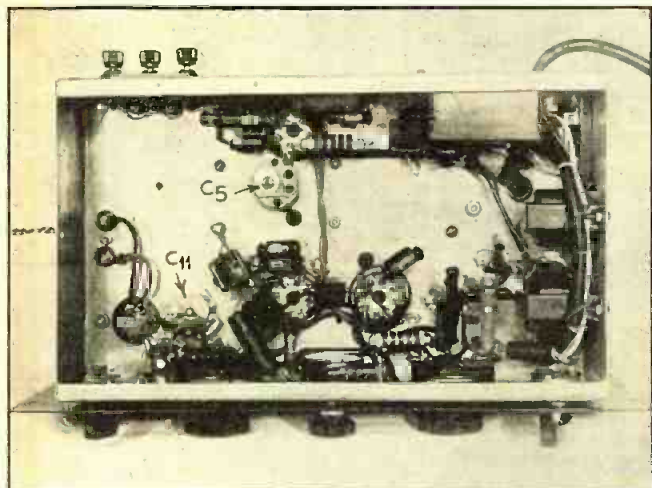

BELOW DECK

The relatively open layout makes the wiring job well within the ability of the average builder.

tapped so that the circuit will break into oscillation at a little beyond the center position of the potentiometer.

Antenna connections are provided to permit the use of an ungrounded pick-up coil for doublet antennas. If doublet input is not desired, a single-wire antenna lead may be connected to one and the other two posts connected together, or the antenna may be brought directly to a suitable point on the grid coil through a trimmer condenser. Once the converter has been built and the coils adjusted for proper tracking, various antenna connection schemes may be tried, all realignment readjustments being made with C5.

Easy Aligning

Oscillator tuning is extremely sharp, and detector tuning is moderately sharp with the regeneration control advanced for maximum feedback. The r.f. stage remains relatively broad, so little difficulty is experienced in keeping the r.f. and detector circuits in line for single control.

Band Spread

Coverage of about 8 megacycles is had over a 270-degree scale using an i.f. between 1500 and 1800 kc.; 28 mc. strikes near the center. Of course, with 20 mmfd. variable condensers, the degree of 10-meter spread will be limited. Due to the extended dial scale and the 14:1 vernier action, the tuning of the ganged r.f.-mixed circuits is opened wide enough for practical communication purposes.

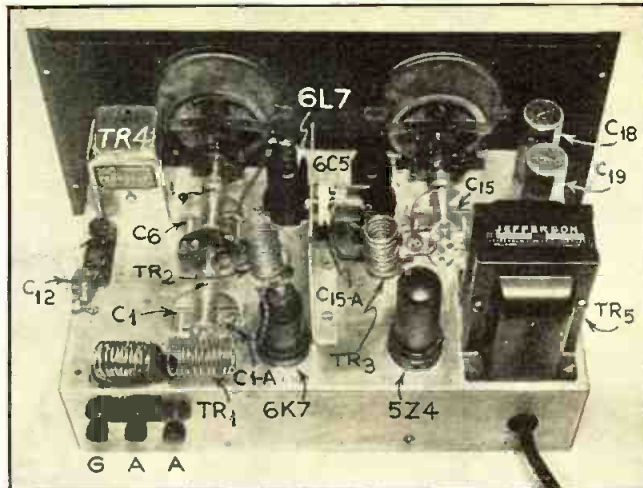

THE CHASSIS LAYOUT

The arrangement of parts is clearly shown here for constructors who wish to duplicate this model.

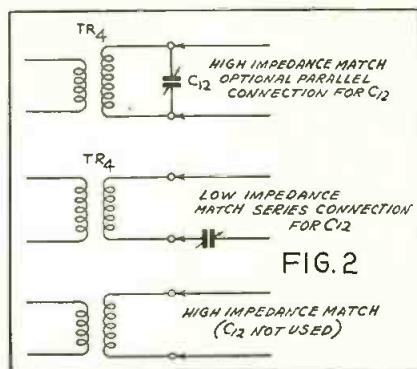

OUTPUT CONNECTIONS

Figure 2. Here are three methods for connecting the converter output to your receiver. In most cases the condenser C12 will probably not be required.

The oscillator is much too critical, however, and band spreading is therefore used in this circuit. This is accomplished by connecting the 20 mmfd. tuning condenser (C15) across only the lower 6 turns of the oscillator coil, and the screw-driver adjusted air trimmer

condenser (C12A) across the whole coil. By properly adjusting the trimmer and the coil, the 10-meter band can be spread over the entire oscillator dial.

The output transformer is a broadcast r.f. job of the Ferrocart (iron core) type with its trimmer removed and its windings "in reverse." A Hammarlund APC midget variable paralleled across the "primary" permits us to tune the plate circuit to the desired intermediate frequency, which may be anything from 1700 to 1500 kc.

Some Needed Pointers

We do not propose to go into tiresome construction details which Mr. Average Ham probably won't follow anyway. We'll simply list and perhaps enlarge upon a few points of importance:

1. Give us credit for some serious "trial and error" experimentation and take it for granted that the layout as shown in the photographs is recommended.
2. Keep r.f. leads short and direct. Bring all ground returns for each circuit to one point wherever possible. One of the mounting screws for the associated variable condenser is the logical place. Connect by-pass condensers close to socket terminals and other components.
3. Don't center-tap the filament winding. Cut back or tape all power transformer filament leads except the blue ones for the rectifier and a pair from the 6.3-volt winding for the other tubes.
4. R.F. and de-

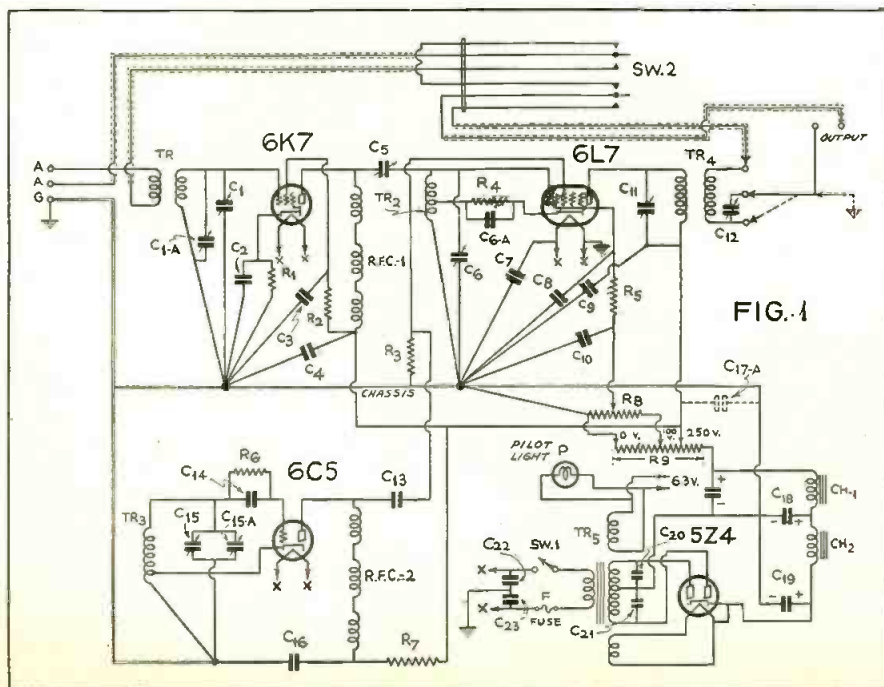
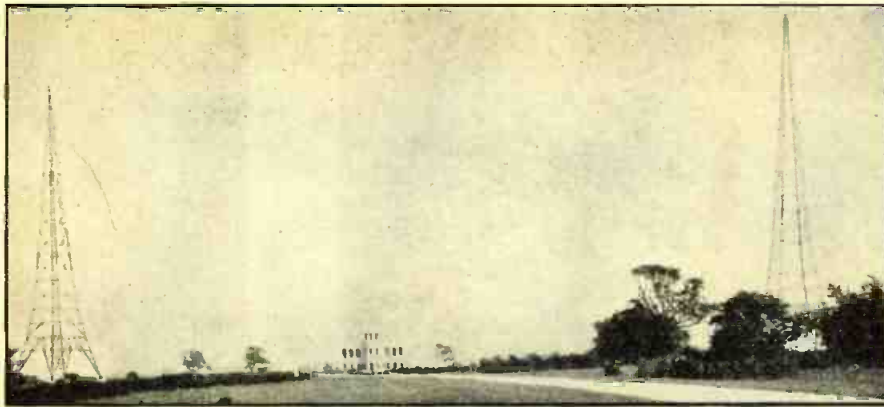

FIG. 4



THE DX CORNER

S. GORDON TAYLOR
(For Broadcast Waves)

CONSOLIDATED FOREIGN "BEST BETS"

FOLLOWING is a list of the foreign stations being heard by Official Observers in different sections of the U. S. and Canada, and the hours (local time) when heard best. Wherever either an asterisk (*) or a number appears in a column it indicates that the station has been heard. Heavy numbers represent p.m. and light numbers a.m.

This list is made up from Observers' reports: Column 1—Observers Woytan, Kentzel, Lonis and Tomlinson, New York; Wilson, Maine. Column 2—Observer Traux, Illinois. Column 3—Observers Hunt, California; Tarr, Washington; Law, Alberta.

Kc.	Call	Location	1	2	3
546	HAL	Budapest, Hungary	*
570	2YA	Wellington, New Zealand	2
590	JOAK1	Tokyo, Japan	2
600	4QN	Cleveland, Australia	2
620	Brussels	Belgium	*
625	TIPG	San Jose, Costa Rica	8
640	5CK	Crystal Brook, Australia	2
650	1YA	Auckland, New Zealand	5	5	2
660	XGOA	Nanking, China	6
670	LS4	Buenos Aires, Argentina	9	8	..
680	JOVK	Hakodate, Japan	4
690	JOBK1	Osaka, Japan	2
700	2NR	Grafton, Australia	5	5	2
710	TNT	Kelso, Australia	2
720	3YA	Christchurch, New Zealand	2
740	2BL	Sydney, Australia	2
750	JFAK	Teihoku, Japan	3
750	KGU	Honolulu, Hawaii	..	2	11
770	JOHK	Sendai, Japan	2
780	JOPK	Shizooka, Japan	2
790	4YA	Dunedin, New Zealand	5	5	2
790	JOGK	Kumamoto, Japan	3
800	PRB7	Rio de Janeiro, Brazil	8
800	4QG	Brisbane, Australia	2
810	JOIK	Sapporo, Japan	2
830	JOFK	Hiroshima, Japan	4
830	LR5	Buenos Aires, Argentina	8	8	..
830	3GI	Longford, Australia	2
841	Berlin	Germany	*
855	OAX4A	Lima, Peru	9
870	JOAK2	Tokyo, Japan	2
870	LR6	Buenos Aires, Argentina	8	7	..
904	Hamburg	Germany	*
920	HHK	Port-au-Prince, Haiti	8
940	JOBK2	Osaka, Japan	2
950	LR3	Buenos Aires, Argentina	10
950	2UE	Sydney, Australia	2
959	Poste-Parisien	Paris, France	*
977	North Ireland	Belfast, Ireland	2	1	..
980	JOXK	Tokushima, Japan	3
980	PRE8	Rio de Janeiro, Brazil	8
990	JOCK2	Nagoya, Japan	3
990	LR4	Buenos Aires, Argentina	9	9	..
1005	HJ3ABH	Bogota, Colombia	9
1010	3HA	Hamilton, Australia	2
1020	2KY	Sydney, Australia	2
1030	3DB	Melbourne, Australia	2
1040	5PI	Crystal Brook, Australia	5
1040	Rennes	France	..	12	..
1050	CX26	Montevideo, Uruguay	8
1050	HJ3ABX	Colombia	8
1050	JOHG	Kagoshima, Japan	3
1060	HJ1ABE	Bogota, Colombia	1
1060	JOIG	Toyama, Japan	3
1070	LRI	Buenos Aires, Argentina	2	1	..

1080	LR3	Rosario, Argentina	9
1090	CX28	Montevideo, Uruguay	11
1090	3LK	Melbourne, Australia	2
1100	7LA	Lancaster, Australia	2
1110	LS5	Buenos Aires, Argentina	9
1110	2UW	Sydney, Australia	2
1120	4BC	Brisbane, Australia	2
1150	HJ1ABJ	Colombia	8
1150	LR8	Buenos Aires, Argentina	8
1150	2WG	Wagga, Australia	2
1190	LS2	Buenos Aires, Argentina	9	9	..
1190	2CH	Sydney, Australia	2
1210	TGW	Guatemala City, Guat.	..	1	..
1213	Lille	France	..	1	..
1220	PRA9	Rio de Janeiro, Brazil	9
1220	4AK	Oakey, Australia	2
1230	LS8	Buenos Aires, Argentina	9	7	..
1230	2NC	Newcastle, Australia	2
1240	3TR	Sale, Australia	2
1249	Saarbrucken	Germany	2
1260	3WR	Shepparton, Australia	2
1270	LS9	Buenos Aires, Argentina	8
1285	PRG3	Rio de Janeiro, Brazil	8
1310	LS7	Buenos Aires, Argentina	9
1320	KGNB	Honolulu, Hawaii	..	2	1
1380	4BH	Brisbane, Australia	2
1400	FFZ	Shanghai, China	*
1400	KHBC	Hilo, Hawaii	..	2	11
1410	2KO	Newcastle, Australia	2
1480	4BU	Bundaberg, Australia	2

COOPERATION FROM NEW ZEALAND

The following offer made by Observer L. C. McCormick, 73 Baird Street, Invercargill, N. Z., will undoubtedly be of interest to readers of the DX Corner:

"I wish to advise that the following services are open to readers of your magazine:

(1) "DX'ers hearing and desiring to report to Australia or New Zealand hams whose addresses are not available, may send their reports to me. I will be pleased to send these reports on to the stations provided each is accompanied by a 5 cent stamp to defray postage costs. Reports for VK's will only be sent on if accompanied

WHIO

The RCA high-fidelity, 5000-watt transmitter installed at this Dayton Daily News station at the beginning of the present season

Courtesy — Observer DeLaet

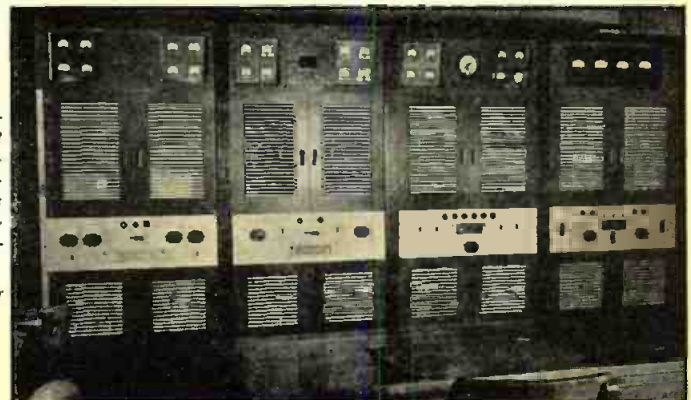

WENR—"THE VOICE OF SERVICE"

This Chicago station, on 870 kc., radiates a beautiful signal from a beautiful location, with 50 kilowatts of power behind it.

by 10 cents in stamps as postage to the U. S. is higher than the N. Z. rate."

(2) "Supplies of New Zealand and Australian stamps for return postage on veris are available at six for ten cents payable in 5 or 3 cents U. S. stamps. Canadian stamps also accepted."

DX CALENDAR

APRIL

BELOW are given lists of special DX broadcasts which are scheduled for April. The initials following an item indicate the organization to which the program is dedicated and where a RADIO NEWS special has been arranged for an Observer, his name is given in the schedule.

Don't fail to tune in the RADIO NEWS specials on this list and as many others as possible—and above all, don't fail to report to each station tuned in, giving them as much information as you can concerning their signal strength, fading, quality, etc. Where verifications are desired it is always desirable to enclose return postage.

Hours shown are Eastern Standard Time and are all a.m. unless otherwise indicated.

Day	Hour	Kc.	Call	State	Kw.	Club
1	2-3	1160	CMHI	Cuba	.2	NNRC
7	6-8:15	1270	WASH	Mich.	.5	NNRC
	6:15-6:30	1270	WOOD	Mich.	.5	NNRC
8	3:50-4:10	1320	KGHW	Colo.	.5	R. News Atkins
	4:10-4:30	1420	KGIW	Colo.	.1	R. News Atkins
9	4:30-4:50	1370	KIUP	Colo.	.1	R. News Atkins
10	4:30-5:30	1370	KVL	Wash.	.1	NNRC
	5:10-5:30	1370	KRKO	Wash.	.05	R. News Atkins
	5:50-6:10	1210	KGY	Wash.	.1	R. News Atkins
12	2-2:20	1420	WJBO	La.	.1	R. News Golson
	4:30-4:50	1370	KGAR	Ariz.	.1	R. News Atkins
	4:50-5:10	1370	KRE	Calif.	.1	R. News Atkins
	5-6	1160	CMHI	Cuba	.2	
15	4:45-5:50	1160	CMHI	Cuba	.2	
21	6-6:15	1270	WASH	Mich.	.5	NNRC
	6:15-6:30	1270	WOOD	Mich.	.5	NNRC
28	3-4	1400	KHBC	T. H.	.25	NNRC

PERIODIC

Thursdays—

5 p.m., 920 kc., WAAF, Chicago, Illinois, 1 kw. (tips)
8:45-9 p.m., 1320 kc., WORK, York, Pa., 1 kw., (NRC) (tips)

Fridays—

5 a.m., 1000 kc., KFVD, Los Angeles, Calif., .25 kw., (R News) (Atkins) (tips)
Midnight, 980 kc., KDKA, Pittsburgh, Pa., 50 kw., (Ed Lips) (tips)

Saturdays—

12-12:05, 690 kc., CFRB, Toronto, Ont., 10 kw., (Ed Hill) (tips)
2:55 a.m., 780 kc., KEHE, Los Angeles, Calif., .5 kw. (R. News) (Atkins) (tips)
1:15-1:30 p.m., 830 kc., WEEU, Reading, Pa., 1 kw.

7:15-7:30 p.m., 1310 kc., WRAW, Reading, Pa., 1 kw

Sundays—

12-6 a.m., 1210 kc., TGW, Guatemala City, Gua., 10 kw.
 12:45 a.m., 1470 kc., WLAC, Nashville, Tenn., 5 kw.
 (Cappie Hadley) (tips)
 1:15 a.m., 640 kc., KFI, Los Angeles, Calif., 50 kw., (tips)
 1:30-1:45 a.m., 1360 kc., KGER, Long Beach, Calif., 1 kw., (R. News) (Atkins) (tips)
 Until 2 a.m., 1220 kc., PRES, Rio de Janeiro, 10 kw.

NOTES FROM READERS

Observer Collis (Belchertown, Mass.): "Heard CMCD, with Alec Kinghorn announcing, who stated that this station would be on the air every Sunday morning from 2 to 3 a.m., E. S. T. on 950 kc. with a special program. Received a verification from K1D, a very showy one with large red letters. CHSJ sends out a large verification with a picture of the studio."

Observer Bauer (Baltimore, Md.): "I have recently heard several new Cbnans including CMKW, 1330 kc.; CMCR, 1350 kc. and CMGH, 790 kc. Reports on reception of the Thursday morning tests from Belfast, Ireland should be sent to Carroll Weyrich, 4310 Evans Chapel Road, Baltimore, Md., and five cents in stamps or coin enclosed. This is the only way that verifications can be obtained as the B. B. C. doesn't verify. Reports for WJRD should be sent to Arthur Foerster, 1926 Hoyt Avenue, Indianapolis, Ind. with three cents postage enclosed."

Observer Parfitt (Cleveland, Ohio): "KGGM gave Radio News a wonderful tribute during their big gala DX spree on February 25. KQW, 1410 kc. stays on until 4 a.m. E.S.T. FKWB, 930 kc. is also on until this hour. WEDC, 1210 kc. now signs off at 1 a.m. E.S.T. instead of remaining on all night as heretofore. CHSJ, 1120 kc., heard daily 5 to 5:05 a.m. with weather reports. CJRM, 540 kc., on from 11 p.m. to 12:15 a.m. Sundays with messages for the Far North."

Observer Roman (Chicago, Ill.): "The following stations either are, or will be, testing with increased power: 1500 kc., KDB, Santa Barbara, Calif., .25 kw.; 1290 kc., KDYL, Salt Lake City, Utah, 5 kw.; 1310 kc., KFYO, Lubbock, Texas, .25 kw.; 1420 kc., KRBC, Abilene, Texas, .25 kw.; 1200 kc., WCAN, Burlington, Vt., .25 kw.; 1370 kc., WGL, Fort Wayne, Ind., .25 kw.; 550 kc., WKRC, Cincinnati, Ohio, .5 kw.; 1310 kc., WMBO, Auburn, N. Y., .25 kw.; 1290 kc., WNEL, San Juan, P. R., .25 kw.; 880 kc., WQAN, Scranton, Pa., 1 kw."

Observer Truax (Aurora, Ill.): "WFOY, 1210 kc., St. Augustine, Fla. broadcasts each Friday morning except the second Friday of each month. These programs will be known as the "Midnight Jamboree". They continue from 1 to 3 a.m. E.S.T. and will be dedicated to various clubs."

Observer Davis (Elkhart, Texas): "Reception poor here but have had a few good mornings. Have sent twenty-five reports to Japanese stations recently. 2NR, Lawrence, N. S. W., Australia, 700 kc., doesn't require International Reply Coupons because their verifications are sent out by the Postmaster General. They returned my I. R. C. with my verification. The TA's have faded out of the picture down here."

Observers Carl and Anne Eder (Willmar, Minn.): "February frequency checks generally poor because of fading and noise. However, picked up twenty-three stations during checks of February 8 and twenty-one on the 13th. Weather conditions here changeable, temperature ranging from 18 below zero to 26 above on February 13."

Observer Coales (Southsea, Hants, England): "Now have 92 verifications from broadcast station in ten countries 3000 miles or more distant. Also have 30 states verified on the broadcast band. I would award WOR first prize for the best signal from a U. S. A. station, CRCM from Canada, LR1 from Argentina, and PRES from Brazil. Received a verification from Jerusalem for my report on the I. D. A. special of January. This verification was in the form of a letter so maybe something has happened to those special verification cards which were supposed to have been prepared. Listening on the ultra-short waves I am daily hearing W3XES, 35.6 megacycles. It is heard well at times but

at other times suffers bad interference from police station W1XAO at Boston which puts in an R9-plus signal. I am also hearing a number of 10-meter amateur phones from the U. S. A."

Observer Pick (Leipzig, Germany): "DX reception here poor as static has been running high. Only the high-powered station of South America have been coming through. The Latvian stations have been making some changes. Madona, formerly on 1104 kc. is now on 583; Kuldiga has shifted from 1258 to 1104 kc.; Riga has changed from 583 to 1258 kc. In Norway stations at Frederikstad and Bergen formerly at 776 and 850 kc. are now on 722 kc. In Germany the new station "Kaiserslautern" is operating with .5 kw. power on 1429 kc. In England a station has opened at Penmon and operates using .5 kw. on 804 kc. (the same frequency as West Regional)."

AUSTRALIAN STATION CHANGES

The following information submitted by Observer Randolph Hunt of Encinitas, Calif., shows Australian changes as given in report received by him from Australia during the latter part of February:

New Stations

6WA, South West Regional, 560 kc., 10 kw., Minding near Wagin, Western Australia.
 6GF, Goldfields Regional, 720 kc., 2 kw., Kalgoorlie, Western Australia.
 3LK, 1090 kc., 2 kw., 3DB Broadcasting Co. Pty., Ltd., Flinders Street, Melbourne C. 1, Victoria.

Cancellation

3HS, Horsham Delete all particulars

Frequency Changes

2BH	Broken Hill	from 1330 to 1060 kc.
2DU	Dubbo	1060 660
2MO	Gunnedah	1360 1370
3MA	Mildura	900 1360
3SH	Swan Hill	1080 1130
4AY	Ayr	1450 860
4MK	Mackay	1160 1080
4WK	Warwick	900 1360
*3AR	Melbourne	580 630

Increased Power

3YB	Warranambool	from 50 to 100 watts
4WK	Warwick	50 100 watts

Change in Address

2AD, Armadale, from "Northern Broadcasters LTD." to "New England Broadcasters"
 5MU, Murray Bridge, Licensee's address should now read: Advertiser Building, Weymouth St., Adelaide, S. Australia
 *—As reported by CDXR

CANADIAN FREQUENCY CHECKS

This list of Canadian frequency checks was obtained by James Walsh, Jr., direct from Ottawa. Each station listed transmits its test programs on the 19th and again on the 20th of each month, at the hours indicated:

A.M., E.S.T. Call	City	Kc.
01:11-01:19	CJCB Sydney	1240
01:21-01:29	CKCW Moneton	1370
01:31-01:39	CHNS Halifax	930
01:41-01:49	CFCY Charlottetown	630
01:51-01:59	CJLS Yarmouth	1310
02:01-02:09	CRCS Chicoutime	950
02:11-02:19	CHSJ Saint John	1120
02:21-02:29	CFTB Fredericton	550
02:31-02:39	CHRC Quebec	580
02:41-02:49	CFCH North Bay	930
02:51-02:59	CJKL Kirkland Lake	1310
03:01-03:09	CRCY Toronto	1420
03:11-03:19	CKSC Sudbury	780
03:21-03:29	CJIC Sault Ste. Marie	1500

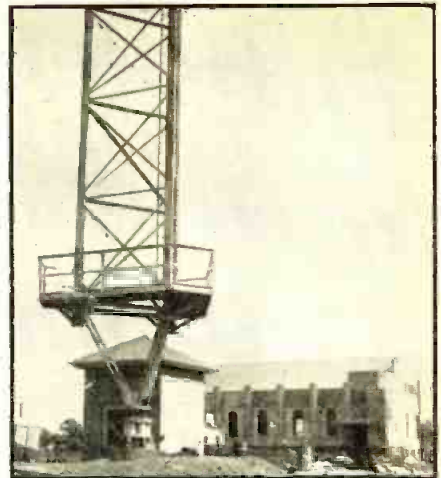

VERTICAL RADIATOR AT IYA
An interesting shot of the base of IYA's 500-foot vertical antenna. Note the cluster of insulators which support the entire mass

BRITISH RECEIVER LICENSES

Observer Coales, of Southsea, England, offers the following comment on the caption which accompanied the reproduction of a British listener's license in the DX Corner for February.

"The License certainly came out very well, and I hope it interested folks in the States. The B.B.C., however, are not Government owned. They operate under a 10 years Royal Charter from Parliament which was recently renewed. The Post Office collects the license money, and deducts quite a bit out of each license for expenses, etc. Therefore, only a certain proportion of each 10 shillings finds its way into the coffers of the B.B.C. Technically the license is for the right to operate a receiver, and not for the right to listen to the B.B.C. There was a License before the B.B.C. was born."

DIRECTIONAL ANTENNA

Observer Harry M. Gordon uses a directional antenna system which has been giving him excellent results. Unfortunately, most DX'ers do not have the space to duplicate this installation, but for those who do have the space, a description will be of interest.

The system consists of four antennas running north, east, south and west from a central mast 100 feet high. All of them use No. 12 solid copper wire, enameled. The lead-ins are taken from the end of each nearest the center pole and are brought down to a switching arrangement near the receiver. The north and south antennas are each 600 feet long, the east antenna 700 feet long and the west antenna 1000 feet long. The supports at the outer ends of the antenna are likewise 100 feet high. In this arrangement the antenna extending north has its lead-in at its south end and is, therefore, directional south. The antenna that extends westward from the center pole is the antenna used for reception from the east, etc.

To show the effectiveness of this antenna system we quote from a letter received from Observer Gordon:

In using this antenna we find that when there is QRM in listening to one station, we can clear it up by changing directions, providing that the station to which we are listening and the one causing the QRM lie in different directions from our location. For example, on 800 kc. at 10:30 a.m. we tuned in WTBO but could hear a station

(Turn to page 694)



KULDIGA
This 10-kw. station at Kuldiga, Latvia, has been heard by a number of Observers in the U.S.A. this season.

Courtesy—Observer Yoshimura, Japan

OXA4B	Lima	1200	0.35
OAX4L	Miraflores (Lima)	1250	0.06
OAX4C	Lima	1300	0.06
OAX6C	Arequipa	1350	0.03
OAX6B	Arequipa	1405	0.06

URUGUAY

CX2	Montevideo	570
CX4	Montevideo	610	1.0
CX6	Montevideo	650	10.0
CX8	Montevideo	690
CW9	Montevideo	720	0.12
CX10	Montevideo	730	1.0
CX12	Montevideo	770	1.0
CX14	Montevideo	810	5.0
CX16	Montevideo	850	10.0
CX18	Montevideo	890	1.0
CX19	Rochia	920	0.05
CX20	Montevideo	930	2.0

CX22	Montevideo	970	0.25
CW23	Salto	1000	0.25
CX24	Montevideo	1010	2.5
CW25	Durazno	1040	0.5
CX26	Montevideo	1050	2.0
CW27	Salto	1080	0.25
CX28	Montevideo	1090	3.0
CW29	Mercedes	1120	0.05
CX30	Montevideo	1130	0.5
CW31	Salto	1160	0.25
CX32	Montevideo	1170	0.5
CW33	Florida	1200	0.075
CX34	Montevideo	1210	0.5
CW35	Paysandu	1250	0.25
CX36	Montevideo	1250	0.25
CW37	Colonia	1280	0.025
CX38	Montevideo	1290	0.5
CW39	Paysandu	1320	0.1
CX40	Montevideo	1330	0.5

CW41	San Jose	1360	0.05
CX42	Montevideo	1370	1.0
CW43	Lavalleja	1400
CX44	Montevideo	1410	0.2
CX46	Montevideo	1450	1.5
CW47	Canelones	1480	0.1
CX48	Montevideo	1490	1.5

VENEZUELA

YV5RA	Caracas	960	5.0
YV5RG	El Valle	1100	0.25
YV5RE	Caracas	1110	0.3
YV1RF	Maracaibo	1120	0.25
YV1RD	Maracaibo	1153	0.075
YV4RG	Caracas	1153	0.1
YV5RB	Caracas	1200	1.2
YV4RA	Valencia	1350	0.5
YV6RA	Ciudad Bolivar	1400	0.25
YVIRA	Maracaibo	1500	0.2

The RADIO WORKSHOP

Items of interest for beginners, experimenters and radio constructors.

Conducted by The Associate Editor

Reports Improved Reception

In some locations the natural soil contains very little moisture, especially so in the dry season, and the earth, as I have found in my particular district, is a poor conductor to the ground rod, with the result that I experience poor and erratic radio reception.

When such conditions are encountered, the resistance of the earth connection may be decreased by driving a second ground rod, and connecting it to the first rod as shown. The second rod, to be most effective, should be located not less than ten or twelve feet from the first one.

In event that the use of two or more ground rods does not result in a sufficient low order of resistance, a further decrease in resistance may be generally effected by treating the soil immediately adjacent to each ground rod with one of several various chemical solutions. An inexpensive solution for this purpose is common rock salt. A convenient method of applying the salt is shown in the accompanying sketch. A length of tile, six inches or more in diameter, is set vertically in the earth close to one ground rod and on a layer of crushed stone, gravel, broken brick, clinkers or other similar loose material of a kind which will permit free drainage. The layer of drainage material

need not be more than eight or ten inches.

The tile is next filled to the top with coarse salt, and then flooded with water, after which the tile is again filled with the salt to replace that which seeped away during the flooding process.

A removable cover of some kind, perforated to permit surface water to drain into and percolate through the salt, should be fitted to the bell or top of the tile. During dry seasons of the year, the tile should be occasionally flooded with water to maintain the salt and soil surrounding the ground rod in a moist condition. More salt should be added periodically to replace that which seeps away or which is absorbed by the soil.

The entire arrangement is such that as the salt is gradually dissolved by the surface water and the periodic floodings, the solution permeates the soil surrounding the ground rod and lowers the electrical resistance of the earth connection. This method has proven very effective in maintaining a low electrical resistance in earth connections under naturally adverse soil and moisture conditions.

P. A. STARCK,
Sioux City, Iowa.

A Kink Worth Trying

My radio receiver is without benefit of cabinet or dust-cover and, looking over the chassis, I noticed that it had quite a number of finger marks and smudges that were distinctly unattractive. After a little experimenting with cleaning fluids and powders, I found that Gre-Solvent removed all the spots, and what's more, it accomplished the job easily and quickly. The chassis in this case was white metal, but I have also tried this cleaner on electroly, and other composition metals with equally good results.

WILLARD CHASE,
Chicago, Ill.

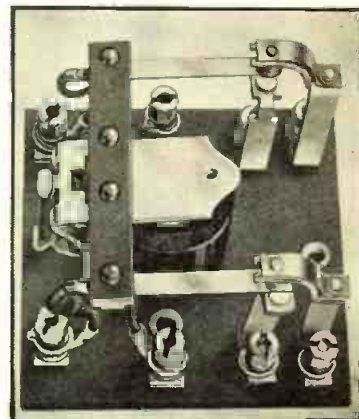

R. F. Relay

Ward Leonard radio-frequency relays are available in two sizes, 4- and 15-ampere capacity. The new midget type, illustrated, has 4-ampere contacts arranged for double-pole-double-throw and is available for operation on 6-8 volt d.c. and 110-volt a.c. circuits. A micalex insulating base and cross-arm and 2-inch spacing of contact arms insures against leakage of radio-frequency currents.

These new r.f. relays are specially designed for antenna change-over and for switching directional antennas. The midget size, 3-inch square base, is particularly adapted for mobile installations such as police or aircraft transmitters. They are also suitable for other high-frequency applications.

New Tool Finds Many Uses

A very handy tool to have in the workshop or the service bench is a small hand reamer of the type herewith illustrated. They are available in various sizes, but the one I found most useful is the type No. 5T, made by the Greenwich Tap and Die Company. At the top or shank it is 1/2 inch in diameter, tapering to a 1/8-inch point. It is extremely useful in obtaining the necessary clearance for all kinds of mounting holes in chassis, panels, etc. The tool can

(Turn to page 690)

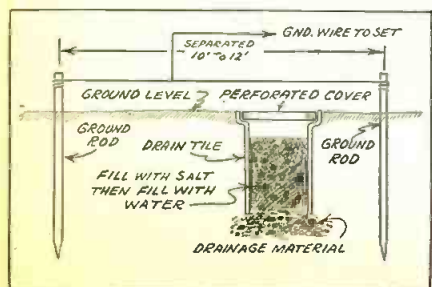
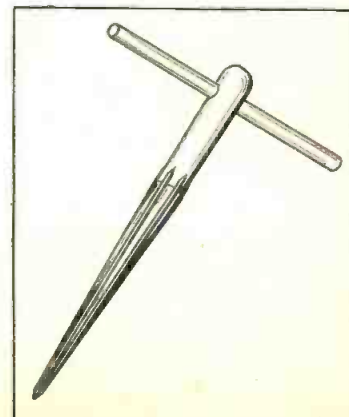



WELL-EQUIPPED DX CORNER

This is the Listening Post of H. E. Howard, of Beverly Hills, Calif., who has a fine array of receivers, antennas and loudspeakers for short-wave DX work.

The fiftieth installment of the DX Corner for Short Waves contains the World Short-Wave Time-Table for 24-hour use all over the world and Official Observers' reports of stations heard this month. Consult these two items regularly and make your all-wave set pay big dividends!

ANNUAL SHORT-WAVE NUMBER

Next month, the June issue, brings us around to our Annual Short-Wave Number in which are featured new and necessary data for short-wave Observers and Listeners the world over. Maps, complete short-wave Station Lists, Time Charts, Station Addresses and other new features, will make this number one that every short-wave listener will cherish. Tell your friends about it.

CREDIT WHERE IT IS DUE

The outstanding reports from our Listening Posts this month, those which have contained the most important information

regarding schedule changes, new stations, wavelength changes and the like, were those furnished by Observers Westman, Chiang, Coover, Alfred, Howald, Fallon, Hartzell, Ralat and Eder. Their reports are noted for: 1, accuracy; 2, careful preparation; 3, conciseness and 4, promptness. Hats off to these fellows for their fine reports!

Reports of Listening Post Observers and Other Short-Wave Readers of the DX Corner

Listed in the following columns is this month's consolidated reports of short-wave stations heard by our worldwide listening posts. Each item is credited with the Observer's surname. This allows our Readers to note who obtained the information. If any of our Readers can supply Actual Time Schedules, Correct Wavelengths, Correct Frequencies and any other Important Information (in paragraphs as recommended), the DX Editor, as well as our Readers, will be grateful for the information. On the other hand, Readers seeing these reports can try their skill in pulling in the stations logged and in trying to get complete information on these transmissions. The report for this month, containing the best information available to date, follows:

Europe

HBJ, Geneva, Switzerland, 14,535 kc., 3:30-4 p.m. (Herzog). 2-3 p.m. (Tynan, Hartzell). Address: Radio Nations, 12, Quai de la Poste.

EA9AH (EAH?), Madrid, Spain, 7020 kc. (Magrie, Spanish News, Mott, Harris), 3-4 p.m. (Mills), anti-red station, not located in Madrid (from veri) (Stevens). Slogan: "Radio Tetuan."

Radio Requete, San Sebastian, Spain, 7200 kc., daily in evenings. (Betances.)

EGP1, Barcelona, Spain, 6995 kc., war news. (Ralat.)

EF1, Valladolid, Spain, 7010 kc., 4:15 p.m. (Ralat, Betances.) Slogan: "Falanges Espanolas No. 1."

Madrid Radioaire, Madrid, Spain, 9450 kc. (Croston.)

ECGI, Barcelona, Spain, 6996 kc. (EGP1?). (Betances.)

UGT, Madrid, Spain, 31.65 meters (EDZ-EAH). (Houghton.)

"LA VOZ DEL PACIFICO"

A "Veri" from station HJU, submitted by Jose Lopez, L.P.O. for Cuba. At right: Mrs. John F. Leonard of Waynesboro, Va., who shares with her husband a fine flair for short-wave DX'ing.

The DX for the

Conducted by

Laurence

EAJ33, Caramaca, Spain, 10,350 kc. (abt.), 8:50-9:23 p.m. (Shamleffer.)

EAJ43, Seville, Spain, 10,360 kc., until 9:26 p.m. (Shamleffer), 10,250 kc., war news (Corube, Ralat). Slogan: "Radio Club Tenerife EAJ43."

EAQ, Madrid, Spain, 30.43 meters, 9 p.m. (Coover, Westman, Hausdorff), 2:30-4:30 p.m. (Fallon, Houghton, Alfred), Thursday, Friday, 3-4 p.m., 9860 kc. (Shamleffer), 5:15-9:30 p.m. (Hartzell, Mott, CW ORM—Eder), Saturday 1-2:30 p.m. (Foshay, Hamilton). Slogan: "La Voz de España."

RV96, Moscow, U. S. S. R., 38.89 meters, Sunday, 1 p.m. (Smith), Sunday 4-7:30 p.m., 15,185 kc. (Sporn).

RIR, Tashkent, U. S. S. R., 29.46 meters, signing at 3:25 p.m. (Westman.)

RIO, Bakot, U. S. S. R., 10,170 kc., almost daily 12-2 a.m. (Kosynsky, Howald.)

RIM, Tashkent, U. S. S. R., 15,252 kc., daily 7 a.m. (Hartzell.)

RKI, Moscow, U. S. S. R., 15,145 kc., daily 7 a.m. (Hartzell.)

DZB, Zeesen, Germany, 10,420 kc., 3:55 p.m. (Alfred.)

DZH, Zeesen, Germany, 14,460 kc., 3:22 p.m. (Alfred), 7-8 p.m. (Anca.)

DZC, Zeesen, Germany, 10,285 kc., 6 p.m. (Alfred), Saturday 5:15 p.m. (Piechuta, Ralat), 5-5:30 p.m., requests reports (Tynan), 7-8 p.m. (Anca.)

DIP, Zeesen, Germany, 14,410 kc., 3 p.m. (Alfred.)

DJP, Zeesen, Germany, 11,855 kc., 1:15 p.m. (Piechuta), signed at 10:50 p.m. (Ralat, Eder.)

DFC, Nauen, Germany, 12,985 kc., 6:40 a.m. (Hartzell.)

DGH, Nauen, Germany, 10,446 kc., 3:30 a.m., used when DGU is not in use (Chambers.)

GBL, Rugby, England, 20.45 meters, 6:45 a.m. (Atherton.)

GBU, Rugby, England, 12,290 kc., 6:30 a.m. (Atherton.)

Radio Alianca, Lisbon, Portugal, 5960 kc., Saturday 3:45-4:30 p.m. (Combe.)

CSW, Lisbon, Portugal, 30.18 meters, 6 p.m. (Coover), 11,000 kc., 9940 kc., up to 5 p.m. (Chiang, Westman.)



Los Ferrocarriles Nacionales, agradecen a usted su atenta comunicación de fecha 7/5/37, a la cual nos informa haber escuchado la estación de onda corta

"LA VOZ DEL PACIFICO"
H J U

Nuestra emisora trabaja los días Lunes, Miércoles y Viernes, en una frecuencia de 9510 kilociclos. De las 12 m. a las 2 p.m. y de las 8 p. m. a las 11 p. m. en sus programas regulares.

La potencia del transmisor es de 1 Kw. Los estudios están localizados en la Estación del Ferrocarril del Pacifico

Ferrocarriles Nacionales
FERROCARRIL del PACIFICO
Buenaventura, Colombia S. A.

Corner SHORT WAVES

M. Cockaday



LISBON'S VERIFICATION CARD

Mr. Orley McLaughlin, of Carrollton, Ohio, sends us in this attractive card which has a bright blue background with the station letters in white. It is a good one to go after!

strikes of bell at close (Lopez), 6-8 p.m. (Dressler), 4-8 p.m. (Kosynsky, Shamleffer). 9640 kc. also, 8-9 p.m. (Alfred, Staley, Piechuta), 10,700 kc. (Fallon), 11,040 kc., 2-2:45 p.m. (from ann.), (Combe, Messer, Ralat, Eder, Hartzell, Cox, Black, Chambers, Herzog, Hamilton, Sands, Wagnuson). Slogan: "Emisora Nacional."

CT1AA, Lisbon, Portugal, 31.09 meters, 5-8:30 p.m. (Westman, Hausdorff), Tuesday, Thursday, Saturday, 4-7 p.m. (Johnson, Hare), 12,050 kc. (Combe), 9650 kc. (Rolat), Saturday, 11:30 a.m. (Smith), 9740 kc., no definite schedule (Dressler, Eder).

HAT, Budapest, Hungary, 5400 kc. (from veri.). (Messer.)

HAS3, Budapest, Hungary, 15,370 kc., Sunday, 6-7 p.m. (Ozevedo, Hausdorff), Sunday, 9-10 a.m. (from veri.), (Dressler), Sunday, 7-10 a.m. (Smith, Messer, Foshay). Address: Radiolabor, Hungary, 4966 Budapest.

YTC, Belgrade, Yugoslavia, 6100 kc. (Stevens), Sunday, 2:15 a.m. (Portmann).

LKJ1, Oslo, Norway, 9530 kc., 11 a.m.-7 p.m. (Alfred, Hare, Kentzel), Address: Ministrie du Commerce, Administration des Telegraphes du Royaume de Norvege, Oslo.

Beograd, Belgrade, Yugoslavia, 49.18 meters, 4:30 p.m. (Mills), 1 a.m.-5:30 p.m. (Fallon).

CS5CS, Stockholm, Sweden, 11,630 kc., Sunday, 10 a.m., University of Stockholm Station (Combe).

SM5SX, Stockholm, Sweden, 11,705 kc., daily 11 a.m.-5 p.m. (Hynek), Sunday, 3-7 a.m., 9 a.m.-5 p.m. (Partner, Smith, Piorko, Yoshimura), daily 1:20-2:05 a.m. (from veri.), (Magunson). Address: Royal Technical University.

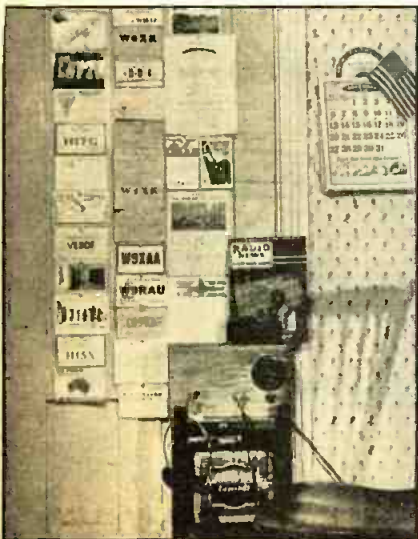

LZA, Sofia, Bulgaria, 14,970 kc., Sunday (Rehrer, Robinson), actual frequency 14,920 kc. (Ozevedo), daily 5-6:30 a.m., 12-2:45 p.m., sometimes 5-7 p.m. (Harris, Eder), Sunday, 1-2 p.m. (Magunson, Hartzell).

TFJ, Reykjavik, Iceland, 12,280 kc., Sunday (Rehrer), 12,235 kc., Sundays, 1:40-2:40 p.m. (Ozevedo, Chiang, Mills, Messer, Herzog, Eder, Foshay, Magunson). Address: Icelandic State Broadcasting Service, P. O. Box No. 547.

OLR, Prague, Czechoslovakia, 6020, 11,840 kc., also on 9550 kc. (Ozevedo, Self, Messer, Hare), 4 p.m. (Fallon), 11 p.m. (Mills, Combe), 15,230 kc. (Ralat), 15,320 kc., 7:30 p.m. (Hartzell), 6030 kc. (from veri.), (Cox), Sunday, 2-5 a.m., 2:30-4:30 p.m., Monday, Wednesday, Thursday, Saturday, 2:30-4:30 p.m. (Herzog, Angel City DX'er), 11,760 kc. (Sands, Piorko, Eder, Yoshimura, Stevens). Address: Praha 12, Fochova 16.

ORK, Ruysselede, Belgium, 10,330 kc. (Ozevedo, Hausdorff), daily 1:30-3 p.m. (from veri.), (Markuson, Alfred, Howald, Dressler, Fallon, Eder).

SPW, Warsaw, Poland, 13,635 kc. (Ozevedo), Monday, Wednesday, Friday (Chiang, Hausdorff), Monday, Wednesday, Friday, 1:30-2:30 p.m. (Alfred, Hare), Monday, Wednesday, Friday, 11:30 a.m.-1:30 p.m. (Westman, Bowes, Portmann, Eder). Address: Polskie Radio Warsaw, 5 Mazowiecka St., Warsaw.

OER2, Vienna, Austria, 25.42 meters (Self, Hare), Monday to Friday, 9 a.m.-5 p.m., Saturday, 9 a.m.-6 p.m. (Smith, Herzog), 11,780 kc. (Eder).

PFA, Hilversum, Holland, 31.7 meters, 6:10-8:10 a.m. (Self).

Central America

TGWA, Guatemala City, Guatemala, 9450 kc., 10:15 p.m. (Ozevedo, Staley, Shamleffer); Saturday, 4-6 p.m. (Westman, Hartzell); schedule daily except Sunday, noon-2 p.m., 8-9 p.m., Sunday, midnight-6 a.m. (Dressler).

TG2X, Guatemala City, Guatemala, 5940 kc., 10:35 p.m. (Piechuta, Eder); Sunday, 12-6 a.m. (Tarr).

TI4NRH, Heredia, Costa Rica, 9670 kc., daily 8:30-10 a.m., 11:30-12 noon (Hynek, Croston, Hartzell).

TIRCC, San Jose, Costa Rica, 6550 kc., Wednesday 9:45 p.m. (Ralat).

FROM THE EASTERN STATES

At left: Listening Post of J. G. Underhill, an ardent listener of North Attleboro, Mass., who believes in battery sets for DX'ing. At right: The Listening Post of Observer E. W. Turner of Culpeper, Va., who uses a "mill" for making out his FB reports.

TIOW, Puerto Leinon, Costa Rica, 6850 kc., Wednesday 10:30 p.m. Desires reports. (Ralat).

TIGPH, San Jose, Costa Rica, 5830 kc., irregularly at 9:30 p.m. (Azevedo, Piechuta, Eder).

YNGU, Managua, Nicaragua, 32.26 meters, 6-8 p.m. (Messer).

YN7AM, Managua, Nicaragua, 7250 kc., daily evenings. (Betances). Slogan: "The Voice of Pacific."

YNLF, Managua, Nicaragua, 9655 kc. (Rehrer).

YNLG (YNVA?), Managua, Nicaragua, 8590 kc., 12-1:30 p.m., 6:30-9:00 p.m. (from veri.) YNLG call being used and other one discarded. (Ather-ton).

YNOC, Managua, Nicaragua, 5758 kc., 9 p.m. (Ralat). Slogan: "Emisora Boyer".

HRN, Tegucigalpa, Honduras, 5875 kc., daily 7-10 p.m. (from veri.) (Ralat, Eder).

West Indies

HH2S, Port-au-Prince, Haiti, 5915 kc., daily at 8 p.m. (Azevedo); about (Turn to Page 676)

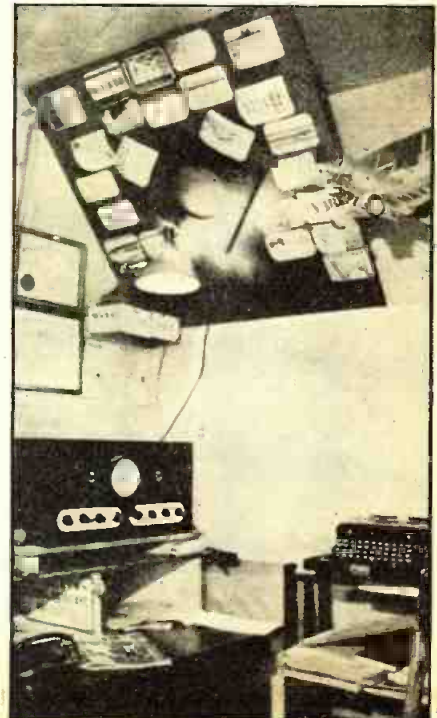



WORLD SHORT WAVE TIME-TABLE



Compiled by LAURENCE M. COCKADAY
Hours of transmission for the World's Short Wave Broadcast Stations

FILL IN LOCAL TIME												EASTERN STANDARD TIME												GREENWICH MEAN TIME																																			
8	9	10	11	M	1	2	3	4	5	6	7	8	9	10	11	N	1	2	3	4	5	6	7	13	14	15	16	17	18	19	20	21	22	23	00																								
01	02	03	04	05	06	07	08	09	10	11	12	13	14	15	16	17	18	19	20	21	22	23	00	13	14	15	16	17	18	19	20	21	22	23	00																								
HOURS OF TRANSMISSION												HOURS OF TRANSMISSION												HOURS OF TRANSMISSION																																			
												Wave-length Meters												Call Letters												Frequency Kc.												City Country											
												13.93 WAXK 21540 Pittsburgh, Pa.																																															
												13.94 W2XE 21520 New York, N. Y.																																															
												13.97 GSH 21470 Daventry, England																																															
												16.86 GSG 17790 Daventry, England																																															
												16.87 W3XAL 17780 Bound Brook, N. J.																																															
												16.89 DJE 17760 Zeesen, Germany																																															
												19.56 DJR 15340 Zeesen, Germany																																															
												19.57 W2XAD 15330 Schenectady, N. Y.																																															
												19.62 LRU 15290 Buenos Aires, Arg.																																															
												19.63 DJQ 15280 Zeesen, Germany																																															
												19.65 W2XE 15270 New York, N. Y.																																															
												19.66 GSI 15260 Daventry, England																																															
												19.68 TPA3 15243 Pontoise, France																																															
												19.71 PCJ 15220 Huizen, Holland																																															
												19.72 W8XK 15210 Pittsburgh, Pa.																																															
												19.74 DJB 15200 Zeesen, Germany																																															
												19.75 ZBW4 15190 Hong Kong, China																																															
												19.76 GSO 15180 Daventry, England																																															
												19.82 GSF 15140 Daventry, England																																															
												19.84 HVJ 15121 Vatican City																																															
												19.85 DJL 15110 Zeesen, Germany																																															
												20.04 LZA 14970 Sofia, Bulgaria																																															
												20.55 IVH 14600 Nazaki, Japan																																															
												22.16 SPV 13653 Warsaw, Poland																																															
												24.52 TFI 12235 Reykjavik, Iceland																																															
												25.00 RV59(RNE) 12000 Moscow, U. S. S. R.																																															
												25.24 TPA3 11885 Pontoise, France																																															
												25.27 W8XK 11870 Pittsburgh, Pa.																																															
												25.36 W2XE 11830 New York, N. Y.																																															
												25.36 W9XAA 11830 Chicago, Ill.																																															
												25.40 I2RO 11810 Rome, Italy																																															
												25.42 IZJ 11800 Nazaki, Japan																																															
												25.45 W1XAL 11790 Boston, Mass.																																															
												25.49 DJD 11770 Zeesen, Germany																																															
												25.53 GSD 11750 Daventry, England																																															
												25.58 PHJ 11730 Huizen, Holland																																															
												25.58 CJRX 11730 Winnipeg, Canada																																															
												25.60 TPA4 11720 Pontoise, France																																															
												25.62 HJ4ABA 11710 Medellin, Colombia																																															
												26.24 COCX 11435 Havana, Cuba																																															
												26.60 HIN 11280 Trujillo, D. R.																																															
												27.35 HS8PJ 10955 Bangkok, Siam																																															
												27.93 IVM 10740 Nazaki, Japan																																															
												28.14 IWN 10660 Nazaki, Japan																																															
												29.04 ORK 10330 Ruysselede, Belgium																																															
												30.43 EAO 9650 Madrid, Spain																																															
												30.75 COCQ 9750 Havana, Cuba																																															
												31.00 CON 9677 Macao, Asia																																															
												31.07 YNLF 9655 Managua, Nicaragua																																															
												31.09 CTAA 9650 Lisbon, Portugal																																															
												31.10 HH3W 9645 Port-au-Prince, Haiti																																															
												31.14 I2RO 9635 Rome, Italy																																															
												31.25 RAN 9600 Moscow, U. S. S. R.																																															
												31.25 HJ1ABP 9600 Cartaxena, Colombia																																															
												31.27 HBL 9595 Geneva, Switzerland																																															
												31.28 W3XAU 9590 Philadelphia, Pa.																																															
												31.28 VK2ME 9590 Sydney, Australia																																															
												31.28 PCJ 9590 Huizen, Holland																																															
												31.28 HP5J 9590 Panama City, Pana.																																															
												31.32 VK3LR 9580 Lyndhurst, Australia																																															
												31.32 GSC 9580 Daventry, England																																															
												31.33 HJ2ARC 9575 Cucuta, Colombia																																															
												31.35 W1XK 9570 Millis, Mass.																																															
												31.38 DJA 9560 Zeesen, Germany																																															
												31.40 TIPG 9559 San Jose, C. R.																																															
												31.41 OLR 9550 Pobebrady, Czech																																															
												31.45 DJN 9540 Zeesen, Germany																																															
												31.48 W2XAF 9530 Schenectady, N. Y.																																															
												31.48 LK11 9530 Jelow, Norway																																															
												31.49 ZBW3 9525 Hong Kong, China																																															
												31.55 GSB 9510 Daventry, England																																															
												31.55 HJU 9510 Buenaventura, Colom.																																															
												31.55 VK2ME 9510 Melbourne, Australia																																															
												31.56 XEFT 9505 Veracruz, Mex.																																															
												31.58 PRF5 9500 Rio de Janeiro, Brazil																																															
												31.58 HJ1ABE 9500 Cartaxena, Colombia																																															
												31.75 TGWA 9450 Guatemala City																																															
												31.82 COCH 9428 Havana, Cuba																																															
												31.35 HS8PJ 9350 Bangkok, Siam																																															
												32.88 HAT4 9125 Budapest, Hungary																																															
												33.53 HC1B 8948 Quito, Ecuador																																															
												34.62 CO9JQ 8665 Camaguey, Cuba																																															
												38.48 HBP 7797 Geneva, Switzerland																																															
												39.95 IVP 7510 Nazaki, Japan																																															
												42.80 EA8AB 7010 Tenerife, Canary Is.																																															
												43.48 H13C 6900 La Romana, D. R.																																															
												43.99 XGOX 6820 Nanking, China																																															
												44.14 H1H 6796 San Pedro, D. R.																																															
												44.44 IVT 6750 Nazaki, Japan																																															
												44.71 TIEP 6710 San Jose, Costa Rica																																															
												45.00 HC2RL 6667 Guayaquil, Ecuador																																															
												45.25 HIT 6630 Trujillo, D. R.																																															
												45.34 PRADO 6618 Riobamba, Ecuador																																															
												45.38 RV72 6611 Moscow, U. S. S. R.																																															



WORLD SHORT WAVE TIME-TABLE



(Continued from the Previous Page)

Hours of transmission for the World's Short Wave Broadcast Stations

FILL IN LOCAL TIME																							
EASTERN STANDARD TIME																							
GREENWICH MEAN TIME																							
HOURS OF TRANSMISSION												HOURS OF TRANSMISSION											
8	9	10	11	M	1	2	3	4	5	6	7	8	9	10	11	N	1	2	3	4	5	6	7
01	02	03	04	05	06	07	08	09	10	11	12	13	14	15	16	17	18	19	20	21	22	23	00
Wave-length Meters												Call Letters											
Frequency Kc.												City Country											
45.80 HI4D												Trajillo, D. R.											
46.01 VV4RA												Valencia, Venezuela											
46.08 HI1S												Trujillo, D. R.											
46.66 HI1S												Puerto Plata, D. R.											
46.85 VV5RH												Caracas, Venezuela											
46.91 HI8O												Trujillo, D. R.											
47.12 VV1RH												Maracaibo, Ven.											
47.24 HRP1												San Pedro Sula, Honduras											
47.54 HI7												Trujillo, D. R.											
47.62 VV4RD												Maracaibo, Venezuela											
47.77 HI6												Trujillo, D. R.											
47.77 COHB												Sancti Spiritus, Cuba											
48.05 HIN												Trujillo, D. R.											
48.11 HRD												La Ceiba, Honduras											
48.15 OAX4G												Lima, Peru											
48.19 HI1ABH												Cienaga, Colombia											
48.39 COKG												Santiago, Cuba											
48.50 HI1A												Santiago, D. R.											
48.70 NEXA												Mexico, D. F.											
48.70 VPH												Colombo, Ceylon											
48.70 CIRO												Winnipeg, Canada											
48.78 VE9CL												Winnipeg, Canada											
48.78 HJ2ABA												Tunja, Colombia											
48.78 VV5RD												Caracas, Venezuela											
48.78 HJ5ABC												Cali, Colombia											
48.86 W8XK												Pittsburgh, Pa.											
48.88 CR7AA												Lourenzo Marques, A.											
48.94 VE9HX												Halifax, N. S.											
48.94 COCD												Havana, Cuba											
48.96 HJ3ABX												Bogota, Colombia											
49.00 HJ1ABB												Barranquilla, Colom.											
49.02 W2XE												New York, N. Y.											
49.10 NECW												Nantocam, Mexico											
49.18 "Beograd"												Belgrade, Yugoslavia											
49.18 W3XAL												Bound Brook, N. J.											
49.18 W9XF												Chicago, Ill.											
49.20 ZTJ (JB)												Johannesburg, Africa											
49.22 HJ4ABE												Medellin, Colombia											
49.26 ZHW2												Hong Kong, China											
49.26 CRCX												Toronto, Canada											
49.30 HJ5ABD												Cali, Colombia											
49.31 HJ3ABF												Bogota, Colombia											
49.32 VQ7LO												Nairobi, Kenya, Afr.											
49.34 HP5F												Colon, Panama											
49.34 W9XAA												Chicago, Ill.											
49.34 ZHI												Penang, S. S.											
49.40 OER2												Vienna, Austria											
49.42 W1RE												Maracaibo, Venez.											
49.50 W8XAL												Cincinnati, Ohio											
49.50 W3XAU												Philadelphia, Pa.											
49.50 OXY												Skamlebaek, Denmark											
49.59 HJ3ABD												Bogota, Colombia											
49.59 HI9B												Trujillo, D. R.											
49.63 HJ3AB1												Bogota, Colombia											
49.65 HI1ABG												Barranquilla, Colom.											
49.67 YDA												Tandjong Priok, Java											
49.67 W1XAL												Boston, Mass.											
49.75 HP5B												Panama City, Panama											
49.83 DJC												Zezen, Germany											
49.83 NEUV												Veracruz, Mexico											
49.85 ZHI												Singapore, Malaya											
49.88 NEW1												Mexico, D. F. Mexico											
49.90 HJ3ABH												Bogota, Colombia											
49.92 COCO												Havana, Cuba											
49.95 HJ1ABJ												Santa Marta, Colom.											
49.96 CFCX												Montreal, Can.											
49.96 HP5K												Colon, Panama											
49.96 VE9DN												Montreal, Canada											
50.00 NEBT												Mexico City, Mexico											
50.00 RV59												Moscow, U. S. S. R.											
50.17 HIX												Trujillo, D. R.											
50.25 HJN												Bogota, Colombia											
50.26 HVJ												Vatican City											
50.50 TG2X												Guatemala City											
50.72 HI1ZS												Port-au-Prince, Haiti											
50.76 HRN												Terucualpa, Hond.											
50.85 VV3RA												Barquisimeto, Venez.											
51.15 HI1J												San Pedro, D. R.											
51.46 TIGPH												Alma Tica, Costa Rica											
51.72 VV5RC												Caracas, Venezuela											
51.90 OAX4D												Lima, Peru											

List of Symbols

- | | | | |
|-------------------------------------|--------------------------------------|--------------------------------|-------------------------------------|
| A—Thursday, Sunday | L—Wednesday, Saturday | V—Sunday, Wednesday | X—Except Saturday, Sunday |
| C—Monday, Wednesday, Friday | M—Monday | W—Wednesday | NA—Except Saturday, Sunday |
| D—Daily | N—Monday, Wednesday, Thursday | Z—Tuesday, Friday | XB—Except Tuesday, Thursday |
| E—Tuesday, Thursday | O—Monday, Tuesday, Wednesday, Friday | AC—Monday, Thursday, Saturday | XC—Except Tuesday, Thursday, Sunday |
| F—Friday | P—Except Tuesday, Wednesday | AG—Tuesday, Sunday | NM—Except Monday |
| H—Sunday, Monday, Wednesday, Friday | R—Sunday, Monday, Friday | AH—Monday, Wednesday, Saturday | XS—Except Sunday |
| G—Tuesday, Thursday, Saturday | S—Sunday | AL—Except Monday, Sunday | XW—Except Wednesday |
| I—Irregularly | T—Tuesday | AM—Monday, Thursday | XV—Except Tuesday, Sunday |
| J—Tuesday, Thursday, Friday, Sunday | Th—Thursday | AS—Tuesday, Saturday | XSA—Except Saturday |
| K—Monday, Friday | U—Sunday, Monday, Thursday | Sa—Saturday | |

SUVA FIJI

AWA

VPD

THE GARDEN OF THE PACIFIC
These islands were discovered in 1643 by Tasman and were ceded to Great Britain in 1874. There are about 250 islands in the group. The population is about 172,000. Principal exports: Sugar, Coconuts, Bananas, Rubber, Cotton and Shell.

Amalgamated Wireless (Australasia) Ltd. operates the wireless services of Fiji. At VPD there are 3 transmitters. All these stations were designed and built in Australia by A.W.A., which also owns and operates Australian Transmitters, Coastal Radio, Ship Stations and Short Wave Overseas Broadcasting Stations 2ME Sydney and 3MF Melbourne.

AMALGAMATED WIRELESS AUSTRALIA LTD. :: SUVA FIJI

The DX Corner (Short Waves)

(Continued from page 673)

5940 kc. (Shamleffer, Alfred); chimes at time intervals, 7-9:45 p.m. (Ralat, Eder, Anderson). Address: Societe Haitienne de Radiodiffusion, Immeuble Magebo.

HH3W, Port-au-Prince, Haiti, 9620 kc., 8:45 p.m. (Shamleffer).

ZFB, Hamilton, Bermuda, 10055 kc., daily at 8:45 a.m. (Dressler).

Fort-de-France, Martinique, 9435 kc., daily noon and evenings. (Betances).

COCA, Havana, Cuba, 26.62 meters, 5-8:30 p.m. (Westman).

COCN, Havana, Cuba, 11990 kc., 8 a.m. (Hartzell).

COKG, Santiago, Cuba, 6200 kc., changed from 6150 kc. (from veri.) (Mott, Hausedorff); daily except Sunday 9:30-10:30 p.m., Sunday 12:01-1 a.m. (from veri.) (Markuson); daily 5-6 p.m. also; 6147 kc., (Ralat, Hartzell, Croston, Fallon, Betances, Mott). Slogan: "Bacardi". Address: P. O. Box 137, Hotel Casa Granda Building.

COCE, Le Cotona, Havana, Cuba, 8823 kc., before announcement 3 chimes, after announcement a whistle. (Houghton), irregular schedule. (Croston).

COCH, Havana, Cuba, 9428 kc. (Azevedo, DeMent); 5:42 p.m. (Oglesby); daily except Sunday 6:58 a.m.-12 p.m. (Alfred, Hartzell); daily except Sunday 5 p.m.-midnight. (Dressler, Sands, Eder).

COCQ, Havana, Cuba, 9750 kc. (Azevedo, Hausdorff, Kashimoto, Westman); heard 8 and 9 p.m. (Coover); 6:50-1 a.m. (Hynek, Lopez, Alfred, Hartzell); daily 5 p.m.-midnight. (Dressler, Eder, Immicke).

HI1J, San Pedro de Macoris, Dominican Republic, 5865 kc., 6:30-9:00 p.m. (Azevedo, Westman, Shamleffer).

HI1G, Ciudad Trujillo, Dominican Republic, 6280 kc., daily 9 p.m. (Azevedo, Boussy); Sunday 3 p.m. (Ralat, Stevens).

HI1Z, Ciudad Trujillo, Dominican Republic, 6316 kc., daily 7 p.m. (Azevedo); daily 7:30-9 p.m. (Alfred). Slogan: "La Voz de los Muchachos".

HI1S, Santiago, Dominican Republic, 6420 kc., 10 p.m., (Azevedo), calling amateurs. (Kosynsky); daily 11:40 a.m.-2:40 p.m., 5:40-7:45 p.m. and

A HIGHLY PRIZED "CATCH"

Mr. John Mills of Maffra, Victoria, lets us see what the Suva verification card looks like. American listeners are brushing up their sets and antenna equipment to win one of these.

9:40-11:40 p.m. (Doyle, Hartzell, Eder, Angel City DX'er).

HI1L, Ciudad Trujillo, Dominican Republic, 6500 kc., 7 p.m. (Azevedo).

HI1D, Ciudad Trujillo, Dominican Republic, 6900 kc., daily 5:30-6:30 p.m. (from veri.); (Ralat, Brensilber). Slogan: "La Voz de la Asociacion Catolica".

HI1C, La Romana, Dominican Republic, 6730 kc., signs at 6:30 p.m. (Ralat).

HI1B, Santiago de los Caballeros, Dominican Republic, 5885 kc., 7 p.m. (Lopez); signs at 7:15 p.m. (Ralat, Betances).

HI1X, Ciudad Trujillo, Dominican Republic, 6330 kc. (Shamleffer, Eder).

HI1Q, Ciudad Trujillo, Dominican

A FAMOUS DX PAIR

Meet Observer Stabler and his charming wife. She looks as proud of him and his DX accomplishments as we are, his friends and associates.



Republic, 6206 kc., 8:45 p.m. (Ralat, Betances).

HIT, Ciudad Trujillo, Dominican Republic, 6630 kc., 6:30 p.m. (Azevedo); 8 p.m. (Coover); Saturday 10:40 p.m.-12:40 a.m. (Cindel); daily 12:30-2 p.m., 6-9 p.m., Sundays 11 a.m.-1 p.m. (Shamleffer, Oglesby, Alfred, Eder). Slogan: "Voice of RCA Victor". Address: P. O. Box 1105.

HIH, San Pedro de Macoris, Dominican Republic, 6796 kc., daily. (Kosynsky); until 9 p.m. (Ralat, Eder).

HI8A, Ciudad Trujillo, Dominican Republic, 6479 kc., Saturday 10:40 p.m. (Shamleffer, Brensilber). Slogan: "La Fadoc en el Aire". Address: P. O. Box No. 1302; P. O. Box No. 1312.

HJ3ABD, Bogota, Colombia, 6050 kc., 11:30 p.m. (Ralat, Eder).

HJB, Bogota, Colombia, 14940 kc., 3:30-4 p.m. (Kentzel).

HJ4ABU, Pereira, Colombia, 6150 kc., 9:30-12 a.m., 6:30-10 p.m. (from veri.); (Azevedo); 9520 kc., 8:30 a.m. (Ralat).

HJ4ABH, Armenia, Caldas, Colombia, 9520 kc., schedule 8-11 a.m., 6-10 p.m. (from veri.); (Cox, Lopez, Kosynsky, Alfred, Hartzell, Smith, Eder, Anca). Slogan: "La Voz del Armenia".

HJ4ABP, Medellin, Colombia, 6030 kc., 9 a.m.-noon (from veri.). (Fallon).

HJ4ABE, Medellin, Colombia, 11 a.m.-noon and 6-10:45 p.m. (Doyle); 6095 kc., 4-6 p.m. on Sunday. (Ralat).

HJ3ABX, Bogota, Colombia, 6122 kc., 8 p.m. (Azevedo); schedule 10:30 a.m.-2 p.m., 5:30-11:30 p.m., Sunday 12-1:30 p.m., 6-11 p.m. (Partner, Tyman). Slogan: "La Voz de Colombia". Address P. O. Box No. 2665.

HJ3ABE, Bogota, Colombia, 6170 kc., 8 p.m. (Azevedo).

HJ3ABI, Bogota, Colombia, 49.63 meters (Westman).

HJ4ABA, Medellin, Colombia, 11810 kc., Monday until 3:30 p.m. (Hartzell).

HJ1ABE, Cartagena, Colombia, 9500 kc., best 4-6 p.m. (Kashimoto); 8 p.m. (Azevedo, Coover, Shamleffer); Monday 10 p.m. (Fallon, Westman); daily 7:30-9 p.m. (Hartzell); works "hams" (Dressler, Foshay, Eder); daily except Sunday 11:30 a.m.-1 p.m., 6-10:30 p.m. (from veri.) (Markuson, Herzog). Slogan: "La Voz de los Laboratorios Fuentes". Address: P. O. Box No. 31.

HJ1ABG, Barranquilla, Colombia, 6042.5 kc. (from veri.); 8-11 p.m. (Eder, Azevedo).

HJ1ABP, Cartagena, Colombia, 9615 kc., 6:30 p.m. (Azevedo); 8 p.m. (Coover, Westman, Margie, Shamleffer); until 10 p.m. (Sesina); 11 a.m.-1 p.m. and 5-11 p.m. daily (Mochrie); wants reports (Alfred, Oglesby, Harris, Hartzell, Smith, Hamilton, Eder, Dressler, Herzog).

HJ1ABB, Barranquilla, Colombia, 6135 kc., 9 p.m. (Azevedo, Westman); 9555 kc. (Oglesby); moved to 9570 kc., 1 p.m. (Ralat); 7 a.m.-12:30 p.m. (Sands).

HJ2ABD, Bucaramanga, Colombia, 5988 kc. (Azevedo); signed at 11 p.m. (Piechuta); 7:30-10:30 p.m. (from veri.) (Ralat).

HJ1ABA, Barranquilla, Colombia, 9550 kc. (Shamleffer, Angel City DX'er). Slogan: "La Voz de Barranquilla".

HJ1ABC, Colombia, changed to 6005 kc. (Sands).

HKV, Bogota, Colombia, 8790 kc., testing at 8:30 p.m. (Piechuta); Monday and Thursday; 7-7:30 p.m. (Ralat).

LRX, Buenos Aires, Argentine. 9660 kc., daily 6-10:30 p.m. (Alfred, Atherton, Shamleffer, Markuson, Ralat, Hartzell, Sands, Eder).

LRU, Buenos Aires, Argentina, 15290 kc. (Rehrer, Westman, Hartzell).

LSX, Buenos Aires, Argentina. 10350 kc., Monday and Friday. 5:06 p.m., wants reports. (Chiang, Westman, Hausdorff); Wednesday and Thursday, 7-10 p.m. (Kasynsky); Monday 8-8:30 p.m. (Sesina, Alfred, Piechuta); 9660 kc. (Fallon, Smith, Ralat, Anderson, Stevens, Foshay). Slogan: "Radio Splendid", "The Voice of Argentina".

YV5RU, Caracas, Venezuela. 6400 kc., 8:30-8:45 p.m. (Shamleffer).

YV5RA, Caracas, Venezuela. 6400 kc., 8:30-8:45 p.m. (Shamleffer); 5800 kc., 4-9:30 p.m. (Ralat, Birnie).

YV4RG, Maracay, Venezuela, 6270 kc. (Shamleffer).

YV1RI, Coro, Estado Falcon, Venezuela, 6210 kc., 9:15-9:25 p.m. (Shamleffer, Ralat, Kentzel). Slogan: "Radio Corro".

YV1RA, **YV1RB**, **YV5RMO**, Maracaibo, Venezuela. 5850 kc., Saturday 11 p.m. (Shamleffer); 8 p.m. (Ralat, Azevedo, Hausdorff, Betances, Eder). Slogan: "Emisora 12 de Julia". Address: P. O. Box No. 37.

YVQ, Maracay, Venezuela. 44.96 and 22.48 meters. (Atherton); 6672 kc. (Foshay). Address: Ministerio de Fomento Servicios de Radiodifusion.

Radio Valencia, Valencia, Venezuela, 5900 kc., 11-12 p.m. (Alfred).

YV6RH, Caracas, Venezuela, 6410 kc. (Angel City DX'er).

YV1RV, Maracaibo, Venezuela. 5850 kc. (Angel City DX'er).

YV4RD, **YV12RM**, Maracay, Venezuela, 6300, 7:30 p.m. (Ralat, Angel City DX'er).

YV5RP, Caracas, Venezuela, 6270 kc., (Markuson); 6-8 p.m., desires reports. (Kosynsky, Betances, Angel City DX'er). Slogan: "La Voz de la Philco". Address: P. O. Box No. 508.

YV1RH, Maracaibo, Venezuela. 6320 kc., 8 p.m. (Azevedo); 6360 kc., signs at 10:50 p.m. (Leim); wants reports. (Kosynsky); 6420 kc. (Alfred, Staley); daily 9:50-10:50 p.m. (Fallon); 10:30 a.m.-12:30 p.m., 6:30-9:45 p.m. (from veri), (Ralat, Betances, Eder, Anca, Angel City DX'er). Slogan: "Ondas del Lago", "Emisora Philco". Address: P. O. Box No. 261.

YV1RD, Maracaibo, Venezuela, 6170 kc. (Angel City DX'er).

YV3RA, Barquisemito, Venezuela, 5880 kc., 7:10 p.m. (Ralat, Angel City DX'er).

YV5RB, Caracas, Venezuela, moved to 6158 kc., 8-10 p.m. (Ralat).

YV1RG, Valera, Estado Trujillo, Venezuela, 6230 kc., 7:30 p.m. (Ralat); 6345 kc. (from veri). (Betances); 6200 kc. (Kentzel). Slogan: "Radio Valera".

YV5RG, Caracas, Venezuela. 6400 kc., 8 p.m. (Ralat). Slogan: "Ondas Populares".

YV15RV, Maracaibo, Venezuela, 5910 kc. (Eder).

YV1RE, Maracaibo, Venezuela, 6070 kc., 8:15 p.m. (Ralat).

YV1RL, Maracaibo, Venezuela, 5930 kc. (Ralat). Slogan: "Radio Popular". Address: P. O. Box No. 247.

HC1PM, Quito, Ecuador, 51 meters. (Lopez). Slogan: "El Palomar". Address: J. Leonard Ponce, P. O. Box No. 664.

HC2RA, Guayaquil, Ecuador, 9440 kc., signs at 10:45 p.m. daily. (Tarr).

(Turn to page 686)

KENYONIZE TO MODERNIZE AND ECONOMIZE

Kenyon Transformer Co., Inc., is pleased to announce 38 additions to the "T" line which are designed to take care of newer tubes and circuit developments.



KEN-O-TAP

The Universal Modulation Transformer

KEN-O-TAP is the Practical Solution to the Modulation Problem

This new low-cost universal modulation transformer may be used with any type of tube or tube combinations in transmitters. The multi-taps provide impedances to match any combination of modulator and class "C" conditions encountered in amateur transmitter applications. Will never become obsolete. Secondary designed to carry the full class "C" load.

Type T-493	Audio Level	40 watts	Will modulate	80 watts	Net Price \$ 4.20
Type T-494	Audio Level	75 watts	Will modulate	150 watts	Net Price \$ 6.00
Type T-495	Audio Level	125 watts	Will modulate	250 watts	Net Price \$12.00
Type T-496	Audio Level	300 watts	Will modulate	600 watts	Net Price \$18.00



KEN-O-DRIVE

The Universal Driver Transformer

KEN-O-DRIVE is the Modern Answer to Critical Driver Operation

Will match a 500-ohm line or any driver plate or plates to class "AB" or "B" grids. Type T-264 Level 7 watts Net Price \$4.20 Type T-263 Level 18 watts Net Price \$5.40

RK39 MODULATION OUTPUT TRANSFORMER

Our type T-462 is especially designed for RK39 beam power tubes in class "AB". The secondary winding of this transformer will carry the class "C" load and is tapped to match many of the popular 250-watt tubes.

Secondary impedances are 4,000, 6,000 and 8,000 ohms
Secondary maximum D.C. 300, 250 and 200 MA Net Price \$9.90



RK39 LINE AND SPEAKER OUTPUT TRANSFORMER

T-307 is similar to the above unit except the output is 500-200 or 15-8-4 ohms. May also be used for push-pull parallel 6L6 tubes in class "AB2". Primary 6400 ohms or 1900 ohms. Net Price \$9.60.

For full information on these units ask your dealer for the new catalog describing our complete line of amateur and P.A. audio and power components.

Chief Engineer Sound Division

KENYON TRANSFORMER CO. INC.

840 Barry St., New York, N. Y.

Export Dept.: 25 Warren St., New York, N. Y.

Cable Address: SIMONTRICE—NEW YORK

FASTEST WAY TO LEARN CODE

Easy, Fascinating, LEARN by EAR To Be a GOOD OP.

The New All Electric Master Telex Code Teaching Machine is exactly what thousands are looking for. No experience needed. Ideal for beginners — steps up WPM for ALL Ops. There is no guess work with Master Telex, because it records your sending in visible dots and dashes, you SEE and HEAR exactly how you are making your signals. You learn code the way you'll be using it—by SOUND. Complete schools and several governments for teaching code. Low cost easy terms. MONEY BACK GUARANTEE. Send now for booklet RN5, no obligation. Post card will do.

TELEPLEX CO.
72-76 Cortlandt St. New York, N. Y.



Trindl ELECTRIC ARC WELDER

Works Off Any Storage Battery or Ordinary Light Socket

This new electric arc welder is made possible by the invention of a low voltage carbon. Auto batteries may be used without removing from car. Uses about same current as four headlight bulbs. Can be used on electric light socket by using a Trindl converter in place of battery. Broken parts are simply melted together by the white hot electric arc, in just a few seconds. Produces about 7000 degrees heat.

HOTTEST FLAME KNOWN

Melts iron and steel instantly. Welds fenders, radiators, holes in bodies, milk cans, tanks, brazes broken castings. Works on anything iron, steel, brass, copper, tin or galvanized metal. Permanent repairs made for almost nothing. Used by factories in many operations. Positive money back guarantee by a responsible firm.

AGENTS
Men with cars to sell mechanics, repairmen, farmers, radio and battery shops, factories. Five minute demonstration to make a sale. U. S. O. 150% profit. Write today.

TRINDL PRODUCTS
2229-KT. CALUMET AVE., CHICAGO, ILL.



FOR YOUR P. A. JOBS CHOOSE THIS RCA EQUIPMENT —and here's why!

This new 12 watt portable sound system provides volume for auditoriums seating as many as 1600 persons. It gives performance based on RCA's unequalled experience in sound pick-up, amplification and reproduction. Provides many quality features. Sells at low cost. Assures you satisfied customers, good profits. See your RCA Sound Distributor now!



RCA Portable Public Address System Model PG-98 . . . complete with 2 dynamic speakers, amplifier, RCA Velocity Microphone . . . only \$179.50.



for PUBLIC ADDRESS SYSTEMS

RCA Manufacturing Co., Inc., Camden, N.J.
A Service of the Radio Corporation of America

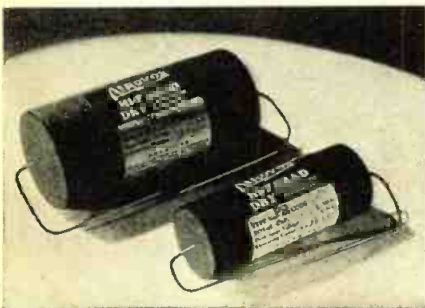

TUBULAR ELECTROLYTICS



- ★ Inexpensive, compact, dependable capacitance for filter networks and by-pass functions.
- ★ Sturdy cardboard tube units with 2 1/2" leads that won't pull loose.
- ★ 25, 50, 100, 150, 200, 300 and 450 v. working. 5 to 50 mfd. in lower voltages. 2 to 8 mfd. in higher voltages.
- ★ Double-section units, 25, 50 and 100 v. working. 5-5 and 10-10 mfd.

FREE! Latest catalog covering complete condenser line. Also sample copy of monthly Research Worker.



THE SERVICE BENCH

(Continued from page 656)

tuning being effected through a long dial cable. Wrapping tape around the cables and control pulleys before removing the chassis will prevent a tangled mess and make for easier reinstallation.

General Electric A-87

"This receiver was dead except for a few sporadic code signals. Smoke wafting its way ceiling-ward from the sentry box. No voltage on the anode grid of the 6A8. The trouble was caused by a shorted .1 mfd. 200-volt condenser, which in turn burned up a 10,000-ohm, 1/2-watt resistor. These units are fastened on the switch assembly in the foremost of the three sentry boxes. To get at them, the sentry box is demounted by removing the side fastening bolts, the dial-mechanism nuts and the terminal leads. The band-switch shaft must be removed before the box cover can be lifted. With the sentry box removed from the chassis, the dial gears can be disengaged and the shaft removed by lifting the reduction drive and the dial assembly. This allows the switch-shaft gear to pass the dial-scale gear when the shaft is pulled straight out. Use a .1 mfd. 400-volt condenser for replacement. When replacing the switch and dial mechanism, make sure they are in the correct position, otherwise the calibration will be destroyed.

Brunswick S-31 Panatrop

"Abnormal hum, set cuts out, changes in volume, and the phonograph is dead. Outside of that the set was okay. For hum, try various 24As in the detector socket, check the ground, and clean and adjust the "radio-phone" switch contacts. The cut-off was due to defective radio-frequency screen-grid-to-cathode by-pass condensers. Replace with .1 mfd. 400-volt units. The variation in volume trouble was corrected by replacing the volume control and cleansing the contacts on the local-distance switch. The dead phonograph was due to a broken lead in the sound head. Handle this unit with care."—Thank you Mr. Schmidt!

THIS MONTH'S SERVICE SHOP

From the other side of the world comes our heading photograph this month—from A. R. Burden, box 162, Port Augusta, South Australia, who organized and maintains the radio department in a watch-making concern. In the upper left is the starting switch for a rotary converter—Port Augusta being a d.c. district. a.c. is required for some of the test equipment, and, as Mr. Burden's territory embraces many thousands of square miles, he runs into plenty of a.c. sets. The panel with the three meters is a vacuum-tube voltmeter. The center panel is a universal type tester, and a Clough-Brengle oscillator is just to its right. A Supreme tube checker will be observed on the extreme right. With the exception of the oscillator and checker, the equipment was designed and made by Mr. Burden. The two speakers labeled "Tucker's Radio" are part of the P. A. equipment. There is also a complete complement of portable equipment for use in the field—for many sets cannot be brought to the shop, and Mohammed must venture forth with test apparatus in hand. Let Mr. Burden tell the story—

"Port Augusta is 200 miles from the city of Adelaide and is the starting point of the Trans-Australian and Central Australian

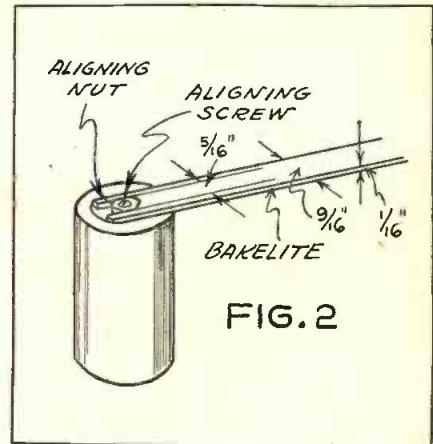

FIG. 2

FIGURE 2

A special wrench for tuning Meissner r.f. units easily made out of a flat strip of bakelite.

railroads. The nearest big town on the Trans-Australian Railway is Kalgoorlie, 1037 miles away. So you can see we have a fairly large territory. I have just returned from a 540-mile trip, in our radio truck, to the far north of Southern Australia. Most of the country between Port Augusta and Kalgoorlie is taken up with big sheep and cattle stations, often comprising 2000 to 3000 square miles. Most of our work comes from these pastoralites, and from the railroad permanent way maintenance camps." Talk about rural servicing!

Tuning Meissner I.F. Units

"On Meissner tuned primary and tuned secondary i.f. coils, one section is tuned with a nut and the other with a screw. Often when adjusting the screw, the nut will also turn, detuning that section. I have devised the simple tool shown in Figure 2 which enables me to hold the nut while the screw is turned. It is nothing more than a thin, flat bakelite wrench. The wrench head was cut out on a jig-saw, and filed smooth with a small file."—Al R. Dayes, Brooklyn, N. Y.

SERVICE NOTES

About the time this issue of RADIO NEWS is published the RCA 1937 service lecture meetings will be in full sway. Every serviceman should do his utmost to attend the meeting in his territory. As in the past, these get-togethers are being sponsored by the Service Division of RCA and its wholesale distributors in more than 100 cities. The present series is entitled "Training the Ear and Eye for Radio Servicing." A unique feature in the demonstration is the use of a specially designed board large enough to be visible to a good-size audience. Various circuits will be displayed on the board, behind which will be apparatus corresponding to the circuits exhibited. It will be possible to make various changes in the circuits shown and the indicated variations in the apparatus being demonstrated, in this manner creating a variety of effects which will be studied visually—on the circuit, and in the oscilloscope—and aurally through associated speakers.

Radio Field Service Data

This is a new book by Alfred A. Ghirardi that unquestionably deserves a place on the shelves of every serviceman. Primarily it

is a collection of case histories of over 1500 receiver troubles. As interesting and useful as this information is, to our mind the greater value of the book lies in the various addenda—a compilation of miscellaneous and practical radio information made readily available to the serviceman between the covers of a single book. Items included are complete circuit diagrams of practically all automobile electrical systems (and make believe that information won't help the *intelligent* serviceman track down many a case of ignition interference!), grid-bias resistor charts, resistance-current-voltage-power rating resistance chart, tube charts, rectifier characteristics, drill and tap sizes, and the RMA standard color—codes for fixed resistors, condensers, dynamic speaker connections, battery cables, power transformer leads, i. f. transformer leads and audio transformer leads. We venture to predict that of all books in the service library, this will be one of those to which reference will most frequently be made. The 468 pages that comprise this book are in an attractive loose-leaf binding—with plenty of room for more pages to come—at the rate of two supplements per year.

What About Television?

Mr. E. H. Rietzke writes in the CREI News what he thinks about approaching television and the types of men it will give employment. There seems to be a prevailing idea that television is some new subject whereas it is just a branch of radio. Therefore, it is absolutely essential that the prospective television technician must be thoroughly familiar with the principles of radio engineering and electrical engineering. But let us quote Mr. Rietzke: "We feel that there is no question about the fact that one of these days television will be with us, and on a scale equivalent to present-day broadcasting. This will without question mean thousands of new jobs and opportunities.

"We feel that these opportunities will open up to the better-than-average men *now in radio*. The problems of television engineering are simply specialized problems of radio engineering. The fact that the program is picked up by a photo-electric device instead of a microphone, and reproduced by means of a cathode-ray tube instead of a dynamic reproducer, does not alter the fact that everything between these two extremes consists of wide-range amplifiers, selector circuits, and radio transmitters and receivers.

The good television engineer must first be a highly competent radio engineer. All his basic training will be that of the radio engineer, just as radio engineering is simply a specialized branch of electrical engineering. The men who get in on the ground floor of television will not be the inexperienced young men who take a course in "Television", neglecting the most necessary part of all, basic electrical and radio engineering training. They will be the men now in radio who are outstanding in the allied fields of broadcasting and manufacturing—who keep right up to date in their own work and who take the trouble to learn from every available source what there is to know about the principles directly relating to the specialized field of television—photocells, cathode-ray tubes, scanning devices, optical systems, etc."

Farnsworth Television

(Continued from page 655)

boundary, as one approaches the transmitter building, the first impression is of a very small rural farm town. Although the

studio and transmitter building is just two average commercial stories in height, it stands out prominently on the country terrain. The structure is of the prefabricated type, perhaps the nation's only transmitter building of such construction.

The first thing that attracted us on entering the building was a television theatre where accommodations are provided for a large group of lookers-in. The several rows of chairs face a new Farnsworth receiver. The set differs from most other American types demonstrated in recent seasons in that the picture is seen right off the tube instead of by a mirror-lid reflection. This permits the cathode-ray tube to be mounted horizontally and, because the valve uses magnetic rather than electrostatic deflection, its length permits a shallow cabinet depth. Although the set demonstrated yielded a picture only six inches square, it was apparent that the direct framing of the tube's screen in the face of the cabinet gave an illusion of a still greater size. The use of a tilted mirror lid with a vertically mounted tube sets the picture back some inches from the face of the cabinet and seems to yield a smaller image.

The adjoining combination control and transmitter room is as professionally equipped as a standard broadcasting station with the feature of boasting "video" as well as audio units in its multiple-panel control boards.

But the surprising highlight of our visit was the studio! Here was a chamber 40 feet long, 24 feet wide and 24 feet high equipped in cinematic fashion with lights, props and full-sized and miniature sets. Every day for many months programs were being built and performed in this studio. The only transmissions have been over wire lines to the Farnsworth Philadelphia laboratories, we were told, but the actual air transmission schedule on a television carrier of 62.75 megacycles and a sound carrier of 66 megacycles was expected to be effective by the time this article reached print. If it's not, it will be within a very short period. While the tests are not intended for public reception, any amateur within some thirty miles equipped with a receiver tuned to these channels and adjusted to the 441-line pictures with an interlace of two to one can get the program. The station will have an ultimate power of 4 kilowatts video and 1 kilowatt sound.

Mounted on a 150-foot mast, the antenna is of the vertical di-pole type.

It should be noted that the sound and video carriers are 3.25 megacycles apart, as recommended by the R.M.A. The Farnsworth station also intends to abide by the R.M.A. standards in the matter of band width, this being 2.5 megacycles.

The studio has a steel-beamed ceiling. There are no pillars. The pick-up cameras are mounted on tripods and permit the televising of any portion of the studio. Although all programs will originate in this single large room, the studio is so equipped that even with different scenes and settings, action will be unbroken and continuous. It is apparent that right from the start of a public-participating service, television will have no need for the "One minute, please!" sign that was so widely used in the early movie days when reels had to be changed.

Two, three and even more scenes can be prepared simultaneously within the same studio. Switch-overs are made instantly without program delay. A couple of portable partitions, about the size of telephone booths, are, in effect, miniature studios designed to hold audience attention while the larger scenes are prepared. Also, there are tiny sets in the studio, which obviously will be used to blend with the life-

(Turn to page 688)

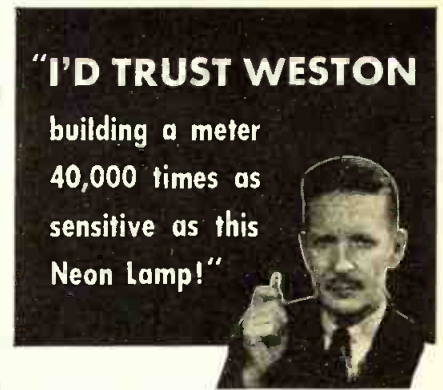

The tiny Neon Lamp in your checker probably is the 1/4 watt size. The meter in the new Model 772 Analyzer consumes only 6 1/4 millionths of a watt ... almost 40,000 times as sensitive.

THE WESTON MODEL 772 SUPER-SENSITIVE ANALYZER 50 MICROAMPERES FULL SCALE



\$46.50 NET
To dealers in U. S. A.

You can *do more . . . make more . . .* with the WESTON 772 Super-Sensitive Analyzer. With its big, 50 microampere meter . . . its sensitivity of 20,000 ohms per volt, resistance ranges *usable* up to 30 megohms, current measurements as low as 1/2 microampere . . . you can get into and thoroughly check *all* receiver circuits; including those you could not check with former servicing instruments. But in addition, you can get *extra* business —extra profit—servicing sound movies, P.A. systems, photo-cell circuits, sensitive relay systems, and even television with Model 772. Introduced by WESTON just seven months ago, Model 772 has become standard equipment in most aggressive service shops . . . because of its wide range of usefulness . . . its time-saving facility . . . its money-making ability . . . and because WESTON builds it. Servicemen recognize WESTON's years of experience and leadership in building the highly sensitive instruments for governments, scientific laboratories and for industry the world over, as the best guarantee that even a highly sensitive instrument like Model 772 will *stand up . . .* serve dependably and profitably for many years. Let us send you all the facts. Return the coupon today.

WESTON Instruments can be purchased on deferred payments through the WESTON Investment Plan.

Weston Electrical Instrument Corporation,
615 Frelinghuysen Avenue, Newark, N. J.
Rush me complete data on WESTON Radio Instruments.
Name _____
Address _____
City _____ State _____

*Now
It's easy to
Learn Radio!*

**THE COMPLETE
GHIRARDI COURSE**

*For only
\$4!*

For only a small fraction of what you would expect to pay you will get Ghirardi's world-famous RADIO PHYSICS COURSE that gives you a thorough knowledge of "Everything about Radio." Bound in one big volume of nearly 1,000 pages (9 1/4"x6 3/4") you'll find it the easiest and best way to learn the fundamentals of electricity, radio and sound. No previous electrical training is needed. Everything made clear and easy to understand, with hundreds of good diagrams and photos. It's concise, authoritative and up-to-date—the most popular radio course in the world! Teach yourself with Ghirardi and become a well-trained radio technician! **SEND COUPON TODAY.**

—SUBJECTS—

- | | |
|--------------------|---------------------------------|
| Sound and Speech | AF & RF Amplifiers |
| Electron Theory | Loud Speakers |
| Electric Currents | Battery Operation |
| Electromagnetism | Power Supply Units |
| Inductance | Receivers |
| Capacitance | Sound Systems |
| Filters | Short-Wave |
| Measurements | Photoelectric Cells |
| Radiation | Television |
| Broadcasting | Antennas and Grounds |
| Receiving Stations | Servicing |
| Vacuum Tubes | Sound Pictures |
| Amplification | Appendixes |
| Supernets | Review Questions for Self-Study |

**RADIO
PHYSICS COURSE**

972 pp. 508 illus.

**MONEY-BACK
GUARANTEE!**

Examine and use this course for 5 days. Then, if you decide it is not worth to you many times its cost, return it to us undamaged, and your money will be promptly refunded. You take NO RISK in ordering!



MAIL TODAY!

RADID & TECHNICAL PUBL. CO
45 Astor Place, New York
Dept. RN-57

- Enclosed find \$4 for RADIO PHYSICS COURSE Postpaid. (Foreign \$4.50)
- Please send free descriptive circular "P".

Name.....
Address.....

GET KINK-AIDS

More than 3000 filed and indexed service kinks to repair those hard-to-fix home and auto radios. Just pull out the card corresponding to the name and model of the set you are repairing, and there you have listed the service troubles found in that radio and how to fix them.

NEW REVISED KINK-AIDS

- Clearly printed on 250 wear-resisting cards
- Filed by set name and model number
- Enamelled steel cabinet. FREE
- Supplements issued quarterly

\$1.95

Sent postpaid for only.....

FREE—Write for Bulletin RN-5 and sample cards. Jobbers write for attractive proposition.

AKRAD PRODUCTS COMPANY
362 Wooster Ave. Akron, Ohio

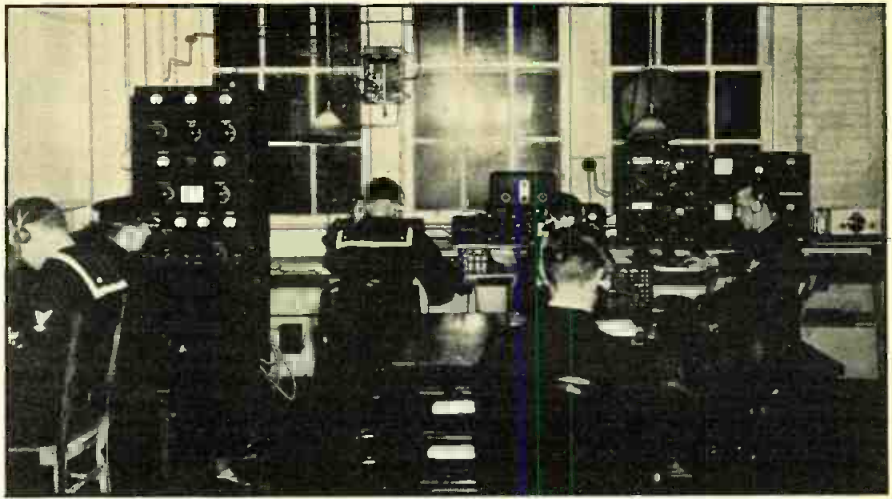

QRD? QRD? QRD?

CONDUCTED BY GY

A "necessary evils," we feel proud to know that we are members of a profession who answer the call of duty when called upon during times of stress and trouble as manifested in the terrible holocaust of fire and flood which ravaged the central portion of the U. S. A. recently.

AMATEUR "Hams" did their part in the great flood most nobly, standing by their phones and broadcasting news to the World when other means had failed. BC men acted their part. WHAS broadcasts of Louisville directed rescue workers in radio equipped boats to marooned refugees from a candle-lit studio room until its power failed. WLW's new studios which were burned through by fire were abandoned and they went on the air from their old studios under real handicaps. During navy and coast guard enlistments for seamen to man the rescue boats in the Louisville area, we noted with pride that two radiomen were amongst those present when the entire contingent set out via Pennsyrrail. They were W. A. Lintz and John Petersen both of New York and the ARTA who answered the plea of WHAS for radio experts. Which goes to prove something or other. We've been trying to stress the necessity of radiomen where it would do the most good, but with the results already shown we humbly believe and suggest that with strong-arm methods failing, a bit of diplomacy could be tried.

A chance for amateur operators to really accomplish something with their hobby and be of useful service to their fellow men is offered by becoming a member of the Naval Communications Reserve. Photo in our heading shows a group receiving instruction at an N.C.R. control station.

We understand that Brother Rathborne took an interest in a trial of some men in 'Frisco who had been looking at dynamite with one eye and an oiltanker with the other. So Mr. Rathborne wrote a letter to the Judge in S. F. and a copy was sent to the District Attorney with the result that Mervyn was hit with a fine of one hundred dollars, which he paid. After this strike it is understood that there are plans on the griddle to tackle the tankers again. It's terrific giving advice, especially when it does not coincide with our views. Did you-all ever try it? So we'll continue with a fair question. Li'l Willie will please tell the class: "How come the oil companies and Mackay know where to get ops when they want them, and where

do they get the addresses and phone numbers of men seeking jobs?"

Plenty of dope is coming over the desk of ye Ed and from the smoke that is being raised there seems to be a tendency on the part of some men to minimize dissatisfaction and others to exaggerate any situation. One mimeograph circular, without signatures, states that certain ARTA members of the Seattle Local were kept out of the ILA hall because of Pyle. If this is so, the Labor Relations Board would be happy to listen to complaints and adjust the matter to the satisfaction of all. Another states something to the effect that the ARTA organization has aided its members to gain wages and jobs. Then brother N. J. Beck, having had card number sixty-eight, member in good standing and charter member of said organization, tenders his resignation with a letter directed to Pres. Haddock. "Please understand that there is no personal criticism involved or intended, as I believe and know that you are both honest and capable and have made a great many sacrifices for what you believed to be the best for the organization. Possibly I am just too nearsighted to see the horizon". All we can say is why can't radiops weigh arguments and dig for facts? We want to recall to all those who care to remember that EVERY former radio union or telegraphists union has collapsed because of the weakness of the men at the top. The membership were too much like sheep and would not tolerate those "lone voices" who had vision and could see the trend of the leaders. The present time might be considered as a crisis in the affairs of the ARTA organization and we believe that this outfit is fundamentally and basically an economic union designed for the purpose of increasing wages and improving the working conditions of its members. So what?

Safety at Sea legislation will very definitely help the employment situation of radiops as more companies are planning construction of new vessels under the subsidy act and this will start the impetus. And concurrent with this line of thought we note with approval the interview given by Hoyt Haddock of the ARTA in reference to the Automatic Alarm device con-

templated being installed by shipping companies. He says that these have been used on European ships since the Convention at London in 1929, but they have never been perfected as it occasionally goes off at the wrong time and cites the fact that there were eleven vessels within a 100-mile radius during the burning of the Morro Castle when it sent out its distress calls, and not one of them went to her aid. This proves that either they did not get the signal or else they did not pay any attention to it, and it is hard to believe the latter. Furthermore, he continues, due to its use, only one man is required to operate the apparatus aboard a vessel and this would make the government a strike breaker if it permitted shippers to have them installed as there were about 1200 radiops involved in the recent strike.

Our West Coaster reports that about 14 marine radiomen were given Civil Service PTP jobs just before the start of the West Coast strike so that instead of standing in picket lines they were sitting in nice warm billets. Which goes to prove that "if it isn't one thing it's another" that pays \$150 per month, 40-hour week and holidays off. Mr. A. F. Hazel, who was the delegate of PTP, BC and Airways of ARTA Local 15, became angry because the city hired the men from Local 7 ARTA, secretaried by Brother Jordan. And it seems that Mr. Hazel is no more with us, as Local 15 has been closed. The death of this local is considered by many of the discriminating as a public improvement, for it eliminates a blacklist system which had been used there. We understand that he, the former secretary and delegate of said Local 15, now has a teletype school. For any individual who may be interested, please note that for the present Mr. Jordan is handling what is left of the affairs of Local 15 at Marine Headquarters in San Pedro, California. . . . We are happy to note a steady rise in BC salaries, although there is no union interested in all the boys. We can truthfully report that the lowest salary we have heard about is \$90 per month, but most of them average from \$120 to \$180 per month and more. More jobs are to be had, too. Many boys who tramped the streets are now on steady, at broadcasts, PTP and Airways. It would seem that after every major airline disaster there is a new job created for some radiop so "it's an ill wind that doesn't blow somebody some good".

Did you ever see a dream walking? Well, we did when we saw the Tunaboat ops, their shacks and the boats upon which they spend their time and energy. Operators make more money, get seasick more often and talk fish until you're feeling as though you can't look another tuna in the face without squirming. No real schedules, no uniforms, and steady jobs with no layoffs—and that's a thumbnail sketch of a billet. San Diego and San Pedro, California, are the home ports of this peculiar type of radio-fisherman who fishes more than he operates and who's at sea a greater length of time per year than any other type of operator excepting a Navy radiop.

For those ops who are interested in BC work and in the organization of ACBT, Mr. Kleinman, the snappy secretary of the New York Chapter, informs us that the Atlantic Broadcasting Corporation has been liquidated and also that henceforth the N. Y. Chapter will be the cognomen of his local of this national organization. They are publishing a small and interesting booklet named "Under Control" which will be a storehouse of news, information and anecdotes. So again good luck, gang, and keep out the "human element" with unselfishness and loyalty to yourselves.

Suggestions come in from time to time
(Turn to page 688)



CATCH THEIR FANCY WITH AN AIRLINE SOUND SYSTEM

The young lady in the window above is successfully utilizing balmy Spring weather and a 5-watt Airline Sound System to sell Ironers. The entire outfit, including mike, speaker and amplifier, sells for \$25.95; and she pays only \$3 Down, \$5 monthly on Wards Monthly Payment Plan. Model pictured at right has crystal mike; 4 metal tubes, carrying case . . . only \$5 Down. Whether 5 or 100 watts, Wards has the Sound System for your needs. Send for catalog giving descriptions and terms.

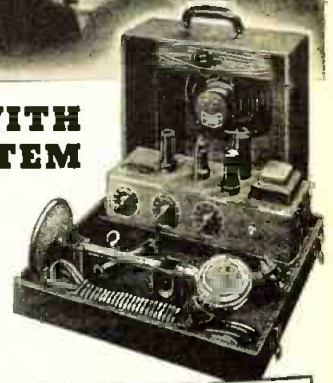

Mail coupon to nearest Ward House
MONTGOMERY WARD Dept. RN-6
 Name.....
 Street.....
 City.....State.....

MONTGOMERY WARD

Largest Distributors of Sound Systems in U. S.
 CHICAGO • BALTIMORE • ALBANY • KANSAS CITY
 DENVER • ST. PAUL • PORTLAND • OAKLAND
 FT. WORTH • JACKSONVILLE

ROYAL TYPEWRITER FREE To National Union Servicemen



National Union and the Royal Typewriter Co. have negotiated a plan to provide free typewriters to National Union servicemen. . . . A choice of either the Royal DeLux model (shown here), which Lists for \$64.50, or the Royal Model O, which Lists for \$54.50, may be had with—

NATIONAL UNION TUBES

—purchased over a two-year period as follows: 1000 tubes plus \$35.00 dealer deposit secures the DeLux model typewriter. . . . Purchase of 850 tubes, plus \$29.00 dealer deposit gets the Model O machine. . . . This is at the rate of only 8 to 10 tubes a week, purchased on the 2-year period—depending on model. . . . Deposit assures immediate delivery of typewriter. . . . Offer good only in U. S. Send coupon below for further details.

Ask your jobber for new booklet, "Your Pocket Book—What About It?"



National Union Radio Corporation
 570 Lexington Avenue, New York City

RN-537

Tell me how to get Royal Typewriter and other equipment FREE. Name.....
 Address.....
 City.....State.....

National Union offers a complete line of radio tubes in glass, metal and G-types—the outstanding favorites in the radio service profession.

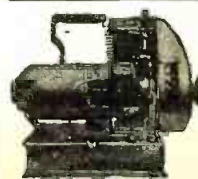

110 VOLTS A. C.
 Anytime! Anywhere! With **KATOLIGHT PLANTS**
 350 watt 110 v. 60 cycle AC. \$89.60
 300 watt 22 volt. DC plant. 78.40
 15 amp. 12 volt charger. 59.95
 25 amp. 6 volt charger. 49.95
 AC & DC Generators. Rotary Converters 32 Volt 800 Watt Wind Plant. . . . \$141.00
 Write For Details.
KATO ENGINEERING CO.,
 Mankato, Minnesota, U. S. A.

ELECTRICAL ENGINEERING
 For those who can't afford the time and expense of a 4-year college course, Bliss offers a condensed **ONE YEAR** residence training, combining essential Theory and Practice. 45th year. **CATALOG ON REQUEST!**
BLISS ELECTRICAL SCHOOL
 475 Takoma Ave., Washington, D. C.

MIDWEST.
FACTORY TO YOU
SAVES 50%



18 TUBES For the Price of 10

Why be content with an ordinary 6, 8, 10, or 12-tube set when you can buy an 18-tube deluxe Midwest for the same money... direct from the factory, at half the cost! Not a cut-price set, but a more powerful super-performing radio in a big, exquisitely designed cabinet.

Only **\$39.95** AND UP
(LESS TUBES)



ZIP...
and your station flashes in!

Your radio enjoyment is doubled with Dial-A-Matic Tuning* (optional) the amazing new Midwest feature that makes this radio practically tune itself. Zip! Zip! Zip!... stations come in instantly, automatically, perfectly... as fast as you can push buttons.



30 DAYS FREE TRIAL
You have a year to pay... terms as low as 10c a day... you secure privilege of 30 days free trial in your own home.

SEND FOR FREE 40-PAGE CATALOG
Dept. N-11 Midwest Radio Corp., Cin'ti, O.

MIDWEST RADIO CORPORATION
DEPT. N-11 CINCINNATI, OHIO

Send me your new FREE 40-page catalog.

Name.....
Address.....
Town..... State.....
User-Agents Make Easy Extra Money. Check Here for details.

Meissner

Dual Universal WAVE TRAP



The only wave trap on the market that will eliminate both channels of interference (I.F. and Broadcast) AT THE SAME TIME.

RANGE:— 400 to 1900 kc.
DUAL CONTROL:— 2 channels
HIGH "Q":— Iron Core
ATTENUATION:— Minus 40 db.

SOLD BY ALL LEADING JOBBERS

MEISSNER MFG. CO.
Mt. Carmel - Illinois



THE TECHNICAL REVIEW

CONDUCTED BY THE TECHNICAL EDITOR

Television Reception, by Manfred von Ardenne, translated by O. S. Puckle; D. van Nostrand Co., 1936. A translation of the German book by this well-known author. For the first time the reader can obtain a book which contains actual circuits, design data and constructional details of receivers for television reception. Of course, all equipment shown and the tubes specified are of European make, but the advanced experimenter will probably have no difficulty in determining the equivalent American tubes. The book is devoted exclusively to the reception of television signals by means of cathode-ray tubes. The text is clearly written, contains practically no mathematics and should be easily understood by those familiar with radio.

The first chapter states the different problems to be solved in order to have television with a brief explanation of each. The second chapter deals with the cathode-ray tube, the third with the power supply. Sweep circuits and interlaced scanning are treated in the fourth chapter; here is also shown a circuit which does not employ thyatrons. Push-pull sweep circuits for large cathode-ray tubes are also described. The fifth chapter describes the methods of filtering out synchronization impulses. The final chapters describe the detector and a suitable ultra-short-wave superheterodyne for television as well as a receiver for the sound. Numerous half-tones illustrate the text.

Electrical Engineers' Handbook, Volume V: Electric Communication and Electronics, by H. Pender and K. McIlwain. Third edition. John Wiley and Sons, 1936. Handbooks used to be called "pocket books" until they became too big for the pocket. Now the handbooks have become so large that they become unwieldy and difficult to handle. Engineers will no doubt welcome the publisher's policy of dividing the subject and publishing the handbook in five volumes. The books now have a larger format than the usual handbook and still contain over 1000 pages each on the average. The first volume deals with mathematics, physics, etc. The second and third volumes are for the mechanical engineer. The fourth volume is for the electrical engineer working with power equipment. This, the fifth volume, covers electrical communication and electronics. It includes telegraphy, telephony, facsimile and television by wire and by radio, as well as sound recording, industrial and medical applications of electron tubes.

The book is divided into 17 sections, each devoted to a main subject such as: Properties of materials; resistors, inductors, capacitors or, electron tubes. There is no need here to enumerate all the headings; they cover the whole field. Most of the material has been written by the con-

tributors, each of whom is a recognized specialist. A bibliography is included at the end of each article.

Some of the parts which impressed this reviewer are the unusually complete list of materials with their properties. These include dielectric, luminescent and magnetic materials. There is also a tube table which includes all the transmitting tubes, all the gas-filled tubes, photoelectric tubes. The characteristics of the tube and its manufacturer are listed. In the section on recording, the system employing a steel tape has been included. The sections on transformers, on filters, and on medical apparatus are complete and should prove useful to the reader.

Review of the Proceedings of the Institute of Radio Engineers for February, 1937

Radio Progress During 1936, by the Technical Committees. A yearly survey of the various branches of the industry: Electro-acoustics, Electronics, Radio Receivers, Television and Facsimile, Transmitters, and Antennas.

Two-Mesh Tuned Coupled Circuit Filters, by C. B. Aiken. A study of the double-tuned coupled circuits as used in r.f. and i.f. amplifiers in a way which is useful for designers. Some universal resonance curves are given.

Review of Contemporary Literature

THE following are reviews of articles appearing in recent issues of technical magazines; the name of the magazine and its date are given after the title of each article. Copies of these articles are not included under the "Free Booklets"—they are available from your book-dealer or direct from the publishers. Addresses of publishers will be furnished on request.

Automatic Alarm, by I. F. Byrnes and H. B. Martin. RCA Review, January, 1937. Description of receivers and selectors for the automatic detection of distress signals at sea.

Applications of Visual-Indicator Type Tubes, by L. C. Waller, RCA Review, January, 1937. Operating principles and practical circuits for the 6E5 and the 913. Besides the conventional circuits, diagrams are shown of the 6E5 used for miscellaneous other purposes: v.t. voltmeter, null indicator, etc.

A Half-Meter Tube, by C. E. Fay. Bell Laboratories Record, February, 1937. A description of a new tube, the Western Electric 316A, and its circuit, which will provide oscillations at 600 mc. The power output is 4 watts at this frequency.

Radio References. A bibliography compiled by L. D. Batson, published by the Department of Commerce. A classified list of publications bearing on any phase of radio. They include books, magazines, and government publications. Copies of this bibliography may be purchased from the Electrical Division, Bureau of Foreign and Domestic Commerce, Washington, D. C.

A Wide-Band Tuner, by W. N. Weeden. Electronics, February, 1937. A constructional article describing a band-pass r.f. tuner comprising two r.f. stages and aperiodic coupling to a diode detector. Specifications of all parts are given.

More on the Directivity of Horizontal Antennas, by George Grammer. QST, March, 1937. An addition to the article in November QST. Directional effects of half-wave antennas when tilted at different angles and when harmonic operation is used.

FREE BULLETINS

Valuable Booklet

RADIO NEWS offers through the courtesy of the Readrite Meter Works a new booklet entitled "101 Radio Troubles and Their Cures". This worthwhile little book compiled by the Ranger-Examiner engineers will be especially appreciated by servicemen and dealers. It is devoted to a list of common causes for receiver breakdown with probable reasons and the type of testing instrument most applicable to detect the trouble. Send your request for a free copy to RADIO NEWS, 461 Eighth Avenue, New York City.

Special Folder

The new catalog of the Chicago Wheel and Mfg. Co. describes in detail their new "Handee" tool of 1001 uses. This is a small motor-driven hand tool that can be used to grind, drill, cut, carve, sand, saw and engrave on a host of different materials. It includes many photographs illustrating a number of operations performed by the tool. The catalog is obtainable without charge from RADIO NEWS, 461 Eighth Avenue, New York City.

Resistor and Volume Control Catalog

The new International Resistance Co. catalog No. 41 lists their complete line of IRC resistors, power wire-wound units and the new Metallized volume controls. Free copies are available to our readers for the asking. Address requests to RADIO NEWS, 461 Eighth Avenue, New York City.



New Instrument Manual

The Supreme Instruments Corp. presents a 60-page design manual on tube and radio testing circuits, based on their new 1937 testing instruments. It describes at length the functions, circuits, and design procedure of tube and other radio testing instruments. It includes numerous diagrams and technical information extremely helpful to all servicemen, amateurs, and experimenters. To obtain a copy free, write to RADIO NEWS, 461 Eighth Avenue, New York City.

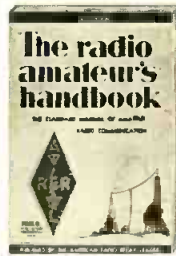

The Radio Amateur's Handbook

The 1937 "Radio Amateur's Handbook," published by the American Radio Relay League, containing approximately 422 editorial pages, is considerably larger than the last edition. The book is intended both as a reference work for the veteran amateur and as a source of real helpful information for those who want to become amateurs but have little idea on how to get started. Considerable space is given to ultra-short-wave equipment, antennas, and the operation of a station. Included are numerous charts, tables and up-to-date data on receiving and transmitting tubes.

RADIO NEWS has arranged to supply copies to readers for the regular price of \$1.00 (\$1.25 outside the United States.) Forward check or money order to RADIO NEWS, 461 Eighth Avenue, New York City.



Latest Amateur Call List

Radio amateurs throughout the world will be interested in knowing that the winter 1936-1937 edition of the "Radio Amateur Call Book Magazine" is now ready for distribution. The new book measures 8 3/4 by 9 3/4 inches, contains 293 pages and is arranged by call letters accompanied by the names and addresses of amateurs for all countries. Copies of this new call book can be obtained by forwarding check or money order for \$1.25 to RADIO NEWS, 461 Eighth Avenue, New York City. Foreign cost \$1.35.

Text Book Catalog

A free copy of the latest D. Van Nostrand Company's general book catalog is available to our readers for the asking. This 135-page manual contains descriptions on all their publications, covering science and technology. There is a special section on electrical engineering and radio with outlines on such well known books as Sterling's Radio Manual, Foster's Electrical Engineers' Pocketbook, and others. Address requests to RADIO NEWS, 461 Eighth Avenue, New York City.

Volume Control Guide

The accompanying illustration shows the latest Centralab Volume Control Guide, which is available free to servicemen and dealers. It contains 168 pages, listing the (Turn to page 689)

I'LL PROVE IT!...

...JUST 17¢ A DAY CAN PREPARE YOU FOR A GOOD-PAYING JOB IN RADIO!

Sprayberry Training does much more than teach you all branches of Radio, Television, Electronics, Sound, etc. It teaches you modern business methods—helps you make spare time profits WHILE YOU LEARN—sets you up for an actual start in a good, money-making profession—backs up every step of your training with complete

PROFESSIONAL RADIO EQUIPMENT



Learn how the Most **SUCCESSFUL Home Training Plan in Radio ACTUALLY SETS YOU UP FOR BUSINESS** in an industry that is **Providing Fortunes for Wide-Awake Men.**

Any of These Fascinating Jobs May Be Yours

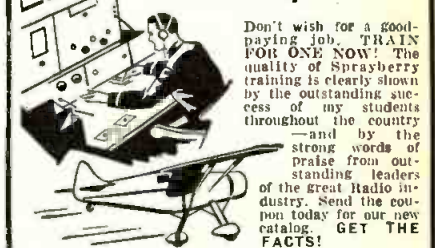

I ACTUALLY SET YOU UP READY FOR BUSINESS

No matter what kind of Radio Training you take, it is **ABSOLUTELY NECESSARY** that you have professional equipment of the kind I supply, before you're ready to start making **REAL MONEY.** I teach you to use it under actual working conditions. That's why Sprayberry training is so easy to learn at home—why many students make extra money on Radio work almost as soon as they start—and why, upon graduation, they are ready to enter business **AT ONCE** for full or part time profits.



F. L. SPRAYBERRY

THE MOST IMPORTANT COUPON YOU'LL EVER CLIP
SPRAYBERRY
ACADEMY OF RADIO

F. L. Sprayberry, President
2546 University Place, N. W., Washington, D. C.

Without obligation on my part, please send your Free Book, "MORE MONEY IN RADIO," and other details of your famous Sprayberry Training.

Name.....

Address.....

Address..... RN-5-37

PASTE ON PENNY POSTCARD AND MAIL TODAY

FREE SIMPSON INSTRUMENTS

To National Union Service Men

By special arrangement, the Simpson line of testers is now obtainable FREE with special deals on

NATIONAL UNION TUBES

... a complete line of highest quality tubes in glass, metal and G-type. Note special offers at right (good only in the United States) ... Coupon will bring further details. Ask your jobber for new booklet, "Your Pocket-Book ... What About It?"



NATIONAL UNION RADIO CORPORATION
570 Lexington Ave., New York City
Tel. me how to get Simpson Testing Instruments
Name.....
Address.....
City.....
State.....

FREE

New Simpson Set Tester No. 250 (20,000 ohms per volt) with purchase of 650 National Union Tubes over 2-year period and dealer deposit of \$21.00 for immediate delivery of tester. If you bought this instrument it would cost you \$38.50.

Other National Union Offers

(On Tube Purchases Over 2-Year Period)

Simpson Set Tester No. 225 (10,000 ohms per volt)—with 500 tubes; deposit \$15.00.

Simpson Roto-Ranger Tube Tester No. 220—with 950 tubes; deposit \$33.00.

Simpson All-Wave Signal Generator No. 210 (AC)—with 800 tubes; deposit \$28.00.

Simpson Roto-Ranger Volt-Ohm-Milliammeter No. 201—with 500 tubes; deposit \$15.00.

Simpson Roto-Ranger Volt-Ohm-Milliammeter No. 202—with 550 tubes; deposit \$17.00.

Be a RADIO EXPERT—Learn AT HOME

RADIO SPECIALISTS NEEDED

Modern receivers with their complicated circuit systems have knocked out the old time cut-and-try radio fixer. Trained men with up-to-the-minute knowledge are needed to service these new sets.

HERE IS YOUR OPPORTUNITY

Your possibilities of making money and getting ahead are limited only by your ability and skill—but you must know more than the other fellow. You must be a radio service specialist. as R.T.A. can train you.



FREE

OF EXTRA COST

PRACTICAL TRAINING AT HOME

Our home study course is practical "shop and bench" training combined with a thorough set of practical lessons prepared by an experienced Radio service engineer. Four working outfits are also furnished.

MAKE SPARE TIME MONEY

Our training is complete and practical. We show you how to make money almost from the start. The course can easily be made to pay its own way. Investigate now, write for free book of details.

WHAT R.T.A. STUDENTS SAY

Norwood, Ohio.
I have connected with a large firm as Radio Service Manager and wish to extend my thanks for your help.
Joseph Rapien, Jr.

Yorkville, Ohio.
From Aug. 1 to Dec. 7, 1936, I repaired 163 radios and put up 43 aerials which is very good for part time work while studying your course.
Chas. Koerber.

To start you making money without delay we equip you with this Circuit Analyzer and Point to Point Resistance Tester.

RADIO TRAINING ASS'N OF AMERICA

4525 Ravenswood Ave., Dept RN-75, Chicago, Ill.

HANDEE

Tool of 1001 Uses

A whole shop full of tools in one. Does away with slow hand work. Plugs in any light socket AC or DC. 110 v. 13,000 r.p.m. Uses 200 different accessories—grinds, polishes, routs, drills, cuts, carves, sands, saws, sharpens, engraves.

Get A Demonstration at Hardware, Dept. Stores, Tool Dealers or order on 10 Day Money-Back Trial, \$10.75 and up postpaid, 3 Accessories Free. De Luxe Model \$18.50, with 6 Accessories. Catalog Free.

CHICAGO WHEEL & MFG. CO., 1101 W. Monroe, Dept. AB, Chicago



For Faster Better Jobs

New CRAFTSMAN Project Book
"Pleasure and Profit with a Handee." Easy working plans forming many interesting and unusual projects 25c, stamps or coin.

CRYSTAL HEAD PHONES

SOUND CELL MICROPHONES

Information on request

THE BRUSH DEVELOPMENT CO.
3311 PERKINS AVE. CLEVELAND, OHIO

TYPE G AIR TUNED

A precision design using air trimmers with ALADDIN Polyiron cores.



I-F's FOR 1600 KC.

Especially advantageous for the 5 meter band.

Type	Frequency Range	Factory Setting	Gain	Band Width	Between	Use	List Price
G1601	1550-1650 kc	1600 kc	25	2X 50	6K7-6K7	Converter	\$10.00
G1600	1550-1650 kc	1600 kc	70	18 47	6K7-6K7	Interstage	10.00
G1604	1550-1650 kc	1600 kc	30	37 200	6K7-6H6	Diode	10.00
G1605	1550-1650 kc	1600 kc		Silencer	8.00

Aluminum Shield 1 7/16" x 1 7/8", 4" high. 1 3/8" Mtg. Centers. Type G Air-Tuned 1600 kc. 1-F Transformers

Send for 536 technical bulletin

466n WEST SUPERIOR ST. ALADDIN RADIO INDUSTRIES, INC. CHICAGO, ILLINOIS

The "Ham" Shack

(Continued from page 665)

that strikes the reflector passes back again to the radiator 360 degrees behind the instant at which it left the radiator. Or, in other words, in time to be in phase with the next wave form, thus making it twice as strong.

The directive properties of such an antenna also might be increased by incorporating a director in the array. Many 28 megacycle operators are using this arrangement with excellent success. This type will perform best in a vertical plane. A director for such an antenna should be placed 3/8 wavelength away from the radiator in the direction the signal is to be radiated. This will have the effect of sharpening the beam and at the same time increase the effectiveness of the signal. To give some indication of the value of using an array at 28 megacycles, measurements show that the use of a reflector will give a signal increase in a given direction of 3 decibels over an ordinary half-wave radiator and a director will add as much as 2 decibels.

In designing an array of this type the radiator itself should be cut in accordance with that used for the usual half-wave antenna; i.e., 95 percent of half wavelength. The reflector which is placed one-quarter wavelength from radiator, however, should be slightly more than half wavelength, or 97 percent. Directors should be shorter; viz., 87 percent of half wavelength.

Next in popularity among 10-meter antennas are the multi-wavelength affairs which by virtue of their length increase radiation in two or more directions. These are essentially of two types: the multi-wavelength affair with each half wavelength section operating out of phase, and the multi-wavelength affair with each half-wave section in phase. The results obtained with each are entirely different. The in-phase radiator is a broadside radiator and the out-of-phase unit tends toward "end firing."

The out-of-phase antenna is not the signal booster the array is. Its essential advantage is that it frequently provides a means of overcoming a direction problem where it is possible to erect an antenna in only one direction. The half-wave, single-unit antenna may for all practical purposes be assumed to be non-directional wave for a slight drop in radiation off the ends. This drop in end radiation seems to increase as the frequency increases. Radiation from a half-wave antenna, however, is maximum at 90 degrees off the axis; i.e., broadside. This, therefore, gives a 2-lobe radiation pattern. But the multi-unit, out-of-phase antenna breaks up each of these lobes in two other main lobes and a number of small ones. The greater the number of half wavelengths in an antenna of this

type, the more inclined it is to be an end radiator. For instance, one one wavelength long would radiate its principal lobes at 54 degrees off the axis—one in each of the four directions. Radiation from an antenna one and one-half wavelengths long would be 42 degrees; from a two-wavelengths antenna, 36 degrees; from five wavelengths antenna, 22.5 degrees, 17.5 degrees. There is little to be gained from using an antenna longer than this, as the angle toward end fire decreases in small amounts beyond this point and the losses increase.

Directivity in a horizontal plane seems to be the most desirable at 28 megacycles, according to reports from most stations operating at this frequency. One of the simplest and most practical antennas in this category is the multi-unit in-phase radiator. This type of antenna is a broadside fire affair, and if properly constructed will materially increase the signal strength in the two broadside directions.

In order to have each radiating portion of such an antenna operate in phase, it is necessary to take up 180 degrees between each radiator. This is most easily done, particularly where the antenna is to be out of doors, by the use of quarter-wave stubs which are essentially half-wave antenna, doubled back on each other, thus providing in-phase feeding to the principal radiators.

Simplest of the antennas of this type is the two-unit affair. Such an antenna would be a center-fed, half wavelength, 20-meter antenna with tuned feeders an odd number of quarter wavelengths long. Curiously enough, however, it has been found with antenna of this type, the half wavelength sections should be slightly longer than the usual half-wave antenna. Tests have shown that slightly more than 97 percent of half wavelength is necessary. The same rule applies to the quarter wavelength matching stubs. Incidentally, the quarter wavelength-matching stubs do not have to be necessarily tuned but may be shorted at quarter wavelength points and the feeders connected on at a point along the feeder which matches the impedance of the line. The point at which the feeders is attached is best determined by experiment, but for all practical purposes with a medium impedance feeder, the starting point should be about one-quarter the feeder length (not wavelength) from the bottom or "shorting" stub.

By increasing the number of units in the antenna of this type the directivity broadside increases considerably. Tests have shown with an antenna of this type containing four quarter-wave horizontal sections and three matching stubs, the center one being used for feeding will give an effective power gain of almost five times at the broadside directions. This is something to consider at 10 meters.

Another type of array which has proved particularly popular with 10-meter operators is the so-called "H" array. This is a little more complicated to construct than the multi-unit, in-phase affairs just described, but embodies the same principles and requires less space to obtain about the same results. It too, is a broadside radiator. The same formula is used for computing the length of the half-wave sections; viz., 97 percent of half wavelength.

The "H" antenna may be erected either in a horizontal or vertical plane. It consists of four half-wavelength sections, two of which are end to end and parallel with the second two at quarter wavelength apart. A quarter wavelength matching stub to which the feeders are attached is mounted in the center.

This type of antenna is very effective. It has been found to work best at between

half wavelength and one wavelength above the ground. One station in the East using an array of this type is working about everything that comes along with less than 75 watts input.

The rhombic or diamond antenna is an excellent performer at 28 megacycles, but few amateurs have the space to erect it. Its principal disadvantage is that it is unidirectional, and in order to make it radiate in two directions it is necessary to provide a switching arrangement for feeding at either end. In order to get the most from this type antenna, each leg should be more than three wavelengths long, making the total length about six wavelengths, and the height of the whole unit above ground must be the same at all points, otherwise the directional properties will be impaired.

One West Coast amateur using a rhombic antenna on 28 megacycles gave the following dimensions for its construction: Length of each leg, 109 feet, height above ground, 33 feet; angle at back and front, 64 degrees, and angle at the sides, 116 degrees. The antenna was fed with a 600-ohm line, and the end resistance 800 ohms. He reported that measurements had been made on his signals at a New York laboratory, and the "diamond" array resulted in a 16-decibel increase in signal strength over a simple half-wave radiator. That is a ratio of 40. He was using 100 watts input, so that means he had effective signal equal to 4 kilowatts!

The height of any radiator above ground plays an important part in the resultant radiation pattern. The higher the antenna, the lower the angle of radiation, but, unfortunately, there does not seem to be any most desirable angle of ground radiation because of constantly varying conditions on the ultra-high-frequency bands. For all practical purposes, however, most 28-megacycle operators have found the most useful angle of ground radiation is between 7 and 20 degrees. Therefore, antennas less than half wavelength above ground are practically useless, as these merely give an egg-shaped pattern that goes nowhere. The ground radiation angle at half wavelength is about 36 degrees; at one wavelength, 19 degrees; at 1½ wavelengths, 11 degrees, and 2 wavelengths about 8 degrees. These angles will vary somewhat under different conditions, the nature of the soil under the antenna having some effect on the effective height.

Directive antennas are equally effective for receiving as transmitting, and the stations equipped with such arrays should make it a point to use their elaborate antenna for reception as well as transmission. It is interesting to note that the use of directive antennas provides the amateur with a means of increasing effective power at small cost. He, by the use of a directive beam, may make his 50 watts do the work of more than a kilowatt, and the station with a kilowatt can make it perform in the manner of a 20-kilowatt station if he takes advantage of all of the possibilities of directive antennas.

CALLS HEARD

By Paul C. Bird, Oak Road, R. F. D. 4, Vineland, N. J., on 20-meter 'phone: CO2MT, CO2JJ, CO8MN, CO8AC, CO8VZ, CO8EC, CE3DW, E16G, F8AV, F8OK, F8MC, G2XV, G2IN, G2MD, G5PW, G5ZJ, G5PB, G5NG, G6OS, G6VX, HC1JW, H160, HK1JD, HK1GK, HJ3RC, HJ4AG, HJ4JH, HK4EA, HK5BC, K6KQP, K6JLD, K6MVP, K7PQ, LU6KE, LU7ET, LU9BP, ON4PA, PA0WV, PA0MQ, SU1RO, SU1KG, T12DC, VK2AZ, VO2Z, VP7NA, VU7FY, W10XDA, XE1FY, XE1KQ, XE1LB, XE2FM, XE3X, XE3XA, YV3AA, YV3AD, YV5AK, ZU6P.

Now—

TEN METERS WITH NEW "SUPER-PRO"!



HAMMARLUND now announces a special "Super-Pro" receiver, to cover from 7½ to 240 meters, that affords new outstanding results!

The new 7½ to 15 meter range in this latest model is the result of painstaking research and engineering, and is not just a casual makeshift! Two steps of R.F. amplification are used in this range as well as in the remaining four ranges from 15 to 240 meters. This provides an image rejection ratio of 150 to 1, and a sensitivity of 0.8 micro-volt (30% modulated) with a signal to noise ratio of 6 to 1 at 10 meters!

The 2000 kilocycle span on the 10 meter amateur band is covered by 90 degrees of the band spread dial. Similar wide band spread is available on the other popular high frequency bands.

All of the other popular features that contribute to the success of the standard 15 to 560 meter "Super-Pro" have been retained in this model, viz.—direct tuning, accurately calibrated 3 to 16 kc. band-width panel control, graduated audio and sensitivity controls, calibrated beat oscillator control, 8 metal and 8 glass tubes, stand-by switch, AVC-manual switch, rugged self-contained tuning unit with trouble-free cam operated knife switch, variable crystal filter, etc.

Complete details on this model and the standard model appear in a special booklet. Mail coupon below for your copy!

Hammarlund Mfg. Co., Inc. RN5
424-438 W. 33d St., New York

Please send me new "Super-Pro" booklet.

Please send me new "37" catalog.

Name

Address

City State

HAMMARLUND'S 25TH YEAR

Get this FREE BOOK of

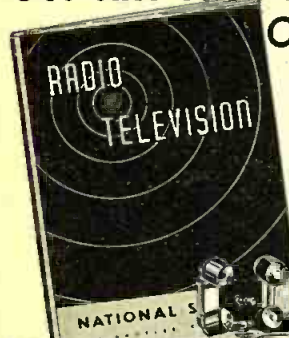

Opportunity
Brimful
of terse
instructive
facts

**TELEVISION
RADIO
SOUND RECORDING**

If you seek a new field of opportunity, get this interesting free book. Tells how you can become trained in this interesting Profession. Written in plain, understandable language. Subjects include Television, Theory and Instruction, Pick-up Systems, Receivers, Troubleshooting, Sound-recording on Disc, Talking Picture Projection, Radio Communication, etc. More than 30,000 graduates. Students can earn room and board while learning. This service only for residents of U. S.

National Schools allow coach railroad fare to Los Angeles.



NATIONAL SCHOOLS
Los Angeles

National Schools, Dept. 5-RR
4000 So. Figueroa St., Los Angeles.

NAME.....AGE.....
ADDRESS.....
CITY.....STATE.....

SUCCESSFUL in
PERFORMANCE..DESIGN..
CONSTRUCTION..SALES..
say leading P.A. men

AMPERITE VELOCITY
ACHIEVES
UNIQUE RECORD
IN ACTUAL USE



Featuring..

1. Output increased 6 DB.
2. Triple shielded—against all RF or magnetic fields—entirely eliminating hum pickup.
3. Eliminates feedback troubles.
4. Excellent for close talking and distant pickup.
5. Acoustically designed to eliminate any possibility of cavity resonance.
6. Fitted with switch and cable clamp.

NEW! MODELS RBHn (High Impedance): RBMn (200 ohms) with Cable Connector and Switch. **\$42.00 LIST**

NEW! MODELS RBSn, RSHn, streamline: slightly lower output and frequency range than above, with switch only. **\$32.00 LIST**

Models RAL (200 ohms); RAH (2000 ohms). Built to Amperite standards: No peaks. Flat response. Triple shielded. Shock absorber. Swivel bracket. **\$22.00 LIST**

Finishes: All microphones have the new standard Gun-metal Finish. Available in Chrome, extra. \$1.00 List.

FREE: WINDOW DECAL advertising your SOUND SERVICE. Four-color design. 5 1/4 x 9 1/4. Write for it now.

AMPERITE Co. Cable Address: Alken, New York
561 BROADWAY NEW YORK

AMPERITE Velocity **MICROPHONE**



**The DX Corner
(Short Waves)**

(Continued from page 677)

Guayaquil, Ecuador, 8404 kc., daily 8-10 p.m. (Lopez). Slogan: "Ondas del Pacifico".

HC2EBA, Guayaquil, Ecuador, 9443 kc., 8-9:30 p.m. (Kentzel). Slogan: "La Voz de Alma".

PRF5, Rio de Janeiro, Brazil, 31.56 meters, irregularly from 4-6 p.m. (Westman).

PSI, Rio de Janeiro, Brazil, 14935 kc. (from veri); Friday 3 p.m., signed at 4 p.m., Sunday 11:30 a.m. (Combe).

PRF3-8, Rio de Janeiro, Brazil, 14500 and 10340 kc., 6:27-11:15 p.m. All Spanish. (Messer).

Radio Club of Brazil, Rio de Janeiro, Brazil, 27.5 meters, 9-10 p.m. (Smith).

VP3MR, Georgetown, British Guiana, 5975 kc., 6:45-7:15 p.m. (Margrie, Bishop); 6010 kc., week days 7-11 p.m. and 10 a.m.-12:30 p.m. (from veri.), (Herzog, Foshay). Slogan: "The Voice of Guiana".

CEC, Santiago, Chile, 10670 kc. infrequently. (Shamleffer); signed at 10:30 p.m. (Howald); 12250 kc., Friday 5-6 p.m., Wednesday from 6 p.m. on. (Combe); 15850 kc., (Angel City DX'er).

CEB, Santiago, Chile, 12300 kc., 8 p.m. (Black, Howald). Address: P. O. Box No. 761.

"Radio Service", Santiago, Chile, 12300 kc. (Atherton); 5-9:28 p.m. on Sunday. (Howald, Sesina, Amstead, Tarr). Address: P. O. Box No. 761.

CB960, Santiago, Chile, 9600 kc. (Angel City DX'er).

CDM, Aliane, Chile, 8900 kc. (Angel City DX'er).

Radio Nacional, Santiago, Chile, 12330 kc. (from veri.), (Angel City DX'er). Address: P. O. Box No. 361.

CED, Chile, 10230 kc., 5 p.m. except Saturday and Sunday (Doyle).

OAX4G, Lima, Peru, 48.15 meters, (Westman).

OAX4J, Lima, Peru, 9380 kc., off at 11 p.m. (Picchuta); 9330 kc. (Tarr, Atherton). Address: P. O. Box No. 1166.

OAX5B, Ica, Peru, 11810 kc., 7-10:30 p.m., weak signal. (Shamleffer); signs at 11 p.m. daily. (Tarr).

OAXJ, Lima, Peru, 9310 kc. (from veri.), (Angel City DX'er). Address: P. O. Box No. 1163.

GIRLS BECOMING INTERESTED

Another family pair who have taken up DX'ing seriously are Gustave A. Magnuson and his wife, who reside in Rhode Island. Picture shows his Listening Post graced by "the better half" who is perusing a copy of "our magazine" for DX tips.

OAX4H, Lima, Peru, 9800 kc. (Angel City DX'er).

OAX5A, Lima, Peru, 11800 kc. (Angel City DX'er).

OAX4Z, Lima, Peru, 6090 kc., re-lays OAX4A, signs at 11:30 p.m. daily. (Tarr, Angel City DX'er). Slogan: "Radio Nacional de Lima, Peru". Address: Marconi Wireless & Telegraph Co.

Radio International Lima, Peru, 9220 kc., 7-11:10 p.m. (Ralat).

HP5K, Colon, Panama, 6000 kc., 7 a.m. (Eder); 10-10:15 p.m. (Shamleffer, Angel City DX'er).

HP5I, Aguadulce, Panama, 11895 kc., until 9 p.m. on Sunday. (Kentzel).

HP5F Colon, Panama, 49.34 meters, (Westman); 6080 kc., 8:30 p.m. (Azevedo); 7-10:30 p.m. (Doyle, Foshay). Slogan: "The Voice of Colon".

HP5B, Panama City, Panama, 6030 kc., 8 p.m. (Azevedo); 5-10 p.m. (Foshay).

HP5J, Panama City, Panama, 9615 kc., 8:45 p.m. (Azevedo); 7 p.m., desires reports. (Fallon); noon-1:15 p.m. (Ralat, Smith, Foshay, Eder). Slogan: "The Voice of Panama".

Africa

Guardia Civil, Tetuan, Spanish Morocco, 6340 kc., daily up to 5 p.m. (Betances).

Radio Tetuan, Tetuan, Spanish Morocco, 6550 kc., heard 4:30 p.m., (Ralat, Smith).

EA9AH, Spanish Morocco, (Magrie), gives Spanish news. (Mott), 7020 kc. (Harris).

Radio Algiers, Algiers, Algeria, 12120 kc., heard irreg. and near 3:30 a.m. (received veri.), (Chambers).

ICK, Tripoli, 9460, heard 3 a.m. (Partmann).

FIQA, Tananarive, Madagascar, 6000 kc., irreg., relays IU. (Croston).

IUC, Addis Ababa, Ethiopia, heard irreg. 12-1 a.m., with music (Croston).

ICU, Addis Ababa, Ethiopia, heard around midnight, "Pronto Roma" (Robinson).

ZTFI, Johannesburg, S. Africa, 6090 kc., 3:30-7 a.m., 9 a.m., 4 p.m., (Fallon).

EA8AB, Tenerife, Canary Island, 41.6 meters, heard daily 1-4:30 p.m. (Westman).

Oceania

VK8SC, Port Healand, Australia, 6900 kc., is known as "The Flying Doctor." (Croston).

VPD2, Suva, Fiji Island, 9540 kc., (Mills) 9520 kc., heard 6-7 a.m. (Pickering, Alfred) 9540 kc., (Herzog 8720 kc. now 5:30-7 a.m. Fallon) 8750 kc., (Birnie) daily ex. Sunday, (Stevens, Tarr) 9450 kc., daily ex. Sunday 5:30-7 a.m., Formally VPD (Robinson). Address reports to: Amalgamated Wireless Ltd., 47 York St., Sidney, N. S. W.

VPD, Suva, Fiji Islands, 1:075 kc., Ceased transmitting. (Stevens).
 ZMBJ, S.S. Adatear, irreg, heard late at night. (DeMent) (Croston) 8960 kc., heard frequently 1-2:30 a.m. (Partmann) address: Union S.S. Co., Auckland, New Zealand.
 VK3ME, Melbourne, Australia, 9510 kc., daily to 7 a.m. (Pickering 9490 kc., (Alfred) Sunday 4-7 a.m. (from veri.) (Ralat, Atherton) daily ex. Sunday 6-13-7 a.m. (Dressler) Wednesday 4-4-3 p.m. (Sparn, Eder).
 VK3LR, Lyndhurst, Australia, 9580 kc., heard Monday 2-50-2:58 a.m. (Margrie), (Seiru, Ozevedo) heard Saturday and Sunday 8-45-9-45 a.m. (Self, Pickering) 4-7 a.m. (Alfred, Hare, Harris, Mills, Dressler, Eder).
 ZLT, Wellington, New Zealand, 11050 kc., heard calling V.L.K. (Tarr).
 KIO, Kahuku, Hawaii, 11680 kc., heard Thursday only 9-30-10 p.m. (Alfred) Signed at 4-33 p.m. (Shamleffer).
 FO8AA, Papeete, Tahiti, 7100 kc., 11 p.m.-midnight. Opens with Marseilles and closes with Oloha Oe. (Herzog) Tuesday and Friday 11 p.m.-midnight (Rheiner, Smith) Friday 11 p.m.-midnight, Angel City DX'er.

North America

W9XHW, Minneapolis, Minn., 31600 kc., schedule 7-15-11 a.m., 4 p.m.-12:30 a.m. Monday, Thursday, Friday—On Saturday and Sunday 9 a.m.-12:30 a.m. (Wood).
 W9XF, Chicago, Illinois, 6100 kc., 11 p.m.-2 a.m. (Doyle).
 KES, Bolinas, California, 10410 kc., heard midnight (Howald) 7:23 a.m. (Herzog).
 KEI, Bolinas, California, 9490 kc., Tuesday at 10 p.m. (Dressler).
 KEE, Bolinas, California, U.S.A., 7715 kc., heard midnight (Dressler), 7:23 a.m. (Herzog) 12-1 a.m. (Kentzel).
 W6XKG, Los Angeles, California, 31600 kc., 100 watts, (Russell) Will change to 25950 kc. (from ann.) (Rheiner) on 24 hours a day (DeHaven, Tarr).
 KEJ, Bolinas, California, 9010 kc., 11-11:15 p.m. (Bishop, Alfred, Dressler), midnight-2:30 a.m. (Cax, Kentzel).
 W9XAZ, Milwaukee, Wisconsin, 26400 kc., (Russell) daily to 11 p.m. (from veri.) (Law, Tarr, Stevens).
 W9XPD, St. Louis, Missouri, 31600 kc., 100 watts (Russell).
 WIXEQ, New Bedford, Massachusetts, 31600 kc., daily 3-9 p.m. (Fallon).
 W3XL, Bound Brook, New Jersey, 6125 kc., heard 3:15 a.m. (Hartzell).
 W2XBJ, Rocky Point, New York, 9450 kc., heard 5 p.m. (Ozenedo).

Mexico

XEWI, Mexico City, Mexico, 11900 kc., (Kasheimoto) heard 6-8:30 p.m. on Monday, (Sesina) Tuesday and Thursday, 7:30-8:45 a.m., 10:30 a.m.-12 p.m.
 XEBT, Mexico City, Mexico, 5990 kc., heard 8 a.m. (Hynek) heard 9 p.m. (Coover) heard midnight, (Westman, Eder).
 XEUZ, Mexico City, Mexico, 6100 kc., 2-3 a.m. (Kentzel) address—Av. 5 de Mayo, 19, Mexico City.
 XETW, Mexico City, Mexico, 6100 kc., heard 12-1 a.m. (Alfred) address, P.O. Box 8403.
 XEPW, Mexico City, Mexico, 6120 kc., (Birnie) Angel City DX'er.
 XELI, Mexico City, Mexico, 6710 kc., 10 p.m. (Howald).
 XEXA, Ciudad, Mexico, 6171 kc., heard 9:30 p.m. (Ozevedo, Eder).
 XEC, Ciudad, Mexico, 7380 kc., heard Sunday 6-7 p.m. (Ozenedo) Requests reports. (Alexandre, Hamilton) address, Bucareli St. No. 12.
 XEME, Merida Yuculan, Mexico, 9520 kc., heard 2:30-3 a.m. (Alfred) address, Calle No. 59, Num. 517.

XRQ, Guadalajara, Jalisco, Mexico, 9440 kc., daily from 9 p.m. (from ann.) (Betances).
 XEDQ, Guadalajara, Jalisco, Mexico, 9480 kc., (Umstead, Birnie).
 XEBR, Hermosillo, Sonora, experimental station, (Russell) 11850 kc., (Umstead) heard 1-4 p.m. (Tarr).
 XEBN, Mazatlan, Sinaloa, 15440 kc., Sunday noon-4 p.m. (Partner).
 XELL, Mazatlan, Sinaloa, 15400 kc., (Angel City DX'er).
 XENI, Durango, 6700 kc., (Howald).
 XEFT, Vera Cruz, 9505 kc., heard 9-11 p.m. (Lopez) 6120 kc., (Croston) 9490 kc., (Betances) slogan: "La Voz de Vera Cruz."

Canada

VE9BJ, Saint John, N.B., Canada, 6090 kc., heard 7-8:30 p.m. (Hynels).
 VE9CS, Vancouver, B.C., 6080 kc., 9:30-2 a.m. daily (Doyle).
 CZ2W, Toronto, Ontario, Canada, 10250 kc., heard 3:30 p.m. Wishes reports. Address, Hydro Electric Co., Toronto, Ont.
 CFRX, Toronto, Ontario, 6070 kc., heard 11:30 p.m. (Tarr).
 VE5PD, Nottingham Island, 14210 kc., transmits official business to Ottawa (Fallon).

Asia

XGOW, Nanking, China, 6820 kc., 6 p.m.-midnight, Mon., Tuesday, Thursday (Sporn).
 ZBW3, Hong Kong, China, 3149 meters, week days, closes 9 a.m., Saturday 10 a.m., Sunday 9:00-3:00 a.m., (Self), 9325 kc., daily 4-10 a.m., (Tarr, Yoshimura, Herzog).
 XGW, Shanghai, China, 10420 kc., 11 a.m., (Black).
 ZBW, Hong Kong, China, 9525 kc., (from veri.), (Chiang, Dement), 7-8 a.m., (Herzog), 1-40 a.m., (Law, Darling, Eder, Alfred). Address: Hong Kong Broadcasting Committee, P. O. Box No. 200.
 XGM, Shanghai, China, 17,650 kc., (Kehrer).
 VVW3, Hukce, India, 34.50 meters, (Law).
 VUC, Calcutta, India, 49.1 meters, daily 2:06-3:06 a.m., (Smith).
 VUB, Bombay, India, (from veri.), (Messer), 31.36 meters, Mon., Thurs., Friday, Saturday, 11:30 a.m.-12:30 p.m., (from ann.), (Westman) Sunday 1-2 a.m., (Smith).
 HS8PJ, Bangkok, Siam, 15230 kc., Monday 8-10 a.m., (Hynek), 10955 kc., 4:20-4:55 p.m., (Alfred), Monday, Thursday, (Herzog, Smith).
 RV15, Khabarovsk, Siberia, 51.15 meters, 5-8:30 p.m., (Westman), 5730 kc., Wednesday, Saturday, 10-30 a.m., (Sporn).
 PLP, Bandoeng, Java, 11,000 kc., (Azevedo), 5:30-7 a.m., (Pickering, DeMent), 5-8 a.m., (Herzog, Howald, Darling), daily 8-10:30 a.m., (Smith).
 PMN, Bandoeng, Java, 10260 kc., no verifications now, (from veri.), (Azevedo), around 5 a.m., (Hynek, Westman), 5:30-7 a.m., (Pickering, Demant), Sunday until 11 a.m., (Howald, Darling), daily 8-10:30 a.m., (Smith).
 YDB, Sourabaya, Java, 9640 kc., (Darling, Dement), daily 4:30-9:30 a.m., (Smith), 9660 kc., (Eder).
 YDC, Bandoeng, Java, Sunday 8:30-10:30 a.m., (Self), 9525 kc., Monday 8:30 a.m., (Shamleffer, Smith).
 FZR, Saigon, French Indo-China, 9530 kc., (Anderson), Address: Michel Robert, Enterprises, 98, rue d'Espagne, Saigon.
 FZP, Saigon, French Indo-China, 9530 kc., daily 7-9 a.m., Monday 11 a.m.-noon, (Birnie).
 Radio Saigon, Saigon, French Indo-China, 25.7 meters, regularly 7-10 a.m., (Mills), Address: P. O. Box No. 295, Saigon.
 JVV, Nazaki, Japan, 10660 kc., Sunday, Monday until 5 p.m., Wednesday, Thursday, (Shamleffer), 12:40-12:50 a.m., (Lopez, Law). Concludes with imperial anthem.
 JZH, Nazaki, Japan, to be changed to JZJ, (Staley).

THERE ARE MANY REASONS FOR ITS EVER INCREASING Popularity



MODEL 1210-A

THE MASTER UNIT TUBE TESTER

1. Tests All Types of Radio Tubes.
2. A Single Unit . . . Not Part of a Compound Tester.
3. Portable and Flexible.
4. Maximum Protection Against Obsolescence . . . Hard to Misuse . . . Simple to Operate.
5. Additional Co-related Master Units Can Be Added as Business Expands or Circumstances Permit.

\$20.00

Tests all types of radio tubes. Direct reading GOOD-BAD scale. Tests for shorts and cathode leakage. Individual tests on diodes and full wave rectifiers. Line voltage regulation. Housed in black metal case with popular wrinkle finish. Complete with rectifier tube and all necessary accessories.

Dealer Net.....\$20.00

A TRIPLET MASTER UNIT

One of a series of co-related single unit testers; made in standard sizes; the most economical method yet devised for completely equipping the all-around radio service shop with high quality instruments.

SEE YOUR JOBBER WRITE FOR CATALOGUE



The Triplet Electrical Instrument Co. 155 Harmon Ave., Bluffton, Ohio

Without obligation please send me more information on _____ Model 1210-A; _____ Triplet Master Unit Model _____

Name _____
 Address _____
 City _____ State _____

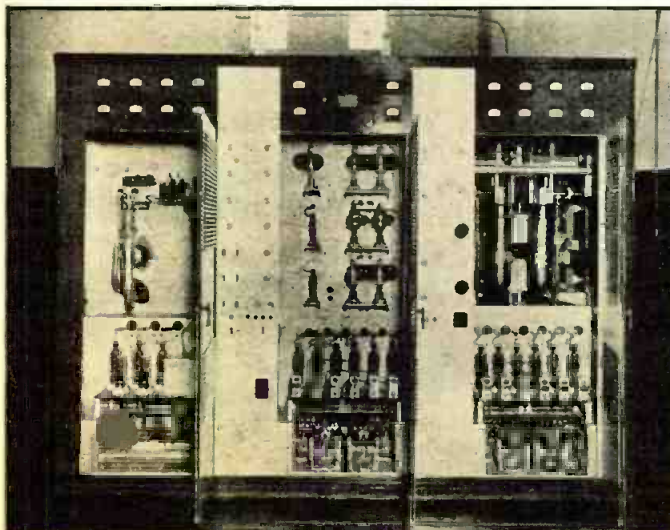

STATION LRU
 Photograph of the transmitter of Station LRU at San Fernando, Argentina. The doors are opened to view the tube panels.



A SMALL END-LEAD RESISTOR in a new and convenient package.

Like all Centralab Resistors they are thoroly insulated from all adjacent parts. Its smaller mass results in reduced capacity coupling to adjacent parts. Its effective resistor length is actual length of resistor . . . and its r.f. resistance is practically the DC resistance. Size $\frac{1}{8}$ " x $1\frac{1}{16}$ "—rated at $\frac{1}{2}$ watt.

Specify Centralab at your jobber



Centralab

DIVISION OF GLOBE UNION, INC.
MILWAUKEE, WIS.



C. H. RIETZKE PRES. OF CREI

THE GOOD MEN IN RADIO HAVE GOOD JOBS . . .

There's a real future for ambitious men in every field of Radio today. New developments are constantly opening new fields and new opportunities for men with MODERN training. If you're not getting "somewhere" it's your own fault . . . there is always opportunity for **TECHNICALLY TRAINED** men!

You Need Something More Than "Good Intentions"

It means study now . . . but your CREI diploma will be the best reference you can give. Radio executives recognize the superiority and ability of CREI trained men.

3 Convenient Methods of Study in Practical Radio Engineering

1. Practical Radio Engineering Home Study Course.
2. Complete 1-Year Residence School Course.
3. Combination Home-Study and Residence Course.

Free Catalog on Request!
CAPITOL RADIO ENGINEERING INST.
Dept. RN-5
14th & Park Road, N. W., WASHINGTON, D. C.
29 Broadway - NEW YORK CITY

JVD, Nazaki, Japan, 15860 kc., 5:40 p.m., (Hartzell, Portmann).
JZP, Nazaki, Japan, 38 meters, 3 p.m., (Combe). Address: Broadcasting Corp. of Japan, Htagoyama, Tokio.
J2AA, Haneda Airdrome, Tokio, Japan, 6500 and 9840 kc., daily 1-7 a.m., (Tarr).
JVT, Nazaki, Japan, 6750 kc., (Leins), 6-7 a.m., (Pickering), 12:30 a.m., (Eder, Tarr).
JVP, Nazaki, Japan, 7510 kc., (Leins, Staley).
JZI, Nazaki, Japan, 9335 kc., 2:30 p.m., (Azevedo), until 10 p.m., (Atkinson, Self, Staley), 4-5 a.m., Monday, Thursday, (Markuson, Combe, Smith, Shamleffer).
JZJ, Nazaki, Japan, 11800 kc., daily, (Messer, Chiang), until 10 a.m., (Atkinson), irreg. 12:15-1 a.m., (Cox), daily 4-5 p.m., (Alfred, Piechuta, Herzog, Markuson, Dressler, Shamleffer, Coover, Kelly, Fallon, Hartzell, Eder, Magnuson, Foshay, Hamilton, Partmann), daily 9-10 a.m., (Kentzel), Address: Broadcasting Co., of Japan.
JDY, Manchukuo, 9925 kc., calling Tokio at 2:30 a.m., (Partmann).

Readers Who Are Awarded "Honorable Mention" for Their Work in Connection with This Month's Short-Wave Report

Elmer Samson, Kenneth Dressler, George Hare, Raymond Harrigfeld, Earl P. Hill, John Coad, John C. Kalmbach, Jr., Elmer Patrick, Manfred Johnson, Werner Howald, Jack Staley, Joseph A. Piechuta, K. Mochrie, W. A. Youngblood, J. W. Lade, Earard De Ruadhal, Elmer S. Rose, Carl L. Horton, Angelo M. Rosa, Joseph John Binder, Jr., Thomas B. Baker, James E. Moore, Jr., Charles Robinson, R. S. Seaward, James Black, Howard Spafford, L. W. Skipper, George H. Matthews, Harold S. Bauer, Hugo Richter, Louis Schmidt, W. F. Herzog, William James Campbell, Angel City DX'er, Pierre A. Portmann, R. F. Shamleffer, Harry E. Kentzel, Arthur Immicke, Fred Atcherton, Leslie Mott, Erroll R. Birnie, P. Piorko, M. J. Markuson, Augusto Anca, T. E. Tynan, Leon Stabler, R. Stevens, Herman Ruppert, Carl and Anna Eder, Clayton D. Sands, Clarence Hartzell, Anthony C. Tarr, Irving Sporn, David Brensilber, Arthur Hamilton, Shokichi Yoshimura, Morgan Foshay, Gustave A. Magnuson, Rudolph Kure, Anshwell Tracey Bower, Wm. Skinner, Charles Ford, Charles F. Clark, Cyril Ruddoch, Lawrence Moore, S. G. De Marco, Henry Camp, Richard Nelson, Karl D. Beckemeyer, Daniel R. Bitner, D. Summers Smith, V. V. Labega, Denzel D. Murphy, Mr. and Mrs. John F. Leonard, J. Carroll Balloch, Frank Sakely, Herman Ruppert, R. C. Messer, George M. Hill, Campbell Matheson, Jr., Robert Pierce, Jr., Lloyd Ludwig, Alice R. Bourke, Merrill Marks, Wade Chambers, C. H. Tanis, Melvin Pulley, Ernest W. Law, Earl G. De Haven, Peyton Black, Manuel Betances, Thomas Fallon, Austin M. Rheiner, Fred Cox, L. Alexandre, Bill Culp, N. C. Smith, C. P. Kelly, Arthur B. Coover, A. M. Darling, Harold W. Bower, H. Westman, Jorge Ralat, W. G. Umstead, J. Richardson & Sons, J. Combe, Zane Sprague, John Mills, Wilbur Croston, Alfred T. Anderson, James Doyle, Simon M. Cartin, Chas. Massicott, H. J. Potthoff, Homer Bohlander, F. C. Foltz, Clement E. Suemper, Louis T. Haws, Orley McLaughlin, Everett A. Reese, James A. Resch, D. R. D. Wadia, P. James Prosser, Jr., E. W. Turner, Fletcher W. Hartman, Barry Sesma, Albert Pickering, Roy E. DeMent, Harold J. Self, Armand A. Boussy, Jose L. Lopez Bill Robinson, E. J. Margrie, Dr. Hausdorff, Alvaro Azevedo, O. Westwan, Fisher Rehner, Paul R. Leim, Anton J. Cindel, Graham H. Russell, Cecil R. Margerison, John J. Stoika, Jr., Kazuto R. Miyamoto, Bob Walls, Harold Bunker, R. Gronholm, J. Gorham Underhill, C. Tavaniotis, Frank Prentiss, John White, Herman E. Wittig, Zane Sprague, Art. E. MacLean, Howard Corwin, Charles Gunther, Howard N. Schmidt, Harold E. Schrock, Dick Allen, Robert Howard, R. F. Majewski, V. M. Poll, E. R. Pills, William Dean Noyes, Elmer R. Fuller, Frank Courtney, Herman H. Forester, Carl Hays, John Frederick, Barry Sesma, M. R. Kiser, Jr., Mrs. Ida P. Rogers, James C. Keithly, Milton Ortol, Joseph Lezky, H. E. Howard, Stanley Wojnarski, J. T. Atkinson, R. S. Houghton, A. Kosynsky, A. M. Rheiner, J. Wendell Partner, Walter E. Bishop, Anton J. Cindel, G. J. Harris, E. W. Law, William W. Oglesby, Jr., B. Kashimoto, Paul R. Leim, Li Chi Chang, Jerry M. Hynek, Fred W. Alfred, Frank Andrews.

Under this plan, when action takes place before a big building—a castle, for example—only a gate and hedge are provided in life-sized facsimile in the studio. But the long shots showing the entire castle are provided from a papier-mâché or plaster model and the illusion is effective over the air.

Lieutenant Eddy (U. S. N., retired) is a radio engineer as well as scenic designer and production expert. The combination of talents in the studio director resulted in a highly-developed performer staff at Wyndmoor even before test transmissions had begun. Eddy has recruited talent from Philadelphia and New York on the basis of schooling performers in the new art so that they could be on hand when the starting television gun in the U. S. A. is fired. There are actors, musicians, dancers and other specialty performers on his talent roster. Also, there are "cosmetics" and make-up experts. There are even composers writing special scores for the visual programs.

There is a separate unit in the building for the pick-up of movie film, which suggests the likelihood that live and filmed subjects will be combined for certain program effects.

Wyndmoor is twenty minutes from the Philadelphia business section by rail and arrangements will be made to shuttle talent back and forth. Subsequent to the launching of a regular commercial service, the station expects to be served by a remote-control coaxial link with a new studio in the heart of the Quaker City.

Although the receiver the writer saw demonstrated had an image of black and green tone, Philo T. Farnsworth has already shown black and white pictures on other occasions. Also, according to A. H. Brolly, his chief engineer, the firm has developed a projector-type, cathode-ray tube capable of giving sharp pictures on a large-size screen. The commercial type of Farnsworth receiver, according to Mr. Brolly, will have "something less than thirty tubes." No estimate would be given of its approximate cost. The Farnsworth firm intends to license manufacturers and not to produce the equipment itself. (Farnsworth Television, Inc., has authorized RADIO NEWS to publish the copyright photographs and receiver diagram accompanying this article.)

QRD? QRD?

(Continued from page 681)

for the good of radio techmen and radiops. We have reprinted a few and here are a few more which will be played up in accordance with the amount of comment we receive on them. Suggestion number one is to the effect that due to the advent of television sometime in the near future it wouldn't be a bad idea for radio techmen to organize with this specific type of station in view! These men would be experts on this specialized angle of broadcasting, and therefore, if properly organized, might be able to command real good salaries and other emoluments which BC men have had to fight for, due to not being unionized in the very beginning of radio broadcasts. Of course we believe that if men will only study and make themselves indispensable when the call comes for this type of radio-techmen he will be able to command a handsome figure as regards the filthy lucre, but we leave it to you-all. What do you boys and girls think of it???? The second suggestion would be modeled after the ARRL. The idea is to "band-into-one-whole" all radiomen, sort of a vertical

Farnsworth Television

(Continued from page 679)

sized props in giving long-distance and depth effects. Lieutenant W. A. Eddy, designer of the toy-sized sets, did not want to disclose how they would be applied, but it is our own guess that they will be used in the same manner as miniatures are employed in Hollywood and by the British Broadcasting Corporation in its London television transmissions.

union, with examinations to be held regularly for each specific type of radio work which you are qualified to perform such as telegraphy, telephony, television, servicing, etc., and then give a certificate or card stating that you have been examined and found efficient in whatever field you have satisfactorily passed. Our correspondent feels reasonably sure that such an organization would be backed up by manufacturers and companies who are finding it difficult to get good men to fill the vacancies which are steadily occurring due to the rapid advancement being made in radio. The standards would necessarily be high because an organization of this type, in order to be recognized, would have to be exacting in the matter of membership. Not so had an idea, what? But what are your ideas and your reaction to these thoughts? So we leave you pondering over it, with 73 ge GY.

The Technical Review

(Continued from page 683)

correct Centralab replacement control for over 400 individual types of radio sets. The book also lists their latest switches, rheostats, and other products. Requests should be sent to RADIO NEWS, 461 Eighth Avenue, New York City.

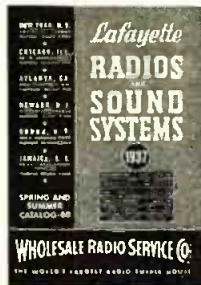

New Spring and Summer Catalog

Through the courtesy of the Wholesale Radio Service Company, their latest 116-page illustrated catalog is offered gratis to all readers. It contains descriptive information on receivers, replacement parts, transmitting equipment, service apparatus, and features a new line of Lafayette coordinated sound systems. Copies can be ordered free of charge from RADIO NEWS, 461 Eighth Avenue, New York City.

Enter Your Name for Free Condenser Catalog

The Solar Manufacturing Corporation has just brought out a finely illustrated



catalog, describing in detail their full line of condensers. The manual has been prepared for easy reading and quick reference. To obtain a copy free, address requests to RADIO NEWS, 461 Eighth Avenue, New York City.

RADIO NEWS Booklet Offers Repeated

For the benefit of our readers, we are repeating below a list of valuable technical booklets and manufacturers' catalog offers, which were described in detail in the December, 1936, January, February, March and April, 1937, issues. The majority of these booklets are still available to our readers free of cost. Simply ask for them by their code designations and send your requests to Radio News, 461 Eighth Avenue, New York, N. Y. The list follows:

- D1—Latest Radio Parts Catalog of Allied Radio Corp. Free.
- D3—Resistor Catalog, Free. Atlas Resistor Company.
- D4—Public Address Bulletin of United Sound Engineering Co. Free.
- Jal—1937 Radio Parts Catalog of Wholesale Radio Service Co. Free.
- F2—Speaker Bulletin. Free. Wright-DeCoster, Inc.
- F3—Instrument Catalog of Weston Electrical Instrument Corp. Free to servicemen, dealers and engineers.
- F4—Free Condenser and Resistor Catalog. Aerovox Corp.
- F5—New Centralab Parts Catalog. Free.
- F6—Triad Tube Manual. Free to servicemen, dealers and engineers.
- Mh1—Parts Catalog. Tobe Deutchmann Corp. Free.
- Mh2—Free Test Equipment Catalog. Clough Bregle Co.
- Mh3—Engineering Bulletin on 6L6 Tube. Ken-Rad Tube and Lamp Corp. Free to engineers and servicemen.
- A11—Free 56 page Catalog. Montgomery Ward & Co.
- A12—Parts Catalog. Hammarlund Mfg. Co. Free.
- A13—McGraw-Hill Publishing Co., General catalog listing radio text books. Free.

COIL DATA FOR LES-TET TRANSMITTER

Here are the coil specifications for the doubler and amplifier 6L6 stages for the 5, 10, and 20-meter crystal-control transmitter, which was described in the January, February, and March, 1937, issues of RADIO NEWS. This data was unfortunately omitted. The coil data for the final RK35 stage is shown in the March number.

Coil Data

- Five meter coils using forty meter crystal
 - 16T 1 1/2" dia. 1 1/2" long No. 14 wire
 - Doublet grid coil tapped at 7th T from grid end No. 14 wire
- Ten meter coils using forty meter crystal
 - Same as above
 - 19T 1 1/2" dia. tapped at 8th T from grid end 2" long No. 14 wire
- 20 meter coils using eighty meter crystal
 - 25T 1 1/2" dia. 1 1/2" long No. 14 wire
 - 26T 1 1/2" dia. tapped at 7th T from grid end No. 14 wire
- Doubler plate coil 6T 1 1/2" dia. 2" long center tap. Link 4T 1 1/2" dia. No. 14 wire
- Final grid coil 6T 1 1/2" dia. center tap 2" long No. 12 wire
- Final plate coil 6T 1 1/2" dia. center tap 2" long No. 12 wire
- 12T 1 1/2" dia. center tap 2" long No. 12 wire
- 12T 1 1/2" dia. center tap 2" long No. 12 wire
- 16T 1 1/2" dia. center tap 2" long No. 12 wire
- 16T center tap 2" long No. 12 wire

All the above coils are self-supporting, depending on the rigidity of the wire itself. The turns are spaced to make the coil the length specified above. They can be mounted on strips of mycalex or any other good insulation.

Coming Next Month!

The June issue will be a special annual short-wave number of great interest alike to amateurs, DX S.W.L's, and experimenters.

DEALERS... Equip Your Sound Trucks with the All-Purpose

Can Be Used For: **SOUND SYSTEM**
for 6 Volt D. C. or 110 Volt A. C.

Rentals or Sales. As Portable or for Fixed Location. Outdoors or Indoors. Automobile, Truck or Ship Work—6 Volt Operation if Power Line Not Available. Small at Large Enclosures.

A sound system that can be used anywhere. For any size audience to 10,000. Has all the latest refinements including tone control, crystal microphone, two heavy duty permanent magnet speakers. All units especially designed with large factor of safety to insure satisfaction under all conditions. System is complete with all accessories including phonograph turntable.

30 WATTS OUTPUT



Model 530
Note phonograph turntable is built into amplifier.



Amplifier delivers 30 watts undistorted output. It is a new design using beam type tubes and housed in attractive steel case with japanned finish. Uses 5 tubes on 6 Volt DC and 8 tubes on 110 Volt AC.



Latest type crystal microphone.

Improved high efficiency Permanent Magnet Speakers.

- Fully Licensed
- Strict Dealer Policy
- Time Payment Plan

SALES PROMOTION HELPS:

Webster-Chicago Dealer Helps are showing dealers the enormous possibilities now present in the sound market. The single All-Purpose system is all you need stock at the start. Webster - Chicago manufactures a complete line of Public Address Equipment and Sound Accessories including

For more information, send coupon. Learn all about Webster - Chicago's fast selling merchandise and the money-making possibilities for the Sound Specialist. Get new 1937 Catalog.

New AMPLICALL INTER-OFFICE COMMUNICATION SYSTEM

WEBSTER - CHICAGO

WEBSTER-CHICAGO, Section MY-6, 3825 W. Lake St., Chicago, Ill.

() Please send me complete information on the All-Purpose Sound System.

() Please send me New 1937 Catalog.

Name.....

Address.....

City..... State.....

WITH THESE 2 BOOKS
YOU WILL MASTER
ALL 417
ESSENTIALS
OF RADIO
SERVICING



MODERN
RADIO
SERVICING
and

RADIO FIELD SERVICE DATA

TEST INSTRUMENTS SPECIAL SERVICING PROBLEMS

Complete explanation of all kinds of radio test equipment. Principles of operation and design. Description of latest commercial models, with circuit diagrams. Construction data, etc.

Auto Radio Installation and servicing. Location and elimination of noise and interference in All-Wave sets. High Fidelity sets, etc.

SERVICING METHODS

FIELD DATA

Latest test and repair methods. Receiver analysis. Repairing individual components. Aligning sets with test oscillators and latest Cathode-Ray Oscilloscope methods. AVC and QAVC circuits. All clearly explained in detail with copious diagrams, etc.

"Case Histories" of over 1,500 receivers, with trouble symptoms and remedies for each. I.F.'s for 5.424 superhets. Automobile electrical wiring diagrams and ignition interference data. Trouble-shooting chart. RMA Color Codes, wire tables, etc.

SUPPLEMENTS twice a year for Data Book

1,736
Pages

813
Illus.



CLIP AND
MAIL
TODAY!

Radio & Technical Publ. Co.
45 Astor Pl., New York,
Dept. RN-57

Encl. and \$6. for both servicing books, including Jan. & June '37 Supplements to Data Book. Postpaid. (Foreign \$6.50).
Send free Circular "CO".

Name.....

Address.....

THE
NEW NATIONAL
NC-101X SUPERHET
RECEIVER

DESIGNED TO COVER ALL FIVE
AMATEUR BANDS
FULL COVERAGE ON EACH BAND
SUPPLIED WITH TUBES—POWER AND
10" DYNAMIC SPEAKER CHASSIS.

NET PRICE \$125.00 COMPLETE

Write for new 1937 Catalog

CAMERADIO

963 LIBERTY AVE. PITTSBURGH, PA. 30 TWELFTH ST. WHEELING, W. VA.
Established 1919

The

RADIO
WORKSHOP

(Continued from page 671)

be turned by hand or, if desired, it can be used with a regular brace.

K. A. CONSTANT,
New York City, N. Y.

How to Repair a Noisy Control

The accompanying drawing shows a quick and easy way for repairing noisy volume controls. This method does not apply to burnt-out controls; it is only intended for units where the wiper arm assembly has lost part of its original pressure,

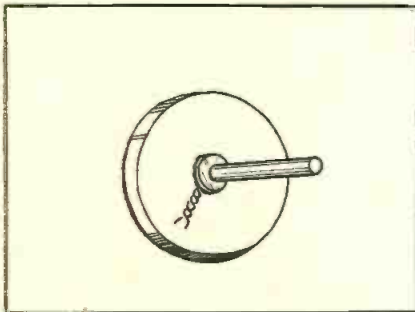

with the result that contact is not uniform over the entire resistance. Positive contact can be regained by pulling the shaft forward and inserting a piece of magnet wire behind the washer and around the shaft as illustrated.

HERMAN GERTZ,
New York City, N. Y.

Try This Kink for Increased
Selectivity

The selectivity of a standard i.f. transformer can be increased considerably by simply winding a single turn of No. 14 bus wire around the core between the two coils and grounding it to the chassis as shown in the drawing. The grounded turn reduces the coupling between the plate and grid tuned circuits.

Experiments with iron-core transformers seem to indicate that the single turn of

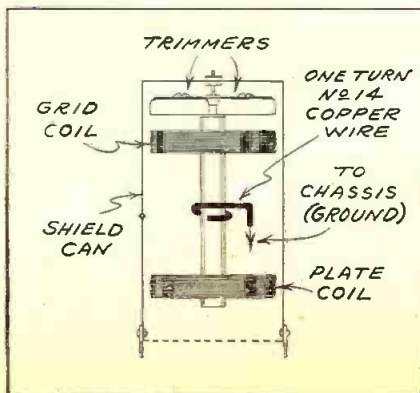

copper wire has about the same effect as moving the two coils one-half inch farther apart. When the wire is disconnected from the chassis, the coupling and selectivity of the transformer returns to normal.

H. D. HOOTON,
Beech Hill, W. Va.

Group Headphone Connections

The "Radio News Ear Aid" originally described in January, 1932, issue of RADIO NEWS and in response to many reader requests, reprinted in the April, 1937, issue, can be successfully employed as a group hearing device. This article outlines an effective multiple headphone connection arrangement where it is desired to use this or similar instruments in this capacity.

There are 6 outlets in the system described; several more can be used without any appreciable loss in volume. As shown, a 10,000-ohm potentiometer is connected across each outlet, all six potentiometers are connected in series with the output terminals of the hearing aid. The arm of the potentiometer is connected to one side of the corresponding single-circuit open jack, the other side of the jack is connected to the end of the resistance as shown. In this arrangement the headphones are connected in a series, each of them shunted with its individual volume control. This method permits each listener to vary the volume of his headpiece to meet his individual requirements. One-thousand-ohm headphones are suggested. With six of these 'phones in the circuit and with each

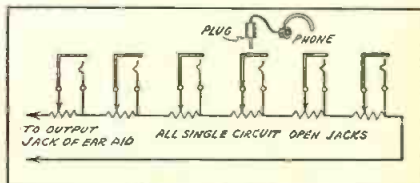

volume control set for maximum volume, the total load on the tube, at 600 cycles, is an almost exact match. As the volume-control setting is decreased at each 'phone, the overall impedance of the load goes up, but, as the usual practice is to work an output tube into a load of twice the tube impedance, this increase in load impedance is of relatively small importance, particularly as maximum tube efficiency is not required when the listeners do not require a high volume level.

Repairing Soldering Irons

A common cause for a burnt-out soldering iron is the poor insulation in the metal stem. This is easily corrected and pre-

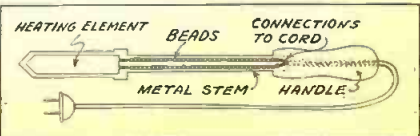

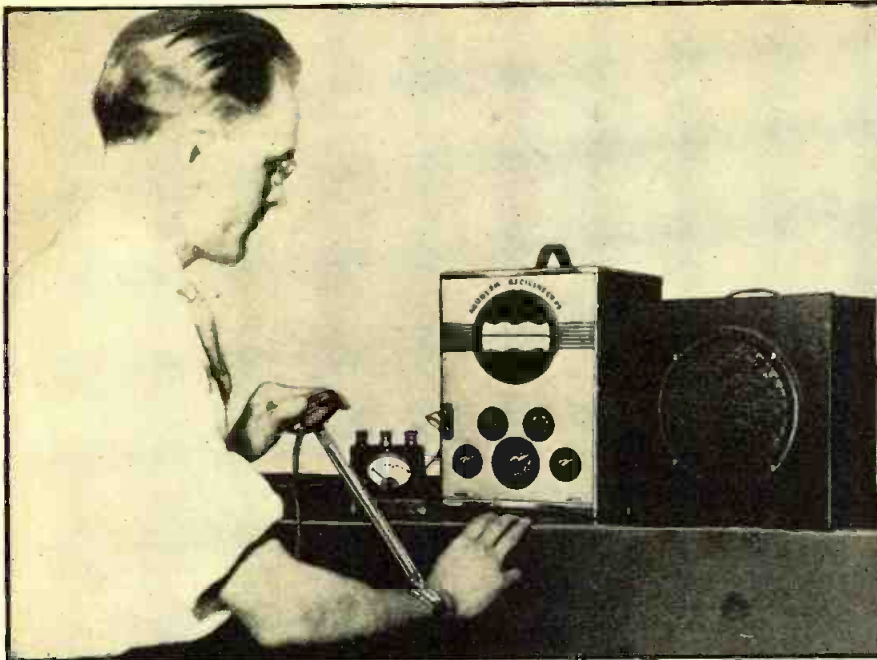

New Device Fills Long-Felt Need

Realizing that the reduction of vibration and noise is becoming increasingly important in engineering and industrial work, the Sundt Engineering Company recently introduced a new crystal inertia type, vibration pick-up.

The illustration shows the instrument being used in connection with the Sundt "Neobeam Oscilloscope", which has a built-in amplifier and a voltmeter connected to the output, to determine the frequency, amplitude, and velocity of vibration. The new pick-up is said to be so sensitive that it can pick-up the vibrations from the escapement of a wrist watch, yet, rugged enough to withstand vibrations up to 1/16 of an inch amplitude.

The bimorph crystal is mounted inside of the aluminum case and has no direct mechanical connection with the prod. When the case (which weighs only 4

ounces) vibrates, the crystal flexes of its own inertia and sets up voltage impulses of exactly the same wave form as the mechanical motion. The response is practically linear up to the resonant frequency of 2500 cycles. The output sensitivity is relatively high, 2 volts r.m.s. with .001 inch motion at 400 cycles per second. An 8-inch duralumin test prod is provided.

Using this same set-up, vibration study and measurement could be applied to: production testing of electric motors, ball bearings, crankshafts, gear trains, fans, air conditioning equipment, and locating source of vibration in reciprocating or rotating machinery; checking relative smoothness of surfaces, such as paper, polished metal, gauges, glass plate, etc., checking longitudinal rods for fracture, and the relative efficiency of materials for deadening sound.

A folder describing how to use and set up the model 156 pick-up and neobeam oscilloscope meter combination for vibration study is being prepared and will be available in the near future.

vented by the method shown in the drawing. The glass beads are obtainable from a 5 and 10 cent store or from a discarded ladies' handbag, necklace, etc.

J. S. NAPORA,
Uniontown, Pa.

Simple Crystal Holder

The radio beginner will find this crystal holder and mounting ring practical and easy to make. First, take a control-grid cap from a discarded tube and clean out all of the cement. Now, melt and fill the cap almost to the top with solder, but just before the metal cools, press into it the piece of galena, silicon, or other metal which is to serve as the crystal detector. Be sure that the top of the crystal protrudes above the cap as shown.

A holder for the mounted crystal is made by screwing to the panel or baseboard of

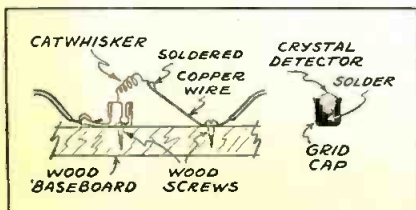

the set a grid clip which has a small hole in the top and a wire ferrule serving as a soldering lug, as illustrated. The grid cap containing the crystal detector may now be pushed into its holder, making a neat job and a perfect connection.

EDITOR'S NOTE—Manufacturers use a soft metallic alloy (with a low melting point) called Wood's metal for mounting crystals. It is said that using ordinary solder for this purpose causes loss of sensitivity. Some experimenters use tin-foil for packing and mounting crystals.

MAX HOLLABAUGH,
Spencerville, Ind.

Announces 15-Inch High-Fidelity Speaker

A new 15-inch heavy-duty dynamic type reproducer for both d.c. and a.c. operation has been recently introduced by the Magnavox Company. This large de luxe speaker is available in three models to meet the various requirements of public address and the theatre sound equipment. The manufacturer's specifications shows the speaker's power handling capacity to be 25 watts average signal power with sufficient reserve to provide for peak outputs. A matching transformer can be supplied to match any standard output impedance.

2,199

IDEAS

THEY COME OUT HERE!

THEY GO IN HERE!

FOR YOUR OWN SHOP!

Out of this one big book you'll get over 2,000 ideas for building up your radio service and set business. Practical, store-tested plans, methods, sales talks and ad specimens, which you can put to work TODAY. They'll make that old cash register sing sweet tunes! This great new Ghirardi book will keep you out of the ruts and show you how to put your business on good solid ground. Mail the coupon today for a **FREE Circular** describing Ghirardi and Ruggles' "RADIO BUSINESS" BOOK.

HOW TO SELL—Getting leads and prospects. Store- phone and outside selling. Sales talks. Breaking down sales resistance.

HOW TO ADVERTISE—Planning. Costs. How to write your own advertising. Tested appeals. Displays. Direct Mail. Newspaper and other forms of advertising. Free publicity. Merchandising. Contests. Follow-ups.

BUSINESS METHODS—How to start and run a business. Equipment and layout. Bookkeeping. Collections. Forms and records. Policies.

OVER 400 PAGES
OVER 200
ILLUS.

RADIO BUSINESS

Mail Today!

Radio & Technical Publ. Co.,
Dept. RN-57
45 Astor Pl., New York

Please send free Circular "BB" describing Ghirardi and Ruggles' RADIO BUSINESS PROMOTION AND MANAGEMENT.

Name.....
Address.....

FREE CIRCULAR!

THE METAL TUBE SELF POWERED FIVE BAND PRESELECTOR BOOSTER

- Continuous Band Spread
- Built-in Power Supply 110-V AC-DC
- Pre-Adjusted Low Loss Coils
- Calibrated Tuning Dials
- Volume Control and AC Switch
- Black Craekle Metal Housing
- Operates with Doublet or Single Antenna
- Tuning Range 9 to 560 Meters

Boosts Weak and Fading Signals, for use with T.R.F. Regenerative or Super Receivers, by Amateurs or Short Wave Fans. Builds up tremendous increase in signal strength also sensitivity and selectivity. Decreases noise to signal ratio and assures low image frequency response.

Kit of all parts, chassis, housing, diagram..... \$4.95
Kit of 6 Coils, 9 to 560 M..... 2.05
Kit of 3 Tubes, 6J7-6C5-K105A..... 2.50

Wired and tested, all coils, tubes, ready to operate \$12.00

STANDARD RADIO, RN-116 West St., N. Y. C.

VALUE PLUS . . .
Powertone 800 Tube Tester

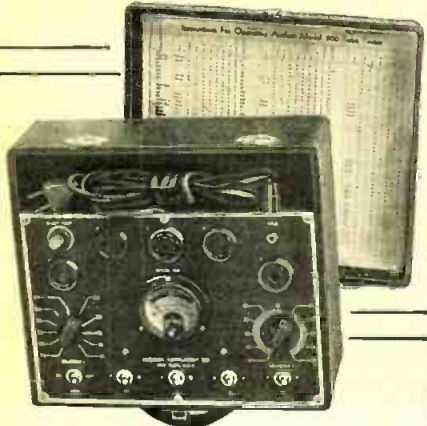

- Tests All Tubes Including Metal
- D'Arsonval Moving Coil Meter
- English Reading "Good"/"Bad" Scale
- Separate Section Tests
- Accurate Tests on All Tubes
- Portable Leatherette Covered Case
- Compact—Can be Carried Anywhere
- Requires But Two Settings For Tests
- Combination Short Test and Meter Fuse
- Chart For Testing All Tubes

Complete Net Dealer's and Serviceman's Price **\$11.50**

MODEL 801

Volt-Ohmmeter

A sensitive, compact and accurate volt-ohmmeter that will be the busiest instrument in your "lab," or out on jobs. DC voltage readings .0-5-50-500 and 1000-resistance readings from 1/2 to 500 and 200 to 500,000 ohms. Will read from 0 to 1 Ma. Low resistance range direct reading. Meter has 1000 ohm per volt sensitivity. Battery is self contained. Panel is clearly lettered. Compensator provided for zero adjustment. Complete with test prods. Measures only 5"x3 3/4"x2 1/4".



DEALER'S NET PRICE **\$5.75**
WITH BATTERY AND TEST PRODS.
Send 10c for instructive S.W. and P.A. Manual

TRY-MO RADIO CO., INC.
85N CORTLANDT ST. N. Y. C.

Be a RADIO and TELEVISION EXPERT



Qualify for U. S. Government License In 6 Months
Recognized as one of America's finest in Radio-Television Training, First National's course is so thoroughly organized you can qualify for U. S. Gov't. Operator's license in 6 months. That's your ticket to the big jobs.

Learn In Our Broadcast and Television Stations—Six short months intensive training with actual experience "on the job" at the controls of Radio Station KXBY and Television Station WGNAL fits you for the big jobs in Radio. Don't miss this chance at SUCCESS. Write today for complete information.

FIRST NATIONAL TELEVISION, INC.
TRAINING DIVISION
Dept. DD5 Power & Light Bldg., Kansas City, Mo.

BIG FREE BOOK TELLS ALL !

CODE—TAPES FOR EVERY NEED

For Example: Airways Tapes
On Weather, Maps, APOBS,
Winds Aloft



You can easily learn or improve your code—typical messages are sent you by the INSTRUCTOGRAPH. Practice any time at any speed desired. You may buy or rent at low cost. Send for full information today to—INSTRUCTOGRAPH CO., Dept. NR-S, 912 Lakeside Pl., Chicago, Ill. Representatives for Canada: Radio College of Canada, 863 Bay St., Toronto

We Also Handle—

HALLICRAFTER SHORT WAVE RECEIVERS—MICROPHONES—VIBROPLEXES—TAYLOR TUBES: Cash or Terms



Television Now Ready

(Continued from page 653)

MAKE-UP IMPORTANT IN TELEVISION

Models, preparing to participate in the television fashion show, prepare as carefully as they would for the movies or stage.

very serious objection to the use of this proposed range for television. This is found in the fact that the range of coverage (in miles) of a station operating below 60 megacycles is extremely variable. A transmitter which on one day finds its range limited to perhaps 25 miles may, due to atmospheric or other natural conditions, find its signals being picked up several thousand miles distant the next day—or even the next hour.

What, then, will happen to the signals from other television stations operating on the same frequency as the transmitter mentioned? Each station will require a band several megacycles wide for its sight-and-sound transmissions and with the total proposed television frequency range there will be only about a dozen channels. The normal expected coverage of a single station will be an area approximately 25 miles in diameter and therefore to provide television programs over even the more populous portions of the U. S. will require hundreds of transmitters. The hodge-podge that will result at such times as these frequencies "open up" can well be imagined.

For a moment let us consider the facts about the varying phenomena encountered on the ultra-high frequencies so far as their mileage range is concerned. The range of 28-30 megacycles is considered the best range in the frequency spectrum for long-distance transmission with low power. Amateurs using "fly-power" of only 10 to 50 watts establish practically daily contacts during the winter with other amateurs thousands of miles away. The broadcast and commercial stations operating between 30 and 40 megacycles are heard, some of them consistently, at distances up to 10,000 miles. The sound transmissions from the N. B. C. Empire State Tower television station, operating on 52 megacycles, are quite commonly heard by experimenters in Europe, and the European television transmitters are frequently heard on experimental receivers in the U. S. All of these facts point to the futility of employing these frequencies for television—and their desirability for other services which can use their distance range to advantage.

The 56-60 megacycle amateur band is likewise unsuited for television, even if the Federal Communications Commission could be induced to dispossess the amateurs. Eight months ago Laurence M. Cockaday

started a series of test transmissions on 58 megacycles from his amateur station, W2JCY, at North Pelham, New York, and arranged for a group of amateurs in England to listen for his signals from 1:00 to 1:15 a.m., E.S.T., each Sunday morning. As a result of these tests, out of a total of 15 transmissions, 5 were reported heard in England and the reports accurately and completely verified. His 5-meter signals were first heard in Wales one year ago, that being the first verified crossing of the Atlantic on this frequency. This series of tests was inaugurated to provide a further check on the belief held by Radio News that these frequencies are not suited to television.

The British amateur station G5BY more recently inaugurated a similar series of tests on 56 mc., with the result that his signals have been heard by a half dozen New York hams.

In view of this situation, why delay television by continuing to argue for a group of frequencies which, if obtained, would be found largely unsuited to television—only to face further delay in demanding another range that would be better suited to the purpose and in rebuilding transmitters. It would seem far more logical for the R. M. A. to accept the obvious and change their recommendation to include the range between approximately 70 and 120 megacycles. This is a range for which there is little or no demand for other services and it is highly probable that the F. C. C. would speedily grant such a revised request.

This emphasis is being placed on frequency assignment in this article because the television interests have seen fit to emphasize this as one of the main things holding up television development.

RADIO NEWS went on record months ago to the effect that television was being unnecessarily delayed—for reasons best known to these television interests. The interests now announce that television will not be made available to the public during 1937, and perhaps not during 1938. There still remains a great deal of doubt as to why this should be so. Several of the European countries have established television systems, with receivers on the market for anyone who cares to buy. In the earlier days of radio broadcasting the radio busi-

ness in the U. S. developed far more rapidly than that of foreign countries.

With the engineering and production facilities of American plants, the tremendous buying power of the American public and the ability of manufacturers to promote sales, there seems to be little reason why this same condition cannot apply to television. But it is not likely to apply if the present system of laboratory incubation is continued. Open competition is needed as a spur for development and perfection of television. Under the present system the smaller manufacturer cannot afford to participate in the development—nor can he force the hands of the "big shots" by actually producing and selling television equipment—for the simple reason that through their patent holdings a few large companies have an effective strangle hold on the situation. Until they give the word "Go!"—and this evidently is not going to occur until they have the patent situation completely sewed up—the public can sit and wait.

The fact is that Philco and others have repeatedly demonstrated television of an order of perfection which any average citizen would enjoy having in his home.

Following is summarized data covering the Philco equipment employed:

Transmitter

Sound Transmitter—Frequency 54 megacycles. Power 25 kilowatt.

Television Transmitter—Frequency 49 mc.; power 4 kw. (peak).

Modulation System—Philco high-fidelity system responding to an unusually wide band of modulating frequencies, the maximum being about 4.5 mc.



PHILCO CAMERA TUBE

P. J. Koukle, Philco television engineer, about to place this "electric eye" in the television camera.

Call Letters—Both sound and television stations operate under a single set of call letters—W3XE, Philadelphia.

Antenna—Height above street level—210 feet. Television transmitter antenna consists of array composed of two dipoles, each fitted with a reflector. The sound antenna consists of a vertical half-wave. Both antennas are fed by coaxial transmission lines.

The System

Number of Lines—441.

Frame Frequency—30 per second.

Field Frequency—60 per second, interlaced.

Aspect Ratio—4:3.

Polarity of Transmission—Negative.

Synchronizing—Amplitude selection is used in connection with the "narrow vertical" synchronizing pulse.

Receivers

Philco Field Test Receivers—Receivers use independent television and sound sections for flexibility. These tune over the range 42-86 mc.

Total Number of Tubes Employed—26.

Picture Tube—12 inches in diameter, giving white and black pictures approximately 7½ x 10 inches.

(High-fidelity picture reproduction on these receivers results from a design which gives an extremely wide receiver acceptance band, wider than 4.5 mc.)

Modern Oscillograph

(Continued from page 657)

do this job by any point-to-point method takes altogether too much time and it is also very difficult to tell when the best fidelity consistent with adequate gain has been obtained. With the oscillograph, the problem is greatly simplified and it becomes practical to take on work of this nature at a price attractive to the set owner.

In all aligning operations, the vertical plates of the oscillograph are connected across a load resistor in the detector circuit. A frequency-modulated oscillator must be employed. But there are many other tests which may be made without this additional equipment.

Auto-radio vibrator testing is another field wherein the cathode-ray oscillograph stands supreme. When the vertical plates are connected across the transformer primary circuit, examination of the wave pattern indicates instantly whether the vibrator is in proper condition and whether the buffer condensers are of the proper value. This is particularly important in the case of synchronous vibrators. There will be a break in the curve which should occur near the horizontal axis if the buffer condensers are of the proper value. If this break occurs elsewhere, the vibrator will have short life even though functionally normal at the time of test. At the present rate of auto-radio sales, the replacement vibrator business soon promises to compare with tube sales as a service revenue-producing item.

In replacing parts, it is frequently impossible to secure exact duplicates of the original type. In the case of power transformers, if the replacement is of inadequate power for the job at hand, a distorted wave form will result from the excessive load. A brief examination with the oscillograph will reveal this condition. Often, too, the first section filter condenser will blow and require replacement. A test with the oscillograph will determine whether the peak voltage developed at this point is within the condenser's rating and perhaps save a "no-charge" replacement job in the near future as well as the customer's good-will.

Experimenters will find among the innumerable other applications of the cathode-ray oscillograph a quick and simple method of determining tube characteristics under actual operating conditions. We may, for instance, select grid and plate voltages and then apply a.c. to the grid. By examining the resulting waveform across a load resistance in the plate circuit we will have a complete picture of the tube's operating characteristic.

For transmitting amateurs, this instrument is indispensable. Proper excitation of Class C stages, correct modulation and other characteristics of transmitting apparatus may be rapidly checked.

Detailed information for making a wide variety of tests is given in bulletins issued by the manufacturer. A handy reference book on the subject is "The Cathode-Ray Tube at Work," by John F. Rider. For more advanced students, "Engineering Mathematics," by Steinmetz, is recommended.

**THIS SERVICE TRUCK
FREE!
WITH BUILT-IN
LOUD SPEAKER SYSTEM**



WE ARE

*Giving it
Away!*

**—ALSO 500
other FREE
PRIZES!**

You still have time to enter this easy Raytheon Contest and win any one of 500 prizes, a V-8 service truck with a complete built-in sound system—or \$600 in Cash! All you do is answer a simple question—one that every dealer or serviceman gives to his customers, two or three times a week. The first prize winner's answer, name and photograph will appear in our advertisement in the Saturday Evening Post! May 1st is the deadline—so don't put it off any longer! Send your entry in today!

SEE YOUR JOBBER!



RAYTHEON PRODUCTION CORPORATION

420 Lexington Ave. 55 Chapel Street
New York, N. Y. Newton, Mass.
445 Lake Shore Drive 555 Howard Street
Chicago, Illinois San Francisco, Cal.
415 Peachtree St., N. E.
Atlanta, Ga.

**RAYTHEON IS THE MOST COMPLETE LINE—ALL TYPES
OF GLASS, OCTAL BASE, METAL, RESISTANCE AND
AMATEUR TRANSMITTER TUBES.**

The SKY CHALLENGER!



AMATEUR RADIO'S GREATEST VALUE! A New Hallicrafters' Communications Receiver

A sensational new short wave receiver that's making a hit with amateurs and short wave listeners everywhere. Everything needed for efficient short wave reception, with sensitivity and selectivity that's equal and better than most much higher priced receivers. Covers all active amateur bands including the 10 meter band. See it at your dealer's or write for complete information.

FEATURES

- 9 Tubes—6 metal—3 glass
- 38 MC. to 535 KC. (7.9 to 540 meters)
- 5 Band 338" Main Tuning Dial
- Electrical Band Spread
- Iron Core I.F. Transformers for improved selectivity
- Direct Calibration Tuning—No Charts or Tables
- Automatic Volume Control
- Single Signal Crystal Control (Optional)

the hallicrafters

inc.

2603 Indiana Ave., Chicago, U. S. A.
Cable Address: "HALLICRAFT"

ADVANCED HOME TRAINING RADIO SERVICE and PUBLIC ADDRESS

TERMS AS LOW AS \$5 monthly

Technical training is no longer a "luxury"—it is a NECESSITY! R.S.T. Service course was prepared and is being constantly revised, by experienced men FOR experienced men. No waste material—but a complete home study training that starts paying for itself right from the start. Begin any time—take up to 3 years to complete.

MAIL POSTCARD TODAY FOR **FREE** BOOKLET "The Key to Successful Servicing"

RADIO SERVICE INSTITUTE
SUBSIDIARY OF CREI
Dept. RN-5, 3308 14th St., N. W., Wash., D. C.

FOR TELEVISION EXPERIMENTERS



One Watt Resistor Send for Catalog 341

MORRILL AND MORRILL
30 Church St., New York, N. Y.

RADIO ENGINEERING

broadcasting, aviation and police radio, servicing, marine radio telegraphy and telephony. Morse telegraphy and railway accounting taught thoroughly. Engineering course of nine months' duration equivalent to three years of college radio work. School established 1874. All expenses low. Catalog free.

Dodge's Institute, Oak St., Valparaiso, Indiana

The DX Corner (Broadcast Band)

(Continued from page 669)

in the background. Shifting antennas brought in WFAA on this frequency. Our east antenna brought in WTBO with an R9 signal, while our south antenna would bring it in R6-7, but would bring up WFAA so that we could easily log the latter. Using the west antenna, WTBO dropped to R5 and WFAA to R3, thus providing an opportunity to bring in other signals on this frequency."

Observer Gordon uses a three-stage battery-operated preselector ahead of a Philco '34 seven-tube al-wave receiver. He finds that the preselector gives him a great increase in sensitivity and selectivity. He likewise has a distinct advantage in that there are no power lines or telephone lines within 2½ miles of the house.

Sounds like a close approach to a DX'er's Paradise to us.

Don Lee Television

(Continued from page 651)

resistor has a value of only 15,000 ohms. This resistor in the usual communications type receiver would have a value of perhaps one-half megohm. The low value here used is necessary in order to nullify the reactance of the unavoidable capacitance of the "high" side of the components and the "high" wiring to ground. It will be noted that the lead from R2 to the grid of VT6 is shown as a solid line, with a dotted line adjacent to it. This is to indicate that this lead, as well as others to follow, should be run in a direct manner, and as far away from the chassis as possible, so that its capacitance to ground will be small. The short metal tube in front of the last intermediate-frequency transformer shield can be the diode, and it will be noted that it is above the chassis by 1¼ inches. This is for the purpose of reducing the capacitance of the wire to ground.

Similarly, the acorn triode, VT6, is elevated above the chassis. In this circuit the plate lead to the high end of resistors R4 and R40 and the associated components must all be located as far from grounded objects as possible. Condenser C12 and resistor R5, coupling condenser and grid leak for the cathode-ray tube respectively, can best be located adjacent to the grid terminal of the cathode-ray tube rather than immediately adjacent to VT6. The lead from the junction of resistors R4 and R40 to the synchronizing circuit condensers C30 and C31 and resistor R33, which comprise the synchronizing circuit, and the leads to the grids of the vacuum tubes VT11 and VT12 of the scanning sources should be of low capacitance by being short and by being removed from ground as far as convenient.

The glass tube in the rear of the chassis of Figure 3 is the 83-volt full-wave rectifier. Directly behind it is the power transformer TR2 and the chokes L13, associated with the low-voltage power supply shown in the lower left-hand corner of Figure 1. This power supply operates the television receiver and the two scanning sources.

The simple type of gas triode sweep-circuit oscillator, with a constant-current pentode as a plate resistor, has been used

in the interest of simplicity. The high-frequency and low-frequency sweep circuits are alike, except for the value of condensers C22, C25, C23 and C26. Resistors R18 in each circuit vary the frequency. These two controls are front-panel controls, for adjusting the lock-in of both the low and high-frequency sweep circuits.

The components C30, C31 and R33 convey energy from the output of the receiver amplifier through circuits particularly suited to synchronize the low- and high-frequency sources.

Transformer TR1, rectifier tube VT8, condensers C28 and C29 and resistor chain R8, R9, R10, R11, comprise the high-voltage power supply for the cathode-ray tube. This is essentially standard cathode-ray tube practice. However, it is notably different from ordinary receiver tube practice in that the plate of the cathode-ray tube is grounded and the heater cathode and grid of the cathode-ray tube are the high-voltage leads of the device. These must be treated with respect in installation, and not touched when in operation! These leads are some 2000 volts "below ground" potential, but whether or not such a lead is "above" or "below" ground potential by a large amount makes no difference in its ability to give a severe shock. It is improbable that there is sufficient energy in the equipment to produce fatal results unless the subject should die of fright. Consequently, if the circuits are accidentally touched, attempt to minimize the effect in the mind, which should tend to put the person in the best condition. (It is to be understood that the Don Lee organization incurs no liability of any kind in connection with such accidents or in any other matter, because of the information furnished herewith. Such information is furnished free for non-commercial use and no patent or other license is granted or may be inferred.)

Figure 4 shows the sweep-circuit, high-voltage, power-supply chassis, with gas triodes and accompanying pentode resistor tubes shown in alignment at the front end of the chassis. Behind them is transformer TR1, rectifier VT8 and porcelain lead-through insulators, which carry the high voltage to the cathode-ray tube. Condensers C28 and C29 are below the chassis. Resistors R18 are shown on the small panel at the front right of the chassis. On the rear of the chassis are located controls R9 and R11, which control the focus and intensity of the cathode-ray tube respectively.

Figure 2 shows the completed receiver. The curving black lead in the foreground, from receiver to the rear of the cathode-ray tube shield, is the output "high" lead which goes to the grid of the cathode-ray tube. The cable leads in the rear which also enter the rear of the cathode-ray tube shield are the cathode-ray voltage supply leads. It is desirable that the cathode-ray tube be mechanically, electromagnetically and electrostatically shielded. To accomplish this, a piece of 6- or 7-inch diameter stove-pipe is suitable for a 5-inch diameter tube. In the receiver constructed, this shield, the two supporting panels and the bottom shelf were cadmium plated. This presents a pleasing appearance, regardless of the lowly origin of the stove-pipe.

The mechanical arrangements shown in the photographs do not have to be rigidly followed. Several rules of construction must be observed, however, and these are given herewith. Most important: power transformers and chokes should not be located closer than one foot from the cathode-ray tube, particularly if near the rear end thereof. If located closer, the stray magnetic field from these devices deflects the electron beam directly by the mechanism of the electromagnetic deflection and

an irregular vertical margin is found on both sides of the blank field of view of the cathode-ray tube, even if all signal circuit leads are disconnected therefrom. If it is desired that the tube and chassis be close together, the transformers must be located at the front of the tube near the fluorescent screen. All components may be located on one large chassis if these precautions are followed. Another allowable arrangement consists of locating the receiver and scanning sources on an upper chassis and the two power supplies on a lower, the latter being placed below the former in the cabinet.

Also, it is not necessary that metal vacuum tubes be employed. The corresponding glass types are suitable. *It is important that an acorn triode be used for VT6, however!* Another acorn triode connected as a diode may be used for VT5, if desired.

In connecting the cathode-ray, tube-deflection plates, the numbers on the diagram when viewed from the front of the cabinet are: (1) right rear; (2) lower front; (3) upper front; (4) left rear. When this arrangement is observed, the picture will appear right side up and printing will read from left to right.

The receiver is put into operation in the following manner: All connections having been made and checked, the power circuit is turned on by SW1. After about a one-minute warm-up period, a rectangle of light should appear on the cathode-ray tube screen. This should be adjusted by resistor R11 until it is of average brilliancy. If the resistor R11 is adjusted too much in one direction the rectangle of light will be extinguished; if too far the other direction it will be very bright and unsuited for displaying the television image. The neutral or blank screen should be of half-brilliancy so that the black portions of the picture will extinguish the cathode-ray spot and the bright portions carry it to full brilliancy. The resistor R9 controls the focus of the tube, and this should be adjusted until the scanning lines are most clearly seen.

With no signal being received, there should be no variation of intensity over the screen, except for a very slight darkening at the top, which is permissible. Any traveling or stationary variations of intensity having several dark and light horizontal portions, indicate the presence of alternating current hum. This might come from improper circuit connections or conditions in the high-voltage rectifier for the cathode-ray tube; hum in the output of the radio receiver or improper connection of the cathode and heater of the cathode-ray tube. It is usually found that connecting the cathode to one side of the heater gives less hum in the field than connecting to the other side. Whether or not the hum comes from the television receiver can be checked by removing the connection to condenser C12. If the horizontal variations of intensity disappear, the hum is in the receiver. As previously mentioned, irregularity of the vertical sides of the beam usually indicates deflection of the cathode-ray beam directly by transformers or magnetic field. This must be cured by further separation between these units and the cathode-ray tube. This type of interference might occasionally produce residual intensity variations of the field of view and give rise to the horizontal variations of intensity which are characteristic of power supply hum. A slight amount of such variation can be tolerated, since the incoming signal is much stronger and the variation is not seen, when an image is being received. When the receiver is properly constructed and adjusted, however, all hum will be removed.

After making the above adjustments without a television signal, the next step is to tune in the test signal of W6XAO. When this is properly received, it appears as 38 parallel horizontal bars in the field of view. In order to receive the signal, the several condensers C3, C4 of the intermediate-frequency transformers must be aligned. If necessary at the start, headphones (with a series blocking condenser) can be shunted from the plate of VT6 to ground and the weak signal, which will probably be received in any event, brought to maximum intensity by such adjustment, and the separate tuning condensers C1 and C15, which are best left free of each other in this preliminary adjustment. The intermediate frequency is 8000 kilocycles and the oscillator operates 8000 kilocycles above the incoming frequency. Its condenser, C15, will consequently be at a smaller capacitance than condenser C1 to bring this about. The setscrews of the coupling between C1 and C15 may be tightened when maximum signal is secured.

If fewer bars than 38 are received, the low-frequency scanning source is operating at *too high* a frequency and if more than 38 are received, it is operating at *too low* a frequency. The proper frequency is 24 cycles per second. The high-frequency source must operate 7200 cycles per second. With the low-frequency source properly adjusted, this is the point where the individual scanning lines just begin to merge into a solid field for the typical 5-inch cathode-ray tube.

The next step is to receive an image. With the high-frequency source "off" frequency, as it probably will be in this first adjustment, a great number of small black and white dots and dashes will undoubtedly be received. Vary the high frequency, adjusting knob R18 until this closes up to a single image. This is identified by a black bar at the right of the field of view and a single orderly representation of an image across the field of view. Preliminary to securing this adjustment, one or more images may appear slanting one way or the other, depending upon whether the source is adjusted to too high or too low a frequency. After proper high-frequency adjustment, it is possible that the image will be moving up or down. This is remedied by adjusting the low-frequency resistor, R18, until the image becomes stationary. Proper adjustment of both of these knobs should now make the image lock in step and continue to be displayed without further interruptions. It will be found with these simple types of sweep circuits that the natural frequency of the sources may tend to vary during the first few moments of receiver operation. Consequently, a few moments' warm-up period is needed. If the receiver signal is not sufficient to fully modulate the cathode-ray tube, the synchronization may not be secure and steps should be taken to increase the signal strength.

To bring the detail in the image to a maximum, the several intermediate-frequency condensers, C3, C4 should now be adjusted while examining the picture. The condensers C1 and C15 should also be checked as to over-all tuning adjustment and relation between the two as determined by the setting of the coupling.

If insufficient signal is secured, the addition of one or even two more intermediate-frequency stages is indicated. This is not difficult, because these stages are of low gain compared to the usual communications type, intermediate-frequency stage. For instance, the gain of the three stages, when properly constructed and adjusted for wide band pass, may not be more than one or two high-gain stages as used in usual short-wave or broadcast reception. The use of

(Turn to page 697)

QUICK

SEND FOR THIS PROFIT MAKER!



It's Worth Dollars-a-Week to You —Yet Costs Only 15c

Thousands of service men—who know real value when they see it—are using the Sylvania Technical Manual on the same jobs you're working on today! Why? Because they've found this handy pocket manual saves time . . . and time is money!

With a 50% increase in contents . . . 184 pages of information and tips . . . its cost to you is still only 15c. It lists 193 types of tubes, with important circuit application information on each—tells all about glass, metal, and "G" type tubes, including those for Majestic receivers—and gives you full information on Sylvania "Ballast Tubes." *You need it in your business. Don't wait—send for it now!*

Hygrade Sylvania Corporation, makers of Sylvania Radio Tubes and Hygrade Lamps. Factories at Emporium, Pa.; Salem, Mass., and St. Mary's, Pa.

SYLVAN A

THE SET-TESTED RADIO TUBE

Hygrade Sylvania Corporation
Emporium, Pa. RN-57

Please send the Sylvania Technical Manual. I enclose 15c in stamps.

NAME

ADDRESS

CITY STATE

WHAT'S NEW IN RADIO

WILLIAM C. DORF



STANCOR

**40 WATTS
OUTPUT FOR \$40**

A low-cost transmitter that has EVERYTHING! Uses Crystal control... 6L6 tube for oscillator... Type 10-825 or T-20 amplifier tubes... Room for buffer stage or R.F. for phone operation. It's stable... efficient... compact... economical. Build this professional-appearing transmitter... you'll get perfect performance.

Complete layout template AT-1 with complete operating instructions will be mailed for... **25¢**

**STANDARD
TRANSFORMER
CORPORATION**

850 BLACKHAWK ST., CHICAGO

New Auto Receivers Feature Automatic Tuning

The new 1937 line of "Admiral" auto receivers manufactured by the Continental Radio and Television Corporation feature "Touch-O-Matic Tuning", an advance which will undoubtedly command interest



from all motor radio enthusiasts. As illustrated, this new automatic tuning control is attached to the steering wheel column and by simply pressing a button it is possible to tune in any one of five preselected radio stations. The control is housed in a compact case attractively faced with chromium, measuring 4½ by 4¼ by 2½ inches. "Touch-O-Matic Tuning" can be easily installed and used with any car radio. When so installed it constitutes an added refinement and allows the regular tuning controls to be used for tuning in stations other than those provided for by the automatic tuner control.

Complete Portable 20 Watt Sound System

The attractively designed portable sound-system illustrated below is manufactured by Montgomery Ward and Company. The amplifier is capable of providing 20 watts



undistorted power output. It employs 9 tubes, utilizing two 6L6s in the power stage. The input circuit of the amplifier is arranged to handle 3 microphones, either two crystal or velocity mikes, or a carbon microphone. The specifications show the fidelity response to be plus or minus 2 db. from 60 to 10,000 cycles.

High-Gain 20 Watt Amplifier

The new Webster model 2L-20 portable amplifier illustrated below is compactly designed, light in weight, and has input con-



nection arrangements for two microphones or phonograph pick-ups. The output circuit is tapped at 3, 6, 250 and 500 ohms. The amplifier is rated 124 db. gain and seven tubes are employed which include two 6L6 beam power tubes.

Latest Tube Checker

The Million Radio and Television Company announces their latest model TV tube tester and analyzer. The new instrument tests all types of glass and metal tubes, includes d.c. voltmeter range at 5000 ohms per volt, measures resistance from 0 to 10,000 ohms and 0 to 15 megohms, has a capacity measurement range from .01 to 3 mfd., and current measurement ranges of 0 to



300 microamperes, 0 to 3, 30, 300 and 600 milliamperes, and 0 to 9 amperes. It also incorporates a neon short and leakage testing circuit.

Service Laboratory

To take the place of the jumbled work bench, generally full to overflowing with a motley array of different size testing instruments, the Clough-Bregle Company is introducing a complete service laboratory that can be assembled from any of their rack type instruments. The new laboratory cabinet can be purchased with one or more panel instruments, such as an oscillator, oscillograph, or analyzer, and will then be supplied complete with blank filler panels.

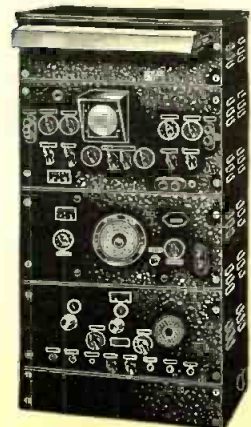

GREATER ACCURACY

**WIDER TESTING
RANGE**

LOWER COST

DEPENDABLE

Model 409
AC-DC Multitester



Only \$17.95

- Large 5" Fan Type D'Arsonval meter • Accuracy within 2% • Separate high and low ohm-meter scales. • 4 ohm-meter ranges (no external batteries) • High range of 7,500,000 ohms • Low range has center of scale at 2 ohms • Each of first 10 divisions reading 1/20 ohm. Low current drain • Can be used on AC and DC—25 and 60 cycle • AC voltages as accurate at 20,000 cycles as at 60 cycles • No frequency, wave form or temperature error in rectifier. • Linear AC voltage scale—same as DC • 2000 ohms per volt DC; 1800 ohms per volt AC • 5 DC current scales include microamps, amps. • AC and DC volts.—0-5-50-500-1000 • DC microamps—0-300 • DC milliamps—0-5-50-500 • DC amps—0-5 • Ohms—0-100-7500-75,000-7,500,000.

• SEE YOUR JOBBER •

Write to Dept. N for catalog

RADIO CITY PRODUCTS CO.

88 PARK PLACE
NEW YORK CITY

"DEPEND ON
DEPENDABLE"

RADIO COURSES

RADIO OPERATING: Prepare for Gov't License Exam. • **RADIO SERVICING:** Including Short Wave • **AMATEUR CODE** • **ELECTRONICS** • **TELEVISION**

Day and Evening Classes—Booklet Upon Request

NEW YORK Y.M.C.A. SCHOOLS

7 W. 63rd Street, New York City

As additional instruments are desired, these panels may be removed to make the needed room, thus eliminating obsolescence and allowing the service laboratory to be kept up-to-date at all times. This new service cabinet not only presents an imposing appearance, but saves time and bench space.

New Motor Car Set Has A.F. Control

Three new metal tube auto receivers were recently announced by the General Electric Company. Motor car radio en-



thusiasts will be interested in these new sets, particularly in the model FA-80 illustrated above. As a contribution to simplified tuning, this instrument incorporates automatic frequency control. It also features three-point tone control, compensating automatic volume control, a 6½ inch dynamic type speaker, and is designed to deliver 7 watts power output.

Heavy-Duty Tap Switch

Here is a new Ohmite band-switch which has special interest for the "Ham". With

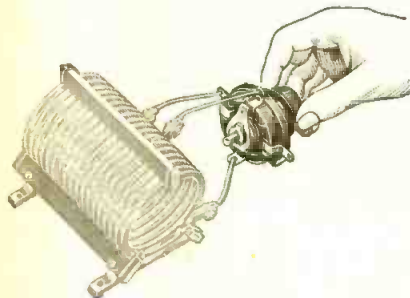

this new unit, panel-control band-switching can be provided in all stages of a transmitter. The new switch is said to be exceptionally efficient because of its low-loss porcelain construction, low contact resistance, and high current carrying ability. The switch is sufficiently small in size for use in crystal oscillator and compact low-powered stages and it can be safely used in power amplifier and output circuits up to 1 kw. rating. The switch has 3 contacts. Two or more switches can be ganged for single control by using a ¼-inch insulated shaft coupling.

Don Lee Television

(Continued from page 695)

a directional antenna is an excellent way to increase the signal strength and decrease the interference from automobiles or other sources, if this is required. This is accomplished by placing a parasitic reflector, consisting of one piece of ¼-inch diameter copper tubing, 11 feet long, 4 feet away

from the antenna and on the side directly opposite to the television station from which it is desired to receive. This reflector is not connected to the antenna or any other metallic object in any way. It does not attenuate signals in a range of about 160 degrees in the direction toward the station to which it is aimed, but does reduce signals coming from the rear 200 degrees.

The ordinary 5-inch-size cathode-ray tube has been chosen for this receiver because of its low cost and availability. It is possible to employ any size tube with the receiver. The 1-inch or 3-inch sizes are not recommended, however, because the focus of the spot is not sufficiently fine to secure the proper detail in the present high-definition television images. For a larger cathode-ray tube, symmetrical push-pull amplifiers should be added to the scanning sources, if a plated type anode on the conical side of the tube is employed in its construction. It is understood that large-size tubes (without this feature) are available, that mercury-vapor, gas triode tubes can be used to give large scanning-source outputs without amplification (DuMont).

The confidential Don Lee television receivers, as used for demonstrations, differ materially from the design of this particular receiver. However, this unit has been constructed and adjusted according to the above directions by the Don Lee organization and also by a number of individual constructors in Southern California who already have receivers in operation.

It is felt that such constructors can assemble a receiver of this type will not have difficulty in modifying or improving it in the future to keep pace with the forward march of the television art.

List of Parts

- R1—500-ohm, 1 watt, Morrill or equal
- R2—15,000-ohm, 1 watt, Morrill or equal
- R3—1000-ohm, 1-watt carbon
- R4—5000-ohm, 1 watt, Morrill or equal
- R5—1-megohm, 1 watt, Morrill or equal
- R6—50,000-ohm, 1-watt carbon
- R7—5000-ohm, 4-watt potentiometer, wire-wound
- R8—1-megohm, 3-watt carbon
- R9—0.5-megohm, 1-watt potentiometer
- R10—150,000-ohm, 2-watt carbon
- R11—0.1-megohm, 1-watt potentiometer
- R12—4-megohm, 1-watt carbon
- R13—4-megohm, 1-watt carbon
- R14—400,000-ohm, 3-watt (need 2)
- R16—75000-ohm, 1-watt carbon (need 2)
- R17—1500 ohm 1 watt carbon (need 2)
- R18—50,000-ohm, 1-watt potentiometer (need 2)
- R19—1000-ohm, 1-watt carbon (need 2)
- R20—300,000-ohm, 1-watt carbon (need 2)
- R30—2500-ohm, 10-watt, wirewound
- R31, R32—15,000-ohm, 25-watt, vitreous enamel, adjustable
- R33—10,000-ohm, 1-watt carbon
- R34—100-ohm, 1-watt carbon
- R35—20,000-ohm, 2-watt carbon
- R36—50,000-ohm, 1-watt carbon
- R37—10,000-ohm, 1 watt, Morrill or equal (need 7)
- R38—25,000-ohm, 1 watt, Morrill or equal
- R39—25,000-ohm, 1 watt, Morrill or equal
- R40—10,000-ohm, 1 watt
- L1—1 turn No. 14 enamel, 1" diameter
- L2—6 turns No. 14 enamel, 1" diameter, spaced to make coil 1" long
- L3—1.4—23 turns No. 30 enamel per coil, wound solid on ½" bakelite form (outside diameter). Coils ¼" long spaced 1/16" apart
- L11—5 turns No. 14 enamel, ¾" diameter, ¾" long
- L12—3 turns No. 14 enamel 1" diameter spaced to make coil ½" long
- L13—Inca D-22 or equal 20-henry choke (need 2 or 1 double one)
- C1—25-mfd. variable, isolantite insulation
- C2—.01-mfd., 400-volt paper (12 needed)
- C3—50-mfd. midget variable (bakelite ends satisfactory or mica compression type may be used)
- C4—ditto
- C11—25-mfd. electrolytic condenser, 25 w.v.
- C12—.01-mfd. mica, 2500-volt
- C13—50-mmf. mica, 500-volt
- C14—100-mmf., 500-volt mica
- C15—25-mmf. variable, isolantite insulation
- C16—50-mmf. mica, 500 volt
- C17—.01 mfd. paper, 400-volt (2 needed)
- C18, C19, C20—3-section electrolytic, 8 mfd. per section, 525-volt peak
- C22—.01 mfd. paper, 400 w.v.
- C23—1-mfd. paper, 400 w.v. (2 needed)

(Turn to page 704)

More Money Per Week
Coyne Training has helped me to keep a job during the depression... I am making more money per week than I have ever made before.
J. J. Broadwell, S. Car.

An Increase in Salary
"Since my graduation, I have worked every day and with an increase in salary."
Joe. Schuster, O.

Thousands of Trained Men Make \$30-\$40-\$50 a Week in ELECTRICITY

TRAIN AT COYNE FOR YOUR START!

Progress With COYNE Training
"My progress so far has been made possible only with the training received at Coyne."
W. Ellis, N. C.

Easier Hours
"Before coming to Coyne, I was a farmer working early and late... I now have a good job."
Lester S. Alt, Ohio

LEARN BY DOING AT COYNE

Industry everywhere is being modernized with new electrical equipment — will use more electricity. Power Plant operators, Electric Maintenance men, Refrigeration and Air Conditioning Service men, Armature winders and Aviation Ignition men make as high as \$30 — \$40 — \$50 a week. Other branches of Electricity also pay good money.

Get out of the untrained class! Better your place in life. If you're in a low pay, discouraging job, get into Electricity... the gigantic, growing field that employs more men than any other industry on earth. Coyne gives you the training for a real start in this better paying field.

TRAIN IN 90 DAYS

ON ACTUAL EQUIPMENT IN COYNE SHOPS

COYNE Training is not by correspondence or Home Study. You work on full size generators, dynamos, switchboards, diesel engines, airplane motors, do many practical electrical jobs. No recitations. No text books. You don't need advanced education or previous experience. It is this practical job training that enables COYNE to train you for a better pay job.

EASY TUITION PAYMENT PLAN — LOW COST BOARD AND ROOM PLAN

Man alive, don't waste the golden years of your life saying: "I can't afford specialized training!" Send for my catalog—see how we help graduates. A special plan takes care of living expenses. Get training first, then pay tuition in 18 easy payments, starting 5 months after you begin school.

PART TIME EMPLOYMENT

Need part time work to help pay living expenses? Write and tell us. We have helped hundreds.

Air Conditioning, Refrigeration, Diesel

Included — extra instruction without extra cost.

JOB AFTER GRADUATION SERVICE — We keep in touch with many large firms, ready at all times to supply their needs for trained electrical men. Graduates get Free Lifetime Employment Service.

GET MY FREE BOOK — NOW

Send for the big FREE COYNE Book of facts... jobs... salaries... opportunities... photos. See PROOF that we assist graduates — PROOF that COYNE training pays!

CLIP THE COUPON RIGHT NOW! SEND IT! There's no obligation.

Mr. H. C. Lewis, President,
COYNE ELECTRICAL SCHOOL,
500 S. Paulina Street, Dept. 57-81, CHICAGO

Send your Big FREE Illustrated Catalog.

Name..... Age.....

Address.....

City..... State.....

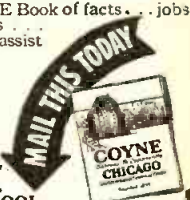

Learn RADIO from REAL RADIO ENGINEERS!

HERE THEY ARE



Kendall Clough
Chief Engineer,
Clough-Brengle
Company.
E. E. Gramer
Chief Engineer,
Standard Trans-
former Co.
Marl E. Hasset
Chief Research
Engineer,
Zenith Radio
Corp.
F. H. Schnett
Radio Engineer,
Granov Radio
Dr. C. M.
Blackburn
Production Dept.,
P. R. Mallory
and Co.

Many R-T-I Trained Men Earn up to \$75 a Week and More

These industry appointed engineers, who work for large radio manufacturers, will supervise your training at home, and get you ready for good-pay jobs in Radio Broadcasting, Installation, Servicing, Public Address System and Photo Electric Cell work. Also for coming activity in Television. Opportunities for properly trained men better than ever before. Earn while you learn. Some make \$5 and \$10 a week extra in spare time one to two weeks after starting. Many earn up to \$75 a week in full time jobs, or their own business. Some even more. No other training like mine. Get the facts if you want a better job. Write now for my free book.

RAY D. SMITH, President.

RADIO AND TELEVISION INSTITUTE
Dept. 45, 2150 Lawrence Avenue, Chicago, Ill.

MAIL COUPON FOR FREE BOOK

RAY D. SMITH, President
Radio and Television Institute (R-T-I)
2150 Lawrence Ave., Dept. 45, Chicago, Ill

Without obligating me, send me FREE Book about spare-time and full-time radio opportunities and how I can train for them at home.

Name.....
Address.....
City..... State.....

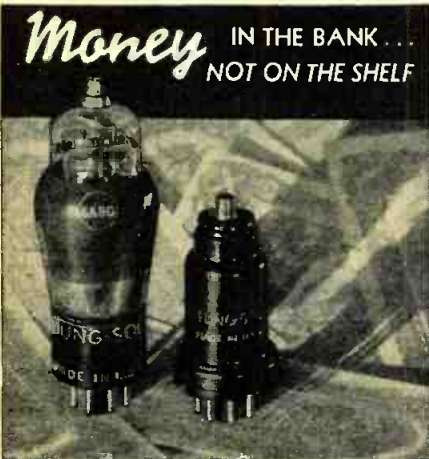

That's only one of the advantages of the TUNG-SOL CONSIGNMENT PLAN. No outlay for an adequate stock of these high quality tubes. No repeated investments to keep that stock up to the minute. Sell—collect your profit—then remit the cost price. That's "velvet"—for you! Tung-Sol performance means repeated, full-profit sales. There are still desirable locations for the appointment of reputable dealers... who can qualify. Write for the name of your nearest Tung-Sol wholesaler.

TUNG-SOL
Flow radio Tubes
TUNG-SOL LAMP WORKS, INC.
Radio Tube Division
NEWARK, N. J.

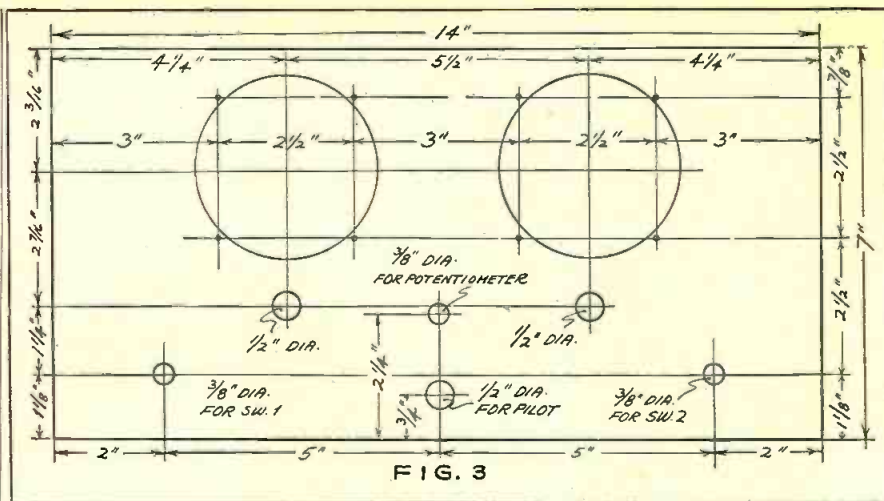

10-Meter Converter

(Continued on page 667)

tector coils should consist of 12 turns of No. 14 tinned copper wire and should be 5/8 inch inside diameter. The oscillator coil should have 11 1/2 turns. All coils are spaced to length of about 1 1/2 inches. An oscillator cathode tap 2 1/2 turns up from the ground end will be satisfactory. On the detector coil the cathode tap is connected 1 1/2 turns above ground.

5. As the variable condenser rotor frames are secured to the isolantite insulation with hollow rivets, the ground leads from the coils may be conveniently mounted and soldered in them—affording excellent support for the inductances. Grid leads are then soldered to the stator terminal lugs. The condenser spring contacts should be connected to the mounted ground leads.

6. The voltage supplied from the filter system will be much more than 250, so the voltage taps on R9 become quite necessary for proper converter operation. C17A will be optional. It is used in the model shown here and is, with C17, a dual 8-8 mid. cardboard container electrolytic.

7. Leads from the change over switch to the r.f. coil and to other associated components should be shielded in low-capacity shield tubing to avoid undesirable interaction.

8. When using the particular cabinet specified, it will be necessary to set the chassis back about one-eighth inch from the panel. This is done by placing spacers over the protruding shafts (SW1, SW2, and R8) before the panel is set in place. The dial assembly cutouts will be required to drop the dials for both condenser shaft alignment and proper panel hole matching.

With his converter constructed, a trial set of coils built and installed, and continuity and components carefully checked, a builder should first get voltage readings. Point X, on R9, must be adjusted to give 250 volts at full drain, and the 6L7 screen tap moved to provide 100 volts at the socket screen terminal. R2 should drop the B plus to about 100 for the 6K7 screen. The 6C5 plate should read 100 volts, the 6K7 cathode —3.

If hum is in evidence, add C17A to the circuit. If it still persists check the grounding and by-passing of the filament at the detector socket. There should be no hum trouble if the various components specified are used and the layout at least approximates that of the laboratory model.

The first step in placing the receiver in operation is to connect the antenna to the grid cap of the detector tube, tune the re-

ceiver to about 1600 kc. and then tune the output transformer (C11) for maximum noise. Also try the three coupling schemes shown in Figure 2 and adopt the one which provides the highest noise, retuning the plate condenser as each change is made.

The antenna should next be connected to the antenna terminals of the converter, and the two dials manipulated until noise is loudest. With the 75 mfd. oscillator trimmer condenser adjusted so its plates mesh about 1/4 inch, this circuit will probably resonate in the 10-meter band, so forget about it for the moment, and concentrate on the r.f. and detector circuits. By spreading or closing the coils, and by adjusting the mica trimmer (C1A) these circuits are aligned in the usual manner. The 10-meter band covers only about 20 degrees on this tuning dial so it is not necessary to worry about alignment over the entire dial. In the model receiver this band extends from 61 to about 80 on the detector dial. If alignment is poor, the regeneration control will have to be varied considerably as the detector is tuned through the range so this provides a good check on the alignment.

The oscillator coil is next adjusted. With the oscillator tuning condenser set at maximum capacity, adjust the trimmer C15A (tuning the r.f. and detector circuits at the same time) with a screw driver to a frequency a little lower than the lowest signal heard on the 10-meter band. Then tune the converter (both dials) to the highest signal heard on the 10-meter band. If the band is found spread over 50 degrees or more leave it that way for a while and practice tuning until familiar with its operation. Then by adjusting the oscillator coil and readjusting C15A it will be possible to spread the band over the full 100 degrees.

It is impossible in a limited space to give complete detailed directions for this adjustment of coils, trimmers, etc., but a little experimentation on the part of the constructor, based on the suggestions given above, will do the trick nicely. When finished, the r.f. alignment should be so good that in tuning from one end of the 10-meter band to the other, regeneration will remain maximum without having to readjust the regeneration control more than 1 or 2 degrees at the most; the oscillator dial will just cover the 10-meter band; and this band will spread over about 20 degrees on the detector dial (or more if a turn or two are taken off the r.f. and detector coils so the ganged condensers will operate near full capacity).

The condenser C5 should finally be adjusted for best results. It is best to adjust this on a weak signal, striving not necessarily for maximum signal strength, but rather for the best signal-to-noise ratio.

Slight readjustment of the r.f.-detector alignment may be necessary after this is done.

Leads from the converter to the receiver should be short and, if they show any tendency to pick up noise, twist them together.

The model shown in the photographs does not have the antenna change-over switch wired in because it was intended for use with a special 10-meter antenna and another antenna was used when tuning the main receiver in other bands. Switching the receiver from the converter to its own antenna was accomplished externally.

In closing, it is well to advise those who are not familiar with 10-meter operation, that ignition noise is a far greater nuisance on this band than any other. If you live on a street where auto traffic is heavy, don't blame the converter for the noise picked up. Other types of noise, on the other hand, will be negligible.

List of Parts

- TR1, 2, 3—See Text
- TR4—Meissner type 1497 Ferrocart (iron core) R.F. trans.
- TR5—Jefferson type 463-381 power transformer
- CH1 and CH2—Jefferson type 466-420 filter chokes
- F—Jefferson 469-841 fuse block, with 188-534 fuse
- SW—ICA or EBY S.P.S.T. rotary line switch
- SW2—Yaxley type 760 D.P.D.T. jack switch
- P—Yaxley type 310-G Dial light
- RFC1 and RFC2—Hammarlund CH-X 2.1 mh Rf chokes
- C1, C6, C15—Hammarlund MC-20-S variable condensers
- C1A—Hammarlund type MEX, 30 mfd. mica trimmer condenser
- C5—Hammarlund 1BT-70 isolantite-based trimmer
- C11—Hammarlund APC, APC-75, ACR trimmer, 75 mfd.
- C12—Hammarlund trimmer (size determined by trial)
- C3, C2, C6A, C7, C8—Aerovox type 1467—.006 mfd. (mica)
- C4, C9—Aerovox type 484—.1 mfd.
- C10—Aerovox 284—.1 mfd.
- C16—Aerovox 284—.05 mfd.
- C13-C14—Aerovox type 1468—.0001 mfd.
- C15A—Hammarlund APC-75, air trimmer, 75 mfd.
- C17-C17-A (latter optional) two PBS 5 8 mfd single section electrolytics, or single dual section PBS 5 8-8 (Aerovox)
- C18-C19—Aerovox GLS-5, 8 mfd. miniature electrolytics
- C20-C21—Aerovox 1467—.002 mfd.
- C22-24—Aerovox 484—.05 mfd.
- R8—Electrad 995W (10,000 ohms wire wound) or 205 (50,000 ohms, carbon) potentiometer
- R9—Electrad type A—100 ten-watt voltage divider, with two extra sliders
- R1—Continental, 500 ohms, 1 watt
- R2—Continental, 100,000 ohms, ½ watt
- R3, R6—Continental, 50,000 ohms, ½ watt
- R4—Continental 600 ohms 1 watt
- R5—Continental 5,000 ohms ½ watt
- R7—Continental 10,000 ohms 1 watt
- 1—EBY three-post antenna-ground assembly
- 2—EBY two-post assemblies (for output connection and antenna coil support)
- 1—EBY multi-point screw terminal strip for TR4 output winding connections underneath chassis
- 1—ICA 3830 cabinet—14x8x7, lift cover
- 1—ICA 1527 chassis to match (12x7x3 inches)
- 3—American Phenolic RSS-8 Steatite octal sockets
- 1—American Phenolic S-8 moulded octal socket
- 2—Crowe type 371 Micrometer dials
- 2—Crowe type 282 knobs, less pointers
- 1—Crowe type 591 knob, with pointer
- 1—Crowe type 541-A "Change-O-Name" dial plate
- 2—Crowe 274 switchplates or equivalents
- 10 feet no. 14 tinned wire
- 3—Hammarlund "FC" insulated couplings
- 1—piece aluminum about 4"x4½" for partition to serve as mounting for C15A

Thoughts on 10-Meter Sets

(Continued from page 661)

The sensitivity measurements were made to determine sensitivity at a given signal-to-noise ratio. The signal-to-noise ratio of 6 to 1 was selected because this is a standard which represents excellent recep-

tion with negligible perceptible noise. This measurement was made by varying the input from the signal generator until a level was reached where an output meter indicated a 6-volt signal when modulated (400 cycles, 30 percent), but dropped to 1 volt when the modulation was turned off (leaving only noise). Under these conditions the sensitivity of the highest-frequency band (20-40 megacycles) proved to be 1.45 microvolts at 20 megacycles, .9 microvolts at 25 megacycles, .75 microvolts at 28 megacycles and .75 microvolts at 30 megacycles. Measurements at frequencies from 30 to 40 megacycles could not be made due to the fact that the signal generator employed had a range limited to 30 megacycles. In considering the results of these measurements, it should be borne in mind that these figures do not represent absolute sensitivity but rather the sensitivity at a signal-to-noise ratio which represents substantially complete freedom from noise. Had the measurements been made at a signal-to-noise ratio of 1 to 1, for instance, the sensitivity would appear a good deal better.

Actually, the external noise pick-up when using a receiver in even an excellent location is so much greater than the noise developed in the receiver circuits that it is never possible to take advantage of the full sensitivity of a receiver as sensitive as this one is proved to be by these measurements. Incidentally, a check of these figures against the sensitivity curves shown for this receiver in the February issue will show a striking similarity to the sensitivity of the 10-20 megacycle range.

Measurements of image selectivity were made at 14 megacycles and again at 28 megacycles. This was accomplished at 14 megacycles by adjusting the signal generator to resonance and cutting down the signal input until the output meter showed an output of 6 volts. The signal generator was then tuned to the image frequency and its output increased until the initial value of 6 volts was again shown on the output meter. The ratio of the original 14 megacycle signal to the value required at the image frequency represents the image-selectivity ratio. This same procedure was repeated at 28 mc. At 14 megacycles the ratio proved to be 1200 to 1, and at 28 megacycles, 150 to 1. Actually, image selectivity of 150 to 1 is normally considered excellent even at such low frequencies as 10 to 15 megacycles. To obtain this degree of excellence at 28 megacycles is a real accomplishment which guarantees complete freedom from image interference except under the most extreme conditions. It is extremely important, too, because if repeat points were present they would fall within the 10-meter band and cause serious interference.

Finally a check of the band-spread tuning was made on the 28 to 30 megacycle band. With the tank condenser set at 30 megacycles and the band-spread dial set at 100, this band was found to spread over 91.5 divisions of the 100-division band-spread dial. In other words, a 28-megacycle signal would tune in at 8.5 on the band-spread dial, a 29-megacycle signal at 57, and a 30-megacycle signal at 100. This means that tuning in this range is almost as spread out as tuning in the broadcast band. As a matter of fact, it is easier than tuning most broadcast receivers because of the large size of the band-spread dial of the Super-Pro.

These measurements prove quite definitely that except for image-selectivity, we can logically expect the same effectiveness in the 28-30 mc. range of a well-designed receiver as we can in the lower frequency ranges.

Some problems are naturally encoun-

EVERY SERVICEMAN SHOULD OWN

....This Combination VOLT-OHM-MILLIAMMETER AND FREE POINT TESTER

Model 640-740

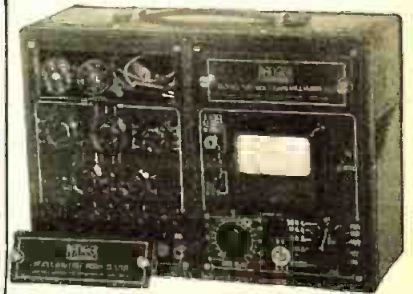

- Precision Built
- No Extra Cases To Buy
- Designed to Withstand Rough Field Servicing

DEALER PRICE \$27.00

Just what you need for field use. Every large service shop should own duplicate servicing instruments, as protection against rush work, instruments damaged in service, and for taking care of other emergencies.

The Ranger-Examiner Model 640 Free Point Tester has eight automatic switch type and ten single action jacks. Five sockets handle any type tube.

Model 740 Volt-Ohm-Milliammeter has 3" square Triplett Precision Instrument. Scale readings: 10-50-250-500-1000 A.C. and D.C. Volts at 1000 Ohms per Volt (D.C. Accuracy 2%; A.C. 5%); 1-10-50-250 D.C. M.A.; 0-300 low Ohms; High Ohms to 250,000 at 1.5 Volts. Rheostat adjustment for 13-½ volts for Ohm readings to 2.5 Megohms. Batteries may be added permitting such readings in 250,000 ohms steps. Low Ohms to ½ ohm with 25 ohms in center of scale. Backup circuit is used. Current draw is only 1 M.A.

Model 640-740—Portable Free Point Tester and Volt-Ohm-Milliammeter

DEALER NET \$27.00

Model 640—Free Point Tester only in Portable Case

DEALER NET 9.90

Model 740—Volt-Ohm-Milliammeter only in Portable Case

DEALER NET 18.60

FREE Booklet. Lists 101 most frequent Radio Troubles, How to Detect and How to Cure. Nothing like it before. Greatly simplifies everyday servicing. Send coupon now.



READRITE METER WORKS,
515 College Dr., Bluffton, Ohio

Please send me more information on Model 640-740; Model 640; Model 740. Free booklet, "101 Radio Troubles and Their Cures."

Name

Address

City State

**FINEST FOR Every
RADIO NEED**



Because...

- Famous Metallized Type Resistance Element.
- Fully insulated—no shorting.
- Sealed throughout—impervious to atmospheric effects.
- Enclosed positive contact—will not break or become "open".
- Small, sturdy, light in weight.
- Both RMA color coded and imprinted with resistance value and wattage rating.

1/2 WATT, List 17c, NET 10c
1 WATT, List 20c, NET 12c
2 WATTS, List 30c, NET 18c.

IBC
INTERNATIONAL
RESISTANCE CO.
401 N. Broad St., Phila., Pa.

**INSULATED
Metallized RESISTORS**

**RADIO
ENGINEERING**
DEGREE
IN 2 YEARS

Complete Radio Engineering course in 96 weeks. Bachelor of Science Degree. Radio (television, talking pictures and the vast electronic field) offers unusual opportunities for trained radio engineers. Courses also in Civil, Electrical, Mechanical, Chemical, Aeronautical Engineering; Business Administration and Accounting. Also short diploma courses in Surveying (36 weeks), Drafting (36 weeks). Low tuition, low living costs. World famous for technical two-year courses. Those who lack high school may make up work. Students from all parts of the world. 54th year. Enter June, September, January, March. Write for catalog.

1657 College Ave. Angola, Ind.

**TRI-STATE COLLEGE
ELECTRIC EYES**

Be the first in your community to install electric eye devices and reap a rich reward. Simple electric eyes for opening doors, announcing people in offices, safety protection across doorways and many other uses can be bought at low cost. \$10.00 cash with order or C.O.D. brings you a marvelous electric eye complete with caesium photo cell. Operates from 110 volts AC or DC. Money back guarantee. If not satisfied return unit to us in good condition within 10 days and money will be refunded. We can supply photo electric equipment for any purpose, sorting machines, grading machines, traffic counters, laundry counters, oil burner safety controls and many other devices. A postcard will bring complete information for any special applications.

ELECTRONIC PRODUCTS COMPANY, 2 St. Charles, Illinois

**TRIMM WORLD FAMOUS
FEATHERWEIGHT HEADSETS**

The first choice of amateurs and commercial operators

TRIMM RADIO MFG. CO.
1770 W. Berneau, Chicago

tered in this ultra-high frequency range, but it is apparent from the above tests that these problems can be overcome. In receivers such as this, it is, of course, necessary to use relatively high tank tuning capacity with the result that when the inductances become as tiny as those required at 40 megacycles, the LC ratio becomes highly unfavorable. In this receiver compensation for this was provided by, among other things, adopting tuned impedance coupling in the r.f. circuits and by giving very close attention to efficient coil design. A photograph of the ultra-high frequency oscillator coil unit appears as one of the accompanying illustrations. Figure 1 shows the two types of coupling employed in this receiver. "A" is the straight inductive type employed on all except the 20-40 mc. range. "B" shows the tuned impedance type of coupling used on this latter range.

Incidentally, all of the refinements of the receiver are taken advantage of in this highest frequency range as well as on the lower frequencies. The two stages of tuned r.f. preselection function on all ranges as does the a.v.c. system, variable selectivity feature, etc.

Every ham who has recently operated on the 10-meter band knows that its phenomenal, low-power DX possibilities are attracting a horde of stations with the result that on a Sunday afternoon, for instance, QRM is a definite problem. This, together with the wide-range fading which is peculiarly characteristic of this band, make the use of a good receiver more and more a necessity. A receiver which offers sensitivity, selectivity and a good signal-to-noise ratio, combined with a good antenna, will result in fewer unfinished contacts and proportionately greater satisfaction and enjoyment.

While this article has been directed at the amateur, it will, of course, be of interest to engineers and operators of commercial, police and other stations operating in the higher ranges. The short-wave listener, whether interested in the international band around 21 mc., or in the high-fidelity broadcasting in the 30-40 mc. range, should likewise find it informative.

The Capatron

(Continued from page 659)

calibration process. It is well, therefore, to pick up some short-wave stations of accurately known frequency and beat against them, spotting the points on the calibration curve.

In the very high-frequency ranges, image repeat points should be watched for. These will occur at a point twice the i.f. from the actual frequency. With a receiver having 450 kc. intermediates, for instance, the oscillator may push through a signal at 18,900 kc. when the receiver is tuned to 18,000 kc.

The modulation percentage calibration may conveniently be made with a cathode-ray oscilloscope, using either the trapezoidal method or, more roughly, from the modulated envelope. In the former method, no sweep circuit will be required. The ungrounded vertical plate of the cathode-ray tube is connected to the plate of the 6J7 oscillator through a blocking condenser. The corresponding horizontal plate is connected to the suppressor grid. The modulation percentage control is then adjusted until the trapezoid just becomes a triangle. About 6 volts r.m.s. will be required. This point represents 100 percent modulation. Add sufficient resistance in series with the modulation control and the jack to make this point occur at "full-on" setting. If a

linear control is employed, as specified, the percentage modulation will then be well spread out over the range. With 3 volts at 400 cycles, 50 percent modulation is secured; at 1.2 volts, 20 percent, etc. If there is any difficulty in obtaining the 10-megohm linear control, which is not a stock size, R20 may be eliminated and a .5 megohm linear control substituted.

External modulation may be employed by plugging the output of a beat-frequency oscillator, or other a.f. source, in the jack provided. A separate tube voltmeter will be required for checking the audio voltage supplied.

In operation, the output level should first be adjusted with the r.f. control set to give some predetermined voltage, say 1 volt, using an unmodulated signal. The modulation percentage should then be set, disregarding any change in the voltmeter reading. If the attenuation ratio is 20 to 1, as described before, the zero level is now 50 millivolts. A dummy antenna is inserted between the output cable and the receiver input, not at the signal generator output, and tests may be conducted in the usual manner.

At ultra-high frequencies, it will not be possible to obtain accurate sensitivity measurements, due in part to the inherent difficulties in making such tests and partly to the low output of the oscillator. It is hard to read .2 volt with any degree of accuracy with such an inexpensive tube voltmeter design. Also, considerable care will be necessary in grounding the cable if the attenuator is to be most effective. In some cases, the cable will have to be very short and placed close to the receiver input, otherwise there will be an appreciable difference of potential between the receiver and signal generator. In such cases, the decreased capacity of the output circuit caused by shortening the cable may be made up by placing an equivalent mica condenser across the signal generator output. With a little practice, however, excellent results will be had. On the other bands, though, these difficulties are not present and tests may be conducted with ease and assurance.

With the cable connected to the receiver, it should be possible to obtain a minimum output of 1 microvolt at 17 megacycles. At lower frequencies, using additional capacity across the output terminals, even lower output is obtainable.

Growing Dollars in the P.A. Field

(Continued from page 659)

tion at instruction classes, etc.

Schools, Colleges—Centralized radio, re-broadcasts, for auditorium use, for individual classroom, for central talking to any one or all rooms, for principal to listen to activities in any room, music, recordings, etc.

Ships—Centralized radio for passengers, paging system, general announcements, for amplifying music, for general entertainment—also requirements of Department of Commerce for purpose of safety on ships of certain size and purpose.

Garages—To call car wanted and thus speed up delivery of parked cars, calling for information on repairs, paging, etc.

Other uses not specifically listed above include: Apartment houses, armories, assembly halls, auction rooms, ballrooms, clubs, court rooms, dining rooms, docks and wharves, night clubs, office buildings, roof gardens, sound trucks, swimming pools, gymnasiums, trailers, vaudeville, window demonstrations.

HERE IT IS!

The Instruction Book That
Thousands of Radio News
Readers Asked Us To
Publish!



GIVEN FREE!

With a Subscription for 5 Months
Radio News at \$1

"34 Lessons in Radio and Television" will guide you, step by step, in clear, easy-to-understand language, from the elementary theories of radio and electricity to the intricate problems involved in constructing modern radio receivers. You learn how to build carefully-designed, high-efficiency receivers—and understand how and why they work! You find out how vacuum tubes operate—what radio frequency, audio-frequency, regeneration and automatic volume control mean and what they accomplish—how to become a radio amateur—and all of the other information you have always sought!

In addition, this book covers the History of Television to date—Television with Kerr Cells—Scanning Disk Television—Cathode-Ray Tubes in Television—Television Receiver Design—and Present-Day Television.

You can obtain a copy of "34 Lessons in Radio and Television"—a large 3" by 11" book—*absolutely free* by placing a new or renewal subscription today for 5 issues of Radio News at \$1. Act Now—the supply is limited!

MAIL THIS COUPON TODAY!

Radio News, Dept. 375A
461 Eighth Ave., New York, N. Y.
Enclose find \$1. Enter my subscription for the next 5 issues of Radio News and send me "34 Lessons in Radio and Television" free of charge. (Canada and Foreign \$1.25).

Name.....

Address.....

City..... State.....

If you are a serviceman, please check here ()

Flood Relief

(Continued from page 663)

exists."

Broadcasting stations, too, did their part. They co-operated with amateurs and formed relay networks. Many of the principal broadcasting stations in the flood area suspended regular broadcasting to take part in the relief work. They maintained constant communication with amateurs and were authorized by the authorities to carry on two-way communication with these stations. There was WLW in Cincinnati, WHAS in Louisville, WMC in Memphis, WSB in Atlanta and others. All of these stations were in constant communication by both amateur radio, and where possible, by telegraph and telephone, with relief agencies such as the Red Cross, the Coast Guard and the Army engineers. Many of the broadcasting stations sent their own short-wave portable transmitters into the flood zones and helped maintain two-way communication. They broadcast warnings to listeners and instructions to residents in threatened areas.

This co-operation between communication agencies did much to help the efficiency and dispatch of traffic. Without a doubt the amateurs participating in this flood relief work were as efficient in the handling of their traffic as any commercial agency. They deserve tremendous credit for the work they did. Every message handled was of great importance. Unlike previous disasters, there was no cluttering up of the wavebands with useless messages and there was little trouble experienced with interference. Transmissions were short and terse. This was true of both telephone and telegraph operators.

It would be impossible to list all of the stations that had a hand in handling the important flood traffic. There were literally hundreds on all of the bands used. As the flood waters rushed down the Ohio, amateur stations all along the line sprang into action. First at Cincinnati, then Evansville, Cairo, Harrisburg, Ill., Louisville, Memphis, Chicago, and other small towns in the area. Many of these operators passed as many as 100 hours without sleep; others were helped by their wives and other operators whose stations were put off the air by the flood. Many found it necessary to rig up emergency power apparatus when generating plants were put out of commission by the flood waters.

The United States Naval Reserve and the Army Amateur Net pressed all of their facilities into service. The Navy Communication Reserve, particularly, helped in supplying communication between rescue boats on the rivers, including many of those of the Coast Guard and Army engineers. The Navy Department stated that approximately 100 officers and 800 enlisted men of the Communication Reserve were operating 200 radio stations in co-operation with the Red Cross and local officials in connection with rescue and relief work in the flooded areas. Members of the Naval Communication Reserve maintained watch at stations in the 4th Naval District Headquarters at Philadelphia; 5th Naval District Headquarters, Norfolk; 8th Naval District Headquarters at Charleston, S. C., and 9th Naval District Headquarters, Great Lakes, Ill. These Naval Reservists, the majority of whom are amateurs, served on a volunteer basis and in some cases were on duty during the entire period of the flood. They were mobilized in accordance with the Navy Department's Red Cross Emergency Plan. The control stations handling the Naval communications operations were NDC and

RIDER BOOKS



Look this List over
CAREFULLY

- NEW** ALIGNING PHILCO RECEIVERS
8,000,000 Philcos produced! You need this book, giving complete instruction for fast alignment operation on EVERY Philco in existence. 176 pp. \$100 hard cover—only
- PRACTICAL** THE CATHODE-RAY TUBE
Written especially for servicemen, you need this if you have bought or plan the purchase of an oscillograph. \$250 336 pp. 450 ill.
- MODERN** SERVICING RECEIVERS BY MEANS OF RESISTANCE MEASUREMENT
How to use Ohmmeter. This method is in line with continuity data now furnished by set manufacturers. \$100 203 pp. 93 ill.
- COMPLETE** "HOUR A DAY WITH RIDER" ON AVC
Make your Automatic Volume Control work easier and more profitable. Written in Rider's personalized style. 96 pp. 48 figures. Hard cover, 60c
- REVISED** SERVICING SUPERHETERODYNES
This popular book in a new edition brought up to date and just published shows how to make repairs quickly. 288 pp. many ill. \$100
- OUT, MARCH** A. C. IN RADIO RECEIVERS
Explanation of behavior of radio frequency and other currents in radio receivers. Order Today—Out March 1st. Hard cover 60c

BE SURE YOUR SET OF RIDER MANUALS IS COMPLETE

Vol.	Covering
VII	\$10.00 1936-37 1600 Pages
VI	\$ 7.50 1935-36
V	\$ 7.50 1934-35
IV	\$ 7.50 1933-34
III	\$ 7.50 1932-33
II	\$ 6.50 1931-32
I	\$ 7.50 1920-31



JOHN F. RIDER, Publisher 1440 Broadway, New York City

RIDER MANUALS

NOW IN SEVEN VOLUMES

Doing a world-wide job....

little giant

SOLAR
COMPACT Dry Electrolytic CAPACITORS

So small... efficient... completely equalling standard sizes in dependability! All usual capacities; two ratings, 450 v.w. and 200 v.w. You won't believe your eyes!

SOLAR MFG. CORP.
599-601 Broadway, New York, N. Y.

Descriptive literature upon request.



Announcing the New PHILHARMONIC!

Far surpasses all previous standards of distance, power, tone and beauty. "PROVED" performance heretofore considered impossible by engineers. Has EIGHT NEW FEATURES (patents applied for). Guaranteed to outperform any radio receiver ever built. 30 Tubes... Tonal Range 30 to 16,000 Cycles... Six Bands 3.75 to 2000 Meters... Greater Continuous Selectivity 2 to 16 Kc... more perfect Automatic Gain Control on R.F. and I.F. Amplifiers... more usable Sensitivity... finer Custom-Built Quality... Guaranteed 5 years. Prices begin at \$250.00

SEND THIS COUPON!

E. H. SCOTT RADIO LABORATORIES, INC.
4440 Ravenswood Ave., Chicago, Dept. 5H7

Please send interesting FREE technical data on new Scott Philharmonic. (No obligation).

Name _____

Address _____

STUDIOS: CHICAGO - NEW YORK - LOS ANGELES

Clear
sound
reproduction



Be sure your transformer is an AmerTran if you're aiming for clear, dependable amplification. The combination of AmerTran's fine materials and manufacturing skill produce units whose reliability is acknowledged by experts throughout America and the world. Write for free Bulletin 1002.

AMERICAN TRANSFORMER CO.
178 Emmet St. Newark, N. J.

AMERTRAN
QUALITY TRANSFORMERS SINCE 1901

N8AAO at Pittsburgh; NDE at Wheeling, W. Va.; N8PSR, Huntington; NDK, Norfolk; NDS, Chicago; NID, Akron; NEG, Cincinnati; AX9H, Louisville, and DG9C at Centralia, Ill.

Many reports of the heroic work of the amateurs have been recorded. One in particular reveals how fellow amateurs brought help to one of their number who had been doing yeoman service and became stranded in a tent on a railroad crossing west of Shawneetown, Ill. The operator was Robert T. Anderson, W9MWC, of Harrisburg, Ill. Early one morning during the peak of the flood he made frantic pleas for food and medical supplies and a boat to save thirteen stranded with him. Anderson was using a portable transmitter, operating it from batteries. His signals died before he was able to get detailed word of the group's need through.

William R. LaVie, of Louisville, Ky., who heard the report, made an urgent plea for other stations in the area to attempt to pick up W9MWC's feeble signals. He succeeded in contacting Koester E. Schonert, W9HQD, who was twenty miles from Anderson. W8CXR at Wheeling, W. Va., broke in and offered his help, stating he possibly could hear all the stations participating because of the "skip-distance" benefit he had. After several hours of frantic effort, W9ELL managed to contact W9MWC. His first message was: "Need food badly; all medical supplies..." So finally W9HQD and W9MWC established contact.

"Hello, Bob," said W9HQD. "Let's get all the Red Cross stuff through before taking up the personal. How much foodstuff you got? Do you need money? Medicine?"

"Tell us specifically what you need. Bob, divide up the group into committees. Have each group take up certain angles. Boats are leaving here at 8 a.m., but we've got to know what you need. Airplanes are coming down. We're passing along whatever you need to the Naval Reserve. Go ahead."

(Turn to next page)

DON'T MISS ALL THE F !

The Skilled Operators You Hear are **CANDLER TRAINED**

You'll learn fast when you practice right. The CANDLER way is always successful. Radio Code champion McElroy and thousands of others owe their success to Walter Candler. This system is taught at Harvard University by champion McElroy. Candler training is so inexpensive, so easy, so sure of results that students say, "I was cheating myself when I tried to learn code alone." You can be sure of success in your future radio code work. Everyone knows that CANDLER trained men are fast, accurate and capable.

With CANDLER training, your Gov't. Exam. will be fun. Ask the Experts!

SEND FOR FREE BOOK OF FACTS

CANDLER SYSTEM CO.
Asheville Dept. N-5 North Carolina

T. R. McELROY

WORLD'S CHAMPION RADIO TELEGRAPHER
23 Bayside Street, Boston, Mass.

MAC KEY @ \$7.95 a real speed key
MAC KEY DELUXE @ \$15.00
MAC CORD @ 1.00
MAC CASE @ \$3.95
MAC OSC @ \$3.95 ac-dc oscillator tone control
If u hv Mac Key wri me fo xmy ipt & dsrb lfn.
All my stuff emcy god best pduts obl. 73 Mac.

RADIO BEGINNERS!

All installments of "The Radio Beginner" which have appeared to date are included in the new book "34 Lessons In Radio And Television"—together with other valuable data on radio and television which could not be included in the original lessons due to space limitations. Make sure you get a copy—see our special offer on Page 701.—RADIO NEWS

INDEX TO ADVERTISERS

Aerovox Corp.	678	Meissner Mfg. Co.	682
Akrad Products Co.	680	Midwest Radio Corp.	682
Aladdin Radio Industries, Inc.	684	Million Radio & Television Lab.	703
Allied Radio Corp.	Back Cover	Modell's	704
American Transformer Co.	704	Montgomery Ward	681
Amerite Corp.	686	Morrill and Morrill	694
Bliss Electrical School	681	National Radio Institute	641
Bond Radio Co.	704	National Schools	686
Brush Development Co., The	684	National Union Radio Corp.	681, 684
		New York Y.M.C.A. Schools	696
Cameradio Co.	690	RCA Institutes, Inc.	704
Candler System Co., The	702	RCA Manufacturing Co.	678
Capitol Radio Engineering Inst.	688	Radio City Products Co.	696
Central Radio Laboratories	688	Radio Service Inst.	694
Chicago Wheel & Mfg. Co.	684	Radio & Technical Publishing Co.	680, 690, 691
Clark Co., The	704	Radio & Television Inst.	698
Classified Ads.	703	Radio Training Ass'n of America	684
Clough-Brengle Co.	647	Radolek Co., The	703
Cornell-Dubilier Corp.	704	Raytheon Production Corp.	693
Cornish Wire Co., Inc.	703	Readrite Meter Works	699
Coyne Electrical School	697	Rider, John F.	701
Dodges Institute	694	Scott Radio Labs., Inc. E.H.	702
Electronic Products Co.	700	Silver Corp., McMurdo	Inside Back Cover
First National Television, Inc.	692	Solar Mfg. Corp.	701
General Electric Co.	Inside Front Cover	Sprayberry Academy of Radio	683
Goldentone Radio Co.	704	Standard Radio	691
Hallierafters, Inc.	694	Standard Transformer Corp.	696
Hammarlund Mfg. Co.	685	Teleplex Co.	677
Hygrade-Sylvania Corp.	695	Triad Manufacturing Co., Inc.	704
Instructograph Co.	692	Trimmo Radio Manufacturing Co.	700
International Resistance Co.	700	Trindl Products	677
Kato Engineering Co.	681	Triplet Electrical Instrument Co.	687
Kenyon Transformer Co., Inc.	677	Tri-State College	700
Lincoln Engineering School	703	Try-Mo Radio Co., Inc.	692
McElroy, T. R.	702	Tung-Sol Lamp Works, Inc.	698
Mallory & Co., Inc. P.R.	648	Utah Radio Products Co.	702
		Webster Company, The	689
		Weston Electrical Instrument Corp.	679
		Wholesale Radio Service Co.	645
		Wright-DeCoster Co. Inc.	703

MILLION

ILLUMINATED METER



TUBE TESTER and ANALYZER

1. All tubes.
2. Short hot.
3. Leaks hot.
4. 0 to 10 M. ohms.
5. 0 to 15 Meg. ohms.
6. .01 to 3 MF.
7. 30 - 300 - 900 VDC. 5000 ohms per volt
8. Electrolytics

MODEL TV

\$27.95

NET

MODEL TM Without analyzer scales. Write for Literature **\$18.95**

MILLION RADIO AND TELEVISION LABORATORIES
363 W. SUPERIOR ST., CHICAGO, ILL.

Correspondence Courses in RADIO and ELECTRICAL ENGINEERING

ELECTRICAL ENGINEERING Covers complete electrical field. Most modern courses. So simplified anyone can grasp quickly. Prepares you for secure future. **LOW COST.**

RADIO ENGINEERING Ultra-modern course in radio, public address, photo-electric work. Trains you to be super-service man, real vacuum tube technician. Diploma school pin given. Experimental kit—on limited time offer. Tuition ONLY \$25. either course. **SEND NOW!** Ask about deferred payment plan.

FREE!

Send name for copies of school outlines, student magazine, etc. **SEND NOW!**
Lincoln Engineering School, 931-2250, 37th St., Lincoln, Nebr.

On broadcast as well as shortwave frequencies, in any location, you can eliminate "man-made" static with

NOISE-MASTER

ALL-WAVE ANTENNA

Send for complete literature.

CORNISH WIRE CO., 30 CHURCH STREET, NEW YORK CITY

Read Classified Advertising—It Pays

Advertisements in this section sixteen cents a word for each insertion. Name and address must be included at the above rate. Cash should accompany all classified advertisements unless placed by an accredited advertising agency. No advertisements for less than 10 words accepted. Objectionable or misleading advertisements not accepted. Advertisements for these columns should reach us not later than 3rd of 2d month preceding issue.

TECK PUBLICATIONS, INC.
461 Eighth Ave. New York, N. Y.

Correspondence Courses

USED Correspondence Courses and Educational Books sold or rented. Inexpensive. Money-back guarantee. Write for Free Catalog listing 4000 bargains. (Courses Bought.) Lee Mountain. Pisgah, Alabama.

BIG BARGAIN Catalogue Courses 10c. Handling, P-799 Broadway, New York.

Patent Attorneys

PATENTS. Instruction "How to Establish Your Rights" and form. "Evidence of Conception" sent Free! Lancaster, Allyn & Rommel, 414 Bowen Building, Washington, D. C.

PATENTS—Advice and booklet free. Highest references. Best results. Prominence assured. Watson E. Coleman, Patent Lawyer, 724 9th Street, Washington, D. C.

Patents and Inventions Wanted

INVENTIONS COMMERCIALIZED. Patented or unpatented. Write Adam Fisler Company, 278 Enright, St. Louis, Missouri.

Radio Instruction

AMATEUR RADIO, Commercial Radiotelephone and Radiotelegraph licenses, complete training. Resident and correspondence courses. Every graduate a licensed operator. N. Y. Wireless School, 1123 Broadway, New York.

Radio

GHIRARDI'S Radio Field Service Data (1st Edition). Frequencies, codes, symptoms, remedies. Originally \$1.50. Reduced to 89c. Kenbner Radio Book Co., 1123 Broadway, New York.

Wind Electric Plants

BUILD wind light plant from automobile generator. Dime brings complete plans and catalog. Fan Belt A. C. Generator; 50 other changes. Lefay Manufacturing, 1354 Lake, Minneapolis, Minn.

"We can't contact Shawneetown," W9MWC replied. "We're seven miles from there."

"Can you send up flares? Can you get any information into Shawneetown?" came the reply.

W9MWC's signals faded down at this point. He was advised to switch to c.w. It was reported later that W9HQD asked WEBQ, the broadcasting station, to broadcast of story of Anderson's plight and suggest to listeners in the vicinity that they forward all available storage and B batteries to Anderson if it was possible to reach him by boat so that he may continue his work. His party of thirteen finally was rescued.

Two other stations that contributed much to the success of the emergency communications were W9WC and W9RSC. The former is operated by W. O. Conrad and the latter by John M. Larson. Both are engineers of the National Broadcasting Company at Chicago. They were granted temporary leave by the broadcasting company so they might continue their excellent service during the emergency. They handled many important messages and maintained contact with several of the broadcasting stations conducting emergency traffic. There were hundreds of other stations that did similar service. Among them was W4FK, of Memphis. This station is operated by E. C. Frase, Jr., who is a member of the engineering staff of WMC. His work consisted of handling official communications for the Red Cross, the U. S. Engineers, the Naval Reserve, the Arkansas and Tennessee National Guard units and other agencies. He was helped by his wife and another amateur. The station was on the air continuously, the operators sleeping in shifts.

As far as known, this is the first disaster in which broadcasting stations were pressed into emergency communication service. Ordinarily their licenses prohibit point-to-point communication, but this requirement was waived by the Commission during the emergency. They, as well as the amateurs, demonstrated their value. They provided a means of broadcasting warnings to listeners in their homes who might not otherwise have known what was coming.

Among these stations was WMC, WHAS, WAVE, WLW, WKRC. As an example of the work done by these stations, station WHAS broadcast 16,500 separate appeals for help in five days. Louisville was one of the hardest hit of the larger cities. Power was completely cut off. WHAS pressed into service emergency power generating equipment and maintained operation during the duration of the flood. Over this station Mayor Neville Miller, of Louisville, broadcast frantic appeals to the outside world to bring airplanes, policemen, seamen, trucks, medicines, food, relief supplies, and other necessities for the city of 300,000 persons. It is estimated at least 100,000 persons were taken from their homes as a result of the broadcasts over WHAS. The staff was on duty twenty-four hours a day.

Similar service was done by WMC at Memphis. This station pressed into service both its regular facilities and short-wave equipment normally used for remote broadcasting. It suspended its regular broadcasting for seventy-two hours. A typical example of the work of this station is related in an account of the rescue of 263 persons. They were on an island designated as No. 37 in the Mississippi River near Wilson, Ark. Flood waters were covering the island for the first time in history. They were caught almost unaware. There was little time to spare. Their plight was learned by engineers aboard the steamer *Sequayah*, whereon was

Model



836

1937's

Most Popular Auto Speaker

The above model is a combination of our new automobile speaker cabinet and the model 682—8" Nokoil speaker which requires no field current, thereby eliminating any drain on the battery.

Those who know the quality of the Nokoil Reproducer can well imagine the performance the model 836 is capable of giving.

The steel cabinet has a single stud attached to it, so that the cabinet carries the speaker. This does away with the old type method of drilling a hole in the pole piece of the speaker, making it carry the entire load, which often forces the pole piece off center. In the bottom of the cabinet, holes are provided so it may be base mounted when desired.

List Price Complete with Speaker **\$8.36**

Write for literature and prices on other models. Also name of our nearest distributor.

WRIGHT-DeCOSTER, Inc.
2255 University Ave., St. Paul, Minnesota
Export Dept.: M. Simons & Son Co., New York
Cable Address: "Simonrice".
Canadian Office:
Wright-DeCoster, Inc., Guelph, Ontario

BUILD SALES

WITH

This
FREE
160
Page



RADOLEK PROFIT GUIDE

New 1937 Edition. Just off the press . . . the most complete Radio Parts Catalog ever published . . . completely revised, bigger and better. Everything in radio . . . at the right prices. Over 160 pages of valuable, money-saving "radio-buying" information. Over 12,000 Radio Repair Parts—hundreds of new items—a complete, new selection of Radio Receivers and Sound Amplifiers . . . contains the most complete, exact duplicate replacement parts listings of volume controls, condensers, transformers, vibrators. Every page of this New Radio Supply Catalog brings you extra profits. This is your book—it's FREE. Send for your copy NOW!

RADOLEK

601 W. Randolph, Chicago, Dept. B5

Send me the Radolek Radio Profit Guide FREE

Name:

Address:

Serviceman? Dealer? Experimenter?



Now I standardize on C-D condensers

"There was a time when I would watch pennies! But the couple of pennies I saved by using low quality replacement parts for servicing proved mighty expensive.

Today I use only the finest replacement parts that money can buy. I have found that I keep my customers longer, get a good portion of my business through recommendations and I don't lose money on free repeat calls.

Yessir! I standardize on Cornell-Dubilier condensers. I don't kid myself any longer—I know that the best is the cheapest in the end."

FOR MORE THAN TWENTY-SEVEN YEARS CORNELL-DUBILIER HAS BEEN THE WORLD'S LARGEST EXCLUSIVE MANUFACTURER OF CONDENSERS.

Send for complete catalog No. 137A today!
MICA—DYKANOL—PAPER
WET & DRY ELECTROLYTIC

CORNELL-DUBILIER CORPORATION
1018 Hamilton Blvd., S. Plainfield, N. J.



CAN Take it!

EXCLUSIVE UTAH FEATURES MEAN LONGER LIFE — HIGHER EFFICIENCY

UTAH Vibrators are TOUGH! We've proved it by grueling tests. Manufacturers know it too. That's why UTAH Vibrators are original equipment in more than a million sets. And the 1937 UTAH vibrator is the finest and toughest we've ever made.

Use UTAH Vibrators on your replacement jobs. Prove to yourself they work better, last longer—but cost no more.

Your Jobber has UTAH Vibrators for all radios.
UTAH RADIO PRODUCTS CO.
CHICAGO, U. S. A.

Toronto Buenos Aires
Ontario, Canada (UCOA Radio Products Co.)

"15 YEARS OF LEADERSHIP"

the short-wave transmitter of WMC operating under the call letters WABG. The operator aboard the *Sequayah* in turn reported the information of the 263 stranded persons to WMC. The broadcasting station flashed the report to the Army Engineers headquarters. From engineers' headquarters back over WMC went instructions to other government steamers in the vicinity of the island on how to conduct the evacuation of the stranded persons. All lives were saved.

Five meters also contributed its service to emergency work. Many amateurs in the flood area were equipped with low-powered transmitters and receivers that easily could be operated from batteries. Many of them had transceivers and duplex transmitters-receivers. These were installed on Coast Guard boats, at Red Cross relief stations and other places in the flood area. They supplied reliable short-distance communication without causing interference on other bands. They made it possible to direct the operations of rescue crews in boats without making it necessary for them to touch shore each time a job was done. They enabled the boat crews to request help when their facilities were inadequate to effect the rescue of large stranded groups. It is now quite apparent that the 5-meter band is an extremely important one for local operation between mobile units in time of national emergencies such as this.

Both amateurs and broadcasting stations again did a remarkable piece of emergency communication work. All those who took part deserve tremendous credit. Undoubtedly, had it not been for their work, thousands would have lost their lives and a great disaster might have been tremendously more disastrous.

Don Lee Television

(Continued from page 697)

- C25—.00045-mfd., including stray wiring capacity mica condenser
- C26—0.1-mfd. paper, 400 w.v.
- C28—1-mfd., 2000 w.v., Pyranol or equal
- C29—0.5-mfd., 2000 w.v., Pyranol or equal
- C30—.004-mfd., 500-volt mica
- C31—50-mmfd. midget, set at 20 mmfd.
- SW1—S.P.S.T. toggle switch, 110-volt
- VT1—6L7 first detector
- VT2—6K7 first i.f. amplifier
- VT3—6K7 second i.f. amplifier
- VT4—6K7 third i.f. amplifier
- VT5—6H6 diode second detector
- VT6—955 acorn television ("audio") amplifier
- VT7—6J7 oscillator
- VT8—879 half-wave rectifier, high-voltage
- VT9—905 cathode-ray tube, 5" screen
- VT10—83-V full-wave rectifier
- VT11, VT12—885
- VT13, VT14—58
- TR1—Inca B-7 or equal, sec. 1200 r.m.s.
- TR2—Inca C-66 or equal, sec. 750 r.m.s.

TELEVISION SCHEDULE

THE Don Lee television transmitter W6XAO is located at 7th and Bixel Streets in downtown Los Angeles, and operates on the ultra-high frequency of 45,000 kilocycles (which corresponds to 62/3 meters). Image transmissions are made daily except Sunday. The evening schedule starts at 6:30 p.m. and continues to 7:15 p.m. or later. The daytime programs observe the following schedule: Monday, 9-10 a.m.; Tuesday, 10-11 a.m.; Wednesday, 11-12 a.m.; Thursday, 12-1 p.m.; Friday, 1-2 p.m.; Saturday, 2-3 p.m.

TRIAD

THE CHOICE OF SERVICEMEN BECAUSE THEY ARE USED BY LEADING SET MANUFACTURERS

TRIAD MANUFACTURING CO., Inc.
PAWTUCKET RHODE ISLAND

THE QUALITY NAME IN RADIO TUBES



FREE TO SERVICEMEN

Selling Nationally advertised Radios is as easy as rolling off a log. We carry R.C.A.—Philco—G.E.—Zenith—Delco—Bosch—

Motorola—Emerson—Detrola—Fada—Grunow and many others. Over 500 sets to select from. The discounts we allow you range up to 50% from manufacturers prices.

Become Our Representative in your locality. Write for catalog, descriptive literature and confidential discount sheet to

MODELL'S 58 Cortland St., Dept. G-1 [Wholesale] New York City Since 1889 [Division]

RADIO ENGINEERING

RCA Institutes offer an intensive course of high standard embracing all phases of Radio. Practical training with modern equipment at New York and Chicago schools. Also specialized courses and Home Study Courses under "No obligation" plan. Catalog Dept. RN-37.

RCA INSTITUTES, Inc.
75 Varick St., New York 1154 Merchandise Mart, Chicago
Recognized Standard in Radio Instruction Since 1909

AVOID Q R M retaining crystal control—

The Clark Variable Frequency Crystal and Holder uses an 80 meter low drift "AT" cut crystal, 4 cycles drift per m.c. per degree. Navy type low loss ceramic holder, variable 8 k.c. at 80, 12 k.c. at 40, 24 k.c. at 20, 48 k.c. at 10, 96 k.c. at 5 (as used by W2 IRM). 3500 to 4000 k.c. crystal and variable holder \$7.50 within 5 k.c. exact frequency, \$10.00. Performance guaranteed. Address orders or inquiries to W2IRM (formerly 1XZ).

THE CLARK COMPANY
Sacramento 2-4180, 489 Fifth Avenue, New York

PARTS PRICES SLASHED!

Complete stock of fine-quality replacements for Short Wave—P. A.—Ham and Service work at big savings. Why carry expensive stocks? Use our RUSH shipment plan.

BOND RADIO COMPANY
13137 Hamilton Ave., Detroit, Michigan

RADIOS...SAVE UP TO 50%

DEAL DIRECT...FACTORY PRICES! Many models to select from: AC-DC; All-Wave; Farm sets that operate like city radios! Your name and address on postcard brings you NEW Bargain Catalog in colors FREE. Get details of 30-DAY TRIAL plan and agent-user proposition! **GOLDENTONE RADIO CO.** Dept. A-5, DEARBORN, MICHIGAN

30 DAY TRIAL \$6.98 UP

Free Catalog

A Shower of Applause

JOINED BY EVERY NEW OWNER OF A
MASTERPIECE V

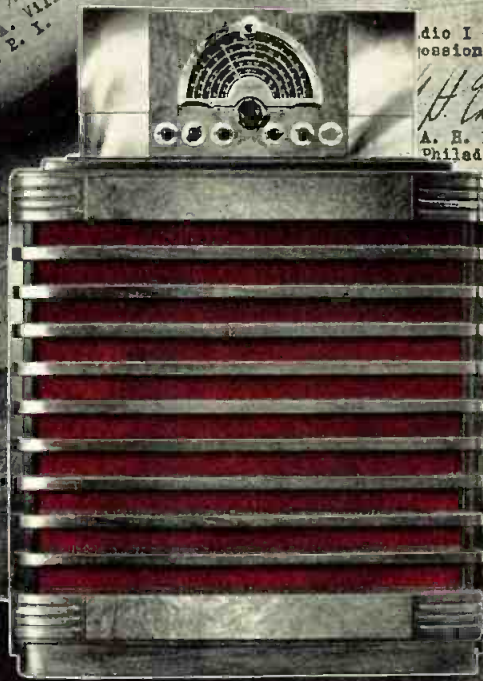

Purchasers of a Masterpiece V expect the finest in Radio performance—and they get it!

Whether they are looking for DX or sparkling life-like tone—the Masterpiece V lives up to every expectation—fulfills every promise.

There's a reason—it's custom built to suit your own home! Mail the coupon today—learn all about this finest of receivers. The most advanced Radio built today!

McMURDO SILVER
MASTERPIECE

"WORLD'S ONLY TRULY CUSTOM-BUILT RADIO"

McMURDO SILVER CORP.
2900-A South Michigan Avenue
Chicago, Illinois, U. S. A.

Please rush me full particulars of the Masterpiece V.

Name.....

Address.....

City..... State.....

24 Great Radio Events

ALLIED'S NEW SPRING CATALOG!

1

156 PAGES OF REAL INTEREST FOR EVERY SERVICEMAN, DEALER, AMATEUR & EXPERIMENTER

Send for the new months-ahead 156-page Spring 1937 ALLIED Radio Catalog—packed with radio values from cover to cover—high-lighted with the industry's outstanding new developments—complete with Everything in Radio—the single, dependable guide for every radio buyer! Includes a tremendous assortment of more than 10,000 quality radio parts; 53 new Knight Radios with exclusive, up-to-the-minute features; complete lines of Amateur transmitting and receiving gear; matched Public Address equipment for every need; dozens of new, low-priced Build-Your-Own kits; latest test instruments; books, tools, etc. Thousands of months-ahead values—Everything in Radio for Everyone in Radio—at low, money-saving prices!

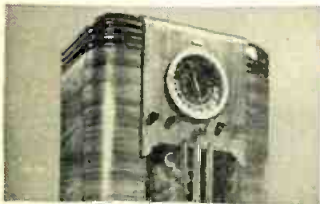
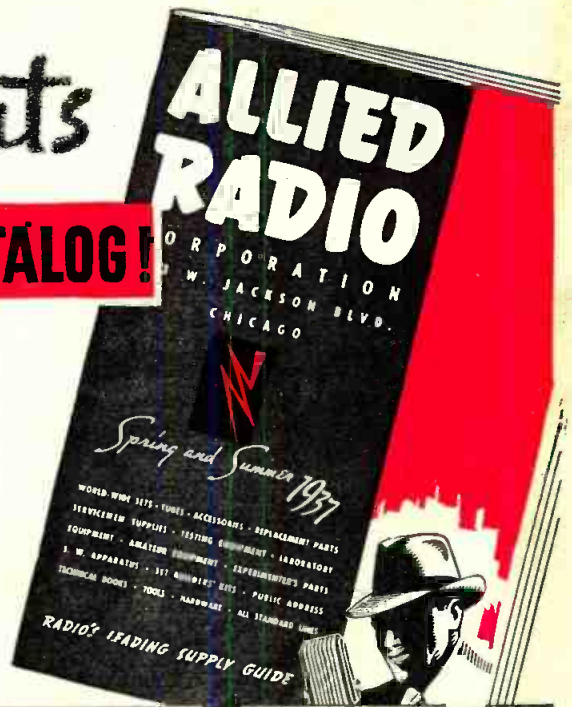

53 NEW KNIGHT RADIOS

The famous line of Knight Radios has been increased, improved and refined. See the sensational new "11 Tube Superhet with Automatic Dialing, AFC, Tone Expansion, etc.; new plastic radios; portable sets; phono-radio combinations, new auto radios with Touch-o-matic Tuning, etc. 53 great models—5 to 19 tubes—for AC, AC-DC, 32 Volt, battery and auto operation—a set for every purse and purpose!

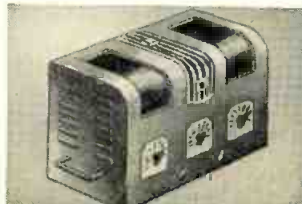

NEW SOUND SYSTEMS

See the newly designed matched Knight Sound Systems—5 to 60 watts—permanent, portable and mobile, for 115 volt, 6 volt and universal operation. Featuring the exclusive "Calibrated Output Indicator", higher fidelity, greater dependability, and beautiful new cases—at new low prices. Here are tremendous money-saving, profit-making opportunities!



NEW AMATEUR GEAR

Join the Daily Hamfest!—see the greater Amateur section in the new ALLIED Catalog! Complete lines of Amateur transmitters, receivers, and transceivers, in factory-built and kit form. See the new RCA-ACR 155, "Sky-Challenger", Utah Add-A-Unit, "Smitter", National Oscilloscope, I.P.S., "Rubber Crystal" and many others. Make ALLIED your Amateur Headquarters.

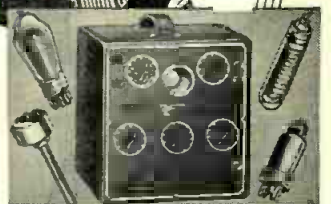

MORE THAN 10,000 PARTS

ALLIED'S new Catalog lists more than 10,000 exact duplicate and replacement parts and the newest test instruments and tools—for repairing or building any radio circuit. SERVICEMEN: Make ALLIED your "Silent Partner"—your headquarters for standard and special equipment! RADIO BUILDERS: See pages 123-45 of ALLIED's Catalog for the latest Build-Your-Own kits!

THE DON LEE TELEVISION KIT!

2

THE FIRST PRACTICAL CATHODE RAY TELEVISION KIT FOR AMATEURS & EXPERIMENTERS—WRITE FOR COMPLETE DETAILS!

ALLIED is first again—presenting one of the greatest radio events of the year—the new Don Lee Television Kit! Tested and approved by Radio News Engineers, it is the first practical Television Receiver procurable by Amateurs and Experimenters. Utilizes a sweep circuit employing the 905 Cathode Ray tube with a 5" screen. Panel control adjustments permit the reception of any of the present television broadcast systems. Set uses two chassis: (1) an efficient Short Wave Superhet circuit for reception and amplification of regular Amateur and S. W. signals; (2) the new dependable television circuit. For complete details, including authorized parts list, write to ALLIED—Foremost Radio Distributors. Remember—if it's new, valuable, practical or important you'll always find it at ALLIED—ready for fast shipment, priced to fit your purse!



THE OFFICIAL DON LEE TELEVISION KIT

FASTEST SERVICE - LOWEST PRICES

ALLIED Radio Corporation Dept. 1-E
833 W. Jackson Blvd., Chicago, Ill.

Send me the FREE new Spring 1937 ALLIED Catalog—Radio's 156 Page Complete Supply Guide.

Send me ALLIED'S FREE Official Parts List for building the Don Lee Television Kit.

Name

Address

City State

SEND FOR YOUR FREE COPY NOW

You can buy with confidence at ALLIED—Radio's Leading Supply House! Our tremendous stocks, our central location, our economical merchandising methods, our super-efficient shipping department mean greater values, faster service and lowest prices for you! Thousands of Radio Dealers, Servicemen, Amateurs and Builders find that they save more time and make more money by ordering from ALLIED. Why shop skimpy, incomplete "radio pamphlets"?—fill ALL your radio needs from the new 156-page ALLIED Catalog—Radio's Complete Supply Guide!

ALLIED RADIO CORPORATION

833 W. JACKSON BLVD. CHICAGO, ILL.