

RADIO'S GREATEST MAGAZINE

RADIO NEWS

REG. U.S. PAT. OFF.

DECEMBER
25 Cents

Over 200
Illustrations



Edited by HUGO GERNSBACK

A Christmas
Dream



EXPERIMENTER PUBLISHING COMPANY, NEW YORK, PUBLISHERS OF
SCIENCE & INVENTION - RADIO LISTENERS' GUIDE - SPARE-TIME MONEY MAKING - FRENCH HUMOR - AMAZING STORIES

\$55.

At this price the Crosley Bandbox is Radio's most astonishing success, not because the price is low, but because the set is magic!

Millions will replace obsolete sets with new, up-to-date receivers this fall.

Experienced radio owners will look first for 3 fundamental points and to every set they consider will address these questions:

1. Is it selective?
2. Is it sensitive?
3. Is it easy to operate?

Satisfied on these points, they will look for:

1. Single dial control
2. Illuminated dial
3. Volume control
4. Single cable leads
5. Console installation adaptability
6. Reasonable price.

Millions will look at the Crosley Bandbox. This amazing little set is now displayed by more than 16,000 dealers.

One dealer, alone, expects to sell a million dollars' worth of Bandboxes this season.

Crosley dealers from Maine to California have this wonderful receiver hooked up for immediate demonstration and will explain its matchless performance in a manner somewhat like this:

The Crosley Bandbox is a 6-tube receiver.

The circuit of this set is of the excellence you would expect from a group of skilled engineers suddenly given the pick of the world's radio patents to work with.

Crosley has always given the radio world its biggest value for its dollar. Contemplate the perfection possible when the doors of the research and development laboratories of The Radio Corporation of America, The General Electric Co., The Westinghouse Co., The American Telephone & Telegraph Co., and the Hazeltine and Latour Corporations were thrown open.

Licensed under their patents!

The Crosley Bandbox is totally and completely shielded. Every element is absolutely separated from every other element by solid shielding. Coils are covered with copper. This could have been done cheaper, but

efficiency would have been sacrificed. Condensers are housed in cadmium-plated steel. All wiring is separated and shielded from all other parts of the receiver. Solid, sturdy, substantial, the entire set is assembled on a heavy metal chassis.

The tuned radio frequency amplification stages have been absolutely balanced through use of the Neutrodyne principle. The set is a genuine Neutrodyne!

To the initiated this means much. To the layman it manifests itself only as a radio receiver that does not squeal or howl when you are trying to get a station.

The shielding makes the Bandbox highly selective—the circuit, acutely sensitive and the design, extremely easy to operate.

The Bandbox is operated with a single station selector (one dial).

In most localities and in most owners' hands the single station selector will find all the programs anyone could possibly wish. But there are some owners who demand greater ability like the possessors of 90 horse power motor cars who may never step on it but like to be conscious it's there. For such have the Acuminators been designed. Far away stations of weak power but perhaps good music are captured by the use of these little auxiliary tuners. Their function is best likened to a pair of field glasses. As the lens bring the distant scene to nearby aspect, so do the Acuminators bring the remote station signals up to room filling volume. Ordinary one dial radios can never perform like this. Hair line tracking of the con-

densers together is difficult—but the Acuminators, little secondary adjustments *exclusive* to Crosley give the Bandbox a substantial command of the air and *all* that is in it.

The dial of the Bandbox is illuminated.

Volume Control is necessary on good radio today. Nearby and high powered stations send terrific impulses into the receiver. Detuning has been a favorite method of softening this loud reception but with stations closer and closer together on the dial detuning particularly in large cities creates an overlapping of programs. The ear like the eye is only good for one thing at a time. Under the

towers of the heaviest stations the volume control of the Bandbox cuts the loudest blast down to a veritable whisper. No distortion whatsoever!

A single cable leads all outside and power connections from the Bandbox.

The adaptability of the Bandbox to installation in all types of cabinets is a feature. The metal case of the Bandbox lifts off the chassis. This leaves the closely grouped dial, switch and volume control shafts to be stuck through holes in the panel of any sort of cabinet. The escutcheon is quickly screwed over them and the console installation is not only complete but has no earmarks of a makeshift.

Much has influenced the \$55 price of the Bandbox.

Back before radio became the entertainment force it is today Powel Crosley, Jr., held an ideal that the things which give people pleasure should be made to sell at low prices so that millions may enjoy them.

When radio was a bundle of hair pins turned with the knobs from typewriter carriages, he had the idea that if he could make radios in sufficient quantities, he could supply millions with a means of enjoying this new source of pleasure at moderate prices.

Every radio year has been a year of mass production experience to Crosley. This year saw an invest-

ment of over half a million dollars in equipment that a fine radio might be made at such speed and in such quantities that a price of nearly half a hundred dollars could be maintained.

Throughout the country millions examine the Bandbox today. They see in it the achievement of an organization who began its development when radio as we know it today began. Its success has been tremendous if clamorous demands from dealers are any indication.

An AC model Bandbox takes its power from the electric light.

Former power supply with its constant annoyance and expense is entirely eliminated.

The new R.C.A. AC tubes provide clear, smooth and loud reception comparable in every way to the most efficient wet storage battery power.

POWER CONVERTER Alternating current ripple is smoothed out in the compact little power converter which is sold with the AC Bandbox. This device needs no attention—is half the size of an ordinary storage "A" battery and matches the Bandbox in finish and color.

The AC Bandbox is \$65. The Power Converter is \$60.

This gives you a complete, direct AC radio adaptable to any type of installation you may choose—bookcase, console, desk, cabinet, armchair or tuck it away on the corner of the table—for \$125.00.

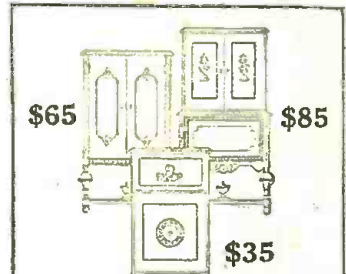
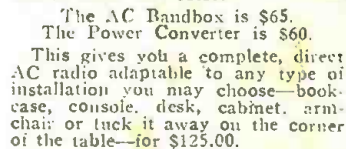
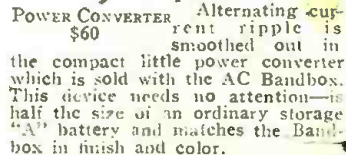
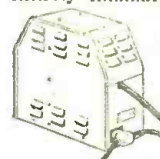
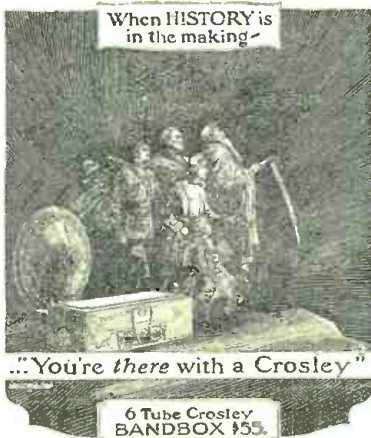

APPROVED CONSOLES

"I want the public to have as great a value in consoles this year as I have given them in the Bandbox," said Powel Crosley, Jr.

Prominent furniture manufacturer. ers thru their long experience promised beautiful cabinets at moderate prices. Designs submitted were admired, praised, tested, approved! The Musleones were built in. Crosley dealers now sell them. Purchasers may know they are best suited for Crosley radio by looking for the "approved label" in each one. Crosley dealers get these cabinets only from The H. T. Roberts Co., located at 1340 S. Michigan Ave., Chicago. Sales representative for The Showers Brothers Co., Bloomington, Ind., and The Wolf Manufacturing Industries, Kokomo, Ind.

Write Dept. 22 for descriptive literature.

CROSLEY RADIO

THE CROSLEY RADIO CORP.
Powel Crosley, Jr., Pres.
Cincinnati, Ohio



Crosley is licensed only for
Radio Amateur, Experimental and
Broadcast Reception

Montana, Wyoming, Colorado, New Mexico and West prices slightly higher.

INDEX TO ADVERTISERS

A	Page		Page		Page		Page
Abox Co., The	661	Cunningham, Inc., E. T.		K		R	
Accusti-Conc Laboratories.	711	Inside Front Cover		Karas Electric Co.	660	Radiall Co.	711
Acme Apparatus Corp.	653	Curtan Mfg. Co.	713	Kelsey Co., The	670	Radiart Laboratories Co.	704
Acme Electric & Mfg. Co.				Kodel Radio Corp., The	667	Radio Association of	
The	674	D				America	577
Acme Wire Co., The	666	Daven Radio Corp.	672-686	L		Radio Equipment Co.	656
Aero Products, Inc.	670	Deutschmann Co., Tobe	658	Lacault Radio Elec. Labs.		Radio Institute of America	716
Aerovox Wireless Corp.	684	Dubilier Condenser Corp.	664	R. E.	696	Radio Specialty Co.	673
Airgap Products Co.	700			Lacey & Lacey	705	Rajah Co., The	709
Algonquin Electric Co.	649	E		Langbein-Kaufman Radio		Randolph Radio Corp.	588, 650
All-American Radio Corp.	683	Eby Mfg. Co., Inc., The		Co., The	696	Raytheon Mfg. Co.	681
All Radio Co.	705	H. H.	719	Leutz, Inc., C. R.	664	Rose Mfg. Co., Frank	699
Allan Mfg. Co.	685	Electrad, Inc.	654, 662, 674, 686	Lucas & Sons, John	711	Rowan Battery Supply Co.,	
Allen-Bradley Co.	658	Electric Specialty Co.	719	Luxem & Davis Mfg. Co.	692	Walter	670
Allen-Rogers-Madison, Inc.	695	Elliott Radio Corp.	659				
Alter Co., The Harry	676	Engineer's Service Co.	582	Mc		S	
Aluminum Co. of America	705	Erie Fixture Supply Co.,		McGraw-Hill Book Co.,		S. R. S. Co.	687
American Auto & Radio		Inc.	698	Inc.	687	Samson Electric Co.	700
Mfg. Co.,		F				Sangamo Electric Co.	719
662-670-686-690-707-716		F. & H. Radio Labs.	702	M		Shure Radio Co.	656, 666, 682
American Bosch Magneto		Fansteel Products Co., Inc.	653	M. & H. Sporting Goods		698, 704, 717	
Corp.	587	Fast & Co., John E.	713	Co.	672	Silver-Marshall, Inc.	695
American Hard Rubber Co.	712	Formica Insulation Co.,		Mack Co., Inc.	691	Smith, B. Hawley	716
Amrad Corp., The	691	The	701	Magnavox Co., The	680	Southern Toy Co., Inc.	678
Arcturus Radio Co., Inc.	665	Freshman Co., Inc., Chas.	692	Marwood Radio Corp.	671	Sovereign Electric & Mfg.	
		Frost, Inc., Herbert H.	699	Metro Electric Co.	581	Co.	682
		Fyr-Fyter Co., The	703	Midland Wholesale Co.	712	Sprague Specialties Co.	672
				Midwest Radio Corp.		Starrett Mfg. Co.	707
B		G		Inside Back Cover		Sterling Mfg. Co., The	712
Barawik Co., The,		Gardiner & Hepburn, Inc.	707	Miller-Welles Co.	687	Straus & Schram	583
674-696-701-707-711-719		General Electric Co.	693	Muter Co., Leslie F.	586		
Belden Mfg. Co.	652	General Radio Co.	708			T	
Benjamin Air Rifle & Mfg.		Gold Seal Electrical Co.,		N		Telephone Maintenance Co.	677
Co.	666	Inc.	668	National Carbon Co., Inc.	655	Teleplex Co.	689
Benjamin Elec. Mfg. Co.	674	Gould Storage Battery Co.,		National Company, Inc.	709	Televocal Corp.	716
Bernard Furniture Co.	701	Inc.	703	National Radio Institute		Temple, Inc.	707
Bogue, B. N.	690	Gray & Danielson Mfg.		584, 585, 678		Thordarson Elec. Mfg. Co.	662
Boudette Mfg. Co.	701	Co.	650	National, State, and Local		Tower Mfg. Corp.	687
Boutin Electric Co.	684	Graymore Radio Corp.	717	Tuberculosis Ass'ns of		Townsend Laboratories	697
Brady, John B.	716	Grigsby-Grunow-Hinds Co.	717	the U. S., The	664	Triple-A Specialty Co.	682
Bremer-Tully Mfg. Co.	591	Guaranty Radio Goods Co.		Niagara Metal Stamping			
		690-705		Corp.	662		
		H		Norden-Hauck, Inc.	687		
C		Hammarlund Mfg. Co.	699	North American Bretwood			
C. E. Mfg. Co., Inc.,		Hammarlund-Roberts, Inc.	685	Co.	712		
Back Cover		Hammer Radio Co., S.	693	O		V	
Cable Supply Co.	654	Hampton-Wright Co.	710	Omnigraph Mfg. Co., The	697	Van-Ashe Radio Co.	709
Carborundum Co., The	677	Harco Co., The	705				
Carter Radio Co.	658	Hesslein, William	716	P		W	
Central Radio Labs.	690	High Frequency Labs.	684	Palmer & Palmer	710	Walker Co., The Geo. W.	713
Chaslyn Co., The	716			Parker, C. L.	678	Warren Electric Co.	656
Chemical Institute of N.		I		Pathfinder, The	672	Western Radio Mfg. Co.	664
Y., Inc.	675	Independent Electric		"Peridyne"	669	Westgale Electric Co.	663
Chicago Radio Apparatus		Works	692	Penn Radio Sales Co.	678	Westinghouse Elec. Mfg.	
Co.	654	International Resistance		Pilot Elec. Mfg. Co., Inc.	657	Co.	590
Chicago Stock Gear Works	719	Co.	679	Polymet Mfg. Corp.	682	Wile, Eugene G.	713
Clark & Tilson, Inc.	700	J		Precision Coil Co., Inc.	701	Wirthmore Co., The	672
Cloverleaf Mfg. Co.	720	J-M-P Mfg. Co.	656	Press Guild, Inc., The	692	World Battery Co.	670
Conrad Co., Inc.,		Jewell Electrical Inst. Co.	698				
652, 660, 676, 680,				Q		X-Y	
698, 702, 714, 715				Q. R. S. Music Co., The	700	X-L Radio Labs.	690, 693
Consumers Radio Co.	666					Yaxley Mfg. Co.	686
Co-operative Radio Doctors	698						
Copper & Brass Research							
Ass'n.	719						
Cornish Wire Co.	713						
Coyne Electrical School	592						
Craftsman Radio Products	658						
Cresradio Corp.	684						
Cresley Radio Corp.	579						

All Electric Radio

Single Dial 7 Tube Set—30 Days Free Trial

**Agents!
Dealers!
Big Profits!**

Make Big Money taking orders for Metrodynes—all or part time. Metrodyne All Electric Radios are in a class by themselves. Unequaled for quality, performance and price. Demonstrate at home and take orders. Lowest wholesale prices. Your Demonstrating Set on 30 days' FREE trial. Mail the coupon below for complete details.

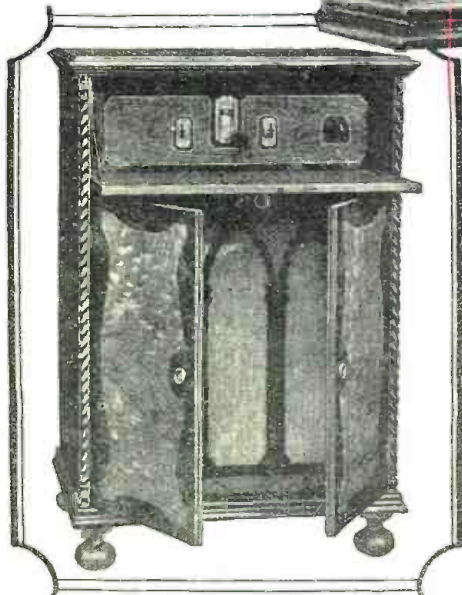
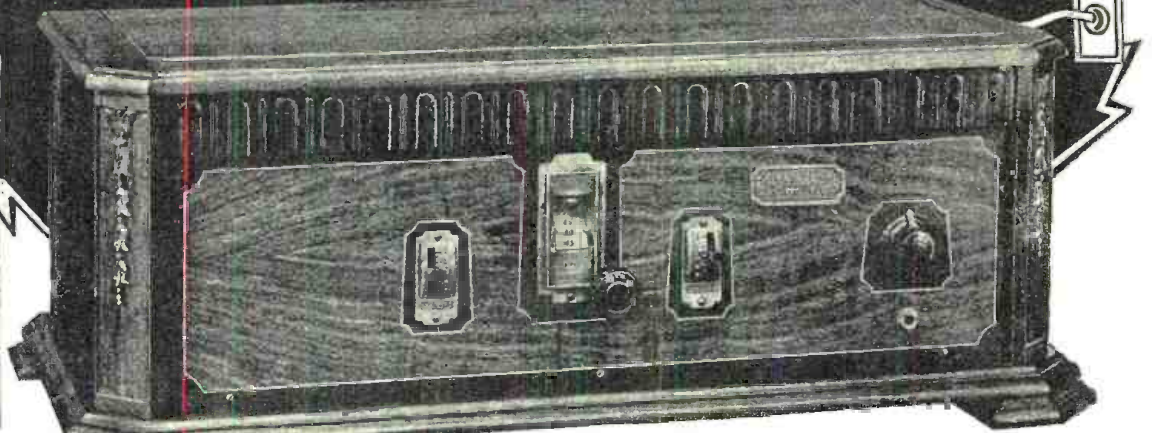

Three Year Guarantee

Metrodyne

ALL ELECTRIC RADIO

“Simply press the switch button and it's on”

NOW! A real electric radio set! Costs less than most battery sets. No batteries—no chargers—no eliminators—no acids—no liquids! Shipped direct from our factory at rock bottom prices and on 30 DAYS' FREE TRIAL.

At last! The radio you've dreamed about! If you have electricity in your home you can now really enjoy coast to coast radio reception without the care, bother and muss of batteries, chargers, eliminators, etc. The Metrodyne All Electric is a real, genuine batteryless radio set. Simply insert the plug in the socket, press the switch button and “tune in.” You could not possibly buy a better radio set than the Metrodyne All Electric, no matter what price you paid.

NO
A-Batteries
B-Batteries
C-Batteries
Eliminators
Chargers
Acids

GORGEOUS CONSOLE ELECTRIC RADIO

Here is the Metrodyne All Electric Console Radio—a gorgeous, genuine walnut cabinet, in a beautiful two-tone finish. Has a built-in genuine Metro-Cone large size speaker. Brings in programs with great volume, reproducing the entire range from the lowest to the highest notes with remarkable clearness and distinction. All metal parts are finished in old gold. Wonderful electric radio, in a cabinet that will beautify the appearance of any home.

**BEAUTY — EFFICIENCY
DEPENDABILITY**

The Metrodyne All Electric table model Radio is a 7 tube, single dial set. Only the highest quality low loss parts are used throughout. Solid walnut cabinet, beautiful two-tone effect, with handsome gilt metal trimmings. Size of cabinet, 28 inches long, 13 inches deep, 10 inches high. Has electrically lighted dial—easy to log stations, even in the dark. Only one dial to tune in all stations. Excellent tonal qualities—wonderful volume—very selective.

COSTS LESS THAN MOST BATTERY SETS

Do not confuse the Metrodyne All Electric radio with ordinary light socket sets, because the Metrodyne is truly an all electric radio — consumes less than 2c worth of electricity a day. Comes to you direct from the factory. Its low cost brings it down to the price of an ordinary battery set. We are so confident that you will be delighted with this wonderful, easy-to-operate batteryless radio that we offer to ship it to your home for thirty days' free trial — you to be the judge.

30 DAYS FREE TRIAL

We are one of the pioneers of radio. The success of Metrodyne sets is due to our liberal 30 days' free trial offer, which gives you the opportunity of trying before buying. Thousands of Metrodynes have been bought on our liberal free trial basis—Write Today!

Mail This Coupon

Learn all about the marvelous Metrodyne All Electric Radio before buying any radio set. Let us send you the proof of quality. Read the letters from thousands of enthusiastic owners. Get our rock bottom direct-from-factory prices and our liberal thirty days' free trial offer.

FREE TRIAL COUPON

METRO ELECTRIC COMPANY
2165 N. California Ave., Dept. 605
Chicago, Illinois

Gentlemen: Send me full particulars about Metrodyne All Electric Radio and your thirty days' free trial offer.

Name _____

Address _____

If you are interested in AGENT'S proposition place an "X" in the square

METRO ELECTRIC COMPANY

2165 N. California Ave. Dept. 605 Chicago, Illinois

assemble *the* **Ensco**

"THE WORLD'S FINEST LOUD SPEAKER"
in less than an hour
at a fraction of the cost!



The Three-Foot Pedestal

This new art model is beautifully finished in polychrome with a heavy metal base, making it practically impossible to tip over. Complete Kit, including pedestal. A practical, beautiful floor model.

Model F-175-36\$17.50
 In Canada.....\$22.50



The Two-Foot Pedestal

Equally as well made and as beautiful as the three-foot model, but smaller. Can be used on top of the set or on any other piece of furniture. Complete Kit including pedestal. Polychrome finish.

Model F-135-24\$13.50
 In Canada.....\$17.50



The Standard and Wall Models Two- or Three-Foot

The wall model kits are furnished with a hard wood wall frame for easy mounting. Made in two and three foot sizes. The standard Kit is used for making console models and roll or book type speakers as described in instruction book—same as Wall Kit, but without frame. You can make your own wall frame if desired.

Standard Model, 2 or 3 feet
 Either Size.....\$10.00
 In Canada.....\$11.50
 Wall Model, 2 or 3 feet
 Either Size.....\$11.00
 In Canada.....\$12.50

WHY pay a high price for a manufactured speaker when you can buy an "Ensco" Kit and assemble the "World's Finest Loud Speaker" at a fraction of the cost. No manufactured speaker, regardless of price, will give you any better reproduction.

The Simplest Cone to Assemble

The "Ensco" Single Cone is by far the simplest cone to assemble, no mechanical or radio knowledge is necessary. If you can use a pair of scissors, a screw driver and a pair of pliers, you can build the "Ensco" as perfectly as an expert mechanic. Within an hour from time you start work, you will be enjoying music, the like of which you never thought possible.

Compare—Let your Ear Be the Judge

Don't take our word for it. Go to your dealer, or any of the offices listed below. Hear the "Ensco" in competition with any speaker, no matter what the price. Then and only then will you know the difference between ordinary and "Ensco" reproduction.

The bass notes, the foundation of all music come booming through in their true relation. The higher notes are equally free from choking or distortion. The tone is clear as a bell, without the slightest trace of mechanical noise.

Absolutely Guaranteed

The "Ensco" is backed by a guarantee that means something. All "Ensco" units are guaranteed to give satisfaction. After purchasing the "Ensco" Kit, you have ten days' trial in which you may test the speaker and return it if not satisfactory. Your money will be promptly refunded.

The Art Models

The first in the field, the "Ensco" is naturally the first to bring out Art Models. The beautiful pedestals must be seen to be appreciated, no picture could do justice to the handsome polychrome finishes. The "Ensco" is now available in two- and three-foot pedestals, which will make any woman glad to have them in her living room.

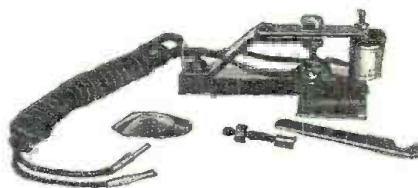

The "Ensco" Unit

This is the heart of the "Ensco" speaker. It is the only direct-drive unit, which satisfactorily operates a 3-foot cone. It has no transmission arms or levers to reduce the motion of the armature.

The "Ensco" Unit is fully patented. Can be used with up to 250 volts without protection and up to 500 with an output system.

Go to Your Dealer

Ask your dealer for a demonstration, then let your ear decide for you. If your dealer has not been supplied, you can order direct from us by using the coupon. You are fully protected by our guarantee.



ENGINEERS' SERVICE COMPANY

25 Church St., New York 73 Cornhill, Boston 28 E. Jackson Blvd., Chicago 331 Bay St., Toronto, Ont.
 144 2nd ST., SAN FRANCISCO, CAL.

If your dealer has not been supplied—Send this coupon

ENGINEERS' SERVICE CO. (Send to nearest office)

Send me

2 foot Standard Kit
 3 foot " "
 2 foot Wall Kit
 3 foot " "
 3 foot Pedestal Kit
 2 foot " "
 3 foot " "

U. S. Prices
 10.00
 10.00
 11.00
 11.00
 13.50
 17.50

Canada Prices
 11.50
 11.50
 12.50
 12.50
 17.50
 22.50

I am enclosing
 Check
 Money Order
 Cash (registered letter)
 Send C. O. D.
 (All shipping charges paid on Standard and Wall Kits only)

Name.....

Address.....

City..... State.....
 R.N.

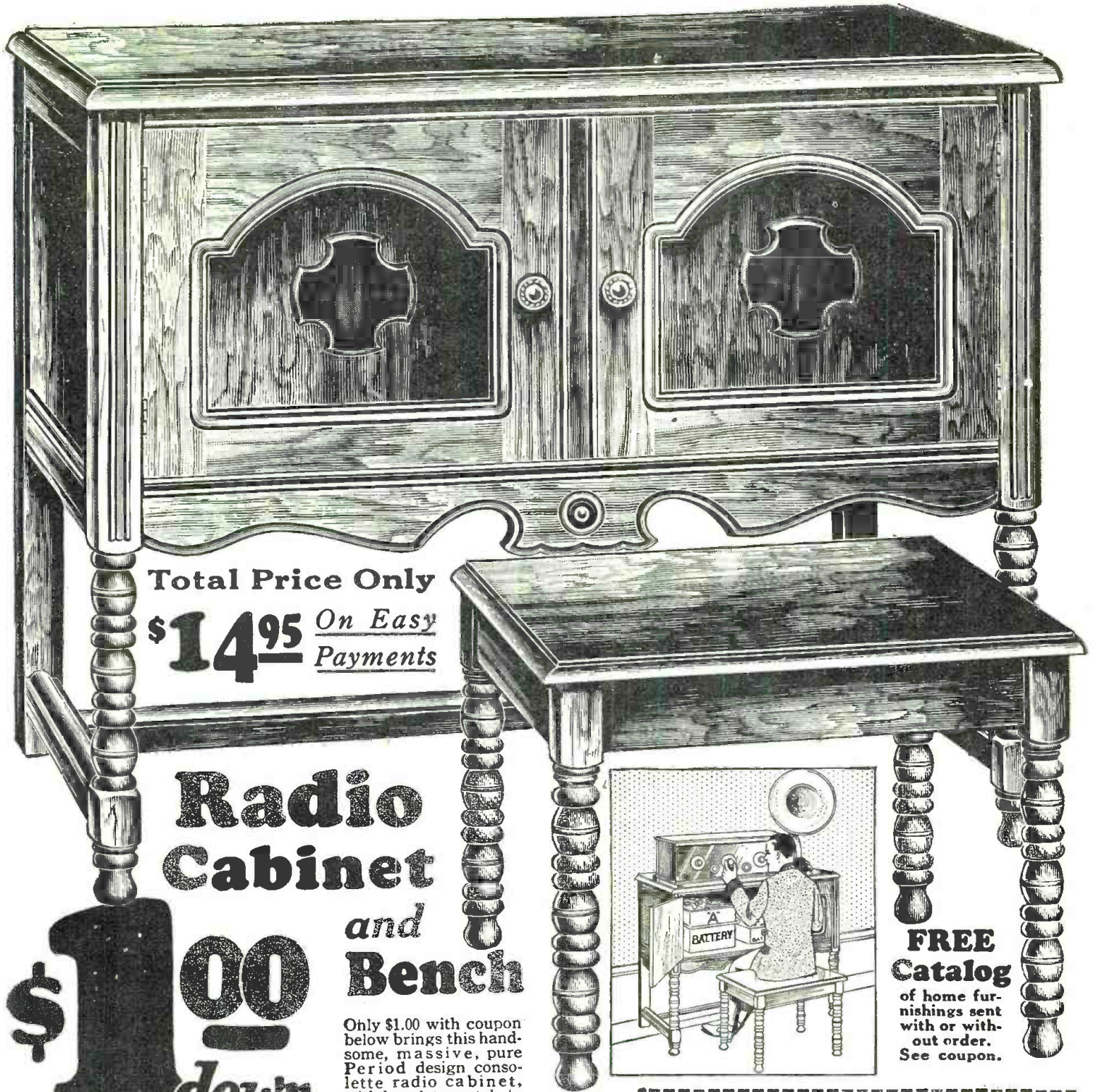

Total Price Only
\$14.95 *On Easy Payments*

Radio Cabinet and Bench

\$1.00 down

Free Trial!

Only \$1.00 with coupon below brings this handsome, massive, pure Period design console radio cabinet, with bench to match, to your home on 30 days

Just the thing you need to give your radio the appearance of a costly set and to beautify the room with a

touch of elegance. Ample space inside of cabinet for all batteries, chargers and eliminators. Keep all unsightly accessories out of sight in this splendid piece of furniture. Made of well seasoned, selected hardwood in **Handsome Walnut Finish**. Two large, French style swinging doors at front with ornamental brass knobs. Front panels of doors in carved panel effects and legs of both cabinet and bench are neatly turned. Edge of top neatly bevelled. Cabinet has lower cross brace to insure rigidity. Top is 33 1/4 x 18 inches, height inside 11 1/2 inches. Full height 33 inches. Bench is 18 inches high.

\$1.50 a Month

After 30 days trial if not satisfied, send Cabinet and

Send Coupon NOW!

bench back at our expense and we'll refund your \$1.00 plus all transportation charges you paid. Or keep them and pay only \$1.50 a month till you've paid our smashed cut price for this sale—only **\$14.95**. Our credit price beats cash prices anywhere. Order by No. B182A. Shpg. wgt. about 70 lbs.

Straus & Schram Dept. R3579 **Chicago**

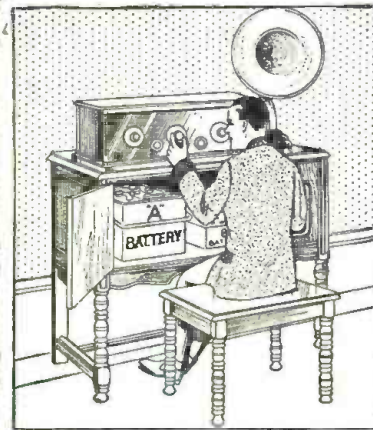

FREE Catalog of home furnishings sent with or without order. See coupon.

Straus & Schram, Dept. R3579 Chicago

Enclosed find \$1. Ship Walnut Finish Radio Cabinet and Bench. I am to have 30 days free trial. If I keep the cabinet and bench I will pay you \$1.50 monthly. If not satisfied, I am to return them at your expense and you are to refund my money and any freight or express charges I paid.
Radio Cabinet and Bench No. B182A, \$14.95

Name.....
 Street, R.F.D. or Box No.....
 Shipping Point.....
 Post Office..... Stats.....
 Married or Single..... Nationality or Color.....
 If you want only our free catalog of home furnishings, mark X here

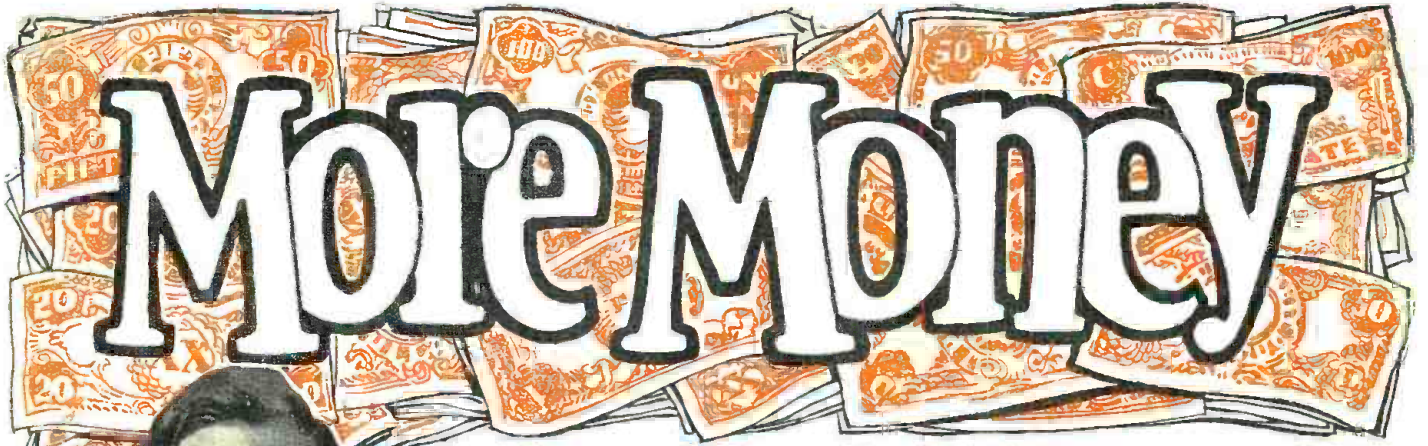

More Money

Be a Trained Radio Expert

If you're earning a penny less than \$50 a week, get my free book of information about the Radio business. Trained Radio Experts are needed in more than 20 different lines of this new and growing profession (300,000 new openings created by the swift growth of Radio in past few years). Why go along at \$25 or \$35 or \$45 a week all your life? Study Radio and after only a short time land yourself a REAL job with a REAL future! Be a man who has money in his pocket and in the bank—don't scrimp and scrape for the rest of your days.

Salaries of \$50 Up to \$250 a Week Not Unusual in Radio

The good positions in Radio pay all the way from \$50 on up to \$150, \$200, and even \$250 a week. Suppose you don't climb to the very top, but that you do advance to a position that pays you \$125 a week, year in and year out. Any chance to make that much where you are now? Then send for my free book, and learn about a field where there's some *real opportunity*. Where good men, if they have the right training, can work their way into really big salaried jobs!

Money Back If You Aren't Fully Satisfied

I'll give you all the training you need to get into any line of the Radio business. And I back up this training by a signed agreement to refund every penny you pay me if I don't give you exactly the training you need. After you finish my training, you'll be the judge. If you think I've earned my tuition fee, I keep it. If not, ask for it and you'll get it right back.

Six Big Practical Outfits Given You to Help You Learn

I teach you both the "why" and the "how" of Radio. You learn to DO a thing, and you learn WHY it's done. I send you, WITHOUT EXTRA COST with your course, six big practical outfits of material to experiment and work with. These outfits are the real thing—not toys. The parts they contain will build approximately 100 different Radio circuits. With all this material you do practical work from start to finish of your training. You get your hand in, and you get confidence in yourself. Then when you run into a Radio problem later on, on the job, you KNOW you can do it because you've already done it, with these six outfits of practical material. With me you don't learn to be a "paper Radio Expert"—you learn to be the kind of expert that shows his worth on the payroll. Full details in my big book—sent free.

Send for Free Book of Information.

GET BOOK!

Find out for yourself about bigger pay waiting for you in Radio! From \$2,000,000 in 1920 to \$504,000,000 in 1926—that's the record of the Radio Industry. Plenty of big Radio jobs are waiting for the man who KNOWS! John Fetzer sent for my free book—now he's Chief Engineer at WEMC and designs and builds broadcast stations. T. M. Wilcox sent for the book—now he's in his own Radio business and reports profits as high as \$70 in one day! All information will be sent to you free, without obligation—just mail coupon on opposite page.

see coupon next page



Broadcasting and commercial Radio land station work appeal to a lot of men—it's a big, growing field and fascinating work. My course prepares you thoroughly to get into this field and make good.

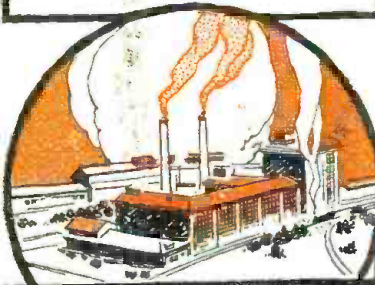

Radio manufacturing has grown faster in the last 6 years than any other big business ever did. It's 250 times as big as it was. That means lots of good chances for the trained Radio Expert.

Six million Radio receiving sets in use in the United States means millions of dollars are going to Radio Service and Repair men everywhere. For this work you must be trained.

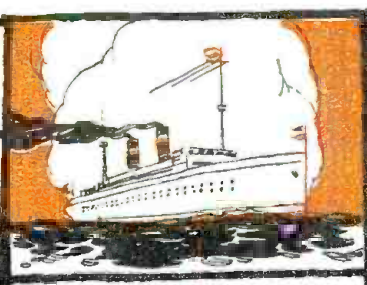

Radio operators on board ship go everywhere—see everything. You sail the world over, all your expenses paid, and draw a good salary besides. It's the life of Reilly.

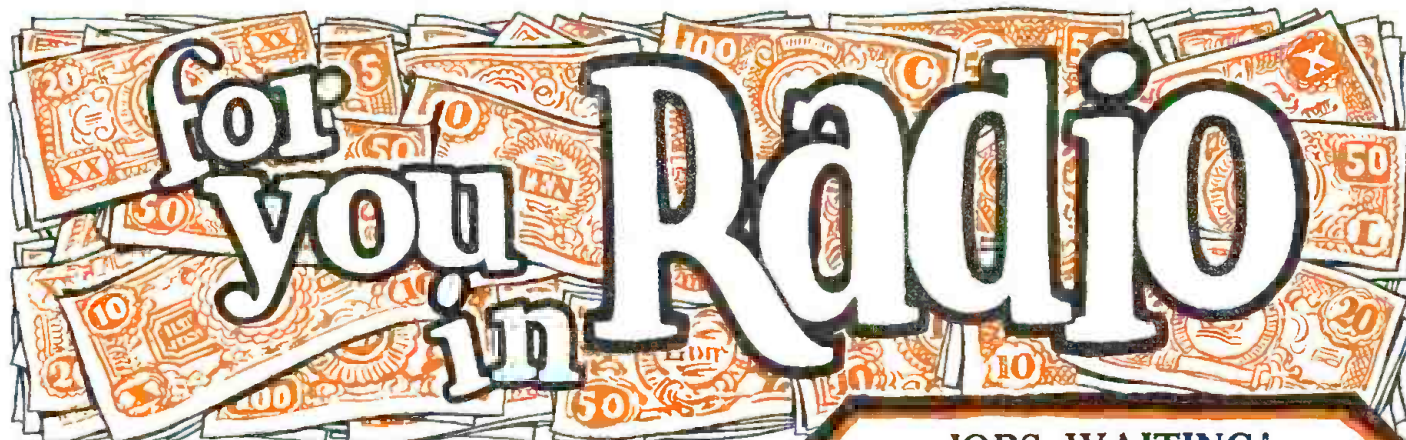

LEARN QUICKLY, EASILY

Train at Home in Spare Minutes

Stay home! Hold your job! I'll bring your Radio training to you, and you can learn in your spare time after work. No need to go to a strange city and live for months on expense when you learn my way. You study in the quiet of your own home. As for this training—it's written just as I would talk—in straightforward, everyday, understandable language. You'll get it, and you'll get it quickly—in a few months' spare time—because I've made it so clear and interesting! No particular education needed—lots of my successful students didn't finish the grades.

Earn \$15, \$20, \$30 Weekly Right Away "On the Side"

Deloss Brown, South St., Foxboro, Mass., made \$1,000 from spare-time Radio jobs before he even finished my course. H. W. Colbentz, Washington, averaged \$45 a week; Leo Auchampaugh, 6432 Lakewood Ave., Chicago, made \$500 before graduation; Frank Toomey, Jr., Piermont, N. Y., made \$833 while taking the course. All this done IN SPARE TIME away from the regular job, while these fellows were still studying the course—and they're only a few of hundreds. As soon as you start this training I begin teaching you practical Radio work. Then a few weeks later, I show you how to make use of it in spare time, so you can be making \$15, \$20, \$30 a week "on the side," all the while you're learning.

64-Page Book Sent Free for the Asking

My big book of Radio information won't cost you a penny, and you won't be under any obligation by asking for it. It's put hundreds of fellows on the way to big pay and brighter futures. Sending for it has been the turning-point where many a man has made his start toward real Success. Get it. See what it's going to mean to you. Send coupon TODAY!

**Address: J. E. SMITH, President,
National Radio Institute,
Dept. PB-9, Washington, D. C.**

JOBS WAITING!

In 7 short years—300,000 new jobs in Radio! Lots of jobs open right now, for those who have the training. The Radio industry has grown by leaps and bounds—so fast it has had to take whatever sort of men it could get. Such men, if they haven't trained themselves in the meantime, are losing out and will keep on losing out. They'll be replaced by men with the KNOW-HOW. But it's trained men ONLY that are needed.

Over 1,000 Openings for Trained Men NOW!

One great Radio manufacturing concern alone has over 1,000 openings to give my graduates this year. These men will be needed all over the United States. Any graduate of mine who stands well in his home town is eligible for this work. The head of the above mentioned concern—one of the biggest Radio organizations in the country—is a graduate of mine. He knows what my training did for him. When he wants new men for his organization he wants men with the same training.

I can't possibly graduate enough men this year to fill these openings. So there will be more openings with this one concern than there will be graduates to accept them.

But there are other openings to choose from, too. My school has trained more Radio Experts than any other school in the world. It's the oldest and largest Radio home-study school in the world. There are N. R. I. trained men in almost every Radio concern of any importance in this country. Many Radio employers are themselves my graduates.

That's where you get your "stand-in" as an N. R. I. graduate yourself. Every graduate of my course is entitled to Life-Time Employment Service, without a penny's charge, from my helpful Employment Department.

Full Information Sent with Free Book

My Free Book contains full information about the Radio employment situation, and the advantages I'm in a position to give you. Also about my Life-Time Employment Service, and Life-Time Consultation Service, too.

Mail Coupon Today!



This big 64-page book, printed in two colors, crammed with interesting facts and photos about money-making opportunities in Radio, sent free to everyone who clips the coupon. No obligation by sending for the book—it's absolutely free. One of the most valuable books about Radio ever written.



Send No Money

J. E. SMITH, President,
National Radio Institute,
Dept. PB-9, Washington, D. C.

Dear Mr. Smith: Kindly send me your big free book "Rich Rewards in Radio," giving all information about the big-money opportunities in Radio and how you will train me to take advantage of them. I understand this places me under no obligation, and that no salesmen will call on me.

Name

Address

TownState

Does Your Speaker ROAR?

For Clear Natural HUMAN Tones, Protect it ~and Remove Paralyzing "B" Current

with the

New Muter Clarifier

[Output Transformer]

When reception sounds as though all the beasts of the jungle were loosed, don't blame your Speaker. It's not the poor thing's fault. High B Voltage is paralyzing the Unit. But while there's life there's hope—if you install a Muter Clarifier, which traps the beast before it can get to your Speaker. Full tone, clarity and volume result.

Easily attached in a few moments without disturbing your set. Try it out to your own keen enjoyment on our liberal guarantee. Truly as Mr. Casagrande informs you in the letter reproduced above—you won't recognize your set.

See Your Dealer—or Send Coupon

Leading dealers stock the complete Muter Line; and any dealer can quickly secure Muter Products for you. However should you have any difficulty obtaining them, mail coupon direct to us. The clarifier, complete with phone cords attached, will be sent promptly upon receipt of price, \$5.00, or C.O.D. if you wish. Let your speaker show you what real reception means—MAIL COUPON NOW!



Dependable Products
Complete Quality Popular Priced Line

Send Coupon for Comprehensive Catalog

LESLIE F. MUTER COMPANY
76th & Greenwood Ave. Dept. 827-T Chicago, Ill.



From Barre, Vt.
"Received Clarifier.
It is just as you
claim. Gives bet-
ter Tone and
Volume. You
would not know
the receiver or
speaker as the
same. I will rec-
ommend the Clari-
fier to all my
friends."
David A.
Casagrande.

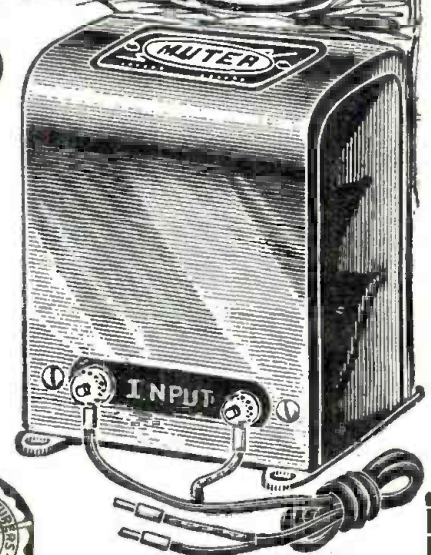

LESLIE F. MUTER CO.,
76th & Greenwood Ave.,
Dept. 827-T Chicago, Ill.

- Send Muter Clarifier at once postage prepaid. \$5.00 is enclosed.
- Send C. O. D.
- Send Complete Muter Catalog.

Name

Address

City..... State.....

BOSCH announces *The* LITTLE SIX

BOSCH
RADIO
*Model
Forty-Six*

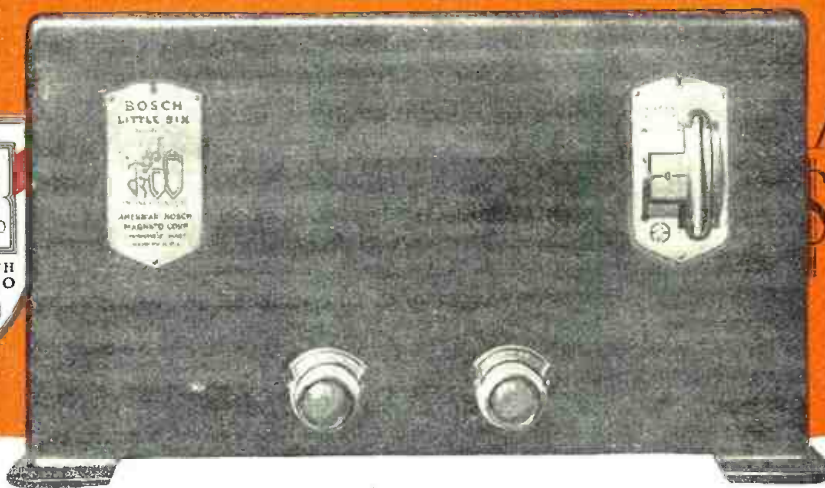

Price
\$68⁵⁰

Those who have seen it, heard it and operated it have named this model Bosch Radio the "Little Wonder Six." They have been amazed that a six-tube, single-dial radio receiver with such tonal quality and perfect performance could be purchased for so little as \$68.50. Consider the features which make the Bosch Little Six an outstanding radio investment at its low price of \$68.50. It is space-saving—but sixteen inches long. It has a Single Station Selector, electrically lighted; six tubes, vibration proof mounted; aluminum chassis, light and strong; the

Bosch Clarifier, the Bosch Volume Control and, best of all, the famous Bosch tonal accuracy. The cabinet is walnut finished and its colonial simplicity of design adds to its richness of appearance. Bosch precision workmanship and Bosch radio engineering are so blended in the Little Six it is a revelation in performance in its class. The Bosch Little Six will appeal instantly to those who have waited for a space-saving, six-tube receiver with power and Bosch tonal quality at a low price. A full description of the Bosch Little Six will be mailed on request.

AMERICAN BOSCH MAGNETO CORPORATION, SPRINGFIELD, MASS.

BRANCHES: New York Chicago Detroit San Francisco

Bosch Radio Receivers are licensed only for Radio Amateur, Experimental and Broadcast Reception. They are manufactured under patent applications of American Bosch Magneto Corp. and are licensed under patent applications and patents of Radio Corp. of America and under application of Radio Frequency Laboratories, Inc.

All Prices Slightly Higher in Canada

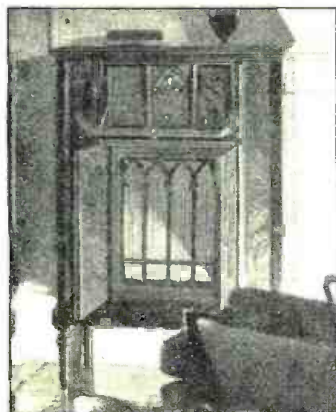

Model 57—7 tube, single station selector, concealed loop \$310



Model 66—6 tube, table type single station selector \$99.50



Model 87—7 tube, single station selector—loop operated \$195



Model 78—6 tube with built-in speaker \$195. Without \$175

These models wired for battery or socket power. Bosch Nobattery "A"—Nobattery "B"—both totaling \$100



All Electric Radio

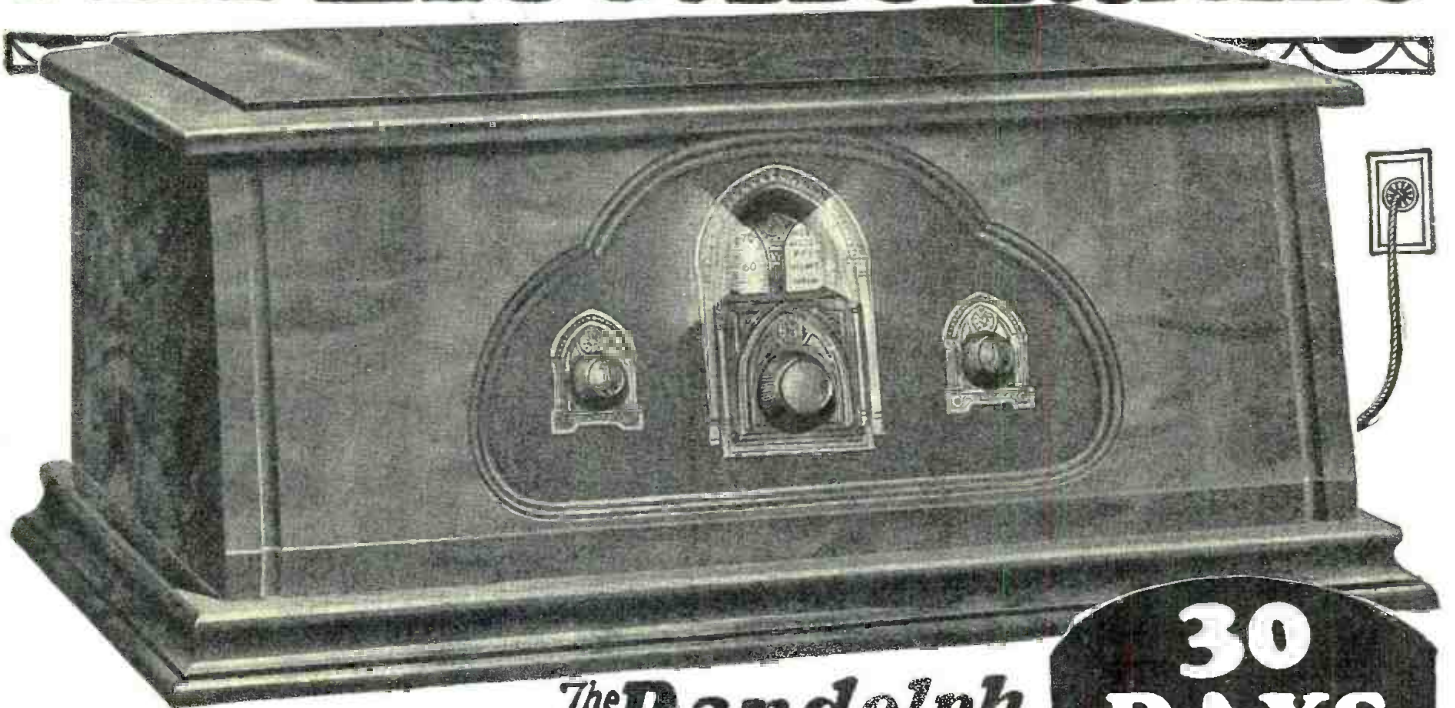

The **Randolph**

7 Tubes-Single Control

JUST plug this Randolph Radio into the electric light socket—and tune in. A powerful, selective radio that gives dependable coast to coast reception. **No batteries, chargers, eliminators, acids or liquids.** Here is complete radio satisfaction whenever you want it. The easy tuning with one control brings on all stations. Illuminated drum allows you to operate the radio in the dark and has space for logging stations. Every detail of the Randolph is modern and perfected—it is the utmost in radio—unsurpassed regardless of price. It is this wonderful radio that you test and try for 30 days FREE before you buy. Listen to it in your own home. When it convinces you by actual performance it is the ideal radio—the one you have always hoped for—you can buy it direct at factory prices. Be sure you write for free descriptive literature today.

30 DAYS FREE TRIAL

6 Tube \$55 Retail Price Biggest Discounts To Agents

Beautiful Amphiphonic Console



Illustrated here is one of the beautiful Randolph Seven Console Models—made of the finest carefully selected heavy solid walnut, hand-rubbed and with burl finish. Has built-in genuine large cone speaker that compares with any on the market. Assures unlimited reception of high notes and low notes clear as a bell. Completely electric—uses no batteries of any kind. Be sure you send for fully illustrated, full color folder giving complete details.

Genuine Walnut Cabinets
The finest of heavy, genuine, solid burl finish walnut is used in the making of all Randolph cabinets. No picture can do them justice. You must see them to appreciate them.

6-Tube Radio
New, modern, single-control, six-tube radio. Do not compare this set with old-style, 2-dial, 6-tube sets selling for about the same price. The Randolph 1928 Senior Six has also been tested and approved by the leading radio engineers. Comes in beautiful solid walnut cabinet of hand-rubbed finish. Single control. Illuminated drum with space for logging. Absolutely dependable and very selective. **Send for 30 days free trial. You test it before you buy.**

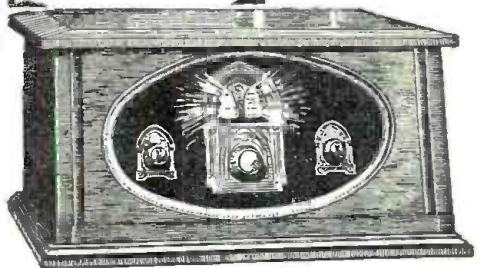

All Sets Guaranteed

Biggest Discounts to Agents
Work either full or part time and make big money. Sensationally big discounts to agents. No experience required. Randolph All-Electric Sets sell on first demonstration. Tremendous advertising campaign helps you. Men and women both make big money this way. Demonstrating set sent on 30 Days TRIAL. WRITE NOW for proposition.

USE THIS COUPON TODAY!

Randolph Radio Corporation
711 West Lake Street, Dept. 318
Chicago, Illinois

Send me full particulars about the RANDOLPH Six and Seven-Tube Electric and Battery Table and Console Sets with details of your 30 Day FREE Trial Offer.

Name.....

Address.....

City..... State.....

Mark here if interested in Agent's proposition.

RANDOLPH RADIO CORPORATION
711 West Lake Street Dept. 318 Chicago, Ill.



Acme E-4-B Supply, \$35
 Acme B Power Supply units were the first on the market to use a Raytheon tube as rectifier. The E-4, above, is the latest B Power Supply achievement of the Acme engineers. Price includes Raytheon BH Tube.

This Year's Programs Deserve Such a Speaker!

PROGRAMS now available to you have become so great that they deserve the finest speaker radio science has been able to construct after years of experience—the Acme K-1A (\$25).

With cones on both sides, each 13 inches in diameter, and with two motors instead of one to “feed” sound to these cones—you enjoy the advantage of two perfect speakers working as one.



Look for
 This Symbol

And . . . what an addition, this Acme K-1A, to home furnishings! Its graceful design blends with furniture background as no other can.

For resonant volume beyond belief . . . have your dealer show you the Acme PA-1 Power Amplifier (\$12.50). It uses socket power whether your set is electrified or not. Makes a power speaker of your present speaker without additional drain on storage batteries.

Acme's two booklets tell (1) how to improve any radio set; (2) the story of lamp socket operation. Fill in the coupon below for the one you want.

ACME APPARATUS CORP.
 Dept. R.N.-3 Cambridge, Mass.

Gentlemen: Please send me a copy of the booklet checked below. I enclose 10 cents for each copy.

Amplification without Distortion
Power Supply for Radio Sets

Name.....
 Street.....
 City..... State.....

ACME

-for amplification

Want trickle charging? Want full rate charging too? then you want Rectigon!

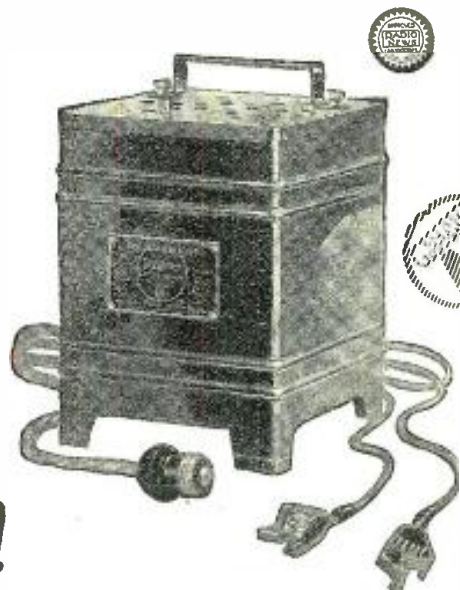

YOU need only one charger—the Westinghouse Rectigon.

Rectigon gives you two charging rates—a “trickle” and a “high”. With it you can get everything that you want from a trickle charger. But, when your set has been in almost continuous operation for a number of hours and a trickle charger can’t bring the battery back—then’s when you’ll need Rectigon most.

For Rectigon’s high charging rate will give the battery its full strength quickly and surely. Another change of the Rectigon leads and you recharge your wet “B”—*all with one charger, the Rectigon.* Also

3 Ampere Rectigon

~~\$18.00~~

now

\$14.00

5 Ampere Rectigon

~~\$28.00~~

now

\$24.00

charges your automobile battery.

Westinghouse makes Rectigon—and Westinghouse knows radio. You remember when the first program came from KDKA—perhaps you’re listening to Westinghouse radio every night now. Rectigon is simple and safe. It uses no acids or chemicals—has no moving parts to break or wear out. No harm done if you tune in while charging—

none if the power goes off while Rectigon is in the circuit. For the cost of a few outside chargings, you can put Rectigon in your cabinet and forget the annoyance of weak or run-down batteries.

Westinghouse Rectigon Battery Charger

WESTINGHOUSE ELECTRIC & MANUFACTURING COMPANY, EAST PITTSBURGH, PA.

Offices in All Principal Cities / Representatives Everywhere

Tune in with KDKA—KYW—WBZ—WBZA

Rectox—for trickle charging only—will transform your wet “A” battery into a light-socket power unit. Replace your power every time you turn off the set. Rectox is trouble free—uses no acids or chemicals, has no moving parts. Adjustable to 1/2 or 3/4-ampere charging rates.



Besides Rectigon and Rectox for better battery charging, Westinghouse also makes Micarta panels and tubing for better insulation, and radio testing instruments for better reception.



Bremer-Tully Discard Old Standards of Comparison

THREE WINNERS

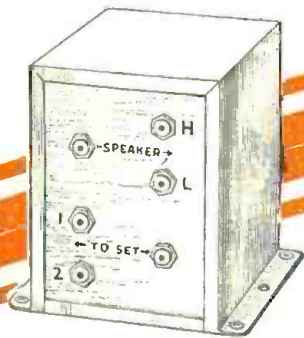

B-T Speaker Coupler Guarantees Improved Tone, Increased Volume, and Saves Speaker's Life.

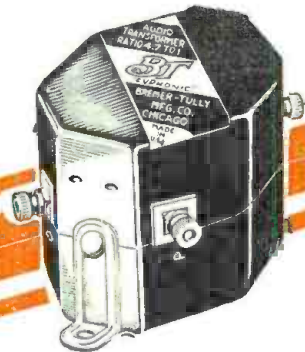

Here's a real answer to Distortion.—the B-T Audio Coupler.

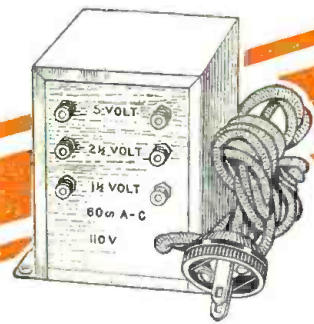

B-T "A" Transformer Makes a Power-Six "Electric"

Six Years' Success Back These New Products

Bremer-Tully have released a new product which should create world-wide discussion.

The old idea of "Amplification Curves" as a basis for comparing audio transformers has been discarded. *It never was anything more than a very secondary matter.*

B-T have always maintained that the real problem was "Harmonic Distortion,"—and—

Now they have proved it in the new B-T AUDIO COUPLER.

It is more than a transformer,—and better,—although no one ever produced a better transformer than BREMER-TULLY.

A constant Impedance Core,—an air-gap,—Tertiary Loading Coil,—and finest laminations, combine to produce **QUALITY UNEQUALLED** anywhere, regardless of size or price.

"Harmonic Distortion" has had practically no attention.—the attempts being to improve transformers by *increased size,—cast cores,* etc. You can readily appreciate that BREMER-TULLY could not release this product if it was not superior.

Type 3-31 is for First Stage; Type 2-22 for second stage or for all stages where three stages are used,—as in replacing Resistance Coupling. Bring your set up to date with a set. Price each, \$6.00.

Read more in **BETTER TUNING**—See Coupon.

BETTER TUNING is a booklet of 80 pages answering the latest questions in radio. Thousands praise it, and profit by it.

SEND THE COUPON.

The POWER-SIX "Electric"

Everyone knows the record of the B-T Power Six.

You can now run yours from the light-socket, without batteries.

Use the new B-T "A" Transformer, instead of storage battery and charger. Price \$7.50.

Complete Diagrams and Instructions for making the change or building a new electric set, \$1.00.

This is what you've been waiting for.

The Speaker Coupler

Put a B-T Speaker Coupler between your power tube and speaker and improve reception wonderfully. The difference is amazing.

You will get Better Tone, and particularly with air column speakers or horns, much Greater Volume.

You will protect your speaker from heavy current flow and prolong its life.

You can match your speaker and power tube through various combinations, as shown, without the use of tools. Simply insert cord tips.

Speaker Coupler, suitable for table use, or may be mounted inside cabinet. Price \$7.50.



520 S. CANAL BREMER-TULLY MFG. CO. CHICAGO, ILL.

COUPON

Send 80-page Booklet.

I am interested in Sets..... Parts.....

I am a Dealer..... Consumer..... or.....

Print Name

Address

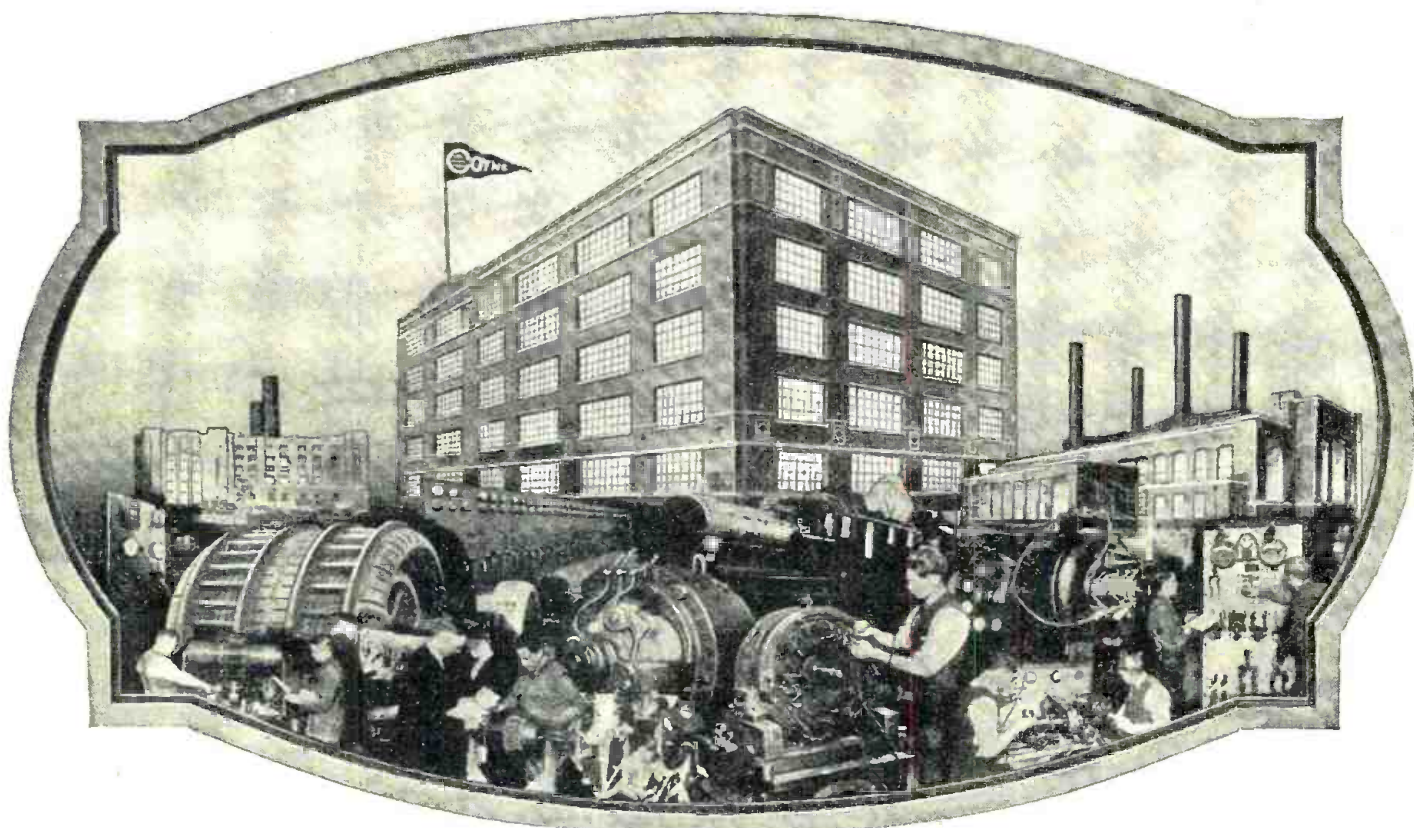

Get into ELECTRICITY

Learn in 90 Days WITHOUT BOOKS OR LESSONS —

Don't spend your life waiting for \$5 raises in a dull, hopeless job. Now . . . and forever . . . say good-bye to 25 and 35 dollars a week. Let me show you how to qualify for jobs leading to salaries of \$50, \$60 and up, a week, in Electricity—NOT by correspondence, but by an amazing way to teach, that makes you a practical expert in 90 days! Getting into Electricity is far easier than you imagine! Act now, today!

NEW—Quick Amazingly Easy Method!

Lack of experience—age or advanced education bars no one. I don't care if you are 16 years old or 48. It makes no difference. Don't let lack of money stop you. Most men at Coyne have no more money than you have.

Earn While Learning

If you should need part time work, I'll assist you in getting it. Then, in 12 brief weeks in the great roaring shops of Coyne, I'll train you as you never dreamed you could be trained.

No Books—No Printed Lessons

You work on real live electrical machinery, building real batteries, winding real armatures, operating real motors, dynamos and generators, wiring real houses, etc., etc.—here in this world famous parent school, with its hundreds of thousands of dollars worth of new up-to-date electrical equipment.

Send for Free Book!

Mr. H. C. Lewis, Pres.
COYNE ELECTRICAL SCHOOL, Dept. 97-77
 500 So. Paulina Street, Chicago, Ill.

Dear Mr. Lewis:—Without obligation send me your big free catalog and all details of Free Employment Service, Radio and Automotive Courses, and how I can "earn while learning." I understand I will not be bothered by any salesman.

Name

Address

City State



Prepare For Jobs Like These

Here are a few of hundreds of positions open to Coyne-trained men. Our free employment bureau gives you lifetime employment service.

- Armature Expert \$50 a Week and up
- Substation Operator, \$65 a Week
- Auto Electrician \$60 a Week and up
- Inventor - - - Unlimited
- Maintenance Engineer \$60 a Week and up
- Service Station Owner \$60 a Week and up
- Radio Expert, \$60 a Week and up

Jobs — Pay — Future

Don't worry about a job. Coyne training settles the job question for life. Clyde F. Hart got a position as electrician with the the Great Western Railroad at over \$100.00 a week. That's not unusual. We can point to Coyne men making up to \$600.00 a month. Easy to get jobs leading to \$50 a week and up, while starting your own electrical business puts you in a position to become independent.

Get the Facts

Send now for my big 56-page book containing 150 photographs, telling the whole Coyne story. It tells you how many earn expenses while training and all about our lifetime employment service. We are now in our new \$2,000,000 school—the finest school in the world devoted to the exclusive training in Electricity.

Coyne is your one great chance to get into electricity. Every obstacle is removed. This school is 28 years old—Coyne training is tested—proven beyond all doubt—endorsed by many large electrical concerns. You can find out everything absolutely free. Simply mail the coupon and let me send you the big, free Coyne book.

My Course Includes Training in **Aeroplane Electricity**

Not a Correspondence School

COYNE Electrical SCHOOL

H. C. LEWIS, Pres., Dept. 97-77—Established 1898
 500 So. Paulina Street, Chicago



RADIO NEWS

HUGO GERNSBACK,
Editor and Publisher

Editorial and General Offices, 230 Fifth Avenue, New York

Vol. 9

DECEMBER, 1927

No. 6

NEEDS OF THE RADIO INDUSTRY

By HUGO GERNSBACK

IT is sad but true, that of late the radio industry as a whole has exhibited little originality. There is entirely too much of imitation in practically all lines of the industry; and this state of affairs, as a rule, leads to stagnation.

Only the very large radio concerns maintain research laboratories in which any really original work is done; smaller concerns as a rule concentrate their engineering talent on the solution of their manufacturing problems. If a new invention does make its appearance, in a majority of cases it does not originate in the big research laboratories, but rather comes from independent outsiders. The Armstrong regenerative circuit, for instance, was invented in a college laboratory. One of the most important inventions of recent years, the television system of Baird, the Scotchman, was evolved in an attic; although in America, the American Telegraph & Telephone Company contributed its share to the American side of television progress. Jenkins, one of the pioneers in television experiments in America, is not connected with any commercial organization. It will be noted, that in a number of these cases, the radio industry, as a whole, had nothing to do with the inventions. The list might be extended indefinitely with many examples, tending to show that the radio industry does little, if anything, toward its own advancement. As in everything else, there are exceptions, but they are not numerous.

It is certain that, if this trend continues indefinitely, the lead that America still maintains in radio will sooner or later be wrested from us.

Take, for instance, the case of the double-grid tube. For two years I have emphasized, editorially and otherwise, the importance of this tube. I explained its high efficiency for radio work, and went to great pains to point out that in Europe it was well established and had even been incorporated in manufactured radio sets. I entered into correspondence with a number of American tube manufacturers, urging them to manufacture such a tube. Very little response, if any, was obtained.

Yet, witness the sad spectacle that arose immediately after our largest radio corporation announced a new double-grid tube. Over night it became important and created a sensation in the radio trade. During the Chicago Radio Show, held in the middle of October, crazed manufacturers were actually bidding \$1,000 apiece for samples of this tube, which will soon sell in the open market for only a few dollars. Every first- and second- and third-rate independent tube manufacturer simply went insane, trying to get one of the new tubes in order to imitate it quickly. This in itself is a huge joke; for practically the same tubes have been manufactured and sold in England and Holland for over two years and can be freely obtained there. The chances are that the European tubes are every bit as good as the new American one.

Of course, this state of affairs is nothing new. The radio industry is in the habit of doing just this sort of thing. Bring out a new socket that is a meritorious one and the whole industry will soon be making one exactly like it. Bring out a condenser, of some new straight-line variety, and immediately we have imitations regardless of the merits of the first condenser. Someone markets a five-tube radio-frequency receiver, and 99 per cent. of the sets manufactured within six months will be patterned after the first one, simply because the first one was commercially successful. If someone brings out a power tube, immediately every tube manufacturer will have one exactly like it.

These imitators have not as yet learned the lesson that the radio manufacturer who pioneers and brings out something new on his own account is always the one who is most likely to benefit; whereas the imitators are usually too late anyhow, because, by the time they get into production, the chances are, that the original manufacturer already has something better.

If the imitators would only appreciate the lesson that there has been more grief, more failures and more money lost in these "Chinese" copies than for any other reasons, they would not be so free in imitating a new and successful product. Outside of that, even if they are sometimes fairly successful in their imitations, they probably will sooner or later be enmeshed in patent suits. Witness the recent scramble for protection by the many manufacturers of tuned-radio-frequency receivers. A little reflection will show that, if they had maintained capable research laboratories, the chances are that they would have evolved circuits and designs that did not infringe upon existing patents. *For the amount of money that these same manufacturers have paid and will pay in royalties, they could have hired some of the best radio engineering talent in the world.*

And let me say here that it is possible to have circuits just as good, if not better, than existing ones, but which do not infringe upon existing patents. But it seems that it is not the radio industry which fosters research work along original lines, but rather outsiders. For instance, a new circuit which not only approaches but exceeds in effectiveness the tuned-radio-frequency system is described in the present issue of RADIO NEWS. A young Southern radio engineer set himself to develop a circuit that did not infringe on any existing patents, and he was successful in so doing. Incidentally, he will be paid over \$200,000 for his invention, and it will be cheap for the buyer.

Right now, the radio industry has its great chance. I refer to television. Inside of the next two years, broadcast stations will be sending out television impulses, and a number of radio manufacturers will literally coin money by supplying television attachments to be attached to existing radio sets. What has the radio industry done toward developing this tremendous potential demand? Nothing. Yet

the field is wide open and, even today a workable television apparatus without wheels and moving parts can be constructed from components that can be secured on the open market.

When I say television apparatus without wheels and moving parts, I refer, of course, to the receiving instruments. At the sending or transmitting end, it will probably be necessary to use moving parts, which may be of the present movable-disc type. At the receiving end, this should not be necessary in the final apparatus.

It may be said that the final television receiver must be as simple to operate as the present day radio receiver. As a matter of fact, it must be even simpler. It may even be unnecessary to have a dial on the television receiver; for the simple reason that the dial on the radio receiver is all the tuning control necessary. It is most probable that the television impulses will be broadcast on the same wavelength that a broadcast station uses, the television impulses being of a frequency above audibility. By a step-down arrangement, the television apparatus will make it possible to translate the received radio television impulses back into the light rays, which will finally become visible on a small screen built into the television attachment. I, personally, foresee the final television receiver, which will have incorporated into it some sort of a vacuum tube, such as the Braun. The Braun tube, instead of using discs, or wheels, employs a *cathode* discharge. This latter, having no inertia, throws upon the screen a moving beam of light which responds to magnetic impulses. There should not be any difficulty in getting this beam to work at any required speed.

Furthermore, many of these parts, including circuits, are not patented and the market is open to practically all.

If the radio industry would employ a few good research men at this time and invest a little money in experiment, possibly enough new television principles could be brought out to create a bonanza for someone for the next two decades.

... In which the Editor comments unfavorably upon the fact that imitation, rather than invention, is the fashion among too many radio manufacturers in America—and that they first ignore progress abroad, and then fall over each other to be in line when a foreign development has been imported—what a really-ingenious outsider can do in the way of bringing out something new—and what an opportunity awaits the industry if it will spend a little to bring television to the public. . . .

Mr. Hugo Gernsback speaks every Tuesday night at 9.30 P. M. from station WRNY on various radio and scientific subjects.

Golden Opportunities of Custom Set Builders

Profitable Work for the Constructor in Educating His Friends
to the Latest Conveniences of Radio

By EARL SOWERS

Of any period in the radio era, this season offers undoubtedly the greatest opportunity for the custom set constructor and the builder of radio receivers, and radio specialties. Never before have there been such possibilities, either in the number of parts and kits available for such work, or in the scope of the field that is open to the man who cares to use his spare time to advantage and profit.

Real money is waiting for the man who will go out after it and, in addition, a great service can be rendered by the radio enthusiast through introducing this most fascinating of new sciences to a new audience, and in making receivers already installed more serviceable and enjoyable. In either case he is aiding the cause of radio and serving as a missionary in the field. Here are some of the possibilities for the wide-awake constructor: building standard receivers in standard cabinets; building special receivers in standard or special cabinets; converting present receivers into A. C.-operated sets; building power units, (either "A" or "B," or both) for sets already in service; and making electric phonographs out of old-fashioned talking machines, either in conjunction with radio sets or by building a special amplifier and providing a loud speaker.

This list might be extended; but these are the high lights and they are sufficient to give an idea of the type of work that the author has in mind. Surely it is a large program and a money-making one; while a little imagination will suggest other possibilities to the clever worker.

MODERNIZING INSTALLATIONS

In this connection there is one other idea that, in some ways, will be worth all of those listed above put together. That is, it will make for real pleasure from radio, for husband and wife alike, and will attract an endless stream of compliments from their guests. To bring that about needs a little thought and a few hours' work by the neighborhood set builder and worker.

Go out and make every set in your neighborhood a 1928 installation. Do away with all wires; put the batteries (if there are such accessories) in the basement; run the ground lead through the living-room floor to the water pipe; bring the aerial lead-in through the walls and install a loud-speaker

circuit (in the walls) reaching every part of the house, with only the jack boxes in the open.

Not much money will be spent in doing these things, but they make radio really enjoyable. And the set owner will never cease to derive pleasure from your work and will boast, boast and boast. That is good business.

OVERCOMING "SALES RESISTANCE"

But to come back to the first suggestion. Many people still "doubt" radio (no doubt you know several); they are always waiting for the thing to be perfected. *The custom set builder can sell them.* About all he will have to do is to install one of his own sets in the home, let it stay for a night or so, and offer to build one exactly like it for the Doubting Thomas. Of course, minor changes in design can be suggested to suit the individual case. The guarantee of the builder will be a big inducement and a sale will not be so hard to effect.

To sell this type of individual, though not so hard under such circumstances, would be almost impossible for the average salesman. The latter has not the time and Mr. Citizen has not the confidence that is necessary to close the deal. Here is where Mr. Custom Set Builder steps in and enlarges the circle of radio users. At the same time, such a set owner is likely to become a very enthusiastic listener-in, will talk much and win others over to radio.

What has just been said applies to the sale of a standard set in a standard cabinet. When that combination fails to attract there is a second proposition: a standard or a special receiver built to order to fit a special cabinet already in the home. This opens a new line of possibilities, and one which is quite extensive.

SETS TO SUIT THE HOME

There are many well-to-do people who have no radio because they have not found or cannot get just what they are looking for. The custom set builder can give them just that. He can build them a three or a ten-tube receiver, working from batteries or the light circuit, and can put it anywhere they want it. He can install it in the library,

the living room, the den, or wherever it is desired. The accessories may be hidden in the basement or in a closet, and the entire assembly carefully concealed or camouflaged if the owner so prefers.

Sectional bookcases in a library offer a

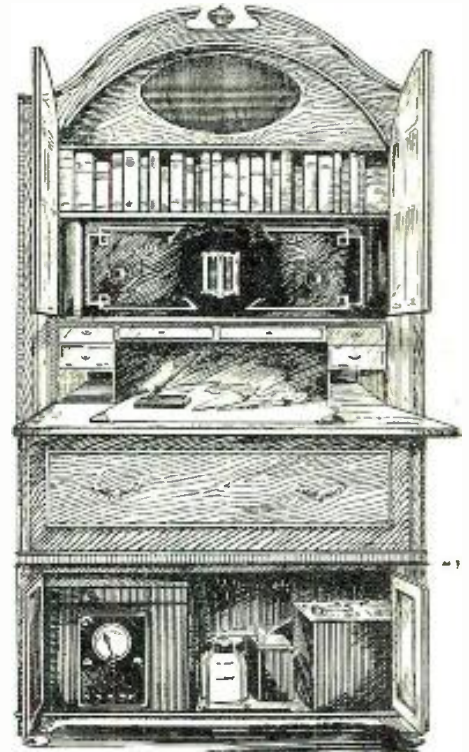

The ingenious custom set builder can easily build radio receivers into existing pieces of furniture. For example, one of the shelves in an upright desk or secretary, as shown above, can be made to accommodate a tuning panel, and the various current-supply units readily placed in the bottom compartment.

fine opportunity. The panel of the set may be made to occupy one bookcase section, and the batteries or socket-power unit placed back of the row of books in a lower section. Console models of the new talking machines are another possibility; secretaries and writing desks still others. In fact, the clever worker has only to be shown the piece of furniture in which it is desirable to build the radio and he can adapt it to the purpose.

Along this line, the next thought is to dispose of the loud speaker in the same unobtrusive way. Locate it in some alcove, either in the same room with the receiver, or in another room. Often a more pleasing effect will be obtained if the speaker is placed in an adjoining hall or room. With an extension cord, the best location is easily found; and then the permanent circuit may be put in under the floor.

Much thought has been given these things by the writer and he has done a number of such jobs for the good of the cause. With little time for radio other than that which comes as a part of his daily job, he has confined his home activities in recent months to just such jobs as these, in the desire to demonstrate to some friends what radio really is and how it can be best enjoyed. These have been all "friendship" projects, and to "sell" radio in places where it has not yet been sold. What has been learned, the writer is passing along, that others may aid him in a little private campaign. It has been a lot of fun; but the home builder can come along and "cash in," if he has the inclination.

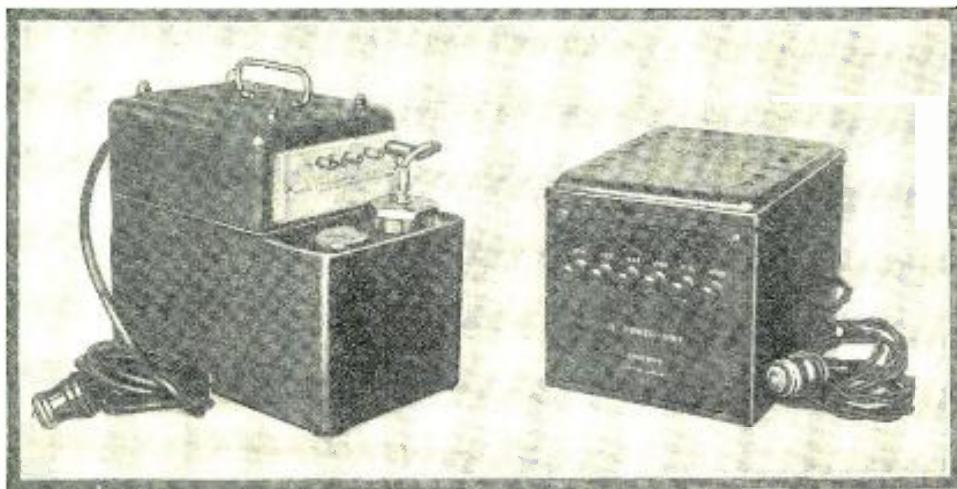

One of the greatest fields for the radio specialist is the "electrification" of old-model radio receivers; that is, their adaptation to house-current operation. Two typical lamp-socket supply units, designed for use with sets employing battery-type tubes, are shown above. At the left is an "A" unit, at the right a "B" device; both work on alternating current. The former supplies "A" current for the lighting of the tube filaments, while the latter provides the necessary "B" current for plate power.

Illustrations courtesy The Abox Company and Leslie F. Muter Co.



Another solution of the "electrification" problem is the use of the new A.C. tubes, which employ alternating current for their filaments. These tubes require merely a small step-down transformer, and involve but few changes in the wiring of a set. Several typical A.C. tubes and two lighting transformers are shown above. A regular "B" supply device must be used with these tubes.

CONVERSION OF SETS FOR A.C.

Few of the estimated eight or ten million receivers now in service are operated from the A.C. lighting mains. The clever worker can, probably, spend the entire winter making over sets in his neighborhood for the new tubes. If work should become slack, an investment of a half-dollar in the "want ad" pages of the leading newspaper would be likely to stock him up for another six months.

The conversion of such sets is quite a simple matter, the method of approach depending upon whether the tubes use raw A.C. or are of the heater type. (See *RADIO NEWS* for November, page 484; other special data may be had from the manufacturers of the tubes used.) Outside of the cost of the transformer, which is reasonable, there is no great item of expense.

When A.C. operation of filaments has been provided there is certainly no reason or excuse for the absence of the "B" socket-power unit. The custom set builder can readily construct one that is entirely satisfactory in every way. For this, there are available on the market any number of transformers, choke coils and condenser blocks; or all three may be purchased in the same housing, greatly simplifying the construction. For his own satisfaction, as well as the customer's protection, the builder should use ample fuses in the 110-volt feeder circuit.

When there is no inclination on the part of the set owner to spend the sum required for the conversion of the receiver into an A.C. operated set, the next best expedient is the really satisfactory battery-and-trickle-charger combination, especially if an automatic relay is installed.

Given a good battery, a good trickle charger and a dependable relay, with the "B" socket-power unit controlled by that

relay, the radio set becomes about as nearly automatic as seems necessary. In addition, this combination easily lends itself to the removal of the battery to a remote location, where there will be no danger of damage from acid and the fumes from the battery will not be noticeable. The basement is an excellent location for this equipment.

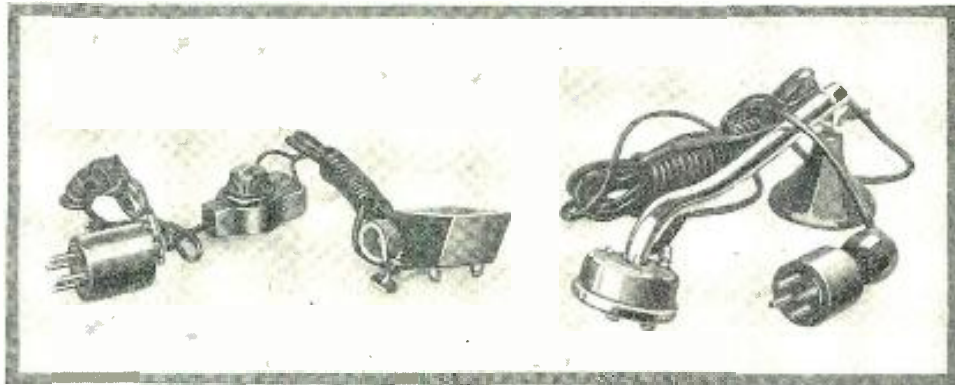

The modernization of old-style phonographs by means of electrical "pick-up" units, which work through the radio-set amplifier and loud speaker, offers another opportunity for the custom set builder. These substitute tone-arms, two popular models of which are illustrated above, are easily installed, and reproduce with fidelity and volume.

Illustrations courtesy Patent Electric Company and Magnaphom Electric Mfg. Co.

From the relay can be run the 110-volt line to feed the "B" power unit which, being dry and noiseless, can be placed almost anywhere, close to the receiver.

PHONOGRAPH COMBINATIONS

Though listed last here, work on the talking machines is by no means the least of the possibilities that are open to the custom set builder. In some ways, it is probably the greatest; because the field is so fertile and the opportunity so new that few

have taken advantage of it. It is quite likely, that the use of the new talking-machine attachments, just being placed on the market, will be one of the outstanding features of the fall and winter radio season.

Given almost any old talking machine, the handy radio man can make a phonograph that will rival the latest models of the manufacturers, made in the new designs. These are simply electric machines, embodying many of the principles that are now used in radio. The "how-to-do-it" is quite easy. In brief, it is something like this:

Install the new electric reproducer or pick-up device in a talking machine, feed this into the amplifier of the radio set and use the loud speaker for the delivery. The mechanical reproducer is permitted to remain on the machine, which can then be used either way. (If there is no radio set in the house, then a good two-stage amplifier and a loud speaker are needed, plus—here is another opportunity—"A" and "B" power supply.)

With a little extra work a switch can be installed on the radio set; so that all tubes except the two audio amplifiers can be cut out when the talking machine is being used. Then, with a throw of the switch, the radio loud speaker will give either radio, or the choice of selections from the talking machine, the latter reproduced with excellent fidelity.

To cap the climax, after the machine has

been converted into an electric phonograph, go one step further and drive the turntable by an electric motor; thus completing the job of an all-electric set-up that works from the light socket. These motors are not hard to get—consult the advertisements.

Turn over in your mind the opportunities of this great season for the custom set builder and, if you are one, go out and go to work. You will make some money and you will have the satisfaction of introducing radio to a circle of new friends.

RADIO REAWAKENS THE OLD WORLD

By C. P. MASON

TO those who have passed through the rapid and unprecedented changes which modern society and modern industry have undergone since the beginning of the twentieth century, it may well seem that nothing more of equal importance can happen. Whatever may be the fate of present fashions in governments, in garments and in coiffures, we shall continue to live in an age of mass production, of motorized transport, of aerial navigation, of moving pictures and of radio.

It is probable—it is certain, that many of the highly-developed devices which we now look upon as marvels of efficiency will be relegated before long to museums; and reappear only, like America's first locomotive,

to show our grandchildren how far they have advanced beyond our crude methods. Machinery will be perfected, new sources of power will supersede the wasteful use of coal and oil, aerial travel will become commonplace instead of venturesome, television will take the place of the news reel; and radio itself will be brought to an efficiency we hardly dream of today. In predicting the near future, the greatest license of the imagination seems sober, after we have compared the present with the recent past.

Yet, great as are the advances yet to be made in the art of radio, it seems impossible

that this utility can be superseded, as will be the case with steam power. There have been four great steps in the development of human communication; speech, writing, printing, and radio. The last has overleaped the limits of space and time which were imposed upon its predecessors. Until man develops a faculty or a science of telepathy, and harnesses it to his needs, radio must be the last word.

There has been held during the past few weeks in Washington a conference in which the principal powers of the world and many smaller nations are represented, in the endeavor to devise for the future development of radio plans and regulations which shall

(Continued on page 680)



What's New in Radio



UNIT SUPPLYING BOTH "A" AND "B" CURRENT TO SETS USING A.C. TUBES

POWER units, for use with receivers employing the new 226- and 227-type (alternating current) tubes, may be of very simple and compact design. This fact is proven by the efficient, compact device pictured on this page. Although it weighs less than fifteen pounds and is only 6½ inches high by 6¾ inches wide by 9 inches long, it is capable of delivering ample power for both the plate and the filament circuits of sets employing seven tubes, with a 171-type power tube in the last stage of amplification. Also the unit may be used in connection with sets employing storage-battery tubes; as it will supply plate ("B") power to all tubes and filament ("A") current for the power tube.

Electrically, the unit consists of a standard plate-power-supply device, together with a special transformer having three additional secondary windings for providing filament current for the A.C. tubes. The plate-power-supply circuit has a maximum output of 180 volts at 50 milliamperes, and there are three taps which provide the voltages usually required. The three low-voltage windings of the transformer deliver the operating potentials required by the filaments of the A.C. tubes. A 1½-volt winding has ample capacity for supplying seven 226-type (A.C. filament) tubes; a 2½-volt winding will provide power to as many as four 227-type (heated-cathode) tubes; and the 5-volt secondary supplies current for the filament of the 112- or 171-type power tube in the last audio stage.

Although there is not a variable voltage regulator on the front panel, it is possible to obtain the exact plate voltage required by making a simple adjustment inside the unit. A 3,000-ohm resistance unit, with taps at 1,000 and 2,000 ohms is used for this purpose; and the proper power is obtained by shifting a flexible lead to either the zero, 1,000-, 2,000-, or 3,000-ohm terminal as required by the tubes of the receiver. When the flexible wire is connected with the zero terminal the unit will deliver maximum power; and when it is connected with the 3,000-ohm terminal the output voltage is minimum, or approximately 135 volts on the high-potential tap.

Two improvements are largely responsible for the compact design of this unit. First, space is saved by employing one transformer with five secondary windings to pro-

vide all potentials; and second, an electrolytic condenser of the new type used requires only a fraction of the space taken up by a paper condenser of equivalent capacity.

A 30-microfarad capacitor is placed in a metal container only 3 inches in diameter



"A-B" power unit as it appears with cover in place. A and B are slots and openings for ventilation purposes; D, hole for battery cable.

Illustration courtesy Harold Powers, Inc.

and 5 inches in height. The unit has three taps which connect with its respective 10-mi. sections, and it is rated at an operating potential of 300 volts. Also, it has the important virtue of healing itself if it should be broken down by high voltages.

In the power transformer there is a high-voltage winding with a center tap which provides plate current to the 213- or 280-type full-wave rectifier tube, and there is a 5-volt winding which provides the rectifier with filament current. In addition, there are the three low-voltage windings for the filaments in the receiving set.

Two choke coils and the condenser described above are used in the filter circuit of the plate-supply system. At the output of the filter circuit is connected a resistor of high value, for obtaining the lower voltages required. Two taps are used for this purpose, and provide 90 and 45 volts when the unit is in operation.

To place this device in operation, the top is removed to insert the rectifier tube and for making connections to the low-voltage windings of the transformer. The high-voltage output terminals of the unit are located on the bottom and are accessible from the outside. The voltage adjuster is located in the top compartment.

The three accompanying pictures show the appearance of the device from different an-

gles. The exterior view shows the unit ready for service with the metal cover in place. It will be noticed that slots have been cut in the sides of the metal box at A, and two holes in the cover at B, to provide ventilation for cooling the unit while in operation. The cord which connects with the lamp socket passes through the base on the right side and a hole is located in the same relative position at D, on the left side, for the battery cable which goes to the binding posts of the receiver.

With the metal cover removed much of the apparatus is revealed. The electrolytic condenser is shown at C, CK1 is one of the choke coils, R is the full-wave rectifier tube, VC is the voltage-control resistor and T is the top of the power transformer. The six binding posts located on the top of the transformer connect with the filament-supply secondary windings. Connection to the plate supply circuit is made at panel P on the under side of the panel.

No separate "C" voltage terminals have been incorporated in the power unit; but these potentials may be obtained by the use of proper biasing resistors in the receiving set.

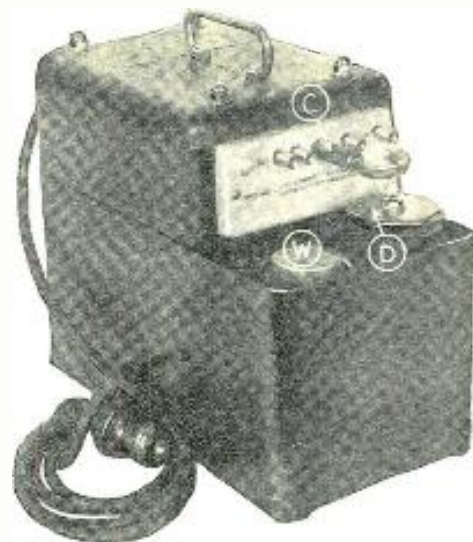

All parts of the "A" power unit are enclosed in a metal case; C, voltage control; D, cap of rectifier; W, hole for adding water.

Illustration courtesy Fansteel Products Co., Inc.

ELECTROLYTIC CONDENSER AND RECTIFIER IN "A" POWER UNIT

A NEW system, which is totally different from that used in the various storage-battery trickle-charger types of "A" power units, is employed in the device pictured on this page. The unit, when connected with a source of 110-volt, 60-cycle power (the lamp socket), will provide two amperes of direct current at a potential of six volts for heating the filaments of tubes in a radio receiver. The cost of operating a receiver in this manner is approximately the same as that of a fifty-watt electric lamp, and the initial cost of the "A" power unit is slightly greater than that of a good storage battery.

In design the device consists of a rectifier and filter circuit, built into a compact unit which weighs less than fifteen pounds. It does not contain a storage battery of any

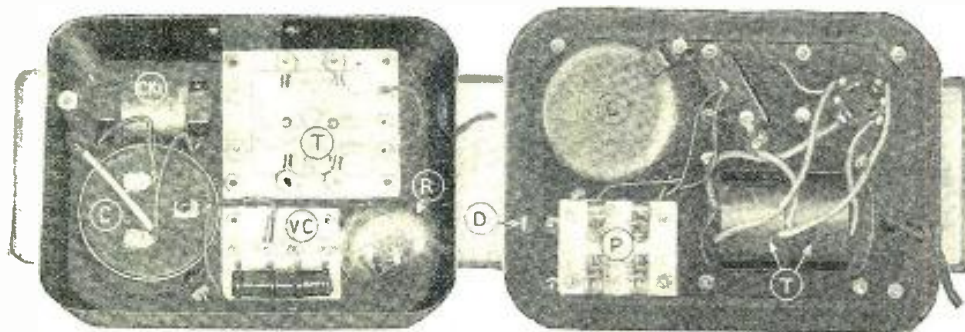

Two views of "A-B" power unit showing (left) arrangement of parts under cover, and (right) apparatus located under base: T, transformer; C, filter condenser; CK1, choke coil; P, binding-post panel; R, rectifier; VC, voltage control.

kind, and requires practically no attention of any kind.

For the rectifier an electric cell of the electrolytic type is employed. This cell is connected to the light-socket circuit through a step-down transformer which changes the lighting voltage to the value required by the power unit. The electrolyte used in the rectifier consists of an alkaline solution, which is covered by a thin film of oil to prevent evaporation. When shipped the unit is dry, and the cell contains only the solid alkaline substance and a small quantity of oil. When the user wishes to place it in operation, it is necessary merely to add distilled water. With continued use over long periods of time, the quantity of water may depreciate to some extent, and after three or four months it may be advisable to add a slight amount of distilled water to the cell. However, even if water is not added, the unit will not be injured.

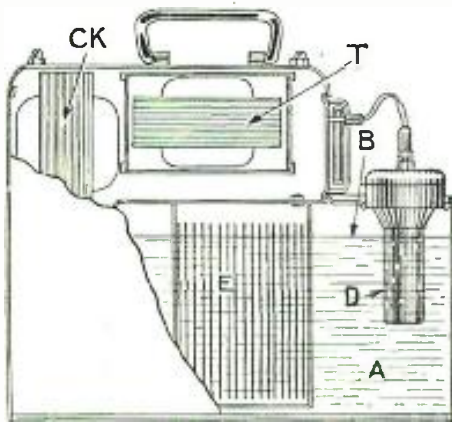

Drawing shows arrangement of apparatus in the "A" power unit: A, electrolyte; B, oil film; CK, choke; D, rectifier; E, condenser; T, transformer.

In the filter circuit of the power unit there are a condenser and choke coil, connected in the usual arrangement. The condenser is also of the electrolytic type and employs the same electrolyte that is used in the rectifier cell. The condenser has two sets of plates submerged in the liquid and, electrically, is employed as two separate condensers.

A device of this type has marked advantages. It does not depreciate to any considerable extent; and requires practically no attention or care. Another feature of importance is that power is always available for the operation of the receiver. The unit does not include a battery which requires charging, but will operate immediately when the current is turned on. Also, current is used only when the set is being operated.

The accompanying illustrations on this page clearly show the construction and appearance of the device. In the external view the cork, W, shown on the left indicates the opening where water may be added to the electrolyte of the condenser and rectifier cell. The flexible connection C may be employed to regulate the power output of the unit. Several contacts are mounted on the front panel and, by connecting the flexible wire with the proper post, the correct voltage for the operation of the receiver is obtained.

The cut-away view shows the arrangement of apparatus inside the unit. The choke coil CK and transformer T are located in the upper compartment, enclosed in a sealing compound. Directly under the transformer and choke coil is located the electrolytic condenser. The rectifier cell is in front of the condenser in the same compartment. The electrical design of the unit is such that the outside plates of the filter condenser act also as the non-rectifying element of the electrolytic rectifier cell.

FIVE NEW TUBES PROVIDE THE "ELECTRIC EYE"

AMONG the scientific radio developments of the month may be included five tubes of new design which have an almost unlimited number of uses, but are particularly well suited to the requirements of radio television and photo transmission. Three of the tubes are described as photoelectric cells, and the remaining two are neon "glow" lamps.

From the viewpoint of the radio experimenter the tubes will prove very interesting, as they may be employed in many ways in the laboratory, and because radio apparatus is used exclusively in all circuits in which the tubes work. It will also be found that the tubes may be used in performing tricks of parlor magic which visitors will find impossible to explain.

An approach to an electric eye is found in the alkaline-hydride photoelectric cell. This device, which is extremely sensitive to light, and to variations in intensity and color of light, transforms optical effects into variations in an electric circuit. Furthermore, the cell responds to these effects with extreme rapidity and a high degree of precision. The result is that the cell has a wide range of application.

To explain the operation of the photoelectric cell a simple circuit will be considered: when the cell is connected in series with a circuit containing a battery, a constant resistance, and a current-measuring device, no current flows when the cell is dark. However, when the cell is illuminated, a current is allowed to pass; and this current will be found to be directly proportional to the intensity of the illumination as well as to the area of the sensitive surface which is illuminated. In such circuits the photoelectric cell acts as a variable resistor, the value of which is determined by the illumination of the cell.

It is astonishing to think of the number of things a tube of this type may be called upon to do for scientific, industrial and commercial purposes. It may be employed in many operations in which the human eye was formerly used; and, in many in which the human eye cannot be used, the cell performs consistently and accurately. A few of its uses are the transmission of photographs by wire or radio, the improved recording of sound on phonograph records, the reproduction of sound in "talking moving pictures," the transmission of moving pictures, the automatic operation of electromagnet relays for the control of artificial illumination operation of fire alarms; inspection of materials according to color, grading of cloth, etc.

Photoelectric cells of the type shown in

the illustration on this page have a glass envelope containing a photoelectrically sensitive surface of potassium hydride. This is prepared in a vacuum from highly purified metallic potassium, and the coating is converted into potassium hydride by a special sensitizing process. The tubes are gas-filled, at various pressures.

In the electrical operation of the cell the sensitive surface is the negative terminal.

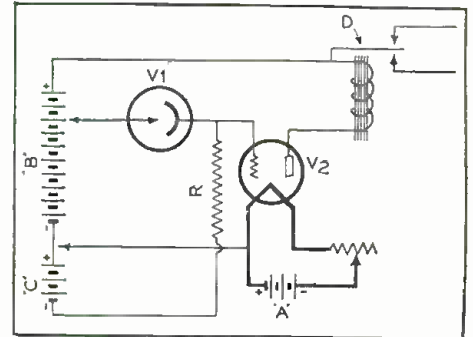

Circuit showing arrangement for connecting the photoelectric cell V1 with a resistance-coupled amplifier for the operation of a relay (D).

and the grid (or anode) is the positive terminal. When the cell is connected properly and light shines upon the sensitive surface, electrons are emitted from this surface and are attracted by the grid. The number of electrons emitted in any unit of time is proportional to the area and intensity of the illumination of the sensitive surface, and is also dependent upon the color of the light.

In actual practice the photoelectric cell does not pass sufficient current to be of much importance in the direct operation of electrical devices, such as relays, etc. Therefore, photoelectric cells are usually connected in the grid circuit of a standard vacuum tube, and the current fluctuations are amplified by the tube. When the cell is used in this manner it is a source of variable potential, rather than of current; as in this case only a "charge current" flows through the cell, and the potential acquired by one of the electrodes is proportional to the intensity of illumination.

A practical arrangement will be found in the circuit on this page. In the diagram shown, a one-stage resistance-coupled amplifier is used in connection with a photoelectric cell to operate a relay. This circuit is applicable to many practical operations. When the cell is dark, the grid bias is varied by adjusting a "C" battery or potential. (Continued on page 686)

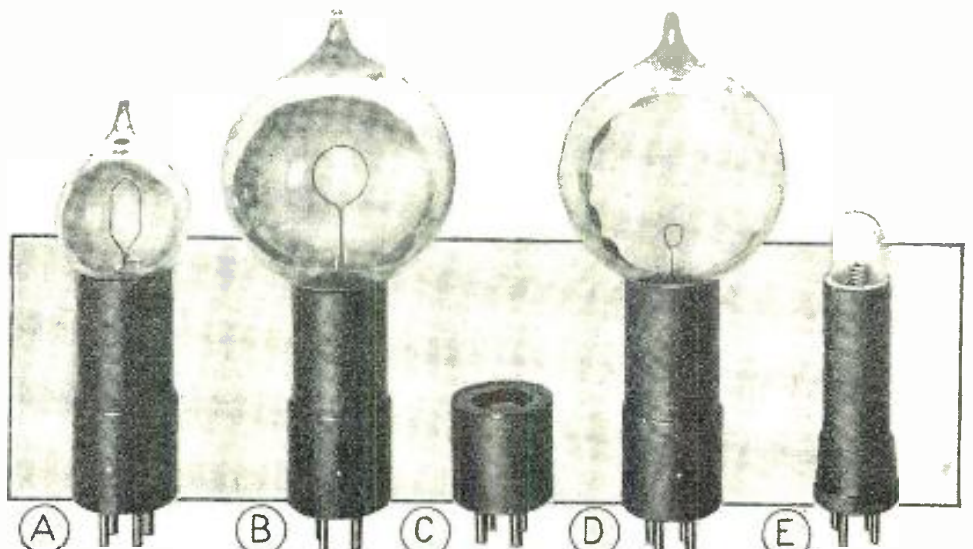

Five new special-purpose tubes. A, B and C are photoelectric cells, and D and E are neon "glow" lamps. Their construction and uses are described below.

Illustration courtesy G-M Scientific Manufacturing Company.

Principles of Superheterodyne and Autodyne Reception

A Simple Discussion of the Alternating-Current "Wave" Phenomena Involved

By CLYDE A. RANDON

IT is often difficult for the radio fan, who has not had the advantages of a technical education, to understand the functioning of some types of circuits. One of the most difficult — and at the same time, most interesting—is the superheterodyne. Various "frequencies" are mentioned glibly by writers, but mean little to the average layman. Mr. Randon has cleared up the matter to a very great extent in the accompanying article, which explains the nature and cause of different frequencies encountered in the superheterodyne and the autodyne circuits.—EDITOR.

THE superheterodyne and autodyne modes of reception are in such common use that a thorough understanding of the underlying principles is fundamental. The principles involved are really simple and the discussion may be easily followed by the beginner by referring to the various diagrams supplied with the text. The "sine-wave," so often met in radio literature, and its graphical construction are discussed; suggestions are given which allow the reader to study the action of two combined frequencies and the resulting "beat-note," for instance, at first hand.

Whenever two different frequencies are present in the same circuit, there always exists a third frequency which equals the exact difference between these two frequencies. For instance, if a frequency of 30 cycles (per second) is combined with a frequency of 20 cycles, there will be present a frequency equal to their difference, or 10 cycles. Similarly, if a frequency of 1,000,000 cycles (corresponding to a wavelength of 300 meters) is combined with a frequency of 1,001,000 cycles, there will result an audible frequency of 1,000 cycles (per second). It is this combining of frequencies in a radio set which gives the disagreeable whistles when two broadcast stations operate on nearly the same wavelength, or frequency; both frequencies must be present in the set and these must be close enough together in

frequency to give an *audible* note (the audible "frequency range" that is, the range of frequencies which human beings can hear, being from about 20 to 20,000 cycles per second). If a frequency of 50,000 cycles were present, it would not be troublesome; for the ear could not detect it.

DIAGRAM OF A SINE-WAVE

The production of these "beat frequencies" can readily be shown by a few simple drawings. Fig. 1 shows the construction of a "sine-wave," the common wave-shape for alternating currents of both low frequencies (such as the 60-cycle current supplied to most residences) and high frequencies (such as radio frequencies). The value of the current rises to a maximum, falls again, passing through zero, and then reverses in direction. The amount of current flowing in one direction is represented above the line, and current flowing in the other direction below. The end of a line revolving about a fixed point generates a circle, representing one "cycle," as shown at A. Every time the line has swept through 360°, one cycle has been completed. The circle shown here is divided into 12 equal parts, or 12 equal angles of 30°.

If we start at X in Fig. 1 and proceed around the circle counterclockwise, we pass the points, 1, 2, 3, etc., successively. These points can be projected into a line in the familiar wave-form, as at B. Here a scale is chosen along X-X' to represent the angles moved through by the turning "vector," or radius of the circle in A. Thus, when the vector has moved 30°, its end has reached point 2; this point can be plotted, giving point 2 on the wave at B. When the vector has moved through 60° the line has reached point 3, and another point is determined on the wave. Thus our sine-wave ("sine" because of the mathematical relation between the height of the end of the line above the axis X-X', and the angle through which it has turned) is developed and we can continue as far as we desire by repetition of the first "cycle."

CREATING A CYCLE

While this wave-form is a mathematical

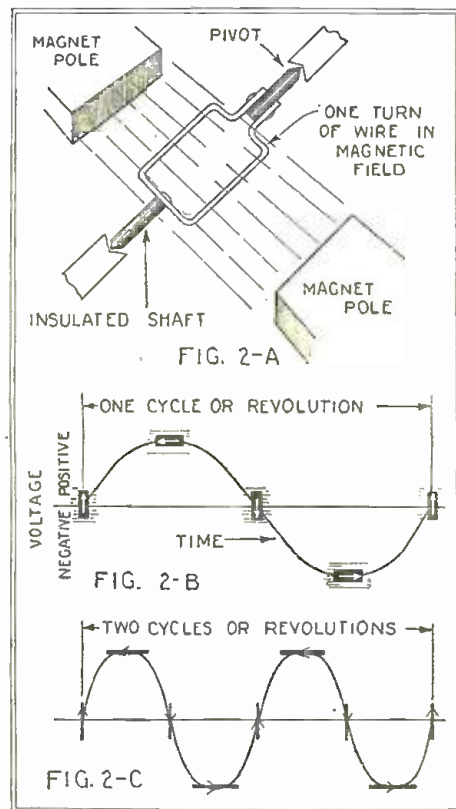

The sketch and curves above illustrate the manner in which an alternating current is generated in an alternator.

abstraction, representing numbers rather than actual motion of electrical particles, or the "ether," this method of representing cycles diagrammatically is very convenient. The following shows how an electric cycle may be created. Whenever a coil of wire is moved in a "magnetic field," such as that existing between the poles of a magnet, voltage is induced which will tend to send a current through the wire. This current cannot flow unless the ends of the wire are connected. In Fig. 2A is shown a coil consisting of one turn of wire, pivoted so that when it is revolved it remains in the field caused by the magnet.

Another simple fact is that the voltage induced in a turn of wire is directly proportional to the *speed* at which "lines of force" are cut. In Fig. 2A, the coil will thus generate the least voltage when it is cutting lines of force most slowly, and this is when the sides of the coil are moving parallel to these lines. Similarly the voltage generated will be greatest when the coil is cutting lines most rapidly or moving at right angles to the "field." If we measure this voltage at successive positions of the coil and construct a curve (as shown in Fig. 2B) with voltages measured vertically and time (or positions of the coil) measured horizontally, we have a sine-wave of voltage and, if the circuit were closed, there would flow a current which may be represented by a sine-wave also. The various positions of the coil are as represented on the wave.

Note that, along the "zero axis," the coil reverses and cuts the lines in the opposite direction, therefore giving a voltage which forces current in the opposite direction; this is shown below the line. When the coil has returned to its initial position, a cycle has

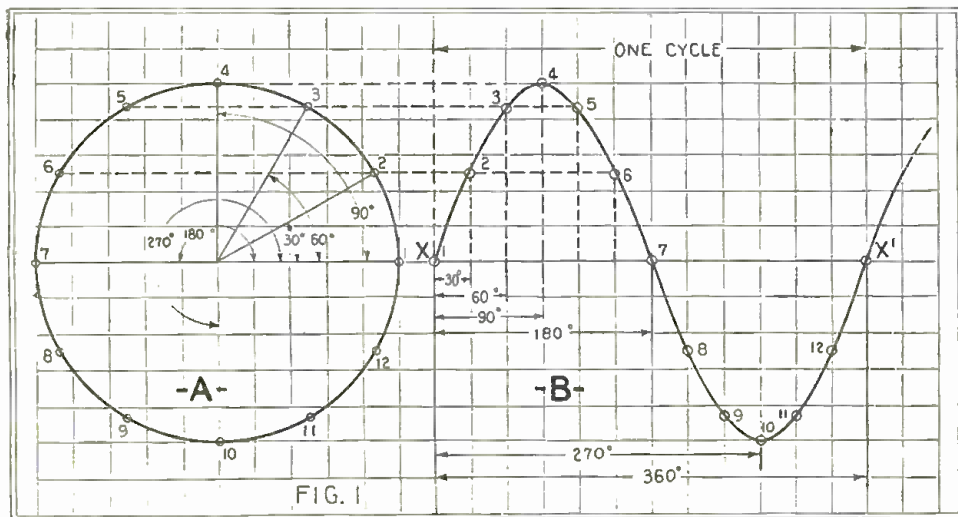

The construction of a "sine wave" on graph paper is a simple matter if this method is employed. If a more accurate curve is desired, smaller angles, say 15°, can be used.

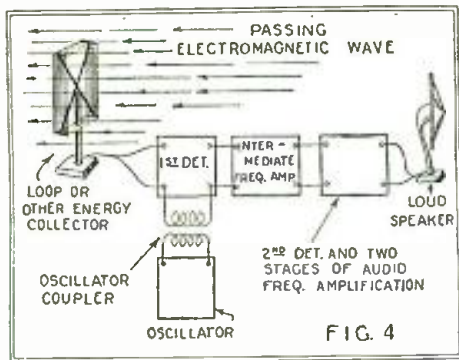

Plan of a superheterodyne loop receiver, showing the steps in the amplification of the "signal" at different frequencies.

been completed. If the coil were revolved twice as fast, there would result two cycles or revolutions in the same time as shown at Fig. 2C and the frequency would double. Generators cannot furnish the enormously high frequencies necessary for modern high-frequency radio communication; but vacuum tubes can easily be made to oscillate at radio frequencies and furnish waves of voltage and consequent current. With an understanding of the important sine-wave and how it may be produced, let us proceed to combinations of these, as used in the superheterodyne and autodyne modes of reception.

THE BEAT-FREQUENCY

In Fig. 3, at A and B, are shown two frequencies of 16 and 18 cycles in any given unit of time (this unit may be as small as one-hundred-thousandth of a second at broadcast frequencies). Assume that the frequency shown at B is received from a broadcast station (in this condition it is, of course, not audible.) The oscillator tube supplies that frequency shown at "A," let us say. These two frequencies, when combined, produce resulting wave as shown at "C" in Fig. 3. Note that the "beat-frequency" is the difference between the other two. This wave is obtained by superimposing curve "A" on curve "B" and then adding them together; that is, for each point on one of the waves, the vertical distance on the other, was added to it, giving the resultant wave "C." Since the vertical heights ("ordinates") are simply added, it is evident that any "kinks" (such as those due to modulation) in either of the curves will give similar "kinks" in the resultant curve.

Try drawing one of these waves some time; draw single cycles similar to those in the figure, on a piece of white celluloid and punch holes in the celluloid with a pin at various points on the wave. By placing this celluloid on a line and punching holes into a piece of paper with a pin at successive positions, different waves can be drawn and combined by adding the vertical distances as shown at D in Fig. 3. Distances above the line are positive and distances below, negative, so that these must be added algebraically; that is, height above the line is cancelled by an equal depth below it, and vice versa.

THE SUPERHETERODYNE

One frequency in the superheterodyne is furnished by the incoming signal, which, in broadcast transmission, is modulated; modulation is simply the combining of frequencies. That is, the wavelength or fundamental ("carrier") frequency of the station is combined with voice or music frequencies, these latter being, of course, audible frequencies. A modulated frequency is thus impressed on the grid of the first detector of the superheterodyne. Another frequency is simultaneously impressed in the grid-circuit by means of a vacuum-tube oscillator; and these frequencies combine, giving a fre-

quency equal to their difference and having also the modulation of the incoming frequency. This difference-frequency is called the intermediate frequency and is always a lower frequency than either of the other two. (There is also a higher frequency, equal to the sum of the combining frequencies, but this is not used in the regular superheterodyne.)

The reason for using a lower frequency is simply that radio-frequency amplifiers usually give the best amplification at low frequencies; at high frequencies the capacity between the elements of the tubes used has considerably more by-passing effect, which results in troublesome feed-back, oscillation in the amplifiers themselves, and consequent poor amplification.

The intermediate-frequency amplifier is a radio-frequency amplifier tuned to the intermediate frequency and used to amplify this frequency before it is impressed on the second detector and there rectified to audio frequencies. Since the detector works much more effectively when larger input is supplied, the sensitivity of the arrangement is very great. It is safe to say that a well-designed superheterodyne will receive with a loop aerial signals which other sets under similar circumstances are unable to detect;

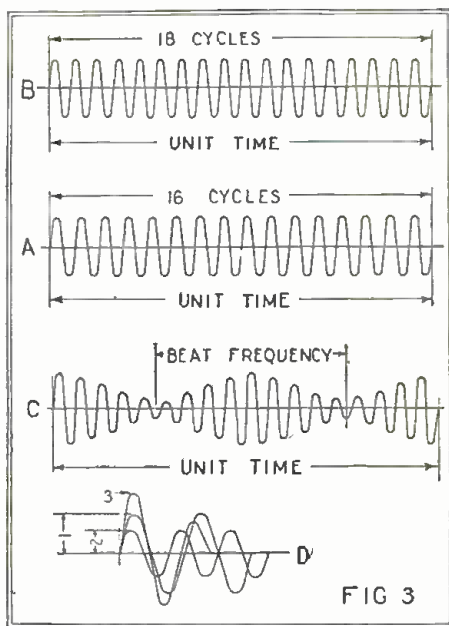

A and B show sine waves of 16 and 18 cycles and C is the resultant wave. Three waves of different frequencies are superimposed at D to show how 1 and 2 add to make 3.

sensitivity is not the controlling factor in the selection of a good receiver, usually, however. This scheme is shown in Fig. 4. The passing waves induce a small radio-frequency voltage in the loop aerial having a definite ("signal") frequency. The oscillator, through magnetic coupling, supplies another frequency which combines with the incoming signal frequency, producing the intermediate frequency; this is then amplified by the intermediate-frequency amplifier and rectified by the second detector, and the audio-frequency thus produced is amplified and passes through the speaker windings.

"DOUBLE-READING" EFFECT

Since the intermediate-frequency is the difference between the incoming and the oscillator frequencies, it is evident that the oscillator-frequency may be either, say, 45,000 cycles (an intermediate frequency often used) above or 45,000 cycles below, the incoming frequency to give this intermediate frequency. This is the cause of the double-reading effect in superheterodynes.

The intermediate-frequency should be so chosen that no long-wave stations operate

at the intermediate-frequency, which, of course, corresponds to definite wavelength. Powerful code-stations operate at comparatively low frequencies and these would be heard. At the lower frequencies it is possible to design very efficient and selective radio-frequency transformers; and the intermediate frequencies ordinarily employed are between 30,000 and 100,000 cycles, or between 30 and 100 kilocycles. At these relatively low frequencies, all the difficulties experienced with the higher frequencies, such as 1,000,000 cycles (300 meters) are greatly alleviated.

As previously stated, the broadcast carrier frequency is combined with the audible frequencies, resulting in a modulated wave which is "broad" because of this modulation. If the circuits of the intermediate-frequency amplifier are constructed so that they tune too sharply, only that portion of the modulated wave which is in tune will be amplified. Thus the wave will be "sharpened" by its passage through the amplifier and some of the "outlying-tones" which often give music its sweet, natural quality will be cut off; so that distortion will result. This is one of the problems for the engineer to solve and great progress has been made in the direction of "tonal-design" in the last few years.

THE AUTODYNE

So much for the superheterodyne. In this arrangement, an external oscillator or "mixer" is used to create the intermediate frequency in the grid circuit of the first detector. If the same tube supplies this frequency and combines it with the broadcast frequency, the arrangement is known as an "autodyne." In the autodyne, the first (which acts as both detector and oscillator) tube is maintained in an oscillating condition and its tuned circuit must be detuned from the incoming frequency to an amount determined by the desired intermediate frequency. For broadcast reception, the superheterodyne scheme is usually the better of the two.

The phenomenon of "beats" is perhaps best explained by an example in sound. Have you ever noticed, when a clock and a watch are on the table together, that the watch sounds as though it periodically starts and stops? This is an experiment in "beats" that can be repeated by anyone. Set the clock about two feet from the ear, and the watch about a foot or so, and listen to the watch ticking. It will appear as though the watch periodically starts and stops ticking. See Fig. 5. Actually, the two frequencies at which the watch and clock tick are combined, giving a "beat-note."

"Beat-notes" are very common; strike two adjacent bass notes on the piano and note the periodic "hum, hum, hum" as the two add to or cancel each other. So it is with electrical oscillations; beat-notes between heterodyning signals are silently produced and they in their silent way pass through the receiver, but, finally, at the loud speaker burst into whistles.

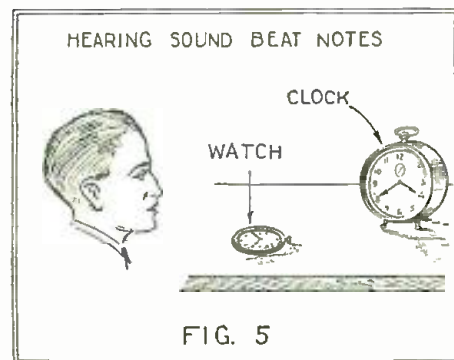

By placing a watch and clock, as shown, beat notes are set up which can be easily heard.



OUT OF THE KITCHEN!

Editor, RADIO NEWS:

Those of us who have made that promise ending with the words "I do," find ourselves rather closely tied down to the daily tasks of "keeping" house. Our job has little variation in it. Monotony is our curse. From New Year's to Christmas our minds and souls are steeped in those things, those common, menial, necessary—but deadly monotonous—tasks of cooking, cleaning, sewing, nursing and saving!

Therefore Mr. Radio Man, when we do have a moment to spare in which we can close our eyes and drift off in our imagination to some distant island of enchantment, there to rest our bodies and refresh our minds, in Heaven's name do not send us such earthly, prosaic messages as "Salads," "Baby's Colic," "How to Clean Rugs," or "Hints on the Family Budget."

Rather, carry us out of the kitchen to Romance and Travel and Poetry and Music. House-wearily yours,

MRS. MARIE NIGHTINGALE,
Dayton, Ohio.

(It may be that this is a minority viewpoint. The woman listeners who voted in the expression of preference obtained by the New York Edison Co., through station WRNY, declared kitchen talks the most valuable of the features intended specially for them. But all work and no play is undoubtedly as dulling to Jill as to Jack.—EDITOR.)

APPLAUSE, AND HOW TO GET IT

Editor, RADIO NEWS:

The article, in the November issue of RADIO NEWS—"What Every Station Wants—Applause"—states the numerous ways which have been tried to get the listener to express his appreciation; samples, etc. I believe, and having been a listener since 1921, think I have some right to know, that the broadcast stations are trying to put the shoe on the wrong foot. When I want anything I usually make some effort to get it. In other words, if the broadcast stations want applause, I believe it is up to them to go out after it.

In the first place the average listener does not know the specific mailing address of every station he listens to; in the second, he should not have to write a letter about it. If you go to the theatre simply clapping the hands is applause; you are not even required to sign your name, much less write a story about it. Therefore I feel that the broadcast stations should make applause so easy for the listener that he cannot help but take advantage of it. It is not necessary to offer prizes nor samples, nor even for the station to acknowledge the applause.

I suggest that the broadcast stations as a group print applause cards in quantities so vast that every set owner and every store will be flooded with them; make them easy to get; give 50 or 100 with every radio set sold; pack them with the set when it leaves the factory; include them with accessories; let them lie loose in radio stores; take every opportunity to get them into the hands of set owners. I remember when the Dictograph people put out an applause card, five or six in an envelope; most of them were hidden

under the dealer's counter and to get them you had to ask for them—possibly to be told that they only furnish them with Dictograph speakers, etc.

As a suggestion, let me say that an applause card should be so prepared that it will leave very little for the listener to fill in; then supply him with a lot of them and there is no reason why he will not send them in. How many applause cards will you find within reach of the average set today? I doubt if one per cent have them.

Now for the card itself. The Post Office Department should accept cards addressed by station-call letters and city; therefore the address side of the card should contain about the following:

Radio Station
City
State

And the reverse side of the card should

THIS page belongs to the readers of RADIO NEWS. It is theirs for the purpose of discussing fairly and frankly the needs of broadcasting from the standpoint of the great public who listen in. The letters represent, not necessarily the editorial opinion, but that of the writers; who are, in the editorial belief, fairly typical of groups of opinion among the radio public. Make your letters concise and offer constructive criticism when you can; remembering always that there is something to be said for the other fellow's side.

Address The Editor, RADIO NEWS, 230 Fifth Avenue, New York City.

be so composed that it will leave very little for the listener to fill in; something like this:

Date.....

We have listened to your program which was broadcast this (evening) (afternoon) (morning) (noon) and want to express our appreciation.

We especially commend that portion of the program rendered by

Or the following particular selections

Signed
City
State

Furnish your listeners with cards such as this, with the expectation that about one out of ten will be sent in; but distribute them by the tens of thousands and maintain the supply and you will get results.

IRA B. WALTZ,
Akron, Ohio.

A CRITIC OF WAVE ASSIGNMENTS

Editor, RADIO NEWS:

Your latest editorial says, "The average 500-watt station costs anywhere from \$100,000 per year upwards to run, if it is oper-

ated on any decent basis whereby the public gets fair entertainment." If the Commissioners would put on a single wave, all stations giving "service only," who do not spend that much money, neither South Dakota nor the rest of the 48 states would be singing that German song, "Es wär so schön gewesen," regretting the passing of all things beautiful. The commissioners have confined themselves to the placating of Cook County and the village of Manhattan—no waves left for the United States. In those villages an A.C. shielded "trick circuit," with 400 volts on the last tube, is obviously the proper choice.

For the rest of the country the issue cannot be covered up by any talk about "too much sensitivity and not enough selectivity," and the "air" furnishes nothing worth 400. or even 180 volts; even KDKA has a squeal on Saturday nights. I use a two-inch duolateral for a fairly directional loop,—it will "put on" CHYC, or PWX, and I am hoping that the new station of WEAF will drown Bay City, so I can get that "chain" consistently, direct. I had to use a 125-foot aerial on WGN last night, and couldn't use that station Saturday for the baseball in New York because of the natural frequency of some local "noise."

Why should anyone want to "broadcast"? It seems, in most cases, to be the "narcissistic ego."

D. BURKHALTER,
Bloomington, Indiana.

(A number of correspondents of this and other publications seem to enjoy "panning" the results of a policy of bringing about better conditions without radical action. Others are more inclined to look upon the plump doughnut of radio entertainment, rather than the hole—as does the writer of the following letter.—EDITOR.)

AND A DEFENDER

Editor, RADIO NEWS:

I note in the November issue the letter of "A Reader" of Hague, South Dakota, which strikes me as being rather hard on the Radio Commission.

All throughout the summer I have had splendid reception here using two tubes with reflex. Just the other night, with an underground antenna and with a set of run-down "B" batteries which registered about 40 volts together, reception was as good as anyone could desire—making allowance for the poor batteries which caused scratching sounds. With this equipment, the Pacific coast was easily brought in; that is to say the stations located there, and with clarity and tone unimpaired.

Broadcasting on the whole has been improved, there is no doubt about that, and the listeners should appreciate the fact. Where there is complaint or cause therefor, the listener should look into his set or have someone do so for him. We get splendid programs, well rendered; and, while there are some less desirable on the air every night, no one has cause for complaint. However, we all have some idea of how broadcasting could be improved, the value of these inexpert ideas however is doubtful.

There is one thing which could be done,
(Continued on page 683)

Soprano of the
Metropolitan Opera
Company, who has sung
on the Alwater Tent
and other outstanding
broadcast programs.

MARY LEWIS





Gladys Rice

Popular member of Roxy's famous 'Gang' and a frequent broadcaster... Her soprano voice is one of the best on the air



Janet Winters

*Concert soprano who
is heard frequently
over station WOR.
She has made a name
for herself in musical
revues*

"Hello, Everybody!"

A Trip "Back Stage" Elicits "Roxy's" Personal Story

By LUCILLE HUSTING



"ROXY" AND "MIKE"

LET us take a trip "behind the scenes" with "Roxy," one of the most beloved, fascinating, and widely known personalities in the public eye today. A proof of his tremendous following lies in the fact that he has received over two million letters from radio and movie fans all over the country, from "folks" in every walk of life, from every place. His precious letters make one think of our childhood saying—of "doctor, lawyer, merchant, chief"—for he has touched the heart strings of all.

These letters, more than anything else, show the bond between Roxy and his public, which he so wholeheartedly serves. His radio broadcasts find millions eagerly "listening-in" for the glad "Hello, Everybody!"

Roxy (whose full name is Samuel L. Rothafel) was born in Stillwater, Minnesota, where he lived until the age of 12. His parents then moved to New York, little dreaming that in later years their little boy was to be one of the city's most prominent figures. His first job in New York was in a Fourteenth Street department store, but even then, he was restless, dissatisfied, longing for "something," he knew not what. Many thought him an idle dreamer, whose head was in the clouds. He was advised "to come down to earth," to try and be a "good" cash boy, and make an honest living even though not a glamorous one.

Roxy's first great sorrow came when he was just sixteen. He lost his mother. With nothing now to keep him in New York, and with a boyish desire for adventure, he joined the United States Marine Corps. In the service he received what has been the firm foundation of his remarkable career: terrific lessons in training, self-discipline, squareness, fairness, and clean-cut manliness.

After serving his enlistment he returned to New York, and again came that urge and longing to find himself. Having always had a great hunger for beauty, a love of art, he

was one of the first to see in our primitive moving pictures the beginning of a new and powerful world industry.

UP FROM THE BEGINNING

His entrance into the world of the "movies" was in Forest City, Pa.; his first theatre was an empty store, with chairs from the local undertaker's parlor. His first audience consisted of hardened miners, the habitual patrons of the saloon; his first picture was presented on a fluttering screen, with a faulty projector and poor lights. But, in this crude workshop, he found himself. It was the "corner stone" of the present "Cathedral of the Moving Picture"—the Roxy Theater in New York. There he put his dreams into practicality, there he experimented, planned, and thought.

New ideas came, ideas concerning presentations, stage effects, lighting, synchronized music, atmospheric prologues. He went back to the city of Minneapolis, in which he had once been a "failure." Here he put his ideas into effect, long before New York paid any heed to them.

From that time on Roxy's life has been one of the greatest romantic dramas on any

stage. His return to New York was accompanied by neither music nor acclaim. No one on our great street of adventure, Broadway, had heard of him; but, this time, he knew himself. In 1913, at the Regent Theatre on Seventh Avenue, he enlightened the city of New York by giving the motion-picture public what it had always wanted, and he "arrived". With the opening of the Mark Strand in 1914 (at that time our finest movie theatre), Roxy was made the managing director. Following that, he devoted his inspired energies, his farsightedness, and his magnetic personality to the Rialto, Rivoli, and Capitol theatres successively—and successfully. Early this year he opened his own theatre "The Roxy", which is regarded as the largest, the most beautiful and the most luxurious in the world.

IN THE STUDIO

Let us take a trip to the top of Roxy's theatre, where we find the broadcast room. We sit in a tiny balcony, watching the scene below. There is a tension in the air that makes us tingle, perhaps with anticipation, with expectancy. Here come Roxy himself, program in hand. He is tense, smiling, alert. The grand pianos and the organ are ready, in their respective corners. The music stands are arranged on either side of the "mike"; musicians in evening dress are waiting for their signal to begin. The audience, surely, are more nervous than they.

The announcer says "It's Roxy's Hour—WJZ," and Roxy goes to the "mike." The welcome "Hello, Everybody!" goes on the air. Somehow that seems to break the tension, and we relax.

In the studio, Roxy reminds us of a race-horse, every nerve on edge, straining, eager to begin. His showmanship is remarkable; he seems to be a combination of Belasco and Whiteman. He is a genius, with the absolute feeling for the mood of each and every number. Those who listen-in may know that, throughout his program he gives, absolutely, of himself. He guides, directs, restrains, uplifts, with an uncanny instinct for the right effect. A charming love ballad is being sung by two equally charming young people. There is Roxy beside them, smiling, beaming, living it with them. Next his orchestra plays an exquisite selection. Roxy is again with them, his hands guiding the musicians, softening tones there, bringing wondrous effects here. Then comes jazz music, and with it another Roxy, swaying, almost charlestoning with them.

The final number was a new one, rendered by a group of colored singers, the "Carolina Serenaders." Their rich voices were unbelievably beautiful, rising and falling like

(Continued on page 670)

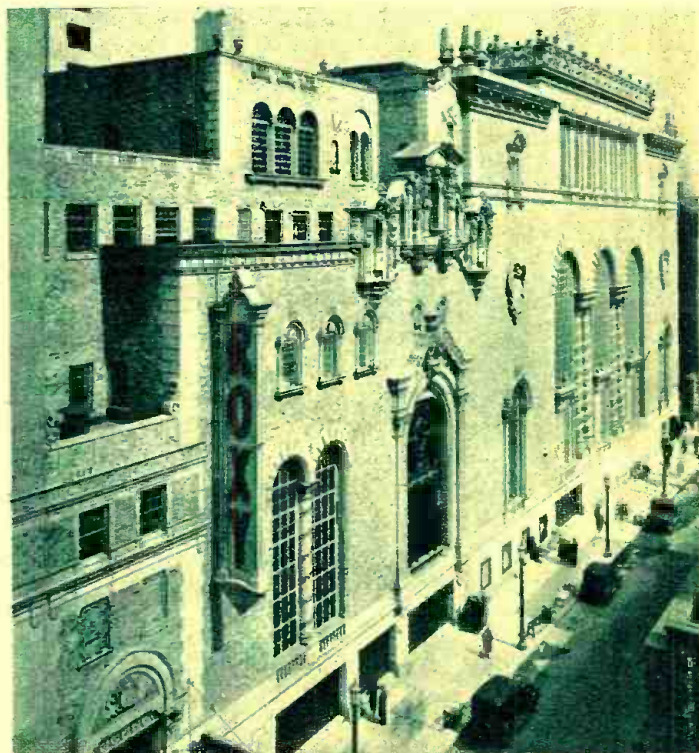

The house that radio built. The palatial Roxy Theatre at Seventh Avenue and 50th Street, New York City, from which the Sunday-afternoon and Monday-evening programs of "Roxy and his Gang" are broadcast.

Raising the Curtain on Godfrey Ludlow

By JULIA DUNCAN

MAY I raise the curtain on the life of Godfrey Ludlow, the famous Australian violinist who broadcasts each Sunday from WJZ and its associated stations? You who sit in your homes, listening-in to the magic of his music, have you not wondered about the man himself, he who gives so freely of that genius within him? The radio will always seem something supernatural, for through it we can almost feel the souls of those to whom we listen—coming from the nowhere, regarding neither time, space, nor distance.

I met Mr. Ludlow recently. It was an inspiring, happy afternoon at his charming home over which his mother graciously presides. The rooms seemed to radiate the love of music, of beauty—it was restful and peaceful. The setting was perfect for a glimpse "behind the scenes."

Mr. Ludlow surprised me; perhaps I expected to find an older gentleman—surely a temperamental, nervous one, not of our world—"soulful" looking and "musiciany." However, a splendid-looking young man briskly entered the room, there was a firm handshake, a crisp, pleasing voice, and eyes which at once gave me the impression that the owner possessed a keen sense of humor. For the benefit of the feminine readers, may I add that Mr. Ludlow is unmarried?

You have heard many times that the truly great are the simplest, the most kindly and sincere—and it is so true. I felt that Mr. Ludlow had been an acquaintance for a long time, for he, unquestionably, has all these attributes. We discussed music, the radio, a mutual friend—before we came to the important business of the afternoon—our interview. It must be said here Mr. Ludlow is an extremely modest man, for at the word "interview," I was turned over to his mother.

One could write at great length on Mrs. Ludlow, and it would be of the keenest interest, for theirs is a delightful partnership. She, herself a splendid musician and a sculptress of note, has been, I am sure, his greatest inspiration. She told me that after each Sunday-night broadcast at WJZ, her telephone rings, and it is her son, desiring above all mother's opinion of his work.

ABOUT THE WORLD

Mr. Ludlow was born in Australia, and with him was born the love of music. When a child, he took lessons on the violin from his mother. At the age of nine he entered the musical examinations being held for children between the ages of nine and fourteen in New South Wales; he came out victorious. Five years later he was sent to Prague, where he studied for three years. Later came two years' study with Sevcik, in Vienna. At seventeen he entered in the Meister Schule of the Imperial Royal Academy of Music in Vienna. Following this came a two-year tour of Europe, with appearances before the Sultan of Turkey, the royal family of Greece, and, by a command, at Buckingham Palace, London. Two wonderful years with Auer in Russia were followed by the outbreak of the war. At that time of upheaval Mr. Ludlow was in Germany, en route to London from Russia. He was twice arrested as an alien enemy and then interned in the Ruhleben prison camp. For four years of deadly inactivity he was a prisoner. Finally he was allowed his violin and he played, as perhaps he had never played before, for his inmost nature was touched by the bleeding bodies and souls of the war. It was a strange audience—this prison one—of homesick, heartsick, war-sick men.

Out of prison in 1918, he went to London and toured the British Isles with Dame



Godfrey Ludlow, staff violinist of Station WJZ, with his Stradivarius.

Nellie Melba. In 1924, Mr. Ludlow came to America. But even then he was not through with poverty and hardships, for he came unheralded—unknown. We are always far too busy to listen to the heart-hungry—to those who have only the intense longing, to be able to give that "something," which seems to consume them. It is only when the head-lines blaze forth the news that a "Second Bernhardt" or a "Second Kreisler," has been discovered, that we sit smugly back and say "Oh, yes—I always *knew* he had it in him."

HIS RADIO CAREER

Mr. Ludlow's connection with WJZ began one certain day, when his financial possessions amounted to forty-four cents. He went to the station's directors, believing in himself, and persuaded them to engage him as their staff violinist. And they did so—WJZ was the first radio station in the country to have one. Mr. Ludlow was the first violinist to give a "muted" program, and it was highly successful; five hundred letters were received after his first broadcast. His trip to WJZ that particular time must have been an inspired one, and the days of a financial fating of forty-four cents are happily past. What an inspiration to the rest of us, who are oftentimes similarly situated—financially.

Mr. Ludlow is again the recipient of the same glory and fame, which had formerly been showered upon him in Europe. He has merrily sensed that the world is music-hungry, longing for the beauty of the old masters, and he confines his programs to the classics, giving one sonata a month.

Since beginning his broadcasts, Mr. Ludlow has received fifty thousand letters from people in every walk of life, all over the country. These letters express genuine appreciation and gratitude. Mrs. Ludlow kindly read some of them, wonderfully sincere letters, as well as exquisite poems. These letters are all appreciated by them, and I know the "partners" find great joy and satisfaction in the knowledge that their audience is so whole-heartedly with them. Mr. Lud-

low thoroughly enjoys broadcasting, in fact, finds in it the same thrill that he does in his concert work. It is good to know this, for it gives us an even greater happiness in listening-in.

A MAGICAL HARMONY

The medium for Mr. Ludlow's violin witchery is a priceless Stradivarius which he uses in all his WJZ recitals; it was obtained from the vault of the De Rougemont family, at Brighton, England, where it had lain for almost a century. Little is known of its actual history, save that it was played in Berlin late in the eighteenth century and in the early part of the nineteenth century before the Emperor Napoleon at Versailles.

It has been said that Mr. Ludlow has taken Kreisler's place in writing transcriptions; his "Estrellita" has had a colossal sale. His style of playing, also, has been compared to that of the noted Norwegian violinist, Ole Bull.

AN ENJOYABLE EXPERIENCE

Mr. Ludlow has had many amusing experiences. At one time he was giving an out-of-town concert and found it necessary to change from his train to a bus at a certain junction. Unfortunately the bus had already gone and another conveyance was at once needed. An obliging man offered to motor him the remaining miles, not knowing who his passenger was. As they were driving along, Mr. Ludlow remarked that there seemed to be a great number of radios in the vicinity. The driver agreed, and offered the information that he, too, had a radio, which he greatly enjoyed—particularly in getting a New York station, WJZ. They had a certain violinist on that station every Sunday evening, he went on, and he listened for this number every time. "Yes, sir—that violinist couldn't be beat." They drove on for awhile in silence and then Mr. Ludlow asked the name of the violinist who had so impressed his host. Well—he thought it was something like "Ludlow—Mr. Godfrey Ludlow." The drive continued in silence for a few

(Continued on page 670)

Radio Listeners Vote for Favorite Composers

Beethoven, Schubert and Herbert Leaders in Ballot: Classical Music Popular

A NATION-WIDE expression of opinion by radio listeners shows that the favorite composer is Beethoven, and Wagner's Overture to *Tannhäuser* the favorite type of music, according to a statement issued recently by Mr. Arthur Williams, vice-president (commercial relations) of the New York Edison Company. These opinions were obtained through a questionnaire distributed by the company in

"One of the significant things shown in the questionnaire, which seems to indicate that the tastes of listeners everywhere are alike," Mr. Williams stated, "is that the rela-

to *Tannhäuser*, Wagner; *Poet and Peasant* Overture, von Suppe; *Marche Militaire*, Schubert; *Fifth Symphony*, Beethoven; *Unfinished Symphony*, Schubert; Ballet Music from *Faust*, Gounod; Meditation from *Thais*, Massenet; *Liebesfreud*, Kreisler; *H. M. S. Pinafore*, Sullivan; *Nutcracker Suite*, Tschaiakowsky.

Ludwig Van Beethoven, the unsurpassed master of instrumental music who was elect-



connection with the Edison Hour, which is broadcast weekly over WRNY, the Radio News broadcast station in New York.

"The standard of musical taste of radio audiences is very much higher than perhaps it is commonly rated," said Mr. Williams, reviewing the results of the questionnaire, in which 4,800 radio listeners cast a total of 79,800 votes for 50 composers and 18 types of musical compositions. "Following close after Beethoven—considered by musicians the master of composers—with 3,245 votes, comes another of the great immortals, Franz Schubert, with 2,971 votes. Third is our popular American composer, Victor Herbert, whom 2,935 of the 4,800 included in their preference.

"Second in popularity to Wagner's masterpiece, the Overture to *Tannhäuser*, as a type of musical composition, comes the *Poet and Peasant* Overture by Franz von Suppe, with the *Marche Militaire* of Franz Schubert third. The musical tastes of men and women are practically alike," Mr. Williams said, telling of some of the interesting facts revealed by the questionnaires. "Instrumental solos proved to be more popular than vocal solos, with 2,720 votes favoring the former, and 1,422 for the latter. 2,110 votes were cast for orchestral music alone.

five positions of the leading composers and compositions were the same for each thousand of the questionnaires tabulated. The space left on the questionnaire for remarks provoked much lively comment. The men had more to say, and were much more positive in their opinions than women. Thirty asked for jazz, and more than 135 denounced it in no gentle terms.

"Radio announcements came in for their share of comment. 1,741 desired brief announcements, while 2,465 indicated a preference for longer descriptive announcements. Few, however, contented themselves with a mere indication of choice. The opinions of most on this score were expressed very definitely, and positively, and even at great length.

"In the few questions appended concerning the broadcasting of household matters, the women indicated a preference for talks relating to cooking," Mr. Williams concluded.

The first ten composers in order of choice are: Ludwig van Beethoven, Franz Schubert, Victor Herbert, Richard Wagner, Felix Mendelssohn, Fritz Kreisler, Franz Liszt, Charles Gounod, Peter Tschaiakowsky, Wolfgang Amadeus Mozart.

The first ten compositions are: Overture

ed the favorite composer of radio listeners, was born in Bonn, Germany, on December 17, 1770. Both his father and grandfather were singers, so it was not surprising that at the early age of four he showed a love for music. His father, who is described as a shiftless character possessing only mediocre musical ability and a craving for liquid stimulants, recognized his son's interest and decided to instruct him on the piano so that he might exhibit him as an infant prodigy. The parent proved a cruel taskmaster, and the young son acquired much musical knowledge before he was many years older.

Beethoven's musical talent was so evident that he made rapid progress in the institutions of training he attended. When he was only eleven he wrote his first compositions, but it was his renditions of them on the piano and the organ, rather than the works themselves, that attracted attention. He progressed rapidly with his studies of piano and composition under the tutelage of the best musicians of the period (1793), spending most of his time in Vienna. He began his public career at the age of 25, and in spite of his independence of spirit and his uncouth manners, received flattering receptions in the houses of the nobility. He was

(Continued on page 704)

Till the Clouds Roll Dry

By ROBERT FRANCIS SMITH

RA VE on, MacBluff," commands the hausfrau, advancing the left flank of her lines with a vacuum tank. "I gotta do my spring renovating, ain't I? Can I help it if you got the cog-wheels yanked outa your four-tube set? Roller-skate outa that corner and help me move the desk."

"Easy, femine," I growls, "tread not on these sacred precincts or I'll knock you for a loop aerial. Whatsa idea, spring house-cleaning in July? And just when I got all these small parts in piles so I won't get 'em mixed! Let the dust stay!"

Old Ironsides heaves a mop in my direction. "Slide that mess of five-and-dime hardware onto the porch until I disinfect the woodwork. Why'd you have to bolshevik the set, anyway? And why here? Ain't you got repairing rights at The Master's?"

"And ain't I also got a home?" I counters. "All right, Galloping Gold Dust. I'll accommodate you this once. But just for that I gotta good notion to sashay over to Jerry's pronto."

"You've been eating Mexican chili again!" bats out Doris. "Exit! A husband outa work is as dangerous as a revolving door on a saloon!"

I don't like the acoustics in that crack about labor. "Who's outa work?" I demands. "Ain't we just run up nine months in the *Inanities*? Ain't we got a bank balance that uses a flock of ciphers on the sunny side of the decimal point? And ain't we the proud owners of this hideaway here at Brightmere-on-the-Deep? Whadda you want a guy to do—die hoofing on Broadway?"

The eternal agony kinda smiles, wan and discouraged. "Oh, Joe, dear, I'm sorry I was cross. But this house—it's so dirty—and I've not had a good chance to clean it for months—now be a good boy and go roll your hoop."

It's so seldom that I gets a chance to play hookey without needing a certified alibi that I don't give the girl no time to change her mind and find some job for me to swear

over. I ankles through the back gate and canters up the hill to The Master's.

We're Mr. and Mrs. Joe Hammerstein, dancers on Broadway, late of the *Inanities* and now basking on the sands of Long Island in blissful ignorance—and how!

The gentleman I'm due to visit is our old friend, adviser and comedy relief, Jerry Lawson. He's a millionaire by several bonds, and a scientist by many brains, but as a humorist he's as original as a Christmas card and thicker than plots in Russia. The Master—so-called by the help—has a brand new laboratory building, constructed to fit his own ideas, whims and fancies. But I'm wise, and don't tease any strange push-but-

tons. "Hello, Jerry," I greets, popping my celebrated skull through the door into the main joint. "Working hard?"

It's a sorta platitude I use, since you gotta label comedy with Jerry, though he's improved wonderfully since I took him in charge three years ago. Today he's squatting in his wrecked morris chair—thinking chair, he calls it; it looks more like it was sinking—head back, his dark wavy hair mussed, horn-rim cheaters askew. He gives me the usual how-do, and I flops onto a box. The Master's silent for a spell.

"What's the birdie been saying?" I inquires, at length.

"Birdie—oh, you mean—why, I was just thinking of several things."

"Original, ain't you?" I grins. "Most of us have only single-track minds."

Jerry smiles faintly, and sits erect, brushing his hair from his orbs with a vague gesture of indecision. "Oh, it's just my weather control again," he sighs. "I don't dare use even one twentieth of the full power input except for a few moments early in the morning. It's tying up my experiments."

I might crack that Jerry's midnight-oiling a gag to bump Jupiter Pluvius off his political job with the cloud trust. Just at present the gears don't mesh, or the belt slips, or something; anyway, it ain't successful enough to rate any twenty-four sheets. I gets a lot of innocent pleasure kidding him about it.

"If you gotta use so much juice, won't your dingus be just as impractical later as it is now?" I demands, showing a ray of sense. "If you bloop now, won't you bloop in the future, success or no?"

"Well put," lauds The Master. "Yes, it would, Joe, only once I have definitely ascertained the correctness of my principle, it will be but a small detail to lessen input and at the same time evolve a more effective output. Merely a matter of efficiency and time. That will come later."

"Unfortunately," continues Jerry, "my top power input right now is so great that only in the remote regions of the globe will I dare use it at all. My one chance is apparently in mid-ocean; in fact, I am even today partially engaged in fitting up the *Aurora* with apparatus conducive to that end."

(Continued on page 711)

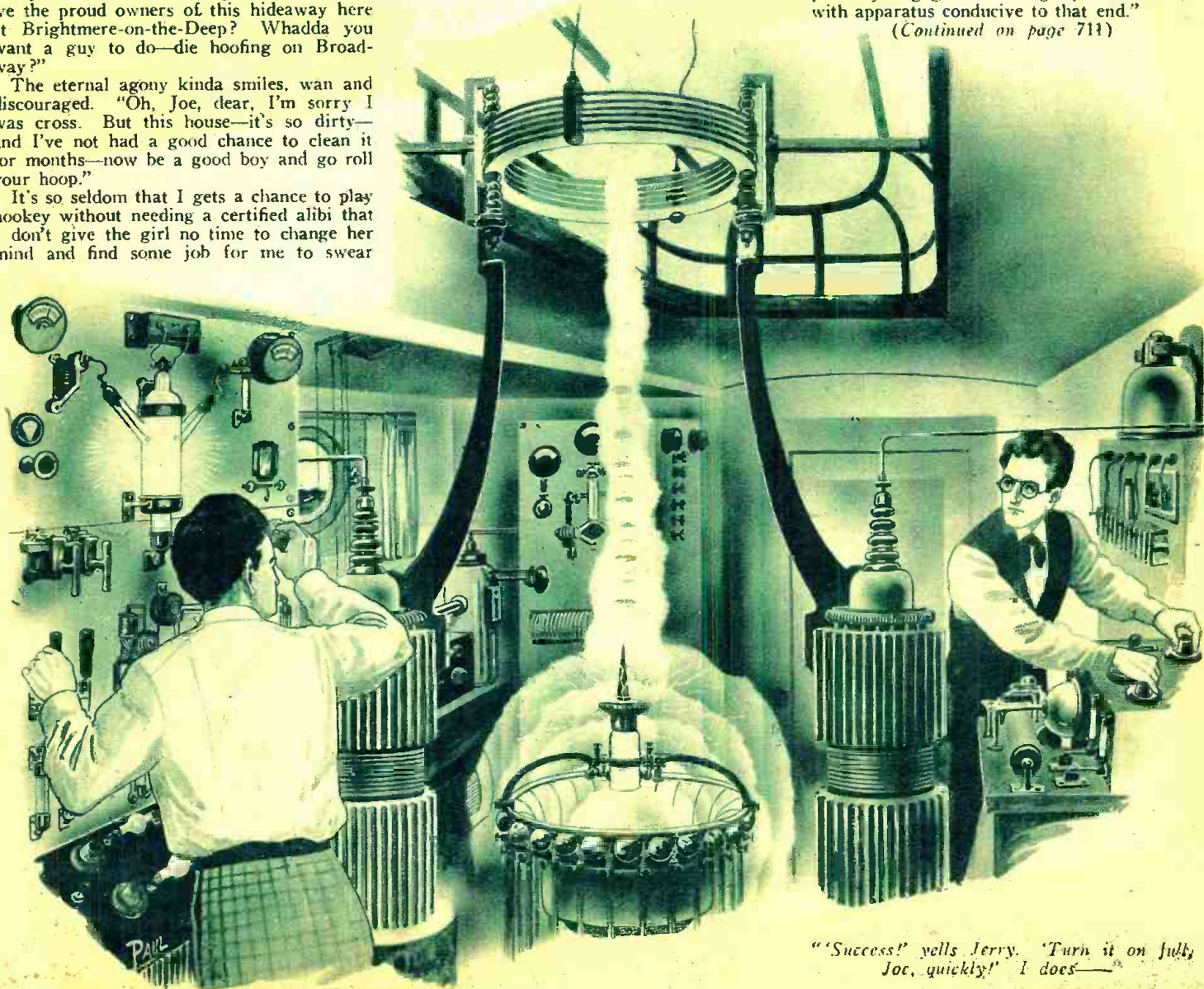

"Success!" yells Jerry. "Turn it on full, Joe, quickly!" I does—

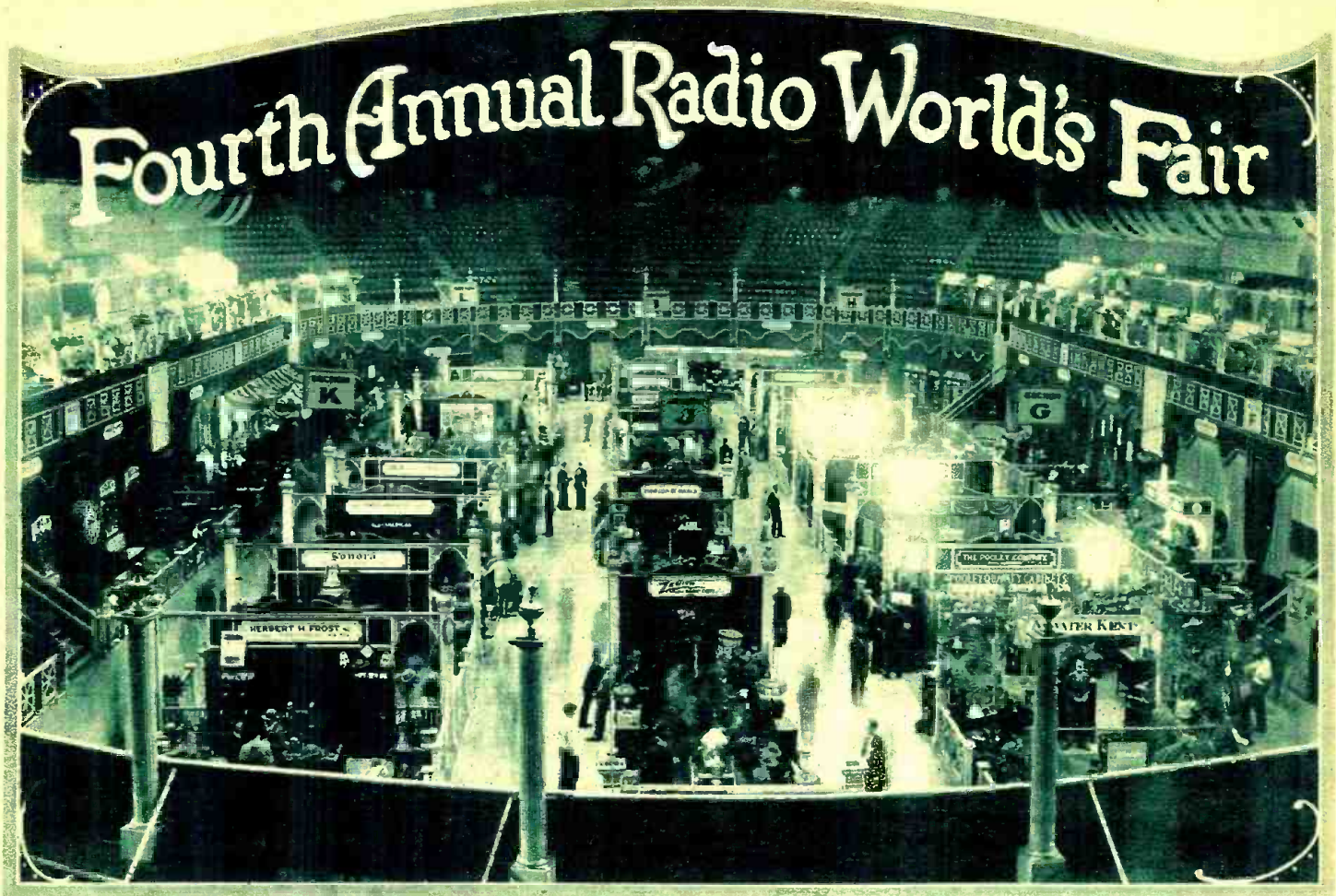

A general view of the arena floor and the mezzanine of the Madison Square Garden, giving an idea of some of the elaborate exhibits at the Radio World's Fair.

© International Newsreel

DURING the week of September 19-24, 1927, the products of more than three hundred manufacturers of radio apparatus were on exhibit at the Fourth Annual Radio World's Fair, held in Madison Square Garden, New York City. Thousands of dollars were spent by the exhibitors in an effort to make this year's show bigger and better than the preceding ones, and the consensus of opinion was that they had succeeded.

On the main arena floor of the vast Garden were the booths of the set manufacturers, while in the Exhibition Hall in the basement and on the mezzanine above the

arena were the exhibits of the manufacturers of parts and accessories. Also in the basement was the glass-enclosed broadcast studio, from which programs of all types were put on the air during show hours, from 1 to 11 P.M. The presentation of prizes was made in this studio and the speeches of visiting celebrities were broadcast from it.

In general the number of tuning controls on receiving sets has been reduced to one or two. The majority of the receivers shown employ from six to eight vacuum tubes and some form of shielding. Some of the sets are completely shielded, even the



Above are shown Betty Burke holding a home-built receiver appropriately named after the Spirit of St. Louis, and the smallest three-tube set with loud speaker entered in the Amateur Set Building Contest.

© International Newsreel.
At the left, John H. Muller and his glass-enclosed A.C.-operated, 6-tube T. R. F. receiver. At the right is the entry of H. W. Press, who carved out the "DX-hound" panel with a jack-knife.
© Herbert Photos, Inc.

vacuum tubes being hidden beneath protective "cans." The more elaborate sets have loud speakers built into the consoles, which have ample space for socket-power units also.

Many of the receivers that are being presented for the coming season use the new A.C. vacuum tubes, which obtain their filament power from the alternating-current house mains. A set using these tubes and a "B" socket-power device is completely "electrified."

THE THEATRE OF WONDERS

A great deal of interest was shown by visitors in the scientific experiments that were performed daily in the "Theatre of Wonders," which occupied one end of the Garden's vast basement. The research laboratories of the General Electric Company and the Westinghouse Electric and Manufacturing Company supplied the apparatus. Capable lecturers explained the modern miracles to the visitors.

It is difficult to enumerate all the marvels that were shown in this theatre, but a few were of such extraordinary interest that they stand above the rest. For instance, the atom and the electron are almost household words in this day and age, but it is extremely doubtful if many of the readers of *RADIO NEWS*, except those who visited the Radio World's Fair, have heard or seen these minute particles. The smallest voice in the world—that of the atom—was magnified twenty trillion times by a device which is said to be so sensitive that the growing of a rose sounds like thunder. Then it was possible to visualize the atom in its journey through space. X-rays were brought to the aid of experimenters for this machine, so that one could actually "see" the atoms, such as those which are thrown off from the sun. The electrical atom, it must be remembered, is approximately 100,000,000,000 times smaller than the point of a pin, yet by means of a machine, that rightly was in the Theatre of Wonders, it was possible to measure the electrical charge of a single atom.

One of the most interesting of all the exhibits was the cathode-ray tube, developed by Dr. Coolidge of the General Electric Company. With this tube it is possible to get an electron stream about eighteen inches long outside the end of the tube, across which is a voltage of 350,000. It is estimated that the electrons are travelling at the rate of 150,000 miles per second, which is only 36,000 miles per second slower than the speed of light and radio waves. Many intensely interesting experiments can be performed with these rays; for example, if a piece of mineral crystal is exposed to the rays for a very



A large model of the Peridyne shield and coil exhibited at the RADIO NEWS booth at the Radio World's Fair. Miss Sadie Bernstein is holding the normal-size Peridyne shield, which was developed by Hugo Gernsback, editor of this magazine.

short time it glows as if it were red hot, but it can be held in the hand with no perceptible change of temperature.

The latest development in the field of magnetism was demonstrated by keeping a bar of steel six inches long and one-half inch square floating above a similar bar; the two bars, magnetized with like poles opposite, were held apart by the magnetic repulsion between them, which exceeded the force of gravity. These two pieces of cobalt steel alloyed with tungsten, according to a formula developed by Dr. P. H. Brace of the Westinghouse Company, make the strongest permanent magnet known. This new alloy is so highly magnetized that a piece of it used as a horseshoe magnet will lift a bar thirty times its own weight; this represents a strength five times that of the ordinary magnet. In addition the alloy retains its magnetism permanently.

A demonstration that was of particular interest to amateur radio fans was a unique miniature broadcast station, transmitting on a wavelength of three meters. The wave itself was illustrated by a rope, oscillated by a motor, so that the movements of the rope corresponded exactly with that of the radio wave. A pair of parallel wires (Lecher wires) were strung beside the oscillating rope and over these the radio waves passed. In order to show the points on the wires at which the voltage nodes of the wave were located, the demonstrator passed a small flashlight bulb along them. The lamp glowed with the greatest brilliancy at the nodal points and these corresponded exactly with the nodes as illustrated by the rope. A neon-filled tube was also employed instead of the flashlight.

Another scientific marvel shown was the grid-glow relay, recently developed by D. D. Knowles, a 28-year-old research engineer of the Westinghouse Company. This relay has an amplifying power of approximately one hundred million. The energy required to operate it is about one-billionth of a watt, or about 1/40,000th of the energy exerted by a fly in crawling vertically upwards one inch in one second. This infinitesimal amount of energy is sufficient to start a current as high as 25 milliamperes flowing through the grid-glow relay tube. This latter current is sufficient to start a current as high as 25 about 25 amperes, which in turn is ample for operating almost any machine.

It was this same device which figured in one of the last public acts of the late Judge Elbert H. Gary, chairman of the United States Steel Corporation. Seated in his office in New York, Judge Gary passed his hand over a crystal ball, which controlled the amount of light going to
(Continued on page 707)

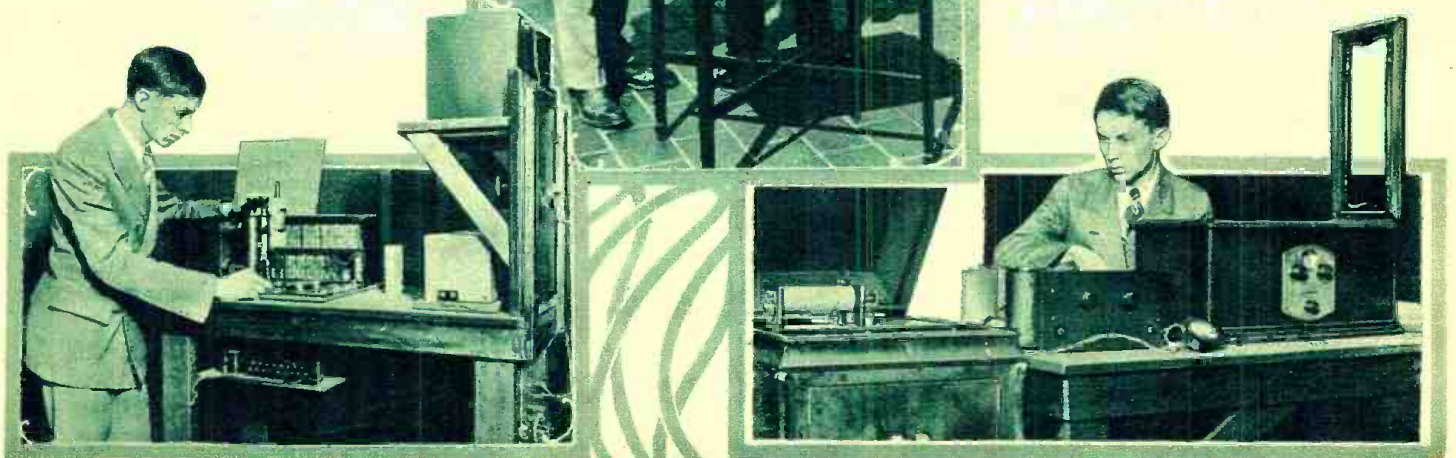

In the center are G. Clayton Irwin, Jr., Director of the Radio World's Fair and Gov. Alfred E. Smith of New York, examining a picture of the governor sent by radio. To the left is the picture-transmitting apparatus developed by Austin G. Cooley, and at the right is Mr. Cooley with his picture-receiving apparatus.
© International Newsreel.

The New Radio Styles From Paris

Latest Developments and Novelties by French Inventors

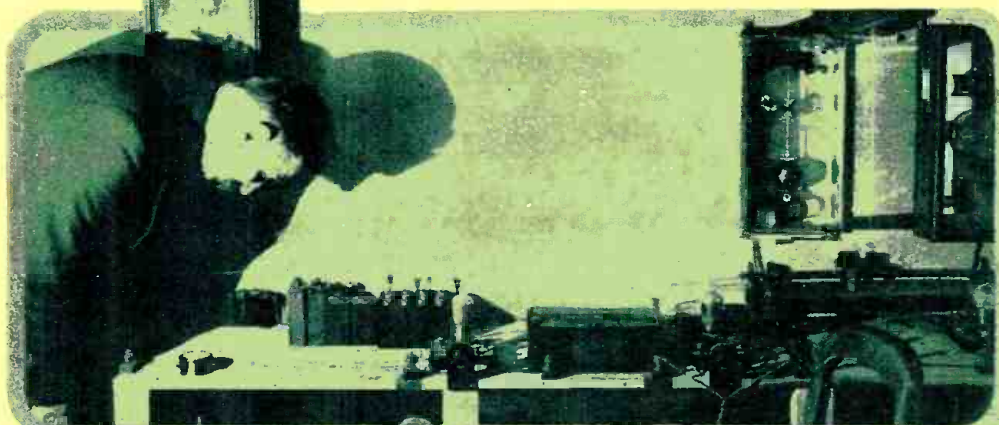

At the left is Captain Raymond Jonaust checking his electromagnetic clock which is controlled by a potassium-coated photoelectric cell. A beam of light from the right-hand wall-case strikes a mirror on the pendulum in the case at its left. This beam is reflected back to the photoelectric cell in the middle of the first case. The cell sends through an amplifier an electric impulse which corrects the clock at the left. Below is Capt. Jonaust with his assistant, Jean Calle, working on the electromagnetic clock for the Paris Observatory.



Above is a French pocket crystal receiver with ring-shaped coils for antenna and a rotary switch for finding sensitive spots on the crystal. Below, Lu Fong Chai, a young Chinese inventor, who has introduced this small loud speaker to the Parisians. Its relatively long horn is said to be an excellent reproducer, as well as conveniently compact.

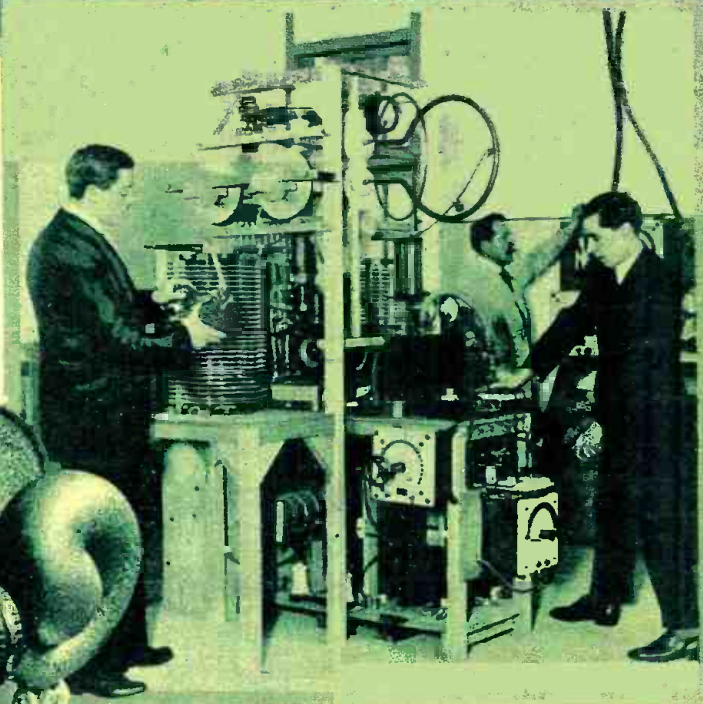

M. Descarsins, a French military radio engineer, has developed a circuit into which he can put as much as 20 kilowatts, using a 45-meter wave. His transmitter has been heard throughout Europe and the East as well as South America. He utilizes a new type of the Holweck demountable tube, which can be repaired if it is damaged.

© Photos by Wide World.

Some of America's Radio Fashions

Recent Applications of Engineering Skill to Practical Purposes.

Below is D. D. Knowles, the 28-year old inventor of the grid-glow relay tube which bears his name. This relay has been said to be the most sensitive current-controlling device ever developed, as it functions on a billionth of a watt. It is set in operation by the light of a match, or the approach of a human hand or a drop of water. Mr. Knowles was recently awarded the John Scott Medal, which is given in recognition of inventions useful for mankind. © P & A Photo



During a recent welcome by New York City to the homecoming aviators, these giant loud speakers were installed on the roof of an office building on lower Broadway, so that "downtowners" were able to listen to their own greetings to the heroes. These "three-quarter-mile" horns were described in our August, 1927, issue. © Westinghouse Electric & Mfg. Co.

Below is shown the equipment which is employed to broadcast for the benefit of aircraft, bulletins on weather conditions from the Weather Bureau in Washington, D. C. Information on rain, sleet and snow is now sent out on three different wavelengths by the transmitters of NAA at Arlington, Va.; so that aviators can be informed of weather conditions while in flight. The transmitter at Arlington is under remote control by the instruments shown in the illustration below; the tape makes and breaks contact, forming the dots and dashes of code messages. © Harris & Ewing.



At the headquarters of the U. S. Navy in Washington, has been installed radio equipment for transmitting to ships at sea facsimiles of maps, drawings and written orders. Admiral Eberle, Chief of Naval Operations, is seen beside the apparatus, which sent the first message of this kind to the U.S.S. Seattle, the flagship of Admiral Hughes, who is in command of the Fleet. © Times Wide World.

260,000 Good Customers Waiting for Radio

\$26,000,000 Conservative Estimate of Apparatus Needed

By ARMSTRONG PERRY

THERE are 260,000 prospective customers who seem to have been overlooked by radio manufacturers, dealers and community set builders.

They spend over two billions of dollars a year for other things. Radio would be useful and valuable to them and there is no doubt that they would buy apparatus if they were approached by efficient salesmen.

There are many reasons why they should make regular and systematic use of radio. Some of them already recognize that. They see others in the same line of work using radio receivers, and here and there one that has a transmitting outfit also; naturally, they do not wish to be left behind in the march of progress.

They need the best receiving sets, and \$100 each would be a conservative average expenditure to cover their radio needs. That, in the aggregate, would amount to over \$26,000,000.

This enormous field is almost untouched, as is shown by an investigation in which many of the prospective customers have been so kind as to assist. The customers are scattered throughout the United States and there are many within the reach of every local radio dealer and community set builder.

These prospective buyers of radio are the public schools of the United States. They are without radio, except for a negligible percentage, although there is no place where radio is more needed, more useful or more appreciated than in a school. If the schools of other countries were included—and they need radio as much as ours do—the figures would stagger the imagination.

MORE THAN A QUARTER MILLION SCHOOLS NEED RADIO

There are 263,204 public schools in the United States. In these schools are more

than 25,000,000 pupils. There are more openings for making a sale to a public school than for selling to a private citizen.

First, consider the school board. The boards are inclined to be conservative about adding new equipment, but radio demonstrations at schools and in the homes of members of school boards have produced sales. Where the school board would not buy at first, pupils, parents, teachers and the public sometimes have been aroused to ask that the schools be equipped with receivers.

When the tax payers speak, the school board listens. Many tax payers realize, when the matter is placed before them, that pupils ought to be hearing, in their schools and under the supervision of educators, the music, the lectures, and the talks by men and women who are making history, these being broadcast daily. Those who object to certain radio features that they do not want their children to hear, have to agree that the only way to make sure that they will hear the best is to have them listen where competent teachers control the tuning dials.

If school officials will not appropriate money for radio, there are other ways of securing it. School teachers and pupils have arranged entertainments, exhibitions and sales to raise money for radio, as well as for other things that they wanted in the school room.

Some community set builders and dealers have made sales by installing receivers in schools and bringing in events of outstanding interest, such as the superlative concerts or the championship football games. Admission fees sometimes have brought in enough to buy the receivers. School chil-

dren like to sell tickets for school events and the public buys them.

Another good opening is with the Parent-Teachers' Associations. They give to schools many things that cannot be purchased from school funds without too long delay or too much hard work in securing action. In some communities they have supplied all the schools with radio sets. A school board may make excuses for not buying a radio receiver, but where is a board that will reject such a gift, especially when it is offered by an influential organization?

Then the public-spirited men and women in every community are glad to give something of real value to a school. Often a popular school principal or teacher is on such good terms with well-to-do people as to be in a position to suggest that a radio receiver be presented to the school. It is as fitting a memorial to a prominent citizen or to a boy or girl, who died while of school age, as a bronze tablet, and is much more useful. Some dealers have approached school principals and teachers on such matters and have found them enthusiastic allies. The donor of a radio set deserves and has the appreciation of the whole community.

SALES TO SCHOOLS INCREASE DEMAND IN HOMES

The installation of a radio receiver in a school creates a demand for tubes, batteries, socket-power units, parts for home-built sets and all accessories. Many schools need more than one receiver, and several loud speakers attached to each receiver, in order to serve their classrooms.

A school requires a larger and better radio outfit than many private residences have, and the use of one of the latest and best receivers in a school creates a demand for better sets in the homes of the pupils. The adoption of radio by a school also influences those conservative persons who wait until a new article or method is well established before investing in it.

Some schools encourage pupils to build receivers for home use. Some have workshops where the young set builders work under the supervision of manual-training teachers. In one state, in a single year, school officials reported that more than 4,000 receivers were built by pupils and it is believed that as many more were built, but not reported.

Here and there a school principal has permitted an enthusiastic pupil to organize a radio club, build a transmitter and get into the amateur game. Is there any activity that interests boys of scientific tendencies more, or accomplishes more satisfactory educational results with such boys?

SET BUILDERS, DEALERS, MANUFACTURERS, SHOULD GRASP OPPORTUNITY

It seems obvious that the public schools offer one of the greatest fields for the radio manufacturer, distributor and community set builder, a field in which they can secure profitable business and also perform a needed service for every school, every community and the cause of education.

The organization of school systems makes it possible to sell radio receivers to many schools in a town, city, district, county or state by dealing with one man or group of men. School books and equipment often are endorsed by officials in a way that makes it almost sure that all schools under their supervision will use the article endorsed.

And yet, great as this field is, and near as it is to every man and concern in the radio

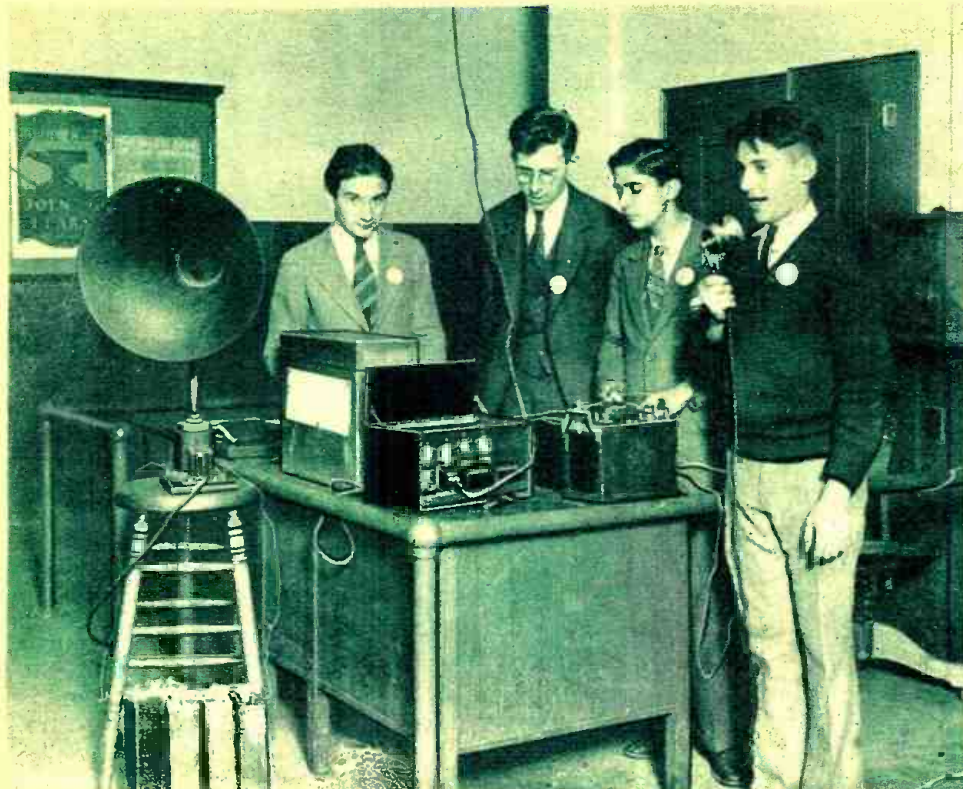

An example of how radio is arousing scientific interest amongst students. The official "cheering-section" at athletic events stands at the right whispering into the mike the cheers which will be magnified by the amplifier on the table and used to dumbfound the "enemy." This stunt was devised by students of the Brooklyn Tech. High School in New York City.

© Herbert Photos, Inc.

As may be seen from the comparative sizes of these buildings, entirely too few schools in the United States employ radio receivers as means of education for younger children, who would doubtless be much benefited by the use of radio.

SCHOOLS NOT
EQUIPPED WITH
RADIO RECEIVERS
Probably 99%



SCHOOLS EQUIPPED
WITH RADIO
RECEIVERS
Probably only 1%



business, not one per cent of more than 500 national, state and local school officials approached in my investigation even so much as intimated that they ever had been approached with plans for equipping schools with radio. A newspaper article stated that Mr. Atwater Kent had cooperated in the equipping of the schools of Atlanta, Georgia, with receivers, and there may be a few others who have not been asleep at the switch. Atlanta has become an outstanding example of a city that knows how to utilize radio in the public schools.

No state superintendent of education was found who had even gone so far as to compile a list of the schools in his state that were using radio. Letters addressed to all the superintendents of school districts in two states, at the suggestion of the state superintendents, brought information of a few schools in which radio is used, but the proportion is small.

The National Education Association, the great organization and clearing house of the educators of America, stated that "Radio will become an increasingly important factor in the daily life of our people and its influence will be more and more recognized."

but said also: "The National Education Association has no committee to work out a definite project for schools and radio broadcasting stations, and so far has done (no) work on that subject." (The word "no" apparently was omitted through a clerical error.)

It is time for community set builders, local dealers and manufacturers to interest educators in radio as a help to education.

EDUCATORS CONSERVATIVE, BUT NOT UNFRIENDLY

Educators are conservative. They have to be, for a mistake might handicap whole generations of children and set the nation back a quarter of a century in matters of education.

Often they are handicapped by politics and lack of funds. They have not yet adapted the work of the public schools completely to the changed industrial, economic and social conditions of the twentieth century. Motion pictures still have but a small place in our school system, although they have become one of the greatest factors in the education of the whole world, for better or for worse.

The radio industry, in grasping the great opportunity presented by public schools, will run no risk of offending educators so long as the business methods employed are proper. The educators who so kindly assisted in this investigation had no commercial motive, nor had I. The facts are being placed before the radio industry on the low plane of a money-making opportunity only because industry must, of necessity, see prospective profits before it can act.

The ultimate interests of educators, of men in the radio industry and of citizens in general are the same, and the fact that a business man has to make financial ends meet does not mean that his ideals are low. A radio set, even if it were placed in a school through sordid, mercenary motives, would still deliver educational materials just as surely as water mains, even if laid by grasping hydraulic companies, would supply a community with life-giving water.

No such objections as have been raised against the use of motion pictures in schools can be made in the case of radio. Highly inflammable film, running past lenses that concentrate heat upon it, has caused fires, panics and loss of life. No such disaster ever has been caused by radio; it is safer than electric lights.

Motion picture producers have reduced the hazard by using non-flam film, but they never yet have produced enough films suitable for use in schools to supply the demand. Educators who have tried to produce educational films have made flat failures more often than successes, because of their ignorance in the special technique of the movies.

The cost of producing motion pictures is so great that few organizations ever have undertaken to produce enough to provide the schools with even one reel a week. Radio, on the other hand, enables the educators themselves, at very low cost, to broadcast programs of any sort that they wish to conduct. They can be received by thousands of schools. Often the owners of commercial broadcast stations are willing to bear part of the expense, or even all of it. If a program does not produce the desired result, the loss is negligible and a new type of program can be substituted immediately.

RADIO HAS PROVEN ITS VALUE IN EDUCATION

Aside from the natural and proper conservatism of school officials, there is nothing to stand in the way of a movement to give America's school children the benefits of radio. (Continued on page 664)



Wherever radio has been used in schools both teachers and pupils have become enthusiastic disciples of the "School of the Air." Our artist has pictured a school whose pupils are listening with keen interest to an educational address. A thousand schools might well enjoy such a talk at once.



Broadcastastics



A NATURAL ERROR

MRS. SEE: "Turn off the radio, dear. The static is awful!"

MR. SEE: "It isn't static, my love. It's only one of those modern-music concerts."

THEORY PUT IN PRACTICE



"If you are a DX fan, use a small, opaquely-shaded bulb as the only source of illumination." —RADIO NEWS.

"Petting Rule Holds for Radio; Best Results in Dark." —Headline in Massachusetts paper.

chusetts paper.

TOO MANY TUNING DIALS

NEIGHBOR: "How many controls are there on your radio set?"

OWNER: "Three; my mother-in-law, my wife, and my daughter."

WHAT'S SAUCE FOR THE GOOSE—

SMART SAM: "I see Senator Sorghum's radio bill is to be presented before Congress."



DUMB DORA: "They ought to make the senators pay their own radio bills."

OPTIONAL

CLERK: "You had better get this new power tube for that set."

CUSTOMER: "Is it a necessity?"

NEW CLERK: "No, it's an RZA."

THE BEST KNOWN CALL LETTERS FOR THE MOTORIST



CON: "I got Station WMBC, Detroit, last night!"

STRUCT: "You can't kid me like that. Detroit is FOB."

—Louis Greenspan.

PAREGORICALLY SPEAKING

The linking of the British empire by radio is a big step toward the circumlocution of the globe.—Punch, London.

And television, it is to be hoped, will shortly lead to its greater circumspection.

A RADIO FAN'S LOVE NOTE

Your is lonely, little
Why this , dear?
I am no , and admit
I 'cause you're not here.

My sorrow into tears,
My 's just useless-- dead.
No from you inducing cheers,
I along unfed!

There is that new Place
Where you and I could dyne;
Then that motor-boating race -
The program would fine.

My arm would you while we roamed
Amidst the Balsa Wood;
I'd let no bakelite-domed
Beset you where you stood

You are so sweet, my
My love doth amplify:
Do you are coming home
To by and bye!

Doris K. Sutcliffe.

ONE MAN'S MEAT—

SMITH: "I got Greece on the radio last night!"

BROWN: "Huh! I'd like to know how to get rid of it when I tune up my car!"

—News of the World, London.

SAFETY FIRST

SONNY: "Daddy, mother wants you to look at a cobweb before she brushes it away."

DADDY: "What's so wonderful about it!"

SONNY: "She's afraid it's part of the radio."



—William Herrmann.

EVERY FAN HIS OWN LINDBERGH



"Cloyd Clevenger, world war ace, is giving practical lessons in airplane flying, from station KOA, Denver. A genuine airplane motor will be set up in the studio to add greater realism."

—Exchange.

Here we have the radio student of aviation, adding a little realism on his own account to his studies.

REVISED VERSION

There was a young fan of Centralia
Who fished every night for Australia:
He got some good practice,
But, sad as the fact is,
His efforts so far are a falia.

TOOT! TOOT!

BILLY: "Say, Ernie, I just got a radio set."

ERNEST: "Is that so? What kind of a set is it?"

BILLY: "I dunno, but I call it a railroad receiver."

ERNEST: "Why is that?"

BILLY: "Because it whistles at every station."



THIS page is devoted to humor of purely radio interest; and our readers are invited to contribute pointed and snappy jokes—no long-winded compositions—of an original nature. For each one of this nature accepted and printed, \$1.00 will be paid. Each must deal with radio in some of its phases. Actual humorous occurrences, preferably in broadcasting, will be preferred. Address Broadcastastics, care RADIO NEWS, 230 Fifth Avenue, New York City.

RADIO RHYMES

NO. 2



"OH GEE -- I WISH I HAD THE DOUGH TO BUY MYSELF A RADIO!"



IT MUST BE FUN TO TWIST THE DIALS AND PULL THEM IN FOR MILES AND MILES!



TO SETTLE BACK AND LISTEN AS THE ATMOSPHERE IS FILLED WITH JAZZ!



WELL HOLY GOSH! -- IF THAT AIN'T GREAT! -- JUST 15 MINUTES MORE TO WAIT!

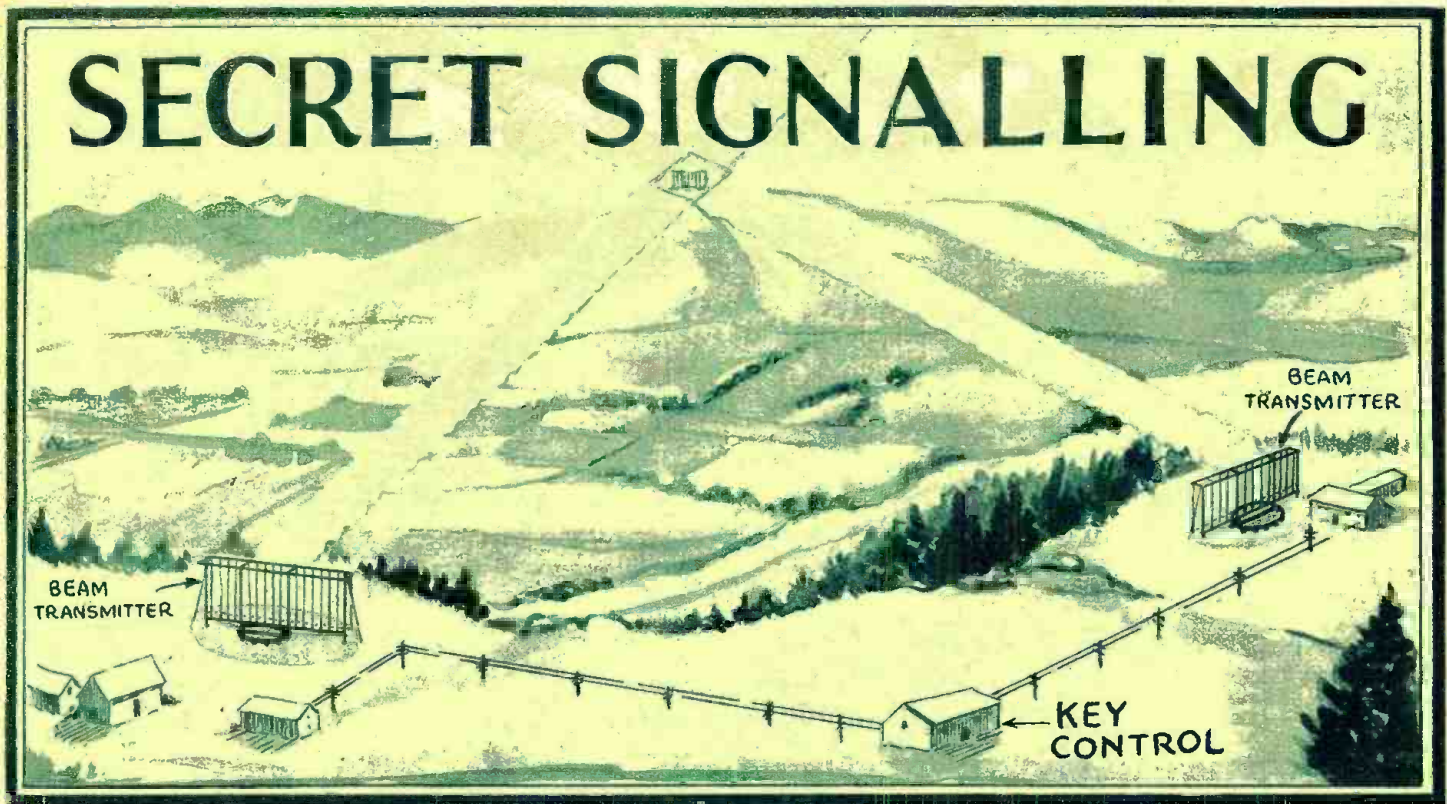

The picture above illustrates an ingenious British suggestion for insuring secrecy of messages. The two beam transmitters send alternate fragments of a dispatch, the whole of which is receivable only in the small area of intersection.

It has been often thought that telegraph lines and cables possess one great advantage over radio, in that messages transmitted over the former are secret. It is for this reason that many business firms and some governments have not turned more readily to radio communication; for it can be easily understood that many times it is imperative that messages be sent and received without their contents being known to anyone except those for whom they are intended.

This may all seem logical on the surface, but in view of the recent developments in secret radio transmitting and receiving it is not quite true. In the first place, messages transmitted by wire are not proof against the skill of determined wire-tappers, as they are called. By means of delicate pick-up coils and tube amplifiers, it is possible for the unscrupulous to tap a telegraph line without cutting the wire or giving any indication whatsoever that the message is being intercepted.

A message that is secret can be sent in

code or cipher. But it is a difficult task to find a system which can not be deciphered. This fact was proved numerous times during the World War, when the military intelligence department, oftentimes, found the key to enemy messages.

CIPHER SYSTEMS

In code transmission, such as generally used for commercial purposes, entire words or phrases are replaced by letters or numbers taken from a special code book, of which copies must be in the hands of both the sender and the receiver of the message. Such code books are readily obtainable in many places and at once yield the true significance of the message. Even when elaborate secret codes are used, as in war time, the mere fact, that several copies of the book are in existence, increases the chance of the key falling into the wrong hands.

Cipher messages can be divided into two classes, *transposition* ciphers and *substitution* ciphers. In the former, the letters of

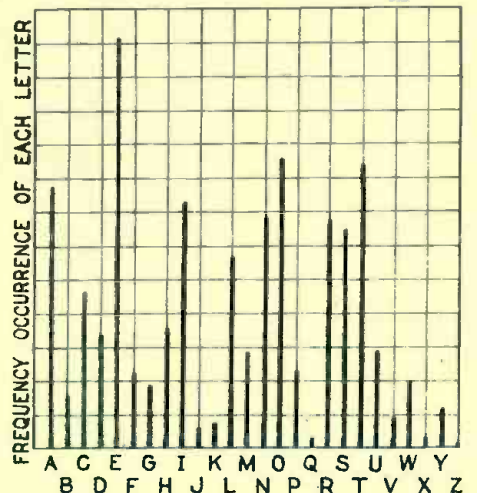

Fig. 1. The relative frequency of letters in the English language is shown by the above graph. (It may be compared with the radio code, in which the most common letters are represented by the shortest signals). This will afford a good key for solving any "substitution" cipher.

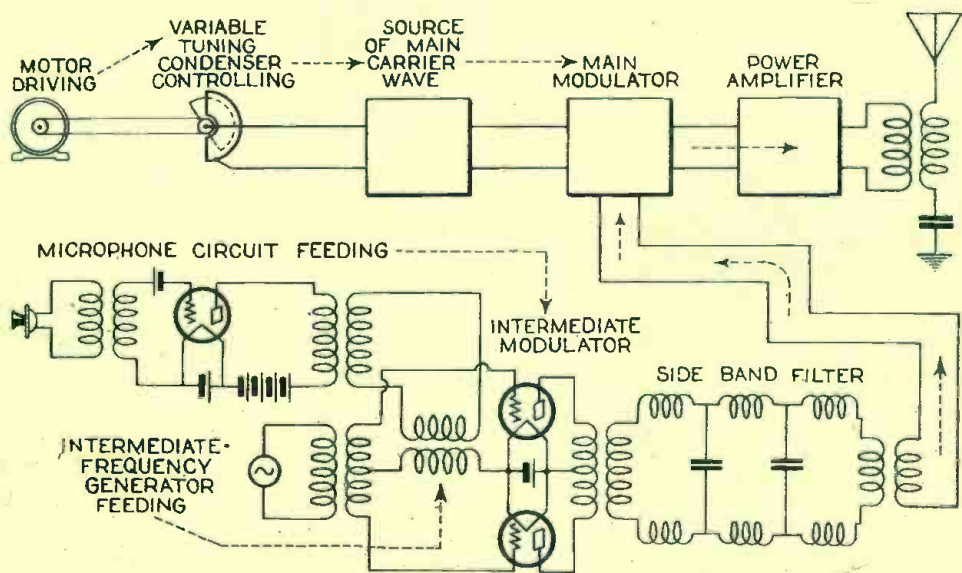

Fig. 2. above, shows a system of telephony for the reception of which equally-complex apparatus must be used. The doubly-modified carrier has a continually-varying frequency, doubly-modulated as explained in the text.

the "clear" message are rearranged according to a definite system known to the recipient of the message. The second method is obtained by allowing the order of the letters in the message to be unchanged, but substituting for each an equivalent taken from one or more cipher alphabets.

It is claimed that both these systems are easily deciphered by an expert, providing that he has sufficient material upon which to work. The system that an expert follows in dealing with a substitution cipher is the one which Edgar Allen Poe explains in his famous mystery story, "The Gold Bug;" that is, he makes an analysis of the number of times certain letters or characters occur in the message.

SOLVING CIPHERS

A table has been prepared which shows how frequently the letters in the alphabet occur in a message. (See Fig. 1.) This chart holds good only for the English language in which the letter E occurs oftener (Continued on page 709)

How "The Lady of the Snows" Listens In

A Description of the Main Differences Between the Systems of the United States and Canada

SOMEWHERE in the neighborhood of eighty broadcast stations cover the Dominion of Canada from coast to coast. Every section of the vast expanse which makes up the nation is adequately covered with a net-work of entertainment and information-giving voices, which cover ranges from fifty to ten thousand miles.

To the radio fan come the voices of the Maritimes, wending their way from Halifax and Moncton; the French and English announcements from the studios in Montreal, Quebec and Ottawa, lend an air of romance and by-gone times to the everyday words of the newest of showmen—the radio announcer; from Toronto, Ottawa, Hamilton, Brantford, London and a number of other cities in populous Ontario are received some of the best programs broadcast on the continent; from Winnipeg, Saskatoon, Regina and Edmonton, the vastness of the prairies reverberates; while the magic touch of the Pacific sea board is heard from Vancouver.

The stations in the Dominion are licensed by the Department of Marine and Fisheries. Each is operated by a competent government-examined official, and all are under constant supervision from the local radio inspectors. In fact, a nightly checking-up on each station is made by inspectors throughout the Dominion.

The entertainment which comes winging to us over the air comes not from private persons, nor from large radio trusts; but from newspapers, railways, religious institutions and research societies. All of these, with stations, from one end of the country to the other, furnish music for which we pay not a copper and to which it is our pleasure to listen or from which we can turn away.

Radio and electrical concerns top the list with stations in operation, while the newspapers come a good second and the Canadian National Railways come third. Religious organizations and churches, private persons, radio societies and financial companies finish the list in this order. It is a very varied assortment, giving entertainment as they think entertainment should be given.

It is interesting to note that the Canadian National Railways operate eleven stations, extending from Moncton to Vancouver. Not all of these are stations owned by the railway, some being rented for the night of broadcasting from some other station owner.

PHANTOM LICENSES

And this brings us to a point which few know about. One often hears a great number of Canadian stations in one city and wonders if each of these has its own station. A number of concerns have what is known as a "phantom" license: that is, a license un-

By JAMES MONTAGNES

der which they can operate from some other station. For instance, when station CHNC at Toronto puts on a concert it is actually broadcast through station CKNC.

Canadian stations are each assigned a wavelength. This wavelength is assigned to a city or locality, so that all broadcast stations in a certain territory shall be on the same wavelength. With this arrangement no two stations are allowed to put on a concert simultaneously in the same city. Thus there is not the overcrowding that is prevalent in the United States, and one is able to tune out a local program, with some assurance of getting one from some other center. This system has worked out wonderfully,

main, so he does not have to go home in rain or snow. But the artists never see the interior of these stations. For them is provided a studio in a downtown hotel or art gallery, from whence their music is fed by telephone lines to the distant transmitting equipment.

RANGE OF STATIONS

The range of Canadian stations is continent-wide and some are heard in such distant points as the West Indies, Hawaii and Australia. They serve each bit of local territory as well as more distant points. In order to give an adequate idea of the regular reception of Canadian stations, the writer was furnished with a special analysis of reception reports by the Canadian National Railways. These charts show that every inch of the country is well covered. For instance, the station at Moncton, N. B., is heard regularly throughout the Maritimes, Newfoundland, and all the American states in the Eastern Standard Time zone as far south as Georgia. Some difficulty in the reception of this station is had in St. John, N. B., Halifax, Fredericton, Campbellton and Cape Breton. On the other hand, CNRA is reported in the British Isles, Holland, Spain, the Northwest Territories and Central America.

Take the case of CNRW at Winnipeg, where station CKY is used for broadcasting. This station has a regular audience of nearly all Manitoba, part of Saskatchewan, Ontario as far east as Fort William, and eight states to the south and southeast. Besides this it is heard with some regularity on both the east and west coasts, and has been reported in England, Hawaii and the Isle of Pines in the West Indies.

The Vancouver station of the chain covers perhaps more territory than any other Canadian station: east as far as Manitoba, north to Alaska and south to Mexico, on regular broadcasts, with the occasional report from eastern Canada, Oceania, the Antipodes and Hawaii.

Every station could be described in this manner, but some idea of the distances covered can be gleaned from the above. That the stations in the Dominion, although fewer in number than those in the United States, cover their territories to a good degree is one reason why there are not more stations in Canada. It is felt that they are not necessary. A great many more stations would cause interference problems. Incidentally the license fee for a Canadian station is \$50 per annum, and the initial cost for a good broadcasting station is in the neighborhood of \$25,000.

The Canadian Government has wisely regulated the disposal of broadcast stations and in doing so has kept in mind the fact that a population of ten millions, stretching out over three thousand miles, must be entertained. It has found a very good way of providing everyone with Canadian entertainment.

(Incidentally, their neighbors in the United States also are thus favored with an attractive addition to their radio programs; as well as an opportunity to make better DX records. —EDITOR.)



The broadcast stations located in the cities marked on the map have ranges of reported regular reception equivalent to the arrows, showing that Canada is very well covered. They are well known to most listeners in the United States.

the broadcast station owners arranging their own time schedules by mutual agreement.

Only in Montreal and Toronto has there been a deviation from this practice. This is so arranged that any stations now built to operate from Toronto or Montreal must be erected at least ten miles outside the city and then they are put on a different wavelength from that assigned to either Montreal or Toronto.

These stations, situated at a distance from the city, usually in desolate and barren spots, so as to be efficient from a radio standpoint, do not have magnificent studios in which to receive noted artists. They are equipped so that on a stormy night the operator can re-



The "Peridyne" Five*

Construction of a Highly-Sensitive Receiver Using the New System of Variable-Shield Tuning

By HUGO GERNSBACK

Member, American Physical Society; Member, American Association for the Advancement of Science.

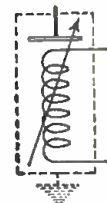

IN my previous article, in the November issue of RADIO NEWS, I sketched briefly the theoretical considerations of the "Peridyne" action of shield-tuning. Since that article appeared, I have received the usual number of letters (totalling four at the time this is written) in which the claim is made, also as usual, that the idea of variable-shield tuning is an old story.

This was to be expected; because nothing new is ever brought out without some one's coming along and claiming credit for it. The trouble with those people who have written to me is that they, evidently, did not read my article, and came to a hasty conclusion merely from relying upon the drawings. One of the letters pointed out that there is such a thing as "spade tuning," whereby a movable piece of metal is slid across a honey-comb or spiderweb coil. Another letter pointed out that a neutralizing scheme, using a metal vane inside of a coil, had been used for many years.

All these things, of course, were previously well known to me. I went to great pains, in my article in the November issue, to point out that at no time should the "Peridyne" shield be called a loss; because, in a carefully-balanced "Peridyne" shielded set, the shield is never near enough to the coil to act as a loss, as this term is usually understood.

When tuned radio-frequency amplification first came into general use for broadcast reception many metallic losses were used; notably in certain Freshman sets, where the coil was as near as an eighth of an inch to the metallic frame of the variable condenser which turned it. Here we had a real loss. In the "Peridyne" system, it is an exceptional condition when the shield must be brought nearer to the coil than an inch. There is a tremendous difference between these arrangements; the fact that

THE "PERIDYNE" FIVE set described here has been designed by the author for the special purpose of "DX" work. It may be termed the DX set par excellence. The author, in New York, has brought in Pacific Coast stations at a distance of over 2,400 miles, airline, even in the summer time. The electrical system used is the popular Interflex circuit described by the author in his articles on Interflex receivers, two years ago. In addition to this, full use is made of the new "Peridyne" variable-shield tuning system, whereby the set can be balanced to a degree of accuracy which has been impossible, heretofore, in tuned-radio-frequency circuits. At the same time, the set is fully shielded.

The "Peridyne" Five has only two controls; only one of them a tuning control. An important consideration in this set is also the fact that, though this set can be made to oscillate violently, it does not radiate in the least. The author demonstrated this by placing another receiver a few feet away from it; although the "Peridyne" could be made to squeal and oscillate violently, the effect could not be picked up on the nearby set. The set is very simple in its construction, and we know that our readers will want to try this excellent circuit immediately.

—EDITOR.

mounting the coil on the end-plate causes eddy-current effects in the metal, due to its close proximity, whereas the "Peridyne" shield is too far away for this action.

This difference is really very great, and becomes apparent only after you have built and operated a set using the "Peridyne" principle of variable-shield tuning. I took pains to point this out in Figures 3 and 3A, in my former article (page 487, of the November issue of RADIO NEWS) and I pointed out also that the inductances of the coils are altered, not by losing energy, but because the shield changes both the self-inductance and self-capacitance of the coil. Once you get familiar with the difference, interesting possibilities from the use of the "Peridyne" principle immediately open up.

RECEPTION WITH THE "PERIDYNE"

The "Peridyne" Five set described in this article is, frankly, a highly-developed DX receiver. I started out with the idea of showing that a 5-tube receiver, plus crystal detector, could accomplish anything and everything within the powers of an 8- or 10-tube set, no matter what circuit was used; and I am ready to prove that this circuit, using but five tubes, will eclipse many an excellent superheterodyne loop receiver, for the following reasons.

I must point out again that, in the circuit I am about to describe, there are practically none of the losses that are usually encountered in most sets. Quite the contrary; the

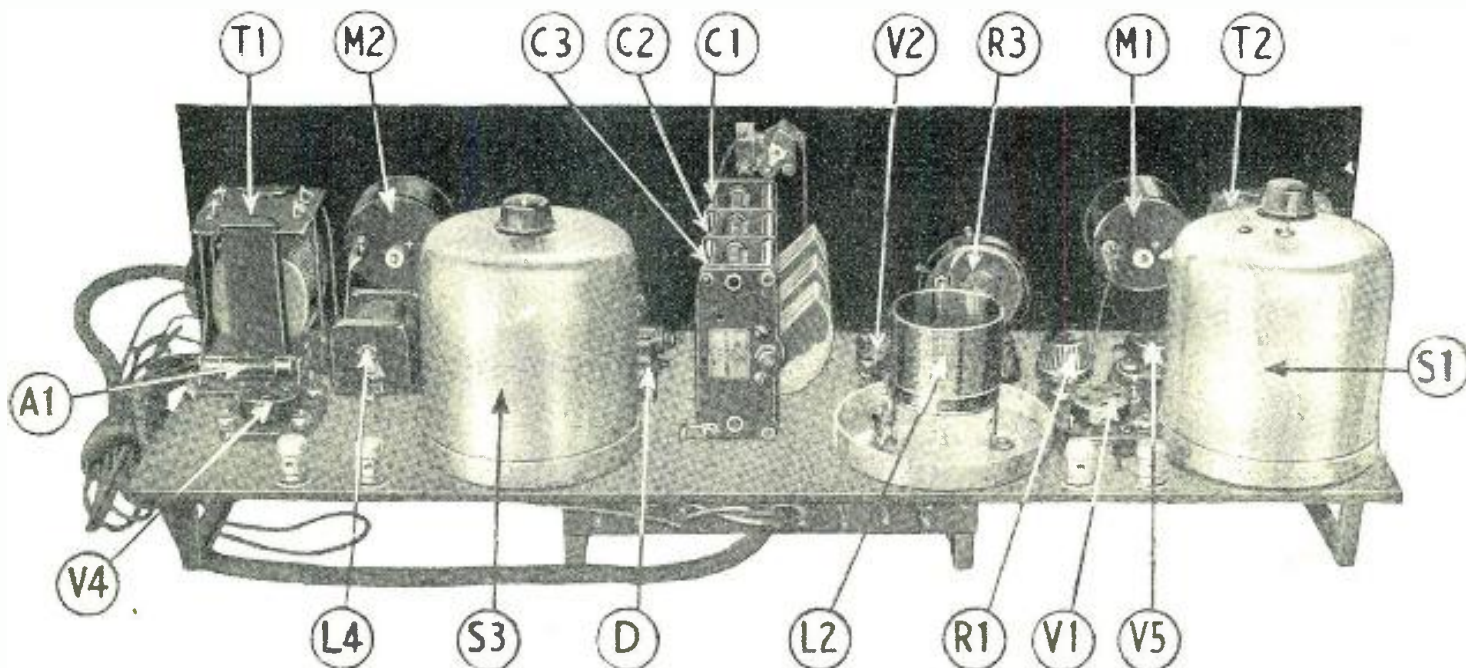

The rear view of the "Peridyne" Five shows C1, C2, C3, the three-ganged variable condensers; S1 and S3, R.F. coil shields; L2, an R.F. transformer; M1, filament voltmeter; M2, plate voltmeter; R1, R.F. rheostat; R3, volume control; D, detector; L4, R.F. choke; A1, amperite; and T1 and T2, A.F. transformers.

* RADIO NEWS Blueprint Article No. 37.

last fraction of possible efficiency is obtained from this set, because of the extremely fine balancing possible with the "Peridyne" shields. Instead of suppressing oscillations, instead of having the usual losses, we keep the "Peridyne" Five usually just below the oscillation point by means of a simple oscillation control; and hence the highest possible efficiency is created and maintained.

May I say that this set has been in use by me since last December, and has been tried out under all circumstances? Though, of course, winter reception is better, still extraordinary results have been achieved throughout the summer in the city of New York, where conditions are not too good at any time; while in the winter time, with this 5-tube set, I have been able to receive KFI, Los Angeles (the distance of which is 2,430 miles, air-line) almost nightly when that

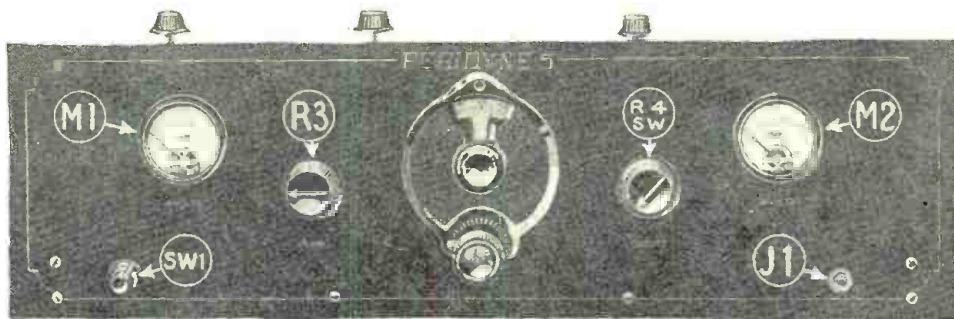

On the "Peridyne's" front panel are the filament and plate voltmeters, M1 and M2, and the switch, SW1, that controls them; R3, volume control; R4-SW, combination switch and rheostat; J1, output jack; and the single control for the three condensers.

of 1,000 miles could not be brought in on the loud speaker. I therefore claim that this set is most unusual when it comes to distance; in fact, for city use the set really is too sensitive and often entirely too loud. For that reason, when I wish to receive local stations with this set I use an indoor antenna 30 feet in length; but, even with such an antenna, stations as far away as Cleveland (425 miles distant by air-line) could be brought in on the loud speaker without undue fussing. Most of some twenty-odd local stations were still uncomfortably loud, when using but 90 volts "B" battery.

I wish to point out here that the set gives an unusual amount of power; for, comparing this 5-tube set with many 9- and 10-tube sets in the RADIO NEWS LABORATORIES, we have not found one, with the exception of the Strobodyne, that delivered more power on 90 volts than the Peridyne. I know that these are strong claims, and I do not wish to be over-enthusiastic concerning this circuit, simply because I originated it; I would much rather let the builders of this set speak for the circuit after they have constructed "Peridyne" Fives themselves. I believe I have rather underestimated the results than overestimated them.

CLASS OF SERVICE
This is a full-rate Telegram or Cablegram unless its character is indicated by a symbol in the check or in the address.

WESTERN UNION

SYMBOLS

DL	Day Letter
NL	Night Message
NL	Night Letter
DD	Deferred
CC	Cable Letter
WEL	Week End Letter

The filing time is shown in the date line on full-rate telegrams and day letters, and the time of receipt of satisfactory delivery on all messages, a STANDARD TIME.

Received at

NA6 27 COLLECT NITE 1 EXTRA LOSANGELES CALIF JAN 24

H GERBACK.

99 EDITOR RADIO NEWS 53 PARK PLACE.

YOUR RECEPTION OF KFI SATURDAY JANUARY TWENTY TWO CORRECT

THANKS FOR YOUR WIFE SORRY NOT TO HAVE ANSWERED SONNER

ALWAYS GLAD TO HEAR FROM YOU.

EARLE C ANTHONY INC KFI.

station was on the air. I have been able, even in the summer time, with plenty of static, to receive the California station at

least once a week when conditions were fair. During the past summer there has been hardly a night when stations within a radius

NEED OF SHIELDING

While I have pointed out in my theoretical article that the Peridyne system of shield

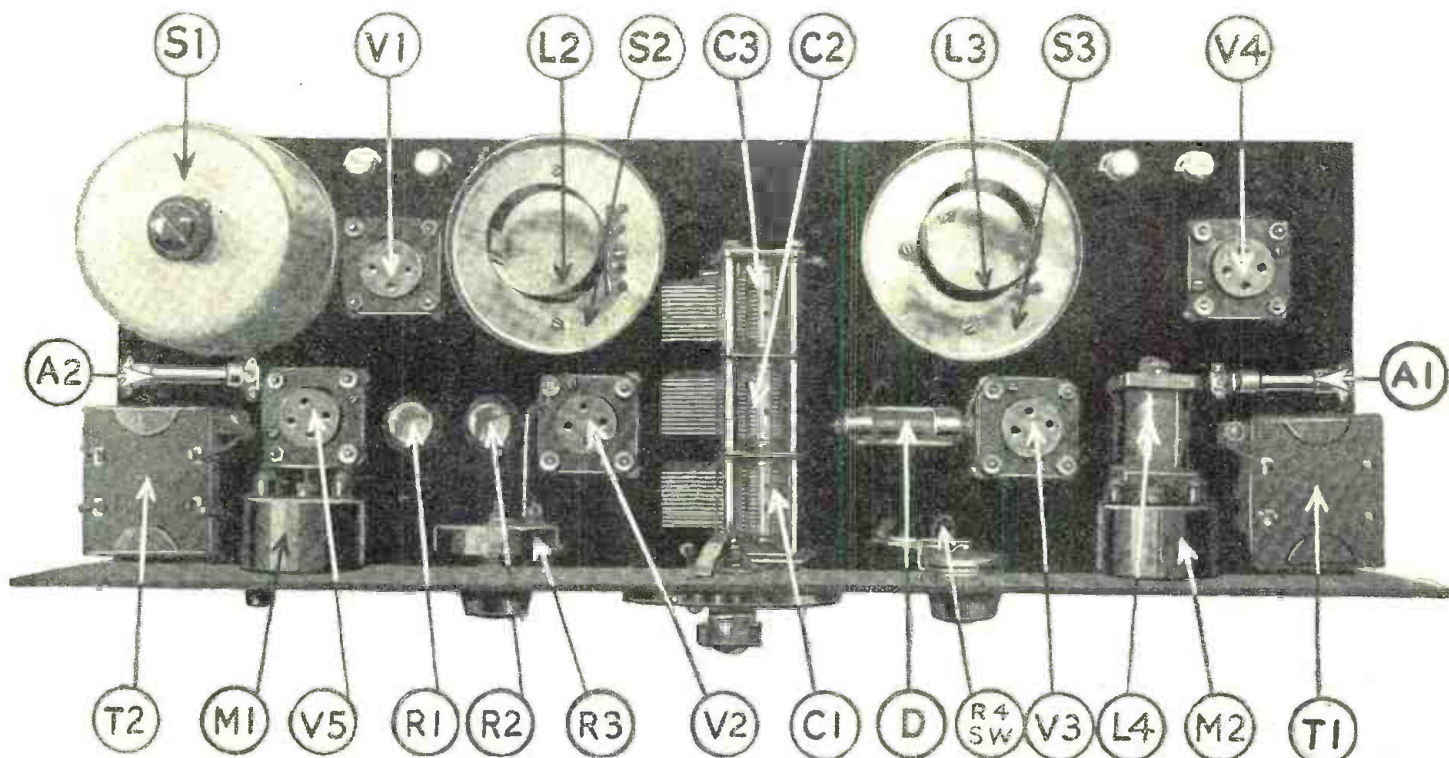

In this view of the "Peridyne" Five are clearly shown two R.F. transformers, L2 and L3, on their shield bases, S2 and S3; R1 and R2, rheostats; V1 and V2, R.F. amplifier sockets; V3 and V4, A.F. amplifier sockets; V5, power-tube socket; A1 and A2, amperites; and L4, R.F. choke. The other components bear the same symbols as those in the opposite illustration.

tuning can be used without enclosing the shield itself in a can, it is necessary, in my estimation, for best results, that the system be used exactly as specified in this article. In the first place, particularly when it is used in cities where there are several broadcast stations, an unshielded set today is practically useless. If the inductors are not totally shielded, the windings themselves become pick-up coils and act like an antenna. This is quite easily proven. If, after constructing the set, aerial and ground are disconnected, you will find that it will be practically impossible to receive any signals at all, even from a nearby station. But the moment the cans are lifted from their inductors, stations will come in quite loud; and it will also be found immediately that there is considerable interference, not only from waves coming from various stations, but from strays within the set. Total shielding of the inductors, I therefore consider absolutely necessary.

I seek to emphasize that, if a constructor wishes to build the entire set, making all the parts himself as far as possible, none of the dimensions, particularly those of the inductors and cans, should be changed in the least. It will interest the builder to know that I tried some eighty different kinds of inductors, small and large, short and long, heavy and thin wire, with all sorts of insulation, before I finally decided upon the construction which I now use.

There is no hocus pocus about this set at all; rather, it is very simple in construction. I believe that it is a set far easier to construct than many more pretentious ones. There is a minimum of wiring and no instruments and components that are not absolutely essential are used in this set. I have tried to eliminate anything not of vital importance to the receiver. Any number of refinements, that could have been placed in the set, have been left out; because, after using them, I have convinced myself that, in most cases, the set will work practically as well without them.

INTERFLEX PRINCIPLE INCORPORATED

The circuit used contains nothing revolutionary; the only novelty lies really in the "Peridyne" system of shield tuning. Those who have used or constructed any one of my Interflex circuits, such as the Balanced Interflex, and the Regenerative Interflex, know that the insertion of the crystal detector immediately in the grid lead of the first audio amplifier tube will do wonders. For those who have not read my former articles on the Interflex action, let me repeat that the Interflex system does a number of important things.

First of all, the crystal detector entirely replaces one tube; the "Peridyne" Five, which uses five vacuum tubes, is therefore in reality a 6-tube set and must be considered as such. The detector is a half-wave rectifier and passes practically no radio-frequency currents. Inserted in the grid lead it does away with the condenser and grid leak, and the usual losses. It should be noted that the tube to which the crystal detector is connected becomes the first audio amplifier. There are, therefore, three stages of A. F. amplification in this set, which accounts for its tremendous volume.

The circuit itself, as I have said, presents no great novelties, except that, although a three-gang condenser is used, no compensating condensers are required. All compensation is accomplished by means of the "Peridyne" shields, a point that should be remembered.

CONSTRUCTION AND ASSEMBLY

As to the constructional details, I need not go to any length, because the illustrations which I present are pretty thorough and

MAROON - B+ 22 1/2 V. (1 ST. AUDIO)
 BLACK & RED - B+ 90V. (R.F.)
 RED & MAROON - B+ 90 TO 180 V.
 BLACK & YELLOW A- C+
 YELLOW A+ B-
 BLACK & GREEN C- 4 1/2 V.
 IF 201-A TUBE IS USED IN LAST STAGE CONNECT THESE TWO POSTS TOGETHER.
 IF 112 OR 171 TUBE IS USED CONNECT ADDITIONAL "C" BATTERY ACROSS POSTS INSTEAD.

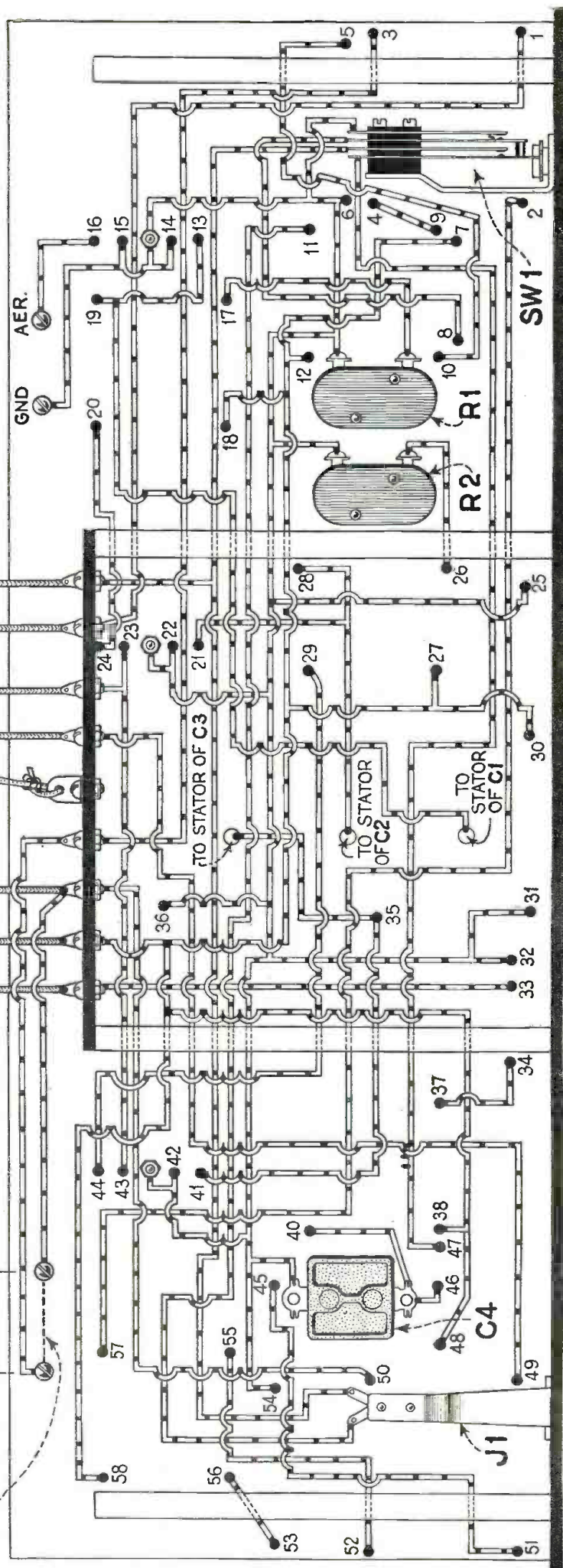

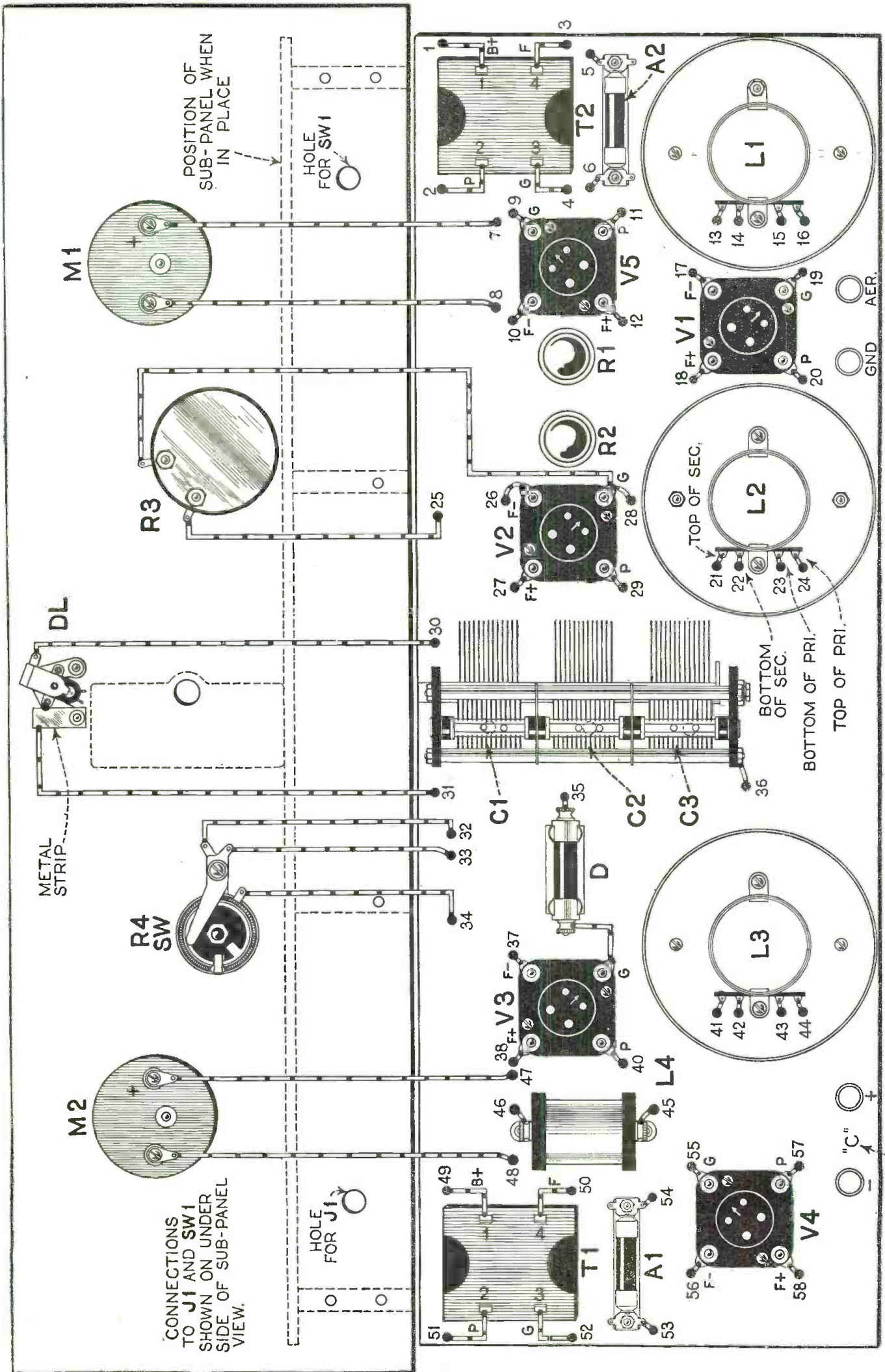

SEE NOTE ON UNDER VIEW OF SUB-PANEL

The rear of the front panel and the top of the sub-panel are shown on this page, with the wires that go to the different instruments. Notice that the holes going through the sub-panel are numbered, corresponding

to those in the under view of the sub-panel shown on the opposite page. As the set is wired, the connections should be crossed off on the diagrams.

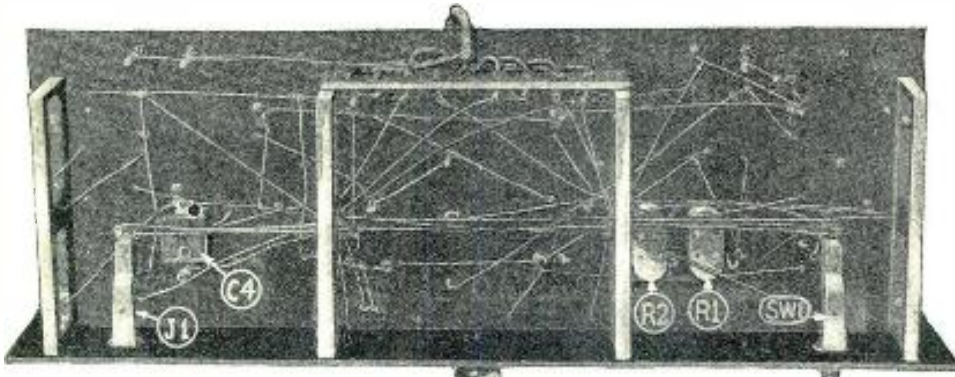

The under side of the sub-panel, showing J1, the output jack; C4, .001 mf. fixed condenser; R1 and R2, rheostats; and the voltmeter switch, SW1.

complete. Use only the best of materials throughout. Use good insulation, and when running your wire connections, see that no radio-frequency wires run parallel to each other. One of the illustrations shows the extreme simplicity of the wiring on the bottom of the panel.

In building the set, for simplicity's sake, I have used flexible Celatsite wire, which comes in different colors, and makes the wiring of the set rather simple. This wire is quite thin and has stranded wires, with good insulation. In this set I have used four colors, as follows:

- Red for plate and "B" battery;
- Green for grid, grid returns to "A—" and "C—";
- Yellow for "A+" battery leads;
- Black for "A—" battery and other leads at ground potential.

All connections made must be soldered. I do not believe the same results can be had from this particular set with screw-connections, as they very often give rise to losses; for in this set such losses must be reduced to the irreducible minimum.

IMPORTANCE OF METERS

I found it quite necessary (as a matter of fact I don't consider it possible to use this set without them for DX work) that the specified voltmeters be used. The reason is, that the set is exceedingly sensitive to the operating temperature of the radio-frequency tubes, and these must always be kept at their exact voltage. Only by using a voltmeter

(M1) across the "A" battery can you tell at all times that the voltage is exactly the

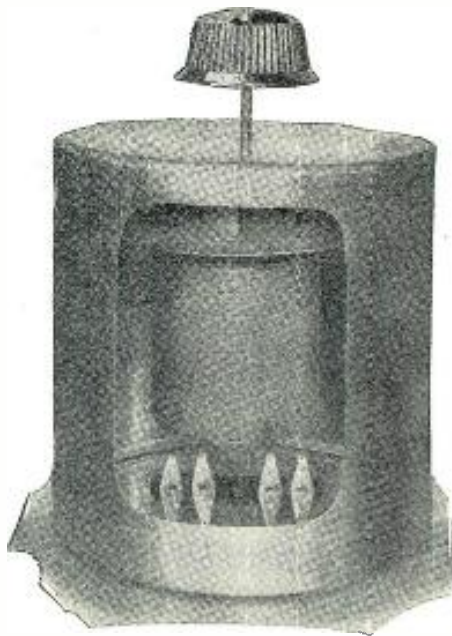

A cut-away view of a "Peridyne" transformer and shield. The tuning shield is shown here much closer to the coil than it will be used.

same. If it is not, then the two radio-frequency rheostats must be hand-adjusted; which should never be necessary if the sup-

plied voltage is that to which the set has been originally balanced.

And here I wish once more to tell those who work with sets of this kind, of the importance of knowing at all times that the voltage in their sets is correct. This is the case with, not only the "Peridyne" Five, but many other sets. Radio constructors have found that at certain times their sets are really excellent, but, little by little, they lose their sensitivity. The reason usually is drop in voltage, as a result of which the set no longer operates at its highest efficiency. For this reason, I continue to wonder that so many sets are made without a good voltmeter. Without this instrument, you operate your set blindly; it is like driving your car without a speed indicator, which no sane person will do.

Oh yes! I have forgotten to mention that in the "Peridyne" Five I use just one bypass condenser, whereas most sets of this kind incorporate any number of them. I do not find it necessary to use more than one. This, of course, simplifies the set a great deal.

The oscillation control in this set is a 100,000-ohm smooth-action variable resistor (R3), used in the first radio-frequency stage. It is possible, as will be explained further on, to do without it for city use, when the "Peridyne" shields are used as lossers; but for DX work it is highly important, as a matter of fact, one of the most important adjuncts to the entire set.

I maintain, as do many others, that no radio circuit which suppresses regeneration entirely can ever be as sensitive as a set that regenerates strongly. Practically all neutralizing methods consume some energy and thereby reduce the distance-getting ability of the set; whereas, the regenerating set, nine times out of ten, is better for distance reception. As this is frankly a DX set, I use a suitable regeneration control, by means of which the set can be brought to the highest efficiency for its particular wavelength reception without the usual lossers.

TESTING THE DETECTOR

A word about the detector. As I have stated in my former Interflex articles, I have found, so far, that only the carborundum detector works well in the grid circuit of a tube; that is, in the Interflex system. I have tried practically all other crystal detectors with mediocre results. It seems that the carborundum crystal gives an entirely different action; the reason being prob-

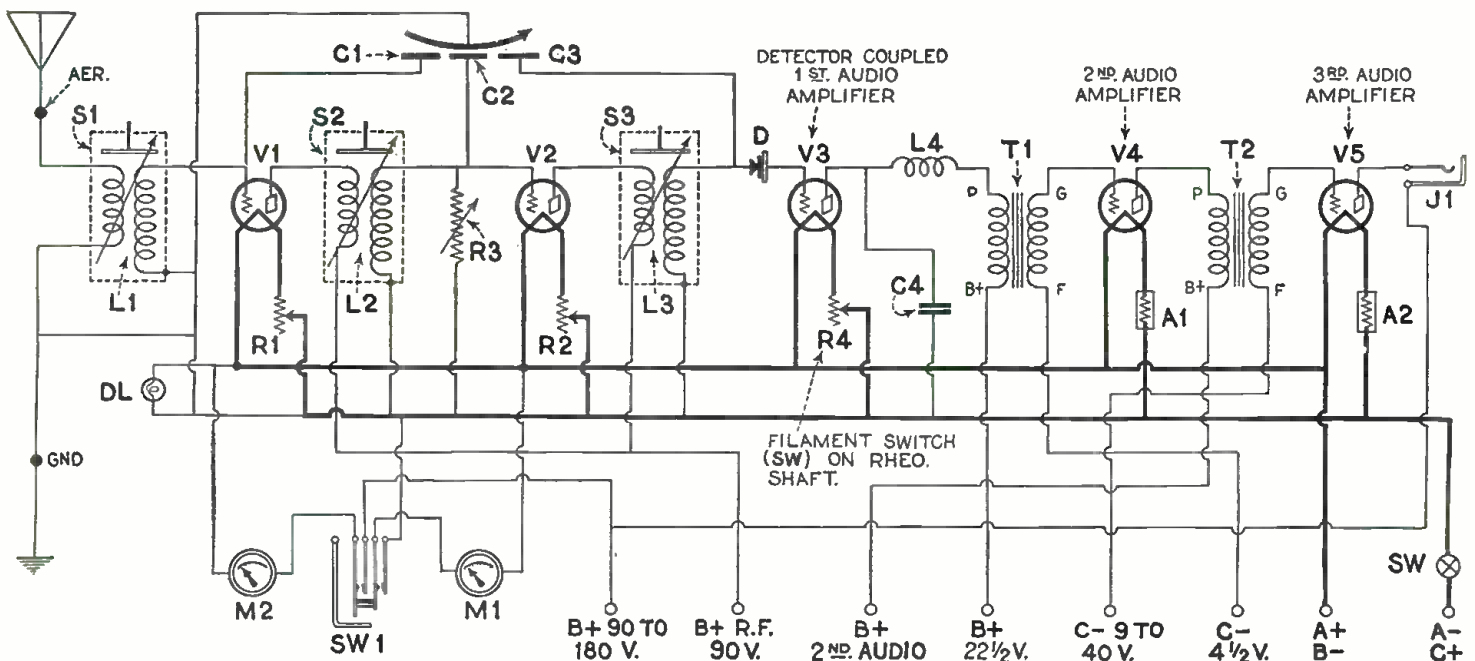

The parts indicated in this schematic diagram of the "Peridyne" Five are numbered and lettered to correspond with those in the other diagrams and illustrations. Note that DL is the miniature lamp illuminating the tuning dial.

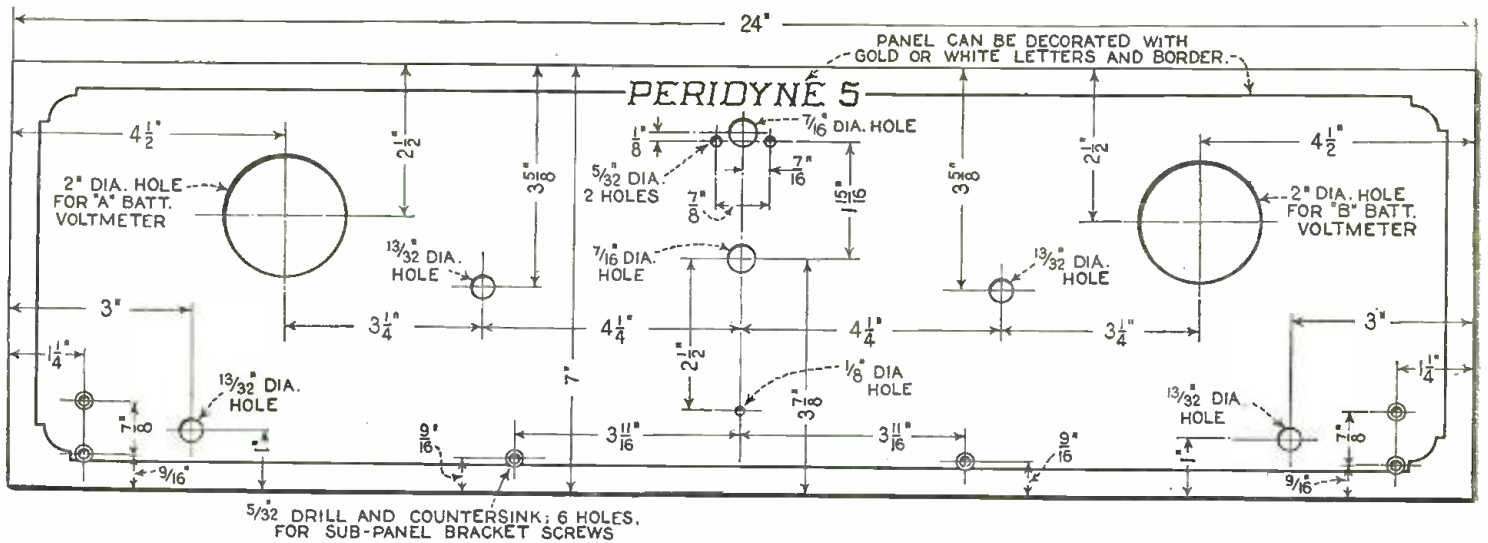

Comparatively few holes have to be drilled in the front panel of the "Peridyne" Five. The layout of this panel gives an attractive balance to the receiver, as may be seen in the illustration on page 619.

ably that, of all crystal detectors, the carborundum type usually operates best with a slight biasing potential. That slight potential exists in this circuit, and hence the carborundum detector actually replaces a tube. This statement can easily be proven by short-circuiting the detector, when the volume of the set will be observed to drop considerably. On the other hand, not all carborundum detector crystals work alike; some are more sensitive than others. I would recommend to all who build the set to have at least three such detectors on hand, and find out which works the best.

And let no one think for a minute that a crystal detector in a set is a "fussy" article. As to the 6,000 Interflex sets that have been built in this country, I have on file hundreds of letters from owners who have worked their sets right through the summer, when static and actual sparks came crashing through the set, without the crystal being impaired. In the carborundum detector we have a crystal held against a steel block under several pounds of pressure. In this detector nothing is likely to be burnt out, because this crystal can be subjected to a tremendous amount of heat without changing its efficiency.

During the summer time, while using the "Peridyne" Five, I never disconnected the

aerial, and at times I have drawn out from the crystal detector itself sparks half an inch long at the approach of a thunderstorm. Yet, strange to say, it did not impair the set at all. In one of my Interflex sets, which is now over three years old, I still use the same old carborundum crystal, having never replaced it; while in the same period I have replaced some tubes three and four times. Thus, the carborundum crystal has outlasted the vacuum tubes. So, if you have any idea in mind that a crystal detector is a perishable article, in a DX set, this lengthy statement should disabuse your mind; because, once a good crystal has been found, you need pay no more further attention to it than if it were a binding post.

The important part of the carborundum detector is that it works best only one way, which has to be found by experiment. On local stations not much difference, if any, can be detected. It becomes important only when you are listening to a DX station; then you will find that a reversal of the carborundum detector will practically kill all reception, while in the correct position reception will be excellent.

Furthermore, I insist, and many critics have found the assertion true, that a crystal detector inserted in the grid lead, providing all other conditions are right, makes for

purity of sound, that is usually not found in other sets. The nasal, twanging sound of so many sets is practically absent when the crystal is used in the Interflex way. All those who have used it thus will never again use another method. This quality becomes particularly apparent when you are listening to talk; comparatively few sets reproduce speech in a natural tone. Scientists are all agreed that there is no clearer-sounding detector than the crystal. In this respect it is more efficient than the vacuum tube. Hence the great purity of sound obtained by the Interflex method.

MAKING COILS AND SHIELDS

In the "Peridyne" Five I use a factory-made inductor, which is self-supporting, the coil being held together by a thin film of celluloid. As this construction requires special forms, I have substituted, for those who wish to build their own coils, a simple method whereby the secondary and primary of the inductor are wound on a cardboard tube.

It is absolutely essential that the lower part of the winding be exactly 1 1/8 inches away from the bottom of the can; otherwise the constants will all change from those given. The secondary is first wound with

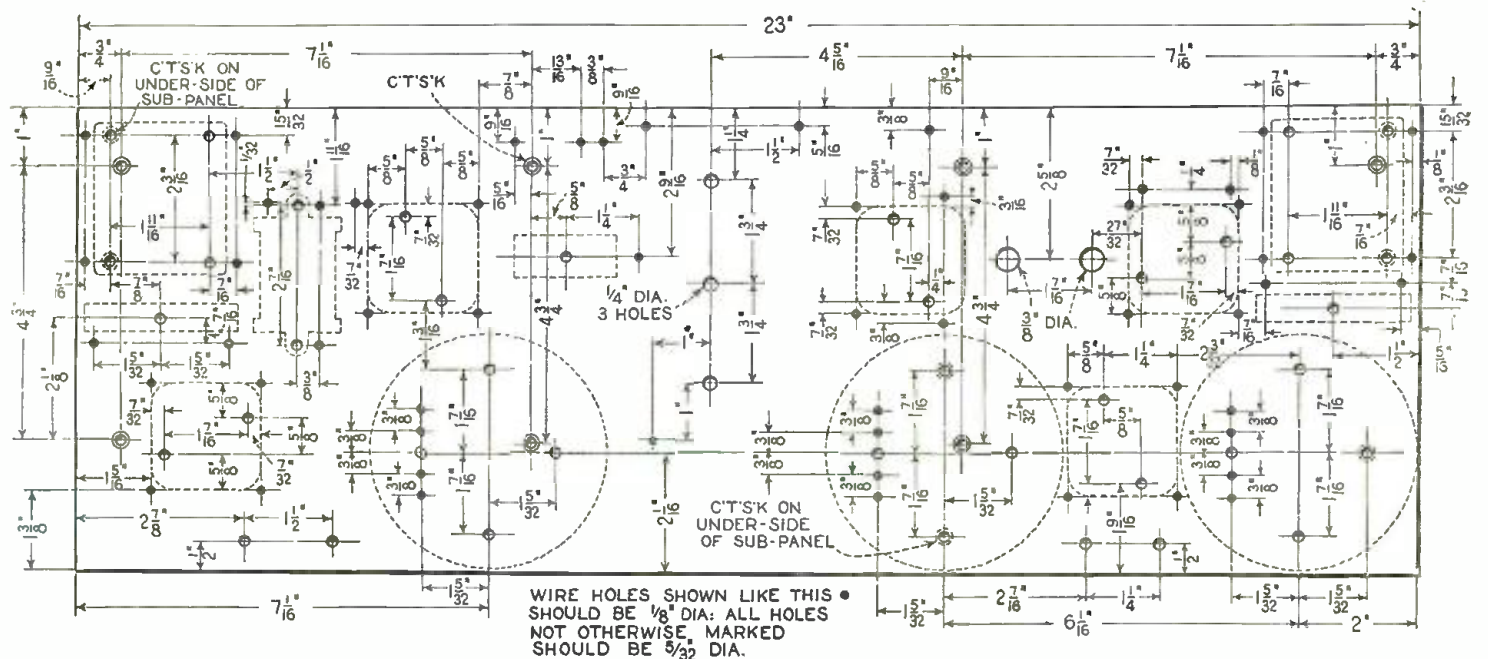

The drilling instructions are given for the holes necessary in the sub-panel. The holes indicated by a solid circle are numbered in the diagrams on pages 620 and 621 in order to facilitate the wiring of the receiver.

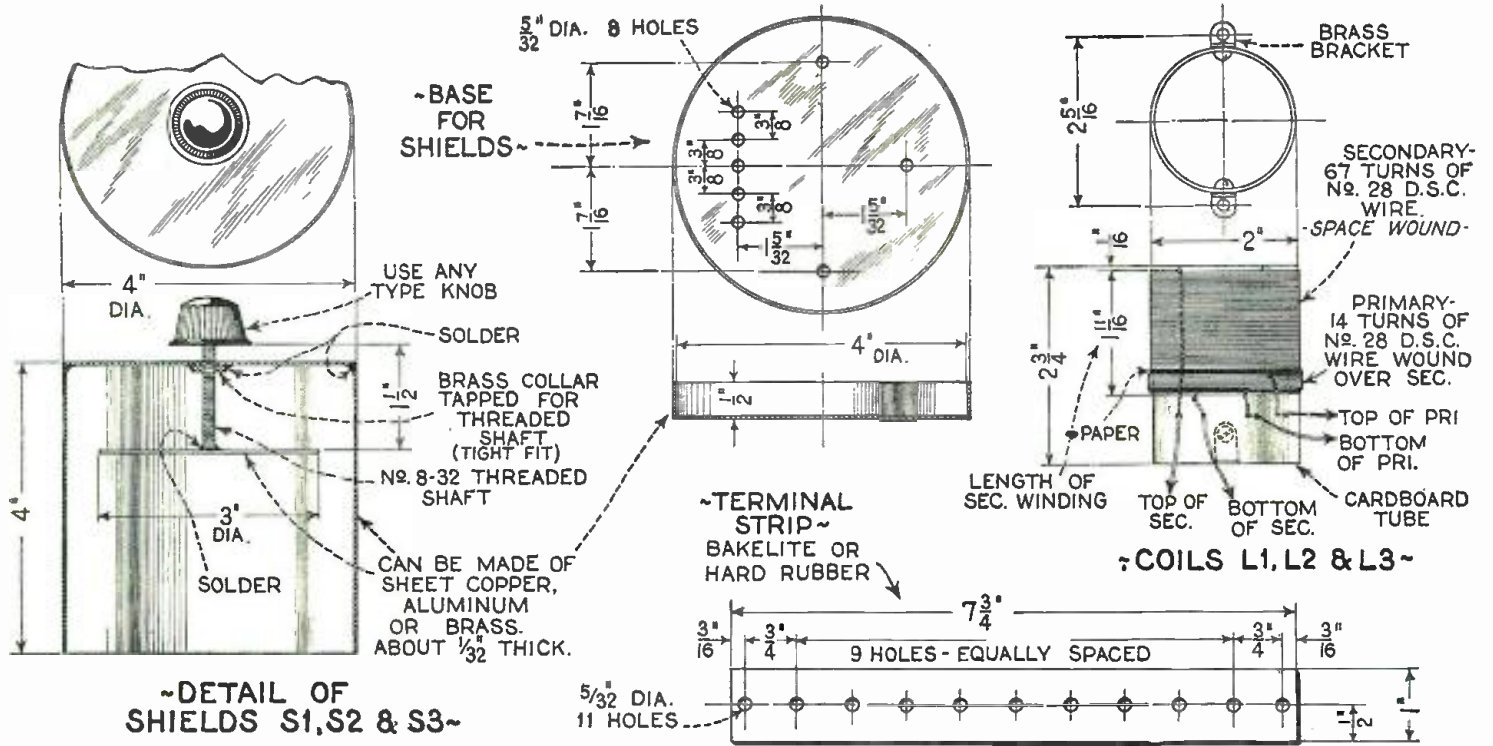

The constructional details for the "Peridyne" shields, R.F. transformers, and terminal strip. Great care should be exercised in the construction of these parts; as the first two mentioned are extremely important.

67 turns of No. 28 double-silk-covered wire, space-wound, which can be effected by using a silk thread between the windings. This silk thread can be taken away afterwards. The primary is wound beginning at the exact bottom of the secondary; there are

14 turns of No. 28 D.S.C. wire. The primary is wound on top of the secondary by interposing a piece of stiff bond paper. If you are enterprising enough to build your own cans, the dimensions are given in the illustration. They can be made of sheet

copper, zinc, aluminum or brass; if you make these yourself, you will probably use copper or brass, on account of the soldering. The brass collar should be tight enough so that the 8/32 threaded shaft will work without play. This is most important, as will be seen afterwards. The bottom of the can may be made similarly out of two pieces of brass or sheet copper. Dimensions are given for the movable shield, and little else need be said about this.

A most important consideration, however, is that the top part of the can must fit the bottom part tightly. If the fit is loose, a rattling noise will be heard in the loud speaker; for the reason that the shield is a condenser and, if there is play between the can and the bottom part, this will amount to a loose contact, and your set will be noisy. If, therefore, the shields do not fit tightly, this can be remedied by inserting pieces of tin foil between the tops and the lower parts, to make a good mechanical connection. You will then experience little trouble.

Of importance are rheostats R1, R2, and R4. R1 and R2 are Bradleystats, which are mounted on the sub-panel, and are never touched after the set is balanced. R4 should be a 30-ohm wire-wound rheostat, because the first audio amplifier tube is very often critical and works best only with the exact voltage. Choke L4 should be of 85 millihenries and is quite necessary for the operation of the set, to choke back any incidental radio-frequency currents which might be passed through the first audio amplifier tube and through the crystal detector in case the set is overloaded. The second and third audio amplifier tubes require no rheostats, but use amperites.

ADJUSTMENTS

After the set has been completely wired, you can begin to test. Remember first that the inductors must be connected right. If the set has been wired correctly, and no results are obtained, the chances are that either the secondary connections or the primary connections of the coils have been reversed. If they are connected as shown in the illustration, the arrangement is correct and no

SYMBOL	Quantity	NAME OF PART	REMARKS	MANUFACTURER *	
C1, C2, C3	1	Triple Var. Cond.	.0005 mf. each section	1	2
L1, L2, L3	3	R. F. Transformers	Special	3	
S1, S2, S3	3	Coil Shields	Special } special Peridyne units	2	
T1, T2	2	A. F. Transformers	3:1 ratio	3	9, 20, 21, 22, 23, 24
R1, R2	2	Rheostats	Carbon type	4	
R3	1	Variable Resistor	0-100,000 ohms	5	6, 12, 26, 36
R4, SW	1	Switch-Rheostat	30 ohms; combination instrument	6	12, 26, 35
A1	1	Amperite	5 volts, 1/2 ampere type	7	
A2	1	Amperite	5 volts, 1/2 ampere *	7	
D	1	Detector	Carborundum type	8	
L4	1	R. F. Choke	85 millihenries	9	2, 3, 23
C4	1	Fixed Condenser	.001 mf.	10	6, 22, 25, 26, 27, 28, 29, 33, 42
M1	1	Voltmeter	0-8 volts	11	30, 31, 23
M2	1	Voltmeter	0-150 volts	11	30, 31, 23
J1	1	Jack	Single circuit type	12	6, 26, 27, 28, 32, 36
SW1	1	Jack-Switch	Two circuit type (D.P.S.T.)	12	6, 26, 27, 28, 32, 36
	1	Vernier Dial		13	8, 23, 27, 32, 35
	5	Socket	UX type	24	1, 3, 23, 27, 28, 32, 33, 34
	4	Binding Posts		25	12, 15, 23, 27, 34
	1	Panel	7 X 24 X 3/16 inches	17	16, 40
	1	Sub-Panel	8 X 23 X 3/16 inches	17	16, 40
	4	Brackets	6 1/2 X 2 inches, hard rubber	17	27
	1	Battery Cable	With fuse, 7 wires	18	6, 12
V1, V4	4	Vacuum Tube	20L-A type	37	38, 39
V5	1	Vacuum Tube	112 type	37	38, 39
	1	Terminal Strip	7 1/2 X 1 X 3/16 inches	17	16, 40
	4	Rolls Hook-up wire	Black, Yellow, Red, and Green	19	18, 41

NUMBERS IN LAST COLUMN REFER TO CODE NUMBERS BELOW.

1 Ameco Products, Inc.	2 General Radio Mfg. Company	3 Silver Marshall, Inc.
4 Allen Bradley, Inc.	5 Central Radio Laboratories	6 Carter Radio Company
7 Radiall Company	8 Carborundum Company	9 Samsen Manufacturing Company
10 Aerovox Wireless Company	11 Jewell Electric Instrument Co.	12 Yaxley Mfg. Company
13 National Company, Inc.	14 Bestulm Elec. Mfg. Company	13 E. L. Radio Labs.
16 Nicarta Fabricators	17 American Hard Rubber Co.	18 Baltes Manufacturing Co.
19 Arma Wire Company	20 Thorngren Elec. Mfg. Company	21 American Transformer Co.
22 Sargamo Electric Company	21 General Radio Company	24 All-American Radio Corp.
23 Dubilier Condenser Corp.	26 Electrad, Inc.	27 Pilot Electric Co., Inc.
28 De Jur Products Company	29 Toke Deutchmann, Inc.	30 Weston Elec. Instrument Co.
31 Roller Smith Company	31 Pacant Electric Company	33 Electrical Research Lab. (E.R.L.)
34 R. H. Kby Mfg. Co., Inc.	35 Brooklyn Metal Stamping Company	36 Herbert Frost, Inc.
37 E. T. Cunningham, Inc.	38 Radio Corporation of America	39 C. E. Manufacturing Co. (CeCo)
40 Formica Insulation Company	41 Cornish Wire Company	42 Polymet Manufacturing Co.
43	44	45

* THE FIGURES IN THE FIRST COLUMN OF MANUFACTURERS INDICATE THE MAKERS OF THE PARTS USED IN THE ORIGINAL EQUIPMENT DESCRIBED HERE.

If you use alternate parts instead of those listed in the first column of manufacturers, be careful to allow for any possible difference in size from those originally used in laying out and drilling the panel and sub-base.

(Continued on page 678)

The Construction of the 9-Tube Super-Hilodyne*

Details of a Receiver Embodying New Circuits Possessing Exceptional Characteristics

By FRED A. JEWELL



The author tuning the Super-Hilodyne Receiver in the RADIO NEWS Laboratory.

should reduce to a minimum the amount of interference of any type, and yet receive broadcast signals efficiently. Something entirely new was a necessity, due to the congestion of wavelengths in large communities, as well as some circuit that would give as good reproduction on distant stations as on locals.

SOMETHING DIFFERENT DESIRED

In the development of the Super-Hilodyne circuit no attempt has been made to evade the patent situation, as it was found that many of the previously patented circuits are not capable of producing the results that the writer had in mind, as a goal towards which to work. For instance, in the case of the superheterodyne circuit, which would be ideal if it were not for the fact that it has a double beat-note, reception is oftentimes spoiled, due to the undesirable beat-note from a station that is not wanted. It is possible to add one or two stages of radio-frequency amplification before the set to overcome this condition; but, if this is done, the circuit becomes more complicated than ever. However, tuned radio-frequency has many faults of its own.

When this type of amplification is used it is necessary to introduce some means whereby oscillations are prevented and, in general, when this is done the circuit does not function efficiently over the entire waveband of broadcast stations. When steps are taken to keep the signal intensity equal over the waveband, additional means for preventing inter-stage coupling must be introduced if a high degree of amplification is desired. Generally when this is done by adding several stages of cascade coupling side bands are cut off, and distortion results. Unless gang condensers are employed to get maximum efficiency, each stage has to be individually tuned, which in turn offers more complications.

The Super-Hilodyne circuit is the result of a great number of experiments and, as already explained in the November issue of RADIO NEWS, it is something new. Not only

The Super-Hilodyne circuit has been pronounced, by Prof. Reginald A. Fessenden, the eminent radio inventor, unique and something that appears to be entirely new. It is extremely rare that a circuit can be called new in every sense of the word; for in the majority of cases it is a matter of dressing up an old circuit in new clothes.

Mr. Jewell, who is the developer of the Super-Hilodyne receiver and other radio devices, is an example of an amateur who has come into his own after years of experimenting. The rights to this circuit were sold to a manufacturer for a consideration that is almost without parallel in the history of radio; so here is another instance where it is again proved that manufacturers are ever on the alert for something new and good in the field of radio, no matter who develops the idea.

The article which appears in this issue of RADIO NEWS gives complete constructional data for the Super-Hilodyne receiver, which, incidentally, does not infringe on any of the radio patents that are receiving so much attention at this time. We heartily recommend this set to the readers of RADIO NEWS as one that should fulfill all the requirements of a first-class receiver.—EDITOR.

SINCE the advent of broadcasting, as we know it today, that great portion of the public which is interested in radio reception has been deluged with a multitude of so-called new circuits. They have been given fancy names, but the old adage at once comes to mind, "What's in a name?" And this is certainly true in the case of the majority of radio receiving circuits; for, when they are closely analyzed, it is found that each can be resolved into one of a limited number of fundamental circuits.

For example, let us consider a circuit which has been announced under some high-sounding title. Scattered throughout the diagram are most likely many coils, condensers and resistors. When these are eliminated and the circuit is stripped of its unessentials, the chances are that it will be found to be something of more or less ancient vintage, like the regenerative or the Reinartz circuit. The cause of this is that it is generally easier to take a well-known fundamental circuit and make improvements in it than to start out with a novel idea and develop that into some new system of reception.

Some time ago the writer did quite a bit of experimenting along the line of interference eliminators and reducers. After numerous experiments had been performed and the impracticability of the effort proved, it was decided to work upon a circuit that

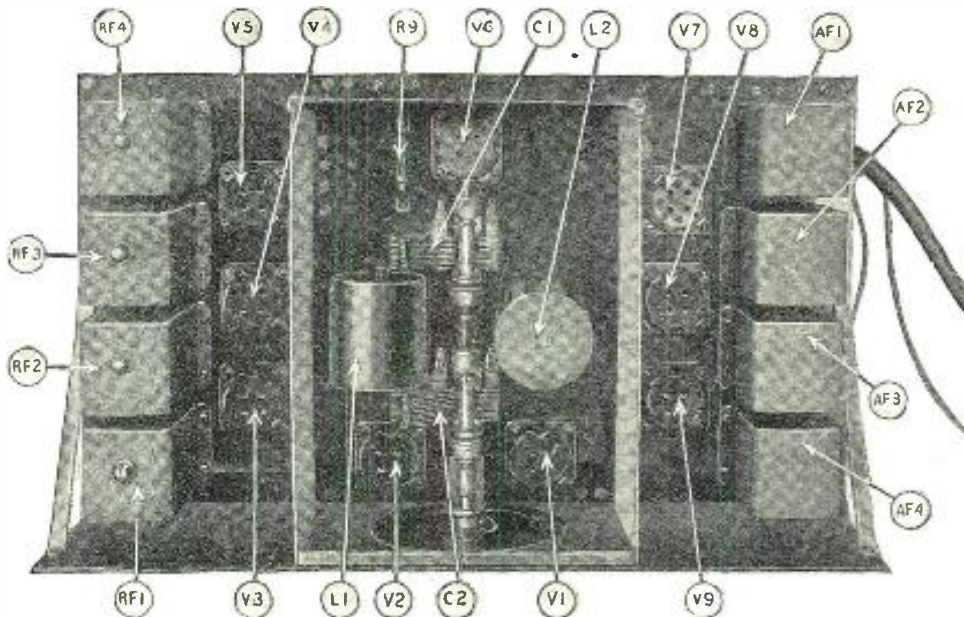

Fig. A. The top portion of the shield has been removed in order to show the tuning portion of the Super-Hilodyne Receiver. The cover has been removed from the adjusting screw of the resistor in the radio-frequency unit, RF1.

* RADIO NEWS Blueprint Article No. 38.

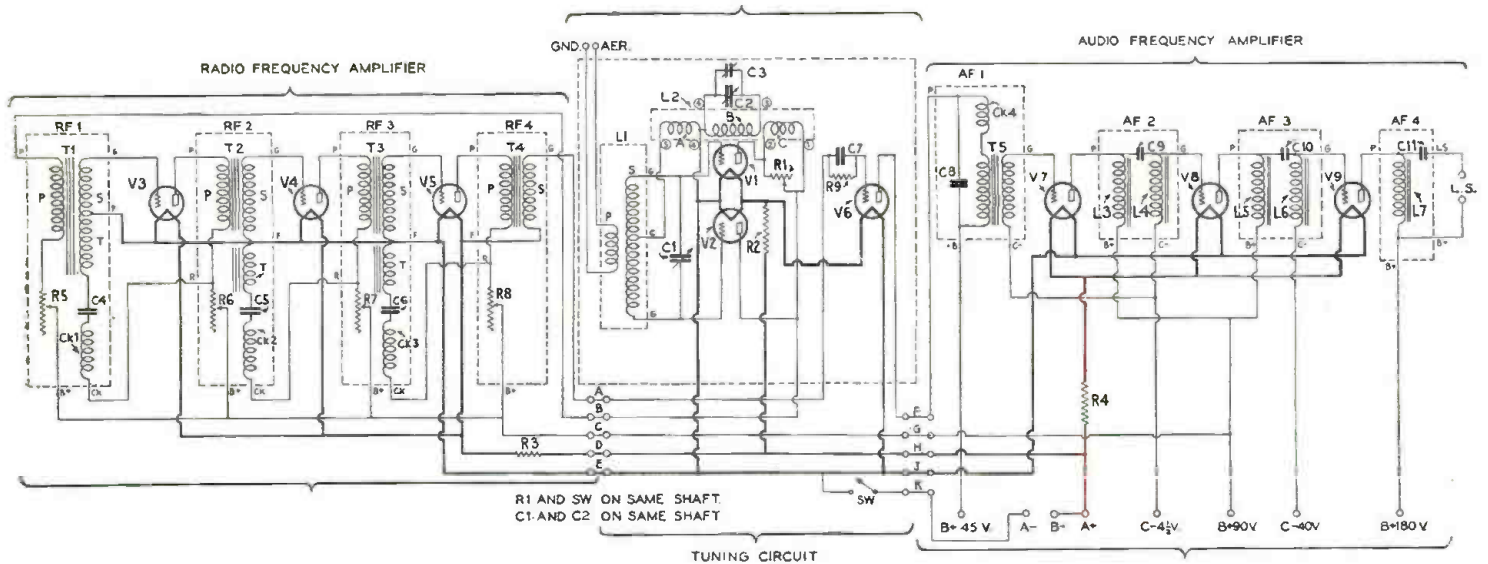

Fig. 1. The schematic diagram of the Super-Hilodyne is laid out to correspond with the arrangement of parts as shown in the sketch below.

can the electrical portion of the circuit be so designated, but the method of construction has been simplified to the greatest possible extent, as will be explained later in the article.

THE TUNING CIRCUIT

In the center of the schematic diagram (Fig. 1) may be seen the two tubes, V1 and V2, which are connected in push-pull. Let us consider the path followed by a signal after it is picked up in the antenna circuit L1. The variable condenser C1, which is in shunt across the secondary S of L1, tunes this circuit; and each side of the condenser is

connected to the grid of one of the push-pull tubes.

An incoming signal charges the grids of the tubes, V1 and V2, negatively and positively alternatively. When the grid of V1 is positive the grid of V2 is negative, and *vice versa*. When the grid of V1 is negative this will cause a drop in the plate current of that tube and the opposite effect will take place at the same instant in V2 with an increase in the plate current in the same proportion. Now, if the coil C is short-circuited by the resistor R1, the flow of current at the point X, will be always the same; as the plates of V1 and V2 are in parallel

just opposite to the input circuit. In other words this circuit is neutralized, as signals of all frequencies are balanced out.

If we were to allow the circuit to remain in that form it would be useless as a receiver. However, on further consideration it will be seen that a variation of current exists between the plate of each tube and the point X. Therefore, on connecting the coil C in series with the plate of V1, we have a variable signal flowing in this coil, if the resistor R1 is opened. The coil B, which is shunted by the variable condensers, C2 and C3 (the latter being a vernier) is tuned to the frequency which it is desired to get through

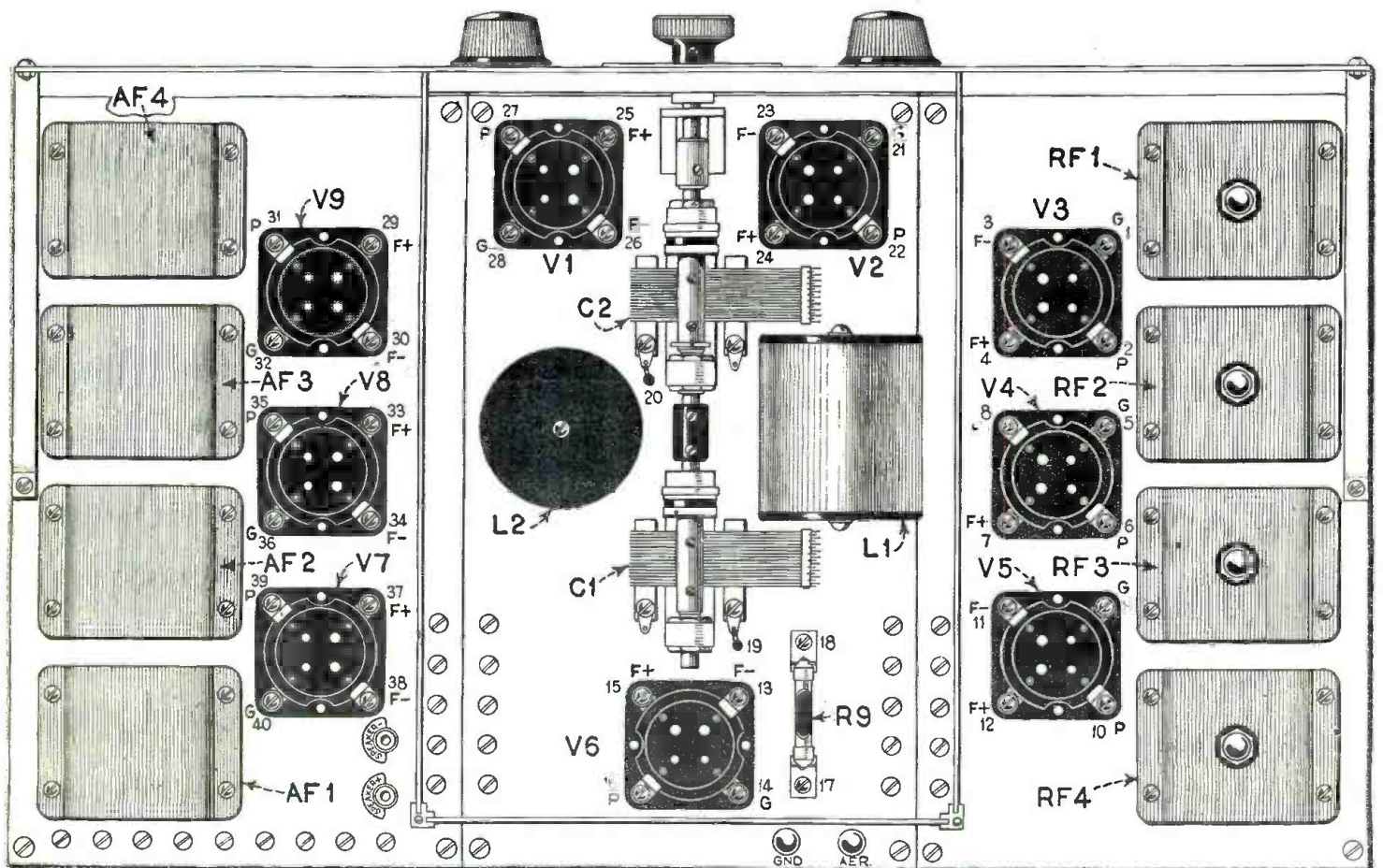

V1 and V2 are the push-pull tuner sockets; V3, V4 and V5, the R.F. sockets; V6, detector; V7, V8, A.F. sockets; V9, power amplifier socket; RF1 to RF4, Hilograd units; AF1, R.F. filter and transformer; AF2 and AF3, dual-impedance units; AF4, output filter; C1 and C2, variable condensers; and R9, grid leak. Components have the same symbols in all illustrations.

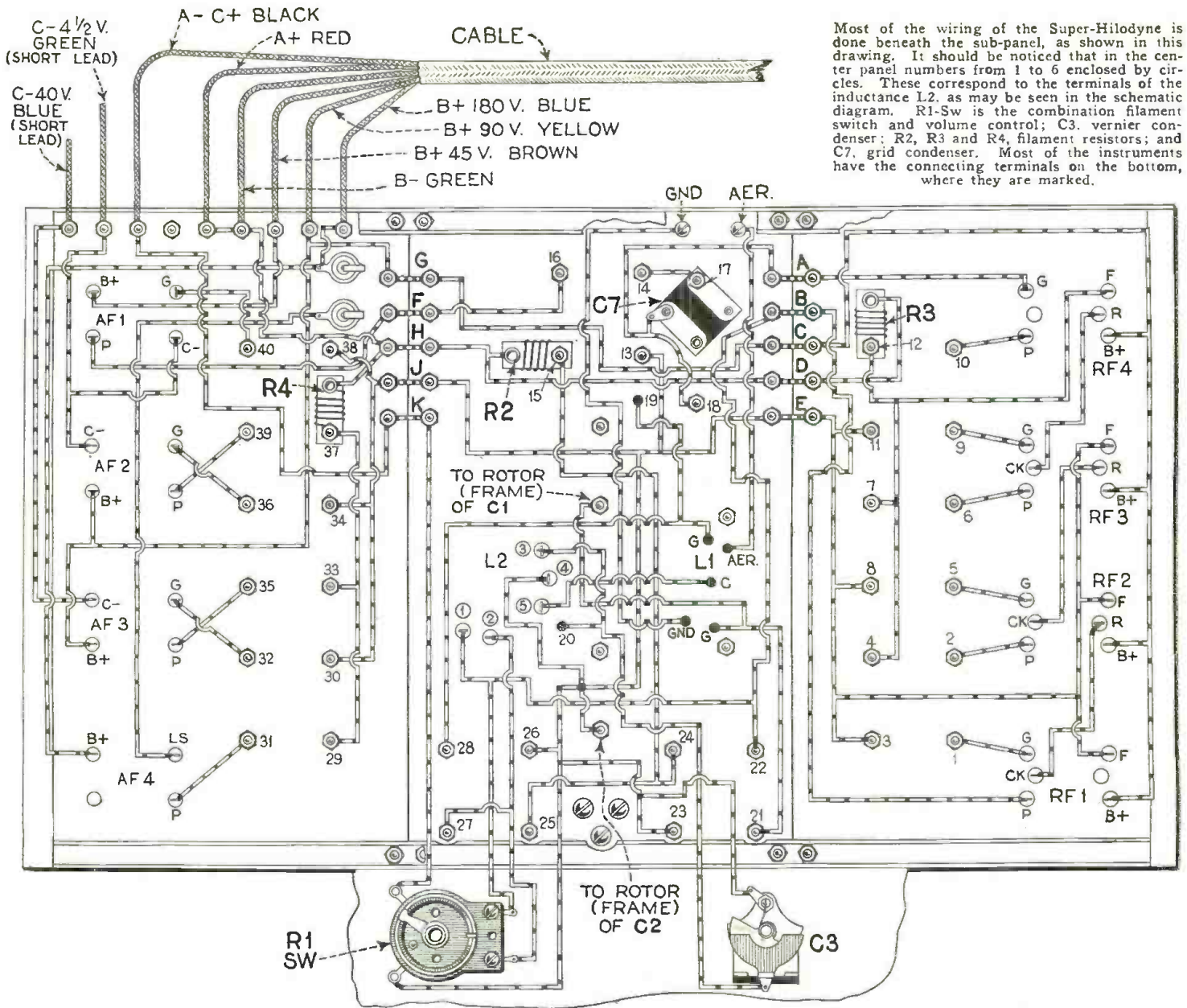

Most of the wiring of the Super-Hilodyne is done beneath the sub-panel, as shown in this drawing. It should be noticed that in the center panel numbers from 1 to 6 enclosed by circles. These correspond to the terminals of the inductance L2, as may be seen in the schematic diagram. R1-Sw is the combination filament switch and volume control; C3, vernier condenser; R2, R3 and R4, filament resistors; and C7, grid condenser. Most of the instruments have the connecting terminals on the bottom, where they are marked.

to the loud speaker, and all others are cancelled out. This desired frequency is picked up by the coil A and charges the grids of the two tubes in the phase just opposite to that of the current picked up in the antenna coil. In this way the grid of V1 is reinforced by the current transferred through the coil system, A, B and C, while the grid input of V2 is balanced out, thereby causing no current flow from its plate to the point X, no matter to what frequency B is tuned. Therefore an amplified current, at whatever fre-

quency is passed by coil B and its attendant condensers, flows in the primary of the radio-frequency transformer RF1; while all the other signals are cancelled out.

THE INTERMEDIATE RADIO-FREQUENCY AMPLIFIER

After the signal has passed through the tubes V1 and V2 it leaves the center panel (See Fig. 1) and goes to the left to the input of the intermediate radio-frequency amplifier. The Hilograd system of amplification (which has given such great satisfaction

in the six-tube receiver described in the November issue of RADIO NEWS) is one that is untuned and in which there is little danger of cutting off any of the sidebands.

The four radio-frequency transformers, RF1, 2, 3 and 4, are untuned and give high amplification between 220 and 300 meters. In order to eliminate oscillations, resistors are placed in the primaries of these transformers. These resistors are so adjusted that the R.F. amplifier operates just below the point of oscillation, making it function

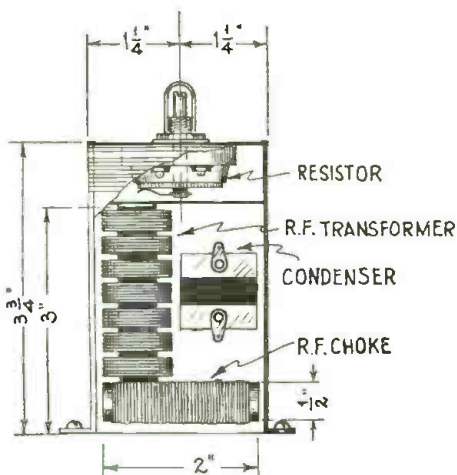

At the left is a sketch, Fig. 2, of the interior of one of the radio-frequency units, the different parts being indicated. At the right is a view, Fig. B, showing the underside of the sub-panels of the Super-Hilodyne. As may be seen in the drawing on the opposite page, each unit is built on a separate sub-panel and these connected by the ten jumpers, A to K, in the drawing above. It might appear, on first glance, that the wiring is rather complex; but in reality there are comparatively few connections that must be made, because of the wiring already done in the interior of the A.F. and R.F. units.

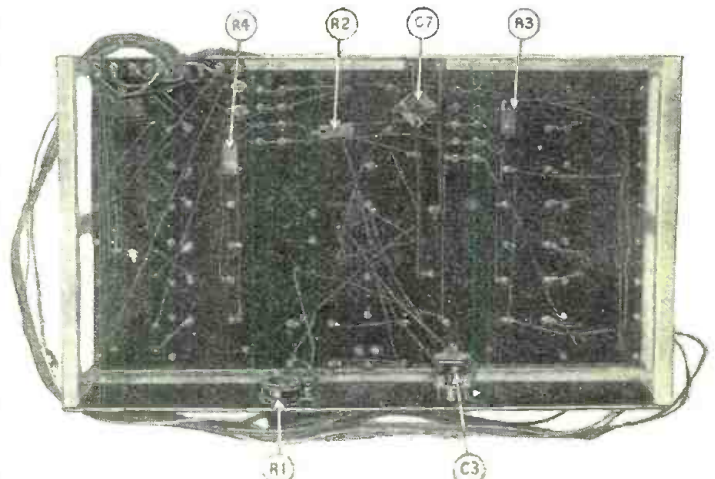

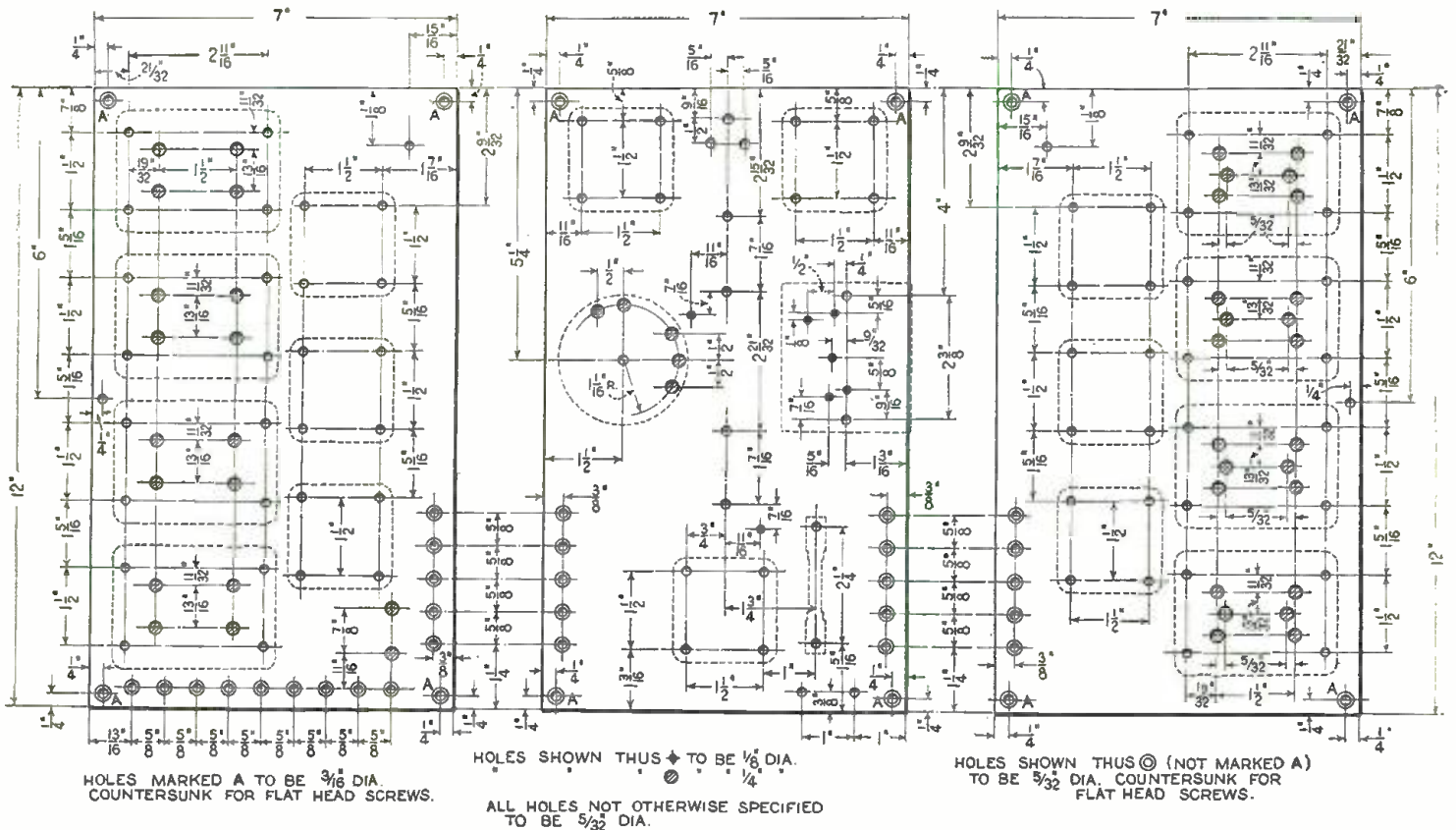

The drilling of the three sub-panels is clearly detailed in the above drawings, which also carry outlines of the components for which the holes are drilled.

most efficiently within the wavelength band mentioned above. As the amplification factor begins to drop off, above 300 meters, a portion of the plate current is fed back to the grid circuits through the radio-frequency chokes, CK1, 2 and 3. This current is forced through these chokes and the condensers, C4, 5 and 6, to the coils, T and thence to the filaments or ground. This is because these chokes have a lower impedance than the resistors at the lower frequencies, or higher wavelengths.

The impedance of a choke coil drops when the frequency is lowered; therefore, the increase of current fed back to the grid circuit is in proportion to the drop in frequency. As the coil T is coupled through the secondary of the radio-frequency transformer, we have an electrically automatic form of regeneration that compensates for the drop in amplification at the higher wavelengths; and therefore keeps the amplifica-

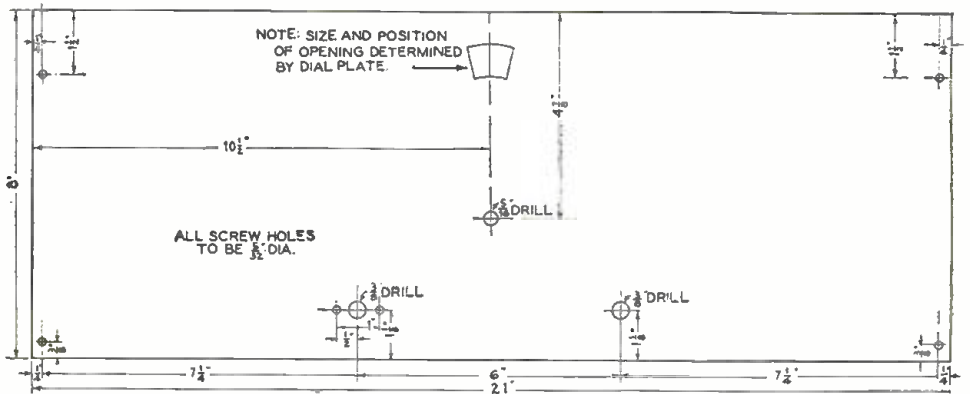

The drilling details for the front panel, which is composed of special laminated iron. This style of panel is employed, mainly because of its shielding properties, in connection with the tuning unit on the center sub-panel.

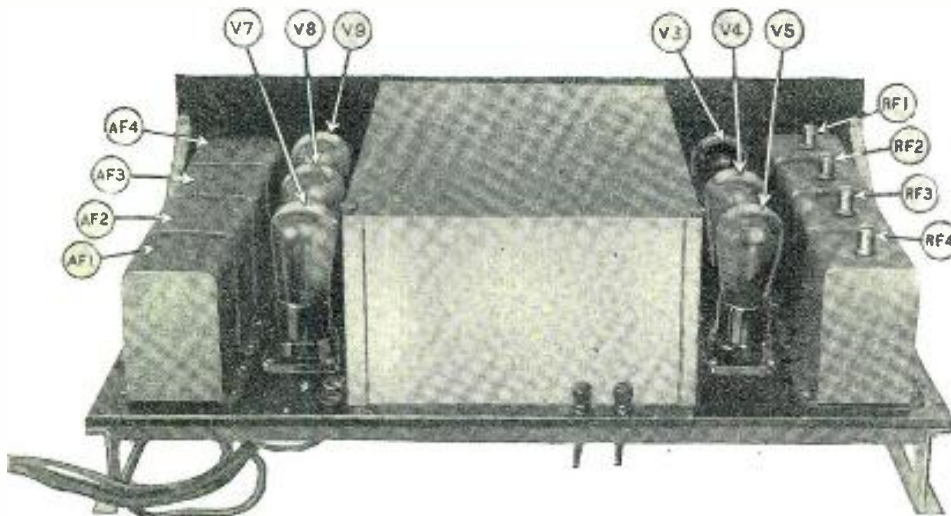

Fig. C. The rear view of the Super-Hilodyne receiver, which shows the Aerial and Ground binding posts and the place at the rear of the sub-panel from which the battery cable comes.

tion factor at its highest efficiency over the entire broadcast wave band.

THE AUDIO-FREQUENCY AMPLIFIER

From the output of the radio-frequency amplifier, at the left, the signal returns again to the center panel where it is rectified in the detector tube, V6. From the plate of this tube it goes to the right-hand panel, on which is located the audio-frequency amplifier, which embodies the dual-impedance system of coupling that has been developed by the writer.

This type of audio-frequency amplifier has several advantages. One of these is that, by placing the audio transformer in the first stage, where the signal is weakest, and the impedances in the following stages, the resulting signal is stronger and less distorted than is usual. The high and low frequencies are amplified with equal intensity because of the large values of the condensers, and because the values of the inductances are staggered, one being high and the next being low.

In the output of the last stage of the am-

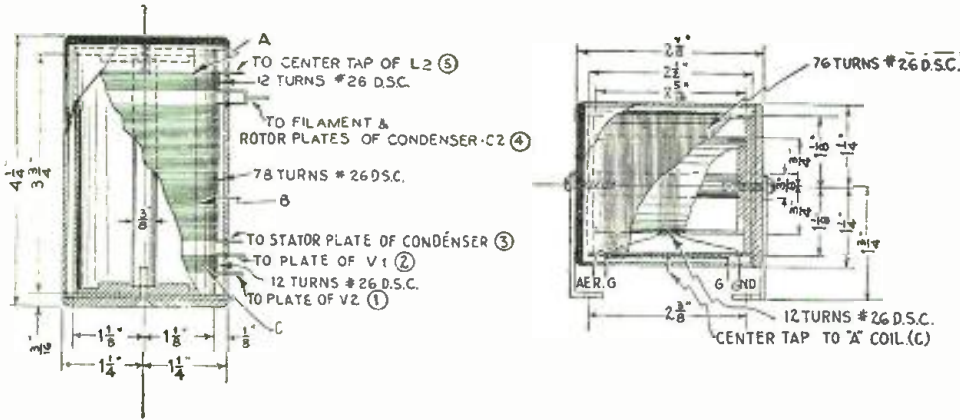

Fig. 3. The construction of the inductors, L1 and L2, in the tuning unit. The numbers in circles indicate the terminals and are likewise shown in the wiring diagram on page 627.

plifier, in which a power tube is employed to prevent any distortion, is an audio-frequency choke coil L7 and a condenser C11. These are placed at this point so that no high voltage can get into the windings of the loud speaker. A similar system, CK4 and C8, is used at the input of the audio-frequency amplifier to keep the radio-frequency currents from entering the primary of the audio-frequency transformer AF1.

CONSTRUCTION OF THE RECEIVER

From an inspection of the receiver as shown in the accompanying illustrations, it will be seen that the tubes, V1, V2 and V6 (the push-pull tubes and the detector respectively) are located within the shielded portion, in which are also the two variable condensers C1 and C2 and the two systems of coils used in the tuning circuit. On the left panel of Fig. A are the three radio-frequency amplifier tubes together with the shields enclosing the transformers, chokes, condensers and variable resistors. On the right-hand panel is mounted the audio system with its three tubes, the one nearest the front panel being the power tube, V9.

In Fig. B (the bottom view of the three sub-panels) the very few wires necessary are clearly shown. On the front panel, which is of metal, are mounted the combination volume control and filament switch (R1 and Sw) and the vernier condenser C3. On each of the three sub-panels is mounted a specially-wound resistor which takes care of the filament current to all the tubes on that panel. The grid condenser is mounted immediately under the grid leak in the center panel.

In the lower right hand corner of Fig. B are the eight outlets for the battery leads, which are connected to a cable. As the sub-panel is in three sections, it becomes necessary to support them at the rear of the set as well as along the sides. A special rear bracket is provided with spaces which allow the antenna and ground terminals, as well as the cable terminals, to be placed at the rear out of the way.

UNIT ASSEMBLY

As previously mentioned, the receiver is composed of three separate units: the tuner and detector, the radio-frequency amplifier, and the audio-frequency amplifier. Each unit is built up separately and then the three are assembled on the brackets and front panel. The wiring is done in the main part under the sub-panel and each unit can be wired before mounting on the brackets. They can then be connected together by the ten short jumpers lettered from A to E and from F to K in Fig. 1.

It is easily understood that such a method of procedure is extremely simple. If it is so desired, the constructor can assemble the instruments of the sub-panels himself; or he can obtain the three units wired ready for assembling on the brackets and front panel.

In Fig. 2 is shown how the different components are placed within the shields in the radio-frequency amplifier. On one side is the radio-frequency transformer, with the choke coil and condenser on the other. In a small compartment in the top of the shield is placed the variable resistor which is in series with the primary of the transformer.

In the audio amplifier, the two impedances are placed perpendicular to the base of each unit, with the condenser standing vertically at the side.

The variable condensers C1 and C2 are dissimilar in capacity, as it was necessary to add one plate to C2, making the number of plates on C1 seventeen and on C2 eighteen. The reason for this departure from the usual custom is that the vernier condenser C3 is thereby made more effective in its functioning as a fine adjustment for tuning.

The two coils in the antenna coupler L1 are wound on forms 1 1/2 and 2 1/4 inches in diameter, the primary P having 12 turns and the secondary S 76 turns tapped at the 39

turn. These are wound with No. 26 wire. In the systems of coils in L2, A has 12 turns, B has 78 turns and C 12 turns of No. 26 wire wound on a form 2 1/4 inches in diameter. Each of these groups of inductors is enclosed in a cylindrical cover, and they are mounted at right angles to each other on the middle panel.

ADJUSTMENT AND OPERATION

After the connections have been made and the various circuits tested to see that they are correct in every detail, insert eight 201-A tubes in the sockets, V1 to V8 inclusive. In the last socket V9 is placed the power tube with the appropriate negative grid-biasing voltage connected to the lead provided for it. The loud-speaker connections are plugged into the tip jacks at the rear of the sub-panel on which is mounted the audio-frequency amplifier. The aerial and ground connections are made to the binding posts at the rear of the set. The aerial should be between 100 and 125 feet in length.

It is, first of all, necessary to adjust the resistors in the radio-frequency amplifier; when these adjustments have been made the dust-proof caps are replaced over the slotted shafts. The procedure of adjustment is as follows: a station that operates on a wavelength in the neighborhood of 480 or 500 meters is tuned in and the resistors on the top of the shields enclosing the radio-frequency units are varied in turn until all howls are eliminated from the signals. For example, let us follow the adjustment of the resistor R6. A point will be found, by turning the shaft to the left, at which the squeals in the loud speaker just stop; which means that the particular stage is operating just under the point of oscillation on the high wavelengths. Each of the stages is adjusted in the same manner.

(Continued on page 656)

SYMBOL	Quantity	NAME OF PART	REMARKS	MANUFACTURER *
L1	1	Variocoil	Tapped antenna coupler (special)	1
L2	1	Hillocoil	Coils A, B and C in one unit (special)	1
C1	1	Var. Condenser	18 plate - .00037 mf. (special)	1
C2	1	Var. Condenser	17 plate - .00085 mf. (in tandem with C1)	1
C3	1	Widget Condenser	9 plate (special)	1
R1, Sw	1	Switch-Resistor unit	0 - 5,000 ohms	1 6
RP L4	4	Radio-Frequency unit	One set Hillocrad units (special)	1
AF 1	1	Audio-Frequency unit	A.F. transformer, choke and condenser	1
AF 2-3	2	Audio-Frequency units	Double-impedance couplers	1 13, 14
AF 4	1	Audio-Frequency unit	Output filter	1 12, 15
R2, R3, R4	3	Ballast Resistors	5 volts - .75 amperes	1 2, 3, 12, 16, 17, 18
R8	1	Grid Leak	1 to 3 megohms	1 2, 3, 12, 16, 17, 18
C7	1	Fixed Condenser	.00025 mf. (grid condenser)	1 4, 6, 12, 17, 18, 19
	9	Sockets	UX type	1 5, 7, 8, 13, 15, 18
	1	Vernier Dial	Special	1
	1	Shield Cover	Special	1
	1	Front Panel	Laminated iron 8 X 21 X 1/8 inches	1
	3	Sub-Base Panels	7 X 12 X 1/2 inches each	1 9, 10, 11
	1	Battery Cable	6 wire	1 6
	2	Braces	For sub-base panels	1
	2	Brackets	For chassis mounting	1
	2	Binding posts		1 5
	2	Phone tip jacks		1 6
	1	Condenser coupling	Couples C1 and C2	1
	8	Vacuum Tubes	201-A type	20 21, 22
	1	"	171 type	20 21, 22

NUMBERS IN LAST COLUMN REFER TO CODE NUMBERS BELOW.

1 Algonquin Elec. Co., Inc.	2 International Res. Co. (Durham)	3 Daven Radio Corporation
4 Dabiller Condenser Corp.	5 H. H. Fay Mfg. Company	6 Corrier Radio Chassis
7 Herbert H. Frost, Inc.	8 Benjamin Electric Company	9 Amer. Hard Rubber Company
10 Micarta Fabricators	11 Formica Insulation Company	12 Leslie F. Vuter Company
13 General Radio Company	14 Ford Mica Company, Inc.	15 Electrical Research Lab. (FRL)
16 Arthur Lynch, Inc.	17 Polymet Manufacturing Co.	18 Amco Products, Inc.
19 Sangamo Electric Company	20 C. E. Manufacturing Co. (CoCo)	21 Radio Corporation of America
22 E. T. Cunningham, Inc.	23	24
25	26	27

* THE FIGURES IN THE FIRST COLUMN OF MANUFACTURERS INDICATE THE MAKERS OF THE PARTS USED IN THE ORIGINAL EQUIPMENT DESCRIBED HERE.

If you use alternate parts instead of those listed in the first column of manufacturers, be careful to allow for any possible difference in size from those originally used in laying out and drilling the panel and sub-base

A Conveniently-Adjustable "B" Power Unit*

Adapted Especially for the Use of the Experimenter in Obtaining Optimum Results

By JOSEPH RILEY

POWER TRANSFORMER SHIELDING

The transformer which is selected for use in a "B" power unit must be so designed that, when it is in operation, its core laminations will not produce a 60-cycle hum, which is usually the result of loose assembly. The better types of transformers now available overcome this difficulty, not only by clamping the core-pieces substantially together, but by imbedding the entire transformer assembly in a wax compound. Of necessity, the transformer must be enclosed in a metal can, which acts as a shield, to prevent the lines of electromagnetic force set up by its wind-

THE significant feature of this very efficient "B" socket-power unit, which will commend it especially to the reader, is the fact that the voltages at the detector and R.F.-amplifier taps may be varied to the heart's content without affecting that at the "B+90" which serves the audio tubes. The latter is kept constantly at its rated value, irrespective of changes in the load, by a "glow-tube" which serves as an automatic ballast in its circuit. The unit is easy to construct, and will supply adequate plate current for any standard receiver; providing also, when desired, filament (A.C.) current for a large power tube in the last stage—an important adjunct in the search for highest quality in reproduction.—EDITOR.

ered when designing for home construction a representative type of "B" power supply device which incorporates the most up-to-date features permitted by present-day standards of components. In other words, rather than to present arbitrarily a list of the parts which enter into the construction of any one type of "B" power-supply unit, it is its purpose to discuss the various requirements of the several parts employed, and the device as a whole, and then to describe the mode of assembly which is most satisfactory.

In general, "B" power circuits may conveniently be divided into three parts: first, the transformer-rectifier unit; second, the filter unit, and finally the voltage-divider unit. Under the first classification come the transformer, which steps up the house current to a

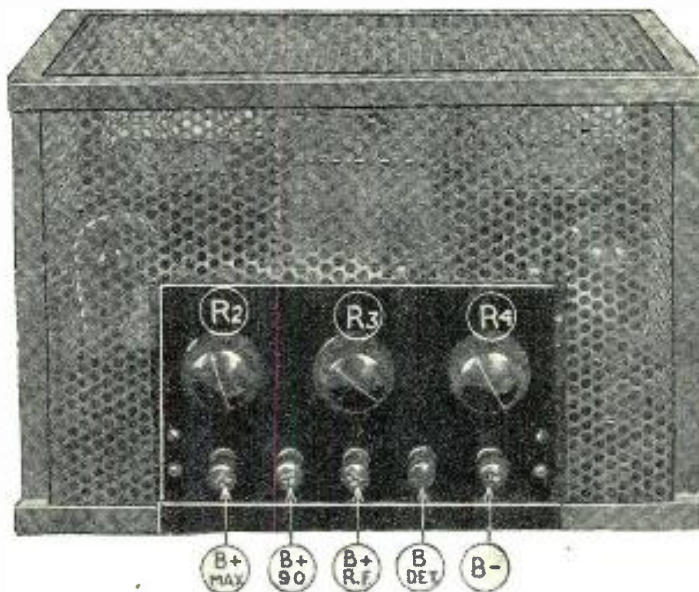

The front view of the socket power unit. The terminals shown below the resistor controls are those connected to the receiving set.

IT is quite customary for an author, when describing the fine points of something which he has built, to launch immediately into a discussion of the mechanical and assembly features involved. Rarely does he take the reader into his confidence concerning the whys and wherefores which have prompted him to decide upon the definite type of construction, or the use of the particular parts which finally go to make up the finished product.

This is true especially of "B" power-supply units: for, heretofore it has usually been taken for granted that, because of the very slight deviation from the accepted fundamental circuits which are employed in such units, there is little or nothing to tell, beyond a description of the mode of assembly, and perhaps a few pointers on the wiring. While it is true that we might be able to get along with such condensed constructional descriptions, they are, nevertheless, only part of the story.

This article endeavors to acquaint the reader with all the facts that were consid-

ered when designing for home construction a representative type of "B" power supply device which incorporates the most up-to-date features permitted by present-day standards of components. In other words, rather than to present arbitrarily a list of the parts which enter into the construction of any one type of "B" power-supply unit, it is its purpose to discuss the various requirements of the several parts employed, and the device as a whole, and then to describe the mode of assembly which is most satisfactory.

ings from interfering with nearby pieces of apparatus. There has been manifest recently a trend toward the combining of the audio amplifier of a radio receiver with the "B" power-supply device. Where such a construction is attempted, shielding attains special importance; as there is a possibility of the audio units picking up the 60-cycle disturbance, when the transformer is not suitably enclosed. The grounding, not only of the center-taps of the several transformer windings, but of the transformer can itself, is highly desirable and constitutes an additional safeguard against unstable operation.

THE RECTIFIER

As to the rectifier element, there are several types which may be employed; but special attention is directed to the new gaseous tube which will satisfactorily handle currents up to and including 125 milliamperes. This is an important item, because the use of this tube in "B" power-supply devices enables the owner of a multi-tube receiver to "power" it from the lamp-socket without the probability of operating the power unit at its limit of handling capacity.

With the usual five- and six-tube sets, this reserve power, which constitutes a large margin of safety, makes for an unusually stable receiver with little chance for overtaxing the output limitations of the "B" power-supply device. So much for the transformer-rectifier section.

FILTER CIRCUIT

The filter section, that part of the "B" power-supply device which directly follows the transformer-rectifier section, has as its

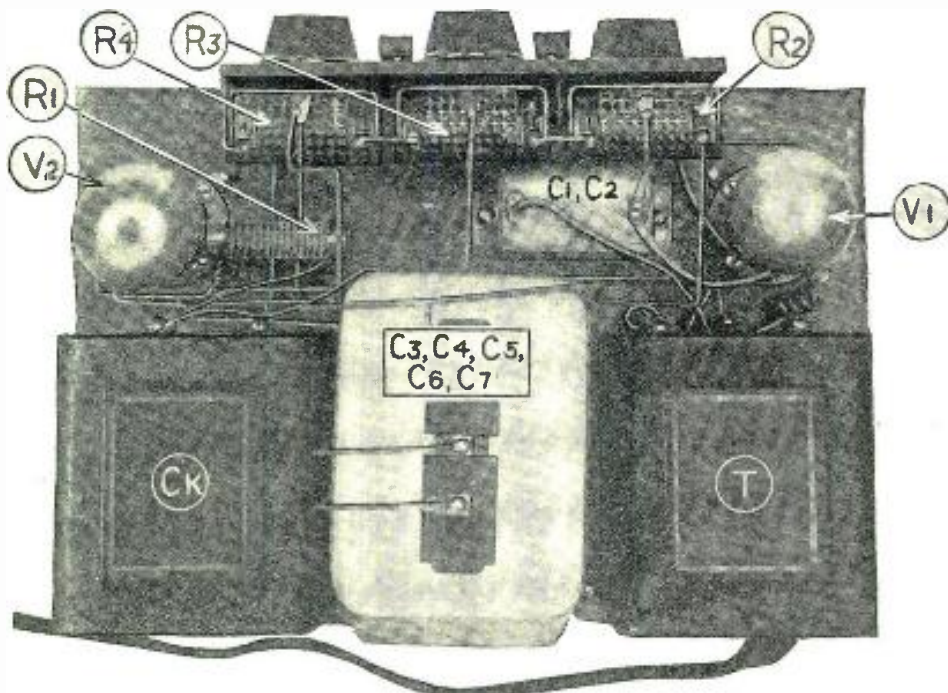

T is the power transformer; CK, the choke; C1-C2, 0.1 mf. condensers; C3 to C7, filter-condenser block, R1, fixed resistor, 50,000 ohms; R2, R3 and R4, variable resistors; V1, rectifier; V2, voltage regulator.

* RADIO NEWS Blueprint Article No. 39.

main function the smoothing out of the pulsations or ripples which exist in the current as it comes from the rectifier tube. The filter consists of a combination of choke coils and condensers, the chokes acting as a smoothing agent and the condensers functioning in the dual capacity of smoother and storage tank. It is the business of the chokes to retard or impede the series of pulsations manifested in the direct current delivered at the rectifier output. At the same time the chokes must not have a high direct-current resistance; otherwise there would be too great a reduction in the voltage available for use at the power-supply output.

The use of a rectifier tube such as the new 125-milliamperer gaseous type imposes certain requirements on the apparatus used in the filter circuit. First, the chokes must contain plenty of iron in the core; that is, the core must be quite "husky." Second, the coils must be wound with heavy wire, so that they will not offer too great a D.C. resistance. The air-gap of the core must be such that the chokes will pass satisfactorily 100 milliamperes of current without saturating the iron. The chokes (two are employed) may be assembled in one container, and should be enclosed in a metal shield for the same reasons as in the case of the transformer.

GOOD CONDENSERS NEEDED

The condensers composing the storage tank of the filter circuit must meet certain

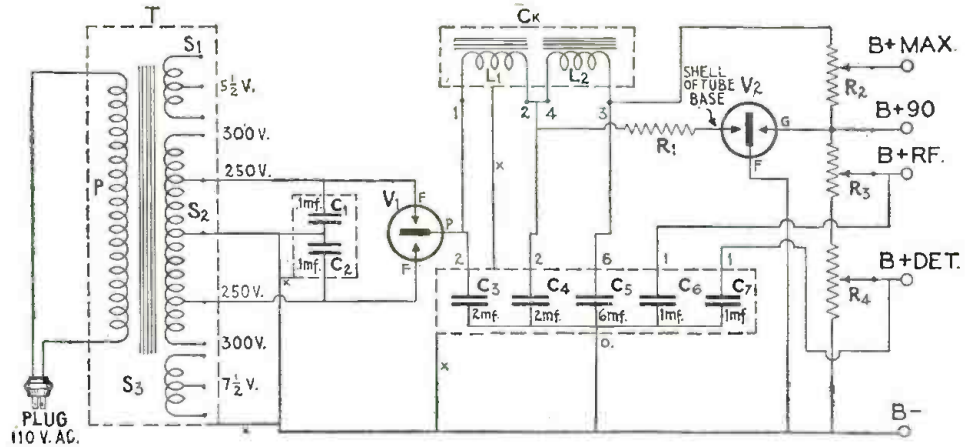

The schematic diagram of the "B" socket-power unit, using a full-wave rectifier tube and a voltage-regulator for the 90-volt tap.

requirements which fix their practical worth. First, they must be of the proper capacity; that is, the several condensers contained in the block must not be lower in capacity rating than the label on its front indicates. The only way to be sure that the condensers finally selected are satisfactory in this respect is to purchase units which have made a reputation for themselves and which are in every way entirely reliable. Second, these condensers should be of a voltage rating

which makes them satisfactory for the particular type of "B" power supply in which they are to be employed. This factor depends largely upon the transformer which is selected to work with the type of rectifier tube employed.

For instance, in some filament types of rectifier tubes only a 300- or 400-volt secondary winding on the transformer is needed, because the rectifier system is of the half-wave type. However, when the tube under

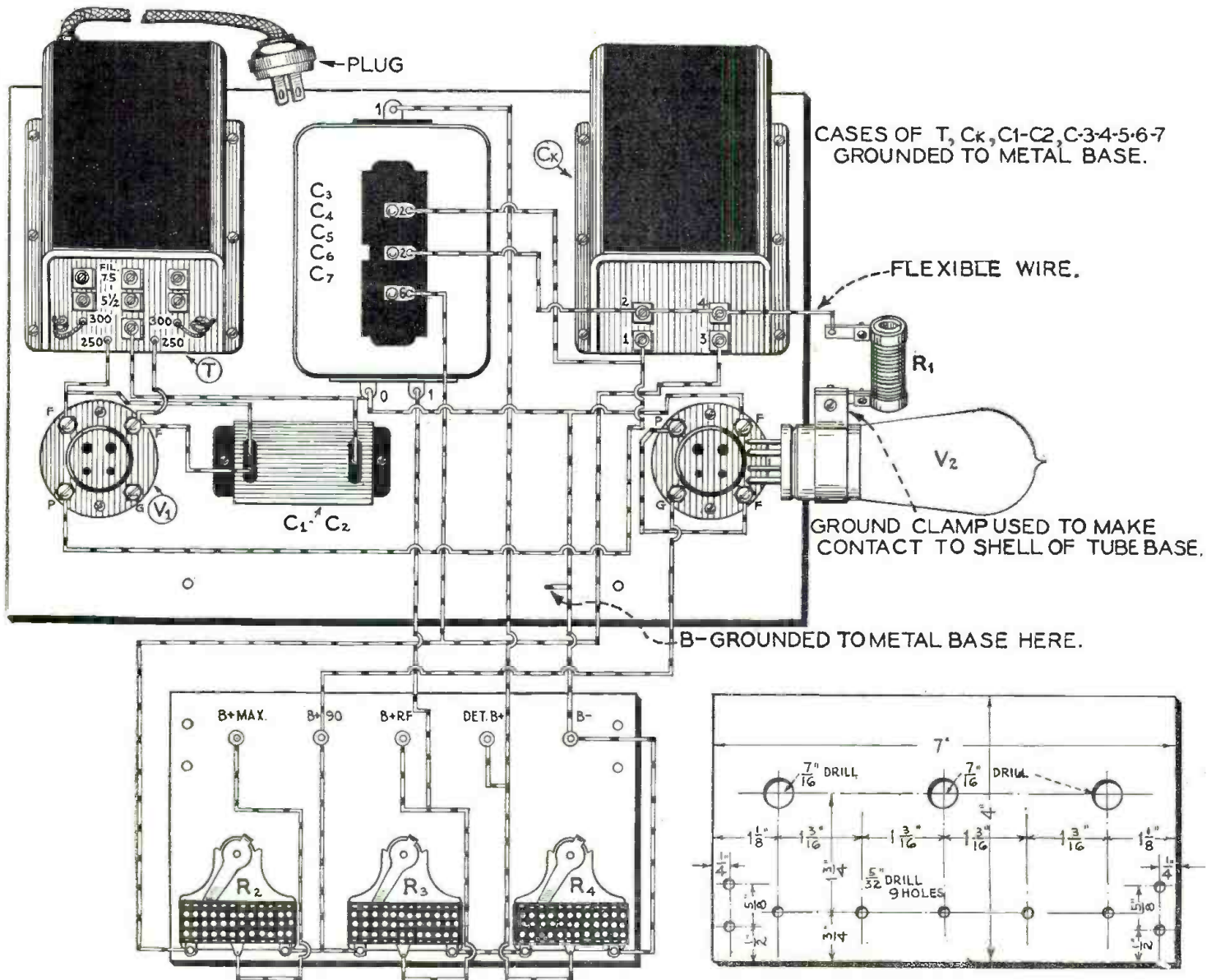

The wiring diagram of the complete "B" socket-power unit. The three resistors, R2, R3 and R4, are mounted on the rear of the seven-inch insulating panel, the drilling layout of which is diagrammed in the lower right corner.

discussion is employed as the rectifier in a full-wave circuit, then the transformer necessarily must have a higher secondary-voltage output, usually in the order of 500 or 600 volts. Since the voltage drop across the rectifier tube is only slight (a mere fraction of the output voltage of the transformer sec-

The arrangement of the apparatus on the sub-panel is illustrated at the right, with all necessary dimensions.

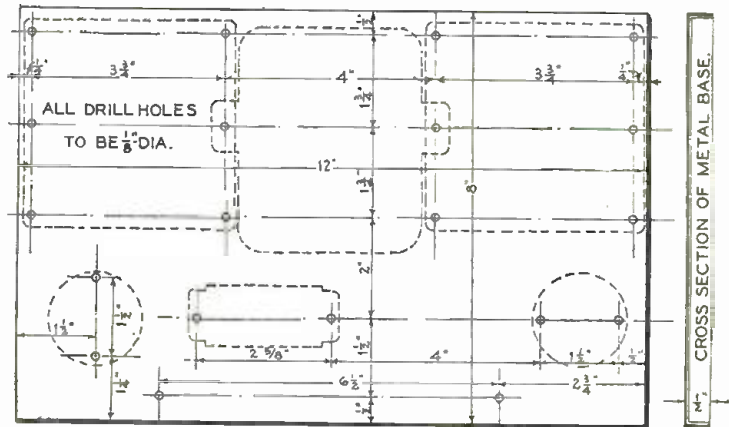
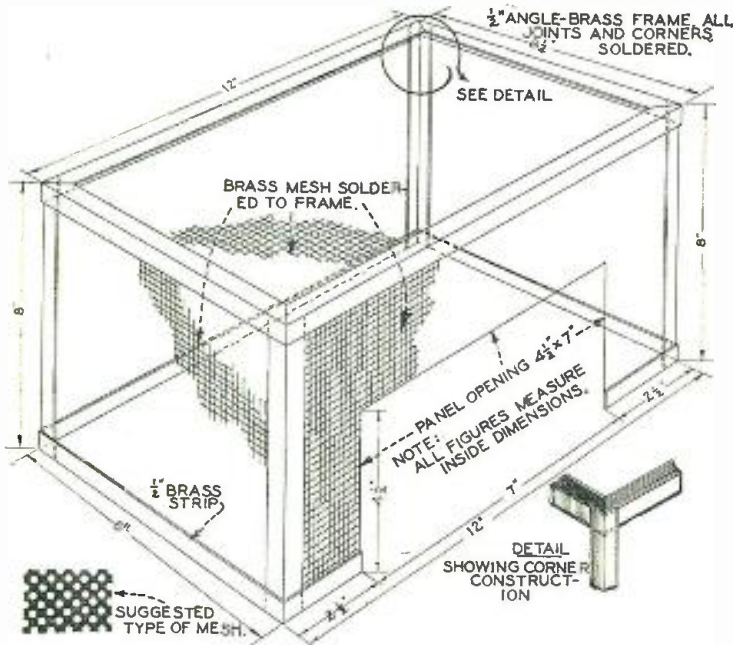

ondary), it is well to choose filter condensers which are rated at a working voltage either equal to or in excess of the transformer's secondary-voltage output. This is a particularly important point; because if a poor make is selected it is quite probable that such a filter unit will be short-lived. One or more of the sections may break down, making them useless and endangering the others.

heretofore been found in regulator tubes, there is incorporated in this type a third or "keep alive" element and its associated circuit. The complete "keep-alive" circuit is unique in that it consists of a tube within a tube; the inner one is operated from a point of high voltage off the filter circuit at no-load and keeps the gas within the tube in an ionized state. If, for any reason, the voltage across the operating electrodes should fall below a value required to maintain the gas in an ionized state, the potential of the third element will be sufficient to maintain ionization. A 50,000-ohm resistor is employed between the filter circuit and the tube to minimize the additional drain on the rectifier and filter, and limits this parasitic current to approximately three milliamperes. (For a com-

plete description of this tube see page 346 of RADIO NEWS for October, 1927.)

REQUIREMENTS OF RESISTORS

As with everything else which may be classed as radio apparatus, resistors suitable for use in "B" power-supply devices have not been left unchanged. Not being entirely satisfied with the existing types of resistors, some manufacturers have made great strides in the perfection of this very necessary piece of apparatus; and this season has brought forth the wire-wound, high-current-capacity types of variable and fixed resistors.

One in particular has claimed the attention of the writer and has been included in the construction of the "B" power-supply device described here. Nichrome wire, it was found, contains all the essential features which are necessary to a good resistance wire and, in the units employed here, this wire is first wound by machine on an asbestos-covered core, which is in turn then wound on a slotted or grooved form of isolantite, an insulating material of high quality. A sliding arm makes contact with the various turns of nichrome wire and insures a constant perfect connection.

VOLTAGE REGULATOR USED

Together with the filter section of a "B" power supply may very well be considered the use of another new product, the three-element voltage-regulator tube. The inclusion of such a tube in a "B" supply circuit presents several advantages. First, because the tube has the property of functioning like a condenser in smoothing out any slight ripples which may have been incompletely filtered by the chokes and condensers, it makes possible the selection of a condenser bank with less capacity than was formerly required. In the older types of "B" power-supply units it is customary to have a condenser bank consisting of a total of 14 microfarads, composed of five sections, as follows: 2, 2, 8, 1, 1 mf. each. With the use of this regulator, which is known as the type-R tube, a condenser bank totaling only 12 microfarads is sufficient. The main purpose of the tube is to maintain at a steady figure the voltage from an intermediate tap at the output of the complete "B" power supply unit, regardless of the total current drain, which might fluctuate under varying conditions of load.

The prevention of "motorboating," that troublesome noise which prevents satisfactory reception of radio signals when the receiver is powered from a poorly-designed power-supply device, is attributed to the inclusion of a regulator tube to maintain the intermediate voltage at a steady value. Probably one of the most serious objections to former types of regulator, or "glow" tubes, as they were called, was the tendency to oscillate and thereby introduce into the output of the power supply noises and other disturbances, often of such disagreeable nature as to make reception virtually impossible. But now, after many months spent in careful research, there is available a tube in which these disadvantages are not present. Besides the usual two elements, which have

THE CIRCUIT

Before starting the construction or selecting the parts, the circuit diagram shown on (Continued on page 698)

SYMBOL	Quantity	NAME OF PART	REMARKS	MANUFACTURER *
T	1	Power Transformer	300 volt secondary	1 9, 10, 11, 12, 13, 14, 15
CK	1	Filter Choke	Two coils in single case	1 7, 10, 11, 12, 13, 14, 15
C1, C2	1	Buffer Condenser	2 - .1 mf. units	2 3, 16, 17, 18, 19, 21
C3, C7	1	Condenser Bank	2, 2, 8, 1, and 1 mf.	2 3, 10, 17, 18, 19, 24
R1	1	Fixed Resistor	50,000 ohms, wire wound type	3 19, 20, 21, 22, 34
R2	1	Variable Resistor	2,000 ohms, wire wound type	3 21, 22
R3, R4	2	Variable Resistors	5,000 ohms, wire wound type	3
V1	1	Rectifier Tube	125 milliamperes gaseous type	4 28, 29
V2	1	Regulator Tube	Three-element type	4
	2	Tube Sockets	UX type	5 6, 10, 12, 15, 21, 23, 24, 25, 26, 27
	5	Binding Posts		6 7, 21, 23, 25, 30
	1	Front Panel	7 X 4 I 3/16 inches	7 31, 32
25A		Connection Wire	Insulated	8 17, 33
		Metal Sheet	9 X 13 inches; for base	
75 in.		1/2" Angle Brass		
40 "		1/4" Flat Brass Strip	For protective casing	
50 "		12" Wide " sheet		

NUMBERS IN LAST COLUMN REFER TO CODE NUMBERS BELOW.

1 National Company, Inc.	2 Tubular Condenser Corporation	3 Electrad, Inc.
4 Raytheon Manufacturing Co.	5 Newjahn Manufacturing Co.	6 H. H. Eby Manufacturing Co.
7 Micarta Fabricators	8 Cornish Wire Company	9 Gemson Electric Company
10 Silver Marshall, Inc.	11 Duncan Electric Company	12 General Radio Company
13 Jefferson Electric Mfg. Co.	14 Thurston Electric Mfg. Co.	15 Lester F. Muter
16 Tobs Deutchmann Company	17 Acme Wire Company	18 Potter Manufacturing Co.
19 Aerovox Wireless Company	20 Ward-Leonard Electric Company	21 Aneco Products Company
22 Carter Radio Company	23 Pilot Electric Company	24 De Jur Products Company
25 Electrical Research Lab. (ERLA)	26 Herbert H. Frost, Inc.	27 Precision Manufacturing Co.
28 Q.R.S. Music Company	29 C. E. Mfg. Company (Q&C)	30 XL Radio Laboratories
31 American Hard Rubber Company	32 Formica Insulation Company	33 Belden Manufacturing Co.
34 Polymet Manufacturing Co.	35	36
37	38	39

* THE FIGURES IN THE FIRST COLUMN OF MANUFACTURERS INDICATE THE MAKERS OF THE PARTS USED IN THE ORIGINAL EQUIPMENT DESCRIBED HERE.

If you use alternate parts instead of those listed in the first column of manufacturers, be careful to allow for any possible difference in size from those originally used in laying out and drilling the panel and sub-base.

Copyright, 1927, E. P. Co.

Is Voltage a Certain Indication of Merit?

A Study of the Requirements for a Satisfactory Plate-Current Supply Unit

By JAMES MILLEN



Equal output voltage—what about the regulation and the margin of available power?

WHEN "B" power-supply devices first made their appearance on the radio market, not so many years or—for that matter—months ago, there were in the mind of the public in general many misconceptions regarding their proper use. Gradually most of these errors have been corrected, until now the average radio set owner has a rather clear idea of just what a "B" power unit is and what it will do. There still exist, however, a few erroneous ideas that can well stand correction.

One such is the present-day method of differentiating, between various "B" socket-power units, employed by the average radio dealer. He has learned the necessity for using a high-resistance voltmeter for checking "B" units. He has, undoubtedly, invested in one or more of the special instruments made for just such a purpose. Having such an instrument, however, it is not very long before he notices that some power units give slightly higher voltages than others. Perhaps, at one time, he has actually obtained better performance from a set when using a "B" power unit with a higher voltage output than that of another power unit. The result is that he soon considers his voltmeter as an indicator of merit and begins to judge the excellence of "B" units solely by their voltage output. The higher his voltmeter reads the greater, to his mind, the merit of the power unit.

A SELLING ARGUMENT

As a result, manufacturers' salesmen soon found that they had trouble in selling their "B" units to a dealer unless these could furnish a higher voltage output than their competitors. Consequently, the manufacturers began to raise the output voltage of their "B" units.

Within certain limits, such a general trend toward higher-voltage "B" units was a very desirable event. The 171-type power tube came along about the same time, and the higher voltages were necessary for its most successful operation.

But, there is always danger in going from

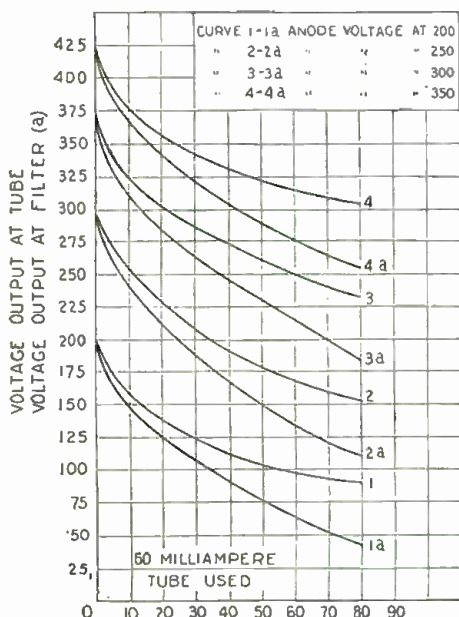

Fig. 1. This chart shows the voltages delivered, from given values of the supply source, by a 60-milliamperer tube, as the load upon it varies, up to an amount in excess of its rating.

one extreme to another like the proverbial pendulum.

A year ago, the average "B" socket-power unit would not supply sufficient power at a voltage high enough to operate, to the best advantage, a receiver employing a 171-type power tube. Today the average high-grade "B" unit meets this requirement. But still the tendency seems toward even higher voltages; not because of sound engineering practice, but because of the dealers' no-longer-valid method of using voltage as an "indicator of merit."

What is the voltage and current that a "B" power unit should deliver to the average radio receiver in order to insure the optimum performance?

WHAT IS REALLY NEEDED?

First, let us consider voltage. The highest plate voltage is used only for the power tube, which may be of either the 112 or the 171 type. Because of the greater undistorted volume obtainable from a set equipped with a 171 power tube in place of a 112 tube, the former is more generally used. According to the tube manufacturers, the optimum plate voltage for use with this tube is approximately 180. As all of the other tubes in a receiving set operate at a plate voltage less than 180, this power-tube voltage determines the maximum voltage which the "B" unit must deliver, while supplying sufficient current to operate the receiver.

As a result of the study of the characteristic curves of the general-purpose tubes and the collection of data on the current drain of various popular commercial receivers, it has been found that the great majority of sets impose on the "B" power unit a total load between 30 and 35 milliamperes. There are some sets that draw as much as 40 milliamperes, but they are very few.

In order to segregate this total load into its various components, the following data are given:

- "B" current in milliamps.
- Average R.F. amplifier per stage, at 67½ volts 2.5 (usually 2 or 3 stages)
- Average R.F. amplifier per stage, at 90 volts 5 (usually 2 or 3 stages)
- Average A.F. amplifier per stage, at 90 volts 5 (usually one stage general-purpose tube)
- 171-type power tube at 180 volts. 20 (40.5 volts—"C" bias)

This gives from 32.5 to 37.5 milliamperes as the total "B" current required for the

average set. (Note: the detector tube is omitted, as its drain is quite negligible—usually well under 1 milliamperer.)

Thus, to meet fully the requirements of the average receiver, a "B" power unit need be capable of supplying but 40 milliamperes at 180 volts. Granted that it is well to have a little margin for good measure, in order that sufficient power at a high enough voltage shall be still obtainable as the rectifier tube gets fairly well along toward the natural end of its useful life—let us set the maximum desirable rating as 60 milliamperes at 180 volts. Why, then, go further? Surely there is no use, at this time, for higher voltages, or higher currents at the same high voltage.

Far better would it be for the manufacturer to provide for the absorption of the power, in excess of 60 milliamperes at 180 volts, by means of a parasitic-load resistor or a voltage-regulator tube located within the power unit in order simultaneously to improve the voltage regulation and to decrease the effective output impedance.

PURCHASE OF NEW TUBES

While on the subject of the fallacies regarding "B" power units which are entertained by the radio public to a considerable extent and by the radio dealer almost universally, it may be well to say a few words about replacement of rectifier tubes.

It seems to be generally believed—particularly by radio dealers—that, when the rectifier tube in a "B" power unit has served its useful life and the time comes for its replacement, it must be replaced by a tube of the identical rating. While this is a safe rule to follow, in some cases it deprives the user of the advantages to be gained from a newer development, or from a reduction in the cost of a formerly higher-priced device.

At this time both of these reasons apply to the use of the Raytheon 125-milliamperer rectifier tube as a replacement tube for the original 60-milliamperer tube.

There are now, according to all available (Continued on page 708)

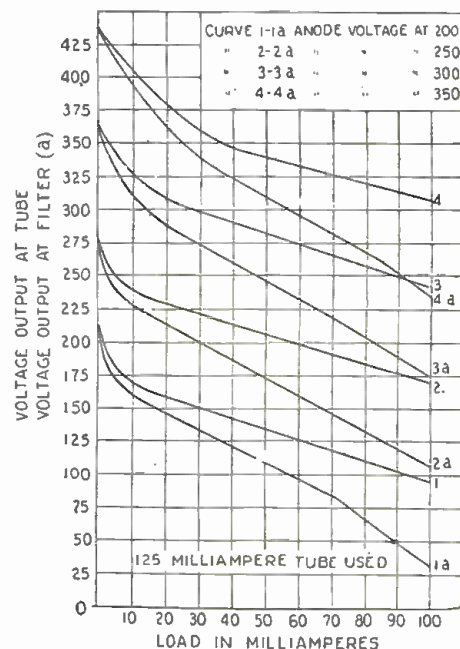
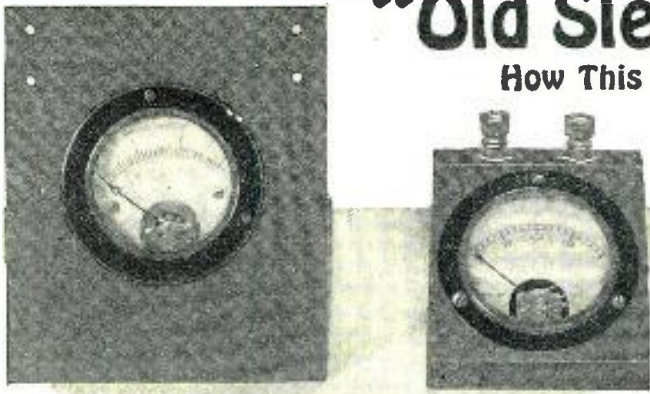

Fig. 2. A comparison of the curve for a 125-milliamperer tube with the preceding diagram will show how much the margin of reserve power counts for in holding voltage steady as the current drawn increases.

"Old Sleuth"—The Milliammeter

How This Handy Instrument Detects the Guilty Parts

By RALPH W. HALLOWS



At the left, two specimens of instruments of a high degree of accuracy, suitable for such work as this article describes, in mountings suitable for convenient use on the experimenter's table.

Photos by courtesy of the Jewell Electrical Instrument Co., and the Weston Electrical Instrument Co.

THE man who possesses a milliammeter never need find trouble-hunting a long or laborious job; for, if properly used, this simple instrument is capable of tracking down almost every common fault to which the radio receiving set is liable. The most suitable instrument for general radio use is one reading from 0 to 25 milliamperes, or 0 to 50 if the tubes are such that the total current consumption of the set is high. In any case, the maximum reading of the milliammeter should be large enough to enable it to record the total plate or "B" current of the receiving set with which it is to be used. The milliammeter may be wired permanently, as shown in Fig.

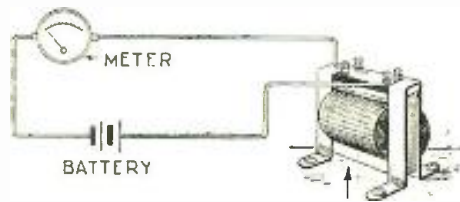

FIG. 3

Either the primary or the secondary of an audio-frequency transformer is quickly tested in the manner shown above.

1, between the "B—" binding post and the negative post of the "B" battery; or it can be brought into use just as it is required, being placed in the position indicated whenever a breakdown occurs.

The first thing to do with the milliammeter is to read with it the normal plate current of each tube in the set; this may be done by placing the tubes one at a time in their proper sockets. Next take the total "B" current for the whole apparatus. A careful note should be made of the figures obtained, so that they may be referred to at any time, should the set not be up to form. The figure for the total current when the set is functioning properly may be regarded as the radio equivalent of the doctor's "nor-

mal temperature." The milliammeter, in fact, helps to diagnose radio diseases just as a clinical thermometer helps to diagnose those of the human body. In addition to its value as an aid to trouble hunting, it will act also as an infallible detector of distortion in reproduction.

TESTING REPRODUCTION

When the radio set is switched on, and a broadcast station tuned in, the needle of the milliammeter should swing to its normal reading and, once there, it should remain dead steady. If you find that the needle shows a tendency to kick when certain notes are played or sung, or when sibilant consonants (such as "S," "SH," "SCH," "CH," and "Z") occur in speech, you know at once that your reproduction is not all that it should be; for this symptom shows that distortion is taking place from one of two causes. Either the output tube is being overloaded by being called upon to handle more energy than it can deal with properly, or the "C" voltage is wrong, causing the working point to be either too high or too low on the "characteristic."

Fig. 2 shows diagrammatically what happens in these cases. If the working point is too high, positive half-cycles cause grid current to flow and mutilation of the upper halves of wave forms takes place; if it is too low, negative half cycles take it down to the bottom bend, producing re-rectification and mutilating the lower halves of the wave forms in the plate circuit.

When the milliammeter kicks during reception try first of all the effect of altering the "C" voltage. You may find that just a little more or a little less will bring the working point to the middle of the straight portion of the characteristic and keep the needle steady. Supposing, however, that no alteration of the "C" voltage produces the desired result, it is most likely that the tube is being overloaded, as shown in Fig. 2C. You can test for this by de-tuning a little, which reduces the amplitude of the grid swing reaching the last tube. Should de-

tuning steady the needle, then you have been trying to get a volume of sound rather greater than the radio set is capable of giving with the particular tube in the last socket. To obtain such signal strength without distortion, a tube of lower impedance is required.

WHERE TO START

Now for the milliammeter as a trouble sleuth. We will suppose that some evening, when you switch on the set, it is either off color, giving much less than its usual signal strength, or that it is altogether silent. Obviously there is trouble somewhere; the milliammeter will help you to see exactly where and what it is. Should there be complete silence, see before doing anything else

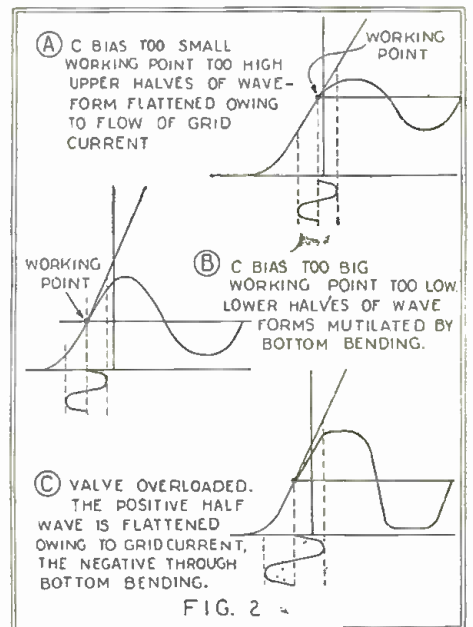

These sections of the "characteristic curve" of a tube show what happens when either incorrect "C" bias is used, or the tube (in the last audio stage) is overloaded by powerful signals.

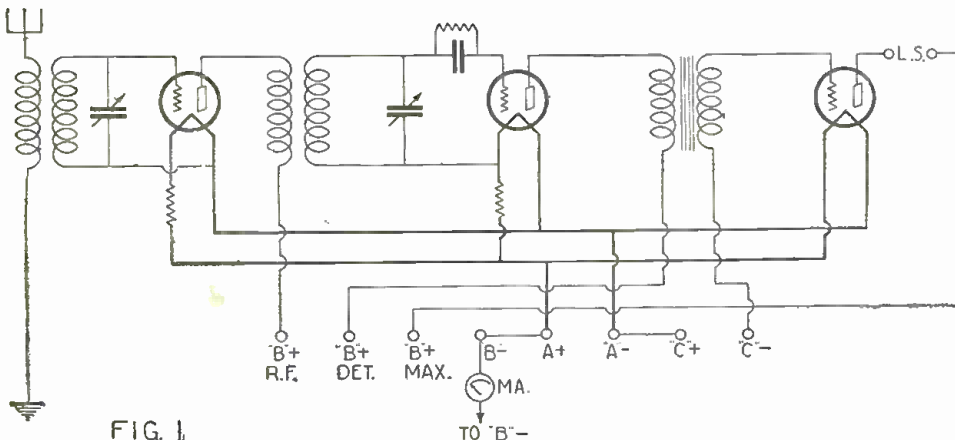

FIG. 1

The best position, generally speaking, for the permanent mounting of a milliammeter in a radio set is between the "A+" post and the "B—" battery lead—if these two, as usual, have a common terminal. When this connection has been made, the normal plate current of each tube in the set should be noted for future reference.

that the aerial and ground leads are connected and that the grounding switch is in the proper position for reception. Many a radio man has spent profane hours in a fruitless endeavor to track trouble, through neglect of this seemingly obvious precaution. Certainly I have; so have Blank and Dash and Asterisk. What, you have too? Fine, let's shake!

Next see what the milliammeter has to say about it. In practically every case where the set is completely silent, the reading will be either normal or below normal. We will discuss the indications given by these readings in a moment.

Weak signals of exceptionally poor quality may be accompanied by a milliammeter reading that is higher than it ought to be. Such a reading indicates that the trouble is due to one of three causes. There may be a short-circuit, partial or complete. In this case the flow of current will generally be sufficient to send the needle of the milliammeter right over against its stop pin. A figure just a few milliamperes above normal means either that the "C" battery is run down or that there is a disconnection, probably in one of the A.F. grid circuits. Test the voltage of the "C" battery first of all. In most cases it will be the culprit. Should the "C" battery be up to the mark, one of the A.F. grid

(Continued on page 700)



The Cause and Elimination of Fading

An Explanation of Some of the Troubles Experienced in Reception and Their Possible Cures



THE discovery that radio waves, unlike their first cousins, light waves, are able to travel in curved paths around the surface of the earth and thus be received in the Antipodes, was regarded with astonishment. In the first place, it was definitely contrary to the theory then existing and, in order to explain it, the so-called Kennelly-Heaviside layer was postulated. It is reasonable to suppose that sunlight, falling upon the earth's atmosphere, may ionize it, and produce a layer of elec-

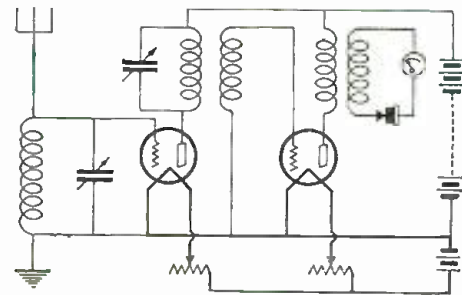

FIG. 1 CIRCUIT USED FOR INTENSITY MEASUREMENT OF SIGNALS.

The circuit employed by Dr. Appleton to measure the fading of signal strength.

trons at a high level. It has been shown by Larmor and others, that a radio-wave, entering this region, will be either absorbed, retarded, or bent back toward the earth; depending partly upon the amount of ionization, partly upon the wavelength of the radiation itself. It is thus possible to explain many facts about radio reception.

No theory of the propagation of radio waves over the earth's surface will be complete, however, unless it also explains the large and rapid variations of signal intensity and direction of propagation of the waves as observed at night, and, to some extent during daylight, particularly in winter. It has been recognized for some time that the phenomenon of "fading" may possibly be due to interference between the direct wave along the earth and the wave reflected from the Heaviside layer; but experimenters have found great difficulty both in proving this and in accurately describing the exact mechanism of the phenomenon.

Dr. E. V. Appleton, the well-known professor of Physics at Cambridge, England, has performed a series of brilliant experi-

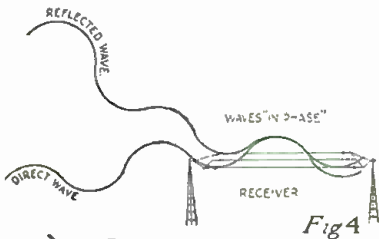

Fig 4

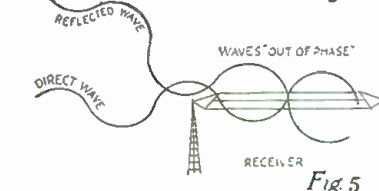

Fig 5

If the ground and the reflected waves reach the receiver's antenna in phase (Fig. 4) reception will be good, but if they arrive out of phase (as in Fig. 5) reception will be greatly lessened.

By DONALD H. MENZEL

ments which deal with the crux of the question. He and his collaborators first set out to discover definite experimental proof of the existence of the Heaviside layer.

MEASUREMENTS OF RECEPTION

The fact that temporary variations of signal intensity are experienced at night for short-wave transmissions is well-known to many broadcast listeners. In a normal case of signal fluctuation, such as may be experienced with a receiver 150 to 200 miles from the sending station, the variation of signal intensity is so marked as to be noticeable in the phones. In order to measure accurately, however, the variation in intensity, Dr. Appleton discarded audible estimates as unreliable and obtained an accurate gauge of intensity by means of a galvanometer. The

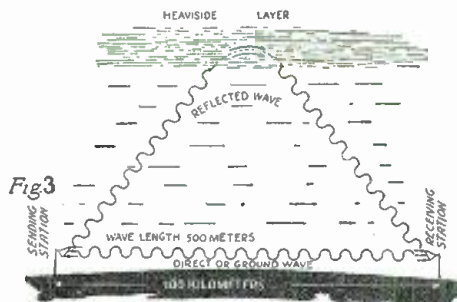

This diagram shows how a radio wave breaks up into a ground wave and a reflected wave and the path each travels.

circuit used is shown in Fig. 1. It employs tuned radio-frequency amplification which is coupled on the output side to a detector circuit with a crystal rectifier and a galvanometer in series. In the preliminary experiments, galvanometer readings were taken every six seconds and plotted to obtain a curve. In the later investigations, however, greater accuracy was obtained by recording

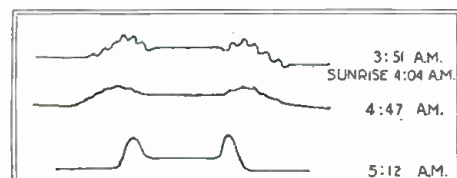

FIG. 7 SIGNAL VARIATIONS DURING SUNRISE PERIOD.

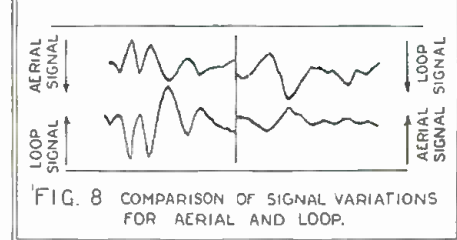

FIG. 8 COMPARISON OF SIGNAL VARIATIONS FOR AERIAL AND LOOP.

Fig. 7. The influence of sunrise on the fading of radio signals. Fig. 8. These curves confirm Heaviside's theory, that waves are deviated vertically and not horizontally.

the beam of light reflected from the swinging galvanometer mirror, on a moving photographic film.

Fig. 2 shows the general character of the fading and its increase after sunset. In order to explain the observed phenomenon, it is

necessary to assume that rays of appreciable intensity are reflected at night from the Heaviside layer. These interfere with the ground wave at the receiving station in such a way as to produce fading.

WAVE INTERFERENCE

In order to picture the process, let the reader refer to Fig. 3, where the two paths are represented. Let us suppose, to make the calculation easy, that the wavelength is 500 meters and the distance between the two stations 100 kilometers (100,000 meters): there will be, then, 200 waves in the direct path. If the reflected wave traverses exactly twice the distance, the two waves will be

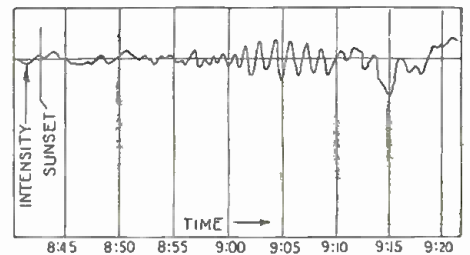

FIG. 2 CHARACTER OF FADING AFTER SUNSET.

This curve illustrates the variations in the intensity of radio signals after sunset. The fading becomes more marked.

"in phase"; i.e. vibrating similarly at the receiver, as pictured in Fig. 4. Since the crests of the waves coincide, the two waves will assist each other and the reception will be good.

Suppose, now, that the radio-station's wavelength is changed from 500 to 498.75 meters. It is easily calculated that we will have 200.5 instead of 200 direct waves, and 401 instead of 400 indirect waves. The extra half-wave changes conditions, as shown in Fig. 5. The waves will arrive, "out of phase," vibrating in opposite directions, and tend to annul each other. If the wavelength be further decreased, we have another maximum of intensity, and so on.

Prof. Appleton arranged with a broadcast station that its wavelength should be systematically and regularly varied through a small range, say ten meters, in the period of half a minute. The coils used on the receiver were specially wound with high-resistance wire, so that broad flat tuning was obtained. The results showed definitely the maxima and minima predicted by theory and further enabled the eminent investigator to place the height of the Heaviside layer at

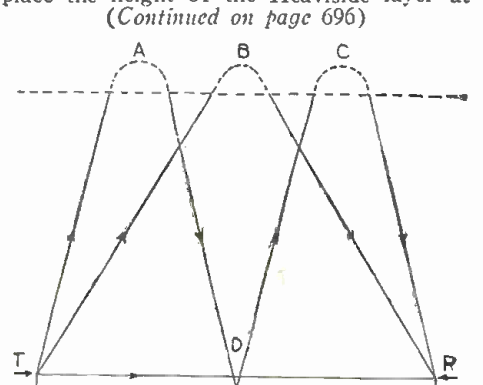

FIG. 6. WAVES SINGLY AND TRIPLY REFLECTED.

How radio waves are reflected from the Heaviside layer; two sets of impulses may arrive at a receiver and interfere with each other and the ground wave.

Hints on Tuning The Knickerbocker Four

THE "Equamatic" system of variable coupling, as employed in the Knickerbocker Four receiver (described in the October, 1927 number of RADIO NEWS), is a practical method for either maintaining a constant transfer of energy between two circuits, or providing an automatically progressive variation in energy-transfer, directly proportional to the variation in the wavelength to which the circuits are tuned.

In the case of the Knickerbocker Four receiver, the Equamatic feature is used to maintain practically constant energy-transfer between the antenna and the radio-frequency tube. It is also used to maintain maximum permissible energy-transfer from the detector-plate circuit back to the grid circuit; thus providing at all times, maximum regeneration, but avoiding actual oscillation.

The operating efficiency of this receiver will, naturally, depend upon the proper adjustment of the coupling coils and it is impossible to suggest one specific adjustment that will exactly fit all the receivers that have been constructed from the plans given in the previous article.

Variation in detector-tube characteristics, for instance, will cause one receiver to require generally looser tickler coupling than another receiver which employs the same circuit and parts. Antennas of different sizes also require slightly different adjustments in the antenna coupler. The aim of this article is to provide an explanation of the working and adjustment of the whole system. With a thorough understanding of these fundamentals, any constructor or owner of a Knickerbocker Four can then make the adjustments which will provide maximum efficiency for his particular receiver.

MECHANICAL OPERATION

For the moment we can disregard the primary coil of the R.F.-detector coupler L2, (see October RADIO NEWS for circuit details), and consider only the rotor and stator coils. The stator coil, or secondary, is mounted on the baseboard of the set by means of a bracket with a slotted base which can be slid back or forth under the head of the mounting screw, or may be swung around to bring the secondary coil at any desired angle to the front panel (or to the condenser shaft upon which the rotor coil is mounted). The rotor coil is mounted directly on the rear end of the shaft of the variable condenser which tunes the secondary coil; by means of a swivel this coil also may be

By JOSEPH CALCATERRA

placed at any desired angle to the condenser shaft.

If either coil is left in a position with its axis at right angles to the panel (parallel to the condenser shaft), there will be no variation in coupling as the condenser shaft is turned; because, at any setting of the rotor, the angle formed by both axes remains the same. This is illustrated in Figs. 1 and 2. In Fig. 1, the rotor coil turns in the same plane and therefore cannot vary its relation to the stator coil. In Fig. 2, the rotor coil is no longer parallel to the panel; but, nevertheless, the same angle is maintained between the axes of the two windings regardless of the setting of the condenser, when the stator, or secondary coil has its axis at right angles to the panel.

The minute both coils are so adjusted that neither of the axes is at right angles to the panel, the coupling between them begins to vary. Thus, if the two coils are left parallel to one another, but are swung around so that their axes make an angle of 45 degrees to the panel, turning the shaft through 180 degrees will swing the rotor coil around so that, instead of its windings being parallel to those of the stator coil, there will be a 90-degree difference. This is shown by the dotted line in Fig. 3.

VARIATIONS IN COUPLING

In its practical application in the case of coil L1 (the antenna coupler) in the Knickerbocker Four, this means that, if the axes of the primary and secondary coils are made to coincide at an angle of 45 degrees to the panel, when the condenser plates are completely meshed, then when the condenser rotor is turned to bring the rotor plates all the way out, the axis of the primary coil will have maintained its 45-degree angle to the panel, but will be at right angles to the secondary coil, instead of parallel. In other words, the coupling between the two coils will have changed from maximum to minimum as the condenser's capacity changed from maximum to minimum. At any intermediate point in the condenser range the coupling will have changed approximately in proportion to the capacity.

Of course it is never desirable to reduce the coupling to zero; because then there would be no energy transfer between the

coils. It is, therefore, never necessary to adjust the coils to an angle as small as 45 degrees. An angle of about 58 degrees, between the axes of the coils and the plane of the panel, is usually found to be about right.

Whatever the angle of adjustment, the two coils should always be parallel when the condenser dial reads 100 (plates fully meshed). This provides the close coupling required at high wavelengths. If the coupling is too close at the longer waves, it may be decreased by sliding the secondary away from the primary—still keeping the two coils parallel. These two adjustments fix the maximum coupling. The range of variation of coupling, and the minimum coupling required at the shorter wavelengths, are regulated by changing the angle of the two coils in relation to the panel. If the angle between the coil axes and the panel is $67\frac{1}{2}$ degrees ($22\frac{1}{2}$ degrees between the plane of the coil windings and that of the front panel) the range of coupling will be 45 degrees. That is to say, coupling at zero on the condenser dial will be equal to 50 per cent. of the full coupling obtained when the condenser dial is set at 100; inasmuch as a 90-degree change (from parallel to right angles) in coupling is the maximum attainable range and represents a change from maximum to zero coupling.

The range of coupling is always equal to twice the angle formed between the front panel and the plane of the coil windings at maximum coupling. This is a good point to remember. Thus, when the coils are adjusted so that their windings are parallel to the panel, there is no variation in coupling as the condenser shaft is turned. If the coils are adjusted at an angle of 45 degrees to the panel, the coupling range will be from maximum to zero, or through an angle of 90 degrees; and so on.

ANTENNA COUPLING

The proper degree of coupling of the coupler L1 can be determined by two things: first, if selectivity is adequate at the higher wavelengths but not at the shorter, it will be evident that the coupling is correct at the high waves but too close at the shorter. In that case the range of coupling variation is too small and the angle between coils and shaft should be decreased slightly. If selectivity is adequate at the shorter waves, but tuning is broad at the higher wavelengths, then the angle between the coils is correct; but the secondary should be moved farther from the primary. This reduces the coupling at the high wavelengths but has little effect at the shorter.

The second consideration that governs the adjustment of the coupling variation is the tendency of the stage to oscillate. In the R.F. stage it will be difficult to prevent oscillation if the coupling is too close. This will be most noticeable at the lower wavelengths. But, with the coupling range properly adjusted, the R.F. circuit will be easy to neutralize and the selectivity of the receiver will be excellent.

FEEDBACK COUPLING

In adjusting the coupler L2 an approximate adjustment should first be made. An angle of about 60 degrees is good for a starter. Then, with the knob of the neutralizing condenser NC turned all the way to the left, the dials are rotated until a station is heard, or at least the "birdie" whistle which indicates a station's carrier wave. Then turn down (clockwise rotation) on the neutralizing knob, a little at a time, until the whistle stops and the signals from

(Continued on page 658)

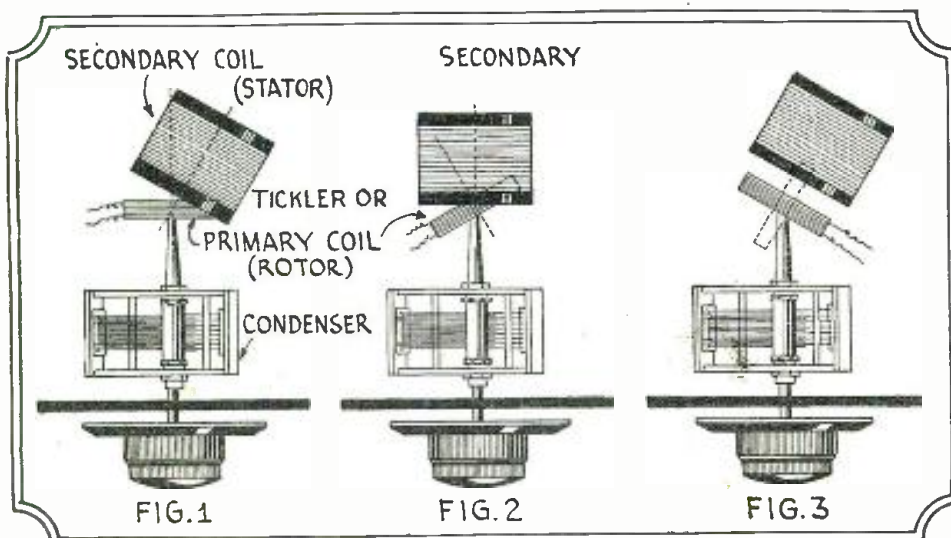

If the axis of either of the primary or secondary is parallel to the condenser shaft there will be no variation in the coupling. (Figs. 1 and 2). When the inductors are in the position shown in Fig. 3 the coupling is varied as the condenser is varied.

Aerial and Ground Design and Connections

A Review of Some Common Types and Their Respective Merits

By **CLYDE A. RANDON**

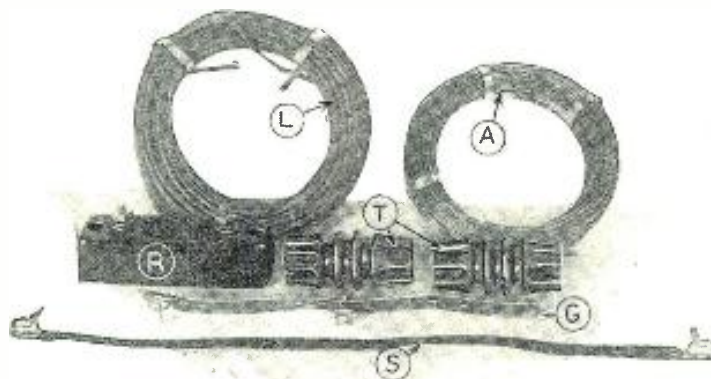

FIG. 2

Fig. 2. At the left is shown an aerial of the cage type, which is suspended in a vertical position.

Below is illustrated a typical aerial kit consisting of A, stranded aerial wire; L, rubber-covered lead-in wire; T, insulators; R, lightning arrester; G, ground clamp and S, window lead-in strip. With these accessories a good outdoor antenna can be erected.

Photograph by courtesy of Belden Mfg. Co.



experiment, as the conditions under which the devices are used vary considerably. They are very inexpensive, however, and are well worth trying, for they may save the trouble and expense involved in the erection of a regular outside aerial.

Sensitive sets may well use a loop for reception with increased selectivity. With the more sensitive sets, the volume control must usually be turned down on nearby stations; so that a little loss in volume matters little, while selectivity is better with the smaller aerial. There are several different types of loop antennas; these all consist, essentially, of a closed coil which is

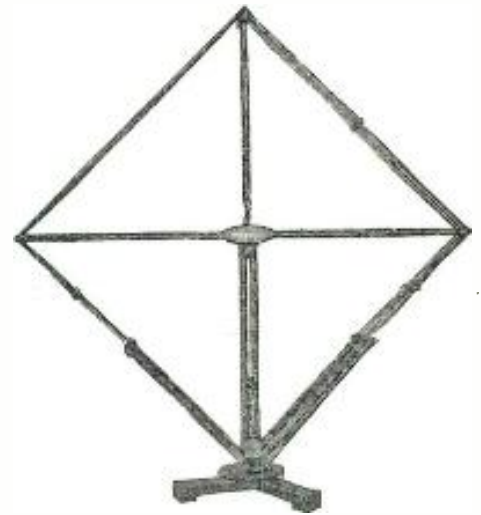

A commercial type of loop antenna shown diagrammatically at the bottom of this page (Fig. 1A.)

center of the winding. Some sets require a center-tapped loop. The loop may be tuned, and somewhat better results thus obtained, if it is shunted by a variable condenser, say a 23-plate size (.0005-mf.).

SPECIAL FORMS OF LOOPS

Non-directional loops are often used, where the listener does not care particularly for any extra selectivity which the other types could furnish. A good non-directional loop may be made by passing a length of insulated lamp-cord a few times around the walls of a room near the ceiling. This also may be tuned for better response. A large loop of this nature gives response approaching that of an outdoor aerial. Another suggested form of non-directional aerial, having comparatively low resistance, is shown in Fig. 2. The reader will recognize this as an ordinary "cage" aerial, used by some amateurs for transmission. It has one lead and is used with a ground connection. The springs of a bed are often used as an antenna and these have non-directional characteristics.

Listeners often erect on the roofs of their homes large cage-aerial arrangements, especially where there is no room for aerials of the ordinary type. A large vertical-cage loop (Continued on page 674)

An aerial properly-designed, with a good ground connection, can well be looked upon as a radio-frequency amplifier of the best kind. The response in the set with no aerial and ground is but a very small fraction of that given with a properly-designed energy-collector. It would take a very good R. F. amplifier, indeed, to furnish to a set without an aerial signal-strength which could compare with the results from the same set having a properly-designed aerial. There are aerials most suitable for different purposes; every set must have one of the types which will be discussed.

A small antenna, such as a loop, gives little energy to actuate the receiver and an outside aerial causes considerably better response. An enormous antenna system would give somewhat better "pickup," but there are other considerations. Selectivity is quite as important as signal-strength; so that for aerials there are definite sizes which give best all-around efficiency. It is generally understood that a single wire, 100 feet long is sufficient and best for broadcast reception. Shortening an aerial always increases the selectivity; if it is made shorter and shorter, finally but a few feet of wire will remain and, of course, this is a very selective aerial. An ordinary coil of wire can be used for an aerial on the more sensitive sets. Since the received energy oscillates between the aerial and ground, the ground connection must be equally good; otherwise a good aerial may give only poor results.

ANTENNA DESIGN

Light-socket devices for use as antennas comprise an attachment which screws into the light socket; they are provided with a small condenser which allows passage of the high-frequency radio currents picked up by the lighting wires but insulates the set from the 110-volt line. The operation of one of these lamp-socket plugs in a given location cannot be predicted, but must be learned by

connected to the receiver and serves for both aerial and ground connections. Some different types of loop antennas are shown in Fig. 1.

At A is shown a common type; those shown at both A and B have two leads, although three may be used, as in the type shown at C. As a rule, the type shown at B has the better directional characteristics. These loops are supported on frames and are free to rotate, so that the direction which gives best reception may be used; thus obtaining the highest volume and selectivity. In receiving nearby stations, the loop may usually be turned in any direction, with very little noticeable change in volume; but stations distant a few miles or more will give a very large increase when the loop is properly "oriented."

The three leads from a loop are simply the ends of the winding and a tap taken off the

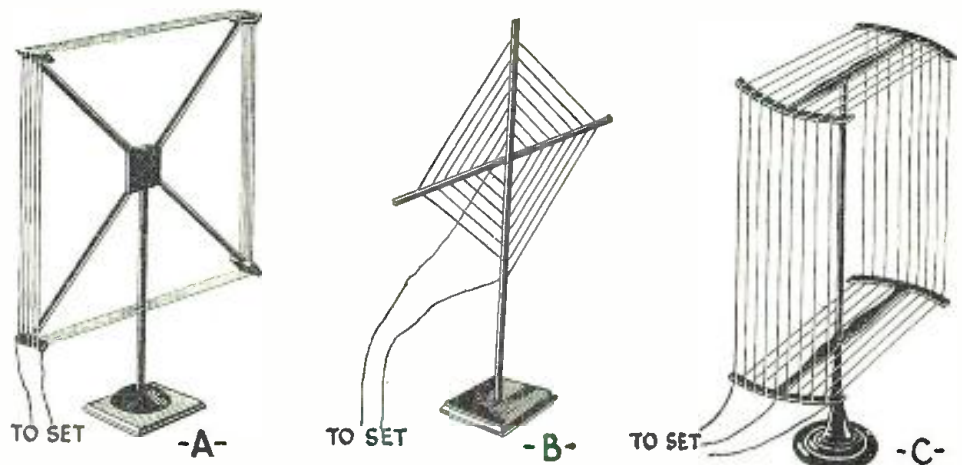

FIG. 1

Three different types of loop antennas. A has its windings flat on the top and sides; B has its windings all in the same vertical plane, and C is partly like A, except for a center tap.

Changes in Frequency Due to Shielding

An Authoritative Article on the Shielding Effects on Various Types of High-Frequency Transformers

By HAROLD A. ZAHL

IN the July issue of RADIO NEWS appeared an article by this writer on "The Effects of Shielding," which discussed in general terms the effects caused by the introduction of a grounded shield into the field of a radio-, or intermediate-frequency, transformer. Emphasis was laid on the fact that the presence of a shield decreases the efficiency of the transformer-condenser unit. Accompanying curves showed how this efficiency reduction begins when the shield is as much as three inches from the coil, the slope of the curves becoming greater as the distance between the

voltage component of the current, was identical with the one described by the author in the July RADIO NEWS. To eliminate the inductive and capacitive effects of the voltmeter circuit, the secondaries of the transformers tested were coupled inductively to the voltmeter.

Had absolute measurements of the voltage been required, one would have had to connect the voltmeter directly to the terminals of the secondary. The problem studied in this article made use of the voltmeter in indicating only the resonance-frequency and not the secondary voltage. The two shields which were used could be moved towards the coils, the distance from which could be measured to an accuracy of less than one millimeter.

The process of experiment was as follows: With the transformer (either a radio-, or intermediate-frequency, type) tuned to a frequency such that the galvanometer of the vacuum-tube voltmeter showed maximum voltage transmission, two grounded shields, perpendicular to the field of the transformer, were moved by small intervals towards the coils until they touched the windings. At each position of the shields the oscillator setting was changed to a frequency which corresponded to the new resonance-frequency of the unit. It was found that the resonance-frequency of the unit increased as the dis-

shield in the field of the secondary or tuned side of the transformer.

In another phase of this same experiment, the oscillator-frequency was kept constant as the shields were brought towards the coils, while the capacity of the tuning condenser was varied until resonance was obtained.

RESULTS OF TESTS

One might expect that, since the resonance-frequency increased as the shields were brought closer, that the capacity of the tuning condenser would decrease, but such was not the case; for, as the shields approached the windings, the capacity required to main-

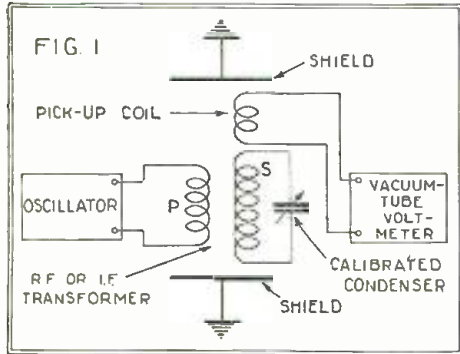

The general layout of the instruments used in the tests herein described.

shield and coil is decreased. It was stated that a grounded shield in the proximity of a tuned unit may change the resonance-frequency of the unit, giving the effect of poorly-matched parts.

In the present article we shall consider both the cause and the effect of this change of frequency.

METHODS OF MEASUREMENT

Fig. 1 shows the general layout of the apparatus used in making the measurements shown by the curves. The radio-frequency oscillator was of standard design and capable of producing a wave with a fairly constant amplitude, having a frequency range of from 500,000 to 1,500,000 cycles. The intermediate-frequency oscillator was essentially the same as the one used for radio-frequencies, except that the inductances used were of a considerably higher value. The frequencies which this oscillator was capable of producing ranged from 35,000 to 90,000 cycles per second. The vacuum-tube voltmeter, which was used to measure the peak of the

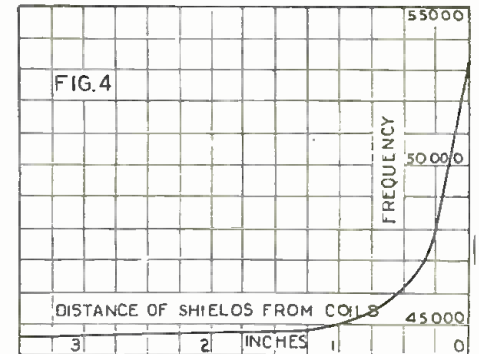

A frequency change of approximately 9000 cycles occurred when intermediate-frequency transformers were tested.

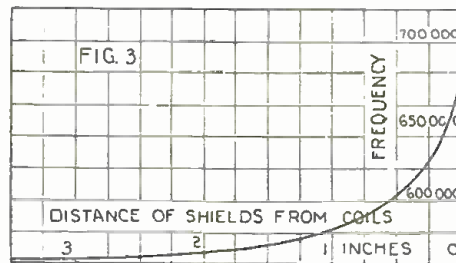

Several types of solenoidal R.F. transformers were used to get this average curve.

tain resonance increased. This point will be discussed at more length further on.

Figs. 2 and 3 show how the resonance-frequency of several types of commercial radio-frequency transformers increased as the shields were brought closer. Fig. 2 represents the curve obtained by plotting the average values obtained when using several variations of the spider-web-type coil. Fig. 3 was obtained by using several solenoidal types of radio-frequency transformers.

We note that in the spider-web-type transformer, in which the change is greatest, that there is a frequency change, of from slightly above 560,000 to 820,000 cycles. (The frequency used as a starting point was taken arbitrarily. If a higher initial frequency had been chosen, the total frequency-increase would have been slightly greater.) This change of frequency for the spider-web-type transformer, in terms of wavelength, means a change from 535 to 365 meters.

The contrast of effects shown by the flat-faced spider-web coil and the solenoidal type is what one might expect. The former has most of its field exposed to the shield; while the latter, or solenoid, has the major portion of its field within the coil. It is due to its enclosed field that the toroidal transformer boasts superiority. Measurements show that the toroidal transformer is little affected by the presence of a shield.

It is clear, then, that, for the great majority of transformers, the position of a shield in the construction of a receiver must be taken into serious consideration; otherwise, besides its absorbing current, it may throw the entire set out of balance.

Where intermediate-frequency transformers are used, as in a superheterodyne, we have a similar effect, though not quite as marked. Fig. 4 shows an average curve obtained from a set of four air-cored intermediate-frequency transformers, tuned approximately to 45,000 cycles per second, where a frequency-change of about 9,000 cycles occurred.

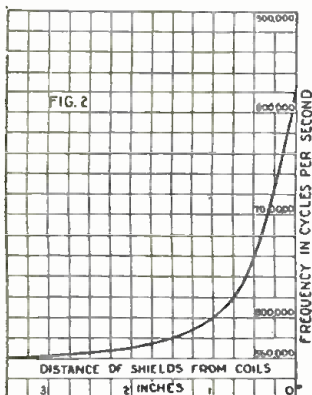

Fig. 2 shows average readings of frequency change when spider-web transformers were used.

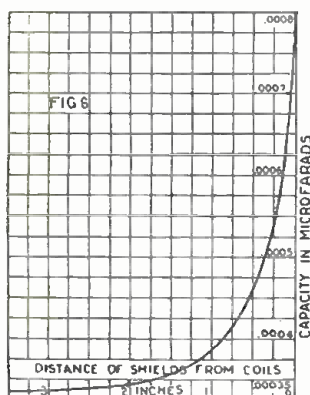
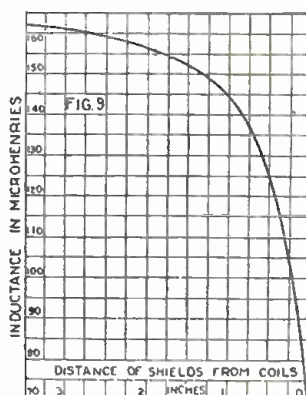
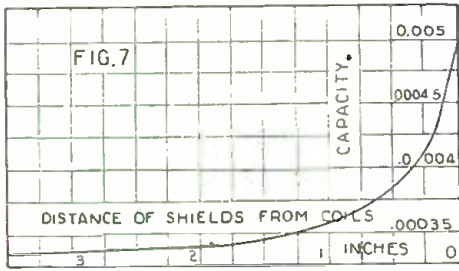

Fig. 6 shows the change in capacity needed to keep the spider-web transformers in resonance as the shielding was varied.



Curve showing how the apparent inductance of the secondary of a spider-web-type radio-frequency transformer decreases as the shield is brought closer.



Curve showing how the capacity necessary to maintain resonance increases as a shield is brought closer to the windings of a solenoidal type radio-frequency transformer.

RESULTS IN PRACTICE

Now let us consider what this might mean, if applied to a set in actual operation. Suppose we have a superheterodyne using four air-cored intermediate transformers, tuned to 45,000 cycles. We will assume that the transformers were reasonably well matched to begin with, and all peaked at approximately the same frequency. Now suppose that a grounded shield is brought into the field of one transformer. The resonance-frequency of the transformer-condenser unit will shift upward, the amount depending on how close the shield is to the transformer's secondary. If it shifted upward 5,000 cycles we would have a condition something like that shown in Fig. 5. Transformers 1, 2, and 3 would amplify together at a frequency of 45,000 cycles. Transformer No. 4 would amplify at 50,000 cycles.

This would mean, not only that, one transformer would be useless, but it would act as an impediment to proper signal transmission. This out-of-tune transformer would cause an undesirable hump in the average amplification curve of the entire intermediate stages. Side-bands would be unequally amplified; the desired signals would not receive the amplification possible; and the receiver would lose much of its selectivity.

If the presence of a shield shifts the resonance-frequency of a tuned transformer, we may ask: why not use this phenomenon in bringing improperly-matched transformers into resonance with the others? This would be well enough if the shield did not absorb energy. In using a shield to match a bank of intermediate-frequency transformers, we must not overlook that what we gain in one way we may lose in another. It will be advantageous to use a shield only in ascertaining which transformers are not matched.

If introducing a grounded shield into the field of an I. F. transformer brings about more selectivity or better tone quality, we know that this transformer-condenser unit is not peaked to correspond with the others. As the shield increases the resonance-frequency of the unit, we know that what the transformer needs is less capacity across the secondary. Oftimes, merely by trying other condensers of supposedly the same capacity, we can bring the unit into tune. This is because the capacity of many commercial fixed condensers will vary from the rated capacity sufficiently to bring about the desired change.

This method of using a temporary shield to determine an out-of-tune transformer can be applied only when that transformer is operating at a frequency below the average frequency transmitted by the other transformers.

The superheterodyne fan should always remember that it is the proper functioning of the intermediate-frequency stages that determines whether his receiver is really a "super" heterodyne.

THEORY OF THE PHENOMENA

We have noted earlier in the article how the bringing of a shield towards a tuned unit increases the capacity necessary to maintain resonance, instead of decreasing it as one might suppose. Figs. 6 and 7 show the curves

obtained when using the same sets of transformers as those for Figs. 2 and 3. Fig. 6 shows the curve which resulted when, at a constant frequency of 680,000 cycles, the capacity of the tuning condenser was varied to maintain resonance as the shields were brought towards the transformer coils, keeping the shields perpendicular to the field. A change of from slightly below .00035 mfd. to .0008 mfd. resulted. This effect is somewhat less for the solenoid radio-frequency transformer (Fig. 7), and still less for an intermediate-frequency transformer (Fig. 8). It is hardly noticeable when using a toroidal type transformer.

In order to explain best this phenomenon we must resort to some simple mathematics. The formula for frequency is:

$$\text{Frequency} = \frac{5033}{\sqrt{LC}}$$

In which L is the inductance in millihenries, and C is the capacity in microfarads. If we have two different resonant circuits,

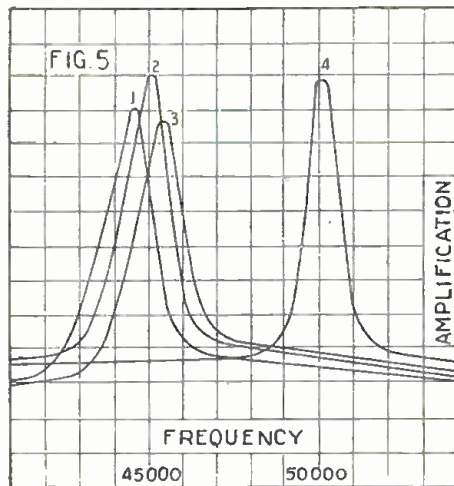

Curves showing how one intermediate transformer improperly shielded can throw the entire unit out of adjustment.

both tuned for the same frequency, but having different values of L and C, the following is true:

$$LC=L'C'$$

In which L is the inductance in circuit No. 1; C is the capacity in circuit No. 1;

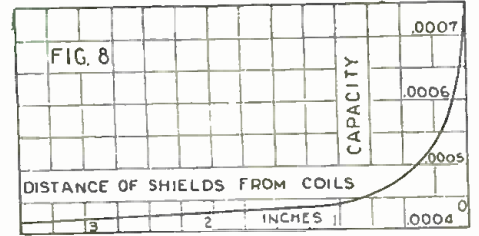

Curve showing how the capacity necessary to maintain resonance increases as a shield is brought closer to the secondary of a tuned air-core intermediate-frequency transformer.

L' is the inductance in circuit No. 1; C' is the capacity in circuit No. 2.

Thus we see that, in these two circuits, which are tuned to the same frequency, the product of the inductance and capacity of the one always equals the product of the inductance and capacity of the other.

The introduction of a shield and the addition of capacity to maintain resonance fulfills the requirements of the above equation, L' and C' changing for each successive position of the shield. Knowing the changes of capacity, we are able to calculate the changes of inductance brought about by the presence of the shields. Though the inductive value of the primary of the transformer changes also, we are interested only in the changes of inductance in the secondary. The change in the apparent inductance of the secondary (knowing its initial inductance) is expressed by the following equation:

$$L' = \frac{LC}{C'}$$

Where, L' is the new inductance value of the secondary; L is the original inductance of the secondary; C is the original capacity of the tuning condenser; and C' is the new capacity required to maintain resonance.

This gives us a value of the apparent inductance of the secondary for each successive setting of the shields. This has been plotted for the case of the radio-frequency transformers of the spider-web type. The resulting curve is shown in Fig. 9. The apparent inductance in this case was found to vary from 162 to 70 microhenries.

NATURE OF INDUCTANCE

Now just why should the introduction of a shield decrease the inductive value of a (Continued on page 695)

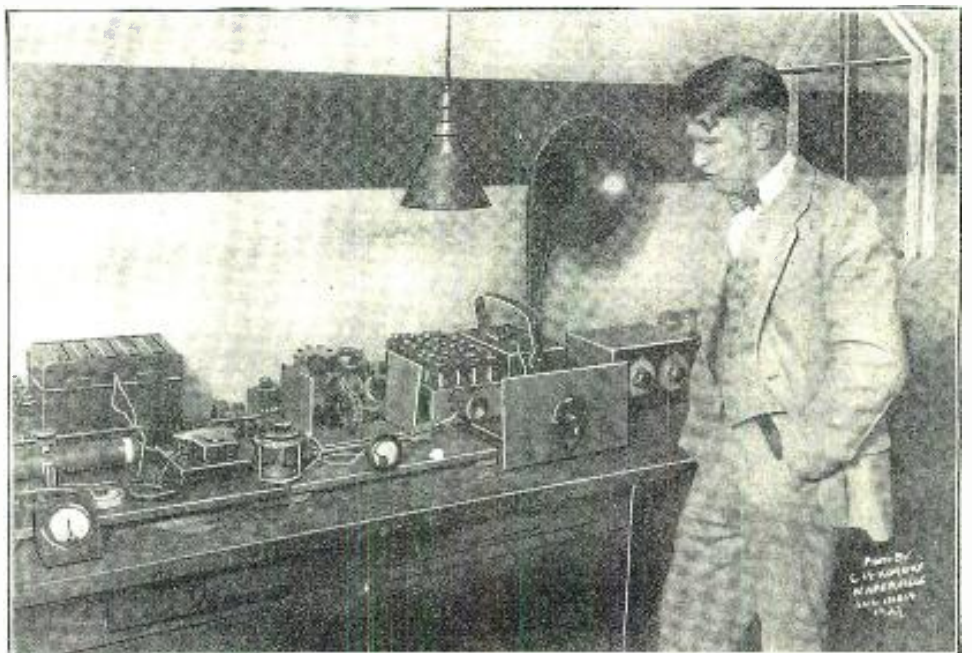

The author with his testing apparatus, which is from left to right, vacuum-tube voltmeter, variable shielding arrangement, R.F. oscillator.

Photoelectricity, the Means of Television

The "Electric Eye" and the Principle of its Operation

By JOHN P. ARNOLD

SINCE the recent art of visual communication—the electrical transmission and reception of, not only "still" pictures, but also of the images of objects in motion—has been demonstrated experimentally and successfully applied to many practical uses (such as the commercial service of sending photographs by land wire and cable, the broadcasting of weather maps by radio, and the television transmissions in this country and England) much descriptive writing has found its way into print, mainly expressed in awe and with fanciful predictions for the future; but very little has been told of the scientific principles on which these systems are founded.

Many branches of human knowledge have been levied upon to furnish the appliances of this art; for picture transmission is a group achievement, the product of many workers in varied fields of thought, in which individual genius has played only a contributory part. Chemistry, mechanics, electricity, and more specifically telephony, optics and photoelectricity, have aided in its development; and it is only through the study of these sciences that we may expect to find the answers to problems for which we have no present solution.

Photoelectricity is probably the least familiar of the above-named subjects and, as it deals with the light-sensitive cell, which has the same great importance in this form of communication as the "thermionic" vacuum tube in radio broadcasting, the theoretical and practical aspects of this science and the general facts regarding cells are considered here.

THE PHOTOELECTRIC EFFECT

The photoelectric cell itself is a converter of light intensities into electric currents which may be amplified and employed in accordance with ordinary electrical practice. The conversion of light into extremely minute electrical impulses is brought about by what is known as the photoelectric effect. This effect is due to the fact that an insulated metallic conductor loses negative electricity when illuminated. The loss of negative electricity is caused by the emission of electrons from the conducting surface. Moreover, the quantity of electrons emitted varies with the intensity of the light which influences the action. Thus, stated in the form of a rule, we say that the photoelectric effect is proportional to the intensity

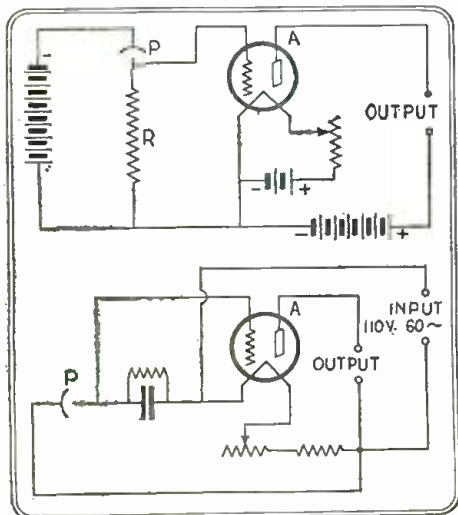

Fig. 2. Two methods of connecting a photoelectric cell in the grid circuit of an amplifier tube, which is necessary in advance of a mechanical relay. One draws its current from a battery, and the other from the lighting mains.

of the illumination and to the time during which it acts.

This proportionality between the intensity

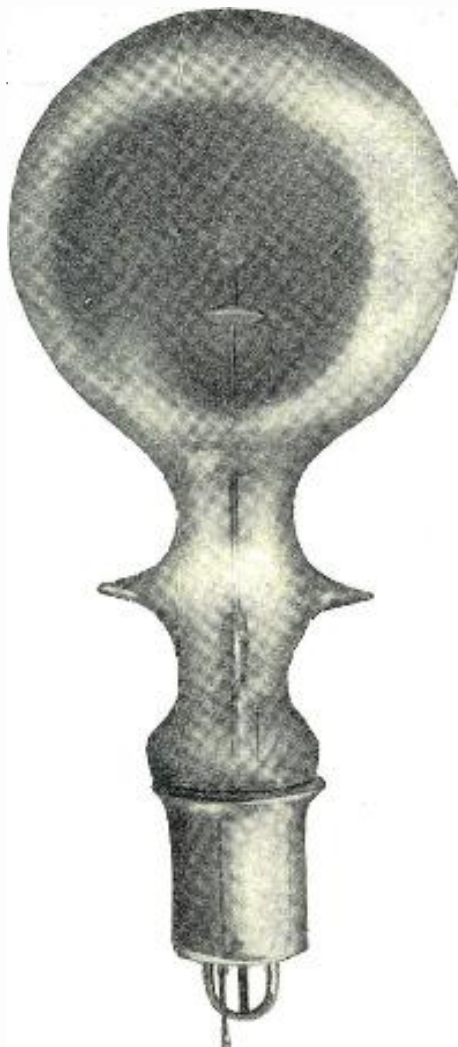

Fig. 1 illustrates the construction of a photoelectric cell. The sensitive material of the cathode or "plate" is deposited on the inside surface of the glass, leaving a small window of clear glass to admit light. The second element, or anode, extends down the middle of the tube.

Photograph by courtesy of General Electric Co.

of the illumination and the electronic emission is strictly true; and whatever apparent departure from this law is noted may usually be attributed to incorrect design or to certain conditions of ionization which are especially characteristic of the gas-type cell.

Investigation has shown that, for whatever metal is used as a conductor, there is a definite wavelength at which the photoelectric effect takes place. The minimum frequency required to produce this phenomena shifts continuously toward the red end of the spectrum as the light-sensitive material is made more electro-positive. (See RADIO NEWS for June, 1927, page 1422.) As the "alkaline" metals (sodium, potassium, lithium, caesium and rubidium) respond to radiations in the visible part of the spectrum, these substances are used in cells for visual communication.

The loss of electrons which a photoelectric body undergoes when illuminated may be observed to take place either in a vacuum or in gases. This has led to the development of two general types of cells, both using

for the conductor or plate one of the alkaline metals in the form of a hydride (a compound of the metal with hydrogen), which is more sensitive than the pure metal. They differ mainly that in one the plate is placed in a highly-evacuated tube; while in the other it is contained in an inert gas, such as argon at low pressure. In the construction of such cells great care is taken to prevent oxidization of the plate and, for this and other reasons, they are more thoroughly exhausted than the ordinary vacuum tube.

CONSTRUCTION OF THE CELL

To illustrate more clearly photoelectric action, it is useful to describe the modern cell. The PJ-1 and PJ-5, gas-filled and vacuum types respectively, are taken as examples. These cells are 5 3/4 inches long and the glass tube has a maximum diameter of 2 3/4 inches. The light-sensitive material is deposited on a silvered surface, on the inside of the tube, with a connection leading out through the glass. The only other element is the anode, or filament, which has a lead also brought out of the tube. A small aperture of clear glass allows light to fall on the plate. When a potential is applied and the plate illuminated, a current flows from the latter to the filament. Fig. 1 shows the typical cell; but others vary in size, shape and design.

Two methods of connecting cells to the input of the familiar three-element tube, using either a direct or an alternating potential across the terminals of the cell, are shown in Fig. 2. Either the gas-filled or the vacuum types may be used with these circuits; the essential difference being that the gas-filled cell, because of ionization, passes a greater current. In the diagrams P indicates the conventional symbol for the cell. In order to minimize the effect of tube leakage, the value of R lies between one and ten megohms. Theoretically, however, the higher the resistance used, the more sensitive the circuit will be.

Fig. 3 is a graph showing the current-voltage characteristic curves of a gas-type cell with direct current applied across its terminals. These curves were taken at the distances indicated from the source of illumination, which was a 250-watt Mazda lamp.

(Continued on page 707)

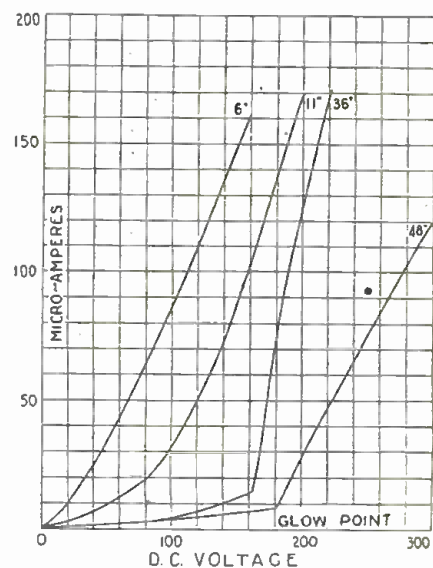

Fig. 3. The characteristic curve of a photoelectric cell. As it approaches a given source of light, proportionately less voltage is required to produce unit flow of "plate" current. The "plate" in this tube, however, corresponds electrically to the filament of the ordinary tube.

Radio Wrinkles

HOME-MADE RHEOSTAT

VARIABLE rheostats, which provide a fine control for the detector or other critical tubes, may be constructed easily from an old battery carbon, a renewable fuse (250-volt 100-ampere size), a knob, two springs, and a piece of threaded rod with nut to fit.

With a hack saw cut twelve carbon discs, $\frac{1}{8}$ -inch in thickness, from the battery carbon. Next take a piece of 8/32 threaded rod, two inches long, and a nut to fit the thread. A hole just large enough to pass this rod is drilled in the fuse cap. The nut may now be soldered outside the fuse cap in such a way that the rod will pass through the thread of the nut and into the hole in the cap. With the rod in position, place a spring on the inside of the fuse cap and hold it in position by soldering a metal disc, the size of a cent, on the end of the rod. A second spring may now be placed on the inside of the other fuse cap and the unit assembled as indicated in the drawings.

In operation the twelve carbon discs serve as the variable-resistance element. When they are stacked up under an applied pres-

14 insulated copper wire; and some charcoal.

The first operation is to remove the zinc case from a dry cell intact with no deter-

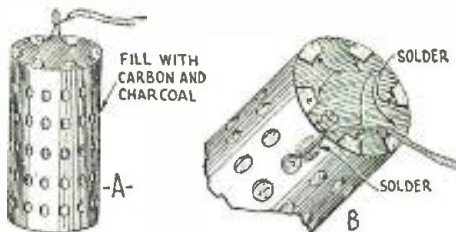

Worn-out dry-cell batteries of the round type may be used to advantage when making a ground for your set.

oriented spots. Then measure the diameter and cut two pieces of zinc sheet to fit the top and bottom of the cylinder. One of these is put in the bottom and soldered in place. The next operation is to crush up carbon, obtained from the dry cells, into lumps about half an inch in diameter and enough to fill half of the case. Then procure enough charcoal to fill up the remaining half. Put both the carbon and charcoal into a pan of water and let it stand twenty-four hours.

Next punch the zinc, all but the bottom, full of holes with a leather punch, and fill it with the carbon and charcoal, allowing about a quarter inch to put the top in. Mix the elements well. Put in the top, crimp the edge, and solder tight. Now scrape the insulation off the No. 14 wire; a piece is required long enough to reach from the ground post of your set to a depth of about three feet in the ground. The insulation should be scraped off clean for about 3½ inches. Wrap one turn around the binding post on the cell, and solder it tight.

All that remains now is to sink this into the earth; the proper depth depends on the type of soil; for clay, three feet is sufficient. For sandy soil, put it about five feet deep with a layer of pebbles around it. The location should be either under a faucet or where the rain will reach it. Before sinking it, make sure the wire is tight on the binding post. As an extra precaution solder may be flowed over the nut to prevent its loosening. If directions are followed, this ground will be found very satisfactory.

—Contributed by Morris S. Burton.

POWER-CONTROL SWITCH

WHEN using a "B" socket-power unit and a six-volt storage battery with a trickle charger for the operation of a receiver, it is sometimes necessary for the operator to throw as many as a half dozen switches when turning the set on or off. The difficulty is that, frequently, one switch is forgotten with very annoying, if not costly, results.

As a remedy for this trouble, several manufacturers have placed on the market automatic relay switches, but they are expensive.

A switching circuit which is equally as simple, and accomplishes exactly the same results, is shown in the accompanying diagram. One standard D.-P. D.-T. switch and a few feet of wire are the only parts re-

quired, and these are far less expensive than a power-control relay. The system is entirely foolproof and may be installed by a novice without difficulty.

By throwing the switch from the left- to the right-hand position the trickle charger is disconnected from the power circuit and from the "A" battery, the "A" battery is connected to the filament circuit of the receiver, and the "B" socket-power unit is connected with the power circuit. Returning the switch to the left hand position disconnects the socket-power unit, disconnects the "A" battery from the receiver, and connects the trickle charger with the battery and lighting circuit. These two operations are the only adjustments necessary in controlling the power to the receiver.

Another point of interest is that the switching system may be provided with an added use by raising slightly one of the poles of the switch (the one connected with the "A+" post of the receiver) with a small piece of metal. This change causes the tubes of the receiver to light before the "B" power is applied, and removes the latter before the tubes are extinguished. This

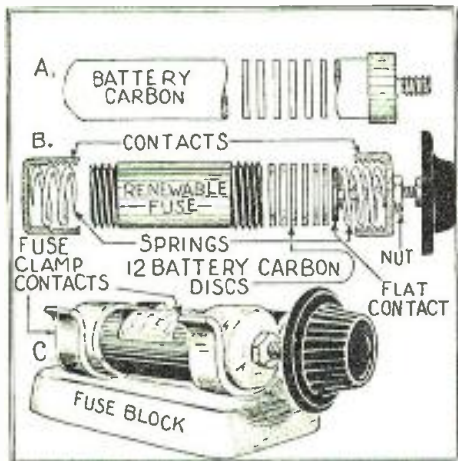

Parts which are available in almost every junk box may be employed in the construction of this efficient rheostat.

sure, the resistance is at a minimum; as the pressure is decreased, the resistance increases. The working principle is the same as that of the carbon microphone, in which various degrees of pressure are applied to carbon grains. Several rheostats are on the market which also operate in the same manner.

—Contributed by F. L. Ulrich.

AN IMPROVED GROUND CONNECTION

AS most fans know, if the earth around the ground wire or (where the water pipes are used as a ground) the pipes is kept very damp, much better reception is obtained. As it is almost impossible to keep the earth damp, here is a suggestion how to make a ground which will act like the hump on a camel's back, by storing up the moisture, and keep the earth continually damp around it.

The materials needed are several worn-out dry-cells of the round type; a piece of No.

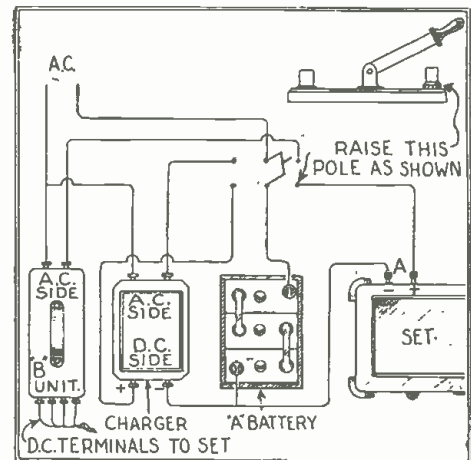

D.P.D.T. switches, when connected as shown above, provide a complete power control for a radio receiver.

is the desirable procedure, as it prevents voltage surges in the plate circuit, which might possibly cause damage to condensers.

—Contributed by A. Ferrand.

REDUCING HUM IN A.C. SETS

MANY radio fans have found it difficult to eliminate the alternating-current hum in the output circuit of receivers using the new A. C. tubes. In many cases it has been found that the hum is caused to a large extent by the close proximity of the radio-frequency and detector circuits of the set to the wires which carry the alternating current to the filaments of the tubes. By twisting the A. C. wires the hum may be reduced, but, in a compact receiver, it is sometimes necessary to employ shielding in order to obtain results.

For the purpose of shielding the A. C. wires it will be found that double armored cable, of the type used in automobile lighting circuits, may be used with success. The

(Continued on page 652)



Hook-up Review



Readers desiring more complete information about any of the sets described below can obtain it by writing to Hook-Up Review Editor, RADIO NEWS.

THE MAGNAFORMER 9-8

FOUR stages of intermediate-frequency amplification provide the superheterodyne circuit used in the Magnaformer 9-8 receiver with hair-splitting selectivity and extreme sensitivity. Nine tubes are used in the set, in a system comprising an oscillator, first detector, four intermediate stages, second detector, and two audio stages, including provision for a 112-type tube in the first stage and a 171-type power tube in the output circuit.

All-modern features have been incorporated in the mechanical design of the set. For tuning controls, lighted drum dials controlled by knobs are employed. In construction, practically all of the apparatus is mounted directly on the sub-panel, and all

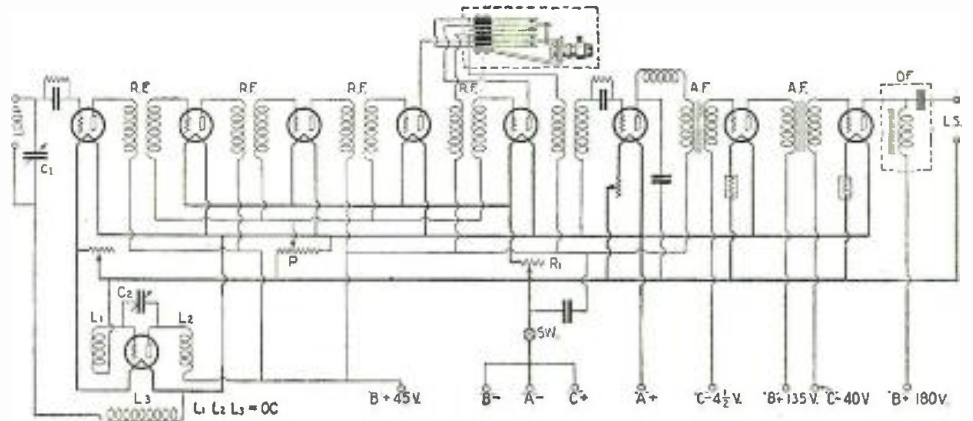

Lettering in the schematic wiring diagram of the Magnaformer 9-8 receiver (above) corresponds to that in the picture on the left: OC, oscillator coupler; R.F., intermediate-frequency transformers; A.F., audio transformers; C1, loop condenser; C2, oscillator condenser; R1-Sw, rheostat and switch; OF, output filter; P, volume control. The jack switch makes it possible to change from three to four stages of intermediate amplification.

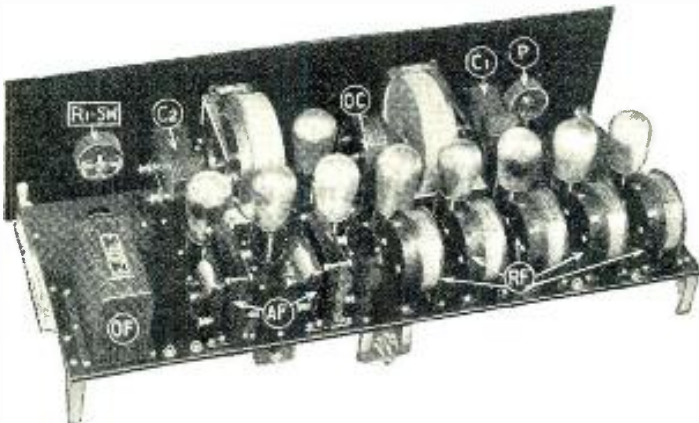

wiring is concealed under this panel in such a way that it cannot be seen from above. For making connections between the receiver and batteries, or power units, a cable plug is employed. Also, the battery switch is mounted on the shaft of the rheostat, thus reducing the number of controls.

In operation a loop antenna is used under most conditions, as ample sensitivity is thus available. For local reception only three

stages of intermediate amplification are required, but for distance four stages sometimes prove valuable. Such a change may be accomplished by turning a switch-knob on the front panel. If desired, an outdoor antenna may be employed, to gain still greater sensitivity, by connecting the antenna coupler into the circuit; but this is seldom necessary.

The parts required for the construction

of this receiver are available in convenient form. The complete list of apparatus employed follows:

Five Magnaformer transformers, R.F. No. 61; one "Unicoupler," C.U. No. 71; two Remler .0005-mf. variable condensers, and two "Universal" drum dials; two Ferranti A.F. transformers; one National tone filter; one Samson R.F. choke coil; two Aerovox .00025-mf. grid condensers, with mountings, and two Durham 2-megohm grid leaks; one Aerovox 1-mf. by-pass condenser and one Aerovox .001-mf. fixed condenser; one Frost "DeLuxe" 400-ohm potentiometer; three Frost rheostats, one 30-ohm, one 10-ohm, and one 10-ohm in combination with battery switch; two amperites, No. 112, with holders.

Front panel, 7x26 and sub-panel 9x25 inches, of 1/8-inch formica; two Benjamin sub-panel brackets, 2 inches high; nine Benjamin sockets; four Frost tip jacks; Yaxley cable connector and plug; one Yaxley jack switch; 12 feet Acme bus-bar (No. 14 round tinned) and 25 feet Acme flexible spaghetti-covered wire; one wood block 3/8x3/8x2 inch for the sub-panel's center support and two 2-inch right-angle supports for rear of sub-panel; wire, screws, nuts, bolts and solder.

THE MADISON-MOORE "ONE-SPOT" SUPERHETERODYNE

"ONE-SPOT" reception is the chief claim of the designers of the new Madison-Moore Superheterodyne Receiver for their novel eight-tube circuit. In the past, reception with many receivers of the double-detection type has often caused annoyance due to two inherent difficulties experienced with their design. One is the fact that, frequently, the "high beat" of one

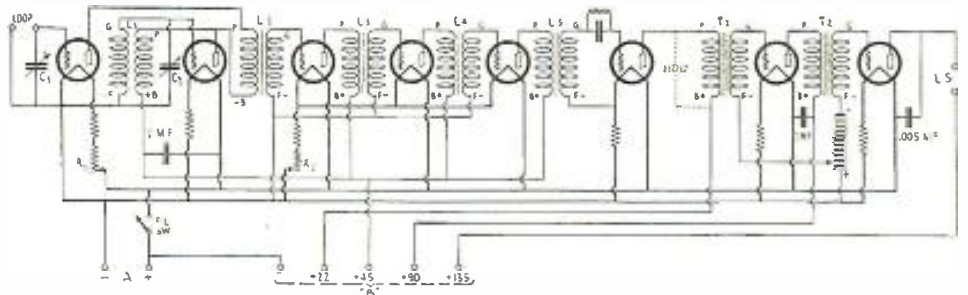

Eight tubes are used in the Madison-Moore "One-Spot" superheterodyne circuit (above). The rear view (left) shows the arrangement of parts: L1, oscillator coupler; L2 to L5, intermediate-frequency transformers; C1, loop condenser; C2, oscillator condenser; R1 and R2, filament rheostats; T1 and T2, audio transformers.

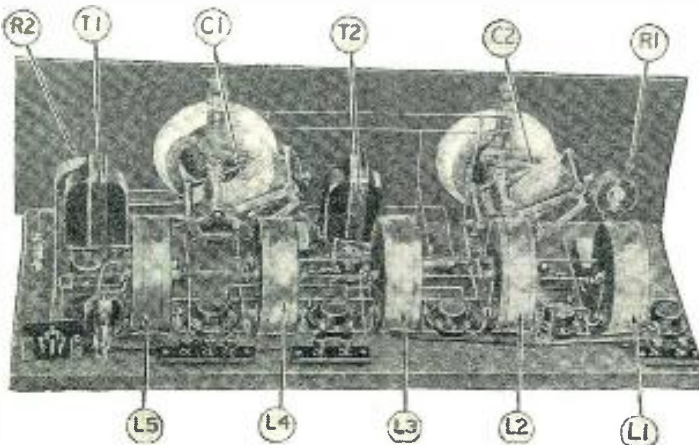

station would interfere with another station whose wavelength corresponded on the dial to the setting of the first station's "high beat." Secondly, in many superheterodyne designs, the reappearance of a station at two or more points on the dial is quite possible. In congested broadcast areas these two characteristics of the circuit detract greatly from the utility of the receiver.

In the receiver under discussion a new circuit is employed which gives the set extreme selectivity, yet makes it incapable of bringing any particular station twice within the tuning range, provided the circuit is properly adjusted. The way in which this circuit differs from others is in the method of providing the heterodyne action, and the means of coupling the intermediate frequency to the amplifying tubes.

(Continued on page 694)

Radiotics

ALMOST A PORTABLE



Hefty item from the *New Haven Evening Register* of Sept. 21: "The average radio receiver contains approximately 1,500 POUNDS, including the last screw and lug and other minute parts. It must be that sets have to be weighted down these days so they won't reach out after too many DX stations. Hey, Johnnie, get me a couple pounds!"

Contributed by H. A. Smith.

DOES IT RATTLE OR HONK?

This gem was found in the *Omaha Bee* of Sept. 18: "Apparatus for AUTOMOBILE reception of SOS signals is being fitted to British ships carrying only one radio operator." We are sending Mike out on this story, as we want to know whether the signals come in better on a Ford or a Stutz.



Contributed by L. M. Marks.

AND A YARD WIDE?



Influence of the clothing industry on radio, expressed by an advertisement in the *Detroit News* of Sept. 16: "An ALL-WOOL horn gives you a clear, rich, natural tone." You might think that the shoemaker would stick to his last and the tailor to his goose; but then nobody is ever satisfied with his lot in this world.

Contributed by Max J. Reynolds.

HUSBANDS, PLEASE NOTE

Marital order from a caption in the *Bridgeport (Conn.) Times-Star* of Sept. 10: "Check all connections. Permit no WIFE to make contact with metal of unit." This sounds like ordinary good sense to us; for, if there is one thing that women as a whole do not know enough about, that thing is radio. Believe us, we know.



Contributed by Edward Krumm.

AND IN THIS CORNER—



A receiver designed evidently for reception of prize fights is advertised in the *Rochester Democrat and Chronicle* of August 7, as follows: "Bosch BRUISER, List Price, \$100." We have not yet found out if this set's nickname is the Manassa Mauler; but it is said to have a great capacity for punishment.

Contributed by W. E. Hayes.

OIL MEN, ATTENTION!

New electrical gadget for well-diggers mentioned in the *New York Herald-Tribune* of August 7: "Three 5-volt, 1/4-amp. voltage, REDUGLATORS." Instead of the older method of using the go-level to start up an oil well, our guess is that the modern digger uses one of these, while he sits back and watches it dig.



Contributed by T. F. Maher.

WONDERFUL DEVELOPMENT IN TUBES



On page 54 of "How to Make a One-Tube Regenerative Set" we find under the title of "Electron Tube Rectifier" that it is a device "for rectifying A.C. by utilizing electron flow between a HAT cathode and a relatively cold ELECTRON-EMISSIVE anode in a vacuum." No wonder the cathode high-hats the anode when the latter takes its job away.

Contributed by Gilbert Hartley.

HINT FOR EMPLOYERS

How to speed up salesmanship is explained in the *Freehold, N. J. Transcript* of July 15: "ELECTRICALLY CHARGED Workers Make a Record Selling Preferred Stock." The stunt is, Mr. Employer, to get a battery charger and, before you send your gang to work in the morning, give each of them a good healthy shock.



Contributed by Herman Swerdloff.

WE DON'T WANT IT



too much,

Contributed by Walter Hawkins.

One of the eight distinctive features of a new circuit explained in the *Citizen's Radio Call Book* of September, 1927: "5 or 10 TUNE reception by the throw of a switch. Local or DX." To our mind that's not such a hot recommendation for any set. Our motto is just one tune at a time; that's plenty—sometimes

WHAT! NO ELECTRONS?

Another enormous stride forward is shown in the *Barwick Co.'s* catalog, in an advertisement on page 51: "This construction with proper arrangement of the grid provides perfect symmetry in OMISSION and control of electrons." What on earth do they want to control the little things for if they omit them altogether? 'Sunny.



Contributed by Charles R. Kimes.

ALL TANGLED UP!



ttery cells? Oh migosh!

From the *New York Daily Mirror* of August 31, we gather in this advice: "The easiest way to get four volts for your 99 tubes is to take a TAPE off the second bridge of your 6-volt storage battery." Will some kind soul come to our aid and tell us why, oh why was tape ever put on the connector of the storage-battery cells? Oh migosh!

Contributed by Helene A. Maher.

IN DAYS OF OLD

Financial news from the *Iowa Homestead* of August 18: "The value of radio sets and accessories sold in the U. S. in 1926 was \$506,000,000, an increase of \$76,000,000 over 1925." We think that these latter figures are just a little off. If we remember correctly Christopher didn't hit these shores till a few years after.



Contributed by Willard Brinegar.

IS THIS THE TANK CIRCUIT?



Scientific note from the birthplace of the electron, in the *Schenectady Gazette* of Sept. 10: "Electrons Play Biggest Role in Vacuum CLEANER." (This is the title of an article on radio.) We know the vacuum cleaner is an important thing around the home, but we'd like to debate the above statement.

Contributed by J. P. Hauschild.

A NEW TERM FOR BLOPING

New radio word invented by the *Detroit Sunday News* of August 14: "Trouble with BROADCASTING . . . is that the radio audience may believe its ears." Undoubtedly this word applies to some sort of a squealer, whether it be a broadcaster or receiver. If some of the people near us don't stop broadcasting, we're going to sic Mike on 'em and he's rough.



Contributed by W. G. Mortimer.



Radio News Laboratories



RADIO manufacturers are invited to send to RADIO NEWS LABORATORIES samples of their products for test. It does not matter whether or not they advertise in RADIO NEWS, the RADIO NEWS LABORATORIES being an independent organization, with the improvement of radio apparatus as its aim. If, after being tested, the instruments submitted prove to be built according to modern radio engineering practice, they will each be awarded a certificate of merit; and a "write-up," such as those given below, will appear in this department of RADIO NEWS. If the apparatus does not pass the Laboratory tests, it will be returned to the manufacturer with suggestions for improvements. No "write-ups" sent by manufacturers are pub-

lished in these pages, and only apparatus which has been tested in the Laboratories and found of good mechanical and electrical construction is described. As the service of the RADIO NEWS LABORATORIES is free to all manufacturers, whether they are advertisers or not, it is necessary that all goods to be tested be forwarded prepaid, otherwise they cannot be accepted. Apparatus ready for, or already on, the market will be tested for manufacturers free of charge. Apparatus in process of development will be tested at a charge of \$2.00 per hour required to do the work. Address all communications and all parcels to RADIO NEWS LABORATORIES, 230 Fifth Avenue, New York City,

A. C. VACUUM TUBE

The vacuum tube shown, submitted by the Sovereign Electric & Mfg. Company, 127 No. Sangamon St., Chicago, Illinois, operates from the A.C. house-lighting line and is of the heated-cathode type. The electron-emitting element or cathode has the shape of a narrow sleeve. It is made of a thin nickel strip, 1-3/8x 3/16 inches, coated with oxides of rarer metals, and adheres closely to the insulating portion of the heater. The heating element, which is connected to the prongs of the base of the tube, operates at 3 volts and takes 1.1 amperes. The grid and



the plate are of conventional cylindrical section. This tube uses a four-prong standard-type base and does not require a special socket. The plate voltage may be as high as 190 volts. The average value of the amplification constant of a tested group of six tubes was 8.3; the average impedance was approximately 14,000 ohms at 90 volts and 17,000 ohms at 45 volts. This tube has been found to operate very satisfactorily, both as an amplifier and as a detector.

AWARDED THE RADIO NEWS LABORATORIES CERTIFICATE OF MERIT NO. 2117.

CAGE-AERIAL EQUIPMENT

The aerial shown, submitted by the Radio Test Laboratories, 3036 Fifth Avenue, Los Angeles, Calif., is of the cage type. It is approximately 18 feet long and is composed of six stranded brass cables, soldered

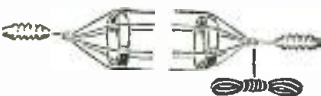

to four sturdy brass rings spaced about four feet apart. At both ends of the aerial the wires are soldered to short, heavy brass rods, to which are connected pyrex insulators. A rubber-insulated lead-in cable is fastened to one of the rods.

AWARDED THE RADIO NEWS LABORATORIES CERTIFICATE OF MERIT NO. 2129.

RADIO-FREQUENCY TRANSFORMER

The R.F. transformer (type 4B shown) submitted by the Precision

Coil Company, 209 Centre Street, New York, N. Y., is of the binocu-



lar type. Two bakelite tubes, 2 3/4 inches long and 1 1/2 inches in diameter, are used for each transformer. The tubes are threaded and thus ensure a uniform and secure spacing for the winding, which is of enameled wire. The primary is wound in the centre of one of the tubes and is of silk-covered wire. Two brackets permit very easy mounting. This coil covers the broadcast range when tuned by a variable condenser of .000275-mf. capacity.

AWARDED THE RADIO NEWS LABORATORIES CERTIFICATE OF MERIT NO. 2141.

VACUUM TUBE

The vacuum tube (type N-27 shown) submitted by the C. E.



Mfg. Co., Inc., Providence, R. I., is designed to be used as a detector or an amplifier in radio receivers, and operates on raw A.C. The electron-emitting element (cathode) is insulated from the heated "filament," which serves only to bring it to the temperature necessary for the emission. The normal heating current is 1.75 amperes and a potential of 2.5 volts across the filament is required. The plate voltage is 45 when the tube is used as a detector, and 90 or 135 volts when it is used as an amplifier. The characteristics of this tube were found to differ very little from those of the "A"-type tube made by the same company; its operation as a detector is very satisfactory. This tube has a 5-prong base and can be used with the new standard "Y"-type sockets.

AWARDED THE RADIO NEWS LABORATORIES CERTIFICATE OF MERIT NO. 2151.

BATTERY CLIP

The battery clip shown, submitted by the Shanklin Manufacturing Company, 2729 South Eleventh Street, Springfield, Ill., is made of a lead-covered steel band. It is very sturdy and insures a perfect contact with the battery terminals. A screw and a lug permit an easy and safe attachment of this clip to the battery cable.



AWARDED THE RADIO NEWS LABORATORIES CERTIFICATE OF MERIT NO. 2154.

VERNIER DIAL

The vernier dial shown, submitted by the Ormond Engineering Co., Ltd., 205 Pentonville Road, London, N. 1,



England, is very well constructed and of extremely neat appearance. The 4-inch dial is of aluminum and is fastened by means of three screws to the frame, which is of black molded bakelite. One of those screws is of sufficient length to pass through the dial to the latter. The upper half of the dial has two scales, an outer and an inner. The first is divided into 180 degrees, while the second has 100 equally-spaced divisions. The lower half of the dial is divided by eight radial lines for logging purposes; the indicator used is of the hair-line type and permits very accurate reading. A large split hollow screw attaches the indicator to the condenser shaft. The vernier arrangement is of the friction type, and has a ratio of approximately 14.

AWARDED THE RADIO NEWS LABORATORIES CERTIFICATE OF MERIT NO. 2156.

PLATE-POWER UNIT

The "Duo Power" (Model 28-A shown) submitted by the R. C. E. Sales Co., Minneapolis, Minn., is a "B" power-supply unit which operates on 110-volt 60-cycle house-lighting current, and uses a full-wave gas-filled rectifier tube. The current output of this device is sufficient to operate almost any radio receiver on the market. The quality of the



current delivered is satisfactory and no hum whatever was heard.

AWARDED THE RADIO NEWS LABORATORIES CERTIFICATE OF MERIT NO. 2161.

METALLIC PANEL

The "Universal" panel shown, submitted by the Wireless Radio Corporation, Varick Avenue and Harrison Place, Brooklyn, N. Y., is 7x 18 inches and made of iron, having a brown crystalline finish. Two illuminated vernier dials of the back-panel type, of very simple construction, are mounted on this panel. Fiber bushings in the holes intended for the mounting of rheostats, potentiometers or switches, insulate them from the panel. The panel is supplied with brass brackets for base-board or sub-panel mounting.



AWARDED THE RADIO NEWS LABORATORIES CERTIFICATE OF MERIT NO. 2164.

TUNING-CONDENSER UNITS

The "Tandem Panatrol" shown, submitted by the same company, is a combination of two condensers controlled by one shaft. Both condensers are mounted on the same stamped brass panel. The link connection between the condensers, which is mounted on the rear ends of the shafts, is so well constructed

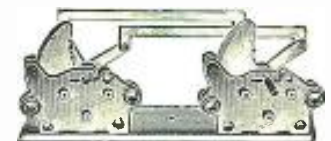

that the driven condenser follows exactly all the motions of the driving unit. This unit can be used for baseboard or panel mounting.

AWARDED THE RADIO NEWS LABORATORIES CERTIFICATE OF MERIT NO. 2165.

The drum-dial outfit shown, submitted by the same company, consists of two gangs of two condensers each, rigidly mounted on two small bakelite panels which, together with special brass brackets and rods, form the mounting frame. A drum dial is mounted on the inner end of each shaft; the knurled rims of the

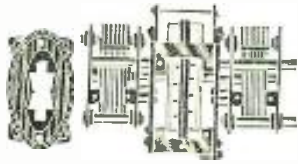

dials are so close that both gangs can be operated simultaneously with the same finger. Two geared wheels, mounted on the shaft of each gang between the condensers, permit vernier control. The condenser assembly is supplied with a very neat front panel.

AWARDED THE RADIO NEWS LABORATORIES CERTIFICATE OF MERIT NO. 2166.

AUDIO-FREQUENCY TRANSFORMERS

The A.F. transformer (type M or type M2 shown) submitted by the Modern Electric Mfg. Co., Toledo, Ohio, is electrically a very efficiently-designed instrument. The amplification of this transformer, within the range of the audio frequencies practically used, has almost a constant value, a fact which explains the very fine reproduction of music and speech when this transformer was used in an audio-frequency amplifier, in connection with 201A-type tubes having the correct "A" and "C" voltages. This transformer is shielded completely in an iron shell with a brown crystalline finish.

The output transformer submitted by the same company, is similar in construction to the instrument described above. It has a ratio of 1:1 and is intended to be used between the last audio tube and the loud speaker, to prevent the flow of direct current from the plate to the loud-speaker winding. The external dimensions and appearance are the same as that of types M1 and M2.

AWARDED THE RADIO NEWS LABORATORIES CERTIFICATE OF MERIT NO. 2167.



The A.F. transformers (types M4 and M5) submitted by the same company, are of the push-pull type, and embody the general features of the audio-frequency transformers (types M1 and M2) made by the same company. These are designed to be used in the last audio stage, where they must handle without distortion a very heavy load.

AWARDED THE RADIO NEWS LABORATORIES CERTIFICATE OF MERIT NO. 2168.

VARIABLE CONDENSER

The variable condenser shown, submitted by Magnettandning, Klara Ostra Kyrkogata 1, Stockholm, Sweden, is of unique construction. Four thin, specially-shaped nickel-silver plates are separated by three thin but strong mica sheets, 2 1/4 x 1 1/2 inches, and form the capacity elements of this condenser. The forward and backward motion of a



molded bakelite plate at the rear of this condenser is controlled by a threaded shaft. This bakelite plate

compresses the curved condenser plates and tends to flatten them out, thus decreasing the spacing between them and varying the capacity. About five and a half revolutions of this shaft are necessary to obtain the maximum capacity, which is approximately .0005-mf. The celluloid dial of this condenser is divided on its periphery into 100 equal parts, and is provided with a spiral groove of approximately 5 1/2 turns, which are numbered from 1 to 5. The pointer of the bakelite knob is a short rod, on which a little wheel slides very smoothly. The pointer is very close to the dial and the position of the little wheel is controlled by the grooved spiral; so that the number of revolutions of the condenser shaft is shown by the position of the wheel in the groove. This condenser is very compact, light and well-built mechanically.

AWARDED THE RADIO NEWS LABORATORIES CERTIFICATE OF MERIT NO. 2169.

"Y"-TYPE TUBE SOCKET

The tube socket shown, submitted by the Pilot Electric Mfg. Co., Inc.,



323 Berry Street, Brooklyn, N. Y., is of black molded bakelite and designed to be used with the heated-cathode A. C. vacuum tubes of the UY-227 type, having five prongs. This socket is well built and insures a good contact with the prongs of the tube.

AWARDED THE RADIO NEWS LABORATORIES CERTIFICATE OF MERIT NO. 2172.

FIXED CONDENSER

The fixed condenser shown, sub-



mitted by the same company, is of the paper type and intended for use as a buffer condenser, across the secondary of the step-up transformer in "B" power-supply units. It has two sections, each with a capacity of 0.2 mf., and is sealed in a japanned iron can, whose external dimensions are 5 x 2 x 3/8 inches. It is rated to operate on 300 volts direct current.

AWARDED THE RADIO NEWS LABORATORIES CERTIFICATE OF MERIT NO. 2173.

CONDENSER BANK

The condenser block shown, sub-



mitted by the same company, is designed to be used in filter systems of power supply units for radio receivers. This block is formed of six individual condensers, each of 2-mf. capacity, and one double buffer condenser, of the type above described. All of those condensers are held together by four threaded rods, two plates and two brackets. Each individual condenser has an operative rating of 300 volts direct current, and is enclosed in an iron can, 5 x 2 x 3/8 inches. This way of forming filter blocks is extremely convenient and flexible, as it permits

various combinations and the replacement of damaged elements without much trouble.

AWARDED THE RADIO NEWS LABORATORIES CERTIFICATE OF MERIT NO. 2174.

HEAVY DUTY RESISTORS

The fixed-resistance unit shown submitted by the same company, is of the wire-wound type. The enameled resistance wire is wound on



an isolantite tube, 1 1/8 inches long and 3/16-inch in diameter. Two narrow rings, tightened upon the tube by screws and nuts, immobilize the ends of the resistance wire with which they make contact. Two mounting brackets are attached to this unit by a screw passing through the isolantite tube. This resistance element is capable of carrying relatively heavy loads.

AWARDED THE RADIO NEWS LABORATORIES CERTIFICATE OF MERIT NO. 2175.

TAPPED RESISTOR

The resistance unit shown, submitted by the same company, is similar in constructional principles to the element described above. Its isolantite tube is somewhat larger, 4 1/2 inches long and 3/8-inch in diameter, and is provided with taps so that the resistor can be used very conveniently in "B" or "A" power-supply units.



AWARDED THE RADIO NEWS LABORATORIES CERTIFICATE OF MERIT NO. 2176.

HEAVY-DUTY SWITCH

The toggle switch shown, submitted by the same company, is of molded bakelite and very neat in appearance. It is supplied with either a black or a polished-nickel front plate. This switch is rated to break safely a circuit carrying 1 1/2 amperes on a 110-volt line.



AWARDED THE RADIO NEWS LABORATORIES CERTIFICATE OF MERIT NO. 2177.

SHIELDED TUBE SOCKET

The shielded socket shown, submitted by the Tyrman Electric Corp., 143 W. Austin Ave., Chicago, Ill., comprises two parts, the socket itself and the shield. The socket is of molded bakelite, and constructed to allow either haseboard mounting or sub-panel wiring. Its springs insure a good contact with the prongs of the tube. The shield is of aluminum and slides over the socket; it is equipped with screws and nuts for the grounding connection.



AWARDED THE RADIO NEWS LABORATORIES CERTIFICATE OF MERIT NO. 2178.

RECTIFIER TUBES

The "Radiotron" UX-280 tube shown, submitted by the Radio Corporation of America, 233 Broadway, New York City, is a full-wave rectifier, designed for use in "B" power-supply units operating on A. C. The filament is of the oxide-coated type and operates at red heat; it has a normal heating current of two amperes. This current, at 5 volts, is supplied by one of the windings of the power transformer in the "B" unit. Because of the relatively low heating temperature of the filament, the life of the tube is considerably lengthened. Maximum voltage which can be applied is 300 volts A. C. on each plate, and the maximum output is 125 milliamperes direct current. Although this rectifier is designed



for power units with a considerably greater output, it can be utilized very conveniently in "B" power units now using a UX-213. A standard large RCA UX base is used.

AWARDED THE RADIO NEWS LABORATORIES CERTIFICATE OF MERIT NO. 2179.

EXTENSION CORD

The extension cord shown, submitted by the Belden Manufacturing



Co., 2314 So. Western Avenue, Chicago, Ill., is 25 feet long and composed of two rubber-covered stranded wires braided into one cable. Phone tips are soldered to the ends of the wires, and a light but sturdy bakelite extension connector is supplied with this cord.

AWARDED THE RADIO NEWS LABORATORIES CERTIFICATE OF MERIT NO. 2181.

A. C.-OPERATED RECEIVER

The radio receiver shown, submitted by the Metro Electric Company, 2171 No. California Avenue, Chicago, Ill., is of the batteryless type and operates directly on 110-volt 60-cycle house-lighting current. This receiver uses seven Sovereign A. C. tubes of the heated-cathode type. A full-wave gas-filled rectifier tube, in connection with the neces-



sary filter system, supplies the "B" voltages. This receiver embodies three stages of tuned radio frequency, one tuned detector and three audio stages. The tuning of the first four stages is controlled by one dial, as the rotors of all four tuning condensers are on the same shaft. A final adjustment of the tuning is obtained by operation of the levers projecting through the panel on both sides of the dials; these levers permit a slight rotation of the stators of three condensers. A choke coil and a fixed condenser prevent the direct current of the plate of the last audio stage from flowing through the loud-speaker windings. The general appearance of this receiver is very attractive, and its operation is satisfactory with regard to both quality and volume.

AWARDED THE RADIO NEWS LABORATORIES CERTIFICATE OF MERIT NO. 2182.

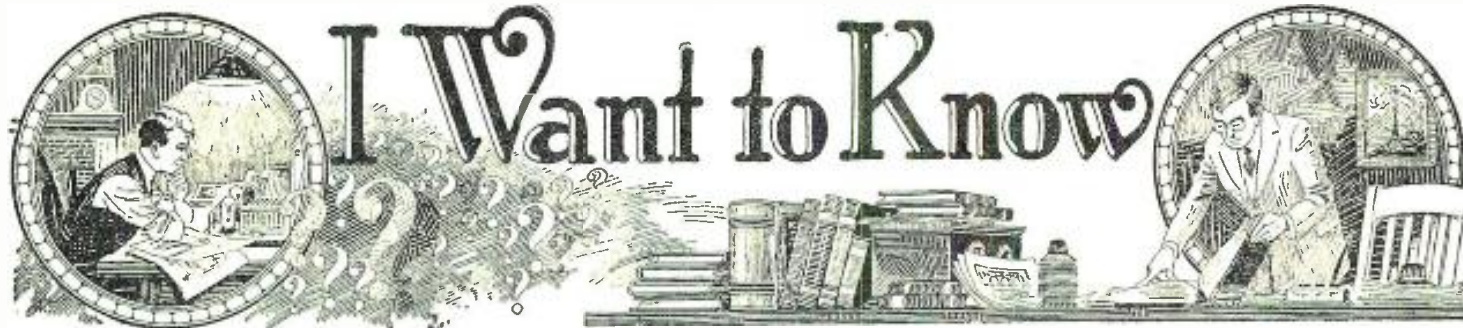

Conducted by C. W. Palmer

THIS Department is conducted for the benefit of our Radio Experimenters. We shall be glad to answer here questions for the benefit of all, but we can publish only such matter as is of sufficient interest to all.

1. This Department cannot answer more than three questions for each correspondent. Please make these questions brief.
2. Only one side of the sheet should be written upon; all matter should be typewritten or else written in ink. No attention paid to penciled matter.
3. Sketches, diagrams, etc., must be on separate sheets. This Department does not answer questions by mail free of charge.
4. Our Editors will be glad to answer any letter, at the rate of 25c. for each question. If, however, questions entail considerable research work, intricate calculations, patent research, etc., a special charge will be made. Before we answer such questions, correspondents will be informed as to the price charge.

SHORT-WAVE SUPER-REGENERATIVE RECEIVER

(Q. 2255.) Mr. G. H. Blake, Tcaneck, N. J., asks as follows:

Q. I would like to have constructional details for building a short-wave super-regenerative receiver. I have heard some reports that super-regeneration on short waves produces extraordinary results, and I would like to experiment to a certain degree with a circuit of this type.

A. You will find the circuit of a one-tube short-wave super-regenerator on this page (Fig. Q. 2255). Some remarkable results have been obtained with

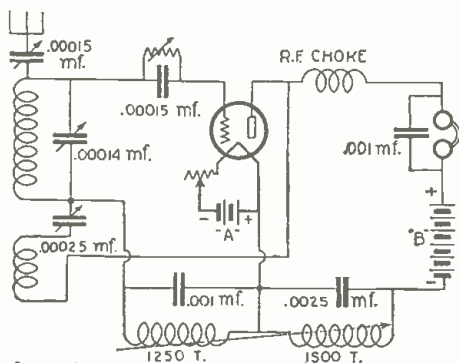

Q. 2255

The schematic diagram of a very successful short-wave super-regenerator is shown above. The .001-mf. condenser across the honeycomb coil should, preferably, be variable.

super-regenerative circuits on short waves; and we believe that you will be highly pleased with the results of this receiver when you get it working properly. The parts are standard and the assembly is simple. The radio-frequency inductors are Aero plug-in-type short-wave coils, both on one mounting; they may be had in a set of three covering a band from 15 to 130 meters. The grid coil is tuned with a .00014-mf. variable condenser, while the regeneration is controlled by a .00025-mf. condenser. The antenna tuning condenser may be of the semi-variable type, such as the "Variodens" manufactured by the X-L Laboratories.

The grid coil of the low-frequency oscillator is a 1250-turn honeycomb coil shunted by a .001-mf. condenser, preferably variable, as its value is somewhat critical. This condenser also may be of the semi-variable type. The plate coil is a 1500-turn honeycomb coil shunted by a .0025-mf. condenser. The coupling between the two honeycomb coils should be easily adjustable, from very loose to very tight coupling.

Good results can be secured with a tube of either the 201A or the 199 type. The filament battery and filament rheostat, of course, are selected to suit the type of tube used. The one difficult point in the operation of this set is the adjustment of the coupling between the two honeycomb coils; these should be adjusted until the oscillating action is just at the point of stopping. This may require several trials but, once it is accomplished, the coupling may be left in its proper position and the set operated without changing it. When nothing is heard except a faint, high-pitched hum, adjust the variable grid leak until the set will go into and out of regeneration with only a slight pop. Then tune for the signals with the usual tuning controls and readjust the grid leak until the best results are secured.

The set has good selectivity, though the tuning

is broad enough to "hang onto" swinging signals. The volume obtained is nearly double that ordinarily obtained on short waves with a single tube. The howls, squeals and rustling noises which too often characterize super-regenerative receivers on broadcast waves are almost eliminated. The radio-frequency choke should be one that will cover the band of frequencies over which the receiver is to be operated, and the .001-mf. condenser across the phones is almost essential.

RAYTHEON BATTERY CHARGER

(Q. 2256.) Mr. E. J. Rhodes, Baltimore, Md., asks as follows:

Q. I would like to construct a full-wave charger using the new Raytheon cartridge units. Can you supply the necessary information for building a transformer and show, also, how the units should be connected?

A. Any well-made transformer of about 20 watts capacity, with a low-resistance secondary having an open-circuit voltage of between 8 and 9 volts, may be used. A transformer of this type may be easily constructed at home by obtaining some .014-inch core iron; you may either have this cut to the shape shown in the illustration or do the cutting yourself. This may be done easily with a pair of tin snips. Sixty-three pieces will be required for the complete core. The coils are wound on a cardboard tube, 7/8-inch inside diameter; and the windings are made as follows:

The secondary consists of two windings, wound directly on the cardboard tube, each consisting of 53 turns of No. 14 S.C.C. wire, wound in layer fashion. The end of the first winding and the beginning of the second are connected together, making a total on the secondary of 106 turns, tapped at the center. Several layers of empire cloth are wrapped over these windings and the primary coil is then wound; this consists of 750 turns of No. 24 enameled wire, also wound in layer fashion.

The small ends of the rectifying cartridges (type "A") are connected together and constitute the positive terminal (see Fig. Q. 2256); while the steel shells of the tubes are connected to the outer taps of the secondary winding on the transformer. The center tap of the secondary is connected to the

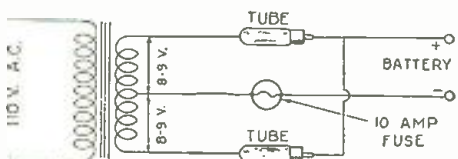
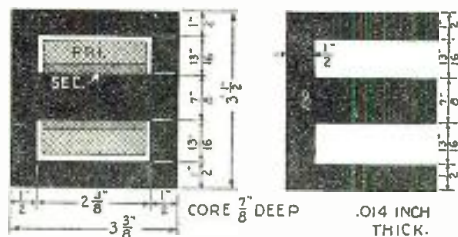

Q. 2256

The core of the transformer used with the Raytheon "A"-cartridge in a charger should be made from .014-inch material, cut to the shape shown.

negative terminal; in this lead a fuse of not over 10 amperes capacity must be inserted, to prevent damage should the output of the charger become short-circuited or the battery be connected incor-

rectly. Small automobilic-type cartridge fuses are excellent for this purpose.

When the windings are completely assembled and have been bound in place with friction tape, the core pieces should be inserted. These are "staggered," by inserting, first, a piece from the left and then one from the right. When all the core pieces have been inserted, they should be fastened into place so rigidly that no vibration will occur. This may be accomplished by drilling holes in the four corners of the transformer (filing down the rough edges so that the transformer core pieces will not be connected together); or else by constructing brass clamps which will fit over the ends of the core, and should be screwed down tightly.

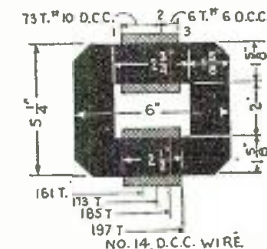
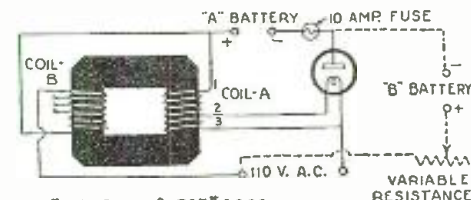

Q. 2257

A tungar charger which uses the five-ampere tube can be made with spare parts from the junk box of most amateurs.

The rectifying cartridges should be mounted, preferably, with the small end up and should be arranged in spring clips so that they may be readily renewed after their useful life is finished. These cartridges are guaranteed to give at least 750 hours of service and, under normal conditions, will give much more than that before replacement is necessary.

FIVE-AMPERE CHARGER

(Q. 2257.) Mr. R. D. Leady, Syracuse, N. Y., writes:

Q. I would like to construct a battery charger using a tungar five-ampere bulb. Can you publish the necessary information for building a charger of this type, including the details for making the transformer?

A. The operation of the tungar or other thermionic rectifier is fairly simple. It is well known that a heated filament in a vacuum will emit electrons which under a stress of potential, will flow in the direction of the applied positive voltage. In other words, if the hot filament be made the "cathode" and the coil plate the corresponding "anode," a stream of electrons will flow from the cathode to the anode. However, no current will flow in the reverse direction, from plate to filament. This effect is utilized in the type of charger which is described here.

To construct the core, 230 pieces of .014-inch core iron will be required. These pieces should be cut "L" shaped. 4 3/4 inches long, 5 1/4 inches wide and 1 3/8 inches deep (See Fig. Q. 2257). The coils are wound on cardboard or fiber forms 1 3/4 inches square and 2 1/2 inches long. Coil A consists of 73 turns of No. 10 D. C. wire. To place the wire on the form, it will be necessary to insert a wooden block in the fiber form because of the large size of wire used. When the 73 turns have been

wound, the coil should be tapped and 6 additional turns of No. 6 wire wound over the others. The wooden block should then be removed and the coil fastened securely. The end of the first coil and the beginning of the second are then connected together and the three wires brought out from the coil.

The other winding consists of 197 turns of No. 14 D. C. C. wire wound on a fiber tube similar to the one used in the first coil. This coil is tapped at the 161st turn, the 173rd turn and the 185th turn. It should be tapped in like manner to the other one.

The next point in constructing the transformer is the assembly of the core. This is done in staggered fashion. Insert the short legs of two of the pieces into the coil forms and make the edges of the two meet. Two more pieces are then inserted from the opposite sides, so that the completed core is bonded. When all of the core pieces have been inserted, a clamp should be constructed, so that the core cannot vibrate. This should be made of strip brass bent to the shape of the core and arranged with screw holes so that it can be clamped tightly in place.

The other apparatus necessary to complete the charger comprises a 5-ampere tungar bulb, one "jumbo" and one standard lamp socket and a 10-ampere fuse. This apparatus should be connected as shown in the diagram. The charger is then ready for operation. If it is desired to use it for charging "B" batteries, a 50-ohm resistor, capable of dissipating at least 1/2-ampere, is connected as shown in the dotted lines. A storage "B" battery of 50 volts can be charged in this way.

Operation

The complete charger can be installed in a metal container if desired. If this is done, care should be taken to insulate all the apparatus from the container so that no short circuits can occur. The variable resistor and the switches can be mounted on one of the sides of the can, if desired, so that they can be easily varied. When the charger has been assembled and connected to the battery for charging, inspection should be made of the initial performance. If possible, the charging rate should be measured, if only with a Ford-dash ammeter or similar device. When charging a 6-volt battery, the charging rate should be 5 amperes; on a 12-volt battery the rate will be about 2 1/2 amperes.

If the charger delivers less current than the above amounts, and still gives more current than zero, the taps on the coils B should be varied until the correct one is found. In case the charger fails to work at all, look first for broken or loose connections. Then try reversing the battery connections to see if charging ensues. Occasionally it will be necessary to add a small amount of wire to the filament winding, in order to obtain satisfactory starting of the tungar arc; but this should be necessary only if the transformer has been assembled or wound carelessly. The extra turns are necessary to offset the excess leakage-flux from the transformer core.

When the charger has been adjusted so that it appears to charge at the proper rate, it should be left charging for two hours, under inspection, before it is pronounced satisfactory. During the inspection period, tests should be made of the temperatures of the core and coil. They will normally run at such a temperature that the hand can just be held upon the hot parts without burning. If any of the parts becomes any hotter than this, look for short-circuited turns, low-quality steel, or careless assembly of the core. Any of these three faults will be sufficient to warrant rebuilding the transformer.

SHORT-WAVE RECEIVER COILS

(Q. 2258.) Mr. A. H. Lester, West Chicago, Ill., writes:

Q. I am looking for a little information in regards to the coils for the *RADIO NEWS Special Short-Wave Receiver*. Can you give me the size of the wire used on these coils, and also the number of turns?

A. The coils used in the receiver are as follows: the primary consists of 10 turns of No. 22

wire. 2 1/2 inches in diameter. This coil is used for all wavelengths and is fastened permanently to the mounting, on a hinge, so that the coupling with the other coils can be varied. The secondary of the smallest coil consists of 3 turns of No. 20 enameled wire, 3 inches in diameter. The tickler, 2 3/4 inches in diameter, is fastened inside the secondary coil and has only 2 turns. The next coil contains 8 turns of wire on the secondary and 4 on the tickler; the same sizes of wire are used. The third and largest set uses 19 turns on the secondary and 6 on the tickler.

The coils used for the broadcast band, from 200 to 500 meters, are both wound with No. 24 D. C. C. wire. The secondary contains 95 turns 3 inches in diameter and the tickler is wound with 12 turns. The large number of turns on the secondary is necessary because of the small capacity of the tuning condenser used with this receiver. The sec-

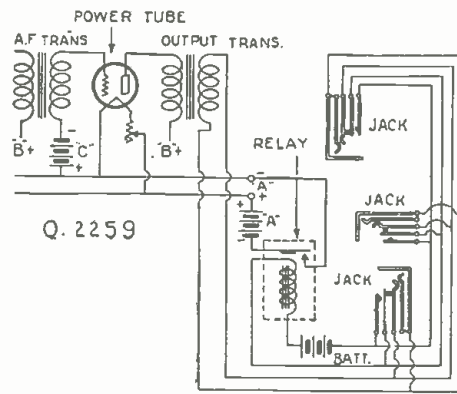

A house-wiring system which is particularly well adapted to large installations is shown here.

ondary coils, of all sizes, are supported on skeleton bakelite tubes; and the tickler and the primary coils are self-supported. The secondary coils used in the three short-wave coils are space-wound, 1/2-inch separation being used.

The differences in antenna constants, as well as in apparatus used, may make it desirable to remove turns from the secondaries, the better to cover the short-wave broadcast bands, as explained in *RADIO NEWS* for October (page 350). The user can quickly discover this by a few experiments.

HOUSE WIRING SYSTEMS

(Q. 2259.) Mr. W. F. Borchers, Bellefonte, Pa., asks:

Q. I have recently tried wiring my house so that phones or a loud speaker could be used in any room. The experiment failed completely, however. The music was distorted and the tubes did not seem to get enough current. Can you help me in this matter?

A. The simplest method for wiring a loud speaker to a distant set is merely to connect a length of electric-light flexible cable between the set and loud speaker. This method works fairly well if the leads are not too long. If they are of too great length, the upper musical notes will be weakened, owing to their being shunted away by the capacity formed, across the loud-speaker terminals, between the two long twisted wires. A considerable length can be used, however, without noticeable loss if ordinary flexible cable is used. If twin bell-wire is used, the higher tones are so reduced that very disagreeable distortion is introduced, and a muffled sound is given to speech.

The reason is that the capacity of this type of wire is high. Apart from this, it is not desirable to run wires all over the house that carry a high

D. C. potential (with respect to the earth); as there is risk of fire if a short circuit occurs, due to some mechanical scraping away of the insulation. This can easily be guarded against by the use of a choke-filter output circuit, or a transformer; and for various other electrical reasons, such as the question of magnetic saturation of the iron cores of loud speakers, a device of this kind should always be employed whenever a power tube is used in the output stage of the receiver.

The use of flexible cable will successfully overcome the capacity difficulty, but we are still bothered with the remote-control problem. This can easily be overcome by shunting a variable resistor of approximately 0 to 50,000 ohms across the loud speaker. Volume-control resistors similar to this, wire-wound or otherwise, can now be obtained, and should be connected permanently across the loud-speaker terminals. This will give a smooth control which is entirely satisfactory. Alternatively, we can use a jack in conjunction with a volume-control plug.

Switching the Filaments

Regarding the method of switching the set on and off, the first idea which occurs is merely to extend two wires, connected directly to the filament circuit, and to place a switch across the two at every place where there is a loud-speaker jack. There are a large number of objections to such a project; one of the principal ones being that there is a certain voltage drop along the wires which, in some cases, might reduce the actual filament voltage below the normal and thus affect the operation of the receiver.

We can get over this difficulty, however, by the use of a "constant-current" relay; this consists of an electromagnet, which, when excited, closes and holds close against a spring, a local switch, which is connected in the "A" battery circuit. The relay itself is operated by a separate battery, which is switched on by closing one of the switches already mentioned; this being installed by the side of the loud-speaker jack. The relay has to be supplied with current passing through its windings all the time; but, since relays of remarkably low current consumption are available, this doesn't greatly matter.

If the ordinary type of open jack with filament control is used, quite a neat and attractive scheme can be worked out. This method is shown in Fig. Q. 2259.

Series and Parallel Systems

It will need no great effort of the imagination to see that the insertion of the loud-speaker plug into one of the jacks will switch on the set via the relay, the effect being the same as though a separate switch situated close to the loud-speaker had been closed. Removal of the loud-speaker plug switches off the set. If a second loud-speaker is inserted we merely close another switch in parallel with the existing closed filament switch. This is an excellent scheme for a block of flats or an institution, with outlets, fed from a master receiver; since the set will remain switched on until the last loud speaker or phone plug is removed. This system has one or two drawbacks, however, for the ordinary home installation. In the first place, it is impossible to use a volume control with each individual loud speaker, as already described.

The "circular" system illustrated in Fig. Q. 2259A operates in a somewhat different manner. To explain it, we will first ignore the filament-switching device and concentrate on the method of switching in the loud speakers. Each of the jack boxes shown contains two double-circuit jacks. Supposing we have, in the same room as the jack shown schematically, a receiver having a telephone plug attached to the secondary terminals of an output transformer or choke coil. In any of the rooms containing the other jack boxes, we can connect a loud speaker and, if desired, a pair of phones as well.

It will be realized that a transformer or choke-coil output device is imperative in this case as, otherwise, the total resistance of the loud speakers and telephones used will be in series with the "B" battery and naturally will reduce the plate voltage to a great extent. Individual volume control can be attained with this method by using modulator plugs, or by connecting a resistance across the loud speaker or phones, as previously explained.

Doubtless the best method for the particular installation in mind will be easily chosen by the individual experimenter; but we would suggest that, for small locations in which it is desired to have separate volume control for each loud speaker, the second method should be used. For large installations, in which separate control is necessary, the first method is better.

POLARITY DETERMINATION

(Q. 2260.) Mr. A. F. Johnson, Brooklyn, N. Y., writes:

Q. I have a storage battery which is not marked on either the positive or negative terminals, although one of the terminal screws is painted red. How can I tell which wires to connect to the positive and negative, respectively, on the set?

A. The red terminal is always the positive. In some cases the terminals of batteries and chargers are not marked in any way. This usually makes it very difficult for the fan to tell which wire is positive and which is negative. If a small amount of salt is dissolved in a glass full of water, and the two wires dropped into the solution, the wire giving off most bubbles is the negative.

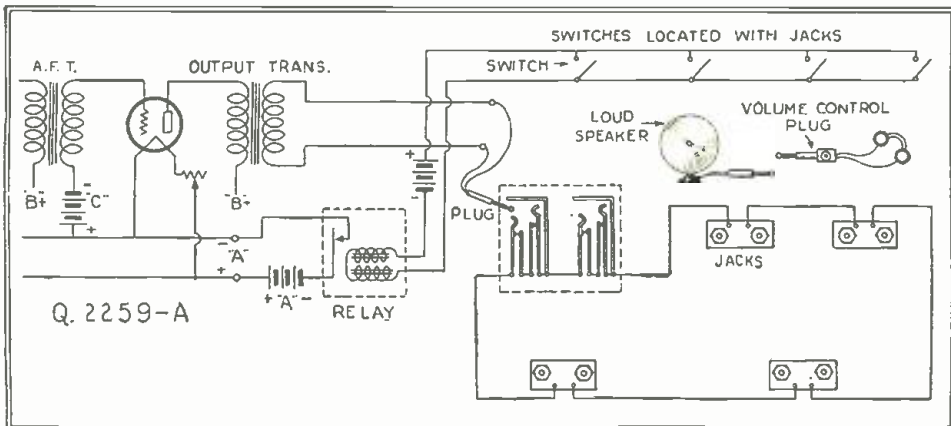

The "circular" system of house wiring is best in small houses where only a few speakers are to be used at the same time.

To Professional Set Builders and Radio Fans!!—

My dear Business Builder:

Each and everyone of you Radio Fans are responsible for the growth of the Radio Industry.

It was YOU that made the Crystal Circuit, the Neutrodyne, the Tuned Radio Frequency and the Super-Heterodyne Circuits popular in their time.

It is years since a new circuit has been devised that is not merely a modification of the aforesaid circuits. Did YOU, Mr. Radio Fan, profit from the enthusiastic labors you put into the Industry popularizing the aforesaid past Radio triumphs? Are you getting any of the profit your enthusiasm and labor created?

I believe that you individually and collectively are the mainspring of the Radio Industry. When you believe in a new development your enthusiastic praise is worth thousands of dollars in advertising, and it is my intention to compensate you for the assistance you are able to give.

One of you Fans, namely, Mr. Fred A. Jewell, a master Radio Fan, who over a period of five years indefatigably experimented with more than 2,000 radio circuits and modifications thereof, has discovered the **GREATEST ACHIEVEMENT SINCE THE INCEPTION OF THE INDUSTRY**. Particulars of this achievement, namely, his new circuit, appears elsewhere in this Issue.

Mr. Jewell, without attempting in any way to evade the Patent Situation, has consistently labored towards the creation of the ideal Radio Receiving circuit, and because of his constant application to his subject has not only created this ideal Receiving circuit, but, remarkable as it may seem, has actually created a new circuit that in no way infringes on existing circuits, and in no way resembles in function or performance anything heretofore accomplished.

Because of the foregoing I have contracted to pay Mr. Jewell a minimum of \$170,000 for his creation, and sincerely believe that he will earn many times that much with me.

I want to keep YOU interested in Radio and to enlist your cooperation in putting this circuit across. It will be the means of your earning a substantial income in your entire or spare time while you are playing with it, and, who knows, you may be able to make some improvement or duplicate Jewell's achievement, through your cooperation.

While cooperating with me in your entire or spare time you will earn the worthwhile to enable you to continue your experimentation, and a great deal more.

Let me send you details. I want your assistance in putting this startling new development in Radio circuits across in a BIG way, and have a plan which will enable you to earn money without interfering with your present occupation, while you are giving this assistance. Thousands of sincere young men have made money with me in the Radio Industry. I want YOU to join the RANKS with a view to accomplishing mutually greater things.

Don't hesitate—fill in the coupon. Get the full details. I know you will become one of us.

LEO POTTER, Pres.
Algonquin Electric Company, Inc.

SUPER HILODYNE

AN ENTIRELY NEW CIRCUIT

The Super-Hilodyne absolutely free from all patent infringement embodying a new method of vario frequency or static reduction. Unrivalled distance getter. Tremendous power, unheard of selectivity with unequalled tone quality and faithful reproduction, with real single control operation.

We Need Demonstrators—Local Service Representatives—and Boosters—If You Have Some Radio Experience and Want to Become One of Our Staff—

Write or fill in the Coupon and mail to us at once.

ALGONQUIN ELECTRIC CO., 245 Fifth Ave., New York

THIS COUPON FOR FURTHER
INFORMATION

ALGONQUIN ELECTRIC CO.,
245 Fifth Ave., New York.

Gentlemen: Kindly send me full details of your plan to help me make big profits. I understand there is no obligation connected with this request.

Name

Address

City, State

REMLER DRUM DIAL

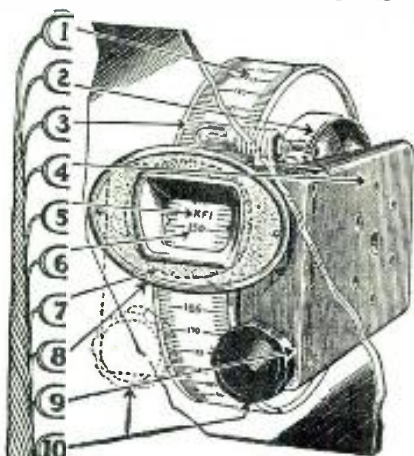

- 1 Readily changeable, white cardboard indicator strips. Supplied for clockwise or counter clock-wise reading.
- 2 No back lash. Fine-tooth gear driven by spiral-cut pinion.
- 3 Station Settings spread over 15 inches of space.
- 4 Heavy brass bracket supports condenser; rigid construction.
- 5 Space provided for call letters.
- 6 Large, easily read figures.
- 7 Round hole for escutcheon plate; no special tools necessary.
- 8 Attractive bronze escutcheon plate.
- 9 Vernier control; Special shaft cannot bind in bushing.
- 10 Right or left hand control.

REMLER TWIN-ROTOR CONDENSER



- 1 360° rotation of shaft and reduction drive give vernier control.
- 2 Proper placing of insulating material minimizes resistance to radio frequency currents.
- 3 Complete insulation of plates from dial and dial shaft and provision for grounding dial and shaft give absolute freedom from body capacity effects.
- 4 Plates carefully aligned by hand and soldered rigidly in position at three points.
- 5 Balanced Twin-Rotor construction gives utmost smoothness of operation.
- 6 Shape of plates permits attainment of very low minimum capacity and wide tuning range.

Write for free folder describing Remler parts
REMLER Division of
Gray & Danielson Manufacturing Co.
 260 First St., SAN FRANCISCO
 CHICAGO NEW YORK
 Eastern Warehouse, Elkhart, Indiana

TWO NOVEL SUPER-REGENERATIVE CIRCUITS

BY H. A. EVEREST

THESE circuits are combinations of the Solodyne and the super-regenerative principles. The low plate voltage (actually supplied by the "A" battery) does away with most of the objectionable noise and instability of the super-regenerator, while super-regeneration gives the Solodyne enough power and sensitivity to make the combined circuit very interesting.

tions and the potentiometer controls the oscillating point. Without an aerial the set is sufficiently sensitive to get all stations within thirty miles.

Tubes of the 201A type should be used with a six-volt "A" battery.

If a loop or a short indoor aerial is used, it should be connected to the center tap of the grid coil directly. If an aerial is used,

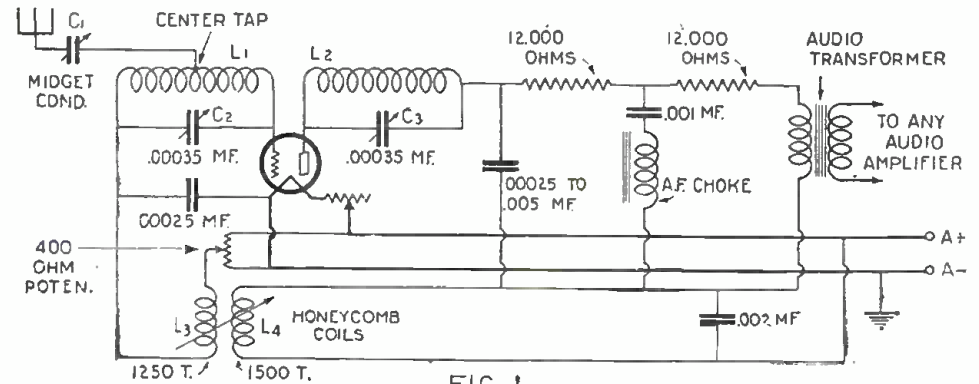

FIG. 1

This odd-looking circuit will produce unusual results from one tube if properly used.

Fig. 1 shows the "Solosuper," a "flivver" Armstrong combination. In tuning, both plate and grid coils (L1 and L2) must be tuned to the wavelength wanted. The L3-L4 coupling is varied from close to a point almost out of oscillation, where the strongest results will be had. The rheostat and detector potentiometer should be set for best

it should be in series with a midget condenser (C1); as the set works best with a small energy input.

Coils L3 and L4 are honeycomb or dualateral coils, of 1,250 and 1,500 turns, respectively.

Most experimenters have enough material on hand to make up the detector unit and,

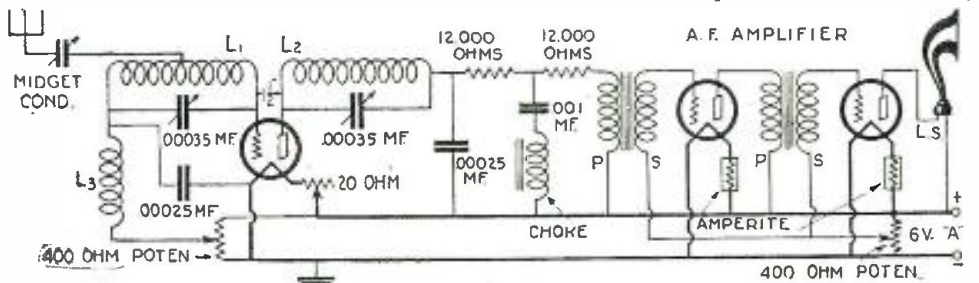

FIG. 2

This circuit is an adaptation of the Autoplex.

results. The set can be logged and results are consistent. Its sensitivity is surprising and the volume is good. Good tuning condensers (C2, C3) and vernier dials should be used. A two-honeycomb-coil mounting is used and the super-regeneration is controlled by changing the coupling.

The special inductor L1-L2 is wound on a form 2½ inches in diameter and 7 inches long. Start ¼-inch from one end and wind 60 turns of No. 22 D.C.C. wire. Skip 1¼ inches and wind another 60 turns. The grid coil L1 must be tapped at its center. If the set refuses to oscillate when the grid and plate coils are in resonance and the potentiometer is moved over the scale, try reversing the leads to the plate coil.

The plate and grid controls tune the sta-

if the audio unit is added, the only parts difficult to get are the two 12,000-ohm resistors. Two 50,000-ohm variable resistors can be used and set for the best results.

Fig. 2 shows the Soloplex, an adaptation of the Autoplex, which is about as sensitive and powerful as the circuit in Fig. 1 and easier to tune and handle. This combination can be used just below the oscillation point with very good effect. The larger honeycomb coil L3 may be anything from 1,000 turns up, 1,250 giving very good results. The tuning inductors L1-L2 are the same as in Fig. 1. Following the filter, a regular audio amplifier may be used. The "B" batteryless amplifier is shown for those who wish a set without "B" batteries.

A MISUNDERSTANDING

RADIO PARSON: "How did you like my sermon yesterday?"

RADIO PARISHIONER: "I couldn't get you at all."

PARSON: "Too much theology?"

PARISHIONER: "No: too much interference."

ANTI-RECEPTION

BOBBY: "Papa, what is 'status quo'?"

FATHER: "Something that comes in over the radio, I think."—Judge.

NOT THE ORIGINAL COST, BUT THE UPKEEP

RADIO DEALER: "Well, Ed, how do you like your new radio?"

RADIO FAN: "Not much."

RADIO DEALER: "Why, what's the matter?"

RADIO FAN: "Well, last night my wife and I were listening in on a sermon; and when they passed around the plate for the collection I forgot and handed my wife a dollar!"—E. W. Burriss.

30^{DAYS} FREE TRIAL

Battery or All-Electric OPERATION

HERE is the great value offer of the day. Test and try this powerful seven-tube RANDOLPH RADIO for thirty days. After it brings in stations from coast to coast with amazing clearness—with easy one-dial tuning—after it easily equals any other radio regardless of cost—after you are more than satisfied then you can buy it direct at factory prices. Every RANDOLPH must make good before it is sold.

The RANDOLPH SEVEN-TUBE CONSOLE illustrated here can be had for use with batteries or connected direct to the electric light socket—absolutely batteryless—no batteries, chargers or acids—just plug in and tune in. 100% efficient either way. Its construction and performance have been tested and approved by leading radio engineers and authorities—by leading radio publications and laboratories.

7 Tubes—Single Control Illuminated Drum

One drum dial operated by one simple vernier control tunes in all stations with easy selectivity to tremendous volume. No overlapping of stations. Illuminated drum permits operation in the dark. Volume control for finer volume modulation. This is a seven-tube tuned radio frequency receiver with power transformers and power amplification. Space wound solenoid coils. Full and completely shielded. A real receiver of the highest quality. Tremendous distance, wonderful tone quality, simple to operate.

Beautiful Walnut Console Built-in Cone Speaker

The Randolph Seven-tube Ampliphonic Console illustrated above is housed in a genuine burl-walnut cabinet with two-tone hand rubbed finish giving it unsurpassed beauty. The same expert cabinet work has gone into the making of these consoles as in the finest furniture. Has built-in cone loud speaker that compares with any on the market. Accurately reproduces complete range of musical notes from the highest to the lowest pitch.

What Users Say

I have logged more than 50 stations from coast to coast.—Lloyd Davenport, Littlefield, Texas. I have logged 52 stations from Cuba to Seattle, the set is a world beater.—J. Tamplinson, Detroit, Mich. Your set is a revelation, has all others tied to the post for distance and selectivity.—Waldo Powers, Vergennes, Vermont. On strength of its performance sold two more sets this week.—T. Scanlow, Orlando, Florida.

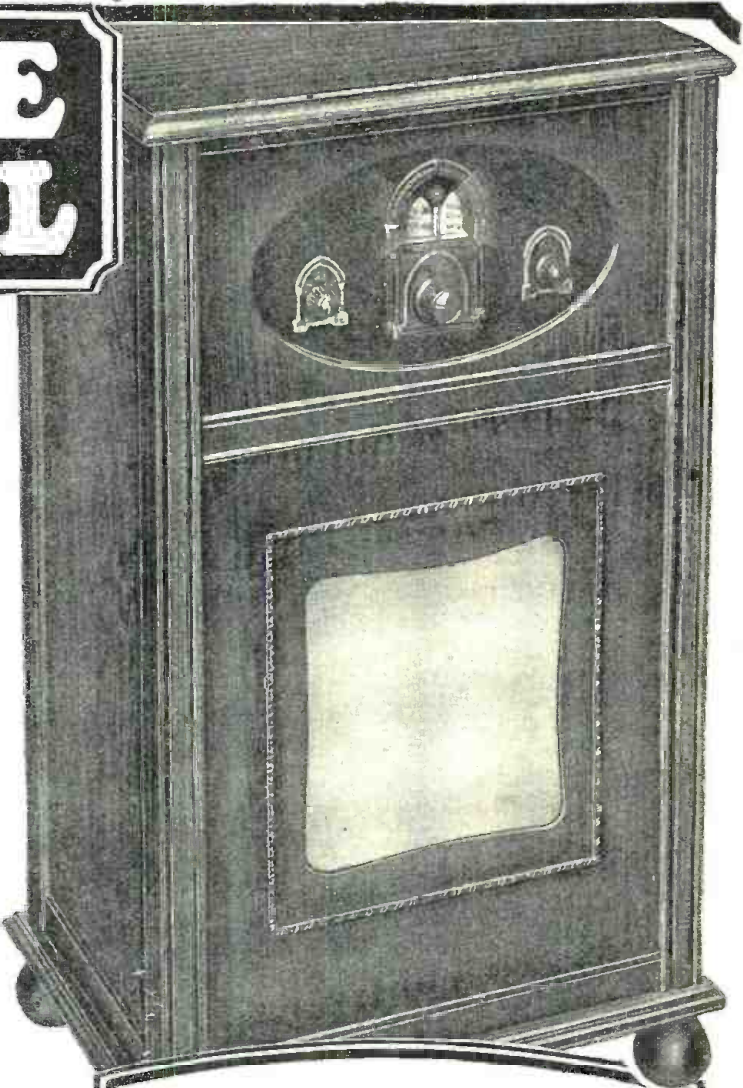

The Randolph 7-Tube Console Single Control **\$ 99** RETAIL PRICE Completely Assembled

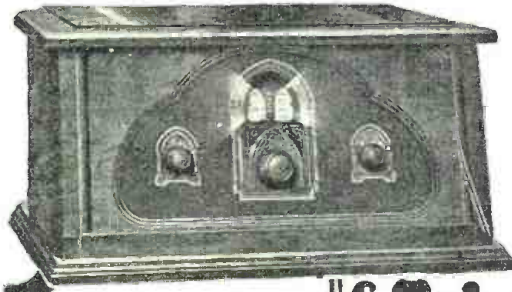

The Senior Six

Now you can have a new, modern, single-control, six-tube radio. Do not compare this set with old style 2-dial 6-tube sets selling for about the same price. The Randolph 1928 Senior Six has also been tested and approved by the leading radio engineers. Comes in a beautiful solid walnut cabinet of hand-rubbed finish. Single control. Illuminated Drum with space for logging. Absolutely dependable and very selective. Sent for 30 Days' Free Trial. You test it before you buy.

6-Tube \$ **55** Retail Price Single Control

MAIL COUPON NOW!

The Randolph Radio Corporation are pioneers in the manufacture of radios. All of its vast and unlimited resources have been used in making and perfecting of the Randolph Receivers. Because of our long and successful experience in the radio business, we are perfectly confident in sending out a Randolph Radio on trial. We know what it will do. Mail us the coupon now for the greatest radio offer ever made.

Sensationally Big Discounts to Agents

Work either full or part time and make big money. Tremendous advertising campaign helps you sell. Regardless of whether you have ever sold before, be sure to get our proposition. The Randolph sells on first demonstration. Men and women both can make money this easy way. Get your demonstration set for thirty day's FREE TRIAL.

Use This Coupon NOW!

Randolph Radio Corporation, 711 West Lake Street, Dept. 304 Chicago, Illinois.

Send me full particulars about the RANDOLPH Six and Seven-Tube All-Electric and Battery Table and Console Sets with details of your 30 Day FREE Trial Offer.

Name.....

Address.....

City..... State.....

Mark here if interested in Agent's proposition.

RANDOLPH RADIO CORPORATION 711 West Lake Street Dept. 304, Chicago, Illinois



A Weatherproof Aerial that can't corrode

It is not necessary to take down your aerial each year to remove corrosion and soot that have accumulated on its surface, if you install a Beldenamel Aerial.

Each strand of a Beldenamel Aerial is protected by a heavy coat of baked enamel which resists corrosion under the worst atmospheric conditions. A Beldenamel Aerial stays bright under this protective coating and maintains maximum range and volume for your set.

A good aerial is just as important as good tubes. Get the best results from your radio receiver by asking your dealer for a Beldenamel Aerial today.

Belden Manufacturing Co.
2314-A S. Western Ave., Chicago



Specify **Belden**
AERIAL WIRE

Radio Wrinkles

(Continued from page 641)

heavy size, which is equivalent to No. 16 solid copper wire, should be employed, and the armor should be grounded to the "B—" battery lead wherever possible. When making connections, the armor should be carried as near as possible without danger of a short circuit, and the ends should be wrapped with friction tape.

—Contributed by W. H. Cameron.

AN A.F. AMPLIFIER FOR TWO SETS

FOR the man whose pocket book requires that he economize, an arrangement is here presented that will save the cost of an extra audio-frequency amplifier. It provides the amplifier for two radio sets; in the writer's case a broadcast receiver and a short-wave outfit.

The amplifier may be built in either set, and instantly changed over to the other by means of a single-pole double-throw switch if separate antennas are used. However, if one aerial is used for both sets, a double-pole double-throw switch must be employed;

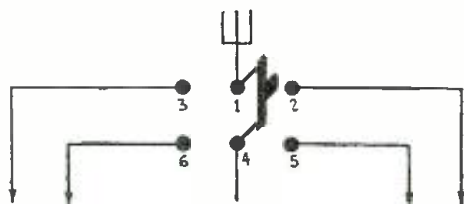

It is possible to change an aerial and audio amplifier, from one receiver to another, at the same time, with a D. P. D. T. switch connected as shown.

one side of the switch being used for changing over the amplifier and the other for switching over the antenna. On each side of the switch, put the plate leads of one set, with the switch arm connected to the "P" post on the first A.F. transformer.

The other side of the switch is used to change over the antenna. The aerial posts of each set are connected to the ends of the switch and the lead-in to the switch arm. Care should be taken that the connections for the proper set are made on the same side of the switch.

—Contributed by Chas. N. Keller.

SPEAKER-CONTROL SWITCH

MANY experimenters spend much of their time building loud speakers of the cone and exponential-horn types with varying degrees of success. In some cases it will be found that home-made speakers of both designs are capable of giving excellent results; but in others it will be found that they are apt to favor either the high- or the low-frequency range. Often the exponential horn will respond very well to the low tones;

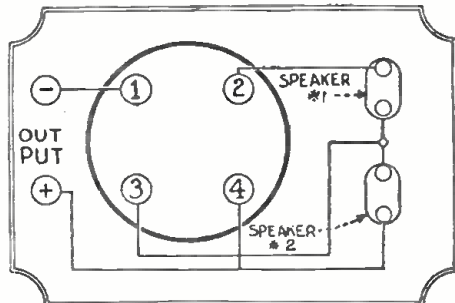

Heater-control snap switches may be used for connecting two loud speakers in either series or parallel.



Ida C. Bailey Allen

International Authority

Presents

the Greatest

Cook Book

America Has Ever Seen!

—in which is presented 2500 complete recipes usable by anyone that reads, including the plain and the fancy, the inexpensive and the expensive, the modern and the old fashioned.

ALSO

—extremely valuable time and money saving information on purchasing of foods, dieting, the Feeding of children, Vegetarian Menus, Seasoning, table settings, using left overs, Feeding the sick, Foreign dishes, Church and Club Suppers, Outdoor Meals, Canning and Preserving, etc.

2500 RECIPES

1001 PAGES

REGULAR PRICE \$2.25

SPECIAL OFFER at \$1.98

Use This Coupon

CONRAD CO., Inc.,
230 Fifth Ave., New York, N. Y.
Gentlemen: I enclose \$1.98, please send me one copy of Ida Bailey Allen's COOK BOOK.

NAME

ADDRESS

CITY STATE

Whatever type of radio power equipment you want—

⌋ WITH BATTERIES OR WITHOUT ⌋



Licensed under Hammond-Andrews Patent

Balkite "A" Contains no battery. The same as Balkite "AB" but for the "A" circuit only. Enables owners of Balkite "B" to make a complete light socket installation at very low cost. Price \$35.00.



Balkite "B" One of the longest lived devices in radio. The accepted tried and proved light socket "B" power supply. The first Balkite "B," after 5 years, is still rendering satisfactory service. Over 300,000 in use. Three models: "B"-W, 67-90 volts, \$22.50; "B"-135*, 135 volts, \$35.00; "B"-180, 180 volts, \$42.50. Balkite now costs no more than the ordinary "B" eliminator.



Balkite Chargers

Standard for "A" batteries. Noiseless. Can be used during reception. Prices drastically reduced. Model "J,"* rates 2.5 and .5 amperes, for both rapid and trickle charging, \$17.50. Model "N" Trickle Charger, rate .5 and .8 amperes, \$9.50. Model "K" Trickle Charger, \$7.50.

*Special models for 25-40 cycles at slightly higher prices

Prices are higher West of the Rockies and in Canada

for whatever type of radio set you own— whatever you want to pay for it—

Balkite has it

First noiseless battery charging. Then successful light socket "B" power. Then trickle charging. And today, most important of all, Balkite "AB," a complete unit containing no battery in any form, supplying both "A" and "B" power directly from the light socket, operating only while the set is in use. The great improvements in radio power have been made by Balkite.

This pioneering has been important. Yet alone it would never have made Balkite one of the best known names in radio. Balkite is today the established leader because of Balkite performance in the hands of its owners.

Because with 2,000,000 units in the field Balkite has a record of long life and

freedom from trouble seldom equalled in any industry.

Because the first Balkite "B," purchased 5 years ago, is still in use and will be for years to come.

Because to your radio dealer Balkite is a synonym for quality.

Because the electrolytic rectification developed and used by Balkite is so reliable that today it is standard on the signal systems of most American as well as European and Oriental railroads. It is this principle, used in all Balkite Radio Power Units, that does away with the necessity of using tubes for rectifying current—that makes Balkite permanent equipment with nothing to wear out or replace.

Balkite has pioneered—but not at the expense of the public.

Today, whatever type of set you own, whatever type of power equipment you want, whatever you want to pay for it, Balkite has it. Production is so enormous that prices are astonishingly low.

Your dealer will recommend the Balkite equipment you need for your set.



Balkite "AB" Contains no battery. A complete unit, replacing both "A" and "B" batteries and supplying radio current directly from the light socket. Contains no battery in any form. Operates only while the set is in use. Two models: "AB" 6-135,* 135 volts "B" current, \$64.50; "AB" 6-180, 180 volts, \$74.50.

FANSTEEL PRODUCTS COMPANY, INC., NORTH CHICAGO, ILLINOIS

Licenseses for Germany:
Siemens & Halske, A. G. Wernerwerk M
Siemensstadt, Berlin

Sole Licenseses in the United Kingdom:
Messrs. Radio Accessories Ltd., 9-13 Hythe Rd.
Willesden, London, N. W. 10

FANSTEEL
Balkite



Radio Power Units



Speed—first essential of modern flight came thru slow development—during years of unremitting research and experiment.

And so it is with Speed Super Emission Radio Tubes. Every distinctive performance feature came only after laborious experiment and scientific investigation by experts in the design and manufacture of things electrical.

Absolute Uniformity

All tubes are tested and double tested to assure satisfactory operation and phenomenal long life.

Perfect Alignment

Special method of manufacture assures perfect grid filament and plate alignment, within 1/10,000 of an inch at all times.

Buy a set of Speed tubes today. Try them and note the improvement in the tone quality of your set. Write for information. If your dealer can't supply you send us your order with your dealer's name and we will see that it is given prompt attention.

CABLE SUPPLY CO., INC.
MANUFACTURERS

Executive Offices: 31 UNION SQUARE
New York, N. Y.

whereas a home-built cone will give excellent results on the high notes.

Combining the two types of loud speakers often gives reproduction which is practically perfect. The speakers may be connected either in series or in a parallel circuit, the best arrangement to be determined by experiment.

In this connection there is a simple electrical device, which may be purchased at any first-class electrical supply house, and will enable the amateur to connect his speakers in any manner desired with ease and simplicity. The device is known to the electric trade as a heater-control snap switch, and is used on heating devices to obtain series-parallel control of the heating elements. When connected to a radio receiver the device will provide three different combinations as follows:

First snap: Both speakers in series;
Second snap: One speaker cut out;
Third snap: Both speakers in parallel;
Fourth snap: Both speakers disconnected.
The circuit used is very simple and will be found illustrated here.

—Contributed by R. F. Petrask.

REPAIRING RADIO TUBES

RADIO tubes that have come loose from their bases may be repaired in a few minutes' time with a small quantity of commercial alcohol. At the point where the tube enters the base, pour a few drops of alcohol. Allow the tube to stand for a moment until the alcohol moistens the cement, then press the bulb firmly into its base and set it aside for five or ten minutes. Upon examination it will be found that the cement has hardened and the tube is as good as new.

—Contributed by F. Darneille.

WHEN TRANSFORMERS BURN OUT

WHEN this system is used, the burning out of an audio transformer does not mean complete cessation of radio entertainment until the instrument is replaced. In the absence of the necessary apparatus temporary reception can be often obtained by the use of very ordinary articles.

If the primary winding is burnt out, two wires from the primary binding posts should be placed in a glass or cup containing water, and the distance between the two wires should be adjusted until best reception is obtained. When it is found that the distance

BURNT-OUT PRIMARY



If an audio transformer burns out, the receiver may sometimes be operated temporarily by making use of the system illustrated above.

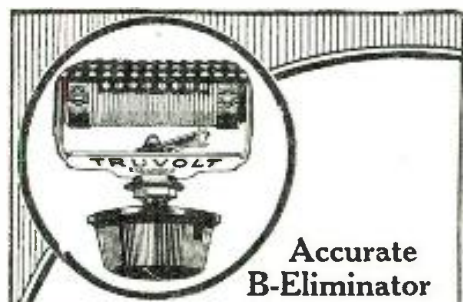

Accurate
B-Eliminator
Voltage

TRUVOLT

An All-Wire Variable
Voltage Control

In constructing your B-Eliminator, you need this highly perfected wire variable high resistance, Built with great radiation surface, it is kept cool like an air-cooled motor, hence the resistance element does not break down and is permanently accurate. Note these advantages:

Made entirely of wire, positive metallic contact always; less fragile because of larger nichrome resistance wire; no heat-holding enamels used. 30 exact readings of resistance.

Type	Ohms Resistance	Milliamperes Current
T- 5	0 to 500	224
T- 10	0 to 1,000	158
T- 20	0 to 2,000	112
T- 50	0 to 5,000	71
T-100	0 to 10,000	50
T-200	0 to 20,000	35
T-250	0 to 25,000	32
T-500	0 to 50,000	22.5

Eight stock types with resistances up to 50,000 ohms. All rated at 25 watts. List \$3.50 each. At your dealers.

Also a full line of Wire Fixed Resistances

Write for free hook-up circular

Dept. 12C, 175 Varick Street
New York City

"This is an Eliminator Year"

ELECTRAD

TRANSMITTING APPARATUS

A Complete Stock at "Chi-Rad"

In addition to our regular broadcast apparatus we carry a very good stock of transformers, chokes, grid leaks, high test condensers, etc., for transmitting purposes.

NEW SHORT-WAVE COILS

Specially built by "Chi-Rad." Write for descriptive bulletin and catalog. Dealers and set-builders please use business letterhead when writing for discounts.

Chicago Radio Apparatus Co.
415 S. Dearborn St., Dept. RN, Chicago

Silent Magic



Here is the Eveready Layerbilt "B" Battery No. 486, Eveready's longest-lasting provider of Battery Power.

TURN your radio dial, and presto! you turn your home into a theater, a concert hall, a lecture room, a cabaret, a church, or whatever you will. Turn the dial and your attentive ear does the rest. That is all there is to this magic of radio.

Or almost all. If a radio set is to work at its very best, attracting no attention to itself, creating for you the illusion that can be so convincing, you must pay a little attention to the kind of power you give it. There is but one direction, a simple one—use Battery Power. Only such power is steady, uniform, silent. It is called by scientists pure Direct Current. Any other kind of current in your



Radio is better with *Battery* Power

radio set may put a hum into the purest note of a flute, a scratch into the song of the greatest singer, a rattle into the voice of any orator.

Don't tamper with tone. Beware of interfering with illusion. Power that reveals its presence by its noise is like a magician's assistant who gives the trick away. Use batteries—use the Eveready Layerbilt "B" Battery No. 486, the remarkable battery whose exclusive, patented construction makes it last longest. It offers you the gift of convenience, a

gift that you will appreciate almost as much as you will cherish the perfection of reception that only Battery Power makes possible.

NATIONAL CARBON CO., INC.
New York  San Francisco
Unit of Union Carbide and Carbon Corporation

Tuesday night is Eveready Hour
Night—9 P. M., Eastern Standard
Time

- | | |
|------------------|--------------------|
| WEAF—New York | WOC—Davenport |
| WJAR—Providence | KSD—St. Louis |
| WEEI—Boston | WCCO—(Minneapolis) |
| WFI—Philadelphia | WCCO—(St. Paul) |
| WGR—Buffalo | WDAF—Kansas City |
| WCAE—Pittsburgh | WRC—Washington |
| WSAI—Cincinnati | WGY—Schenectady |
| WTAM—Cleveland | WHAS—Louisville |
| WWJ—Detroit | WSB—Atlanta |
| WGN—Chicago | WSM—Nashville |

WMC—Memphis

Pacific Coast Stations—
9 P. M., Pacific Standard Time

- | |
|-----------------------|
| KPO—KGO—San Francisco |
| KFOA—KOMO—Seattle |
| KFI—Los Angeles |
| KGW—Portland |

EVEREADY
Radio Batteries
—they last longer

The air is full of things you shouldn't miss

Warren "B"



Only \$35.00
Complete with Tube

GUARANTEED to deliver

from 165 to 252 volts at a compensating milliamperage, as the total current load varies from 75 down to 25 mils—all the voltage you will ever need for clear audio amplification and for about one-half the price you thought you had to pay for the power you always wanted.

- 252 Volts at 25 Mils
 - 233 Volts at 35 Mils
 - 217 Volts at 45 Mils
 - 199 Volts at 55 Mils
 - 182 Volts at 65 Mils
 - 165 Volts at 75 Mils
- from 110 V. 60 Cycle A.C. Current, with the improved type BH 125 M. Raytheon tube

Compact—5½ x 6½ x 9½ inches. Can be used flat, as shown, or vertical.

POWER

The Warren B Model T will "speak for itself" as soon as it is connected to your set. You can adjust the three variable controls, connected to the detector, intermediate, and amplifier taps, to suit the most critical and sensitive requirements of any set. Securing exactly the correct voltage with the necessary milliamperes to assure full B current at all times. The Warren has also a power tap for high power tubes, as well as reserve capacity in the filter to carry smoothly the long sustained notes, particularly the deep tones often undeveloped in radio reception.

The modern radio owners assume a growing pride in their radio equipment from points of quality in reproduction, general appearance, and effectiveness. The Warren Model T is their greatest asset, based upon quality of material, workmanship and construction, in its efficiency, compactness, neat appearance and design. Finished in Old Gold Bronze Lacquer, with bakelite panel for connections, plainly marked with white letters, completes any radio set, and fits into the console as an item of beauty and attractiveness.

No-risk TRIAL before Christmas

The demand for "WARREN B" Supply Model T is unprecedented. Your dealer may not have a sample unit. If not, order direct at once. Mail the coupon today. Send only \$35.00 and save express charges or we will ship C. O. D. for \$35.00 (\$37.50 West of Rockies.) Do Not Delay. Get your "WARREN" now. You run no risk. Try it before Christmas on our money-back guarantee plan. Approval of radio laboratories, experts, and engineers, plus our money-back guarantee, is your protection. Shipped complete, including improved type BH 125 M. Raytheon Tube.

MAIL COUPON TODAY

WARREN ELECTRIC COMPANY.
Dept. R. N., Peoria, Illinois.

Name

Address

City State

Ship at once Model T "WARREN B" SUPPLY. (If you enclose M. O. for \$35 we pay express. W. E. Co.)

Check here if you want literature.

Dealer's Name

Address (Jobbers and Dealers—Take advantage of big demand for WARREN. Write at once.)

between the two wires is very critical, it is wise to dissolve a few crystals of salt in the water.

This simple device will often make it possible to continue listening to a fight or a football game, when this would otherwise be impossible. Of course, the results are not to be compared with those obtained when a perfect transformer is used, but reception is obtained.

—Contributed by Jack Steinberg.

(If the open circuit of the transformer is located near the plate end of the primary coil, the system described above may not give satisfaction. However, in many cases, it will be possible to obtain some degree of reception. Also, a variable grid leak may be used in place of the water with equally satisfactory results.—EDITOR.)

The Super-Hilodyne Receiver

(Continued from page 629)

Then a station operating on a wavelength between 200 or 220 meters is tuned in and the same procedure followed. It will be found that a point can be reached on each resistor, whereby the set will not oscillate at any frequency within the 200 to 550 meter band. When these settings have been finally made, the caps are replaced on the shields and the set is ready for use. As previously explained these adjustments need not be varied unless some changes are made in the receiver, such as the substitution of different tubes, etc.

INTERCHANGEABILITY

The three sections into which the sub-panel is divided have other uses than those outlined above. Let us assume, for example, that we have a receiver which is not selective and we wish to remedy this defect. This is easily accomplished, assuming again that there are already installed a good radio-frequency amplifier and a good audio-frequency amplifier, by connecting a tuning unit (middle section of the Super-Hilodyne) before the R.F. amplifier.

Again, let us consider an R.F. set which is sufficiently selective but will not reach out and get distance. Here the Hilograd intermediate radio-frequency amplifier can be used to good advantage, for it may be inserted in the set, after the tuner.

Then, in the case of a set which has everything but a good audio-frequency amplifier, the dual-impedance amplifier can be substi-



6 TUBE SUPERPHONIC
All Metal Chassis Shielded & Ready to Wire
RADIO ALL PARTS MOUNTED
Only \$16.95
Can be wired in a few minutes

FREE!
6 TUBES
UX 201-A TYPE
Tested and Matched

An amazing value that can't be beat! Latest 6-tube tuned radio-frequency circuit. Extremely selective, marvelous sensitivity. Two stages of radio frequency, detector and 3 audio amplifiers for improved tone quality. Two-dial control. All-metal chassis. Shielded. Clear and realistic reception guaranteed. Beautiful front panel, crystalline finish. Metal panel and sub-panel; all parts mounted. Simply connect a few wires. No special tools needed. Vernier dials for fine tuning. New type UX sockets. All hook-up wire and colored battery cable included. Value \$60.00, our price \$16.95.

Simple Wiring Directions

Very easy to wire this set with the instructions we furnish. Just connect a few wires. That is all. Can be wired in a few minutes by anyone. No radio knowledge needed. Make money by wiring these sets in your spare time and selling them to your friends.

NO RADIO KNOWLEDGE NEEDED

SEND NO MONEY

Just write your name and address on a post card and ask us to send you this great outfit together with 6 tubes. We will ship them right away. When they arrive, pay only \$16.95 plus a small delivery charge.

RADIO EQUIPMENT CO.

Dept. NA 549 S. Wells St. CHICAGO, ILL.

Changes Your Set Into a Short Wave Receiver

Sent postpaid anywhere in U. S. upon receipt of \$15.00 M. O. or C. O. D. plus postage upon receipt of \$1.00 to guarantee carrying charges. When ordering state kind of set so that detailed directions for use may be given if necessary. Also state type of tubes, such as UX199, UV199, WD11 or 201A.



The SUBMARINER

Regardless of the kind of set you have, this device will permit you to listen to short wave stations between 30 and 75 meters. Operates with sets such as T R F, Neurodyne, Super-Heterodyne, regenerative sets and all other types. No additional tubes or batteries required. No changes to the wiring of the set. A short aerial and ground is connected to the "Submariner," and a cable and plug attaches it to the set. Requires less than a minute to attach or detach. Operates as a wave changer with Super-Heterodynes, and as a detector unit with others.

SHORT WAVE RECEPTION

is practical because they penetrate better, and there is less static. There are several powerful stations using the wave band covered by the "Submariner" for broadcasting programs. You may also learn code by listening to amateurs from all parts of the world. Get a thrill by tuning in a station your friends cannot get. You will have a highly efficient short wave receiver when the "Submariner" is attached to your set. Nothing else like it on the market. Take a trip in the low waves on board the "Submariner."

ORDER TODAY

We guarantee to refund if the "Submariner" fails to operate.

J-M-P MANUFACTURING CO.
Dept. 119 Milwaukee, Wis.

free Wholesale Radio Catalog
Send today for it
1928 Catalog
Dealers, set builders — make this your biggest radio season. Shure's great wholesale catalog insures the best in quality at lowest prices. This wonderful book is jammed full of the newest offerings of Nationally known radio parts, kits, sets, accessories, table and console cabinets, etc. Also contains short wave sections showing the finest electrical apparatus for short wave receiving and transmitting. Your request brings on book of a thousand bargains, price list and discount sheet. Write for a copy today.

2000 Items
Big Values

Shure Radio Company
345C West Madison St., Chicago, Ill.

This is the Electric Set You Can Build at $\frac{1}{4}$ th the usual cost with PILOT'S Socket-Power Kit

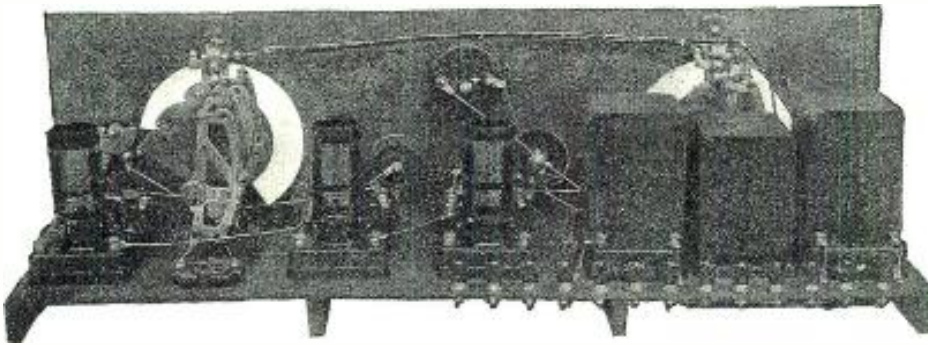

SLEEPER'S PILOT SOCKET POWER 5

AN A.C. operated receiver working direct from your electric light current—costing about \$75—and so easy to build—how is it possible at the price? The answer is found in

M. B. Sleeper's REDI-BLOX WIRED RADIO UNITS

"The Sectional Bookcase Idea applied to Radio"

Redi-Blox Wired Radio Units (produced in world's largest Radio Parts Plant) have completely revolutionized amateur and professional set building! No longer is it necessary to laboriously assemble dozens of separate parts! Build the S-P-5 by hooking up the five Redi-Blox Units* and the easily assembled power-pack—as simple and almost as quick as connecting that number of dry cells!

Only tools needed are screw-driver and pliers. Soldering is optional.

Note: If you are unable to obtain complete parts at your dealer, write us and we will see that you are immediately supplied. Pilot Electric Mfg. Co., Inc., 323 Berry St., Brooklyn, N. Y.

Fully illustrated instructions concerning the S-P-5 are featured in "Radio Design," an entirely new and different radio publication, chockful of advance radio information, edited by M. B. Sleeper, Chief Research Engineer of this Company. Return the coupon for free sample issue containing S-P-5 data, or send 25c for four issues. The best 25c radio investment you ever made!

* Two Redi-Blox R.F. Units, one Redi-Blox Detector Unit, Two Redi-Blox A.F. Units.



S-P-5—Console Cabinets to accommodate the standard 7"x21" Panel used in S-P-5 are available everywhere.

OFFICIAL PILOT PARTS LIST FOR S-P-5

- 2 Illuminated vernier dials
- 1 .00035 mfd. single condenser
- 1 .00035 mfd. double condenser
- 1 Toggle Switch
- 1 3,000-ohm potentiometer
- 1 Resistograd
- 1 7 plate Midget
- 4 1 in. Bakelite brackets
- 1 Redi-blox detector unit
- 2 Redi-blox R.F. units
- 2 Redi-blox A.F. units
- 1 Output impedance
- 1 .002 mfd. condenser
- 1 .00002 mfd. condenser
- 13 Engraved Bakelite posts
- 1 1,200-ohm by-pass
- 1 850-ohm by-pass
- 1 650-ohm by-pass
- 1 2 mfd. output condenser
- 1 Front Panel 7x24x $\frac{1}{8}$ Westinghouse Micarta
- 1 Base Panel 6x23x $\frac{1}{8}$ Westinghouse Micarta
- 1 0 to 100 Jewell milliammeter
- 3 179 plug-in coils

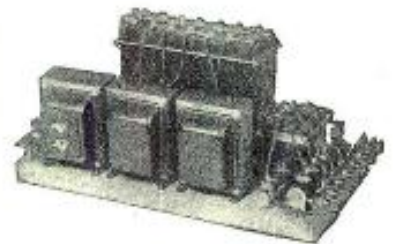

PARTS FOR ABC ELIMINATOR FOR S-P-5

- 1 125-mil Raytheon tube Made by Pilot Electric Co.
- 8 2 mfd. filter condensers
- 1 .1 mfd. buffer
- 2 1 mfd. by-pass condensers
- 1 Condenser block clamp
- 1 No. 41 tube socket
- 1 ABC transformer
- 2 ABC chokes
- 1 ABC resistance
- 1 2250-ohm resistance
- 9 Engraved binding posts
- 1 Micarta terminal strip
- 1 Wooden baseboard



PILOT
ELECTRIC M'FG. CO., INC.
323 BERRY ST., BROOKLYN, N.Y.

Argentine
Australia
Belgium
Brazil

Canada
Cuba
Denmark
England

Finland
France
Germany
Holland

India
Italy
Japan
Mexico

Norway
South America
Spain
Sweden

CLIP THIS COUPON
and mail to Pilot Electric Manufacturing Co., Inc.,
323 Berry Street, Brooklyn, N. Y.
Send me "Radio Design," M. B. Sleeper's new con-
struction publication, showing how to build all latest
sets at fraction of cost.
Enclosed is 25c coin or stamps for 4 issues. Please send sample copy free.

NAME

ADDRESS

RN 12.27

Perfect Radio Parts for Discriminating Set Builders

The BRADLEYUNIT-A



is a fixed resistor that is molded and heat-treated under high pressure. It does not rely on glass or hermetic sealing for protection against moisture. Is not affected by temperature, moisture, or age. The ideal fixed resistor for Beliminator hookups.

The BRADLEYOHM-E

is standard equipment for accurate plate voltage control on many leading Beliminators. Scientifically-treated discs in the Bradleyohm-E provide noiseless, stepless plate voltage control.

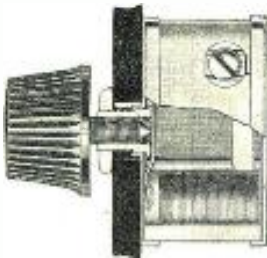

The BRADLEYLEAK

A variable grid leak that provides perfect grid leak adjustment, thereby providing the best possible results with any tube.



The BRADLEYSTAT

The ideal filament control. Gives noiseless, stepless control for all tubes. Can be easily installed in place of wire wound rheostats.



When you build a set or Beliminator, demand Allen-Bradley Perfect Radio Resistors to secure best results

Allen-Bradley Co.
Electric Controlling Apparatus

287 Greenfield Ave. **A.B.** Milwaukee, Wis.

tuted in the receiver and will undoubtedly clear up many of the troubles previously encountered, in the way of distortion, motor-boating and other amplifier shortcomings.

Tuning the Knickerbocker Four

(Continued from page 636)

the station are clearly heard. At this point move the dials back and forth slightly, to make sure that the whistle is completely gone.

Then go back to the adjustment of coupler L2, and vary the angle of the coils (keeping them always parallel at a condenser dial-setting of 100) until the detector circuit is just under the point of oscillation, regardless of the wavelength to which the circuit is tuned.

The primary coil of L2, which is the hinged coil at the back, can next be adjusted to provide just the degree of coupling desired between the R.F. and detector circuits. To a certain extent, the adjustment of this coil is related to the adjustment of the neutralizing condenser and of the tickler coupling. It may, therefore, be necessary to readjust slightly these two, after the primary adjustment has been completed.

When these adjustments have been made, the receiver should tune like a good neutrodyne. That is, stations should slide in and out without any fuss or whistles, as the tuning dials are turned. Yet the receiver will always be in a state of maximum sensitivity unless one or the other of the two rheostats is turned down, which is desirable in the case of local reception.

INCREASING POPULARITY OF LIGHT-SOCKET ANTENNA PLUG

The light-socket antenna plug has come back strong, according to reports from various parts of the country. In large measure this is due to the improved receivers of today, which, with greater sensitivity combined with marked stability, work well with the socket plugs that make an enormous antenna system out of the nearest electric light socket or convenient outlet.

RADIO TERM ILLUSTRATED



"MOVING PLATES"

The unexpected movement of the plates sometimes causes a sudden loss of control.
The Listener-In, Melbourne, Australia.



SAMSON

Chooses TOBE CONDENSERS
for the Samson Power Amplifiers

The unflinching, true and powerful quality of this fine radio instrument matches the unflinching strength of TOBE Condensers and we have not been able to find any kind of a Delilah that will break down TOBE strength.

Just the same, when the orchestra plays Samson and Delilah, the haunting reality of it will ring truly and clearly on the Samson Power Amplifier, and the TOBE'S will insure its being just as good next year as now. Used also in the Samson Block for the official Hammarlund-Roberts Hi-Q.

TOBE-SAMSON B BLOCK No. 713

using one 171 Power Tube

TOBE-SAMSON B BLOCK No. 718

using two 171 Power Tubes in Push Pull

TOBE-SAMSON B BLOCK No. 210

using two 210 Power Tubes in Push Pull

TOBE-HAMMARLUND-ROBERTS

OFFICIAL B-BLOCK for Hi-Q Set

Write for TOBE Power Pamphlet with descriptions of Power Circuits and prices of

TOBE B BLOCKS

Tobe Deutschmann Co.
Cambridge Mass.

CARTER

New "IMP" Power Switches (for 110 Volt Circuit)



New "IMP"
AUTOMATIC
POWER
SWITCH

\$1.50 Replaces relay. Controls any type of "A" or "B" supply. Switches off charger, "B" supply on, and closes filament circuit—3 operations in one.

New "IMP" Power Switch

New snap switch construction for 6-volt filament or 110-volt circuit. Complete with "ON" and "OFF" name plate.



75c.

Any dealer can supply

In Canada:

CARTER RADIO CO., LTD., Toronto
Offices in principal cities of the world



Carter Radio Co.
CHICAGO

\$1.00 WILL SAVE YOUR SPEAKER



The Craftsman Dollar Speaker Filter is Guaranteed to relieve your speaker of the DC plate current (up to 250 volts). It gives speaker a chance to operate at its best. Attached in a second. Send dollar bill NOW!

CRAFTSMAN RADIO PRODUCTS
9 Orchard St. Newark, N. J.

Only \$1 Down Brings You Either of These Guaranteed Eliminators

Super-Power "A" Eliminator

Here is a constant, unvarying, smooth, humless current at 6 volts for any radio receiver using 201-A and power tubes. **Uncertain storage batteries** with their changing power, **chargers** and other bothers are **done away with**. This eliminator completely replaces "A" batteries. In addition your set gets perfect current at all times—it is always ready to do its best. Stations come in easily and quickly.

Not a Battery-Charger Combination

This Super-power "A" Eliminator consists of a large capacity rectifier which changes the alternating house-lighting current into direct current. Then a highly efficient heavy duty filter system of extremely high capacity changes the pulsating direct current from the rectifier into smooth, even current for lighting the filaments in the radio tubes. Anyone can install this Super-power "A" Eliminator in a few minutes. Just attach it to your set and plug it into an electric light socket. Your set is instantly supplied with the correct amount of hum-free current, used only when set is in use. You are assured of good current whenever you want it. This "A" Eliminator works perfectly whether used once or thousands of times a year. It has no moving parts to wear out. Operates from light socket 110-120 volts, 50-60 cycle A.C., output 6 volts direct current for all sets up to 12 tubes with power tubes. **There are no batteries to be charged.** It is fool-proof in operation. Once attached it is permanent—you can forget you ever heard about "A" batteries.

Test It for 30 Days Before You Buy

Just fill out the coupon below and mail it to us with a dollar bill. We will send you this "A" Eliminator to test. It must deliver satisfaction before you buy. After 30 days trial pay only \$5.00 a month until you have paid \$31.50. Only our great buying power enables us to make this liberal offer and to also sell this Super-power "A" Eliminator for easily 1/4 less than is ordinarily asked. Take advantage of this offer today.

Remember if you are disappointed in any way we will refund your dollar and pay return postage. You run no risk. Order now.

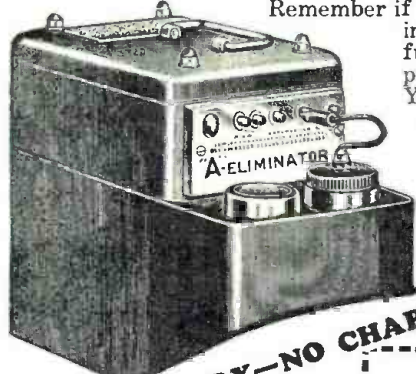

**NO BATTERY—NO CHARGER
NO BULBS
NO HUM
NOTHING TO WEAR OUT OR REPLACE**

ELECTRIFY ANY RADIO

Super-Power "B" Eliminator

Do away with "B" batteries—their annoyance—and the constant expense of always getting new ones. The great "B" Eliminator offered here replaces them permanently. Just attach this eliminator to your set—plug it into an electric light socket—and a steady flow of power is delivered to your set. Hum, noise, distortion and all other disturbances are gone. Built with heavy duty chokes, transformers and the finest of condensers in the filter system, it is 100% efficient at all times—the most modern and flexible "B" Eliminator in the world. **Used with any good "A" Eliminator it completely electrifies your set.**

Complete With Raytheon Tube

This Super-power "B" Eliminator can be used with any set up to 12 tubes. It comes complete with full wave rectifying 85 mil. Raytheon tube, making possible the delivery of great current at a high voltage. This Raytheon tube has indefinite life as it has no filament to burn out. Delivers up to 180 volts.

The case is beautifully finished in olive green Duco with black panel etched in gold. Equipped with rubber-covered cord and socket plug. High voltage taps and variable adjustments enable the use of new power tubes. Operates from 110-120 A.C., 50-60 cycle current. Has tap for intermediate voltage on which 67 1/2 to 90 volts may be obtained. The detector tap will supply 22 1/2 to 67 1/2 volts. Variable adjuster will deliver any desired detector voltage. On and off switch and high and low voltage switch are integral parts of the eliminator. No additional switches or cords are necessary.

Only \$1.00

We make the same liberal offer on both the "B" and the "A" Eliminator. Fill out the coupon and mail it to us with a dollar indicating which eliminator you wish. If both are desired send \$2.00. Each eliminator must then make good while you test it for 30 days before you pay another cent. After test the balance is due in easy installments. This "B" Eliminator ordinarily sells for as high as the cash price of \$42.50. This is your opportunity to get it for only \$29.50 payable in easy installments.

Complete instructions with each unit for wiring to set.

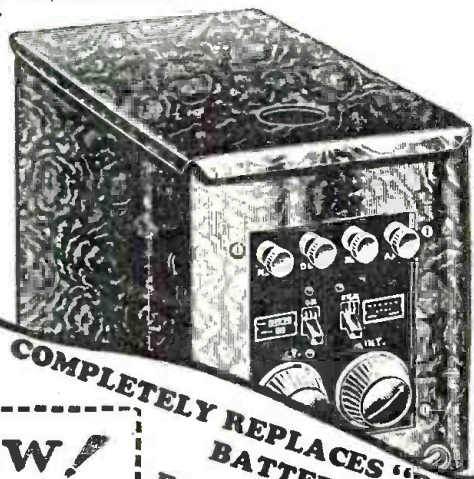

**COMPLETELY REPLACES "B" BATTERIES
EASY TO ATTACH
Plug Into Electric Light Socket**

AT REDUCED PRICES

Mail This Coupon NOW!

ELLIOTT RADIO CORPORATION, DEPT. 327
709 West Lake Street, Chicago, Illinois
Attached find \$1.00 for which you agree to send me () "A" Eliminator at \$31.50, () "B" Eliminator at \$29.50. (Send \$2.00 if both are desired, as described in your ad.) Full particulars will be sent me by return mail and my money refunded if I do not accept your offer.

Name _____
Address _____
City _____ State _____

KARAS PARTS

Give Pep and Power to the famous

KNICKERBOCKER "4"

The Wonder Set

THE Knickerbocker 4 has won first place among all four-tube sets almost overnight. Thousands have built and will build this great receiver because it does more than any other set ever designed with four tubes—does more than some five- and six-tube sets will do. The secret of its pep and power lies in its use of Karas Parts. Just as the secret of its huge success lies in its simplicity of design and construction. We did away with an extra control in the detector circuit, making this control automatic by the use of a Karas 3-Circuit Inductance Orthometric .00037 Extended Shaft Condensers, each \$7.00



For the Knickerbocker 4 you will need 2 Karas Karas 3-Circuit Inductance Orthometric .00037 Extended Shaft Condensers, each \$7.00

Distance! Volume! Tone!

You never saw a 4-tube set get such splendid distance as the Knickerbocker 4. And all of the volume you want, both on local and DX, due to the use of Karas Harmonik Transformers. These also are responsible for the pure, sweet, natural tone of this receiver—for its clear, undistorted reception at all broadcast wavelengths. You will be amazed to find such a well-balanced combination of distance, volume and tone as the Knickerbocker 4 offers.



For the Knickerbocker 4 you will need 2 Karas Harmonik Transformers, each \$3.00

Easy to Build the Karas Way



You can easily and quickly build the Knickerbocker 4. We supply all of the instructions and wiring diagrams, blue prints and reprints and complete information FREE. Anyone, even with no previous experience, can build this set in a few hours. Our detailed instructions make every step perfectly clear. To build this receiver you will need certain Karas Parts, listed below, plus other standard parts, all of which are easily obtainable at your dealer's. Plan to start building this receiver NOW—see your nearest dealer today.

For the Knickerbocker 4 you will need 1 Karas 3-Circuit Inductance, \$5.50, and 1 Karas Equamatic Inductance Coil, \$4.00

Your Dealer Has Karas Parts

Order the following Karas Parts from your dealer, and secure from him the complete list of other parts:
 2 Karas Orthometric .00037 mfd. Extended Shaft Condensers.
 2 Karas Harmonik Audio Transformers.
 1 Karas Equamatic Inductance Coil
 1 Karas 3-Circuit Inductance Coil.
 2 Karas Micrometric Vernier Dials.



Be sure to specify Karas Parts for your Knickerbocker 4, as the circuit was designed for these parts, and finest results will follow only when they are used.

For the Knickerbocker 4 you will need 2 Karas Micrometric Vernier Dials, each \$3.50

Mail the Coupon to Us NOW!

The coupon below, when filled out and mailed to us, brings all information you will need to build the Knickerbocker 4 in the way of blue prints, reprints of editorial matter, wiring diagrams, complete instructions, etc. All sent FREE on request. Also full details on the NEW 2-Dial Karas Equamatic. Mail coupon today.

KARAS ELECTRIC CO.

4038-L No. Rockwell St., Chicago

KARAS ELECTRIC CO.,
4038-L No. Rockwell St., Chicago

Send me complete information about the Knickerbocker 4, including blue prints, wiring diagrams and instructions, reprints, etc. Also complete data about the 2-Dial Karas Equamatic Receiver.

Name
 Address
 City State

RADIO "BUGS"

OUR readers, who have followed with interest these incursions into radio-entomology, will agree with us that some of the best specimens yet captured are pinned up this month for their entertainment. A number of rare "bugs" are still on hand in the editorial files, and may see the light in the following months. The response from our cooperating contributors has been very wide.

Carroll A. Badeau, of New Brunswick, N. J., will occupy, in this month's honor roll, the position of Abou ben Adhem, and also the two subsequent places. First position, with the credit that accompanies it, belongs to his didactic sketch of a "Rectifier Pup Playing With a Young Cycle." A few minutes' study of this, and you will be ready to diagnose the troubles of any socket-power unit.

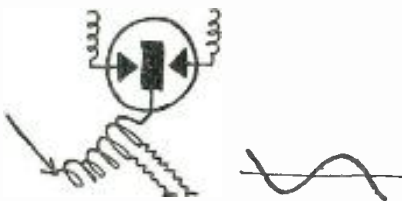

Shakespeare, in his prescient way, according to some antiquarians, described the consequences of broadcasting. Here we have the youthful scion of the Montagues paying his court (no doubt in "Continental" code) to the heiress of the Capulets, while the

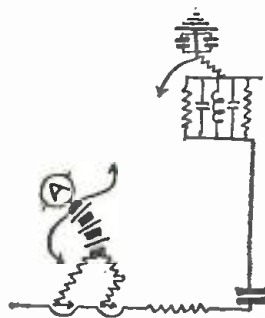

witchery of lutes fills the ambient ether. You will recognize readily the "Balcony Scene from Romeo and Juliet."

Yet, more-mortal lovers who escape the slings and arrows of outrageous fortune are apt to find the plating worn off the edge of romance. Here we have an episode in the life of what our British cousins call a "bright emitter." A tube has just arrived at his home (or socket) and is "all lit up."

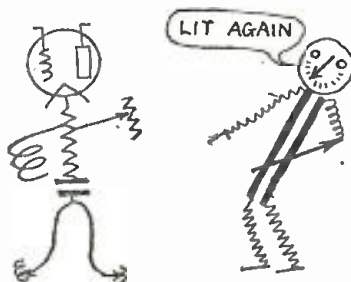

However, from the angle of inclination of the scornful meter, we think it is only a reiteration of the old repartee between the pot and the kettle.

Marad Serrioy, of Palo Alto, Calif. (one of the prize winners, by the way, in our last "What's Wrong?" contest) has evidently spent some time in the contemplation of

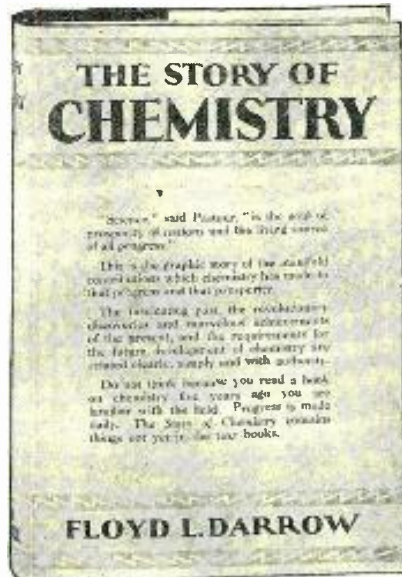

READ

The thrilling, intensely interesting story of the most marvelous science in the world.

"THE STORY OF CHEMISTRY" is what its name implies, the "story" of this strategic science. It is not a hit-and-miss collection of isolated phases of the subject, but a coherent development, leading logically from the days of the alchemist to the over-shadowing importance of chemistry in the modern world.

It gives that broad and comprehensive grasp of the subject, both of past and present, essential to a liberal education. It is for everyone who wishes to be informed on the most practical of sciences, a science which touches modern life at every point.

It is written in simple, understandable English. It is almost entirely free from the chemical formulae, equations and mathematical expressions so forbidding to the non-technical reader. It entertains as well as instructs.

It is authoritative, for it is based on the statements of men who are leaders in chemical investigation and know where they speak.

It is the most nearly down-to-date book on chemistry for the general reader. Aside from the historic portions little of the story that it tells can be found in other books. It is written from the current literature of the most recent researches.

The illustrations are numerous, carefully selected, striking and instructive. They too tell a story.

It is a beautiful, stiff covered book, 6 x 9 inches—a most valuable addition to anyone's library.

SPECIAL PRICE
\$3.98

CONRAD CO., Inc.,
 230 Fifth Avenue, New York City.
 Gentlemen: I enclose \$3.98—please send me one copy of "The Story of Chemistry."
 Name
 Address
 City State

A BOX

"A" BATTERY ELIMINATOR

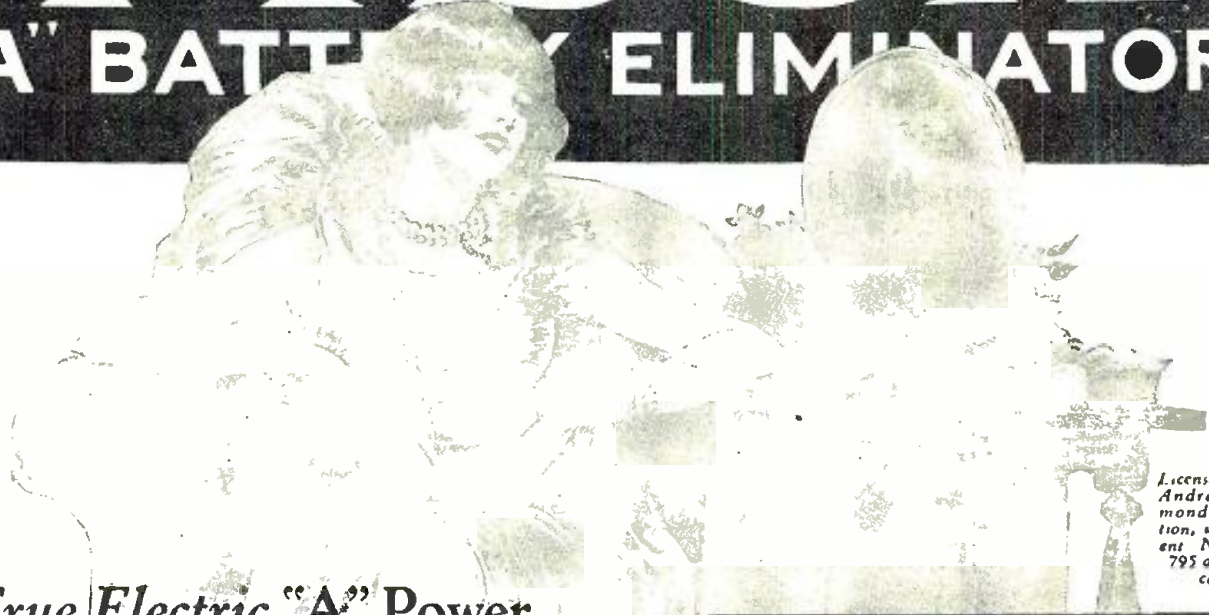

Licensed by The
Andrews-Ham-
mond Corpora-
tion, under Pat-
ent No. 1,637,
795 and appli-
cations

True Electric "A" Power That Never Fails

WHEN you use an ABOX, all trouble with charging and charging equipment is done away with. The storage battery is made obsolete—and your radio set receives true "A" power from the light socket.

An ABOX "A" Eliminator consists of a rectifier and the famous ABOX Filter built into one compact unit. It takes alternating current from the light socket and delivers it to your set as perfect, 6 volt direct current "A" power. ABOX has no battery and operates only while the set is in use.

No more disappointments because of run-down storage battery—ABOX is always ready to deliver the correct amount of current for best results. Your set becomes as reliable and simple to operate as any electric appliance.

See the ABOX, hear it run ANY set, and learn how easily your set can be electrified with no change of tubes or wiring and without the services of a radio expert. Your radio store has ABOX.

[Send for interesting booklet,
"ABOX and The Light Socket"]



\$32.50

Slightly higher west of the Rockies
Input—110 volts, 50-60 cycles A. C. Output—6 volt direct current, 2 amperes. Shipping weight, 25 lbs. Unlimited shelf life.

4-volt model for Radiola sets or any receiver using small tubes **\$27.50**

The ABOX Filter is an entirely different unit from the Eliminator, being the filter circuit alone in a small, compact unit. If you have a suitable charger, it can easily be converted into an "A" Eliminator by substituting the ABOX Filter for the storage battery. Shipping weight, 11 lbs. Price, \$19.50. Slightly higher west of the Rockies. Send for Special Circular

The ABOX Company

215 North Michigan Avenue

Chicago, Illinois

Build Your Own POWER AMPLIFIER!

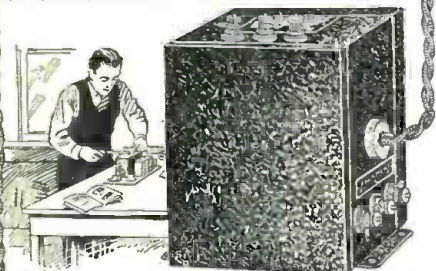

Transform your RECEIVER into a real MUSICAL INSTRUMENT

WITH a screw driver, a pair of pliers, and a soldering iron you can build a Thordarson Power Amplifier and B-supply in your own home that will equal the finest commercial amplifier on the market. Complete constructional booklet and simple diagram accompany every transformer.

Thordarson R-210 Power Compact

The Thordarson R-210 Power Compact is scientifically designed to give maximum electrical efficiency and to make home assembly of power amplifiers as simple as possible. The R-210 power compact is the foundation unit and contains the following apparatus: (1) A power supply transformer designed for UX-216-B rectifier; (2) Two filter chokes of 30 henries inductance and 65 M. A. current carrying capacity; (3) A 7½ volt supply center tapped for the filament of one UX-210 power tube. Wiring of the complete amplifier is simple—20 leads complete the assembly.

R-210 Power Compact - - \$20.00



New Metal Baseboard for R-210 Compact Amplifier

To further simplify home construction of the R-210 type amplifier, you can now buy this new crackled finished metal baseboard. All spring sockets and binding posts are mounted and included in the list price. All mounting holes are drilled. All holes for sub-panel wiring are carefully insulated. Location of all sub-panel wiring is marked under baseboard.

R-211 Metal Baseboard, including sockets, binding posts, mounting screws, and hook-up wire - - \$5.00

THORDARSON ELECTRIC MANUFACTURING CO.
Transformer Specialists Since 1895
WORLD'S OLDEST AND LARGEST EXCLUSIVE TRANSFORMER MAKERS
Huron and Kingsbury Streets - Chicago, Ill. U.S.A.

THORDARSON ELECTRIC MFG. CO.
599 West Huron St., Chicago, Ill.

Gentlemen:—Please send me a copy of your free booklet "Power Amplification Simplified."

Name _____
Address _____
City _____ State _____ (3571A)

bathing-beauty contests whether on shore or screen. He enters a sketch of "Portable Polly," who has certainly ambitions to be "Miss Radio" of 1928.

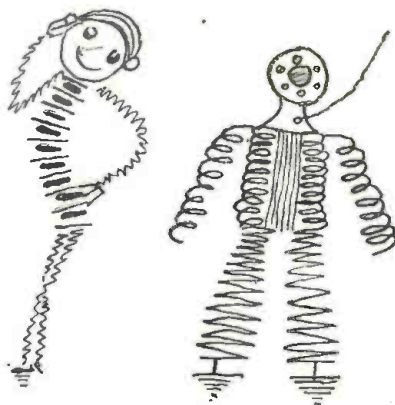

Beside her stands the "DX Diver," as limned by E. R. Osborn, of Albany, N. Y. Perhaps the gentleman has been doing some supersonic sounding. At any rate, he seems ready to plunge into the waves, whether marine or ethereal, at a moment's notice.

The last group of radio characters whom we present in this month's showing are the conceptions of Leo D. Keller, of Rochester, N. Y. At the left, "Jack Phone"—not Mike R.—and at his side, we imagine, Mrs. Phone in a new insulating coat.

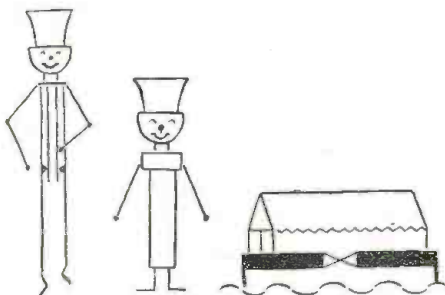

At the right of this illustration—yes, you have guessed it without being told! "Noah's Arc!" Noah had no neighbors to complain of interference; but neither, unfortunately, were there any to pick up his "..."

A few good "bugs" can still be used; but, as we have said before, they must have merit in their conception and consist entirely of radio symbols. All should be drawn with ink on white paper or card; those shown here have been reproduced without retouching, from the entries as submitted. Address The Jingle Editor, RADIO NEWS, 230 Fifth Avenue.

THE RADIO FOOTBALL REFEREE



Safety first in outdoor sports, as pictured by our Scandinavian contemporary, Radiolyssnaren.



Exclusively Licensed by Technidyne Corporation Under U. S. Patent 1598658, July 27, 1926.

At Last!

"TONATROL"

A True Tone and Volume Control

Electrad, Inc., has scored another triumph with this new and improved volume control. TONATROL controls volume smoothly from a whisper to full power.

A smart addition to any set. Very easy to install. At your dealer's.

"Tonatrol"—Standard Volume Control...\$1.50
"Tonatrol"—Type W.S. (with filament switch attached).....\$2.00

Write for free installation booklet for the correct way to control volume.

Dept. 49B, 175 Varick St., New York, N. Y.

ELECTRAD



THIS neat, permanent and economical mast of rustproof tubular steel fits any roof—flat, pitched or sloping—as well as ends or sides of buildings.

Readily adjustable—telescopes into a 4 foot section for easy erection. Put up collapsed. Make your attachments. Then erect.

Ample strength to withstand the strain of tightening aerial or weight of sleet covered wires. Two lengths—7 and 10 feet—\$2.00 and \$3.00 respectively. At your dealers or direct from

20 in. 2-section adjustable steel outrigger arm. Telescopes to 12 in. White porcelain insulator on end.

Niagara Metal Stamping Corp.
Dept. RN-4 Niagara Falls, N. Y.

PREMAX Parkerized Rustproof Metal Specialties

5 TUBE RADIO

At Low Factory Prices

It's a wonder for power and selectivity. Famous ARL circuit. Coast to coast reception! Finely built of selected, tested parts. Thousands now in use.

FREE Log and Call Book and New 132-p. Catalog with thousands of nationally advertised bargains. Latest in radio tube savings. Write for Free copy.

AMERICAN AUTO & RADIO MFG. CO.
HARRY SCHWARTZBERG, PRES.
Dept. 10 I, American Radio Bldg., Kansas City, Mo.

AMERICAN RADIO BARGAINS

Insure your copy reaching you each month. Subscribe to RADIO NEWS—\$2.50 a year. Exporter-Publisher Publishing Co., 230 Fifth Ave., N. Y. C.

30 Days FREE TRIAL

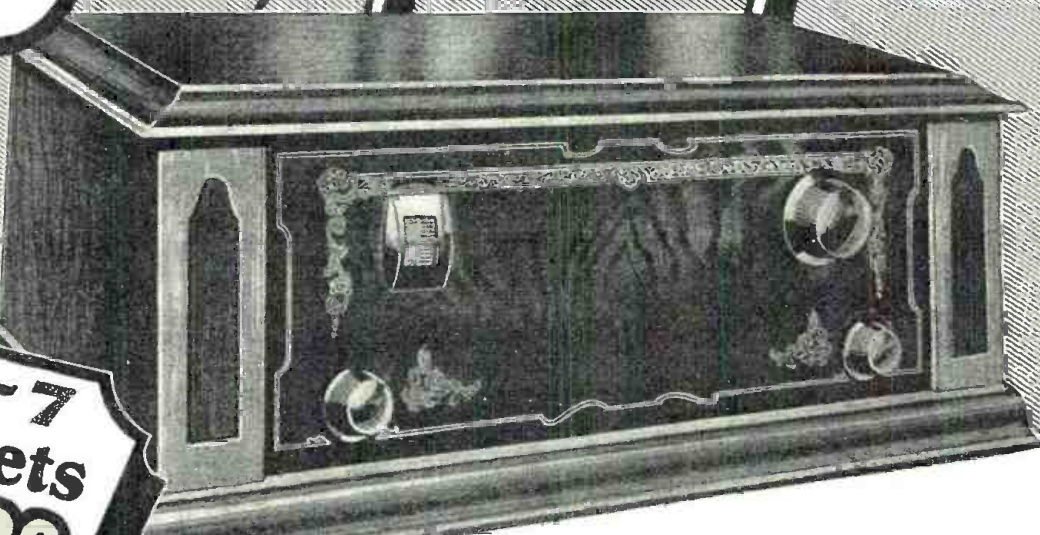

**5-6-7
Tube Sets
\$47.00
to
\$72.00
RETAIL PRICES**

Westgale Radio Sets

NOW!—you can get the finest quality Radio, DIRECT FROM FACTORY on 30 Days Trial and save almost half. Now you can put any of the new 1928 WESTGALE models in your home and use them to your heart's content for 30 Days at our risk. Listen to the music, concerts, news, sports, market reports from all over the country. Test the Westgale Radio for distance, selectivity and REAL Tone value. Compare it for quality and price with any other Radio. Then if not convinced that Westgale gives you the biggest value for the money—YOU DON'T HAVE TO KEEP IT.

*The Last Word in
Guaranteed
Radio
Sets
and
the
Biggest
Values
Ever
Offered*

Westgale Sets Are Licensed Under R.C.A. and Associated Companies Patents

For the 4th consecutive year Westgale offers you the newest and latest in Radio at lowest prices. Our 1928 models are licensed under the basic patents of the Radio Corporation of America and Associated Companies. That assures you dependable service. Beware of an un-licensed Radio. Why not have the best? Why pay high prices? Why take chances when you can test out any Westgale model in your own home on 30 Days Trial. Our retail prices are low factory prices. Our Agent's prices are lower. Send for our new 1928 catalog and see for yourself.

24 Models to Choose from Table Styles—Consoles—De Luxe Cabinets

This season Westgale offers you 5 tube—6 tube—and 7 tube models in your choice of a beautiful array of table styles, consoles and period type walnut cabinets. Don't buy any radio until you send the coupon for our new catalog which pictures and describes our complete line in almost any size or style you could wish for. Don't wait—a special introductory discount from retail prices for those who write quick. Mail the coupon today—get posted before you buy.

Mail Today - Don't Delay

WESTGALE ELECTRIC CO.,
Dept. 912, 1751 Belmont Ave.,
CHICAGO, ILL.

Please send me your FREE catalog on the new 1928 Westgale Radio Sets. Also full particulars of your Special Discount Offer on the first outfit placed in each community.

Name.....
Address.....

Why Not Be Our Agent?

Buy at cost. We want Agents and Dealers in every locality to demonstrate and take orders for these amazing new 1928 Westgale Models. This is your chance to get a Westgale Radio at a big discount and make it pay you big money. Millions of radios will be sold this season. Get a Westgale set on 30 Days Trial—demonstrate to your neighbors and friends and get your share of these big radio profits.

Your Own RADIO Free

Our new Catalog also explains a plan whereby you can put a Westgale Radio in your home on 30 Days Trial—demonstrate it to your neighbors and friends in your spare time and get your own set without cost before the trial period is up.

Special Discounts to Agents

To quickly introduce these wonderful new 1928 models we are offering for a limited time a big reduction, way below retail prices, on the FIRST Westgale set placed in each community. So get busy now! Be first in your locality to mail the coupon for our FREE catalog and get full particulars of this special discount offer.

Westgale Electric Company
Dept. 912
1751 Belmont Ave., CHICAGO, Ill.



5 Tubes—1 Dial
Only
\$87.00
Retail Price
Including Speaker

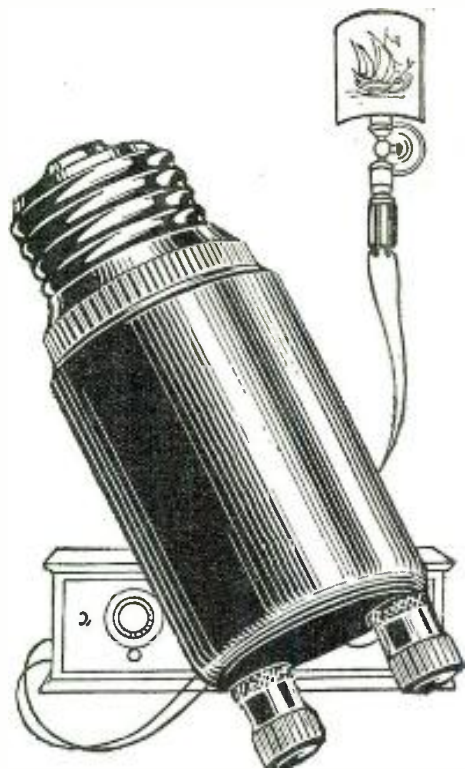

The Era of Light-Socket Operation---

Right in line with the latest developments in batteryless receivers is the Dubilier Light-Socket Aerial. Just as the power unit simplifies and improves radio, this competent, efficient device eliminates troublesome, unsightly outdoor aerials and greatly improves reception. Uses no current whatever and absolutely does away with the lightning hazard. Sold on a 5-day money-back basis. Price \$1.50.



Building A Power Unit?

Then you'll want condenser blocks you can bank on for long life and safety under heavy loads. Dubilier Blocks are official with such well-known manufacturers as Raytheon, Acme, Thordarson, General Radio, etc., and with experimenters who have always turned to Dubilier as a matter of course for dependable condensers.

All good dealers have them.

Dubilier Condenser Corporation
4377 Bronx Blvd. New York

Dubilier Condensers

260,000 Customers Waiting for Radio

(Continued from page 613)

dio. The improvement in receivers and the increased power of broadcast stations has placed every school within reach of radio programs. One chain of stations can reach more than half the population of the United States at one time. Educators respond generously to invitations to speak into microphones.

Enough schools have been equipped with radio receivers, on their own initiative, to show that radio can be used successfully for routine instruction and for supplementary features. Some cities have developed systems by which all their schools are reached at one time; certain grades receive class instruction in prescribed subjects at stated hours.

Counties and rural districts have used radio lessons, talks and music to supplement the instruction given in widely scattered schools. School superintendents have talked to more schools in ten minutes, by radio, than they could visit in ten weeks. At least two states have experimented successfully with radio instruction that covered their entire areas; one of them reached 275,000 pupils in five states with its first broadcast lesson. The governor of another state is so impressed with the value of radio in education that he has asked the legislature to appropriate money to erect a state broadcast station through which the schools can be served.

The schools of the British Isles have had five years of successful experience with a national system of instruction by radio that includes a wide variety of courses. The results of the examinations following the broadcast courses exceeded the expectations of even the optimists and astounded those educators who had refused to believe that the new method could succeed. Even conservative educators must take such evidence into account.

APPROACH CAN BE MADE TO LOCAL, DISTRICT OR STATE OFFICIALS

Educators are not opposed to radio. Here and there an old foggy may be encountered who started with the dead languages and then went backward—such are found in all professions and businesses—but the majority are open minded and there is a percentage of live wires who are ready to do pioneer work. Practically all teachers and school officials know something about the use of radio in the home, but there is a lack of definite plans for the installation and use of radio apparatus in schools.

Some teachers still look upon radio as they did upon the phonograph forty years ago, when lecturers went around demonstrating machines on which tinfoil was wrapped about a cylinder to receive and reproduce a few words; they consider it merely as an interesting scientific device to be demonstrated once so that pupils may see how it works. They do not know that radio has been used for years in some schools with success.

The colleges have been using radio for years. Eighty-seven American broadcast stations are operated by universities, colleges, high schools and other institutions of learning. High schools are following the lead of the colleges and grammar schools follow the lead of high schools.

As the situation stands today, the community set builder seems to have the most immediate opportunity to place radio sets in schools. He knows radio and has enough experience with local conditions so that he can select the type of receiver that will be best for the school, build it, install it and



The nation's strength is the nation's health

Buy

Christmas Seals and help preserve it

THE NATIONAL, STATE, AND LOCAL TUBERCULOSIS ASSOCIATIONS OF THE UNITED STATES

BIG RADIO CATALOG
From the "Big, Friendly Radio House"
NEW 1928 Book offers finest, newest well-known sets; parts, eliminators, accessories at lowest prices.
WRITE for this CATALOG

Western Radio Mfg. Co.
126 West Lake St., Dept. 19, Chicago, Ill.

C. R. LEUTZ, Inc.
6th and Washington Avenues
LONG ISLAND CITY NEW YORK



ARCTURIZE YOUR RADIO

*Now you can have all the convenience and economy
of A-C operation — plus unfailing reception of
unusual tone quality with the reliable*

ARCTURUS A-C TUBES

With but a few simple changes in wiring, you can modernize the radio receiver you now own. The only A-C Tube on the market with but four prongs, the Arcturus A-C Tube fits present sockets, can be installed in any circuit without the addition of condensers, or potentiometers.

The changeover to Arcturus A-C Tubes does not take long or cost much. The uniform quality reception they give you is your assurance of complete satisfaction.

For Your New Set

When you are selecting a fine, new set, make sure that you will reap all the benefits of A-C operation, the absolute reliability, convenience and economy that can be yours only with Arcturus A-C Tubes.

ARCTURUS RADIO COMPANY

INCORPORATED

253 Sherman Avenue, Newark, N. J.

30 DAYS FREE TRIAL

SEND NO MONEY FOR *the* CON-RAD SINGLE DIAL CONTROL **6**

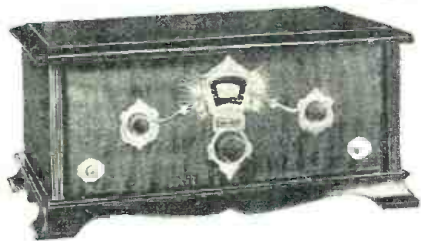

SUPER SIX 6 TUBES—DIAL COMPLETELY ASSEMBLED **66⁶⁶** RETAIL VALUE

SAVE 1/3 TO 1/2!

You can now buy at wholesale the famous Con-Rad sets—manufactured under license grants from Radio Corp. of America; Westinghouse Electric Mfg. Co.; General Electric Co.; and American Telephone and Telegraph Co. The Con-Rad Super Six—with single control and illuminated dial—is the ultimate in radio receivers. A 30 Days' Free Trial will convince you of Con-Rad superiority. Latest 1928 Model—Walnut Cabinet—shielded chassis—can be operated by a child—and guaranteed to give complete satisfaction.

A CON-RAD IN YOUR HOME MEANS MONEY FOR YOU

Men and women making big profits selling Con-Rad Receivers through home demonstrations. Full or spare time. Low factory wholesale prices enables you to cash in on the radio sensation of the year. Write today for complete information.

Retail Value \$34.75



6 TUBES—1 DIAL Completely Assembled

Another Con-Rad success! Six tube model—single dial control—completely assembled in latest model table cabinet. Tremendous buying power enables us to sell this set at this low price. Con-Rad Radio sets are sold exclusively by the Consumers Radio Co. Our generous Free Trial offer makes it easy for you to hear a Con-Rad in your own home.

CONSUMERS RADIO CO.

4721 Lincoln Ave. Chicago, Illinois

Consumers Radio Co.
4721 Lincoln Ave., Chicago, Ill.

Dear Sirs:

Without obligation on my part, send me full details of the Con-Rad 30 Days' Free Trial Offer.

Name

Address

City

State

Also send me Home Agents Proposition.

service it. Usually he knows school principals and teachers, who are specially interested in radio. Often he is acquainted with members of the school board, with officials of the Parent-Teachers' Association, and with men and women who have the means to present radio sets to schools.

The local dealer has almost as good a chance. If he is a real salesman, who goes after business instead of hanging around the shop and waiting for it to come in and wake him up, he can sell radio to schools. Much is said about local dealers, confidentially, by wholesale distributors and manufacturers. Much of it is illustrated by what can be seen in any average radio shop. But there are local dealers who know a good thing when they see it, and who get to it before the other fellow has come out of his doze and stretched himself.

STATE AND NATIONAL SALES EFFORTS COMING

Eventually, some manufacturer or national distributor of radio will organize a campaign of education for educators that will give his goods a start which will be hard to overcome. It will not begin with: "Mr. School Man, we have some very nice radio receivers that we would like to sell you for use in your schools."

The long-headed business man may meet the far-sighted school executive at the club or on the golf links, but wherever the radio representative brings about the meeting, I imagine the conversation will run something like this:

"Say, Bill, how is it that the public schools are slower than everybody else about using radio?"

"Are they?"

"Certainly they are—don't you know the figures?"

"No—couldn't get our appropriation increased enough to cover the cost of an investigation."

The radio man will pull out the statistics gathered by his company.

"Here's a sample county in your state: seventy-five one-room schools, in charge of the youngest, poorest trained, least experienced and lowest paid teachers under your supervision. Only one radio set in the lot. That's typical of your whole state, and that don't take into consideration all the village and city schools, the consolidated or the high schools."

"Well, most of the pupils have radio in their homes," the school man apologizes.

"Do they! Only one radio set to seven homes—less than the national average, which is one set to five homes. It's a shame, Bill—a dozen good broadcast stations were shooting out stuff all day long that those kids ought to have heard, yet they missed even the course in music appreciation; they didn't even hear Lindbergh!"

"Well, what can I do about it? I have to fight for every dollar in the whole appropriation. Anything new that I suggest they fight tooth and nail."

"I see—you mean the politicians. Want to be greased?"

"Greased? Say, they demand more grease than a girl swimming the Channel without a bathing suit."

"Well, suppose you issue a statement endorsing the use of radio in the public schools of the state—something that I can use—and leave the dirty work to me."

"Somebody would raise a howl about commercializing the schools the minute you started to use it."

"Not as loud a howl as the local school people and the public will raise if you don't show a little leadership. Parents want their children to have the benefits of the latest educational methods. They know that radio can give them contacts with the brightest minds of the century and they want them to listen in where they can't twist a dial and sidetrack the good stuff for jazz. If you

ACME



Flexible Celatsite Wire

A cable of fine, tinned copper wires with non-inflammable Celatsite insulation. Ideal for sub-panel or point-to-point wiring. Strips easily, solders readily. Nine beautiful colors; sold only in 25 ft. coils, in cartons colored to match contents.

Acme Celatsite Wire

Tinned copper bus bar hook-up wire with non-inflammable Celatsite insulation, in 9 beautiful colors. Strips easily, solders readily, won't crack at bends. Sizes 14, 16, 18, 19; 30 inch lengths.

Stranded Enameled Antenna

Best outdoor antenna you can buy. Seven strands of enameled copper wire. Presents maximum surface for reception, resists corrosion; this greatly improves the signal. Outside diameters equal to sizes 14 and 16. (We also offer solid and stranded bare, and stranded tinned antenna.)

Battery Cable

A rayon-covered cable of 5, 6, 7, 8 or 9 vari-colored Flexible Celatsite wires for connecting batteries or eliminator to set. Plainly tabbed; easy to connect. Gives set an orderly appearance.

Send for folder
THE ACME WIRE CO., Dept. D
New Haven, Conn.

ACME WIRE

MAKES BETTER RADIO

FREE TO BOYS

"THE SHOOTER'S ART" Send Now!

Tells how to hold, aim and handle rifles; helps you guide others in correct knowledge of guns. Gives facts that make crack shots. Contains safety and common sense instruction every parent and boy should have. Helps to make boys leaders. Your copy Free. Write at once.

The NEW BENJAMIN AIR RIFLE
America's Original Air Rifle
\$5 at your dealer's or sent postpaid. Write! Air Rifle & Mfg. Co., 605 N. Broadway, St. Louis, Mo.

FREE Wholesale Radio Catalog
Dealer-Set Builders! Save Money!
Send for this book of bargains. Everything in Radio—all the newest hook-ups, sets, kits, parts, cabinets, consoles and supplies. If you want the best for the least money, you need this catalog.
SHURE RADIO COMPANY
351C West Madison St. Chicago, Ill.

Public Lands New Radio Socket Power

RADIO electric power has been reduced to a simple switch, exactly as you operate an electric sweeper, iron or toaster. Through continuous scientific research a new metal, known as Kuprox, is revolutionizing the entire electrical world, making possible great advancements not only in radio but in telephone, telegraph, railroad and other industrial developments that heretofore faced the problem of electrical power rectification.

For years radio fans hoped eventually to take all radio power direct from the light socket. That day is here. At last, radio power without acids, liquids, or charging bulbs is a certainty. Almost over-night the bothersome electrolytic trickle chargers, with the nuisance of acid fumes has been eliminated. In Kuprox Radio Power Devices any radio receiver may be made truly electric, without any change to your set. Simply plug into the light socket, turn the switch, and your radio troubles of run-down batteries, acids, watering or burned-out charging bulbs, are gone forever. And, Kuprox lasts indefinitely for it is a hard, dry metal, without moving parts of any kind. There is nothing to wear out.



The Replacement Unit, a series of simple Kuprox metal discs, riveted together.

In addition to its use in complete A, B, and C electric radio power devices, Kuprox is also being manufactured in an ingenious device that brings to an end all the bother and trouble experienced heretofore with all electrolytic trickle chargers.

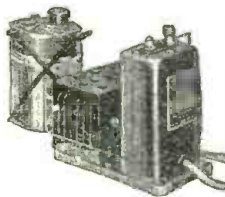

How the Kuprox Replacement Unit replaces the acid jar on trickle chargers.

With this device, known as the Kuprox Replacement Unit, and retailing for only \$4.50, it is possible to convert any standard wet trickle charger or power unit into a dry rectifier that requires no attention. It is easy to attach. Simply disconnect the present jar of acid and throw it away. Install the Replacement Unit in its place by two simple binding post connections. Besides eliminating all the watering and attention, the new replacement delivers about twice the former charging rate, resulting in much higher efficiency of the battery to which it is attached.

Makes Any Radio Entirely Electric!

Eliminates Acids, Liquids, and Charging Bulbs

Dry, permanent power that requires no watering or attention!

NOW you can make your radio operate entirely from your light socket! No more of the bother and worry about batteries... none of the troublesome watering or attention.

KUPROX Radio Power Devices supply dry, permanent radio power without acids, liquids or charging bulbs... just attach them to your set and forget them.

The complete line of KUPROX Radio Power Devices is now on display at all good radio stores. See them.

KUPROX

RADIO POWER DEVICES

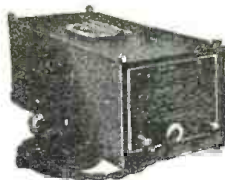

KUPROX "A" TRANSIFIERS—Batteryless, noiseless, electric "A" power. Dry, dependable, needs no attention. Operates any receiver. 4-volt or 6-volt. \$28.50 and up.

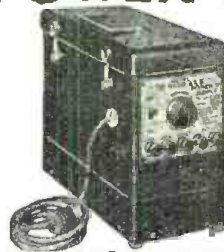

KUPROX A & B TRANSIFIERS—All radio power from a single unit. Controlled from set switch. Absolutely dry, requires no attention. \$57.50 and up.



KUPROX "B" TRANSIFIERS—Dry, permanent, free of hum. Models for all sets and circuits. \$14.50 and up.



KUPROX Replacement Unit—For replacing acid jar on all standard trickle chargers and power units. \$4.50

KUPROX Trickle Chargers—1-amp. rate. Large model gives 2½-amp. booster charge. \$10.50 and \$18.50.



WRITE FOR FREE BOOKLET—"The Secret of Successful Battery Elimination" describing KUPROX Radio Power Devices.

THE KODEL RADIO CORPORATION, 501 E. Pearl St., CINCINNATI, O.

© 1927 K. R. Corp.

**Better tubes
FOR
Better radios**



**All
Standard Types**

The price of perfect radio reception—clear, rich and flawless—is infinite attention to every detail. With a good set and a good speaker, don't "take a chance" on cheap tubes. Install a full set of the reliable

**Gold Seal
Radio Tubes**

There have been great improvements made in tubes—is your equipment up-to-date? Enjoy the latest developments in radio reception. You can make the change yourself easily.

Send for free copy of our new booklet, "Better Tubes for Better Radios"—full of helpful information. Use coupon below.

Gold Seal Electrical Co., Inc.
250 Park Avenue, New York

Send me copy of the new booklet.

Name

Address

R. N. 12-27

don't go ahead, they are going over your head. Some have already."

And Bill, known to the public as Dr. William, with half the alphabet in the degrees that he is entitled to write after his name, will take the situation in hand.

**CONVINCING INFORMATION NOW
AVAILABLE**

Information that will be useful in placing radio in the schools will be published for the benefit of manufacturers, dealers and community set builders.

We have statements from the National Commissioner of Education, many of the state superintendents of education, school superintendents in the territories and islands under the supervision of the United States. At the suggestion of two state superintendents we have corresponded with the local superintendents in their states and they have given us facts that must convince any educator of the need of radio in the schools and of the practicability of using it there.

We have visited schools and colleges and talked with men who have used radio in education and know its value. Our travels have taken us into more than half of the states of the Union.

We have the complete report of the development of the marvelous system of education by radio that is putting new life into the schools of the British Isles.

Broadcasters have told us of their desire to broadcast programs that will be helpful to teachers and pupils, during school hours and also in that part of the day spent in the family circle.

School officials have spoken enthusiastically of conducting classes in scores of schools at one time, classes taught by teachers of such outstanding ability that no one of these schools could have engaged any of them for even one class session, because of the expense. Some officials have broadcast addresses to the parents and public, addresses that brought about mutual understanding of common problems and secured better co-operation and increased financial support for the schools.

We have accounts of how pupils raised money for school radio sets; built receivers in school workshops for use in school and at home; constructed and operated school radio stations, complete with transmitters and receivers, that kept the school in touch with the radio amateurs and their scientific experiments in all parts of the country; erected and conducted school broadcast stations, so that school musical clubs, debating societies and dramatic organizations could be heard by pupils in other places. One school receiver even reduced the amount of sickness in the schools of a large district.

Such evidence, when placed before a school official or teacher, commands attention. It shows that progressive schools have secured the benefits of radio, in spite of difficulties. It points the way for action in other places.

**GREATER DX ON "SUPERHET"
WITH LIGHT-SOCKET ANTENNA**

Recent tests conducted in a crowded city district with a superheterodyne receiver and an improved light-socket antenna plug in place of the usual loop indicate that a marked gain in signal strength and distance covered can be readily obtained.

Heretofore, with stations operating with little separation between broadcast channels, the loop has been essential for the required selectivity; but with the present 50-kilocycle separation now in force, the loop may be replaced in many instances by a more efficient wave interceptor, while still retaining sufficient selectivity. A coupling coil, in place of the loop, must be used with the lamp-socket arrangement.

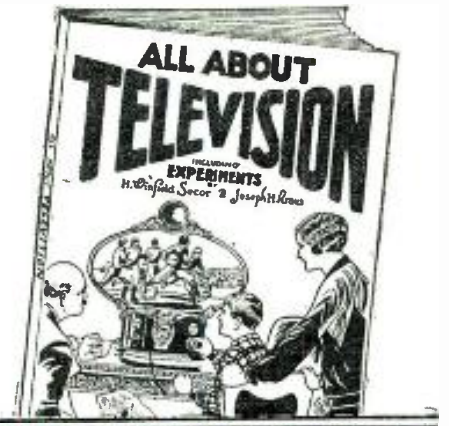

**TELEVISION
is Here!!!**

**Radio Fans! Mechanics!
Scientific Men!—Everybody—
Build a TELEVISION SET.
The greatest and most
amazing development of
the 20th Century**

HERE, friends, is the first book to be published giving you the history of TELEVISION, from the first crude experiments at the beginning of the 20th Century—to the comparatively perfect machines just put into daily operation. From this book you can build your own, workable television set that will serve as a fundamental apparatus for hundreds of tremendously interesting and amazing experiments.

Get in now on this new development. You may be fortunate enough to discover some improvement to Television that will be worth many thousands of dollars.

Start with a copy of this new book today. 116 Pages, 9 x 12 inches, illustrated.

**50c ON ALL
NEWSSTANDS**

*If your Newsdealer cannot
supply you, use this coupon.*

EXPERIMENTER PUB. CO., Inc.
230 Fifth Ave., New York, N. Y.

Gentlemen: I enclose 50c for one copy of "ALL ABOUT TELEVISION."

Name

Address

City, State

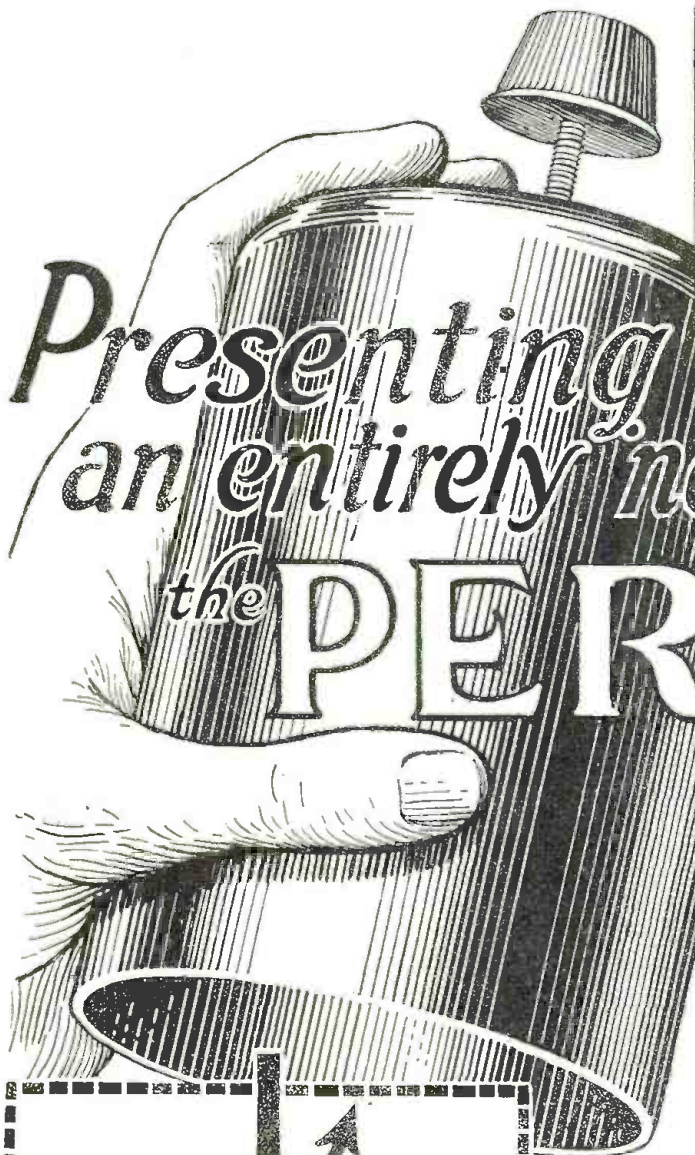

Presenting
an entirely new circuit

the PERIDYNE

WHAT RADIO NEWS SAYS ABOUT THE "PERIDYNE"

RADIO NEWS says:
The "Peridyne" receiver, is revolutionary. It embodies an entirely new principle in what we have named the "Peridyne" method of shield-tuning.

A new radio symbol, the "Peridyne" character, had to be created by the author, as no symbol for this arrangement is provided in the present radio practice.

We predict great commercial possibilities for this invention; which makes it possible to bring a single

dial set into perfect interstage resonance and consequently to operate it at the maximum possible efficiency.

The "Peridyne 5," a receiver you can easily build yourself, is a five-tube set, by means of which the author in New York receives Pacific Coast stations several times during the week, even during the summer.

RADIO NEWS further says:
The "Peridyne 5" is the greatest 5-tube DX set that has ever been described, anywhere.

You can easily build this new remarkable circuit. It has been designed by Mr. Hugo Gernsback, Member of the American Physical Society, Member of the American Association for the Advancement of Science, Editor of Radio News, Science and Invention and a dozen or more scientific and practical Radio Books. It presents the one TRUE, and most effective receiver for perfect inter-stage Resonance on Single Control giving the maximum efficiency possible in this type of Receiver.

There is a reason—an obvious reason apparent at a glance, for the unmatched efficiency of this remarkable receiver.

The "Peridyne" employs a new principle, the circuit of which is shown in the lower left hand corner of this page.

By means of this simple, yet amazing instrument, Mr. Gernsback has combined the two principal means employed today to obtain True Interstage Resonance.

The "Peridyne" is the perfect one-control set—the perfect distance receiver.

The official parts listed below have been combined to work most effectively in the "Peridyne." This combination of quality parts endows the "Peridyne" with its remarkable performance. The cost of building the "Peridyne" is astoundingly low for the results achieved.

OFFICIAL LIST OF PARTS FOR THE "PERIDYNE"

- | | |
|---|---|
| 1 Amsco Triple Var. Cond. .0005 mf. each section | 1 Yaxley Jack, Single-circuit type |
| 3 Hammarlund R. F. Transformers, Special (Special Peridyne units) | 1 Yaxley Jack-Switch, Two-circuit type (D. P. S. T.) |
| 3 Silver-Marshall Coil Shields, Special (Special Peridyne units) | 1 National Vernier Dial |
| 2 Silver-Marshall A. F. Transformers 3:1 ratio | 5 Benjamin Sockets, UX type |
| 2 Allen Bradley Rheostats, Carbon type | 4 X-L Binding Posts |
| 1 Centralab Variable Resistor, 0-100,000 ohms | 1 Am. Hard Rubber Panel, 7x24x3/16 inches |
| 1 Carter Switch-Rheostat, 30 ohms; combination instrument | 1 Am. Hard Rubber Sub-Panel 8x23x3/16 inches |
| 1 Amperite, 5 volts, 1/4 ampere type | 4 Am. Hard Rubber Brackets, 6 1/4 x 2 inches, hard rubber |
| 1 Amperite, 5 volts, 1/2 ampere type | 1 Belden Battery Cable, with fuse, 7 wires |
| 1 Carborundum detector, Carborundum type | 4 E. T. Cunningham Vacuum Tubes, 201-A type |
| 1 Samson R. F. Choke, 85 millihenries | 1 Cunningham Vacuum Tube, 112 type |
| 1 Aerovox Fixed Condenser, .001 mf. | 1 Am. Hard Rubber Terminal Strip, 7 1/4 x 1 x 3/16 inches |
| 1 Jewell Voltmeter, 0-8 volts | 4 Acme Rolls Hook-up wire, Black, Yellow, Red and Green |
| 1 Jewell Voltmeter, 0-150 volts | |

The coupon below, with 50c, will bring you the official Construction Book, for the "PERIDYNE," including full sized blueprints and detailed instructions to make it.

"PERIDYNE"

1150 BROADWAY NEW YORK, N. Y.

"PERIDYNE," 1150 Broadway, New York, N. Y.
Gentlemen: I enclose 50c, kindly send me one copy of the Official Sixteen-page "PERIDYNE" Booklet with full sized Blueprints.

Name

Address

City State

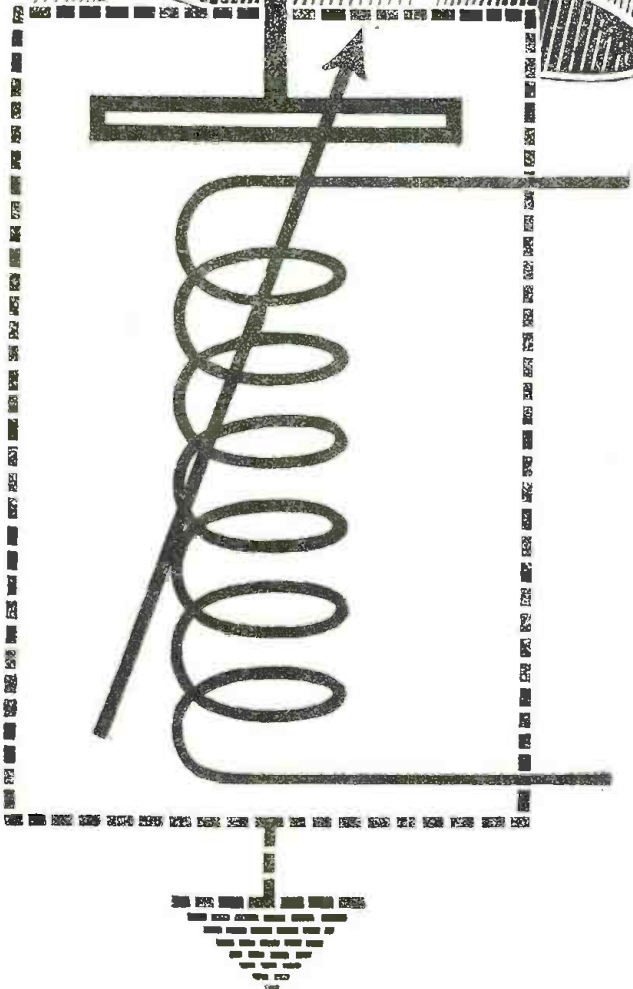

NEW AERO KITS USED IN IMPORTANT CIRCUITS

The Improved Aero-Dyne 6, the Aero 7 and Aero 4—all popular new circuits—are built around these marvelous coils

You Should Learn About Them NOW!



AERO Universal Tuned Radio Frequency Kit

Especially designed for the Improved Aero-Dyne 6. Kit consists of 4 twice-matched units, adaptable to 201-A, 199, 112, and the new 240 and A. C. tubes. Tuning range below 200 to above 550 meters. This kit will make any circuit better in selectivity, tone and range. Will eliminate losses and give the greatest receiving efficiency.

Code No. U-16 (for .0005 Cond.)... \$15.00
Code No. U-163 (for .00035 Cond.)... 15.00



AERO Seven Tuned Radio Frequency Kit

Especially designed for the Aero 7. Kit consists of 3 twice-matched units. Coils are wound on Bakelite skeleton forms, assuring a 95% air dielectric. Tuning range from below 200 to above 550 meters. Adaptable to 201-A, 199, 112, and the new 240 and A. C. tubes.

Code No. U-12 (for .0005 Cond.)... \$12.00
Code No. U-123 (for .00035 Cond.)... 12.00



AERO Four Kit

An exceptionally efficient kit for use in the Aero 4 and other similar circuits. Consists of one Aero Universal Radio Frequency Transformer and one Aero Universal 3-Circuit Tuner. Uses 201-A, 112, 199 and new A. C. tubes.

Code No. U-95 (for .0005 Cond.)... \$8.00
Code No. U-953 (for .00035 Cond.)... 8.00

NOTE: All AERO Universal Kits for use in tuned radio frequency circuits have packed in each coil with a fixed primary a twice matched calibration slip showing reading of each fixed primary coil at 250 meters and at 500 meters; all having an accurate and similar calibration.

A NEW SERVICE

We have arranged to furnish the home set builder with complete Foundation Units for the above named Circuits and for the Chicago Daily News 4-Tube Receiver, drilled and engraved on Westinghouse Micarta. Detailed blueprints and wiring diagram for each circuit included in foundation units free. Write for information and prices.

You should be able to get any of the above Aero Coils and parts from your dealer. If he should be out of stock order direct from the factory.

AERO PRODUCTS, Inc.

Dept. 105
1772 Wilson Ave. Chicago, Ill.

Raising the Curtain on Godfrey Ludlow

(Continued from page 605)

more minutes when Mr. Ludlow, laughingly asked: "What would you think if that same violinist happened to be sitting in your back seat?" The car was brought to an abrupt and terrifying stop, as an awed voice said, "My God—Godfrey Ludlow!"

A critic on the New York World writes:—"What is Godfrey Ludlow's magic secret? I'd like to know the secret back of his violin. I know of no other violinist on the air who is able to get his music 'across,' as he does. It is like a Sabbath benediction to listen to his Sunday concert."

What is your magic secret, Mr. Ludlow? It must have come into the world with you, and has been with you always. As a boy, competing for the first prize; as a student, winning greater honors; as a man, touring Europe, appearing before royalty; then in the prison camp, suffering with you; and now, here with us, pouring its glad song into each of our hearts. It is a magic secret, and we'll cherish it with you—always.

"Hello, Everybody!"

(Continued from page 604)

the roll of waves. Here Roxy was the master stage director, re-arranging the voices. In one number, "The Water Boy", the soloist was led backward and forward from the microphone, to gain the effect of distance, then of nearness, then dying away again. When it was over, we sat spell-bound, entranced.

A BOUNDLESS REPERTOIRE

Perhaps you who have been "listening-in" wonder where Roxy secures some of his tender ballads, his "heart" songs, that you hear when his "Gang" broadcasts. He has a huge mental musical storehouse, in which every type of song seems to have found its own particular pigeon hole. Having always loved music, even as a boy, he has responded to its every mood; it has been one of his chief inspirations. In that first little theatre, in Forest City, music was an important part of his program.

Being the possessor of an uncanny, almost indelible memory, once he hears a song, he never forgets; so his musical repertoire seems limitless. His mind reminds one of an unexcelled filing system; for, whenever a certain type of musical sentiment is desired, he has only to go into consultation with his "memory,"—and presto—there it is! !

Shortly after the death of Victor Herbert, Roxy purchased the composer's entire musical library, an invaluable collection of scores and selections. This forms the nucleus of one of the largest musical libraries in the country. Then too, Roxy has many ballads written especially for him. One Sunday afternoon he and his Gang journeyed to Rye, N. Y. to attend some official opening. In a prettily-terraced garden was a sun dial bearing the inscription—"Somewhere the sun is shining everywhere".

"What a pretty sentiment for a song," Roxy said to Daddy Jim Coombs, a popular member of the "Gang." Daddy Jim agreed, and after Roxy walked away, Daddy Jim took out his pencil, and in his notebook, composed the now popular ballad.

Upon their return to the N. Y. studios, Leo Russato, pianist and composer, also with the Gang, wrote the music, and the following night, Arthur Lang sang it over the air.



Save 50%

No better "A" Socket Power Unit can be obtained even at twice this amazingly low price. Combines all the efficiency of plate current with the undoubted convenience of socket power. No bothersome hauling around of batteries to be charged. No hum or noise. Highest quality Westinghouse electrical equipment. Operates on 50 or 60 cycles at 110 volts A. C. Thousands of satisfied users prove the worth of World Power Units. Approved by rigid tests of Radio News and other leading Laboratories.

Send No Money address; and we will ship day order is received by express C. O. D. subject to examination on arrival. 5% discount for cash in full with order. NOW is the time to do it.

WORLD BATTERY COMPANY

1219 So. Wabash Ave., Dept. 60, CHICAGO, ILL.
Station W5BC owned and operated by World Battery Company

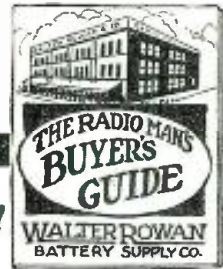

Free!

Free!

Professional Set Builders and Dealers

Write today for this big new Catalog. It's yours for the asking without obligation. Contains everything worth while in Radio, including all popular kits described in this and other leading publications. We carry in stock a complete line of parts, accessories, consoles and cabinets.

Buy Direct

from the largest Jobbing house in the middle west and save money on all radio equipment. Try us for quick, accurate service. No delays, no substitutions.

Walter Rowan Battery Supply Co.
227 N. Peoria St. Chicago, Ill.



One Dial Latest advanced circuit. All steel chassis totally shielded. Balanced parts of best quality. Marvelous power and selectivity. Gets the long range stations as clear as a bell. One dial single control. An unsurpassed value—just one of our many mighty bargains.

FREE Log and Call Book and Big New Catalog—just off the press. Full of Radio Bargains. Send for your free copy now!

American Auto & Radio Mfg. Co.
Harry Schwartzberg, Pres.
Dept. 102, American Radio Bldg., Kansas City, Mo.



Print Your Own

Cards, Stationery, Circulars, Paper, etc. Save money. Print for others, big profit. Complete outfits \$3.85. Job press \$11. \$29. Rotary \$149. All easy, rules sent. Write for catalog presses type etc. **THE KELSEY CO., P-72, Meriden, Conn.**

Insure your copy reaching you each month. Subscribe to **RADIO NEWS**—\$2.50 a year. Experiment Publishing Co., 230 Fifth Ave., N. Y.

**30 Days
FREE
TRIAL
5 Year
Guarantee**

MARWOOD

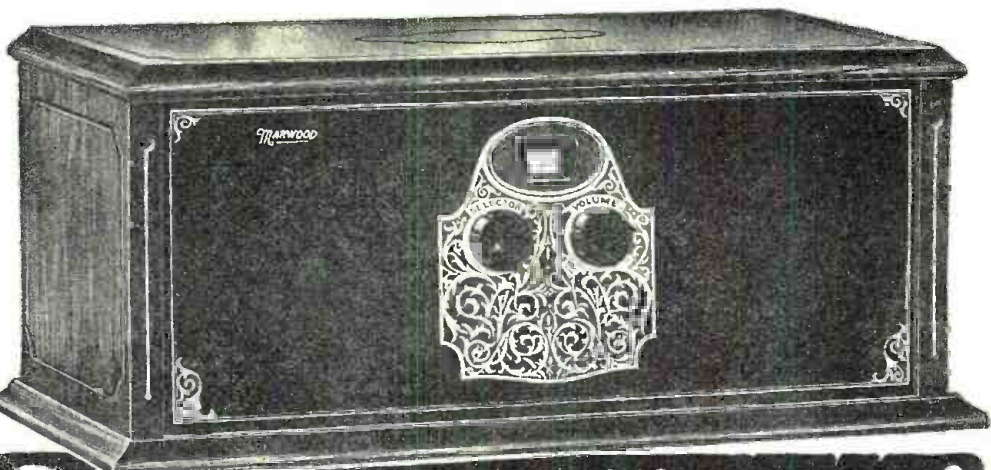

**The 1928 Sensations!
8 Tube-1 Control**

**All Electric
Or Battery Operation**

AGAIN Marwood is a year ahead—with the Radio sensation of 1928—at a low price that smashes Radio profiteering. Here's the sensation they're all talking about—the marvelous 8-Tube Single Control Marwood for BATTERY or ALL ELECTRIC operation. Direct from the factory for only \$69.00 retail price—a price far below that of smaller, less powerful Radios. Big discount to Agents from this price. You can't beat this wonderful new Marwood and you can't touch this low price. Why pay more for less quality? To prove that Marwood can't be beat we let you use it on 30 Days Free Trial in your own home. Test it in every way. Compare it with any Radio for tone, quality, volume, distance, selectivity, beauty. If you don't say that it is a wonder, return it to us. We take the risk.

**Only
\$69 RETAIL PRICE
Big Discount
to Agents
From This
Price**



New Exclusive Features

Do you want coast to coast with volume enough to fill a theatre? Do you want amazing distance that only super-power Radios like the Marwood 8 can get? Do you want ultra-selectivity to cut out interference? Then you must test this Marwood on 30 Days Free Trial. An amazing surprise awaits you. A flip of your finger makes it ultra-selective—or broad—just as you want it. Every Marwood is perfectly BALANCED—a real laboratory job. Its simple one drum control gets ALL the stations on the wave band with ease. A beautiful, guaranteed, super-efficient Radio in handsome walnut cabinets and consoles. A radio really worth double our low price.

**ALL
ELECTRIC
8 Tube
1 Control
\$98 RETAIL PRICE**

**Get Our Discounts Before
You Buy a Radio**

Don't buy any Radio 'till you get our big discounts and catalog. Save half and get a Radio that IS a Radio. Try any Marwood on 30 Days Free Trial at our risk. Tune in coast to coast on loud speaker with enormous volume, clear as a bell. Let your wife and children operate it. Compare it with any Radio regardless of price. If you don't get the surprise of your life, return it. We take the risk. Don't let Marwood low prices lead you to believe Marwood is not the highest quality. We have smashed Radio prices. You save half.

Buy from Factory—Save 1/2

Why pay profits to several middlemen? A Marwood in any retail store would cost practically three times our low direct-from-the-factory price. Our policy is highest quality plus small profit and enormous sales. You get the benefit. Marwood is a pioneer, responsible Radio, with a good reputation to guard. We insist on the best—and we charge the least. If you want next year's improvements NOW—you must get a Marwood—the Radio that's a year ahead.

6-Tube—1 Control

This is the Marwood 6-Tube, 1 Control for BATTERY or ALL ELECTRIC operation. Gets coast to coast on loud speaker with great volume. Only \$47.00 retail. Big discounts to Agents. Comes in handsome walnut cabinets and consoles. This low price cannot be equalled by any other high grade 6-tube Radio. Has the volume of any 7-tube set. If you want a 6-tube Radio you can't beat a Marwood and you can't touch our low price.

**Big Discount to Agents
From this Price**

AGENTS

Make Big Spare-Time Money

Get your own Radio at wholesale price. It's easy to get orders for the Marwood from your friends and nabors. Folks buy quick when they compare Marwood quality and low prices. We want local agents and dealers in each territory to handle the enormous business created by our national advertising. Make \$100 a week or more in spare time demonstrating at home. No experience or capital needed. We show you how. This is the biggest season in Radio history. Everybody wants a Radio. Get in now. Rush coupon for 30 Days Free Trial, beautiful Catalog, Agent's Confidential Prices and Agents' New Plan.

**\$47
RETAIL PRICE
Big Discount
to Agents
from This
Price**

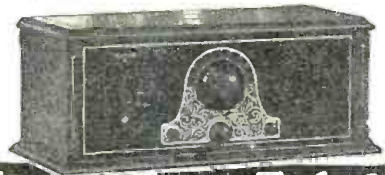

Has Complete A-B Power Unit

A REAL ALL ELECTRIC Radio with one of the best A-B power units on the market—no batteries needed—at the world's lowest price. This Marwood can't be excelled at ANY price. If you have electricity in your home, just plug into the light socket and forget batteries. No more battery trouble and expense. Costs less than 2c. a day to operate. Always have 100% volume. ALL ELECTRIC Radios are high priced because they are new. We cut profit to the bone and offer a \$250.00 outfit for \$98.00 retail price. Big discount to Agents. Don't buy any Radio 'till you get details of this sensational new ALL ELECTRIC Marwood.

Rush for Free Trial

Marwood Radio Corporation,
5315 Ravenswood Ave., Dept. B-5, Chicago, Ill.
Send Agents' Confidential Prices, 30 Days Free Trial,
New Catalog and Agents' New Money Making Plan.
No obligations on my part.

Name

St. or BFD.....

CityState.....

**MARWOOD RADIO CORP.
5315 RAVENSWOOD AVE.
Dept. B-5, CHICAGO, ILL.**



DAVEN TUBES

"Kick" the added power which means the difference between mediocre and excellent reception—between not quite bringing in that distant station and getting it strong, clear and undistorted.

Daven Tubes bring added "Kick" to your set—and in addition insure quiet, clear, tone perfect reception. Three types for any storage battery set.

The New Daven 201-A Amplifier and Detector

Try just one of these tubes in your set—the difference you will find in added power will make you replace the others. 5 Volt— $\frac{1}{4}$ Ampere.

The Mu-20—The Finest Detector Tube Made

On account of its unique characteristics the Daven Mu-20 is, we honestly believe, the finest detector tube ever designed. Quiet in operation, non-microphonic, amplification factor of 20, and exceptionally long life. Also the standard tube for resistance and impedance audio amplifiers. 6 Volt— $\frac{1}{4}$ Ampere.

The Mu-6—The Power Tube for All Storage Battery Sets

The special filament insures long life—its characteristics make it possible to use a stronger signal without overloading or distortion. 6 Volt— $\frac{1}{2}$ Ampere.

The New Daven AC Tubes

5 types to meet every requirement—the largest line on A.C. Tubes on the market. 4 Prong, platinum coated filaments, no hum, non-microphonic. Amplifier, High Mu, Detector, Power and Rectifier.

FREE CATALOG

Giving complete information about these and other Daven Products, at your dealer or direct from us.

"The Sine of Merit"

DAVEN RADIO CORPORATION
TRADE MARK "Resistor Specialists" REGISTERED

142 Summit St.

Newark, N. J.

We asked Roxy to tell us the secrets of his success as an impresario. It was after nine o'clock and his day's work was done. We were hoping that he might feel in sort of a "reminiscing" mood. It was our lucky day, for he was; but he asked us to be permitted to "wander on in his own way" and here is "Roxy speaking"!

"MIKE" AND ROXY

"First let me tell you something about 'Mike'. I've known him for many years now, and he's made thousands of friends for me throughout the world. He has been probably the most valued and indispensable friend in my long career. Without him, we could never have had our theatre, and his services are inestimable in the progress of that theatre. No man or woman can have contact with the great listening-in public without being benefited by it, both spiritually and practically. 'Mike' has a way of going straight to the hearts of the people, and if you don't touch their hearts genuinely, they are not interested in you.

"Like the hero in Austin Strong's play, 'Seventh Heaven,' 'Mike' is a 'very remarkable fellow.' You can't fool him. If you are gloomy, pessimistic, intent upon dwelling on your hard luck, that is the message 'Mike' is going to take right out into the world. If you are eager to do your bit, eager to give the other fellow a lift, or make him smile once in a while, 'Mike' will do that for you gladly.

"No matter what the philosophers tell you, I believe that, when all is said and done, it's sentiment that makes the whole world akin. If you can touch people's hearts, you've got 'em—why? I don't know; but, as I've knocked about since I was a cash boy in a Fourteenth Street department store, it's been my experience, that's all.

"Some may say sentiment isn't dignified; but what has dignity to do with it? Aren't we all children at heart anyway? On our birthdays, don't we put on paper caps, and hope to get the prize out of the frosted cake, just the same as when we were kids? Well, anyway, I do.

"I get a tremendous kick out of the morning's mail, after a broadcast session. It's just like a big surprise bag to me. Just as 'Mike' reflects your own personality, whether you like him to, or not, so does the radio mail reflect unerringly the opinion of the public. It isn't always complimentary, but that doesn't matter. You soon learn to boost yourself by the knocks, if you are determined to profit by your mistakes. Many an idea has come to me through a radio letter, many a constructive criticism too. They have a way of saying exactly what they think, these listeners-in; and, believe me, it is not only a revelation of the public's mind, but an inspiration to 'carry on.'

"When I say a man cannot have contact with the listening public without deriving a spiritual benefit, let me cite, as an example, a message I found on my desk some days ago from a convict in the West Virginia State Penitentiary.

"'Yes, Roxy, we know we don't amount to much—but if you could tune in and receive the messages broadcast from each heart among the convict sick, you would then know, and understand, that there is gratitude and appreciation vibrating from the soul of those who were, once, men.'

"It makes you feel humble, doesn't it? A good moment. I should say, to sign off, before you ask me to."

A remarkable personality, a wonderful soul! No wonder the millions adore him, those who sense his deep-rooted love for and understanding of humanity through the medium of radio. One feels that he has suffered much, lived much, and through it, has gained the gift of "understanding." It is in his eyes, the look of one who sees always "beyond the horizon." I told him that, and he said, simply: "One just has to, you know."



Check Your Condensers

Compactness, simplicity and dependability are the new quality standards for better set construction. Sprague Midgets, small, compact and dependable meet every set building requirement.

Order the new .1 M.F.D. from your dealer or send one dollar for sample complete with mounting bushings. It is the outstanding condenser revelation of the season.

SPRAGUE SPECIALTIES CO.
Dept. N
Quincy, Mass.



THE OUTSTANDING CIRCUIT OF THE YEAR

STROBODYNE

We Have the Complete Kit as Specified by R. E. LACAULT

Headquarters for All the

NEW SAMSON POWER UNITS

Our Circular On All Kits is Now Ready It Will Pay Set Builders to Send for it

M & H SPORTING GOODS CO.
512 Market St. Philadelphia, Pa.

Wirthmore Radio Cabinets



SAVE MONEY

Right in your own city are many people who have saved money by buying Wirthmore Cabinets direct.

You too can buy a Better Cabinet and save Money. A Complete Line of Consoles equipped with Newcomb-Hawley Speakers.

Get Your Catalog

THE WIRTHMORE COMPANY
910 Wirthmore Street, Rockford, Ill.

10 LUCKY TEN 10

Send 10 cents for 10 weekly issues of THE PATHFINDER, the most unusual magazine in America. Sparkling with interesting, informative, educational and entertaining. Best fiction obtainable! Pictures! Specially conducted departments. Send name and address and 10 cents IMMEDIATELY! THE PATHFINDER, Dept. Y 88 Washington, D.C.

WHOLESALE PRICES

--- for Dealers, Community Set Builders, General Repairmen and Agents ---

Be sure to get this great 100-page book with net prices to the radio trade.

Radio Specialty Company is radio's oldest radio parts mail order house in the country, and the new confidential prices on standard radio merchandise are the lowest of any radio house.

We are ready now to appoint additional agents in all parts of the country. If you are contemplating making big money in radio merchandise, be sure to get in touch with us at once.

WHEN WRITING
TO US,
USE YOUR
LETTERHEAD

1927
Edition

No. 17

500
Illustrations

NEW
Enlarged
Edition



THIS
100 PAGE
RADIO
CATALOGUE
FREE
75 HOOKUPS

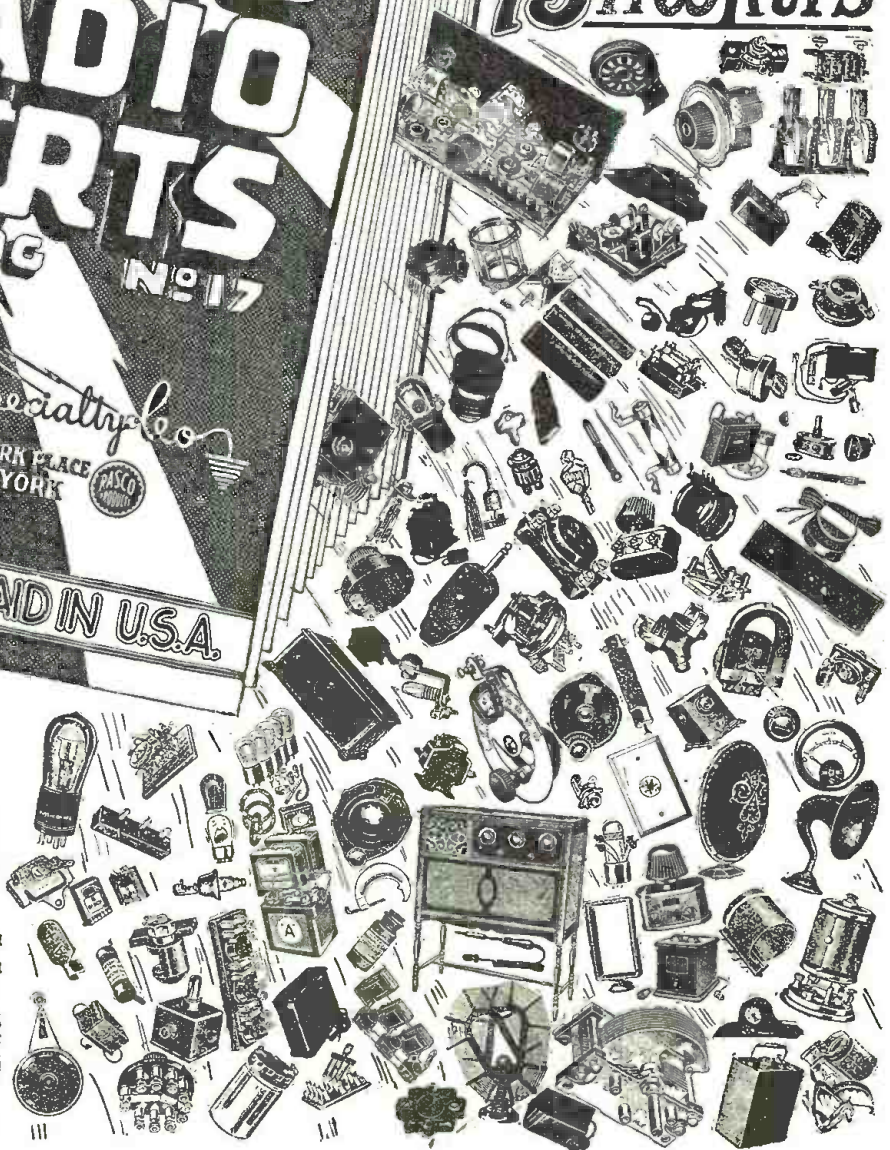

BUY!!
from Radio's Oldest
Mail Order House

We are the oldest established, exclusive radio mail order house in the country. Our motto is "Quick Shipment." All orders are shipped within 24 hours. Quick, prompt, courteous service. We carry a larger variety of radio parts and findings than any other radio house in the country.

"RASCO HAS IT"

If you are in need of certain small radio parts that other radio and mail order houses do not bother to carry, get the Rasco parts catalog and you will find them there, anything from a screw to copper ribbon and telephone diaphragms, as well as thousands of other small radio findings. Just to mention a few:

Lugs, nuts, dials, vernier dials, jacks, plugs, every kind of knob, cords, panels, screws, sliders, washers, selenium, tin foil, switches, crystals, cap nuts, Litz wire, cord tips, brass rods, resistances, name plates, spring binding posts, switch parts, metal ribbon, carbon balls, binding posts, all types, switch points, switch levers, lock washers, carbon grains, ground clamps, metal pointers, insulated tubing, low melting metal, antenna connectors, bus bar wire, as well as thousands of other articles.

We carry the Largest Variety of Small Radio Parts in the World. BUT We also carry ALL standard radio merchandise. ANYTHING IN RADIO

RADIO SPECIALTY CO.

98W PARK PLACE
NEW YORK CITY, N. Y.

BENJAMIN

TRADE MARK

Red Top Cle-Ra-Tone Sockets

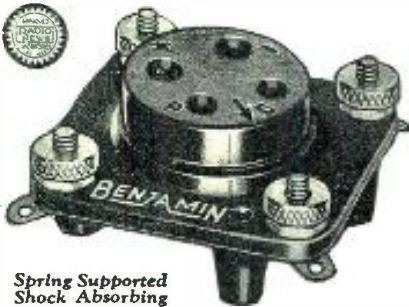

Spring Supported Shock Absorbing

Makes the socket stand out from the dead black of the base and panel

Easier to establish correct position of tube and prongs Improves the appearance of the set

Have all spring supported and shock absorbing features of the famous Cle-Ra-Tone Sockets. Non-microphonic. Unaffected by stiff bus wiring. Tube holding element "floats" on four finely tempered springs.

Used in most of the leading circuits. Among the most recent for which Cle-Ra-Tone Sockets have been specified are:

- Strobodone 8
- Magnaformer 9-8
- Camfield Super-Selective 9
- Lynch Suppressor Circuit
- H. F. L. Nine in Line
- World's Record Super 10
- Melo-Heald Fourteen
- St. James Super
- Karas Two-Dial Equamatic
- Knickerbocker 4
- Hilograd Receiver
- International One-Spot
- Thompson Super 7
- Hot Spot Fourteen

PRICES

Push Type, on Mounting Base

Benjamin Cle-Ra-Tone Sockets 75c each
Without Mounting Base 50c each

Green Top Sockets for A. C. Tubes

Specially designed, for use with 5-pronged A. C. Radio Detector Tubes:
For direct attachment to panel 90c each
For mounting on top of panel \$1.20 each

Insist on the socket used by those who know and want the best. ASK FOR BENJAMIN "RED TOP," or "GREEN TOP."

At all Radio Jobbers and Dealers

Made by

Benjamin Electric Mfg. Co.
120-128 So. Sangamon St., Chicago

247 W. 17th St.
New York

448 Bryant St.
San Francisco

Manufactured in Canada by the Benjamin Electric Mfg. Co., Canada, Ltd., Toronto, Ontario

Aerial and Ground Design and Connections

(Continued from page 637)

may often be used in such cases, and with good results. One can use for an energy-collector a large copper ball supported on a pole and insulated from it. A copper ball a foot in diameter has the surface of a hundred feet of heavy wire. The ball is silvered, or coated in some way to prevent corrosion, and a lead from the ball passes to the receiver. This aerial is used with a ground connection. The fundamental wavelength of one of these spheres, with a 20-foot lead is about 270 meters. Ordinarily, results are not as good as with a 100-foot aerial; but these devices furnish good selectivity and are ideal for some locations.

A LABOR-SAVING AERIAL

The spring aerial is another type which should prove interesting to a large number of radio users, especially those living in crowded apartment-house districts. The important mechanical characteristic of this type of aerial is that it consists of a spring which adjusts itself automatically to the space available. Therefore, when erecting the aerial it is not necessary to cut any wires; and the lead-in may be attached and soldered in place at the owner's convenience, rather than on the roof after the aerial has been erected. These features greatly facilitate aerial construction.



An easily installed spring aerial, useful to fans living in apartment-house districts.
Photo by courtesy of Mack Co., Inc.

Spring aeriels are available in two forms. The first is for use when a single "L"-type aerial, ranging in length between 60 and 125 feet—is required. The aerial is supplied with pyrex insulators attached to each end and a binding post for connecting the lead-in. The second is for a two-wire aerial between 20 and 60 feet in length; this type has in the center of the aerial a binding post for the lead-in and is provided with four pyrex insulators, and two wooden spreaders.

GROUND CONNECTIONS

The ground connection should be very good; a few clamps on a waterpipe, where it enters the ground, will serve. In apartment buildings, the ground may be attached at the waterpipe; though a copper wire, paralleling the pipe to a clamp near the ground, is better. When a ground clamp is attached at a distance above the ground, the intervening length of pipe acts as a resistor; so that the connection should be made as near the ground as possible. Iron pipe, although large in diameter, has a high resistance and causes loss of radio-frequency currents, which are very small at best. In some locations, it will be necessary to use a buried conductor of some sort as a ground. One can often bury a length of fence wire, a large galvanized metal plate or something similar. The ground lead should be soldered to the buried conductor and the soldered joint should be enameled, so that it will not corrode and break loose. Heavy rubber-covered wire will serve as the lead.



Licensed by Rider Radio Corporation
Pats. Pending.
Pat'd 5-2-16 and 7-27-26.

Kill R. F. Oscillations!

"PHASATROL"

Reg. U. S. Pat. Off.
A True Balancing Device for Radio Frequency Amplifiers
Price \$2.75

PHASATROLS are the latest achievement in radio frequency amplification and can be installed in any radio frequency set in a few minutes—no technical knowledge or skill is necessary.

PHASATROLS simplify tuning, stop radio frequency oscillations and distortion, enable your tubes to work at maximum efficiency and prevent them from radiating interference to your neighbors.



At your dealer's
Write for hook-up circular for any set or circuit

Dept. 45C, 175 Varick St., New York, N. Y.

ELECTRAD

IT'S HERE!

The Sensational

DRI-LINE RADIO POWER UNITS

Type AB-280 delivers 180 volts at 40 mills. Uses the new 280 tube. The A rectifier is the new approved Dri Type.
Lists East of the Rockies \$54.50
With Tube \$59.50



ACME "B" POWER UNIT Type B-280

using the new 280 tube, delivers 180 volts at 40 mills.
Lists East of the Rockies \$22.00
With Tube \$27.00
Ask your Dealer to show you these new sensational units.

Write for our folder giving complete information
THE ACME ELECTRIC & MFG. CO.
1412 Hamilton Avenue CLEVELAND, O.
Established in 1917

Popular ACME in Price

FREE RADIO GUIDE

BIG NEW 1928 CATALOG—4000 items
Shows the latest circuits, the newest developments in radio at startling low prices. Get the parts you want here and save money. The best in parts, kits, complete factory-built sets and supplies. Orders filled same day received. Write for free copy now.
Barawik Co., 129 N. Jefferson St., Dept. 111, Chicago, U. S. A.



SUCCESS

from

CHEMICAL INSTITUTE OF NEW YORK
16 East 30th Street, New York City.

Mountoursville, Pa.

Gentlemen: I must tell you the success I have had since taking your chemistry course. My salary has been increased several times, and different industrial plants are coming to me for a little advice on different things, netting me a fair side income.

I am only sorry that I did not make my whole life study of the wonderful science.

(signed) *M. E. Van Sickle.*

CHEMISTRY

NOW
is the Time to Study
Chemistry

Not only are there boundless opportunities for amassing wealth in Chemistry, but the profession affords congenial employment at good salaries to hundreds of thousands who merely follow out its present applications. These applications are innumerable, touching intimately every business and every product in the world. The work of the chemist can hardly be called work at all. It is the keenest and most enjoyable kind of pleasure. The days in chemical laboratory are filled with thrilling and delightful experimentation, with the alluring prospect of a discovery that may spell fortune always at hand to spur your enthusiasm.

Easy Monthly Payments

You don't have to have even the small price of the course to start. You can pay for it in small monthly amounts—so small that you won't feel them. The cost of our course is very low, and includes everything, even the chemistry outfit—there are no extras to buy with our course. Our plan of monthly payments places a chemical education within the reach of everyone. Write us and let us explain our plan in full—give us the opportunity of showing you how you can qualify for a highly trained technical position without even giving up your present employment.

CHEMISTRY has no equal as a profession in the modern world. There is mystery, romance and fortune awaiting the man in the laboratory.

Millions have been made by the discoverers of the chemical formula of dynamite, bakelite and many other world known chemical products.

Opportunities in the chemical profession abound on every hand—and as modern business and competition progresses the chemist will play an important part.

Profit by the experience of Mr. Van Sickle and many others, resolve to study chemistry NOW.

YOU CAN LEARN AT HOME

To qualify for this remarkable calling requires elaborate specialized training. Formerly it was necessary to attend a university for several years to acquire that training, but thanks to our highly perfected and thorough system of instruction, you can now stay at home, keep your position, and let us educate you in Chemistry during your spare time. Even with only common schooling you can take our course and equip yourself for immediate practical work in a chemical laboratory. Dr. Sloane gives every one of his students the same careful, personal supervision that made him celebrated throughout his long

career as a college professor. Your instruction from the very beginning is made interesting and practical, and we supply you with apparatus and chemicals for performing the fascinating analyses and experimental work that plays such a large part in our method of teaching, and you are awarded the Institute's official diploma after you have satisfactorily completed the course.



T. O'CONNOR SLOANE.
A.B., A.M., LL.D., Ph.D.

Noted Instructor, Lecturer and Author. Formerly Treasurer American Chemical Society and a practical chemist with many well known achievements to his credit. Not only has Dr. Sloane taught chemistry for years but he was for many years engaged in commercial chemistry work.

Special 30 Day Offer

Besides furnishing the student with his Experimental Equipment, we are making an additional special offer for a short while only. You owe it to yourself to find out about it. Write today for full information and free book "Opportunities for Chemists." Send the coupon right now while it is fresh in your mind. Or just write your name and address on a postal and mail it to us. But whatever you do, act today before this offer is withdrawn.

DON'T WAIT—MAIL COUPON NOW!

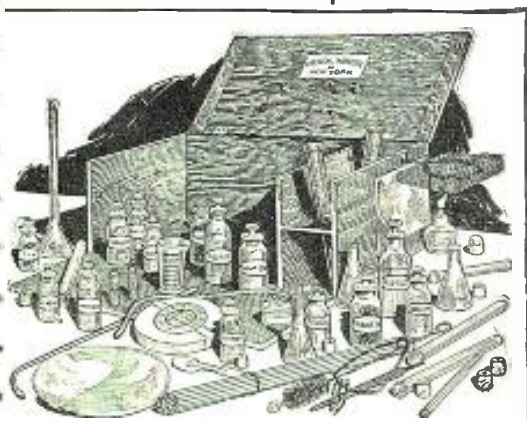

EXPERIMENTAL EQUIPMENT FURNISHED TO EVERY STUDENT

We give to every student without additional charge this chemical equipment, including forty-nine pieces of laboratory apparatus and supplies, and forty different chemicals and reagents. These comprise the apparatus and chemicals used for the experimental work of the course. The fitted heavy wooden box serves not only as a case for the outfit but also as a useful laboratory accessory for performing countless experiments.

Chemical Institute of New York

Home Extension
Division 12

16-R- East 30th St.
New York, N. Y.

CHEMICAL INSTITUTE OF NEW YORK
Home Extension, Division 12
16-R—East 30th Street, New York City.

Please send me at once, without any obligation on my part, your free Book "Opportunities for Chemists," and full particulars about the Experimental Equipment given to every student. Also please tell me about your Plan of payment and your special 30 day offer.

NAME

ADDRESS

CITY STATE.....
R.N. Dec. '27.

FOR RADIO DEALERS ONLY

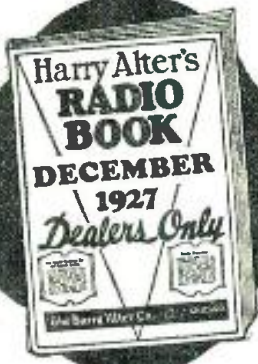

ROCK BOTTOM PRICES ON EVERYTHING IN RADIO

Only the newest and latest (1927-1928) radio goods; no obsolete products; no "seconds" or sub-standards. All goods of tested and proved quality and established reputation — absolutely guaranteed.

Get this Wonderful NEW PRICE GUIDE

Compare its money-saving values. Test our "Minute-Man" shipping service with a trial Rush order. Write now for your copy of Harry Alter's new "Radio Book."

The Harry Alter Co.

1796 Michigan Ave. CHICAGO

MAIL THIS COUPON

The Harry Alter Co.,
1796 Michigan Ave., Chicago
Send at once a copy of your December price guide.

Name

Address

City State

In ground which is wet all-year-round, the conductor may be near the surface, but it should be below the permanent water-level.

TESTING THE ANTENNA

The experimenter can compare antennas, to determine which is the best, with the aid of a regenerative receiver. Whenever a circuit is tuned to the same wavelength as a regenerative receiver, a click is heard in the phones. Connect a 23-plate condenser in series with a 55-turn coil (that is, make a wavemeter circuit which covers the broadcast range); bring this circuit close to the secondary of the regenerative receiver, and listen for this click. The lower the losses in the wavemeter circuit, the farther from the set may this circuit be placed and the click still heard.

An aerial, connected to the ground through the primary coil, is also a series-circuit, with inductance, resistance and capacity in series. With an antenna-series condenser, tune the antenna for the same click and note how far away the primary coil can be placed so that the click is still heard. Insert a non-inductive resistance in series with the aerial, and try it again. It will be noted that the antenna, with no extra resistance connected, will give a click at the greatest distance; therefore, if another antenna were connected which has lower resistance, the click could be heard still farther away. Antennas can thus be compared. One should be careful



The type of aerial shown here is nothing more than a fixed condenser which is inserted in the light socket.

to have the regenerative receiver always under the same operating conditions; that is, tickler-coil at the same position, plate-voltage the same and filament-setting identical.

Antennas of the same length should be compared. It is interesting to note the effect of loosening the ground clamp slightly, or connecting this clamp at a much greater distance from the ground. As surrounding objects and conditions greatly affect the antenna, one can determine which is best for the particular location by the simple process outlined. The experimenter will obtain real enjoyment from having an actual measure of the efficiency of the antenna he uses.

INSULATION

It is also interesting to try the effect of supporting one end of the aerial without an insulator. It will be found that leakage from an antenna has much the same effect as resistance. The insulation should be of the best, and the insulators should be such that

Modern Air-Craft

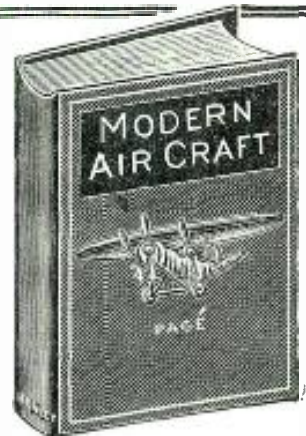

THE AGE OF AVIATION —IS HERE—

Learn Design, Construction, Operation and Maintenance

Contents of each chapter—1. Aircraft Types. II. Lighter-than-Air Craft. III. Early Airplane Designs. General Design Considerations. IV. Design and Construction of Aerofoils. V. Arrangement, Fabrication and Bracing of Airplane Wings. VI. Airplane Fuselage and Landing Gear Construction. VII. Airplane Power Plant Types and Installation. VIII. Aviation Engine Design and Construction. Air-cooled Engines. IX. Aviation Engine Design and Construction. Water-Cooled Engines. X. Aviation Engine Auxiliaries. XI. Aircraft Propeller Construction and Action. XII. Airplane Equilibrium and Control Principles. XIII. Uncrating, Setting Up and Aligning Airplane. XIV. Inspection and Maintenance of Airplanes and Engines. XV. Details of Modern Airships and Airplanes. XVI. Seaplanes, Flying Boats, Amphibians and Other Aircraft. XVII. Some Aspects of Commercial Aviation. XVIII. Aircraft Instruments and Aerial Navigation. XIX. Standard Nomenclature for Aeronautics. Report No. 240, Part I.

This book is written in simple, understandable language.

**700 Pages : 500 Illustrations
Price, \$5.00**

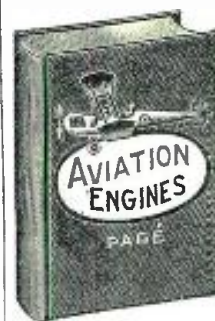

AVIATION ENGINES

This book describes the basic principles of aviation, tells how a balloon, or dirigible is made and why it floats in the air. Describes how an airplane flies. It shows in detail the different parts of an airplane, what they are and what they do. Describes all types of airplanes and how they differ in construction; as well as detailing the advantages and disadvantages of different types of aircraft. It includes a complete dictionary of aviation terms and clear drawings of leading airplanes.

274 Pages. Price, \$1.25

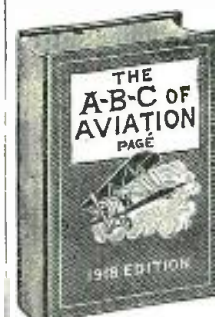

A. B. C. OF AVIATION

This treatise, written by a recognized authority on all of the practical aspects of internal combustion engine construction, maintenance and repair, fills the need as no other book does. The matter is logically arranged; all descriptive matter is simply expressed and copiously illustrated, so that anyone can understand airplane engine operation and repair even without previous mechanical training. This work is invaluable for anyone desiring to become an aviator or aviation mechanic.

Price, \$1.25

CONSRAD COMPANY, Inc.
230 Fifth Avenue New York

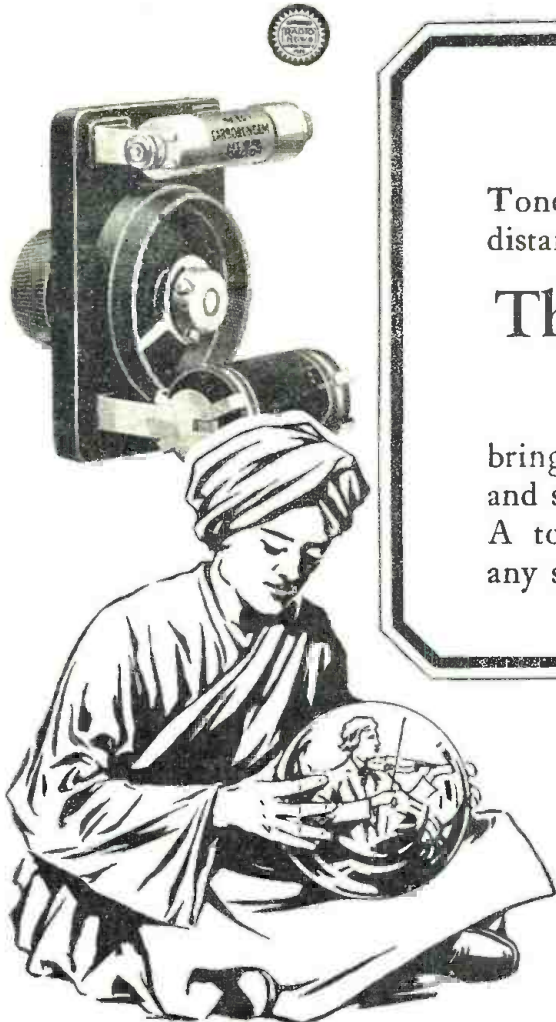

Carborundum is the Registered Trade Name used by The Carborundum Company for Silicon Carbide. This Trade Mark is the exclusive property of The Carborundum Company.

Crystal Clear Tones

Tone quality is what radio listeners want. Volume and distance mean nothing if the tones are blurred.

The Carborundum Stabilizing REG. U. S. PAT. OFF. Detector Unit

brings you natural tones clear as crystal with assured volume and selectivity.

A tone perfecting unit that can be used on practically any set.

\$3.50 in U.S.A. Dealer or direct. Or the Carborundum Detector alone for \$1.50.

The Carborundum Company
Niagara Falls, N. Y.

Send for free
Hook-up Book D-1

THE CARBORUNDUM COMPANY
NIAGARA FALLS, N. Y.
CANADIAN CARBORUNDUM CO., LTD.
NIAGARA FALLS, ONT.

SALES OFFICES AND WAREHOUSES IN New York, Chicago, Boston, Philadelphia, Cleveland, Detroit, Cincinnati, Pittsburgh, Milwaukee, Grand Rapids

The Carborundum Co., Ltd.
Manchester, England
Deutsche Carborundum Werke
Dusseldorf, Germany

Name _____
Street _____
City _____ State _____

IT'S HERE!

You Will Like It—and Profit!

THE WORLD'S GREATEST

RADIO CATALOG

New kits featured include: Aero—Bodine—Camfield—Citizens—H-F-L—Infradyne—Karas—Melo—Heald—Scott's—Silver Marshall—St. James—Tyrman—etc.

Complete stock carried. Prompt, efficient, dependable service, always.

Established 1918

Now Free—Send for your copy today!

The best in Radio—at a **big saving**—all under one roof. You don't need to look elsewhere. Contains all the information you need.



WHOLESALE ONLY

TELEPHONE MAINTENANCE CO.
123-R South Wells Street Chicago, Illinois

CHICAGO'S OLDEST RADIO HOUSE



See the World FREE!
Taste Romance and Adventure In the Far Lands of the Earth.

How often you've longed to see for yourself the awe of Egypt's pyramids—the beauties of the gorgeous Mediterranean sunset—the squalor of China's ancient cities!

Spend a few years, or the rest of your life, tasting high adventure on the seven seas and in all the world's great ports—roving the earth's high-ways and byways! You can do it FREE—all your expenses paid—and earn a good salary besides!

Only one profession will carry you around the world at will, traveling like a gentleman, but that's the most interesting and pleasant work there is—Radio Operating! Easily and quickly learned, there's no other profession like it for the man who wants the experiences and pleasures of world-travel. Radio operators are needed—all sea-going ships like the one shown here must carry from one to half a dozen or more.



Take a Look Beyond the Skyline Without a Penny's Expense

Radio operators aboard ocean liners live luxuriously—they rank as officers of the ship. Meals, a private cabin, all other living needs are furnished free, and besides the operator draws a good salary. You can learn quickly and easily at home in your spare time to be a Radio operator through our practical training methods. Take a look at the FREE BOOK which tells how—mail coupon below.

This U. S. Government-recognized school has been training successful operators since 1914. Our graduates are all over the world. We maintain an Employment Department to put you on your own ship. The world-famous NATROMETER, our own patented invention, obtainable only by students of this Institute, is recognized as the best and easiest way to learn the Radio code. A few short months, with the aid of the famous Natrometer and our quick home training, and you too can be a fully qualified Radio operator, sitting in your cabin like the one shown above, bound out for Liverpool or Nagasaki!

Read the Free Book that tells all about this fascinating profession and our practical Government-recognized methods of training you for it. Send coupon TODAY—no obligation. Special tuition offer now on, includes world-famous Natrometer free of extra cost with your course! Act at once.

**NATIONAL RADIO INSTITUTE
WASHINGTON, D. C.**

SPECIAL OFFER COUPON

National Radio Institute,
Dept. PB-99, Washington, D. C.
Gentlemen: Without obligating me in any way send me your free book and information about your offer of Natrometer with course.

World-Famous Natrometer

Name.....
Address.....

wet weather does not impair their efficiency appreciably. Long, thin insulators are the best, and ordinary glass towel bars, which are often over a foot in length, are good and can be obtained quite cheaply. To prevent any changes in capacity when the wind blows, the wire should be securely fastened down; and, to prevent the aerial from corroding, it should be of enameled wire.

Small changes which are made, though they seem to do no perceptible good, so far as received volume is concerned, may actually do considerable good, although the ear is not sensitive enough to detect the difference. Scientists have found that the volume must sometimes be quadrupled before the human ear detects that the sound has doubled in intensity.

It is the radio enthusiast who pays particular attention to seemingly small details, who will actually do exceptional distance work when the test comes.

The "Peridyne" Five
(Continued from page 624)

trouble should be experienced. Remember that the (detector-coupled) first audio amplifier tube requires only 22½ volts, when using good tubes. It is a rarity that 45 volts are used here; and I, personally, never recommend such a high voltage, because it is not necessary and tends only to distort the signals.

A word about tubes. This set, as I have mentioned several times, is first of all a DX set; as such it must have good tubes. Use only the best; insist upon having a set of matched tubes from your dealer, tubes that do not vary more than 10 percent in their characteristics. Even then you may find that "switching around" the tubes will give you the best results.

If everything is connected up, you will find little difficulty in bringing in local signals. The important point now becomes the adjustment of rheostats R1 and R2, located behind the panel and mounted on the sub-panel. These are extremely sensitive. When using the set normally, you do not require more than 90 volts; that is, if no power tubes are used. Be sure that your voltmeter on the "B" side (M2) reads 90 volts exactly; and that on the "A" side (M1) 6 volts exactly. Then balance your set.

At first the chances are that it will howl its head off. Tune in a weak station and adjust rheostats R1 and R2. Keep R4 turned on practically full. Tune to a midway frequency, let us say around 300 meters, such as KDKA, WRNY, etc. If the set howls, that is, oscillates too loud, adjust R1 and R2 carefully. Now the oscillation control R3 comes into use. *This oscillation control, by the way, is most important.* It is intimately related to R1 and R2. This oscillation control, that is, its high resistance of 100,000 ohms, controls not only oscillations, but volume as well. When it is turned all the way towards the right, stations, even the most powerful, become practically inaudible. Turning it to the left makes the set oscillate freely.

The trick of the set is to balance the three controls in such a way that the set will oscillate slightly, but not too loudly, on the highest wavelength. Then by tuning in the station at the lowest wavelength, around 200 meters, where the set oscillates most freely, it becomes a matter of carefully adjusting rheostats R1 and R2. No exact directions can be given on this, but five minutes' playing with the set will easily show you where the best point is. If the oscillations are too wild on all frequencies try reducing the R.F. voltage from 90 to 67½, or even 45.

**Radio's Finest
3-ft. Cone Speaker**

No. 3 Kit complete
\$13.50
for
3-Foot DOUBLE Cone Speaker



G·R·P
3 FOOT CONE SPEAKER
Build It Yourself

In one short hour or less you can assemble the finest speaker you ever heard. G. R. P. Simplified Assembly makes experts of novices; and the finest unit and other parts that can be designed and built assure you a speaker of unequalled tone quality. Reproduces all frequencies within range of human audibility—the low notes as well as the high. Operates perfectly at all voltages; will not lock or rattle. G. R. P. Unit is only Doubly Adjustable 4-pole, balanced armature unit. Same unit furnished with both kits.

No. 4 Kit complete
\$10.50
for
3-Foot Single Cone Speaker Wall Type

Ask Your Dealer

for genuine G. R. P. Kit—either No. 3 or No. 4. Refuse substitutes; if your dealer will not get them for you, we will supply you direct f.o.b. N. Y. C., on receipt of price. Write for "How to Build 7 Practical 3-Foot Speakers." by C. Denton; price 50c; for a limited time sent for 10c., coin or stamps. Write for your copy today.

Penn Radio Sales Co. Selling Agents
104 5th Avenue Suite 2790 New York City



The Blue Ridge Mahogany or Walnut Finish

The Blue Ridge Cabinet is made from best grade birch, noted for the quality and the beautiful finish it takes. Specializing for years in wood-working craftsmanship we are especially equipped to produce cabinets famous for quality of construction and lustrous finish. The Blue Ridge, finished either in gleaming Mahogany or Rich Walnut has full length nickeled piano hinge and nickeled lid support, rubber anti-vibration feet and free non-warping baseboard. Send us your order today. It will be on its way within 12 hours of receipt.

Dimensions	Prices
7x18x10.....	\$6.00
7x21x10.....	6.50
7x24x10.....	6.75
7x26x10.....	7.25
7x28x10.....	7.75
7x30x10.....	8.25
7x18x12.....	7.50
7x21x12.....	8.00
7x24x12.....	8.25
7x26x12.....	8.75
7x28x12.....	9.25
7x30x12.....	9.75

C.O.D. half price with order

All Prices f.o.b. Hickory **12** hour service factory to you

Southern Toy Co. Inc.
Manufacturers Hickory N.C.

C. L. PARKER

Ex-Examiner U. S. Patent Office

Attorney-at-Law and Solicitor of Patents
McGill Building, Washington, D. C.

Patent, Trade Mark and Copyright Law

THE "PERIDYNE" COMPENSATION

But before all this is settled, we come to the most important part, and that is the "Peridyne" action. First, turn the movable shields all the way up, with the knobs extending as high as they can go. You will find, as a general rule (and I have tried this hundreds of times) that the following will be the best procedure.

Sitting in front of the set, we have the three cans with their knobs from left to right. The first is the antenna coil, the second the second radio-frequency coil, the third, the third radio-frequency coil. It will be found that, in most cases, the first knob is turned down lowest, the second higher, and the third one still higher. You will find that the middle coil is the most sensitive to the "Peridyne" shield tuning. This shield tuning should be attempted only when listening in to a DX station. On local stations it is difficult to balance the set. Inasmuch as all inductors and all shields vary, it is quite impossible to give exact directions as to how far down or up the tuning shield should be turned. But you will master this quickly by tuning for a weak station or a DX station. Then you will find that even a single turn makes a tremendous difference. Be absolutely sure that the screw which holds the shield is not loose in its bushing; otherwise there will be a rattle in the loud speaker. As I stated before, when you start compensating, turn all three knobs up as far as they go. Then manipulate the middle knob until the signal comes in loudest. Further compensation is then had by turning the knobs of the first and third cans. The further away the station, the more important the "Peridyne" action becomes.

It should be noted that, once the set has been balanced to its highest efficiency the "Peridyne" shields are never touched again. The set as described here must oscillate (though weakly) on the highest wavelength. It will do this when the oscillation control R3 is turned down all the way to the left. In this position the lower wavelengths will oscillate violently, in which case R3 is turned up more to the right. Remember, rheostats R1 and R2 are important in this, because they are intimately related to the oscillation control R3. The "Peridyne" shields are really used only to bring the three-gang condensers, with their respective inductors connected to them, into resonance at exactly the same wavelength. That is the reason why no compensating condensers are connected with the gang condensers.

When you have tuned in a DX station and you have balanced your set where the signal comes in loudest, you will find that you can leave all adjustments in this position and the stations will roll in, one after another, faithfully and with tremendous volume. In actual operation, rheostat R4 is set to its best position; with most sets this position will be with the rheostat practically turned on full. The quality of the signals can be bettered by very slight adjustments; even $\frac{1}{8}$ of an inch makes a very big difference as the detector-coupled first audio amplifier is quite critical as to the filament voltage.

TUNING

If everything has been exactly compensated, you will now be able to tune the set with the two controls; namely, the knobs of the gang condenser and the oscillation control R3. You tune in any whistle of any station, then adjust carefully R3 until the whistle is cleared and the station comes in. As a rule, turning the knob towards the left will increase the loudness of the signal. If it is turned to the left, beyond a certain point, the set will oscillate and howl. On DX stations, even the most minute difference will result in a great change of volume. If by any chance the action of R3 is reversed



Durham Leadership

The Original Metallized Resistor — Adopted by Finest Set Manufacturers — Endorsed by Foremost Radio Engineers — Sold by Leading Dealers!

DURHAM Resistors and Powerohms have won their position of leadership because they have never failed to deserve the recognition of radio leaders who appreciate flawless accuracy and utmost dependability.

Ever since their first appearance, years ago, manufacturers, engineers, professional builders and radio fans have adopted Durhams in steady progression. Today Durhams are in use wherever fine results are a foremost consideration.

If you are not using Durhams now, an experiment with replacements may prove why they are the accepted leaders in their field.



DURHAM POWEROHMS
For "B" Eliminator and Amplifier Circuits. Made in 2.5 and 5 watt sizes in ranges from 500 to 100,000 ohms.



DURHAM RESISTORS
Made in ranges from 500 ohms to 10 megohms. Standard or Special tips.

Adopted and Used by Leading Radio Manufacturers

- | | |
|----------------------------|---------------------------|
| <i>Pbilco</i> | <i>Kokomo Electric</i> |
| <i>Fansteel Products</i> | <i>Garrod Radio Corp.</i> |
| <i>Western Electric</i> | <i>Browning-Drake</i> |
| <i>F. A. D. Andrea</i> | <i>Howard Radio</i> |
| <i>Sterling Mfg. Co.</i> | <i>A-C Dayton</i> |
| <i>Kellogg-Switchboard</i> | |

DURHAM METALLIZED RESISTORS & POWEROHMS

INTERNATIONAL RESISTANCE CO., 2½ S. 20th St., Dept. H, Phila., Pa.

SPECIFIED FOR THE KNICKERBOCKER 4 and KARAS EQUAMATIC

MAGNAVOX

Magnetic Cone Speaker



M-7 Unit

Distortion-free on power tube volume

This speaker goes far beyond previous magnetic cone reproducers. By reason of the new type pole piece construction, patented by Magnavox, new beauty of tone and new range of equalized volume are possible.

The M-7 passes low frequencies down to about 100 cycles with substantial volume. It also reproduces unusually high frequencies without distortion provided tubes are not being overloaded. It is extremely sensitive and responds easily and with little energy to weak signals and low notes. Takes volume from biggest sets and power tube.

The unit is only 8 3/8" inches in diameter,—it fits into any radio or phonograph cabinet and is simple to install, only 4 screws to turn. Unit list price \$15.00.

Warwick Cabinet Model



Has standard M-7 unit mounted on beautiful burl walnut circle on enameled metal base. List \$27.50.

Dynamic Power Cone Speaker



Built under electro dynamic patents made famous by Magnavox. Operates from A battery. Gives full power volume but at a fraction of other power speakers.

You should hear this speaker and realize the great advance in musical reproduction. R-4, 6 volt unit only \$50. In mahogany cabinet \$75.

R-S, 110 volt D. C. unit only for Electric phonograph and A. C. circuits, \$55.

Send for Speaker Bulletins

They give full information on Magnavox magnetic and dynamic type speakers. We will give you name of nearest dealer.

The Magnavox Co.

Oakland California
Chicago Sales Office 1315 So. Michigan Ave.

(that is, the loudest signals are when the knob is turned to the right rather than to the left) this immediately proves that the "Peridyne" shields are set wrong. It means simply that the gang condensers and their respective inductances are out of resonance. You will quickly find that, by manipulating the knobs of the "Peridyne" shields, this condition is remedied, and will familiarize yourself with the correct action of the set. Once you get the hang of it you will never forget it.

You will find that this set tunes with an unheard-of sharpness and that even nearby stations can be easily cut out without background and overlapping of signals. As the set is extremely delicate, I recommend the use of only spring-type sockets. The tubes should be weighted down with separate anti-howl tube weights, to keep them from howling, as otherwise they surely will do this, on account of mechanical feed-back from the loud speaker, particularly when the set is not placed in a cabinet. I therefore do not recommend use of the set except in a cabinet, to do away with audio feed-back from the loud speaker.

For city use, where DX reception is not desired, the oscillation control R3 can be practically eliminated. In that case the "Peridyne" shields can be used as lossers, by turning them down so that the shields come within a quarter of an inch of the coils or less. It will be found that, in this position, an effective balance of the set can be made very nicely; but it will tune somewhat broadly because it no longer oscillates, the shields now being used as actual lossers. But for city reception, where only a single, solitary tuning knob and no other controls are desirable, this method can be used; although in some locations there will now be some "cross-talk," particularly from nearby stations. They will seem to overlap because the set no longer tunes sharply. If it should tune too broadly, manipulation of rheostats R1 and R2 will bring the receiver nearer to the point of oscillation.

Of course, I, personally, do not advocate the use of this set in this manner; that is, by using the "Peridyne" shields as lossers, because that is not the way they are intended to be used. But I have mentioned it for only the one reason; and that is, if the losser method is used, the set becomes really a very capable *single-control* receiver, with all that that word implies. But, of course, in that adjustment, the set is practically valueless when it comes to DX reception. DX reception and broad tuning do not go together.

I have found it desirable to use cable leads instead of binding posts in this set. The particular cable that I have used is most desirable and economical in the long run, because it is fused and will prevent blowout of the tubes.

In my next article I shall give some further practical hints on the operation of this set. I should be very glad to hear from those who have built the "Peridyne" Five and shall be glad to give technical advice to those seeking it.

Radio Reawakens the Old World

(Continued from page 595)

be most beneficial to all. In this conference two different schools of thought have met. The Americans are strong in their confidence that private enterprise, which has already produced such wonderful developments in the art of radio, should be free to work out the great problems of making it most serviceable. The nations of the old world incline to the belief that so great a force, with all its psychological as well as material

Build the

STROBODYNE

with the
New Improved
"Consrad"

BOOK PATTERN

THE sensational Strobodyne circuit, the greatest of Super-Heterodyne receivers that combines the best features of every circuit and has amazed Radio, is now ready for home and community set builders.

Consrad, the greatest radio book and Pattern publishers, has printed a brand new pattern for this amazing Strobodyne circuit. A sixteen-page, 9x12, book gives every last detail in the building up of reliable Strobodyne receivers.

In this booklet are drawings and photographs of various parts of the receivers. The few parts of the hook-up that require special attention are fully covered by special simple instructions.

FULL SIZE BLUEPRINTS

With this Strobodyne pattern come four full size blueprints. These blueprints are complete, accurate and highly simplified. Anyone can build a Strobodyne receiver, whether they have built a radio set before or not.

The Blueprints are as follows:

- No. 1. Panel layout Blueprint — Size 11x27 inches.
- No. 2. Sub-Panel Layout.
- No. 3. Wiring for Apparatus (Shown in perspective form) —
- No. 4. Underside view of Sub-Panel — Size 16x27 inches. Size 23x27 inches.

Until you have studied the Strobodyne you are a back number in Radio—a man of the older school—the Strobodyne is not just a new circuit—it is an epoch in Radio.

50c THE COPY

USE THIS COUPON

CONSRAD COMPANY, Inc.,
230 Fifth Ave., New York.

Gentlemen: I enclose 50c for one copy of the New Official STROBODYNE PATTERN containing complete construction information and all Blueprints.

Name

Address

City, State

potentialities, must be controlled and restricted cautiously by the public authorities.

In no other field, it must be said, is universal cooperation so necessary. A nation which withdraws from the postal union or the copyright conventions will thereby inconvenience few except its own citizens; but a nation which governs its use of radio without regard to others will thereby cause vexatious interference with the business and the pleasure of the rest of the world.

It has been said that China has valued most highly the philosophy of Confucius, because that is devoted to the art of getting-on well with the neighbors; and in China neighbors are nearer and more numerous than anywhere else in the world. But, since that saying was first coined, radio has made all the world very close neighbors.

One of the most important eras in the history of the world's races has just begun—that of the re-awakening of the peoples of the old world. That is to say, not those of the civilized extremities of the "Eurasian" continent, the peoples of the Atlantic border and the Pacific islands, but those of China, of India, of that vast inland area which has been called "the factory where nations are made."

We are somewhat inclined, while contemplating the present disparity between East and West, in wealth, organization and culture, to forget that from a thousand to five hundred years ago the conditions were quite reversed; that Central Asia was once the centre of the world's imperial power, science and wealth. (Why it has fallen from its high estate is a question too intricate to consider here; some scientists attribute it to the climatic changes caused by the variation in the sun's radiation, which has caused the drying-up of Asia, but invigorated Europe, which the great sunspot period of the fourteenth century had brought almost to destruction.)

RADIO IN ASIA

Returning to our subject, now that the West has developed radio to its present position as a necessity of civilized life, the East is seeking its benefits with avidity. A year or so ago, there was hardly a broadcast station on the mainland of Asia; now every few days brings the announcement of a new installation, often of high power. Until a few weeks ago, even radio reception was outlawed in China; now there are several broadcasters. Transmitters of high power have been put in operation in India; the Soviets are carrying out a most ambitious program, not only in European Russia, but in the vast area of Northern and Central Asia, twice the size of the United States. Great stations are to be erected in places of whose very existence most Westerners are still uninformed.

The Mohammedan countries, for the past two hundred years in a lethargy, are now stirring; Turkey has taken the lead in the development of governmental broadcasting, while others are still working on the problem of radio communication to overcome the disunion caused by their deserts.

In these last cases, the primary purpose has been political; but it must be remembered that, in the less-favored countries of the world, people are less content or less indifferent politically than in America, and the importance of holding tightly the reins of propaganda is uppermost in official minds.

We see today, therefore, radio making its first bow to half the human race—that half which is least linked together already by good roads, by telegraph and telephone, by mails and periodicals. Upon the spread of radio, and its application in the next ten years, will depend the political and the cultural history of mankind in the remainder of the twentieth century.

The problem is less simple than it sounds. The development of radio in the East has been through its introduction by the domi-

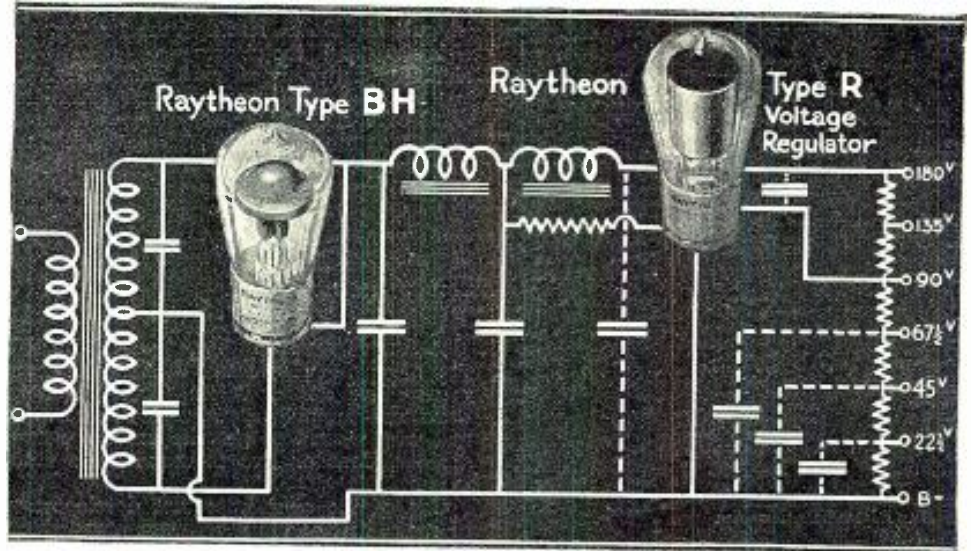

Here is the power unit you'll want to build

In the advancement of light-socket receiver operation, Raytheon Research Laboratories have designed several circuits which take the fullest advantage of Raytheon Long Life Rectifying Tubes. Look at the diagram above. There is a power unit which maintains constant voltage on the 90 and lower volt taps and greatly improves voltage regulation on the 180 and 135 volt taps regardless of variations in either the line voltage or load current.

This unique performance is accomplished through the use of that remarkable tube—Raytheon Type R Voltage Regulator. Its advantages are many. It eliminates ripple and "motor boating", dispenses with enough parts in the construction of a power unit to pay for itself, and improves reception beyond the possibilities of any other regulator.

Circuit diagram and latest bulletin on Type R Voltage Regulator tube gladly sent upon request—write today!



RAYTHEON TYPE BH
Standard for "B" Power Units

Because its output does not drop off in service, this 125 milliamper tube is especially valuable for use in conjunction with the Type R Voltage Regulator. At all reliable dealers. Price \$4.50.



RAYTHEON TYPE R
Voltage Regulator

Maintains constant voltage on the 90 and lower volt taps regardless of changes in line voltage or in load taken from the unit. Eliminates ripple and "motor boating". Starting anode obviates "going out". Price \$4.00.

RAYTHEON MANUFACTURING COMPANY
307 Kendall Square Building Cambridge, Mass.



Finally—the Perfect “A” Eliminator

For Your Present Set or the Set
you eventually buy



Our 4-volt “A” Eliminator
Fits Into All Radiola Consoles

Silver Beauty POWER

Replaces “A” storage battery and charger; has full wave “dry” rectification; maintains required voltage in uniform, constant flow; operates automatically by moving a switch; economical—uses minimum amount of current (about 1-10 cost of using electric iron); has rheostat control for additional refinement in voltage and reception; gives maximum power to radio tubes and lengthens their life; no acids to test or spill. Satisfactory results guaranteed.

Its principle is simple and correct!

The 110 volts Alternating Current is scientifically reduced with the famous “Silver Beauty” transformer coil to deliver the proper voltage to an especially developed dry, noiseless rectifier, which transforms the electricity to direct current. This current of exact voltage, is then transmitted through a patented special filter which clarifies the current, eliminating all foreign noises caused by rectifier or generator.

The Silver Beauty “A” Eliminator is endorsed by prominent radio engineers—adopted by leading distributors and dealers—approved by thousands of users. These are sufficient reasons for making Silver Beauty your choice.

\$39 ⁵⁰	\$43 ⁵⁰	\$39 ⁵⁰
6-volt; 2 amp.	6-volt; 3 amp.	4-volt; ½ amp.
\$2 Higher West of Rockies		

Silver Beauty “B-C” UNIT

Does away with “B” and “C” batteries

Embodies every up-to-date refinement and principle, insuring smooth, unflinching reception. As beautiful as it is efficient.

No. 450
180 Volts—40 Milliamperes
\$45

No. 460
135 Volts
\$35

Individual adjustment adapted to all sets.

Silver Beauty CHARGERS

Employing an entirely new method of rectification. Two models—with or without bulbs.

See Your Dealer or Jobber

Triple-A-Specialty Company
Manufacturers of the famous Silver Beauty Chargers
312-316 South Hamilton Ave., Chicago, Ill.

nant peoples of the great empires, the British and the Dutch leading; the French, the Belgians, and the Portuguese have been similarly active in Africa and along the Indian Ocean. The Japanese, the Australians, and the New Zealanders, of course, being sufficient to themselves, have developed broadcasting on the lines of its progress in Europe and America. In the colonial portions of the empires, however, comparatively few have yet been able to avail themselves of radio, and one of the most important demands of the European population is a closer linking with the mother countries.

There are two great difficulties, however. The first is distance. Letters have come to the office of RADIO NEWS from men in Africa and India, whose “local” stations were five hundred, a thousand miles away; and who wished to get the nearest distant stations, four or five thousand miles from them.

One of the most important developments of radio, that of the short-wave broadcaster, is being made practicable just in the nick of time. American short-wave stations have been heard the world around; so has Holland’s new one, and to work with the latter, Java has now a high-power station on ultra-short waves, seeking to pierce the thick blanket of tropical static. In Eastern Siberia the Soviets have just erected a powerful station, designed with the same possibility in mind, which will readily be heard in America when it is put in operation.

An even more important difficulty, as regards the spread of radio among the people of Asia, is the poverty of the average dweller in its congested districts, and the distance of its less-settled regions from the products of civilization. In Russia the government has met somewhat similar conditions by the institution of the community radio set in villages; the American ideal of a high-quality, sensitive receiver in every home is still absolutely out of the question in most countries, even in Europe.

In spite of all these things, however, the introduction of radio into Asia is taking place, and it is impossible that the changes which are thus being occasioned shall be without effect, in creating a greater world-consciousness among people who have hitherto lived to themselves alone, ignorant of the very existence of others. No matter how carefully governments seek to confine the utility of radio to their own purposes, where they have once placed in the hands of their nationals the power of hearing the voices of all the world, there must be an increase of enlightenment, a dispelling of ignorance, and a better appreciation of the common humanity of earth’s many races. Even America must and will share in this process of universal education.

AN OLD SONG REVISED

[Experts in television say that the “note” produced by a face is quite different from that of a hand. In time will beauty or plainness be determined in this way?]

*Sing to me only with thy face
When we are far apart
For television solaces
Full oft a lover’s heart.
The notes that thou dost televise
Now form my daily chart,
For such sweet melody shows forth
How wondrous fair thou art!*
—Leslie M. Oyler, in *Wireless Magazine*, London.

CAUSE AND EFFECT

YOUNG HOPEFUL: “Mr. Sodder, you shouldn’t whistle when you’re building a radio.”

RADIO FAN: “Why not, Bobby?”
YOUNG HOPEFUL: “My daddy whistled when he was building our set, and now it whistles all the time!”
—William Herrmann.

POLYMET CONDENSERS

They Stand Abuse!

At All Dealers Polymet Filter Condensers

They are selected by leading engineers and incorporated as standard equipment by nationally known manufacturers of receiving sets and power units. Follow the leaders.

Write for Polymet Catalog

POLYMET MFG. CORP.
599-601 Broadway, New York City

POLYMET

Sovereign A-C

Standard Socket

Tube and Kit

Don’t be a “back number.” Throw away all “A” Batteries, “A” Eliminators and Chargers. Slip Sovereign A-C Tubes into your circuit, plug into the light socket for “A” power, and enjoy clear, clean, crackless, truthful reproduction.

Sovereign A-C Tubes give astounding satisfaction—unequaled performance—transmit no hum—no disturbance—require no new sockets.

If your dealer cannot supply you, we will send C. O. D. Specify line voltage and number of cycles.

Get free booklet on A-C Tubes and Circuits.

SOVEREIGN ELECTRIC & MANUFACTURING COMPANY
125 N. Sangamon St., Chicago, Illinois

FREE Wholesale Radio Catalog

Dealer-Set Builders! Save Money!

Send for this book of bargains. Everything in Radio—all the newest hook-ups, Sets, kits, parts, cabinets, consoles and supplies. If you want the best for the least money, you need this catalog.

SHURE RADIO COMPANY
349C West Madison St. Chicago, Ill.

The Listener Speaks

(Continued from page 600)

and which would add to the listeners' satisfaction; and that is the frequent announcing of call letters. Not the regular station announcement but simply the calling of the three or four letters—for there is very little logging of stations now since the re-allocation and the stations would get the listener's "applause" if this were done.

CHARLES L. RIECKE,
Summerville, So. Car.

ADVERTISING MUST NOT REPEL
Editor, RADIO NEWS:

I wish to convey to you my appreciation for the ideas which you have advanced in your many editorials, and I want to suggest a subject which I think is worthy of your pen: I refer to direct advertising by broadcasters.

Recently, a department store was opened in Dallas, with a "Style Show," at which time the "mike" of one local station was in the hands of a publicity man for four hours. This is the most vile type of commercial advertising that can be imagined. The station is located in the heart of the downtown section and, because of its proximity to the majority of listeners, covers a broad band on their sets. If this practice is allowed to continue, it will drive the "fan" from the field and close a very profitable market to the manufacturers of parts and sets.

I realize that the operation of a broadcast station entails considerable expense, and that revenue must be secured to continue the station. I favor indirect advertising, because it is from this source that our best programs are received; but when radio stations degenerate to the level of paid advertising space, it is time that their licenses be cancelled.

This instance which I have cited may be an extreme case, but it is not confined to Dallas. The practice is developing. It but serves to illustrate the class of broadcasting material which may be expected in the future, unless subjected to restrictions.

D. H. WILSON,
Dallas, Texas.

(The penalty for bad advertising is automatic—it is loss of business. The radio advertiser who is wise and experienced never hazards the loss of good will for which he has paid good money, by wearying or annoying his audience. However, we wonder whether the feminine listeners of Dallas enjoyed the Style Show program which so aggravates a mere man? If so, it is to be feared that the less deadly sex will have to tune out during fashion hours.—EDITOR.)

EDUCATIONAL FICTION

Editor, RADIO NEWS:

I am writing to comment on the story "The Voice of the People" which appeared in your November issue. Perhaps all the praise should go to Mr. Mountain and Mr. Gleason; but I write you because I feel you should know how we feel toward printing stories of this sort.

That is the best article that I have read for years. It is the kind of reading that is instructive as well as intensely interesting. Stories of a scientific nature, as was this story, is always welcome around this place. I find RADIO NEWS the best radio magazine printed. I like the articles in your magazine very much; but a story or two of the nature of the above mentioned seasons it to taste.

May your magazine grow in leaps and bounds; as I know it will if you adhere to your present policy.

E. R. QUACKENBUSH (Principal),
Public Schools, New Bloomfield, Mo.

Products of ALL-AMERICAN
TRADE MARK

To the right you see an illustration of the beautiful ALL-AMERICAN Reproducer. This is a cone type speaker with filter system built in. Assures fine tone qualities, lasting protection against high voltages and freedom from burnt out windings. Has handsome all-metal case. A unit adjustment screw allows perfect balance with any set.

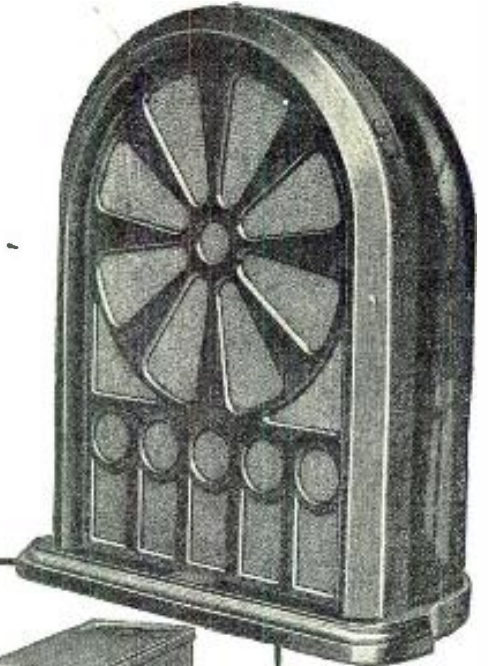

(Top) The new popular cone type Reproducer sells for \$25.00.

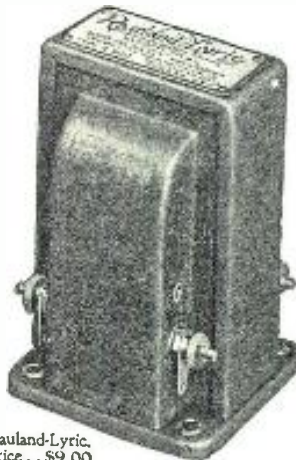

Rauland-Lyric. Price... \$9.00



Rauland-Trio Impedance Unit. Price... \$6.00



Audio Transformer, all ratios. Price... \$4.50



(Left) Equip your radio with this efficient Socket B Power. Price... \$27.50. Prices slightly higher on West Coast.

ALL-AMERICAN Socket "B" Power employs the long life Raytheon tube principle of rectification. Delivers 180 volts. Noiseless, clean, low-priced.

* * *

Every ALL-AMERICAN Audio Unit assures natural reproduction and smooth, flawless amplification. Guaranteed electrically and mechanically perfect.

You will find that it means lasting satisfaction and money saved to use the products of ALL-AMERICAN. Ask your dealer to show them to you.

ALL-AMERICAN RADIO CORPORATION
4209 Belmont Avenue, Chicago, Illinois

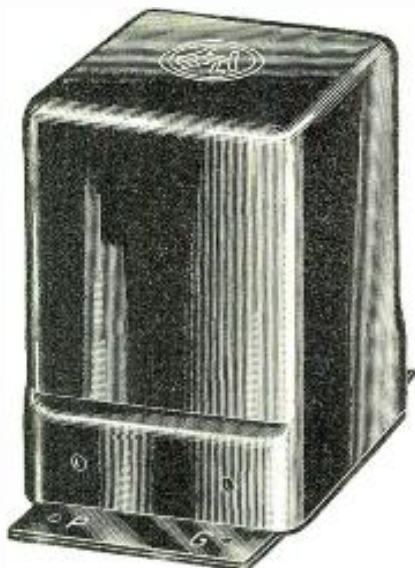

H.F.L. Transformers

H.F.L. C-16 Audio Transformers and C-25 Output Transformer—
New Companions of a Great Circuit

H.F.L. C-16 is the most efficient Audio Transformer built. It carries signals at highest volume and lowest amplitude without blasting or developing harmonics. Operates with all power tubes as well as standard tubes.

H.F.L. C-25 Output Transformer handles the voltage output of power amplifying tubes, at the same time matches the impedance of the average speaker to the tubes. Protects loud speaker unit without reducing plate voltage.

Mechanical features of these two transformers are: A coil designed and treated to exclude moisture and withstand heavy electrical surges without breaking down—complete magnetic shielding to avoid interstage coupling—terminals brought out so as to insure short leads.

Endorsed by America's Leading Engineers—Guaranteed by the Manufacturers

The new C-16 and C-25 Transformers will work in any circuit and will improve any Radio Set.



PRICES	
H-210 Tran.	\$8.00
H-215 Tran.	8.00
L-425 R. F. Choke	5.50
L-430 R. F. Transform.	5.50
C-16 Transf.	8.00
C-25 Output Transform.	8.00

Set Builders and Dealers

If your jobber cannot supply you with H. F. L. Transformers, write us for name of nearest jobber.

High Frequency Laboratories

135D NORTH WELLS STREET CHICAGO, ILL.



Letters from Constructors

(Continued from page 646)

patented but I do not really know whether or not it could be patented. But this is not the first time I have picked up a magazine or newspaper and have seen where my ideas had been put into effect, not only in radio but other electrical appliances.

I hope you will pardon me for taking up your time with this letter, but when I saw that circuit in your magazine, it surely was the "straw that broke the camel's back," and I just had to tell you about it. I guess there is nothing I can do about it now, but let Mr. Gomez carry away the honors.

M. JOHN CASTLE,

116 East 61st Street, Seattle, Wash.

(Mr. Castle accompanied his letter with two of his hook-ups and several photographs; one of each is here reproduced. His letter illustrates the fact that when many experimenters are working on the same lines independently, they are apt to reach the same conclusion independently. The history of many modern inventions is a neck-and-neck race to the patent office, with Federal judges picking the winner. If you have invented a workable improvement in radio, protect yourself by publication at the earliest moment, whether you are seeking the cash or only the credit.—EDITOR.)

THE EXPONENTIAL HORN

Editor, RADIO NEWS:

The Exponential horn of square cross-section, described in October RADIO NEWS, was constructed by the writer, and is well worth the time and trouble of building. The tone quality is wonderful and far superior to any other type I have listened to. A Baldwin type-C unit, also a base of the Magnavox R3 were used; the results were exceptional in both cases.

A small knife, well-greased, was used to cut the beaver board; thus making it slide through the cut very easily. The outside of the horn was covered with wall paper of the same pattern as that used in the room; and the bell of the horn was finished with the same border, inside and out.

A. DIVEY,

160th and Mansfield Ave., Harvey, Ill.

Editor, RADIO NEWS:

I have constructed one of the square exponential horns, using three-ply cottonwood and Spittordf unit, and find that it makes a splendid loud-speaker, giving very true tone and unlimited volume; yet very clear and sweet when throttled down. I stand it up, with a sounding board like a piano's over the top, which diffuses the music and does away with the "speaking-at-you" feeling which so many loud speakers give.

W. BARCLAY,

1324 Lyall St., Esquimaux, B. C., Canada.

Editor, RADIO NEWS:

I have just finished and placed in operation one of these horns, following the directions. The tone and quality of reproduction received from this horn is even better than orthophonic music reproduced from records and has my \$55.00 loud speaker backed off the board. Can heartily recommend the horn to anyone that wants the best in radio music.

WALTER J. STANTON,

111 West Plume Street, Norfolk, Va.

JOYS AND WOES OF CORRESPONDENCE

Editor, RADIO NEWS:

I regret my last letter to you because of the correspondence received from practically every state in the union. Alberta (Canada), Mexico, Germany, Warsaw (Poland). I want to tell you that I did not realize the scope of your magazine until, like a darn fool, I wrote about my experience with the Tropadyne. Since then and until this day I have letters to answer regarding my experiences, published in your February issue.

I also want to thank you for the advertising; this article afforded me the opportunity to buy unsatisfactory sets, and this has enabled me to pick up intermediate tunable transformers which are now off the market. The construction of these sets, which I pick up, leads me to think that the average radio constructor needs more education; because I take a set completely wired which fails to work and rewire the same. It then works equally as well, or better than my own, which has all-home-made transformers. Tube for tube, carrying the same voltage, there is not in my experience of the past eight or ten years, any set that can do more than the Tropadyne; and mine operates on a 24-inch-square diagonal loop with a ground connection on the inner tap of the spiral.

E. A. SCHNELL,

2349 Charleston Ave., Toledo, Ohio.

BUT IT'S A LIVELY CORPSE

Editor, RADIO NEWS:

I have read with great interest the editorial on page 321 of your October issue and thoroughly approve of it. It is good to hear you say that the parts business is coming back; for it has become steadily more and more difficult for the amateur to get parts for experimental work. I do not mean serious experimental work; I mean just play. Radio was a godsend to the family man a few years ago. It gave him something to fill up his evenings. Fooling around his kitchen laboratory was great stuff and made for happiness in many a home where boredom had previously prevailed.



Selectivity and Stability

The "bypass" condenser plays an important role in every tuned radio frequency amplifier—because it governs the selectivity and stability. An individual "bypass" condenser should be employed for each radio frequency amplifying tube.

AEROVOX "bypass" condensers, sealed in Bakelite, are particularly effective in radio frequency amplifiers because of their construction.

They are non-inductive—impervious to moisture and are available in all capacities up to 1 mfd. and rated at 200 volts D. C.



70 Washington St., Brooklyn, N.Y.

DUO-POWER B CURRENT SUPPLY



\$29.50—Slightly higher west of the Rockies

Sturdily constructed and dependable in operation. Embodies all the latest improvements in B Power Unit manufacture.

Adaptable to any receiver requiring up to 180 volts at 60 m's. Easy to install. Fixed resistances insure selection of proper voltages for any set.

BOUTIN ELECTRIC COMPANY
724 So. 4th St. Minneapolis, Minn.

User agents wanted. Write for very attractive agency proposition.

A Laboratory Product



CRESCENT LAYITE RESISTANCES

Insure Distortionless Amplification and a clarity of tone not obtained through any other resistances. All capacities 12,000 Ohms and up. List price \$1.50. Special sizes to order. Write for full information.

Cresradio Corp., 166-32 Jamaica Ave., Jamaica, N. Y.

But it seems to me that you have missed one feature that has hurt the amateur builder more than any other. I refer to the practice, of some radio papers and radio departments in newspapers, of giving insufficient details in their hook-up designs. These papers are evidently intent only on selling kits or special parts for certain, particular advertisers.

That would be harmless enough, were it not for the adventurous, play, psychology of the amateur, who does not want to assemble parts, but wants to use the same old parts over and over, or pick up parts where and how he can. In other words, he wants to experiment. If he liked only the radio programs he would buy a set and be done with it. In many cases, he buys a set for his family, and then amuses himself to his heart's content with DX-hounding and other foolishness—useless, but lots of fun.

And—incidentally—he spends a lot of money. He buys all of the new parts that are advertised and tries them out on his sets. It would pay set manufacturers—and would be a boon to amateurs—if these facts were recognized and acted upon. That is to say, it would stimulate part buying enormously if hook-up designs in the radio papers would give building details; i.e. coil diameters, turn numbers, size of wire, spacing, etc., condenser capacities (*Beq pardon, but RADIO NEWS does so.*—EDITOR) and so on, so that the builder could go ahead and try his luck. I know RADIO NEWS does this to some extent (not as fully as this "faithful reader" would like, but to some extent). But many of the other papers give absolutely nothing except an advertising write-up for the purpose of selling a kit or some special parts, which will invariably be found advertised in the same issue.

It is that, and nothing else, that has killed the parts business.
FRANK PATTERSON,
113 West 57th St., New York, N. Y.

TRANSPACIFIC WORK ON THE INFRADYNE

Editor, RADIO NEWS:

I am a constant reader, and like Mr. Willington of West Vancouver, I have heard Australian stations for over two years. By official report from Tokio, I was the first to report reception of the three Japanese stations, which was on Aug. 6, 1925. They threw a cable back at me, and were willing to pay for a reply. This was on a five-tube Freed-Eisemann. I have now a ten-tube Infradyne, which I constructed myself, using Quadraformer coils and a Silver-Marshall oscillator coil; taking out the rotor and winding 7 turns of No. 26 D.S.C. in the slot just below grid and plate windings, which gave considerable more kick.

If Mr. Staves wishes to ship his set up here, I will get him Australian stations with it, or any other half-decent set of five or more tubes. Static was bad last night, but I sat up and listened to Australia, turning from one station to another (*List enclosed of reception, with program numbers, etc., of seven Australian stations*) and made the notes, a copy of which I am sending to 3L.O. Melbourne. I can get most of these consistently at this time of year (Aug. 29) nine nights out of ten. They are not always good, but I can hear them. I have quite a bunch of verifications.

C. A. BLACKINGTON,
Box 51, Wrangell, Alaska.

RECEPTION IN INDIA

Editor, RADIO NEWS:

I send you two programs of the radio stations on the air in India, trusting they will be of interest. The local 7BY is very powerful, and cannot be cut out to get Calcutta or Colombo (Ceylon) on the usual type of receiver, though I haven't tried a superhet. This complaint comes in even from places 100 miles distant.

The stuff they broadcast is quite good so far, but does not possess variety. I enclose a snapshot of my receiver (two R.F., detector, three A.F.), on which I have tuned in Moscow, Leningrad, Vienna, Barcelona, Prague, duly confirmed, and several other unidentified stations.

I am rather keen on the *Strobodyne*, which seems a red-hot circuit. My receiver was made up when I was in London with the aid of my chums, and still uses the original tubes (Cussor and B. T. II.) which have served from 1922 to 1927. It has a wavelength range from 80 to 7,000 meters, with different coils. The "A" battery is charged from 230-volt mains. As soon as I get a super, I intend "hogging it" for more DX, but down your way.

I have been one of your keen readers since 1922, when I last won a prize in your other great magazine, *SCIENCE AND INVENTION*. Wishing you the best of luck.

J. R. D. WADIA (Barrister-at-Law),
7 Marine Lines, Bombay, India.

(*The photograph sent by Mr. Wadia reads too small to reproduce clearly; the set is of typical European style, with tubes on the panel and numerous controls. Many foreign letters complain of inability to separate stations hundreds of miles and nearly as many kilocycles apart.*—EDITOR.)

NEW QRAs

5AQW, (portable) George W. Fahrnel, Box 2126, Auburn, Ala.; 15 watts. Pse QSO.
NC-3AQ, Montrose Werry, 217 Delatre St., Woodstock, Ont., Canada. 80 meters.

Calls Heard

9APY, F. J. Hinds, 3337 Oak Park Blvd., Berwyn, Ill. (September); oa-2to, 2ui; 2yi, 3cs, 3wm, 7cw; oh-6bd1; oz-4ac; kzct; pjc; Xen-oqq.

The Celestial Stradivarius
The Advanced Hi-Q Six*
BOTH CUSTOM-BUILT!



The Hi-Q SIX—the newest advance in radio—four completely isolated tuned stages—Automatic Variable Coupling—symphonic amplification. This non-oscillating, super-sensitive receiver assures maximum and uniform amplification on all wave lengths and establishes a totally new standard of tonal quality.

Hi-Q*: High Ratio of Reactance to Resistance. High ratio—great selectivity—loud signals.

JUST as Antonio Stradivari gave the priceless CUSTOM-BUILT violin to musicians of his day, so does Hammarlund-Roberts offer music lovers of our day the CUSTOM-BUILT Radio—the advanced "Hi-Q Six" designed by ten of America's leading manufacturers—made with America's finest parts—incorporating every modern constructional feature—and built under your own eyes from plans so complete, so exacting and so clear-cut that the only outcome can be absolute radio perfection.

In addition to its unprecedented performance, the Hi-Q Six offers equally unprecedented economy, for by building it yourself you can save at least \$100.00 over the cost of fine factory-assembled sets. Complete parts, including Foundation Unit of chassis, panels and all wire and special hardware, cost only \$95.80.

The Hi-Q Instruction Book tells the complete story with text, charts, diagrams and photos. Anyone can follow it and build this wonderful instrument. Get a copy from your dealer or write us direct. Price is 25 cents.



HAMMARLUND-ROBERTS, INC.
1182-C Broadway New York City

Associate Manufacturers



FREE!

AMAZING INTRODUCTORY OFFER UNTIL DEC. 25th ONLY



X112



X300

Think of it, an \$8.50 value, yours without cost. WHY? The one best way to acquaint you with VOGUE quality is to make our offer so interesting that you just can't resist. Then you'll tell your friends of their marvelous results and your friends will ask their dealer for VOGUE tubes and that's our reward. We only ask that you purchase the 3-201-A of our combination matched set at the regular price of \$1.75 each and the

power and superdetector selling for \$4.50 and \$4.00, respectively, are yours FREE. This beautifully packed set makes an ideal Xmas gift. Thus we extend our offer until December 25th.



FULLY GUARANTEED

Allan Mfg. Co., 102 N. 5th St., Harrison, N. J.

Enclosed herewith is \$5.25 for which please send the pre-paid one combination matched set.

Name

Street

City

DAVEN AMPLIFICATION

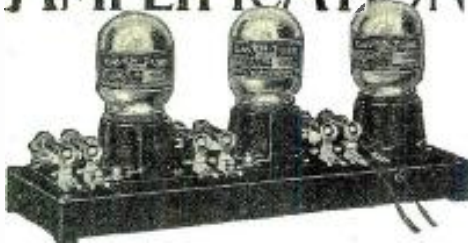

**Still the Superior
Audio Amplifier**
Use it in the Strobodine and all other circuits

After three years, Daven Amplification is still the most faithful audio amplifier. No matter what your favorite circuit Daven Amplification will improve it. Only with Daven can you get absolutely straight line amplification over the entire audible range. No motor boating on good "B" Eliminators.

Daven Amplification is now engineered for either AC or DC Tubes, for use with "B" Eliminators or Batteries. With AC operation, the new Daven AC-15 Tubes are used in the first two stages and an AC-10 or Mu-6 in last stage.



GLASTOR THE TRANSPARENT RESISTOR



Glastor, made only by Daven by a secret process makes the glass itself conductive. Glastor cannot change in value, cannot become noisy while the glass remains intact.

Make your last change
Replace your resistances now, it will be the last change as long as the set is in use. Glastor is made in a full range of values.

The DAVEN BALLAST

Good for life

The Daven Ballast, the Standard Filament Control will not burn out.

Good for the life of any set. Made in 5 sizes to control from 1 to 5-5 volt tubes. Sold with or without special mounting as shown.



Free Catalog at your dealer or sent direct upon request.

The Sine of Music
DAVEN RADIO CORPORATION
TRADE MARK "Resistor Specialists" REG. U.S. PAT. OFF.
143 SUMMIT STREET NEWARK, N. J.

What's New in Radio (Continued from page 597)

tiometer till little or no current flows in the plate circuit. When the cell is illuminated, its resistance changes, and the grid bias on the amplifier tube changes; as a result, the plate current increases and operates the electromagnetic relay. This relay circuit can be used to regulate artificial illumination—that is, to close the lighting-circuit switch when the intensity of the natural illumination falls below a predetermined value. Another interesting and useful application is its use as an optically-controlled counting device. With this simple mechanism it is possible to record accurately the number of times a shadow is cast upon a given point.

The second, or neon "glow" type of tube, provides a highly-efficient source of cold light which may be readily modulated. That is, these tubes are of such design and are filled with the gas at such a pressure that the light intensity varies most readily with the voltage applied. The response to such voltage changes is practically instantaneous, with the result that the tube is most valuable in a variety of applications.

In operating the neon glow tubes, they may be placed in either direct- or alternating-current circuits with voltages which are obtainable in the ordinary radio amplifiers. They are used in television, telephoto and other places where a modulated light source, or "light valve" is required.

POST-CARD RADIO RECEIVER IS LATEST NOVELTY

IN the novelty field of radio, the post-card receiving set is one of the latest developments to make an appearance. The one illustrated in these columns has been received recently from Germany.

In appearance this unusual receiver re-

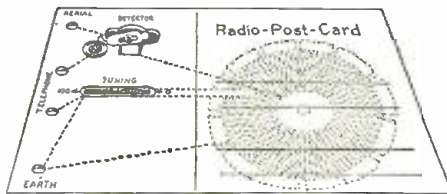

Complete crystal receiving set built in post-card size; dotted lines in illustration show location of wiring and coil.

Illustration courtesy Willy Zöbisch (Dresden, Germany).

sembles the average illustrated post-card. It is the standard size (5½x3¼ inches), and the chief difference between it and the usual post-card is in its thickness and weight, which are slightly greater. The back of the card is decorated with a picture, and on the front a line divides the card in two sections. Space on the right side of the line is for the stamp and address, and on the left side of the line are the tuning controls and four points of electrical contact. Also, there is ample space to write a short message.

Electrically the post-card receiving set incorporates an efficient crystal receiver. The tuning inductance of the set is a spiderweb coil, the detector of the adjustable galena-crystal type, and the tuning control is a slider which makes contact with the various turns of wire on the coil. The coil is 2¼ inches in diameter and wound with No. 28 enameled wire. At the point where the slider makes contact with the coil, the enameled insulation has been removed from the wire.

For operating the receiver the only acces-

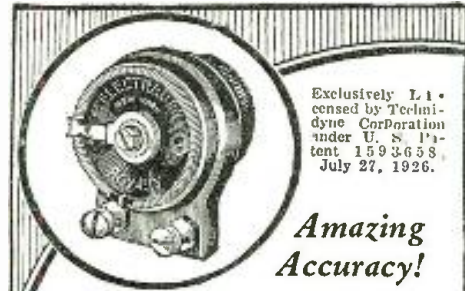

Exclusively Licensed by Technidyne Corporation under U. S. Patent 1,593,638 July 27, 1926.

Amazing Accuracy!

ROYALTY VARIABLE HIGH RESISTANCES

The foremost radio experts specify these resistances and give them their unqualified endorsement.

This is because of their remarkable accuracy and reliability wherever variable high resistances are required in the circuit.

- 1—Same resistance always obtained at same point.
- 2—Resistance element not exposed to mechanical wear.

A range for every purpose—A to L. Type E \$2.00. All other types \$1.50. Write for hook-up circular.

Dept. 48C, 175 Varick St., New York, N. Y.

ELECTRAD

YAXLEY APPROVED RADIO PRODUCT



Automatic Power Control FOR CHRISTMAS

The gift of gifts for the set owner
Makes radio more convenient because it handles the switching of the trickle charger and B eliminator automatically. Controls charger or eliminator separately or both in combination. When the set is turned on the trickle charger is cut out and the B eliminator is switched in. When the set is turned off the trickle charger is cut in and the B eliminator is switched off. Better reception and greater satisfaction are assured. The A battery is charging when the set is not in use. It is always ready with plenty of kick when the set is turned on. The B eliminator is on only when the set is in use; the tubes last longer and give better service, and there is no waste of power.

No. 444. Series Type \$5.00
YAXLEY MFG. CO.
Dept. N, 9 So. Clinton St., Chicago

RADIO WHOLESALE

Write for my Big 1928 Radio Catalog—just off the press. Thousands of marvelous bargains in nationally advertised goods. All the LATEST IN RADIOS and equipment. Lowest wholesale prices.
FREE Agents Wanted.
It's a regular encyclopedia on Radio. All about trouble finding. **FREE Log and Call Book and Catalog.** Get your copy today. Send postcard now!
American Auto & Radio Mfg. Co.
HARRY SCHWARTZBERG, PRES.
Dept. 103 American Radio Bldg., Kansas City, Mo. 3

Insure your copy reaching you each month. Subscribe to RADIO NEWS—\$2.50 a year. Experimenter Publishing Co., 230 Fifth Ave., N. Y. C.

series required are aerial and ground connections and a pair of headphones. Leads are connected from these to the four metal eyelets at the extreme left of the card. To tune in a station, it is necessary only to adjust the detector until a sensitive point is found and then adjust the slider until the strength of the signals is greatest.

This receiving set has been actually tested, and found to operate on local stations in this city.



Front view of new drum-type horn loud speaker with silk mesh in place.
Illustrations courtesy Temple, Inc.

NEW HORN SPEAKER IS SHAPED LIKE DRUM

DURING the past year, many changes have been made in the design of loud speakers; and these have produced instruments which are not only much more decorative in appearance, but provide more realistic reproduction. These improvements have not been confined to any particular type of loud speaker; but are found manifested to a greater or lesser extent in all designs, including those of the horn, cone and baffle-board construction.

Today, an examination of the newest cone and horn-type speakers will show that they often present a very similar appearance. Speakers of both classes will be found within cabinets of similar design, and also in metal drums of similar appearance.

From the external appearance of the speaker illustrated on this page it is difficult to tell whether it is of the horn or the cone



Dotted lines indicate shape of the horn which is housed inside the drum. U is the speaker unit.

A HIGH-POWERED 10-TUBE MODEL FOR 1928

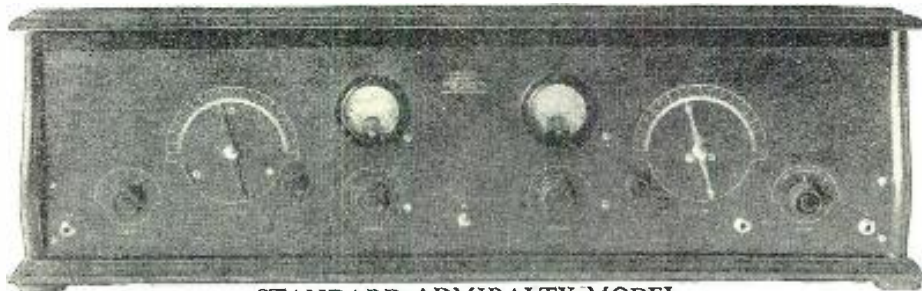

STANDARD ADMIRALTY MODEL

NORDEN-HAUCK IMPROVED SUPER-10

LICENSED UNDER HOGAN PATENT 1,014,002

"Highest Class Receiver in the World"

This new and advanced design brings to you all the luxury and performance you could possibly desire in a radio receiver. Absolutely nothing has been omitted to provide supreme reception—a new standard previously unknown.

The up-to-the-minute engineering principles found exclusively in the improved Super-10 are comparable to the high compression head and super charger in an automobile engine.

In the Norden-Hauck Improved Super-10 you have

- Wonderful Selectivity
- Faithful Reproduction with any Degree of Volume
- Signals received at only one point
- Two major tuning controls for all wave lengths
- Wave band 200/550 meters (adaptable down to low waves and as high as 6000 meters with removable coils)

Material and workmanship conform to U. S. Navy specifications.

The improved Super-10 is sold complete as a manufactured receiver, or we are glad to furnish blue prints and all engineering data for home construction.

Upon request, new attractive illustrated literature will be promptly mailed to you without cost or obligation on your part.

Tear off and mail today—

Your correspondence or inquiry for further information is cordially invited

Write direct to
NORDEN-HAUCK, INC.
ENGINEERS

"Builders of the Highest Class Radio Apparatus in the World"

MARINE BLDG., PHILA., PA., U. S. A

Cable: Norhauck

NORDEN-HAUCK, Inc.,
MARINE BLDG., PHILA., PA.

Gentlemen:

- Without obligation on my part send me complete literature on the new improved Super-10.
- I enclose \$2.00, for which send me, postpaid, complete Blue Prints and operating instructions for the new improved Super-10.
- I enclose \$1.00, for which send me Blue Prints of the Model 500 B. C. Power Unit.

Name.....
Address.....



Every new radio development is shown in this big catalog, including such hook-ups as the Tyrman Ten, 9 in Line, Camfield, Silver-Marshall, Karas, Carter, Daven, Aero Seven and numerous others. All nationally advertised radio parts and accessories are listed and described. Everything worth while in Radio now in stock and ready for shipment. Orders filled and shipped same day they are received. **LOWEST PRICES** given to Set Builders and Dealers. Write today for this catalog.
Miller-Welles Co., 20-M W. Kinzie St., Chicago, Ill.

ELECTRICITY THIS BOOKLET FREE

There's a big-pay job and a future of unlimited possibilities for ambitious, capable men in the electrical field. Our FREE booklet, **YOUR FUTURE IS IN ELECTRICITY**, describes these opportunities and tells you how you can win success in this fascinating field. The booklet also describes the **CROFT LIBRARY**, America's standard reference library and home-study set on practical electricity.

This famous 8-volume set gives you a complete electrical training at a cost of only 7c a day. 39,000 sets now being used by beginners as well as experts throughout the country. Send for descriptive booklet **TODAY**. It's FREE!

McGraw-Hill Book Co., Inc.
Dept. R 370 Seventh Ave., New York City

RADIO—SETS—PARTS
Eliminators at amazingly low prices
Write for latest money-saving literature
S. R. S. CO., N-427 16th St., New York City

TOWER RADIO PRODUCTS
ON SALE EVERYWHERE

DEALERS

Attention!

DEALERS' PERSONAL SERVICE

new new new new news new new new new new new new new

HELPING YOU, SIR,
TO—

Easier Profits

Because the DEALERS' PERSONAL EDITION will show you the number and purchasing power of prospective customers—we will attend to many selling details—

You will know your customers.

Quicker Turn-over

Because we will tell good radio buyers in your vicinity about you—then they will come first to your store—

Your customers will know you.

Easier Buying

Because we will help you gain greater dividends from your stock-buying dollar—practically—tell you the standing of every manufacturer and his products—

You will know your manufacturer.

To Help You, Sir, To—

Know what your customers will demand next month—in sets, in parts, in accessories—a quarter of a million RADIO NEWS readers buy what is advertised in RADIO NEWS—put in your reservation now for this free dealers' edition.

FREE!

AT your service: The equivalent of a merchandising expert in the January number of the DEALERS' PERSONAL EDITION—that's the story! Fill in the coupon below and we will send you the new DEALERS' PERSONAL EDITION. It will give you a merchandising service absolutely gratis—a service you could not duplicate in any other trade magazine.

This dealers' edition is made up specially for you. It is just chock-full of market research—practical selling helps—profit-making plans—knowledge expensive to learn through personal experience—and it is absolutely free.

Without a penny of cost to you we will send it to you, but be sure to attach the coupon to your letterhead. No obligation. Mail the coupon now, in time for the first issue, out December 10th.

news new news new news new news new news new news new news

GOOD ONLY IF ATTACHED TO YOUR LETTERHEAD

RADIO NEWS, Merchandising Dept., 230 Fifth Avenue, New York City.

My name.....

My address.....

My firm.....

(Please make sure I receive the first issue of the DEALERS' PERSONAL EDITION promptly—I want your fine buying chart, which is to be in the January number.)

R. N. M.—12/27

DEALERS' PERSONAL EDITION



type. However, if the front cover is removed a horn-type reproducer of improved design will be found.

The speaker is built within a cylinder 13 inches in diameter and 7 inches deep. The case is of metal and has a dull brown finish. It is mounted on a base of walnut, which is two inches high. The front of the speaker is covered with a silk mesh which is stretched tightly over a wire screen.

The loud-speaker unit and the horn of the speaker are both of modern construction. The speaker unit is of the non-adjustable electromagnetic type, and the horn is of the semi-exponential design. The air column of the horn has been coiled in order to provide it with the length which is required for good reproduction.

IMPEDANCE LEAK IN AUDIO STAGE A REMEDY FOR "MOTORBOATING"

"MOTORBOATING," that disturbing noise heard in many loud speakers, which resembles the sound of a motorboat's exhaust, is largely responsible for the fact that audio-frequency amplifiers of the resistance-coupled type are not more popular with broadcast listeners than they are.

With resistance coupling it is possible to obtain amplification which is practically free from distortion; provided, of course, all parts of the amplifier are correctly designed and operated. Another advantage of the system is that it is very simple and inexpensive to construct. On the other hand, when a resistance-coupled amplifier is operated in connection with plate ("B") socket-power units, "motorboating" fre-

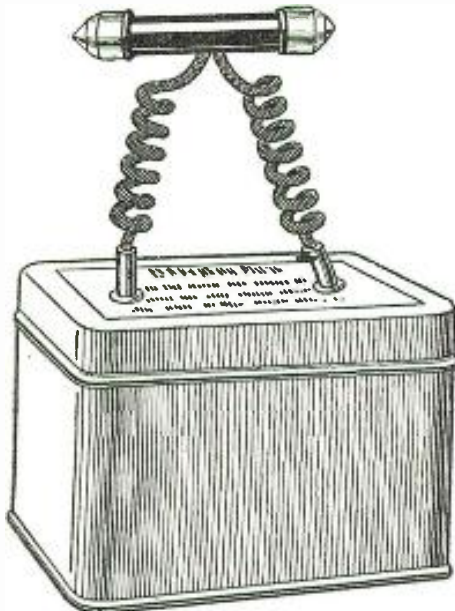

This simple device has been designed to reduce the "motorboating" effect in resistance-coupled amplifiers.

Illustration courtesy Davon Radio Corporation.

quently results. In some cases the effect is hardly noticeable, but in others it entirely ruins reception.

Both the cause and prevention of "motorboating" have been subject to considerable discussion and experiment on the part of radio engineers. Also, many methods for eliminating the effect have been presented.

The instrument illustrated in these columns provides a very simple means of reducing "motorboating," and usually it will be found effective. It consists of an impedance leak which may be substituted for the grid leak in the second stage of amplification. The unit is easy to install, since it is provided with a contact which will fit in the clips originally used for the grid leak. This makes it possible to make the necessary alteration in the amplifier without changing a single wire.

Who gets the difference?

Why do other good "B" Eliminators sell for as much as \$65.00—while the Ferbend sells for \$12.50? ❁ ❁ ❁

Generally accepted in the minds of the radio public is the fact that "B" Socket Power is best from every standpoint—convenience, lasting satisfaction, better reception. There remains only the question of price. Of the best "B" Eliminators, many are as high as \$65.00, while the Ferbend—which is equal to any, not only in operation, but in quality, durability, workmanship and appearance—sells for only \$12.50.

Original cost less than half of any equipment of similar quality; lowest maintenance cost. Sooner or later you will change to "B" Socket Power. Why pay the difference?

Model III for all sets using 90 volts, \$12.50. Model IV for extremely large sets and sets using power tubes; delivers up to 180 volts, \$17.50.

Tested and approved by the Rigid Laboratory Tests of Radio News and Popular Radio.

See Your Dealer or Send Direct

Shipment made direct on receipt of price, or C. O. D. if preferred. Use for 10 days to convince yourself—if unsatisfactory, write us within that time and purchase price will be refunded. Send Coupon TODAY.

FERBEND ELECTRIC COMPANY
425 W. Superior St., Chicago, Ill.

Your Proof of Lasting Satisfaction

Have been using one of your Eliminators for over a year and it has given excellent service.
William M. Biggs, Rensselaer, Ind.

Your Eliminator is the best yet. Have had four makes all higher priced and all were noisy. No hum in the "FERBEND."
G. A. Connan, Portland, Ore.

Eliminator ordered December 28, 1925, is still working like new.
R. L. Welsh, Youngstown, Ohio.

Well pleased with Eliminator purchased from you a year ago. It gives as good if not better results than one a neighbor has for which he paid \$35.00.
A. H. Falkenhainer, Des Moines, Iowa.

The first Ferbend B Eliminator is still in use and giving good service.

FERBEND ELECTRIC CO.,
425 W. Superior St., Chicago, Ill.

-Send \$12.50 Model.
-Send \$17.50 Model.
-Send at once. Payment enclosed.
-Send C. O. D.
-Send Literature.

Name.....
Address.....
City.....State.....

FERBEND "B" ELIMINATOR

CODE QUICKLY LEARNED
With THE *New!* **PORTABLE**

TELEPLEX

The ONLY instrument that REPRODUCES actual sending of expert operators. Sends messages, radiograms, etc.—5 to over 80 words per minute. FIVE TIMES as many words on one tape as any other instrument, and SIX are furnished. Quickest, easiest way to learn Morse or Continental code, and to increase speed. Eliminates months of tedious practice. Satisfied users everywhere. Used by U. S. Navy. Fully guaranteed.

Write for Booklet N. R.
TELEPLEX CO.
76 Cortlandt Street New York City



Insure your copy reaching you each month. Subscribe to Radio News—\$2.50 a year. Experimenter Publishing Co., 230 Fifth Avenue, N. Y. C.

BLUEPRINTS OF INEXPENSIVE DX RECEIVERS

THE FIVE-TUBE DIAMOND OF THE AIR, a very selective circuit of thrilling tone quality, that brings in distant stations to the great delight of the fans, is easily built, in fact can be constructed in a couple of hours. The authorized blueprints that make this speed and efficiency possible are just off the press and will be shipped at once, together with a booklet of full textual exposition of construction, including winding of coils, how to connect coil terminals, what values of condensers and resistors to use, etc. If you want a tone quality set that will give you great enjoyment, be sure to build this five-tube Diamond of the Air. The receiver consists of a stage of tuned radio frequency amplification, a specially sensitized detector, first stage of transformer audio and next two stages of resistance audio. It is easily adapted to playing phonograph records on your speaker. Get acquainted with this NEW delight.

THE FOUR-TUBE DIAMOND represents the most that is obtainable from four tubes. A stage of tuned radio frequency amplification, a specially sensitized detector, and two stages of transformer coupled audio. Follow the diagrams as shown in the blueprint and you can't go wrong. You will be amazed at the results. Build the set from parts that you have. Full instructions cover utilization of such apparatus. Thousands are eager to build an economical set and this one is the most economical in cost of construction and upkeep, where one considers the surpassing results. Works splendidly from batteries, with either type 99 or type 01A tubes, and can be used with A and B eliminators, power packs, etc., with great success.

Look Over Both of These blueprints and read the text in both cases before choosing the receiver you are to build.

SEND NO MONEY!

Just fill out the coupon below, and note what you get FREE!

Guaranty Radio Goods Co.
141 West 45th Street, New York City
Please send me one newly-printed official blueprint of the 5-tube Diamond of the Air, one newly-printed official blueprint of the 4-tube Diamond, and the textual data giving full directions for constructing these sets. I agree to pay the postman 75 cents on delivery. Also, you are to send me, without extra cost, one Auto Strop Safety Razor, one blade and one automatic razor strop.

Name
Address
City..... State.....

AUTOMATIC CODE INSTRUCTOR USES WAX PAPER TAPES

An instrument of improved design for self-instruction in telegraphy has been recently developed. It will send a message of 400 words in the "Continental" code, used in radio, or in the "Morse" used in American telegraph operation, at a speed which may be regulated from five to as high as eighty words per minute. The beginner, using the device for home practice, will find that it is not difficult to acquire speed and accuracy in a very short period of time.

In construction the device is very compact and of pleasing design. It has been placed in a box, covered with green leather, which measures 11 x 8 x 7½ inches when closed, and is equipped with a convenient handle.

In design, the instrument comprises a phonograph motor with a sensitive speed regulator. The motor is employed to rotate rolls of tape on which are registered the



View of code instructor with cover raised: A, vibrator; B, speed control; C, motor crank; D, "code roll" in operating position; E, extra code rolls.
Illustration courtesy the Teleplex Company.

code messages which the machine transmits. Perforations in the tape cause a contact spring to make and break an electrical circuit, as required to produce the dots and dashes of the message.

Specially-treated, waxed-paper ribbons are used for the tapes, and these will wear out with ordinary usage. Each tape carries two rows of perforations, with the advantage that the corresponding reading matter is printed in opposite directions, thus avoiding the necessity of rewinding the tapes. When one side of the tape has been run through the transmitter it is necessary only to turn over the tape in order to send the message a second time.

Many advantages are claimed for the tape system for self-instruction in telegraphy. In the first place, five times as many words are sent with one tape as are furnished with other instruments; and six tapes are supplied with each device. Secondly, in recording messages on the tapes expert operators send into specially-constructed perforators which faithfully register the dots and dashes exactly as they are received. Thus the student receives the reproduction of actual sending with all of the human elements of error as well as the individual characteristics of the various operators. It should be explained that this is a decided advantage; for, if the sending were perfect, the beginner would find it very difficult to receive regular messages over the air, as few radio operators send perfect signals.

When using this instrument, an external device is required to produce the sound of the signals; as the spring contact only makes and breaks the electrical circuit as required. If the beginner wishes to learn the radio ("Continental") code, a buzzer and a battery are usually connected to the binding posts provided on the device. On the other hand, a telegraph sounder may be connected if it is desired to learn the "Morse" code.

Tapes are available, in both the Morse and Continental codes, for the instruction of



Added Power for Tone and Volume

CENTRALAB TONE AMPLIFIER

EVERY owner of a set with two stages of audio amplification can work wonders with a Centralab Tone Amplifier. It adds a power stage of amplification, which gives any set better tone and greater volume, without distortion, from ANY station tuned in.

Using the .71 tube, the Centralab Tone Amplifier reproduces tone and volume so faithfully that the artist seems actually

\$16

(Without Tube) In an attractive walnut finish cabinet that will harmonize with most sets.

moved into your presence. One knob controls volume from whisper to maximum. A tone filter protects the speaker. Easily attached in a few minutes without tools or alterations. A demonstration will convince you.

At Your Dealer's, or C.O.D.

Central Radio Laboratories
19 Keefe Ave. Milwaukee, Wis.



Easier tuning — correct tube oscillation — more volume and clearness with an X-L VARIO DENSER in your circuit. Specified and endorsed by foremost radio authorities in all leading circuits.

MODEL "N" VARIO DENSER Micrometer adjustment easily made, assures exact oscillation control in all tuned radio frequency circuits: Neutrodyne, Roberts 2-tube, Browning-Drake, McMurdo Silver's Knockout, etc. Capacity range 1.8 to 20 micro-micro farads. Price \$1.00.

MODEL "G" Obtains the proper grid capacity on Cockaday circuits, filter and intermediate frequency tuning in super-heterodyne and positive grid bias in all sets. Capacity range: Model G-1 .00002 to .0001 Mfd. Model G-5 .0001 to .0005 Mfd. Model G-10 .0003 to .001 Mfd. Price complete with grid clips \$1.50. FREE Big, new 16 page book of wiring diagrams of popular circuits including the LOTTIN-WHITE constant coupled radio frequency circuit. Stroboddyne, etc. sent free on request.

X-L RADIO LABORATORIES
2426 Lincoln Avenue Chicago, Ill.

BIG NEW CATALOG FOR RADIO BUILDERS
FREE My big 1928 Radio Catalog, Call Book and Troubleshooting Guide. 122 pages about Radio. Chock full of newest circuits—kits, transmitter parts, short wave outfits, eliminators and speakers. Thousands of bargains at lowest wholesale prices. A regular Radio Encyclopedia—Free. Write today.
American Auto & Radio Mfg. Co.
MARY SCHWARTZBERG, PRES.
Dept. 105 American Radio Bldg., Kansas City, Mo.

LATEST RADIO CIRCUITS

You can be quickly cured if you

STAMMER

Send 10 cents for 288-page book on Stammering and Stuttering "Its Cause and Cure." It tells how I cured myself after stammering 20 yrs. B. N. BOGUE, 6974 Bogue Bldg., 1147 N. 111 St., Indianapolis.

beginners, advanced students and operators. There is a selection covering more than 100 commercial subjects. Some of the tapes have been designed to aid the person just starting to learn the code and others are intended to improve the efficiency, speed and accuracy of operators. Also, if desired, special tapes may be obtained.

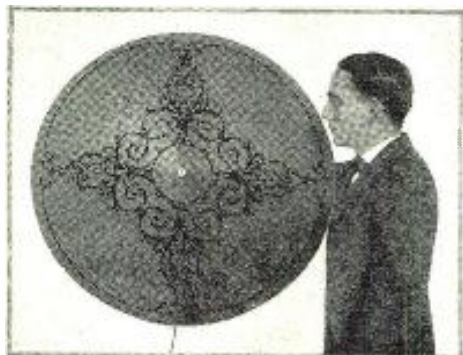

Front view of the 3-foot cone speaker built from this kit in the RADIO NEWS Laboratories.

LOUD-SPEAKER KIT IS EASY TO ASSEMBLE

A LOUD speaker of novel design, which is intended for home construction, has been recently introduced. It is a double, fixed-edge cone three feet in diameter, which is exceptionally simple to assemble. The illustrations on this page show the appearance of the speaker which was assembled in the RADIO NEWS Laboratories from the kit provided.

In order to appreciate fully the simplicity of the design it is necessary to be familiar with the method of assembly. The following paragraphs tell briefly how the cone may be made at home:

The parts included in the cone-speaker kit comprise a marked and decorated sheet of special paper for front of cone, 38 x 38 inches; a marked sheet of special paper, for back of cone, for the same size; the speaker unit; one back ring with latch, nuts, bolts and washers; 114 inches of edging braid; one cone apex assembly; rubber bumpers; adhesive tape; one loud-speaker unit mounting; cement.

After all of the essential parts have been secured; the construction may be started. First, the paper for the front and back faces of the cone should be removed from the mailing tube. These sheets must be flattened by rolling them in the opposite way from which they were rolled; in doing this great care must be exercised as, if they are rolled too tightly in the wrong direction, they are apt to crack.

The back sheet may be prepared by cutting along the solid lines with a sharp pair of shears. Next lay the paper for the front cone on the floor with the decorated side down and cut out the sector (wedge-shaped piece) with a sharp knife.

When the two sheets have been prepared as described place the front sheet on a smooth surface, such as a large table or the floor, with the decorated-rough-side down, and place upon it the cut-out back cone, with the two smooth sides facing each other. Care should be taken to see that the edges of the back cone coincide with the dotted lines of the front cone; and the three arrow heads on the back cone, marked X, Y and Z, should meet those on the front cone. The two sheets of paper should be held in position with weights, such as heavy books, flatirons, or other objects with smooth surfaces, for the next operation.

At this stage of construction the two diaphragms of the cones are joined together with cement. With the forefinger of the

The AMRAD MERSHON CONDENSER

Fills an important place in the
ELIMINATION OF BATTERIES
and the
IMPROVEMENT OF TONE QUALITY

A properly designed eliminator will improve any radio set—and can be built in one evening. Mershon condensers will lower the cost and improve the quality—as well as enormously simplifying the construction.

Or if you buy an eliminator—look for one containing the MERSHON CONDENSER

Mershon Condensers eliminate the hum in an 8 or 9 tube set, produced by an ordinary eliminator.

They are about one third the size of paper condensers of equal capacity.

It is possible to connect Mershon Condensers in series for extremely high voltage.

Paper condensers are often affected by weather conditions, especially dampness and heat, while Mershons are not.

Mershon Condensers prevent “thumping” or “motor-boating” of B-Eliminators.

They will greatly prolong the life of ordinary B batteries. Mershon Condensers are self-healing, whereas when other forms of condensers are punctured they are useless and must be thrown away.

Write today, addressing Desk RN for FULL information, prices, etc.

The **AMRAD** Corporation
MEDFORD HILLSIDE, MASS.

NEW SUPER MACK SPRING AERIAL

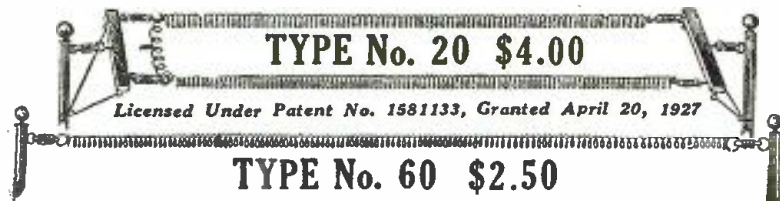

GUARANTEED to improve distance reception of any set in any locality

EASY TO ERECT No. 20 for 20 to 60 ft. stretch
No. 60 for 60 to 125 ft. stretch

Better looking and more efficient Antenna, built to fit your roof having 2 to 5 times as much capacity, 4 to 10 times as much induction, greater selectivity and non-directional reception.

If your dealer cannot supply you send check, money order or order **MACK CO., Inc.** 44 North Fourth Street PHILADELPHIA, PENNA.

Dealers and Jobbers Write for Our Proposition

Insure your copy reaching you each month. Subscribe to Radio News—\$2.50 a year. Experimenter Publishing Co., 230 Fifth Avenue, N. Y. C.

Enjoy LOUD SPEAKER OPERATION from a CRYSTAL

NO "TUBES" - NO "B" BATTERIES - NO COSTLY "ELIMINATORS"

THE SKINDERVIKEN TRANSMITTER BUTTON

Simple microphone button provides a most effective and inexpensive way to satisfactory speaker operation. Easy to build and operate circuit.

FOR several years our English cousins have been able to purchase on the open market a radio amplifier of the microphonic type, which enables one to operate a loud speaker from a crystal detector, thus obviating the use of vacuum tubes, "B" batteries, etc.

Everybody can do this now with a Skinderviken Button.

The Skinderviken Button is fastened to the diaphragm of the speaker unit. It will act as a "microphonic relay." Every time an incoming signal actuates the diaphragm, the electrical resistance of the microphone button will be varied correspondingly and the current from the battery, in series with the button and the loud speaker, will fluctuate accordingly.

Thus the problem of securing sufficient power to actuate the Loud Speaker is simply and adequately solved.

The results from this very novel and simple unit will astound you.

The expense of this hookup is trifling compared to elaborate tube circuits that give no greater actuation of the speaker.

Besides this there are many other valuable uses in Radio Circuits for this marvelous little button. Every builder of Radio sets should have a few on hand.

LISTENING THROUGH WALLS

This Unit makes a highly sensitive telephone, the real thing—you listen through walls with ease. Plenty of fun and real detective work too.

CONDUCTING SOUND THROUGH WATER

Make yourself a miniature submarine signaling apparatus like those used during the war. Simple circuit with this microphone unit gives splendid results.



95¢ EACH
TWO FOR \$1.75

FREE 8-page circular fully explaining these and many other uses for these units sent with each order.

PRESS GUILD,
16R E. 30th St., New York, N. Y.

Enclosed find \$.....for.....Microphone Units as advertised above.

Name

Address

City-State

left hand holding the back cone tightly against the front cone, so that the cement cannot seep between the two, slowly place a thin stream of cement around the circumference of the back cone. Do not work too rapidly, but give the cement a chance to set before removing your finger. It is wise to repeat the cementing operation twice, and then allow ample time to dry thoroughly before cutting away the remainder of the front cone on the solid line.

The next step is to fasten the back ring in place. This is accomplished by spreading cement evenly over its outer ring, and then holding the ring in position with weights until dry. The back-ring latch may then be attached with brass bolts passed through the holes provided.

To form the cone, bring the two edges of the back ring together and close the latch. Now lay the cone face down on a smooth hard surface, bring the two edges of the slit in the front cone tight up against one another and join them to-

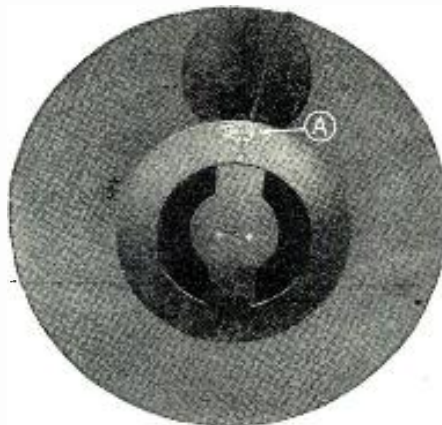

Rear view of speaker shows method of assembly. A is the back-ring latch. Illustrations courtesy G. R. P. Products Co.

gether on the inside of the cone with strips of adhesive fabric.

Before installing the speaker unit a small cone, about four inches in diameter, should be made and fastened in the apex with cement, to reinforce the large cone. Then the apex unit should be installed. The cross arm of the back ring should be attached and the loud-speaker unit may be mounted. The method of performing these four operations is obvious after examining the parts to be used.

To complete the cone, screw the rubber bumpers into the back ring, about three inches on each side of the back-ring latch, and fasten the binding braid around the circumference of the cone with cement. The braid should straddle the circumference—that is, half of it should be on the front and the other half on the back of the cone, and it should be held in position with clothes pins until the cement is dry.

When the loud speaker is finished it should be hung from a hook on the wall, about seven feet from the floor.

LAMP AND SPEAKER COMBINED IN ORNAMENTAL DESIGN

APPEAL is made to both eye and ear by the unique lamp-speaker illustrated on this page. The unit combines a table lamp of pleasing design with an efficient cone-type reproducer. The same unit is also available in a floor lamp of somewhat similar design.

In electrical design, the loud speaker employed in this unusual device is of the electromagnetic cone type. The cone is of the single fixed-edge baffle-board design and is twelve inches in diameter. It is mounted under the shade of the lamp and cannot be seen under normal conditions.

The lamp is equipped with two outlets and provides an ideal light for reading purposes.

Make this Amazing FREE TEST! GOLD WAVE AERIAL

Prove at our risk the famous GOLD WAVE AERIAL actually does amazing things we claim. Test this triple gold-plated aerial 10 days to prove it will GIVE STATIONS YOU HAVEN'T RECEIVED—BRING IN FAR GREATER DISTANCE—IMPROVE TONE AND QUALITY MARVELOUSLY! This aerial is filled with conductivity—it draws and is GUARANTEED to produce these results on any make set. 7 strands—gold triple plated—Aerial 100 feet long. Installed in or outdoors like any other.

SEND NO MONEY
If dealer can't supply, send name and address. Pay postman only \$1, plus few pennies postage. Use 10 days. If not delighted money refunded. Learn why thousands of radio owners and even broadcasting stations use it. All radio engineers recommend. Sold in all European countries.

NOW
\$4.00

LUXEM & DAVIS MFG. CO.
Dept. B-12, 6229 Broadway Chicago

DISTRIBUTORS
JOBBER—DEALERS—AGENTS write for liberal discounts and generous proposition. Fastest radio seller. Exclusive territories.

NO MORE "LEAKING"
Wonderful TUFFGLASS ALL-WEATHER ANTENNA INSULATOR. Positively resists temperature changes. Cut out grind and squeal! Stops leaking! Corrosion proof. 91,000 volts high frequency resistance. Only 35 cents.

FRESHMAN THE ELECTRIC RADIO

Always Ready—
Always Right

no acids
trouble
batteries
water
excuses
makeshifts

Write for complete literature illustrating and describing the entire Freshman Electric Line.

CHAS. FRESHMAN CO., INC.
Freshman Bldg. New York

\$75 to \$125 Weekly

Charging Batteries Starts You

Let me show you how to make big money right from the start. I've prepared a FREE book explaining all details. First week's profit pays for all equipment. You can get all the battery charging business in your community with my Service Station Charger—it's years ahead of ordinary chargers—handles 50% to 70% more batteries. I explain everything—start you in a business of your own and put you on the way to big money. Write for FREE BOOK.

C. F. HOLMES, Chief Engineer, Dept. R.N.
Independent Electric Works
5116 Ravenswood Ave. Chicago, Ill.

FREE BOOK—Just Out

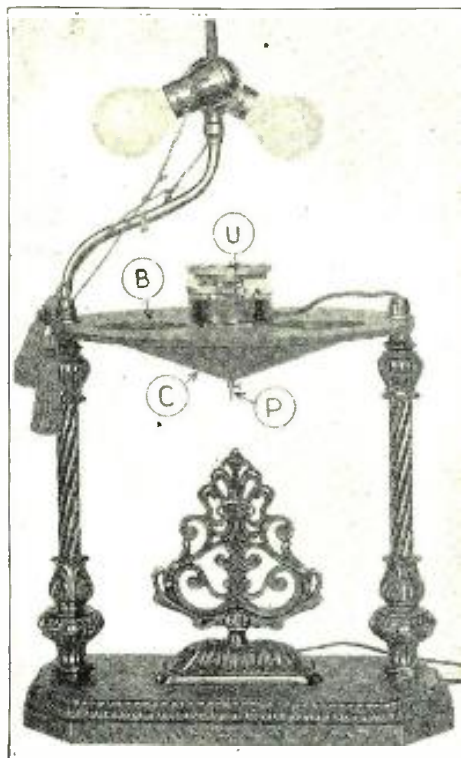

When the shade is removed the speaker assembly is visible.

It is available in a number of exquisitely ornamental designs which have bases of gold-plated metal, black-and-gold marble, or genuine onyx.

In the picture of the lamp with the shade in place it is clearly shown that the device is not unusual in appearance. The tip of the driving pin of the loud-speaker unit, which is visible below the shade, and the loud-speaker cord are the only things which indicate that the lamp might house a loud speaker.

When the shade is removed the loud speaker may be seen with ease. The single fixed-edge cone C is mounted in a horizontal position on the baffle board B, above which the loud-speaker driving unit U is mounted. The driving pin P, at the apex of the cone, is equipped with a small adjustment screw.



View of lampspeaker with shade in place. Illustrations courtesy Apex Novelty Lamp Co.



Peppy Batteries always
... if the Christmas list includes a General Electric battery charger!

Tungar (the name of the General Electric Battery Charger)—put that on your list. For Dad, or Jack . . . or maybe, just for yourself. Every radio set should have its Tungar to keep batteries always peppy.

The two-ampere Tungar has been a particular favorite because it gives both trickle and boost charging rates.

But different sets really require different chargers. Your radio dealer will tell you which is best for your set. Now that Tungar prices are lower than ever before, be sure you settle your battery charging problems for all time. And do as much for all the other radio fans on your Christmas list.

New Low Prices

- 2-ampere Tungar, \$14
- 5-ampere Tungar, \$24
- Trickle Charger, \$10
- [East of the Rockies]

Tungar causes no radio interference. It cannot blow out tubes.

An overnight charge costs about a dime.

It is a G-E product developed in the Research Laboratories of General Electric.

The 2- or 5-ampere Tungars charge 2-, 4-, and 6-volt "A" batteries, 24- to 96-volt "B" batteries, in series; and auto batteries, too. No extra attachments needed.

Merchandise Department
General Electric Company
Bridgeport, Connecticut



Tungar—a registered trademark—is found only on the genuine. Look for it on the name plate.

GENERAL ELECTRIC

New! GENUINE BAKELITE XL

INSULATED X-L Push Post

At last a perfect Push Post. Convenient, simple, permanent connections. You don't have to remember to tighten X-L Push Posts. Just push down, insert wire, remove pressure. Connection is tight and will stay tight. No vibrations can loosen; releases instantly. All standard markings or boxed in complete sets for all popular circuits. Price each 15c. If your dealer can't supply you, write direct.

FREE big, new, up-to-date book of wiring diagrams of all leading circuits. write today.

X-L RADIO LABORATORIES
2426-B Lincoln Ave., Chicago, Ill.



DEALERS and PROFESSIONAL SET BUILDERS!

Your Big New 1928 Catalog is Now Ready!

Contains Nationally Known Parts and Kits

- | | |
|--------|-----------------------|
| YAXLEY | AERO COIL |
| CARTER | WESTON |
| ACME | BENJAMIN |
| SAMSON | PRECISION COIL |
| TOBE | HAMMARLUND |
| | SILVER-MARSHALL, ETC. |

Send for it Now! it's FREE!

S. HAMMER RADIO CO.
307 Atkins Avenue Brooklyn, N. Y.

transformer-coupled audio amplification. The hook-up is very simple and the controls and adjustments have been reduced to a minimum. On the front panel, two illuminated dials serve as the only wavelength (tuning) controls, and two rheostat knobs and a battery switch are the only other adjustments.

As for the construction, all apparatus is mounted above the wooden baseboard. At the rear are the five radio-frequency transformers and five tube sockets; these instruments, together with the two variable condensers, compose the entire radio-frequency circuits of the set. The audio equipment is mounted at the front; this apparatus consists of the two A.F. transformers and two tube sockets. In connection with various tubes of the set, filament ballasts are employed to reduce the number of rheostats.

The following is a complete list of the apparatus used in the construction of the Madison-Moore superheterodyne receiver: one set of Madison-Moore precision units, type HW; one .0005-mf. Karas orthometric variable condenser; one .00025-mf. Karas or Metralign variable condenser; two Marco illuminated dials; eight General Radio or Benjamin UX tube sockets; one General Radio or Karas audio transformer (medium ratio); one General Radio or Karas audio transformer (high-impedance primary type); one Frost 10-ohm rheostat; one Frost 20-ohm rheostat; one Frost filament switch; four Elkay type-4 equalizers; one Elkay type-2 equalizer; one Elkay type-4/3 equalizer; six Daven mountings for equalizers; one 2-megohm Dubilier grid leak; one .00025-mf. Sangamo fixed condenser; one .005-mf. Sangamo fixed condenser; one 1-mf. Sangamo by-pass condenser; one pair of Sangamo grid-leak clips; one Yaxley or Jones cable connector, complete; seven Eby engraved binding posts; one Lignole drilled and engraved front panel, 7x26x1 1/8-inches; one drilled formica terminal strip, 3/4x3 1/2x 1/8-inches; two drilled formica terminal strips, 2 1/2x3 1/4x 1/8-inches; one wooden baseboard, 10x25x3/4-inches; 60 feet of No. 14 tinned copper wire.

Changes in Frequency Due to Shielding

(Continued from page 639)

coil? A simple explanation of the meaning of inductance may help clear this up.

The value of the inductance of a coil depends upon the magnetic field surrounding the coil. This magnetic field is more commonly referred to as "flux." The magnetic flux associated with the current may be compared to the momentum associated with a moving body. Because of its mass or inertia, a body in motion opposes any changes in its momentum. For example, if we are riding in a train and it stops suddenly, we are thrown forward in our seats. Inertia, therefore, must be considered, not as a form of friction, but rather as something which opposes a change in momentum.

Inductance is a form of electrical inertia. For direct currents there is no such thing as inductance, for there is no change in flow. For alternating currents, in which there is always a change going on, depending on the frequency, there is inductance. As the amount of inductance depends upon this magnetic field or flux, any weakening or diminishing of the latter will lower the inductance. This is exactly what happens when a shield is brought into the field of a radio-frequency transformer.

When the shield is brought into the field, a current is generated within the shield (known as an eddy current) which materially decreases the current flowing in the circuit. In the generation of this current, the result is the same as weakening the effect



Selected for the Peridyne



For his newest invention the Peridyne receiver, Mr. Hugo Gernsback has chosen S-M 240 audio transformers to secure perfect and natural tone. Mr. Gernsback has also arranged to have the special Peridyne adjustable shields furnished by Silver-Marshall, Inc. and they are available in sets of three, designed exactly to his specifications, completely pierced.

The new S-M 240 audio transformer, specified for the Peridyne, is unquestionably the greatest transformer value ever offered. Its 3:1 ratio provides high amplification, and its generous design gives uniform amplification from 100 to 5000 cycles, with the famous S-M 5000 cycle cut-off that renders the Peridyne so free from heterodyne squeals and static. S-M 240 transformers are worth twice their price, for they contain more silicon steel and more copper wire by far than any other transformer, excepting only the S-M 220, the finest transformer money can buy. Price, 240 audio transformer—\$6.00. Type 241 output transformer should also be used with the Peridyne to prevent loud speaker overloading and distortion, price \$5.00. S-M type 639 Shield Kit contains three shields specially manufactured to Mr. Gernsback's exact specifications, for his new Peridyne circuit. The kit of three is priced at \$6.00.

The use of these genuine and approved parts in your Peridyne will insure your getting the truly remarkable results that this newly invented circuit will deliver.

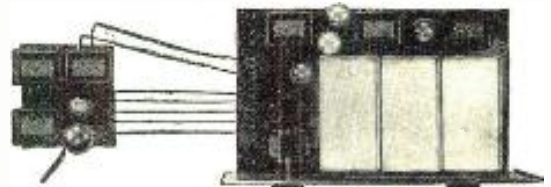

The Famous Shielded Six— With A.C. Operation

The Improved Light Socket Shielded Six was described in the last issue of RADIO NEWS. It is the finest receiver kit on the market, with tremendous DX ability, wonderful selectivity and tone guaranteed finer than that of any other set. The light socket model uses new A.C. tubes, obtaining all ABC power from the small dry power unit at the left of the illustration. Price, 630 A.C. kit, containing all parts for the light socket Shielded Six, \$99.00. Type 652A, ABC power kit is \$36.50. The regular 630 Shielded Six kit for battery or eliminator operation is \$95.00 complete.

We can't tell you here about all the new S-M developments but if you'll send us 10c for postage we'll send you more information on light socket operation, super audio amplification and other pertinent subjects than you can read in a week.

SILVER-MARSHALL, INC.

848 West Jackson Blvd. Chicago, U. S. A.

Silver-Marshall, Inc.
848 West Jackson Blvd., Chicago.

Please send me full information on the new S-M developments for which I enclose 10c.

Name

Address

Lowest Wholesale Prices!

Send for your copy of the FREE New 1928 Buying Guide, giving lowest wholesale prices on all latest Radio Parts, Accessories and Sets. One hundred pages chock full of radio information. We endeavor to sell, day by day, for

RADIO

Set Builders!

less than the prices of our legitimate competitors. When comparing prices, remember we allow a discount of 3% for cash. Compare our prices with others. If they quote lower than we do, furnish us with the name of the concern and the page number of their catalog, and we will meet their price. Write now for catalog RN.

Allen-Rogers-Madison

35 WEST 31ST ST. INCORPORATED NEW YORK, N. Y.

Insure your copy reaching you each month. Subscribe to Radio News—\$2.50 a year. Experimenter Publishing Co., 230 Fifth Avenue, N. Y. C.

Mr. John Harrison Hartley
Using Corwico Radio Wire
Again Wins the
World's International
Set-Building Championship



CORWICO

New!

BRAIDITE

HOOK-UP WIRE

"The Braid Slides Back"

"CORWICO" RADIO WIRES
"Best from the Ground Up"

Antenna Wire (Solid Stranded and Braided)
Complete Aerial Kits
Magnet Wire
Battery Cable
Bus Bar Wire
Hook-up Wire
Lead-in Wire
Annunciator Wire
Loop Aerial Wire
Litz Wire
Flexible Wire

Braidite is the neatest, fastest and easiest working hook-up wire made. In making a connection it is not necessary to strip back the insulation. Simply push it back, and after soldering the insulation snaps right back into place, leaving no exposed sections of bare wire. Braidite holds its shape permanently after bending and you cannot scorch or burn it with a soldering iron.

For Best Results USE CORWICO RADIO WIRES
Sold By All Dealers

CORNISH WIRE COMPANY
30 Church St., New York

or diminishing the magnetic field or flux. That is to say—the apparent inductive value of the coil decreases. As a consequence of this decrease in the inductance, the frequency of the unit naturally increases. If the resonance-frequency of the unit is to be kept constant, this necessitates the addition of capacity to compensate loss of inductance. This explains the phenomena shown by the curves.

The Cause and Elimination of Fading

(Continued from page 635)

about fifty miles. He obtained also some results which indicated the presence of some triply-reflected rays; *i. e.* over the path T A D C R as well as over T B R (Fig. 6). He also found that the angle of the down-coming ray was not constant.

The most obvious explanation of fading would be to ascribe it to the frequency-variation of the transmitter, but a little thought will show that it would be a poor station indeed which would be unstable by a full meter. An alternative theory, and one which has met with wide acceptance, is that rapid variations in the height of the Heaviside layer are the cause of fading. It will be shown later, however, that this view is untenable.

RECEPTION AT SUNRISE

The effect of daylight is extremely well shown in Fig. 7. The observations were taken respectively at 3:51, 4:47, and 5:12 a.m., and illustrate the type of fading at the transition period, from dawn to sunlight. The wavelength of the transmitter (375 meters) was gradually increased by ten. During this stage it will be noted that the intensity of the signal varied periodically, and that the changes were exactly duplicated as the wavelength returned to its original value. Sunrise occurred at 4:04 a. m., and with it came an increase in atmospheric ionization, a lowering of the Heaviside layer to a height of 30 miles or so, and a consequent "attenuation" (thinning out) of the reflected ray. The fading is much less at this time, as seen from the diagram.

It has been urged by some that the reflected ray, instead of being deviated vertically, as in Heaviside's theory, has suffered horizontal deflection instead. Appleton has

REL

We have all the specified parts for the latest circuits including the new—

STROBODYNE

and the latest

Hi-Q-6

Josh Billings once said—"Success don't Konsist in never makin' blunders, but in never makin' the same one twict"—let me help you get the best results from your next set; two heads are always better than one.

R. E. LACAULT

ADIO ELECTRIC LABORATORIES
116 West 65th St., New York City
Only firm having exclusive services of Mr. R. E. Lacault, E.E.

Send for New Handbook
IT'S FREE

THE RADIO ELECTRIC LABORATORIES
HANDBOOK
A Selection of Radio

AMAZING STORIES IN OUR DECEMBER ISSUE

ROBUR THE CONQUEROR. by Jules Verne. (A Serial in 2 Parts) Part I. Written long before the invention of the airplane, Verne's picture is that of an excellent aerial machine of a perfection that has not even today been fully approached. Excellent science, mixed with fine adventure or travel, makes this story an outstanding one that we know you will like.

THE COUNTRY OF THE BLIND, by H. G. Wells. Here is one of the most unusual stories that you could wish for. As is usual, also, with Mr. Wells, he again springs a surprise. He takes a more or less innocent subject and manages to make something quite extraordinary out of it. You will like this story.

HICKS' INVENTIONS WITH A KICK. ("The Hicks Electro-Hydraulic Bank Protector"), by Henry Hugh Simmons. Being a true inventive genius, Hicks is undaunted, and he bobs up again with a more marvellous invention than ever. This time it is a contrivance for the absolute protection of banks against any and all robbers.

CRYSTALS OF GROWTH, by Charles H. Rector. Since it is generally agreed that growth is a matter of thyroid glands, why might it not be possible, sometime, to stimulate these glands systematically and create a race of giants? The author spins a fascinating tale around this possibility.

And other scientific stories of excellent merit.

Send for Latest
RADIO CATALOG
and GUIDE

Big New 1928 Catalog—4,000 Items
Write for free copy. The Barawik Co., 129 N. Jefferson
St., Dept. 111, Chicago.

ELKAY EQUALIZORS

and Suppressors are made by The Langbein-Kaufman Radio Co. (Dept. N), 62 Franklin St., New Haven, Conn. Write for prices and tables of values.

shown that if the first theory be true, fading should be stronger on a vertical than on a loop antenna; while, if the second be correct, the reverse should be the case. In an investigation of the question, he finds evidence decidedly in favor of Heaviside, as Fig. 8

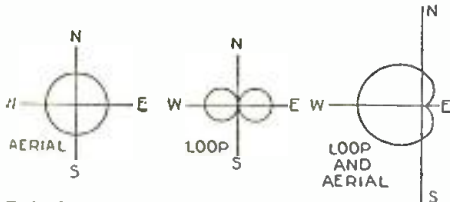

FIG 9 COMPARATIVE RECEPTION OF AERIAL, LOOP AND COMBINED ANTENNA.

The sensitivity curves of different types of aeri- als. These were obtained with the circuit of Fig. 10.

shows. The galvanometer deflections are in opposite directions. This result is one of particular interest to radio fans; especially since it indicates a possible solution of the fading problem.

A COMBINATION ANTENNA

It is not too well known that a combination of loop and aerial provides a simple means of eliminating signals from one direction. The sensitivity of reception of the ordinary antenna is shown at the left, that of the loop in the center, and their combination at the right, in a curve known as the cardioid. The hook-up used is shown in Fig. 10. Employing this device, Dr. Appleton found it possible to eliminate the ground ray entirely and study the indirect ray by itself.

The results appear quite conclusive. They show, primarily, that the intensity of the reflected ray is by no means constant; and that its variation is definitely allied with fading. This is direct evidence against the view that fading may be attributed either to the variation of the station's wavelength or to fluctuations in the height of the Heaviside layer. We must, instead, postulate *varying absorption of the indirect wave*, as the cause of the intensity change.

During the course of the investigation, it was determined that the reflectivity of the ionized layer is small—from 0.2 to 6%—hence it is easy to see how a small change here will produce a marked effect in the receiver. Dr. Appleton has shown that about

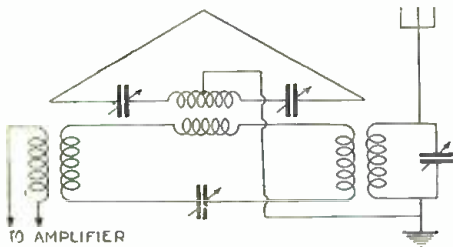

FIG. 10 COMBINED LOOP-AERIAL SYSTEM FOR ELIMINATION OF SIGNALS FROM ONE DIRECTION.

The circuit diagram of the equipment used for obtaining the curves in Fig. 9.

100,000 electrons per cubic centimeter must exist in the Heaviside layer to account for the observations. During the winter and during the night, when the ionizing power of sunlight is at a minimum, the reflecting region becomes higher and more attenuated and, while longer distance reception is possible, fading is more marked than in daylight hours or in summer.

Dr. Appleton has conducted some experiments with a view to eliminating fading. While he has attained considerable success, he feels that the system will not completely do away with this trouble. Briefly, he reasons thus: Since fading is shown to be due mainly to fluctuation in the intensity

A Sensational Success!

They are **Enthusiastic**

All three Eliminators received from you are working well and the owners are entirely satisfied to say the least. One is working on 60 cycle current, another on direct current, and the other is on 25 cycle current in Windsor, Canada. I am thoroughly convinced in your statement that they will operate on any lighting circuit or any frequency.

J. G. Mullan—Detroit, Mich. I could scarcely wait to report to you the fine results of your Eliminator. Since receiving it the house has been filled with fine clear music, the local stations tune very sharply and the increase in volume is remarkable. We never want to use noisy B Batteries again. It is the best bargain I have struck and I wish to compliment you on this Eliminator.

Frederick Leon—Seattle, Wash. Have been using your Eliminator since last February and it certainly works fine.

Fred A. Peters—Dallas, Tex.

You will be **enthusiastic, too**

Townsend "B" Socket Power

Approved and passed by the rigid laboratory tests of Popular Radio and Radio News

Over 25,000 sold the first 6 months

—Overwhelming evidence that VALUE is quick to be recognized and appreciated. Unsurpassed quality is built into the Townsend "B" Socket Power Unit with money saved by unified production methods and lower merchandising costs.

You get more—you pay far less—for the most remarkable value in Radio today. New thousands of Radio set owners are learning this daily by installing Townsend "B" Socket Power.

Sold on REAL GUARANTEE OF MONEY BACK IF NOT SATISFIED. Delivers up to 100 volts on any set, on DC. or AC.—any cycle. Full tone, clarity and volume.

SEND ORDER TODAY

Simply fill out the coupon and slip it into an envelope with only \$1.00 and mail at once. Your Townsend "B" Socket Power Unit will be sent promptly. Deposit only \$5.85 plus postage with the postman. Try out for 10 days—then if it does not do everything we say, return it to us and purchase price will be refunded.

TOWNSEND LABORATORIES Dept. 25 713 Townsend St., Chicago, Ill.

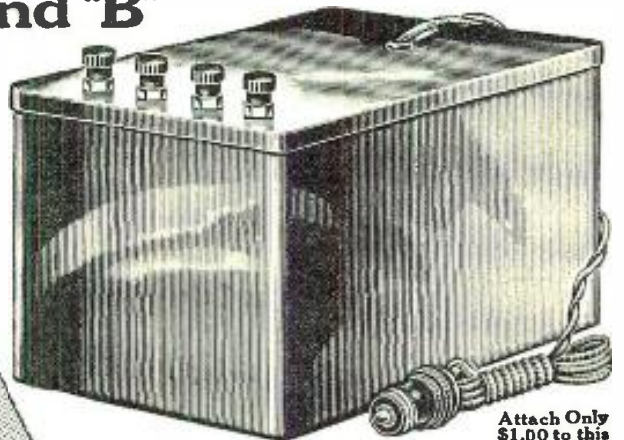

Attach Only \$1.00 to this Coupon



TOWNSEND LABORATORIES 713 Townsend St., Dept. 25 Chicago, Ill. Gentlemen: Attached find \$1.00. Kindly send at once Townsend "B" Socket Power Unit. C.O.D. for \$5.85, plus postage, on guaranteed 10-day free trial.

Name
Address
City..... State.....

LEARN THE CODE AT HOME

WITH THE OMNIGRAPH

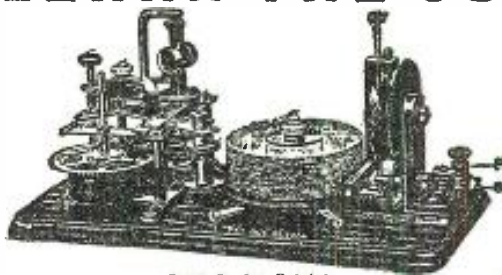

THE OMNIGRAPH Automatic Transmitter will teach you both the Wireless and Morse Codes—right in your own home—quickly, easily and inexpensively. Connected with Buzzer, Buzzer and Phone or to Sounder, it will send you unlimited messages at any speed, from 5 to 50 words a minute.

THE OMNIGRAPH is not an experiment. For more than 15 years, it has been sold all over the world with a money back guarantee. The OMNIGRAPH is used by several Depts. of the U.S. Govt.—in fact, the Dept. of Commerce uses the OMNIGRAPH to test all applicants applying for a Radio license. The OMNIGRAPH has been successfully adopted by the leading Universities, Colleges and Radio Schools.

Send 5c for Catalog THE OMNIGRAPH MFG. CO.

DO IT TODAY. 15 HUDSON STREET, NEW YORK CITY

If you own a Radio Phone set and don't know the code—you are missing most of the fun

Insure your copy reaching you each month. Subscribe to Radio News—\$2.50 a year. Experimenter Publishing Co., 230 Fifth Ave., N. Y. C.

1 ONLY FOR EIGHT

Brilliant Novels

in BOOK FORM

YOUR CHOICE of EIGHTEEN POPULAR TITLES

SENSATIONAL BOOK OFFER

EACH novel complete in a 144-page 5½x8 book set in large, readable type and profusely illustrated with scenes from the film. Greatest book value ever.

If you have seen the pictures, the fast moving, brilliantly written stories will thrill you. If you read the books first, you will find greater pleasure still in seeing the characters live for you with your favorite stars.

This is the most sensational book offer this season. It may never again be repeated. We expect thousands of requests for these books. Place your order now to insure prompt delivery.

Below are given 18 titles, of which you may choose any 8. Clip the coupon below and enclose \$1.00, mentioning the books you desire, and we will send them to you at once postpaid.

HERE ARE THE TITLES:

1. New York	7. The Dixie Flyer	13. The Road to Mandalay
2. Campus Flirt	8. The New Klondike	14. Tracked by the Police
3. Almost a Lady	9. Forbidden Waters	15. Tell It to the Marines
4. The Love Thief	10. Sensation Seekers	16. What Happened to Jones
5. Les Miserables	11. The Rambling Ranger	17. The King of the Jungle
6. That's My Baby	12. Don't Tell the Wife	18. The Cat and the Canary

of the atmospheric ray, it should be possible, by eliminating this, to receive a fairly steady ground signal, even in the nighttime.

"WOBBLING" OF THE REFLECTED WAVE

He uses the same type of antenna system employed to suppress the ground ray and finds, on the whole, signal reception much steadier. He ascribes his failure in obtaining complete success to the variation of the angle of incidence of the indirect wave, as mentioned before; i.e., while he may be able to stop a ray received at a constant angle, it is impossible to do this when the inclination of the ray is rapidly and irregularly changing.

Since the suppressed-atmospheric-ray system described above will not receive rays striking the ground in a given direction, it is also incapable of radiating waves in the same direction. If this type of antenna be used at the transmitting station, to eliminate the indirect ray at its origin, it may be possible to reduce or completely get rid of fading; but Dr. Appleton, in the absence of experimental evidence, is somewhat skeptical regarding the probable success of such a scheme, owing to the lack of symmetry of the radiation. Nevertheless, there is no question but that it should be tried.

Dr. Appleton's researches have thrown considerable light on the causes, nature, and elimination of fading. His results are verified by experiments conducted over relatively short distances, not exceeding a few hundred miles; and it is uncertain whether or not the fading of a very distant station is to be attributed to the same causes. We shall look forward expectantly to seeing more of the brilliant results which are being obtained by this eminent investigator.

Adjustable "B" Power Unit

(Continued from page 632)

page 631 should be carefully examined. First notice the power transformer, T, at the extreme left of the diagram. This unit is housed in a metal shield, as indicated by the dotted lines, and has four windings, one primary and three secondary. The primary winding, P, is connected directly to the lamp socket. The secondary winding, S1, has an output of 5½ volts and is used for heating the filament of the 171-type power tube in the last stage of the audio amplifier. S3 is a 7½-volt secondary winding, which is used when a type-210 power tube is employed in the audio amplifier. S2 is the high-voltage winding; this winding has five terminals and as a result the constructor has a choice of a low or high output voltage. One set of sec-

Place Your Order While the Supply Lasts

CONSRAD CO., INC., 230 Fifth Ave., New York, N. Y.
Gentlemen: I enclose \$1 for books Number.....

Name

Address

City State.....

MAIL YOUR ORDER NOW

CONSRAD CO., Inc.
230 Fifth Avenue
New York, N. Y.

RADIO DOCTORS

(Trade Mark)

are making BIG MONEY

This is the only National Radio Service Organization. Send for Booklet No. 37. CO-OPERATIVE RADIO DOCTORS
131 Essex St., Room 312, Salem, Mass.

LIGHTING FIXTURES
Ready to Hang
Direct from the manufacturer. Completely wired, including glassware. Send for new catalogue No. 28. Just Reduced Prices.

Special Proposition To Dealers.
Eric Fixture Supply Co., Inc., Station R. Erie, Pa.

FREE Wholesale Radio Catalog

Dealer-Set Builders! Save Money!
Send for this book of bargains. Everything in Radio—all the newest hook-ups, sets, kits, parts, cabinets, consoles and supplies. If you want the best for the least money, you need this catalog.

SHURE RADIO COMPANY
347C West Madison St. Chicago, Ill.

WRITE
For Our 32 Page
Radio Instrument Catalog
No. 15-C

JEWELL ELECTRICAL INSTRUMENT CO.
1650 Walnut St. Chicago

Station
WRNY
NEW YORK
309.1 Meters—970 Kilocycles
is owned and operated by the publishers of this magazine
Our Editors will talk to you several times every week—
See your Newspaper for details
TUNE IN ON
WRNY

Insure your copy reaching you each month. Subscribe to Radio News—\$2.50 a year.
Experimenter Publishing Co., 230 Fifth Avenue, N. Y. C.

ondary terminals provides a potential of 250 volts on either side of the center tap, and the other gives a potential of 300 volts.

In the rectifier circuit V1 is the new full-wave 125-milliamperce gaseous-rectifier tube. This tube fits in a standard UX-type socket. The two F terminals connect with the transformer, while the P terminal connects with the choke coil. Terminal G of the rectifier-tube socket is not used. Condensers C1 and C2 in the rectifier circuit are buffer condensers which protect the tube from voltage surges. They are housed in the same metal shield and each has a capacity of 0.1 mf. with a voltage rating of 600.

CHOKE CONNECTIONS

Choke coils L1 and L2 of the filter circuit are mounted in a single case, Ck, but each has separate terminals. Terminal 1 of choke L1 connects with the rectifier tube, terminal 2 of L1 connects with terminal 4 of L2, and terminal 3 of L2 connects with the output circuit.

Condensers C3, C4 and C5 are used in the filter circuit, and C6 and C7 are by-pass condensers of the voltage-dividing circuit. The first 2-mf. condenser has a rated operating potential of 600 volts and the other condensers in the block have a 400-volt rating. The capacity of each unit is indicated in the diagram. The variable resistors R2, R3 and R4 comprise the voltage-dividing circuit of the power unit. R2 has a resistance of 2,000 ohms, and R3 and R4 have each a resistance of 5,000 ohms. The slider connected with R4 provides any desired voltage for the detector tube, so that it is possible to obtain any potential between zero and approximately 45 volts. The slider on R3 provides the R.F. potential for the receiver; this voltage is variable between 45 and 90 volts. The slider of R2 provides power for the last stage (power tube). The binding post marked "B+90" provides exactly 90 volts for the operation of the audio tubes, by reason of the operation of the voltage-regulator tube.

In the voltage dividing circuit the by-pass condensers C6 and C7 are connected between binding post "B+R.F." and the "B-," and between binding post "B+Det." and the "B-," respectively. These condensers have a capacity of 1 mf. each and are located in the condenser block. A by-pass condenser is not required between the "B+90" post and the "B-," on account of the action of the glow tube.

The connections to the voltage-regulator tube are interesting. Wires are connected to the F and G terminals of the socket as indicated in the diagram, and the third connection is made to the shell of the tube base, which is brass. A fixed resistor, R1, with a value of 50,000 ohms, is connected in series with the wire from the shell of the regulator tube base to terminal 4 of the choke, Ck.

After all parts have been secured construction should be started as follows:

CONSTRUCTION AND ASSEMBLY

The writer obtained from a tinsmith a piece of sheet metal which was formed into an inverted tray, the side walls being 1/2-inch high and the flat surface 8 inches wide by 12 inches long. On top of the tray or chassis, as it might be called, were arranged along the rear edge the power transformer, T, the condenser block, C3 to C7, and the filter choke, Ck, running from left to right in the order named. On a piece of 1/4-inch insulating panel 4 inches wide by 7 inches long were mounted three variable resistors, one of 2,000 ohms, R2, on the left, and two of 5,000 ohms, R3 and R4 on the right. Below these resistors were located five binding posts as follows, "B-," "B+Det.," "B+R.F.," "B+90" and "B+Max." By means of two angle pieces this panel assembly was mounted on the front edge of the chassis,

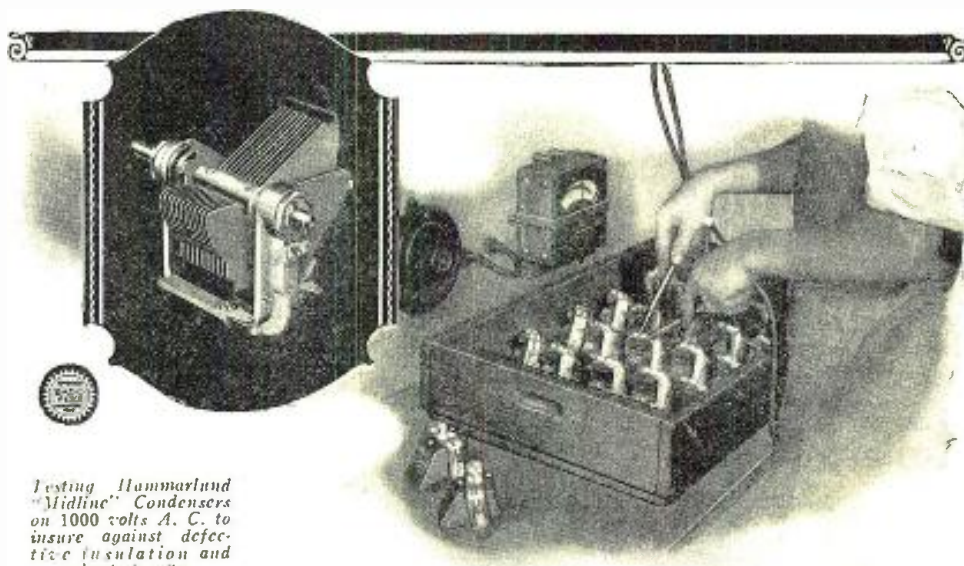

Testing Hammarlund "Midline" Condensers on 1000 volts A. C. to insure against defective insulation and short-circuits.

Hammarlund Precision Means Your Protection

THE word "Precision" as applied to Hammarlund Condensers, Coils, Chokes and Shields means precisely what it says.

It means soundness of design, accuracy of manufacture, fineness of finish and scientific testing. Precision has given Hammarlund Products undisputed leadership in their respective fields.

From the very first, Hammarlund has stood for quality and Hammarlund has never deviated from that principle.

But you pay no premium for Hammarlund reputation. Hammarlund Products are standard-priced. You can pay far more and get far less than Hammarlund Products give you.

Write for the Hammarlund descriptive folder before planning your new receiver.

HAMMARLUND MANUFACTURING COMPANY
424-438 W. 33rd Street, New York

More than a score of radio designers officially specify Hammarlund Precision Products for their latest circuits.

For Better Radio
Hammarlund
PRECISION PRODUCTS

Dealer inquiries invited concerning several new and appealing Hammarlund developments having a wide sales demand.

More Power Better Reception

No More Ground Troubles

Doubles the enjoyment from your radio set. Clearer reception. More volume. Greater distance. Eliminates faults of water pipes and radiators. Rusted joints, insulating gaskets, lime deposits cannot affect it.

ROSE SILVER STREAK GROUND ROD

No need for a bunch of shovels, shovels and post hole diggers. Drives like a nail. Improved solderless connection. Highly sensitive. Pointed. Galvanized to prevent rust. No. 2, 6 feet long, 90c.; No. 1, 4 feet long, 60c. Sent postpaid if dealer doesn't have it. Guaranteed.

FRANK ROSE MFG. CO.,
Dept. R-1 Hastings, Nebr.

6 ft. 90¢
4 ft. 60¢

Dealers—Write for attractive dealer offer. Big season now here. Sell on sight. Write for details.

FROST-RADIO De Luxe Apparatus

Frost De Luxe Gem Rheostats

The first really good small rheostats. Are but 1 1/2 in. in diameter yet operate as smoothly and efficiently as our larger types. Precision built throughout. Have a Bakelite pointer knob, hand buffed nickel plated exposed metal parts, and finest quality resistance wire wound on new flexible Bakelite strip. We make them with or without filament switch, and also supply them wound as potentiometers. Plain Gem Rheostats, 3 to 50 ohms, 75c. With switch, \$1.00. Potentiometers, \$1.00. Demand from your dealer by name.

HERBERT H. FROST, INC.
Main Offices and Factory: Elkhart, Ind.

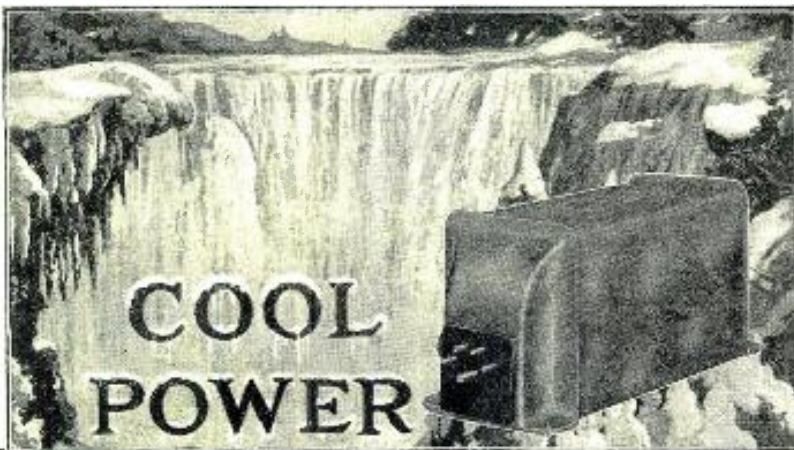

Samson Power Block No. 210—The only block which will supply 500 volts at 80 mills to two 210 tubes.

Powerize with Samson Units for Best Results

For new SAMSON Power Units insure the best there is in radio current supply by

1. Doing away with hum, motor boating and poor voltage regulation.
2. Remaining so cool after 24 hours continuous operation under full load that they will be well within the 20° rise of temperature specified by the A.I.E.E.
3. Being designed to more than meet the specifications adopted by the National Board of Fire Underwriters.
4. Insuring safety against shock because of protected input and output terminals.
5. Insuring for all tubes the correct filament voltages specified by their manufacturers.
6. Compensating for lighting circuit voltage variation by the use of a special input plug and terminal block to which is attached a 6 ft. flexible rubber-covered connecting cord and plug.

Our Power Units bulletin descriptive of these is free for the asking. In addition, our construction bulletin on many different "B" Eliminators and Power Amplifiers will be sent upon receipt of 10c. in stamps to cover the mailing cost.

SAMSON ELECTRIC COMPANY

Manufacturing Since 1882

Principal Office, CANTON, MASS.

For Your "B" Battery Eliminator Ask Your Dealer for Guaranteed



Q·R·S
Trade Mark
Registered

Gaseous Rectifier Tubes

Are Better

60 MILLIAMPERES

\$4⁵⁰

85 MILLIAMPERES

\$4⁵⁰

400 MILLIAMPERES

With Ionizer 300 Volts
for A, B and C Eliminators
with Charts and Diagrams

\$7⁰⁰

Manufactured by **The Q·R·S Company** CHICAGO
MUSIC

Established 1900. References: Dun, Bradstreet or any bank anywhere.



The **AIRGAP**
SOCKET
"It gets that last mile"

Watch for new No. 222 low-grid-plate capacity tube made for this socket.

At all dealers or direct postpaid 60c each.
AIRGAP PRODUCTS CO., 56 Clinton St., Newark, N. J.

DEALERS & SET BUILDERS!
Complete stock of nationally known parts and accessories. Send for illustrated catalog and discount sheet.
Radio Exclusively Since 1921
CLARK & TILSON, Inc.
122 CHAMBERS ST. New York
The Nationally Known House

evenly located in its center. At either end of the chassis, and directly in front of the transformer on the left and the filter choke on the right, were fastened two sockets: the one at the left for the rectifier tube, and the one at the right for the regulator tube. In the intervening space were located the buffer-condenser unit, C1 and C2 and the 50,000-ohm resistor, R1, which is connected in the "keep-alive" circuit of the regulator tube. The wiring is accomplished with the use of a stranded, heavily-insulated wire, which, when bent into position, will keep its shape. As a guard against shocks due to unintelligent handling of the "B" power supply device when in operation, and as an additional shield against pickup, a brass frame was constructed from 1/2-inch angle brass and over it were soldered sheets of perforated brass.

The several drawings which accompany this article will prove helpful in the construction of this unit and no difficulty should be experienced. The wiring is very simple and the only point which it should be necessary to emphasize especially is that regarding the four wires marked "X" in the wiring diagram. These wires ground the shielding of the various units of the device to the "—" post, and aid greatly in reducing A.C. hum. It might also be explained that in making connection to the shell of the tube a ground clamp may be employed, and the resistor R1 may be mounted directly to the clamp.

"Old Sleuth," the Milliammeter

(Continued from page 634)

circuits is affected. Which is it? Test out the A.F. tubes one by one. This is best done by removing one at a time from its socket and increasing the negative "C" voltage on the grid of the other. If the grid circuit of a tube in use is sound, the milliammeter reading will become less and less as the negative "C" voltage is increased. Should raising the "C" voltage produce no effect upon the milliammeter current with either tube, you may feel pretty sure that the lead between "A—" and "C+" has become disconnected. If, however, one tube gives proper results under test and the other does not, then there is a disconnection of some kind in the grid circuit of the latter. It may be that the grid lead is broken within the base or the bulb of the tube. Substitute another tube in the socket; if this gives normal

40 Non-Technical Radio Articles

every month for the beginner, the layman and those who like radio from the non-technical side.

SCIENCE & INVENTION, which can be bought at any newsstand, contains the largest and most interesting section of radio articles of any non-radio magazine in existence.

Plenty of "How To Make It" radio articles and plenty of simplified hook-ups for the layman and experimenter. The radio section of SCIENCE & INVENTION is so good that many RADIO NEWS readers buy it solely for this feature.

Radio Articles Appearing in DECEMBER Science & Invention

Hands Create Radio Music
Our Part in Ruth Elder's Flight
Portable One-Tube A. C. Set, By Paul Welker
New Eight-Tube Loop Set
Radio Oracle—Questions and Answers
Radio Wrinkles
Latest Patents
Science Questions and Answers
Hints for the Mechanic

results then the first tube has broken down. If, however, the milliammeter does not then respond to changes in the "C" voltage, it is probable (always supposing that there is no disconnection or loose lead in the wiring) that there is a breakdown in the transformer secondary, or in the grid leak if the amplifier is resistance-coupled or choke-coupled.

A transformer secondary may be tested out in the way shown in Fig. 3; two or three dry cells being wired in series with the milliammeter and the leads connected to the secondary binding posts of the transformer. The best way of testing a gridleak is by substitution.

It will be realized, then, that there is no difficulty in tracking down to its source any fault which causes the milliammeter to read high.

BATTERIES OR TUBES?

But when the set is sulky or altogether dead the milliammeter reading will most likely be below normal. This indicates either that the "A" or "B" battery is run down, or that something is amiss with the plate or filament circuit of a tube. We can soon see whether the batteries are to blame by taking the current reading for individual tubes. Should this be below par for all tubes then one or both of the batteries requires renewal or recharging. If, however, we find that the current passing is normal for all tubes but one, then we have tracked down the trouble to the particular tube that shows a falling off. Possibly the tube which shows a reduction in its plate current is an old one and has lost its emission, either through long service or because its filament has been injured by overheating. To discover whether this has happened, remove the tube from its socket and replace it with another of the same type. Should the milliammeter now give a normal reading, the original tube has most likely come to the end of its useful life.

If, however, the substitution of another tube produces no appreciable increase in the milliammeter's reading, there must be a defect in either the plate or the filament circuit. See first of all whether the prongs of the tube are making proper contact with their opposite numbers in the socket. If the filament lights up properly, the trouble is somewhere in the plate circuit. Should there be no current reading at all on the milliammeter, it is probable either that the tube is suffering from a broken lead in its base or that there is a disconnection in the wiring, or that the plate impedance, whatever form it may take, has broken down.

The best test for a complete breakdown within the tube itself is to place it in another socket and to see whether the milliammeter now records a flow of current. If it does not, we may regard the tube as dead; but, if it does, there is either a wiring disconnection or a breakdown in the plate impedance of the original circuit. A careful examination of the wiring will show whether it is implicated or not. Some lead may be found either loose or altogether disconnected.

TESTING IMPEDANCES

Let us suppose, though, that the tube gives normal results in another socket and that the wiring is above suspicion. In this case the odds are that the plate-circuit impedance is to blame. We can make assurance doubly sure by testing out this impedance (whether it takes the form of a coil, transformer primary, resistance or choke) with the aid of the ever-useful milliammeter. Fig. 3 shows how the primary of an A.F. transformer, or an A.F. choke may be tested. If connections and windings are in good condition, the instrument will measure a flow of current whose amount depends upon the resistance of the windings. R.F. chokes and transformer primaries or secondaries may be tested in a similar manner; but here it is

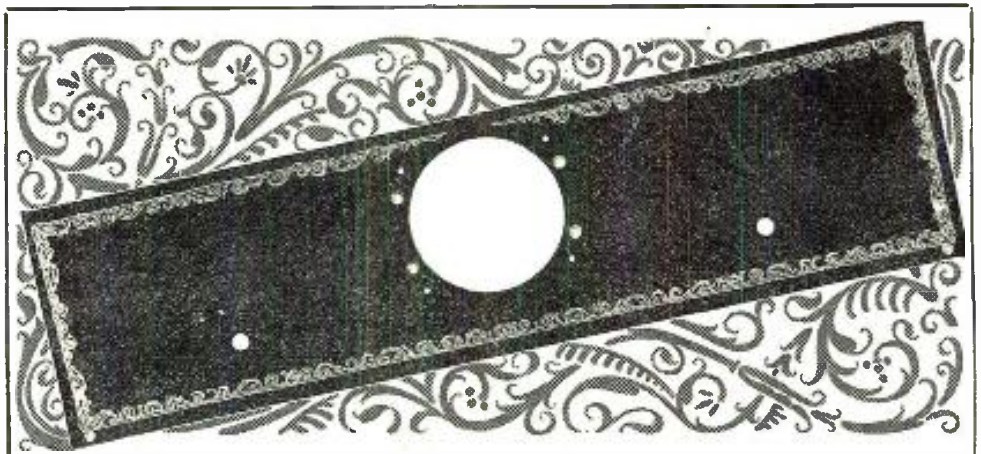

Handsome Panels for These Kit Sets!

Formica has prepared handsomely decorated panels for the leading kits of the year so that the home builders can make sets of better appearance. Many of these panels are fully drilled and ready for assembly.

Among the panels offered are Magnaformer, front and sub; World's Record Super Ten, front and sub; Camfield Nine, front and sub; Tyrman, front and sub; Madison-Moore International One Spot for A. C. operation, and many others.

Plain Formica panels of any size are also available.



THE FORMICA INSULATION COMPANY

4618 Spring Grove Avenue

Cincinnati, Ohio

Leading jobbers everywhere can provide you with Formica products.

FORMICA
Made from Anhydrous Bakelite Resins
SHEETS TUBES RODS

Formica has a complete insulating service for manufacturers.



The **SONOCHORDE** CONE \$25.
Brings the Studio Home



Radio Table \$3.95

Most extraordinary value is offered radio fans for a limited time. Full size 13 x 27 in. with battery shelf. Table is knocked down for safe shipping. Sent upon receipt of check or money order for \$3.95.

Send for catalog of Complete Battery Cabinets and Radio Tables.

BERNARD FURNITURE CO. 38 So. 2nd Street, Philadelphia, Pa.

1/5 OF 1%

is the accuracy to which some of our coils are wound. All are accurate to 1% or better.

Send for new catalog
PRECISION COIL CO., Inc.
209 Centre St. New York, N. Y.

Send for Latest RADIO CATALOG and GUIDE

Big New 1928 Catalog—4,000 Items

Write for free copy
The Barawik Co., 129 N. Jefferson St., Dept. 111, Chicago

Insure your copy reaching you each month. Subscribe to Radio News—\$2.50 a year. Experimenter Publishing Co., 230 Fifth Avenue, N. Y. C.

ELECTRIFY YOUR SET
660W. 250 V.
25c

at Home!

HOW TO ELECTRIFY YOUR RADIO SET
by Victor L. Osgood

PRICE **25c**
THE E. I. CO., NEW YORK CITY

All About Electrification and "How to Build" Latest Apparatus Explained in New Book

What is Electrification? Why is it now being used on all modern Receivers? How can it be adapted to my set? How can I build a satisfactory unit to electrify my set?

ON ALL NEWS-STANDS

All these questions and more are simply, fully and practically answered in the newest, latest and most complete book on Electrification "HOW TO ELECTRIFY YOUR RADIO RECEIVER."

The book is illustrated with drawings, diagrams and photos of electrical units and parts. It is 6 x 9 inches in size and bound with a special hand-drawn 2-color cover.

Get your copy now and enjoy the benefits of steady, unvarying power at any voltage for your Radio.

25c THE COPY EVERYWHERE

If your dealer cannot supply you, write direct

THE CONSRAD CO., Inc., 230 Fifth Ave., New York

necessary to use a single cell only and to interpose in series with the milliammeter a resistance with a value of several hundred ohms in order to cut down the current to reasonable dimensions. An A.F. choke or transformer primary known to be in good condition will serve quite well to provide this resistance. When testing out plate resistors it must be remembered that one volt is required to drive one milliampere through 1,000 ohms. Supposing, therefore, that the resistance under test has a value of 50,000 ohms, it may be wired in series with the milliammeter and a 45-volt unit from the "B" battery. This should give a reading, if the component is in proper condition, of just under 1 milliampere. Better still, use the whole "B" battery voltage available, as shown in Fig. 4, and leave the circuit connected up for a few minutes, watching the milliammeter needle the while. There should be no variation whatever in the reading during

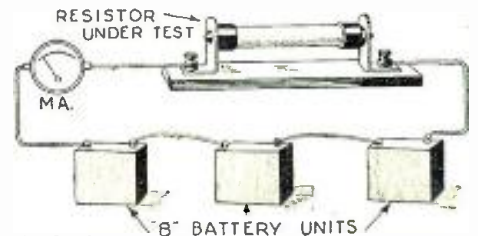

FIG. 4
If a plate or grid resistor is being tested, use between 135 and 180 volts from the "B" battery connected as in Fig. 4. The needle of the milliammeter should not vary.

this time. If the needle of the milliammeter is unsteady, or shows a gradual small rise or fall of current, then the resistance is inconsistent and will probably cause noisiness in the receiving apparatus.

IN THE FRONT END

We have thus seen how a fault in either the filament or plate circuit of any tube in the receiving outfit or in the grid circuits of the A.F. tubes can be tracked down by the milliammeter. Its usefulness is not confined to these circuits only; it will also diagnose faults in R.F. and detector grid circuits and their components.

It has been shown that, when anything is wrong with filament or plate circuits or with A.F. grid circuits, the milliammeter gives an abnormal current reading. If the defect which causes the set to be silent is in one or more of the R.F. or detector grid circuits, the instrument will show a reading which is normal or almost normal. Suppose, then, that we can obtain no signals and that the milliammeter's reading is neither higher nor lower than usual; we may regard our trouble hunt as narrowed down to these grid circuits. Which of them is "laying down?"

Try the detector first of all. Remove the other tubes from their sockets and take the milliammeter reading when the detector only is working. Now take out the grid leak; there should be a slight decrease in current when you have done so, for the grid is no longer receiving a positive bias. If the current remains unaltered, substitute another grid leak and see whether the addition and removal of this cause current variations.

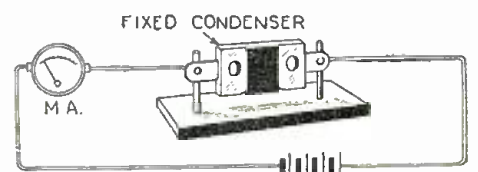

FIG. 5
When a condenser is under test, the needle of the meter should give one kick; and then return to zero and remain there.

"When a station is hard to get, and it is a distant hit, Use a REESONATOR"

Equip your radio with this new instrument. The Reesonator will boost your volume from three to twenty times on distant stations, making it possible to cut thru interference and bring in stations that were infinitely out of your reach before. Made especially for single and two dial radios: Can also be used to great advantage on three dial tuned radio frequency receivers. Decreases A and B battery consumption and can be installed by anyone in less than a minute. **WE GUARANTEE SATISFACTION.** Try one for three days at our risk; if not thoroughly satisfied your money will be cheerfully refunded. Sent complete and postpaid on receipt of \$4.75 or send C.O.D. Dealers inquiries solicited.

F & H RADIO LABORATORIES
Fargo North Dakota
 Spartanburg, S. C.

Pat. Pending
IMPROVED MODEL
\$4.75

REFERENCES:
 First and Fargo National Banks

Six or eight weeks ago I bought from you a Reesonator—I just want to tell you that your device is everything you claim. As a matter of fact it would be hard to get along without it. It makes it possible to get stations under the most trying conditions.
 (Signed) Name on request.

Should they fail to do so, you may feel sure either that the tube is dead, or that there is a wiring disconnection, or that the secondary of the R.F. transformer is broken down. Examine the wiring carefully and try another tube in the detector socket. Still no results? Then the R.F. transformer secondary is almost certainly to blame and should be tested out in the way already indicated.

The only other possibility is that the grid condenser may be faulty, either a short-circuit or a breakdown in it having taken place. Fig. 5 shows how the grid condenser, or any other fixed condenser, may be tested with the milliammeter for an insulation breakdown. Wire it and the instrument in series with a battery giving a moderately high voltage. There should be a kick of the needle when connection is first made, owing to the charging up of the condenser as current flows into it. The needle should, however, immediately return to a zero reading and should then remain absolutely steady. Any deflection of the needle, indicating that current is flowing, means that the insulation is broken down; for a condenser should provide an absolute barrier to the flow of direct current. On the other hand, if in good condition, the condenser should allow alternating current to pass.

Fig. 6 shows how a fixed condenser may be tested for a breakdown of its connec-

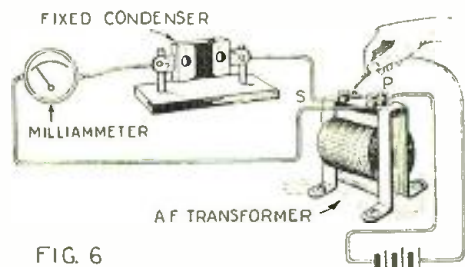

FIG. 6

How to apply a "break down test" to a condenser.

tions. The condenser and the milliammeter are wired in series with the secondary of an A.F. transformer. One pole of a small battery is connected to one of the primary binding posts of the transformer, while a lead from the other pole of the battery is held in the fingers and brushed against the unoccupied primary binding post. As this lead makes contact with the binding post there is a flow of current in one direction through the secondary of the transformer; and, as contact is broken, current flows in the opposite direction through the same circuit. If, therefore, the condenser is in proper condition, brushing the lead against the binding post should cause the milliammeter to show a series of kicks.

Supposing that the detector grid circuit is found free from all blame, the trouble must lie in one or other of the R.F. grid circuits. Before making further tests, try substituting a fresh tube for each of the existing ones in turn; one of them may have given out. Should there still be no signals, inspect the wiring of each R.F. circuit carefully and make sure that there is no disconnection.

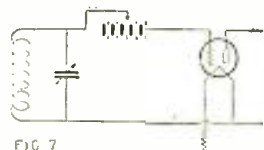
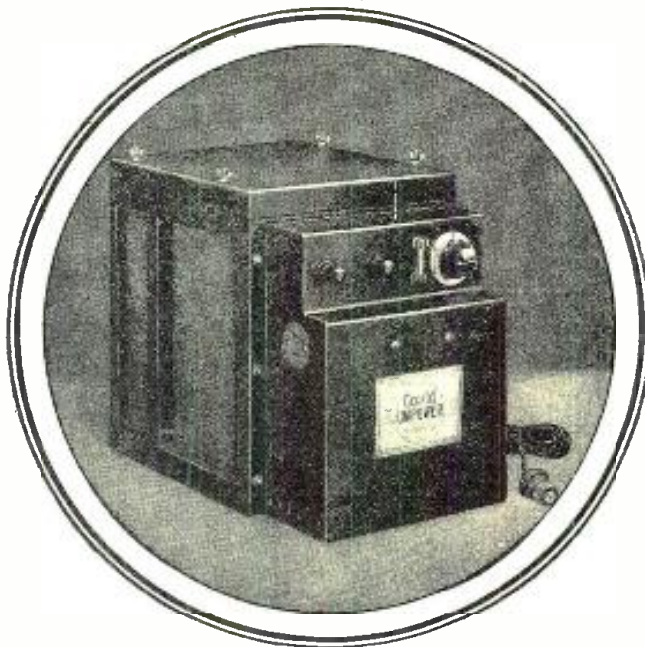

FIG. 7

R.F. circuits may be tested with the meter in the "B-" lead as explained in the accompanying text. Compare with Fig. 1.

If the source of the trouble has still not been discovered, test each R.F. circuit out in the way shown in Fig. 7; the milliammeter of course remaining connected to "B-." Unfasten the lead which runs to the grid connection of the tube socket and connect it to one of the negative posts of a "C" battery. Wire the positive end of the "C" battery to the grid contact of the socket. Switch off the other tubes in the set or re-

THE IMPROVED UNIPOWER



Time-tested design with an added feature

— the new KATHANODE
Submarine type battery element

The new improved Gould Unipower embodies the same features of design that have built its reputation for reliable service from the start.

But in the hidden battery ele-

ment a new rugged submarine type of battery construction is now employed for the first time in radio history. It means still longer life — with less attention — and it practically ends all service expense.

Gould Storage Battery Co., Inc.,
250 Park Ave., New York City

Ask to see the finest
Unipower Gould ever built

The new
IMPROVED
Kathanode

Unipower

A GOULD PRODUCT



**Ford
Auto
FREE!**

We have a plan whereby our active workers can get a Ford without cost, in addition to their big cash earnings. Get the plan—quick!

"I have averaged \$7000

Per Year for Three Years—Have Made
Over \$90 PROFIT in One Day"

That is the statement of Frank DePries, one of our live-wire representatives. Keeton of Mississippi made \$252 on his first sale. Vickers of Alabama made \$118 in one week. Conant quit a \$6,000 job to come with us.



DePRIES

AGENTS WANTED

We need more men like these, because the demand for our Super Fyr-Fyter is growing by leaps and bounds. Sells to garages, stores, factories, schools, homes, hotels, auto owners. Approved by the Underwriters. If you are willing to work and ambitious to make some real money, get our plan. You need no experience, as we train you without cost for the work. No great capital required. Good territory going fast. Better write us at once.

THE FYR-FYTER COMPANY

1633 Fyr-Fyter Bldg.,

Dayton, Ohio

Insure your copy reaching you each month. Subscribe to Radio News—\$2.50 a year.
Experimenter Publishing Co., 230 Fifth Avenue, N. Y. C.

HERE'S THE ANSWER TO EVERYMAN'S RADIO QUESTIONS

1001 RADIO QUESTIONS AND ANSWERS
 COMPILED BY THE STAFF OF
Edition
RADIO NEWS

PRICE **50c**

50c on all Newsstands

1928 EDITION!
of Radio's Greatest Question & Answer Book

H—about this circuit, that circuit, this method or that method of Amplification, Balancing, Regeneration, Transmission, Set construction, Operation, Speaker design, control, Electrification, Accessory installation, Antenna possibilities—anything and everything in Radio?

Your question is answered in the greatest and most complete Book of Radio problems in print, the new 1928 edition of "1001 RADIO QUESTIONS AND ANSWERS." Radio is Worldwide, its problems, its intricacies are Worldwide as well. The questions that hundreds of Radio men ask are the same questions you want answered.

These 1001 Questions and Answers are selected from those asked by readers of the greatest of all Radio Publications "RADIO NEWS" magazine.

Every question is worth the price of this book—Real Radio problems of every conceivable nature are propounded and answered. You may think you know something about Radio Circuits and the practical, useful side of Radio but this book will double or triple your knowledge.

You can get a copy now—today, tonight. Just visit your newsdealer. 50c the copy everywhere.

Or you can write us direct if you choose—We pay postage.

50c ON ALL NEWSSTANDS

or direct from

EXPERIMENTER PUB. CO., INC. 230 Fifth Ave., New York

move them from their sockets. The milliammeter should now show a reading much above the normal for the tube under test, and the reading should increase as the grid of the tube is made more positive by means of the "C" battery. If this effect does not take place, and there is no disconnection in the wiring, then there must be a breakdown in the secondary of the R.F. transformer, which can be verified by testing as previously described.

There is practically no form of trouble in the receiving outfit that cannot be tracked down with the help of the radio sluth. Its use saves an immense amount of time; for, by working on the lines described, one can generally locate a defect in a very short while. The great thing about trouble hunting is to be systematic and not to become hot and bothered. With the milliammeter one can see at once what the possibilities are; and these can be eliminated one by one until only a single certainty remains.

Radio Listeners Vote for Favorite Composers

(Continued from page 606)

a prolific worker, his works including nine symphonies and hundreds of other pieces.

A bachelor, irregular in living habits, Beethoven was never a healthy man, and in his later years was troubled with deafness, a tragic ailment for a composer of music. He died finally on March 26, 1827.

Franz Schubert, the second choice of the radio audience, was, like Beethoven, something of a child wonder. He was born in Vienna on January 31, 1797, and took his first violin lesson at the age of eight. He wrote some of his immortal works between his seventeenth and twentieth years, being only nineteen when he composed two of his most famous songs, *The Erlking* and *The Wanderer*. He is known chiefly as a writer of songs, the number of which exceeds 600. He died on November 19, 1828, when he was still a very young man. He was buried near the grave of Beethoven.

The name of Victor Herbert, third on the list of favorites, is well known to Americans. Herbert, although regarded by many people as an American, was actually an Irishman, having been born in Dublin in 1859. He died only about three years ago. Like Beethoven and Schubert, he too was surrounded by musical influences from early childhood, and at the age of seven was already studying music in Germany. His first important engagement was as cellist of the Court Orchestra at Stuttgart, which was followed in 1886 by a similar position with the Metropolitan Orchestra in New York. From 1894 to 1898 he was bandmaster of the Twenty-Second Regiment, of New York City. In 1898 he founded the Pittsburgh Symphony Orchestra, which he conducted for six years.

Herbert wrote scores of compositions, chiefly instrumental, the names of which are practically household words. Among other things, he wrote the music for several of the most successful Ziegfeld "Follies," many light operas, and likewise a one-act opera which was produced at the Metropolitan Opera House in New York 1914.

Following are the complete results of the questionnaire. The figures indicate the number of votes for each question.

- (1) "What type of music do you like best? Indicate by checking your favorite types of music among the compositions listed below."

- Rank
- 1—Overture to Tannhäuser (2778), Richard Wagner
 - 2—Poet and Peasant Overture (2631), Franz von Suppe
 - 3—Marche Militaire (2578), Franz Schubert

free Wholesale Radio Catalog Send today for it

1928 Catalog Dealers, Set builders—make this your biggest radio season. Shure's great wholesale catalog insures the best in quality at lowest prices. This wonderful book is jammed full of the newest offerings of Nationally known radio parts, kits, sets, accessories, table and console cabinets, etc. Also contains short wave sections showing the finest electrical apparatus for short wave receiving and transmitting. Your request brings our book of a thousand bargains, price list and discount sheet. Write for a copy today.

2000 Items **Big Values**

Shure Radio Company
 343C West Madison St., Chicago, Ill.

HELLO JAPAN!

The thrill of receiving Tokio, Japan and Sidney and Melbourne, Australia on a Magnaformer 9-8 was experienced by K. G. Ormiston and party on the night of September 11, 1927—6,000 to 8,000 miles on the loud speaker with a world of volume. The thrill of great distance added to the soporific, true-to-life tone quality for which the Magnaformer 9-8 is famous, gives you a truly supreme entertainment combination. The Magnaformer 9-8, Creator of True Tone Quality, "Commander in Chief of the Air", is the finest and most powerful receiving set ever designed. The secret lies in the perfect Magnaformer Intermediate Long Wave R. F. Transformers with which it is equipped. Prominent Radio Editors are giving these coils highest praise in editorial articles in Radio, Popular Radio, Radio Doings, Citizens' Call Book, Radio World and other magazines and numerous newspapers. Each coil is unalterably peaked at 69.75 Kilocycles (4300 meters). They are so securely and scientifically put together mechanically that nothing can change their electrical characteristics. It is the greatest set in the world. Build it from the fully illustrated official construction sheet 28x34 inches, both sides printed solid.

Send at once, right now while you have it in mind, for FREE illustrated Magnaformer story, wonderful testimonials and full account of K. G. Ormiston's unique experience—W. D. Scott's challenge and defeat. Don't build a set till you hear from us in a day or two.

RADIART LABORATORIES COMPANY
 Dept. 19, 19 S. La Salle Street Chicago, Ill.

Insure your copy reaching you each month. Subscribe to Radio News—\$2.50 a year. Experimenter Publishing Co., Inc., 230 Fifth Avenue, N. Y. C.

- 4—Fifth Symphony (2525), Ludwig van Beethoven
- 5—Unfinished Symphony (2363), Franz Schubert
- 6—Ballet Music from "Faust" (2243), Charles Gounod
- 7—Meditation from "Thais" (1941), Jules Massenet
- 8—Liebesfreud (1912), Fritz Kreisler
- 9—"H. M. S. Pinafore" (1675), Sir Arthur Sullivan
- 10—Nutcracker Suite (1619), Peter Tschai-kowsky
- 11—The Firefly (1600), Rudolph Friml
- 12—Symphonie Pathetique (1518), Peter Tschai-kowsky
- 13—Dagger Dance from "Natoma" (1495), Vic-tor Herbert
- 14—In the Morning (1318), Edvard Grieg
- 15—Invitation to the Dance (1282), Carl Maria von Weber
- 16—Overture to the Marriage of Figaro (1178), Wolfgang Amadeus Mozart
- 17—Scheherazade (970), Nikolai Rimsky-Kor-sakow
- 18—Poupee Valsante (521), Edwin Poldini

(2) "Who are your favorite composers? Please indicate those in this list whom you prefer."

- Rank
- 1—Ludwig van Beethoven (3245)
 - 2—Franz Schubert (2971)
 - 3—Victor Herbert (2935)
 - 4—Richard Wagner (2846)
 - 5—Felix Mendelssohn (2491)
 - 6—Fritz Kreisler (2225)
 - 7—Franz Liszt (2130)
 - 8—Charles Gounod (2005)
 - 9—Peter Tschai-kowsky (1935)
 - 10—Wolfgang Amadeus Mozart (1920)
 - 11—Gioacchino Rossini (1886)
 - 12—Edvard Grieg (1858)
 - 13—Anton Dvorak (1815)
 - 14—Edward McDowell (1759)
 - 15—Johann Strauss (1676)
 - 16—Sergei Rachmaninoff (1634)
 - 17—Giuseppe Verdi (1502)
 - 18—Jules Massenet (1454)
 - 19—Johann Sebastian Bach (1445)
 - 20—Anton Rubinstein (1434)
 - 21—Sir Arthur Sullivan (1413)
 - 22—Georg Handel (1409)
 - 23—Robert Schumann (1263)
 - 24—Johannes Brahms (1251)
 - 25—Rudolph Friml (1221)
 - 26—Richard Strauss (1162)
 - 27—Nikolai Rimsky-Korsakow (1112)
 - 28—Camille Saint-Saens (1099)
 - 29—Franz von Suppe (1041)
 - 30—Jacques Offenbach (1016)
 - 31—Alexandre Bizet (951)
 - 32—Franz Haydn (895)
 - 33—Carl Maria von Weber (794)
 - 34—Claude Debussy (750)
 - 35—Giacomo Meyerbeer (605)
 - 36—Ruggiero Leoncavallo (542)
 - 37—Benjamin Godard (454)
 - 38—Christoph von Gluck (437)
 - 39—Leo Delibes (419)
 - 40—Cesar Franck (328)
 - 41—Ippolitow-Ivanow (317)
 - 42—Ermanno Wolf-Ferrari (298)
 - 43—Igor Stravinsky (290)
 - 44—Hector Berlioz (287)
 - 45—Modest Moussorgsky (203)
 - 46—Mikhail Glinka (169)
 - 47—Jean Philippe Rameau (147)
 - 48—Alexander Glazounov (137)
 - 49—Anatole Liadov (71)
 - 50—Edwin Poldini (65)

(3) "Do you prefer (961) music you have never heard before, or (3385) familiar music?"

(4) "Do you find (2110) orchestral music alone most interesting, or do you like in addition (1422) vocal solos, and (2720) instrumental solos?"

(5) "Of vocal solos, do you prefer (1471) operatic arias, (1560) selections from light opera, (898) negro spirituals, (1083) folk songs, (1403) classic songs, or (1679) popular ballads?"

(6) "Do you prefer (1471) very brief announcements, or (2405) longer descriptive announcements? The following are examples:

- (a) "The Edison Ensemble will next play the first movement from the Fifth Symphony of Ludwig van Beethoven."
- (b) "The Edison Ensemble will now play the first movement from Beethoven's Fifth Symphony—a work which is conceded to be one of the master's greatest. Concerning the principal theme of this movement—a series of four notes rapidly repeated—Beethoven himself said that it is "Fate knocking at the door of human existence," a fate which is insistent and ominous in the music. The theme recurs again and again throughout the movement. When he wrote this symphony, Beethoven's deafness was fast developing, and he was oppressed by many other misfortunes. It may be considered the expression of his own feelings while "Fate was knocking at his door."

Look for Aluminum Shielding in the newest sets

THIS year's Radio Shows demonstrated that Aluminum has been more widely adopted for shielding by the leading manufacturers than ever before.

This metal is especially effective as a shield at radio frequencies and has been accepted as standard by many of the foremost radio engineers.

Aluminum has more applications in radio receiving sets than any other metal, and is rapidly becoming a mark of quality quickly recognized by the layman.

"Aluminum for Radio"—a booklet explaining these manifold uses, will be mailed to you upon request.



ALUMINUM COMPANY OF AMERICA
2467 Oliver Building, Pittsburgh, Penna.
Offices in 18 Principal American Cities
"ALUMINUM IN EVERY COMMERCIAL FORM"

FREE

WHOLESALE RADIO CATALOG

The Book they are all talking about

WHOLESALE
RADIO CATALOG

Listing thousands of items in standard radio parts, kits, accessories, complete sets, furniture, etc. Every set builder and dealer should have a copy. Real wholesale prices. Send for your copy today.

THE HARCO COMPANY

1257 So. Wabash Ave. Chicago, Ill.

The HARCO CO., 1257 So. Wabash Ave., Chicago

25 Cents

Brings ALL THIS!

One Official Blueprint of the Five-Tube Diamond of the Air
One official booklet describing in detail how to build this famous set, wind coils, etc.

Act Now! Send That Quarter to
GUARANTY RADIO GOODS CO.
141 W. 45th Street, New York City

INVENTORS who derive largest profits know and heed certain simple but vital facts before applying for Patents. Our book Patent-Sense gives those facts; sent free. Write **LACEY & LACEY**, 631 F St., Washington, D. C. Established 1869.

EVERYTHING IN RADIO

AT ATTRACTIVE PRICES. SETS OR PARTS. Orders shipped exactly as ordered. Prompt Service. Write for Prices. Mail Order Only. Send Your Address. **ALL RADIO COMPANY**, 417 North Clark St., Chicago

What is a COOKOO NUT?

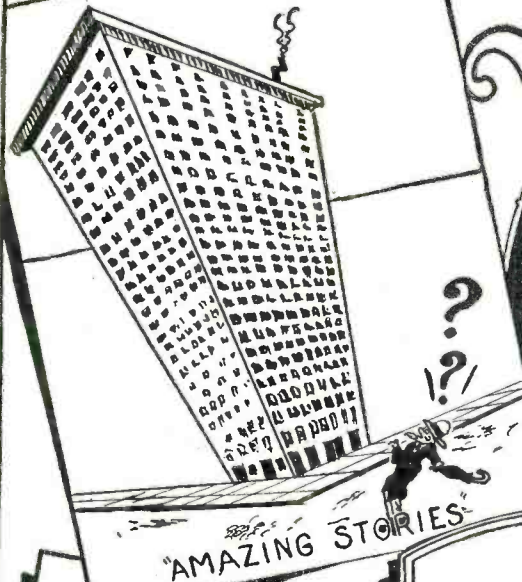

A COOKOO NUT is a new wrinkle to pass away your time. Far more interesting, more entertaining and more humorous than a cross-word puzzle. The COOKOO NUT illustrates an ordinary, well-known saying in a distinctly new manner. Study the examples on this page. The test of a COOKOO NUT is that there must be no question as to the correctness of the description. The quotation must absolutely fit the COOKOO NUT, otherwise it does not go. Cover up the captions of the COOKOO NUTS on this page, and make your friends guess what each COOKOO NUT stands for. An exciting new game is to play COOKOO NUTS at parties where everyone is asked to make up an original COOKOO NUT. The most mirth-provoking one gets the party prize. The best COOKOO NUT printed in FRENCH HUMOR gets a weekly prize of \$5.00. For every other one accepted FRENCH HUMOR pays \$1.00.

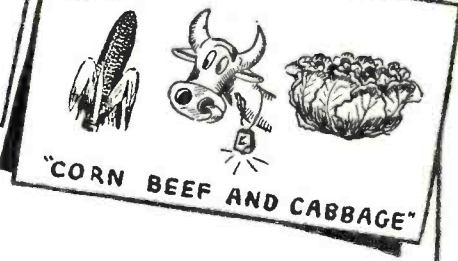
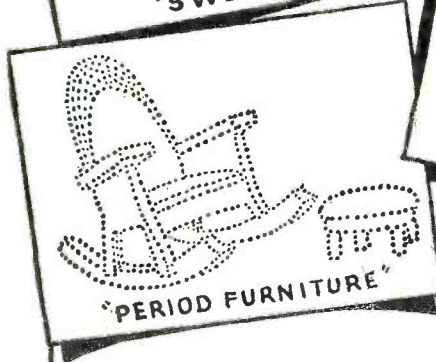
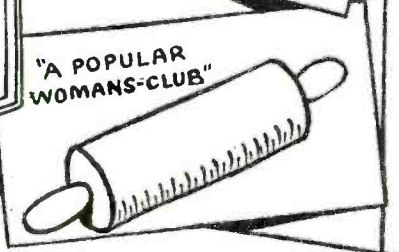
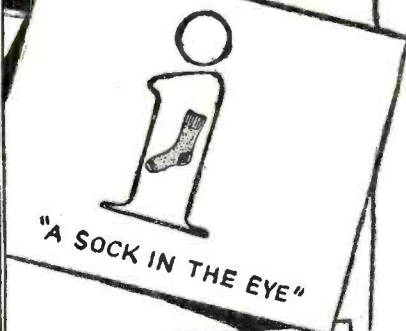
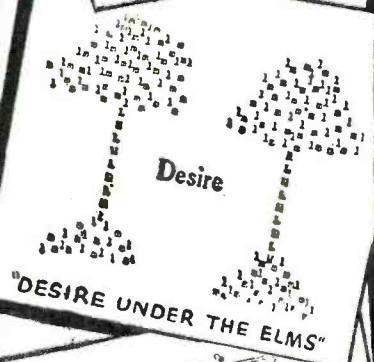

See
FRENCH HUMOR

France, that magic land of humor, wit, and keen, knife-edged "parlay," offers humor-loving Americans, its choicest, finest humor through the new weekly magazine, "FRENCH HUMOR." Your first copy of "FRENCH HUMOR" will prove what we

say—hundreds of choice jokes and original illustrations by French Artists, with all the illustrated jokes printed first in French and then in English. It's the funniest, wittiest and most entertaining magazine you have ever read.

10c WEEKLY ON ALL NEWSSTANDS

Fourth Annual Radio World's Fair

(Continued from page 609)

the relay, this act setting in motion a new electrified steel mill in Pittsburgh, Pa. This same action was shown to the visitors at the Radio World's Fair, with the exception that the motor and lights were in the Theatre of Wonders.

TRANSMISSION OF PHOTOGRAPHS

An exhibit that attracted great attention was the reception of photographs by radio with receiving apparatus that can be attached to an ordinary radio receiver in place of the loud speaker. The apparatus, which is shown in the accompanying illustrations and which was developed by A. G. Cooley, is said to be of such simple construction that it can be built by an amateur. The photographs are received on sensitized paper, which is placed around a cylinder. The picture is built up line by line.

The Radio Corporation of America demonstrated a similar system with the exception that the transmitted photograph or sketch could be enlarged to many times the size of the original. The printing of the picture is controlled by a relay regulating a flow of hot and cold compressed air.

Photoelectricity, the Means of Television

(Continued from page 640)

In operation these cells will glow under excessive potential and while glowing, of course, are not sensitive to light variations. Efficient operation is secured somewhat below this point. If the rated voltages of the cell are exceeded, its life is considerably shortened. The manufacturers of the above-described cells specify that they should not be operated at a temperature above 30° Centigrade, which is 86° Fahrenheit.

To those familiar with the action of the thermionic tube, the application of the photoelectric cell to visual communication is not hard to understand. The current through the cell rises and falls with the varying intensities of the light directed on the plate. This current may be made to influence the grid of a sensitive vacuum tube, as shown in the circuit diagrams; and the output of the latter is fed into an amplifier.

PRACTICAL DIFFICULTIES

This description of the way of handling the output of cells sounds simple enough on paper; but the fact of the matter is that difficulty is often experienced in designing amplifiers which will give an adequate response to the extremely minute impulses involved and to the rapid fluctuations necessary to transmit pictures or, especially, scenes of motion. This provides radio experimenters with a problem which is definitely within their province to solve, in addition to those questions of static elimination and fluctuations of signal strength, which must be answered before radio will become a practical channel for such communication.

It is fortunate for the progress of visual communication that the photoelectric cell, although it has some disadvantages, is a device of great speed and precision. Cells of the better type are capable of translating extremely rapid fluctuations of light and shade without appreciable lag or "hang-over," for the emission of electrons is practically instantaneous.

Individual cells of the same type vary widely in their characteristics, as do radio tubes; and when two or more cells are used together, often the case in television systems,

The TEMPLE air column-speaker

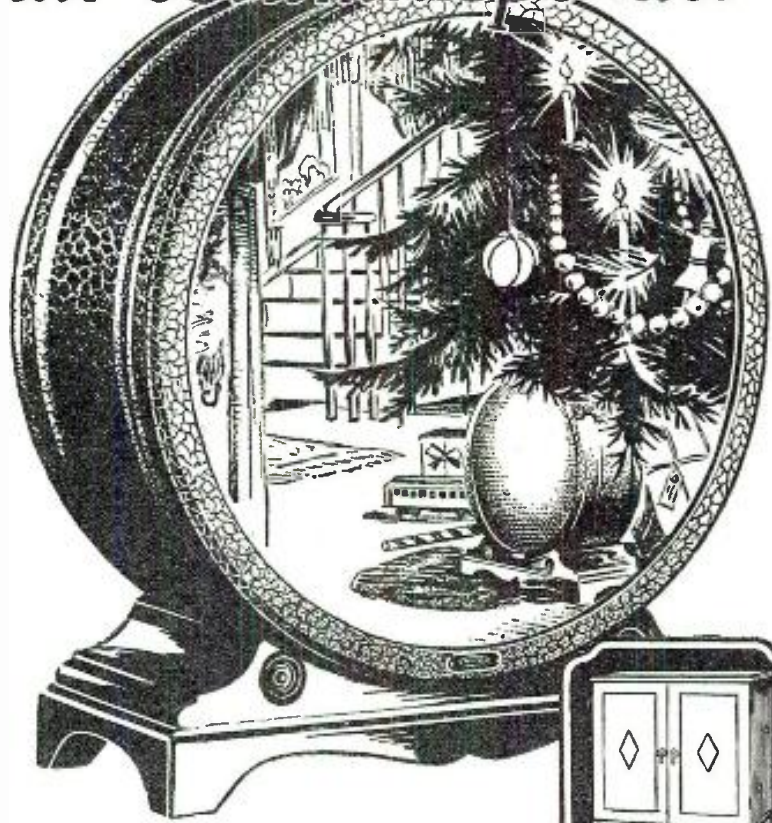

The Ideal Christmas Gift

Radio fans—here's your opportunity to be a real Santa Claus—to bring a gift home that the folks can enjoy Christmas Day and every day in the year—a TEMPLE SPEAKER, the ideal Christmas gift. Nothing will give greater pleasure in radio than a TEMPLE—the speaker that has been the sensation of every radio show, the joy of thousands of fans all over the country. Do your Christmas shopping early—buy a TEMPLE, Console or Drum Type Model. Either will bring you a richness and purity of tone reproduction that is far beyond what you ever thought was possible. Ask your dealer for a demonstration on the TEMPLE COMPARATOR.

Temple Models Priced at \$29.00—\$48.50—\$65.00—\$85.00

TEMPLE, INC.,

213 S. Peoria St., Chicago

The Best Radio
Made

Is Only as Good
as Its Speaker

NOT A

CONE



IMPROVED TURN-IT

Variable Grid Leak (Non-Evaporating)
.5 to 12.6 megohms. \$1.00
If your dealer can't supply you write direct
GARDINER & HEPBURN, INC.
611 Widener Bldg. Phila., Pa.

Radio on Terms

Play While You Pay!
A marvelous set for distance, tone, selectivity, 6 tube—1 dial (illuminated). Beautiful cabinet. Easy monthly payments while you enjoy nation-wide programs. FREE Log and Call Book and the Catalog containing thousands of Radio Bargains. Write today for copy.
AMERICAN AUTO & RADIO MFG. CO.
HARRY SCHWARTZBERG, PRES.
Dept. 107 American Radio Bldg., Kansas City, Mo.

RADIO PANELS

OF GENUINE BAKELITE

Cut, drilled and engraved to order. Send rough sketch for estimate. Our Complete Catalog on Panels, Tubes and Rods—all of genuine Bakelite—mailed on request.

STARRETT MFG. CO.
520 S. GREEN ST. CHICAGO

FREE RADIO GUIDE

100 Items illustrations, and radio parts, sure to get this Big New 1928 buy. Write letter or postal NOW. Gives special. Jefferson, Dept. 111, Chicago, U. S. A. Shows big complete thrif to Radio News—\$2.50 a year. R-n Avenue, N. Y. C.

Insure your copy reaching you each
Experimenter Publist

Vital Factors

in attaining

High Quality Reproduction



TYPE 285
Audio Transformers
Available in Two Ratios
1 to 3 for 1st Stage,
Price \$6
1 to 6 for 2nd Stage,
Price \$6

High quality reproduction depends upon three things; correctly designed coupling units, proper use of amplifier tubes, and an efficient reproducing device.

For over a decade the subject of audio frequency amplification has been extensively studied in the laboratories of the General Radio Company, with particular attention given to the design of coupling units.

As a result of this exhaustive research the General Radio Company has been, and is, the pioneer manufacturer of high quality Audio Transformers, Impedance Couplers, and Speaker Filters.

If the amplifier of your receiver is not bringing out the rich bass notes and the mellow high tones as well as those in the middle register, why not rebuild your amplifier for *Quality Reproduction* with *General Radio* coupling units.

Write for our Series A of amplification booklets describing various amplifier circuits and units.

GENERAL RADIO Co
CAMBRIDGE, MASSACHUSETTS

it becomes necessary to balance their outputs by means of resistors. Cells after some use show evidence of *fatigue*; that is, a deterioration of the photoelectric surface, often due to leakage currents which flow when the cell is not exposed to light. This difficulty regarding "dark currents" is, however, eliminated by careful design.

The thought will arise that cells may be more sensitive to certain light frequencies than to others; this is a fact. The cells we have discussed show a maximum sensitivity in the blue-violet part of the spectrum, while yellow-green elicits the greatest response from the average eye.

In conclusion it may be mentioned that the photoelectric effect has been produced with other than the metallic elements. Crystalline substances and many inorganic compounds respond to the action of light, but these facts, while interesting, are of no service in communication work and need no further consideration here. (A discussion of this subject will be found on page 32 of *RADIO NEWS* for July, 1927.)

Does Voltage Indicate Merit?

(Continued from page 633)

statistics, in use between 600,000 and 700,000 "B" power units which were designed for use with the original 60-milliamper tube. As by far the greater percentage of these units have been in service for a length of time close to the normal life of the tube, some data on this subject should be at present of interest to the readers of *RADIO NEWS*.

Though the 60-milliamper rectifiers cannot, as a rule, be used to replace a 125-milliamper rectifier, there are a great many instances in which several worth-while advantages are to be had by the use of the 125-milliamper tube as a replacement unit for the smaller one.

The first of these is increased output. In gaseous-conduction rectifiers the voltage drop across the tubes is very nearly a constant; about 120 volts for the 60-milliamper tube and 90 volts for the 125-milliamper tube, regardless of the load current. As the majority of power units originally designed for use with the former type tube were of the lower-voltage type previously referred to, there is generally an advantage to be gained by increasing their output. Most such power units have a maximum voltage output in the neighborhood of 150 volts at 40 milliamperes.

By the use of the 125-milliamper tube, the output is increased to about 180 volts and 40 milliamperes or sufficient to operate a 171-type tube at full plate voltage, while supplying sufficient current for the great majority of radio receivers.

CONDENSER SAFETY MARGIN

Perhaps it may be thought that this higher output voltage will damage the filter condensers in the power unit. Such is, however, not the case, as the condensers of all reliable power units are made to withstand voltages very much higher than the normal operating voltage; an increase of thirty volts is quite insignificant.

The manufacturer, in the design of the condensers for his power unit, must, in fact, provide against the possibility of the device being operated without load; as this would result if the power unit were turned on without being connected to a radio receiver, or if the filament switch of the receiver were turned off while the "B" unit remained in operation. In this case, the voltage across the filter condensers might well be two or more times the normal operating voltage. It will be seen that the slight increase in voltage due to the use of a 125-

Good Reception Assured

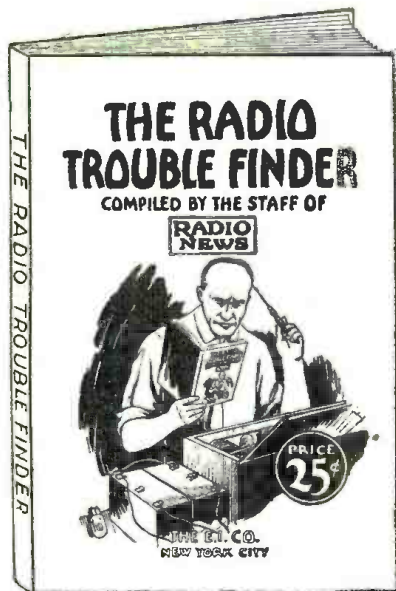

THE "RADIO TROUBLE FINDER" is a book prepared by a Radio Expert with many years of practical experience. It is a proven fact that 99 out of every 100 complaints from Radio set owners can be traced to simple and minor troubles that a child could repair with a simple book of instructions—and only once in a lifetime the average man need pay an expert to repair his set—if he has a copy of the "RADIO TROUBLE FINDER."

This simplified 64-page book charts all troubles and how to correct them.

It is the simplest thing imaginable to use it. Even the more difficult jobs of changing internal mechanism of the set can be accomplished successfully.

The "RADIO TROUBLE FINDER" contains 64 pages, many of which are illustrated. It is size 6 by 9 inches with a colored cover—PRICE 25c.

ON ALL NEWSSTANDS

or order direct

CONSRAD CO., Inc.

230 Fifth Ave. New York

RADIO NEWS

DECEMBER BLUEPRINTS

You can obtain a complete set of Blueprints for these receivers direct from RADIO NEWS.

- THE RAYNE FIVE Radio News Blueprint Article No. 37 \$1.50
- THE SUPERB "B" SOCKET DYNE RECEIVER Radio News Blueprint Article No. 38 \$1.50
- Or UNIT 23 Article No. 39 \$1.00

MENTION NAME OF RECEIVER AND ARTICLE NUMBER from RADIO NEWS, 230 FIFTH AVENUE, NEW YORK, N. Y.

milliamper tube in place of a 60-milliamper tube one seems even more insignificant.

The voltage across the buffer condensers is determined by the power transformer and not by the rectifier tube. Thus, the strain on these condensers is the same, regardless of the voltage drop across the rectifier tube.

In fact, the use of a tube of the 125-milliamper type in place of a smaller one may even reduce the strain on the condensers, in the case of some "B" power units which are equipped with "high" and "low" voltage switches; the former tube with the switch at "low" position gives about the same output as the latter with the switch at "high" position.

LARGER TUBES LAST LONGER

But perhaps the most important reason for replacing a small tube with a larger one when the occasion arrives, is that the latter will ensure longer life and smoother operation. Anyone will readily appreciate the fact that any device—whether an automobile engine or a radio tube—will last longer and perform more smoothly, if operated below its maximum rated output. It is only reasonable to expect that the 60-milliamper tubes, having a normal life of 1000 hours (which is equivalent to one year of average use), will not last as long while operating close to full load as a 125-milliamper tube, also having a life rated at 1000 hours, but only operating at less than half its full load.

When the 125-milliamper rectifier is used to replace a 60-milliamper one, it may be found necessary to readjust slightly the voltage controls on the power unit and, perhaps, to increase the negative "C" voltage in the last audio or power stage.

Secret Signalling

(Continued from page 615)

than any other, the letters, O, T, A, I, following in that order. By dealing in a like manner with a cipher, and comparing the letters or numerals which occur most often with those in Fig. 1, an expert will have little difficulty in deciphering a message.

In the case of transposition ciphers the same procedure is used. The difficulty here is somewhat increased due to the fact that the letters occurring most frequently are different; but by a study of the "crest" letters (those appearing most often) the expert can again solve the problem, if a message sufficiently long is available. These two methods are not the only ones by any means that can be used for code work, but the others are far too complicated to go into here.

Having seen that the secrecy that telegraphic ciphers are said to enjoy is not so very secret after all, it will be of interest to consider one of the latest systems for secret signalling in radio. Naturally ciphers can be used in radio in the same manner in which they are used in land wires, but the question at once arises: Can a radio signal be safeguarded against interception by an unauthorized listener to the same degree that an ordinary line can be protected from a wire-tapper?

Obviously, while the land wire is localized along a particular path, which may be kept under supervision, radiated magnetic waves spread out in all directions and therefore offer a wider area of attack. In the illustration at the head of this article will be seen a plan developed by Mr. R. D. Bangay.

DOUBLE-BEAM TRANSMISSION

Two separate transmitters are used, these being situated some distance apart. The an-

NATIONAL



AN ENTIRELY NEW AND UNIQUE HEAVY-DUTY BETTER-B

SUPPLIES
 Detector voltages, 22 to 45, adjustable;
 R. F. voltages from 50 to 75;
 A. F. voltages from 90 to 135;
 Power tube voltage to 180 fixed.

AN EXCLUSIVE FEATURE
 Tubes and by-pass condensers are protected against excessive and harmful voltages. Designed for lasting service with liberal factors of safety.

A STRICTLY HEAVY-DUTY POWER UNIT
 Output rating is 70 mils at 180 volts.
 Uses R. C. A. UX-280 or Cunningham CX-380 Rectron. Licensed under patents of Radio Corporation of America and Associated Companies. For 105-115 Volts, 50-60 cycles A. C.
 List price with cord, switch and plug, \$40. Rectifier tube, \$5.
 Write National Co., Inc., W. A. Reedy, Pres., Malden, Mass., for new Bulletin, W-124.

NATIONAL-B
 Type 7180
A "B" That's Built for Service



NATIONAL TUNING UNITS — THE HEAVENLY TWINS
 More National Tuning Units have been used by set builders than all other similar components combined.
 Standard since 1923



BROWNING & DRAKE
 THE OFFICIAL DESIGN

Set Builders!
Dealers!



FREE

Standard parts and equipment at money-saving prices, with discounts that show you a real profit. Electrical phonograph—plek-us—latest kits. New A. C. tubes and transformers—parts for any circuit—power audio equipment—short wave supplies—they are all in our big new 1928 Catalogue. Write for it today, with discount sheet, 12-hour shipment guaranteed.

Van-Ashe Radio Co.

210 North 10th ST. ST. LOUIS, MO.

Insure your copy reaching you each month
 Experimenter Publishing Co.

RAJAH SOLDERLESS SNAP TERMINALS

Instantaneous in Operation—Positive Contact. For Panel, Ground and Battery Connections.



Patented—Sept. 23rd, 1924

The base stud is tapered and furnished with 8-32 screw and washer. This fits all "B" Batteries with screw posts.

As used on
TUNGAR—RECTIGON—PHILCO—EXIDE B ELIMINATORS

Terminal, complete... 15c. Extra base studs...
 Furnished with

BAKELITE FERRULES—EN

in three colors—BLACK, RED



25 cents each
 direct from the factory postpaid

CO. Bloomfield, N. J.

to Radio News—\$2.50 a year.
 Avenue, N. Y. C.

**"Thanks, Folks!
Orders are
Coming
in Fine!"**

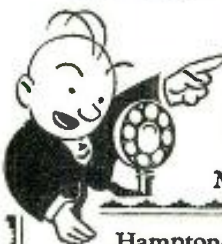

Mail This TODAY!

**Hampton-Wright
128 Darmody Building
Indianapolis, Ind.**

Gentlemen: Rush to me today one of your free 1927-28 catalogs of unusual bargains in radio parts and accessories.

Name _____
Address _____
City _____ State _____

Radio Fans all over the country are acclaiming this superior Hampton-Wright radio merchandise. They've found bargains galore, all the products of the country's best known makers, in this new

1927-28

**HAMPTON-WRIGHT
FREE CATALOG of RADIO
PARTS and ACCESSORIES**

Order this "Book of a Thousand Radio Bargains" and let our merchandise and service satisfy your radio needs. Join our host of friends. This is Hampton-Wright's biggest year—take advantage of it. **Mail the coupon— Today!**

"KEEPING PACE WITH RADIO"

**HAMPTON-WRIGHT
RADIO PARTS AND ACCESSORIES
DARMODY BUILDING + + + INDIANAPOLIS**

**Tune Out With
SUPER TUNER
VARILOOP**

Directional Allocating
Comp. ELIMIN. Positive Control

Cuts out undesired settings. Can be used with outside aerial, a long antenna with sharp points without changing dial For ALL SETS — no loop or in connection Antenna, Tuner and Eliminator signal strength of directionally guaranteed, order characteristics of loop. Write for particulars or necessary. FROM YOUR DEALER or PALMER & PA. Unconditional. PALMER & PA. 404 WEST UTICA ST. Ind.

tennas used are of the kind which transmit a beam of waves; i. e., the radio waves are concentrated in a narrow path instead of being spread out in all directions. These two beams will intersect at a certain point, and it is here that the receiving station is located. The messages are sent from a keying station midway between the two aerials, and the keying circuit is so arranged that neither transmitter sends the entire message. For example, it can be so planned that one of the transmitters sends the dots of the Continental code and the other sends the dashes. This is accomplished by using a key that sends dots in one position and dashes in the other.

The result is that, while the area of possible reception by an unauthorized listener is limited in each case to the line of the beam, an eavesdropper if placed in one or the other of these two paths, will pick up only a part of the message—only a series of dots or dashes. The only points where the entire message can be received lie in the area of the intersection of the two beams. The aerial of each transmitter may be mounted on a revolving platform, so that the two rays can be converged at any point within the range of the two transmitters, excluding all others.

As an additional precaution each beam may transmit a continuous carrier wave, upon which the signals are impressed at different super-audible frequencies. At the receiving station the two "supersonic" frequencies are combined to give an audible beat-frequency as the ultimate effect.

SPECIAL CARRIER SYSTEMS

Even in the case of telephony secret systems of radio transmitting have been developed capable of baffling the most determined efforts of an eavesdropper. If speech is used for modulating a carrier wave of fluctuating frequency instead of one of the usual constant frequency, the tuning of the receiving station must be kept constantly in step with the variations of the transmitter. Otherwise, only unintelligible fractions of the messages could be picked up on an ordinary receiver.

If the carrier wave is suppressed at the transmitter so that only one of the side bands is transmitted, it is impossible to pick up an intelligible signal with an ordinary set. This type of reception can only be accomplished by using an oscillating system at the receiving end to supply the missing carrier wave and "beat" the side-band down to audible frequencies. If, in addition, the suppressed carrier wave is a fluctuating instead of a constant frequency, the eavesdropper must keep his circuit oscillating exactly in step with the fluctuations of the transmitter before he can pick up an intelligible message.

The message can be further garbled by applying the microphone currents to an intermediate frequency and selecting the lower of the side-bands for modulating the main carrier wave. The speech frequencies are thus inverted or converted from their original form into a confused noise. These can be restored to intelligibility only by reversing the modulating process at the receiving end; an operation that necessitates two sets of oscillators. It would seem that these complications would make for secrecy. A simple diagram of such an arrangement is shown in Fig. 2.

In this diagram the original microphone current from the amplifier is first applied to a balanced modulator fed by a source of intermediate-frequency current. The resulting side-bands are so filtered that only the lower one reaches the principal modulator. The main carrier wave is generated separately, the tuning condenser being continuously varied by a motor to keep the carrier frequency at a constantly changing value.



**The 4th and Greatest
edition of RADIO NEWS
AMATEURS'
HANDIBOOK**

HERE is the greatest Radio Handbook ever published! Right up to date—a brand new edition of the very finest selected articles that have appeared in RADIO NEWS, Radio's Greatest Magazine, this year.

All new Radio—Plenty of latest model circuits with blueprint diagrams, ready for building. This is the most popular Radio Book ever printed. The past three editions were completely sold out.

—And now we offer the biggest and best edition of them all—116 pages of 1927 Radio complete with elaborate circuit diagrams and illustrations and parts. Size 9x12 inches.

Copies are going fast, get your order in now—or see any newsdealer.

**50c
ON ALL
NEWSSTANDS**

If your newsdealer cannot supply you use coupon below.

EXPERIMENTER PUBLISHING Co., Inc.
230 Fifth Ave., New York

EXPERIMENTER PUB. CO., Inc.
230 5th Ave., New York, N. Y.

Gentlemen: I enclose 50c. for one copy of the new 1927 AMATEURS' HANDIBOOK.

Name
Address
City, State

Till the Clouds Roll Dry

(Continued from page 607)

The *Aurora* is The Master's private yacht; one of those vessels originally intended for an ocean liner, but that smoked too much when young and got stunted at 250 feet. It's the last word in floating palaces; besides elaborate quarters for fifty guests, including a ballroom and a flock of tucked-away decks, Jerry has his own science suite, being a replica of his land laboratory except in space. I've made a couple of week-end trips on the big canoe, and she's a wow.

The Master goes on, gazing abstractly out of the window. "I have in mind a trip to that point in the Atlantic Ocean farthest from land. It will take about three weeks, more or less. What do you say we make a cruise of it—get up a party?"

"I'll ask the family accountant," I says, "but I'll bet it'll be a pushover."

Jerry smiles. "Why, of course, we'll have to consult Doris about the guest list, and such. Women are so competent along those lines."

"You've been peeking!" I reprimands. "But come on over to dinner tonight and we'll lay the plans."

"I'll be there," promises The Master. "Tell Doris to have ham and eggs."

Having only two French chefs, the poor boy don't get much real food, and he likes to dine with us for variety's sake. I goes home and tells the Sweeping Sweetie the glad tidings. If it were anybody else I was bringing home to dinner, my helpmate would rave, but The Master praises her cooking, and consequently stands ace high with Mrs. Joe.

At six o'clock Jerry comes in, and chatter fills the air until after the coffee, when Doris gets out a pad and pencil and orders action.

"Whom do you wish to invite?" she asks.

The Master's so much of a recluse he ain't got any intimate gang except us and ours, and he pauses before replying.

"Well, there's Mr. and Mrs. Doc Maxwell, and my cousin, George Gurney. They're about the only ones in Brightmere. And can't we get Tap Jones and Mildred? Where are they now?"

"Honeymooning in Connecticut," I says. "I'll wire 'em—they'll be tickled cerise."

"And the McKennas, with Shakespeare, the crow?"

"Out on the Orpheum," replies Doris. "Out of reach."

"And couldn't we—" Jerry blushed heavily, "couldn't we get one or two of the girls that were in the revue with you?"

"In midsummer, with half the town outa work?" I grins. "Boy, just name the lucky lassies!"

"Ask Betty, and what's-her-name—the red-head—oh, yes, Yvonne."

That makes a total of ten, which we decides is enough, there being five couples, if you can count on The Master, besides three unmarried officers and a crew of forty able seamen, for the girls' sakes.

"We'll sail on or about Sunday, July 17th," says Jerry, in parting. "I'll attend to all details except the guests themselves; you'll call them up and make sure that they can come, won't you?"

"With pleasure."

During the next week I'm busier than a one-armed fat man with Saint Vitus' dance rewinding a honeycomb coil in an upper berth, but everybody invited is tickled cerise to come, because after we're through experimenting The Master agrees to take a much-needed vacation and cruise about the West Indies, and you know what that means!

The Master, incidentally, is the hardest worker of all. The yacht's thoroughly gone

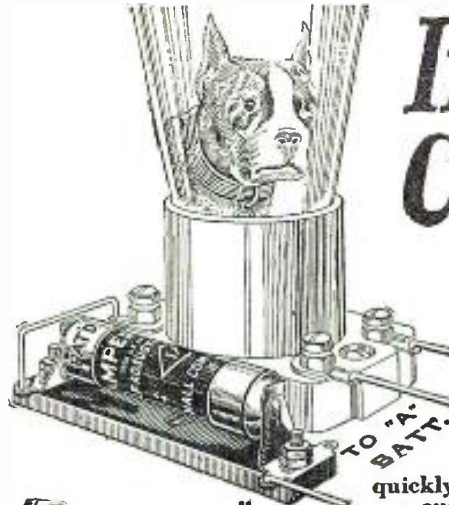

"AMPERITE"
Watch Dog
of your
Tubes

If TUBES Could Talk!

They would tell you—that only at the precise and definitely prescribed filament current, or temperature, can their tonal qualities, clarity and sensitiveness be brought out to the full. That "A" battery current constantly varies according to the age of the battery and state of charge—and operation with too little or too great current is certain death to efficient tube performance—and too quickly, of the tube itself. That only AMPERITE can automatically supply and control this exact current despite battery variation—as long as sufficient current is to be had. That you should never confuse AMPERITE with fixed filament resistors which do not do the Amperite's job. AMPERITE is sold by dealers everywhere. Price \$1.10 mounted (in U. S. A.).

Write for FREE "Amperite Book" of the season's best circuits and latest construction data. Address Dept. RN-12

Radiall Company

50 Franklin St., New York

AMPERITE

REG. U. S. PAT. OFF.

The "SELF-ADJUSTING" Rheostat

WORLD'S
GREATEST
LOUD SPEAKER

UNEQUALLED
TONE QUALITY

The ORIGINAL
ACCUSTI-CONE

3 FT. DOUBLE CONE SPEAKER



PRICE
\$12.50

STAND
\$3.00 EXTRA

HERE IS THE MOST POPULAR 3-FT. DOUBLE CONE SPEAKER IN THE COUNTRY—You can build it in less than fifty minutes.

We furnish everything in Kit form with free instructions and blue prints. Everybody is building one. You can do it, too! and at such a low price. With this the ACCUSTI-CONE original 3-ft. Cone speaker you hear ALL the tones. It brings out the true depth and beauty of orchestral and instrumental music. Truly unequalled in tone quality and the greatest speaker in Radio today. BUY this wonderful speaker, which works on any set, under our "absolute Money back if not fully satisfied guarantee." You will admit after hearing it that it equals any speaker selling today for \$75 or more. Imitators only imitate shade, but not ACCUSTI-CONE quality.

24-INCH ACCUSTI-CONE SPEAKER KIT \$11.
Accusti-Cone Speaker Unit Adjustable \$7 (Life-time Guarantee).
Cone Speaker Cement 30c. and 50c., Apex Fittings, 25c. Fon-O-TEX 38 x 38, Alhambra Cone paper 75c., and many other items illustrated in our new free Catalog. Write for one.

SEND CHECK OR MONEY ORDER TODAY
Dealers and Jobbers—Write for Accusti-Cone
Attractive Profit-Making Proposition

ACCUSTI-CONE LABORATORIES,
Dept. N
11 N. 7th Street, Philadelphia, Pa.

THE SPEAKER
THAT
SATISFIES

GREATEST VALUE
IN RADIO
TODAY

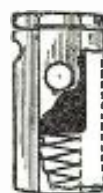

Lucas Spring Binding Post

A Spring Binding Post unequalled for service and simplicity, requiring but a press of the finger to make necessary connections giving you satisfaction unequalled. Seven posts to a slab. Marked or plain. Single 10c. Double 15c. Manufacturers, Dealers and Jobbers write for prices.

JOHN LUCAS & SONS
654 N. Talman Ave., Chicago, Ill.

FREE RADIO GUIDE

BIG NEW 1928 CATALOG—4000 Items
Shows the latest circuits, the newest developments in radio at startling low prices. Get the parts you want here and save money. The best in parts, kits, complete factory-built sets and supplies. Orders filled same day received. Write for free copy now

Barawik Co., 129 N. Jefferson St., Dept. 111, Chicago, U. S. A.



Better by Far

Than any fixed leak in the detector circuit is the

BRETWOOD VARIABLE GRID LEAK

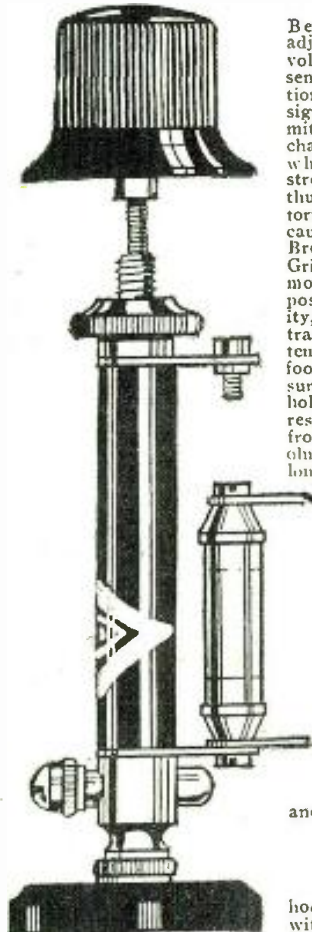

Because it allows adjustment of grid voltage to maximum sensitivity for reception of far-distant signals, while permitting faster discharge of electrons when receiving strong local stations, thus preventing distortion from this cause. Therefore a Bretwood Variable Grid Leak means more miles plus best possible tone quality, without any extra tubes. A patented plastic and foolproof plunger insure permanence in holding any desired resistance setting from .25 to 10 megohms, as well as very long life of the leak itself. As no grid leak can function any better than its grid condenser, be sure that you use a leak-proof Bretwood Bullet Condenser, of mica dielectric, and of .00025 mfd. capacity (another precision product, accurate to plus or minus one per cent.). Get these two parts and also get our

FREE

hookups, supplied with each purchase. Just fill out and mail the attached coupon.

The New Bretwood De Luxe Variable Grid Leak with Condenser Attached

Don't Send a Solitary Cent!

The Bretwood Leak may be baseboard or panel mounted. Works the same in any position. No fluid used.

North American Bretwood Co.,
141 West 45th Street, N. Y. City.

Please mail me at once one New and Improved 1928 Model De Luxe Bretwood Variable Grid Leak (price, \$1.75) and attach one Bretwood Bullet Condenser (50 cents extra), for which I will pay the postman \$2.25 on receipt. Both must be the genuine Bretwood articles, imported from England.

NAME

STREET ADDRESS

CITY..... STATE.....

N-11

over, and made extra-saworthy, and we installs his outfit in the science suite, by tacit agreement I being his only official assistant during the trip, with Doc Maxwell to help in case we needs an extra pair of mitts. Aside from Doc, and maybe myself, there ain't anyone on board that's advanced in radio further than the dial-and-panel stage, which is fortunate, since nobody will understand enough to ask foolish questions.

Everything's jake by the 17th, the gang all being on time and in good spirits. The day's clear and balmy, and it looks like a case of continuous hallelujah, if you get my intimation. Excepting George Gurney, we're all acquainted, and George is congenial, so we don't have to study each other more'n a minute before the dirt starts to fly.

"Some hulk, this!" sums up Betty, promenading in a white sailor outfit that was meant for a stiff breeze on the upper deck. "Gee, what luck—a month or two and not a dime to pay for rent or eats!"

"Altruistic, ain't you?" I grin. "You shoulda asked for salary, too, and been normal."

"And no agent to slip ten percent!" almost wails the frill. "But no, Joe, I'm too kind-hearted for that. When's lunch?"

"An army isn't the only thing that travels on its stomach," I opines. Whereat Betty gives me a playful sock on the proboscis and wanders off in search of a single man, already having designs on the second mate.

We sails-outa town with the best wishes of the City Council, the Elks' Lodge and the Country Club Loafers, and into a sea of azure, quiet and tangy. Marvel of all, everyone seems to have taken Doc's advice about eating and we're under way a full hour before the first rail bird—Mildred—sorta wanders downstairs with the green showing through the rouge. Me, I'm holding my own, and I mean it literally, too.

For a craft of her size, the *Aurora* rides like a million. For an hour or two I wanders about, assisting others to explore, until it dawns on me that I ain't seen Jerry about, so I knocks on his door and am bade to enter the science suite.

"Just in time, Joe," says The Master. "I was going to send for you."

"At your call," I bows. "What can I do to mess things up?"

The Master's brought along his wrecked morris chair, and flops into it for a resting spell.

"Since you're to be my assistant, Joe, I thought it would be well if you were to know the basis upon which this system is to operate."

"You told me once," I states. "Concussion, wasn't it?"

"Yes, but that's merely the beginning. Joe, have you ever heard of St. Elmo's fire?"

I nods. "Vaguely, in my schooldays. Ships at sea sometimes run into it."

Jerry smiles. "St. Elmo's fire is identical with the brush discharge in laboratory experiments; to be practical, it is the passing of electricity from the atmosphere to the earth. Is that clear?"

"As a bell."

The Master continues. "The atmosphere, then, is saturated with electricity. Lightning is the commonest form of atmospheric electricity, and of course the most violent. Lightning may be either from cloud to earth, or as is more often the case, merely from strata to strata of clouds. Rain, in providing an outlet for such electricity, often stops lightning.

"The earth is normally negative to the atmosphere, but this is by no means to be accepted as definite; different sections of the globe, in various seasons, alter this potential.

"My object, bear in mind, is to create an intense and if possible steady, continuous celestial concussion, high enough to be within the level occupied by rain-bearing clouds, and at a rate of vibration beyond the ability of human ears to detect."



Light Socket Power is within your reach

WHEN you buy a Sterling "B" Power Unit, you get power regulation which means tone quality at its best. You get power for any set having 4 to 8 tubes including a power tube. You get light socket convenience and the utmost in reliability. At the remarkably low price of \$28.50, Sterling "B" Power Units are within the reach of every purse.

A Sterling demonstration will be a revelation. Any Sterling dealer will be glad to prove it.

Sterling

"B" Socket Power

Model R-81 "B" Power for sets from 4 to 8 tubes

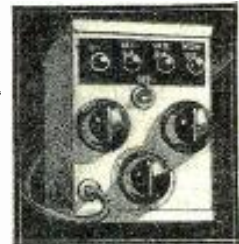

Price \$28⁵⁰ complete with Raytheon Tube

THE STERLING MFG. COMPANY
2831 Prospect Avenue Cleveland, Ohio

Build Any Set but use ACE Hard Rubber PANELS

Their high insulating values insure the utmost protection against leaks and losses which often cause poor reception.

Made with Crackle or plain Polished Surface in all regular sizes:

- 7 x 10, 7 x 12, 7 x 14
- 7 x 18, 7 x 21, 7 x 24
- 7 x 26, 7 x 30 inches.

Low prices at all dealers or write to

AMERICAN HARD RUBBER CO.
11 MERCER STREET
NEW YORK, N. Y.

Makers of famous RADION PANELS

I nods. "I get you, in a vague, dense way."

"You may have noticed that this ship is almost entirely of steel, even to most of the furniture. There is a reason for that."

"Yes?"
Jerry's just getting warmed up to his subject. "As you know, when dealing with electricity, opposites attract and likes repel. To induce rain, I shall utilize a large condenser as a negative—assuming the clouds to be positive—this negative to be gradually increased so that positive electricity, always present in the atmosphere, will be slowly drawn to it by sheer difference in potential, incidentally producing a form of thunder vibrating so rapidly as to be noiseless to humans, yet effectively assembling the clouds I desire."

I jumps up, excited. "Do you mean we're going to be struck by lightning?" I demands. "Are you crazy?"

"Be calm, Joe," smiles The Master. "Yes, we will be 'struck' by lightning, but not in the manner you doubtless have in mind. The current attracted to the negative will be comparatively small, quite invisible and thoroughly safe. Strictly speaking, Joe, we are not dealing with electricity in its commercial form, but with ions."

"Ions?" I repeats. "I've heard you use that word before and it don't translate yet."

"Nor could I satisfactorily explain it to you, other than to say that it is precisely what happens when the earth intercepts the discharge from a sun spot."

I grins. "That means a lot."
The Master hunts a moment in a stack of books. "Oh, here it is," he says. "This volume will explain more thoroughly than I can the true nature of ionic force."

"I'll do my best with it," I promises. "Maybe it'll make it less dense in my skull if I understand you're going to do a small-time imitation of Old Sol. and cast a few spots on your own hook. Is that the opus?"

"Correct," smiles Jerry. "When the sun-spots occur, the weather is visibly affected for the worse in some localities; the exact relation between atmospheric changes and sun-spots is not fully comprehended at present, though sufficiently so to permit my experiments being based on much more than mere hypothesis. It is my aim to prove definitely that our weather is affected by these ionic discharges, and evolve some means whereby they can be counteracted. Do you understand better now?"

"Much," I says. "But keep it up."
The Master leads me into another room. "You wondered, the other day, as to what this was. Well, it's the principal part of my system for propagating the ions. Although the term is not etymologically correct, we shall henceforth refer to this device as the ionic generator."

Next we goes upstairs and on up the front mast, which is built more like a battleship's conning tower, and I'm formally introduced to the hymn that does the dirty work.

"This instrument is either anode or cathode, depending upon whether we are inducing rain or summoning fair weather," states Jerry. "It is my own arrangement."

Nobody'll argue it with him, I thinks, but I pokes about and asks a few kiddish questions, to keep in practise.

"In operation, the ionic discharge will be at first emitted in the form of a narrow stream, in all like a spotlight drawn down to a crater image. This will 'burn' a hole in the clouds, to put it simply. Then, in analogy, we slowly move the beam from 'spot' to 'flood,' widening the circle gradually, until the entire horizon has been cleared, or as much of it as we desire. Picture, Joe, the vista of an immense, round hiatus of blue sky surrounded by evil, menacing clouds of rain. A sight seldom to be witnessed, eh?"

"Rather," I agrees. "Is the apparatus controlled from up here or down below?"

"Either," he replies. "At first, during



"I wanted to be sure of Quality so I built a VICTOREEN"
T. W. GROGAN President
The T. W. GROGAN COMPANY
Union Mortgage Bldg. Cleveland, O.

Frank expressions of approval from the lips of men who know, are the best evidence of Victoreen superiority! Those who have spent much time and money in an effort to achieve the ultimate in radio, eventually find complete satisfaction in a Victoreen Super. Tone brilliancy, distance, knife-like selectivity and simplicity of assembly. These are the outstanding qualities which account for the great wave of Victoreen popularity in high places.

You can build a Victoreen "Super" and be assured of quality results. Send today for the 1928 blue print of the Victoreen circuit, there is no charge.

The GEORGE W. WALKER Co.
MERCHANDISERS OF VICTOREEN RADIO PRODUCTS
2825 CHESTER AVENUE CLEVELAND OHIO

Victoreen

Amazing New Ground Antenna

Gets Far Away Stations Loud and Clear Regardless of Static Conditions

Radio Engineers and hundreds of users report that Aer-O-Liminator, the sensational new Ground Antenna, gets better long distance reception, almost unbelievable freedom from static and outside noises, far greater selectivity and marvelously clear and sweet tone quality.

R. Curtis of Ill. says "There's no such thing as static trouble since I got my Aer-O-Liminator. I get stations I never got before—so loud and clear I would almost swear they were in the next room." In addition you are free from troublesome overhead aerials that everyone now knows are static-gatherers. Aer-O-Liminator (Ground Antenna) is simple and easy to install. Takes but a few minutes.

FREE TRIAL

Make this thrilling test at our risk! Install an Aer-O-Liminator (Ground Antenna). Leave your old overhead aerial up. Try out on a night when static is bad. If you do not get a wonderful improvement in freedom from static, greater selectivity and clear, sweet tone without interfering noises, if you can't get good reception on stations that are drowned by static on your old aerial, you need not pay us a red cent for this test. Send coupon today for scientific explanation of Aer-O-Liminator (Ground Antenna), proof of performance, and our conclusive iron bound guarantee and remarkable Free Trial Offer. Send coupon today!

CURTAN MFG. CO.
154 E. Erie St., Dept. 827-T
Chicago, Ill.

Rush This Important Coupon

Curtan Mfg. Co.,
154 E. Erie St., Dept. 827-T
Chicago, Ill.

Please send me at once complete description of Aer-O-Liminator with details of guarantee, Scientific Proof and FREE TRIAL OFFER.

Name

Address

City

State

Quality Fixed Electrical Condensers
Fast Hi-Test extra-capacity Condensers for all purposes meet all tests. High insulation resistance. One-piece die-press, steel housing impervious to climatic changes. Laboratory treatment—moisture content removed, assures dependable service. Millions in use since 1919. Fit all units. Write for free attractive booklet.
3982 Barry Ave., Dept. R.N., Chicago, U.S.A.

JOHN E. FAST & CO.

BLUEPRINTS and COMPLETE DATA
for the
PERIDYNE
Sent Postpaid on Receipt of 50c. Kit Price on Request.
SUPERHILODYNE
Blueprints \$1.50. Kit Price on Request.
EUGENE G. WILE
7 North 10th Street Philadelphia, Pa.

Try this!

Save Big

You Can
Now, for the First
Time, Order Three Different
Magazines SENT TO THREE DIFFERENT ADDRESSES and Still Get the Very

Lowest Wholesale Prices on Best Magazines!

THIS is News! Big news for magazine readers of all classes! By special arrangement with a number of publications, we are able to offer you wholesale prices on the best of the standard magazines. Buy your magazines now under this great offer and you will save half or more than half the price at the single copy or newsstand rates. And you will save almost half in nearly every instance over the regular yearly subscription rates. Furthermore, we shall be glad to send each magazine to a different address if you direct, or all to one, as you wish.

Never Before Such An Offer!

Never before have magazine clubs been offered in this way. Always heretofore all magazines in the club had to be sent to one person. We have changed all that! You can now have all the magazines sent to yourself, or only one or two to yourself and the other ones to different persons.

Go In With Your Neighbors

Show this offer to your friends, relatives or neighbors. Give them the advantage of wholesale price on their favorite magazine! For instance, you'd like "Radio News," one friend wants to renew his subscription for six months to "Review of Reviews," and another one would like "Illustrated Monthly." Separately the price would be \$6.00; but you can buy them now for only \$2.99! Less than half!

Every Magazine for a Full Year

Every magazine (except two) subscription will be for one full year. "French Humor" will be 26 issues or six

months. And "Review of Reviews" may be had for six months if full year is not desired. If subscriber is already taking any magazine and present subscription is not yet expired, mark that name with an X on the coupon order and subscription will be added on to present one.

Three Excellent Xmas Presents

What would please friends and relatives more—What would remind them of your thoughtfulness so many times during the year, as a subscription to a nice magazine! What three presents could you buy for so little money that would look so big? A dollar or so apiece wouldn't buy much of a gift, but think what it buys here. If you will mark "Xmas" on the Coupon Order we will send the first copy of each magazine to reach the name given just be-

fore Christmas and will also send a beautifully engraved Christmas Card announcing it as your gift.

How to Order—Read Carefully

Before the name of each magazine is a number. Order by number only. If you want "Radio News," "Illustrated Monthly" and "Success" sent to you, order numbers 1, 2 and 29. If you want "French Humor" (26 issues) and "Illustrated Monthly" and "Success" order 5, 2 and 29. If you want these three sent to three addresses, indicate by number which magazine is to be sent to the respective name. Be sure to send order coupon properly filled out and don't fail to enclose remittance—your check will be acceptable. Order NOW. We will be rushed later. Get in early and get quick service.

CONSRAD CO., 230 Fifth Ave., New York

References: Equitable Trust Co., New York City; Experimenter Publishing Co., or the publisher of any of the magazines quoted.

GIVE THEM FOR CHRISTMAS!

Money on Quality Magazines

SELECT FROM BARGAINS BELOW:

All Magazines Are for One Year Each, Unless Otherwise Mentioned. Order at Once.

THESE PRICES NOT GOOD IN CANADA NOR ELSEWHERE- OUTSIDE UNITED STATES

You get the pair of magazines listed in each column heading plus any one magazine below. Order by reference number shown in brackets in front of each magazine.	(1) RADIO NEWS (2) Illustrated Monthly and any magazine below.		(3) AMAZING STORIES (2) Illustrated Monthly and any magazine below.		(4) SCIENCE & INVENTION (2) Illustrated Monthly and any magazine below.		(5) FRENCH HUMOR-6 mo. (2) Illustrated Monthly and any magazine below.	
	REGULAR	OUR PRICE	REGULAR	OUR PRICE	REGULAR	OUR PRICE	REGULAR	OUR PRICE
(6) American Boy	\$6.00	\$3.99	\$6.00	\$3.99	\$6.00	\$3.99	\$5.50	\$3.69
(7) American Magazine	6.50	5.01	6.50	5.01	6.50	5.01	6.00	4.51
(8) Better Homes & Gardens	4.60	2.79	4.60	2.79	4.60	2.79	4.10	2.49
(9) Boy's Life	6.00	3.76	6.00	3.76	6.00	3.76	5.50	3.39
(10) College Humor	7.00	4.16	7.00	4.16	7.00	4.16	6.50	3.89
(11) Collier's Weekly	6.00	4.66	6.00	4.66	6.00	4.66	5.50	4.39
(12) Cosmopolitan	7.00	5.01	7.00	5.01	7.00	5.01	6.50	4.69
(14) Delineator	7.00	4.98	7.00	4.98	7.00	4.98	6.50	4.69
(15) Etude	6.00	4.01	6.00	4.01	6.00	4.01	5.50	3.66
(16) Everybody's Magazine	6.50	4.28	6.50	4.28	6.50	4.28	6.00	4.09
(17) Golden Book	7.00	4.01	7.00	4.01	7.00	4.01	6.50	3.69
(18) Good Housekeeping	7.00	5.01	7.00	5.01	7.00	5.01	6.50	4.73
(19) Hunting & Fishing	4.50	2.98	4.50	2.98	4.50	2.98	4.00	2.62
(20) McCall's Magazine	5.00	3.14	5.00	3.14	5.00	3.14	4.50	2.86
(21) Modern Priscilla	6.00	3.56	6.00	3.56	6.00	3.56	5.50	3.29
(22) Motion Picture Magazine	6.50	4.48	6.50	4.48	6.50	4.48	6.00	4.19
(23) Open Road for Boys	5.00	2.69	5.00	2.69	5.00	2.69	4.50	2.46
(24) People's Home Journal	4.50	2.71	4.50	2.71	4.50	2.71	4.00	2.48
(25) Pictorial Review	5.50	3.75	5.50	3.75	5.50	3.75	5.00	3.54
(26) Review of Reviews	8.00	4.98	8.00	4.98	8.00	4.98	7.00	4.76
(27) Rev. of Reviews (6 mo.)	6.00	2.99	6.00	2.99	6.00	2.99	5.50	2.74
(28) Screenland	6.50	3.48	6.50	3.48	6.50	3.48	6.00	3.29
(29) Success Magazine	6.50	3.79	6.50	3.79	6.50	3.79	6.00	3.58
(30) Woman's Home Comp'n.	5.00	3.49	5.00	3.49	5.00	3.49	4.50	3.31
(31) Youth's Companion	6.00	3.69	6.00	3.69	6.00	3.69	5.50	3.47

Special Combinations

Or you can have either of the four pairs of magazines given in column headings plus these:	REGULAR	OUR PRICE
(29) Success and (12) Cosmopolitan	\$9.50	\$6.01
(23) Open Road for Boys, (19) Hunting and Fishing, (8) Better Homes and Gardens.....	6.60	3.65
(20) McCall's, (8) Better Homes and Gardens, and (24) People's Home Journal	6.10	3.49
(28) Screenland, (10) College Humor, and (20) McCall's.....	10.50	5.99
(32) Popular Science and (33) Scientific American	10.00	7.49
(34) Woman's World, (8) Better Homes and Gardens, (24) People's Home Journal and (35) Needlecraft	6.10	3.69

Please be careful to mention numbers. We positively will not break combinations. These offers not good in Canada or elsewhere outside the U. S.

SPECIAL OFFER COUPON!

Please Cut Out Along Broken Lines and Mail This Coupon with Remittance.

CONSRAD CO., Dept. R, 230 Fifth Ave., New York City.

I enclose \$..... for following subscriptions:

Send Magazine No.....to	Send Magazine No.....to
.....
Send Magazine No.....to	Send Magazine No.....to
.....

Send me Magazine } My Name.....
 No. } Address

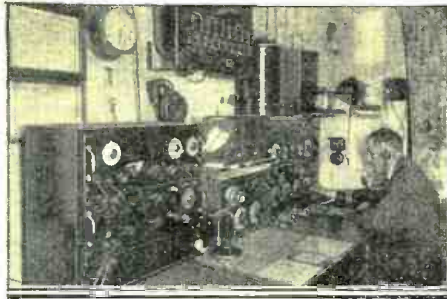

THOUSANDS of our graduates have made good!

You, too, can make rapid strides of advancement in Radio, the field of fascinating work and attractive salaries. Trained radio men are always in high demand—as ship operators, sailing to foreign lands, and in big jobs on shore.

Study At Home

Radio Institute of America offers the finest radio instruction obtainable—qualifies you to pass the U. S. Government Commercial or Amateur License Examination. The cost of the course is low. Time payments are allowed. And you can study at home! Mail the coupon now!

RADIO INSTITUTE OF AMERICA
324 Broadway, New York City

SEND THIS IN

RADIO INSTITUTE OF AMERICA
324 Broadway, New York City

- Please send me full information about your Home Study Course of code and technical radio instruction which qualifies for the U. S. Government Commercial or Amateur Radio License.
- Please send me full information on your technical course for radio dealers, jobbers and salesmen.

Name _____

Address _____

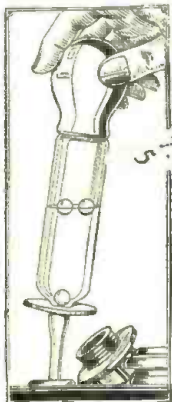

THINGS DON'T JUST HAPPEN

That nothing to equal the patented *Chaslyn* cells for accuracy, unshakability and simplicity of reading has been discovered is why the big manufacturers of Batteries use them as *Charge Indicators* in Glass-Cased Batteries and Power Units.

**Easiest to Read
Nothing to Break**

- Swim all three—charged fully
- Sinks the white—charge still right
- Sinks the green—charge is lean
- Sinks the red—charge is dead.

Ask your dealer. If he can't supply, send 75c. to us. Chaslyn Corrosion Cure for Battery Terminals protects contacts. A large tube is 30c.

THE CHASLYN COMPANY
4617 Ravenswood Ave. CHICAGO, ILL.

Special Library of Information on

RADIO PATENTS and TRADE MARKS

JOHN B. BRADY

Patent Lawyer

Ouray Building Washington, D. C.

Cable address: **RADIOPAT** Telephone: **Main 4806**

minor experiments, I shall operate it from up here; later, when I begin using heavier loads, we'll have to handle it from the suite."

"Yoo-hoo," yells a voice, feminine, from the deck. The Master looks down.

"You're neglecting us terribly, you two," says Betty, the demon stepper. "Come on down—it's almost time for dinner."

Jerry smiles, in his faint manner. "Salt air breeds heavy appetites, doesn't it? I'm hungry myself."

"Not like that bimbo," I grimace. "With her it's heredity. Her mother dined in boarding houses for years, and developed an acute case of Boarder's Reach. She moved to Los Angeles and went crazy in a cafeteria."

We hits the deck, and Betty, now reinforced by Yvonne, another memory for the visiting Kiwanis, hooks onto The Master with all natural weapons unlimbered. Although they've known Jerry for months, this is the first time they've had him where he couldn't get away, and it looks like a fight to the death with no odds asked or given.

"My, isn't this just the sweetest yacht!" gushes Yvonne, sticking onto The Master's left arm like a tattoo mark. "I've been walking all over it and there's so many perfectly adorable places!"

"And the dance floor in the ballroom is simply *per-fect!*" puts in Betty, ringing the welkin on her own. "We're going to dance after dinner, Mr. Lawson, if you don't mind."

"Not at all," smiles Jerry. "The ship is *carte blanche* to you all. If you'll allow me, may I have a dance or two with each of you?"

How naive! Either of those sweet she-bas 'd throw away her compact for a struggle with The Master, but he don't realize it, bless his heart.

Dinner's served at six, and everybody shows up, except Mildred, who ain't become adapted to any roll except that from a bank. After that we cuts loose and makes merry, Jerry joining in and actually enjoying himself away from his beloved laboratory. The sea's smooth, and there's a moon.

With two chorus cuddlers to show him how, The Master takes up the art of Terpsichore avidly, and by midnight is well into the Charleston stage, with aspects of eventually becoming a super-het black-bottomer. The boy's limber, even in the feet; his head we all knows is active.

"Oh, Jerry, you dance simply divine!" breathes Yvonne, who has him in tow.

Doc Maxwell, who's been doing a little radio duty, reports good weather ahead, and we all bunks up with dreams of an azure sky over the well-known coral strand, or something.

Several days later we arrives at Latitude 22 degrees north, Longitude 38 degrees west, which is the nautical way of expressing location when there ain't no billboards or mile posts to guide by.

"Well, here we are," says Jerry, ordering the engines to be stopped. "We are now about as far from land as we can get in this ocean."

It's a beautiful day, not a cloud in sight, and a gentle breeze blowing. The gaug immediately decides to go for a swim, and tosses over a couple of life rafts to use as floats. I'm making a dash out to join the others when The Master highballs me.

"Oh, Joe," he calls. "Come here a minute."

"Need help?"

"Not just yet. But I'm going to start the ionic generator shortly, and when I get the full power on I'll let you know. It will be quite interesting to watch what will happen, and I may need assistance in manipulating various controls. Keep within call."

"Do I look like Gertrude Ederle?" I cracks. "Where could I go and be out of call?"

The Master muses. "You might drown," he says, and I'm the avuncular relative of an

NOW!
TELEVOCAL TUBES
For A.C. Sets

Electrify your set with the New Televocal A. C. 226 and A. C. 227 Tubes. Using these tubes, you can operate on A. C. current without "A" Batteries. Thoroughly tested; genuine Televocal quality; guaranteed. Also use Televocal T. C. 112A and T. C. 171A Power Tubes. Now made with oxide-coated filament, current consumption is reduced 75%—from 1/2 to 1/4 amperes. Televocal Tubes are made in all standard types.



TELEVOCAL CORP'N
Televocal Bldg.
Dept. A-4, 588-12th St.
West New York, N. J.

TELEVOCAL QUALITY TUBES

90 Volt Power Unit :: \$12.75

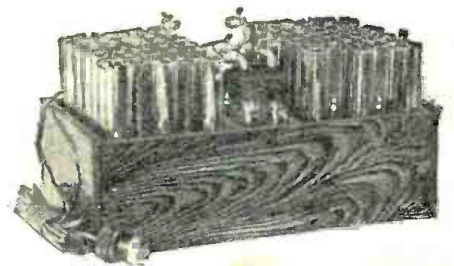

Hums, line noises, etc., positively impossible with this new advanced unit. Plug in and forget Non-acid and noiseless. All detector and intermediate voltages plainly marked. Simpler to hook up than dry cells. Operates any type set 1 to 12 tubes. Greater volume and clearness guaranteed. If not thoroughly satisfied return after using 30 days for complete refund. Guaranteed further 2 years. For 110-120 volts A.C. 25 to 60 cycle current. 90 volts. \$12.75; 112 1/2. \$15.25; 135. \$17.50; 157 1/2. \$19.50; 180. \$24.00; 202 1/2. \$26.00. Also built for D.C. current 110 and 32 volts at only \$3.00 additional. Any size above. Ample stocks—same day shipments. Simply say—SHIP C.O.D. or write for my interesting literature, testimonials, etc.

B. HAWLEY SMITH

334 Washington Ave.,

Danbury, Conn., U. S. A.

RADIO ACCESSORIES at WHOLESALE

Radio Sets, "B" Eliminators, Chargers, Tubes, Kits, Parts—everything new in Radio at lowest wholesale prices. Thousands of nationally advertised bargains. All listed and illustrated in my Big New Catalog and FREE Call Book. 132 Pages of valuable Radio information—trouble finding, set building—Radio knowledge of all kinds. Write today! HARRY SCHWARZBERG PRES. AMERICAN AUTO & RADIO MFG. CO. Dept. 104 American Radio Bldg. Kansas City, Missouri



FREE BIG BARGAIN CATALOG

OLD COINS

large Spring selling catalogue of coins for sale, free. Catalogue quoting prices paid for coins. 10c. William Hesslein, 101 K, Tremont St., Boston, Mass.

Insure your copy reaching you each month. Subscribe to Radio News—\$2.50 a year. Experimenter Publishing Co., 230 Fifth Ave., N. Y.