

# RADIO NEWS

REG. U.S. PAT. OFF.

MAY  
25 Cents

Over 200  
Illustrations



Edited by HUGO GERNSBACK

**\$300.00**  
IN PRIZES  
**What's Wrong**  
WITH THIS  
PICTURE?  
*See Page 1328*

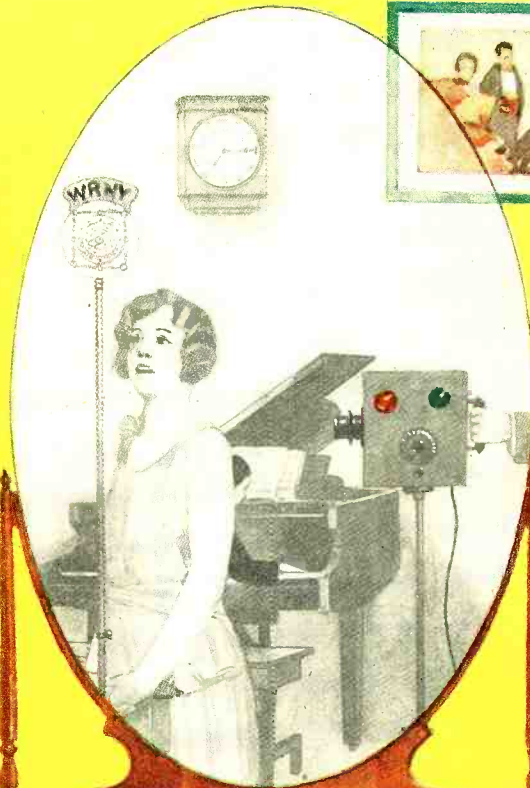

**RADIO'S GREATEST MAGAZINE**

EXPERIMENTER PUBLISHING COMPANY, NEW YORK, PUBLISHERS OF  
SCIENCE & INVENTION - RADIO LISTENERS' GUIDE - AMAZING STORIES - MONEY MAKING - RADIO INTERNACIONAL

# The New Cunningham

## HI-MU Amplifier

# type CX-340



Price  
**\$2.25**

Five Volt  
 $\frac{1}{4}$  amp. Filament  
Mu of Thirty

The development of radio centers around the radio tube. In offering this new type we take another forward step in fulfilling the obligation of leadership.

With the advent of the CX-340, heights of efficiency heretofore unattainable in resistance and impedance coupled audio circuits are placed within easy reach of the radio world. This new Cunningham Radio Tube is especially designed for use in receiving sets employing resistance or impedance coupled audio frequency amplification.

Consult your dealer as to its proper installation or write us for the special CX-340 Bulletin.

*Sixteen Types all in the Orange and Blue Carton*

**E. T. CUNNINGHAM, Inc.**

NEW YORK

CHICAGO

SAN FRANCISCO

Manufactured and sold under rights, patents and inventions owned and/or controlled by Radio Corporation of America.

here's your  
CONE

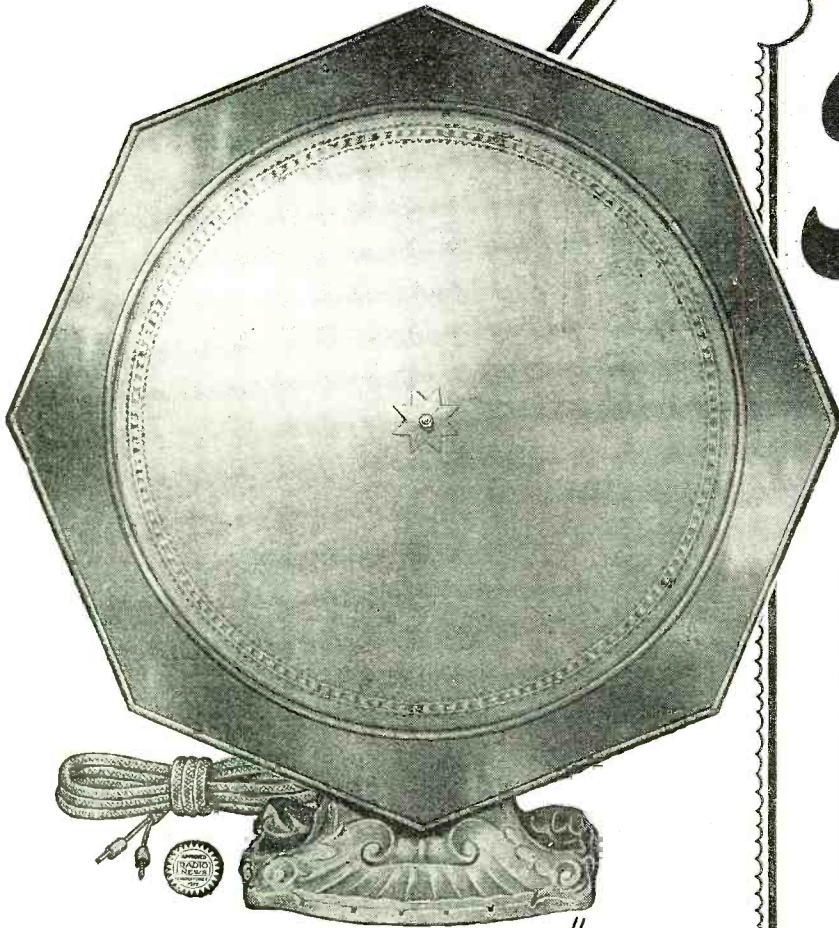

### The Double Duty Speaker

Use the Meistersinger as a Table Model or detach the art metal base and hang it on the wall. (15 ft. of cord with each Cone.)

**\$15-**

# Tower



## Meistersinger

Why pay \$25 or \$30 for a radio speaker, when you can enjoy a superb quality of reproduction for much less?

Thousands of owners from coast to coast are delighted with the tone quality of the Meistersinger—a Cone of magnificent physical beauty that covers the entire range of broadcast music. Due to the exclusive direct-drive unit with *eight* connections to the diaphragm, this Cone easily handles the output of the most powerful multi-tube receivers.

Ask Your Dealer to Demonstrate or Write Us.

**TOWER MFG. CORP.**  
Boston, Mass.

# RADIO NEWS

Published by EXPERIMENTER PUBLISHING COMPANY, Inc., Publishers of "Radio News," "Science and Invention," "Radio Internacional," "Radio Listeners' Guide," "Spare-Time Money Making" and "Amazing Stories."

H. GERNSBACK, President. S. GERNSBACK, Treasurer. R. W. DEMOTT, Secretary.

Member: Audit Bureau of Circulations Radio Magazine Publishers Association

Editorial and General Offices: - - 230 Fifth Avenue, New York City

VOLUME 8

MAY, 1927

NUMBER 11

## Contents of This Issue:

New Radio "Things" Wanted, By Hugo Gernsback	1315	The Phono-Radio Combination Set, By Fred A. Jewell	1338
Radio Aids to Navigation, By C. William Rados	1316	Modernizing the Browning-Drake Receiver, By Arthur H. Lynch	1343
The Pleasures of "Hamming", By Andrew R. Boone	1317	Building a 36-Inch Cone Speaker, By Warren T. Mithoff	1348
What Is Next In Home Entertainment? By Earl C. Hanson	1318	A New Era in Push-Pull Amplification, By Joseph Riley	1352
The Radio Act of 1927,	1318	Advancement in R. F. Stabilizing Systems, By M. L. Muhleman	1356
Radio News of the Month Illustrated, By George Wall	1319	Short Waves in Siberia, By A. Kalachnikoff	1357
From Netherlands to Indies,	1320	Some Suggested Aerial Installations, By A. Binneweg, Jr.	1358
New Argentine Station,	1321	A Double Heterodyne Receiver, By A. Dinsdale	1359
The Radio Beginner—Beginning Experimental Work, By A. P. Peck	1322	Letters From Home Set Constructors,	1360
What's New In Radio,	1324	Progress in Radio,	1361
\$300.00 Prize Contest—What's Wrong With Our Cover Picture?	1328	Radio Wrinkles—Awards of \$50 Prize Contest,	1362
Below 50 Meters With Reinartz, By G. C. B. Rowe	1329	Correspondence from Readers,	1364
List of Broadcast Stations in the United States,	1330	Radiotics,	1365
Radio News of the Month, Experiments on a Superheterodyne, By L. W. Hatry	1332	RADIO NEWS LABORATORIES, With the Amateurs—Short-Wave-Oscillator Adjustment and Operation, By A. Binneweg, Jr., 6BX, 6XAA	1368
The Loftin-White Circuit With High-Mu Tubes, By Robert H. Marriott	1333	I Want to Know, By Joseph Goldstein	1369
Circuits Favored by British Listeners, By Norman Edwards	1334	Darkened Room Aids DX Reception,	1378
Ways of Reducing Interference, By Sylvan Harris	1336	Book Review, By Robert Hertzberg	1405
		Current Radio Articles.	1406

## In Forthcoming Issues:

### FURTHER ADAPTATIONS OF THE EL-FONIC PICK-UP

By F. A. Jewell

In the next article of this series Mr. Jewell will tell how his capacity pick-up can be used with any radio receiver.

### THE PROGRESS OF TELEVISION

By A. Dinsdale

An explanation of the recent very interesting work of John L. Baird with "invisible light."

### A NEW "A, B AND C" POWER UNIT

A unit employing a new radio rectifier tube, capable of passing enough current for lighting 201-A type tubes with their filaments connected in series.

RADIO NEWS is published on the 10th of each preceding month. There are 12 numbers per year. Subscription price is \$2.50 a year in U. S. and possessions, Canada and foreign countries, \$3.00 per year. U. S. Coin as well as U. S. Stamps accepted (no foreign coins or stamps). Single copies, 25 cents each. Checks and money orders should be drawn to order of EXPERIMENTER PUBLISHING CO., INC.

All communications and contributions to this journal should be addressed to Editor, RADIO NEWS, 230 Fifth Ave., New York, N. Y. Unaccepted contributions cannot be returned unless full postage has been included. All accepted contributions are paid for on publication. A special rate is paid for novel experiments; good photographs accompanying them are highly desirable.

RADIO NEWS, Monthly. Entered as second class matter, July 12, 1924, at the Post Office at New York, N. Y., under the Act of March 3, 1879. Additional entry at Long Island City, N. Y., and San Francisco, Calif. Title registered U. S. Patent Office. Copyright, 1927, by The Experimenter Publishing Co., Inc., 230 Fifth Ave., New York. The contents of this magazine are copyrighted and must not be reproduced in the United States without giving full credit to the publication. Translation into foreign languages must not be made unless permission is obtained from the publishers. Copyrighted in Germany. Reproduction of articles in Germany is reserved for Radio, Berlin 42.

RADIO NEWS is for sale at all newsstands in the United States and Canada, and at Brentano's, Ave. de L'Opera, Paris, France. European agents: S. J. Wise Et Cie, 40 Place Verte, Antwerp, Belgium.

HOW TO SUBSCRIBE FOR RADIO NEWS. Send your name, address and mittance to Experimenter Publishing Co., 230 Fifth Ave., New York. Mention the name of the magazine you are ordering. We also publish SCIENCE AND INVENTION, RADIO INTERNACIONAL, RADIO LISTENERS' GUIDE, SPARE TIME MONEY MAKING and AMAZING STORIES. Write clearly.

RATES AND TERMS. The subscription rate for RADIO NEWS is \$2.50 per year. (12 numbers). When remitting do so by check, money order, or registered letter if cash is enclosed. Avoid sending cash through the mail if possible. Subscriptions for less than one year are not accepted. Subscription may be made in combination with SCIENCE & INVENTION, RADIO INTERNACIONAL, RADIO LISTENERS' GUIDE, SPARE TIME MONEY MAKING and AMAZING STORIES.

POSTAGE. We prepay postage in all parts of the United States, Mexico and island possessions. For foreign or Canadian subscriptions we require 50 cents in addition to the subscription price for additional postage charge.

CHANGE OF ADDRESS. Notify us as far in advance as possible. It requires several weeks to make an address change on our records. Always write clearly.

General Advertising Dept., 230 Fifth Avenue, New York City

### ADVERTISING REPRESENTATIVES

L. F. McCLURE, 720 Cass Street, Chicago, Ill.  
DAVIES, DILLON & KELLY, 15 West 10th St., Kansas City, Mo.  
T. F. MAGRANE, Park Square Bldg., Boston, Mass.

HARRY E. HYDE, 548 Drexel Building, Philadelphia, Pa.  
A. J. NORRIS HILL CO., 5 Third St., San Francisco, Calif.  
412 West 6th St., Los Angeles, Calif.

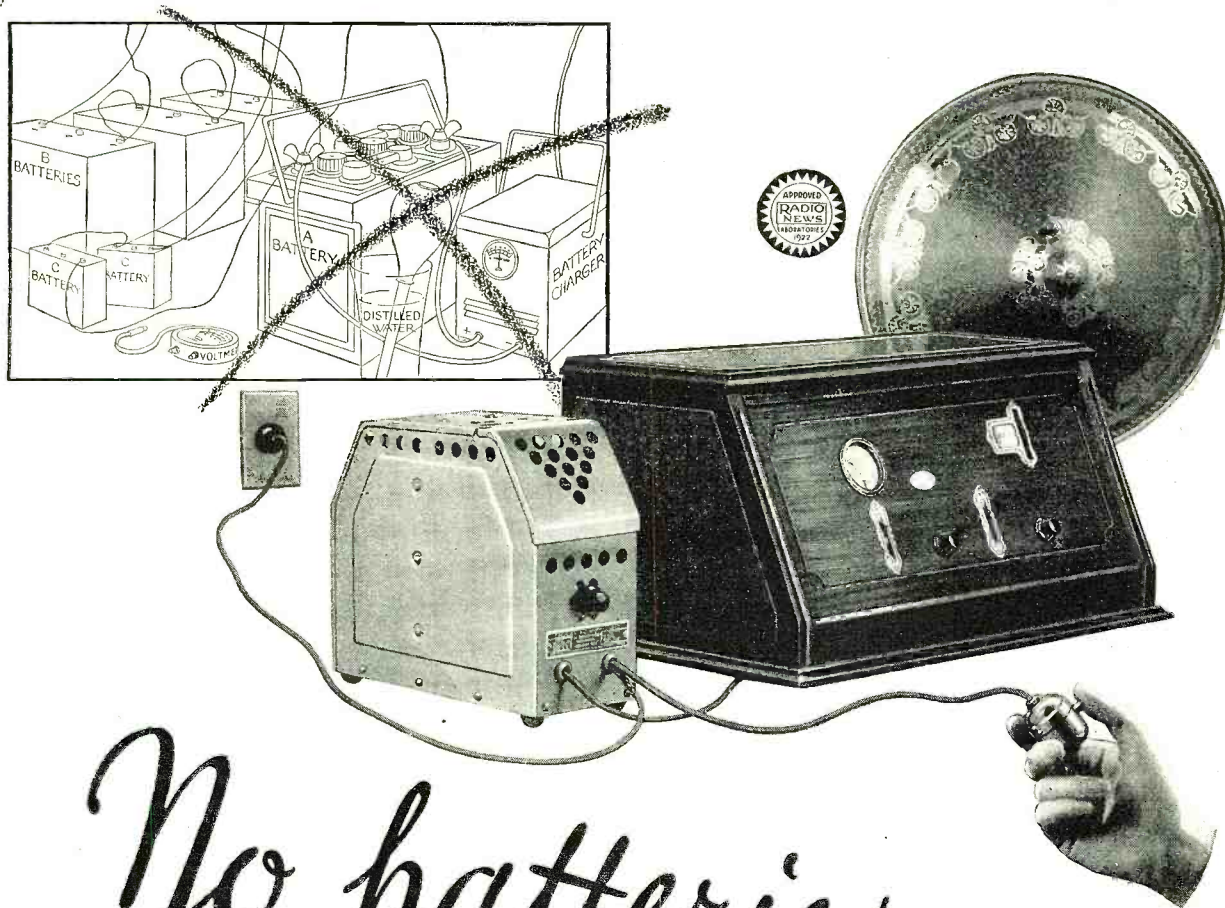

*No batteries—*

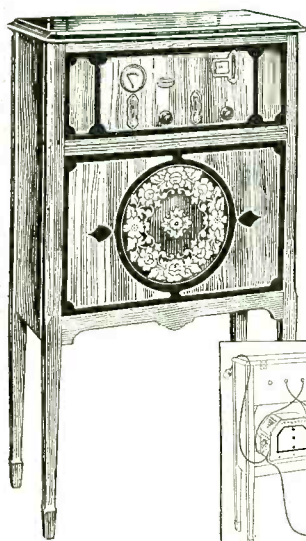

Radio's most revolutionary development! Run this radio direct from house current outlet. Ordinary 110 volt 60 cycle domestic electricity transformed mechanically into smooth, quiet radio A, B and C power as you use it. Radio power supply annoyances ended for all time. A snap of the switch is the only demand radio will make upon you from NOW ON.

- No more batteries to fuss with.
- No more trickle chargers to watch.
- No more keeping something filled with water.
- No batteries to renew or recharge.
- No upsetting the home to have the radio serviced.

See these wonderful sets at any Crosley dealers, or write Dept. 22 for descriptive literature.

**The Crosley Radio Corporation**

Powel Crosley, Jr., Pres.

Cincinnati, Ohio.

**Radio Energy Unit**

Crosley Radio Energy Unit weighs only 13 lbs., is only half the size of an ordinary "A" storage battery—operates without interfering hum and with the certainty of an electric motor.

**\$50**

**6-tube AC Receivers**

*for use with Crosley Radio Energy Unit*

Crosley radios designed for use with this marvelous power supply are the AC-7, a 6-tube, table model at \$70 and the AC-7-C, a 6-tube console at \$95.

Crosley sets are licensed under Armstrong U. S. Patent No. 1,113,149, or under patent applications of Radio Frequency Laboratories, Inc., and other patents issued and pending. Price slightly higher west of the Rocky Mountains.

**CROSLEY**  
**RADIO**

**CROSLEY  
ULTRA  
MUSICONE  
\$9.75**

# INDEX TO ADVERTISERS

INDEX TO ADVERTISERS

Page	Page	Page	Page
<b>A</b>	<b>E</b>	<b>K</b>	<b>R</b>
Acme Apparatus Co. ....1396	Electrad, Inc. ....1386	Kamstone Holding Corp. ....1404	Radiall Co. ....1400
Acme Electric & Mfg. Co., The 1398	Electric Specialty Co. ....1393	Karas Electric Co. ....1394	Radio Association of America ..1393
Adams-Sibley Development Corp. ....1389	Emerson-Radval Corp. ....1403	Kellogg Switchboard & Supply Co. ....1372	Radio Corp. of America ....1371
Aero Products, Inc. ....1394	Engineers' Service Co. ....1404	Kodel Radio Corp., The ....1404	Radio News Ensemble ....1403
Aerovox Wireless Corp. ....1384	Erie Fixture Supply Co. ....1400	Kokomo Electric Co. ....1399	Radio Specialty Co. ....1379
Airgap Products Co. ....1402			Randolph Radio Corp. ....1404
Alden Mfg. Co. ....1390			Raytheon Mfg. Co. ....1392
All-American Radio Corp. ....1404			Rhodes Mfg. Co. ....1396
All Radio Co. ....1402			Rola Co., The ....1374
Allen-Bradley Co. ....1382			
American Auto & Radio Mfg. Co. ....1398	<b>F</b>	<b>L</b>	<b>S</b>
American Chime Clock Co. ....1386	Fansteel Products Co., Inc. ....1404	Lacault Radio Labs., R. E. ....1393	Sheridan Plaza Hotel ....1396
American Hard Rubber Co. ....1400	Ferbend Electric Co. ....1376	Lacey & Lacey ....1389	Shure Radio Co. ....1392
Amplion Corp. of America ....1390	Ferguson, Inc., J. B. ....1394	Lancaster & Allwine ....1394	Silver-Marshall, Inc. ....1386
Amrad Corporation ....1373	Ferranti, Inc. ....1384	Leutz, Inc., C. R. ....1397	Smith, B. Hawley ....1395
Associated Set Builders ....1395	Formica Insulation Co., The ..1383	Lignole Corp., The ....1388	Southern Toy Co., Inc. ....1387
	Freshman Co., Inc., Chas. ....1404	Lundstrom Mfg. Co., The C. J. 1392	Sparks Radio Service Co. ....1392
	Frost, Inc., Herbert H. ....1388	Lynch, Inc., Arthur H. ...1390-1404	Starrett Mfg. Co. ....1400
			Steinite Labs. ....1399
<b>B</b>		<b>Mc</b>	Stirling Mfg. Co., The ....1382
Barawik Co., The ....1396	<b>G</b>	McCarrie Schools of Mechanical Dentistry ....1400	Stewart Battery Co. ....1401
Bathgate Co., Inc., Walter ....1389	Gearhart-Schluetter Radio Corp. ....1394		Straus & Schram .....Back Cover
Bogue, B. N. ....1388	General Industries Co., The ..1398		
Boudette Mfg. Co. ....1382	General Radio Co. ....1402	<b>M</b>	<b>T</b>
Box 265 ....1390	Goodrich Rubber Co., The B. F. 1394	M & H Sporting Goods Co. ....1390	Tarbell System, Inc. ....1386
Brady, John B. ....1396	Gould Storage Battery Co. ....1387	Mars Novelty Co. ....1390	Thordarson Electric Mfg. Co. ...1392
Bremer-Tully Mfg. Co. ....1378	Gray & Danielson Mfg. Co. ...1396	Martin-Copeland Co. ....1399	Tilson & Tilson ....1400
	Grigsby-Grunow-Hinds Co. ....1314	Metro Electric Co. ....1398	Tower Mfg. Corp. ....1309
		Midwest Radio Corp. ....1404	Townsend Radio Labs. ....1380
<b>C</b>		Morris Park Radio Co. ....1387	
C. E. Mfg. Co., Inc. ....1395	<b>H</b>	Muter Co., Leslie F. ....1401	<b>V</b>
Carborundum Co., The ....1392	Hammarlund Mfg. Co. ....1388		Valley Electric Co. ....1395
Carter Radio Co. ....1396, 1402	Hampton-Wright ....1394	<b>N</b>	Vimco Mfg. Co., Inc. ....1388
Central Radio Labs. ....1384	Harco Co., The ....1398	National Carbon Co. ....1389-1399	
Chemical Institute of New York, Inc. ....1381	High Frequency Labs. ....1401	National Company ....1394	
Chicago Radio Apparatus Co. ...1402	Hommel & Co., Ludwig ....1382	National Radio Institute ....1313	
Chicago Salvage Stock Stores ..1386		Norden-Hauck, Inc. ....1385	
Consrad Co., Inc., The 1405, 1408, 1409, 1411, 1412		North American Bretwood Co., The ....1375	
Cooper Corp., The ....1402	<b>I</b>		<b>W</b>
Copper & Brass Research Ass'n 1401	International Resistance Co. ...1382	<b>O</b>	Walker Co., Geo. W. ....1384
Cornish Wire Co. ....1398	Interstate Sales Co. ....1388	Omnigraph Mfg. Co., The ....1399	Webster Co., The ....1400
Coyne Electrical Schools ....1400			Western Radio Mfg. Co. ....1402
Cresradio Corp. ....1402	<b>J</b>	<b>P</b>	Windsor Furniture Co. ....1397
Crosley Radio Corp., The ....1311	J-M-P Mfg. Co. ....1402	Parker, C. L. ....1392	Wirt Co. ....1400
Culver-Stearns Mfg. Co. ....1382-1402	Jewell Electrical Instrument Co. 1397	Pilot Electric Mfg. Co., Inc. ...1391	World Battery Co. ....1394, 1398
Cunningham, Inc., E. T. Inside Front Cover		Press Guild, Inc., The ....1384	
			<b>XYZ</b>
<b>D</b>			X-L Radio Labs. ....1404
Deutschmann Company, Tobe ..1392			Yahr-Lange, Inc. ....1388
Dexter & Sons, Inc., C. H. ....1390			Yaxley Mfg. Co. ....1390
Dodge's Institute ....1387			Zenith Radio Corp. ....1377

# FREE!

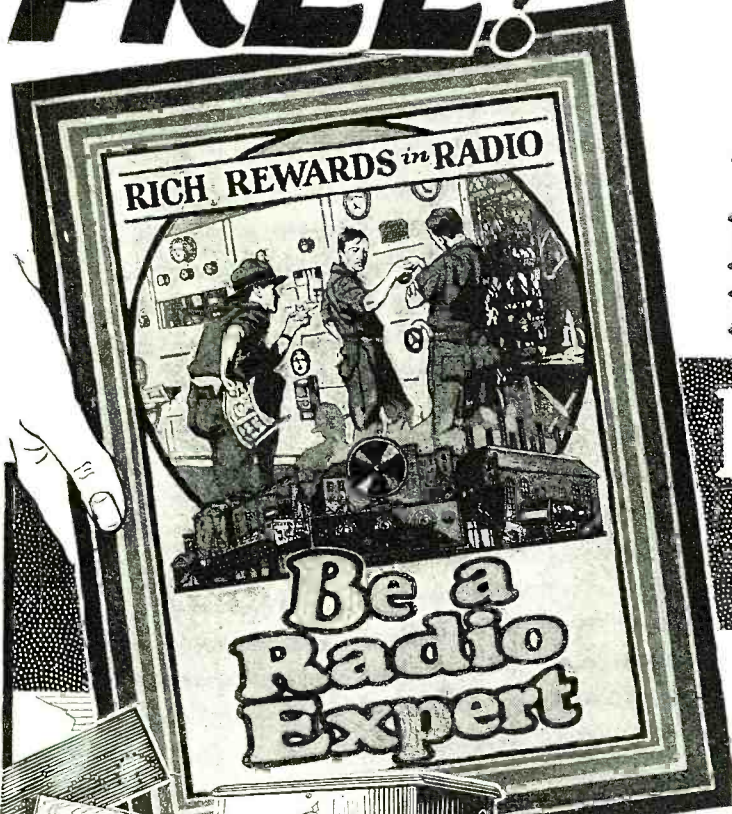

## “MEN! Here's the 'dope' you've been looking for

### HOW TO GET INTO THE RADIO BUSINESS”

J.E.S.

## EARN BIG MONEY in Work That is Almost Romance

If you're earning a penny less than \$50 a week, clip coupon now for FREE BOOK! New Book, 64 pages, profusely illustrated, tells all about the Radio profession, thousands of opportunities—in work that is almost romance! YOU can learn quickly and easily at home, through our tested, improved methods, to take advantage of these great opportunities! Why go along at \$25 or \$35 or \$45 a week, when you can pleasantly and in a comparatively short time learn to be a Radio Expert, capable of holding the big pay jobs?

### Clip Coupon for Free Book

Don't envy the other fellow who's pulling down the big cash! Our proven home-study training methods make it possible for you, too, to get ready for a better job, to earn enough money so you can enjoy the good things of life. One of the most valuable books ever written on Radio tells how—interesting facts about this great field, and how we can prepare you, quickly and easily in your spare time at home, to step into a big-pay Radio job. You can do what others have done through our training. GET THIS NEW FREE BOOK. SEND COUPON TODAY.

J. E. SMITH, President

NATIONAL RADIO INSTITUTE

Dept. EB-9

WASHINGTON, D. C.

### BIG RECEIVING OUTFIT INCLUDED IN COURSE

Instruments shown here and others—sent to our students free of extra cost.

Clip coupon now—find out all about this big unequalled offer while you still have time to take advantage of it. Our training is intensely practical—these instruments help you learn to do the practical work. Receiving sets, from simplest kind to thousand-mile receiver. Many other big features.



J. E. SMITH  
President

### My Radio Training Is the Famous “Course That Pays for Itself”

Spare time earnings are easy in Radio when you know it the way we teach you. Increase your income almost from the start of your course thru practical knowledge we give you. We show you how to hold the job, then our Employment Department helps you get one. Free book “Rich Rewards in Radio” tells how.

Howard B. Luce of Friedens, Pa., made \$320 in 7 weeks during his spare time. D. H. Suitt of Newport, Ark., writes, “While taking the course I earned in spare time work approximately \$900.” Earl Wright of Omaha, reports making \$100 in a short time while taking his course—working at Radio in his spare time only! Sylvester Senso, 207 Elm Street, Kaukauna, Wis., made \$500.

And when your training is completed you're ready to step into a real big Radio job like C. C. Gielow, Chief Operator of the Great Lakes Radio Telegraph Company; E. W. Novy, Chief Operator of Station WRNY; Edward Stanko, Chief Operator of Station WGR; and hundreds of other N. R. I. Trained men. The National Radio Institute, originators of Radio Home-Study Training, established 1914, today offers you the same opportunities these men had, under a contract that pledges you full satisfaction or money refunded on completing our training. It's your big chance to get into Radio—mail coupon for FREE Book and proof.

Coupon Brings Free Book Mail It NOW!

Radio Needs Trained Men

National Radio Institute  
Dept. EB-9  
Washington, D. C.

Dear Mr. Smith: Without obligating me in any way, send me your FREE BOOK, “Rich Rewards in Radio,” and all information about your practical, home-study, Radio Course.

Name.....

Address.....

Town..... State.....

## SEND THIS COUPON TODAY

It will never "Run Down!"

## Majestic "B" Current Supply

delivers pure direct current from your light socket

"B" Power at full strength  
any time and all the time

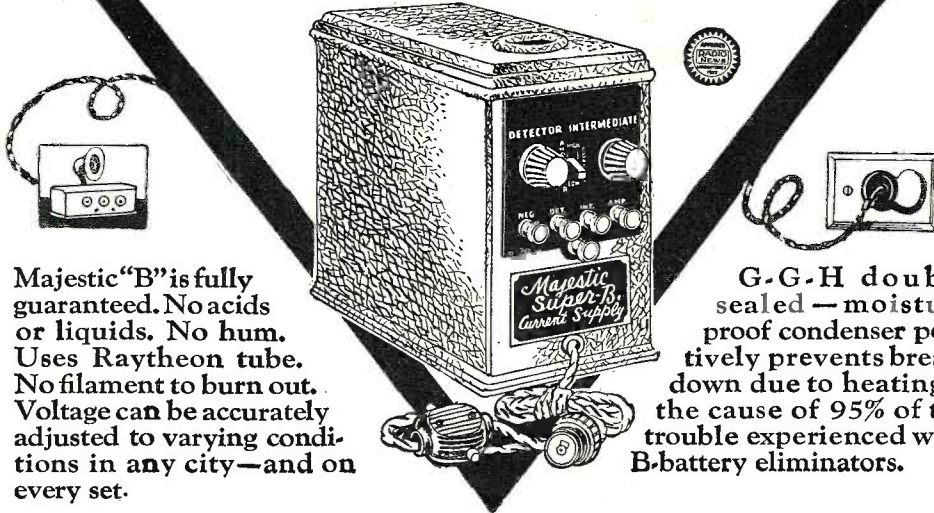

Majestic "B" is fully guaranteed. No acids or liquids. No hum. Uses Raytheon tube. No filament to burn out. Voltage can be accurately adjusted to varying conditions in any city—and on every set.

G-G-H double sealed — moisture proof condenser positively prevents breakdown due to heating — the cause of 95% of the trouble experienced with B-battery eliminators.

When you buy a Majestic "B" you say "Good-bye" to trouble

caused by poor "B" power. Majestic gives you an even, continuous flow of "B" current today, tomorrow — whenever you turn on your set. It's economical, too. When you put a "Majestic" to work it stays put. You'll never have to "replace" it as you did "B" batteries. Majestic's first cost is low, and the upkeep only a fraction of a cent per hour.

To know how good, really good radio reception can be, try a "Majestic" on your radio set. Your dealer will arrange a trial without obligation to buy. Phone him today.

**Majestic Standard-B**  
Capacity, nine 201-A tubes or equivalent. 45 milliamperes at 135 volts.

**\$26.50**

West of Rocky Mts., \$29.00  
Raytheon Tube \$6.00 extra

**Majestic Super B**  
Capacity one to twelve tubes, including the use of power tubes. 45 mils. \$**29.00**  
at 150 volts..

(AS ILLUSTRATED)

West of Rocky Mts. \$31.50  
Raytheon Tube \$6.00 extra

**Majestic Master-B**  
Positive control of all output voltage taps. For sets having high current draw or heavy biasing batteries. 60 mils. at 150 volts.

**\$31.50**

West of Rocky Mts. \$34.00  
Raytheon Tube \$6.00 extra

Can Be Purchased on Deferred Payments

GRIGSBY - GRUNOW - HINDS - CO. 4572 ARMITAGE AVE, CHICAGO-ILL.





# RADIO NEWS

HUGO GERNSBACK,  
Editor and Publisher

Editorial and General Offices, 230 Fifth Avenue, New York

Vol. 8

MAY, 1927

No. 11

## NEW RADIO "THINGS" WANTED By HUGO GERNSBACK

THE progress of Radio has been rather slow during the past two years. From the experimenter's standpoint there have been few really new things to occupy him. There have been no revolutionary circuits, nor, as a matter of fact, do we expect them. Radio progress during the past two years may be said to have been refinement and improvement of what we already had. But there are many things still to be worked out, and a great deal of progress, as a matter of fact, the greatest progress, is as yet to come. The trouble with most of us is that we follow the well-beaten path, and as a rule we follow the leader. Very few experimenters and designers have the courage to step out from well-worn radio paths, because, as a rule, they are afraid that the results of their labors will be called freaks or worse.

A condition of this kind, of course, does not worry the progressive man, who, many times, has seen the very thing that was condemned come into favor and acclaimed in the end. When, in 1908, for instance, I published the first book on radiotelephony, entitled "The Wireless Telephone," there was no such thing as a radiophone, because we did not then have the necessary vacuum tube. I described minutely many systems for accomplishing the thing, and I was laughed at by the press and others for my pains, but nevertheless it all came about practically along the lines I had predicted.

When, in 1921, I prophesied the single control, multi-tube radio set, it was said that such a thing was impossible of accomplishment, and the experimenters as well as the trade for years refused to work on such sets, but nevertheless they are an actuality today and will be the standard during the next two years.

The random thoughts which I set down here at this time may prove to be of a similar nature and time alone will tell whether the ideas are sound or not. RADIO NEWS, at my instigation, recently started a set-building contest along the Super-Regenerative lines. The Armstrong Super-Regenerator is one of the most wonderful circuits that we possess. It is believed that in time this circuit will be the one that may yet prevail, because by means of it we can, with one or two tubes, accomplish the same thing that is done today with anywhere from 6 to 10 tubes. Unfortunately the circuit has never been perfected, due to its critical nature, but it is believed that sooner or later a solution will be found which will make this circuit come to the fore.

It certainly deserves this recognition. The Super-Regenerator is the ideal set for portable purposes, and where room is limited, all of this providing it is built so that it can be controlled. Here is a most fertile ground for research and for experimental work, and I suggest to experimenters that they busy themselves with this circuit. Perhaps some new combination will be found that will solve the problem.

Right here I wish to say that it is not always the new and revolutionary thing that is apt to become important. Sometimes an old and forgotten principle can be brought to the fore under new circumstances. For instance, the principle of the Marconi Radio Beam System of today was discovered by Heinrich Hertz in 1888. It was minutely described by him, but nothing much was done for some twenty years, until Marconi picked it up again and is now utilizing it.

The same is the case with many other well-known radio principles, which may be found in text books, in magazines, and in the patent press. These things may have been obsolete ten, fifteen, or twenty years ago, but, due to later and newer developments of other apparatus, are of great importance today, or will be in the future.

At the present time there is need for the following new equipment: Experimenters and manufacturers need a new miniature vacuum tube. Such a radio tube, of the 199 type, should measure about 1/2-inch diameter by an inch to an inch and a quarter high, over all. This would make it the smallest tube commercially available. It could be equipped with a bayonet socket to take up little more room than the diameter of the tube, and with such a tube it would be possible to make a small portable radio set the size of a box camera.

RADIO NEWS has already taken the initiative, and is urging tube manufacturers to bring out such a tube, which we hope they soon will. It is felt that miniature radio sets will be in great demand. There is no such thing as a convenient portable set on the market today. Most of the sets made are far too large and too heavy. With these small tubes it should be possible to build a set that does not weigh more than two or three pounds, and that can be slung around the shoulder like a camera, to be taken on long trips, for vacation purposes, and for general traveling.

Furthermore, small sets of this kind can be made for apartment dwellers, and wherever a small set is needed to be carried from one place to another. It may be said that, given such miniature vacuum tubes, we would still need small condensers. It is possible to make

such condensers today, to take up a minimum of room, if such condensers are needed. It is known, for instance—a fact which has been forgotten for many years,—that by placing a variable condenser into castor oil, or some other high grade oil, the capacity of the condenser will be quintupled. In other words, by employing the oil immersion, we could make a 13-plate condenser one-fifth as large as we have at the present time for any given capacity. Furthermore, the equivalent of a 17-plate (.00035 mf.) condenser can be made by means of two metallic plates, separated by a sheet of mica. Of course the losses in such a condenser are comparatively high, but it is believed that these losses can be overcome by a greater efficiency elsewhere in the circuit.

It certainly is possible to turn out the equivalent of a 17-plate condenser in a space not larger than a paper book of matches. Inductances can be correspondingly small by means of the spider-web type of coil or even by means of a more efficient cylinder type of coils, wound with small wire such as No. 36 B. & S. gauge, enameled. It may be said that such coils also have losses, but we need not be concerned with this, because it is most likely that the set will have an oscillatory circuit, when it becomes necessary to kill oscillation anyway, and we might just as well have the losses in the coils or condensers as to get the losses by other "doctoring" means.

On the other hand, the future portable radio set, of the 5- or 6-tube variety, will probably not have any variable condensers at all. We may visualize the following system, which, to the best of my knowledge, has never been described so far.

Imagine three small stationary spider-web coils. Then imagine three like coils mounted on a shaft, all to be parallel to each other. The three spider-web coils mounted on the rotating shaft swing back and forth approaching the stationary coils, or receding from them. The scheme may be likened mechanically to three variable condensers mounted on one shaft, except that instead of the plates we have six spider-web coils, three stationary, three rotatable. The tuning is then done by means of the rotating shaft. The six coils, of course, will be the radio-frequency transformers functioning as variometers. The stationary coils may be the secondaries, and the rotatable ones the primaries, or vice-versa. Such coils can be made very small, and need not be larger than about 2 inches in diameter. The thickness need not be more than one-eighth of an inch. Shielding may be applied between the various units, if this be necessary.

We have here, then, a condenserless set, which should be excellent for portable purposes, and where there is a minimum of room available. Having disposed of the small tube, the small condenser (which, after all, may not be needed), and the problem of small inductances, you may now rightly ask, "What becomes of the aerial and ground?" Here again there seems to be no difficulty. I have tried, with very good success, a device which I call the "Cane Loop," and which was made up as follows: I wound rather heavy single-conductor lamp cord on a stick 1/4" in diameter by 33" long. This used up approximately 100 feet of wire. The "Cane Loop" can be used like any other loop, and is directive, as is the regular loop, and while it may not be quite as efficient, it still does the work nicely and brings in distant stations very well.

The "Cane Loop" can be used either horizontally or vertically. It may be laid on the floor or stood in a corner, or otherwise tucked out of the way. It has not quite the directive qualities of the square loop, which may be said to be a good thing, because it need not be rotated and turned, as does the usual loop. This, of course, makes it not quite so selective, but for purposes of portability, and where there is a minimum of room, it will prove ideal.

You will still say that such a loop is too big and can not be compressed into the space of a box camera. I already have an answer for this, as well. A collapsible and flexible "Cane Loop" may be constructed as follows: On a smooth broom handle start to wind 100 feet of lamp cord, similar to that described before, but see that between successive convolutions 1/2" cotton tape is placed in such a way that one turn of wire goes over the cotton tape, the next one under it, and so forth. There should be two such pieces of tape, one on each side of the "Cane Loop." Then, when the loop is finished, the ends of the tape may be sewed to the insulation of the wire, and the broom handle may be slipped out. This gives a flexible sort of "snaky" loop which may be rolled up into a very small compass and placed on the inside of the portable set. When you need it, pull it out and let it hang down, to be used in this position. There are, of course, other ways by which to arrive at the same results, as, for instance, using thin twine instead of tape, etc. Another flexible loop of this kind can be made by winding the wire on a rubber hose, although this is not quite as effective, because it can not be rolled into such a small compass as by the other method described.

*... In which the Editor comments on the present tendency in radio circles to follow the well-known Calf Path—and suggests a few profitable lines for future experiment—what the Super-Regenerator promises—the need for truly portable sets—and the desirability of commercial apparatus to make them practicable—new tubes, new condensers, new coils—and finally adds a practicable "scrinkle" of his own invention—the "Cane Loop," which makes a most compact and portable antenna for any set ...*

Mr. Hugo Gernsback speaks every Monday night at 9 P. M. from station WRNY on various radio and scientific subjects.

# Radio Aids to Navigation

## Radio Compass and Direction Finder Are Explained

By C. WILLIAM RADOS

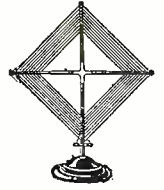
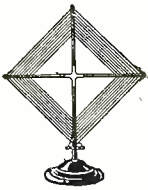

**I**T is a dark, stormy night. Thick, wet, impenetrable fog descends. Soon the decks are wet, the vision is cut off and the ship slows down to a slow speed. The fog horn blats forth its long roars while the officers vainly try to pierce the gloom. But while they cannot see, there is a means by which they can determine their direction and their position. Radio furnishes both, accurately and quickly.

Years ago, a ship in fog was lost: lost not only to the sight of others but even to the men operating it. They could not tell where they were. Many cargoes and lives paid tribute to this terrible demon, Fog.

In contrast to conditions in the old days, we have now on shore the radio compass stations operated by the United States Navy and furnishing the position of a vessel at request. On board the vessel there is the direction finder by which the ship's officers can determine what course they are on, and where they are, without asking or waiting for any stations or radio operators. As the radio compass station is the older of the two systems, the Navy system will be described first.

At every large and important harbor, the Navy has erected a radio station for the express purpose of furnishing any and all vessels with position bearings, by radio. The transmitter has about it nothing peculiar, except that in many cases it operates from a remote-control system. Spark and tube transmitters are used. The receiving equipment is somewhat unusual, however. A carefully calibrated loop-receiver is used. Three stages of radio-frequency amplification precede the detector tube. Only the first and detector circuits are tuned by condensers, the other two stages being coupled with iron-cored fixed transformers. In appearance then, the set is a two-dial affair with the four tubes all in one cabinet, and greatly resembles the standard Navy tuners, IP-501, SE-143, etc. With this receiver an external two-stage audio-frequency amplifier of conventional design is used. Shielding, verniers, calibrated dials, a wave-length range of 250 to 1400 meters, rugged construction, and excellent performance are some of the characteristics of these sets.

With the receiver is used the well-known loop. While in theory the loop does not

differ a particle from the loops one sees everywhere in the radio stores, the Navy loop is much better constructed, and is calibrated. It is placed several feet above the receiving equipment and rotated by the operator. Switches enable him to secure any adjustment of the twelve turns of insulated wire which form the loop.

As the loop is connected to the grid and filament circuits of the first tube, we see that an unbalanced situation exists. The grid circuit is very short. The filament circuit (to ground, etc.) is very long. To compensate this condition, a "balancing condenser" is used which connects from grid to ground. When continuous-wave signals are being received, this is varied to the proper position, as indicated by the sounds in the telephones. With all the compass installations an accurate clock is furnished.

### OPERATION OF COMPASS

When a ship desires a radio-compass bearing, it calls any compass station within range and sends "QTE?" This signal, on 800 meters, means, "What is my true bearing?" The compass station signals back to transmit on 800 meters. While the ship transmits, the receiving operator swings his loop until the ship signals fade out entirely;

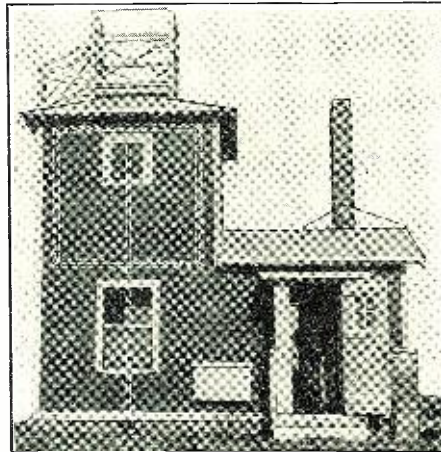

As indicated by the dotted lines, the loop antenna is in the upper part of the house. Photograph courtesy of U. S. Navy.

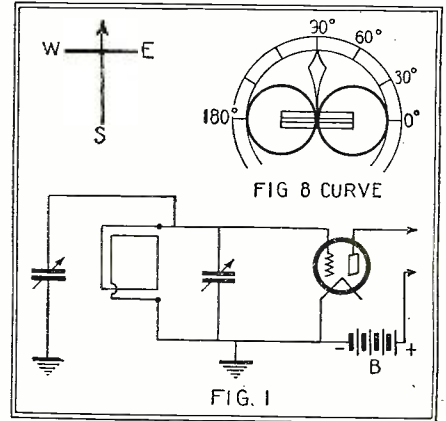

To find the exact bearing of a ship or beacon it is sometimes necessary to reverse the connections to the grid of the tube.

if impossible to eliminate them, then the loop is swung to the minimum sound. At the minimum position the operator stops; he reads the bearing of the compass pointer and signals the result, with the correct time, to the ship. If a bearing from another shore station is procured, the ship will know its position accurately. If only one station is within range the ship may obtain one bearing, then steam along for some minutes and obtain a second report. Then, by a matter of simple mathematics, the navigator determines his position. Where a group of three compass stations is located, at the entrance to an important harbor, like San Francisco or New York, one request from the master of the ship is answered by the reports of three simultaneous readings from as many independent receivers. This is a very accurate means of determining the ship's position.

### DIRECTION FINDER

Valuable and helpful as this system is, it has serious shortcomings. In time of fog, when every ship on the coast seems to "open up" with full power and asks for bearings, the congestion is heaviest and the delays longest. Since ships on the coast are in great danger during fog, it is imperative that they be furnished information at once. The radio compass on shore cannot do this; hence shipping companies are installing the direction finder, or loop equipment, aboard ship. This very handy device enables the navigator to get his own bearings from the shore station without waiting. Around the important harbors, the government has erected tube transmitters operating on 1000 meters. These are automatically operated and are of one-half kilowatt, I.C.W. type. Every hour in clear weather, and continuously in foggy weather, these transmitters send out series of dashes similar to the lighthouse code signals. For instance, station A may send three dashes for twenty seconds, and then remain silent for twenty seconds. Since this information is recorded in the navigation bulletins, ship captains and radio operators may readily determine what station they are hearing.

The captain dons a pair of 'phones. Swinging the compass loop, which is up above on the "flying bridge," he turns it to a position where he can no longer hear the dashes and dots of a radio beacon. He glances at the pointer of the compass loop dial. It reads, say, N.N.W. Then swinging his loop again, he picks up another compass beacon and gets a bearing line from that station. In this

(Continued on page 1401)

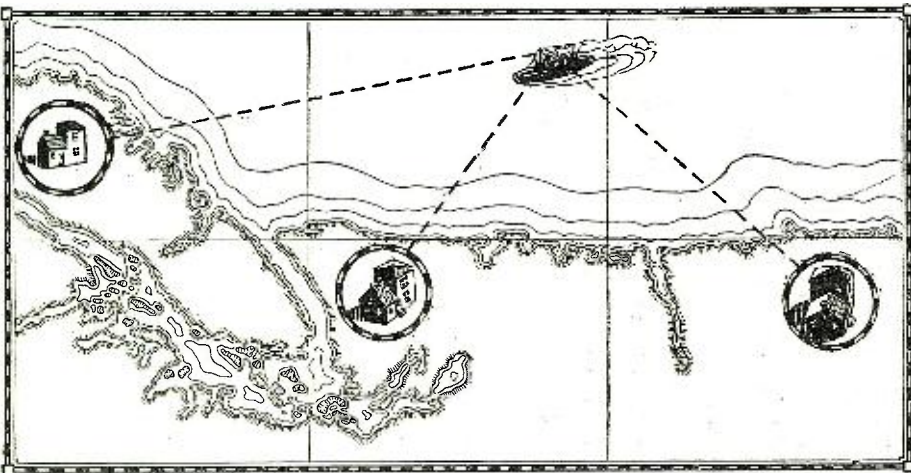

By a simple method of triangulation, a ship captain can determine his position by means of radio signals, answered by the shore compass stations sending the ship its bearing.

# The Pleasures of "Hamming"

How a 100% Radio Amateur Combines His Hobby  
and His Education

By ANDREW R. BOONE

FROM his battered and patched shack, which shivers and shakes in the face of inconsiderate winds sweeping in from the Pacific Ocean and across San Francisco Bay, Brandon Wentworth, 20 years old and a senior at Stanford University, California, talks regularly to his friends, on all continents and aboard ships in all oceans, on 20- and 40-meter bands. For a year and a half now he has plied his key on the hill, which sweeps the magic Santa Clara valley for miles around and San Francisco Bay toward the northeast, free from local power-line and radiating-receiver interfer-

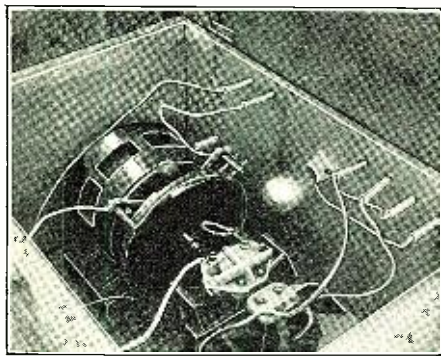

The synchronous rectifier built by Mr. Scofield for 6OI.

ence. No trees or nearby mountains threaten. His messages are free to shoot out in all directions.

Pacific Coast amateurs experience difficulty in crossing the mountainous barriers during daytime. Wentworth strove faithfully to get across the United States during the lighter hours and even hoped to add the Atlantic Ocean to his eastern daytime radius, but never succeeded. Twice a day, at 7:30 A. M., and at the same evening hour, he clamped his headphones tightly to his ears and, for an hour or longer on each occasion, strained for whatever auditory impressions the air would bring from the European continent or England.

His first satisfactory reward crashed about him on a cold morning—across the Rocky mountains or bouncing on the waves of the Pacific—the signals of Operator E. A. Mayer, G-2LZ, Wickford, Essex, England. "Some DX 16,000 miles, hi!", the Britisher appended to his verification card forwarded to the American conversationalist that day. 6OI, as Wentworth's station is known, had called G-2LZ at 7:30 A. M., Pacific Standard Time, and worked him with a signal intensity of "R3".

## IN TIME OF EMERGENCY

Nor is this Wentworth's only good work. His name first carried around the world from Santa Barbara when that city was stricken by the 1925 earthquake. Well within an hour after the major quakes the amateur, luckily on the spot, had brought together a few batteries and a very old spark outfit and in a short time was in touch with a ship off the immediate coast. This operator in turn communicated with naval headquarters at San Diego and a fleet of destroyers was dispatched with guards aboard to prevent rioting in the stricken city.

Wentworth, working under special orders

from the mayor, was the first to communicate with the "outside world," and for four days, or until commercial companies had restored their lines, handled 500 messages daily with amateur station 6ZH at San Ysidro, near Los Angeles.

In his cabin, one's eye is first attracted to a bank of DX cards tacked to the wall above his transmitter. Two of his prizes show he talked with G-2LZ and NTT, the U. S. S. *Scorpion*, when the latter was off Trieste, Italy; he was the first Pacific Coast amateur to work the United States navy in European waters.

The list of countries reads like the stops on a world cruise, for he has piled on his desk verification cards to prove communication with all districts of Canada, Alaska, Panama, Cuba, Mexico, Brazil, Argentina, Chile, England, Italy, South Africa, Australia, New Zealand, Japan, China, Philippines, French Indo-China, India, Hawaii, Tahiti, Samoa, Tasmania and Haiti. "Some DX! Hi!"

## THE EQUIPMENT

The transmitter of 6OI uses a 50-watt tube in a three-coil Meissner circuit, of tuned-grid, tuned-plate type and low-loss construction, having a normal input of 200 watts, to cover both the 20- and 40-meter bands. For its power, rectified alternating current is brought into the shack through a synchronous rectifier, built by the "chief engineer," Philip Scofield, a young graduate electrical engineer and half-owner of the station. The cost of this particular bit of the apparatus totaled \$15.00, which included one burned-out motor (obtained gratis from the Federal Telegraph Company's station near Stanford), a 2-kw. 6600-volt transformer, similarly rebuilt, and the amateur's time. The source of the power is a 4400-volt

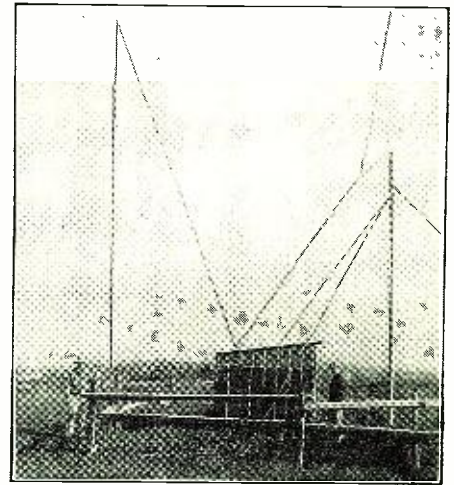

The antenna system of 6OI, above the shack, which overlooks San Francisco Bay.

line from Stanford University, two miles away.

The receiver uses Schnell's hook-up, with a wavelength range of 15 to 100 meters. It, too, is low-loss; a two-tube affair with one step of audio amplification. At the outset Wentworth maintained a wavelength of 200 meters, but moved down to 40 and 20 when he found he could get greater distance, for both sending and receiving, on the lower bands. The receiver and wavemeter are of sturdy construction. There is no wavering in their performance, even though they are amateur-made.

Except for the rectifier, all the apparatus was made during spare time, before and after classes. Some of it may not be expertly finished, but it has cost very little; for the amateur is a student of economics, not electrical engineering. He heats the shack, for instance, by means of two coils salvaged from a burned-out heater and installed in an inverted tin sauce pan. Total cost: \$0.15.

The apparatus is not "fancy stuff," but is serviceable and stable. Wentworth has built for efficiency, low power and low loss, as

(Continued on page 1382)

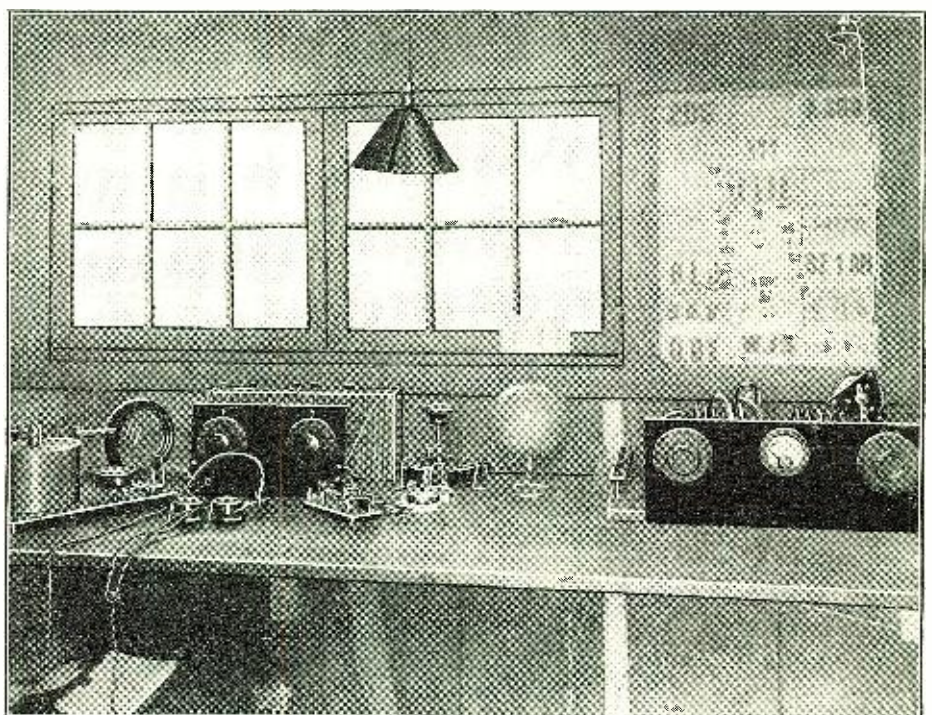

Interior of 6OI; left to right, wavemeter, receiver, using Schnell hook-up, range 15 to 100 meters; keys, switches and plate-power rheostat; globe, stuck with pins of stations received; and the transmitter; all built by Mr. Wentworth. A thick stack of DX cards is piled behind the wavemeter.



# What Is Next In Home Entertainment?

Combination of Motion Pictures and Radio Reception Available

By EARL C. HANSON



**R**ESearch for years in the science of cinematography has resulted in the commercial development of motion-picture equipment adaptable for use in the home. In order to make this

proof cabinet to contain the motion-picture projector.

Music to accompany the showing of the film may be produced by the high-power vacuum-tube electric phonograph described

trical phonograph may be mounted in a suitable cabinet together with a loud speaker, (electrical energy from the home-lighting circuit actuating the apparatus), and a motion-picture screen. When it is desired to use this screen, it may be placed in an upright position in one section of the front of the cabinet. At other times it is retained in a space provided for it directly below the top of the cabinet. A loud speaker of the cone type, for example, could be placed behind the screen.

The motion-picture projector may be placed in a cabinet lined with acoustic felt, such as used in broadcast studios, sounds from the projector mechanism being thus confined. Opening the cabinet to put on new film reels allows any accumulation of heat produced by the special electric lamp to escape. In the same cabinet, in a separate compartment, are the electric phonograph-motor, turn-table, suspension arm, and magnetic pick-up. With this arrangement the person operating the equipment may change records and films without stepping across the room to the cabinet containing the screen, loud speaker, etc.

By means of a remote-control board the operator of the phonograph-projector unit may shut off room lights, start and stop the phonograph motor, govern the volume of sound emanating from the loud speaker, change the artistic lighting effects of the cabinet, tune the radio set and operate the lights in the projector and phonograph-motor compartments of the cabinet. One form of this remote-control unit is shown in the illustration of the writer's experimental cabinet. In one end of the cabinet the induction-type phonograph motor, the magnetic pick-up, and the suspension arm may be seen. A miniature electric light is mounted on the pick-up to facilitate the changing of needles.

When the moving-film type of phonograph records is available to the public for use on electrical reproducing instruments, instead of the present disk type using needles, the disadvantage of changing records every few

(Continued on page 1398)

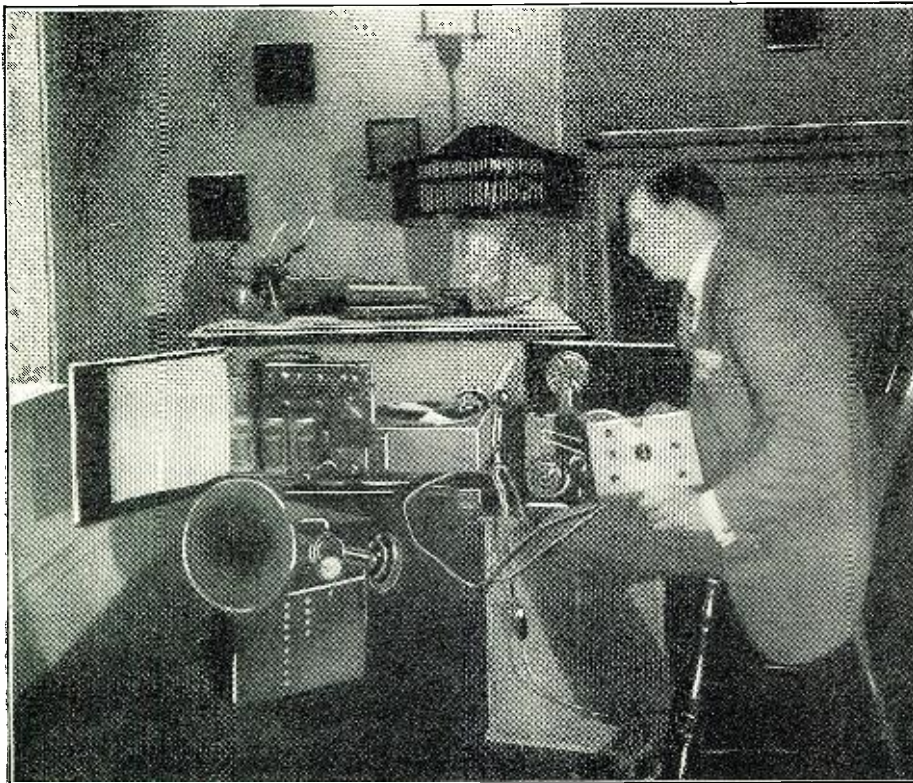

The author's experimental home-entertainment cabinet for reproduction of moving pictures, accompanied by music from radio broadcasting or a phonograph, as preferred.

practical it has been necessary to perfect, first, a miniature machine for taking motion pictures; second, safety films; third, a compact projector; and fourth, a sound-

in an article entitled "Electrifying Your Phonograph," appearing in RADIO NEWS for December, 1926, or by a radio receiving set. The radio set and audion-amplifier elec-

## The Radio Act of 1927

### 69th Congress Passes Act Greatly Needed by Radio Industry

**R**ADIO NEWS is pleased to print here the entire Radio Act of 1927, for the benefit of our general readers, as well as the entire radio industry, who may have occasion to refer to the new act, which is now law.

The new Radio Commission has assembled at Washington, and is already in action. It is everyone's hope that the Commission will be able to work out the tremendous problem which now confronts it, of bringing order to the broadcast industry, and to insure that the rights of listeners, as well as the rights of broadcasters, will be brought into a harmonious co-ordination. While, of course, the rights and the wishes of the public are paramount, and while radio broadcast stations should serve, first and last, the listening public, it should not be forgotten that the broadcasters have their rights as well; because in many instances they have expended fortunes in the erection of their stations, and one of the greatest problems that face the new Radio Commission will be to see that the capital investment of these

broadcasters is not destroyed. While difficult of solution, it is not impossible.

It is most fortunate that the selection of the Commission has been so wisely made, because practically the entire Commission is composed of men who know radio in and out, and who may be trusted to work out a solution that will be acceptable to the public and to the broadcasters as well.

The new Radio Law is a compromise between two bills and, as is the case with most compromises, it is not 100 per cent. perfect. It is, however, the best that could be obtained under the circumstances. A law was badly needed, and it is to be hoped that the provisions in the new law are adequate to meet all conditions.

On the other hand, it should be noted—and RADIO NEWS has pointed this out a number of times—that, in the end, the present troubles of radio can not be wholly eliminated by any law. They are, first and last, a technical problem, and sooner or later the present law will be obsolete in many respects; because the radio engineers will have

solved the troubles caused by interference. If it were possible, at the present time, to operate 5,000 broadcast stations in the United States without interfering, no law would have been needed.

As radio progresses, and as we learn more about radio itself, the time will come when practically all radio problems will have been solved by technical methods. Until we have arrived at such a period, the present law will be a great boon to the industry as a whole. In the meanwhile, the country is to be congratulated upon the appointment of a most excellent Radio Commission.

#### AN ACT

For the regulation of radio communications, and for other purposes.

Be it enacted by the Senate and House of Representatives of the United States of America in Congress assembled, That this Act is intended to regulate all forms of interstate and foreign radio transmissions and communications within the United States, its Territories and possessions; to maintain the control of the United States over all the channels of interstate and foreign radio transmission; and to provide for the use of such channels, but not the ownership thereof, by individuals, firms, or corporations, for limited periods of time, under

(Continued on page 1392)

# Radio News of the Month Illustrated

By GEORGE WALL

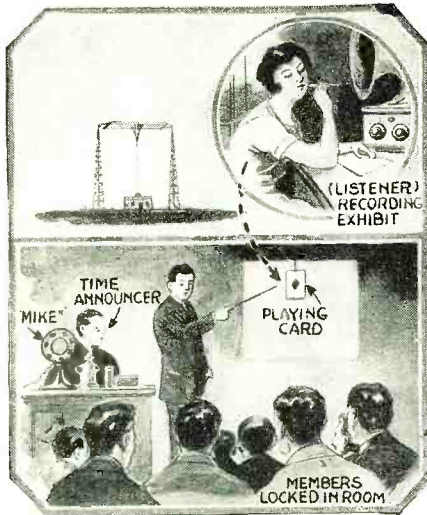

A group of six psychical experimenters were locked in a London studio: while listeners-in were asked by the announcer to concentrate their attention, and, if possible, tune in on the thoughts of the mental broadcasters. To synchronize this, the announcer held up a card, for instance; asked the group of thinkers present to picture it in their minds; and then requested the "thinkers-in" to make notes of their impressions and mail them to the Society for Psychical Research.

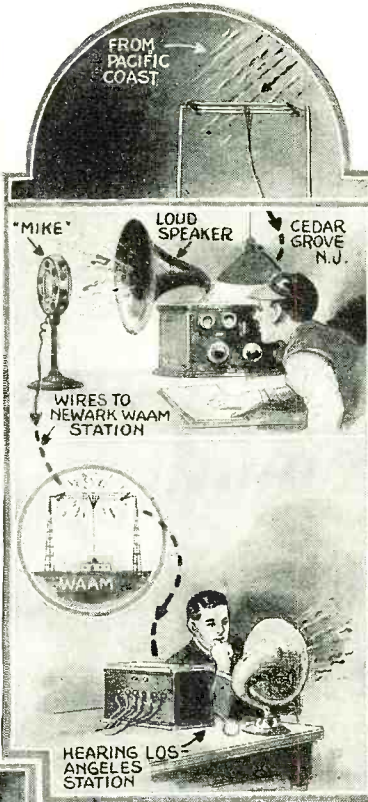

The procedure of rebroadcasting a distant station, without land-lines, is indicated in this diagram of a recent rebroadcast of California stations, picked up on a six-tube set, as shown, in Cedar Grove, near Newark. Very distant rebroadcasts have been effected from the transmission of programs on the shorter waves; Perth, Australia, has several times rebroadcast 2XAF, Schenectady (WGY's 32.79-meter transmission) on its own wavelength, at a distance of almost exactly half the diameter of the globe; and President Coolidge's Washington's Birthday speech was rebroadcast in Paris. It is also announced that 2LO, London, will rebroadcast American stations every Tuesday when conditions permit.

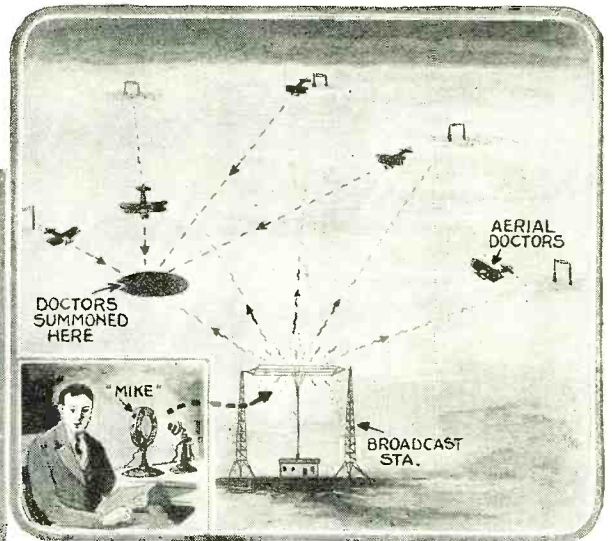

The Commonwealth of Australia has divided its sparsely-populated areas into zones, which may be covered by an aeroplane in an hour or two. To these have been assigned machines, which will serve as aerial ambulances for the medical men assigned to this work. While the radius of each zone is about 200 miles, in an emergency, a broadcast may readily summon a staff of physicians to report at any point where they may be needed. Short-wave transmitters would be exceedingly valuable in every isolated community.

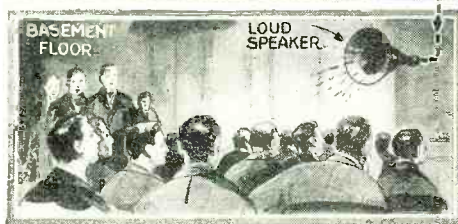
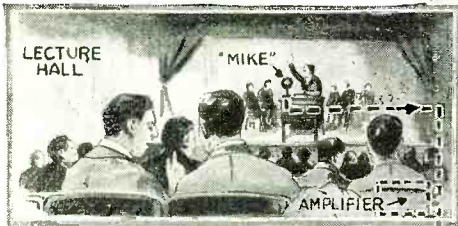

A recent meeting of fraternal organizations, several of which were not on particularly cordial terms with each other, was recently held in Jersey City. The problem of making one audience, without contacts which might have led to unpleasantness, was solved by dividing the attendance into two parties, one above and one below the main floor, who heard all that went on equally well. The police, who attended to preserve the peace, found it well enough kept without them. Radio has apparently solved the problem of bringing people together, while keeping them sufficiently apart to avoid the consequences of uncongenial propinquity.

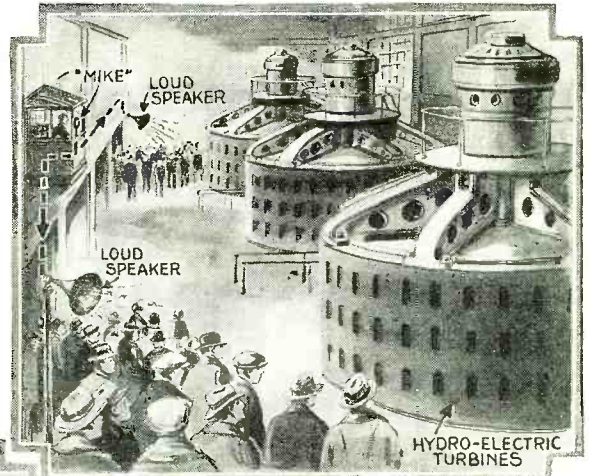

Niagara Falls has been broadcast: but radio has made the human voice audible even above the roar of the falls and the gigantic power plant beside them. Guides who show visitors over the latter found the greatest of difficulty in speaking to those beside them, until an amplifying system was introduced. Now they can be heard for hundreds of feet, without the need of straining their voices above the normal tone.



This ingenious advertising device has been called "The Voice from the Sky" by its promoters. The voice of the singer, John Charles Thomas, a well-known baritone, was carried down nearly a mile to New York crowds, which heard the words as plainly as if he had been among them. The amplifying apparatus weighs 1,500 pounds and requires over a horsepower to work the speaker unit. The possibilities, not only for publicity, but for use in the handling of commercial aircraft, and perhaps for military purposes, of this invention appear most interesting.

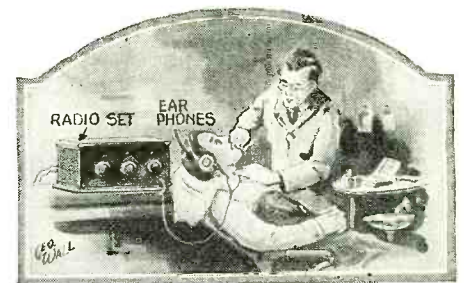

Radio may even alleviate that most acute of human miseries, the dentist's chair. Recent experiments have shown that minor operations can be readily performed, with local anesthetics, or even without, under the stimulating influence of radio music. It removes the element of mental shock, with which surgeons have so long had to contend.

# From Netherlands to Indies

**Holland's High-Power Radio Station at Kootwijk  
Gives Direct Communication  
with Java**

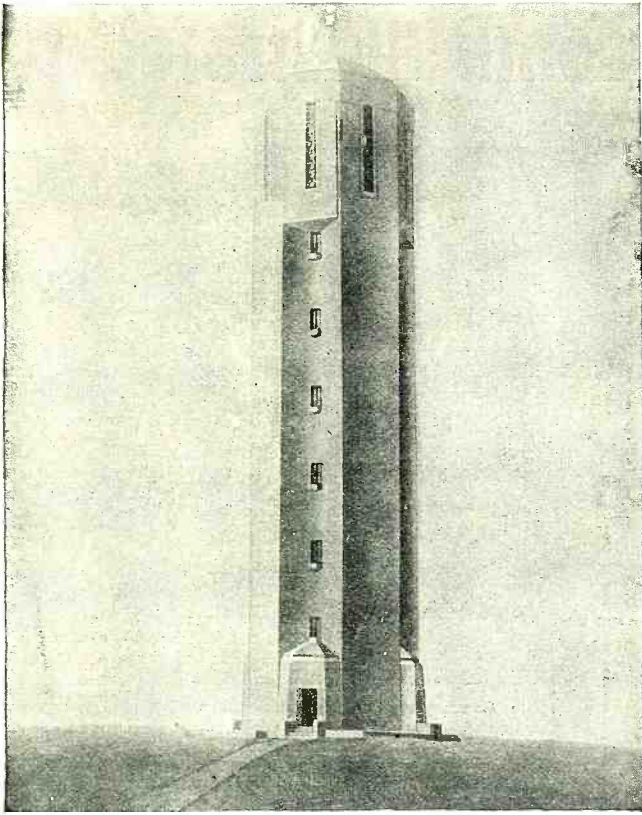

The water-cooling tower at Kootwijk.



Emblematic figures over the entrance to the station. These figures are symbolical of the union, by means of radio, of the peoples of Java and Holland.

**T**HE Netherlands have been among the last of the European countries with distant colonial possessions to establish means of direct communication with their colonies by the use of radiotelegraphy. This has presented many problems in establishing a link with her far-flung empire in the East Indies: for Java, most important of these distant outposts, and almost half-way round the world, is a hotbed of static.

The home station, PCG, of the Dutch radio system is at Kootwijk; and radio operators may hear it at intervals

through the day, on either 9,000 or 18,000 (approximately) meters, patiently transmitting at 15, or even 10 words a minute, and often repeating, in the endeavor to penetrate the eternal crash and roar of the tropical static that surrounds the operators at the corresponding station, PKX, in far-away Java.

The Kootwijk station, whose modern architecture and decoration is illustrated on this page, is equipped with high-frequency alternators; and the load placed upon these machines during keying is responsible for the peculiar and characteristic whine of PCG's note, familiar to operators.

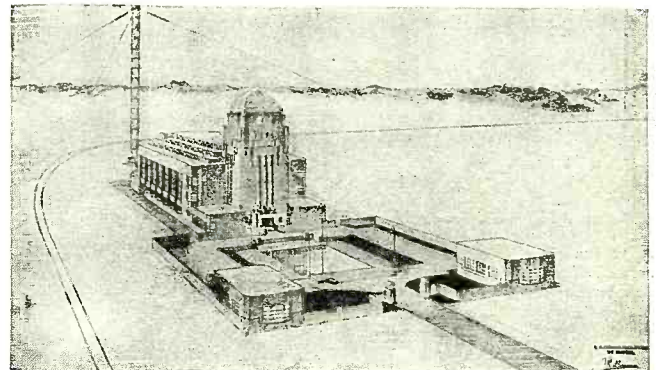
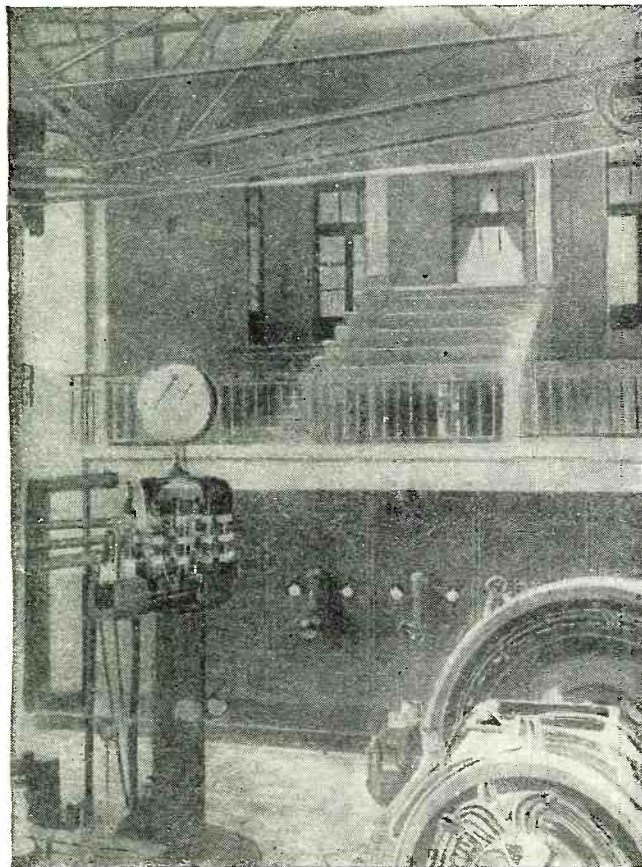

Above, a general view of the buildings and part of the antenna system at Kootwijk. A complete mat is formed by the radial wires of the ground system in the electrical shadow of the aerials, a model of which is illustrated below. At lower left, a partial view of the generator hall.

*Cuts supplied by A. Dinsdale*

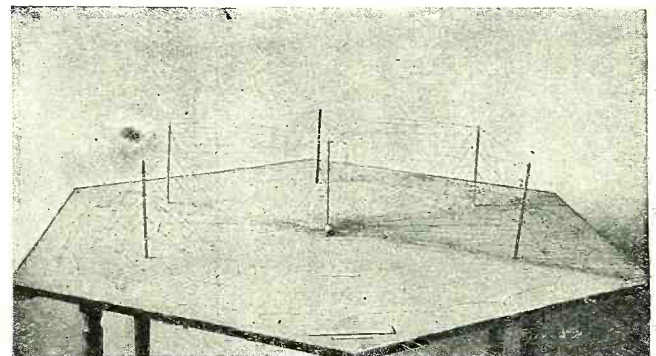

# New Argentine Station

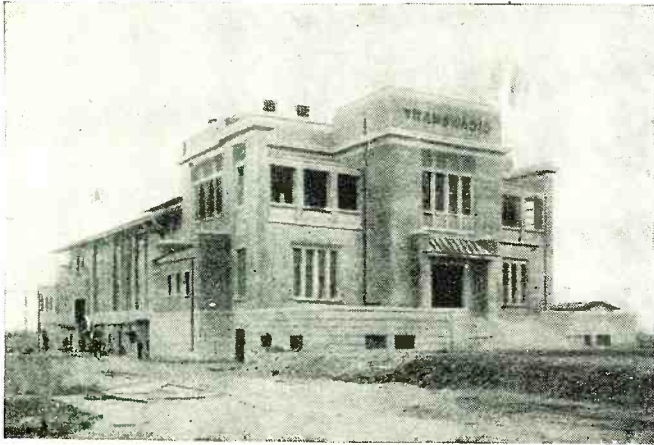

Above is an illustration of the recently-completed administration building of the station at Monte Grande, near Buenos Aires, which links the Argentine Republic directly with Europe. Below, a glimpse of the transformer room.

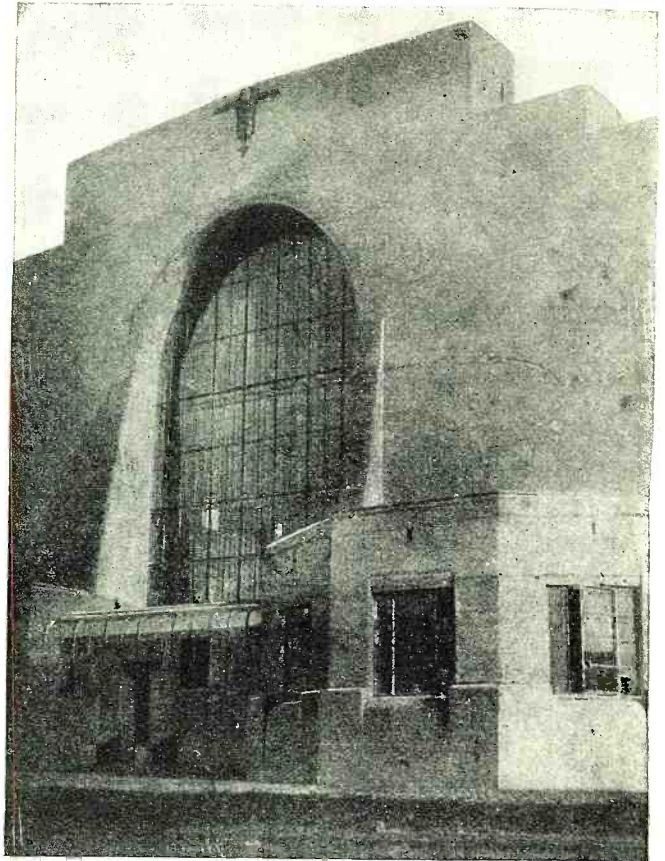

The entrance of the station proper, whose massive architecture may be compared with that of the Dutch building, shown opposite. Below, plan of the elongated aerial system at Monte Grande.

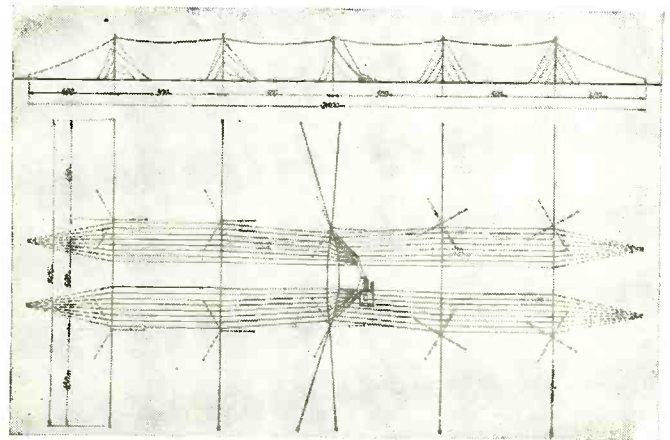
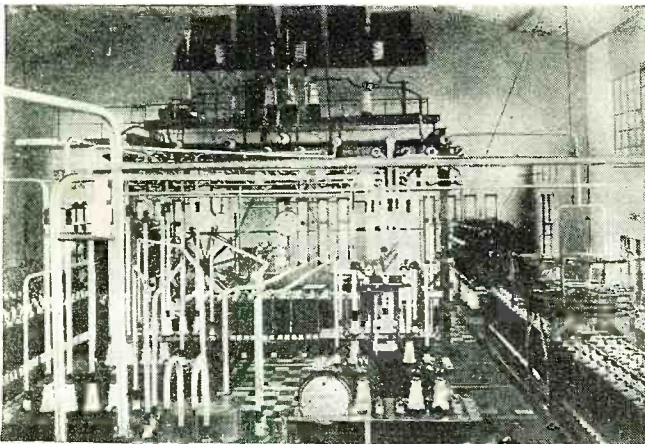

The lead-ins of the Argentine station are shown, at the opposite end of the building from that pictured at the top of the page.

Below is a striking picture of a power line insulator undergoing breakdown test in a German research laboratory. Voltages of between 80,000 and 120,000 are here seen at work, forcing currents to jump over the surface of the insulator to ground. Cuts supplied by A. Dinsdale.

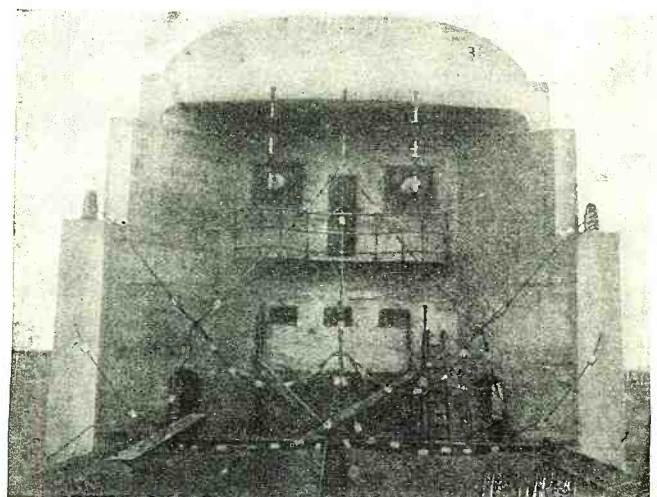
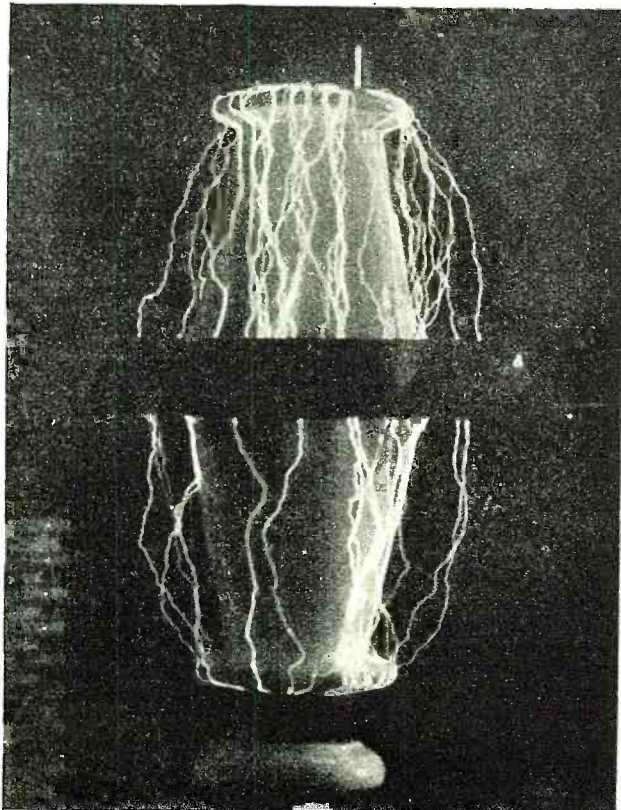

# The Radio Beginner

## Beginning Experimental Work

How the Constructor May Lay Out His Workshop Most Conveniently

By A. P. PECK

**A**FTER the first thrill of pulling in in a distant station on any multi-tube radio set, did you ever get the desire to find out a little more about what goes on inside the set, and just why it is possible for you to listen to music and signals which originate hundreds or perhaps thousands of

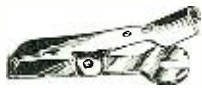

FIG. 1

By soldering a clip of this character to each end of an insulated wire, connections can be quickly made.

miles away? Or possibly your set didn't work quite up to your expectations; and you thought "Isn't there something I can do which will make this set operate more to my satisfaction?"

When this happens the average radio beginner is ready to begin experimental work; and, if he attacks the problem with the proper enthusiasm and with the proper guides, he will derive not only the pleasure of a hobby from it, but also much knowledge of the more technical side of radio work.

Since this department is devoted and dedicated to the Radio Beginner, we must naturally start at the very beginning of experimental work. This requires some study. Therefore, the first step in the process is to purchase two or three good books which deal with the fundamental principles underlying radio. There is a wealth of such material on the market today, and the majority of these texts are written in such a way that even the novice can grasp, after a little study and thought, the fundamentals of radio. Thus equipped, the experimental work offers greater fascination and becomes more practicable from the standpoint of the education of the experimenter, as well as from the angle of obtaining better results from existing radio sets.

While we are on the subject of books it might be mentioned, that if the reader is not quite sure of just what volumes to purchase, he will be supplied with a list of

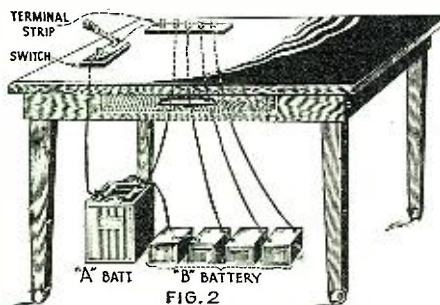

FIG. 2

How "A" and "B" batteries can be conveniently connected for testing purposes.

them upon receipt of a stamped, self-addressed envelope. Address the Editor, RADIO NEWS, 230 Fifth Avenue, New York, N. Y.

### WORKING "ON YOUR OWN"

Just what is experimental work? It consists of trying out various combinations of radio apparatus under different conditions, and determining for yourself just what particular combinations and arrangements best suit your taste, pocketbook and location. All three of these considerations must enter into the determination of the best radio apparatus to use for any particular set; and, in any case, they must be determined by each individual.

There are scores of different types of radio receiving sets described and illustrated in the various current periodicals, and the average radio constructor who is new in the game, usually wants to build them all. That is where he falls down, because he

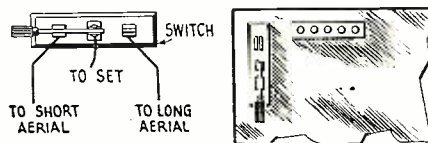

FIG. 4

The aerial lead-ins can be connected to a S. P. D. T. switch for testing.

tries to do too much at once. If, however, he would study the fundamental principles of radio as mentioned above, and then would sit down and study the various circuits as published in the magazines, he would soon see that there is much in common in most of them. He would find that they all are based on only a few fundamental circuits, and that sets which appear on the surface to be entirely different, are really very closely related. When this has been discovered, the trying out of the various circuits becomes simplified. It will not be necessary to try two dozen receivers, but a scant four or five will suffice. However, it will be possible and in fact profitable, to try out various pieces of apparatus in each set; and thus determine, for instance, which transformer seems to give the best results, or which combination of radio-frequency coil and variable condenser seems to tune best in any one particular circuit.

### EASY CONNECTIONS

For hooking up various pieces of apparatus there seems to be nothing better available at the present time than a quantity of short lengths of flexible wire with a clip soldered to each end. This clip may take the form of that shown in Fig. 1, and should be firmly soldered to one of the bared ends of the flexible, insulated wire.

This wire may be ordinary lamp cord. If the cotton covering of the cord is left in place, a turn or two of tape at each end,

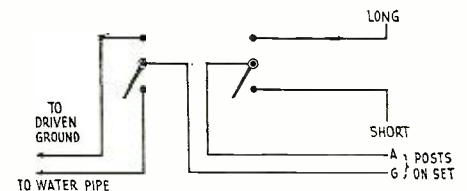

FIG. 5

This shows the connections for trying different aerial and ground combinations.

overlapping both the shank of the clip and the cotton covering, will prevent fraying. The writer, however, prefers to remove this cotton covering before soldering the clips in position. The wire is then a little easier to handle, does not get dirty as quickly, and there is no possibility of fraying.

It is advisable to have at least two dozen of these clip leads on hand, and they should vary in length from one foot to three feet. By using them to connect the various pieces of apparatus, the testing of a circuit will be greatly simplified, particularly if the breadboard layout described below is employed.

### THE WORK TABLE

The radio experimenter should preferably have a small room to himself, or lacking this, a plain wooden table in some isolated corner where it will not be continually disturbed. Then this table can be set up for the testing of various sets and apparatus in the easiest possible manner. Figs. 2 and 3 outline two different arrangements. In Fig. 2 the table is laid out for the use of "A" and "B" batteries to be connected to the set under test. These batteries are placed on the floor or on a shelf under the table and a series of five wires

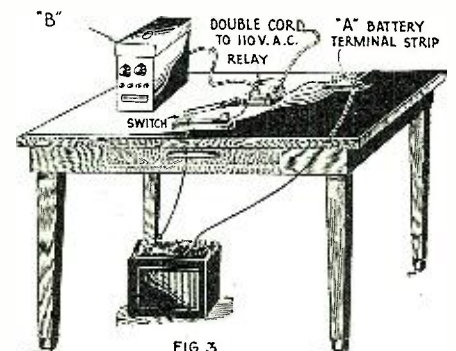

FIG. 3

Method of using a socket-power unit for supplying "B" current in a permanent testing hook-up.



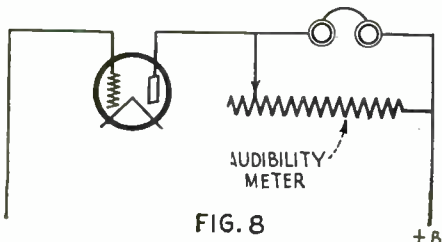

FIG. 8

How the audibility meter is connected in an output circuit.

run from the batteries to a terminal mounted on the rear left-hand corner of the table. This strip is merely a piece of hard rubber or bakelite 1 inch wide by 6 or 7 inches long, drilled with five holes for the binding posts. The binding posts are placed in position plainly marked according to the terminals of the batteries to which they connect, and the wires are soldered firmly to them. In this particular layout the negative "B" battery lead is permanently connected to the positive "A" battery lead. Two wires run from the "A" battery to two posts on the terminal strip. The other three wires are for plus 22½ volts, plus 67½ volts and plus 90 volts, from the "B" batteries. The lowest voltage tap will usually be sufficient for the operation of the detector tube, while the medium voltage may be applied to the radio-frequency amplifiers, and the high voltage to the audio-frequency amplifiers.

Located on the top of the tables and close to the binding post strip may be a small single-pole, single-throw switch, connected in series with the "A" battery circuit. This enables the experimenter to turn off the current at any time.

FOR HOUSE-CURRENT SUPPLY

The second table arrangement, shown in Fig. 3, is for those who possess a "B" socket unit. Together with this, it is recommended that an automatic relay switch be used. This is connected according to the diagram in Fig. 3 or according to the circular furnished by the manufacturer of the switch. This switch is to open automatically the 110-volt lighting circuit, which connects to the "B" eliminator when the "A" battery switch is open. Here again a small switch is connected in series with the "A" battery. One lead of the latter is wired as shown. The "A" battery itself is placed on the floor or on a shelf as mentioned before. The reason for placing the eliminator on the table and not on the floor is that the voltage controls will be more convenient to the operator.

AERIALS AND GROUNDS

Certain sets operate better with a long aerial than with a short one, or vice versa. Therefore, the really serious experimenter should erect two aerials, one not over 50 feet over all, and the other about 125 feet over all. These, for the purpose of comparative test, should run in the same direction. The lead-ins may then be connected to a single-pole, double-throw switch mounted on the table top or in the wall as preferred. See Fig. 4.

Two different grounds may be desirable: as for instance a driven ground which will give the best results in wet weather, and which may consist of several short lengths of iron pipe driven in the ground, to which a common connection is made by means of standard ground clamps; and another connection made to a water pipe or radiator which will usually give the best results in very dry weather. These two grounds may be connected to the set at will by means of another single-pole, double-throw switch placed in the vicinity of the antenna switch. When this has been completed it is

possible to obtain several different combinations, such as a short aerial with either one of the grounds or the long aerial with either one of the grounds. It will be noted that it is necessary only to connect the center pole of the switch to the set and the selection of antenna or ground may be made by dropping the switch to the desired point. It is advisable to mark the switch posts plainly so that there will be no question as to which antenna or ground that is being used at any particular time. The circuit in Fig. 5 indicates the connections to be made between the two switches and the two aerials and grounds.

THE SIMPLEST LAYOUT

Possibly the best way of laying out apparatus for experimental work is that known as the "bread-board" form. In order to facilitate this work it is advisable to have a standard bread board equipped with such apparatus as may be necessary in virtually all radio circuits; and then to add temporarily any other apparatus which it may be desired to test. Fig. 6 shows how this is accomplished. Four sockets, three automatic filament-control resistances, one rheostat, a grid leak and condenser, and a small switch are mounted on the bread board and wired up as shown. These wires are left permanently in position. Under ordinary circumstances they need never be changed for the testing of any particular circuit. A tiny single-pole, double-throw switch is connected in the circuit so that the grid leak may be connected either

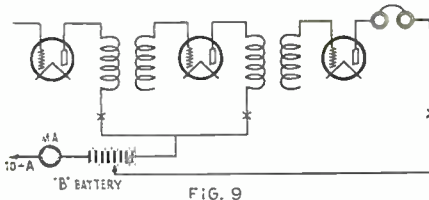

FIG. 9

How to connect the milliammeter in the plate circuits.

across the grid condenser or from the grid to the filament circuit.

It will be noted that this bread-board layout will be useful only for the connection of a radio-frequency and detector circuit. Therefore, a pair of phones must be used for testing this layout, unless a separate standardized one- or two-stage audio-frequency amplifier is added. This can readily be done, and the amplifier can be left permanently hooked up; for, in the final analysis, the majority of changes will be found in only the radio-frequency and detector circuits.

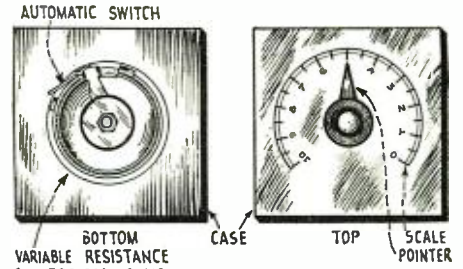

FIG. 7

The back and front of the audibility meter.

A HANDY DEVICE

A simple little piece of apparatus of immeasurable value to the radio experimenter is what is known as an audibility meter. This is exceedingly simple to make and is shown in various views in Fig. 7. The audibility meter is nothing more or less than a resistance valued up to 500,000 ohms. This resistance should have a minimum value very close to zero, and should be of the type shown; which is equipped with a circuit-opening switch, so that when the resistance value is increased to its highest point the switch will be opened and the circuit of the audibility meter will automatically be broken. In this way the meter can be left permanently connected in the circuit, and need only be turned to its "on" position in order to render it inoperative.

An audibility meter is connected directly across the phones or loud speaker as the case may be, as shown in Fig. 8. The phones or loud speaker are of course connected in the conventional manner to the output and "B" battery circuit of either the detector tube or the audio-frequency amplifier.

The audibility meter is calibrated, starting with its lowest figure at the point of highest resistance, and increasing in units or tens down to the point of lowest resistance.

The use of this audibility meter is as follows: Let us presume that you desire to test the relative efficiency, as far as signal strength is concerned, of two different types of radio-frequency transformers. One stage of radio-frequency amplification and the detector circuit are hooked up on the bread board and a moderately loud station is tuned in. This is done with the audibility meter set at its lowest reading, which is obtained with the automatic switch opened. The resistance is gradually decreased and it will be noted that the

(Continued on page 1388)

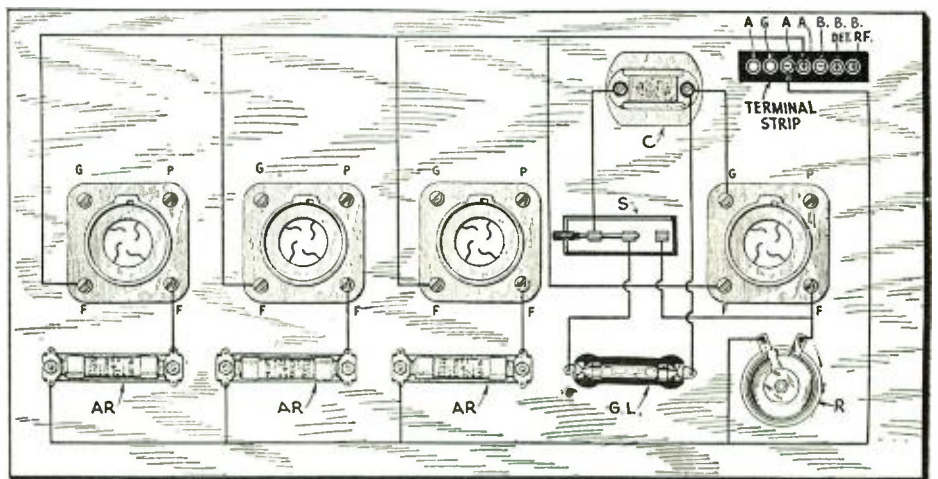

FIG. 6

The fundamental apparatus, arranged "bread-board" style, to which other parts can be easily added for testing.



# What's New in Radio



## FEWEST POSSIBLE CONTROLS ON NEW SIX-TUBE SET

THE ultimate in simplicity of control, probably, has been reached in the new six-tube, one-knob radio receiver of a prominent manufacturer. On the front panel of the set there is merely a single-tuning knob K, a combination switch and rheostat RH, an incidental switch SW, and a chassis fastening screw, W. The screw is fixed permanently in place and plays no part in the operation of the set, while the switch SW is touched only at rare intervals to overcome temporary conditions of interference.

The receiver is operated entirely by means of the knob K and the adjustment RH. A person desiring to hear broadcasting simply turns RH a few notches to the right and then grasps K in one hand; by revolving it slowly throughout the range of the indicating scale, he will be able to pick up station after station without finding it necessary to make supplementary adjustments of any kind. To turn the instrument off, he twists the button RH completely around to the left until he feels it stop.

The receiver is enclosed in a mahogany cabinet. All connections for the necessary batteries or socket supply units, loud speaker and aerial and ground connections are made through the back.

The six tubes are connected in a circuit to form two stages of tuned-radio-frequency amplification, a non-regenerative detector, and two stages of transformer-coupled audio amplification. This takes into account five bulbs; the remaining one, actually the first in the set, is coupled to the antenna through an untuned circuit containing a fixed choke coil. This coil consists of 400 turns of fine wire, wound jumble fashion on a form about an inch and a quarter in diameter and about half an inch thick. It is tapped at its eighty-fifth and its three-hundredth turn, the first tap leading directly to the aerial post of the receiver and the other through a 500-ohm fixed resistance to one side of the switch SW. Thus the choke may be considered as an auto-transformer, the entire winding being the secondary and the first 85 turns the primary.

This odd untuned arrangement obviates the necessity for individual adjustment of

each receiver for real single-knob tuning. If the antenna circuit were tuned, its constants would be seriously affected by different lengths of aerials and a second control in addition to the main one would be necessary to keep the entire receiver in

called "vernier" control. The condensers have a capacity of 350-mmf. each.

The mechanical construction of this six-tube set is both strong and ingenious. The front panel and the rear chassis or frame F are made of iron, rendered rustproof by

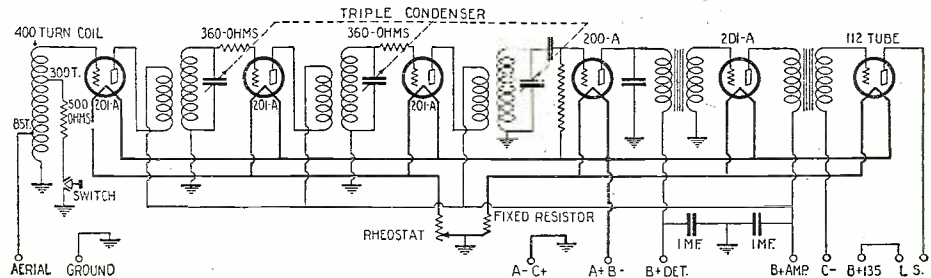

Complete wiring diagram of the six-tube, one-control receiver.

resonance. In this set even wide variations in antenna characteristics have practically no effect on the constants of the three tuned circuits; for the choke coil is untuned and therefore a little more or a little less antenna inductance and capacity makes no difference in the behavior of the first tube.

The three variable condensers C, tuning

a patented process. The chassis holds all the parts of the receiver, the front panel supporting the weight of only the tuning knob. The chassis and panel are held together by the switch SW and the aforementioned screw W.

A bakelite strip, SS, which holds the six tube receptacles and one R.F. trans-

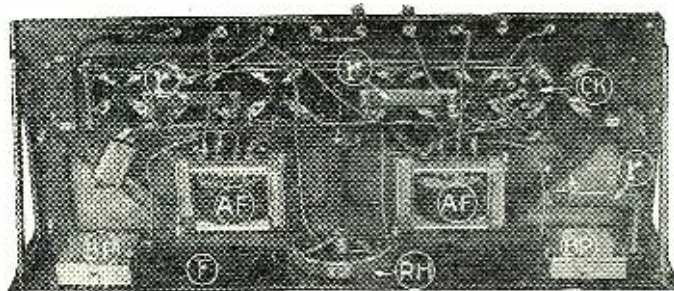

Under view of the set chassis of the 6-tube, single-knob receiver described on this page. Illustrations courtesy Chas. Freshman, Inc.

former RF, is suspended from sponge rubber straps in a long rectangular opening cut in the rear of the chassis. At the extreme back edge of the latter is mounted a terminal rack, TR.

The three R.F. transformers RF are very small coils, being 2 1/4 inches long and 1 1/4 inches in diameter. They are so widely separated that shielding between them is not used. The audio transformers AF, the rheostat RH, the by-pass condensers BP, the choke coil CK and the fixed resistors, (r) all are mounted on the under side of the set chassis. The resistance (r) in the lower right-hand corner is that marked 500 ohms in the wiring diagram. The other two are the 360-ohm grid-damping resistances in the R.F. circuits.

The metal framework of the receiver is grounded, forming the negative leg of the filament circuit. All lines in the wiring diagram leading to a ground symbol terminate at the framework.

The R.F. and A.F. arrangement of the set is of standard design, as can be seen in the hook-up. The rheostat which acts as the volume adjustment controls the three R.F. tubes, while a fixed resistor regulates the detector and audio bulbs. A 112-power tube is used in the last audio stage.

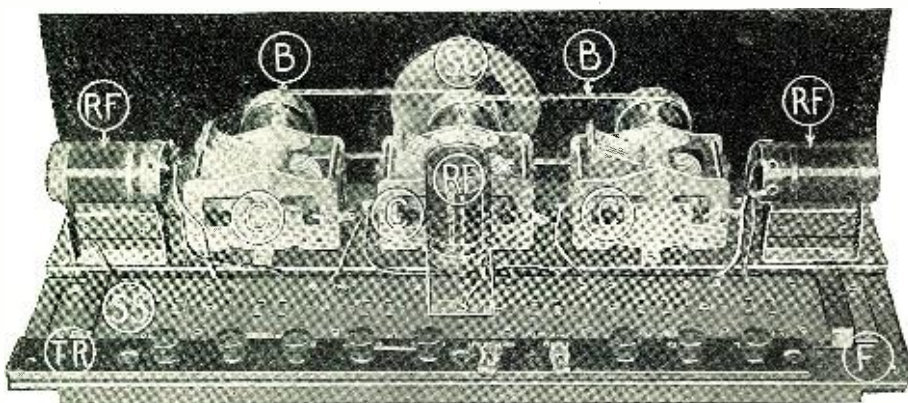

Rear view of the receiver unit. The lettering is fully explained in the text.

When the switch SW is pulled out, the 500-ohm resistance is thrown into the circuit, tending to decrease the sensitivity of the receiver. The set is deliberately deadened in this manner, the manufacturers explain, to eliminate the interference a distant station might be causing to a local broadcasting on the same wavelength.

In the table model, the outfit, over all, is 19 inches long, 9½ inches high and 10 inches deep. The panel is 18 by 7 inches, and the chassis is 7 inches deep in the rear. The front surface is finished in a dark-brown crystalline effect of pleasing appearance. The same electrical unit is also built into console and cabinet models containing cone speakers and battery compartments.

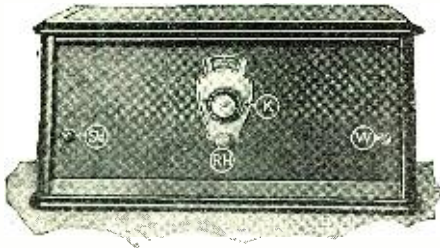

The simplicity of the front panel is evident in this view, from a photograph of the 6-tube set described on the opposite page.

**LOOP-OPERATED SET IS COMPLETELY SELF-CONTAINED**

A SELF-CONTAINED radio receiver which can be carried around conveniently and set up for use anywhere in a few minutes is now being produced by a Western radio firm. The outfit is a complete receiving station in itself, containing within its small case all the batteries necessary for the operation of the vacuum tubes, a loud speaker, and a loop aerial, in addition to the receiver unit proper.

The case of the set is made of leatheroid. All closed up for carrying, it measures 16x14x9 inches over all, and weighs forty pounds. While of course this weight would soon tire a person who attempted to carry the outfit by hand any considerable distance, the instrument is extremely compact, and may easily be handled like a small piece of baggage. It would be particularly valuable to the automobile owner going away for a week-end or even a day's jaunt; for it can

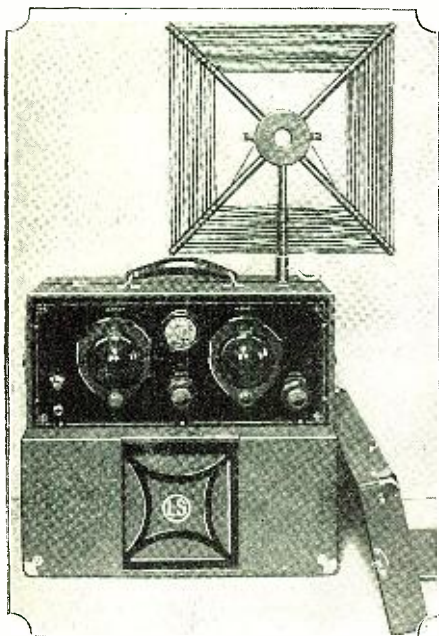

Front view of the portable receiver, set up ready for use.

Illustrations courtesy Kemper Radio Laboratories.

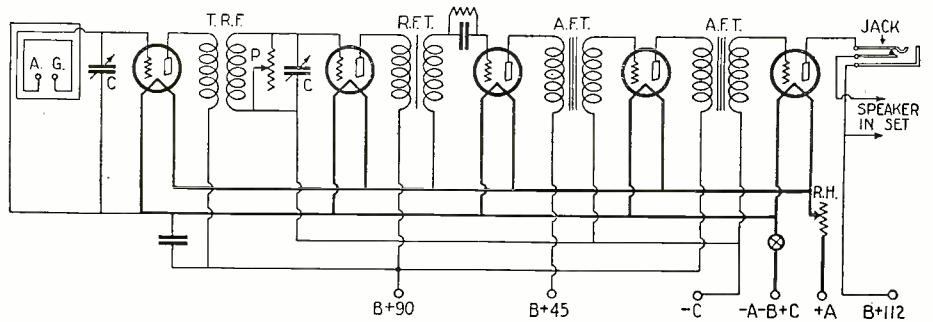

Wiring diagram of the five-tube portable receiver, illustrated below.

be thrown in with the golf bags and lunch baskets and will occupy little room.

The receiver employs five tubes, two as R.F. amplifiers, one as a detector, and two as A.F. amplifiers. The actual hook-up is given here on this page. The loop aerial is bridged directly across the grid circuit of the first tube, being shunted by a variable condenser C, which tunes it. Between the first and second tubes is a radio-frequency

hinged sections is such that when the front and back covers are closed in position all the compartments in the set are securely locked.

When the receiver is to be used, the owner simply unhooks the set front F, opens the back B, removes the loop therefrom, and pushes the plug attached to the end of the latter into a receptacle on the top of the case. He then snaps on the battery switch,

In this illustration of the portable receiver, opened from the rear, the tips of the tubes, T, the battery compartments BC, the loud-speaker unit SU, and the loop aerial L are shown.

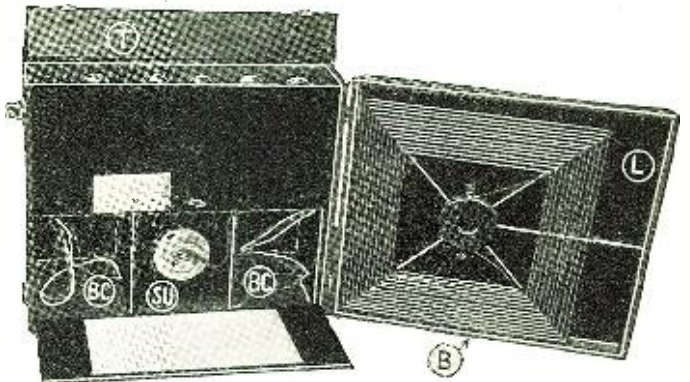

transformer, TRF, tuned by another variable condenser, C. The detector circuit is not controlled manually in the same manner as the preceding circuits, being coupled to the second stage by a fixed R.F. transformer, R.F.T. The tuned-R.F. stage is kept under control by means of the variable resistor P, which is connected directly across the secondary of the T.R.F. transformer.

turns the tuning knobs; and, if any stations within range are broadcasting, music soon floats out of the loud speaker.

A rheostat, RH, regulates the filament current to all five tubes in the set. The rheostat and variable-resistor knobs appear on the front panel of the receiver, the former between the two condenser tuning dials and the latter to the right of the right-hand one. A small voltmeter is also provided to enable the set owner to adjust the rheostat correctly for 199- and 201A-type tubes, either of which may be used.

The audio amplifier of the receiver is of orthodox design, using regular audio transformers of good quality. A jack of the single, closed-circuit variety in the lower left-hand corner of the panel allows the use of a pair of telephone receivers, if desired; normally, with no phone plug in it, it keeps the loud speaker connected to the last amplifier tube. The filament snap-switch is directly above the jack.

The containing case of this portable set is rather cleverly constructed. When it is completely closed, a T-shaped front, F, covers the loud-speaker opening LS, and the front panel holding the tuning controls. The loop aerial L, which is just thirteen inches square, fits inside the shallow back, B, which closes against the battery compartments BC, and the loud-speaker unit, SU, contained within the body of the case proper. The five tubes T are inserted through a narrow door in the top of the box. The arrangement of the various fastening snaps on the



The convenient size of the portable receiver, as it appears in its carrying case, can be judged from this photograph.

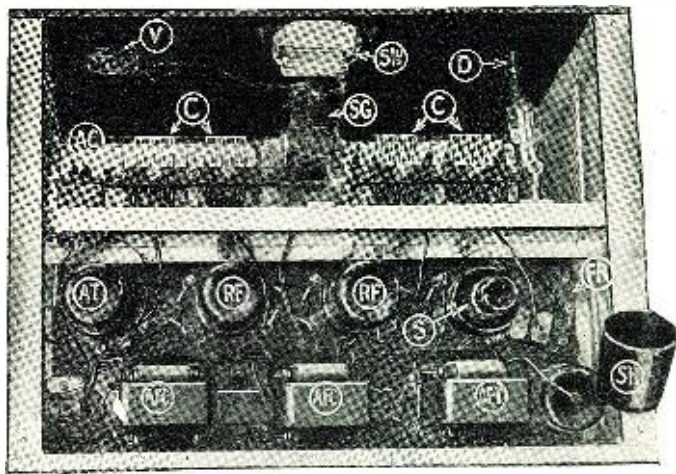
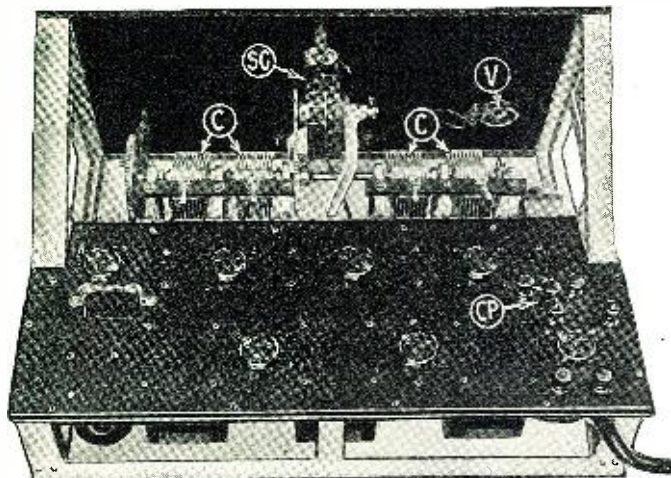

Left: Back view of the receiver, showing the quadruple tuning condenser and the bakelite sub-panel holding the tube sockets. Right: Under view, revealing the A.F. and R.F. components. The lettering corresponds to that of the wiring diagram and is explained below.

**SKILLFUL ENGINEERING IN SEVEN-TUBE RECEIVER**

THE radio set illustrated on this page is a high-grade instrument of truly single-control type, embodying in its design numerous electrical and mechanical refinements, thoroughly representative of the great advances made in broadcast-receiver construction during the past two years. It employs seven tubes, having a tuned-radio-frequency amplifier of high stability and sensitivity, and to the natural advantages of such an arrangement adds an external appearance that places the outfit decidedly in the class of a tasteful addition to the furnishings of any home.

The various details of the set are shown in the halftones and the wiring diagram. The basic unit is an aluminum-and-iron chassis bearing the various circuit components. The front panel is of iron, eighteen inches long and nine high. It is attached at an oblique angle to a rigid aluminum framework, on the rear of which is mounted a sub-panel of bakelite. The front panel holds only a decorative window, through which an indicating scale (S) can be observed, the single tuning knob (K), a volume adjustment (V), and an on-off switch, (SW). As can be seen from the illustration of the set in its cabinet, the front may be completely covered by a hinged wood panel opening downward. In its open position, this wood front acts as a rest on which the operator may support his hands comfortably while adjusting the receiver.

The details of the mechanical construction are brought out in the rear and under views of the chassis. It will be observed that the four variable condensers which serve the purpose of tuning the R.F. circuits are coupled together by a common shaft, which is turned by a worm-gear drive. In the under view, the letter D

indicates the drive rod, which terminates on the front panel in the tuning knob K and at the left-hand end of the condenser assembly as the worm part of the gear. The indicating scale SG is actuated by another pair of gears, one attached to its own shaft and the other to the condenser shaft. This scale is held in the proper position in relation to the panel by means of a rigid curved member which is part of the cast-aluminum chassis. It is illuminated on the front side of the panel by a tiny flashlight bulb which is controlled by the same switch that turns the entire receiver on and off.

The device marked V in the back view is a variable high resistance, which acts as the volume control of the receiver. The three binding posts to which the letters CP

is completely enclosed in a metal can, as are the next three radio-frequency transformers R.F. The cans are in two sections, and cover inductances of the straight solenoid type. The top of the right-hand shield SH has been removed to expose the secondary S of the R.F. transformer.

A fourth can, similar in appearance to the others and occupying the space in the extreme lower right-hand corner of the set in the under view, contains a radio-frequency choke coil (CH in the wiring diagram), instead of another R.F. transformer.

Near the exposed coil S and mounted on the under side of the bakelite sub-panel is a fixed resistance, FR, which controls the current to the filaments of all the tubes in the set.

The device marked AFT is an audio-frequency amplifying transformer, while the two cans AFC are audio-frequency choke coils, or coupling impedances. The part in white (SW) on the back of the front panel is the filament switch.

The accompanying diagram shows the electrical arrangement of the receiver. The four variable condensers, which are operated as one, are marked separately with the letters C to show their actual connection in the circuit. Various other condensers are BP, which serve to by-pass the radio-frequency components of the plate currents in the R.F. and detector tubes around the "B" battery direct to filament; AC, antenna series condenser; GC, grid condenser for the detector; and BC, blocking condensers in the impedance-capacity-coupled audio stages.

A two-point switch AS disconnects the antenna coil AT if a loop aerial instead of an outside wire is to be used with the receiver. The variable high-resistance V is directly in series with the 67-volt "B" supply to the R.F. tubes, and provides smooth and even control of the regenerative tendencies of the latter.

The R.F. choke CH keeps wandering R.F. currents out of the audio amplifier, where they might cause serious trouble. The audio amplifier itself comprises one stage of transformer coupling and two of impedance-capacity, an excellent combination that assures the set owner both volume and clarity.

The various battery input posts are clearly marked and need no explanation.

This receiver was tested in the RADIO NEWS laboratories, and performed in a most creditable fashion. The tuning was sharp, the volume far greater than necessary to fill two good-sized rooms, and the quality of reproduction extremely high. Altogether, the receiver may be considered a fine example of engineering skill.

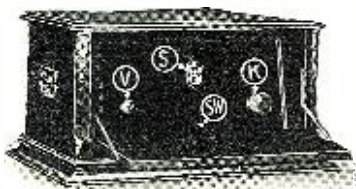

Front-panel view of the one-control receiver.

point allow the connection of the correct batteries or socket-supply units for the operation of a power tube in the last stage of audio amplification.

The under view of the chassis reveals the placement of the R.F. and A.F. instruments. The knob at the left-hand end of the condenser frame adjusts a small antenna series condenser, which must be varied for different locations to adapt different aerials to the constants of the receiver circuit and thus to allow successful one-dial tuning. Directly behind this condenser is the antenna and first grid circuit) tuning coil. It

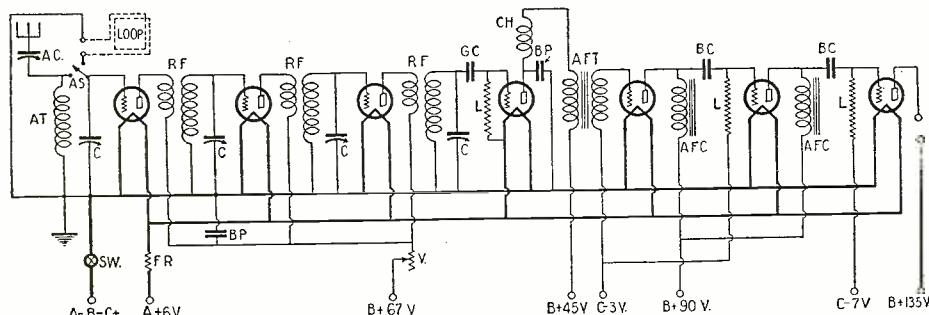

Complete wiring diagram of the seven-tube, one-control receiver, showing three stages of tuned-radio-frequency amplification and three of audio amplifications. Of the audio stages, one is transformer coupled and the other two impedance-capacity coupled.

Illustrations of this set courtesy All-American Radio Corporation

**ELECTROLYTIC CONDENSERS IN "B" SUPPLY UNIT**

A NOTABLE feature of a new "B" socket-supply unit, designed to convert the standard 110-volt alternating house current into smooth direct current for the "B" circuits of radio receivers, is the use it makes of filter condensers of the electrolytic type. These condensers, of which there are two in the device, are of unusually high capacity, totalling 35-mf., and are secure against the permanent breakdowns which condensers of the paper type suffer when subjected to unreasonable overloads.

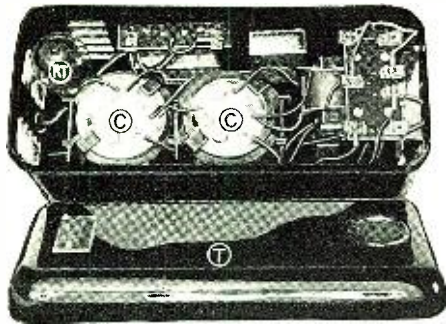

Inside view of the supply unit. Photographs courtesy The Amrad Corporation.

The large capacity of the filter condensers has the effect of absorbing and storing the choppy direct-current impulses delivered by the rectifier tube and of feeding these impulses in a smooth, steady stream to the radio circuit; the action is much the same as that of a reservoir tank which takes water in spurts from a pump and supplies a steady stream from a hose connected to its output side.

The electrical design of the "B" unit is more or less conventional. A transformer steps up the 110-volt A.C., a vacuum tube rectifies the secondary output, and the filter condensers and a pair of heavy choke coils smooth out the ripples.

At 180 volts the output of the instrument is 50 milliamperes. Four voltage taps are provided for 22½ or 45 volts, 67, 90 and 135 or 180 volts. Other intermediate voltages may be obtained if desired, and once selected, maintain a constancy of value, due to the use of efficient wire-bound resistances.

The various parts of this "B" supply unit are mounted on a metal base and are encased in a substantial steel box, finished in shiny black enamel. Over all, it is 14 inches long, 6 inches wide, and 8 inches high. All the components are readily accessible, no sealing compound or other filler being used.

In the illustration showing the inside of



Outside view of the "B" socket supply unit, showing the terminal strip and the rectifier tube.

the instrument, RT is the rectifier tube, C the electrolytic condenser, and T the removable top of the case. Behind the condensers is the power transformer, and at their right the filter-choke coils.

**"CLARIFIER" PROTECTS LOUD-SPEAKER WINDINGS**

A NEW "tone clarifier," recently introduced, is designed to prevent the direct-current of the high-voltage "B" battery, connected to the last audio stage of a receiver, from flowing through the windings of the loud speaker. It accomplishes this by means of a special dual-choke coil and a high-capacity fixed condenser, wired as shown. The choke permits the D.C. of the battery to reach the plate of the amplifier tube, while the fixed condenser keeps it out of the speaker. Because of its high impedance, the choke forces the audio-frequency component of the plate current—the voice- and music-carrying component—through the condenser and speaker, the latter responding audibly to the fluctuations. The condenser, unlike the choke, has a low impedance to the A.C., although it completely blocks the D.C.

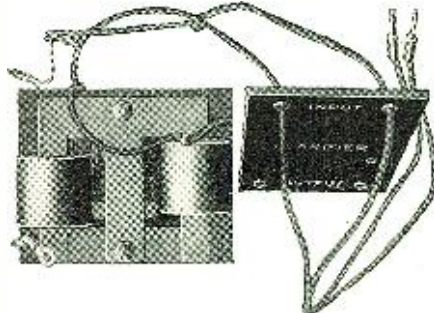

The fixed condenser is hidden in this view by the dual choke.

The use of this device is to be recommended for several reasons: it obviates the danger of partial paralysis or complete burnout of the speaker; lengthens the life of the permanent magnets; improves invariably the quality of reproduction; and permits great volume without loudspeaker rattle. With any of the new power tubes which have become very popular of late, it is practically a necessity; for the high



The instrument complete. Illustrations courtesy Leslie F. Muter Co.

plate voltages and heavy currents of these bulbs are too much of a load for the hair-like wire on loud-speaker bobbins.

The device is made in compact and convenient form; it is 3 inches long, 2½ wide, and 1¾ high, neatly finished in bakelite and nickel-plated brass. It is provided with two flexible wires fitted with cord tips, which plug into the regular output posts of the receiver, and with two tip jacks which accommodate the loud-speaker cord.

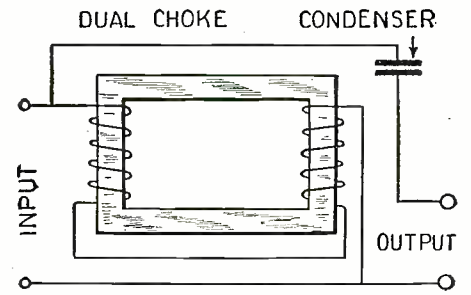

How the dual choke and the condenser are connected.

**EXCELLENT QUALITY FEATURE OF LOUD SPEAKER**

A SOUND chamber of unusually great length gives a new loud speaker a deep, resonant tone, and permits the reproduction of voice and music with strength and fidelity. The instrument is intended for connection to any standard radio receiving set, and is capable of handling more than enough volume for the home.

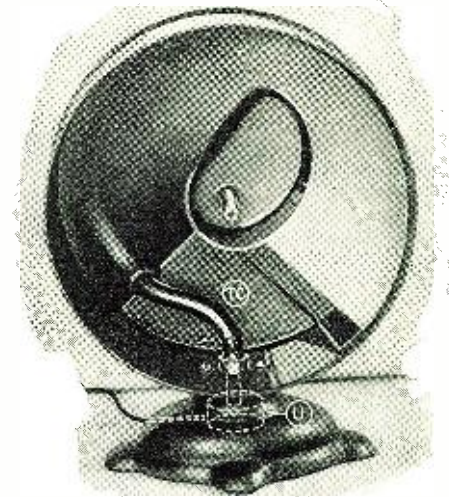

The speaker with its front cover removed. TC is the tone chamber, U the speaker unit. Photographs courtesy Duro Metal Products Co.

The body of the speaker is finished in walnut, while the faces and the base are of a dull morocco leather finish. The overall dimensions are: height, 16½ inches; diameter, 13¾ inches; depth, 5½ inches.

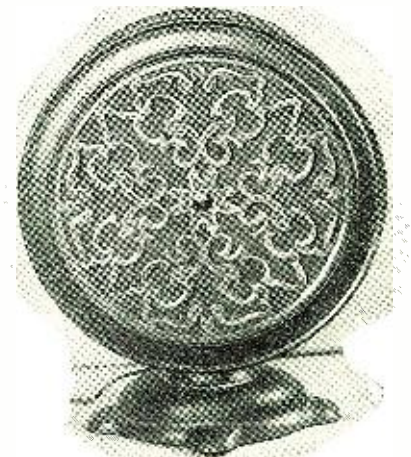

General view of the speaker.



# \$300 Prize Contest

## What's Wrong With Our Cover Picture?

As Reported by "Fips," Chief Office Boy

PERHAPS you now it, and perhaps you don't, but success has evidently gone to our heads; because we are now safely ensconced in our new offices on the world's greatest thoroughfare, namely, Fifth Avenue. Last month, as you perhaps recall, or maybe you don't, we moved our headquarters to 230 Fifth Avenue, where we are now located, within easy reach of all.

However, be that as it may, the outstanding fact remains that moving a big publishing office, with a string of publications, is no cinch. The Boss verifies this; so much so, in fact that, when the usual time came around for him to concoct his front-cover masterpiece, everything was so upset and things were upside down to such an extent that he found it impossible to segregate and piece together his usual ideas.

So what was more natural than that the Chief should call me in, pat me on my tousled head, and devastate himself of the following outburst:

"Fips, my boy, you have been with the company now for well on to 25 years—24, to be exact. I have a great deal of confidence in you, and I believe that in time you will get somewhere. Everybody's chance comes once in a lifetime. Opportunity knocks but once."

At this point, loud hammering was heard, and the front partition fell down. I took this as a good omen, as the Chief pursued his volley.

"You see, Fips, it is impossible for me, with this noise and hubbub, to get out my monthly cover for RADIO NEWS. Now, then, I thought that perhaps you could relieve me of the task, and here is where I give you your chance. I give you 'Carte Blanche,' as they say in the story books, and you are to deliver to me a cover already painted, one week hence—and be sure it is a good one. If you make out satisfactorily, that long-promised raise of \$5.77 will be duly coming to you. Now go to it!"

Just then the top of a filing cabinet was knocked off and landed on my head, which prevented me from blushing my appreciation. So the bump is there on my head to testify to the fact that I did not get a "swell" head, but, rather, a "swelled" one. Anyhow, I left the Chief's office, or whatever there was left of his office, highly elated, and immediately started to work on the cover idea.

I said to myself that people are mostly interested today in Television, so what better opportunity is there than to show what is going to happen when Television actually will be with us, which, as the Boss has informed us so often, is right around the corner? So I got together with the fellow who smears the monthly masterpiece, and we soon had it all doped out, and the last day before going to press I managed to wheel the cover on a hand truck into the new office, and presented it to the Chief.

He looked at it and started to beam all over. He patted me on the head and said it surely was a masterpiece. He looked at it from various angles, and through various colored lights, to get the best effects. He then examined it with a telescope and spectroscope in turn, and finally with the biggest magnifying glass he could find. But suddenly I caught a dangerous flicker in his starboard eye. Evidently everything was not rosy! Then I noticed that his hair was slowly beginning to bristle and finally stood

up straight. He then turned ashen white and next became purple. These omens boded no good, and I kept out of his reach.

He said nothing, however, but kept on making notes on a handy gold-plated pad, on which he wrote with his platinum, diamond-studded pencil. When he was all through, he gave a deep sigh, which was followed

series of epithets at me when I had the idea of my life. Said I: "Why not make a prize contest of this illustration, and let the readers see how many of the 16 mistakes they can find? Give prizes of about \$300, and the situation will be saved; because, patently, it is impossible to repaint the cover at this late date, seeing that we go to press tomorrow."

Well, at that the Chief grabbed hold of me and hugged me real hard. "Fips, my boy," said he: "You have the makings of a great editor in you, if you keep this up. It never occurred to me, and I must apologize for all the nasty things I called you before, and, to show you my appreciation, I shall give you that long-promised raise of \$5.77 immediately—which you will be kind enough to pass along to the readers, as you will notice that 52 times \$5.77 makes approximately \$300, which is the amount of the prize money. Inasmuch as you made the mistakes and are responsible for them, your first year's raise will, therefore, not go into your pocket."

I beamed my satisfaction at that, because I was glad that I hadn't been fired, anyway, and so there you are.

Now then, it is up to you to find the 16 mistakes. These are all genuine mistakes, and there can not be any doubt about them at all. Remember, that what you see is a future scene, somewhere in the United States. The lady is sitting in front of her radio, which radio is equipped with a television apparatus, built into the machine so that you can both see and hear what is going on at a distant station.

At the studio we have the future television camera, and the operator's hand can just be seen at the right side. The camera is supposed to transmit the studio scene by radio.

Please do not try to find fault with the radio outfit itself, that is, the design of it; as, for instance, there are purposely no switches for the volt- and ammeters, so this is not a mistake. The whole apparatus is supposed to work by the throwing of the center switch when the radio is put into operation. The tuning is done by the middle dial. The artist did not show any of the wires that supply the power to the set, nor the aerial and ground leads, but these may be presumed to be in the back somewhere, so this also should not be considered as a mistake.

On the original drawing the figures on the electrical meters, as well as the dial, were quite distinct. In the reduction of the front cover, and the illustration printed on this page, the reproduction suffered. Do not look for mistakes here, because there are none.

The picture on the wall is supposed to hang by a concealed wire or hook. No wire therefore shows, and there is no mistake here.

There are 16 unmistakable mistakes all the way through. There are no more—there are no less. The publishers ask you to make a list of the mistakes, sign your name to the list, and write not more than 25 words, which may be witty or not, at the bottom of the list. Those who have the list most correctly, and those who have the best remarks as to the picture, will be judged as to various prizes. It goes without saying that many will name the

(Continued on page 1382)

### \$300 PRIZE CONTEST

#### Cash Prizes

First Prize.....	\$100.00
Second Prize.....	75.00
Third Prize.....	50.00
Fourth Prize.....	25.00
Fifth Prize.....	10.00
Sixth to Thirteenth Prizes, each \$5.00.....	40.00
Total.....	\$300.00

by a string of profanity which had better be left out at this juncture. He said: "It's a beautiful cover, and looks right until you start to reason it all out. But perhaps, you little insect, you did not notice that there are no less than 16 mistakes in this contraption that you have the temerity to show to me. For instance, if you will study the cover closely you will find that the television screen shows a red and a green light.

"While this in itself may not be a mistake, it would certainly be a mistake to have color on the screen in two spots, but no other color for the rest of the picture. When everything is in black and white, as



There are sixteen mistakes on the cover, of which the above is a reproduction. See if you can find them all, working from the cover.

on a motion picture screen, certainly *everything* must be black and white. This is one of the mistakes. Then there are the following:"

Here the Boss cited 15 more, and with each one I shrunk about 1/15 of my normal size. He was just about to roar another



# Below 50 Meters with Reinartz

Short-Wave Expert Suggests Transmitting Kinks

By G. C. B. ROWE



“FOR the love o’ Mike, is that all the antenna that Reinartz uses? Good night!”

“Must be, Jimmy, I don’t see any other; and anyhow that pole is about twenty-five long and, say the garage roof is about fifteen feet high, that would make forty and I think that he works on thirty or forty meters most of the time. That would be about right, wouldn’t it?”

“That’s right. Let’s see if he is at home.”

We rang the bell and after introducing ourselves to John L. Reinartz, were ushered into his radio room. After due comment on the wetness of the South Manchester (Conn.) variety of slush, we were shown some of the radio apparatus that was spread over the room.

It was the kind of room that would delight the heart of a dyed-in-the-wool radio

of things to which the average ham pays very little attention.”

“It is very important that the antenna of a transmitter should be connected at the plate side of the antenna inductance. Take this circuit for example”—and he drew the hook-up, shown herewith, which is the one used in his set-up—“the side of the antenna coil at which the condenser is placed must be next to the inductance in the plate circuit. This will result in extremely sharp tuning and eliminate harmonics. Let me show you.”

**A HINT FOR HAMS**

He adjusted the condenser, C<sub>1</sub>, and then

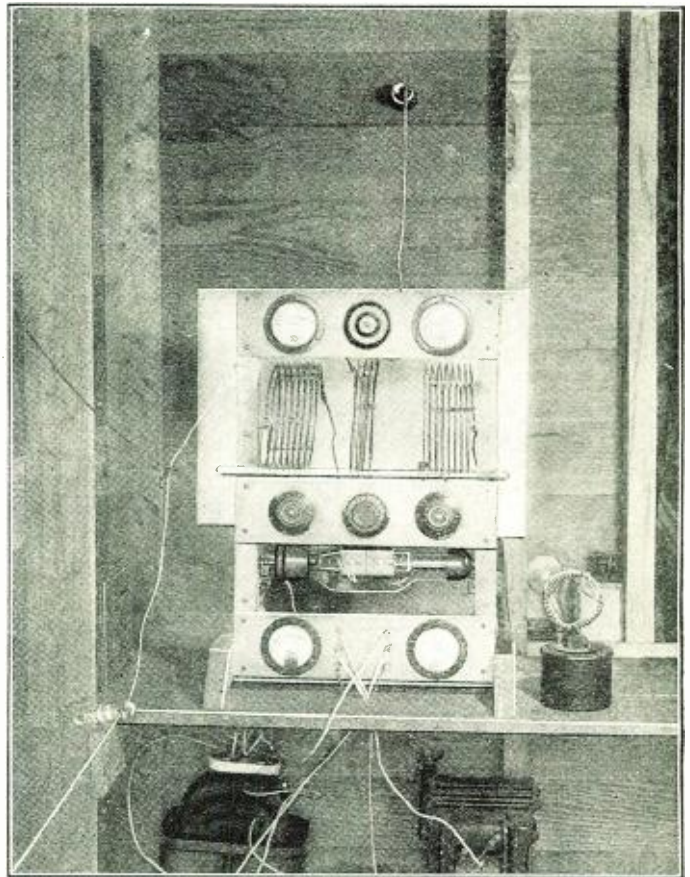

“There were three boards carrying meters and condensers, two glass towel racks supporting the inductances and a rack for the glowing 500-watt tube.” The counterpoise is shown at the left and wavemeter at right.

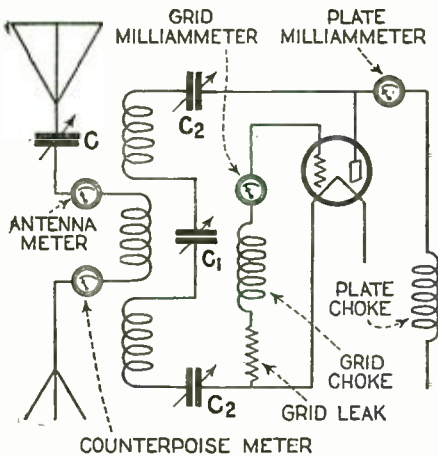

“It is very important that the antenna of a transmitter should be connected at the plate side of the antenna inductance.”

“ham.” Over in one corner, behind the door, was a small table on which were a small receiver, a key and a couple of switches. Another larger table held the inevitable parts, tubes, magazines, and miscellaneous junk, so necessary to the real experimenter. We inquired if his short-wave transmitter were out in the garage and remotely-controlled.

“Yes,” Mr. Reinartz answered: “By a simple system of relays, operated by closing this switch, I light up the tube and I’m all set to work all over the place. Would you like to see the set-up that I have out there?”

**A SIMPLE LAYOUT**

We most certainly did, and said so. When we arrived at the garage, which was about twenty feet from the house, we expected to see a vast layout of apparatus, judging from some of the other ham stations that we had looked over; but all that there was to be seen here was located in one corner. There were three boards supported by two uprights carrying meters and condensers, two glass towel rods supporting the copper-ribbon inductances, and a rack for the glowing 500-watt tube. This was mounted on a shelf, beneath which was a power transformer.

“Is this the transmitter which you had with you when you went up to Greenland?”

“No,” said Mr. Reinartz: “But it is just about the same and, by the way, the circuit in this transmitter is a mighty interesting one and I want to show you a couple

C, the latter being very slowly rotated. Being told to watch the plate milliammeter carefully, we saw the needle suddenly rise and fall sharply, denoting a very definite resonance peak. To illustrate further, he brought out a very simple wavemeter, which consisted merely of an enclosed condenser across which was shunted a coil. Resonance was indicated by a miniature neon lamp, seen through a small hole in the top of the condenser case. This little lamp glowed brightly suddenly and then was dark

again, as he very slowly turned the condenser handle of the wavemeter. There was certainly nothing broad about that output.

Then he reversed the leads to the antenna coil; in other words interchanging the antenna and the counterpoise, which by the way, was a wire twenty feet in length; fastened for about twelve or fifteen feet, two feet above the floor of the garage, the remainder lying upon the ground. Now, no matter where the condenser, C, was set, (Continued on page 1374)

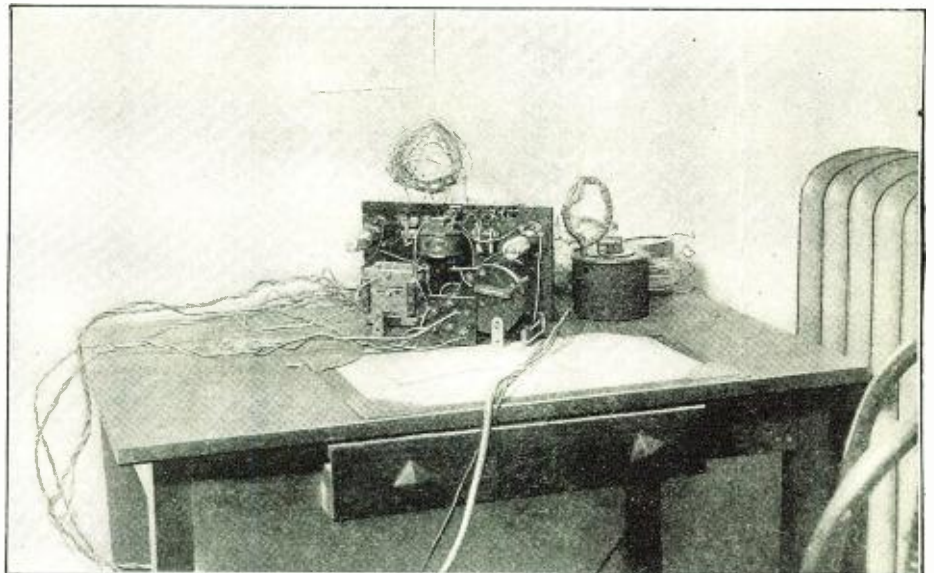

“Over in one corner, behind the door, was a small table on which were a small receiver, a key and a couple of switches.”







# Radio News of the Month



## A REVERSIBLE BEAM

**T**HE new Marconi beam stations linking England and Australia have been tested satisfactorily. They operate like those of the English-Australian link, hitherto described; except that as England and Australia are almost antipodal, two systems of aeri-als have been constructed at Melbourne: one on each side of the reflectors. Thus the beam is reflected over which-ever hemisphere is most covered with the darkness favorable to good trans-mission. It will be perplexing, to those who have no globe at hand, to learn that England lies southeast of Aus-tralia, as well as northwest.

## FOR BLIND RADIO FANS

**R**ADIO magazine for the blind, printed in Braille (raised) characters, is now being issued in Paris by a well-known publishing house. Radio sets have been constructed and put in operation by sightless students hitherto; and such a publication will un-doubtedly be a boon to many more.

## ACCIDENTAL "REBROADCASTING"

**A**N odd phenomenon was observed recently in connection with two of the broad-cast stations in Boston. WNAC, a 500-watt station, is in the same building as WASN, a 100-watt station broadcasting an "air shop-ping news" bulletin, and their aeri-als are in close proximity. When the latter was in op-eration, and WNAC's carrier wave was presumably un-modulated, it seemed to be rebroadcasting, faintly, but perceptibly, WASN's an-nouncements. Strangely enough, the reverse action did not seem to occur, as WNAC did not affect WASN's car-rier. The occurrence sug-gested that the effect was caused by induction between either the aeri-als or lead-ins. —Thomas Dadson.

## THE RADIO MOVIE

**R**ADIO and moving picture projec-tion were synchronized in a re-cent display before an audience in Ber-lin (Germany), and the experiment is reported to have been highly success-ful. The program at the broadcast studio was timed by a similar movie, run by a motor which traveled at the same speed as that in the the-atre. The topic selected was scientific. The demonstration opens the possibil-ity of the chain motion picture in com-bination with the chain broadcast; while its further extension to the home is predicted in an article on a preced-ing page of this issue.

## THE RADIO COMMISSION

**I**N accordance with the new Radio Act (the text of which appears in this is-sue), on March 1 President Coolidge ap-pointed the following commissioners: Rear Admiral William H. G. Bullard, U. S. N. (retired) for 6 years; Orestes H. Caldwell, editor of "Radio Retailing," 5 years; Eugene C. Sykes, lately justice of the Mississippi Supreme Court, 4 years; Henry A. Bellows, director of station WCCO, 3 years; John F. Dillon, super-visor of radio, sixth district, 2 years. The appointments met with general ap-proval from the press; but the Senate failed to confirm those of Messrs. Cald-well and Bellows before the close of the session. Recess appointments were then issued by President Coolidge. The new commission, working under a handicap because of the lack of an appropriation, is to have a free hand in the allotment of the new licenses (superseding those which were automatically revoked by the signing of the Radio Act on Feb. 23) and the administration of the new regu-lations it will create.

## LOCAL RADIO RULES

**M**INNEAPOLIS has a new ordi-nance, forbidding any radio broadcast transmitter located in the city from using over 500 watts power; this regulation is extended to any transmitter connected with a studio in the city. Higher power is regulated according to the distance of the trans-mitter, any amount being permitted 25 miles away. Stations are limited to 12 evening hours a week, and the si-multaneous operation of two broadcast transmitters inside the city is barred. All but one of the local stations have accepted the regulation, but it will be tested in court by WAMD.

## PACIFIC TIME SIGNALS

**D**OT-AND-DASH broadcasting of time signals on the Pacific Coast is now being done hourly by the Western Broad-casting Co., operating KEX, KJR, KYA. An automatic device sends a series of dots each second just before the hour, and a dash on the exact hour.—Clarence Starker.

## BEATING THE BOOKIES IN AUSTRALIA

**R**ADIO broadcasting from the racetracks near Syd-ney, Australia, has caused grief to a bookmaker who did not keep up-to-date with it. A "commission agent" took up bets for him, and reported at the starting time of the race. It appeared that the "agent" was acting in collu-sion with a violinist; who, with phones on his ears, was receiving the names of the winners from a portable set in a motor car, and trans-mitting the data in musical code. Thus the trustful bookmaker was accepting bets against a sure thing. However, the tables were re-versed from previous prac-tice, when the bookmakers were receiving information over "private and unofficial lines."

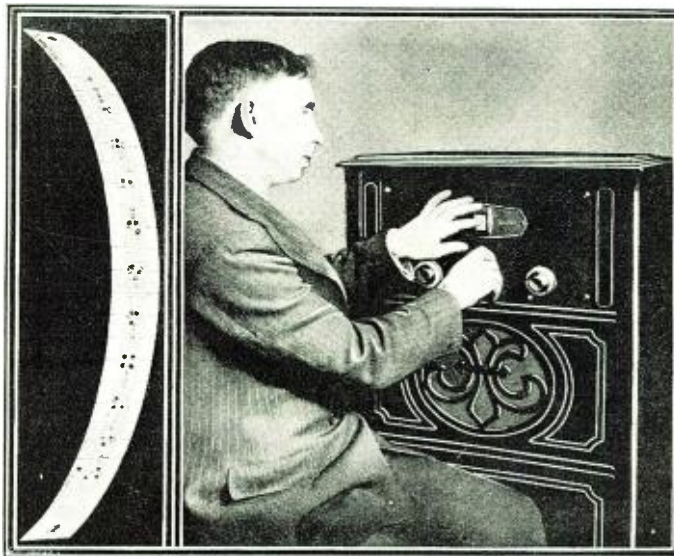

## A BLIND MAN'S TUNING DEVICE

Everett Astel, of the Institute for the Blind at Portland, Maine, has marked the control drum of his set with pinheads, so that his sensitive fingers can read the station numbers at a touch. The dots at the side represent A, B, C, etc., in Braille characters, reading down.

Photo courtesy Federal-Brandes, Inc.

## WIRED RADIO IN HOLLAND

**A**T The Hague telephone subscribers are enabled to listen to concerts or other broadcasts, without special appar-atus for reception; the receivers and am-plifiers being located at "central." The great advantage of the system employed is that the ordinary telephone service is not cut off. If a message for the listener-in comes through, the broadcast service is automatically cut off until the conver-sation is finished.—L. Reid.

(Continued on page 1378)

## THE RADIO AIRWAY

**C**OMMERCIAL aviation first avail-ed itself of the new "radio-beacon" system, on which the U. S. Army and the Bureau of Standards have been working on so long, when a Stout-Ford airplane, carrying eight passengers, made the flight from Detroit to Day-ton and returned, guided on its entire flight by the beacons at McCook Field, Dayton, and at Detroit. The beacon sends out a signal received by the air-plane. A change in its character ad-vises the pilot if he turns to the left or right of his due course. Colored lights may also be used.

# Experiments on a Superheterodyne

## Keeping the R.F. Out of the A.F. Stages

### By L. W. HATRY

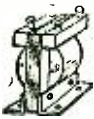

ANYONE whose work in radio has included the construction of a superheterodyne, or the repair of sets of this type, has soon found many things deserving of his experimental attention, whether with or without the aid of measurements.

With intermediate frequencies between 30 and 60 kilocycles, a particularly bothersome effect often experienced is the "graw-r-r-r" caused by oscillation when the adjustment of the potentiometer permits this condition. This is most annoying, in view of the fact that, with the headset or phones in the detector jack, oscillation occurs smoothly and without excessive noises. Even the first stage of amplification usually sounds fairly decent when oscillation occurs in the R.F. amplifier; but, with the employment of the two-stage, transformer-coupled amplifier, a horrible roaring and rasping noise is occasioned.

This noise, attendant on the advent of oscillation, can be very greatly reduced by heavy by-passing of the primaries of the audio transformers. With a 30-kc. I.F. amplifier, it is not unusual to find by-pass condensers in the order of .01 mf. required on each audio transformer. These facts point to the presence of an excess of some influence in the A.F. stages, most likely of the R.F. energy from the I.F. amplifier. In this case, it is obvious that the A.F. transformers do not afford the value of impedance which is indicated by their primary inductance. Out of curiosity, the writer has made some experiments, whose results, he believes, will be illuminating.

#### A.F. TRANSFORMERS IN I.F. STAGES

I observed that an A.F. transformer of excessive primary inductance permitted operation with by-passing of very low capacity, compared with the .01 mf. above mentioned. At a 70-kc. I.F. frequency, .001-mf. on the primary of the first stage only was sufficient to obtain quiet oscillation, although two A.F. stages were available with an eight-tube arrangement.

Where oscillation is controllable up to its "edge," the greatest regenerative amplification is obtainable. Where other conditions are equal, the bias-stabilized amplifier does not obtain the added bit of amplification permitted by exact control. Hence I am assuming that complete manual control of oscillation is desirable; from the viewpoint especially of sensitivity, I think it is.

The test was simple; the untuned transformers in the I.F. amplifier were replaced by "five and ten" audio transformers (cost-

ing actually \$1.00 each) whose primary inductance is notoriously low. The intermediate circuit is shown in Fig. 1; the entire circuit was the usual "super" arrangement. The tuned transformer was one of standard make, with a 30-kc. resonance peak. The test showed that these audio transformers made excellent 30-kc. "untuned" transformers; oscillation occurred, and everything was satisfactory.

Curiosity compelled experiments with other frequencies and the discovery resulted that these audio transformers seemed to be good long-wave R.F. transformers at a frequency as high as 60-kc., astonishing as this appeared.

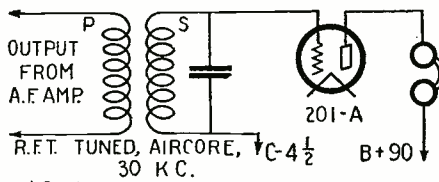

FIG. 3

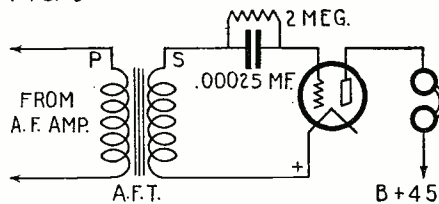

FIG. 4

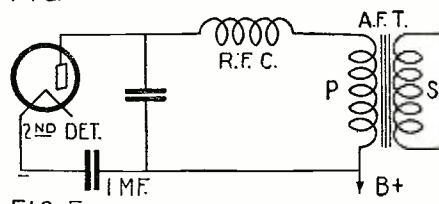

FIG. 5

A few of the test circuits employed by Mr. Hatry in his novel experiments to determine the effects of R.F. and A.F. currents in a complete superheterodyne receiver.

The next step was the trial of better audio-transformers; three 6-to-1-ratio transformers of a well-known make were used at 30-kc. While acceptable, the performance was not as good as before; but it was too good for an audio transformer, because it meant that the R.F. acceptance of this transformer was so great that, without resort to excessive by-passing, an A.F. transformer associated with a 30-kc. amplifier would be saturated with R.F.

Until an A.F. transformer of 100-henry

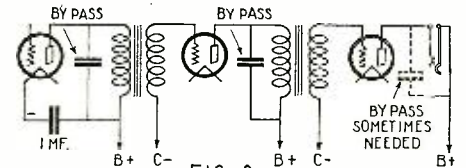

FIG. 2

The use of large by-pass condensers across the A.F. transformer primaries is one method of eliminating "R.F. saturation," but affects quality.

(primary) inductance was tried, none was found which did not work, to some fair degree, as a 30-kc. R.F. amplifier. The 100-henry primary seemed to stop the R.F. impulses fairly well. Likewise, this transformer performed as it should in the A.F. amplifier of a superheterodyne. One transformer, of better construction, though of an obsolete design, was so effective that it seemed to have a resonance peak at nearly 30-kc. Measurements with a buzzer and wavemeter confirmed this.

These results explained the tendencies of the average A.F. amplifier, as well as the misbehavior of many. The use of sufficiently great by-pass capacity (as in Fig. 2) is a remedy of a sort, but results in lessened quality of reproduction, so that the remedy is worse than the disease.

#### I.F. AMPLIFIER NOISES

Another theory to which these tests give support is that concerning noise in the "intermediate" amplifier. It has been asserted that the characteristics of a 30-kc. transformer approach those of an audio transformer sufficiently so that A.F. noises are amplified and passed through to the output, with a resulting increase of a parasitical background in the audio stages. With four untuned iron-core transformers, this possibility exists up to the second detector. If one tuned air-core transformer is used before this detector, its passage of A.F. is theoretically negligible. This was experimentally confirmed by test with an arrangement similar to that diagrammed in Fig. 3.

Aside from the inability of this transformer to pass A.F., the detector itself has very little such tendency, if it is operated with the conventional grid-condenser and shunt resistance. This was tested in the manner shown in Fig. 4. If, however, the detector is biased by a "C" battery, four tuned iron-core transformers do let through, and perhaps, assist A.F. noises. But a tuned air-core transformer before a "C"-battery-operated detector does stop the A.F., and no selectivity is lost, as would be the case with the leak-and-condenser-operated detector.

#### REMEDIES ARE SIMPLE

Briefly, the simple test of Fig. 1 revealed that audio transformers permit too much R.F. (frequencies between 60- and 30-kc.) to pass through them and seem to act (at the lower end of the frequency scale) as voltage amplifiers to boot. Under such conditions the effort to isolate an audio amplifier (using such transformers) from R.F. on the order of 40-kc. requires by-pass condensers of unusually low capacity. Very low-capacity by-passes do damage to overtones and the higher audio frequencies, resulting in "mugginess" and lack of brilliancy in the reproduction. To avoid the necessity of low capacity by-

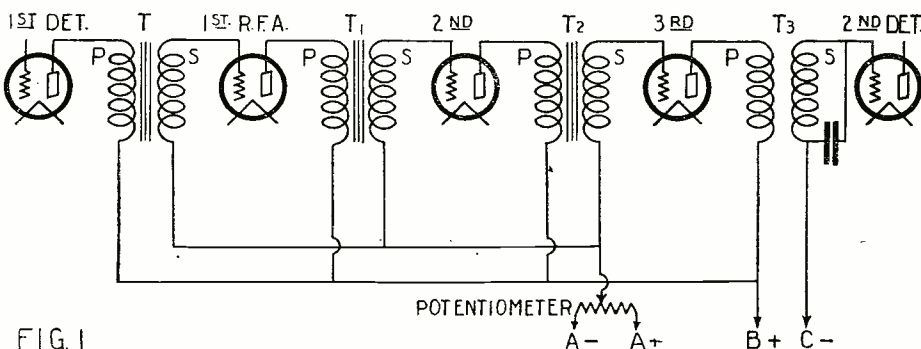
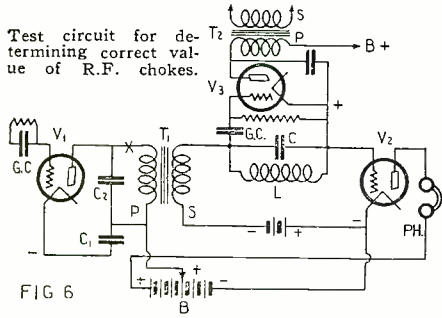

FIG. 1

A conventional intermediate-amplifier circuit for a superheterodyne. In place of the conventional I.F. transformers, the writer used cheap A.F. transformers; they worked very successfully in this position—better than they should, in fact.

passes, a partially satisfactory solution was the use of audio transformers with very high primary impedances, two tests being made with transformers having primary inductances on the order of 75 to 100 henries.

The by-pass idea was no dependable solution of the problem, for every type of audio-transformer was in need of assistance. Too many cases occurred where smooth oscillation was unobtainable until the audio amplifier was by-passed to death. The obvious solution lies in the use of R.F. chokes to whatever extent is necessary. Some time ago I suggested this scheme (shown in Fig. 5) at the second detector; and since then the use of an R.F. choke has been specified in



many superheterodyne constructional articles. What was necessary was to determine whether one choke is sufficient, what size it should be and, if more than one were necessary, the more effective places for them. The set-up for this is simple and is shown in Fig. 6.

Here two detection circuits are shown. V1 is the second detector of a conventional superheterodyne set; it is preceded by the usual intermediate amplifier, etc., and is in operation receiving some broadcast station, or else a modulated oscillator. Only one stage of audio is used in the test arrangement through T1 and V2 and a sampling headset permits check by ear of whatever is going on. The test set-up used to determine the amount of R.F. in the audio-amplifier consists of the circuit LC, tuned to the 30-kc. intermediate frequency, which is the detector section of a normal circuit consisting of GC, V3, etc. This V3 is run through T2, an audio transformer, into the usual two-stage amplifier, with a head-set hooked to the output again to permit ear-checking.

The idea is, simply, that any R.F. in the audio grid-circuit of V2 will operate on the tuned circuit LC and its associate detector, resulting in the usual audio response through the two audio stages of which transformer T2 is part. If no R.F. is in the V2 audio cir-

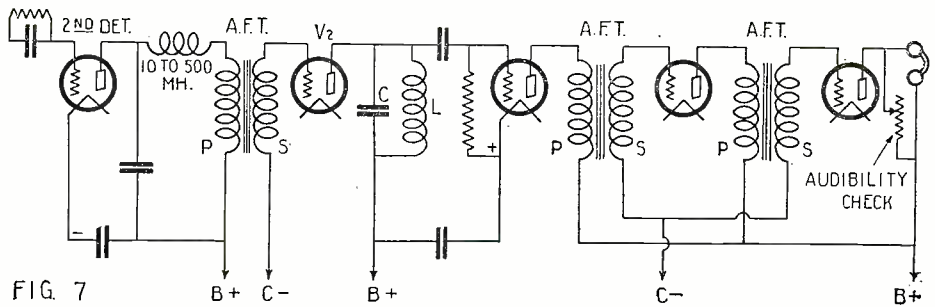

FIG. 7 A reliable circuit, of experimental nature, worked out by Mr. Hatry, which eliminates the faults usually experienced in the A.F. amplifier. Separate "A", "B" and "C" batteries are used.

cuits, no response will be noticeable in the V3 circuits.

As used, C1 was 1. mf. and C2 .005 mf. With the particular transformer T1 used, considerable volume was gotten out of the V3 set-up. When C2 arrived finally at .02 mf., the volume through V3 had abated to a useful point; but the quality of the signals in the phones PH was terrible. Of course, the quality of tone in the V3 assembly remained unaltered; for this controlled its own quality, being a detector and amplifier and working solely from the R.F. passing through and not from the audio present in the secondary circuit of T1.

The V3 tester ran on separate batteries. There are several other ways of connecting LC, but the arrangement shown in Fig. 6 proved very practical.

An R.F. choke was inserted at X and C2 was changed to .001 mf. A condenser of .001 mf. is so small that the ear fails to mark a change in tone with its connection or absence. A standard choke of 10-milli-henry inductance was tried. If this had any effect it was not apparent. Since I felt that more than .001 mf. in shunt to the A.F. transformer primary was not desirable, I decided that 10 mh. was not enough. I had supposed that 120 mh. might be barely enough, which made it seem silly that lower values were used; but starting low and

working up is the sure way. The end came with the determination that nearly 500 mh. is necessary. Less than that would do; about 250 mh. seemed satisfactory, but it took the full 500 to produce an audio amplifier free from 30 kc. energy.

Having satisfied myself with the results from Fig. 6, I changed to Fig. 7, which puts the tuned circuit LC in the plate circuit of the tube V2 and consequently receives any R.F. in the A.F. stage multiplied by the tube's ability. This too checked fairly close to the original method, in showing 500 mh. to be a highly effective value and about 250 mh. well enough. The variable resistance across the headphones, used arbitrarily as an audibility meter, is 50,000 ohms maximum.

In view to achieving the use of standard R.F. chokes, I tried several in different places; the "B+" lead to the I.F. transformers with a heavy by-pass (1 mf.) to assist and in the "B" lead to the first audio transformer, and in the grid lead of the first audio transformer. These were all 10 mh. The result was disappointing. The improvement did not compare with those from the single 500 mh. at x. So I used 250 mh. at x and 250 in the "B" lead to the same transformer and 250 in the grid-lead of its secondary. The results lacked nothing.

(Continued on page 1399)

(Table 1). Reactance of Inductances in Ohms (approximate)

	1,000 cycles	5,000 cycles	30 kc.	60 kc.	600 kc.
2 mh. ....	13	63	377	754	7,540
10 mh. ....	63	314	1,885	3,770	37,700
500 mh. ....	3,140	15,700	94,250	188,500	1,885,000
1 henry ....	6,280	31,400	188,500	377,000	3,770,000
50 henries ..	314,000	1,570,000	9,420,000	18,850,000	188,500,000

(Table 2). Reactance of Capacities in Ohms (approximate)

	160,000	32,000	5,300	2,650	265
.001 mf. ....	160,000	32,000	5,300	2,650	265
.002 mf. ....	80,000	16,000	2,650	1,325	133
.004 mf. ....	40,000	8,000	1,325	663	66
.008 mf. ....	20,000	4,000	663	332	33
1.0 mf. ....	159	32	5.3	2.6	0.26
2.0 mf. ....	80	16	2.6	1.3	0.13

## The Loftin-White Circuit With High-Mu Tubes

Use of these Increases Sensitivity and Further Improves Quality

By ROBERT H. MARRIOTT

THE Loftin-White circuit works better with high-mu tubes than with the tubes ordinarily used in radio-frequency-amplifier circuits. The feature of the Loftin-White circuit which gives it the ability to transfer all radio frequencies equally well also adapts it for use with the high plate-circuit impedance which is a characteristic of the high-mu tubes; and that which prevents ordinary tubes from regenerating and oscillating accomplishes the same result with high-mu tubes.

The ordinary radio-frequency-amplifier circuits used heretofore could not take advantage of the greater amplifying ability of high-mu tubes; because those circuits either would not prevent the tubes from oscillating on the short waves, or would not transfer

the power from the plate circuit of one tube to the grid circuit of the next well enough when the receiver was used to get broadcasts from long-wave stations.

In audio-frequency amplifiers using resistance coupling between tubes, high-mu tubes have been employed but little, apparently, because resistance coupling reduces voltage instead of amplifying voltage. Owing to that limited use high-mu tubes have not been very common; however, now that the Loftin-White circuit can use them to advantage in the radio-frequency amplifier and detector sockets, we may expect the high-mu tubes to become more universally used.

There are a few other types of radio-frequency receivers which can also use the

high-mu tube to advantage as an R.F. amplifier. This fact, taken with increased distribution of high-mu tubes, probably forecasts a general change to high-mu radio-frequency amplification, and better quality in the audio frequencies distributed from the world's loud speakers. In the experiments so far observed where high-mu tubes have been used in the Loftin-White circuit, the most striking feature has been the improvement in quality.

Ordinary circuits, when adjusted to make the radio amplifiers highly regenerative and on the edge of squealing, have been very sensitive and capable of producing loud sounds. The fault to be found with these signals has been that they sometimes sound

(Continued on page 1400)

# Circuits Favored By British Listeners

By NORMAN EDWARDS

**T**HE fashion in radio receiving circuits, so far as Great Britain is concerned, has been very largely determined by the characteristic manner in which the broadcast service of programs is distributed throughout that country.

From the very first, the British Broadcasting Company—which, by the way, is now practically a government department—has taken crystal reception as a standard, and has set out to cover the country with a network of local transmitting-centers so arranged that any listener, no matter where located, can depend upon receiving at least

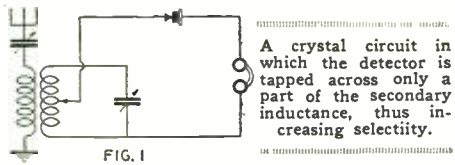

one program on a simple crystal set costing no more than a few shillings to install.

At the present time this ideal has practically been attained. There are some twenty local stations at ratings varying from 500 watts to 2½ kilowatts, and situated more or less uniformly with regard to the main centers of population. In addition there is a high-powered station at Daventry, which has a crystal range of approximately 100 miles, and serves to form a central depot linking up any intermediate areas that might otherwise lie outside the local zones of crystal reception.

### CRYSTAL SETS PREDOMINATE

The natural result is that there are at least three crystal receivers in constant use in Great Britain for every vacuum-tube circuit. There, as in most other places, economy is the primary keynote. If a listener finds he can get clear headphone reception of the local broadcast program for a few shillings, why should he spend as many pounds (twenty times as much), merely to get the same result in a loud speaker?

The really selective tube set, capable of giving a dependable choice of several programs, without mutual interference from nearby stations, is a luxury available only to the man with a long purse. And so, for the time being, the British workman rests content with the cheap and simple crystal. It must, of course, be borne in mind that every listener has to pay a Government tax of ten shillings (\$2.43) a year. For this he is provided with what is, generally speaking, a first-rate program of music and other entertainment, together with a summary of the latest news each evening.

### CRYSTAL SET COMPONENTS

This concentration in choice has very naturally led to various elaborations and modifications of the standard circuit components used in a crystal receiver—mainly with the



This shows the interesting crystal-and-tube combination set diagramed in Fig. 2. The change-over switches will be seen.

with ingenious catwhisker controls, designed to give a sensitive contact that will be both stable and effective. Ingenious tuning-coils

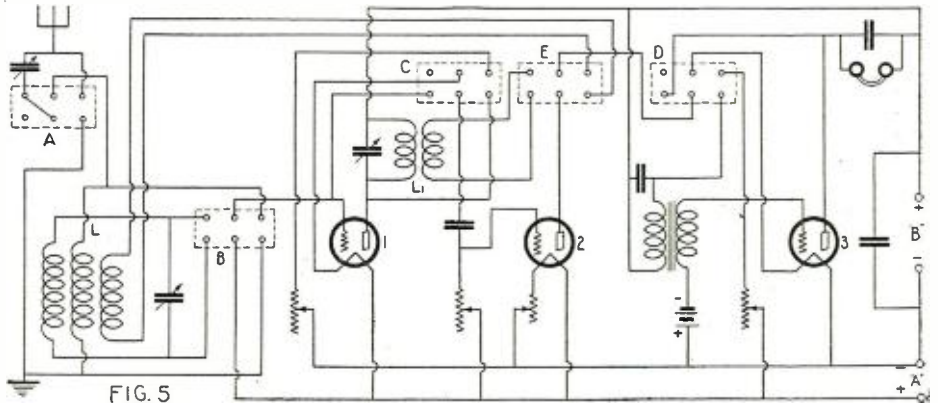

A circuit comprising a tuned R.F. stage, a detector and a two-stage A.F. amplifier. The switches A, B, C and D provide for increasing the selectivity of the aerial circuit, adding regeneration and changing the number of tubes in use.

object of securing as great a range as possible, combined with simplicity and reliability in operation. One finds on the market an enormous selection of crystal rectifiers provided

and variometers specially designed for crystal reception on standard wave-lengths are also very largely in evidence.

### THE BEST CRYSTAL DESIGN

So far as the actual crystal circuit is concerned, there is of course very little scope for anything of a strikingly original nature. Quite recently, however, there has been a considerable vogue of arrangements for reducing the damping effect of the crystal. Fig. 1 shows a typical circuit in which the crystal detector is tapped across a part only, instead of the whole, of a coupled secondary circuit. In this way the load on the tuned circuit is reduced, detector damping is diminished, the selectivity of the tuned circuit is increased, and the resonant voltage available for producing signals in the 'phones is in consequence increased to a maximum.

### TUBE ECONOMY

Having regard to the considerations previously mentioned, it is fairly obvious that the simplest and most economical plan for replacing the headphones by a loud speaker is to combine the crystal detector with a single tube giving audio-frequency amplification. In most cases this will give tolerable loud speaker reception, wherever good headphone strength was previously obtainable.

Accordingly, the second place in popular esteem is taken by various crystal-and-tube (straight or reflex) combinations, varying from a straight crystal-A.F. amplifier to a reflexed single tube-crystal combination capable of simultaneous R.F. amplification, crystal detection, and A.F. amplification.

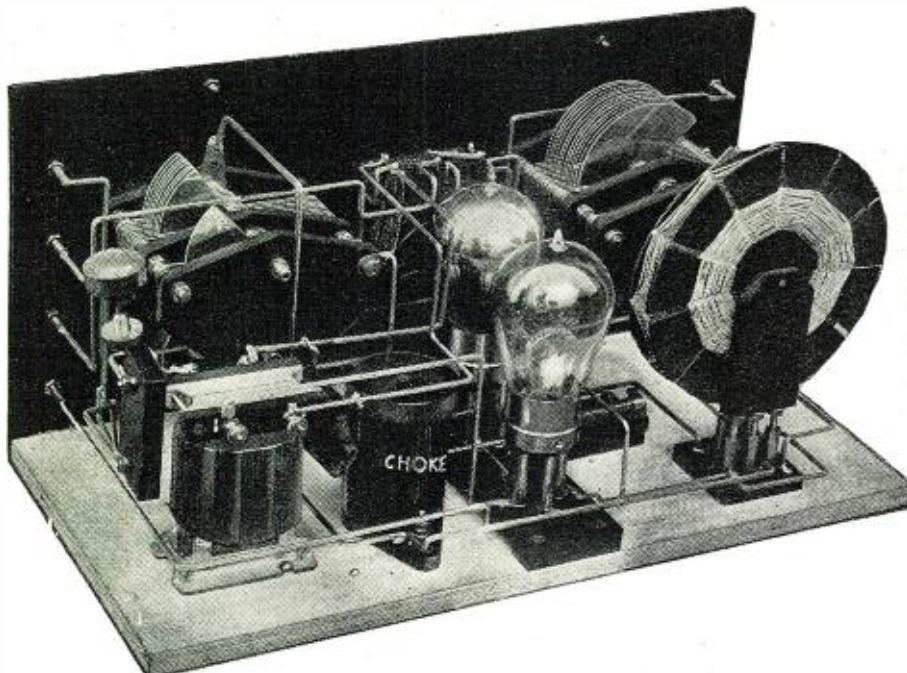

This is a rear view of a two-tube Unidyne (Solodyne) receiver, somewhat similar to the larger hook-up diagramed in Fig. 4. The tubes have each two grids, and require only an "A" battery, which furnishes the plate current as well. Note the plug-in coil.

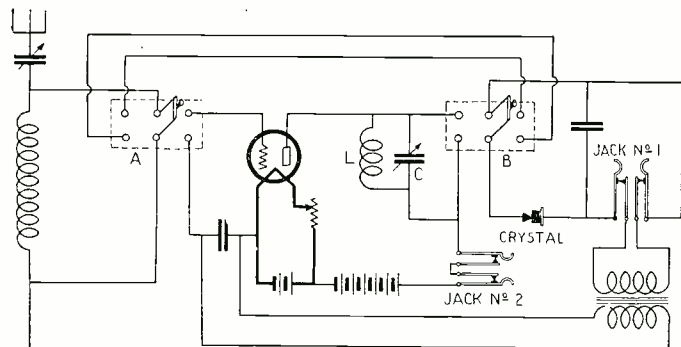

FIG. 2

A very interesting tube-crystal circuit. The switches allow the use of the crystal alone, or the following combinations; R.F. amplifier and crystal; crystal and A.F. amplifier, or a full reflex circuit with R.F., detector and A.F.

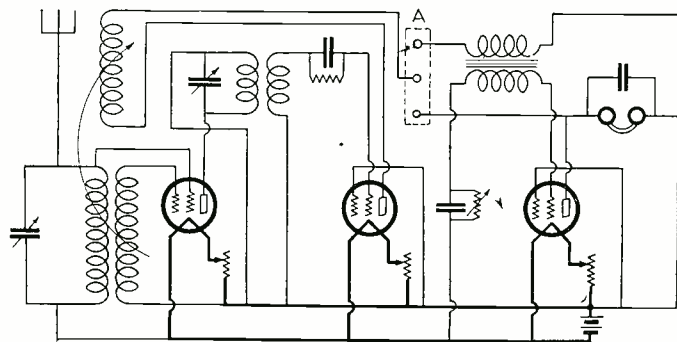

FIG. 4

A three-tube Unidyne or Solodyne circuit, using double-grid tubes. It will be noted that no "B" battery is employed. This is the distinctive feature of the circuit.

**A CRYSTAL-TUBE COMBINATION**

A widely-used circuit of the latter kind is shown in Fig. 2. It gives the maximum service to be obtained from a single crystal-tube combination, and has the additional advantage of flexibility, ranging, from simple crystal reception, crystal preceded by R.F. amplification, or crystal followed by A.F. amplification to a full three-stage R.F. detector-A.F. receiver.

With the switch A in the left hand position, the antenna inductance is connected across the center terminals of switch B. With the latter in the right-hand position, simple crystal reception is obtained by plugging the 'phones into jack No. 1.

By reversing the positions of both switches, and retaining the 'phones in jack No. 1, the signals are amplified at radio frequency, followed by crystal detection. If now the telephones are changed over to jack No. 2, the full sequence is obtained, namely R.F. amplification, crystal detection, and A.F. amplification.

Other combinations can be figured out from the diagram. In the last-mentioned position of the switches the signals pass from the antenna inductances to the grid of the tube, then into the tuned plate circuit LC across which the crystal is shunted. The rectified pulses from the crystal pass through the

A.F. transformer and so back to the grid of the tube, where they receive final amplification before passing into the 'phones on jack No. 2.

Given the necessary purchasing power, a

and audio sides of the detector.

Fig. 3 shows a circuit of this kind which has attained a large measure of popularity. Although only three tubes are employed, the combination gives two stages of radio and two stages of audio amplification. The input signals are amplified twice in succession by the first two tubes, 1, 2, the radio-frequency currents being transferred through the open-cored transformers A, B. These radio currents are bypassed across the iron-cored transformers T1, T2, by the shunted condensers C, C1. The amplified signals are rectified by the detector tube 3; and the audio-frequency currents are fed back to the first and second tubes through the iron-cored transformers T1, T2, as shown.

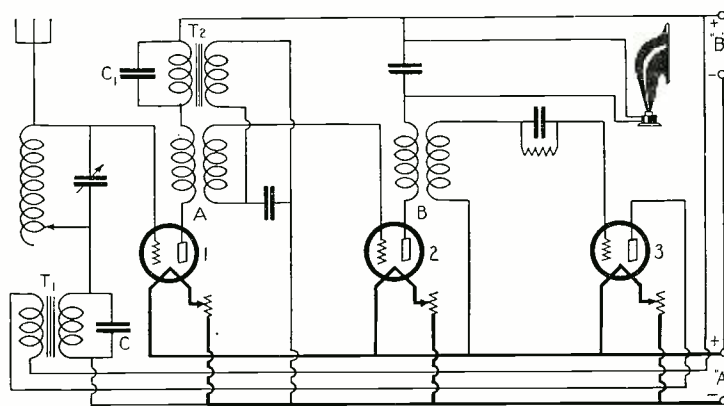

FIG. 3

A three-tube reflex circuit which provides two stages of R.F., a detector and two stages of A.F. amplification.

**THE UNIDYNE OR SOLODYNE**

crystal-tube combination is not to be preferred when two or more tubes are available. Accordingly the next stage in popularity is reached where the crystal is thrown overboard in favor of an all-tube circuit.

Here, however, the natural desire to economize is again responsible for a decided predilection in favor of reflex circuits, in which one or more of the tubes are made to perform double duty, amplifying on both the radio

Apart from being a frequent source of crackling and other unpleasant "noises," particularly toward the last stages of its service, the high voltage or "B" battery is a wasteful "asset" and a source of expense. Its elimination is therefore distinctly a point to the good; particularly where, as in the Unidyne circuit, the saving is accompanied by practically no loss in volume and a considerable gain in purity of reproduction.

(Continued on page 1402)

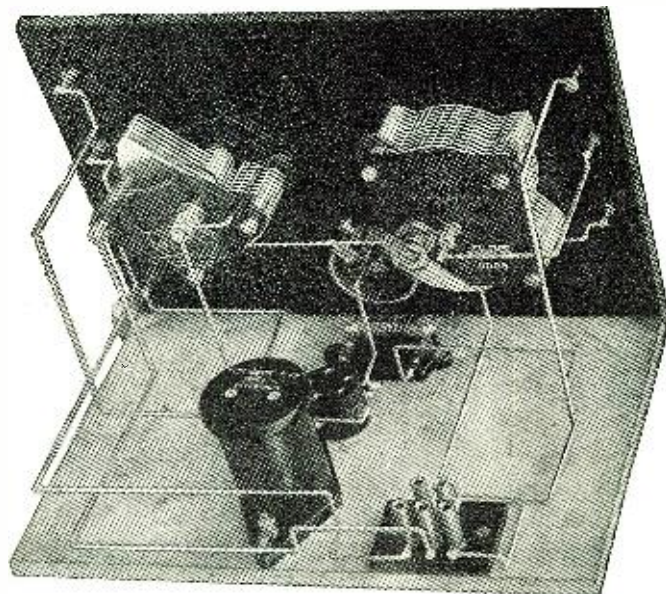
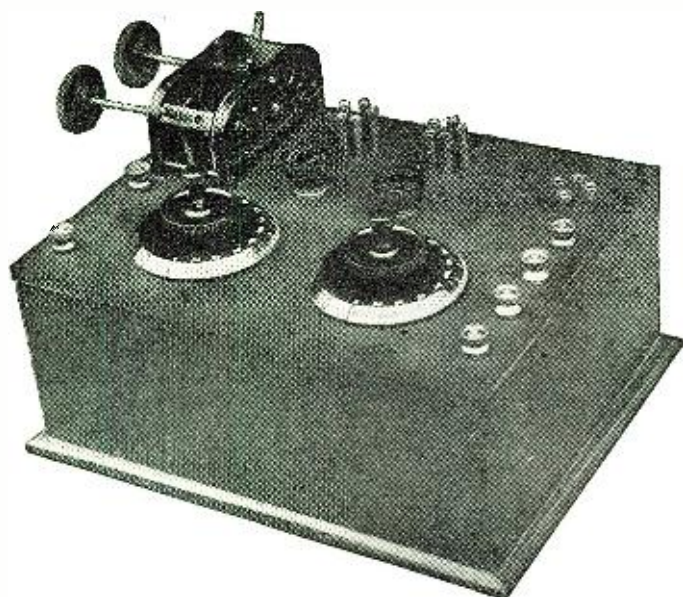

The receiver at the left is another two-tube Unidyne set; at the upper left, coil mountings, and to their right, tube sockettes for the double-grid tubes. The set at the right is a single tube Unidyne. The five-prong socket is in the center, just behind the special choke. The socket at the right permits the use of plug-in coils for the different British wavelengths.

# Ways of Reducing Interference

Suggestions Which Can Be Applied to Your Set

By SYLVAN HARRIS



It is hardly necessary to make any introductory remarks concerning the great number of broadcasting stations we now have on the air, nor to discuss how this congestion can be relieved or regulated. Many articles have been written on the subject, published in RADIO NEWS and elsewhere, many ideas and remedies have been suggested; but it is now up to the Radio Commission to put some of these remedies into practice.

What will finally be done is problematical; there are many things to be considered, from both the scientific and the legal points of view. There are involved also international relations and many other considerations which are beyond the ken of those not trained in such lines.

In the meantime, however, to make conditions more bearable for the radio broadcast listener, there are things which may be done that will permit him to enjoy the many programs which are being broadcast. He will be able to listen to these without undue interference from another station, but there are certain things that he must keep in mind, and one of these is that he must be reasonable.

In the first place let it be understood that the sensitivity of the radio receiver has a great deal to do with its apparent selectivity. We have certain ideas as to what selectivity is; scientifically there is one definition of selectivity, and popularly there is another. Regarding the operation of a radio receiver the popular definition of selectivity is what we must consider; that is, the ability of the receiver to tune in a station without hearing in the loud speaker a "background" from another station.

## VOLUME VS. SELECTIVITY

In Chicago, where the writer lives, the conditions are about as bad as they are anywhere else in the United States—perhaps worse. One evening I took pains to tune in as many of the locals as were on the air, and I heard thirty of them, all transmitting at the same time. By "locals" I mean stations located within a radius of about 50 miles. All these stations were included in about seventy dial divisions out of the hundred, which means that in that range of wavelengths, we had three stations in every ten dial divisions.

The receiver I was using is a rather powerful one, one that brings in DX as well as any I have operated; it had a very good volume control, by means of which I could easily control the output of the loud speaker connected in the R.F. amplifier.

With the volume control set at "maximum" it was well-nigh impossible to separate many of these stations; this is to be expected when we have three stations for every ten dial divisions. Furthermore, the volume output of the loud speaker was too great, as a rule. But when I turned the volume control around a bit, it was possible

to separate all of them, and the output of the speaker was sufficient for practical purposes.

I made another test not long ago, which will be of interest, with an experimental set consisting of several stages of R.F. which I could disconnect at will. The R.F. stages were all constructed alike. I set up two of these stages, followed by a detector and an A.F. amplifier, and observed how I could separate the local stations without much difficulty, even with the volume control on "maximum." Note that this receiver had then three tuned circuits.

After this I added an additional R.F. stage making four tuned stages in all. Having the extra tuned stage, it would seem at first as if we should expect the set to have greater selectivity. But to tell the truth, it was not possible to separate

sible to avoid these until a redistribution of wavelengths is made, but when you are listening to the locals, you can eliminate these heterodyne whistles by cutting down on the volume, just as was done before in separating the locals.

Although these remarks may not entirely solve the difficulty for you, by applying some of these ideas you may find it possible to listen-in to any of your local stations, undisturbed. These are the first precautions to be taken in operating a receiver. If these do not satisfy you, or do not solve your interference problems, you will then have to adopt some of the following expedients. Any or all of these may be tried, and the one which suits your particular conditions you may adopt as a permanent fixture in your receiving equipment. Nearly all of them will involve an additional control, but I would like to point out here that you must also be reasonable in this respect. Radio is a wonderful thing, but we cannot do everything by or with it. If you want volume you may have to sacrifice selectivity; if you want extreme selectivity you may have to sacrifice sensitivity; if you want volume and sensitivity, you may have to sacrifice your idea of a single-control set.

## A NECESSARY COMPROMISE

This is the big problem which manufacturers of radio receivers must contend with. It is not possible to build an ideal set; an ideal set would probably be one that is truly single-control, is extremely selective and extremely sensitive, and gives perfect reproduction. Any of you who have tried to build this "perfect" receiver know what some of the problems are. The best that can be done is to strike a happy medium somewhere, or else so construct the set that it will be fairly selective and very sensitive under one adjustment, and fairly sensitive and very selective under the other adjustment.

The other problem involved, over which the manufacturers of receivers have no control, is the length of the antenna. If a very long antenna is used you may experience considerable interference. If a very short one is used you may find that the DX stations will not come in. Having these things in mind, and assuming that you have adjusted your conditions to the best of your ability, and assuming also that you are not demanding too much of your receiving outfit, let us see what additional means can be used to cut out the interference.

## INCREASING SELECTIVITY

The first of these requires getting into the receiver itself and making a small change in the wiring. Many R.F. amplifiers have the filament circuits grounded; that is, connected to the ground connection, either by a wire soldered in place, or by terminating the grid-returns at the tuning condensers, whose rotors are grounded to a metal panel, or otherwise. These connections are shown in Fig. 1. In Fig. 1A we have the ordinary grounding connection, in which the filament end, or the grid-return end, of the secondary coil is connected to the ground by means of a wire.

In many cases, if this wire is removed, an increase in selectivity will be experienced. It may be found in some receivers, however, that this will materially decrease the sensitivity, or in regenerative receivers, may allow the receiver to oscillate, in which case it will not be well to

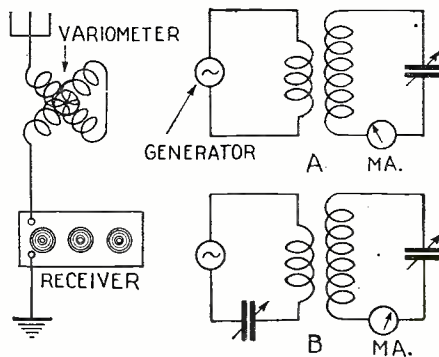

FIG. 2 The selectivity of a receiver can be increased by connecting a variometer in series with the aerial wire. FIG. 3. Illustrating the resonance properties of tuned circuits.

many of the locals with the volume control at maximum. On the other hand, on account of the greater sensitivity of this receiver, it was sometimes possible, when one or another of the locals "shut down," to go through the rest and bring in DX stations, which could not be done without the additional R.F. stage.

## USE OF THE CONTROL

The point I am trying to bring out is that, if we have two receivers which have equal selectivity, but the one receiver is very much more sensitive than the other, the more sensitive receiver may seem broader than the other. But if the volume control is so adjusted that the volume output of the two sets is the same, the ability to separate the stations may be the same for both sets.

Again, if you have a very sensitive receiver, and you are located in a place like Chicago, where the air is very congested, you are not only likely to experience interference between the locals, but you will also encounter heterodyne whistles from distant stations in the background. It is impos-

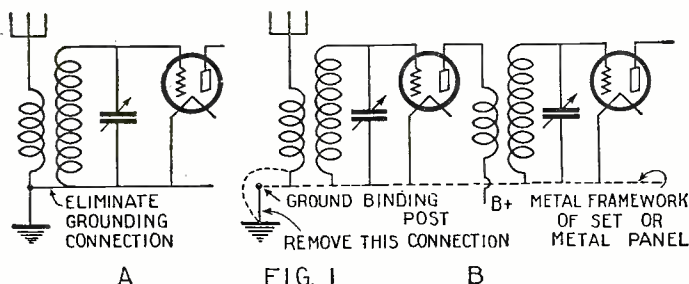
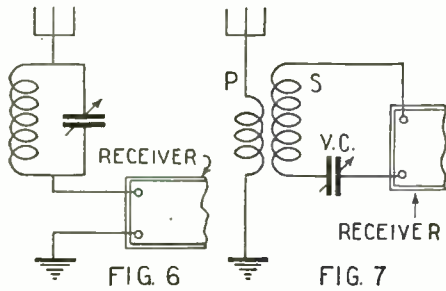

Fig. 1. (A) the ground connection may be removed, which will sometimes improve the selectivity. (B) Where the grounding connection is made through the framework of the receiver, or through a metal panel, the ground end of the primary is unsoldered and connected to the ground directly and the panel is not grounded.



FIGS. 6 and 7 show the connections for two forms of wave traps, which can be used for eliminating station interference.

eliminate this ground connection. You must use your judgment in adopting the expedient that will best suit your needs.

In Fig. 1B we have a similar connection to the ground, but in this case it is made, not by a wire soldered in place, but by the metallic framework, or the metal panel of the receiver, depending upon its construction. When this is so, it is a simple matter to unsolder the ground connection of the primary coil, and connect this to the ground directly, instead of to the metal framework. When you do this the framework is not to be grounded.

But when you try this stunt, you must first look at your "B" socket unit if you are using one. Some of these instruments require grounding, and when so connected you may have the filament circuit of your receiver grounded through the eliminator. If this is the case, the changes indicated in Fig. 1 will be of no use, so that you will have to discard this method and choose another.

**OLD, BUT GOOD**

Although the newer radio fans may not think of using a variometer to tune the antenna circuit, this method is probably the first that would occur to an old radio fan. Nearly all the receivers now on the market use the "untuned" primary circuit; that is, the antenna circuit has no variable element in it, but consists only of the antenna and ground and between them a fixed or non-variable coil called the primary.

The reasons for using this kind of circuit are several. First, it is a good thing to get rid of a control, when we can do so easily; second, it is cheaper than to include a variometer or a variable condenser in the circuit; third, it is easier to "log" the dials.

But there are things to be gained by using a variometer, and these are both selectivity and sensitivity. Whether you have a single-dial set or a four-dial set, you always tune in by adjusting the condensers in the secondary circuits until you have a maximum of current flowing in these circuits. In other words, you get the maximum amount of current flowing in the secondary circuits that is possible when using that means of tuning (i.e. secondary tuning only).

But when you tune both the primary and secondary together, it is possible to obtain a higher maximum. Now this may seem strange to you at first; how is it possible to have greater than the maximum? That depends on what you mean by maximum. Glance at Fig. 3A. This shows an untuned primary circuit coupled to a tuned secondary circuit. We have a generator supplying energy to the primary and a milliammeter in the secondary circuit. The frequency of the supply voltage has a certain value. As we turn the secondary condenser, we will find that the current is at first very small, but gradually increases, until it attains a maximum value; the secondary current begins to decrease as we turn the condenser further. When the current was at its maximum value, the circuits were tuned.

Now, if we do not change the setting of the secondary condenser, but introduce a variable condenser into the primary circuit, as in Fig. 3B, and gradually turn this condenser, we will find that we can obtain a greater maximum value of current in the secondary than we obtained before. In other words, when both circuits are tuned to resonance, we have an increase in the sensitivity of the receiver. Further than this, it will be found that there is a considerable increase in the selectivity, as we have added an additional tuned circuit.

There are two ways of accomplishing this result. One of these is shown in Fig. 2, where we have simply connected a variometer in the antenna circuit. A variometer is merely a variable inductance, consisting of two coils, one rotating within the other.

**INSERTING A SERIES CONDENSER**

Another means of accomplishing the same result is shown in Fig. 4. Here the tuning is done by means of a variable condenser connected in the ground lead of the receiver. There is also required in the antenna circuit, for proper tuning, a loading coil, which is merely an inductance coil similar to the secondary coils in your receiver. It is not possible to say exactly how many turns you will need in this coil, as this depends upon the receiver you are using and the capacity of your antenna. It is an easy matter, however, to build a simple cylindrical coil of say, 60 turns of wire on a two-inch tube; and then, if you

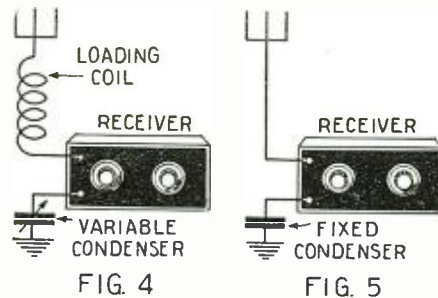

Fig. 4. Increasing selectivity through the use of a loading coil and a variable condenser. Fig. 5. Inserting a small fixed condenser in series with the ground lead will increase selectivity.

find that this gives too much inductance for tuning over the broadcasting range, you can easily remove as many turns as you find necessary.

If you are not particularly interested in keeping the sensitivity of your receiver high, but merely wish to separate the locals, it is an easy matter to increase the selectivity by inserting in the ground lead a small fixed condenser. The connections are shown in Fig. 5. This condenser may have a capacity of about .00025-mf. or less.

There is no advantage in using a variable condenser for this purpose, instead of the fixed condenser, as you cannot tune the primary or antenna circuit to resonance by this means unless you use a loading coil. (This applies to nearly all present-day receivers, with only few exceptions). The condenser in Fig. 5, in the ground lead, will merely increase your selectivity, making the antenna circuit act as if the antenna were shorter than it is, and generally the sensitivity will drop. If you want to keep up the sensitivity, and at the same time increase the selectivity, by using the tuned antenna system, you will have to use either the circuit of Fig. 2, or that of Fig. 4. If you are interested merely in selectivity, and not in sensitivity, you may use the circuit of Fig. 5.

**THE "WAVE TRAP"**

It often happens that there is one particular station that causes you trouble. You may be located so close to it that forced

oscillations are set up in your receiver by that station, no matter how your set is tuned, and these forced oscillations generally seem to "slide in" on another station's carrier wave, when you tune the latter in. You may not hear the interfering station when not tuned to it, excepting when you are tuned to another station's wave. Then you hear it as a "background" in your loud speaker.

In order to stop this kind of interference you will have to use a circuit such as shown in Fig. 6. This is called a "rejector" circuit, or a "wave-trap." It consists of a simple cylindrical coil and a variable condenser connected in parallel, with this circuit in series in the antenna lead. The coil may be exactly the same as the secondary coils in your receiver. In order to adjust the circuit so that the interference by the particular station is eliminated, simply tune your set to that station. Then adjust the variable condenser in the wave-trap or rejector circuit, until the output of your loud speaker is weakest. In other words, you adjust the rejector circuit so that it "rejects" the interfering station.

When you have so adjusted it, note the dial setting of the variable condenser. After that, any time you hear the interfering station in the "background" of another station, simply turn the variable condenser to the proper dial setting and the "background" will drop out.

If the interference between local stations is very serious, this method may not be sufficiently effective. In that case it may be better to use a system like that shown in Fig. 7. This consists of a primary coil "P" of about 10 turns of wire on a tube of, say, 2½ inches in diameter, and a secondary coil "S" having about the same inductance as the secondary coils in your receiver, or perhaps a trifle less. The variable condenser should have a capacity equal to one of those in the receiver.

All the means commonly used for increasing the selectivity of a radio receiver are based on the same principles, viz., they are all either "rejector" or "acceptor" circuits of one form or another. Tuning the antenna, as in Figs. 2 and 4, makes the antenna circuit an acceptor circuit. The same is true of the connection of Fig. 7. Fig. 6 is an example of a rejector circuit. A variation of this circuit is shown in Fig. 8, where the coupling coils "A" can be made exactly the same as the coils in your receiver. The secondary circuit marked "S" is an acceptor circuit, and when tuned to the wavelength of the interfering station, absorbs the energy at that wavelength from the antenna circuit. The combined primary circuit "P" and the secondary circuit "S" constitute a rejector circuit when acting together in this manner.

Any of these rejector or acceptor circuits, or combinations of them, can be used in the tuned circuits within the radio receiver, if the experimenter wishes to put them inside the cabinet. In doing this provision must be made on the panel of the receiver for the variable element, so that

(Continued on page 1389)

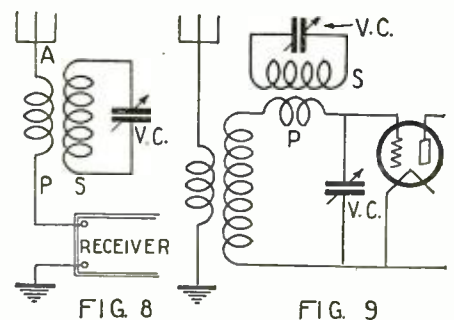

Two more types of wave traps, or "rejector" circuits which will suppress station interference.



# The Phono-Radio Combination Set\*

A Set Employing the New El-Fonic Capacity-Type Pick-Up Device

By FRED A. JEWELL†

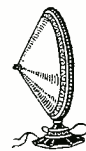

**T**HERE has been much talk of late about an alleged superiority, in the reproduction of music and speech, of the phonograph as compared to the radio receiver; but a very effective answer to this assertion will be found in the performance of the device which is explained in the following article. There is no doubt that the phonograph and the radio must develop side by side, for each has its separate advantages.

A very happy combination of all these has been perfected in the Phono-Radio, here described. This may be used as a reproducer of phonograph records, or, by the throwing of two switches, it is converted into an effective broadcast receiver. The circuit is selective, as demonstrated by tuning in a number of distant stations while the New York locals were broadcasting; and the quality of its reproduction, because of its special A.F.-amplifier, is of the highest order. The same amplifier is used while it is reproducing phonograph music, so that the quality of its output is equally agreeable.—

EDITOR.

existing type, in that it uses a principle similar to that of the condenser microphone, which, by the way, is the most faithful reproducing device yet known. A standard condenser microphone is a very delicate piece of apparatus and, for a number of reasons, has not been found practical for everyday use. In the first place, it is necessary to have perfect insulation; for, if at any time the insulation is not of the best, as it can be when moisture is in the atmosphere, the operation of the microphone is greatly impaired. Secondly, the

oscillator circuit; so that the constant-frequency oscillations fed to the coil from the oscillator are altered merely in amplitude in the pick-up circuit. This means that the variations in capacity between the two plates of the pick-up, as the needle travels through the record's groove, governs the flow of radio-frequency current in the pick-up circuit. This current passes through an untuned radio-frequency transformer, then into a detector, where it is rectified; from which the impulses impressed on the current by the

At the right is a panel view of the Phono-Radio Combination Set. It will be noticed that there is but one tuning control, the variable condenser, C1. R2 regulates the regeneration and R3 is a volume control. In the lower left-hand corner of the panel will be seen three jack switches, SW, J and J1. SW is the filament switch; J and J1 are used for converting the set from radio to phonograph.

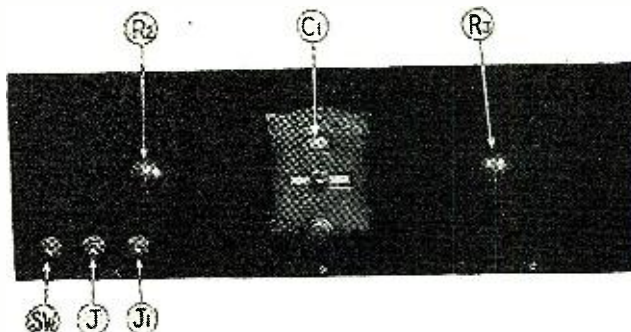

microphone goes out of adjustment very easily. Also, the amount of energy that the microphone delivers to the speech amplifier is so small that a costly amplifier is usually required. The underlying principles of the El-Fonic capacity pick-up and that of the condenser microphone are practically the same; the main difference being that the capacity microphone deals with audio frequencies and the capacity pick-up deals with radio frequencies. However, in the El-Fonic type these difficulties are overcome.

### MODULATION OF RADIO-FREQUENCY

As explained in the first article of this series, the capacity-type pick-up is used in conjunction with an oscillator and vacuum-tube detector. The pick-up is connected in series with a small pick-up coil coupled to

record pass through the audio-frequency amplifier. The latter, although of the double-impedance type, has several new features.

It is obvious, from this description of the operation of the system, that what we have is in a sense a miniature broadcast station, composed of the oscillator, the pick-up and a radio receiver of standard type, made up of a vacuum-tube detector and an audio amplifier. This means that what is primarily our amplifier system for the pick-up is also an orthodox radio receiver, with the exception of the oscillator. It seemed to be a good idea to provide a means whereby the radio enthusiast could have the best type of electrical phonograph known at the present time, and also an excellent radio receiver—all in one.

### A CONVENIENT COMBINATION

This was prompted by the knowledge that the audio-frequency amplifier, as a unit, is far better than the usual run of amplifiers; and most fans would want to use it in connection with their radio receivers, if they possibly could. Therefore, a switching arrangement was developed through which it is possible, by throwing just two switches, to have either an electrical phonograph or an excellent radio receiver. With the two switches thrown to the right, the Phono-Radio is an electrical phonograph and the first tube assumes the rôle of an oscillator. When the switches are thrown to the left, the first tube is changed to a radio-frequency amplifier; so that we have a stage of radio-frequency amplification, a detector and the special audio-frequency amplifier. All the tuning is accomplished by the single variable condenser, which tunes the input circuit. The knob on the panel at the left functions as a regeneration control; and the knob at the right, when then set is functioning either as phonograph or receiver, controls the volume.

### THE A.F. AMPLIFIER

As mentioned before, the audio-frequency amplifier is so designed that the lower notes of the register are passed through and mag-

**T**HE April issue of RADIO NEWS contained a description of the new El-Fonic capacity pick-up device, which is adaptable to use with any type of phonograph, and the attendant especially-designed amplifier. This arrangement, which has been developed by the writer, is superior to many of the existing methods of phonographic reproduction, giving in music all the delicate shades and overtones and in speech and singing perfect voice reproduction.

The pick-up itself is unlike any other

\*Radio News Blueprint Article No. 18.  
†Consulting Engineer, Adams-Sibley Development Corp.

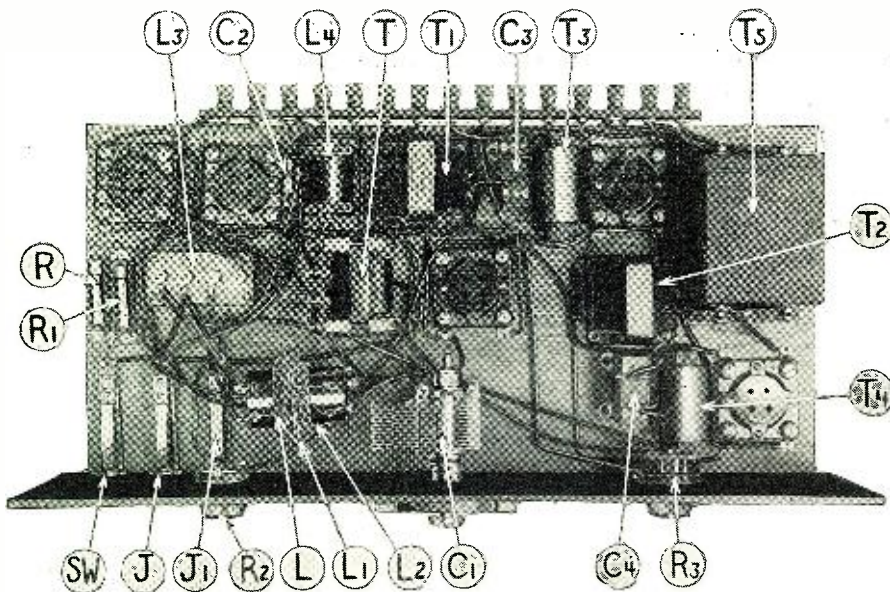

L, L1 and L2, is the oscillator coupler; C1, variable condenser; L3, untuned R.F. transformer; T, A.F. transformer; L4, R.F. choke; T1-T2, plate chokes; T3-T4, grid chokes; T5, output filter; C3-C4, coupling condensers, and R-R1, ballast resistances.



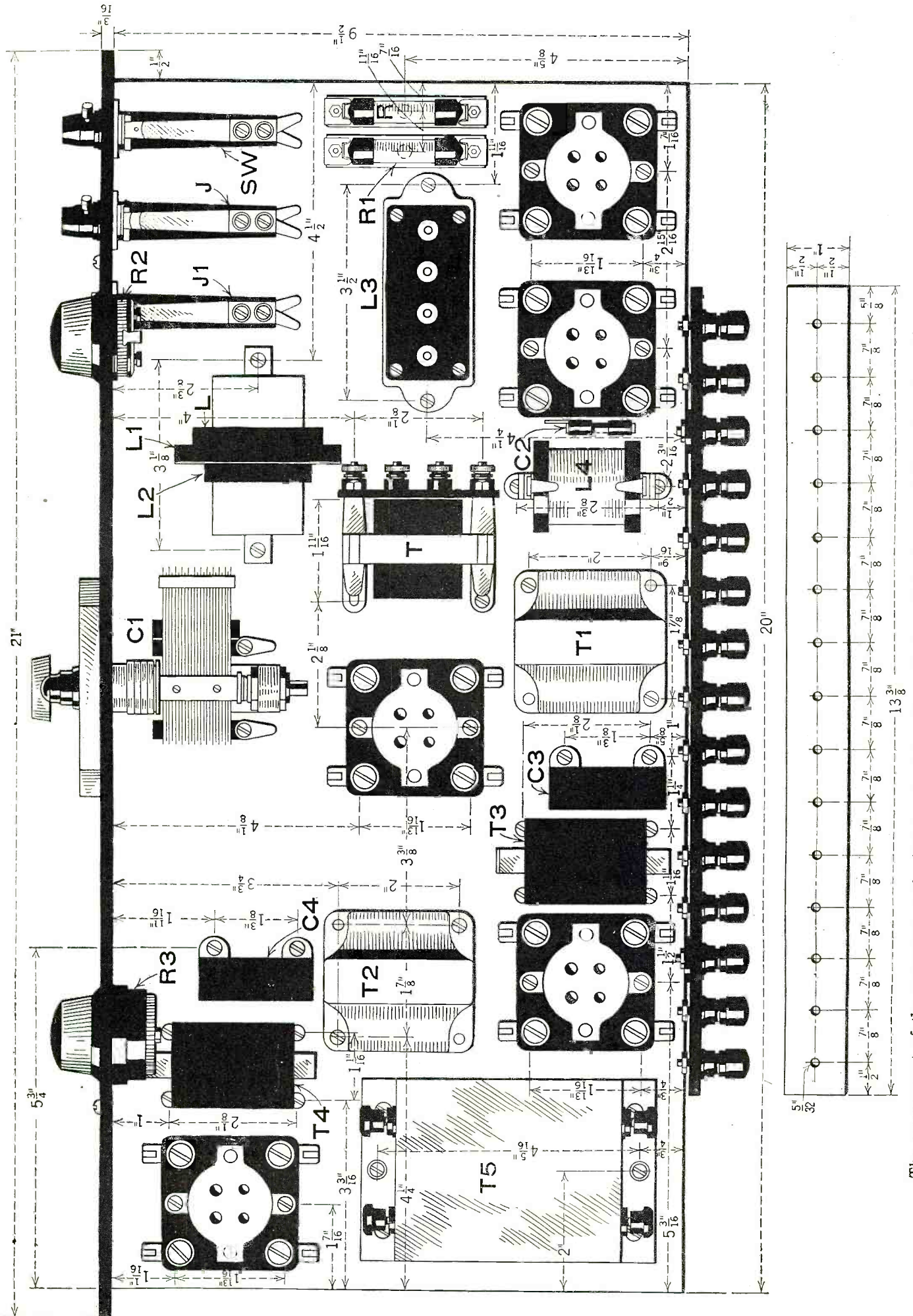

The arrangement of the apparatus on the base-board of the Phono-Radio. At the bottom, drilling dimensions for the binding-post strip.

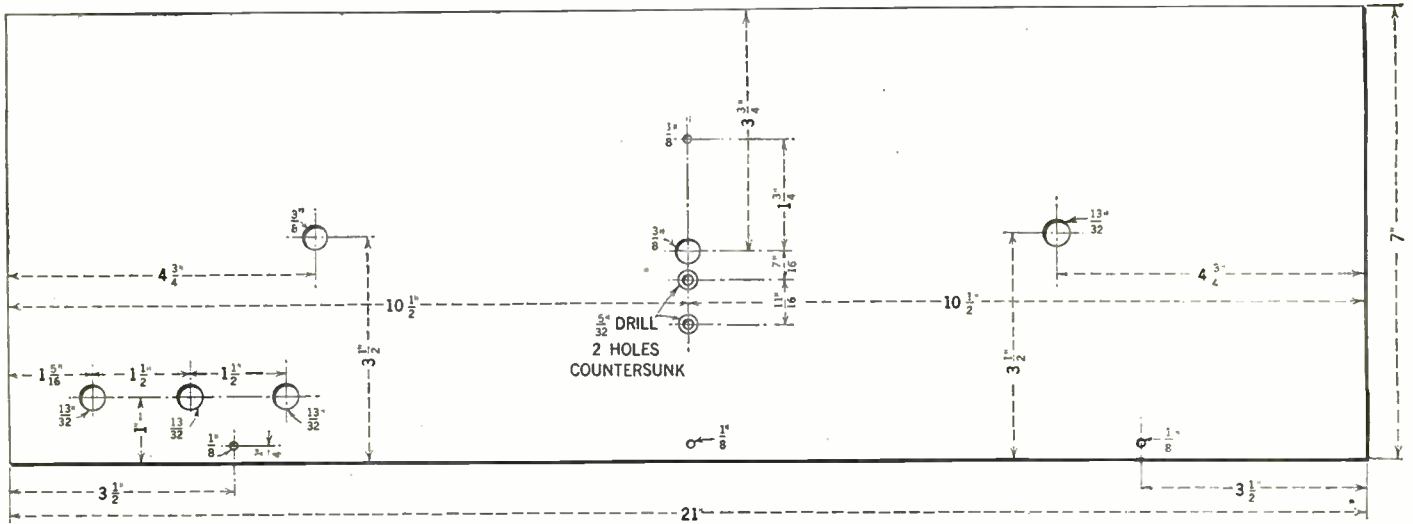

In the above sketch are shown the relatively few holes that have to be drilled in the front panel of the set.

nified as well as the upper ones, and without any distortion. In short, the amplifier is one that will meet the requirements of the most critical music-lover.

Now, in order to get the results that are possible with this amplifier, it must be very carefully constructed and the materials employed in its make-up should be of the highest quality. Let us consider first the audio-frequency transformer, T. It is of the utmost importance that this instrument have a low primary impedance, and about the only ones that have this characteristic are those of the old type. It should have a ratio of  $4\frac{1}{2}:1$  and be high-pitched. With a transformer of this type in the circuit there is no danger of over-accentuation of the bass notes. This may seem peculiar to some readers, when lately such stress has been laid on bringing out the bass notes in a loud speaker; but if a high-impedance transformer is used the bass notes will be so loud and overpowering that they will drown out the melody carried in the treble. This old type of transformer will be found to be just as efficient when the set is being used for radio as when it is reproducing phonograph music; i.e., the low notes will get through in sufficient volume to give the proper "background" to the music.

**ENORMOUS IMPEDANCE VALUES**

Now the grid chokes, T3 and T4, in the diagram. These chokes are unlike any other. The usual choke used in this posi-

tion in an audio-frequency amplifier has an impedance value between 100 and 200 henries, while the value of each of these is 2000 henries! The question might be raised, what is the use of having such a high value of impedance in the grid circuit of an amplifier tube? If the reader will stop to think, he will quickly see that, if the grid and plate chokes were of approximately the

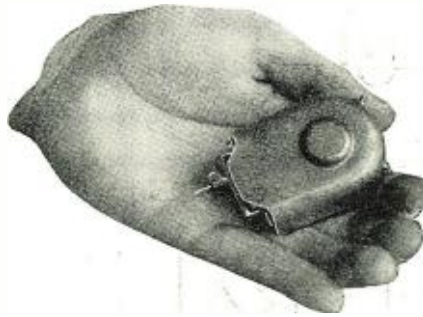

This shows the comparative size of the pick-up device and a man's hand. The two terminals are seen beside the thumb and forefinger.

same value, there might be set-up audio-frequency oscillations due to the two circuits being in resonance—and that would be the end of efficient amplification. However, with 1800 henries difference between the two chokes, this danger has been completely eliminated.

As there is no load in the grid circuits of the amplifier tubes, the value of 2000 henries is obtained by using a closed core, and this does not necessitate the use of a comparatively large winding. As the D.C. resistance of the choke is low, due to the relatively small amount of wire used in the coil, it is impossible for any appreciable charge to accumulate on the grid of the tube. This also permits the use of a coupling condenser of comparatively high capacity, 1.0 mf., an obvious advantage. This system, as worked out, makes the amplifier adaptable for use with "B" socket devices as it prevents "motor-boating." This, unfortunately, can not be said for the usual type of double-impedance coupling.

The radio-frequency choke, L4, and the by-pass condenser, C2, together keep radio-frequency currents from the primary of the audio-frequency transformer, T. At the plate side of the power tube, V4, will be seen a like combination; only this is to keep the direct current out of the windings of the loud speaker. Across the secondary of the audio-frequency transformer, T, will be seen a potentiometer, R3, having a value of 500,000 ohms, (0.5 megohm). This is used as a volume control, not only when the set is used for radio, but also when it is reproducing phonograph records.

**FUNCTIONING OF THE SWITCHES**

There are two D.P.-D.T. jack switches, J and J1, at the R.F. end of the circuit,

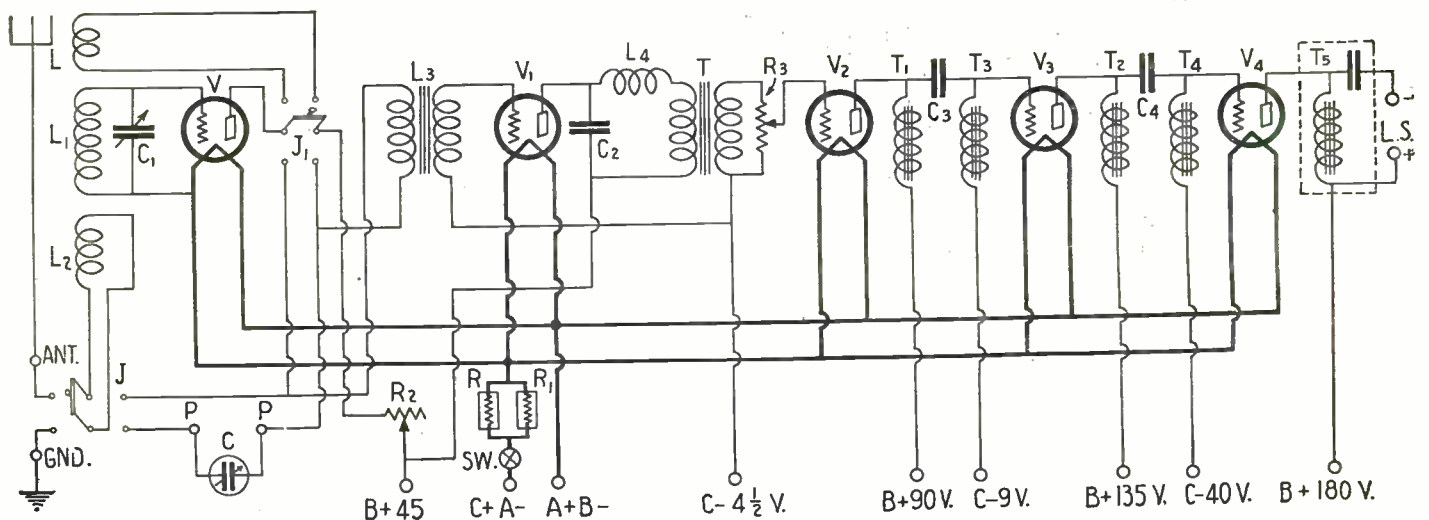

The schematic wiring diagram of the Phono-Radio combination set. By throwing the switches, J and J1, either radio or phonograph reproduction may be obtained at will.

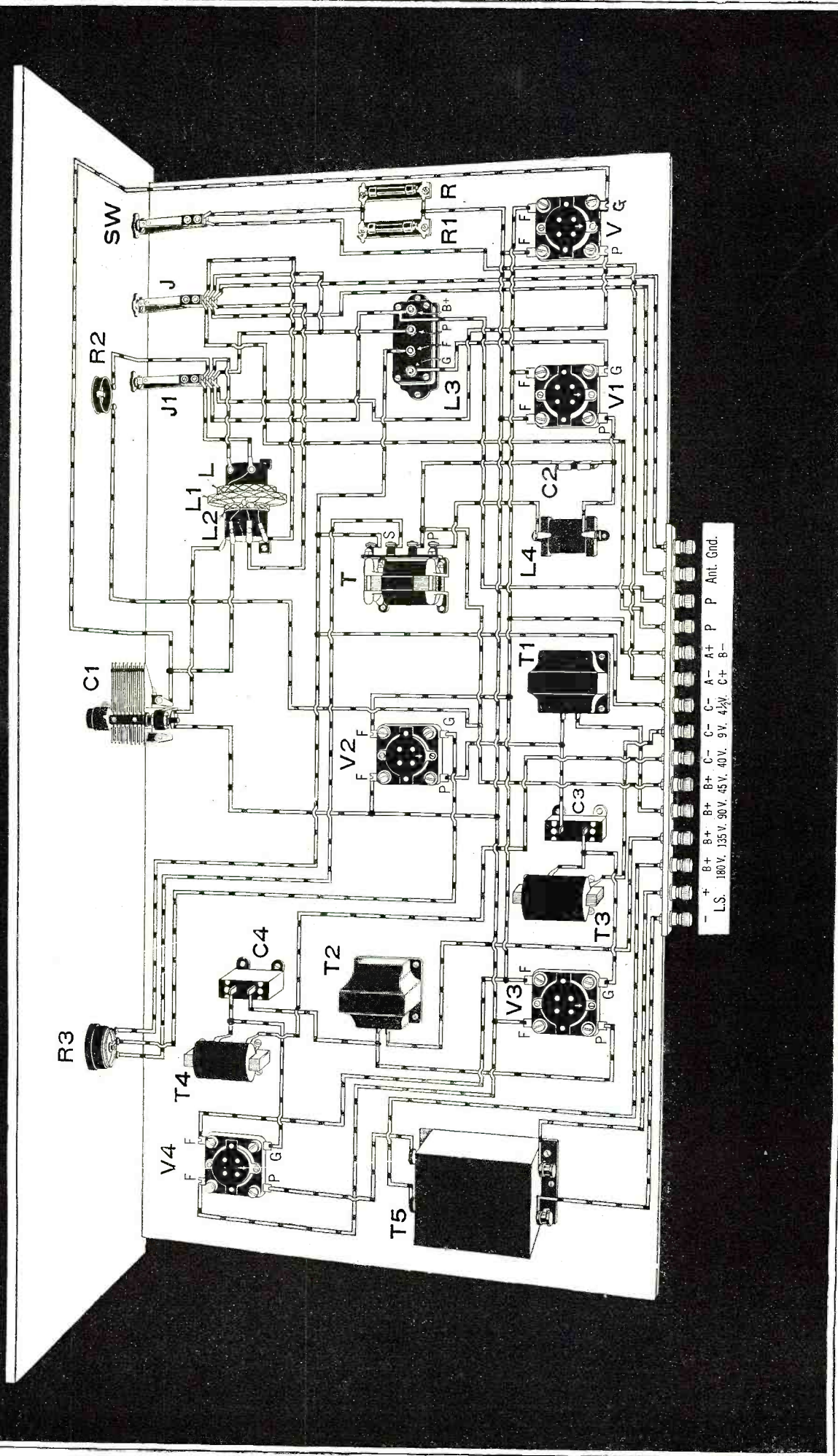

The complete wiring diagram of the Phono-Radio combination set. Much of the wiring can be done before the binding-post strip is mounted in place.

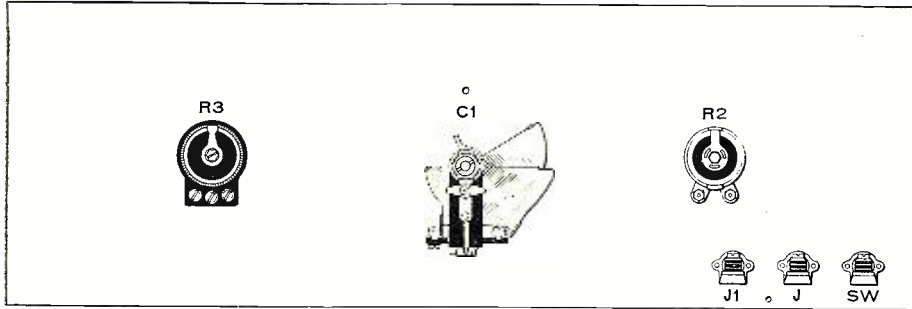

How the parts are arranged on the front panel of the set. (Rear view.)

the purpose of which is to convert the set from a radio receiver to a phonograph reproducer. When the switch J, (see the schematic diagram), is thrown to the left, connecting the antenna and ground to the coil, L2, and the switch, J1, is thrown down, connecting the plate of the tube, V, in series with the primary of the radio-frequency transformer, L3, and plus 45 volts, the set is ready to receive broadcast signals. It will be noticed that the coil, L, is not used. Now when the switch, J, is thrown to the right, connecting the coil, L2, in series with the pick-up device and the primary of the radio-frequency transformer, and the switch, J1, is thrown up, connecting the coil, L, in the plate circuit of the tube, then the set is prepared for reproducing phonographic music.

When the set is prepared for broadcast reception, as outlined above, the coil, L2, functions as the primary and the coil, L1, as the secondary. Across the latter is shunted a .0005-mf. variable condenser, which is the only tuning control. The variable resistance, R2, controls the regeneration by varying the voltage impressed on the plate of the tube, V. When the switches are so thrown that the set is ready to reproduce phonograph records, then the coil, L, becomes the tickler; L1, the oscillator coil and L2, the pick-up coil. In this case R2 is turned full to the right so that all of its resistance is out of the circuit, and the condenser, C1, is adjusted to bring the oscillating circuit to that frequency which will best fit the constants of the untuned radio-frequency transformer, L3. Once this setting of the variable condenser has been found, it remains the same every time the phonograph is used.

**THE CONSTRUCTION**

One of the most important pieces of apparatus in the entire set is the oscillator coupler, L, L1, and L2. This coupler should be most carefully constructed as it really is the heart of the circuit. First the three coils are wound. They are of the basket-weave type of winding and their internal diameter is 1½ inches. There are 25 turns of No. 24 D.S.C. wire on L; 52 turns on L1 and 10 turns on L2. These coils are all wound in the same direction.

After winding, the coils are slipped over an insulating tube (cardboard or bakelite) which is 1½ inches in diameter. On this tube are fastened six soldering lugs, to which the ends of the coils are soldered, and to which connections are made from the apparatus in the set. Two pieces of thin strip brass are used as supports for this coil, as may be seen in the accompanying illustrations.

The filaments of the vacuum tubes are adjusted by two filament resistors, one one-ampere capacity each, connected in parallel so that two amperes are delivered to the filament leads. The tubes V, V1 and V2 are of the 201-A type; tubes V3 and V4, are semi-power and power tubes (112 and 171) respectively. The amount of current supplied to the filaments is not at all critical.

The arrangement of the apparatus on the panel and baseboard places the different instruments in such a position that the connections are as short as possible. When wiring the set it would make things easier for the constructor to do as much of the soldering as possible before mounting the binding-post strip in position; as there might otherwise be found several awkward places in which the iron would be hard to place.

**OPERATION**

It will be seen from the illustration showing the capacity pick-up that there are two connection screws at the top. Wires are run from these connections to the two binding posts marked "P-P," on the strip at the rear of the set. The pick-up C replaces whatever type of reproducer is already on the phonograph and there should

be no trouble in fitting this in place by means of the rubber bushing. The wires connecting the pick-up to the set should be as short as possible.

As explained previously, when the two jack switches are thrown to the left the set can be used for receiving broadcast programs; and when they are thrown to the right the set is ready for the reproduction of phonograph music. It is important that all the plate and grid voltages ("B" and "C" battery values) should be correct. For instance, it will be noticed from an inspection of the schematic diagram that there are no grid-condenser and grid-leak in the circuit of the detector tube; these are eliminated through the use of the proper grid bias of 4½ volts.

There is no doubt that the fan who constructs this set will have one of which he may well be proud. There are many possible combinations of the radio and the phonograph; but the one herein described will be found to be satisfactory to even the most sophisticated critic.

Doubtless many other combinations of a radio receiver and the capacity type of pick-up will suggest themselves to the keen-minded radio experimenter. There are many radio receiving circuits which will adapt themselves admirably to a combination of this kind; but it should be born in mind by the constructor that, in order to get the best results that are possible with this device, it is necessary to have an audio-frequency amplifier and a loud speaker that are of the highest possible types.

SYMBOL	Quantity	NAME OF PART	VALUE OF PART	REMARKS	MANUFACTURER ★
L, L1, L2	1	Coupler		Special	1
L3	1	R.F. Transformer		Untuned type (300 meter peak)	2 4, 15, 16
L4	1	R. F. Choke	85 MH		3 17, 18
C	1	Pickup		Special	4
C1	1	Var. Condenser	.0005 mf.	Straight line tuning type	5 19, 24
C2	1	Fixed Condenser	.001 mf.	By-pass	6 8, 16, 20
C3, C4	2	Fixed Condensers	1.0 mf.	Coupling	6 8, 16, 21
R, R1	2	Auto. Fil. Control	5 v. 1 amp.		7
R2	1	Var. Resistance	10,000ohms	Regeneration control	8
R3	1	Potentiometer	50000ohms	Volume control	6 8, 22, 23
T	1	A. F. Transformer	4½ to 1	High pitch	2 3, 15, 17, 24, 25, 26
T1, T2	2	Plate Impedance	200 Henrys		3 2, 26
T3, T4	2	Grid Impedance	2000 Henrys	Special	1
T5	1	Output Filter		Impedance & condenser in one	1 24, 27
J, J1	2	Jack Switch		Double pole double throw	8
SW	1	Fil. Switch			8 6, 23
	5	Sockets		UX type	9 17, 18, 24, 40
	15	Binding posts			9 24, 28
	1	Dial		Vernier	10 3, 9, 15, 17, 27
	1	Panel		7 X 21 X 3/16"	11 35, 36, 37, 38, 39
	1	Sub-base		Wood 9½ X 20 X 1½"	
V, V1, V2	3	Tubes	5 v. ½ amp.	Standard	12 29, 30, 31, 32
V3	1	Tube	5 v. ½ amp.	Semi-power amplifier	12 29, 30, 32
V4	1	Tube	5v. ½ amp.	Power amplifier	12 29, 30, 31
		Hookup Wire			13 14, 33, 34
	1	B. P. Strip		13½ X 1 X 3/16"	11 35, 36, 37, 38

NUMBERS IN LAST COLUMN REFER TO CODE NUMBERS BELOW.

1 Interstate Sales Co.	17 Silver Marshall, Inc.	33 Belden Mfg. Co.
2 Acme Apparatus Co.	18 Bremer-Tully Mfg. Co.	34 Cornish Wire Co.
3 Samson Electric Co.	19 General Instrument Co.	35 Insulating Co. of Amer. (Insuline)
4 Adams-Sibley Developing Corp.	20 Toba-Deutschmann Co.	36 Hicerta Fabricators, Inc.
5 Hammarlund Mfg. Co.	21 Aerovox Wireless Corp.	37 Formica Insulation Co.
6 Electrad, Inc.	22 Central Radio Labs.	38 Diamond State Fibre Co. (Bakelite)
7 Radfell Co. (Amperite)	23 H. H. Frost, Inc.	39 The Lignole Corp.
8 Carter Radio Co.	24 General Radio Co.	40 Gray & Danielson (Remler)
9 H. H. Eby Mfg. Co.	25 Amer. Transformer Co. (Amatran)	
10 Brooklyn Metal Stamping Co.	26 Thorderson Mfg. Co.	
11 Amer. Hard Rubber Co. (Radion)	27 The National Co.	
12 C. E. Mfg. Co. (Coco)	28 X-L Radio Labs.	
13 Acme Wire Co. (Calziste)	29 Radio Corp. of America	
14 Alpha Radio Supply Co., Inc.	30 F. T. Cunningham, Inc.	
15 All American Radio Co.	31 The Mecravox Co.	
16 Dubilier Condenser Corp.	32 The Van H-rne Co.	

FORM COPYRIGHT 1927 EX. PUB. CO.

★ THE FIGURES IN THE FIRST COLUMN OF MANUFACTURERS INDICATE THE MAKERS OF THE PARTS USED IN THE ORIGINAL EQUIPMENT DESCRIBED HERE.

If you use alternate parts instead of those listed in the first column of manufacturers, be careful to allow for any possible difference in size from those originally used in laying out and drilling the panel and sub-base.

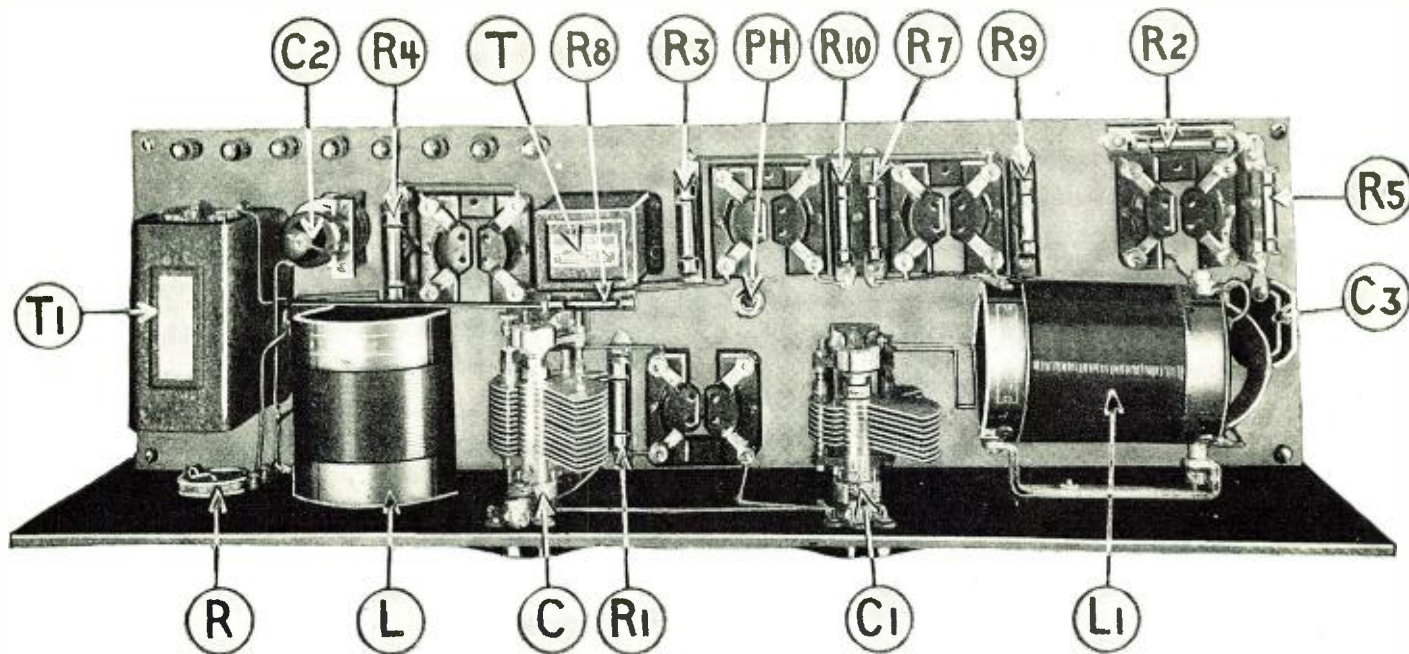

A top view of the Browning-Drake receiver designed by Mr. Lynch. The parts are: L, aerial coupler; L1, R.F. transformer; C, aerial tuning condenser; C1, R.F. tuning condenser; C2, series aerial condenser; C3, grid condenser; R, rheostat; R1, R2, R3, R4, ballast resistances; R5, grid leak; R7, R8, plate resistors; R9, R10, grid resistors; PH, Phasatrol; T, grid impedance; T1, output filter.

# Modernizing the Browning-Drake Receiver\*

The Use of the Phasatrol Serves to Increase the Amplification

By ARTHUR H. LYNCH

THIS article, the second of a series on the Browning-Drake circuit, describes a receiver which embodies many improvements of recent development. The complete instructions will enable the home constructor to build with little trouble an inexpensive set which is economical and easily operated; yet is both sensitive and selective, with great volume and remarkable fidelity to tone.

In June RADIO NEWS Mr. Lynch will recapitulate the previous two articles and will show how all the principles explained may be incorporated in the present model, as well as in another or similar type, in attractive cabinets, and in conjunction with devices now commercially obtainable, which make very satisfactory the operation of any receiver from the light-socket.

If you have not already done so, we recommend that you read Mr. Lynch's preceding article, in RADIO NEWS for April.

—EDITOR.

CIRCUITS have come and circuits have gone, but still that pioneer—a single stage of tuned neutralized radio-frequency amplification and regenerative detector—holds its own. Radio-frequency transformers, condensers, and methods of neutralization have been and still are being improved; but the fundamental circuit remains basically unchanged.

As a result of the improvements made in the component parts which go into a receiver employing this fundamental circuit, however, the performance is markedly

superior to that of one built with the best of parts available even a year ago.

### THE "BROWNING-DRAKE" CIRCUIT:

The circuit diagram of the original "Browning-Drake" receiver, described in April RADIO NEWS, which employs the radio-frequency transformer designed by Glenn H. Browning and Fred H. Drake when they were students at Harvard University, is shown in Fig. 1. While it is often referred to as the "Browning-Drake" circuit, such is not exactly the case. Browning and Drake developed a highly-efficient radio-frequency transformer and used it in this circuit, which is basically the same as that employed by Dr. Walter Van Braam Roberts in the well-known "Roberts" circuit and by the writer in his "Aristocrat" receiver, as well as in several other popu-

lar sets of the past few years. But with this diagram as a basis, let us discuss the various changes and refinements that have been developed during the past year or two and have been finally incorporated in the modernized "Browning-Drake" receiver.

To quote Mr. Browning himself on this subject: "In the set described, a tuned radio-frequency transformer is employed and the design of this transformer is the major factor in the efficiency of the receiver. The transformer was designed by Browning and Drake, from theoretical considerations; the mathematics being first worked out and the maximum possible amplification of a vacuum tube, used with a tuned-radio-frequency transformer, being computed. Investigations made at Cruft Laboratory, Harvard University, showed

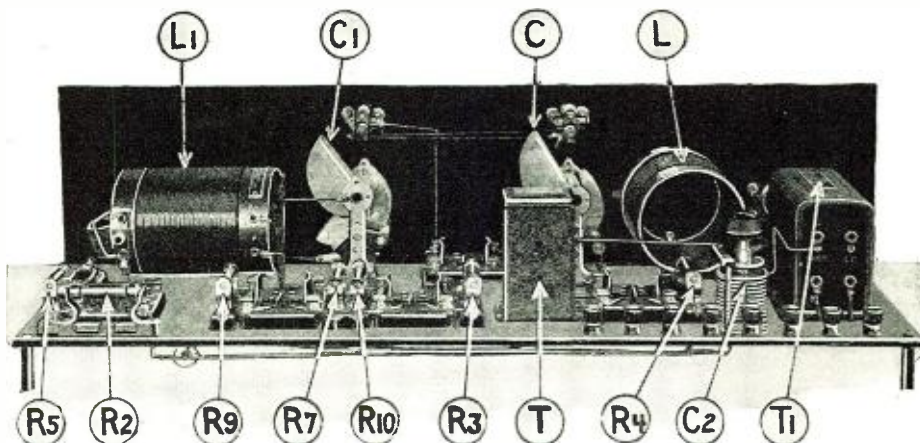

A rear view of the completed receiver. The small dial lights can be seen on the panel, just above the variable condensers C and C1. It is interesting to note that the panel is supported entirely by the variable condensers, which are fastened to the sub-base.

\*RADIO NEWS Blueprint Article No. 19.

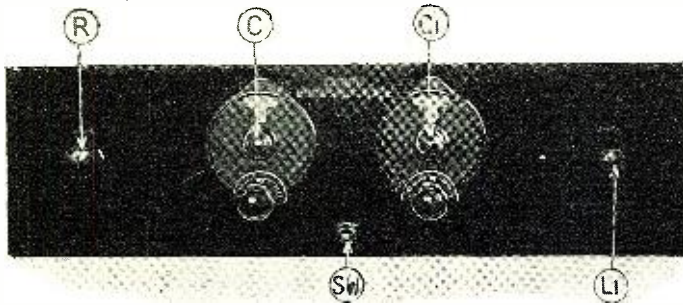

A panel view of the completed receiver. R is the rheostat controlling the radio-frequency tube; C and C1 are the tuning condenser dials, SW the filament switch and L1 the knob controlling the tickler coil in the plate circuit of the detector tube.

John F. Rider has made a simple and dependable expedient available. The Phasatrol makes the B-D receiver stable over the entire tuning range, even when a 201-A tube is used in the R.F. stage; it works particularly well with some of the new special tubes now on the market.

IMPROVED DETECTOR TUBES

At this point, it will be well to say a few words about these new tubes. Though apparently no better on local stations, so far as can be determined by the ear, these new detectors are regarded by many experimenters as giving the equivalent of another stage of R.F. amplification on distant signals. In fact, stations, which are barely audible with a 201A-type detector are often made quite clear by the substitution of a special detector.

When one of these new tubes is to be used, the detector-grid return should be made to the "A-," rather than to the "A+" as usual when using the older types. Fig. 1 shows the old positive grid return,

that only when the capacity coupling between the primary and secondary windings was lowered to a minimum, could maximum voltage amplification be obtained.

"It is the design of the transformer rather than the particular circuit in which it is employed which is the essential feature of the Browning-Drake development. In this slot-wound transformer, capacity coupling is reduced to a minimum."

INCREASED SELECTIVITY

Now that there are so many stations on the air—more than there is actually room for—selectivity, without the loss of sensitivity or tone quality, is essential. In the original B-D receiver the antenna was connected directly to the grid coil of the radio-frequency amplifier. However, it has been found that, with the average single-wire antenna, the sensitivity of the receiver is actually increased by the use of a very small (100 micro-microfarad) variable condenser in the antenna lead. The real advantage from this arrangement is increased selectivity.

As a result of considerable research work done by the radio laboratory of the United States Bureau of Standards at Washington, it has been found that the most efficient inductance for use at broadcast frequencies is a solenoid approximately three inches in diameter, with enameled wire space-wound, so that each turn is separated from its neighbor by a distance equal to half of its diameter.

The new tuning units, which are the work of W. A. Ready, are manufactured to meet these requirements. Variable tuning condensers have been improved in many ways; first, electrically, until the losses were reduced to an entirely negligible quantity, and then mechanically. Perhaps one of the most recent developments is in the shape of the movable plates, which prevents "crowding" of stations in any one section of the tuning dial.

In the original arrangement used by Messrs. Browning and Drake, a 199-type tube was employed as a radio-frequency amplifier. The main reason for the use of this tube for the purpose was the ease with which it could be neutralized with the methods of neutralization understood at the time.

IMPROVED NEUTRALIZING METHODS

The comparatively short life and unre-

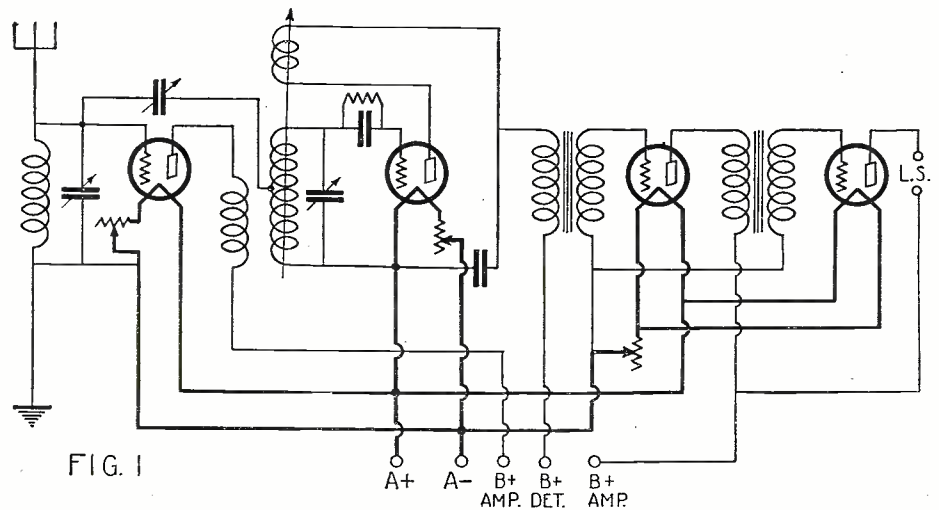

FIG. 1 The original Browning-Drake circuit drawn with the addition of a two-stage transformer-coupled audio-frequency amplifier. This circuit uses a neutralizing condenser.

liability of the 199-type tube has long been the weak spot in receivers of this kind; but when attempts were made to replace it with the 201-A bulb, oscillation in the R.F. circuit could be prevented only by balancing or neutralizing schemes that were difficult to adjust for completely satisfactory operation. However, the perfection of the "Phasatrol" system by Arthur Moss and

and Fig. 2 the negative grid return for the new detector.

RESISTANCE COUPLING ADVISABLE

The plate impedance of the new detector tubes, when low plate voltages are used, is rather high, and as a result it is practically necessary to use resistance coupling, in at

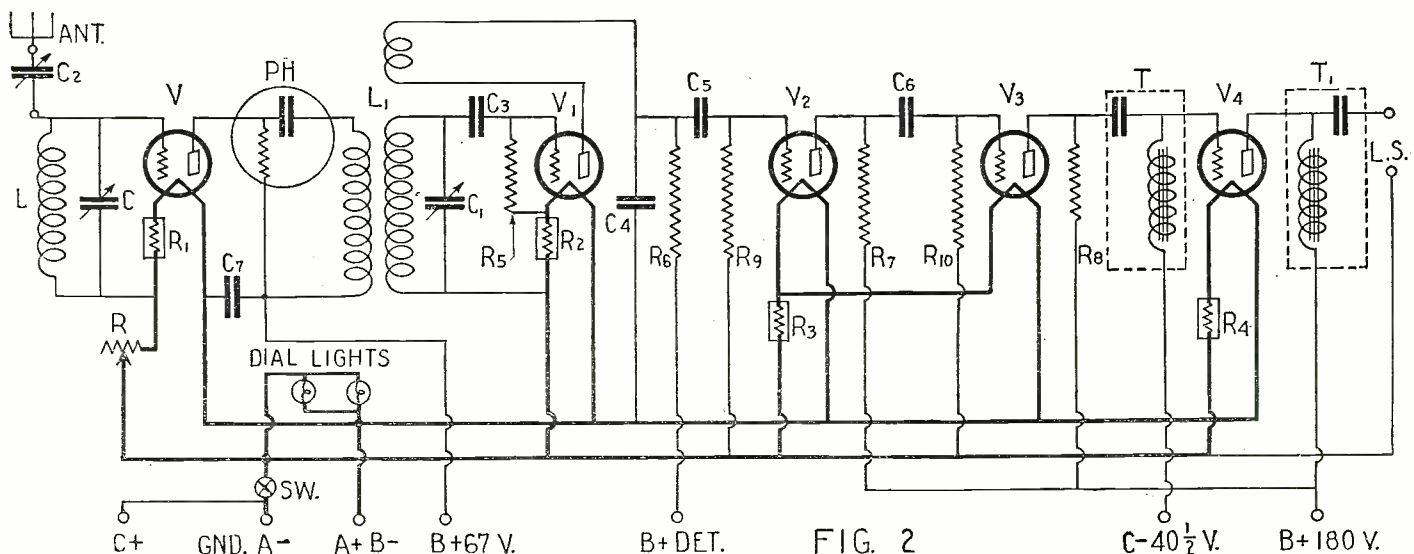
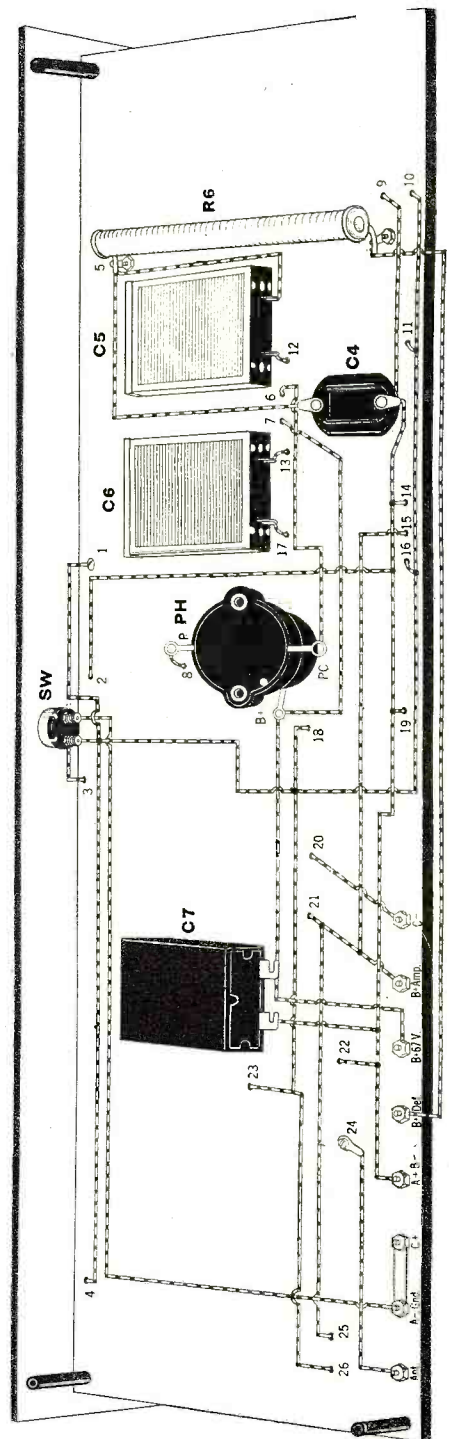
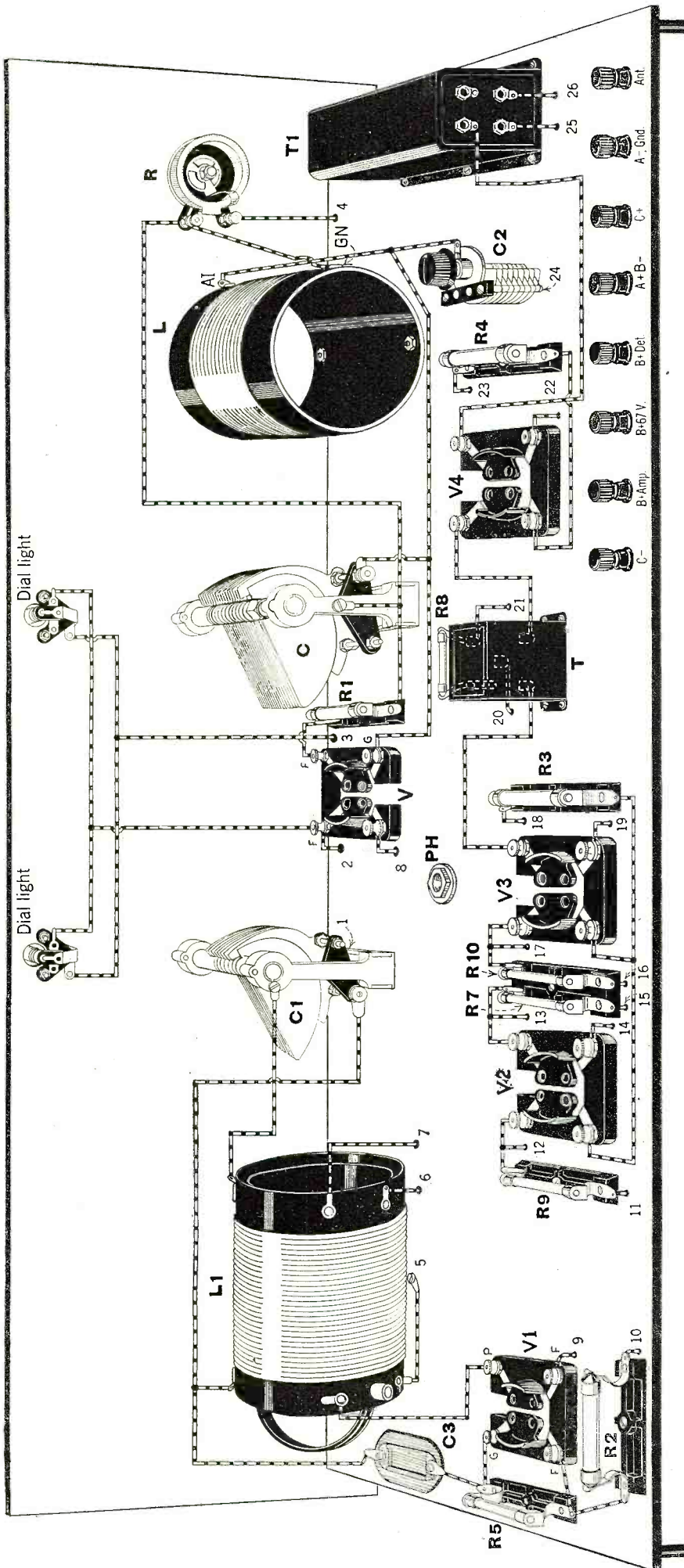

FIG. 2 The complete schematic diagram of the "Modernized Browning-Drake" receiver. PH is the Phasatrol. Note that the two high-mu tubes V2 and V3 are controlled by the same filament ballast resistance.



Left: Picture wiring drawing of the upper part of the receiver. The wiring under the sub-base is shown in the drawing above. The parts here are: C4, by-pass condenser; C5, C6, coupling condensers; C7, by-pass condenser; R6, wire-wound plate resistor; PH, Phasatrol; and SW, filament switch.

least the first stage of A.F., in order to secure the best of tone quality. If transformer coupling is used, the plate voltage should be raised until its value is approximately 90. This is permissible and desirable with the new "hard" type of tubes, but not with the "soft" type; the plate impedance of the former is materially reduced and better amplification of the low notes results.

In the case of resistance-coupled amplifiers, because of the constancy (regardless of frequency) of the input impedance, the detector tube may have a high-plate impedance without loss of amplification on the low notes. High voltage, however,

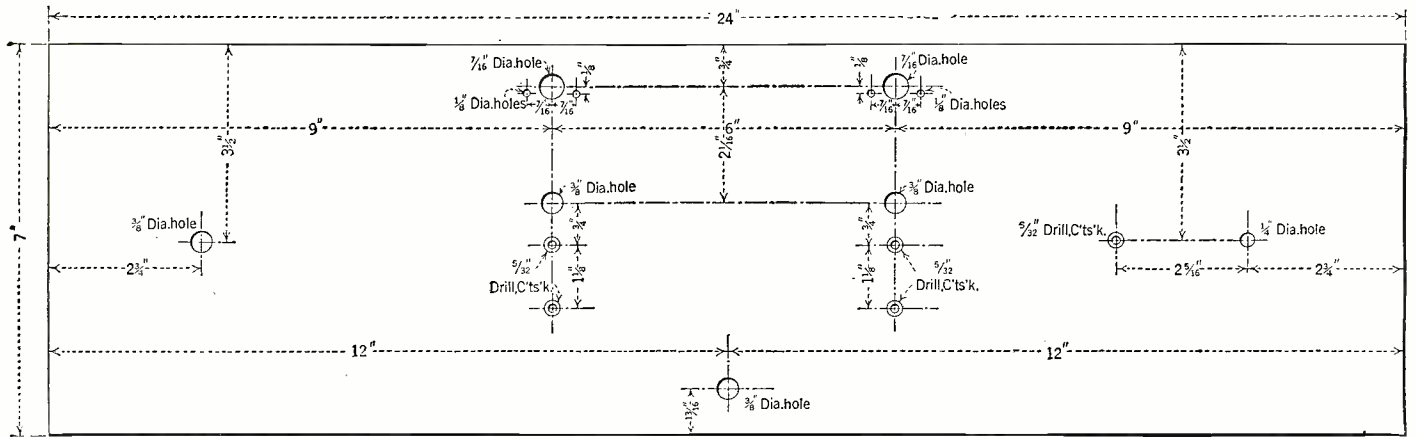

Drilling details of the front panel. All the necessary dimensions are given.

tends to increase the sensitivity of the "hard" tube and for this reason should be employed. Because of the 100,000-ohm coupling resistor in the detector-plate lead, a maximum detector-plate voltage of 135, rather than 90, should be tried.

It is also important that this resistor be of the heavy-duty type (preferably wire-wound) so that it may carry, without gradual disintegration and final failure, the rather heavy-plate current drawn by the

insure the correct voltage on the tube filaments, and needless controls are eliminated. As there are no sliding contacts, another source of noise, frequently mistaken for static, is also absent. The paper-impregnated grid leak, another noisemaker, was often far from its rated value and changed in resistance from day to day. The new metallized-filament resistors are noiseless, within 10% of their rating, and permanent in value.

This system, which is an improvement over the old design of resistance-coupled amplifiers, embodies a practical combination of many well-known ideas and is similar to that used by James Millen in his new amplifier unit.

While resistance-coupling is one of the oldest forms of amplification, there have been many difficulties which prevented its proper use in the past. The development and perfection of metallized-filament resistors, wire-wound resistors of high ohmic value, improved coupling condensers, "high-mu" tubes, power tubes and tone-filters has done much to make the modern resistance-coupled amplifier the excellent system that it is today.

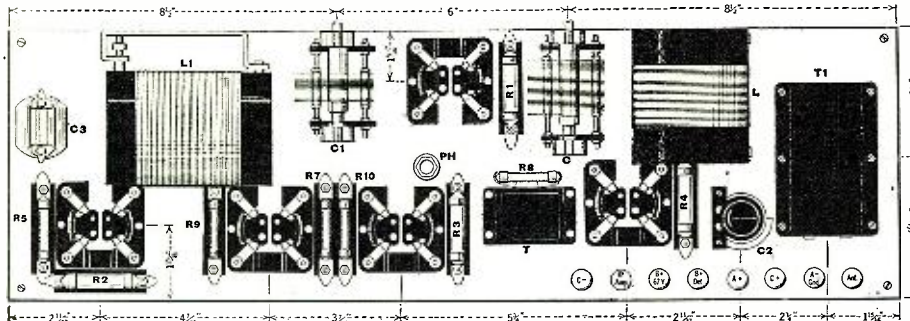

Constructional drawing of the apparatus as it is mounted on the sub-base. The major dimensions are given. Note that the variable condensers also are mounted on the sub-base; they form the supports for the panel, which carries no weight to speak of.

special detector at high voltages; this runs as high as 6 milliamperes in some instances.

In sets of the past, one of the reasons for noise, distortion and short life of tubes has been the use of rheostats to control the filament voltages. Even a very slight increase of filament voltage above the rated value shortened greatly the tube's life, while a reduction of the filament voltage on the A.F. amplifier tubes resulted in distortion. Absolutely correct adjustment required the use of an expensive voltmeter.

Now, however, the perfection of filament-control devices has remedied these conditions. A voltmeter is no longer required to

IMPROVING OUR A.F. AMPLIFIERS

With such improvements being made in the R.F. end of the receiver, it is little wonder that many important advances are being made in the construction of the A.F. amplifier. To improve the old designs, there have been developed new audio transformers, capable of giving an extremely high quality of amplification when used correctly with the new power tubes and a good speaker.

In the improved B-D model, however, a new type of audio amplification is used, in place of the former transformer-coupled audio channel. (Compare Figs. 1 and 2.)

IMPROVING OLD RESISTANCE-COUPLED AMPLIFIERS

A number of resistance-coupled amplifiers have been on the market during the past few years; but while they have given fairly good results, perhaps much better than other forms of amplification available at the time they were introduced, they are no longer all that is to be desired. To modernize such a unit several easily-made changes are necessary:

- (1) Use of a heavy-duty (preferably wire-wound) input resistor for the input coupling unit, to permit satisfactory operation with special detector tubes.
- (2) Use of metallized-filament resistors in place of impregnated-paper type.
- (3) Use of proper tubes—"high-mu" tubes in the first two stages and a power tube in the last.
- (4) Use of proper "C" voltage for the particular "B" voltage employed.
- (5) Use of a suitable output device.
- (6) Substitution of an impedance leak in the last audio stage to permit use with a "B" socket unit. This impedance is

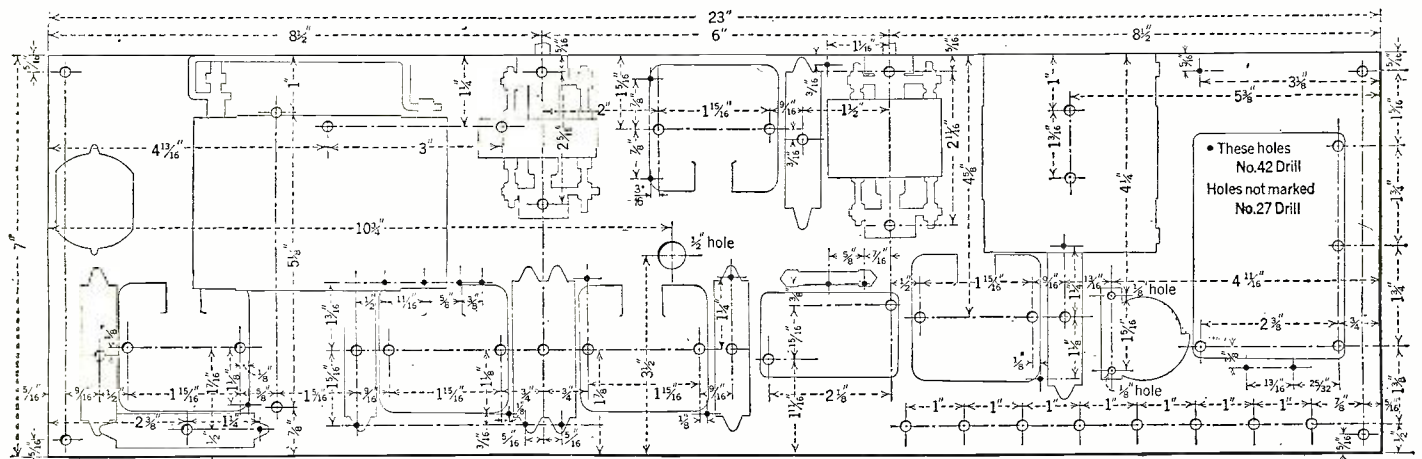

Dimensional drawing of the sub-base, including drilling details. The parts are shown in outline.



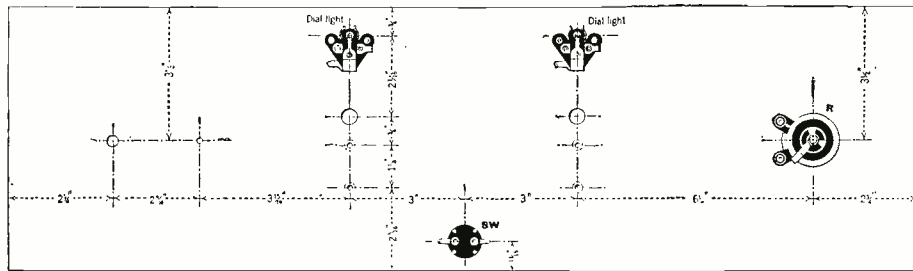

Constructional drawing of the front panel, including all the apparatus which is actually mounted on it. The tuning variable condensers are mounted on the sub-base.

connected to the two clips that formerly held the 250,000-ohm resistor, and is used to change the phase of the grid circuit of the power tube by approximately 90°.

**THE NEW RECEIVER LAYOUT**

The modernized B-D receiver circuit designed by the author is shown in Fig. 2. The general layout presents several new and striking features. One is the method of mounting the coils and condensers to obtain a set with a depth of but seven inches, thus making possible the use of a standard 7x24-inch cabinet. Another feature is the simplicity of the front-panel layout; only the two tuning controls, the two volume controls and the switch are in sight.

While this set was designed primarily for use with batteries, the Millen audio system is employed, making possible the use of a "B" socket unit if desired. In such case, a relay switch should be used with the "B" supply, so that the switch on the front panel will still control the entire set.

**CONSTRUCTION**

The first step in the construction of the modernized B-D receiver is to prepare the front and sub-panels. Should two standard 7x24-inch panels be obtained, then it will be necessary to cut a 1-inch strip off the end of one; as the sub-panel must be at least a half-inch shorter on each end than the front panel, in order to fit in cabinets designed to carry a 7x24 front panel.

When the panels have been drilled, the various units may be mounted in place. As the coils come mounted on the condensers, it will be necessary to separate them and then, with the hardware, which came with them, they are remounted directly on the panel. When this is done, it will be found that the tickler shaft protrudes too far through the front panel. This difficulty is readily overcome by loosening the set screws that hold the tickler shaft and working it back until the knob is at the correct distance from the panel. The excess shaft may then be cut off with a hack saw.

In mounting the two coils, it is desirable to keep them at right angles to each other.

The wire-wound input resistor and the coupling condenser from the A.F. amplifier are located under the sub-panel, through which holes are drilled to receive the terminal lugs by which the resistor is mounted. By the use of separate coupling condensers and mountings (instead of the so-called "resistor-couplers" in which the condensers are located in the hollow base of the mounting) the builder is enabled to substitute condensers of different capacities, if he so desires.

The Phasatrol also is mounted under the panel, in such a way that only its adjustment screw is exposed, as shown. The two variable condensers serve also as mounting brackets to support the sub-panel.

In order to take the remainder of the strain off the sub-panel, the author has used a central support which is formed of the Phasatrol itself. The four outside corners of the sub-panel are supported by bakelite tubes 1 7/32 inches long, with a diameter of 5/16-inch and a 1/8-inch hole. This tubing

is tapped with an 8-32 thread and is held in place by machine screws.

Where bakelite tubing of this character is not available, the home constructor may use a block of wood, the entire width of the sub-panel and 1 7/32-inch high, for the outside support.

**SLANTING PANELS**

In the model here described, a vertical panel is used and all of the units comprising the receiver are mounted directly on the sub-panel. If a slanting panel is desired it is necessary only to mount the condensers on the front panel and to run flexible leads from them to the remainder of the equipment on the sub-panel. In this instance it will be necessary to do one of two things;

either slide the sub-panel back sufficiently to allow the variable condensers to fit in front of it, or mount the condenser frame in a position parallel to the front panel instead of in the vertical position shown here.

**STAGES OF ASSEMBLY**

When everything else has been assembled on the sub-panel, the following procedure will be helpful in placing the coils and variable condensers.

- (1.) Remove the coils from the condensers by taking out the machine screws provided at the factory.
- (2.) Remove the mounting brackets from the condensers by taking out the screws which hold them in place.
- (3.) Mount the condensers on the sub-panel in the position indicated in the diagrams.
- (4.) Mount the antenna-coil bracket on the sub-panel, by inserting machine screws from the bottom, leaving the nuts on top.
- (5.) Fasten the antenna coil to its bracket.
- (6.) Wire condensers and coils to the points indicated in the diagrams.
- (7.) Loosen the set screws which hold the rotor on the shaft of the coil BD-2 and push the shaft back 3/4 inches. Then cut the rod which extends through the coil towards the back by means of a hack saw.

(Continued on page 1376)

SYMBOL	Quantity	NAME OF PART	VALUE OF PART	REMARKS	MANUFACTURER ★
L	1	Ant. coil			1
L1	1	R. F. trans.		With variable tickler coil	1
C	1	Var. condenser	.0005 mf.	S L F type	1
C1	1	Var. condenser	.00025 mf.	S L F type	1
C2	1	Var. condenser	100 mmf.	Midget type	2 12,13
C3	1	Grid condenser	.00025 mf.		3 4,14,15,16,34
C4	1	Fixed condenser	.001 mf.	By-pass	3 4,14,15,16,34
C5,C6	2	Fixed condensers	1 mf.	Coupling condensers	3 4,14,15,16,23,34
C7	1	Fixed condenser	1 mf.	By-pass	3 4,14,15,16,34
R	1	Rheostat	10 ohms	For R. F. tube	4 3,17,18,19,20,25
R1,R2	2	Ballast res.	5v. 1/2 amp.	With mountings	5 21,22,23
R3,R4	2	Ballast res.	5v. 1/2 amp.	With mountings	5 21,22,23
R5	1	Grid leak	2 megs.		5 3,15,16,23,24,34
R6	1	Resistor	.1 meg.	Heavy duty wire wound	5
R7,R8	2	Resistors	.1 meg.	Standard type	5 3,15,16,23,24,34
R9	1	Resistor	1 meg.	Standard type	5 3,15,16,23,24,34
R10	1	Resistor	.5 meg.	Standard type	5 3,15,16,23,24,34
PH	1	Phasatrol		Stabilizing device	3
T1	1	Output filter		Impedance & condenser combined	1 25,35
T	1	Impedance		Grid impedance for power tube	1
	5	Sockets		UX type	6 7,10,18,25,26,37
	2	Dials		Illuminated type	1 17
SW	1	Fil. switch			4 3,18,19
	8	Binding posts			7 18,25
	2	Single mounts		For R5 and R9	5 24
	1	Double mount		For R7 and R10	5 24
	1	Panel		7 X 24 X 3/16"	8 27,28,36
	1	Sub-panel		7 X 23 X 3/16"	8 27,28
V	1	Tube	5v. 1/2 amp.	R. F. amplifier	9 29,30,31,32
V1	1	Tube	5v. 1/2 amp.	Special detector	9 29,30
V2,V3	2	Tubes	5v. 1/2 amp.	Hi-Mu type	9 33
V4	1	Tube	5v. 1/2 amp.	Power or semi-power	9 29,30,31,32

**NUMBERS IN LAST COLUMN REFER TO CODE NUMBERS BELOW.**

1 The National Co.	17 Martin-Copeland Co. (Marco)	33 Ken-Red Corp.
2 Hammarlund Mfg. Co.	18 H. H. Frost, Inc.	34 Dubilier Condenser Corp.
3 Electrad, Inc.	19 Yaxley Mfg. Co.	35 Interstate Sales Co.
4 Carter Radio Co.	20 Central Radio Labs.	36 The Lignola Corporation
5 Arthur H. Lynch, Inc.	21 The Radiall Co. (Amperite)	37 Gray & Denison (Remler)
6 Airgap Products Co.	22 Langbein & Kaufman (Elkay)	38
7 H. H. Eby Mfg. Co.	23 Daven Radio Corp.	
8 Bakelite Corp.	24 Int. Resistance Co. (Durham)	
9 C. E. Mfg. Co. (Ceco)	25 General Radio Co.	
10 Silver-Marshall, Inc.	26 Benjamin Electric Co.	
11 Samson Electric Co.	27 Amer. Hard Rubber Co. (Radion)	
12 Precise Mfg. Co.	28 Insulating Co. of Amer. (Insuline)	
13 L-L Radio Labs.	29 Radio Corp. of America	
14 Sengano Electric Co.	30 E. T. Cunningham	
15 Toba-Deutschmann Co.	31 The Van Horne Co.	
16 Aerovox Wireless Corp.	32 The Magnavox Co.	

If you use alternate parts instead of those listed in the first column of manufacturers, be careful to allow for any possible difference in size from those originally used in laying out and drilling the panel and sub-base.

FORM COPYRIGHT 1927 EX. PUB. CO.

★ THE FIGURES IN THE FIRST COLUMN OF MANUFACTURERS INDICATE THE MAKERS OF THE PARTS USED IN THE ORIGINAL EQUIPMENT DESCRIBED HERE.

# Building a 36-Inch Cone Speaker

A Large Cone Capable of Reproducing Notes of Very Low Frequency

By WARREN T. MITHOFF



IT is with pleasure that we present to our readers this excellent constructional article on a three-foot cone loud speaker. There is no doubt that cone speakers of this size are among the leaders in reproduction of radio broadcast programs, and they are not as difficult to construct as might be thought. The parts for the one described below are inexpensive and easily obtained, and the results from this speaker should satisfy the most critical listener.—EDITOR.

THE broadcast-listener branch of the happy radio family is divided into two major classifications: first, those individuals who go to the store and order their receiving sets installed complete and who are content forever thereafter to pull the switch, turn the dials and listen, whether the resulting music is good, bad, or indifferent; and secondly, the vast group whose inquiring minds delve into all the seeming mysteries of grid leaks, space-wound solenoids, oscillation controls, and the thousand and one other fascinating items that comprise the modern receiving set.

It is safe to say without qualification that every man, woman, and child of this latter group has, at one time or another, stood gazing with fond desire at the smooth brown expanse of a 36-inch cone speaker as it stood in haughty solitude in a store window. Whether or not this fond desire was translated into action, and the cone carried in triumph to the gazer's cosy hearthside, depended solely upon the state of his bank balance.

The writer is one whose radio budget, having suffered ravages from a severe case of superheterodyne construction, would not permit of such gross extravagance just at the time the urge hit him. These 36-inch cones do cost real money, but they are worth every nickel of it, if we judge by results. The only alternative, then, was to build the much-coveted cone. Now there are on the market kits of parts for just this purpose; but the great ambition was to build out of such parts as the junk box afforded.

With this in mind work was started.

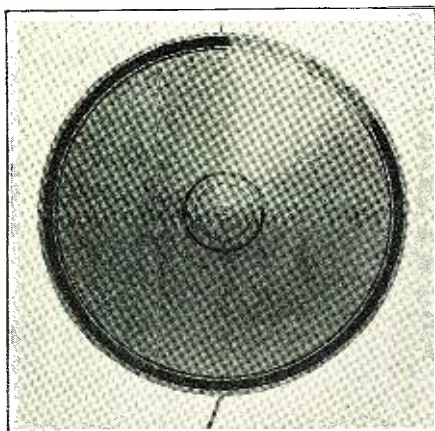
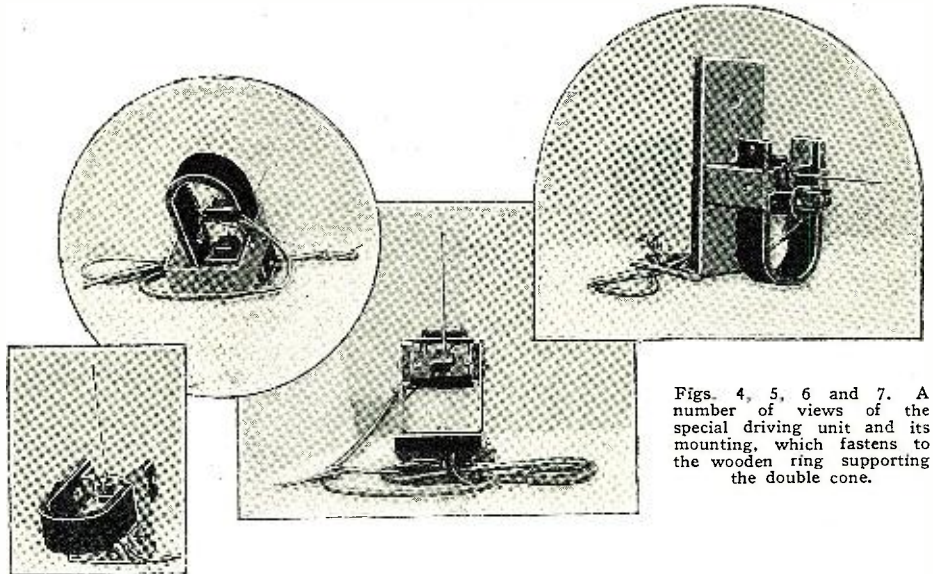

Fig. 1. From the front, the cone presents a very pleasing appearance; and if the constructor is handy with colors it can be made a thing of beauty.



Figs. 4, 5, 6 and 7. A number of views of the special driving unit and its mounting, which fastens to the wooden ring supporting the double cone.

After several months of experimenting an arrangement was found which stood the test; yet the cost was under ten dollars, even with the full market price put upon the junk-box parts.

The only requisites for success along this

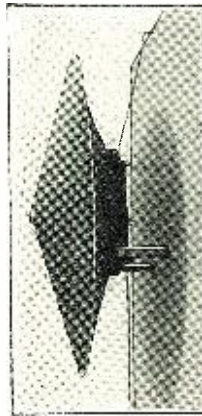

Fig. 2. This shows the manner in which the rear cone is joined to the wooden ring with sealing wax; also the manner of affixing legs, for use in hanging the cone on the wall.

line are the materials, a little patience and care—virtues possessed by every true experimenter—and a good audio amplifier. The amplifier, of course, is important, as a cone speaker will show up distortion entirely passed over by the usual type of horn.

### SELECTION OF PARTS

To start with, certain materials and parts are needed, first in importance being the driving unit. A Baldwin "Type C" is first rate; either the phonograph attachment or one of a pair of earphones. One is being used by the writer with great success, and this article is being prepared with the Baldwin unit in mind. Dimensions and instruction are given accordingly; although the same general procedure can be followed with any unit which has the balanced-armature type of construction. Units which have the thin iron diaphragm supported above the coils will not do for this cone, as they are inclined to rattle, and do not have sufficient power.

A large permanent horseshoe magnet is also needed, and can usually be obtained from one of the firms which make a busi-

ness of scrapping worn-out automobiles and trucks. The magnet required is the kind found on truck magnetos,  $3\frac{3}{8}$  inches across the legs, 6 inches long, and made of  $\frac{3}{8}$  x  $1\frac{1}{2}$ -inch steel. These dimensions are used in this article and the accompanying drawings, and if a magnet of different size is obtained, allowance must be made accordingly. Most of these magnets are already provided with two drill holes on each leg, to pass  $\frac{1}{4}$ -inch machine screws.

The only other major item needed for the speaker is the paper from which to make the cone itself. The very best thing to use here is Alhambra "Low Frequency" paper; as its structure is such that it is not resonant to any particular frequency of its own, but reproduces all frequencies with good uniformity. Other papers can be used with greater or less success, depending on their nature. For example, lampshade parchment, which comes 36 inches wide, is highly satisfactory in actual practice, if not in theory; and it can be stained a rich brown with walnut-wood stain, and decorated with oil paints to suit the constructor's fancy. Some papers used for covers for catalogs and books can also be used, such as Castilian cover, heavy weight; a good printer can suggest something for the purpose. One trouble with the cover stocks is that gen-

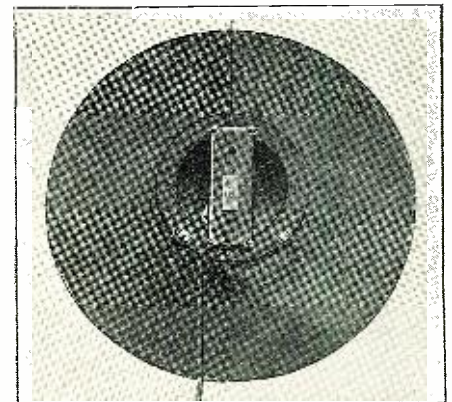

Fig. 3. Showing how the two cones are joined together with sealing wax or glue, and how the cross piece fits across the wooden ring.

erally the largest sheets obtainable are 23 x 33 inches, so they would have to be pieced out to make a 36-inch cone.

Some odds and ends are needed, of course, such as 6 inches of  $\frac{1}{8}$  x  $1\frac{1}{2}$ -inch cold rolled steel; 12 inches of strip brass the same size; some No. 30 gauge sheet copper or brass, No. 30 gauge phosphor bronze, and  $\frac{1}{4}$ -inch, round brass rod. Machine screws in four sizes are used:  $\frac{1}{4}$ -inch, No. 6-32, 4-36, and 2-56. Taps should be on hand for the 6-32, 4-36, and 2-56 sizes.

**ADAPTING THE UNIT**

The first step is the dismantling of the Baldwin unit. The top of the hard-rubber case is unscrewed; the entire mechanism may then be removed, and the double speaker cord disconnected and laid aside for future use. Before doing any more dismantling, it is well to examine what is found inside the Baldwin case. There is a small coil of very fine wire, oval in shape, with an oblong slot through the center of it. Through this slot there is a small, flat, iron armature, one side of which is joined to the diaphragm with a fine brass

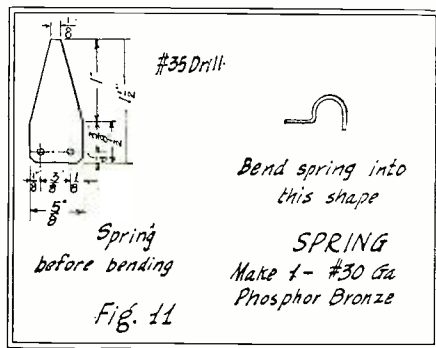

Details of the armature-balancing spring.

wire, and the other held in place with a bent wire spring. Around the coil are "U" shaped pieces of flat steel, and to them is fastened the permanent magnet with machine screws. It is an excellent idea to pay careful attention to the manufacturer's method of assembling this unit, with regard to coil and magnet polarity. In other words, when the unit is re-assembled, this should be done in the same manner as originally, the inner and outer ends of the winding going to the same respective binding posts, and these terminals placed with the same respect to the north and south poles of the magnet. By marking the coil before removing it, no trouble should be experienced in re-assembling.

The diaphragm used in this unit is of mica instead of metal; through the center of it projects the fine brass wire mentioned above, secured with a nut and a drop of solder. The mica should be cut or broken,

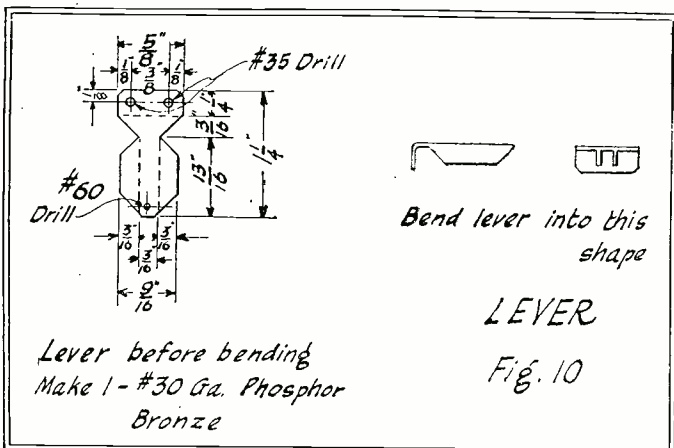

The lever to which is attached the drive rod. One end of the lever is fastened to the frame of the unit, and the other end is attached to the balanced armature.



Details of the brackets, two of which are used for supporting the solenoid. These brackets form a part of the magnetic field.

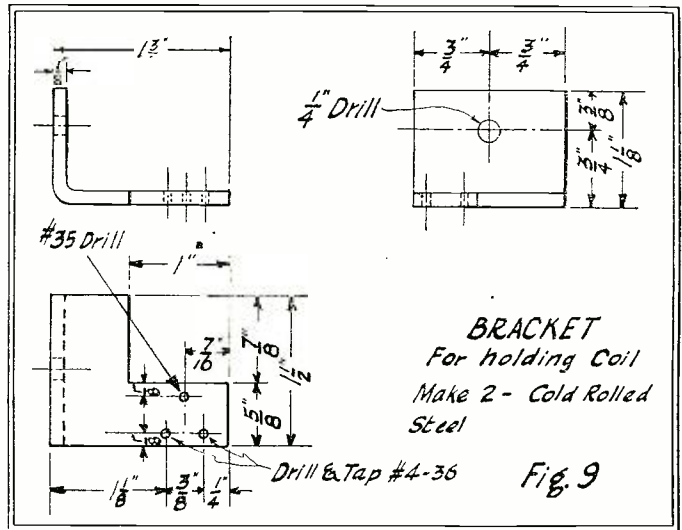

and the wire clipped and unhooked from the projecting end of the armature. The circular magnet is next removed from the coil by taking out the two small screws which hold it in place. Then the tiny wires leading from the coil to the binding posts are unsoldered, care being used that they are not broken. The binding posts may be removed also. The coil, together with the two "U" shaped pieces of steel, is held with three rivets to a metal disc, on which the mica diaphragm originally rested. These rivets must be cut or filed off to permit the coil to be removed; the disc is then thrown away. The small wire spring holding the armature is removed, and the armature is taken out and laid aside.

The coil is now to be mounted on the large horseshoe magnet; but, in order to do this, it is necessary to make two brackets of cold rolled steel, as shown in Fig. 9. These brackets are drilled and tapped as indicated, smoothed off with a file, and mounted with  $\frac{1}{4}$ -inch machine screws on the large magnet, so that there is an even separation between them. The coil, with the two "U" shaped pieces in place, is then put in position, and, if the holes are properly spaced, it can be fastened with two No. 4-36 machine screws, as shown in Fig. 8. It will be noted that the two "U" shaped pieces are already tapped for these screws.

The two brackets should hold the coil level, and the "U" shaped pieces should fit tight against the slot in the center of the coil, both top and bottom. The lever, Fig. 10, and the spring, Fig. 11, are next made. These two, which are of phosphor bronze, are drilled as shown to pass No. 4-36 screws. The lever will be mounted on one side of the coil by means of these screws, fitting the holes tapped in the steel brackets; but, before it is put in place, it should be noted

that in the slot in the center of the coil are two small pins projecting from one side. The armature has drill holes provided for these pins and, when put in position through the slot, the pins fit through the drill holes. The lever should be mounted on the side of the coil which has these pins. The spring is then mounted on the opposite side.

The armature is put in place, and adjusted so that it will rock back and forth easily on the pins. A small hole is drilled in the end of the lever (Fig. 10) and a piece of No. 26 copper or brass wire run through this hole. A small hook is formed on the end of this wire, and caught through the hole in the part of the armature projecting from the slot. The spring on the other end of the armature is engaged, and the wire pulled up tight to balance the pressure exerted by

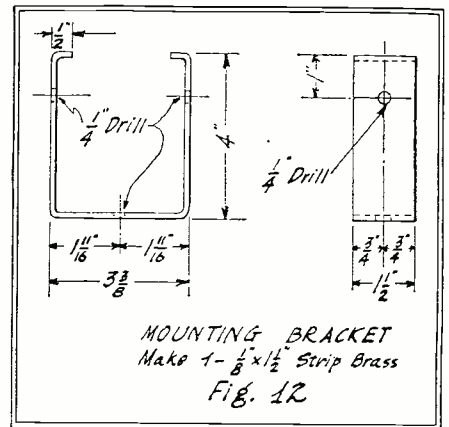

The brass bracket used for mounting the driving unit to the main support.

the spring. The effect sought is so to balance the armature that it will remain stationary midway of the slot, so that any variations of current flowing through the coil will influence the armature magnetically and cause it to vibrate. After this has been achieved, the wire is secured to the lever with a drop of solder.

Binding posts should be provided for attaching the speaker cords, and it is best to use the one originally provided in the unit. These may be attached to suit the constructor's convenience, and the terminal wires soldered to them.

If the reader desires to test what he has done so far, he may at this point connect the unit alone to a set, with a good strong local station tuned in. If the unit is working properly, the armature will vibrate strongly with the signal received, giving a faint muffled sound of music or speech.



If the finger is placed on one of the projecting ends of the armature these vibrations will be plainly felt; in fact it will be difficult or impossible to hold the armature still in the center of the slot. This is exactly the effect desired, as considerable power is needed to drive a 36-inch cone.

After the test has been made, and the unit disconnected, a straight, stiff piece of bus bar, 1/16-inch in diameter, is soldered securely to the lever, about three-quarters or two-thirds of the way back toward the bend, or fulcrum. This bus bar should be about 7 inches long, and should extend out at right angles, as shown in Fig. 8, in the illustrations. The mounting bracket, Fig. 12, and the ring and cross piece, Fig. 13, should now be prepared. The bracket is made of 1/8 x 1 1/2-inch brass, and requires a piece about 12 inches long, bent to shape and drilled as shown. The ring is cut with a jig saw, from 7/8-inch wood, either hard or soft, and has a diameter of 12 inches outside and 8 inches within. A piece of wood, 3 inches wide and 12 inches long, should also be cut, planed, and drilled as indicated, to be used as a support for the entire assembly, being secured to the ring with 1/4-inch machine screws and wing nuts.

**CONSTRUCTING THE DIAPHRAGM**

The next logical step is the making of the cone itself. Assuming that Alhambra paper is to be used, two sheets will be needed, 38 inches square. If the constructor has artistic tendencies, the cone may be decorated to suit his fancy with water colors, mixed and applied rather thick. It is best to do this decorating before making the cone. For the actual construction of the cone, one sheet of paper is laid flat on a table, rough side up; and, around a thumb tack in the exact center of the sheet, a circle is drawn as large as possible, by means of a string and a soft pencil. This circle, allowing for any bent or torn edges on the paper, will be close to 38 inches in diameter when flat, but the shaping of the cone will reduce it to about 36 inches.

When the paper is bought, there will be found a note on the wrapper indicating which way the grain runs; and the sector cut out, to form the cone, must be cut with the grain, not against it. The sector to be removed comprises about 15 to 20 degrees, or from 5 to 6 inches along the outer circumference of the circle. After marking these lines, the circle may be cut out, and the sector also cut; the latter operation being performed with a sharp-pointed knife and a straight edge, to insure a perfectly straight cut.

Next a strip about 1 1/2 inches wide and 19 inches long is cut, not necessarily from the same paper. The two edges of the segment are brought together, with the smooth surface of the paper on the inside, or concave side of the cone, and the strip is glued to both edges so that it holds them firmly together. The glue which works best is one made by dissolving celluloid in

amyl acetate, as this mixture is waterproof. Many fans are familiar with it, having used it in the construction of self-supporting coils. It will be well to try out the glue on some small pieces of paper before using it, to make sure that it will hold properly. A good celluloid-base glue can be obtained from the same source as the Alhambra paper, and is strongly recommended by the makers for this work. Regular glue should not be used, as it may cause the paper to buckle or warp, and may loosen in damp weather.

From the other sheet of paper, another circle is cut, with a diameter 1/4-inch less than the first one. An inner circle, 11 1/2 inches in diameter, is also cut out, as well as the same angular sector as on the first sheet. This cone may also be glued, with

a 1 1/2-inch strip holding the edges together. After the glue has set, this cone should be mounted on the wood ring as shown in Fig. 2. The 11 1/2-inch circle cut from the paper should be centered exactly on the 12-inch ring, leaving about 1/4-inch all around. The paper is fastened temporarily with three or four tacks near the inner edge. The most satisfactory method of making the permanent joint here is to use sealing wax. The stick of wax is heated in a flame, and the wax spread evenly along the inside of the cone, making a tight joint between the paper and the wood.

**MOUNTING THE CONE**

The front cone is now set, with the apex down, into a dish pan or other large round pan to hold it in position. The other cone, with the wood ring affixed, is placed, ring uppermost, on the first one. If the circles have been accurately cut, the front cone, which is lying in the dish pan, should extend about 1/8-inch beyond the other one, all around. It is on this 1/8-inch extension that the glueing is done. There are two methods available for fastening these two cones together. One is to use sealing wax, applying it carefully and sparingly, so that it does not run over on the front of the cone; and the other is to use the celluloid-base glue mentioned previously. If the glue is used, it must be applied quite liberally, to fill the crack or seam between the two edges. The sealing wax is a little easier to work with, as it hardens more quickly, and it seems to make no difference in the operation of the speaker. In using the wax, it must be applied very hot, so it

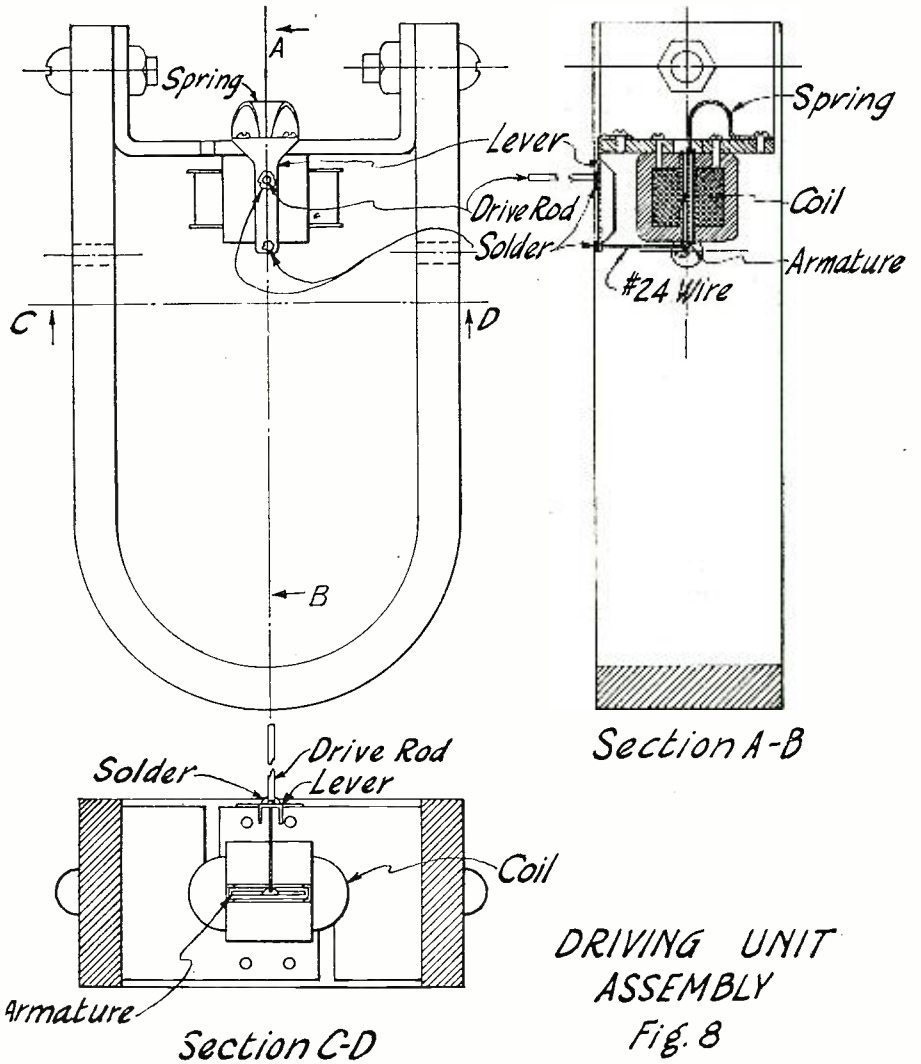

Details of the complete driving unit, as it is when assembled.

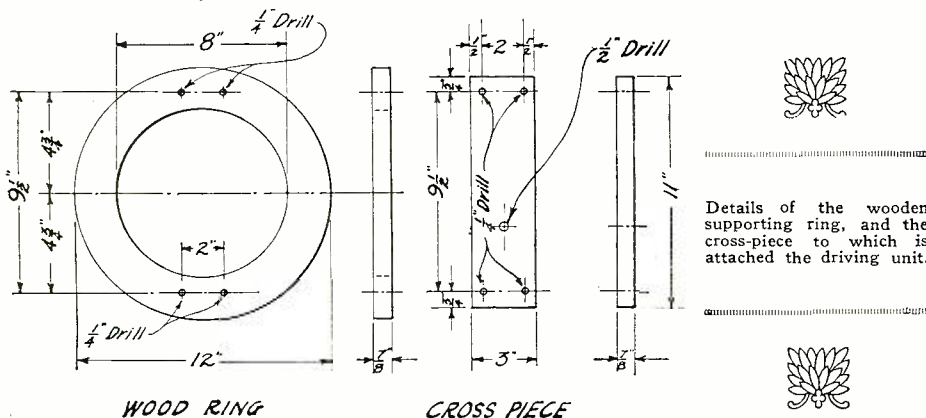

Fig. 13

will flow evenly, and in just sufficient amount to cover thoroughly every inch of the circumference, as seen in Fig. 3.

It is necessary now to provide some means of joining the actuating unit to the cone proper. This is done by means of the tip illustrated in Figs. 15, 16 and 17. The two small circles, Fig. 15, are cut out of thin sheet brass or copper, drilled as shown, and formed into the shape of a cone, being held in shape by means of solder sparingly applied to the seam. Excess solder must be removed with a file. Then the tip is made from 1/4-inch brass rod, drilled through the center, or axially, with a No. 50 drill, slightly countersunk on one end, and drilled and tapped for a No. 2-56 machine screw through the side, as indicated. This tapped hole is for the set screw that holds the driving rod. This tip is then carefully soldered to the apex of one of the small metal cones, so that it fits in place straight, and so that the drill holes do not fill with solder.

This is rather a particular operation, and several attempts may be necessary before a good job is obtained. With reasonable care, however, it can be done successfully. This tip, with its metal cone, is mounted on the apex of the large paper cone, and the other metal cone placed inside. Before putting these in place, it is a good idea to spread a little rubber cement (or the celluloid-base glue may be used) both inside and outside, to join the tip securely to the paper. Further strength is obtained by passing No. 2-56 machine screws through the holes in the metal cones and through the paper, and tightening up the nuts on the inside. This makes a neat and serviceable job.

The bracket, Fig. 12, which was made out of strip brass, is used to hold the magnet and unit in place. The bracket is mounted on the magnet with 1/4-inch machine screws, and the whole assembly laid in position on the cross piece (the wood strip which is fastened to the back of the wood ring), in such a way that the driving rod is exactly in line with the center point of the cross piece. This is of great importance, and care will be needed to see that there is no appreciable variation from the center. When this has been determined, a 1/2-inch hole is drilled in the cross piece, to line up with the 1/4-inch hole in the back of the bracket. A 1/4-inch machine screw is passed through these two holes, and a 1-inch washer slipped over the end of the screw. A suitable square washer can be made from the strip brass used on the bracket. A wing nut is used on the machine screw, as it can be loosened for adjustment without a wrench. It will be noted that the hole drilled in the wood crosspiece is 1/2-inch in size, while the bolt passing through it is only 1/4-inch. This is to permit the entire driving mechanism assembly to be shifted slightly after the cone is put in place, in order to line up the driving rod exactly with the apex of the cone.

The crosspiece, with mechanism attached, is now fastened to the wood ring with

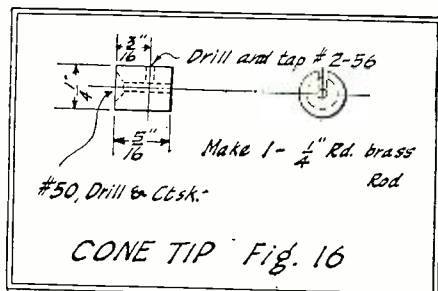

The cone tip, where adjustments of the drive rod are made, is soldered to one of the apexes, as shown in Fig. 17.

1/4-inch machine screws, also using wing nuts to permit easy access. At this stage the writer found it very convenient to construct a rough stand, to hold the cone proper while mounting and adjusting the mechanism. It is very difficult to hold a 36-inch cone with one hand and work with the other, tightening nuts, and fitting the driving rod into the tip of the cone. This stand consisted simply of a board, 3 feet long and 10 inches wide, laid flat on the floor, and two 3-foot uprights nailed on the edges at the center. Another strip was used to brace each upright. The cone was fastened to the uprights with wood screws, and was thereby held firmly in position, leaving both hands free for other work. It is strongly recommended that every constructor build such a stand for use during the early experimental stages.

The reader is cautioned at this point not to allow the driving rod to puncture the paper of the cone while trying to fit the unit into the cone; also to make sure that it fits easily into place. If it does not, then some miscalculation has been made in laying out the various parts, and trying to force it into place may injure the mechanism. It is well to proceed slowly, even though a favorite broadcasting station may be clamoring for a chance to get at that cone.

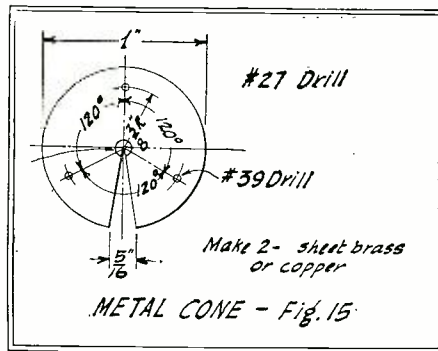

The small metal cone or apex. Two of these are used, at the point where the drive-rod is attached to the cone.

ADJUSTMENT AND OPERATION

If everything fits properly, and all the nuts are tightened, the speaker may be connected to the set. It is best, first to tune in a powerful station clear and loud on the present speaker, and then connect the cone. The first sounds may be disappointing; if so, it is because the set screw on the tip of the cone has not been tightened. A No. 2-56 machine screw should be inserted here and tightened, thereby holding the driving rod securely in place. If the mechanism is properly adjusted, and exactly centered, a surprise will follow—a flood of golden melody such as seldom is heard from a receiving set. After making sure that everything is right, the surplus length of driving rod protruding from the tip is cut off, and the cone may be hung on the wall with picture wire; or perhaps the constructor who is ambitious with carpenter's tools will wish to build a permanent stand, of the three-legged variety, so that the speaker may stand on the floor near the set, or as far distant from it as he may choose. Before hanging the cone from the wall, two wooden strips are screwed to the edge of the wood ring near the bottom, and tipped with sponge rubber. The strips hold the cone away from the wall, while the rubber prevents vibrations being transmitted to it.

In case, however, that flood of melody does not come, there are several minor adjustments to be made that may coax it along. First, it would be well to loosen the set screw on the cone tip, and care-

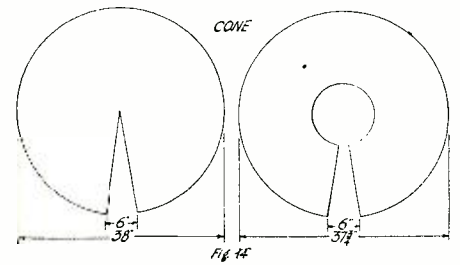

Details of the front and rear cones.

fully pull out or push in on the driving rod. If that brings out the volume and richness of tone, then all is well, and the screw may be tightened. If not, the screw is loosened again, and the wing nut in the center of the cross-piece in the rear is unscrewed a little, and the entire mechanism shifted slightly, up, down, or sideways.

If this is unsuccessful, the unit should be removed from the cone, and examined for evidence of damage that may have occurred while fastening it in place. A bent drive rod, or a lever sprung out of place, will cause trouble. The armature should be examined to make sure that it is centered in the slot and able to move freely. A slight adjustment of the spring will usually take care of this.

Another thing that may help is to put a .005-mf. fixed condenser across the speaker terminals. It was found desirable, on the writer's speaker, and was mounted inside the cone. Reversing the speaker cords may induce a change for the better in the tone quality. As a last resort, if results are disappointing (and it is extremely unlikely that they will be, if directions have been followed carefully) the set itself should be looked to. There must be no distortion here, as a cone speaker will reproduce the distortion faithfully where a horn might pass it over. This is not theory but fact. If a millimeter is available, it should be connected in the "B—" lead to make sure that the proper grid bias is being used on the audio tubes, and that regeneration, if any, is not being pushed too far. This is not the place for a discussion of this subject, which has been covered before in RADIO NEWS; suffice it to say that there should be only the most minute variation of the millimeter needle with the received signals. Anything more than that indicates distortion, which must be cured before the cone can do its best.

One further word about audio amplifiers. A 36-inch cone deserves the very best amplifier that the pocketbook will permit. Careful tests have been made with several different amplifiers, all of which gave fine results. One test was made with a well-known manufactured receiver, using 201-A tubes throughout, and 90 volts of "B" battery, properly biased. Volume and quality were splendid, on both

(Continued on page 1388)

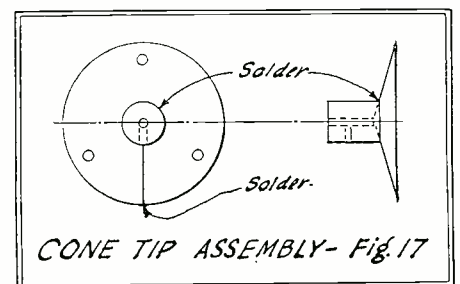

Showing how the cone tip is soldered to one of the apexes.

# A New Era in Push-Pull Amplification\*

## A Push-Pull Power Amplifier of New Design

### By JOSEPH RILEY

IT has been a long while since we have heard much of push-pull amplifiers; they had just about passed out of existence. Now comes a revival, but the push-pull amplifier this time appears in a new dress. It is designed expressly for sets having an output of very large energy, and will take care of any receiver, including the largest superheterodynes. This amplifier uses two power tubes of the 171 type in the push-pull stage and, with only 180 volts "B" supply, is capable of delivering the same amount of output energy to the loud speaker as one 210-type power tube using 350 volts "B". The transformers and the impedance employed are of new design and have excellent frequency characteristics. —Editor.

the very astonishing articles published on the subject. These articles were much like the premature report of the death of Mark Twain: very much exaggerated. At any rate, what counted most was results; and adding a push-pull amplifier to a set of early vintage was like moving the German street band off the block and substituting the Philadelphia Symphony Orchestra. Judging by the enthusiasm created by the push-pull amplifier, the foregoing simile is not exaggerated.

#### WHY "PUSH-PULL"?

What did the push-pull amplifier actually do to better reproduction so much? Any radio fan will tell you that it push-pulled; but that is not exactly the definite answer one might expect. In the first place, the real and original push-pull amplifier used the first power tubes deserving of the name. Today, almost every fan knows that, if any of his audio-frequency amplifier tubes is

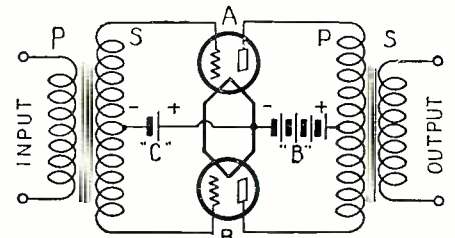

FIG. 1

The basic circuit of a push-pull amplifier as originally devised.

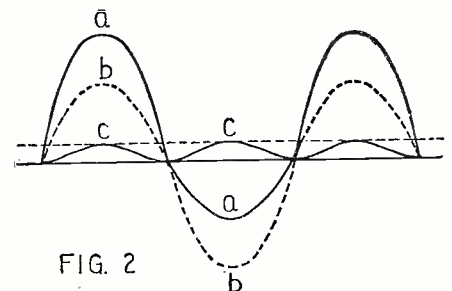
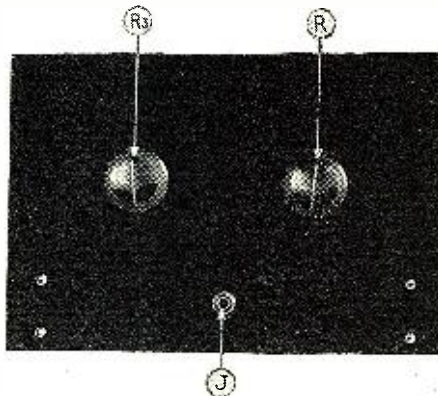

FIG. 2

These curves show, a, the A.F. output current wave as amplified by a transformer; b, the fundamental wave and c, the harmonic. The action of the push-pull circuit is such as to eliminate the harmonics thus introduced.

LONG before the ordinary radio fan took an intense interest in quality reproduction, the Western Electric Company's engineers were devising bigger and better audio-frequency amplifiers. The result of their work was the push-pull amplifier, which, because of its excellence, created quite a sensation when it was put on the market several years ago. At that time there was available no other type of amplifier which could even run a race with it. Anyway, as the story goes, or should go, these wise engineers were ahead of the game, as they usually are, and knew just a bit too much about audio-frequency amplification to suit many rivals.

One out of every fifty or so radio fans acquired about half an idea as to what the talk of push-pull amplification was all about; the other forty-nine or so remained in ignorance or were completely deluded by



A panel view of the completed push-pull power amplifier. R is the power rheostat. R3 the volume control and J the loud-speaker jack.

overloaded by excessive input energy, the result is a nasty form of distortion. If a big "he-man" tube is used in the last stage of amplification, there is very little chance of overtaxing it with the energy output from the average receiver; the tube is perfectly capable of handling "power" without muddling it. All this has a great deal to do with what we call "grid swing" and, in any audio tube, we always want to be sure that

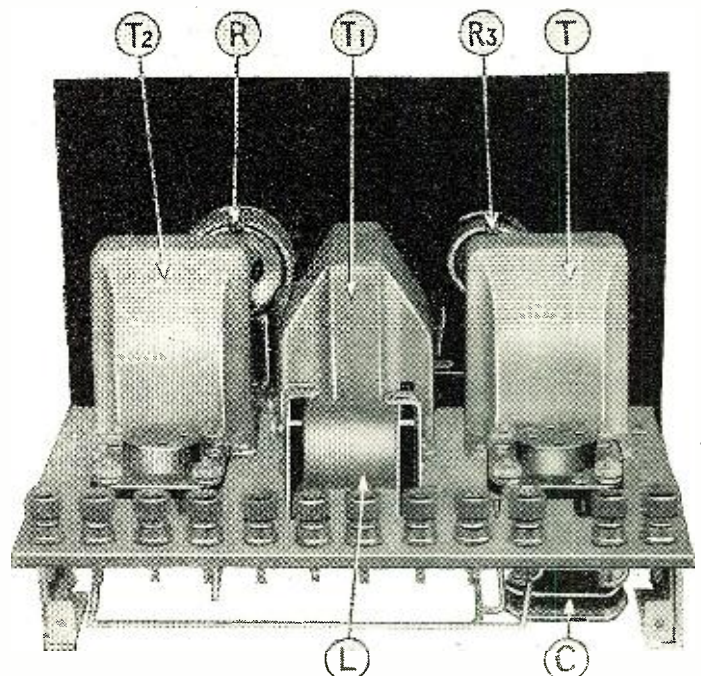
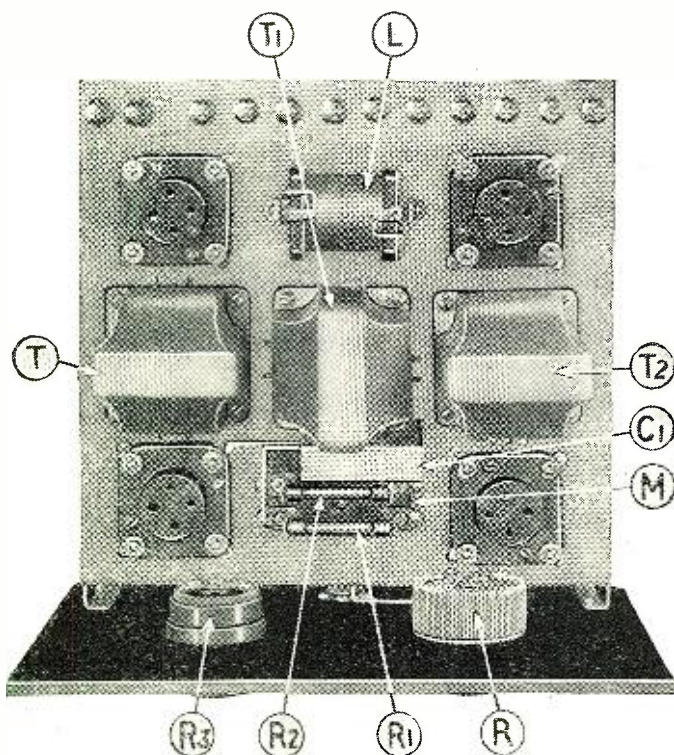

Top and rear views of the complete push-pull power amplifier. The parts are: R, filament rheostat; R1, plate resistor; R2, grid resistor; R3, volume control; M, resistor mounting; L, R.F. choke; C, by-pass condenser; C1, coupling condenser; T, A.F. transformer; T1, push-pull A.F. transformer and T2, push-pull output impedance.

\*RADIO NEWS Blueprint Article No. 20.

the grid of the tube is not allowed to "go positive"; for as soon as it does we get very unequal amplification, or a rectification, which in itself is a form of distortion. That is why we use power tubes with high "B" and "C" voltages.

The push-pull amplifier used three power tubes (we would call them semi-power tubes today); one for the first and two in the second stage of audio. The last two were not connected in parallel, as so many radio fans seemed to imagine. Here is how it was done.

The first audio tube worked into a push-pull transformer which had an orthodox primary winding, but a very unorthodox secondary coil. The secondary was really one long winding with a tap taken off at its exact center. One end of the secondary was connected to the grid of one of the last two tubes, and the other to that of the final tube. The center tap connected to the negative filament leg, or to the negative post of a "C" battery. The next push-pull transformer had an orthodox secondary, but a primary with a center tap. The plates of the two last tubes connected to the outside primary terminals, and the center tap to the positive post of the "B" battery. The total work to be accomplished was equally distributed between the last two tubes; that is, each tube took care of one half of the cycle, while in the usual amplifier one tube handles the whole.

This arrangement is obviously an advantage, as there is practically no chance of overloading, but the push-pull amplifier accomplishes even more than this. It absolutely abolishes the harmonic and amplifies only on the fundamental frequency. Let us get a better understanding of this.

In the first place, there is a definite output current, which, after passing through the transformer, resolves itself into the fundamental and a harmonic of the funda-

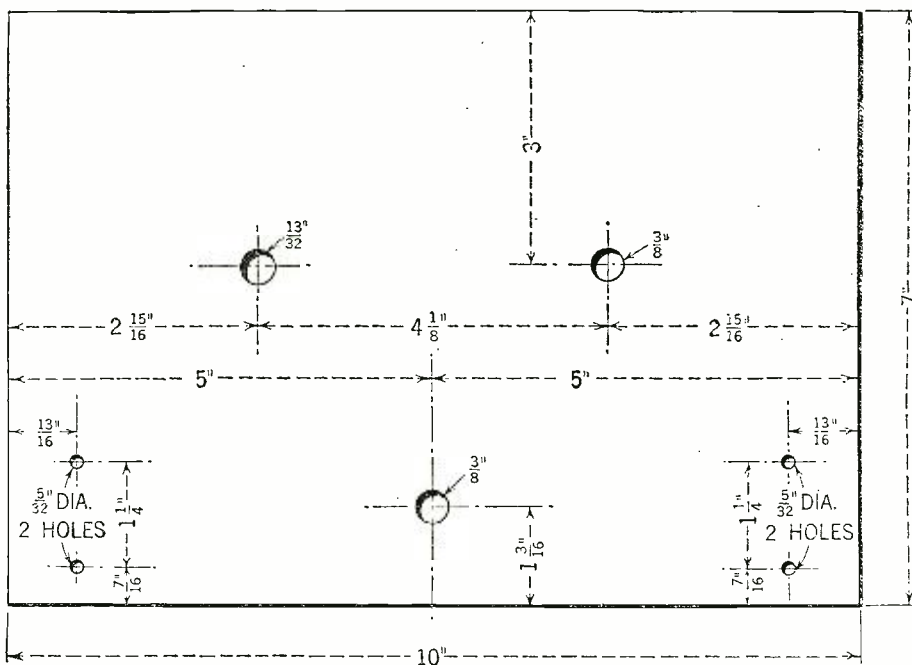

Layout and drilling plan for the panel of the push-pull power amplifier. All the necessary dimensions are given.

mental. This harmonic, which is artificially created, is undesirable, as it can introduce serious distortion. All this is delineated in Fig. 2, where *aa* is the undistorted output current wave, *bb* the fundamental and *cc* the harmonic. Referring to this diagram and that of Fig. 1, it is obvious that the wave shapes in both tubes (A and B) are identical, but that the fundamental *bb* in tube B is 180 degrees out of phase with the fundamental wave *bb* in tube A, while the

harmonic is in phase in both tubes, as it varies merely in amplitude. In consequence, the fundamental waves as amplified by the two tubes are additive in the output circuit, while the harmonic waves, being in phase, will neutralize each other. The resultant output to the loud speaker is an amplified reproduction of the fundamental wave only.

A NEW AMPLIFIER

We admit, without even being questioned, that the original push-pull amplifier was a big step ahead and certainly worth the money, if it was well made; but push-pull amplification suffered a good deal of discredit because of the inferior apparatus placed on the market by some manufacturers, and also because of lack of knowledge on the part of radio fans concerning the system. This, coupled with the fact that since then there have become available very fine power tubes, improved A.F. transformers, impedances and so on, helped to shove the push-pull amplifier into the background. Now, here we are with a bit of momentum behind us, all set to push or pull the push-pull amplifier into the limelight again. And with good reason, for we have with us one of these amplifiers, employing two of the new 171-type power tubes in the last stage, a push-pull transformer of new design with large iron core and high impedance primary, and a new design push-pull output impedance. There are actually three stages in this amplifier. The first or input stage is of the resistance-coupled type, noted for its undistorted amplification; the second is of the transformer-coupled type. The transformer used has excellent characteristics and is capable of amplifying the low notes. These two stages, working together in the order outlined, show a frequency curve which is very nearly flat. The last stage, of course, is the push-pull and, by virtue of the system and the new design of transformer and impedance, completes the amplification without altering the excellent frequency curve obtained in the first two stages.

As previously mentioned, two of the 171-type power tubes are desirable in the push-pull stage. If the very best results are desired this type should be used, with a 112-type semi-power tube in the second stage and a 201A-type tube in the resistance-coupled stage. However, it is not absolutely necessary that this combination be carried out, as good results can be had from other tubes. Dry-cell tubes can be used;

SYMBOL	Quantity	NAME OF PART	VALUE OF PART	REMARKS	MANUFACTURER ★
L	1	R. F. choke	85 MH		1 12,13,28
T	1	A. F. trans.	3 to 1		1
T1	1	A. F. trans.		Push-pull type	1
T2	1	Impedance		Push-pull type, output	1
C	1	Fixed Condenser	.0005 mf.	By-pass	2 3,5,7,14,29,30
C1	1	Fixed Condenser	.1 mf.	Coupling condenser	3 2,5,7,14,29,30,32
R	1	Rheostat	6 ohms	Power type	4 7,15,16,17,20
R1	1	Resistor	.1 meg.	Plate resistance	5 3,6,14,18,19
R2	.1	Resistor	1. meg.	Grid resistance	5 3,6,14,18,19
M	1.	Res. mounting		Double mounting	6 5,14,18
R3	1	Potentiometer	50000ohms	For volume control	5 4,7,16,17
J	1	Jack		Single circuit filament control	7 4,16,20
	4	Sockets		UX type non-microphonic	8 9,12,15,20,27
	12	Binding posts			9 15,21
	1	Panel		7 X 10 X 3/16"	11 22,23,31
	1	Sub-panel		8 1/2 X 9 X 3/16"	11 22,23,31
	2	Brackets			8
V	1	Tube	5 v. 1/2 amp	201-A type	10 24,25,26
V1	1	Tube	5 v. 1/2 amp	112 type	10 24,25
V2, V3	2	Tubes	5 v. 1/2 amp	171 type	10 24,25,26
		Hookup wire			

NUMBERS IN LAST COLUMN REFER TO CODE NUMBERS BELOW.

- |                           |                                       |
|---------------------------|---------------------------------------|
| 1 Samson Electric Co.     | 17 Central Radio Labs.                |
| 2 Sangamo Elec. Co.       | 18 Int. Res. Co. (Durham)             |
| 3 Tobe Deutschmann Co.    | 19 Dubilier Condenser Corp.           |
| 4 H. H. Frost, Inc.       | 20 Patent Elec. Co.                   |
| 5 Electrad, Inc.          | 21 X-L Radio Labs.                    |
| 6 Arthur H. Lynch, Inc.   | 22 Amer. Hard Rubber Co. (Radion)     |
| 7 Carter Radio Co.        | 23 Insulating Co. of Amer. (Insuline) |
| 8 Benjamin Elec. Mfg. Co. | 24 Radio Corp. of America             |
| 9 H. H. Eby Mfg. Co.      | 25 E. T. Cunningham, Inc.             |
| 10 G. E. Mfg. Co. (Ceco)  | 26 Magnavox Co.                       |
| 11 Nicarta Fabricators    | 27 Grey & Danielson (Reuler)          |
| 12 Silver Marshall, Inc.  | 28 Precision Coil Co.                 |
| 13 Bremer-Tully Mfg. Co.  | 29 Wireless Spec. Apparatus Co.       |
| 14 Aerovox Wireless Corp. | 30 Sprague Electric Co.               |
| 15 General Radio Co.      | 31 Diamond State Fibre Co.            |
| 16 Tuxley Mfg. Co.        | 32 Potter Mfg. Co.                    |

If you use alternate parts instead of those listed in the first column of manufacturers, be careful to allow for any possible difference in size from those originally used in laying out and drilling the panel and sub-base.

FORM COPYRIGHT 1927 EX. PUB. CO.

★ THE FIGURES IN THE FIRST COLUMN OF MANUFACTURERS INDICATE THE MAKERS OF THE PARTS USED IN THE ORIGINAL EQUIPMENT DESCRIBED HERE.

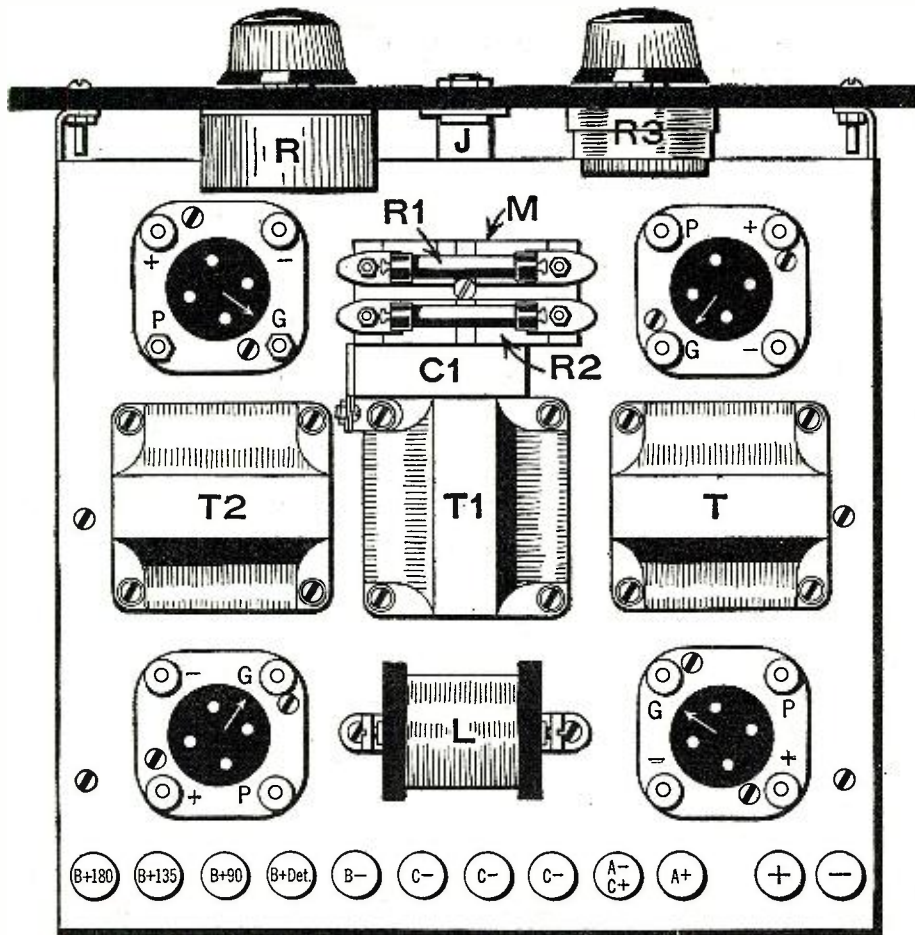

Layout of the apparatus on the sub-base. The parts carry the same symbols as in the other illustrations.

designed with two ideas in mind relative to its adaptability. First, its electrical characteristics are such that it can be used with any type of radio receiver, irrespective of the type of detector tube used. This is not true of all audio amplifiers. Secondly, it is made in compact form, so that it will not hog space, but can be placed at some distance from the receiver itself to eliminate electrical coupling between them. It operates independently of the receiver; that is, it does not go into operation until the speaker is plugged into the jack on the panel. When the speaker plug is pulled out the tubes are automatically turned off. If the user does not like this idea, the speaker may be left connected and the amplifier turned off by turning the single rheostat knob full to the left. This single rheostat, which controls all four tubes, is of the power type with very heavy resistance wire. The volume can always be controlled by the knob on the left of the panel; this governs a 500,000-ohm potentiometer, which regulates the effective voltage reaching the grid of the second amplifier tube. Thus, the volume can be increased from a whisper to a roar; and when we say roar we don't mean blast.

In order that this push-pull power amplifier may operate at maximum efficiency, a radio-frequency choke L, with a value of 85 millihenries, is placed in the plate lead of the detector tube and by-passed by a fixed condenser C, of .0005-mf. capacity. Because of this arrangement, none of the radio-frequency currents can get into the audio-frequency circuits. Usually, a good deal of this current passes by the detector tube without being rectified, and is detrimental to the operation of the audio amplifier if it is allowed to leak into these circuits. The R.F. choke blocks its passage in this direction, but the fixed condenser offers it a free path to the filament end of the detector circuit, which is the normal

two of the 199 type for the first and second stages, and two of the 120 type for the push-pull stage. As for storage-battery tubes, a very good combination is obtained by using two 201A-type tubes, with two 112's in the push-pull stage, or even 201A tubes throughout. Still, it should be kept in mind that if real results are desired, the combination of tubes specified should be used.

Whatever tubes are utilized, it is best to apply the "B" voltages specified by the manufacturer. This is important, for if the "B" voltages are too high the tubes cannot function properly. Take note of the fact that rather a high "B" voltage is supplied to the detector tube through the detector post on the amplifier; this for the reason that there is a large drop in voltage across the plate resistor of the first-stage amplifier, which is in series with the plate of the detector tube. The correct voltage here depends a great deal upon the type of detector tube used; it is a good idea to try voltages ranging from 90 to 135.

**VOLUME WITH QUALITY**

The importance of this amplifier lies in its ability to handle energy without "smearing" it or, in other words, to provide undistorted reproduction with immense volume; an output that can equal the volume of a full orchestra, should you want it. And there are many people who do, for it is just at this point that real tonal results become available. Whether you want this quantity of sound or not, certainly it is a pleasure to have an audio amplifier that will handle all of the output energy from your receiver. Most amplifiers will not; that is why we have power amplifiers. If an amplifier cannot handle the output energy from the receiver, the sounds will not seem natural.

The present push-pull amplifier has been

• THESE HOLES  $\frac{3}{32}$ " DIAMETER.  
ALL OTHER HOLES  $\frac{5}{32}$ "

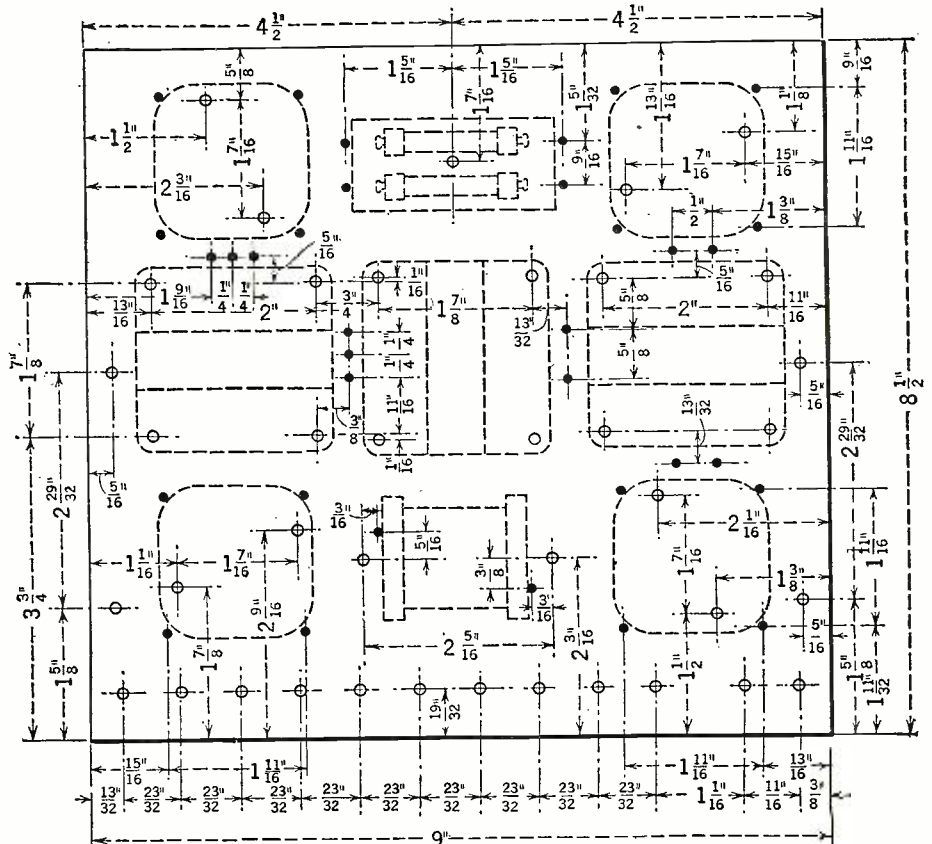

Complete dimensional and drilling details for the sub-base. The parts are shown in dotted lines to make the drawing more easily followed.



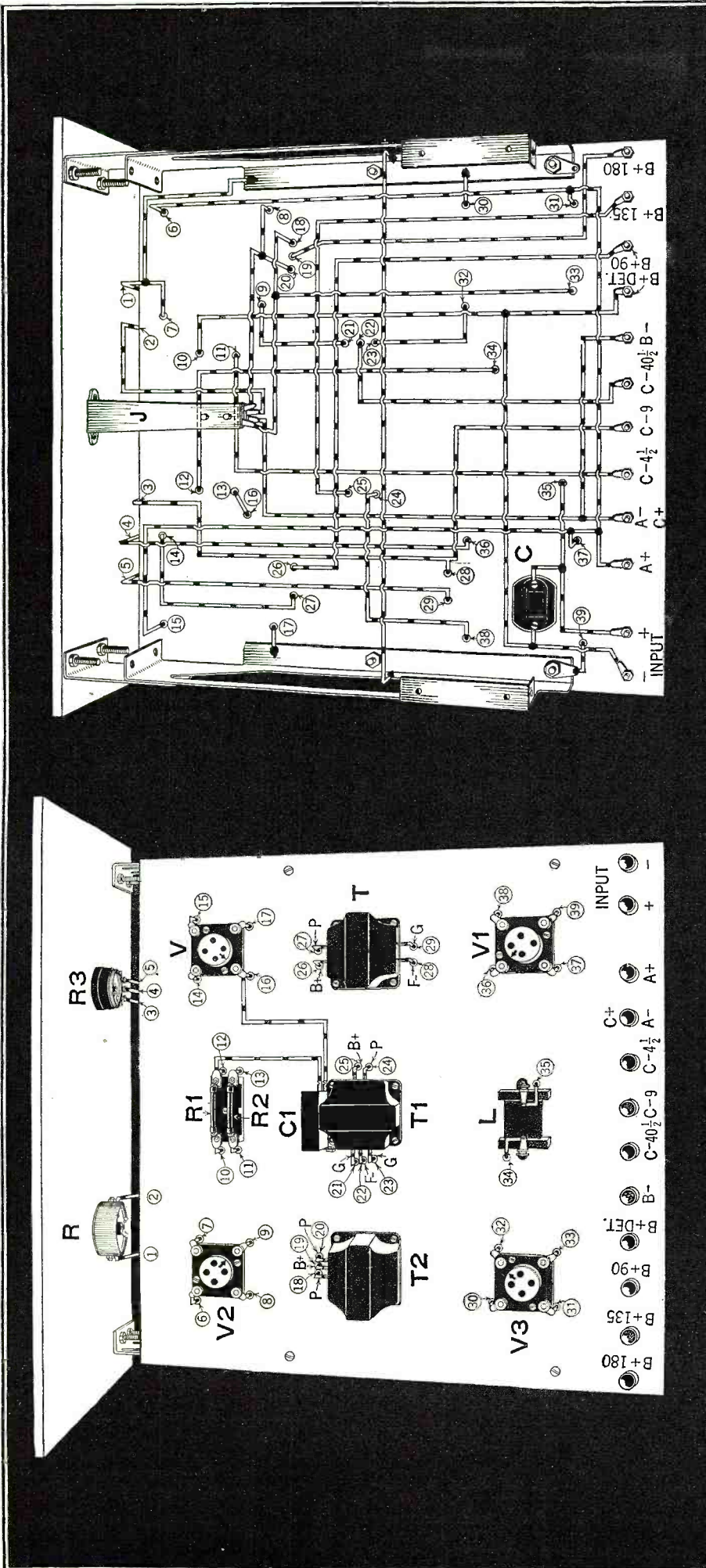

point for the completion of the R.F. circuit. The R.F. choke, however, does not obstruct the passage of the rectified currents, while the capacity of the by-pass condenser is too low to allow these audio-frequency currents to leak off. Consequently, they are passed on to the audio-frequency circuits and are amplified by them.

**OUTPUT DEVICE**

Another point of interest is that the loud speaker is fully protected at all times, as the output impedance arrangement does not allow the heavy direct current of the plate circuit to flow through the loud-speaker windings. This also allows the loud speaker to operate more freely. The usual blocking or stopping condenser employed in output filters is not necessary in this case; as the "B" battery current feeds into the center of the output impedance, through the center tap, and can find a complete circuit only through the plate circuits of the two power tubes.

The construction of this amplifier is comparatively simple, the accompanying wiring

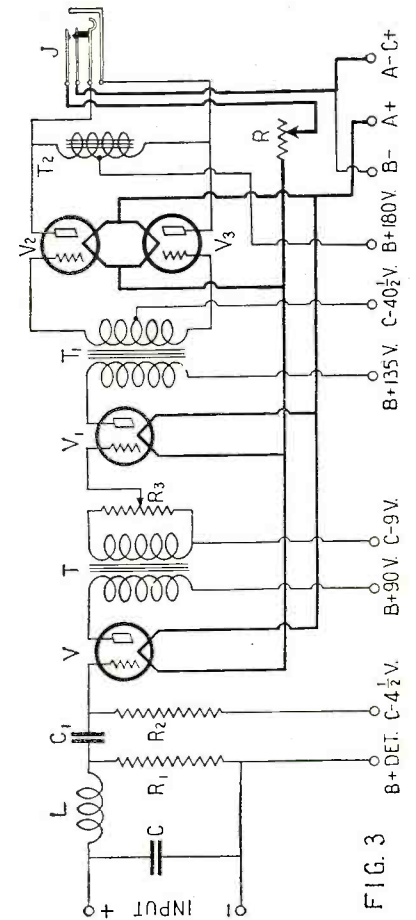

**FIG. 3**

Above, the complete schematic wiring diagram of the push-pull power amplifier. At left, the pictorial wiring diagrams, showing, at top, the sub-base wiring, and beneath, that on the panel and upper side of sub-base. The hole through which each lead passes is numbered alike in both views, so that every connection may be readily traced.

and constructional drawings giving all the necessary details. The panel carries the rheostat, the volume control and the loud-speaker jack. The rest of the apparatus, except for the fixed by-pass condenser C, is mounted on top of the sub-base. It will be noted that practically all of the wiring is completed on the underside of the sub-base. This makes a neat job and at the same time is most satisfactory from the electrical standpoint.

# Advancement in R.F. Stabilizing Systems

## A Comparative Analysis of the Most Popular Methods Hitherto Developed

### By M. L. MUHLEMAN

**R**ADIO took a novel turn when the regenerative circuit was introduced about fourteen years ago. Before that time very little was known about radio-frequency amplification, and about the best we could do was to rely on the effectiveness of a single vacuum tube employed as a straight detector. The introduction of regeneration provided us with a means of increasing the sensitivity of the vacuum-tube detector beyond our greatest expectations, and without the necessity of

limits or the loud speaker is shaken by ungodly noises resembling those made by anything and everything from stuck pigs to disembodied souls.

#### A RADIO DILEMMA

Unfortunately, there is but one cure and that is to stop the oscillation. Unfortunately, too, if we desire sensitive receivers it is necessary to have the circuits so designed and so coupled that we can work fairly near to the point of oscillation. The reason for this is that the regenerative effect itself is a priceless factor and the more regeneration we can produce in a single- or multi-tube set, the greater will be both the sensitivity and selectivity.

I repeat again that radio took a novel turn on the day of regeneration; for in accepting regeneration we necessarily had to accept regeneration's mischievous brother, oscillation. Since this time we have been doing nothing but a lot of heavy compromising. It has been the desire of every radio engineer to get the most out of regeneration, while defeating oscillation; but, like the proverbial bad penny, oscillation horns in at the most undesirable moment.

The whole business has been more of a scientific warfare than anything else and the scientists have devised special weapons for combatting regeneration's bad-acting brother.

It must be admitted that the task is a most difficult one and most of the radio engineers engaged in it have been in the same dilemma as the surgeon who had been allotted the difficult job of parting the Siamese twins. If we can judge from history, the result is quite often the same; the ultimate death of both.

That has been the trouble with many of the so-called balancing, stabilizing or neutralizing systems introduced during the past few years. The weapons have been too crude and of a blundering nature and, in their attempt to prevent oscillation, have just about killed regeneration. It is interesting, therefore, to know just what advancement has been made along these lines and to give the reader some idea of the merits of some of the newer types.

#### CAUSE OF OSCILLATION

First let me say that a radio-frequency amplifier oscillates because too much energy is fed back from the plate to the grid of the radio-frequency tube. This energy gets back to the grid either through the capacity existing between the plate and the grid or through adjacent coupled circuits. Any energy that does get back to the grid is re-amplified, so to speak; it is repeated through the tube and, if the original energy was sufficient, the feed-back action builds up so rapidly and so much electrical momentum is created that the current surges back and forth through the grid and plate circuits. This back-and-forth surging is the oscillation we have been referring to. This will happen in any efficient form of either tuned or untuned-radio-frequency receiver, unless precautions are taken to prevent it.

The earliest form of preventative was the potentiometer. This permitted biasing the grids of the radio-frequency tubes with various values of either a positive or negative voltage. The manner in which the device is connected in a simple radio-frequency circuit is shown in Fig. 1. If the tube or tubes had a tendency to oscillate, all one had to do was to move the arm of the po-

tentiometer towards the positive side until everything was cleared up. This was fine, except that in doing so one introduced heavy losses in the circuits.

A fixed or variable resistance, somewhere in the order of 200- or 300-ohms, inserted in each grid circuit as shown in Fig. 2, is another stunt that is very effective for stabilizing a set; but this scheme also is a lossier and decreases both the sensitivity and selectivity of the set. There have been similar systems, such as those shown in Figs. 3 and 4, which tended to dampen circuits to prevent them from oscillating; but in the end they all amount to the same thing. By using them you may prevent oscillation, but at the same time you defeat the main purpose, which is to get a fair degree of regeneration, so that the set will be selective enough for normal purposes and sensitive enough to warrant the use of the extra tubes. Some of the commercial sets that were placed on the market a few years back were so heavily loaded with damping devices of one type or another that they were practically useless in congested districts, because of the great drop in selectivity. They were unable, also, to pick up distant stations, because of their noticeable lack of sensitivity; *i. e.*, insufficient regeneration. Some of these sets employed as many as six tubes.

Systems of this sort never got us anywhere, as in no case did they allow sufficient regeneration for the satisfactory operation of the receiver. But then, we had no methods that would; as soon as the point of sufficient regeneration was reached the set went into oscillation.

#### THE NEUTRODYNE

The first real advancement came with the introduction of the first original neutraliza-

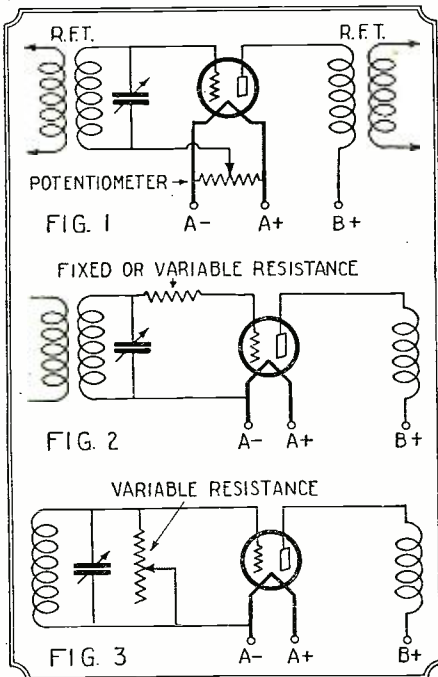

Fig. 1. The potentiometer method of oscillation control. Fig. 2. Stabilizing an R.F. circuit by use of a series grid resistance. Fig. 3. Variable resistance in shunt with the tuned secondary circuit, another damping device.

adding much in the way of apparatus. A comparatively insensitive vacuum tube became; under the functioning of this newborn circuit, about the most sensitive thing in existence, and even today it stands without equal.

Radio took a novel turn on the day of regeneration because it is through this basic principle, and through the medium of a regenerative or feed-back circuit, that we are able to make a vacuum tube oscillate. Oscillation has been, at one and the same time, a curse and a blessing. Oscillation opened up a new and larger field than did regeneration and today the vacuum-tube oscillator is the basis of our broadcast transmitters. But oscillation is like a sore thumb for the listeners, and has been ever since regeneration was discovered.

We all know its effects. In a single-circuit regenerative receiver we run into oscillation if we advance regeneration too far. In present day multi-tube radio-frequency sets we run into oscillation if the set is not properly balanced, stabilized or neutralized. Even in superheterodyne receivers, parasitic oscillations are produced in the intermediate-frequency-amplifier stages, if they are not properly controlled. And in any receiver the result of oscillation is the same; the music is either distorted beyond normal

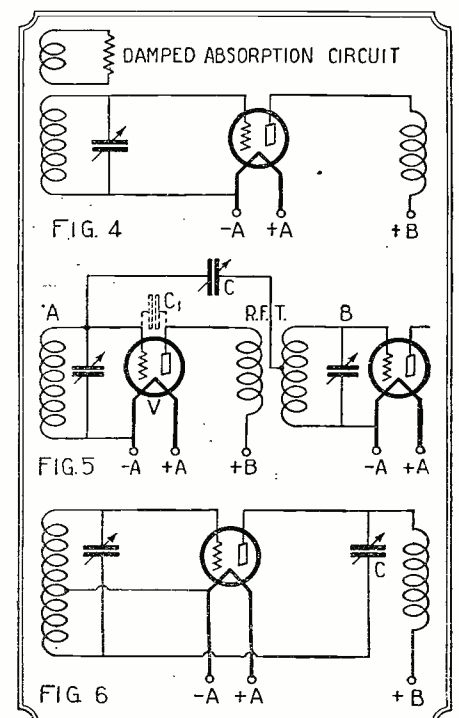

Fig. 4. Damped-absorption method of stabilization; effective, but a lossier. Fig. 5. Illustrating the Neutrodyne principle; a portion of a Neutrodyne circuit. Fig. 6. The Rice system of neutralization, similar to the Neutrodyne and theoretically a form of bridge circuit.

tion system, exploited under the name of Neurodyne. This method demanded no damping of circuits or anything of the sort. The idea might be called a very ingenious one; in essence the scheme as worked out by Professor Hazeltine supplied a means for neutralizing the effect of the internal grid-to-plate capacity of the vacuum tube. This was accomplished by the use of a small, adjustable condenser, C, with a very low capacity value, connected in the circuits as shown in Fig. 5. There is a very long-winded explanation of the functioning of this arrangement which, insofar as the average reader is concerned, runs into foreign territory. Let it be said that the arrangement is one of the many famous bridge circuits and that the explanation of the system in a broad sense is quite comprehensible.

Referring to Fig. 5, let us assume that the circuit is operating without the neutralizing condenser C and that the grid or secondary circuits A and B are not tuned to any particular station and are out of resonance with each other. In this state there is very little regeneration taking place. However, as soon as we tune circuits A and B to the wave of some broadcast station, they reach the point of resonance and there is sufficient feed-back of radio-frequency current through the internal capacity C1 of tube V to cause oscillation, in the manner heretofore explained. Though there is no variable condenser connected across the primary coil of R.F.T., the coil nevertheless takes on a resonance effect, due to the tuning of the associated secondary coil in circuit B. Now, if we connect in the condenser C, something else happens. This condenser introduces in the grid circuit A of tube V a radio-frequency current equal to but *opposite in phase* to the current fed back through the internal capacity C1. In other words, there are two

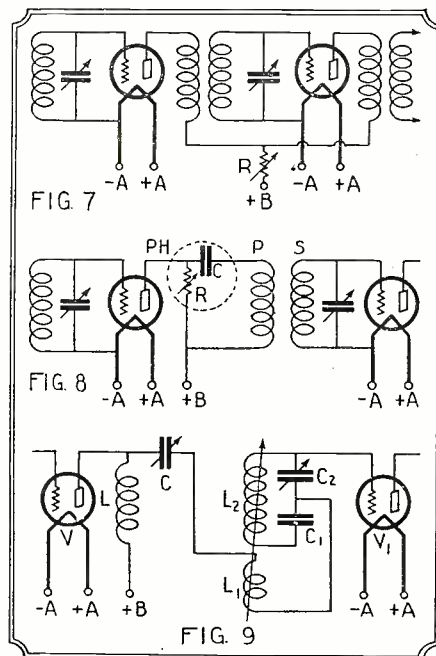

Fig. 7. A resistance-stabilized circuit of improved form, and not a loss. Fig. 8. A circuit employing the Phasatrol, a new and efficient form of stabilizer. Fig. 9. The basic Loftin-White constant-coupling system.

feed-backs: the natural feed-back through the capacity of the tube, and an auxiliary feed-back through the condenser C. Since these two distinct reactive currents are opposite in phase, they neutralize each other, and consequently no oscillation can take place.

The Rice system of neutralizing, shown in Fig. 6, is similar to the Neurodyne ar-

angement, but in this case the condenser C is connected from the plate of the tube to the filament end of the grid. The action and effect is the same; *i.e.*, a current, equal to the natural feed-back current but opposite to it in phase, is fed back into the grid circuit.

There have been a number of other systems devised similar to the two just outlined and they are all about equal in effectiveness. But they have one common fault and that is they do not act the same on all wavelengths. Adjust a set using one of these forms of neutralization for stability on the short wavelengths and there is a noticeable lack of sensitivity on the longer wavelengths. If the set is adjusted for maximum sensitivity on the long waves, it most certainly will oscillate on the short waves. Naturally, the best that can be done is to adjust the neutralizing system so that the set is perfectly stable in operation on the short waves and then to be philosophical about the results obtained on the longer wavelengths.

RESISTANCE STABILIZATION

Whether or not this effect was unforeseen I shall not venture to say; but, at any rate, radio engineers soon learned that there was still much to be done in the way of developing stabilizing or neutralizing systems. The main problem on hand was to devise a means to compensate for the change in electrical coupling between primary and secondary circuits at different wavelengths. The problem was not an easy one, for both capacities (condensers) and inductances (coils) change their reactance or impedance values with a change in wavelength or frequency. The only factor that does not change is a resistance unit and this provided the first form of stabilizer following the bridge circuits. This arrangement is shown

(Continued on page 1384)

## Short Waves in Siberia

IN accordance with the general development of our country, its industry, agriculture, transport, and other branches of people's life, radio also is tremendously developing each hour. There have been published a lot of articles devoted to Russia, and now I would like to talk to you about Siberia.

In the capital of Siberia, Novosibirsk City, there has been installed a powerful

station, which broadcasts all over our vast country. The majority of our radio "amateurs" are really BCLs, as you Americans call them. However, as amateur transmitters are now licensed, it is anticipated that there will soon be a lot of "hams". In Tomsk, scientific centre of Siberia, which has the Institute of Technology of Siberia, and the University of Tomsk, there has been installed during the past year, by the aid of the Nijni Novgorod radio laboratory, a short-wave transmitter for scientific experiments at the University of Tomsk. The call letters of this transmitter are RA19, and were formerly "TUK". It uses two power tubes of 150 watts each, designed by Professor Bontsh Brouyevitsh, and made in the Nijni Novgorod laboratory.

Its plate supply is pure D.C. from a 2000-volt generator. It works on 37 meters every day, from 1700 to 1900 G.M.T., calling CQ for DX QSO, as its chief operator, Mr. B. N. Putkoff, is an ardent radio fan. However, it handles a regular traffic at other times, with RRP (Nijni-Novgorod Radio Laboratory). For the last few months, RA19 has made a lot of good QSO; for example, with a lot of South Africans (OA3B, OA6N, OA7E, etc.), with Italy, France, all over Europe, and its best DX is New Zealand Z-2AC, reported to be QRK 25-26, and also South America. RA19 is anxious to make QSO with any U. S. stations, and will be glad to arrange tests with U. S. hams. Also QSL cards are greatly appreciated.

In the pictures you may see RA19's transmitter and receiver (Reinartz' plus 2 steps A.F.) and some QSL's received by TUK, now called "RA19".

We sincerely hope that U. S. hams will hear our station; and as we hear U. S. stations, we hope, that we will QSO, and really

it will be almost the best possible DX! Is it not so? So let us get started, OM; and look for TUK at 1700 to 1900 G.M.T., on 37 meters or so. FB and best DX with best 73's to you all from this side of the earth, from Russian Radio RA19..

A. KALACHNIKOFF,  
66, Krasnoarmeiskaja St.,  
Tomsk, Siberia, U. S. S. R.

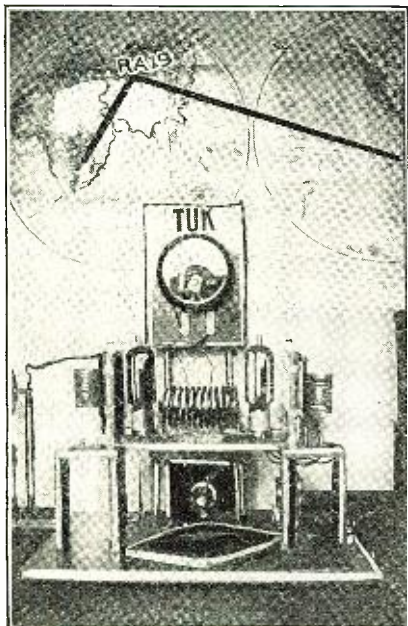

The transmitter of RA19; the location of Tomsk is shown on the map above, with lines indicating some DX records.

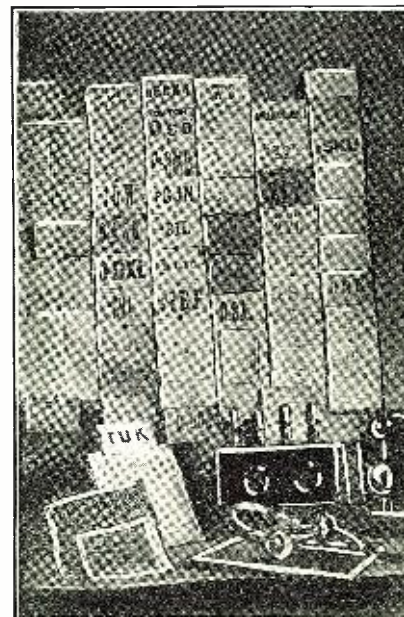

The short-wave receiver of RA19, backed up by a formidable layout of duly QSLd cards from all over the world.



# Some Suggested Aerial Installations



## Details of Modern Construction Meeting Every Need and Pocketbook

### By A. BINNEWEG, Jr.

**W**HAT is more unsightly than a badly-bent aerial mast protruding from the roof of a respectable residence or apartment house? Yet, in every city, one may see scores of ill-constructed poor excuses for poles. Usually the cause is not the lack of proper tools or the selection of unsuitable material, but the improper use of material, and, in general, a lack of experience in setting up aerial supports. It is the purpose of this article to suggest proper methods of procedure in erecting some simple, commonly-used types of these, and to give other useful information.

#### SELECTING THE LOCATION

The efficient performance of an antenna depends upon not only its construction, but also its location with respect to surrounding objects, such as trees, tin roofs, smoking chimneys and similar disturbing influences. Large, nearby trees may change the capacity of an antenna considerably when the wind blows, tin roofs often impair its "pick-up," and smoking chimneys invariably ruin its insulation. These effects should be borne in mind when one is choosing a site for an efficient installation. Keep the entire antenna as clear of surrounding objects as possible. Other factors remaining constant, it is no mystery that one can secure wonderful results with ordinary receivers in small, out-of-the-way country towns, where networks of all sorts of wiring and steel-framed structures are at a minimum.

Select the best site available, remembering that the completed aerial is to have one wire from 50 to 100 feet long, depending upon the set and the selectivity desired, and is to be erected as much in the open as circumstances permit. It is an infinitesimally small current, induced in the antenna by a passing wave, that governs reception; give this current a chance.

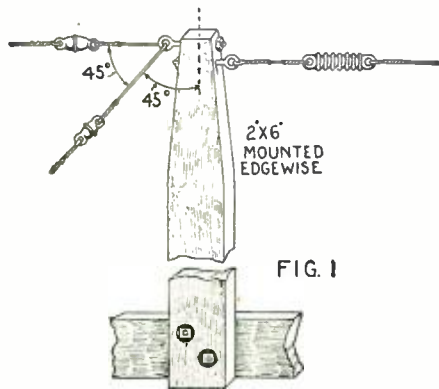

An excellent mast between 15 and 25 feet in height may be constructed from 2x6 lumber, mounted edgewise, as shown.

Severe cases of "fading" may often be traced to a swinging aerial which is too close to a tin roof or other similar conductor; the remedy is obvious. An aerial well away from surrounding objects rarely causes objectionable wave-changing, but a poorly-located lead-in near and parallel to a water pipe often does. All parts of the antenna should be securely fastened down; then, even though part of it must be placed in one of these positions, little trouble will result.

#### PREPARING THE MAST

One must next select a mast that will support the conducting wire above the ground or the roof, as the case may be. The ma-

jority of radio fans will be content with a pole of moderate proportions, such as a single mast from 10 to 25 feet long; others may desire tall masts and still others small poles that will raise the wire well above the roof. An aerial support to suit the individual fancy and pocketbook may be selected from those about to be described.

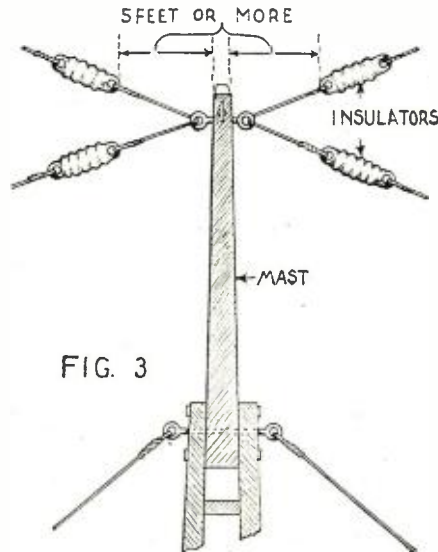

A neighborhood antenna mast can be made with advantage to all, by employing the above system.

In cities it is often difficult to find room for a large mast, so the average used in these localities is about 15 feet high. A simple one, which may be made from one piece of lumber, having a length of from 15 to 25 feet, is diagramed in Fig. 1. The piece of lumber should be wider than its thickness and should be set up edgewise, as shown. An ordinary 2 x 6 plank will serve for this purpose. It will look better if some of the wood at the top is trimmed off, as shown in the sketch. One of this type may remain in place for years and still show no tendency to bend.

The proper method with a mast like this or any pole in which the strain at the top is horizontal, or nearly so, is to place at the rear two guy wires spaced about 45° apart, making the same angle with the horizontal. Guy wires, if improperly placed, will often do more harm than good; do not place them half-way down a single pole; they should be fastened at the same height as the aerial wire which, of course, should be at the top. Large galvanized screw-eyes may be used for fastening all wires to the pole; small holes should first be drilled and then the eyes may be readily screwed in without danger of splitting the wood.

After all the wires have been attached and properly insulated, select suitable "anchors" for the guy wires. For this purpose screw-eyes may be driven into convenient wooden objects or pieces of 2 x 4 may be set in the ground at an angle. Those necessary for an ordinary aerial are easily constructed, but it may be well to put in good, permanent anchors. A piece of 2 x 4, set in a hole about 30 inches deep and properly cemented in place, is about the best and simplest anchor one can conveniently make. The screw-eye may be driven into the wood and the guy-wires attached.

#### ERECTING THE MAST

To raise the mast, lay it toward the guy anchors with its lower end in the proper position; run the guy wire through the screw-eyes in the anchors, and have some one pay out the guy wires while you hold the mast in its proper position and another helper hoists the pole by the aerial wire. If the mast is too heavy to raise by means of this wire, better use three guys, and then the extra guy wire can be used for this purpose. When the mast is vertical, the trouble is about all over and the guy wires should be drawn fairly taut. With the aid of a borrowed level, the mast may be made vertical by leveling first from one side, then from the other and gradually tightening up on the wires. One can usually judge the correct tensions to be applied.

Another mast that can be easily constructed and, with a little patience, made as high as 70 feet, is suggested by Fig. 2. The bottom section is a 4 x 4 which may be made as long as 26 feet; this should be securely set about 5 feet into the ground. The second section consists of two 2 x 4s which are bridged-in with short lengths of the same material and the third and top section is a round pole about 3 inches in diameter at the base and about 2 or 2½ inches at the top. Each joint is securely guyed with at least three guy wires. All holes are drilled and all wires properly insulated and put into place before the mast is raised. Do not forget to put in the rope with which the antenna is to be raised.

To raise this mast, set the first section securely in place, and guy it; then set the second section over the end of the first and place the lower bolt through the proper hole. This section may be pushed into place by having some assistants at its guy wires and pushing the section into place with a pole prepared of some rough lumber. With the

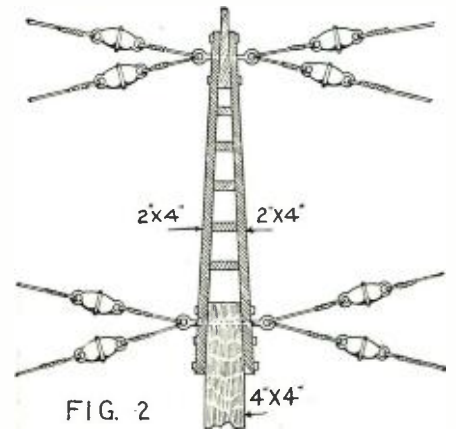

This method of construction can be used in erecting masts up to 70 feet in height.

guy wires tightened, this second section may be readily climbed. The third section may be pushed between two pieces of the second section and guided by means of its guys, as before. When the last section is in position, the bolts are slipped into place, the nuts are tightened and the guy wires are secured.

Probably the best method of connecting two pieces of pole is to use galvanized-iron bolts. Enough of the wood should be allowed to overlap so that a fairly strong joint will result. Washers should be used in con-

(Continued on page 1372)



# A Double-Heterodyne Receiver

The Latest British Development in Super-Sensitivity

By A. DINSDALE\*



**T**HE enormous amount of R.F. amplification obtainable by means of the superheterodyne method of reception is well-known, and even today this type ranks supreme as a long-distance receiver for short waves. No other means of obtaining really efficient R.F. amplification at ultra-high frequencies has yet been developed.

Those who have experimented to any great extent with superheterodynes, however, are well acquainted with their various peculiarities; such as, for instance, the problem of efficiently stabilizing the intermediate stages. It is not a practical proposition to employ more than three I.F. stages, on account of this difficulty, and it is sometimes better to employ only two.

To those superhet enthusiasts who crave still greater sensitivity, and have the money with which to gratify their desires, it will come as good news to hear that the superheterodyne idea has been extended and made use of twice over in the same receiver. This has been done by the British Marconi Company and receivers of the new type have been installed at the new short-wave beam stations.

The first of the various beam services, that between Canada and England, was opened recently and is operating on a wavelength of approximately 26 meters. The design of the receivers for this service is so interesting, and illustrates so fully the application of the new circuit arrangement that it is, perhaps, worth while to give a brief description of the leading features.

### SHORT-WAVE BEAM RECEIVER

Fig. 1 gives a skeleton outline of the system. The input circuit, to which the aerial system is connected, has two low-loss tuned intermediate circuits, so arranged that very loose coupling can be obtained between them. The second intermediate circuit is coupled to the input circuit of the receiver through a variable coupling.

This input circuit is tuned to the frequency of the incoming wave and is connected to the grids of two modulating tubes working push-pull, i.e., one grid is negative when the other is positive. The input tubes and the "filtering amplifier" (or I.F.) tubes all work on the push-pull principle, as this gives perfectly stable and distortionless R.F. amplification.

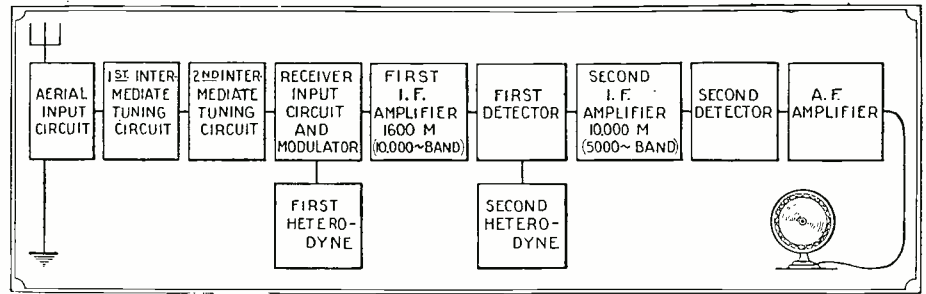

Fig. 1. Arrangement of the type of double-heterodyne receiver employed at the short-wave beam stations of the Marconi Co.

Coupled to this circuit is the first heterodyne, using a single tube which produces, with the incoming signal, a beat wave of about 1,600 meters (187. kilocycles). The signal on this new wave passes on to the first I.F. amplifier, which, with its associated filter, permits straight-line amplification over a frequency band 10,000 cycles wide. Outside this band the amplification is practically zero.

The provision of a frequency band of this width not only insures the distortionless reception of telephone signals, but also takes care of any variation in the frequency of the incoming wave. As long as the incoming wave does not vary more than 5,000 cycles on either side of the frequency to which the first heterodyne is adjusted, no variation in signal strength will be experienced at the A.F. (output) end of the receiver.

The first I.F. amplifier, then, gives three stages of push-pull amplification on a wavelength of 1,600 meters, after which the signals are detected and again heterodyned.

### SPECIAL ADJUSTMENT FEATURE

In the beam stations this second heterodyne is so arranged that it can, by means of a change-over switch, be made to give an audible beat note with the 1,600-meter output of the first I.F. amplifier, so that the operator can listen to the incoming signals and adjust the first part of the circuit up to this point. This done, the heterodyne is switched over to produce a beat wave of 10,000 meters.

The signals now pass on to the second I.F. amplifier, where they are subjected to three stages of push-pull amplification on a wavelength of 10,000 meters. The filter circuit incorporated in this amplifier is sim-

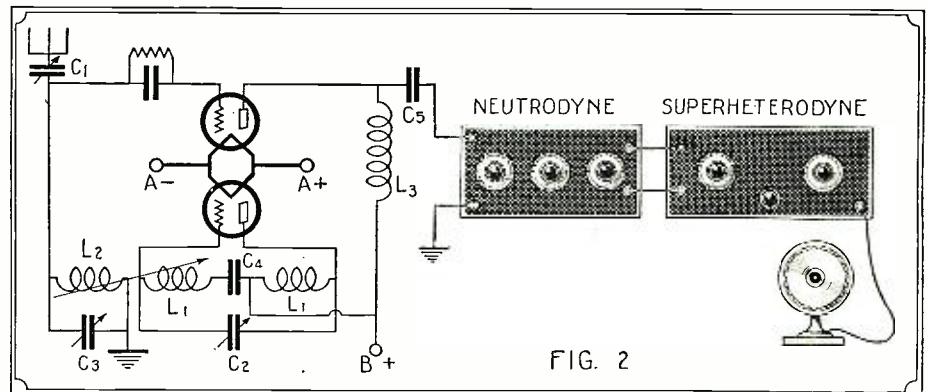
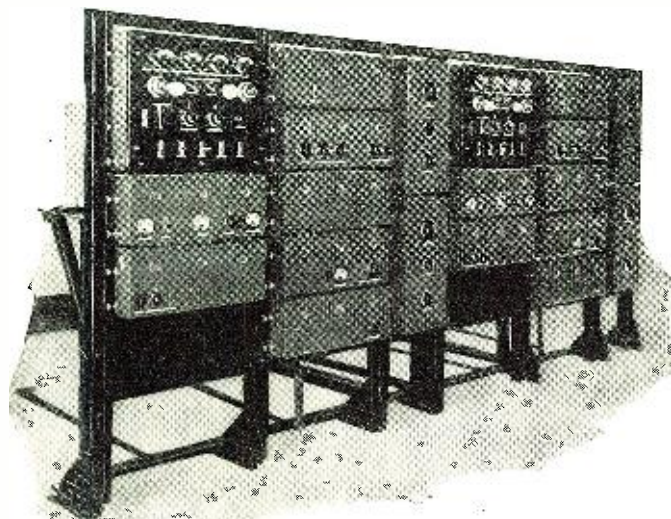

FIG. 2



Above: A complete double-heterodyne circuit, suitable for reception between 25 to 50 meters. C1 is a very small condenser; C2 and C3 are .0001 mf.; L1 has 7 turns slightly spaced on a 2 5/8-in. tube; L2, 11 spaced turns on same tube; L3, (R.F. choke) 1 1/2-in. winding of 44-gauge wire on a 1-inch form; C4 and C5, .01 mf.

Fig. 3. Equipment at the Bridgewater station. Two receivers are here shown, the left one being for South African signals and the one at the right for Canadian reception. Each of these sets is equipped to receive on two wavelengths.

ilar to that used in the first one, except that its band width is only 5,000 cycles. Normally, only three stages of amplification are used in the second I.F. amplifier, as stated above, but two more stages can be switched in if necessary.

After the second amplifier the signals are again detected by two small power tubes connected in parallel, the grids of which are negatively biased to give "plate-bend" rectification. The fact that it has been found necessary to use two small power tubes as detectors will serve in some measure to give an idea of the enormous R.F. amplification obtained in the preceding stages.

The outputs of these tubes are, in the case of the beam receivers, connected to further tubes and automatic signal recording apparatus, not shown in Fig. 1. For amateur purposes ordinary A.F. amplification can be applied after the second detector; but it is desirable to include in the plate circuit of

(Continued on page 1390)

\*Member, Radio Society of Great Britain.



Letters from Home Set Constructors



FINE RESULTS FROM INTERFLEX

Editor, RADIO NEWS: Having always been an Interflex booster I thought you might be interested in the results obtained by one of your readers. After having built six or seven of them, each slightly different from the other, I have finished one which I believe is a real set in every way. I have never heard one with a finer tone, and the distance received on it is remarkable. Am enclosing a diagram of the set exactly as I built it.

The Flexocoupler is exactly as described by you in RADIO NEWS for December, 1925; with the exception that I used a round 2-inch form for the tickler coil, in place of a honeycomb. A Bradleystat was used to control the first tube filament and amperites for the rest; the last being a half ampere. The potentiometer was a Centralab 400 Ohm; the audio transformer, a G.R. 2-to-1 ratio. A .002-mf. condenser was necessary across the first resistance to stabilize the circuit. A C-H. toggle switch and the

potentiometer were mounted on the panel, and a Marco illuminated control was used for tuning. Daven mountings and resistances were used.

There is nothing radically different here, from your original circuit, but the results obtained were so gratifying, that I wanted to let you know of the success I had. There was practically no balancing necessary.

FRANCIS C. REINARDY, Burlington, Wis.

THE "MYSTERY" CIRCUIT

Editor, RADIO NEWS:

This letter is intended as a report, rather than mere correspondence, on a circuit which was printed in the Amateur's Handbook by C. J. Fitch and G. C. B. Rowe. It was called the "Three-Tube Mystery" and was numbered 127.

I should like to report that, when I first attempted experimenting with it, I constructed merely the detector and one stage of A.F. What was my surprise when that evening it began rapping off KDKA, WJZ, and other powerful stations on the speaker!

"Nothin' t' shout about," eh?

WELL! Here's the dope. I used two dim-store tubes (199), 31 volts of "B," a punk aerial and a Manhattan, Jr. speaker.

(Continued on page 1367)

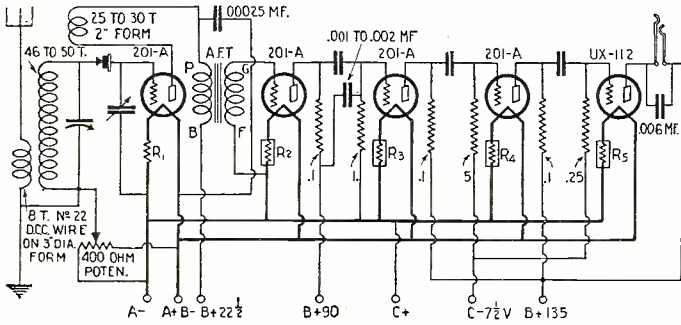

Mr. Reinardy's Regenerative Interflex with a powerful A.F. amplifier. He gives the values of parts, except for the coupling condensers, which are presumably 0.1-mf. The first variable condenser is .0005-mf., and the second a very small neutralizing condenser.

LIST OF BROADCAST STATIONS IN THE UNITED STATES

(Continued from page 1330)

Table listing broadcast stations across the United States with columns for Radio Call Letter, Broadcast Sta. Location, Wave (Meters), Power (Watts), and Wave (Meters), Power (Watts).

LIST OF CANADIAN BROADCAST STATION CALLS

Table listing Canadian broadcast station calls with columns for Call Letter, Location, Wave (Meters), and Power (Watts).

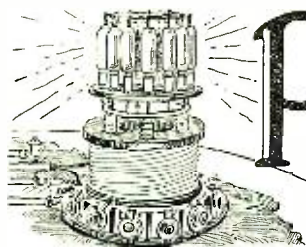

# Progress in Radio



## COIL-DRIVEN LOUD-SPEAKER UNIT

A modification of the Rice-Kellogg type of loud speaker is described in a British patent by C. W. Rice. Readers are no doubt familiar with this type of speaker, which consists essentially of a light diaphragm driven by a moving coil working in a strong magnetic field. An electro-magnet is utilized, in which the turns are arranged concentrically, the moving coil being located in the annular gap between the two poles. It is mentioned in the specification that the

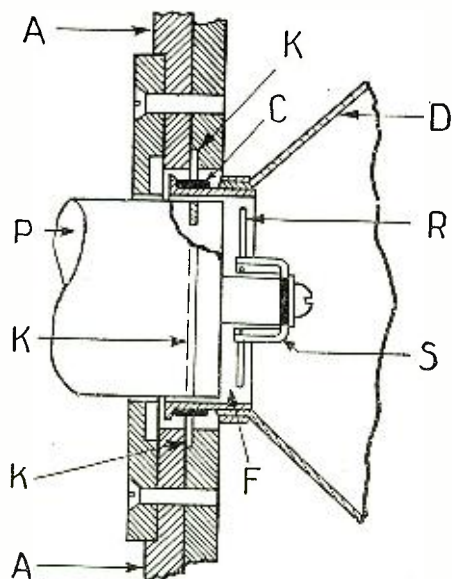

A new design of coil-driven loud speaker, which uses copper rings as a short-circuited secondary winding of the moving coil, to reduce the effective impedance at higher frequencies.

impedance of the coil at various audio-frequencies is determined partly by its ohmic resistance and partly by its reactance.

At very low frequencies the impedance is due almost entirely to its resistance, while at higher frequencies the reactive component may predominate. This, however, tends to give rise to unequal response over the usual speech and music bands, and the object of the invention is to flatten out the response curve, so that for a given voltage over the entire frequency range there will be an equal response. This is accomplished by associating one or two short-circuited turns, preferably in the form of a copper ring, with the moving coil; so that the copper ring acts as a short-circuited secondary winding to the coil. This, of course, considerably lowers the impedance of the winding, and hence tends to equalize its response over the entire range, particularly with the higher frequencies. The accompanying illustration indicates one arrangement of the invention, where a light diaphragm D, the edge of which is omitted, is fixed to a coil C wound on a cylindrical form F, and joined to the truncated portion of the cone. The magnetic system comprises a cylindrical pole P and an annular pole A, energized in the usual way from a source of direct-current supply; and the moving coil C is located in the gap between the two poles. The coil C is maintained in position partly

by means of supports in the form of light rods R fixed to a spider S, screwed to the end of the pole-piece P. The free edges of the conical diaphragm are also supported by thin leather, rubber, silk, or similar material. Two copper rings K are let into the two pole-pieces, i.e., the central pole-piece P and the annular built-up pole-piece A. These rings act as a short-circuited secondary winding to the moving coil C. Lines of force emanating from the moving coil due to speech currents will link with the copper rings, thus lowering the impedance of the coil, and thereby bringing about the desired effect.—*Wireless World* (London).

## WAVEMETER CIRCUIT

It is essential that the constants of a wavemeter should not change in use. Some slight difficulty has been experienced with vacuum tube wavemeters, owing to the necessity of substituting a new tube when the original one, with which the instrument was

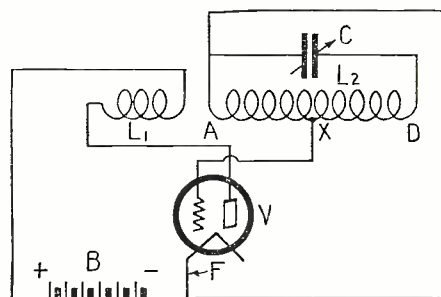

A wavemeter circuit that holds its calibration, even if the tube is changed.

calibrated, burns out. Varying inter-electrode capacities of the tubes, for example, would seriously alter the maximum and minimum wavelength to which the wavemeter will tune, thereby introducing inaccuracies over the whole of the range. Col. K. E. Edgeworth describes in his (British) patent a circuit which overcomes this difficulty. Here it will be seen that a tube V is provided with a tickler coil L1 and a "B" battery. This is coupled in the normal manner to a grid circuit inductance L2, tuned by a variable condenser C. One end A of the inductance L2 is connected to the filament F of the tube; while instead of connecting the free end D directly to the grid of the tube, the actual grid connection is taken to a tapping point X along the inductance L2, so that only a portion of the turns of the inductance are actually in the grid circuit. Obviously, then, the tube capacity is in shunt only with a few of the turns instead of all the turns, as would be the case with the normal arrangement. This means that any slight variation in tube capacity will not materially alter the wavelength of the circuit L2 C; since the capacity variation is only in shunt with a few of the turns.—*Wireless World* (London).

## METHOD OF STABILIZING RADIO-FREQUENCY AMPLIFIERS

A very interesting system for the stabilization of R.F. amplifiers is described in U. S. patent No. 1,605,042, granted to Edward H.

Lange, of New York City. By referring to the circuit diagram, it can be seen that the system is so arranged that any feed-back of energy from the plate to the grid of a tube will be out of phase with the original impulses and so will not combine with them to produce oscillation. This is accomplished by

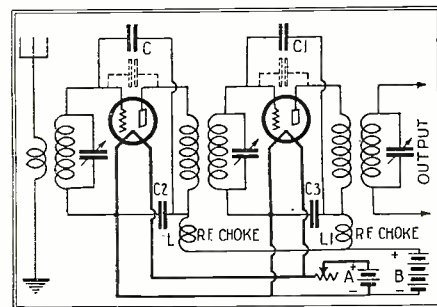

Another stabilized radio-frequency circuit employing "phase-shifting" condensers.

means of the small capacities C and C1. It will be noted that the radio-frequency currents are prevented from passing through the common battery circuit by the R.F. chokes L and L1, and are instead by-passed through condensers C2 and C3 to the filament legs of the tubes.

## A.C. FILAMENT FOR VACUUM TUBES

Jacques Antoine Marie Hawadier, of Paris, has recently been granted a British patent upon an invention which relates to tubes, for use in radio telegraphy, and especially designed to allow the employment of alternating currents for heating the filament.

According to the invention, tubes are provided with two filament elements of identical character, which are arranged parallel to one another, and are connected in parallel

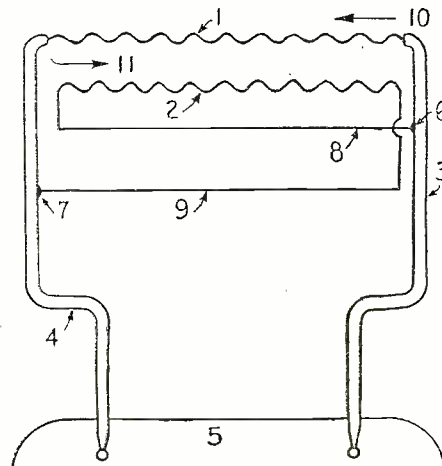

Details of the A.C. filament for Vacuum tubes.

to the leads in such a manner that the currents in them are always passing in opposite directions.

In this manner, the actions of the currents in the two filaments usually compensate one another. The two filaments are preferably of the type which emit at very low temperatures (oxide-coated) so that only a small

(Continued on page 1383)



## First Prize

### USE FOR BURNT-OUT A.F. TRANSFORMERS

By GLEN DECKER

In many radio junk boxes will be found burnt-out audio-frequency transformers; and a new use for them is here offered the experimenter who has saved them. As it is, almost always, the primary of these transformers which burns out, they can be utilized very satisfactorily by connecting a 100,000-ohm fixed resistance across the primary terminals and a .006- to .01-mf. condenser between the "grid" and "plate" terminals of the transformer.

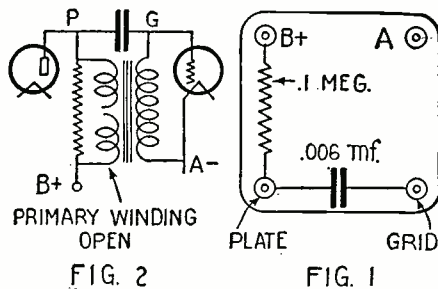

By connecting a 0.1-megohm resistance and a .006-mf. condenser as shown, an efficient impedance-coupling device can be made.

This connection effects resistance-capacity coupling with an impedance leak, and will be found to give very good tone quality, from even cheap and inefficient transformers, though these afford slightly less volume. It is a relatively simple matter to make clips of spring brass, which may be mounted directly on the binding posts of the transformer and which will hold the resistor and the coupling condenser.

## Second Prize

### THE HOME-MADE CIRCUIT BREAKER

By L. G. CAMPBELL

Most of us would use a circuit breaker instead of a fuse to protect our apparatus, whether receiving, transmitting, or other electrical equipment, if we could afford the initial expense. The advantages of a circuit breaker are many. Instead of inserting a new fuse we simply reset the circuit breaker. The fuse requires time to melt in opening the circuit; whereas the circuit breaker operates instantaneously, thus affording adequate protection to valuable tubes, etc. The circuit breaker is adjustable at will to the type of apparatus to be protected.

This home-made circuit breaker possesses the following desirable points:

It requires only common tools and a few screws; it is made in its entirety from a discarded Ford spark coil; adjustment can be made so that it will open the circuit with less than 1 ampere or with more than 10 amperes, according to the requirements; it can be inserted in line either way. This is important for batteries, etc., are protected whether they are *on charge* or *in service*,

## Prize Winners

### First Prize \$25

#### USE FOR BURNT-OUT A. F. TRANSFORMERS

By GLEN DECKER,  
230 Pigeon St., Ligonier, Ind.

### Second Prize \$15

#### HOME-MADE CIRCUIT BREAKER

By L. G. CAMPBELL,  
132 Andrew St., West Lafayette, Ind.

### Third Prize \$10

#### COLLAPSIBLE LOOP ANTENNA

By H. R. WALLIN,  
693 Watkins St., Brooklyn, N. Y.

All published Wrinkles, not winning prizes, will be paid for at the rate of two dollars each.

The next list of prize winners will be published in the July issue.

without reversing the circuit breaker; and you are assured protection all the time, for it is simple and absolute in action.

The diagram indicates clearly all the necessary parts. The magnet M is obtained by

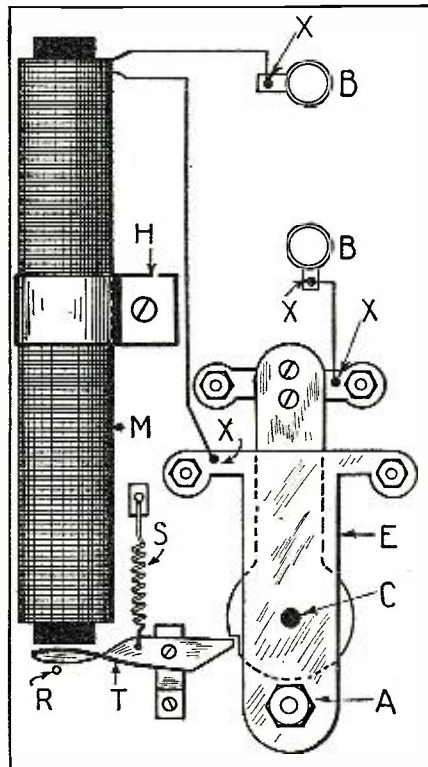

A top view of the circuit breaker; S is a spring from a tire valve core; C and E are lower and upper contacts, meeting at C, and regulated by A. B are binding posts, X, soldered connections; and R is a check limiting the movement of the trip.

opening the Ford coil box and removing it from its surrounding high-tension windings. The iron must be left inside. The two ends of the heavy-wire winding must be found so they may be connected as shown.

The base may be either bakelite or wood; in the latter case the base may be made of one side of coil box if care has been taken not to split it.

The vibrator parts are removed as all these are necessary. The vibrator contacts should be brightened up with a file, this to insure good contact connection. The lower vibrator spring is bent or otherwise adjusted so contacts are about 1/8-inch apart. The trip T is made of soft iron and holds the contacts together; as shown in diagram the circuit is open. The magnet end of this trip is circular and somewhat larger than the end of the magnet core.

The circuit breaker when completed is ready for adjustment. The tension in the spring S, is made just enough to make the trip move easily and to take up any excess motion at its joint. For the adjustment for opening the circuit at various loads, the magnet is shifted in position; it must be noted that, the farther away the magnet is from the trip, the harder it will be for it to move the trip and thus the greater the load must be in order to open the circuit. The closer the magnet to the trip, the more delicate is the release.

Since this job is not difficult, the work will not require more than a couple of hours, in the hands of the average constructor.

## Third Prize

### COLLAPSIBLE LOOP ANTENNA

By H. R. WALLIN

A very neat and efficient collapsible loop which, when not in use, folds out of sight (in rear of cabinet is shown in the sketch on the opposite page).

The scissors arrangement is made of 1/32-inch sheet brass, 3/16-inch wide. As most loops are made for specific sets, no details as to length and height are given; the loop can be made to fit any requirements. A good size is about 18 to 20 inches in height when opened and 10 inches wide. The strips holding the loop wire are 10x2x3/4-inches, split in two and fastened together by screws; the wire being held between the two strips. These strips can be made of wood varnished or polished to match the cabinet, of hard rubber or bakelite.

The sheet brass strips at the two ends of the scissors arrangement are slotted for about half an inch, as shown.

The loop described makes a neat installation for the home set, as many people object to the loop of wire being in sight and collecting dust and dirt. When not in use it is folded out of sight. If there is sufficient room in the cabinet, it can be placed on a bracket inside the set and the cover opened when it is to be used. It can also be made to fit a slot in the cover, so that when folded out of sight it is flush with the top of the cabinet. However, it is necessary to cut a hole in the cabinet to do this.

When folded the loop is very compact, as it takes less than two inches of space. The number of pieces used in the scissors ar-



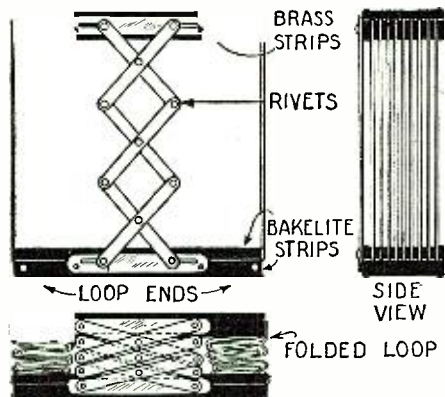

The design of a folding loop antenna, which can be simply constructed.

Arrangement depends on the height the loop is to be made. These are very easy to make and are held together by rivets. These rivets should not be hammered down too tight, as when opening the arrangement, the strips turn about the rivets. The loop described is especially useful for portable sets as it takes up very little room.

**A CHEAP, EASILY-MADE COIL**

Quite often in his experimenting a radio fan needs a coil that is easily-made, cheap and efficient. The materials needed for this coil are: an ordinary drinking glass, some No. 24 D.S.C. wire, a roll of tape, four Fahnestock clips and a piece of thin wood, such as may be obtained from a cigar box.

The wood should be cut to 1 1/4 x 4 1/2 inches and then placed across the middle of the open end of the tumbler. Double a piece of

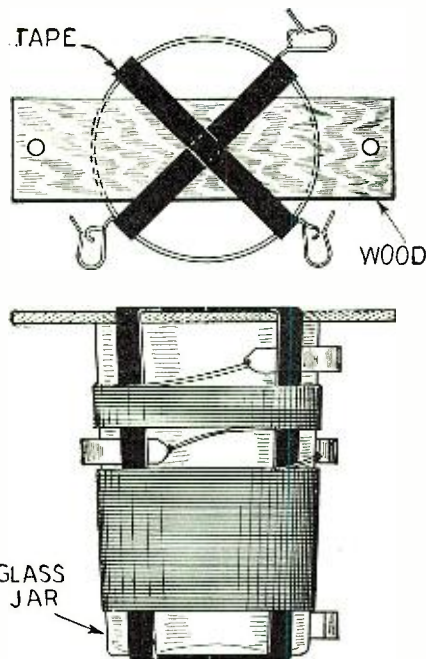

By winding a coil on a tumbler, on the top of which is a mounting board, losses may be greatly reduced.

the tape and wrap it tightly across the glass and obliquely over the wood. Then double another piece of tape and place it over the glass and wood, so that it divides them into four equal parts. Bend the clips in the middle and round them a little so that they will fit against the curve of the glass. Slip the ends of the clips under the tape and to their end solder the wire. The coil can then be mounted by means of holes drilled in the wooden base. If the wire is wrapped tightly around the glass and tape, there will be no

danger of its slipping off, and the coil will be found to be an efficient one.

*Contributed by Philip Sussman.*

**WIRE SKINNING DEVICE**

In using the popular rubber-covered stranded hook-up wire, considerable trouble was experienced in skinning the ends for connections until the following simple tool was devised. It consists of a large battery-connection clamp, the teeth of which are filed smooth. A small notch, in the jaws, roughly the size of the skinned wire, is also made with a file. With this little tool you can do a neater job in a fraction of the time necessary to skin this type of wire with a

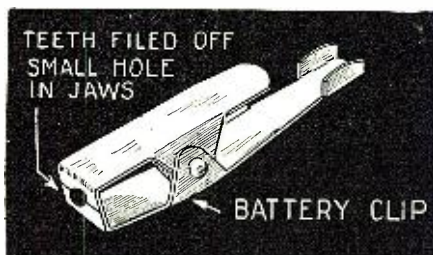

By filing the teeth off a clip, and a small hole in the smooth jaws, an insulation remover can be easily made.

knife, and there is no danger of cutting the fine strands of the wire.

*Contributed by Oliver Scheibell.*

**MAKING A TANDEM CONDENSER**

A variable condenser having 43 plates can be easily made into a tandem condenser, composed of two 17-plate sections. The condenser used for this purpose should be one of the type which is held together by three bolts, so that it can be taken apart. Remove these bolts, being careful not to bend the plates, and cut the long bolts in half with a hack-saw.

Before the condenser is taken apart, it is best to measure the exact distance between the two end plates, so that the bakelite strips can be cut to the exact length. This is necessary because the distance between the bearings of the rotor must be kept the same. In 17-plate condensers there will be 9 stator plates for each section. Since the rotors of a condenser in a R.F. receiver are connected to the "A—" lead, the rotor need not be separated.

Assemble the two end plates and place them on the table, at the same distance apart as they were originally. Measure the distance between the inner edges and make the separators this length. In Fig. 1 the separators are of bakelite rods, drilled and tapped to the size of the condenser bolts. The method of assembly is clearly shown in the diagram. One separator is used for each bolt, and for most condensers three will be required. This is a neat method but a little difficult.

A similar method is shown in Fig. 2. This will be found to be excellent if the bakelite remains firm, but the construction is not as strong as that shown in Fig. 3. Here the two stators are supported by three bakelite strips, about 1/8-inch thick and 1/2-inch wide, and just as long as the condenser was originally. Four small metal brackets are bolted on each strip and then to the stators by means of the original bolts cut in half.

The five center plates of the rotor should be removed and cut down to washers. Replace these washers in the original positions and the rotor will be the same length as before. Thus the two rotors are one, electrically speaking.

*Contributed by J. E. Hayes.*

**4 PLATES, 5 SETS OF WASHERS REMOVED**

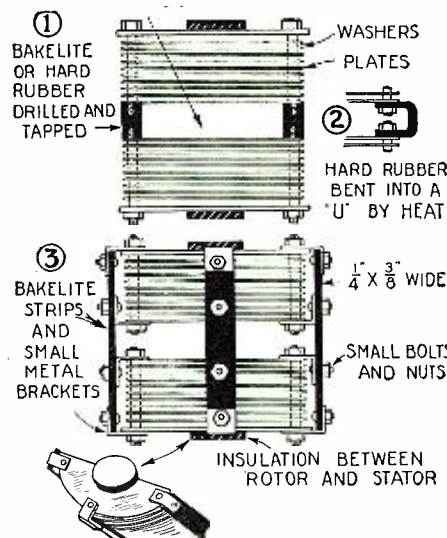

How to construct a tandem 17-plate condenser from a 43-plate condenser. Three methods of insulating the stators are shown.

**PLUG-IN-MOUNTING FOR SHORT-WAVE COILS**

A very convenient and inexpensive set of mountings for short-wave coils can be made from a few UX tube bases, a UX socket, and a few strips of bakelite.

The tube bases are cut off as illustrated and soldering lugs are soldered to the tops of the prongs.

Then a hole is drilled in the center of the tube base and it is bolted to the bakelite strip. Care must be taken that the head of the screw does not project above the surface of the strip, so that it will not come in contact with the coil.

This strip is drilled at the ends and the coil is bolted to it by another strip of the same length. (See illustration).

The socket is mounted on one end of a wider strip and the primary on the other end.

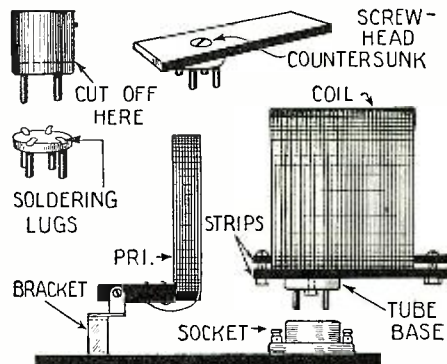

Here is shown a method of making plug-in coils and mounting them in a vacuum-tube socket.

The mounting for the primary is made out of a piece of 1/4-inch bakelite, supported by a bracket which is made from a piece of sheet brass and a piece of brass tubing. The coil is bolted to it by another strip of the piece of bakelite.

Two pieces of heavy copper wire are fastened tightly into holes in the piece of bakelite. These are used as terminals for the primary.

If a sub-panel is used, the socket and the primary may be mounted directly on the sub-panel.

The size of the coils and how to wind them is explained in the article "A 20-Meter Installment" in the February issue of RADIO NEWS.

*Contributed by George Harvey.*



# Correspondence from Readers

## THAT SERVICE FEE

Editor, RADIO NEWS:

I read your article, "Why the Radio Set Builder," in the February issue of RADIO NEWS with great interest; as I am at present building a copy of the set which received first prize in the late contest. But that is not why I write.

According to the debate in congress, if the broadcasters desire, they may even charge for listening in by broadcasting in such a way that an ordinary receiver would not get the broadcasts without some special attachment which could be rented from the broadcasters' association.

If such were the case, your prophecy would be all wrong, because nobody would build sets then. I for one, would rather throw my set in the alley than pay for listening in; and I am sure that I am not the only one.

B. J. BRABEC,

1208 Virginia Ave., Monaca, Pa.

*(We think our correspondent's fears are groundless, in view of the line along which broadcasting has developed in this country. When the radio audience is the most valuable asset of the broadcaster, the latter is not apt to take measures which will radically reduce its size; and the anti-monopoly terms of the new Radio Act of 1927, which the Radio Commission is created to administer, are quite stringent, as will be seen from the text of the law, on other pages of this issue.—EDITOR.)*

## THE AURORA AND RADIO

Editor, RADIO NEWS:

It was with great interest that I read Mr. L. C. Webb's letter in the March issue of RADIO NEWS. In my work in the repeater and automatic department of the Western Union Telegraph Company, I have had occasion to observe "earth currents" or "magnetic storms," as they are sometimes called.

High-speed automatic telegraph circuits are operated at a line frequency of from twenty-five to forty cycles, depending upon the inductive and capacitive conditions of the line and other factors. During the periods of earth currents the usual grounded-duplex method of operation is subject to great interruptions. At such times telegraphic communication is maintained by using the metallic-duplex circuit, using two conductors, in which the battery is entirely disconnected from the earth. Another satisfactory method employs three conductors with the battery using the ground connection. At present telegraph engineers are working on a system utilizing a specially wound relay, which shows great promise of not being affected by earth currents.

These troublesome conditions appear most frequently in the spring and fall. The worst visitation I have observed occurred in the spring of 1918. At that time, I was "riding" a section of an automatic circuit containing about two hundred and fifty miles of line. It was operated on a 60-milliampere current supplied by an emf. of 160 volts. Part of the equipment consisted of a milliammeter with a range of 150-0-150. When no earth currents were felt the meter showed a deflection of 60 ma. As the earth potential rose and fell, the meter at times would swing back to zero and continue until the needle went out of sight on the opposite side

of the scale. Assuming that Ohm's law applies to earth currents, this would indicate a potential difference of over 500 volts between the two stations. At such times, it was possible to hold communication, though rather uncertainly, between points several hundred miles apart with no battery used at either end. It was also observed that at times when no earth currents were apparent between these two stations, a wire grounded at a third station intermediate between them would show a difference of potential to each station. This would tend to indicate that the potential was in the form of an irregularly pulsating wave.

To get back to radio, however, I disagree with Mr. Webb on one point. I have observed that in this locality, at least, radio reception is affected by earth currents. On October 18 and 19, 1926, telegraphic communication was hit by the most serious magnetic storm in the last two or three years. During these two days, and to a lesser degree for several days before and after, broadcast reception was very poor. We were unable to pick up any broadcast stations east of Pittsburgh, which is about forty miles on an air-line from here; nothing at all was heard from the west, the nearest powerful station being at Cincinnati. But the Texas and Florida stations came through with a volume never experienced at other times. This would seem to support the theory that earth potentials consist of a surge moving in an easterly or westerly direction, neutralizing the radio waves in that plane and not affecting those traveling at right angles. This is not an isolated instance; the same condition was observed last winter and early spring.

From these observations the connection between the aurora and earth currents is obvious and both of them seem to depend in some way on sun-spot activities. I have compared notes with a local amateur astronomer and these several phenomena are always observed simultaneously.

I would like to see some more data and comments from other readers on this topic.

AL. J. KIRCHGESSNER,

Western Union Tel. Co., Wheeling, W. Va.

## RADIO HELPS THE PHONOGRAPH

Editor, RADIO NEWS:

In my home town we had formerly two broadcast stations which gave us considerable annoyance when we wished to get out-of-town stations. The music at that time was principally phonographic records and it sounded just as they do.

Soon the records were replaced occasionally with live artists, giving various programs which were very enjoyable, sitting back with the loud speaker and no occasion for jumping up and shutting off the needle. This continued, and every once in a while some especially appealing song or instrumental piece was rendered. One would find himself leaning forward to catch the announcement of the name of that particular piece, which he would note down on anything handy, for he wanted to have it as a record on the phonograph or for the piano. In this manner we found that through various members of the family, each having individual liking for certain pieces, we were buying more music in the course of a year than we had in ten years previous.

About this time first one local station

closed down, and shortly after the other. On making inquiries we found this was caused by suits claiming infringement on copyright music; or in other words, those holding the copyright demanded so much money for the privilege of its being broadcast that these two small stations had to close down.

Now, the conclusion I have formed is this: that copyright music would never have had the sale it has today, nor records of forty minutes' duration have ever been produced, had it not been for the radio.

J. C. PARKER,

212 City Hall Annex, Tacoma, Wash.

## FROM A LISTENER

Editor, RADIO NEWS:

About all the broadcast stations I have written to have answered me, even though I did not expect it; but it must be a considerable expense for some stations to answer them all. It is better for us not to expect it; but, speaking for myself and many thousands of listeners who certainly think as I do, I would like to know what the idea is, when many stations transmit for twenty minutes or more without announcing? This does not help the listener who is probably trying to tune in for a program. Whenever I get a station that fails to give the call letters or something after a number, I tune out at once. If all other listeners would do that, these stations could enjoy their programs alone. I can also call your attention to the excellent manner in which most of the really good stations announce their calls.

O. J. BERGER,

Waysata, Minn.

## THE SERVICE MAN TURNS!

Editor, RADIO NEWS:

On giving RADIO NEWS my usual "once over," I ran into the letter, "Radio Salesmanship and Service," in the March issue, and I feel I must tender the writer my sincere sympathy (?) and a little advice. Move east, where radio is sold by men who know radio—even in department stores.

No two radio sets have exactly the same quality, irrespective of make or price. No two localities are exactly alike, although only a few blocks apart, so how can salesmen know what a set can do in any locality? Regarding putting out sets or speakers to would-be customers, who wants to buy second-hand sets or speakers?

Does the critic get free service on his shoes, clothing, plumbing, or anything else? Why should radio have free service? Of course, I am presuming he wishes a radio expert to do his servicing; one who has usually paid out good money, spent long weary hours in study, to become efficient as a radiotrician.

I meet these "wise birds" every day when on service calls, and have come to the conclusion that the manufacturers should lock and seal all sets from some people who begin to learn radio backward, and by snooping and meddling with their sets, not yet paid for (twenty more payments and only thirty free service calls already!). All service calls should be paid for; *it would stop meddlers.*

J. ERNEST GRIBBIN,

215 Spring Street, Elizabeth, N. J.

# Radiotics

## FIREMAN. SAVE ME CHEILD!



A "hot one" from the Lincoln Nebraska State Journal of Feb. 20, under the head of "Take Care in Soldering," was as follows: "If the FIRE is allowed to wander over the set it is liable to come in contact with the hot soldering iron and the molten metal will drop where it shouldn't be." Care in soldering is right!  
Contributed by A. L. Henriksen.

## DON'T! STOP!

Kick-back to the days of the cavemen, noted in the Syracuse Herald of Feb. 20: "WAUC" will step from a 500-watt to a 5000-watt SUPER-PAWER transmitter." Mike of the Investigation Dept. has reported that all the necking is being done by the young folks these days—and they do say that radio is in its infancy as yet.  
Contributed by Howard Bailey.



Contributed by Howard Bailey.

## IN THIS RING. LADIES AND GENTS—

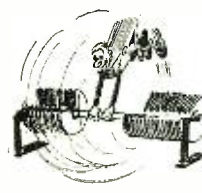

Signs of spring and circus days, found in the seventh edition of Radio Construction: "A small compensating condenser is STUNTED across one of the tandem condensers." The way the family blooper behaves sometimes, we wonder if some condenser isn't doing the loop-the-loop around in our set.  
Contributed by Frank E. Seaman, Jr.

## NOBODY KNOWS HOW DRY I AM

We would say that the fellow who has the set described in the Boston Post of Feb. 21 has no cause to worry over Mr. Volstead's popular (?) amendment. He claims that "the last tube has BEER controlled by a filament control jack." This bootleg tube has been ordered already by this Department for the family blooper. It listens good to us.  
Contributed by G. E. Sprague.



Contributed by G. E. Sprague.

## PAGING MR. BUCKNER



Latest activity of "The Thou-Shalt-Nots," as noted in the Pittsburgh Post of Feb. 18: "Roar of Niagara Falls RAIDED." To make this clearer, the article of which this is the head mentions the fact the Falls has taken its place in the broadcasting field, beside the Liberty Bell, Big Ben in London and the Pacific Ocean. Quite a program, eh?  
Contributed by W. J. G. Cooper.

## WHAT NEXT?

Step forward in financial circles, evidenced by an advertisement in the Minneapolis Tribune of Jan. 27: "Complete \$275, power 5-tube radio DIRECTOR. ALTERNATIVE current. This means that the poor, over-worked capitalists can have radio proxies at their board meetings, instead of attending in person. Pretty soft!"  
Contributed by E. W. Topel.



Contributed by E. W. Topel.

## EFFICIENCY PLUS



Carrying a job too far, as shown by an advertisement in the Newark Sunday Call, of Jan. 23: "0005 Low Loss Balanced Rubber Battery Mats, 15c." We suppose that the low-loss part of it means that there is very little chance of acid doing any harm to the carpet or rugs. Fine stuff, eh?  
Contributed by Harold Gray.

## A BOON FOR THE CONSTRUCTOR

Advice from the New Orleans Daily States of Feb. 6: "A collection of small screwdrivers or extra large "B" BATTERIES in inches... invaluable in tightening screws." Just how you get a grip on the screw head with the battery, or how it rates in inches, we don't know; but this new stunt should be a labor saver.  
Contributed by A. L. Cobb.



Contributed by A. L. Cobb.

## THE HEIGHT OF HOSPITALITY



Constant Reader in the Philadelphia Bulletin of Feb. 5: "I was the owner of a large set and only interested in LODGING about 60 to 100 stations an evening." The generosity of the Quaker Citizens will indeed be taxed, even if they have extra-sized supersized dynes, by so many visitors.  
Contributed by W. G. Miller.

## WE PREFER THE APPROVED TYPE

Combination of radio and the black art announced in the New York Sun of Jan. 29, under the heading: "WITCH Lightning Arrester." Evidently the old ladies who used to ride round on broomsticks and raise thunderstorms have reformed and are helping out the radio set owner.  
Contributed by J. H. Farrington.



Contributed by J. H. Farrington.

## DON'T WIND 'EM—MINE 'EM



The radio industry will be revolutionized by the new device mentioned in Popular Wireless (London) of Jan. 29, describing latest mine-surveying methods: "A Radio COIL Finder." As soon as a pay streak of good low-loss solenoids is located, we can expect these parts for next to nothing.  
Contributed by W. M. Bergin.

Contributed by W. M. Bergin.

IF you happen to see any humorous misprints in the press we shall be glad to have you clip them out and send to us. No RADIOTIC will be accepted unless the printed original giving the name of the newspaper or magazine is submitted with date and page on which it appeared. We will pay \$1.00 for each RADIOTIC accepted and printed here. A few humorous lines from each correspondent should accompany each RADIOTIC. The most humorous ones will be printed. Address all RADIOTICS to Editor RADIOTIC DEPARTMENT, c/o Radio News.

## TOO MUCH AMPLIFICATION

In the Chicago Herald and Examiner of Feb. 13 the following requisition is noted: "20 FEET of 201-A tubes," this being one item in a list of parts. Mike of the Investigation Dept. happened to pass the store and brought us back a sample yard of tubes. You can have 'em; our receiver is only 24 inches long.  
Contributed by N. Flechtner.



Contributed by N. Flechtner.

## IT WORKS WHILE YOU REST



New type of radio receiver mentioned in the Mobile, Ala., News Item of Feb. 15: "Radio FULLY EQUIPPED TO DO BICYCLE REPAIRING." We certainly wish that we could teach our set to do stunts like this. We'd just as soon sit around with our feet on the desk and have a set to do all the work, while we bank the profits.  
Contributed by Clifford Wells.

Contributed by Clifford Wells.

## WHERE DID THIS THING START?

Startling broadcast history from Radio in Australia and New Zealand (Sydney) of Jan. 5: "A few years ago when KDKA was the principal and almost the only broadcasting station in THIS COUNTRY." We suppose the East Pittsburgh Chamber of Commerce slipped in when the Aussies weren't looking and moved the station—like county seats in the old days. Let's have the lockdown on this.  
Contributed by Lawrence Fishell.



Contributed by Lawrence Fishell.

## CLEARING THE ETHER



Removal of the heterodyne whistles foreshadowed in The Lightning Jerker for February, by an account of "The McCaa ANTISTATION device," which will evidently go to the root of the trouble. Perhaps the Radio Commission will equip itself with one of these for its Herculean task.  
Contributed by D. R. Cowan.

Contributed by D. R. Cowan.

## CASH, PLEASE!

From Sears, Roebuck & Company's latest catalog we learn this new use for an audio amplifier: "REGISTER Coupled Panel." This must be on the idea that every time cash is rung up you get a tune from the loud speaker; a sort of combination amplifier and cash register you see. A fine gadget!  
Contributed by F. C. Gunderloy.



Contributed by F. C. Gunderloy.



**APPROVED  
RADIO NEWS  
LABORATORIES  
1922**

# RADIO NEWS LABORATORIES



**R**ADIO manufacturers are invited to send to RADIO NEWS LABORATORIES, samples of their products for test. It does not matter whether or not they advertise in RADIO NEWS, the RADIO NEWS LABORATORIES being an independent organization, with the improvement of radio apparatus as its aim. If, after being tested, the instruments submitted prove to be built according to modern radio engineering practice, they will each be awarded a certificate of merit, and a "write-up" such as those given below will appear in this department of RADIO NEWS. If the apparatus does not pass the Laboratory tests, it will be returned to the manufacturer with suggestions for improvements. No "write-ups" sent by manufacturers are published on these pages, and only apparatus which has been tested by the Laboratories and found to be of good mechanical and electrical construction is described. Inasmuch as the service of the RADIO NEWS LABORATORIES is free to all manufacturers whether they are advertisers or not, it is necessary that all goods to be tested be forwarded prepaid, otherwise they cannot be accepted by the Laboratories. Apparatus ready for the market or already on the market will be tested for manufacturers, as heretofore, free of charge. Apparatus in process of development will be tested at a charge of \$2.00 per hour required to do the work. Address all communications and all parcels to RADIO NEWS LABORATORIES, 230 Fifth Avenue, New York City.

**INTERFERENCE PREVENTIVE DEVICE**

The "Quietus" shown, submitted by the Dayfan Elec. Co., Dayton, Ohio, is designed to be used on small electric generators, motors, vibrators, heating devices, etc., to prevent radio interference from such apparatus. It is provided with five outgoing leads; two of them for connection to the line wires, two others to the terminals of the electric apparatus and the last, marked "G," to be grounded. The device embodies in one case two condensers of 1-mf. capacity each and two inductively-coupled coils, of approximately 72 turns each, wound around the con-

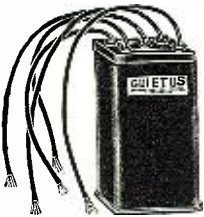

densers; all arranged in such a way that when the "Quietus" is attached each terminal on the electric apparatus is grounded through a 1-mf. condenser.

The operation is very satisfactory, especially when the leads from the "Quietus" to the electric apparatus causing disturbance are very short. The instrument submitted is designed for operating on either A.C. or D.C. voltages, not higher than 220, and carrying less than 8 amperes.

**AWARDED RADIO NEWS LABORATORIES CERTIFICATE OF MERIT NO. 1812.**

**HEAVY-DUTY CHARGER**

The "Blitz Full-Wave One-Day Charger" shown, submitted by the Blitz Elec. Co., Inc., 4344 Wentworth Ave., Chicago, Ill., operates on 110 volts, 50-60 cycle A.C. house-lighting current, and uses two tungar bulbs as rectifiers. The three outgoing leads allow two charging combinations: in the first, one to fifteen



batteries can be charged (the leads marked "—" are connected together); and in the second thirty 6-volt batteries can be charged at the same time with a charging rate of 6 amperes (the "—" leads are separated). The apparatus is very solid and is designed for battery service stations.

**AWARDED RADIO NEWS LABORATORIES CERTIFICATE OF MERIT NO. 1845.**

**A.F. TRANSFORMER**

The audio-frequency transformer shown, submitted for test by the All American Radio Corp., 4201 Belmont

Avenue, Chicago, Ill., is completely enclosed in a heavy steel shell which reduces the interstage coupling effects. The windings of the unit are



protected against all atmospheric conditions by a moisture-proof compound which seals them hermetically in the steel shell. The amplifying characteristic of this transformer, within the limits of the frequencies used in speech and music, is very good. Two types are available, R14, rated 3:1, and R15, rated 5:1.

**AWARDED RADIO NEWS LABORATORIES CERTIFICATE OF MERIT NOS. 1882 and 1883.**

**ILLUMINATED DIALS**

The "Vernier Church Dialler" (No. 180 shown), submitted by W. F. Loughman, 161 High Street, Boston, Mass., is of the back-panel-



mounting type. In order to use this dial, the tuning unit is mounted on a small bakelite or hard-rubber panel, which is fastened to the base-board by the two special brackets supplied with the dial; the latter is illuminated by a small 6-volt lamp behind the panel, and operating from the "A" battery.

**AWARDED RADIO NEWS LABORATORIES CERTIFICATE OF MERIT NO. 1898.**

The "Church Illuminated Dialler," No. 104, submitted by W. F. Loughman, 161 High Street, Boston, Mass., is of the back-panel-mounting type, and identical in

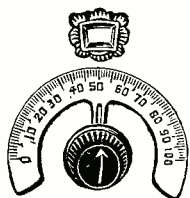

construction with No. 180 except that it has no vernier arrangement.

**AWARDED RADIO NEWS LABORATORIES CERTIFICATE OF MERIT NO. 1899.**

**FIVE-TUBE RADIO RECEIVER**

The "Sterling Five," submitted for test by the Naylor Radio Corp., 161 Chambers Street, New York City, is a 5-tube receiver, having one stage of tuned R.F., a tuned detector, and three stages of resistance-coupled A.F. The appearance of the set is neat and the quality of reproduction is very good.

**AWARDED RADIO NEWS**



**LABORATORIES CERTIFICATE OF MERIT NO. 1909.**

**HEAVY-DUTY RESISTOR**

The wire-wound resistance unit shown, submitted by Arthur H. Lynch, Inc., Fisk Bldg., New York City, consists of a fine resistance



wire wound on a porcelain tube, and protected from mechanical injury by a thin coating of porcelain. This unit is available in different values (from 2,000 to 100,000 ohms) and has been found to be capable of withstanding a very high overload. Units rated at 7½ watts have been tested for several hours with 52 watts load.

**AWARDED RADIO NEWS LABORATORIES CERTIFICATE OF MERIT NO. 1925.**

**A.F. COUPLING UNIT**

The "Rauland Trio" impedance unit, similar in appearance to the A.F. transformer shown above, submitted by the All American Radio Corp., 4201 Belmont Ave., Chicago, Ill., is an impedance-coupling device, which embodies in one housing an inductance unit, the corresponding coupling condenser, and a resistance unit. The instrument is compact and very easy to install. Two types are available; Type R300 is especially adapted for the intermediate audio stage when three stages of audio frequency are used; while Type R310 is designed for the last stage only.

**AWARDED RADIO NEWS LABORATORIES CERTIFICATE OF MERIT NO. 1933.**

**INTERFERENCE PREVENTIVE DEVICE**

The Radio Interference Filter (No. 1 shown), submitted by Tobe Deutschmann Co., Cambridge, Mass., is designed for elimination or reduction of the radio interference from household motors. It consists of two 1-mf. condensers, two inductively-coupled coils having a common iron core, and two fixed resistances, all in one case. There are five outgoing wires; the two on the left side are to be connected to the line, the two on the right side, to the brushes of the motor, and the fifth in the middle to the frame of the motor. This device is designed for A.C. or D.C. motors up to ¼-h.p. The operation during the test was found very satisfactory.



**AWARDED RADIO NEWS LABORATORIES CERTIFICATE OF MERIT NO. 1934.**

**CONE SPEAKER**

The loud speaker shown, submitted for test by the Wirt Elec. Co., 5221 Greene St., Philadelphia, Pa., is of the cone type. A neat looking metal housing with openings in front and back encloses the unit and the cone and protects the delicate parts



from injury. This instrument has very good tone qualities.

**AWARDED RADIO NEWS LABORATORIES CERTIFICATE OF MERIT NO. 1936.**

**COMPACT FIXED CONDENSER**

The "Sprague Midget" condenser shown was submitted for test by the Sprague Specialties Co., 8 Miller Stile Road, Quincy, Mass. It is a small and extremely light paper con-



denser, has a very high breakdown voltage (about 1500 volts) and is very convenient to be used in radio circuits. It is available in different sizes.

**AWARDED RADIO NEWS LABORATORIES CERTIFICATE OF MERIT NO. 1937.**

**VERNIER DIAL**

The "Rathbun" dial, submitted by Norton Laboratories, Inc., Lockport, N. Y., is of molded bakelite and very neat in appearance. It has a vernier ratio of 10 to 1 and a double calibration, from 1 to 100, both clockwise and counter-clockwise. A fine steel wire, with two sharp ends, housed in a small groove of the bakelite frame, keeps it in a fixed position with regards to the panel.



AWARDED RADIO NEWS LABORATORIES CERTIFICATE OF MERIT NO. 1938.

**VARIABLE CONDENSERS**

The variable condenser shown, submitted for test by the Remler Division of Gray & Danielson Mfg. Co., 260 First Street, San Francisco, Calif., is a twin-rotor condenser of the straight-line-frequency type. The shape of the plates is the same as that in the Remler straight-line-wavelength condenser. The straight-line-frequency characteristic is obtained through a special cam, which can be removed when single-dial control is desired, and several condensers are operated in gangs. An interesting feature of this instrument is that it is provided with a special minimum-capacity adjustment. This adjustment does not affect the maximum capacity of the condenser. The condenser is substantially constructed and has a very neat appearance.

AWARDED RADIO NEWS LABORATORIES CERTIFICATE OF MERIT NOS. 1940 AND 1941.



The variable condenser No. 659 which was submitted for test by the Remler Division of Gray & Danielson Mfg. Co., is similar in construction to the instrument described above. It differs from it in having a wider spacing between the plates, and is designed to be used for transmitting purposes where higher voltages are employed.

AWARDED RADIO NEWS LABORATORIES CERTIFICATE OF MERIT NO. 1942.

**LOUD-SPEAKER UNIT**

The "Rival" unit, submitted by Nathaniel Baldwin, Inc., 3474 S. 23rd St., Salt Lake City, Utah, is extremely well adapted for use as a phonograph attachment. It possesses very fine reproducing qualities and affords very good volume.



AWARDED RADIO NEWS LABORATORIES CERTIFICATE OF MERIT NO. 1945.

**FIXED RESISTOR**

The resistance unit shown was submitted for test by the White Mfg. Co., 93-107 Lafayette St., Newark, N. J. The resistance element consists of a glass rod covered with a thin coat of a conductive substance of the graphite type. The resistance of the unit has been found to be close to its rated value.



AWARDED RADIO NEWS LABORATORIES CERTIFICATE OF MERIT NO. 1947.

**POWER-TUBE ADAPTER**

The adapter (No. 171), submitted for test by the Carter Radio Co., 300 S. Racine Ave., Chicago, Ill., allows



the use of a power tube of the UX-112 or 171 type in any stage of an A.F. amplifier without changing the wiring of the set.

AWARDED RADIO NEWS LABORATORIES CERTIFICATE OF MERIT NO. 1948.

**BATTERY CABLE PLUG**

The radio connector plug (Q-51 shown), submitted by the Beaver



Machine & Tool Co., 625 No. 3rd St., Newark, N. J., affords a safe and easy way to connect and disconnect the "A", "B" and "C" batteries from a radio receiver. The instrument is neatly built and its springs ensure a good contact between the battery leads and the wiring of the receiver.

AWARDED RADIO NEWS

**LABORATORIES CERTIFICATE OF MERIT NO. 1949.**

**VACUUM-TUBE SOCKET**

The "Remler" socket (No. 50 shown), submitted by Remler Division of Gray & Danielson Mfg. Co., 260 First St., San Francisco, Calif., is constructed of molded bakelite and designed for use with tubes having UX bases. The springs are combined with soldering lugs and ensure perfect contact with the prongs of the tubes.



AWARDED RADIO NEWS LABORATORIES CERTIFICATE OF MERIT NO. 1950.

**WAVE TRAP**

The "Web" wave trap shown, submitted by Walter E. Bathgate Co., 65 West Broadway, New York City, consists of an inductance coil having 65 turns wound on a 3-inch bakelite tube, and a built-in variable condenser of the book type, operated



by a knob. Although very simple, this device has been found to be very satisfactory in many cases in cutting down or reducing interference from stations which are unduly loud.

AWARDED RADIO NEWS LABORATORIES CERTIFICATE OF MERIT NO. 1952.

**CHARGER-POWER UNIT RELAY**

The "Jewell A-B" relay shown,



submitted by the Jewell Electrical Inst. Co., 1640 Walnut St., Chicago, Ill., operates from the filament current and is so arranged that, when the filament circuit of the receiver is opened, the relay is released; the trickle charger is then connected to the line, and charging the battery. When the filament circuit is closed by the receiver switch, the relay

is operated, the line disconnected from the trickle charger and connected to the "B" socket unit. The relay is available in two types: Type 595 operates on 1 ampere, and Type 593 on 3 amperes. The operation of the instrument is very satisfactory and reliable.

AWARDED RADIO NEWS LABORATORIES CERTIFICATE OF MERIT NO. 1953.

**VARIABLE CONDENSER**

The condenser shown, submitted by Benjamin Elec. Co., 120-128 So. Sangamon St., Chicago, Ill., is of the straight-line-frequency type, and both electrically and mechanically well designed. It is available in different sizes.



AWARDED RADIO NEWS LABORATORIES CERTIFICATE OF MERIT NO. 1954.

**LOUD SPEAKER**

The loud speaker shown, submitted for test by the Amplion Corporation



of America, 280 Madison Avenue, New York City, is of the air-column reproducer type. The unit and the horn are enclosed in a richly-carved mahogany cabinet. The reproduction of music and speech is excellent, with regards to both quality and volume.

AWARDED RADIO NEWS LABORATORIES CERTIFICATE OF MERIT NO. 1955.

**CONE SPEAKER**

The loud speaker shown, submitted for test by the Algonquin Elec. Co., 1819 Broadway, New York City, is of the cone type; the diaphragm is made of a specially impregnated cloth. This reproducer is very attractive and affords good reproduction, with regard to both volume and quality.



AWARDED RADIO NEWS LABORATORIES CERTIFICATE OF MERIT NO. 1956.

**Letters from Home Set Constructors**

(Continued from page 1360)

Maybe I can't impress upon you how wonderful the circuit really was. But I can say that the consequence was I hooked up a four-tube using the "Mystery" as a base. I used a stage of tuned R.F., detector and two of A.F. I found the R.F.-tube needed no potentiometer to control oscillations.

Here is my list for two nights: (Twenty-eight stations, including St Louis, Nashville, Toronto, and Bridgeport).

That's all I could get. Is that enough for four cheap tubes and accessories on two nights? I think so and I'm boosting the "Mystery Circuit" with a stage of R.F.

Mark you, sir, I am not reporting a discovery or anything of the sort. I am merely taking

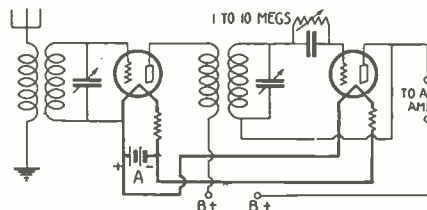

There is no reason for calling it the "Mystery circuit," except that this is its name. Radio experimenters will recognize it as a form of the original de Forest "Ultra-Audion."

these measures to thank you and the two collaborators, Fitch and Rowe, for the circuit. It is a wonder! More power to you!

LOUIS F. HECKART,  
354 Adams St., Williamsport, Pa.

**"A REMARKABLE QUALITY SET"**

Editor, RADIO NEWS:  
I have constructed the Music Lovers' Receiver described in RADIO NEWS for June, 1926 (page

1652). This 6-tube receiver has splendid quality, and one can receive distant stations with almost as good reproduction as local. I use a Tower cone. I have constructed many receivers, but this one is the most satisfactory that I have ever had or listened to. I expect to make two more for friends who are entertained by its excellent tone, ease of operation and selectivity. We live in a suburb of Chicago, about twenty miles out, with WOK about three miles distant.

A. DAVEY,  
Harvey, Illinois.

**FINE WORK ON THE BROWNING-DRAKE**

Editor, RADIO NEWS:  
The writer has built many sets following the data furnished by your good magazine, but believes there has been none of them to compare with the Browning-Drake circuit you featured a few months ago. I built this set according to your specifications and believe you should know that there are really few important stations—outside of the northwestern part of the United States—which I have not received on it with loud-speaker volume. This means Atlantic coast cities and Pacific coast cities, as New York, Los Angeles, Atlanta, Jacksonville, New Orleans, San (Continued on page 1380)



# Short-Wave-Oscillator Adjustment and Operation

Some Suggestions for Securing Maximum Efficiency from Short-Wave Transmitters Employing the Hartley Circuit

By A. BINNEWEG Jr., 6BX, 6XAA

**T**HE Hartley circuit, due to its simplicity and flexibility, can be readily adjusted to oscillate on practically any wavelength. This may seem strange to some, but on very short wavelengths, under certain conditions, it is sometimes difficult to prevent the circuit from oscillating. It is for these reasons and others that practically all amateurs have chosen the Hartley circuit for their transmitters. This circuit, but slightly modified for short-wave operation, is shown in Fig. 1.

In this diagram it will be noticed that no shunt condenser is used across any part of the primary inductance. A circuit, to be oscillatory, must have capacity, to be sure; but on short waves the distributed capacity of the inductance and connecting wires is sufficient. In fact, this capacity is so large that when operating at 5 meters we must use variable grid and plate stopping condensers to cut down the circuit capacity. By all means keep the leads on a short-wave transmitter short; more "effective" inductance may then be used, usually. If the leads are not short and well-spaced, the circuit may also oscillate at a second frequency (independent of that to which the set is normally tuned) determined by the distributed capacity and distributed inductance. This oscillation is not easily detected, but it requires useful power to maintain and therefore it constitutes a waste.

### WAVELENGTH ADJUSTMENT

The wavelength of the primary circuit is determined largely by the number of turns in the inductance between the plate grid taps, and is not dependent on the number of turns in the grid coil (i.e., the number of turns between the grid and filament clips), as generally thought. A large change in the setting of the filament clip affects the wave but little, whereas a small change of the plate clip affects the wave materially. The wavelength at which the transmitter is to be operated is experi-

mentally determined by moving the plate clip toward or away from the grid clip. This wave should be near the fundamental of your antenna. The grid clip may also be varied if desired, but it has been found best to leave this in place and move only the plate clip. For every position of the plate clip there is a corresponding position of the filament tap for best operation.

There are, under certain conditions, two positions of the filament clip at which the circuit oscillates; one position is within one or two turns of the grid end of the inductance; the other is approximately halfway between grid and plate clips, but usually nearer the latter. With the filament clip in the first position the tube oscillates with a very small plate current and may be readily thrown out of oscillation by bringing the hand near the inductance. This adjustment is fairly critical.

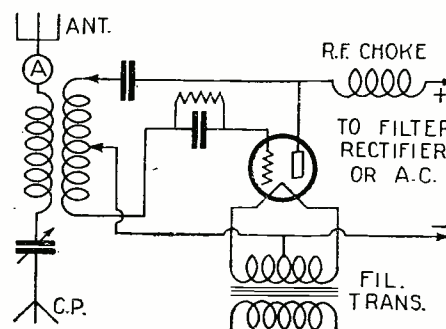

FIG. 1  
The slightly-modified Hartley transmitting circuit.

other two clips and a turn or two nearer the plate tap; the exact position must be determined experimentally. If the plate current is too high move the filament clip toward the grid end. Often it is rather difficult to determine when a circuit is oscillating. One method is to obtain sparks from the plate coil, but this does not always work and touching any instrument to the inductance sometimes throws the set out of oscillation. With given inductance, etc., a circuit usually oscillates with a definite plate current; if, by previous experiment, it is found that the tube oscillates with a particular current, it will usually be oscillating when this current is obtained. Another method is to listen in a receiver, but perhaps the best method is to test with a wavemeter employing a flash-lamp indicator.

### SIZES OF CONDENSERS

The capacity of the plate-stopping condenser for the 20-50 meter range is not very critical. The set will oscillate quite readily with a very small capacity here; but the adjustment of the filament clip is changed considerably and its adjustment is then rather critical. For stable operation any good fixed condenser of .001- to .002-mf. will suffice. For the extremely short waves this condenser must be made variable, for reasons previously stated. A condenser of about 5 plates is usually the right value in this position. It should be double-spaced and care should be taken to see that it does not short-circuit; a short here short-circuits the plate current and something will inevitably burn out.

The size of the grid condenser is not very critical, except that a small variable one is used for the short waves. A 5,000- or 7,500-ohm leak will suffice for most tubes. The DeForest "H" tube often requires 30,000 ohms and sometimes more than this. A high grid resistance always lowers the plate current somewhat. In the vicinity of 5 meters, the leak must be connected as shown in Fig. 2; for the capacity of the grid condenser is low and the

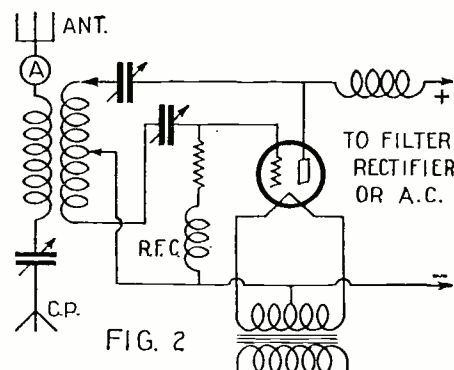
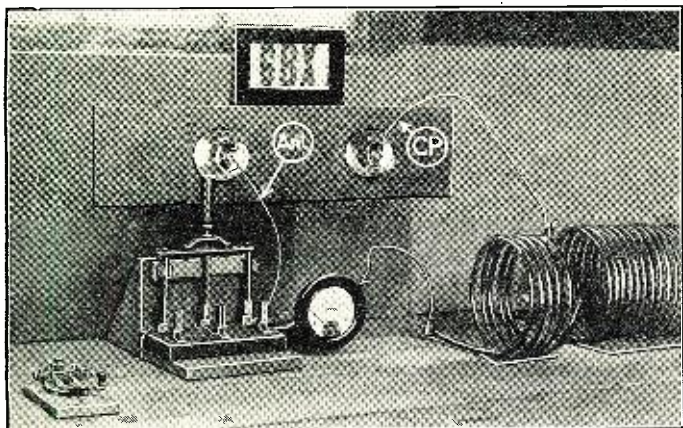
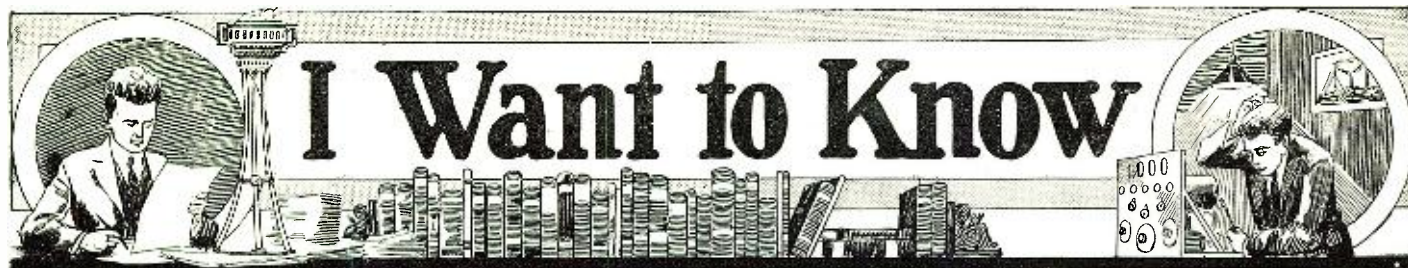

FIG. 2  
For operation below 20 meters the grid-leak should be connected as shown above.

In the second position of the filament clip, the set will oscillate with four or five times the plate current secured at the other position; and the circuit oscillates with greater stability, the adjustment being less critical. Never disconnect the filament clip when adjusting the transmitter, as a dangerous tube flash-over may occur. Between these two positions of the clip practically no current may flow in the plate circuit; beyond the second position a tremendous current may flow, although the tube may not be oscillating. The best position, then, is about midway between the

A very efficient lead-in for the short-wave transmitter; its construction is described in the accompanying text.





Conducted by Joseph Goldstein

**T**HIS Department is conducted for the benefit of our Radio Experimenters. We shall be glad to answer here questions for the benefit of all, but we can publish only such matter as is of sufficient interest to all.

1. This Department cannot answer more than three questions for each correspondent. Please make these questions brief.
2. Only one side of the sheet should be written upon; all matter should be typewritten or else written in ink. No attention paid to penciled matter.
3. Sketches, diagrams, etc., must be on separate sheets. This Department does not answer questions by mail free of charge.
4. Our Editors will be glad to answer any letter, at the rate of 25c. for each question. If, however, questions entail considerable research work, intricate calculations, patent research, etc., a special charge will be made. Before we answer such questions, correspondents will be informed as to the price charge.

**A LOW-LOSS SPACE-WOUND COIL**

(Q. 2210) Mr. J. MacDonald, Little Falls, N. Y., asks:

Q. 1. Please give me the necessary information for winding coils of the low-loss space-wound type.

A. 1. The following is a description of a coil having very low electrical losses, and sufficient mechanical strength to enable it to be used under the most exacting conditions. This coil eliminates two undesirable features found in other low-loss coils, viz., the danger of short-circuiting turns, as in the "basket-weave" type, and the high distributed capacity, as in the "pickle-bottle" type.

Any size of wire between Nos. 12 and 20 will be satisfactory for winding the coil. However, it is recommended that No. 16 or 18 be used if possible. Obtain a bottle whose diameter is equal to that of the coil to be constructed. From a piece of gum-paper tape cut out three strips, 5/16 inch wide and approximately three times as long as the finished coil is to be. Several rubber bands will come in handy here, to hold the tape strips on the bottle while the wire is being wound on. The turns should be spaced by a string which is wound on along with the wire. Ordinary wrapping twine will be satisfactory for the smaller wire, but something bigger should be used for the larger sizes. When the correct number of turns have been wound on, fasten the end of the wire by another rubber band and remove the string. Apply a thick coat of collodion on the wire over the tap

- 1 variable condenser, .001-mf. low-loss type;
  - 1 variable condenser, .0005-mf. low-loss type;
  - 1 variable resistance, 0-25,000 ohms;
  - 2 bakelite tubes, 3 inches in diameter, 4 1/2 inches long;
  - 1/2 pound No. 22 DSC wire.
- L1 consists of 55 turns wound on one of the tubes. L3 is 45 turns wound on the remaining

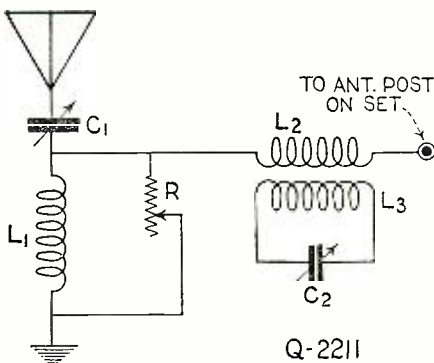

A very efficient wave trap which can be constructed at a very low cost. It will be found of great benefit by those located in the vicinity of a broadcast transmitter.

DCC wire. L2, the other, has 150 turns wound on a 2-inch tube with No. 28 DCC wire. The wavelength of the transmitter may be varied by changing the position of the switch lever on the various loop taps. When maximum deflection is obtained in the "radiation ammeter," the transmitter is operating at its maximum efficiency for that particular wavelength.

A regular transmitting license is necessary for this outfit, as for any other radio transmitter.

**BALLAST TUBES IN ELIMINATOR**

(Q. 2213) Mr. J. Caruso, Spring Valley, N. Y., asks:

Q. 1. I have constructed a "B" socket-unit using standard parts, but I am not obtaining satisfactory results. I have tested the voltage with a "B" unit voltmeter and find that it reads only 90 volts on the 180-volt tap with the tubes in the set. When the tubes are removed it reads 180 volts. Is there any method of regulating the output of the eliminator in order to maintain a constant output voltage?

A. 1. A large number of fans are disappointed with the operation of some "B" socket-supply devices with their receivers. They cannot determine why; but they know that the results with them do not equal the results obtained when "B" batteries were the source of plate potential. The following may therefore be of interest:

The selection of the resistances, that is, the ohmic values of the resistances in the supply unit, is governed by the voltage desired and the

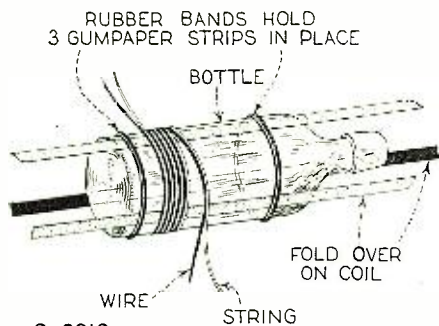

Q-2210

The novel method employed in winding the low-loss coil is shown above.

strip. Allow this to dry and put on a second thin coat. Moisten the tape not covered by the wire and collodion and press down while it is still sticky. When this dries, break the bottle and remove the completed coil.

**ELIMINATING STATION INTERFERENCE**

(Q. 2211) Mr. D. Walker, Norwood, N. J., asks:

Q. 1. I am bothered by constant interference from one particular local station which transmits with 1,500 watts of power. The transmitting station is in the immediate vicinity. Is there any selector or wave-trap circuit that you can give me, which will eliminate this interference? I am positive that the trouble is not in the receiving set, as neighboring friends with radio sets are experiencing the same difficulty.

A. 1. A filter, or wave trap, which will eliminate the trouble you mention is shown in Fig. Q. 2211. Its construction is fairly simple, there being only two parts, although the adjustment of this filter is somewhat complicated. However, once adjusted, it needs no further handling or dial twisting.

The parts necessary for this wave filter are as follows:

tube. L2 is wound on top of L3, but is separated from it by a sheet of empire cloth, or waxed paper, and has ten turns. C1 is the .001-mf. variable condenser. The theory of this wave trap is as follows:  
The incoming signal flows through coils L1 and L2. The circuit comprising L1 and C1 is tuned to the frequency of the interfering station, and the condenser is then set at that position. The circuit including C2 and L3 is what is commonly termed an absorption circuit. The condenser of this circuit is rotated until the signal of the interfering station is heard at a minimum strength. The circuit, when in resonance with the interfering station, will absorb almost all of the energy received from that station. The energy is received from coil L2, which is closely coupled to L3, and is also closely coupled to L1. In this way, signals of other stations will be allowed to pass through, but that of the interfering station is dissipated in the absorption circuit. The resistance across L1 and C1 serves as a static-leak, and is variable to obtain the best adjustment possible.

**LOOP-ANTENNA TRANSMITTER**

(Q. 2212) Mr. K. Washburne, Newark, N. J., asks:

Q. 1. I intend going camping this summer and would like to construct a portable transmitter using a loop antenna. Will you please give me the necessary data, and diagram?

A. 1. For those who intend going to camp this summer, or contemplate week-end trips, this particular transmitter should be adaptable; since it has the necessary characteristics, such as portability, efficiency, ability to operate on a loop, etc. The advantage of the loop antenna in transmitting is that directional signals may be sent by simply pointing the loop in the desired direction.

An ordinary 5-watt tube should be used in this circuit. Plate voltage may be supplied by either "B" batteries, or a generator which may be coupled to the engine of the automobile, or a motor-generator whose motor runs on a single storage battery. Loop should consist of 3 turns of No. 10 wire wound on a wooden frame, about 3 feet square. Both variable condensers shown in the circuit should be of the transmitting type and able to withstand a fairly high voltage.

The radio-frequency choke coil L1 consists of 200 turns, wound on a 2-inch tube with No. 28

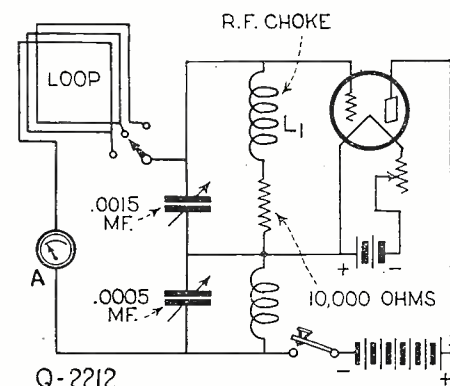

Q-2212

A loop is used in this Portable Transmitter to give a directional effect to the signals.

flow of current through the resistance. Consequently, the lower the load upon any one tap, the higher the voltage at that tap. Conversely, the higher the load at one tap, the lower the available voltage at that tap. This condition obtains if the unit is without a voltage-balancing device, such as some of the ballast tubes available on the market at present. With these devices in use the voltages at the various taps (90 or higher) will remain constant regardless of the load applied, within certain current limits. Hence, with a socket-power device supplying 180 volts maximum and with a 90-volt tap, the use of three of the 90-volt ballast tubes (arranged as shown in Fig. Q. 2212) will give voltage control at the 90-volt tap and at the 180-volt tap.

To obtain the 180-volt control the two 90-volt ballast tubes are connected in series; and to obtain the 90-volt control the ballast tube is connected between the 90-volt tap and the "B-." In view of the characteristics of the tubes, it is necessary that the 180- and the 90-volt taps be so designed that the voltage at these taps, without these ballast tubes, is higher than 180 and 90 respectively.

If the fan is having trouble with excessive

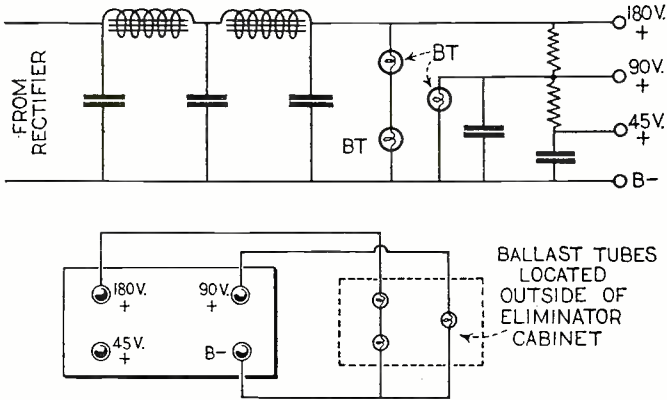

Q-2213

voltages at these taps, such ballast tubes can be added to the socket unit, locating the tubes outside of the cabinet or case. The connections of the ballast tubes would then be across the respective binding posts or voltage terminals.

**BATTERY CHARGER**

(Q. 2214) Mr. J. Reed, Springfield, Mass., asks:

Q. 1. Please give complete constructional details and how to make a Tungar type of battery charger.

A. 1. Fig. Q. 2214 is a schematic diagram which shows the electric apparatus and connections necessary to assemble a two-ampere battery charger, which will operate on the usual 110-volt A.C., 25 to 60 cycles. The diagram shows a transformer with three windings, which we will designate as P, S1 and S2. P is the primary winding and is connected to the 110-volt A.C. light socket. S1 is the filament secondary and supplies the power for heating the Tungar bulb filament. This winding is provided with a center tap B which is used as the positive lead for the charger. Winding S2 is the charging winding and supplies the necessary potential to operate the rectifier tube proper. Leads are taken out from points B and C and run, respectively, to the positive and negative terminals of the storage battery.

To construct the transformer a core is necessary. The simplest way to obtain it is to go to your local electric-light company and ask for a junked pole transformer of about 1-kva. capacity. These transformers can usually be obtained for a small sum. Both primary and secondary windings of the transformer should be removed.

Now for the winding of the coils. A simple way to calculate the correct number of primary turns is to divide the cross-sectional area of the core in inches into 588. For instance, if the core should measure 2x2 inches, the required number of primary turns is 147, of No. 20 DCC wire, wound on one segment of the core.

The charging winding S2 should have one-quarter as many turns as the primary or in this particular case, 37 turns of No. 15 DCC wire, wound on a different segment of the core. The turns of the filament winding S1 are one-fiftieth the number of the primary turns; in this particular instance 3 turns of No. 12 DCC wire. A tap is taken off from the second turn and is used as the midpoint of this winding. Of course, all these different numbers of turns depend on the size of the core, as stated above.

After assembling and wiring the charger as per circuit diagram, an inspection should be made to determine the initial performance. If possible, the charging rate should be measured, if only by connecting a Ford-dash ammeter or similar device in one of the charging leads. When

a 6-volt storage battery is being charged, the rate should be 2 amperes; on a 12-volt battery the rate will be 1 ampere. If the charger delivers less current than the above amounts, and still gives some appreciable current, turns should be added to the winding S2 until the proper rate is obtained.

In case the charger fails entirely to operate, first look for loose wires or broken connections.

The use and location of ballast tubes, to regulate the output of an eliminator, is indicated here.

Then try reversing the battery leads or clips and observe if charging ensues. Occasionally it will require the addition of several turns of wire to the winding S2 in order to obtain satisfactory starting of the Tungar arc; but this should be necessary only when the transformer has been assembled or wound carelessly.

When the charger has been adjusted so that it does operate at the proper rate, it should be left charging for at least two hours under continued inspection before it is pronounced satisfactory.

In normal operation the transformer should get fairly hot after having run several hours. The temperature will be such that it is just a little too hot to touch. If, however, it should heat excessively, look for short-circuited turns, low-quality steel, or careless assembly of the core.

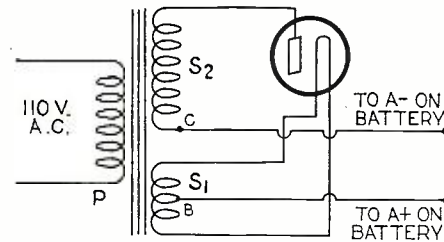

Q-2214

Wiring diagram of a Tungar type battery charger, showing charging (S2) and filament (S1) windings of transformer.

Any of these three points will in itself be sufficient to warrant rebuilding the transformer.

**THE MULTIFLEX RECEIVER**

(Q. 2215) Mr. L. Davis, San Francisco, Calif., asks:

Q. 1. Please publish circuit diagram, and constructional data on the five-tube Multiplex receiver.

A. 1. As it is a five-tube radio-frequency circuit, operating from a loop, the tuning of the Multiplex is very sharp. The inherent selectivity of the receiver is aided materially, first, by the directional effect of the loop, and, secondly, by the variable primary coupling of the double-rotor coupler. Whereas, in a great many sets, one has only the variable condensers to rely on for

separation, in the Multiflex he can loose- or close-couple the primary coil and bring in or eliminate a signal almost entirely by changing the direction of the loop. With these three elements varying the selectivity of the receiver, we certainly should achieve a degree of sharp tuning adaptable to practically all conditions of location.

Suppose one wishes to employ the receiver as a five-tube antenna-operated outfit. In a great many locations the directional effect of the loop will not be required and we shall undoubtedly gain signal strength by using the outside aerial. Here an antenna coupler or adapter comes in handy, converting the five-tube loop set to a five-tube aerial-operated receiver. Certain loops now on the market are equipped with such an adapter, making it unnecessary to disconnect the loop when the antenna is employed.

However, the flexibility of the Multiplex does not stop here. When the plug from the loop is disconnected from the input jack, the first tube in the circuit is automatically extinguished. The set then becomes a single-tuning-control four-tube outfit for antenna operation. Using but one tuning condenser, the selectivity of the four-tube set in the average location is still splendid. The variable-primary-coupling feature is still available, as in the five-tube circuit. It has been found that, in city locations removed a mile or two from the nearest powerful broadcaster, the four-tube combination does very well in separating all the local stations.

This volume and quality are secured with a simple combination of four 201-A tubes and a 112 in the output stage. The maximum "B" voltage necessary is 135 volts.

A glance at the schematic circuit diagram indicates the comparative simplicity of the receiver. Few five-tube circuits today are much easier to handle. A simple tuned-loop circuit, fixed R.F. amplification, a regenerative detector and two stages of well-designed A.F. amplification, well by-passed; that is all there is to it. The cost of the necessary parts is moderate, and the job of assembly and wiring is far from a complicated or involved one.

An automatic filament-control jack takes care of the optional-tuned loop stage, lighting the first tube when the loop is plugged in and extinguishing it when the loop is disconnected. When the loop is not used the antenna connection is made to the binding post marked "Input," which in turn connects to the grid of the R.F. tube. The ground connection is made to the "A-C+" post. With the four-tube circuit only the secondary of the fixed R.F.-transformer is employed, the primary being thrown into the circuit when the loop is plugged into the circuit through the jack on the left of the panel.

The filament control of the tubes is automatic. The receiver can be readily adapted to the use of 199-type tubes by simply changing the amperites in the filament legs of the circuit.

The following is the list of parts necessary for the construction of this receiver:

- 2 A.F. transformers;
- 2 variable condensers, .0005-mf.;
- 1 double-rotor coupler (an ordinary three-circuit tuner will do);
- 1 untuned R.F.-transformer;
- 4 amperites, type 1-A;
- 1 amperite, type 112;
- 5 sockets;
- 1 single-circuit jack;
- 1 single-circuit filament-control jack;
- 1 variable resistance, 500,000-ohm;
- 2 by-pass condensers, 1-mf.;
- 1 fixed condenser, .005-mf.;
- 1 grid leak, 2-megohm;
- 1 filament switch;
- 1 grid condenser, .00025-mf., with leak mounting;
- 2 vernier dials;
- 8 binding posts, marked "Input"; "A-C+"; "A+B-"; "45V+"; "C-4½"; "90V+"; "C-9"; "135V+";
- 1 panel, 7x21;
- 1 wooden baseboard, 7x20x7 inches;
- 1 binding-post strip.

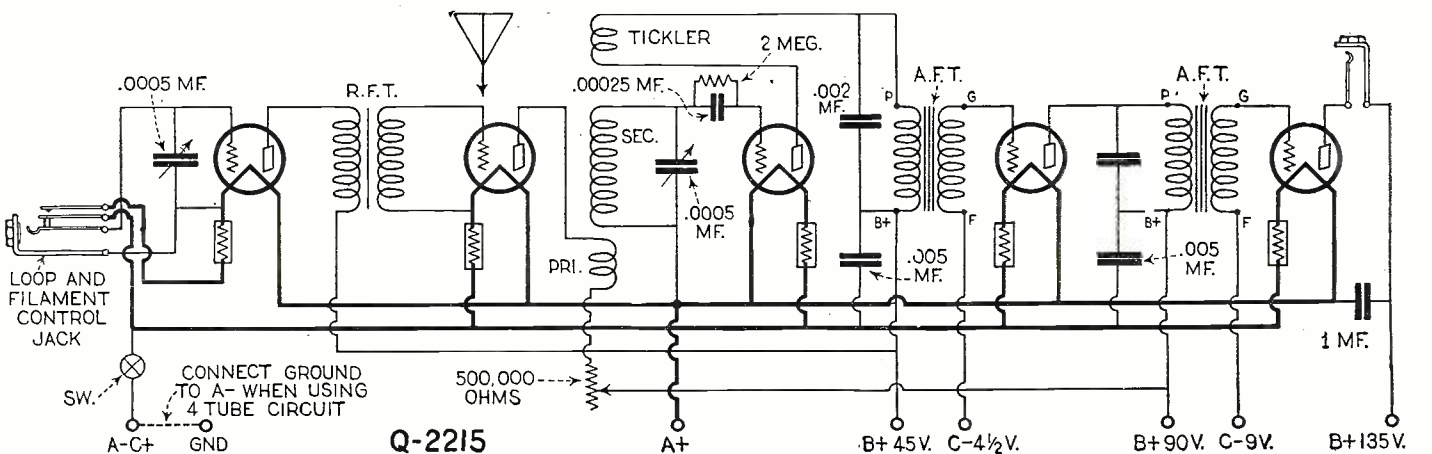

Q-2215

Circuit diagram of the Multiflex 5-tube receiver, which was originally described by Wendall Buck, in the New York Sun. It operates from either a loop or outside aerial with excellent results. The regenerative detector facilitates the reception of extreme DX.



**A REAL  
ABUSE TEST**

So many people run their batteries up too high that, having made good Radiotrons for careful users, RCA set about to make Radiotrons that would stand abuse.

A year ago, an RCA Radiotron could stand about twenty hours of running under too heavy a current. Now it will outlive a hundred hours of such abuse.

Many very minute changes brought about through laboratory study have effected this improvement.

If you have children who are apt to turn up the rheostats carelessly, of course it is hard on the tubes. No tubes can be proof against ruin, but if you are using RCA Radiotrons, you know at least that they'll stand more than ordinary tubes.

Look for that RCA mark! You'll find it on Radiotrons for every purpose.



RADIO CORPORATION  
OF AMERICA  
New York Chicago  
San Francisco



**The stations are there  
get them !**

You're not getting the most out of that storage battery set of yours. The set has a bigger distance reach . . . all it needs is a different tube in the detector socket. Put in the RCA super-detector—Radiotron UX-200-A. You'll get more stations—get the far-away ones more regularly and more easily! It's a small change, but it brings big results.

• • • • •

Bring your storage battery set up-to-date with  
a power RADIOTRON UX-171 or UX-112  
a detector RADIOTRON UX-200-A  
and RADIOTRONS UX-201-A for all-round quality.  
Bring your dry battery set up-to-date with  
a power RADIOTRON UX-120  
and RADIOTRONS UX-199 for all-round quality.

**RCA Radiotron**

MADE BY THE MAKERS OF THE RADIOLA

# Power Tubes

Require a "B" Power Supply Specially Designed to Handle Them

**HERE IT IS!**

# Kellogg



"B"  
Power Unit

**Guaranteed**  
to Deliver 180 Volts with 40 Milliamperes Draw and 110 Volt A.C. Supply

**H**ERE, at last, is the "B" supply unit that fills the crying need created by the 171 Power Tube. It will deliver the necessary 180 volts at a current draw equal to the most extreme conditions.

Don't trust your reputation to the rated volt capacities of Eliminators! Check them with a high resistance volt meter with the supply unit in actual operation on the set with which it is to be used.

## IMPORTANT!

Be sure you are selling a unit that will enable the set you sell to perform at its best when equipped with 171 Power Tubes. The Kellogg "B" Power Unit will stand up to this test on any factory built set now on the market, not drawing over 40 milliamperes, will furnish more than 40 milliamperes at corresponding voltages. The vital importance of adequate "B" voltage is apparent to every dealer concerned with giving satisfaction to his trade—and in reducing service expense to the minimum.

The Kellogg "B" Power Unit produces a remarkably FLAT curve. The voltage holds constant within narrow limits during the varying conditions of set operation. Beautifully pure, undistorted tone is the result. Here is something essential to the well being of Your Radio Business.

**Dealers!  
Jobbers!**

Write at once for details of the distribution plan for Kellogg "B" Power Units.

This coupon will bring you full details—Mail it at once.

**Kellogg  
Switchboard &  
Supply Co.**  
Dept. 1-E Chicago, Ill.

Kellogg Switchboard & Supply Co., Dept. 1-E Chicago, Illinois

Please send me full details concerning your "B" Power Unit, designed especially for supplying adequate voltage for high current consuming sets equipped with 171 Power Tubes.

Name \_\_\_\_\_

Address \_\_\_\_\_

## Some Suggested Aerial Installations

(Continued from page 1358)

junction with the bolts, so that the heads will not work into the lumber and thus loosen the joint. An ordinary pole will require an overlap of at least four feet, and for best results three bolts should be used. The two poles may be laid side by side and the holes for the bolts may be drilled through both at the same time assuring one that the bolts will fit properly.

Sometimes small poles may be secured to the side of the roof, and this may be done with bolts also. However, if the mast is well-guyed, it is usually not so important to fasten its foot very securely. All lumber used for the poles should be free of knots.

Radio poles are conspicuous and should be made to look well before they are erected. A couple of coats of good paint, grey for instance, certainly improve the appearance of a mast and will cause it to withstand the elements longer. Enameled wire for the antenna will prevent corrosion.

### A NEIGHBORHOOD ANTENNA MAST

Occasionally one can erect an antenna mast in some convenient, centrally-located spot, and all the neighbors can be coaxed to help with the expenses. Several aerials may be attached to the pole, the insulators being about 5 feet out from it, and these aerials also support the pole. It is not advisable to have too many antennae attached to the same pole. Set the insulators a good distance from the pole and space the wires 45° apart or more. This will allow as many as eight wires, though fewer would be somewhat better. See Fig. 3.

### SELECTION OF MATERIAL

There are many kinds of antenna wire, but no one has proved that one is any better than another under average operating conditions. About the best is ordinary hard-drawn No. 12 enameled wire.

Screw-eyes should have the strength required of them and preferably be galvanized. There is some advantage in insulating the guy wires properly; however, do not make the mistake of using an excessive number of insulators; one for every 15 or 20 feet of wire is sufficient. Strain insulators of the usual type will do.

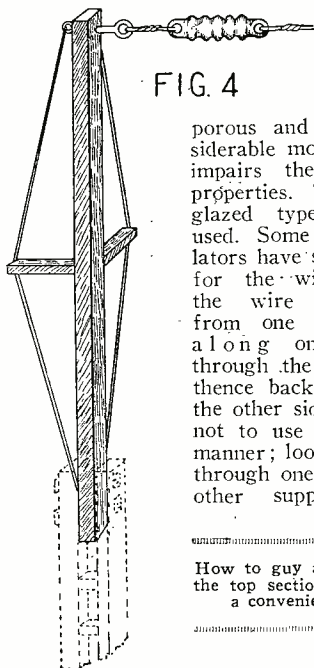

FIG. 4

Ordinary porcelain insulators are quite porous and absorb considerable moisture, which impairs their insulating properties. Those of the glazed type should be used. Some strain insulators have small grooves for the wire, allowing the wire to start from one end, proceed along one side and through the opening and thence back again along the other side. It is best not to use them in this manner; loop the antenna through one hole and the other supporting wire

How to guy a short mast or the top section of a mast in a convenient manner.

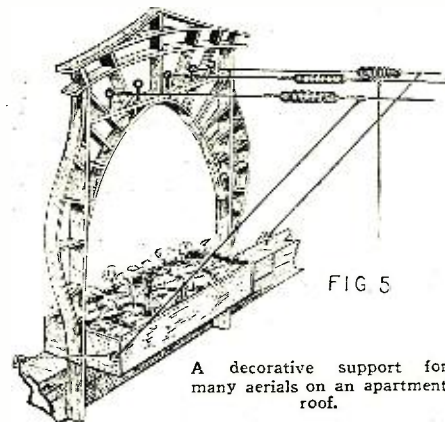

FIG. 5

A decorative support for many aerials on an apartment roof.

through the other. The longer and thinner the insulation the better.

Some glass insulators, particularly those of pyrex, do not allow moisture to spread as a thin film over the insulation; the water draws into small drops and thus causes less leakage than would a film. Sometimes one can procure small glass towel bars, which are often 14 inches in length or longer and have sufficient strength for ordinary conditions. These are cheap and have knobs at their ends to which the wires can be fastened. Wrap the wire around the ends of the bar about three times, then loop it around the end of the knob and splice it to the insulator lead.

Where it is necessary to use more than one wire for an aerial, in congested localities, do not insulate each wire separately, as this has the effect of placing the insulators in parallel and consequently lowering their efficiency. Insulate the wires coming from the spreaders and use the insulators at the point where they converge.

The lead-in should be insulated as thoroughly as the rest of the antenna; for an antenna, like a chain, is no better than its weakest link. Run the lead-in either from the center of the aerial or from one of its ends. The lead-in should go as directly to the set as possible; not wind around all the corners one can find. Instead of boring holes in the window-sill for the lead-in, purchase a flexible lead-in. This may be bent around and under the window and still allow the window to be closed tight.

### GUY WIRES

Small poles should be so constructed that an excessive number of guys is unnecessary. It is not so essential to insulate them if the aerial itself is well insulated; a few insulated guys will help, however, and will make the pole look better. Guy wire, as well as the other metallic parts used, should be galvanized. No. 14 iron wire will serve for the ordinary installation. Heavier wire is difficult to handle and often develops bad kinks, which are not readily removed. When the guys are tightened small kinks will be evident; but these straighten out in time, allowing the wire to sag somewhat. The slack should be taken up when this occurs.

If a rope is used for hoisting the antenna into place, use one that will not shrink greatly when it becomes wet. Some rope shrinks a great deal and this may be enough to bend the top section of a long pole. Ordinary clothes-line rope is suitable for the purpose.

It is often convenient to use guy-wires for either a short mast or the top section of a larger one. Small projecting pieces may be nailed securely in place, about half-way down on the pole, and wires attached at the top of the mast. These are stretched tightly over the ends of the pieces and are fastened at the bottom of the section. See Fig. 4. Heavy staples or screw-eyes will serve to hold these wires. There is usually more difficulty in arranging these wires than in

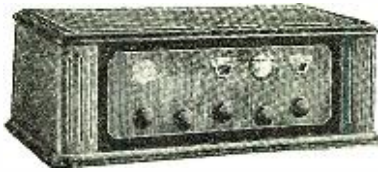

**Model AC-9**

7-Tube, 2-Dial, Batteryless

This two-dial control set is designed especially for AC power, for use with the Amrad A, B, & C Power Unit. Easily operated, marvellous selectivity. Furnished with Power Unit but without tubes.

**\$142**

Console Model \$192

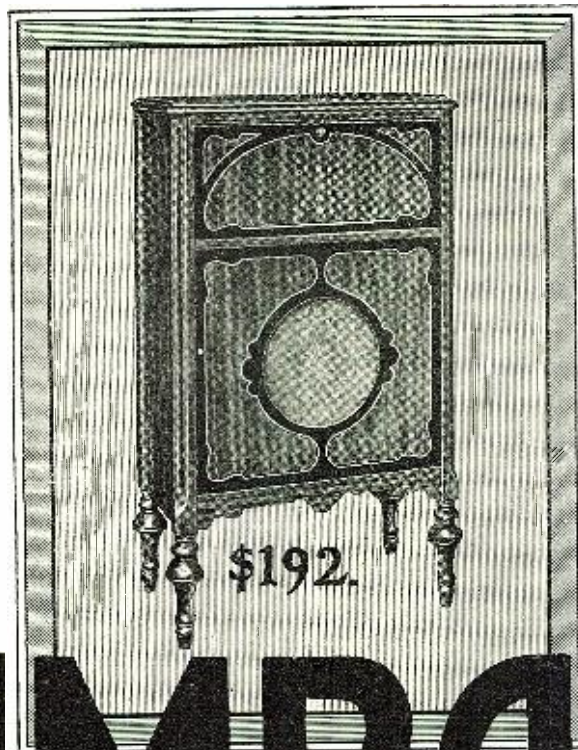

**\$192.**



**Model S-733**

7-Tube, 2-Dial, Battery Type

Owners of this Amrad Neutrodyne report complete satisfaction. High ratio vernier controls simplify tuning. Volume is controlled by a single adjustment. Beautifully designed cabinet finished in two-toned mahogany. Without accessories.

**\$77**

Console Model \$127

# AMRAD

## 7 tube Neutrodynes of Quality and Precision

**A** MRAD Neutrodynes are built with the greatest skill and precision. Each set must pass certain high standard tests before it leaves the factory.

The great skill and engineering feats of the Amrad Laboratories are manifest in the circuit as well as in the beautifully designed cabinets.

Produced under mass production methods influenced by Powel Crosley, Jr., combined with Amrad's engineering skill, these genuine neutrodynes are the greatest values on the market.

The console model AC-9-C is an unusual value. It is a 7-tube set with two-dial control. All the necessary power is furnished by the Amrad A B & C Power Unit, an efficient power supply tested under actual home conditions

for more than a year and operating from AC current, 100-120 volts, 60 cycle. No trickle charger is concealed in this unit. No more power supply troubles. Just snap the switch and set is in full operation. The

cabinet is of beautiful two-toned mahogany finished, with the genuine Crosley musicone built in. This is a wonderful value at \$192, with the power unit, but without the tubes.



**"B" ELIMINATOR**

Will furnish B current voltages 22½, 30 or 45, 69, 90, 135 or 180. Maximum volts, 180 at 50 mls. Unit is housed in a metal cabinet and finished in black enamel.

**\$35**

Write Dept. 1E7 for descriptive literature and information.

**AMRAD CORPORATION**

Medford Hillside, Mass.

## Efficient 5tube genuine Neutrodynes, unsurpassed in the radio market anywhere at this price /

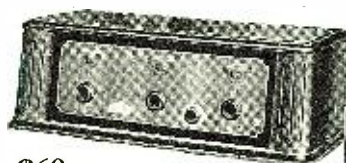

**\$60**

**Model S-522**

5-Tube, 3-Dial, Battery Type

Amrad quality is again exemplified in this beautifully made and proportioned set. The simple, yet elegant lines of this set are pleasing to the eye. Actual reports of performance are remarkable. Simple to tune and easy to operate. Also made in console model at \$110.



**\$125**

**Model AC-5**

5-Tube, 3-Dial, Batteryless

A compact, efficient set delivering the utmost in radio enjoyment at the lowest possible cost. No batteries to fuss with. Operates direct from light current. Unusual selectivity, volume, and tone make this the greatest neutrodyne value on the market. Console Model \$175.



## The Aristocrat of Speakers

FOR beauty of design, for richness of tone, for accurate reproduction—the aristocrat of them all is the *new*, improved Rola Cone Speaker.

The new Rola will give you clear, brilliant reproduction under all conditions — on all sets, irrespective of make, type of tubes, or circuit used.

The superb tone and wonderful articulation of the new Rola Cone are due to the *patented laminated armature* and an exclusive cone material of remarkable acoustic properties.

Your dealer will gladly send a Rola to your home so you may demonstrate to your own satisfaction the superlative results to be enjoyed with this greatest improvement in radio.

Pedestal type \$32.50; table type \$28.50. Both beautifully finished in rubbed walnut.

*Your radio deserves a Rola.*

# Rola CONE SPEAKERS

Manufactured by  
THE ROLA COMPANY  
Oakland, California

properly installing a few ordinary guys, however.

### APARTMENT HOUSE INSTALLATIONS

In some apartment houses, residents must content themselves with indoor antennae or go without their radio. Often one can convince the landlord that a neat antenna installation will actually improve the appearance of the building; all modern built-in installations certainly do. In one house the residents got together one Sunday, designed an antenna system that would be of benefit to all, presented their plans to the owner and received permission for its installation; each did some of the carpentry and helped to defray costs.

With a little care a very neat system of aeri-als may be arranged. An arrangement that may be used with little modification in any large apartment building is shown in

## Below 50 Meters with Reinartz

(Continued from page 1329)

no sharp peak could be found in the plate milliammeter.

### ELIMINATING HARMONICS

"This circuit that I use," he went on, "has everything beat that I have used. You see there is less chance for any other frequencies to be set up in the tube, than as there would be if the inductances were shunted by the condensers. There is just one oscillating circuit. Also the two condensers, C2, do not have to be variable; I have that type in there for experimental purposes only. Their size depends on the number of turns that you have in the plate and grid coils."

"Now let me show you that this system completely eliminates harmonics and that there is no crystal control necessary. I am going to change the antenna and counterpoise back to their correct positions and then we will go into the house and see if we can pick up any interference on the broadcast receiver. Remember that this is a 500-watt transmitter."

The necessary adjustments being made on the set, we returned to the house. Although Mr. Reinartz varied the tuning of the receiver from 200 to 550 meters, we could hear nothing at all that resembled the expected hum. And we were only thirty feet from the garage and he used the house wiring for an antenna!

### SHORT WAVES IN THE ARCTIC

While we were in the living room, Mr. Reinartz showed us some of the souvenirs he had brought with him from Greenland, and also some of the marvelous photographs he took up there. We asked what wavelength he found to be the best for distance; as we had heard that he had been in constant touch with the United States amateurs and had worked in conjunction with the Naval Research Laboratory in Washington, D. C.

"That's rather a long story, but, to put it briefly, we found that, if we wanted to work somebody between one thousand and five thousand miles distant, we should use a wavelength between fifteen and thirty meters. If we wanted to get in touch with a fellow between one hundred and one thousand miles away, we worked between sixty and seventy meters. On the lower band we worked several fellows in Australia and we were constantly in touch with hams in this country.

"Several times, while we were in Greenland and in direct contact with Washing-

ton, which was roughly about 3,500 miles distant, we started sending at thirty meters and gradually lowered the wavelength. They could hear our signals better after we had gone below twenty-two meters and best at sixteen meters, at 12 noon E. S. T. You see there are many things that must be taken into consideration—skip-distances, time of the day, season of the year, the kind of weather at the transmitting and receiving ends—all these things have some direct influence on the matter."

### THE SHORT-WAVE RECEIVER

After returning to the upstairs room we examined more closely the receiving equipment. It was extremely simple, to say the least. A panel, not more than eighteen inches long, supported the two variable condensers and the bunch-wound inductances. On the wooden baseboard were the two 199-type vacuum tubes and the audio transformer for the single stage of amplification. The antenna for the receiving set, which stretched across the ceiling, was about ten feet in length.

While admiring the great assortment of vacuum tubes—both transmitting and receiving—we happened to notice a microscope on the table. We asked Mr. Reinartz if the study of bacteriology was another hobby of his.

"Not exactly," he replied, "but you might be interested in knowing that with this instrument I found out some very useful things about radio reception, which were later on checked and found correct by the experts in Washington.

### EXPERIMENTS IN REFLECTION

"I had observed the fact that reception, at certain places where I happened to be, was very poor from one direction and normal in the others. In most cases, if there was some obstruction towards the south, for instance, the waves from there would not come in so well. Then the same thing occurred when I was at sea and, as there are no mountains or similar obstructions out there, the thought came that there must be some critical angle at which the radio waves are reflected from the upper atmosphere which contains considerable water vapor. This angle was found to be eighteen degrees. This angle was measured by reflecting light on water and measuring the angle at which it was thrown back; the angle of incidence being the same as the angle of reflection.

"While we were in Greenland this theory was checked very closely. While receiving a station, when we were out in the middle of a great bay, we would gradually work the boat nearer the shore, which consisted of mountains several thousand feet in height. As long as the angle from the mountain tops to our ship was less than eighteen degrees we could hear the station perfectly; but, just as soon as this critical

# THEY ALL PRAISE THE **BRETWOOD** Variable Grid Leak

The Bretwood Grid Leak came with today's mail. It is now exactly 9:00 P.M. and the leak was installed about a half hour ago. This note is not only an expression of appreciation but also an attestation of the truth of your advertising. During the past half hour I have tuned in stations "ALL OVER THE DIALS" at leisure, and can adjust reception with the leak almost equal to a variable condenser.

I feel constrained to add that while waiting for reply and then receipt of leak from you, there has been on the set a fixed leak and condenser of well known and thoroughly reliable make, and fairly good reception has been enjoyed, but during this half-hour-only test thus far the results are inexpressibly beyond expectation.

Have been a radio fan only about four years, but feel I have sufficient knowledge and experience to recognize a good thing upon fair trial. Your promptness and desire to satisfy your trade, in this case has won for you another "BRETWOOD BOOSTER." Thank you.  
The Rev. WALTER G. BARLOW,  
Bishopville, Md.

Very many thanks for your kind letter of the 21st ult. and for the grid leak, which works perfectly. I have tried four different makes of grid leaks. The Bretwood "has 'em beat."

M. SAWYER,  
Box 238, Los Gatos, Calif.

Received your grid leak and wish to say that none can compare with it when it comes to clearing up reception.

JOHN A. BLACKBURN,  
5328 Warren Ave., Norwood, Ohio.

Enclosed find P. O. money-order for \$3.00. Please send me two of your Variable Grid Leaks. I am using one and it works fine. Please mail them as soon as possible.

W. H. PERRY,  
119 Congress St., Buffalo, N. Y.

Received your grid leak and many thanks. It is the best \$1.50 that I have spent for radio equipment.

ED. JENKINS,  
703 E. Main St., Louisville, Ky.

Enclosed herewith find check for \$1.50 for one Bretwood Grid Leak. I am using your leak and find it far superior to any others. This is my third Bretwood.

J. C. WHITE,  
422 W. Wooster St., Bowling Green, Ohio.

Will you please send me by return mail two Bretwood Variable Grid Leaks. I enclose herewith check for \$3.25, the 25c. being for a special handling stamp, as these leaks are needed at once.

The leaks are the only satisfactory instrument on the market. I find them absolutely essential in the construction and operation of sensitive experimental receivers.

ED. J. WHITTIER,  
The American Appraisal Co.,  
Milwaukee, Wis.

I want to thank you for your leak. It makes the set 100% better. I was going to have a Diamond of the Air built, but since I have added your leak to my set I am now down in the dining room of the first floor and the set is on the second floor. I can hear the set just as plainly as if I were up there. I can hear every player in any band or music which is on air. The first night I gave the leak a very good test, and I got four stations in Chicago, one in Detroit, one in Canada, one in Atlanta, Ga., and several others without any noise. All were good and clear. It is going to make me spend more money, as I will have to get a good loud speaker. The horn I have now is a Manhattan, Jr., and is good and clear, but as soon as your leak is installed the howling present when using three tubes is immediately stopped.

LEON E. COLE,  
5816 Tilbert St., Philadelphia, Pa.

Grid Leak received and tested out, and find it is the only variable leak I ever used that is really variable. Enclosed find \$1.50, for which please send me another one.

F. E. STAYTON,  
Box 240, Ardmore, Okla.

Thank you for introducing me to the Bretwood Variable Grid Leak! I have installed one in my Three-Circuit Tuner, according to your instructions, and find that it does all you said it would—and more. I am now recommending the Bretwood to all my friends, and those who have used this wonder grid leak have nothing but high praise for it. The fact that it can be adapted for any hookup makes it invaluable to the experimenter.

Although I have only used the Bretwood leak for three weeks I have pulled in several of the weaker stations which were inaudible before, and the microphonic noises which were decidedly pronounced before have entirely disappeared. Please accept my best wishes for your continued success and also for the Bretwood Grid Leak.

S. R. HUBBS,  
180 Quincy St., Brooklyn, N. Y.

Let me say that the Bretwood Grid Leak improves the set 100%.

J. E. McGINNISS,  
27 Lenox Rd., Brooklyn, N. Y.

I wish to take this occasion to thank you for your courtesy in furnishing me with your very excellent Grid Leaks. I have installed one with your Condenser on my own personal radio set, and am delighted with the results.

R. W. DeMOTT,  
Experimenter Pub. Co.,  
230 Fifth Ave., N. Y. C.

I have received the Grid Leak you sent me and it is perfect. It is surely wonderful the way it works. Please send me another by return mail for a friend.

J. F. COOPER,  
1029 Cortlandt St.,  
Cincinnati, Ohio.

**WITH** so much interference these days, why not improve your detector tube action and gain selectivity? Simply install a Bretwood Variable Grid Leak. Price \$1.50.

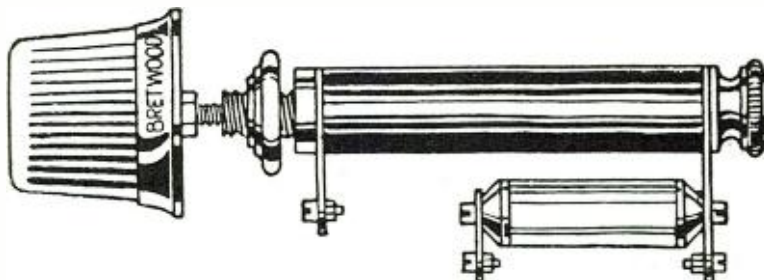

The Bretwood Variable Grid Leak, with grid condenser attached. Precision Range, 0 to 10 Megohms

**Brings in More Distant Stations — Affords Greater Volume — Improves Tone Quality Fits Any Set, Panel or Baseboard.**

**Price \$1.50**

**"IT DOES THE TRICK"**

**The North American Bretwood Co.**

Telephone, BRYant 0559

**141 West 45th Street, New York City**

*Sole Distributors for United States*

North American Bretwood Co., 141 West 45th St., N. Y. City

Gentlemen: Enclosed find \$1.50. Send me at once one Bretwood Variable Grid Leak on 5-day money-back guarantee. (Or \$2.00 for leak with grid condenser attached.)

NAME .....

ADDRESS .....

CITY ..... STATE.....

Inquiries Solicited from the Trade

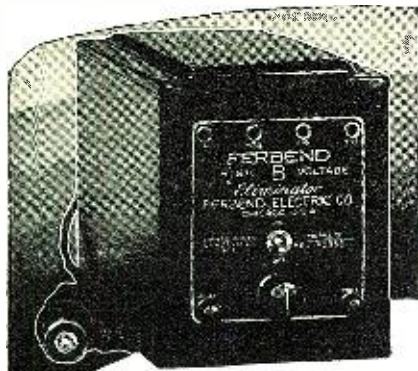

**Lowest Priced  
QUALITY  
"B" Eliminator**

Outstanding quality confirmed by lasting good performance on over 50,000 sets. The following interesting endorsements are but a few out of thousands—but actually your best means of verifying our claim of "singular value" in the good Ferbend "B" Eliminator.

**FROM MELROSE, MASS.**

If radio fans only knew the wonderful kick that can be obtained from your Eliminator, they would not waste any more money on "B" Batteries.—C. S. Merrill.

**RICHMOND, VA.**

Your Eliminator has got it all over any that I ever used and I tried several different makes costing much more.—Wm. H. Bryant.

**DULUTH, MINN.**

I have used your Eliminator for over a year and it is one of the best investments I ever made.—L. W. Peters.

**NILES, OHIO**

The Eliminator I purchased from you a year ago has given results that could not be surpassed regardless of price. I have logged KFI, KGC, KFON, CZE, and 6 KW.—F. J. McGuirk.

Original cost less than half of any equipment of similar quality; lowest maintenance cost.

**\$12.50**

Model III, for all sets using 90 Volts.

Model IV, for extremely large sets and sets using power tubes; delivers up to 180 Volts, 50-60 Cycle, A. C.—\$17.50.

**MONEY BACK GUARANTEE**

**Equal to Any** not only in operation, but in workmanship, quality, durability and appearance. Sooner or later you will change to "B" Socket Power. Why pay more?

Approved and passed by the rigid laboratory tests of Radio News and Popular Radio.

See your Dealer—or Send Direct Shipment made direct on receipt of price, or C. O. D. if preferred. Use for 10 days to convince yourself—if unsatisfactory write us within that time and purchase price will be refunded. Send Coupon TODAY.

**FERBEND ELECTRIC COMPANY**  
425 W. Superior Street Chicago, Illinois

**FERBEND  
"B" ELIMINATOR**

FERBEND ELECTRIC CO.  
425 W. Superior St., Chicago, Ill.

- ( ) Send \$12.50 model.
- ( ) Send \$17.50 model.
- ( ) Send at once. Payment enclosed.
- ( ) Send C. O. D. ( ) Send Literature.

Name.....

Address.....

City.....State.....

angle was passed, the station would fade out."

We assured Mr. Reinartz that all this had been most interesting and said that we thought there were hundreds of radio hams throughout the country that would be glad to know about this transmitter and receiver. He said he would be glad to tell all he could about them in a series of constructional articles.

**ECONOMY IN "HAMMING"**

"However," he continued, "there are several things beginners in the ham field should know. They should know that power and power equipment in a station costs money; but, with the fine tubes we now have and making use of the short waves, wonderful results can be obtained with a very little outlay. 500 volts 'B' battery, at least, is necessary, and therefore the fellow who has to count his nickels should think of a 5-watt tube, using the very same circuit that I am now.

"So often I have fellows inquire why such-and-such a thing is wrong with their transmitter, and I generally ask them if their set is balanced correctly. There's a secret, for under no other conditions do you have proper resonance. Is a vertical, high antenna best? Yes, indeed, that is the one construction that does the trick, and

the correct length and position of the counterpoise is just as important."

We asked Mr. Reinartz if he had done much transmitting on five meters.

"When you get up in frequencies that run that high, there are so many variables that it is impossible to do or have anything like a constant transmitter. There is a great experimental field up there, and some very pretty problems waiting for solution."

We then mentioned the fact that doubtless covering these phases would be of interest to readers of RADIO NEWS and so a series of articles was agreed upon, which is roughly as follows: the construction of a transmitter and receiver for short-wave work; the construction and uses of a wave-meter; other uses for transmitting equipment; experimental work on ultra-short wavelengths with data on the Modulascope.

"I hate to rush you fellows," Mr. Reinartz said a little while later, "but if you're going to catch that 9:12 out of Hartford you will have to skip along."

So after good-byes, and a "See you next month," we "skipped."

**NEW AMATEUR CALLS**

8DTI—ALEXANDER BUCHMAN, 1869 Alva-son Road, East Cleveland, Ohio. 80 meters.

AM-3AB—CHARLES W. RANDALL, Amber Rubber Estate, Johore, Malaya. 45 and 23 meters, 1100 to 1700 GMT. Also look out for AM-2SE.

**Modernizing the Browning-Drake Receiver**

(Continued from page 1347)

- (8.) Remember, when placing the condensers, that the large one is for the antenna circuit and is mounted at the left of the R.F. socket; while the smaller is used for the tuning of the R.F. transformer.

Before fastening the sub-panel to the front panel, the two units should be as completely wired as possible. On the front panel the coils and condensers may be connected together; while on the sub-panel the audio amplifier and all filament wiring may be completed. The two units are then brought together and the work finished. Well-tinned flexible insulated wire should be used. All the filament and "B" leads should be so arranged that they may be gathered together and bound into a single cable when all the connections have been completed.

**USING THE RECEIVER**

With the wiring completed the receiver is ready to be connected to its accessories. Most economical operation will be obtained if the large, heavy-duty "B" batteries are used.

The antenna should not be very long; generally about forty feet, including the lead-in, is enough. A good ground connection to a cold-water pipe, especially if a "B" socket unit is used, is essential.

There is little to be gained in constructing a set capable of well-nigh perfect tone quality, if it is to be used with any speaker other than the best. It is advisable to place the speaker in some other part of the room, preferably in an opposite corner from the set.

**NEUTRALIZING**

With everything hooked up, insert the different tubes, resistors and equalizers in their proper places. Then, before attempting to tune in a local station, gently turn the adjusting screw in the Phastrol as far as it will go in a clockwise direction. Then tune in a local station and slowly turn the adjustment screw on the Phastrol backwards in a counter-clockwise direction until maximum signal strength, without oscillation, is obtained.

The antenna series condenser should next be adjusted until the two tuning dials read approximately the same. The station call letters may then be recorded directly on the dials.

In tuning for local stations the use of the coarse vernier control will generally be found most desirable, as it permits rapid changing from station to station. For distant reception, however, a finer adjustment will as a rule be more desirable. By means of the small levers at the bottom of the dials any ratio from 6:1 to 20:1 is instantly available.

The regeneration control will be found most useful in the reception of distant stations, as its use increases both the sensitivity and selectivity of the receiver. For local reception best quality is obtained when very little regeneration is employed. When reduction of the regeneration to a minimum fails to reduce sufficiently the volume of a local station, then the R.F. amplifier may be gradually cut out by means of the "volume" control rheostat at the left-hand end of the panel.

Because of the use of resistance coupling, it may be necessary to try as much as 135 volts for the detector tube before best results are obtained. It also frequently happens that the use of a higher-resistance grid leak (even as high as six megohms) will prove more satisfactory with some tubes than the 2-meg. unit generally recommended.

**THE POWER TUBE**

There are two types of output tubes available at present for home use; the 112 semi-power and the 171 power tube. The 171 permits of much greater volume, without distortion due to overloading or "blasting," than the 112 type. Where batteries are used as a source of "B" power, however, the 112, with limited undistorted power output, is preferable to the 171 for economic reasons. The 171 draws a plate current of 20 milliamperes at 180 volts. When a "B" power unit is to be used, however, the power consumed need not be considered and of course the 171 is then to be recommended.

# The NEW 1927 RADIO -is here-

No Batteries

No Acids

No Chargers

No Water

No Worry

No Attention

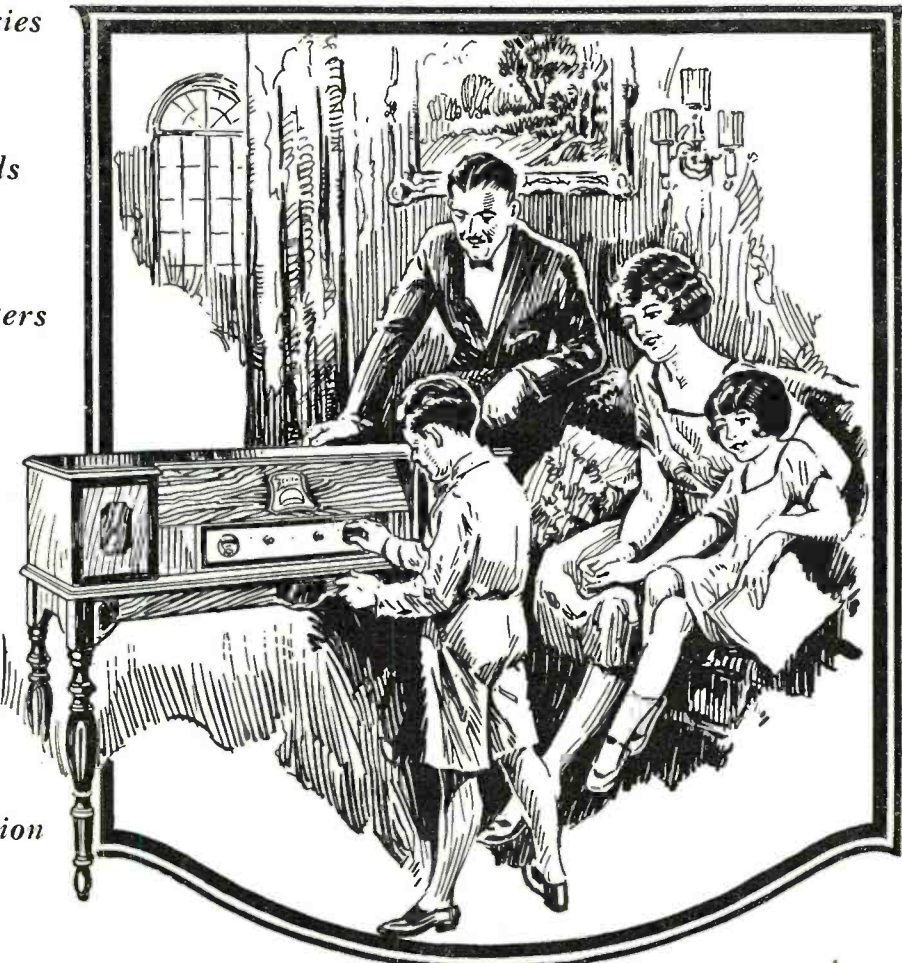

Supreme in  
Tone

Single  
Contol

Doubly  
Shielded

Selective

Powerful

Light Socket  
Operated

# ZENITH

TRADE MARK REG.

## →LONG DISTANCE← RADIO

TRADE MARK REG.

Zenith makes the first and most important announcement in radio for 1927—The New Zenith, Model 17. Not a camouflaged, so called "Light Socket" Radio Set, but a truly custom-built radio, designed to operate *without wet or dry batteries, chargers, acids or water*. Just plug in to the light socket—that is all. No attachments to worry over. Always full power—this new model is adapted for use with 201A and 301A tubes. The tone is incomparable. *Send for descriptive literature*

**ZENITH RADIO CORPORATION, 3620 IRON STREET CHICAGO, ILL.**

## Every fan knows that—

Every B-T product has been an outstanding success—

BESIDE the Counterphase Receivers and Power-Six Kit, B-T offer the following products as the best you can buy.

### B-POWER UNIT

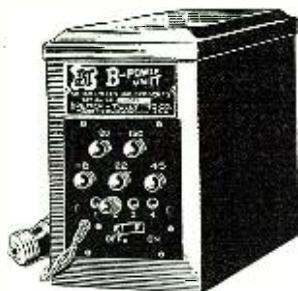

No variable resistances—no knobs to turn with this Unit. There is no guess-work about voltages. It delivers enough voltage to properly operate the power tubes on multi-tube sets. Price complete with Raytheon Tube \$39.50

### UX DETECTOR SOCKET

A detector tube socket with double snubbers to kill the howl (vibrating tube elements). The tube is NOT spring suspended. Protection and silent operation made possible by shock absorbing material which absorbs all vibrations.

**UX Detector Model \$1.00**  
For general use the UX Absorber Socket protects the tube and permits quieter reception.

It doesn't pay to use inferior sockets when the B-T UX-A can be purchased at high-grade dealers for 75c.



### OUTPUT TRANSFORMER



A new Bremer-Tully product for use between the last audio stage and the speaker unit. It protects speaker windings from high current passed by type 171 and 210 tubes. With some speakers it improves tone quality. Made with the same care as the "Euphonic" Audio Transformer.

Six terminals offer a selection of ratios.

Price ..... \$5.50

### CHOKE COIL

It is considered good practice to use choke coils in modern circuits to prevent radio frequency currents from entering audio circuits.

The B-T Choke is housed in a bakelite case and mounts with a single screw.

Price ..... 90c



### BETTER TUNING

You will be repaid for reading this eighty-page booklet. Eleventh edition now out, covering current radio questions. Write for your copy today.

**BREMER-TULLY MFG. CO.**  
520 So. Canal St., Chicago, Ill.

## Radio News of the Month

(Continued from page 1331)

### A RADIO MOTOR HUNT

LISTENERS heard their own voices over the radio in a recent stunt by station 4QG, Brisbane, Australia. A motor car, carrying a party from the station, with a blue light to make it conspicuous, started out on a tour of the principal streets; and at 8:00 p. m. listeners were asked to communicate with the station and report its whereabouts. As reports came in, they were switched in to the speech amplifier, so that the voices of the callers were broadcast. Many telephone messages were received, some serious and some joking. A prize distribution in connection with the affair aroused the popular interest.

### TRANSATLANTIC 'PHONE WORK

FURTHER extension has been made in the radiophone service, across the Atlantic, which is now linked to the whole Bell long-distance system of the United States, California having talked with England on February 26. Among other transatlantic communications has been sending the words and music of a new song from New York to London.

### GERMAN SUPERPOWER BROADCASTS

THE new "Rhinelandsender" station, at Langenberg (near Essen) in Westphalia, is the most powerful in Europe, if not in the world. Though its power is 60 kilowatts, clear crystal reception by daylight is assured for only forty or fifty miles. However, at night crystal reception has been reported even in the Pyrenees, and with single-tube sets it has been heard all over Europe. In Holland the interference is so great that it is almost impossible to receive other stations. The station was constructed by the Telefunken Co., which found special methods necessary to stabilize the enormous energy of this transmitter.—Eng. Hermann Grothus.

Other new stations in Germany are Stuttgart, which is a high-power station, and will use a 379.7-meter wave, reception of which in the United States is expected by the department of commerce. Remote-control studios have been established at Karlsruhe and Mannheim. A new station at Freiburg is operating on 577 meters.

### THE COMMISSION ACTS

AT its first meeting, the Radio Commission extended indefinitely all radio amateur and ship licenses, and required broadcasters and point-to-point communication stations to reapply for licenses. It ordered a series of public hearings from March 29 to April 1, at Washington; and Judge Sykes (acting chairman until the arrival of Admiral Bullard from China) addressed the radio public directly on March 17, through a large chain of broadcast stations. The commission, occupying quarters furnished by the Department of Commerce, has appointed as temporary secretary Sam Pickard, chief of the radio division of the Department of Agriculture.

### NEW ZEALAND STATION

WELLINGTON'S new station, 2YK, will begin operation this month (April) on a wavelength which will probably be 440 meters. The installation provides for an output of 5,000 watts from the aerial, inferior in power to Daventry only, of the broadcast transmitters in the British empire. As Auckland, with one-tenth of this, has readily been picked up in America, it may be expected that Pacific coast fans will have little trouble in getting Wellington.—R. F. D. Burrell.

## Darkened Room Aids DX Reception

IF you are a DX fan and stay up nights nursing dials in an effort to fill your log book with the call letters of distant stations, take a tip from the transmitting amateurs and use a small, opaquely shaded bulb as the only source of illumination in the room. Turn out all the overhead clusters and wall brackets, then set the lamp on or near the radio table, so that it is below the level of your eyes and casts a glow only strong enough to make the dial readings on the receiver discernible. A more effective expedient in easing the reception of the elusive DX-ers you have never found.

The weakness of the light has no electrical effect on the receiver, to increase the latter's sensitivity; but it has a marked effect, on your physical and mental condition, that directly facilitates reception. With a dull light in the room you unconsciously relax your muscles, put yourself at ease, and rest your eyes. You sit back comfortably,



and the inactivity of your other senses tends to sharpen those of hearing and feeling. You are not distracted by a strong light, but feel only the soothing effect of a soft and indirect one. You are able to concentrate, fully and completely, with only your ears and fingers active.

When you turn the dials you are now scarcely aware of their presence, or of the presence of anything else in the room. You merely listen and decipher the sounds the earphones impress on your brain.

It seems incredible that the mere darkening of the room can so influence the mind, but the effect is really marked. Radio operators, who sit at a receiving set for hours at a time and must frequently "read" code signals of heart-breaking weakness, often turn out all light and listen in total darkness. By relieving their sensitive eyes of all strain, and keeping only their ears "alive," they are able to retain whole messages in their heads, and to write them down later on paper without a mistake. In many radio "shacks" the sole illumination is furnished by a lonely 10-watt lamp, hidden inside a blued reflector and hung a little to the side of the receiving set.

The next time you go on the trail of that station in Frisco (or New York, if you are on the Pacific Coast), try this trick. You will be pleasantly surprised to find that it actually works.

### IN THE ORIENT

CALCUTTA, India, is to have a 12-kw. transmitter, it is said, replacing the 1,500-watt station, 5AF, recently closed. Egypt will also have a station by next winter, and a new market for radio equipment is expected.

### 43-METER TESTS

THE Westinghouse experimental station, 2XAI, Newark, N. J., will transmit each evening from April 18 to April 30 on 43 meters, from 8 to 9 P. M., E. S. T. The test is to be international.



# Largest variety of Radio Parts!

**1927 Edition**  
**No. 17**  
**500 Illustrations**  
**NEW Enlarged Edition**

**THIS 100 PAGE RADIO CATALOGUE FREE**

**75 HOOKUPS**

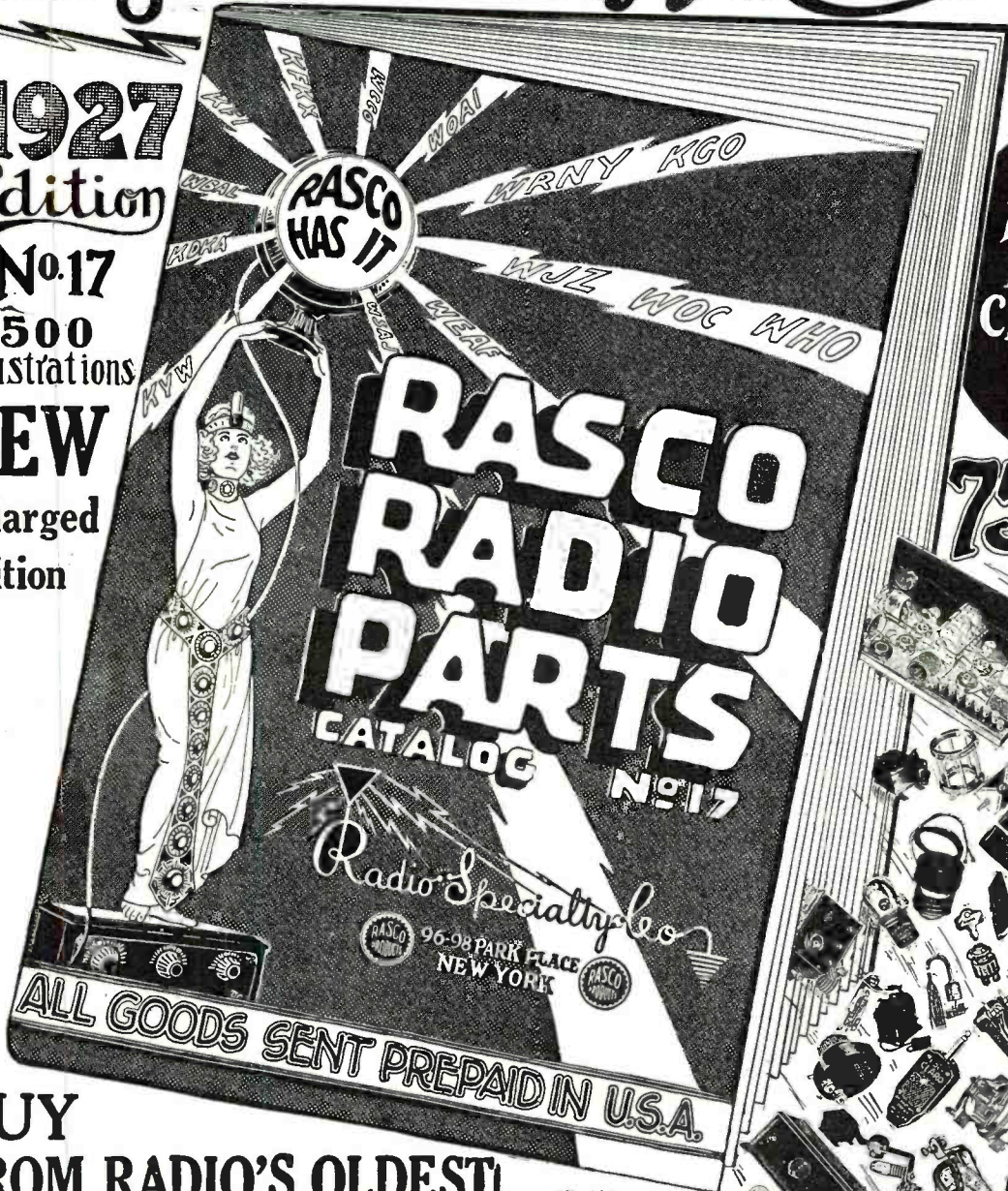

## BUY FROM RADIO'S OLDEST MAIL ORDER HOUSE

WE are the oldest established, exclusive radio mail order house in the country. Our motto is "Quick Shipment." All orders are shipped within 24 hours. Quick, prompt, courteous service. We carry a larger variety of radio parts and findings than any other radio house in the country.

### "RASCO HAS IT"

If you are in need of certain small radio parts that other radio and mail order houses do not bother to carry, get the Rasco parts catalog, and you will find them there, anything from a screw to copper ribbon and telephone diaphragms, as well as thousands of other small radio findings. Just to mention a few:

Lugs, nuts, dials, vernier dials, jacks, plugs, every kind of knob, cords, panels, screws, sliders, washers, selenium, tin foil, switches, crystals, cap nuts, litz wire, cord tips, brass rods, resistances, name plates, spring binding posts, switch parts, metal ribbon, carbon balls, binding posts, all types, switch points, switch levers, lock washers, carbon grains, ground clamps, metal pointers, insulated tubing, low melting metal, antenna connectors, bus bar wire, as well as thousands of other articles.

We carry the Largest Variety of Small Radio Parts in the World. BUT We also carry ALL standard radio merchandise.

### ANYTHING IN RADIO

**THE NEW RASCO CATALOG No. 17** Contains the Following Hookups  
 All Armstrong Circuits: These important circuits are explained clearly, all values having been given. Just to name a few of the Vacuum Tube circuits: The V.T. as a detector and one-step amplifier; Super Regenerator; one-step radio frequency amplifier and detector; three-stage audio frequency amplifier; short wave regenerative circuit; 4-stage radio frequency amplifier; radio and audio frequency amplifier; inductively coupled amplifier; all Reflex Circuits. This catalog is crammed full of small parts and radio findings, literally thousands of them. In addition there is much useful information contained herein.

If you will paste this coupon on a post card and mail today, we will be pleased to send you our new Catalog at once.

**RADIO SPECIALTY CO.**  
 98 Park Place New York, N. Y.



RADIO SPECIALTY CO., 98 Park Place, New York  
 You may send me, without charge or obligation, your NEW CATALOG No. 17. (Write on margin if you desire.)  
 Name .....  
 Street .....  
 P. O. .... State.....

**HERE IT IS!**  
 Marvelous Townsend  
**BELIMINATOR** \$4.95  
 (Complete) only  
 \$12.00 Down Balance Cash

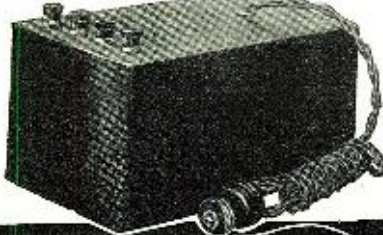

**Direct  
 from  
 Factory**

**10 Days  
 FREE  
 TRIAL**  
 You are the  
 Judge!

**at lowest price on record**

Here is great news! For half the price of a set of "B" batteries you can now enjoy greatly improved reception and be done forever with the nuisance of recharging and renewing unreliable "B" batteries. We make every part that goes in the Townsend "B" Eliminator in our own factory. That's the reason we can give it to you at such a low price—give you a high quality instrument backed by a real guarantee. Users report splendid results. A fine "B" Eliminator at the lowest price on record. Our 10 days Free Trial proves it.

**MONEY BACK**  
 if not amazed and delighted

You alone are the judge. We could not afford to make this guarantee if we were not sure of the Townsend "B" Eliminator's splendid performance. Just plug in to your electric light socket and in a moment you will realize what good reception means. Delivers up to 100 volts on any set, on direct or alternating current—any cycle. Gives full wave rectification. Full tone, clarity and volume—uninterrupted by screeches of fading batteries.

The Townsend "B" Eliminator is completely enclosed in a heavy steel case with beautiful lacquer finish. Handsome in appearance—satisfactory in operation.

**Rush Order Today!**

Simply fill out the coupon and slip it into an envelope with only \$1.00. Get it into the mail at once. Your "B" Eliminator will be sent you promptly by return mail. Deposit \$3.95 only with the postman. Try out the Eliminator for 10 days—then if not astonished and thrilled by improvement in operation, return it to us and purchase price will be refunded in full. You don't need to put up with battery nuisance another day when it is possible to own a "B" Eliminator at this startlingly low price. Send for it today.

**TOWNSEND LABORATORIES**  
 713 Townsend St. Dept. 25 Chicago, Ill.

**Attach Only \$1.00  
 to this Coupon**

**TOWNSEND LABORATORIES**  
 713 Townsend St., Dept. 25, Chicago, Ill.

Gentlemen: Attached find \$1.00. Kindly send at once Townsend "B" Eliminator, C. O. D., for \$3.95, plus postage, on guaranteed 10-day free trial.

Name \_\_\_\_\_

Address \_\_\_\_\_

City \_\_\_\_\_ State \_\_\_\_\_

**Letters from Home Set Constructors**

(Continued from page 1367)

Antonio, Denver, Selma (Alabama), etc. However, last evening I had an experience with it that was very unusual. I tuned in Mexico City, station CYZ, and after listening to a good program, turned the two dials a half space and received Montreal, Canada, station CFCF.

All the above is loud-speaker reception.  
 T. G. MANN,  
 1703 Mondamin Ave., Des Moines, Ia.

**NEW POLICY HELPFUL**

Editor, RADIO NEWS:  
 It was certainly a great surprise to me, on opening the current month's issue of RADIO NEWS, to find out that you have inaugurated a new policy, i.e., giving engineering specifications on all parts that go into the sets built in RADIO NEWS Laboratories.

This new builder's engineering plan has been a hard-felt necessity for a great many set builders; particularly in this country, where radio stores are so poorly stocked, that even with a choice of alternate parts, it is a hard task to make your own.

Allow me to congratulate you most sincerely on this new departure, which I am sure will make RADIO NEWS even more interesting, if such a thing were possible.

J. M. RACUSIN,  
 Rio de Janeiro, Brazil.

**CRYSTAL DX WORK**

Editor, RADIO NEWS:  
 The majority of people will agree, I believe, that the mystical wonder and greatness of radio decreases as the cost and elaborateness of the receiving instruments increases. The thrill received from hearing the blasts from the loud speaker of a powerful super set, coming from a station half-way across the continent, can not be compared with that which comes from listening, possibly with a little difficulty at times, to a station five hundred miles distant while using a lowly set costing but a few dollars.

For the past few months I have secured some interesting results (possibly not unusual), from a home-built crystal set costing well under \$5.00. The set was operated under normal conditions and the results are not, I believe, to be classed with cases of freak reception sometimes reported.

The set is a two-circuit affair using homemade spiral coils and a variable condenser in the secondary. With an antenna 90 feet long (including lead-in), 30 and 40 feet high at the near and far ends respectively, and a cold-water-pipe ground, the following stations were logged during January, February and October of 1926:

- WEAO, WAUC, WTAM, KDKA, WGY, WHAS, WLW, WJR, KYW, WJZ, WSAI, WCB, WBZ, WSB, WOC, WJY, WLS, WCX, WSMB, WEAR, WHT, WMBB, WORD, KFKX, WGN, WSM, WOS, WGHB, WBAP, WLIB, WEBH, WOK, WSW, WBBR, WPG, WOAW, WRAC, WMBC, WRC, WOK, WBCN, WENR, WJAZ, WJJD, WMAK, WCCO, WEEI, WHO, WMAQ, WJAY, WBBM.

At times some of the most distant of the above stations would come in with splendid volume. WGHB at Clearwater would come in nightly for a week at a time. Volume from our own local stations, WEAO and WAUC at Columbus, 25 miles away, was always very good and reliable. On these local stations the phones (Brandes) could be removed several inches and reception carried on very comfortably. Of course, for reliable reception under all conditions, tubes are indispensable; but, for one who finds diversion in getting the most out of inexpensive apparatus, a good crystal set will prove interesting.

JESSE J. CURRIER,  
 62 S. Washington St., Delaware, Ohio

**MORE CRYSTAL RECORDS**

Editor, RADIO NEWS:  
 I have read many articles in different papers concerning the success different people have had with crystal sets. Most of them stated that the average range of a crystal set is about 25 miles; although cases have been known where a distance of ten times that has been reached.

I have built several sets myself and I would like to let you know of the results I have had.

The first crystal set was of the usual type, using a condenser to tune the coil, and a fixed condenser across the phones. I did not have good results with this set. The only station I could get was KFKX at Hastings, Nebraska. This is a 5,000-watt station only 50 miles away, but it did not come in with very good volume. Then I made a set very much different from most. I did not use any condensers; only a coil tuned by a slider and a crystal. With this set I had very good results. Most of the stations came in with good volume.

Following is my log, taking from August 18th to September 5th:  
 KFKX, Hastings, 50 miles, 5,000 watts. KMMJ, Clay Center, Nebr., 60 miles, 1,000. KMOX, St. Louis, Mo., 525 miles, 1,500. KSBA, Shreveport, La., 620 miles, 500. KFBA, Lincoln, Nebr., 150 miles, 1,000. KFEQ, Oak, Nebr., 60 miles, 500.

- KVOO, Bristow, Okla., 350 miles, 500. KFJF, Oklahoma City, Okla., 350 miles, 500. KOA, Denver, Colo., 310 miles, 5,000. KMA, Shenandoah, Ia., 200 miles, 500. KYW, Chicago, Ill., 600 miles, 2,000. WOAW, Omaha, Nebr., 190 miles, 1,000. WOAI, San Antonio, Tex., 725 miles, 2,000. WORD, Batavia, Ill., 600 miles, 5,000. WFAA, Dallas, Tex., 535 miles, 500. WJJD, Mooseheart, Ill., 550 miles, 500. WDAF, Kansas City, Mo., 255 miles, 500. WSMB, New Orleans, La., 875 miles, 500. WCCO, St. Paul, Minn., 465 miles, 5,000. WBBM, Chicago, Ill., 600 miles, 1,500. WJAZ, Chicago, Ill., 600 miles, 1,500. WSW, Chicago, Ill., 600 miles, 1,000. WHO, Des Moines, Ia., 325 miles, 5,000. WHT, Chicago, Ill., 600 miles, 3,500. WLS, Chicago, Ill., 600 miles, 5,000.

Not so bad for a crystal set is it? I can get most of these stations any night.  
 HOWARD GETCHELL,  
 Bloomington, Nebr.

**FROM THE WEST INDIES**

Editor, RADIO NEWS:  
 I have a one-tube set, that I constructed while I have been here. When I first hooked it up they all started to laugh. Well, it was not long before the laugh was on those that laughed first. I use a VT-1 tube, 18 volts "B" battery, and the variocoupler I use was one that I rewound to suit the circuit. It is of the regenerative type, but I have eliminated a lot of the so-called squeal. It never gives me any trouble tuning the stations; and I think that it does very well for the cost of such a set would be small.

I have also used a Ford spark coil for one stage of impedance coupling, and I can get all the stations that average three-tube sets get here, on the loud speaker.

But what makes it such a good DX set is that it does not fade out, and that the stations received are all plain; and audible.

I have about 100 feet away from the set, power lines of 2300-volt A.C. running parallel to the antenna, also two engines, running with open exhausts, which in my mind is not favorable for reception on a set without amplification.

I am sending you a list of stations that I tune in most every night. If this don't place me on the list of long-distance listeners, why then I am entitled to lose the wrist watch.

(List of 26 stations received in one night, including two in California and KFOA, Seattle.)  
 SGR. E. B. GREEN, U. S. M. C.,  
 Brigade Signal Co., Port au Prince, Haiti

**FROM THE FAR SOUTH**

Editor, RADIO NEWS:  
 As I am a regular reader of the RADIO NEWS I notice in the December number that a fan, Mr. Bricker, is having a real set built and I would sure like to see it.

This is what I want to tell you, I have experimented with 5- and 6-tube sets and antennas and am now able to bring in the States very good with a Freshman 5-tube set, and a 6-tube set I have. We have danced to music from WPG.

The stations that come in the clearest are WPG, WGN, WLIB, WSW, KFKX, WJAZ; we also get WORD, WOAI, KDKA.

I have written to some of the stations, giving them some of the program.

Being the only North American here, I am proud being the only one to bring in the States; and as we are so close to the South Pole we have a lot of static. Then, as our seasons are reversed, we always have the heat to go through; but it sure is good to get a program from home.

Our closest station is Buenos Aires which is 1,350 miles; they come in very good.

This is just a line to let you know that we do get the States, and I think every North American in a foreign country is trying to do the same.

A. C. SMITH,  
 Cia. Swift, Rio Gallegos, Argentina  
 (Mr. Smith, whose address is a few miles north of the Straits of Magellan, is undoubtedly one of the southernmost broadcast listeners in the world.—EDITOR).

**FROM JAPAN TO NEW YORK**

Editor, RADIO NEWS:  
 Some time ago you published a letter from a "DX Fan" out in California, announcing his success in receiving Japanese stations. On December 3, 1926, about 3:45 A. M., I picked up a station on my 6-tube Stromberg-Carlson receiver on a wavelength of 360 meters, broadcasting first an organ solo, "The Waters of Minnetonka," and then a song with words sung to my mind either in Chinese or Japanese. The station faded very much and I couldn't get the call letters. My log showed the Japanese station JOCK, operating on that wavelength. I promptly wrote to that station the next morning, telling them just what I heard, and about a week ago I received from station JOCK at Nagoya, Japan, a letter confirming the reception as coming from their station. I think this is more of a feat for New York City than for the Pacific Coast, the distance being about 8,000 miles. I live at 429 West 51st Street, and have a single-wire antenna about 115 feet long. Since I bought my set last August, I have received 210 stations, all verified by Ekko-stamps.

LOUIS HAHN,  
 Master Sergeant, 212th C. A.,  
 120 W. 62nd St., New York

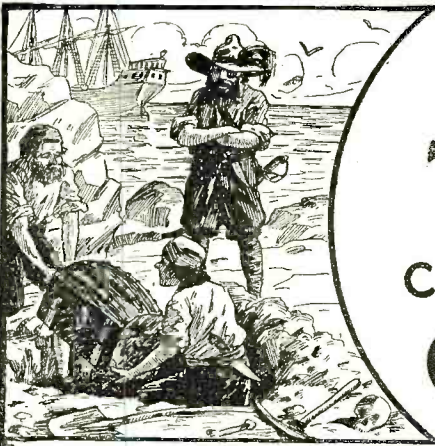

# BURIED TREASURE can still be found in CHEMISTRY



## Good Chemists Command High Salaries

and you can make yourself independent for life by unearthing one of chemistry's yet undiscovered secrets.



T. O'CONOR SLOANE, A.B., A.M., LL.D., Ph.D.

Noted Instructor, Lecturer and Author. Formerly Treasurer American Chemical Society and a practical chemist with many well known achievements to his credit. Not only has Dr. Sloane taught chemistry for years but he was for many years, engaged in commercial chemistry work.

Do you remember how the tales of pirate gold used to fire your imagination and make you want to sail the uncharted seas in search of treasure and adventure? And then you would regret that such things were no longer done. But that is a mistake. They *are* done—today and everyday—not on desert islands, but in the chemical laboratories throughout your own country. Quietly, systematically, the chemist works. His work is difficult, but more adventurous than the blood-curdling deeds of the Spanish Main. Instead of meeting an early and violent death on some forgotten shore, he gathers wealth and honor through his invaluable contributions to humanity. Alfred Nobel, the Swedish chemist who invented dynamite, made so many millions that the income alone from his bequests provides five \$40,000 prizes every year for the advancement of science and peace. C. M. Hall, the chemist who discovered how to manufacture aluminum made millions through this discovery. F. G. Cottrell, who devised a valuable process for recovering the waste from flue gases, James Gayley, who showed how to save enormous losses in steel manufacture, L. H. Baekeland, who invented Bakelite—these are only a few of the men to whom fortunes have come through their chemical achievements.

### What Some of Our Students Say of This Course:

I have not written since I received the big set. I can still say that it far exceeded my anticipations. Since I have been studying with your school I have been appointed chemist for the Seranton Coal Co. testing all the coal and ash by proximate analysis. The lessons are helping me wonderfully, and the interesting way in which they are written makes me wait patiently for each lesson.—MORLAIS COUZENS.

I wish to express my appreciation of your prompt reply to my letter and to the recommendation to the General Electric Co. I intend to start the student engineering course at the works. This is somewhat along electrical lines, but the fact that I had a recommendation from a reliable school no doubt had considerable influence in helping me to secure the job.—H. VAN BENTHUYSEN.

So far I've been more than pleased with your course and am still doing nicely. I hope to be your honor graduate this year.—J. M. NORRIS, JR.

I find your course excellent and your instruction, truthfully, the clearest and best assembled I have ever taken, and yours is the fifth one I've studied.—JAMES J. KELLY.

From the time I was having Chemistry it has never been thus explained to me as it is now. I am recommending you highly to my friends, and urging them to become members of such an organization.—CHARLES BENJAMIN.

I shall always recommend your school to my friends and let them know how simple your lessons are.—C. I. AMDAHL.

I am more than pleased. You dig right in from the start. I am going to get somewhere with this course. I am so glad that I found you.—A. A. CAMERON.

I use your lessons constantly as I find it more thorough than most text books I can secure.—W.M. H. TIBBS.

Thanking you for your lessons, which I find not only clear and concise, but wonderfully interesting. I am—ROBT. H. TRAYLOR.

I received employment in the Consolidated Gas Co. I appreciate very much the good service of the school when a recommendation was asked for.—JOS. DECKER.

## Now Is the Time to Study Chemistry

Not only are there boundless opportunities for amassing wealth in Chemistry, but the profession affords congenial employment at good salaries to hundreds of thousands who merely follow out its present applications. These applications are innumerable, touching intimately every business and every product in the world. The work of the chemist can hardly be called work at all. It is the keenest and most enjoyable kind of pleasure. The day in a chemical laboratory are filled with thrilling and delightful experimentation, with the alluring prospect of a discovery that may spell Fortune always at hand to spur your enthusiasm.

### You Can Learn at Home

To qualify for this remarkable calling requires elaborate specialized training. Formerly it was necessary to attend a university for several years to acquire that training, but thanks to our highly perfected and thorough system of instruction, you can now stay at home, keep your schooling you can take our course and equip yourself for immediate practical work in a chemical laboratory. Dr. Sloane gives every one of his students the same careful, personal supervision that made him celebrated throughout his long career as a college professor. Your instruction from the very beginning is made interesting and practical, and we supply you with apparatus and chemicals for performing the fascinating analyses and experimental work that plays such a large part in our method of teaching, and you are awarded the Institute's official diploma after you have satisfactorily completed the course.

### Easy Monthly Payments

You don't have to have even the small price of the course to start. You can pay for it in small monthly amounts—so small that you won't feel them. The cost of our course is very low, and includes everything, even the chemistry outfit—there are no extras to buy with our course. Our plan of monthly payments places a chemical education within the reach of everyone. Write us and let us explain our plan in full—give us the opportunity of showing you how you can qualify for a highly trained technical position without even giving up your present employment.

### Special 30 Day Offer

Besides furnishing the student with his Experimental Equipment, we are making an additional special offer for a short while only. You owe it to yourself to find out about it. Write today for full information and free book "Opportunities for Chemists." Send the coupon right now while it is fresh in your mind. Or just write your name and address on a postal and mail it to us. But whatever you do, act today before this offer is withdrawn.

**DON'T WAIT—MAIL COUPON NOW!**



### Experimental Equipment Furnished to Every Student

We give to every student without additional charge this chemical equipment, including forty-nine pieces of laboratory apparatus and supplies, and forty different chemicals and reagents. These comprise the apparatus and chemicals used for the experimental work of the course. The fitted heavy wooden box serves not only as a case for the outfit but also as a useful laboratory accessory for performing countless experiments.

## CHEMICAL INSTITUTE OF NEW YORK, Inc.

HOME EXTENSION DIVISION 5

66-R—WEST BROADWAY

NEW YORK CITY

CHEMICAL INSTITUTE OF NEW YORK Home Extension Division 5 66-R—West Broadway New York City

Please send me at once, without any obligation on my part, your free Book "Opportunities for Chemists," and full particulars about the Experimental Equipment given to every student. Also please tell me about your plan of payment and your special 30 day offer.

NAME .....

ADDRESS .....

CITY..... STATE.....

R.N.—May, '27

# Bradleystat

PERFECT FILAMENT CONTROL

For noiseless, smooth filament control and maximum range, ask your dealer for the Bradleystat. This well-known



graphite disc rheostat can be used for ALL TUBES, without change of connections. The bakelite knob is removable, if desired. The one-hole

mounting makes the Bradleystat easy to install.

# Bradleyleak

THE PERFECT GRID LEAK

With a range from 1/4 to 10 megohms, the Bradleyleak offers a variation of adjustment that adapts it to any tube or any circuit. A small grid-condenser can be attached direct to its terminals. One-hole mounting.



# Bradley-Amplifier

Resistance-Coupled PERFECT AUDIO AMPLIFIER

For perfect tone quality, use resistance coupling, and for convenience and reliability, ask your dealer for a Bradley-Amplifier. Ready to install in your radio set.



Mail this coupon to

ALLEN-BRADLEY CO.  
287 Greenfield Ave., Milwaukee, Wis.

Please send me your folders on Allen-Bradley radio devices, including the Bradley-Amplifier.

Name.....

Address.....

## \$300 Prize Contest

(Continued from page 1328)

16 correctly. The first prize will then go for, not only the correct list, but the best 25 words accompanying the entry.

The following rules should be followed by you:

1. Any one may enter this Contest, with the exception of the employees of the Experimenter Publishing Company and their families.
2. Only one set of answers may be submitted by each contestant.
3. All answers must be typewritten or in ink. Pencil matter is not acceptable.
4. List as many mistakes as you can find, using a separate line for each mistake, numbering the first one "1," second one "2," etc., down to "16."
5. Make your answers as short as possible, and append not more than 25 words, which may be humorous, in reference to the subject of the picture.
6. Prizes in their correct order will be awarded to the entries containing the most correct lists of mistakes and best 25-word remarks.
7. In case of a tie, identical prize-winning answers being submitted by different contestants, identical prizes will be paid to those tying for the prizes.
8. This competition closes on June 18th at noon, by which time all answers must have been received.
9. The names of all prize-winners will be announced in our September issue.
10. Address all entries to Editor "What's Wrong Picture," c/o RADIO NEWS, 230 Fifth Avenue, New York City.

## The Pleasures of "Hamming"

(Continued from page 1317)

exemplified in both the receiving and sending sets. He considers the simplicity of his outfit the explanation of his success in working South Africa nearly every night without undue difficulty.

### A HAM'S PERSISTENCE

Of amateur work in general, Wentworth says:

"Most amateurs are too anxious for extraordinary results. They are unwilling to stay at the key and fight for distance. I sit at the key night after night, and nearly every morning for an hour, and if I do one good piece of DX in a week, I think I'm doing well. I clamp the receivers on my ears, then strain for the faintest signals. Other amateurs refuse to spend the time with it and of course they cannot expect the lucky breaks when they come. The ordinary good luck experienced by a 'ham' is in fact the reasonable result of very hard work and infinite patience. From my point of view, the best sending and receiving sets are wasted if the operators do not give their signals an opportunity to get away."

An example of how this young operator makes his luck can be noted in the picture of his shack and aerials. Nothing extraordinary there, perhaps; the station is a scant 400 feet above sea level, which is not as high as many commercial masts are reared; but it commands the country for 100 miles or more north and south and thousands of miles west across that largest of oceans.

His excellent topographical location aids him, then, in working India, French Indo-China, Australia and New Zealand in the early morning, P.S.T., and South America, South Africa and the East coast of the United States between 7 and 8 P. M. His



FREE this 32 page

# Sterling RADIO BOOK

Your most valuable ally in selecting your necessary accessories and home servicing equipment. Tells what testing meters are needed for every purpose, explains the correct use of "B" Eliminators, shows seven types of battery chargers, gives the "how and why" of checking set operation and of renewing the life of tubes at home. Write today for booklet "M"—no obligation.

THE STERLING MFG. CO.  
2831 Prospect Ave. Cleveland

## Rubber Covered Insulators



Actual Size

Neat and efficient. For antenna ground and for lead in wires. Small screw starts readily and makes finished job. Great improvement over ordinary large, unsightly insulators. They keep the wires in place and out of the way. Packed 10 in a box, 25c at your dealers or direct from us.

CULVER-STEARN'S MFG. CO.  
Worcester, Mass., U. S. A.



The SONOCHORDE CONE \$25. Brings the Studio Home

LUDWIG HOMMEL & CO. SATISFIED DEALERS BECAUSE WE HELP THEM. Catalog 466-S is free to Dealers

outside equipment consists of a 30-foot vertical aerial for sending, a 30-foot horizontal counterpoise, extending from the rear of the shack through the boards of the fence to a post sunk outside the enclosure, and a 100-foot single-strand receiving aerial and ground. The sending aerial is built without guy ropes, thus eliminating one source of energy absorption.

Less than a mile from 6OI was recently constructed an electrical experiment laboratory to house six 350,000-volt generators, with a test line to carry 2,100,000 volts, single-phase. Even though he is so close to such super-power, Wentworth's work suffers no undue interference. Such is the advantage of location!

Speaking of interference, Wentworth fears cows more than static or other disturbances. Recently a heavy wind and rain storm tore down his protecting fence. Before he arrived the next morning to repair whatever damages the building and surroundings might have suffered, several of his cloven-hoofed acquaintances had licked much of the tar paper from the outside walls of his castle!

Wentworth, modestly enough, admits two hours a day at the key. He says nothing of sleeping within three feet of his instrument, to be ready early to go on the air. He is what one might term a "professional" amateur in that he has had long experience with radio sending and receiving apparatus. From Boston to Santa Barbara, and finally at Stanford University, he has put his signals on the air. As Scofield said confidentially of him, "he knows radio and is willing to wait patiently." What a fine formula for all amateurs to adopt.

#### AT THE COLLEGE STATION

As a member of the American Radio Relay League and as an official relay station, 6OI handles a large volume of "traffic" in addition to its DX experiments. The A. R. R. L. work Wentworth considers fine experience rather than drudgery, as it makes for him many friends-of-the-air and gives him added technic and ability to work faraway "hams." During his other spare hours he is also one of the two operators of 6XBM, and sends out in conjunction with WWV, at Washington, D. C., standard-frequency signals. 6XBM is located in a small building adjacent to the high-voltage laboratory at Stanford University. Until recently its aerials were superimposed over six high-voltage wires, used for general experimental tests; it now employs two antennas, both approximately 85 feet above ground. Here Wentworth employs two transmitting sets on a master-oscillator power-amplifier system; one for relatively low frequencies and one for frequencies between 1500 and 6,000 kilocycles (50 and 200 meters); and spends some of his remaining time solving electrical problems.

### Progress in Radio

(Continued from page 1361)

cooling takes place in the intervals between the alternations of the current.

Referring to the drawing, 1 and 2 are two filaments, which are absolutely identical. 1 is connected in the usual manner to current conductors 3 and 4, leading from the stem, 5, of the tube. The second filament is connected at 6 and 7, to the same conductors by wires 8 and 9, of sufficient section to obviate any appreciable rise in temperature. As will be seen, the current divides at 6 into two parts, one of which passes through the filament 1, in the direction of the arrow 10, the other passing through the filament 2, in

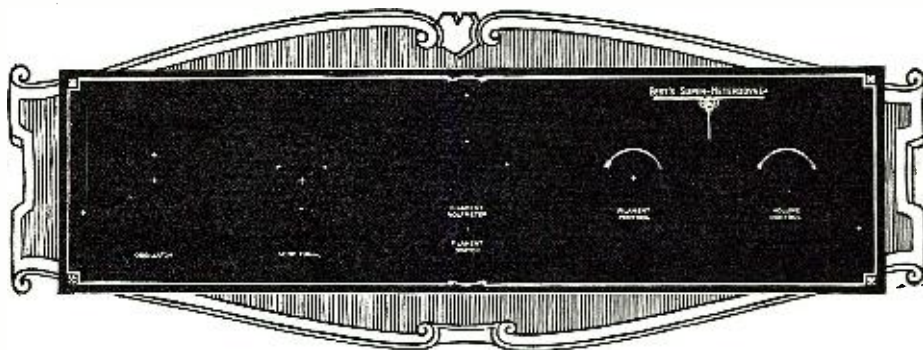

## BEST'S SUPER, KARAS, H. F. L.

**F**ORMICA is supplying handsomely decorated Kit Panels for leading kit sets through leading jobbers and dealers all over the country. These panels make it possible to build at home a very good looking set. There are two sizes of Best's Superheterodyne, Karas Equamatic front and sub panels, H. F. L. Nine-in-Line Superheterodyne with sub panel, Victoreen single dial and two dial control. There is also an Infradyne 7" x 28" and one 7" x 30", Aerodyne, St. James 8 Tube, Browning Drake National, Madison Moore Superheterodyne and Camfield Duoformer.

*Special panels cut to size and Formica Tubing are also available for amateurs*

### NEW WALNUT FINISH FOR MANUFACTURERS

Formica has worked out a new Walnut finish to match the tone of most of the furniture that will be used this year. The graining is fine and uniform over the sheet. It is a splendid stock for front panels. Formica has increased its equipment for producing threaded tubes. These tubes will be used by most manufacturers of single control sets to produce uniform inductances. Sub panels, terminal strips, etc., may be had fully perforated and marked, or if desired with all small hardware attached.



The FORMICA INSULATION COMPANY

4618 SPRING GROVE AVENUE

CINCINNATI, OHIO

Hear the FORMICA  
Orchestra Tuesday  
9 to 10  
over WLW

# FORMICA

Formica has a  
Complete Service on  
Insulating Material for  
Radio Manufacturers

# Thousands Use These Ingenious TRANSMITTER UNITS

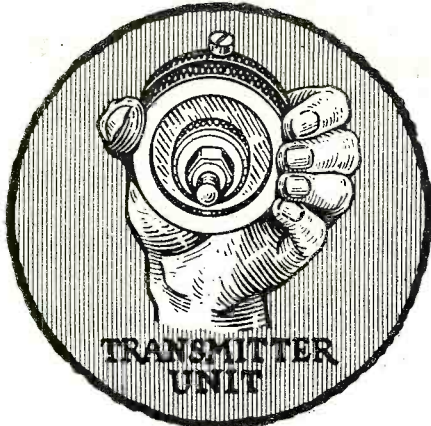

Here's a marvel of Engineering design—a practical miniature transmitter, used by thousands of radio fans and experimenters for amplification purposes. It is a most novel unit, having hundreds of uses. Every amateur should have two or three of these amplifiers in his laboratory.

### A FEW USES FOR THESE UNITS

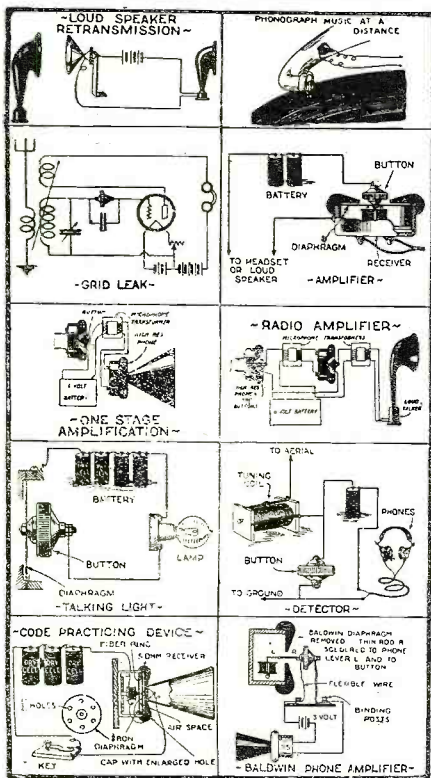

With each unit is mailed an eight-page instruction pamphlet containing suggestions for innumerable uses. Our supply is limited; avoid disappointment by ordering today. The coupon below is for your special convenience.

**SPECIALLY PRICED**  
While they last— **95c**  
(or Two for \$1.75) per unit

THE PRESS GUILD,  
 66-R West Broadway, New York, N. Y.  
 Enclosed find 95c/\$1.75 for which send me postpaid one/two amplifier units as advertised.  
 Name .....  
 Address .....  
 City, State .....

the direction of the arrow 11. When an alternation takes place, the current changes its direction in both filaments.—*Wireless Trader.*

## Advancements in R.F. Stabilizing Systems

(Continued from page 1357)

in Fig. 7 and though it is fairly effective in some respects it has a number of disadvantages. At any rate, it cannot truthfully be called a damping device in the same sense that former arrangements were.

It will be noted from the diagram that a variable resistance, R, is connected in series with the common "B" battery lead to the plates of the radio-frequency tubes. The fact that the resistance is there means that there will be a certain amount of damping, but this is offset by the functioning of the resistance. In the first place it is associated with the primary circuits only and does not act as a damping factor in the grid circuits, where it certainly would decrease both the selectivity and sensitivity of the set as a whole. What it does do is to slightly damp the action of the primary circuits, alter or adjust the plate-filament impedance of the radio frequency tubes and at the same time, in the same move you might say, adjust the "B" battery voltage. The output or plate-filament impedance of a radio-frequency tube might appear to be a factor of little or no importance, but actually it has a bearing on the regeneration and oscillation tendencies of the tube. The lower the plate impedance or resistance of the tube, the more easily will the tube oscillate. If we increase this internal impedance, which can be done by decreasing the filament brilliancy or the "B" battery voltage, we can effectively control oscillation tendencies and still obtain sufficient regeneration. The system outlined accomplishes this by the use of a single variable high resistance for all the R.F. tubes.

### THE PHASATROL

The next real advancement in the art of stabilization of radio-frequency circuits was the Phasatrol, a comparatively recent arrival, which consists of a variable high resistance and a fixed condenser, mounted in a single casing. The internal wiring of the Phasatrol (PH), as well as the manner in which it is connected into a radio-frequency amplifier circuit, is shown in the diagram of Fig. 8. Like a few of the systems already outlined, this one cannot be classed as a damping instrument. Rather, it is a distinctive form of phase-shifting device.

When the Phasatrol is connected in the plate circuit of a radio-frequency amplifier as shown in Fig. 8, the fixed condenser C changes the *time factor* of the feed-back impulses; so that instead of meeting the original signal impulses *in phase* and tending to build them up, they travel through the grid-to-plate capacity of the tube and arrive on the grid just after the signal oscillations have gone. Hence, there is no re-inforcing action and no excessive regeneration to cause undesired oscillation. Theoretically the phase difference is never absolutely complete, some regeneration taking place in each radio frequency circuit. This is highly desirable, for the reasons previously explained. The variable resistance R, being both non-inductive and non-capacitative, has no effect on the phase displacement. It serves primarily to feed the direct current of the "B" battery to the plate of the tube, leaving the primary coil P of the R.F. transformer unrestricted, and, secondarily, as a means for adjusting the plate impedance or resistance

**demand**  
**AEROVOX**

**FILTER CONDENSER BLOCKS**

For Working Voltages of 200, 300, 400, 600 and 1000 Volts D. C.

Flexible leads for connections eliminate all possibilities of leakage from soldering.

AEROVOX WIRELESS CORPORATION  
60-72 Washington Street  
Brooklyn, N. Y.

## Centralab Station Selector

**BIGGEST Dollar's Worth in Radio. Tunes out short wave interference, increasing selectivity of any set (not using loop) on stations close to local, except same wave length stations. Not a wave trap. No adjustments. At dealer's or send us dollar bill. Money-Back Guarantee. Satisfaction guaranteed.**

Central Radio Laboratories  
19 Keefe Ave. Milwaukee, Wis.  
Parts manufacturers for 69 makers of leading standard sets.

**Centralab**

**For Perfect Amplification—**  
FERRANTI

Audio Frequency Transformers Amplify faithfully every note in the scale—each transformer tested ten times—your set needs one for perfect reproduction. Model A.F. 3—\$12.00. Model A.F. 4—\$8.50.

FERRANTI, INC.  
139 West 42nd St., New York, N. Y.

Build a Victoreen Universal using

**VICTOREEN Super Coils**

Send for Folder

Geo. W. Walker Co.  
6528 Carnegie Ave.  
Dent, H Cleveland, O.

of the tube. The advantages of this have already been explained.

**CONSTANT-COUPLING SYSTEM**

The outstanding system of the year is the new Loftin-White Constant-Coupling system of radio-frequency amplification. Here is a stabilized circuit, with no theoretical losses to speak of, which is based on the hard fact that the reactance of a condenser increases as the frequency decreases (or wavelength increases) and vice versa, and that the impedance of an inductance varies in exactly the opposite ratio. In other words, irrespective of whether the wavelength is being increased or decreased, the resistance of either the inductance or the capacity is increasing while the other is decreasing, as the case may be. The circuit of this system, which is shown in part in Fig. 9, has its inductances and capacities so connected that there is both inductive and capacitive coupling. The values of the inductances and the capacities are so adjusted that, as the resistance of, say, the inductance, starts to drop off, the resistance of the capacity increases and vice versa; so that actually the resistance, i.e., the coupling resistance, remains constant for all wavelengths. The coupling is therefore constant. Consequently, after the associated circuits have once been adjusted to prevent oscillation, there is no change in either the amount of regeneration, the selectivity or the sensitivity at any wavelength.

In the circuit diagram of Fig. 9, it can be seen that inductive coupling is gained through the coils L1 and L2, while capacitive coupling is furnished by the condensers C1 and C2. Coil L is a radio-frequency choke which prevents the leakage of any of the radio-frequency currents into the "B" battery circuit; while C is the phase-shifting condenser which is employed primarily for the purpose of neutralizing in the manner previously explained.

**Short-Wave-Oscillator Adjustment**

(Continued from page 1368)

distributed capacity of the leak may be so high that it may act as a condenser. A small R.F. choke coil of about 15 turns of thin wire may be space-wound on a piece of 1/4-inch tube; this choke is placed in series with the grid leak to prevent R.F. currents from flowing through this circuit.

**TEMPERATURE EFFECTS**

Since the amount of energy dissipated in the form of heat varies as the square of the current, it is always best, for highest efficiency, to provide the desired power at a high potential and low current, instead of at a low potential and a high current; however, the maximum safe potential that the tube will withstand should not be exceeded. Allowing some tubes to heat greatly lowers the resistance of the glass supports and a flash-over may result. Never adjust a short-wave oscillator when the plates are red-hot, for it will be found that the set will not oscillate stably until this condition is again obtained. Adjust while cool, and so that the plates do not become hot, for intermittent use. A circuit employing a hot tube has a slightly different wave from one employing a cold one. If a steady signal is desired, watch this.

Sometimes the grid current becomes excessive and the set oscillates very unstably; the remedy is to insert in series with the grid a small graphite rod of sufficient resistance to reduce this current to normal.

The size of the R.F. choke in the plate circuit has been found to have some effect on the stability of a transmitter. A large

**Norden-Hauck Super-10  
AROUND THE WORLD  
WITH THE U. S. NAVY**

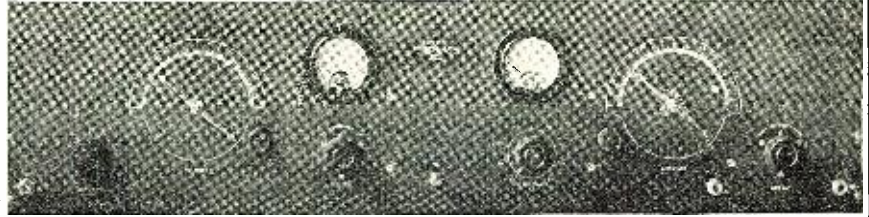

Panel size, 36"x9"x1 1/4" Super 10-tube Standard Admiralty Model Weight: 55 lbs.

A SUPER-10 has been installed on board the "U. S. S. Wright," now sailing for Asiatic waters with the U. S. Aircraft squadrons. This receiver will also be used for entertaining civilian representatives at various ports of call.

**A New and Advanced Model  
Highest Class Receiver in the World**

THE NORDEN-HAUCK SUPER-10 is an entirely new and advanced design of Receiver, representing what we believe to be the finest expression of Modern Radio Research Engineering. It is the product of years of experience devoted exclusively to the attainment of an ideal Broadcast Receiver—regardless of cost.

Results obtained in every respect will upset all your previous ideas of good radio reception. The unusually large number of unsolicited testimonials constantly being received from users—concerns and individuals of international repute—indicates the absolute superiority of the NORDEN-HAUCK SUPER-10.

You, too, may enjoy the advantages of this wonderful receiver at a surprisingly moderate cost. Here are only a few of the host of features that place the NORDEN-HAUCK SUPER-10 far in advance of competition.

- 10 tubes employed to give perfect reproduction with unlimited range and volume power.
- Simple to operate, having only two major tuning controls.
- Super selectivity on all wave lengths.
- No Harmonics. Signals are received only at one Point.
- Built to Navy Standards.
- Special Power Audio Amplifier, operating any loudspeaker and eliminates necessity of external amplifier.
- Wide wave length range without change of coils, 200-550 meters full. (Adaptable 35 meters to 3600 meters if desired.)
- Can be operated directly from house current with socket power devices.
- Use Loop or Antenna.
- Thoroughly shielded at all necessary points.

**Complete Price List for Socket Power Operation**

1 Norden-Hauck SUPER-10, completely constructed and laboratory tested	\$307.00
*1 Heavy-Duty 200 V. "B" Eliminator and Tube, 50/60 cycle A/C 110 V.	42.50
1 Automatic "A" Power Supply, complete	29.50
10 Tested Tubes, including Power Tube	22.50
1 Western Electric Cone Speaker, 540AW or Farrand Sr., and Plug	32.60
1 Set Antenna Equipment, complete	5.00
2 "C" Batteries	2.00

TOTAL COST OF ALL ITEMS—NOTHING ELSE REQUIRED...\$441.10

\* 25/30 cycle A/C current, \$47.50.

PROMPT EXPRESS SHIPMENTS NOW BEING MADE.

Tear off and mail today

**Upon Request** complete literature, will be gladly mailed without charge, or full size constructional blue prints, showing all electrical and mechanical data, will be promptly mailed postpaid upon receipt of \$2.00.

Write, Telegraph or Cable Direct to

**NORDEN-HAUCK**

Incorporated  
**ENGINEERS**  
MARINE BUILDING  
**Philadelphia, U. S. A.**

NORDEN-HAUCK, Inc.  
Philadelphia, U. S. A.

Gentlemen:—

Please send me without cost or obligation on my part, attractive illustrated literature describing the new Norden-Hauck Super-10.

I enclose \$2.00 for which please send me, postpaid, complete full size constructional drawings, and all data for building the Super-10.

Name.....

Address.....

SM

652



## Reservoir B

Have you ever hooked up a B eliminator, anticipating wonderful results, then turned it on and heard a whole crop of new noises, "motor-boating," "putting," and a lot more your local experts couldn't tell you how to eliminate? And then when you did apply a good suggestion for clearing up your troubles, you found that the quality of reception was not up to batteries? And maybe a condenser went West with a discouraging bang? And finally, when you did get it working, turn the knobs as you might, you could only guess at the voltages your tubes were getting?

Those are exactly the points you won't encounter with the new S-M Reservoir B, for it's guaranteed not to "motorboat" with the largest set, and its output voltage is constant to a few percent. No matter if your set uses from one to ten tubes, you KNOW the 90-volt tap won't vary more than good batteries. And the 180-volt tap will really supply enough power to a 171 to give real quality—the 45-volt tap gives a more constant output than any other eliminator! That's the answer of S-M engineers to common eliminator troubles—the 652 kit. You can put it together in two hours on the living-room table, and it's guaranteed to give you greater satisfaction than batteries or other eliminators, for its voltages are always constant, and it won't "motorboat" with any normal set, be it a one or ten tuber.

Price, with full instructions—\$34.50, less one CX-313 and one CX-374 tubes.

**SILVER-MARSHALL, Inc.**  
848 W. Jackson Blvd.  
Chicago, U. S. A.

choke seems to provide steadier operation than a small one. For the upper bands, 250 turns on a 2-inch tube will serve; for the shorter waves, small Lorenz coils 1-inch in diameter must be used. Determine the size necessary and let it alone; changing chokes usually has some effect on the adjustments of the oscillator. If at any time the house lights grow brighter when the key is depressed, currents are finding their way into the power lines. All power leads should be provided with small chokes. Keep all chokes away from the primary; if they must be placed near the latter, set them so that their fields are at right angles.

### ADJUSTMENT PROCEDURE

The following procedure is suggested for adjusting the transmitter. First, select a primary of the proper size. This is determined by the wavelength to be used. For 40 meters, sixteen turns of space-wound, copper tubing make an excellent inductance; for 20 meters seven turns 4 inches in diameter will do; and three turns of No. 12 wire (here the exact number will depend upon circuit conditions) are sufficient for the 5-meter band. Securely solder the grid lead to the proper end, place the plate clip at the other and the filament tap halfway between. Lower the plate voltage, turn up the filament to its rated voltage, throw the power switch and press the key. If the set oscillates, determine the wave either by a wavemeter or by listening-in; if too high move the plate clip in, if too low move it out. Now adjust the filament clip for steady operation and proper input. If the set does not oscillate at first, though all connections are properly made, adjust the filament clip until it does; it should oscillate easily. With the primary in action on the proper wave and all adjustments made as previously described, bring up the antenna coil with the antenna and counterpoise attached.

Bringing up the secondary raises the wave of the oscillator to some extent and, if the coupling is made too tight, the set will oscillate very unsteadily, or not at all. A tremendous amount of power may be induced in the antenna circuit by very tight coupling and very fine adjustment of the primary, but an unsteady signal inevitably results, so that loose coupling is much better and less obtainable interference will reach the antenna. Under no circumstances should the two inductances be closer than two inches; having them farther apart is advisable, for a sharper wave results. It may be found necessary to readjust the filament tap slightly to bring the set to its original, steady condition. The circuits are then brought into resonance by varying the antenna series condenser.

The amount of antenna current has nothing to do with the output; to the novice this may seem strange, but to those acquainted with current nodes it sounds reasonable. The maximum antenna current, at the particular wave, does tell us that the circuits are in resonance, however, and usually that maximum output is being obtained. It is advisable to lower the antenna current slightly from the maximum value, so that small changes in secondary constants will have little effect on the oscillator. It is better, perhaps, to use looser coupling than to detune the antenna system, as any slight detuning then has little effect.

The antenna series condenser has no effect on the wave of the oscillator; it serves merely to adjust the frequency of the antenna circuit to that of the oscillator. The value of capacity necessity in this condenser is dependent upon the size of the antenna and the number of turns in its coupling coil. On the short waves a small receiving condenser will suffice for the low-power transmitters; this condenser may be double-spaced.



Licensed by Rider Radio Corporation.  
Pat'd 5-22-'16.  
Pat'd 7-27-'26

## Clear Reception Without Oscillation

# "Phasatrol"

**E**NJOY your radio to the utmost this Summer. Prevent oscillations in the set you've built, or the set you own—by installing Phasatrols.

**A True Balancing Device for Radio Frequency Amplifiers**

This amazing new Electrad device is easy to install and adjust. Also makes tuning to full signal strength easy—ends interference to nearby sets.

Your dealer or service man will gladly install Phasatrols. Free hook-up circular and description on request.

Dept. 27  
175 Varick Street,  
New York, N. Y.

## ELECTRAD

## FREE

### NEW 1927 Radio Catalog

**B**EFORE you build or buy a radio be sure to consult our new 100 page catalog—sent to you free. All the latest kits, accessories and parts—a million dollar radio stock to choose from.

### WE SAVE YOU MONEY

We handle only brand new apparatus—standard makes that are fully guaranteed. QUANTITY sale of QUALITY parts explains our low prices. Compare with others and see why thousands of fans look to us as radio headquarters. Write for your copy of this new catalog today.

**Chicago Salvage Stock Store**  
Dept. RN, 509 S. State Street, Chicago, U.S.A.

## BUILD YOUR OWN GRANDFATHER'S CLOCK



—and then build them for your friends and neighbors — Everyone wants one—fine profits, no competition. We furnish blue prints and finishing material, works, dial, pendulum, weights, etc.

Plain works as low as \$5.00, others with chimes at a range of prices to suit every customer.

Ask for Attractive Free Offer  
**AMERICAN CHIME CLOCK COMPANY**

1681 Ruffner St.,  
Philadelphia, Pa.

## MAGIC

Earn \$250 to \$1000 Monthly

New! Different! Teaches you Big Tricks, Hissings, Stage Stunts, "Patter" and the Principles of Magic. Learn at home. Earn \$250 to \$1000 a month. Write today for special offer. **TANBELL SYSTEM, INC.**  
1926 Sunnyside Ave., Studio 10-15 Chicago, Ill.



After the transmitter is operating properly, one may find that better output can be secured by "juggling" the coupling, the filament clip and the grid resistance. Lower grid excitation usually gives a better note and circuit conditions may be varied until a good note, comparatively low plate current and good output, is secured. The top of the antenna is the point of highest voltage and should be well-insulated.

**ANTENNA FORMULA**

A simple, rough rule to follow in selecting the length of the single-wire antenna and counterpoise is to divide the desired operating wavelength by 4, which gives the length for both the antenna and counterpoise in meters; this may be changed to its approximate value in feet by multiplying by 3.

A wire parallel to the ground, such as an ordinary counterpoise, has a higher natural wavelength than a vertical wire of the same length, such as the ordinary short-wave antenna. The counterpoise therefore, should be made somewhat shorter than the aerial, say one foot. With a secondary inductance of 4 turns and of the usual size, the 40-meter antenna should have a length of about 30 feet; the counterpoise, which may be run in any direction, as long as it is kept in the clear, may be made about 29 feet long. It is not important to have great height in a short-wave antenna; but it is extremely important to keep it in the clear so that the radiated wave may at least start off right. Height is not so important on the short waves; because the so-called "ground wave" is rapidly absorbed and the great distances are covered by that part of the radiated energy which is reflected down from an ionized layer above the surface of the earth and usually referred to as the "Heaviside" layer.

**DRILLING THE INSULATORS**

A good lead-in may be made from a pair of pyrex bowls. These are drilled with the aid of a small three-cornered file which has been ground down to a point on a grindstone. The piece of file is set into an ordinary breast-drill and the glass is kept moistened with turpentine during the operation. Two holes are drilled in a piece of boxwood, large enough to allow the ends of the howls to slip through to the glass rim, which holds them securely in place when the wood is fastened down. Other holes are drilled in the wall and the wood is screwed down, holding the bowls securely in place over the holes in the wall. The holes in the bowls should be drilled originally to take a No. 10 wire, so that any convenient size may be used later.

Fine antenna insulators may be made from glass towel bars, which are often 18 inches in length. Thick-walled glass tubing may be looped at its ends in a Bunsen flame, and insulators of this type may be made as long as the tubing.

**POWER SUPPLY**

Dry cells may be used as plate supply for low-power, short-wave transmitters; but a rectifier and transformer arrangement is, of course, more economical in the long run. It is better to have separate transformers, one for the filament supply and one for the plate potential, for when any appreciable current is drawn from the lines there will be a drop in filament voltage when the key is depressed, and this is objectionable. An ordinary "B" socket unit may be successfully used on the lowest-power transmitter with gratifying results. The ordinary 5- and 7½-watt tubes should not be operated at voltages higher than 750, ordinarily, if one is to have cool tubes.

Beginners should not attempt to work at the shorter wavelengths until they understand the operation of the oscillator thoroughly. There are so many stations working in the 40-meter band that this is

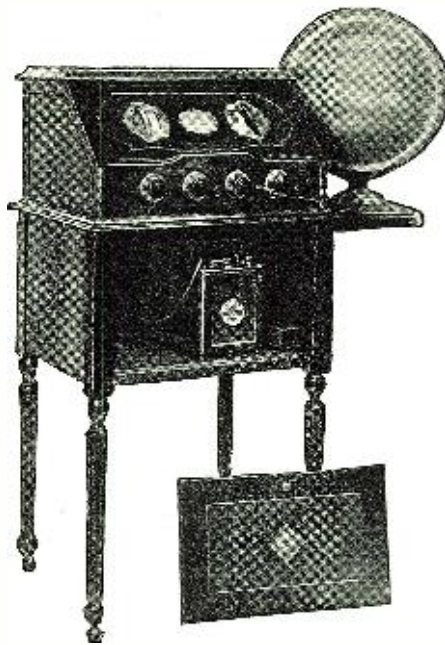

# Light Socket Power for your RADIOLA

**M**ADE especially for Radiola operation, the AC-4 Unipower furnishes ideal "A" current from your light socket. Once Unipower is installed (and it's so easy you can do it yourself!) you are through with trouble from dry "A" batteries. If you want a completely powerized Radiola, just plug a good "B" eliminator into the receptacle in Unipower provided for that special purpose. Unipower controls "B" current automatically.

Unipower eliminates battery fuss and worry. It charges itself automatically at the right rate. If you need rapid charging, Unipower has a special rapid rate in addition to its normal trickle charge. With Unipower no attention is necessary except the occa-

sional addition of distilled water. Even if you forget this, Unipower has an automatic cut-off that prevents damage until you add water.

Unipower is adapted to all Radiolas except Radiola 30. It is made by the makers of the famous Gould Batteries for automobiles, submarines, railways, farm lighting, fire alarm service and emergency city power. Gould Storage Battery Co., Inc., 250 Park Ave., New York.

Unipower AC-4 (for Radiolas) \$33.00.  
For sets using 201A tubes or equivalent — Unipower AC-6-HA, \$42.50.



# Unipower

A GOULD PRODUCT

AUTOMATIC "A" POWER WITH "B" POWER CONTROL

## RADIO CABINETS!

SEVERAL REGULAR MODELS

WE ALSO BUILD CABINETS ESPECIALLY FOR THE LC-27, UNIVALVE, and HAMMARLUND ROBERTS HI-Q RECEIVERS

Write for free catalogue of tables, cabinets, and panels.

Southern Toy Company, Inc., Hickory, N.C.

### WANTED--Radio Merchandise

MORRIS PARK RADIO CO.  
E. 180th St. and Morris Park Ave., New York City

### TELEGRAPHY

(Morse and Wireless) and RAILWAY ACCOUNTING taught thoroughly. Big salaries; great opportunities. Oldest, largest school. Endorsed by Telegraph, Railway, Radio, and Government officials. Expenses low—opportunities to earn large portion. Catalog free. DODGE'S INSTITUTE, Swan Street, Valparaiso, Ind.

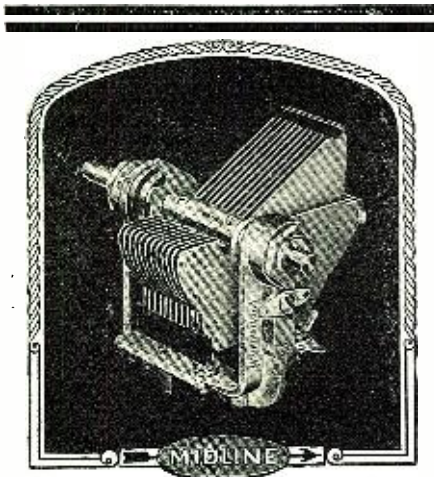

In the New  
**LOFTIN-WHITE**  
Constant-Coupled  
RECEIVER

One of the real sensations of the present radio season, *You will Find*

**HAMMARLUND**  
Condensers and Coils

MESSRS. Loftin and White and twenty-six other well-known designers have paid the highest possible tribute to Hammarlund leadership by officially specifying Hammarlund Precision Products for their newest circuits.

What more convincing evidence could there be of Hammarlund superiority—what better recommendation could you wish before deciding on Hammarlund Condensers and Coils for your receiver?

Write for Descriptive Folder

**HAMMARLUND MFG. CO.**  
424-438 W. 33rd Street, New York City



**FROST-RADIO**

**BAKELITE and METAL FRAME RHEOSTATS**

More than 60 leading set manufacturers are using Frost-Radio Rheostats because they have found they offer utmost value and highest quality at prices that are right. You can pay more than our prices for rheostats but your money will not buy any finer apparatus. Choice of Metal Frame or Bakelite Type, any resistance from 2½ to 75 ohms. List prices: Metal Frame, 50c; Bakelite, 75c. Your dealer can supply you with these and other Frost-Radio products.



Send NOW for our FREE Literature. Write us today for a supply of our valuable folders and booklets telling all about Frost-Radio Rheostats and other items for your set. FREE on request.

**HERBERT H. FROST, Inc.**

160 N. La Salle St. CHICAGO



New York Los Angeles

a good wavelength to select. The complete 20-meter transmitter described in the January RADIO NEWS (see page 840) may be operated successfully at 40 meters with the following modifications:

- Primary coils.....16 turns
  - Antenna.....30 feet long
  - Counterpoise.....about 29 feet long
  - R.F.-choke coil.....100 turns
- Other circuit parts are as given in the previous article, or as herein described.

**Building A 36-Inch Cone Speaker**

(Continued from page 1351)

local and distant stations. Further tests included a different set, with transformer-coupled audio, using the 112 type of tube in the last stage, with 135 volts on the plate, and 9 volts negative grid bias. With this arrangement, greater volume was obtained, together with somewhat better quality, especially when full volume was used. A straight resistance-coupled amplifier was also used, with high- $\mu$  tubes in the first two stages, and the 112 type in the output stage. This amplifier also worked beautifully. Of course, if the larger power tubes, such as the 171 or 210, are available, they should be used, for they will operate the cone more satisfactorily, just as they will any speaker.

One thing is certain: A home-made cone, carefully built and adjusted according to instructions, will work, and work right, provided, of course, that the amplifier is doing its share. And when a 36-inch cone works right, the music has a richness and timbre not even remotely approached by that from the smaller cones and horns; especially on the bass notes, which pour forth with a fine resonant quality that is delightful to hear. The higher frequencies are not by any means slighted, however, and the soft voice of a violin, for instance, is reproduced with marvelous sweetness and purity.

**Beginning Experimental Work**

(Continued from page 1323)

signal strength also decreases until it is hardly audible. Note the result on a piece of paper. Now, without changing any of the tube arrangements or voltages, quickly insert the other radio-frequency transformer, (here the test leads will come in handy), and tune in the same station. This again is done with the meter switch open. Again decrease the resistance until the signal is inaudible. Let us presume that the first radio-frequency transformer gave us an audibility reading of 5 and the second gave a reading of 6. This means that the second signal was stronger because it gave the greatest variation of current in the plate circuit. Therefore, we are quite safe in presuming that the second combination will give the best all-around results. It is, however, best to conduct such a test under various conditions of reception and on both local and DX stations, before final conclusions are drawn.

**USE OF MILLIAMMETER**

It is very often handy to know just how much current is being drawn by the plates of the tubes in a radio circuit. This is best determined by means of having a scale reading from 0 to 50 milliammeters. In order to determine the total drain on the "B" supply, connect the meter in series

**Give Your Radio a Fair Chance!**

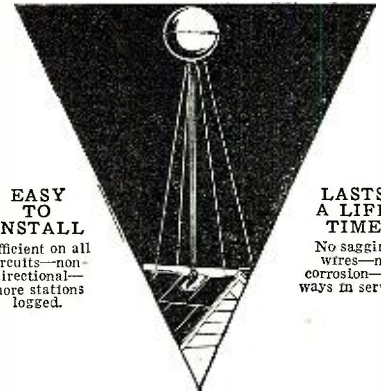

**EASY TO INSTALL**  
Efficient on all circuits—non-directional—more stations logged.

**LASTS A LIFE TIME**  
No sagging wires—no corrosion—always in service.

**"Super Ball" Antenna**

This new Antenna will actually make your set produce results you never thought possible. It will increase the selectivity, clarify the tone and minimize static.

30 Day Unqualified Guarantee By The Manufacturer

See your dealer today. An army of satisfied users in America and Europe.

**YAHR-LANGE**

MILWAUKEE, WIS. INCORPORATED DETROIT, MICH.

**Wonderful New RADIO LIGHT**

Curved Extension Casts Light

Directly On The Dials—No Glare

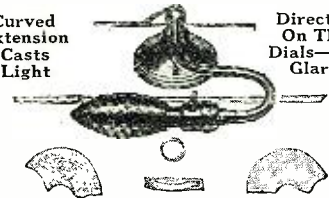

DESIGNED especially for radio use. Adjustable shade permits light to be directed exactly where wanted. Extra long silk cord has standard socket plug.

Finished in beautiful soft bronze over all. Base weighted to prevent tipping.

If dealer cannot supply, send check or money order, amount \$4.00. All charges covered. Money-back guarantee.

VIMCO MFG. COMPANY, INC., 721-C Ellicott Square Buffalo, N. Y.

**VIMCO RADIO LIGHT**

**EL-FONIC**

PARTS FOR PHONO-RADIO COMBINATION SET. See APRIL and subsequent issue of Radio News—article "Combining the Phonograph and Radio."

- Oscillator Coil .....\$3.50
- 2000 Henry Choke .....\$6.00
- Output Unit (Impedance and Condenser in one).....\$6.50

Sent prepaid on receipt of money order. Fully guaranteed. Jobbers and dealers wanted.

Manufactured by

**INTERSTATE SALES CO.**

1142 Broadway New York City



The new specially treated wood panel now used and recommended by leading engineers.

**The Lignole Corporation**

508 S. Dearborn St. Chicago, Illinois

You can be quickly cured if you

**STAMMER**

Send 10 cents for 288-page book on Stammering and Stuttering, "Its Cause and Cure." It tells how I cured myself after stammering 20 yrs. B. N. BOGUE, 6967 Bogue Bldg., 1147 N. Ill. St., Indianapolis.

Insure your copy reaching you each month. Subscribe to RADIO NEWS—\$2.50 a year. Experimenter Publishing Co., 230 Fifth Ave., N. Y. C.

with the "B—" lead as shown in Fig. 9 at MA. To measure the drain of only one tube at a time, connect the meter successively in the positive leads of the various tubes as indicated by the X's in Fig. 9.

The use of a milliammeter is especially valuable for determining the proper grid bias or grid voltage ("C" battery) to be applied to the grid of an audio-frequency amplifier tube. Connect the meter so that it will show the amount of plate current drawn by the particular tube to be adjusted, and tune in a loud signal. The needle will probably fluctuate considerably. Adjust the "C" bias until the needle fluctuates the least under a strong change in signal strength.

**RECORDING YOUR RESULTS**

It is obvious that the suggestions given in the foregoing paragraphs are adaptable to many changes. For instance the experimental table layout can be made to suit any conditions under which the experimenter has to work. Then, too, the audibility meter can be used for testing almost anything from antenna and ground connections to audio-frequency amplifying transformers and grid leaks. Much of the fun of radio is to be found in the comparison of one instrument with another and this can only be done accurately with some sort of measuring instrument, such as the audibility meter described.

There is a final point which must be stressed, and that is that you must always keep records of the results obtained. Otherwise, in a week or so you may have to duplicate your work, just because your memory was not as reliable as you thought it was. Each and every experiment that is carried out should be recorded. Not only must the results be put down, but the particular conditions under which the results were obtained; as well as any unusual phases of apparatus, arrangement, voltages, etc.

Such records as those mentioned are not only valuable to the experimenter himself, but in the past such records have often proved to be of value. For instance, many law suits involving radio patents have been decided by the evidence of memorandum notes made by the experimenter at the time the work was being carried on.

**Ways of Reducing Interference**

(Continued from page 1337)

the shaft may be fitted with a dial or knob.

For instance, in Fig. 9, we have taken a few turns off the secondary coil of the tuner and have replaced them at "P," making it possible to couple to "P" a circuit consisting of a secondary coil and a variable condenser. This secondary coil may be made exactly the same as the secondary coils of the receiver. The coil "P" may consist of perhaps three to five turns of wire wrapped around the secondary "S." This is another form of rejector circuit and when tuned to the wavelength of the interfering station will suppress signals from that station.

It should be possible to remedy, if not cure, any reasonable amount of interference that may arise at the present time by adopting one or the other of these expedients. Each case of interference requires individual attention and treatment. Each case is different, depending upon the local conditions, the number of interfering stations and the power of these stations.

Unless the conditions are extreme the experimenter and listener-in should have no

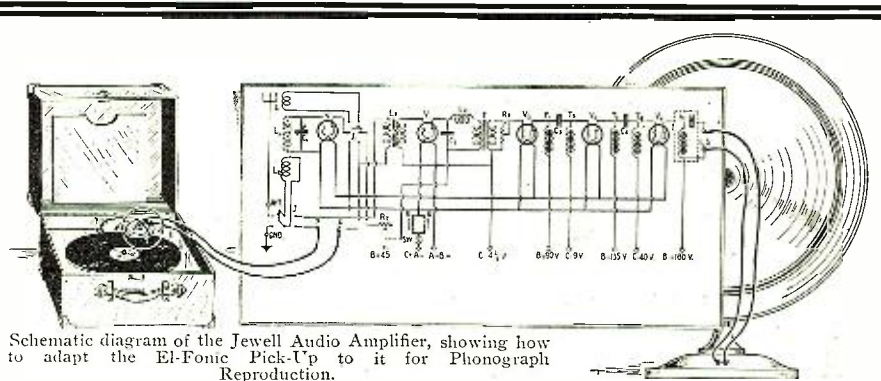

Schematic diagram of the Jewell Audio Amplifier, showing how to adapt the El-Fonic Pick-Up to it for Phonograph Reproduction.

**PRICE \$1450**

Established below list during a limited period for the experimenter only

**FREE**

With every El-Fonic Pick-Up a complete set of blueprints and instructions of how to build the Jewell Audio Amplifier.

And the El-Fonic Phono-Radio Receiver.

*With the*

**EL-FONIC**

*capacity pick up*

**YOU CAN MODERNIZE Your Portable Phonograph**

Put "PEP" and a DANCE PUNCH into it so you will have more than a pig squeal to entertain with, this coming vacation.

A PROFITABLE BUSINESS AWAITS THE AMATEUR AND THE EXPERIENCED RADIO FAN BY ELECTRIFYING OLD MODEL PHONOGRAPHS FOR OTHERS.

The El-Fonic capacity pick-up and the Jewell Audio Amplifier that use the impedance Grid Leak will bring any old model phonograph up to date and the quality of reproduction is far superior to anything that has been accomplished heretofore either in the Phonograph or the Radio.

**EL-FONIC CHOKE**  
2,000 HENRIES GRID IMPEDANCE LEAK

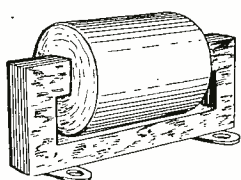

**\$600**

PREVENTS MOTOR BOATING

**BUILD THE EL-FONIC PHONO-RADIO RECEIVER**

and enjoy both Radio and Phonograph as you never have before. The Jewell Audio Amplifier insures perfect reproduction. Complete details in Radio News by F. A. Jewell.

Forwarded by Parcel Post Prepaid upon receipt of remittance.

**ADAMS-SIBLEY DEVELOPMENT CORPORATION**

119 West 63rd St. New York, N. Y.

**POSITIVE ELIMINATION OF**

**INTERFERENCE "WEB" WAVE TRAP**

PRICE \$2.00



Positively eliminates interference. Increases Distance, Increases Volume, Increases Selectivity, Reduces Static. Works on all sets, including loop sets.

ON SALE AT YOUR DEALERS, or will be sent upon receipt of check, money order or cash by the manufacturer, under money back guarantee.

Manufactured by

**WALTER E. BATHGATE CO., Inc., 65 West Broadway, N. Y.**

**PATENTS** As one of the oldest patent firms in America we give inventors at lowest consistent charge, a service noted for results, evidenced by many well known Patents of extraordinary value. Book, Patent-Sense, free. Lacey & Lacey, 631 F St., Wash., D. C. Established 1869.

**RADIO IS BETTER WITH BATTERY POWER**  
NATIONAL CARBON COMPANY, Inc.  
New York San Francisco

# M&H

*Radio's largest kit supply house*

ESTABLISHED 30 YEARS

Build The

## Improved Browning-Drake

The Circuit that has held its popularity for over 3 years . . .

PRICE \$84.85

---

## Samson Push Pull Power Amplifier

PRICE (complete kit) \$45.05

---

## World's Record Super

This famous Super-Het using Scott Transformers, with two filter is working the coast nightly on a loop from Philadelphia.

OUR PRICE \$67.50

---

BUILD THE

## ULTRA "5"

With An Original, Authentic Kit from Radio's Largest Kit House

"The Superhet" Simplified . . . . . Price \$49.75

---

The ONLY SUPER without a Harmonic

## Madison-Moore

WRITE FOR OUR PRICES ON THIS KIT.

---

## Our Circular

IS NOW READY

It Will Pay Set Builders to Send for This

M & H SPORTING GOODS CO.

512 Market Street, Philadelphia, Pa.

*To get the utmost from those new High-Mu tubes*

**D**ESIGNED to official specifications for use with the new Radiotron and Cunningham Resistance-coupled High-Mu tubes, the new Lynch Metallized Resistance Coupled Amplifier Kit will give you perfect tone with full volume. May be used with any receiver. At all good dealers, or by mail, prepaid \$9. Write for literature.

**ARTHUR H. LYNCH, INC.,**  
Member RMA  
250 West 57th St., New York, N. Y.

"LISTEN-IN" on MARS! A WIRELESS from MARS with a big kick! Nine people out of ten ACTUALLY drop it with great astonishment! Send 15c (coin) and "tune-in" on a barrel of laughs!  
**MARS NOVELTY SHOP**  
1914 Crystal St., Chicago, Ill.

difficulty in ameliorating them. But there is one thing which cannot be eliminated at the receiving station: that is heterodyne whistling. This is generated outside the receiver, and the listener-in must accept it until a redistribution of wavelengths is made by those who have the authority to make it.

### A Double-Heterodyne Receiver

(Continued from page 1359)

the rectifier a milliammeter, for the purpose of assisting the operator to adjust the second heterodyne to the mid-point of the second I.F. amplifier band.

#### ADAPTATIONS FOR AMATEUR USE

No doubt those readers who are accustomed to designing and building their own receivers will experience no difficulty in adapting the principle of the double-heterodyne receiver to their own uses. There are several ways in which this can be done. In the first place, of course, a complete outfit can be designed to operate on any desired wavelengths, using intermediate frequencies which need not, of necessity, be the same as those employed in the beam receivers.

For the first I.F. amplifier a wavelength of about 800 or 1,000 meters might be chosen, while for the second I.F. amplifier, a wavelength of about 5,000 would be suitable. Whichever arrangement is adopted, however, very careful shielding will be necessary in order to prevent the various circuits from picking up signals on the wavelengths to which they are tuned. When the arrangement is first tuned, careful adjustment of the intermediate frequencies will also be necessary in order to avoid interference in one or more of the circuits from harmonics of one of the heterodynes.

Those already possessing a superheterodyne can very easily use it in the double-heterodyne arrangement by employing it as the second I.F. amplifier. Its second detector and A.F. stages can then be used as they stand, without further alteration. The only alterations necessary will be in the input circuit. The loop aerial will have to be eliminated and the loop terminals of the set connected to the secondary windings of the filter circuit between the first I.F. circuit and the first detector.

The first I.F. circuit, if the outfit is to be used for ultrashort-wave work, might very well, for experimental purposes, consist of the R.F. portion of a neutrodyne receiver. This would give two or three (as the case may be) very efficient stages of stable first I.F. amplification. Once a suitable wavelength has been found for it to operate upon, the tuning controls of this part of the circuit need never be touched again, unless it is necessary to move them to avoid harmonic interference from the second heterodyne.

The output of the neutralized R.F. stages of the neutrodyne would, of course, have to be disconnected from the detector, and led to the primary of the filter transformer connecting the first I.F. amplifier to the first detector of the superheterodyne unit. This filter would have to be tuned to the wavelength of the first I.F. amplifier.

#### AERIAL INPUT CIRCUIT

The aerial input circuit will have to be built in a special manner. It requires two tubes, one for the first heterodyne and one for the "modulator" circuit.

The entire circuit arrangement is shown in Fig. 2, and values of components are given for an aerial input circuit suitable



Control your "B" eliminator and trickle charger or either automatically with the

### Yaxley Automatic Power Control

Turn on your set and the power control automatically cuts in your "B" eliminator, cutting out your trickle charger. Turn off your set and the control cuts out the "B" eliminator and cuts in your trickle charger. Sure and reliable.

No. 444—Series Type . . . . . \$5.00

At your dealer's. If he cannot supply you send his name with your order to

**Yaxley Mfg. Co.**  
Dept. N, 9 So. Clinton St., Chicago



## Condenser Tissues

**?** IS your Radio set giving trouble? Do the condensers have to be replaced frequently? Are you aware that this annoyance can usually be traced to the use of imperfect condenser tissue paper?

Condensers built with DEXSTAR Condenser Tissue, will give longest service and highest efficiency. ASK your dealer to ask the manufacturers, to use DEXSTAR Tissues only, as insurance against condenser break downs.

**C. H. DEXTER & SONS, Inc.,**  
Specialists on High-Grade Condenser Tissues  
Windsor Locks, Conn.

**Mr. Radio Manufacturer:**  
**Do You Want More Export Business?**  
Man with 15 years merchandising experience desires connection with progressive radio manufacturer wishing to expand his export business, or is desirous of starting an export branch.  
To the progressive radio manufacturer who wishes to more fully develop this highly lucrative market, I desire an opportunity to demonstrate my ability. Salary is not of first consideration. An opportunity is wanted with a wide awake concern, where merit will be recognized.  
Box 265, Radio News, 230 Fifth Ave., N. Y.



**UX POWER TUBES** installed in any set without rewiring by Na-Ald Adapters and Connectoralds. For full information write Alden Manufacturing Co., Dept. K-28, Springfield, Mass.



for reception on 25 to 50 meters. For longer waves the design will, of course, have to be altered. The arrangement shown in Fig. 2 is suggested for experiment, but it is not recommended for general use, because the first heterodyne oscillates on the broadcast waveband, and, being coupled directly to the aerial, it will radiate and cause interference. It is thus better to design a special first I.F. circuit to operate somewhere above 1,000 meters.

When this experimental circuit has been set up and preliminary adjustments made, the only controls which will require manipulation are the condensers C2 and C3 in Fig. 2; i.e., the aerial-tuning condenser and the first heterodyne condenser. All the other controls, once set for most satisfactory operation, remain fixed.

The tuning of such a combination is therefore no more complicated than the tuning of an ordinary superheterodyne; and, as the tuning of the aerial circuit will be somewhat broad, it practically resolves itself into a one-control receiver. In this connection, especially for ultra-short-wave work, the experimenter is advised to use as the first heterodyne condenser an instrument with a very good vernier gear of high ratio; for the tuning here will be exceedingly sharp, and stations will easily be passed over if the control is not fine enough.

Also, as stated above, it will be necessary to screen the first and second I.F. circuits carefully, if this is not already done, in cases where a neutrodyne and a superheterodyne are combined.

In the event of such an adaptation being made use of for experimental purposes, trouble may be looked for in the second detector and A.F. stages of the superheterodyne. Such enormous amplification is obtainable by means of this arrangement that these tubes may easily be overloaded. In such an event either they will have to be replaced by larger tubes or another tube of the same type may be connected in parallel with each socket.

If a seven-tube superheterodyne and the R.F. section of a standard five-tube neutrodyne are employed as adaptors, the total number of tubes required for the entire arrangement amounts to eleven! Hence our opening remarks anent the financial side of the question.

**ENORMOUS AMPLIFICATION OBTAINED**

As to the amount of R.F. amplification which can be obtained by the double-heterodyne method: if the two first I.F. stages are put on a wavelength of about 1,000 meters it is not difficult to get an amplification of six or eight per tube, and a simple resistance method of stabilization can be used.

If we get an amplification of, say, only six per tube, our total amplification for the first I.F. is 36. If we put the second I.F. amplifier on 5,000 meters we shall get an amplification of about 12 per tube; so, with three stages of amplification in the second I.F. we get a total R.F. amplification for the entire outfit of over 60,000! This figure cannot be approached, on ultra-short wavelengths, by any other method of R.F. amplification, and does not take into account the amplification given by the detectors.

There will be no tendency towards interaction for feed-back between the two amplifiers, for they are on different wavelengths, and the wavelengths of both also differ from that of the received signals.

The system can easily be arranged for C.W. reception in a number of ways. One of the amplifiers can be made to self-oscillate to provide an audible beat note, or a third heterodyne circuit can be coupled to the aerial circuit or any of the I.F. stages, and so adjusted that an audible beat note is produced with incoming signals.

# PILOT

## Again Leads the Way to BETTER RADIO with-

### ART-DIAL



A de luxe Velvet-vernier tuning control combining scientific accuracy and artistic appearance. White and black figures in combination give clockwise and counter-clockwise readings. Made the substantial Pilot way to easily carry "gang" condensers without slip or backlash. 95c.

### RESISTOGRAD

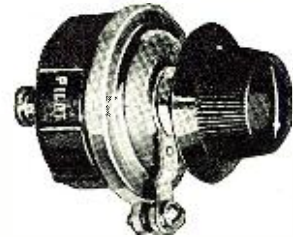

A non-inductive variable Resistor useful as Variable Grid Leak, Oscillation control in T.R.F. circuits, Volume and Regenerative control and as Regulator of voltage output in "B" Battery eliminators. Active compound is hermetically sealed in molded case. Range from practically zero to 30 megohms. \$1.25

### CENTRALINE CONDENSER



(At right) A super-efficient variable condenser with practically no dielectric losses. Its very low minimum capacity brings in low wavelength stations. Very low power factor. Stations are spread equally without crowding. 8 to 23 plates. \$1.90 to \$2.50

Other new Pilot parts include Pilot-lite Illuminated Dial, Pilotran Audio Transformer, Shock Proof Socket.

**BRAZIL**  
Samuel Meyer  
41 Rua Buenos Ayres, Rio Janeiro  
**ARGENTINE**  
Samuel Meyer  
367 Bartolome Mitre, Buenos Aires 1700



**PILOT**  
**ELECTRIC MFG. CO., INC.**  
323 BERRY ST., BROOKLYN, N.Y.

**ENGLAND**  
R. A. Rothermel, Ltd.  
24 & 26 Maddox Street  
Regent St., London, W.1.  
**AUSTRALIA**  
United Distributors, Ltd.  
72 Clarence St., Sydney.

# RADIO NEWS

# MAY BLUEPRINTS

- You can obtain a complete set of Blueprints for these receivers direct from RADIO NEWS
- THE PHONO-RADIO COMBINATION SET  
Radio News Blueprint Article No. 18.....\$1.25
  - THE MODERNIZED BROWNING-DRAKE RECEIVER  
Radio News Blueprint Article No. 19.....\$1.75
  - A NEW PUSH-PULL AMPLIFIER  
Radio News Blueprint Article No. 20.....\$1.25

**Order Direct from RADIO NEWS**

230 FIFTH AVENUE, NEW YORK, N. Y.

**MENTION NAME OF RECEIVER AND ARTICLE NUMBER**

**Supreme** in MUSICAL PERFORMANCE/

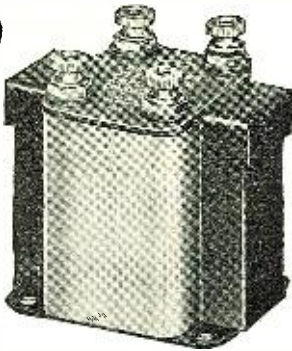

**THORDARSON**

Thordarson transformers are famous for their great tonal purity and are standard equipment on the majority of quality receivers. Unusually faithful reproductive powers. Ideally adapted for use with cone type speakers.

**THORDARSON POWER COMPACT**



The complete power amplifier foundation unit. Contains (1) a power supply transformer, (2) a center tapped filament supply for the power tube, (3) two 30 henry filter chokes, (4) two buffer condensers of 0.1 Mfd. each, — all in one compact filled case. Greatly simplifies wiring of complete power amplifier and B eliminator. Type R-171 for Raytheon rectifier and UX 171 power tube, \$15.00. Type R-210 for UX 216-B rectifier and UX 210 power tube, \$20.00.

SEND FOR THIS FREE BOOKLET POWER from the LIGHT SOCKET

THORDARSON ELECTRIC MFG., CO.  
500 W. Huron St., Chicago, Ill.

Gentlemen: Please send me your booklet "Power from the Light Socket" describing power amplifiers using your new power compacts.

Name .....

Address ..... 3448-A

**Loud Speaker Reception GUARANTEED With MULTIVALVE One Tube Set or Kit**

Multivalve Tube with blue prints of circuit and list of parts ..... **\$6.50**

Multivalve Tube and Coils with blue prints of circuit and list of parts ..... **\$7.50**

Completely Assembled Kit of Standardyne Multivalve Set ready for wiring ..... **\$19.75**

Standardyne Multivalve Set with tube, complete in cabinet ... **\$31.50**

SPARKS RADIO SERVICE CO.  
Dept. R, 35 West 25th St., New York, N. Y.

IMPROVE ANY SET CARBORUNDUM STABILIZING DETECTOR UNIT. CARBORUNDUM GRID LEAKS AND RESISTORS. SEND FOR BOOK-UP BOOK. THE CARBORUNDUM COMPANY, Niagara Falls, N. Y.

**The Radio Act of 1927**

(Continued from page 1318)

licenses granted by Federal authority, and no such license shall be construed to create any right, beyond the terms, conditions, and periods of the license. That no person, firm, company, or corporation shall use or operate any apparatus for the transmission of energy or communications or signals by radio (a) from one place in any Territory or possession of the United States or in the District of Columbia to another place in the same Territory, Possession, or District; or (b) from any State, Territory, or possession of the United States, or from the District of Columbia to any other State, Territory, or possession of the United States; or (c) from any place in any State, Territory, or possession of the United States, or in the District of Columbia, to any place in any foreign country or to any vessel; or (d) within any State when the effects of such use extend beyond the borders of said State, or when interference is caused by such use or operation with the transmission of such energy, communications, or signals from within said State to any place beyond its borders, or from any place beyond its borders to any place within said State, or with the transmission or reception of such energy, communications, or signals from and/or to places beyond the borders of said State; or (e) upon any vessel of the United States; or (f) upon any aircraft or other mobile stations within the United States, except under and in accordance with this Act and with a license in that behalf granted under the provisions of this Act.

Section 2. For the purposes of this Act, the United States is divided into five zones, as follows. The first zone shall embrace the States of Maine, New Hampshire, Vermont, Massachusetts, Connecticut, Rhode Island, New York, New Jersey, Delaware, Maryland, the District of Columbia, Porto Rico, and the Virgin Islands; the second zone shall embrace the States of Pennsylvania, Virginia, West Virginia, Ohio, Michigan, and Kentucky; the third zone shall embrace the States of North Carolina, South Carolina, Georgia, Florida, Alabama, Tennessee, Mississippi, Arkansas, Louisiana, Texas, and Oklahoma; the fourth zone shall embrace the States of Indiana, Illinois, Wisconsin, Minnesota, North Dakota, South Dakota, Iowa, Nebraska, Kansas, and Missouri; and the fifth zone shall embrace the States of Montana, Idaho, Wyoming, Colorado, New Mexico, Arizona, Utah, Nevada, Washington, Oregon, California, the Territory of Hawaii, and Alaska.

Section 3. That a commission is hereby created and established to be known as the Federal Radio Commission, hereinafter referred to as the commission, which shall be composed of five commissioners appointed by the President, by and with the advice and consent of the Senate, and one of whom the President shall designate as chairman: **Provided**, That chairmen thereafter elected shall be chosen by the commission itself.

Each member of the commission shall be a citizen of the United States and an actual resident citizen of a State within the zone from which appointed at the time of said appointment. Not more than one commissioner shall be appointed from any zone. No member of the commission shall be financially interested in the manufacture or sale of radio apparatus or in the transmission or operation of radiotelegraphy, radiotelephony, or radio broadcasting. Not more than three commissioners shall be members of the same political party.

The first commissioners shall be appointed for the terms of two, three, four, five, and six years, respectively, from the date of the taking effect of this Act, the term of each to be designated by the President, but their successors shall be appointed for terms of six years, except that any person chosen to fill a vacancy shall be appointed only for the unexpired term of the commissioner whom he shall succeed.

The first meeting of the commission shall be held in the city of Washington at such time and place as the chairman of the commission may fix. The commission shall convene thereafter at such times and places as a majority of the commission may determine, or upon call of the chairman thereof.

The commission may appoint a secretary, and such clerks, special counsel, experts, examiners, and other employees as it may from time to time find necessary for the proper performance of its duties and as from time to time may be appropriated for by Congress.

The commission shall have an official seal and shall annually make a full report of its operations to the Congress.

The members of the commission shall receive a compensation of \$10,000 for the first year of their service, said year to date from the first meeting of said commission, and thereafter a compensation of \$9,000 per day for each day's attendance upon sessions of the commission or while engaged upon work of the commission and while traveling to and from such sessions, and also their necessary traveling expenses.

Section 4. Except as otherwise provided in this Act, the commission, from time to time, as public convenience, interest, or necessity requires, shall—

- (a) Classify radio stations;
- (b) Prescribe the nature of the service to be rendered by each class of licensed stations and each station within any class;
- (c) Assign bands of frequencies or wave lengths to the various classes of stations, and assign frequencies or wave lengths for each individual station and determine the power which each station shall use and the time during which it may operate;
- (d) Determine the location of classes of stations or individual stations;
- (e) Regulate the kind of apparatus to be used with respect to its external effects and the purity and sharpness of the emissions from each station and from the apparatus therein;
- (f) Make such regulations not inconsistent with law as it may deem necessary to prevent interference between stations and to carry out the provisions of this Act: **Provided, however**, That changes in the wave lengths, authorized power, in the character of emitted signals, or in the times of operation of any station, shall not be made without the consent of the station licensee unless, in the judgment of the commission, such changes will serve public necessity or the provisions of this Act will be more fully complied with;
- (g) Have authority to establish areas or zones to be served by any station;
- (h) Have authority to make special regulations applicable to radio stations engaged in chain broadcasting; and have authority to make general rules and regulations requiring stations to keep such records of programs, transmissions of energy, communications, or signals as it may deem desirable;
- (j) Have authority to exclude from the requirements of any regulations in whole or in part any radio station upon railroad rolling stock, or to modify such regulations in its discretion;

**Lundstrom**  
IT GROWS WITH YOUR LIBRARY  
**SECTIONAL BOOKCASE**  
Endorsed by Over 100,000 Users

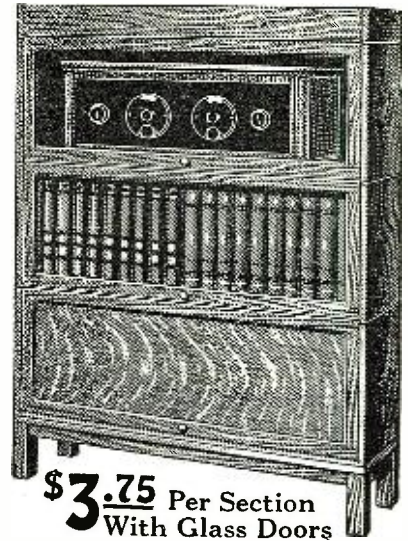

**\$3.75** Per Section  
With Glass Doors

**On Approval—Direct to User**

Made for and universally used in the finest homes and offices throughout the country. Made in sections of different sizes, combining utility, economy and attractive appearance. Equally well adapted for books or radio. Wood panel in lower door to conceal batteries. Price complete as shown above, with top, base and three book sections with non-binding, disappearing, felt-cushioned glass doors in upper two book sections, wood panel door in lower book section, beautifully finished in plain golden oak, \$16.25. In quartered oak, or in imitation mahogany (willow), with doors, \$18.75. In genuine Mahogany, with doors, \$24.00. Other styles at correspondingly low prices. Shipped direct from factory ON APPROVAL at a considerable saving TO YOU. Write for new catalog No. 66-R.

The C. J. Lundstrom Mfg. Co., Little Falls, N. Y.  
Manufacturers of Sectional Bookcases since 1899  
Branch Office and Warehouse: Kansas City, Mo.



Trade Mark Reg'd U. S. Pat. Office

**FIXED CONDENSERS for EVERY PURPOSE**

Time-Tested, Reliable, Accurate

**Tobe Deutschmann Co.**

Cambridge Mass.

**FREE New 1927 Catalog FREE**

Shows photographs and hook-ups of all latest kits, complete line of cabinets and consoles, accessories and parts. We are headquarters for all nationally advertised lines. Dealers and professional set builders write today for your copy of this big FREE CATALOG.

SHURE RADIO CO., 333A-335 W. Madison St., Chicago

**C. L. PARKER**

Ex-Examiner U. S. Patent Office

Attorney-at-Law and Solicitor of Patents

McGill Building, Washington, D. C.

Patent, Trade Mark and Copyright Law



(k) Have authority to hold hearings, summon witnesses, administer oaths, compel the production of books, documents, and papers and to make such investigations as may be necessary in the performance of its duties. The commission may make such expenditures (including expenditures for rent and personal services at the seat of government and elsewhere, for law books, periodicals, and books of reference, and for printing and binding) as may be necessary for the execution of the functions vested in the commission and, as from time to time may be appropriated for by Congress. All expenditures of the commission shall be allowed and paid upon the presentation of itemized vouchers therefor approved by the chairman.

Section 5. From and after one year after the first meeting of the commission created by this Act, all the powers and authority vested in the commission under the terms of this Act, except as to the revocation of licenses, shall be vested in and exercised by the Secretary of Commerce; except that thereafter the commission shall have power and jurisdiction to act upon and determine any and all matters brought before it under the terms of this section.

It shall also be the duty of the Secretary of Commerce—

(A) For and during a period of one year from the first meeting of the commission created by this Act, to immediately refer to the commission all applications for station licenses or for the renewal or modification of existing station licenses.

(B) From and after one year from the first meeting of the commission created by this Act, to refer to the commission for its action any application for a station license or for the renewal or modification of any existing station license as to the granting of which dispute, controversy, or conflict arises or against the granting of which protest is filed within ten days after the date of filing said application by any party in interest and any application as to which such reference is requested by the applicant at the time of filing said application.

(C) To prescribe the qualifications of station operators, to classify them according to the duties to be performed, to fix the forms of such licenses, and to issue them to such persons as he finds qualified.

(D) To suspend the license of any operator for a period not exceeding two years upon proof sufficient to satisfy him that the licensee (a) has violated any provision of any Act or treaty binding on the United States which the Secretary of Commerce or the commission is authorized by this Act to administer or by any regulation made by the commission or the Secretary of Commerce under any such Act or treaty; or (b) has failed to carry out the lawful orders of the master of the vessel on which he is employed; or (c) has willfully damaged or permitted radio apparatus to be damaged; or (d) has transmitted superfluous radio communications or signals or radio communications containing profane or obscene words or language; or (e) has willfully or maliciously interfered with any other radio communications or signals.

(E) To inspect all transmitting apparatus to ascertain whether in construction and operation it conforms to the requirements of this Act, the rules and regulations of the licensing authority, and the license under which it is constructed or operated.

(F) To report to the commission from time to time any violations of this Act, the rules, regulations, or orders of the commission, or of the terms or conditions of any license.

(G) To designate call letters of all stations.

(H) To cause to be published such call letters and such other announcements and data as in his judgment may be required for the efficient operation of radio stations subject to the jurisdiction of the United States and for the proper enforcement of this Act.

The Secretary may refer to the commission at any time any matter the determination of which is vested in him by the terms of this Act.

Any person, firm, company, or corporation, any State or political division thereof aggrieved or whose interests are adversely affected by any decision, determination, or regulation of the Secretary of Commerce may appeal therefrom to the commission by filing with the Secretary of Commerce notice of such appeal within thirty days after such decision or determination or promulgation of such regulation. All papers, documents, and other records, pertaining to such application on file with the Secretary shall thereupon be transferred by him to the commission. The commission shall hear such appeal de novo under such rules and regulations as it may determine.

Decisions by the commission as to matters so appealed and as to all other matters over which it has jurisdiction.

**AMAZING STORIES** IN OUR MAY ISSUE

**THE MOON POOL.** by A. Merritt, ranks first for astounding situations and extraordinary science. Here the author invents an incredibly amazing science, which is neither electricity nor light nor anything you have ever thought of. And every chapter is chock-full of astounding adventure that will sustain your breathless interest throughout.

**THE TIME MACHINE.** Long before Einstein pronounced his theory, H. G. Wells had written this famous story, which tells how an inventor perfects a most ingenious machine which projects him into the future, so he can see what the world will look like, not hundreds, but thousands of years hence.

**THE STAR OF DEAD LOVE,** by Will H. Gray. One of the most charming tales it has been our good fortune recently to read. The scheme is so novel, the science so good, that we do not wish to give it away in advance.

**THE MAN WHO WAS,** by Walter Burch. This new author presents a most unusual tangle that might happen if you should discover something that you were supposed to have been dead.

**THE SINGING WEAPON,** by Bent Prout. Practically everything in nature has its fundamental vibratory reaction. If the note is powerful and persistent enough, objects may even be shattered. The present story has this phenomenon as its basis.

BUILDERS AND OPERATORS OF AMERICA'S FIRST RADIO OPERATED AUTOMOBILE

**HOUDINA RADIO CONTROL CO**

RADIO AND ELECTRICAL ENGINEERS

119 DOTY STREET

KAUKAUNA, WISCONSIN

Address reply to:

Nov. 20th 1926

Electric Specialty Co  
South Street  
Stamford Ct.

Gentlemen:

This is to advise that we have been using an "ES20" Dynamotor for almost two years to supply the plate current for the tubes of our Radio Station "2XAX" which we use to control "America's First Radio Operated Automobile"

This Dynamotor is operated on 6-3 Volt Storage Battery source and we have found it functioning properly at all times, under all conditions and in all kinds of weather.

We do not hesitate to recommend "ES20" products because we know they are meritorious.

Respectfully yours  
HOUDINA RADIO CONTROL CO.

ES/14

**\$75.00 A WEEK BUILDING RADIO SETS**  
—in your spare time

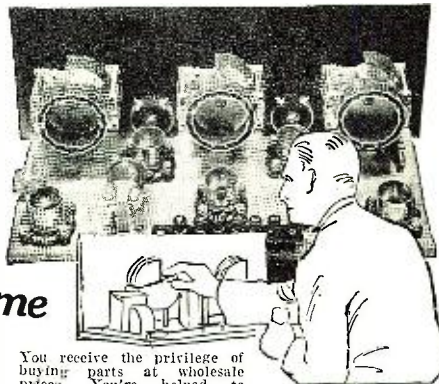

Join the Radio Association of America. Learn how to build and repair radio sets. The Association will train you—start you out in business if you wish. Be the radio "doctor" of your community. \$3 an hour upwards easily made. Radio offers you a big money-making opportunity right now.

You receive the privilege of buying parts at wholesale prices. You're helped to make money.

**JOIN THE ASSOCIATION NOW**

If you're interested in Radio for either pleasure or profit, join the Association without delay, because we have a plan whereby your membership may not—need not—cost you a cent. Only a limited number of these memberships are acceptable. Write now for details. Write before it's too late.

This Association has prepared a beautiful book that gives figure-facts regarding the profit possibilities of the Radio Industry, the purpose of the Association, and the details of the Special Membership Plan.

**MAIL THIS COUPON**

RADIO ASSOCIATION OF AMERICA  
Dept. RN-5—4513 Ravenswood Ave., Chicago.

Send me your book and details of your Special Membership Plan.

Name .....

Address .....

City ..... State.....

**EARN \$500 IN SPARE HOURS**

"I have at last found myself," writes Lyle Fotlick, Lansing, Michigan. "I have already made over \$500 building radio sets after working hours." Werner Eichler, Rochester, N. Y., writes, "I have made over \$50 a week in my spare time."

Our members are starting radio stores, increasing their incomes, securing better positions, earning big money for the most enjoyable kind of spare-time work.

**WHAT A MEMBERSHIP MEANS**

A membership in the radio Association of America enables you to get into radio and make money from the start.

You're taught how to build and repair all kinds of sets.

**DO NOT BUY A NEW SET**  
before you try one of our super power amplifier and power supply units.

**The MAGNIPOWER or the ANODYNE**

plugged on your present set will transform it into a modern receiver giving beautiful reproduction and startling quality with plenty of power. The results will amaze you.

These new products designed by  
**R. E. LACAULT, E. E.**  
Originator of the famous ULTRADYNE are described in a free pamphlet.  
Ask for it.

**Super Heterodyne construction and operation by R. E. LACAULT, E. E.**

is a very complete treatise on the subject. It also contains the complete constructional details on the new L. R. 4..... **Price \$1.97**  
Set of four accurate full size drawings for the construction of the L. R. 4 receiver..... **Price \$1.00**

**The R. E. LACAULT**  
RADIO ELECTRIC LABORATORIES  
1931 Broadway and 116 West 65th Street New York City

# WORLD Radio Units Save You 50%

**"A" Current**  
From  
**Your  
Light  
Socket**  
World



**"A" POWER UNIT**

Automatically provides even, unvarying "A" current from the moment you throw on your set switch. A marvelous improvement—at less than half the cost of any similar equipment. Finer reception, uninterrupted by "fadesouts" and "screeches." Absolutely noiseless. Assures full tone quality from your set and wider D X range. Shipped complete, subject to inspection, on receipt of price—or C. O. D. if you wish.

**\$12.75** Complete

25 Amp. Unit for sets of 4 tubes or less —\$12.75  
60 Amp. Unit for sets of 5 tubes or more—\$15.75

## Clearest Truest "B" Power with World Radio Storage



**"B" Batteries** 12 Cell  
24 Volt

Sturdy construction. Solid Rubber Case protection. Recharged for almost nothing. Endorsed and listed as standard by Radio News Lab., Pop. Radio Lab., Pop. Sel. Inst. Standards, Lefax, Inc. and other famous Radio Authorities.

Just state number wanted, and we will ship same day order is received by Express, C. O. D., subject to examination. 5% discount for cash with order.

Extra Offer: 4 Batteries in series (96 volts) \$10.50.

### Radio Storage "A" Battery—6 Volt

Unequaled battery value! 25 ampere capacity. Ideal for Trickle Charger. Solid Rubber Case. Shipped C. O. D. subject to inspection, for only \$5.00. Send to-day. 5% discount for cash with order on any World Unit.



**\$5.00**

**WORLD BATTERY COMPANY**  
1219 So. Wabash Avenue  
Dept. 75 Chicago, Illinois

*Set your radio dials at 288.3 meters for the  
World Storage Battery Station W S B C.  
Variety—New Talent—Always Interesting.*

## HAMPTON-WRIGHT'S Spring Economy Catalog Will Bring Your Radio Up To Date!

The new issue is now ready—carrying the latest radio developments that will prove a genuine pleasure and help to radio fans and set builders. This great radio organization is at your service as soon as you write for your free copy of the catalog.

*Specify catalog B-8*

**HAMPTON-WRIGHT**  
P. O. BOX 181 INDIANAPOLIS

## SENT FREE

Quadraformer Book FREE, showing how to improve results amazingly wherever Tuned Radio Frequency Transformers are specified.

**WRITE FOR YOUR COPY TODAY**

**Gearhart Schlueter Radio Corporation**  
1719 Van Ness Ave. Fresno, Calif.

For Absolute Tone Fidelity hear a FERGUSON RECEIVER. Ask the nearest Authorized Ferguson Dealer or write us. J. B. FERGUSON, Inc., 225 West 57th St., New York, N. Y.

tion shall be final, subject to the right of appeal herein given.

No station license shall be granted by the commission or the Secretary of Commerce until the applicant therefor shall have signed a waiver of any claim to the use of any particular frequency or wave length or of the ether as against the regulatory power of the United States because of the previous use of the same, whether by license or otherwise.

Section 6. Radio stations belonging to and operated by the United States shall not be subject to the provisions of sections 1, 4 and 5 of this Act. All such Government stations shall use such frequencies or wave lengths as shall be assigned to each or to each class by the President. All such stations, except stations on board naval and other Government vessels while at sea or beyond the limits of the continental United States, when transmitting any radio communication or signal other than a communication or signal relating to Government business shall conform to such rules and regulations designed to prevent interference with other radio stations and the rights of others as the licensing authority may prescribe. Upon proclamation by the President that there exists war or a threat of war or a state of public peril or disaster or other national emergency, or in order to preserve the neutrality of the United States, the President may suspend or amend, for such time as he may see fit, the rules and regulations applicable to any or all stations within the jurisdiction of the United States as prescribed by the licensing authority, and may cause the closing of any station for radio communication and the removal therefrom of its apparatus and equipment, or he may authorize the use or control of any such station and/or its apparatus and equipment by any department of the Government under such regulations as he may prescribe, upon just compensation to the owners. Radio stations on board vessels of the United States Shipping Board or the United States Shipping Board Emergencery Fleet Corporation or the Inland and Coastwise Waterways Service shall be subject to the provisions of this Act.

Section 7. The President shall ascertain the just compensation for such use or control and certify the amount ascertained to Congress for appropriation and payment to the person entitled thereto. If the amount so certified is unsatisfactory to the person entitled thereto, such person shall be paid only 75 per centum of the amount and shall be entitled to sue the United States to recover such further sum as added to such payment of 75 per centum which will make such amount as will be just compensation for the use and control. Such suits shall be brought in the manner provided by paragraph 20 of section 24, or by section 145 of the Judicial Code, as amended.

Section 8. All stations owned and operated by the United States, except mobile stations of the Army of the United States, and all other stations on land and sea, shall have special call letters designated by the Secretary of Commerce.

Section 1 of this Act shall not apply to any person, firm, company, or corporation sending radio communications or signals on a foreign ship while the same is within the jurisdiction of the United States, but such communications or signals shall be transmitted only in accordance with such regulations designed to prevent interference as may be promulgated under the authority of this Act.

Section 9. The licensing authority, if public convenience, interest, or necessity will be served thereby, subject to the limitations of this Act, shall grant to any applicant therefor a station license provided for by this Act.

In considering applications for licenses and renewals of licenses, when and in so far as there is a demand for the same, the licensing authority shall make such a distribution of licenses, bands of frequency or wave lengths, periods of time for operation, and of power among the different States and communities as to give fair, efficient, and equitable radio service to each of the same.

No license granted for the operation of a broadcasting station shall be for a longer term than three years and no license so granted for any other class of station shall be for a longer term than five years, and any license granted may be revoked as hereinafter provided upon the expiration of a license, upon application therefor, a renewal of such license may be granted from time to time for a term not to exceed three years in the case of broadcasting licenses and not to exceed five years in the case of other licenses.

No renewal of an existing station license shall be granted more than thirty days prior to the expiration of the original license.

Section 10. The licensing authority may grant station licenses only upon written application therefor addressed to it. All applications shall be filed with the Secretary of Commerce. All such applications shall set forth such facts as the licensing authority by regulation may prescribe as to the citizenship, character, and financial, technical, and other qualifications of the applicant to operate the station; the ownership and location of the proposed station and of the stations, if any, with which it is proposed to communicate; the frequencies or wave lengths and the power desired to be used in the hours of the day or other periods of time during which it is proposed to operate the station; the purposes for which the station is to be used; and such other information as it may require. The licensing authority at any time after the filing of such original application and during the term of any such license, may require from an applicant or licensee further written statements of fact to enable it to determine whether such original application should be granted or denied or such license revoked. Such application and/or such statement of fact shall be signed by the applicant and/or licensee under oath or affirmation.

The licensing authority in granting any license for a station intended or used for commercial communication between the United States or any Territory or possession, continental or insular, subject to the jurisdiction of the United States, and any foreign country, may impose any terms, conditions, or restrictions authorized to be imposed with respect to submarine-cable licenses by section 2 of an Act entitled "An Act relating to the landing and the operation of submarine cables in the United States," approved May 24, 1921.

Section 11. If upon examination of any application for a station license or for the renewal or modification of a station license the licensing authority shall determine that public interest, convenience, or necessity would be served by the granting thereof, it shall authorize the issuance, renewal, or modification thereof in accordance with said findings. In the event the licensing authority upon examination of any such application does not reach such decision with respect thereto, it shall notify the applicant thereof, shall fix and give notice of a time and place for hearing thereon, and shall afford such applicant an opportunity to be heard under such rules and regulations as it may prescribe.

Such station licenses as the licensing authority may grant shall be in such general form as it may prescribe, but each license shall contain, in addition to other provisions, a statement of the following conditions to which such license shall be subject:

(A) The station license shall not vest in the licensee any right to operate the station nor any right in the use of the frequencies or wave length designated in the license beyond the term thereof nor in any other manner than authorized therein.

(B) Neither the license nor the right granted thereunder shall be assigned or otherwise transferred in violation of this Act.

(C) Every license issued under this Act shall be subject

# Goodrich



## Radio Panels Will Not Warp

Black, Mahogany and Walnut.  
Standard thickness 3-16" and 1/4".  
High softening point prevents warping.  
Low free sulphur content prevents discoloration.  
Machine easier and are better electrically than any other material in common use.

Your radio dealer has them or will get them for you—if not, write to us and we will see that you are supplied.

*Hard Rubber Division*  
**The B. F. Goodrich Rubber Company**  
Established 1870 • Akron, Ohio

## THESE COILS IMPROVE ANY RADIO RECEIVER!



**T.R.F. KIT** List \$12.00

This set of supersensitive Aero Tuned Radio Frequency Coils has never failed to improve the performance of any radio receiver. Tremendously increased power, extreme selectivity, and improved tone quality are sure to result from their use. This kit of Aero Coils has a much lower high frequency resistance than other types of inductances. You should use them in any circuit, if you want the best possible results.

**FREE** Big 8-page 4-colored layout system (actual size blue prints) and complete instructions for building the 5-tube Aero-Dyne Receiver free with each kit. Also insert showing how to wire for a power tube if desired. Extra copies, 75c each.

*Get these Aero coils from your dealer. If he is out of stock, order direct from the factory.*

**AERO PRODUCTS, INC.**  
Dept. 105, 1772 Wilson Ave. Chicago, Ill.

## SO GOOD!

Not just So-So. The RADIO you build with the genuine

# NATIONAL

RADIO PRODUCTS  
National Co., Inc., Cambridge, Mass.

### KARAS EQUAMATIC MANUAL 10c

MAIL 10c today for complete Manual of Karas Equamatic 5-Tube Sensation. Contains simple instructions and complete wiring diagrams for building this great receiver—the most powerful and most selective 5-tube radio frequency receiver ever designed. Address

**KARAS ELECTRIC CO.,**  
1124 Association Bldg. Chicago

## PATENTS

**DON'T LOSE YOUR RIGHTS**  
Before disclosing your invention to anyone send for free blank form "EVIDENCE OF CONCEPTION" to be signed and witnessed.

**LANCASTER & ALLWINE**  
Reg. Pat. Atty. in U. S. and Canada  
270 Ouray Bldg., Washington, D. C.  
Originators of the form "Evidence of Conception"





In terms to the right of use or control conferred by section 6 hereof.

In cases of emergency arising during the period of one year from and after the first meeting of the commission created hereby, or on applications filed during said time for temporary changes in terms of licenses when the commission is not in session and prompt action is deemed necessary, the Secretary of Commerce shall have authority to exercise the powers and duties of the commission, except as to revocation of licenses, but all such exercise of powers shall be promptly reported to the members of the commission, and any action by the Secretary authorized under this paragraph shall continue in force and have effect only until such time as the commission shall act thereon.

Section 12. The station license required hereby shall not be granted to, or after the granting thereof such license shall not be transferred in any manner, either voluntarily or involuntarily, to (a) any alien or the representative of any alien; (b) to any foreign government, or the representative thereof; (c) to any company, corporation, or association organized under the laws of any foreign government; (d) to any company, corporation, or association of which any officer or director is an alien, or of which more than one-fifth of the capital stock may be voted by aliens or their representatives or by a foreign government or representative thereof, or by any company, corporation, or association organized under the laws of a foreign country.

The station license required hereby, the frequencies or wave length or lengths authorized to be used by the licensee, and the rights therein granted shall not be transferred, assigned, or in any manner, either voluntarily or involuntarily, disposed of to any person, firm, company, or corporation without the consent in writing of the licensing authority.

Section 13. The licensing authority is hereby directed to refuse a station license and/or the permit hereinafter required for the construction of a station to any person, firm, company, or corporation, or any subsidiary thereof, which has been found guilty by any Federal court of unlawfully monopolizing or attempting unlawfully to monopolize, after this Act takes effect, radio communication, directly or indirectly, through the control of the manufacture or sale of radio apparatus, through exclusive traffic arrangements, or by any other means or to have been using unfair methods of competition. The granting of a license shall not estop the United States or any person aggrieved from proceeding against such person, firm, company, or corporation for violating the law against unfair methods of competition or for a violation of the law against unlawful restraints and monopolies and/or combinations, contracts, or agreements in restraint of trade, or from instituting proceedings for the dissolution of such firm, company, or corporation.

Section 14. Any station license shall be revocable by the commission for false statements either in the application or in the statement of fact which may be required by section 10 hereof, or because of conditions revealed by such statements of fact as may be required from time to time which would warrant the licensing authority in refusing to grant a license or an original application, or for failure to operate substantially as set forth in the license, for violation of or failure to observe any of the restrictions and conditions of this Act, or of any regulation of the licensing authority authorized by this Act or by a treaty ratified by the United States, or whenever the Interstate Commerce Commission, or any other Federal body in the exercise of authority conferred upon it by law, shall find and shall certify to the commission that any licensee bound so to do, has failed to provide reasonable facilities for the transmission of radio communications, or that any licensee has made any unjust and unreasonable charge, or has been guilty of any discrimination, either as to charge or as to service or has made or prescribed any unjust and unreasonable classification, regulation, or practice with respect to the transmission of radio communications or service: Provided, That on such order of revocation shall take effect until thirty days' notice in writing thereof, stating the cause for the proposed revocation, has been given to the parties known by the commission to be interested in such license. Any person in interest aggrieved by said order may make written application to the commission at any time within thirty days for a hearing upon such order, and upon the filing of such written application such order of revocation shall stand suspended until the conclusion of the hearing herein directed. Notice in writing of said hearing shall be given by the commission to all the parties known to it to be interested in such license twenty days prior to the time of said hearing. Said hearing shall be conducted under such rules and in such manner as the commission may prescribe. Upon the conclusion hereof the commission may affirm, modify, or revoke said orders of revocation.

Section 15. All laws of the United States relating to unlawful restraints and monopolies and to combinations, contracts, or agreements in restraint of trade are hereby declared to be applicable to the manufacture and sale of and to trade in radio apparatus and devices entering into or affecting interstate or foreign commerce and to interstate or foreign radio communications. Whenever in any suit, action, or proceeding, civil or criminal, brought under the provisions of any of said laws or in any proceeding brought to enforce or to review findings and orders of the Federal Trade Commission or other governmental agency in respect of any matters as to which said commission or other governmental agency is by law authorized to act, any licensee shall be found guilty of the violation of the provisions of such law or any of them, the court, in addition to the penalties imposed by said laws, may adjudge, order, and/or decree that the license of such licensee shall, as of the date the decree or judgment becomes finally effective or as of such other date as the said decree shall fix, be revoked and that all rights under such license shall thereupon cease; Provided, however, That such licensee shall have the same right of appeal or review as is provided by law in respect of other decrees and judgments of said court.

Section 16. Any applicant for a construction permit, for a station license, or for the renewal or modification of an existing station license whose application is refused by the licensing authority shall have the right to appeal from said decision to the Court of Appeals of the District of Columbia; and any licensee whose license is revoked by the commission shall have the right to appeal from such decision of revocation to said Court of Appeals of the District of Columbia or to the district court of the United States in which the apparatus licensed is operated, by filing with said court, within twenty days after the date that such decision is effective, notice in writing of said appeal and of the reasons therefor.

The licensing authority from whose decision an appeal is taken shall be notified of said appeal by service upon it, prior to the filing thereof, of a certified copy of said appeal and of the reasons therefor. Within ten days after the filing of said appeal the licensing authority shall file with the court the originals or certified copies of all papers and evidence presented to it upon the original application for a permit or license or in the hearing upon said order of revocation, and also a like copy of its decision thereon and a full statement in writing of the facts and the grounds for its decision as found and given by it. Within twenty days after the filing of said statement by the licensing authority either party may give notice to the court of his desire to adduce additional evidence. Said notice shall be in the form of a verified petition stating the nature and character of said additional evidence, and the court may thereupon order such evidence to be taken in such manner and upon such terms and conditions as it may deem proper.

At the earliest convenient time the court shall hear, review, and determine the appeal upon said record and evidence, and may after or revise the decision appealed from and enter such judgment as to it may seem just. The

# 90 volt "B" POWER UNIT

## \$12<sup>75</sup>

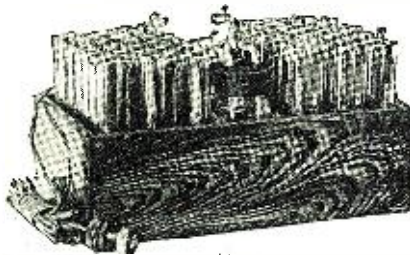

ALREADY hundreds and hundreds have adapted this radically new Power Unit. Unconditional guaranteed not to produce the slightest trace of a hum, line noises, etc. Gives well known battery results with true eliminator simplicity minus the usual hums, costly replacements and doubtful results. Simply plug into your house socket and forget it! Works upon any 110- to 120-volt alternating current line and any cycle, even 25-cycle, which is the bugaboo of all eliminators. Costs approximately one-tenth cent per hour of operation. Comes complete—nothing to purchase extra. Contains no acid. Simpler to hook up than dry cells as all special detector voltages, intermediate and amplifying voltages are all plainly marked. Operates any 1 to 10 tube set.

Prices—only slightly higher than dry cells. Such true, smashing value—with absolute unbelievable results that my 5-year-old, 30-day trial offer refund applies, if it does not meet with your every desire. 90 volts \$12.75, 112½ volts \$15.25, 135 volts \$17.50. Knock-down kits at still greater savings. Also built for 32-volt home lighting plants in any above sizes at only \$3.00 additional. Special or higher voltages built to order. Ample stocks all packed—and same day shipments. Guaranteed for 2 years. Simply say—ship C. O. D. and we'll do the rest, or write for my literature, testimonials, etc.

### New TRICKLE "B" CHARGER

Full-Wave, Noiseless type. Charges any wet, rechargeable "B" storage battery from 90 to 150 volts. Can be left on when receiving. No costly rectifying bulbs to break or burn out. Price \$3.75 complete.

**B. HAWLEY SMITH, 321 Washington Ave., Danbury, Conn., U. S. A.**

*Mr. of "A" Power Units, "B" Power Units, "A" Storage Batteries, "B" Storage Batteries and "A" and "B" Chargers including Trickle*

# SPECIFIED

by the builders of the following receivers

- THE IMPROVED BROWNING-DRAKE
- THE PHONO-RADIO SET
- THE ACME LOOP OPERATED D COIL RECEIVER
- THE SAMSON PUSH-PULL POWER AMPLIFIER

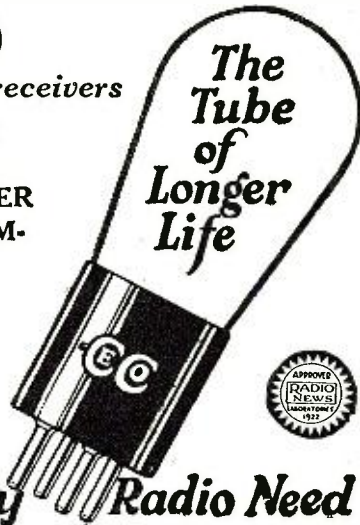

# ECC

See Specifications of above Receivers in RADIO NEWS

## A Type for Every Radio Need

Latest Addition to "CECO" Family of Tubes

# Type "K" Special Radio Frequency Tube

Will make any Good Receiver BETTER!

Write for Data Sheet—C. E. MFG. CO., Inc., Providence, R. I.

## Valley "B" Power Unit

Manufactured by VALLEY ELECTRIC CO. ST. LOUIS, MO.



SET BUILDERS and SET OWNERS

WE CAN SAVE YOU FROM 10 to 50 percent on all Standard National Parts and Accessories.

Send for our Bulletin on Radio Parts.

ASSOCIATED SET BUILDERS 60 Branford Place Newark, N. J.

Insure your copy reaching you each month. Subscribe to Science & Invention—\$2.50 a year. Experimenter Publishing Co., 230 Fifth Avenue, N. Y. C.

# Amazing Invention Revolutionizes Shaving

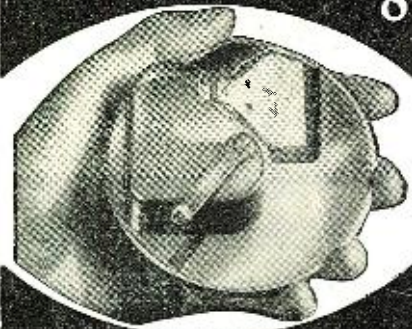

## No More Razor Blades To Buy!

Think of it! 365 keen, cool shaves a year from the same blade! No more bother about remembering to buy new ones. No more "raking" with dull ones! Slick, velvety shaves forever—that's KRISS-KROSS!

This amazing blade rejuvenator stropps your blade on the diagonal. Fits any blade. Employs master barber's secret. Automatic, decreasing pressure and blade, reverse. Nickel jig flies up to notify you when blade is ready with keenest, cutting edge that steel can take.

### Get FREE Offer

Now—to introduce KRISS-KROSS stropper, which is never sold in stores the inventor offers you new kind of razor FREE. Really 3 in one. Instantly adjustable. Absolutely unique and different.

#### AGENTS

Also—big money to agents and demonstrators. H. King made \$66 in one day. J. C. Kellogg made \$200 in 7 days. Even spare time workers make \$5—\$12 extra in an evening. Get details of limited free offer and generous commissions at once. Don't delay. Write M. H. Rhodes, Pres., at address below—tonight!



**Mystery  
Razor  
FREE**

**RHODES MFG. COMPANY**  
Dept. E-2681, 1418 Pendleton Ave., St. Louis, Mo.

Rhodes Mfg. Co., Dept. E-2681 1418 Pendleton Ave., St. Louis, Mo.

Without obligation send me details of new invention—KRISS-KROSS stropper—and offer of FREE mystery razor.

Name .....  
Address .....  
City ..... State .....

Representatives and agents check this square.

# REMLER

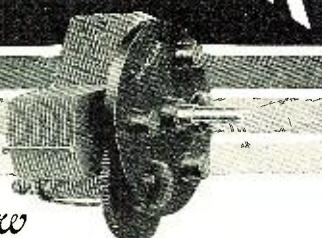

New

## Straight Line Frequency TWIN-ROTOR CONDENSER

As new stations crowd the air, you value Remler tuning accuracy more and more.

(Also Straight Line Wave Length type)

Write for descriptive circular

Capacities .0005 and .00035 ..... \$4.50 each  
Also .0001 in S. L. F. type ..... 4.50 each

# REMLER

GRAY and DANIELSON  
Manufacturing Company

260 FIRST STREET  
CHICAGO SAN FRANCISCO NEW YORK

# FREE RADIO GUIDE

Gives special hook-ups with illustrations. Shows the latest wrinkles and newest developments. Get what you need here at a big reduction. Everything in parts, kits, complete factory-built sets and supplies. Learn how to make your set up to date. Quick service. Write for free 164-page copy NOW; send names of other radio fans.

BARAWIK CO., Dept. 55 Chicago, U. S. A.

revision by the court shall be confined to the points set forth in the reasons of appeal.

Section 17. After the passage of this Act no person, firm, company, or corporation now or hereafter directly or indirectly through any subsidiary, associated, or affiliated person, firm, company, corporation, or agent, or otherwise, in the business of transmitting, or receiving, or relaying, or energy, communications, or signals by radio in accordance with the terms of the license issued under this Act, shall by purchase, lease, construction, or otherwise, directly or indirectly, acquire, own, control, or operate any cable or wire telegraph or telephone line or system between any place in any State, Territory, or possession of the United States or in the District of Columbia, and any place in any foreign country, or shall acquire, own, or control any part of the stock or other capital share of any interest in the physical property and/or other assets of any such cable, wire, telegraph, or telephone line or system, if in either case the purpose is and/or the effect thereof may be to substantially lessen competition or to restrain commerce between any place in any State, Territory, or possession of the United States or in the District of Columbia and any place in any foreign country, or unlawfully to create monopoly in any line of commerce; nor shall any person, firm, company, or corporation now or hereafter engaged directly or indirectly through any subsidiary, associated, or affiliated person, company, corporation, or agent, or otherwise, in the business of transmitting or receiving for hire messages by any cable, wire, telegraph, or telephone line or system (a) between any place in any State, Territory, or possession of the United States or in the District of Columbia, and any place in any foreign country, or shall acquire, own, or control any part of the stock or other capital share or any interest in the physical property and/or other assets of any such radio station, apparatus, or system, if in either case the purpose is and/or the effect thereof may be to substantially lessen competition or to restrain commerce between any place in any State, Territory, or possession of the United States or in the District of Columbia, and any place in any foreign country, or unlawfully to create monopoly in any line of commerce.

Section 18. If any licensee shall permit any person who is a legally qualified candidate for any public office to use a broadcasting station, he shall afford equal opportunities to all other such candidates for that office in the use of such broadcasting station, and the licensing authority shall make rules and regulations to carry this provision into effect. Provided, That such licensee shall have no power of censorship over the material broadcast under the provisions of this paragraph. No obligation is hereby imposed upon any licensee to allow the use of its station by any such candidate.

Section 19. All matter broadcast by any radio station for which service, money, or any other valuable consideration is directly or indirectly paid or promised, or charged, or accepted by the station, or broadcasting, from any person, firm, company, or corporation, shall, at the time the same is so broadcast, be announced as paid for or furnished, as the case may be, by such person, firm, company, or corporation.

Section 20. The actual operation of all transmitting apparatus of any radio station for which a station license is required by this Act shall be carried on only by a person holding an operator's license issued hereunder. No person shall operate any such apparatus in such station except under and in accordance with an operator's license issued to him by the Secretary of Commerce.

Section 21. No license shall be issued under the authority of this Act for the operation of any station the construction of which is begun or is continued after this Act takes effect, unless a permit for its construction has been granted by the licensing authority upon written application therefor. The licensing authority may grant such permit if public convenience, interest, or necessity will be served by the construction of the station. This application shall set forth such facts as the licensing authority by regulation may prescribe as to the citizenship, character, and the financial, technical, and other ability of the applicant to construct and operate the station, the ownership and location of the proposed station and of the station or stations with which it is proposed to communicate, the frequencies and wave length or lengths desired to be used, the hours of the day or other periods of time during which it is proposed to operate the station, the purpose for which the station is to be used, the type of transmitting apparatus to be used, the power to be used, the date upon which the station is expected to be completed and in operation, and such other information as the licensing authority may require. Such application shall be signed by the applicant under oath or affirmation.

Such permit for construction shall show specifically the earliest and latest dates between which the actual operation of such station is expected to begin, and shall provide that said permit will be automatically forfeited if the station is not ready for operation within the time specified or within such further time as the licensing authority may allow, unless prevented by causes not under the control of the grantee. The rights under any such permit shall not be assigned or otherwise transferred to any person, firm, company, or corporation without the approval of the licensing authority. A permit for construction shall not be required for Government stations, amateur stations, or stations upon mobile vessels, railroad rolling stock, or aircraft. Upon the completion of any station for the construction or continued construction of which a permit has been granted, and upon it being made to appear to the licensing authority that all the terms, conditions, and obligations set forth in the application and permit have been fully met, and that no cause or circumstance arising or first coming to the knowledge of the licensing authority since the granting of the permit would, in the judgment of the licensing authority, make the operation of such station against the public interest, the licensing authority shall issue a license to the lawful holder of said permit for the operation of said station. Said license shall conform generally to the terms of said permit.

Section 22. The licensing authority is authorized to designate from time to time radio stations the communications or signals of which, in its opinion, are liable to interfere with the transmission or reception of distress signals of ships. Such stations are required to keep a licensed radio operator listening in on the wave lengths designated for signals of distress and radio communications relating thereto during the entire period the transmitter of such station is in operation.

Section 23. Every radio station on shipboard shall be equipped to transmit radio communications or signals of distress on the frequency or wave length specified by the licensing authority, with apparatus capable of transmitting and receiving messages over a distance of at least one hundred miles by day or night. When sending radio communications or signals of distress and radio communications relating thereto the transmitting set may be adjusted in such a manner as to produce a maximum of radiation irrespective of the amount of interference which may thus be caused.

All radio stations, including Government stations and stations on board foreign vessels when within the territorial waters of the United States, shall give absolute

# Hotel SHERIDAN-PLAZA CHICAGO

Sheridan Road at Wilson Ave.

At this beautiful hotel, in Uptown Chicago, you'll find choicest accommodations at prices lower than those of downtown.

Excellent restaurant and Narcissus Grill Cafeteria. 18 minutes to downtown. Elevated, surface lines, fast motor coaches.



Rooms with private bath, \$2.50 a day and up. 250-car garage directly opposite.

H. A. BIRNBAUM,  
Manager

# CARTER

New

## All Metal Self-Cooling "Midget" Rheostat



All Resistances  
50c

At the Cross Roads. Every man by his decision either makes or mars his life—and the same with his radio set. The majority in most cases are right: they buy Carter—why take a chance?—follow the lead of the leaders. Any dealer can supply

In Canada Carter Radio Co., Ltd., Toronto

# CARTER RADIO CO. CHICAGO

Special Library of Information

## RADIO PATENTS and TRADE MARKS

JOHN B. BRADY

Patent Lawyer

Ouray Building Washington, D. C.

Cable address:  
RADIOPAT

Telephone:  
Main 4806

HEAR the wonderful  
New Acme Speaker  
at your dealer's.

ACME  
for amplification.



priority to radio communications or signals relating to ships in distress; shall cease all sending on frequencies or wave lengths which will interfere with hearing a radio communication or signal of distress, and, except when engaged in answering or aiding the ship in distress, shall refrain from sending any radio communications or signals until there is assurance that no interference will be caused with the radio communications or signals relating thereto, and shall assist the vessel in distress, so far as possible, by complying with its instructions.

Section 21. Every shore station open to general public service between the coast and vessels at sea shall be bound to exchange radio communications or signals with any ship station without distinction as to radio systems or instruments adopted by such stations, respectively, and each station on shipboard shall be bound to exchange radio communications or signals with any other station on shipboard without distinction as to radio systems or instruments adopted by each station.

Section 25. At all places where Government and private or commercial radio stations on land operate in such close proximity that interference with the work of Government stations can not be avoided when they are operating simultaneously such private or commercial stations shall not interfere with the transmission or reception of radio communications or signals by the Government stations concerned shall not use their transmitters during the first fifteen minutes of each hour, local standard time.

The Government stations for which the above-mentioned division of time is established shall transmit radio communications or signals only during the first fifteen minutes of each hour, local standard time, except in case of signals or radio communications relating to vessels in distress, and vessel requests for information as to course, location, or compass direction.

Section 26. In all circumstances, except in case of radio communications or signals relating to vessels in distress, all radio stations, including those owned and operated by the United States, shall use the minimum amount of power necessary to carry out the communication desired.

Section 27. No person receiving or assisting in receiving any radio communication shall divulge or publish the contents, substance, purport, effect, or meaning thereof except through authorized channels of transmission or reception to any person other than the addressee, his agent, or attorney, or to a telephone, telegraph, cable, or radio station employed or authorized to forward such radio communication to its destination, or to proper accounting or distributing officers of the various communicating centers over which the radio communication may be passed, or to the master of a ship under whom he is serving, or in response to a subpoena issued by a court of competent jurisdiction, or on demand of other lawful authority; and no person not being authorized by the sender shall intercept any message and divulge or publish the contents, substance, purport, effect, or meaning of such intercepted message to any person; and no person not being entitled thereto shall receive or assist in receiving any radio communication and use the same or any information therein contained for his own benefit or for the benefit of another not entitled thereto; and no person having received such intercepted radio communication or having become acquainted with the contents, substance, purport, effect, or meaning of the same or any part thereof, knowing that such information was so obtained, shall divulge or publish the contents, substance, purport, effect, or meaning of the same or any part thereof, or use the same or any information therein contained for his own benefit or for the benefit of another not entitled thereto. **Provided,** that this section shall not apply to the receiving, relaying, publishing, or utilizing the contents of any radio communication broadcasted or transmitted by amateurs or others for the use of the general public or relating to ships in distress.

Section 28. No person, firm, company, or corporation within the jurisdiction of the United States shall knowingly intercept or transmit, or cause to be uttered or transmitted, any false or fraudulent signal of distress, or communication relating thereto, nor shall any broadcasting station rebroadcast the program or any part thereof of another broadcasting station without the express authority of the originating station.

Section 29. Nothing in this Act shall be understood or construed to give the licensing authority the power of censorship over the radio communications or signals transmitted by any radio station, and no regulation or condition shall be promulgated or fixed by the licensing authority which shall interfere with the right of free speech by means of radio communications. No person within the jurisdiction of the United States shall utter any obscene, indecent, or profane language by means of radio communication.

Section 30. The Secretary of the Navy is hereby authorized unless restrained by international agreement, under the terms and conditions and at rates prescribed by him, which rates shall be just and reasonable, and which, upon complaint, shall be subject to review and revision by the Interstate Commerce Commission, to use all radio stations and apparatus, wherever located, owned by the United States and under the control of the Navy Department (a) for the reception and transmission of press messages offered by any newspaper published in the United States, its Territories or Possessions, or published by citizens of the United States in foreign countries, or by any press association of the United States, and (b) for the reception and transmission of private commercial messages between ships, between ship and shore, between localities in Alaska and between Alaska and the continental United States: **Provided,** that the rates fixed for the reception and transmission of all such messages, other than press messages between the Pacific coast of the United States, Hawaii, Alaska, the Philippine Islands, and the Orient, and between the United States and the Virgin Islands, shall not be less than the rates charged by privately owned and operated stations for like messages and service: **Provided further,** that the right to use such stations for any of the purposes named in this section shall terminate and cease as between any countries or localities or between any locality and privately operated ships whenever privately owned and operated stations are capable of meeting the normal communication requirements between such countries or localities or between any locality and privately operated ships, and the licensing authority shall have notified the Secretary of the Navy thereof.

Section 31. The expression "radio communication" or "radio communications" wherever used in this Act means any intelligence, message, signal, power, pictures, or communication of any nature transferred by electrical energy from one point to another without the aid of any wire connecting the points from and at which the electrical energy is sent or received and any system by means of which such transfer of energy is effected.

Section 32. Any person, firm, company, or corporation failing or refusing to observe or violating any rule, regulation, or restriction made or imposed by the licensing authority under the authority of this Act or of any international radio convention or treaty ratified or adhered to by the United States, in addition to any other penalties provided by law, upon conviction thereof by a court of competent jurisdiction, shall be punished by a fine of not more than \$500 for each and every offense.

Section 33. Any person, firm, company, or corporation who shall violate any provision of this Act, or shall knowingly make any false oath or affirmation in any affidavit required or authorized by this Act, or shall knowingly swear falsely to a material matter in any hearing authorized by this Act, upon conviction thereof in any court of competent jurisdiction shall be punished by a fine of not more than \$5,000 or by imprisonment for a term of not more than five years or both for each and every such offense.

Section 34. The trial of any offense under this Act shall be in the district in which it is committed; or if the



# Protection

Radio set protection from lightning is very essential. You never know when or where Lightning will strike. Your antenna may be one of the first struck this season.

The Jewell Lightning arrester is listed and regularly checked by Underwriters' Laboratories, thus insuring a uniform product with maximum protection to costly radio equipment.

Ask your nearest dealer to show you one or write us for descriptive circular No. 1019.

**Jewell Electrical Instrument Co.**  
1650 Walnut Street, Chicago, Ill.  
*"27 Years Making Good Instruments"*

*A Quality Product*



*Jewell Lightning Arrester*

*(Listed by Underwriters' Laboratory)*



**WINDSOR HORN and CONE Loudspeakers and Loudspeaker Consoles**  
**WINDSOR FURNITURE COMPANY**  
 1410 Carroll Avenue, Chicago, Illinois  
 Los Angeles Branch, 917 Maple Ave.

**C. R. LEUTZ, Inc.**  
 6th and Washington Aves.,  
 Long Island City, New York

"—the conversion of a sinner in error"

**SILVER—MARSHALL, Incorporated,**

SM

**RADIO EQUIPMENT**  
 846 WEST JACKSON BLVD  
 Chicago, U. S. A.

Mr. Hugo Gernsbeck, Radio Editor  
 RADIO NEWS  
 53 Park Place  
 New York, New York.

February 2, 1927.

My dear Mr. Gernsbeck:

From rumors which are floating around, I gather that you have heard that it was our intention to discontinue advertising in Radio News with the April issue. It gives me very great pleasure, indeed, to inform you that our decision, based upon the apparent results of advertising in your publication has been revised since that time, for we have found within the last few weeks that your publication can "pull" quite successfully in several instances.

This letter really isn't meant to be a testimonial, but, I am rather inclined to believe that it's just about the best possible one you could get for it explains the conversion of a sinner in error.

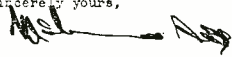
Sincerely yours,  

**WHETHER** your business is ailing or in a healthy state, advertising in RADIO NEWS provides a tonic which will build it up if it needs strengthening or help it to retain its virility.

Obituaries could be written for hundreds of radio manufacturers who failed to recognize the pulling power of RADIO NEWS.

Consistent advertising in RADIO NEWS always pays, as testified by Mr. McMurdo Silver.

# \$10 Loud Speaker

For \$10 you can get the finest loud speaker that money can buy—the new, perfected Dulce-Tone, the unit that utilizes all the scientifically developed, time-tested reproducing elements of your phonograph.

Dulce-Tone and your phonograph will improve the reception from any set. Greater volume, clearer tone, entire freedom from glare and distortion.

Nothing to install. Simple to use. Fully guaranteed. \$10 at your dealer's or with the coupon.



**Dulce-Tone**

**THE GENERAL INDUSTRIES CO.**  
Formerly named  
**THE GENERAL PHONOGRAPH MFG. CO.**  
20 Taylor St., Elyria, Ohio

Enclosed is \$10 for my Dulce-Tone. If I'm not satisfied after 10 days' trial, I'll return it and get my money back.

Name \_\_\_\_\_  
Street \_\_\_\_\_  
City \_\_\_\_\_ State \_\_\_\_\_

## "A & B" SOCKET POWER UNIT

enables you to have your radio as constant as your electric current regardless of the kind or make of radio you operate.

It's new! It's better! One switch controls everything. Snap it on from your house current and you get instantly a strong, steady flow of "A & B" Power. Snap it off and your radio is silent. Especially efficient. Exceedingly compact. Fits any cabinet.

List Price complete ready to operate **\$6750** East of the Rockies

Ask your Jobber or write us for complete information on our entire line of well known Acme Charging Equipment.

**The Acme Electric & Mfg. Co.**  
1412 Hamilton Ave., Cleveland, O.  
Manufacturing for 10 years

**American RADIO** Now—  
Lowest Wholesale Prices on **RADIO!**

**BIG NEW 1927 CATALOG-FREE**

Dealers, Agents, Set Builders—get our big 1927 Catalog—225 nationally advertised lines. Low money-saving prices! Largest, most complete stock. Radio's latest developments. It's FREE—send for your copy now.

**AMERICAN AUTO & RADIO MFG. CO., Inc.**  
1515 McGee Street, Kansas City, Mo.

offense is committed upon the high seas, or out of the jurisdiction of any particular State or district, the trial shall be in the district where the offender may be found or into which he shall be first brought.

Section 35. This Act shall not apply to the Philippine Islands or to the Canal Zone. In international radio matters the Philippine Islands and the Canal Zone shall be represented by the Secretary of State.

Section 36. The licensing authority is authorized to designate any officer or employee of any other department of the Government on duty in any Territory or possession of the United States other than the Philippine Islands and the Canal Zone, to render therein such services in connection with the administration of the radio laws of the United States as such authority may prescribe: Provided, That such designation shall be approved by the head of the department in which such person is employed.

Section 37. The unexpended balance of the moneys appropriated in the item for "wireless communication laws," under the caption "Bureau of Navigation" in Title III of the Act entitled "An Act making appropriations for the Departments of State and Justice and for the Judiciary, and for the Departments of Commerce and Labor, for the fiscal year ending June 30, 1927, and for other purposes," approved April 29, 1926, and the appropriation for the same purposes for the fiscal year ending June 30, 1928, shall be available both for expenditures incurred in the administration of this Act and for expenditures for the purposes specified in such items. There is hereby authorized to be appropriated for each fiscal year such sums as may be necessary for the administration of this Act and for the purposes specified in such item.

Section 38. If any provision of this Act or the application thereof to any person, firm, company, or corporation, or to any circumstances, is held invalid, the remainder of the Act and the application of such provision to other persons, firms, companies, or corporations, or to other circumstances, shall not be affected thereby.

Section 39. The Act entitled "An Act to regulate radio communication," approved August 13, 1912, the joint resolution to authorize the operation of Government-owned radio stations for the general public, and for other purposes, approved June 3, 1920, as amended, and the joint resolution entitled "Joint resolution limiting the time for which licenses for radio transmission may be granted, and for other purposes," approved December 8, 1926, are hereby repealed.

Such repeal, however, shall not affect any act done or any right accrued or any civil or proceeding had or commenced in any civil cause prior to said repeal, but all liabilities under said laws shall continue and may be enforced in the same manner as if committed; and all penalties, forfeitures, or liabilities incurred prior to taking effect hereof, under any law embraced in, changed, modified, or repealed by this Act, may be prosecuted and punished in the same manner and with the same effect as if this Act had not been passed.

Nothing in this section shall be construed as authorizing any person now using or operating any apparatus for the transmission of radio energy or radio communications or signals to continue such use except under and in accordance with this Act and with a license granted in accordance with the authority hereinbefore conferred.

Section 40. This Act shall take effect and be in force upon its passage and approval, except that for and during a period of sixty days after such approval no holder of a license or an extension thereof issued by the Secretary of Commerce under said Act of August 13, 1912, shall be subject to the penalties provided herein for operating a station without the license herein provided.

Section 41. This Act may be referred to and cited as the Radio Act of 1927. (Approved Feb. 23, 1927).

## What's Next in Home Entertainment?

(Continued from page 1318)

minutes will be avoided. This will constitute a great advance in the art.

### WIRED RADIO POSSIBILITIES

It may be feasible in the future to transmit entertainment and instructional programs by line-wire carrier-current telephony from one national studio to your home. A number of different programs may be sent

## 40 Non-Technical Radio Articles

every month for the beginner, the layman and those who like radio from the non-technical side.

**SCIENCE & INVENTION**, which can be bought at any newsstand, contains the largest and most interesting section of radio articles of any non-radio magazine in existence.

Plenty of "How To Make It" radio articles and plenty of simplified hook-ups for the layman and experimenter. The radio section of **SCIENCE & INVENTION** is so good that many **RADIO NEWS** readers buy it solely for this feature.

## Radio Articles Appearing in April Science & Invention

- Details of the Famous Radio Red and Blue Broadcast Network.
- Dressing Up Experimental Work By A. P. Peck
- How to Build a Radio Console By H. W. Weatherby
- Radio Voice From Airplane
- A Knock-down Cone Speaker
- Radio Oracle—Question and Answer Box

## Guaranteed Performance

at a **50% Saving!**

### World Storage "A" Battery

**2-Year Guarantee Bond in Writing**



New Low Prices

**SOLID RUBBER CASE RADIO BATTERIES**

- 6-Volt, 100-Amperes \$10.00
- 6-Volt, 120-Amperes \$12.00
- 6-Volt, 140-Amperes \$13.00

**SOLID RUBBER CASE AUTO BATTERIES**

- 6-Volt, 11-Plate \$10.00
- 6-Volt, 13-Plate \$12.00
- 12-Volt, 7-Plate \$14.50

**WORLD BATTERY CO., 1219 So. Wabash Ave. Chicago, Ill.**

Set your radio dials at 288.3 meters for World Storage Battery Station WSEB. Variety—new talent—always interesting.

## 30 DAYS FREE TRIAL 7 Tube-Single Dial RADIO SET



Write for This Wonderful offer direct from factory

World's greatest radio. Perfect working, single dial control. 7-tube receiver, shipped to your home for 30 days free trial. Test it for distance, volume and tonal quality—and if you are not convinced that it is the best single dial set you ever heard return it to factory.

**RETAIL PRICE \$75 Completely Assembled**

### METRODYNE SUPER-SEVEN

Only one dial tunes in all stations. Get 1,000 to 3,000 miles on loud speaker. Easiest set to operate. Highest grade parts used. Magnificent Two-tone Walnut Cabinet.

**Big Profits to Agents and Dealers**

selling Metrodyne radios. All or part time. Great money making opportunity. Demonstrating set on 30 days free trial. **WRITE FOR OUR OFFER.**

**METRO ELECTRIC CO.**  
2161 N. California Ave., Dept. 105, Chicago, Ill.

## CORWICO AERIAL KITS

COMPLETE FROM THE GROUND UP

"Just what is needed" is the verdict of the radio public—for the new Corwico Aerial kits include everything necessary for aerial, ground and hook-up, making antenna equipment easy to buy and install. Prices list from \$1.75 to \$4.50, the higher priced kits including Storm King lightning arresters.

At All Dealers  
Dealers and Jobbers—Write for proposition.

**CORNISH WIRE COMPANY**  
30 Church Street New York City

## IN LINE FREE WHOLESALE CATALOG

**ALL PARTS in STOCK**

GET YOUR COPY NOW  
Contains all the latest Kits and Unusual offerings in standard Accessories, parts and cabinets. Write for your copy NOW.

**THE HARCQ CO.**  
1255 So. Wabash Ave., Chicago, Ill.

over the same wires conveying the usual telephone conversations. The outstanding features of such a method would be the transmission and reception of undistorted programs, freedom from uncontrollable parasitic interference (electrical strays or static encountered in the operation of radio sets in the home), and the absence of fading signals. In the practical realization of this system, the selective tuning, detecting and filter apparatus would probably be installed and maintained on a rental basis by the telephone company serving the community. The amplifier connected to the output of the frequency-converting apparatus, and actuating the sound reproducer or loud speaker, could be manufactured and sold by various companies, as radio apparatus is at this time.

A film library similar to a book library is now a reality in this country. Among the subjects listed are, for example: travel, sports, manners and customs, industry, forestry and agriculture, popular science, useful arts, natural history. Comedies, juvenile, reconstructed and modern history, animated cartoons, and dramas are also available. Subscribers could obtain films for opera programs to be transmitted from the national studio at a prearranged date.

After a few moments' careful reflection, the reader will readily realize the vast possibilities for home entertainment made available by the combination of the marvelous instrumentalities described.

### Experiments on a Superheterodyne

(Continued from page 1333)

Table 1 gives the reactances of various inductances at five selected frequencies and Table 2 those of several capacities at the same five frequencies. The purpose is to add some meat to the bones which the experimental results give the reader to chew on. The 10 mh. choke which is offered for superheterodyne use at the second detector (i.e., for long-wave choking purposes), gives only 1900 ohms opposition at 30-kc. (10,000 meters); whereas the .001 mf. that I suggest for by-pass has nearly three times as much reactance. If experiment had not, figures would have shown the choke inadequate. But the successful 500 mh. has 18 times the reactance the by-pass condenser shows, so that the much easier path of 5300 ohms is preferred.

It is important to know what effect the large choke has at the higher audio frequencies, for two things can happen: the choke can drop enough voltage across its ohmage to cause a loss from the transformer, and it can develop a degree of opposition to increase the audio by-passing effect of the by-pass condenser. At 1000 cycles, the 3000 ohms from 500 mh. is only 1/100th of the reactance of a 50-henry primary in a good A.F. transformer; and the same ratio holds all the way down in frequency, and up, too. I include data on 1 henry to subdue the ambitions of those who might be inclined to go beyond 500 mh. A combination of 250 mh. and a good A.F. transformer is adequate.

The by-passing effect of the fixed condenser of .001 mf. at audio frequencies of 1000 cycles and above is present and excessive from figures. But the ear apparently dictates no such trouble. Obey the ear or figures, as you wish. A smaller by-pass and the 500 mh. choke is an obvious step to improvement, but since there are so many unknowns to buck against, the gain may be indifferent or inadequate. Notice that the .001 mf. condenser has half the reactance at 1000 cycles of the 50-henry inductance: there is about 30%—probably more—of that frequency lost through the by-pass with a



## For Good Reception!

Guaranteed to remove the battery nuisance and deliver clearer tone and increased volume. Provides three different voltages at the same time. Each tap adjustable over a wide range, making possible any desired voltage from 5 to 150, absolutely harmonizing "B" current supply to your set. Raytheon tube used as rectifier. No noise or vibration. Contains no acid or solution and will not get out of order. Operating cost negligible.

At Your Dealer's

Price, Complete with Raytheon Tube - - \$35.00  
**Kokomo Electric Company**  
 Kokomo, Indiana

# Kingston "B" Battery Eliminator



Fred W. Stein.

## Steinite

Greatest \$1 Value in Radio Today

### INTERFERENCE ELIMINATOR

NO RADIO SET COMPLETE WITHOUT IT

Select stations at will. Especially necessary for 1 and 2 dial controlled sets. Under present conditions the average set fails to bring in the desired stations properly. The Steinite Interference Eliminator shuts out local and other interference. You get one station at a time, the one you want, and tune in loud and clear. Operates on any set—attach to aerial wire and to set—no changes—no extra tubes or batteries.

Over 600,000 Sold

Latest 1927 Model

#### Improved Results with Tube or Crystal

Try entirely at my risk the wonderful improvement this inexpensive little device will make in the reception of your set. Improves results on both crystal and tube sets that use any kind of aerial except loop antenna. Clears up reception wonderfully, increases volume and partially absorbs static.

**MONEY BACK GUARANTEE** Put this interference eliminator on your set and note amazing improvement. No tools needed—install in a moment's time. Connect with set and follow simple instructions. Money back promptly if not delighted. \$1 postpaid when cash with order. ORDER TODAY—a dollar bill will do. References: Exchange National Bank; Atchison Savings Bank.

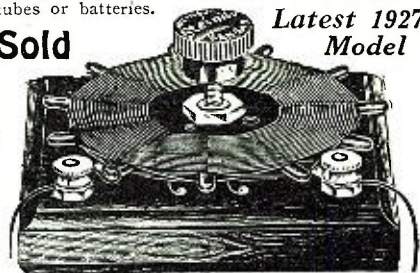

**\$1 Postpaid** If you are not delighted with results you get your dollar back

New Steinite Light Socket No-Battery Radio, \$100; with built-in Speaker, \$125; Console, built-in Speaker \$150. Hear and see them at your dealer. Steinite Long Distance Crystal Set, \$6; Noise Eliminator, \$1; Aerial Eliminator, \$1; Interference Eliminator, \$1; Crystals, 50c each, 3 for \$1

JOBBERS WRITE FOR TERMS AND TERRITORY

**STEINITE LABORATORIES, 402 Radio Bldg., Atchison, Kansas**

## LEARN THE CODE AT HOME

### WITH THE OMNIGRAPH

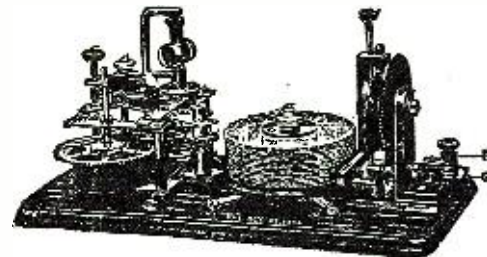

THE OMNIGRAPH Automatic Transmitter will teach you both the Wireless and Morse Codes—right in your own home—quickly, easily and inexpensively. Connected with Buzzer, Buzzer and Phone or to Sounder, it will send you unlimited messages at any speed, from 5 to 50 words a minute.

THE OMNIGRAPH is not an experiment. For more than 15 years, it has been sold all over the world with a money back guarantee. The OMNIGRAPH is used by several Depts. of the U.S. Govt.—in fact, the Dept. of Commerce uses the OMNIGRAPH to test all applicants applying for a Radio license. The OMNIGRAPH has been successfully adopted by the leading Universities, Colleges and Radio Schools.

Send 6c for Catalog

**THE OMNIGRAPH MFG. CO.,**

If you own a Radio Phone set and don't know the code—you are missing most of the fun

DO IT TODAY.

**15 HUDSON STREET, NEW YORK CITY**

**RADIO IS BETTER WITH BATTERY POWER**  
 NATIONAL CARBON COMPANY, Inc.  
 New York San Francisco

## Mar-Co Dials



**DON'T**  
Risk Lightning Dangers!

They're always just over the horizon, and they come up with startling suddenness. Safeguard your set—and your home. The National Board of Fire Underwriters says you MUST. Your own interests say you SHOULD.

**WIRT LIGHTNING ARRESTER**

Provides the needed protection in full measure. It is the approved air-gap type. High voltage insulation throughout. Bakelite "petticoat" gives added protection in wet weather. Terminals are extra heavy—far enough apart to prevent leakage—and designed for connecting to aerial without cutting wire. Can't rust, for all metal parts are brass. Will last a lifetime. Easy to install. Directions on package. Complete with screws for mounting, \$1.25. All dealers.



Don't wait. Storms never do.

**WIRT COMPANY**

5241 Greene St. Philadelphia, Pa.  
Makers of Dim-A-Lite

**Standard**

Specified by leading engineers in all popular circuits as the one perfect form of tube filament control. Insist on Amperite—the only automatic variable filament resistance. Beware of substitutes and imitations. There is only one Amperite and nothing else will do. Eliminates hand rheostats. Simplifies wiring. Types for all tubes. Price \$1.10 mounted (in U. S. A.). At all dealers. Write for Free Hook-Ups and construction data to Dpt. RN5

**Radiall Company**  
50 FRANKLIN ST., NEW YORK

**AMPERITE**  
REG. U.S. PAT. OFF.

The "SELF-ADJUSTING" Rheostat

**EARN UP TO \$125.00 A WEEK**

Making crowns, bridges, plates, etc., for dentists. YOU CAN LEARN Mechanical Dentistry

In a few months. Practical training. 5 Schools, day or night. No books. Uncrowded field. Graduates earn big money. Free R.R. Fare to Phila., Boston, Cleveland, Detroit or Chicago. We help you secure spare time job. Write for FREE BOOK on Mechanical Dentistry.

**McCARRIE SCHOOLS OF MECHANICAL DENTISTRY**  
1338 S. Michigan Ave., Dept. 74 Chicago, Ill.

**ELECTRICITY—EASY AT LAST!**  
Learn By Doing in 90 Days

NO BOOKS—NO LESSONS. Big jobs waiting to pay \$50 to \$200 a week. Come to COYNE for 90 days then get one. Learn by doing. COYNE gives you training and experience. Write for big FREE book and FREE R. R. Fare offer. **COYNE ELECTRICAL SCHOOL**, 1300 W. Harrison St., Dept. 57-77 Chicago, Ill.

good A.F. transformer. The danger of larger by-pass capacities is plain. The larger by-pass capacities are included in the tables as gratuitous information. Notice that I say nothing about 5000 cycles. I feel rather sick when I look at the figures.

Yet, fans with supers with .004 mf. across the primary of each A.F. transformer not only are satisfied, but also proud of the audio quality resulting from their sets; and often enough it sounds all right to me, too. But the less heavily by-passed affair gives an intangible difference in tone which makes me regret my lack of musical training by ear and by eye. It results more pleasantly at any rate.

The use of 30 k.c. seems to me a mistake. But many own super-heterodynes which utilize that intermediate frequency and many more will buy inexpensive transformers for that frequency. I've seen such transformers sell at 25 cents, and decently sensitive sets result from them. With that condition known, and this article at hand, a fairly effective over-all should result, with the use of some intelligence in the assembly.

**The Loftin-White Circuit With Hi-Mu Tubes**

(Continued from page 1333)

somewhat noisy or muffled. The Loftin-White circuit, with high-mu tubes, is sensitive and capable of producing loud sounds without the use of regeneration; which means that the customary distortion due to regeneration is agreeably absent.

**EFFECTS OF FILAMENT TEMPERATURE**

This circuit is interesting, not only because of its advantages, but also because it can be made to do just the opposite of what we have been used to when handling other radio-frequency amplifier circuits. With the average radio-frequency amplifiers, operating near the oscillating point on low filament current, increasing that current causes oscillation and squeals. With high-mu tubes in the Loftin-White circuit, adjusted to operate without regeneration when the rheostat is turned to put five volts on the filament, that circuit will frequently oscillate and squeal if the rheostat is turned to reduce the filament potential to about 3.8 volts.

The explanation which has been given for this peculiarity is that lowering the filament current, in effect, increases the resistance between the cold electrodes and hot filament in the tube. The phase-shifting ability of the capacitance in the plate circuit depends upon its ratio to such resistance as is effective in the total impedance in the feed-back path. If that resistance changes then the amount of the phase shift changes. With the amount of phase shift decreased and everything else the same, for example, then the circuit can oscillate.

**ADJUSTMENTS FOR HIGH-MU TUBES**

Therefore, to adjust the Loftin-White receiver circuit with high-mu tubes, the phase shifting condensers are adjusted so that the circuit will just oscillate operated on too low a filament current. The filament current is then increased until regeneration effects are no longer heard; high-mu tubes are placed in the radio-frequency amplifier and detector sockets, and a 171 tube in the last A.F. stage, with a 201-A tube in the first A.F. Now, with 67 to 90 volts on the detector post marked 45, 90 on the first audio-frequency post marked "90" and 180 on the "B+ Amp" post, together with the first "C" battery post at 4½ volts and the "C" posts near the jack at 45 volts, the set

**New!**  
**Crackle Surface**  
**ACE**  
**HARD RUBBER**  
**PANEL**

of highest insulating efficiency with a distinctly attractive surface finish.

In regular ready-cut sizes:  
7x10 7x18 7x26  
7x12 7x21 7x30  
7x14 7x24

Popular prices. All dealers.  
Made by the makers of the famous RADION PANELS.

Write for price list.

**American Hard Rubber Company**  
11 MERCER ST., NEW YORK

**WEBSTER**

Raytheon equipped socket power units. "LITTLE GIANT B-C" Quiet B and C current—5 controls

Costs 90% less than battery operation, gives any set greater distance, more volume, better tone. Complete with Raytheon tube..... \$50.00  
Super-B—three B controls..... 20.00  
Economy-B—2B Control 25.00  
Popular P—open model 22.50  
DC Model..... 25.00

Write for Free Booklet "Improving Your Radio"

**THE WEBSTER CO.**  
866 Blackhawk St. Chicago

**LIGHTING FIXTURES**  
Ready to Hang

Direct from the manufacturer. Completely wired, including glassware. Send for new catalogue No. 28. Just Reduced Prices. Special Proposition To Dealers.

**Erie Fixture Supply Co., Inc.**  
Erie, Pa. Station B.

**RADIO PANELS**  
OF GENUINE BAKELITE

Cut, drilled and engraved to order. Send rough sketch for estimate. Our Complete Catalog on Panels, Tubes and Rods—all of genuine Bakelite—mailed on request.

**STARRETT MFG. CO.**  
520 S. GREEN ST. CHICAGO

**TILSON**  
Variable Grid-Leak

Helps Your Detector Tube Get Far-Away Stations Attached in a second 75 cents at your dealer or direct. Jobbers and Dealers write for Discounts

**TILSON & TILSON**  
154 Nassau St., New York, N. Y.  
Phone Beekman 1575

is ready to work. (It is to be understood that, because a higher "B" battery voltage is required for the high-mu tubes, it has been necessary to make a simple change in the "B" battery wiring. As the receiver was originally designed, the plates of the radio-frequency tubes connect to the binding post marked "B+ 90." They should be connected to the "B+ Amp." post for the high-mu tubes. This is easily done if reference is made to the layout and wiring drawing of the underside of the sub-panel, shown at the top of page 1242 of RADIO NEWS for April. It will be noted here that a wire connects the two radio-frequency chokes, L3 and L4. Branching off from this lead, and near choke L4, is another wire which connects to the lower left lug of the jack J. This last mentioned wire should be unsoldered from the jack lug and soldered instead to the binding post lug marked "B+ Amp." That is the only change necessary.)

With the volume-control-rheostat arrow straight up and the storage battery fully charged, the plate condensers should either be tightened or loosened, as required. As explained in my article in April RADIO NEWS, the receiver should be just at the squealing point at short and long wavelengths, which can be accomplished by moving the primaries up or down slightly. Then, on turning the volume control to the right, all tendency to regenerate should disappear and the set should work nicely on all wavelengths.

As this circuit is not like others to which we have been accustomed, it is necessary to follow directions carefully. Also, if directions are not clear to the constructor, it is sometimes desirable to write to the kit makers for advice on points that are not thoroughly understood.

High-mu tubes, because of their high resistance, are more desirable than low-mu tubes in the non-regenerative condition. A simple way to explain this is to say that putting a *very high resistance* across the condenser of a tunable circuit does not broaden its tuning as much as putting a lower resistance across that condenser. Another advantage of high-mu tubes is their low "B" battery consumption.

Summarizing the articles, it may be said that another step has been taken in radio development by the introduction of the Loftin-White circuit; in fact it may be said to be three or more steps. It handles all radio frequencies equally well, which is one improvement; it prevents oscillation and regeneration equally well for all frequencies, which is another, and it permits the use of high-mu tubes for radio-frequency amplification, which is a third improvement, effecting greater sensitivity, greater volume and greater selectivity and better quality.

### Radio Aids to Navigation

(Continued from page 1316)

manner he determines the position of his own vessel.

#### FINDING DISTRESSED SHIPS

But suppose a vessel, foundering in a storm, sends out an appeal for aid. It cannot give its position, for the sky has been obscured and the ship has been driven furiously. What then? If the answering ship uses a direction finder it can keep the ship in line to the source of the call by using the loop. And although the distressed vessel may be far away, the loop receiver will accurately guide the rescuing steamer.

Of rugged and simple construction, yet accurate in operation, direction finders are rapidly being installed on all classes of ships. When one radio beacon station transmits,

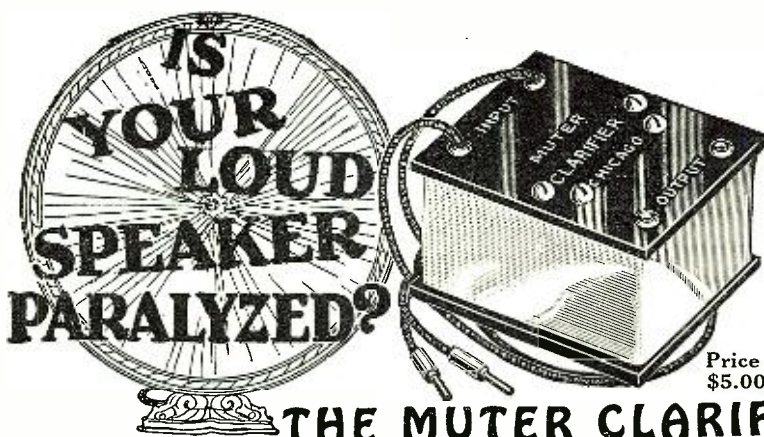

Price \$5.00

## THE MUTER CLARIFIER

intercepts paralyzing high voltage "B" current—

Assuring Improved Tone, Quality and Volume

Most Speaker Units today are partially paralyzed because high voltage "B" current prevents proper response to the output of the set. The Muter Clarifier blocks this shattering current on its way to your defenseless Speaker. The happy result is much greater depth and clarity of tone, with wonderfully improved quality and volume. The Speaker is allowed to produce its utmost, and fear for the life of its coils and magnet is banished. Fans everywhere are talking about this wonderful little instrument. Absolutely nothing else like it.

If your Speaker is one of the great majority which act "dumb" with no apparent cause, get a Muter Clarifier at once. Try it out to your own satisfaction on our liberal guarantee—you won't recognize your set!

### See Your Dealer—or Send Direct

If your dealer cannot supply you fill out the coupon below and mail it today. Prompt shipment will be made on receipt of price, or C. O. D. if preferred. Give your Speaker a chance to show what real reception means. Use Coupon NOW!

### LESLIE F. MUTER CO.

76th & Greenwood Avenue  
Dept. 827-G, Chicago, Ill.

LESLIE F.  
MUTER Co.,  
76th & Greenwood Ave.,  
Dept. 827-G, Chicago, Ill.

Send Muter Clarifier at once.  
\$5.00 is enclosed.

Send C. O. D.



Name .....  
Address .....  
City..... State.....  
My Dealer's Name is.....

For plugs, jacks, clips, condenser  
and transformer parts—

### brass is the logical metal

Used for these screw-machine products, BRASS gives the right electrical conductivity and the mechanical accuracy essential to proper operation of radio sets and parts.

To the manufacturer BRASS means economy in quantity production.

COPPER & BRASS  
RESEARCH ASSOCIATION  
25 Broadway, New York

DESCRIBED  
IN APRIL  
ISSUE  
OF  
RADIO  
NEWS



BUY H F L  
TRANS-  
FORMERS  
AT ANY  
RELIABLE  
DEALER

### SOCKET POWER UNITS

Ask your dealer, or write us for complete information on our complete line of socket power units, chargers. Radio "A" and auto storage batteries. STEWART BATTERY COMPANY  
119 N. Peoria St. Chicago, Ill.

# CARTER

- Rheostats
- Jacks
- Jack Switches
- Potentiometers
- Volume Controls
- Filament Switches
- Fixed Resistors

Again chosen—as usual—for improved Browning-Drake Sampson Push-Pull Power Amplifier Acme D-Coil Loop Receiver Phono-Radio Combination Set. As described in RADIO NEWS.

Engineers who know  
Choose Carter,—  
do you?

Any dealer can supply

In Canada: Carter Radio Co., Limited, Toronto

**CARTER RADIO CO.**  
CHICAGO

## The AIRGAP SOCKET

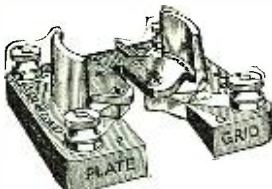

SELECTED as one of the new essentials of the BROWNING-DRAKE

THE GAP has the effect of omitting the socket entirely; it creates a higher resistance path between grid-plate terminals, decreasing high frequency losses, preventing feedback and intercoupling through and over the socket body, making the circuit more easy to stabilize and control, cause your set to go into oscillation more smoothly and not "spill" over until maximum results are obtained.

At Your Dealers or Direct  
Postpaid 60c

Dealers and Jobbers write us  
**AIRGAP PRODUCTS CO.**

18 Campbell St. Newark, N. J.

## A NEW RADIO PLUG



Simple to use, gives perfect electrical contact with any style tip.

Simply push cord tip through plug, loop cord and push tip back into plug.

Sent postpaid on receipt of 50c  
**CULVER-STEARN'S MFG. CO**  
Worcester, Mass.

## GENERAL RADIO

Parts and Accessories. Write for Catalog No. 926-N.

General Radio Co. Cambridge, Mass.

every ship can receive a bearing line immediately. When a lost ship is being sought, the direction finder again will show its superiority over the older radio compass.

### CALIBRATION

With both types of service, however, great precautions are taken to furnish reliable and accurate information. The site for a shore compass is selected only after long consideration. After the receiving equipment has been installed, with due care to placing of wiring, etc., in regard to the symmetry of the loop, the station must be checked from both radio and visible sources. The usual method is to get a radio bearing from a ship within sight, at the same time taking a sight through a surveyor's transit. The sight through the telescope is true. The radio compass loop will be off slightly. This deviation is noted and logged. Many checks are made, both at the beginning and periodically, to make certain the station readings are accurate.

The calibration of a direction-finder is not so difficult, although it is made just as carefully. The apparatus is installed and then the ship makes a run or several runs around the harbor, taking sights and radio readings simultaneously. The rigging, booms, ship's antenna, etc., are all in certain positions when the compass finder is installed. These positions are noted, and as they affect the symmetry of loop reception, they must be the same whenever readings are taken. To find on which side of the "figure-8" curve (see sketch) a ship or fog beacon may be, it is necessary only to reverse the input to the grid circuit.

## Circuits Favored by British Listeners

(Continued from page 1335)

A three-tube Unidyne circuit is shown in Fig. 4. The characteristic feature is the use of four-electrode tubes in place of the standard three-electrode type. In operation the action of the second grid reduces the space charge inside the tube to such an extent as to enable the latter to give practically the same amplification factor as if a high-voltage source was in circuit.

As will be seen, the second or outer grid of the first tube is connected *via* the antenna tuning inductance to the negative of the filament or "A" battery; while the inner grid is connected *via* a special feed-back coil to the positive of the "A" battery.

In each case the plates of the tubes are connected, either directly or through transformer coils, to the positive pole of the "A" battery, which is preferably of the 6-volt type. The switch A allows the A.F. amplifier to be placed in or out of circuit at will.

### THE FAMILY "STRAIGHT" CIRCUIT

The last year or so has seen successive reductions in the market price of British tubes. Partly for this reason, and partly because reflexed circuits are prone to be noisy and somewhat tricky to handle, the most recent tendency is to favor the ordinary "straight" type of circuit.

A notable feature of British design in this connection is the almost universal use of the tuned-plate coupling for the radio-frequency stage. This is chiefly due to the fact that, in the early days of broadcasting, official regulations forbade the use of any feed-back coupling directly to the aerial.

The tuned-plate circuit provides an alternative means of *indirect* regeneration through the inherent capacity coupling between the internal electrodes of the tube itself. In addition, it also allows the use of inter-tube regeneration as, for instance, by directly coupling the output from the detector tube to the coil

## Changes Your Set Into a Low Wave Receiver



Sent postpaid upon receipt of \$15 M. O.—or C. O. D. plus postage. State name of set and type of tubes you use.

## SUBMARINER

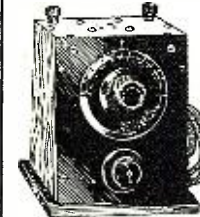

Converts any set, regardless of make or number of tubes used, into a high class short wave tuner, with which you may listen to low wave stations between 30 and 75 meters. No changes necessary to your present set.

**SUMMER RECEPTION PRACTICAL AT LAST**

No jumble of stations on low waves—no disagreeable noises—practically no static. Learn code by listening to amateurs from all parts of the world. Comes ready to attach; no extras needed. Just plug in and you have command of the low wave lengths. Operates as a wave changer in superheterodynes. Connected and disconnected instantly.

### ORDER TODAY

We Guarantee to Refund Your Money if the "Submariner" Fails to Operate

**J-M-P MANUFACTURING COMPANY**  
Dept. 116X MILWAUKEE, WISCONSIN

## Dealers! Set Builders!

Save Money—Write for

## CHI-RAD'S FREE RADIO CATALOG

Madison-Moore—Victoreen  
Browning-Drake—Nine-In-Line  
Transmitting Apparatus

Be Sure to Use Business Letterhead  
When Answering

**CHICAGO RADIO APPARATUS CO.**  
415 S. Dearborn St., Dept. RN., Chicago

## RADIO CATALOG

COMPLETE PARTS  
Dealers! Send for our  
new 1927 Catalog.

Improved Nine-In-Line Super;  
Alo-Head Super Eleven;  
Camfield Super Selective Nine;  
Citizens Super Eight; Victoreen Super; and many other popular circuits.  
Use your letterhead.

**Western Radio Co. MFG.**  
134-136 W. Lake St. Chicago, Ill.

## Cooper "A" Eliminator

Not a Power Unit  
Employs No Trickle Charger  
Operates direct from the  
Light Socket. See Your Dealer

A Laboratory Product



**CRESCENT LAVITE RESISTANCES**

Used in 50 big broadcasting stations  
12,000, 48,000, 50,000 and 3,000 ohms.  
For distortionless amplification. Order a  
Crescent today at \$1.50. Special sizes made to  
order. Discounts to dealers.

Cresradio Corp., 166-32 Jamaica Ave., Jamaica, N. Y.

## EVERYTHING IN RADIO

AT ATTRACTIVE PRICES. SETS OR PARTS.  
Orders shipped exactly as ordered. Prompt Service.  
Write for Prices. Mail Order Only. Write for Catalogue  
**ALL RADIO COMPANY, 417 North Clark St. Chicago**



# OPPORTUNITY AD-LETS

Follow these advertisements every month. Reliable advertisers from all over the country offer their most attractive specials in these columns.

Classified advertising rate twenty-two cents a word for each insertion. Ten per cent discount for 6 issues, 20 per cent discount for 12 issues. Name and address must be included at the above rate. Cash should accompany all classified advertisements unless placed by an accredited advertising agency. No advertisement for less than 10 words accepted.

Objectional or misleading advertisements not accepted. Advertisements for the July issue must reach us not later than May 1st.

**CIRCULATION LARGER THAN THAT OF ANY OTHER RADIO PUBLICATION**

EXPERIMENTER PUBLISHING CO., INC., 230 Fifth Avenue, New York, N. Y.

## Agents Wanted

**Big Money and fast sales.** Every owner buys gold initials for his auto. You charge \$1.50; make \$1.35. Ten orders daily easy. Write for particulars and free samples. American Monogram Co., Dept. 133, East Orange, N. J.

**Guaranteed Genuine Gold Leaf Letters** anyone can put on store windows. Large profits, enormous demand. Free samples. Metallic Letter Co., 422 N. Clark, Chicago.

**Auto Gas Saver Free.** To introduce. Amazing car performance. Doubles mileage. CRITCHLOW, Inventor, 11-18, Wheaton, Ill.

**Sell absolute necessities.** Cost 2c, sells 25c. Prices lowest. Seven different samples 30c. Catalog FREE. Mills Sales Co., 15 East 10th St., New York.

**Lightning Electrolyte.** Charge storage batteries instantly. Gallon costs 50c, sells \$10.00. Make it yourself. Guaranteed formula \$5.00. Write for free circulars. Murphy, Chemist, Tujunga, Calif. Box-D.

## Art

**Genuine French Art Pictures—ten for \$1.00.** R. Wentworth, care Coney Island Post Office, New York.

## Business Opportunities

**Free Book Start Little Mail Order Business.** Pier Company, 72AF Cortland Street, N. Y.

**Co-operative EIA membership** is establishing one honest and industrious man of each county in his own successful industry. Young married men preferred. Write confidentially about yourself. Equitable Industries Association, 151-R Nassau St., New York.

**\$7-\$10 spare time evenings.** If you have built two or more successful receivers. No Selling Scheme. Co-Operative Radio Doctors, Desk 12, 131 Essex St., Salem, Mass.

## Chemistry

**Learn Chemistry at Home.** Dr. T. O'Connor Sloane, noted educator and scientific authority, will teach you. Our home study correspondence course fits you to take a position as chemist. See our full page ad on page 1331 of this issue. Chemical Institute of New York, 66R-W, Broadway, New York City.

## Correspondence Courses

**Used correspondence school courses** sold on repurchase basis. Also rented and exchanged. Money-back guarantee. Catalog free. (Courses bought). Leo Mountain, Pisgah, Alabama.

## For Inventors

**I am in touch with hundreds of moneyed men and manufacturers** who wish to buy good inventions. Hartley, 38 Court St., Bangor, Maine.

## Help Wanted

**Detectives Needed Everywhere.** Travel. Experience unnecessary. Write George Wagner, former Government Detective, 2190 Broadway, N. Y.

**Earn \$25 weekly,** spare time, writing for newspapers, magazines. Experience unnecessary. Details FREE. Press Syndicate, 973, St. Louis, Mo.

**Men, get Forest Ranger job;** \$125-\$200 month and home furnished; permanent; hunt, fish, trap. For details, write Norton, 270 McMann Bldg., Denver, Colo.

**Set Builders!** We furnish jobs for you. (No Fee.) Competent men needed today in every community to build LC-27, Hammelund-Roberts, Ultradyne, Loftin-White and Browning-Drake Sets. Big money for you if you can qualify. Register Now, giving particulars, experience, references. Allen-Rogers, Inc., 118 E. 28th St., New York City.

## Mailing Lists

**Free—Send name and address.** Be put on our free mailing list. Keep posted on latest radio items. Interstate Sales Co., 1142 Broadway, New York.

## Miscellaneous

**Inventors:** Use our special service for presenting your invention or patent to manufacturers. Adam Fisher Mfg. Co., 278-A Enright, St. Louis, Mo.

**Forms to Cast Lead Soldiers, Indians, Marines, Trappers, Animals,** 151 kinds. Send 10c for illustrated Catalogue. H. C. Schiereke, 1031 72nd St., Brooklyn, N. Y.

**Multigraph typewritten letters** sell anything. Two dollars thousand. Meyer Rey Corporation, Monmouth, Illinois.

## Motion Pictures and Supplies For Sale

**Films and Machines,** dirt cheap. Stamp for lists. Box No. 5836 Westport Station, Kansas City, Missouri.

## Motorcycles, Bicycles

**Don't Buy a Bicycle Motor Attachment** until you get our catalog and prices. Shaw Mfg. Co., Dept. 6, Galesburg, Kansas.

## Old Money Wanted

**\$2 to \$500 each** paid for hundreds of Old or Odd Coins. Keep all old money, it may be very valuable. Send 10c for New Illustrated Coin Value Book, 48c. Guaranteed prices. (Get posted). We pay Cash. Clarke Coin Company, 14 Street, LeRoy, N. Y.

## Patent Attorneys

**Inventors—Should write** for our Free Guide Books and "Record of Invention Blank" before disclosing inventions. Send model or sketch of your invention for our Free Inspection and Instructions. Radio, Electrical, Chemical, Mechanical and Trademark experts. Terms reasonable. Victor J. Prans & Co., 923 Ninth, Washington, D. C.

**Patents—Send** for Form "Evidence of Conception" to be signed and witnessed. Form fee schedule, information free. Lancaster and Allwine, Registered Patent Attorneys in United States and Canada, 269 Ouray Bldg., Washington, D. C.

**Patents.** Send drawing or model of your invention for examination and instruction. Advice and booklet free. Highest references. Best results. Promptness assured. Watson E. Coleman, Patent Lawyer, 724 9th Street, N.W., Washington, D. C.

## Patents

**Inventions Commercialized.** Patented or unpatented. Write Adam Fisher Mfg. Co., 278 Enright, St. Louis, Mo.

**Patent Sense—Valuable book free.** See Lacey's ad page 1389. Lacey & Lacey, 631 F St., N.W., Washington, D.C. Established 1869.

## Printing Outfits and Supplies

**Print your own cards,** stationery, circulars, paper, etc. Complete outfits \$8.85. Job Presses \$11, \$29; Rotary \$149. Print for others, big profit. All easy rules sent. Write for catalog presses, type paper, etc. Kelsey Company, F-13, Meriden, Conn.

## Radio

**Boys! Don't Overlook This.** The "Rasco" Baby Detector. Greatest detector ever brought out with moulded base. Fully adjustable. See former advertisements in this publication. Detector with Galena Crystal, complete 50c, the same detector with Radiolite Crystal, 75c prepaid. Send for yours today, Radio Specialty Company, 96-98 Park Place, New York City.

**Attention!**—50 vacuum tube hook-ups. The greatest collection of vacuum tube circuits ever brought under two covers at such insignificant cost. These diagrams will be found in the great "Rasco" catalog, which contains raw materials and parts in a greater profusion than any other catalog. Send for free catalog. Radio Specialty Co., 96-98 Park Place, New York.

**Radiogen 2 1/2 volt Alkaline Storage B \$1.95.** Trickle chargers \$1.95. Eliminators, catalog. Science Specialties, 620 Fayette, Indianapolis.

**Transmitters—Broadcasting and Amateur.** We construct any size station at low figures, having a number in stock for immediate delivery. A few 5-watt outfits, \$30; 10-watt \$45; 20-watt, \$90; 50-watt, \$150; 100-watt, \$350; 250-watt, \$800, etc. Short wave receivers and wavemeters carried. S & S Radio Co., 31 N. Warren St., Trenton, N. J.

**Free Sample Ivory Radio Panel,** the new radio panel now in great demand. Its handsome grained and polished surface, insulating qualities, workability, and permanent finish, will make the most beautiful and efficient set of all. Also Ivory dials and knobs. Ivorylite Radio Panel Co., 3330 Avenue G, Port Worth, Texas.

**Send 25c for catalog.** Amount to be deducted in first order. Dombrowski, 4341 S. Campbell Ave., Chicago, Ill.

**Y. M. C. A. Radio Institute,** 151 East 86th Street, New York. Hundreds of successful graduates. Home Study and School courses. Radio operating or Mechanics. Send for Free Booklet.

## Scenery for Rent

**World's Most Beautiful Settings** for operas, plays, minstrels. Amelia Grain, Philadelphia.

## Song Poems

**Song Poem Writers—Address** Ray Hibbeler, D7X, 2104 No. Keystone Ave., Chicago.

## Stammering

**St-tut-t-tering and stammering** cured at home. Instructive booklet free. Walter McDonnell, 121 Arcade, 1126 Granville Avenue, Chicago, Ill.

## Telegraphy

**Telegraphy—Both Morse and Wireless** taught thoroughly. Big salaries. Wonderful opportunities. Expenses low, chance to earn part. School established fifty years. Catalog free. Dodge's Institute, Cour St., Valparaiso, Ind.

## Wanted to Buy

**Full Value Paid** for Old Gold, Jewelry, Watches, Diamonds, crowns, bridges, dental gold, silver, platinum, gold or silver ore; magneto points, and false teeth. Packages returned if our offer is not satisfactory. United States Smelting Works (The Old Reliable) 29 So. State St., Dept. 16, Chicago, Ill.



**Every Monday 9:15PM.**

to the "RADIO NEWS ENSEMBLE" the high class concert feature under the direction of Millicent Frances, Lillian Tonge, coloratura; Stuart Arles, tenor; Rose Rubenstein, dramatic soprano; Warren McGoldrick, basso.

"ALWAYS GOOD SINGING" For concert engagements, inquiries and copies of souvenir book, address RADIO NEWS ENSEMBLE WRNY The Roosevelt, New York

# M-EMERSON-MULTIVALVE

Seven-element tube with 201A filament, three plates and three grids. Uses any battery. Operates on 5 volts. Draws only 1/4 ampere. Fits any standard socket. Can be used with many circuits. Write for information. List Price \$6.50

Exclusive Licensees and Manufacturers Emerson Radval Corp. 25 West 43rd St. N.Y.C.

# A RADIO EDUCATION

IN 5 VOLUMES

Theory, Design, Construction Operation and Maintenance

LEARN AT HOME

These five component parts of a complete Radio Instruction Course are outlined in five volumes that contain not merely the essentials as so many books do, but more, they contain all that any modern up-to-the-minute textbook on any subject would cover. They are in themselves a COMPLETE radio education teaching every possible portion of Radio science.

Size of each book 6 by 9 inches, handsomely bound and illustrated with charts, diagrams, descriptions of equipment, etc.

SEND NO MONEY for these books. Just forward your name and address. We send you the books at once. On receipt of same you pay the postman \$1.97 plus a few cents postage and then they are yours.

Distributed by

**THE CONSRAD CO.**  
230 Fifth Ave., New York, N. Y.



**LITTLE THINGS CAN MAKE A BIG DIFFERENCE**

as for instance

## X-L PRODUCTS

Endorsed by authorities and specified in all leading bookups.

**Model "N"** A slight turn obtains correct tube oscillation on all tuned radio frequency circuits. Neutrodyne, Roberts two tube, Browning-Drake, McMurdo Silver's Knockout, etc., capacity range 1.8 to 20-micro-microfarads. Price \$1.00.

**Model "G"** with grid clips obtains the proper filter and intermediate frequency tuning in heterodyne and positive grid bias in all sets. Capacity range Model G-1—.00002 to .0001 MFD, Model G-2—.0001 to .0005 MFD, Model G-10—.0003 to .001 MFD. Price \$1.50.

### X-L PUSH POST

Push it down with your thumb, insert wire, remove pressure and wire is firmly held. Releases instantly. Price 15c.

Push Post Panel permanently marked in white on black insulating panel. In box including soldering lugs, raising bushings and screws for mounting, etc. Price \$1.50.

FREE Wiring Diagrams showing use in most popular circuits sent on request. Write today.



X-L Radio Laboratories, 2426 LINCOLN AVE., CHICAGO, ILL.

## Three Foot Cone OR Roll Type Speaker

MAKE YOUR OWN AND SAVE EIGHTY PER CENT OF COST WITH THE FAMOUS ENSCO KIT. ONLY \$10.00.

MAKE YOUR OWN THREE FOOT CONE OR ROLL SPEAKER IN LESS THAN AN HOUR. Complete parts furnished in kit form. We guarantee this speaker the equal of any manufactured cone speaker at any price.

With this THREE FOOT CONE SPEAKER you hear all the tones. It brings out the true depth and beauty of orchestral and instrumental music. Can be operated softly for Living Room Music or Full Volume for dancing, and without trace of distortion.

Kit includes famous "ENSCO" cone unit, the only direct-drive, distortionless unit for large cones; Alhambra Fonotex for big cone, with brass apex, two Sepia Prints showing cabinet or simple stand construction. All necessary instructions.

Buy this wonderful speaker under our absolute guarantee. Your money back if you are not convinced that it is the finest reproducing medium obtainable at any price. It works on any set, with ordinary Tubes or with Power Output.

SEND NO MONEY!

ENGINEERS' SERVICE CO., 25 Church St., (Desk N) New York City

Write your name plainly as indicated below, then mail and complete kit will be forwarded to you. Just pay postman \$10.00 upon delivery.

NAME .....

ADDRESS .....

Enjoy a Big Powerful Radio: 30 Days FREE!



Users everywhere report it gets Coast to Coast, Canada to Mexico, loud and clear on speaker; outperforms \$100 to \$200 sets. Some hear Europe. Marvellous bargains! Don't buy unless 30 Days Trial proves it Most Selective, Clearest and Most Powerful Distance. Getter among big, fine 5-tube radios. Retail LIST price, now \$49.75. **Factory Prices—SAVE Up to 1/2** Every set completely assembled, rigidly tested, fully guaranteed. Single Dial Sets, Speakers, batteries, tubes, etc., at big savings. Free literature, users' testimony and BIG SPECIAL OFFER. **MIDWEST RADIO CORPORATION** Pioneer Builders of Sets. **Send for Proof** 404-C Miraco Bldg., Cincinnati, O.

in the plate circuit of the radio-frequency amplifier.

Fig. 5 shows a standard type of circuit for working the family loud speaker, comprising a tuned-plate radio-frequency amplifier 1, followed by a detector 2, and an A.F. amplifier 3.

The switch A allows a choice of series-tuned or parallel-tuned antenna circuits. The switch B gives direct coupling to the antenna or through a tuned secondary circuit. Two switches C and D, are provided to regulate the number of tubes in circuit, and a

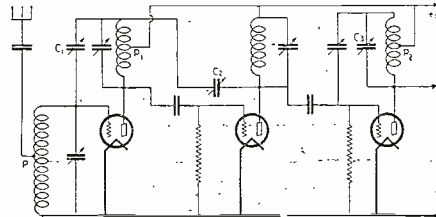

An English "neutralized" tuned radio frequency circuit. This is one of the most popular forms.

switch E to introduce regeneration directly upon the antenna coil L, or through the tuned-plate coil L1, at will.

### "SUPER" CIRCUITS

Although the average Britisher is mainly influenced by the desire for simplicity combined with economy as the keynote of his broadcast receiver, this does not imply that he refuses to take an intelligent interest in what may be called the super circuits. The Armstrong principle of super regeneration, and its derivative, the Flewelling circuit, together with the various types of Reinartz circuit, have many adherents amongst the more advanced amateurs.

The superheterodyne receiver, and the various forms of neutrodyne or radio-frequency balancers, are, however, the chief favorites amongst this class. "Supersonic" reception is of course limited to those to whom cost is a minor consideration; but the neutrodyne principle in one form or another is in fairly general use.

Fig. 6 shows one form of neutralized circuit which has attracted a considerable following. It will be seen that neutralizing condensers, C1, C2, C3, are combined with a mid-point tapping P to the antenna and at P1 and P2 to the plate tuning-coils, so as to ensure the necessary balancing effect. The tendency to produce parasitic noises is minimized, in cases where several stages of radio-frequency amplification are used, by making the mid-point tapping to alternate plate-coils only, as shown.

Station  
**WRNY**  
NEW YORK

373.8 Meters - 802 kilocycles

is owned and operated by the publishers of this magazine

Our Editors will talk to you several times every week

See your Newspaper for details

**TUNE IN ON WRNY**

# LYNCH METALLIZED

WARRANTED FIXED RESISTORS

## HEAVY-DUTY-TYPE

The new Lynch wire-wound heavy duty resistors for eliminator and power work are now ready. These units are ideal for use in Raytheon and all other power circuits.

### EQUALIZORS

For perfect filament control use the Lynch Equalizers. There is a type for every type of tube and for any combination of tubes. A Lynch Equalizer will take the place of your filament rheostats. Complete, with mounting, \$1.00.

Lynch Suppressors and Low-loss mountings mean better radio.

At All Good Dealers

ARTHUR H. LYNCH, INC. 250 W. 57th St. New York, N.Y.

**FREE** This Wonderful Radio Book

The World's Largest Exclusive Radio Mail Order House

will send you—FREE—this wonder catalog of radio bargains containing over 200 items of everything in RADIO, including all the latest Sets, Kits and Parts, at rock-bottom prices that Save you one-third to one-half.

**5-TUBE SETS AS LOW AS \$24.90**

Latest 1927 Models

Table and Console models with built-in loud speakers. Beautiful genuine mahogany and walnut cabinets. All sets at amazingly low prices.

**SEND FOR BOOK TODAY**

Send letter or postal, and this bargain radio catalog will come to you absolutely free. Write Today.

**84 ILLUSTRATED PAGES**

**RANDOLPH RADIO CORPORATION**  
180 N. Union Ave. Dept. 236 Chicago, Ill.

### Will Finance Patents

Commercial value, royalty basis, manufactured for \$10.00 and under. Mail model and copy of patents or full details.

**KAMSTONE HOLDING CORP.,**  
41 East 42d Street New York

### New 1927 Radio Key Book

You'll enjoy reading it—48 pages of interesting, up-to-the-minute facts about radio, simply told. Also full construction details of all leading types of circuits. Send 10 cents (coin or stamps) to cover postage and mailing cost.

**ALL AMERICAN RADIO CORP.**  
4209 Belmont Ave. Chicago

### The Kodol Radio Corp.

The World's Largest Manufacturers of Battery Chargers and Eliminators

**Cincinnati, Ohio**

Watch for our 1927-28 Announcement

Six tubes ~ One Control

## FRESHMAN MASTERPIECE

Sold by Authorized Freshman Dealers Only

## Balkite

### Radio Power Units

FANSTEEL PRODUCTS CO., Inc.  
North Chicago, Illinois

# BOOK REVIEW

By Robert Hertzberg



67

## DEFINITE, PRACTICAL AND WORKABLE MONEY MAKING PLANS

**S**IXTY-SEVEN plans — completely outlined with a procedure for establishing yourself in those most successful and most lucrative Spare Time businesses in the United States.

Each plan consists: First—of a definite workable item that can be retailed by people of limited means and have only a few spare minutes a day to utilize. Second—the best method of production is outlined carefully with suggestions as to what to avoid. Third—Avenues of distribution or selling are given—such methods of selling by mail as are applicable and all similar details are discussed, and Fourth—information of importance in carrying on to reap large, generous profits is discussed.

Altogether you have before you complete, accurate Spare Time businesses that have returned hundreds of dollars to others.

Sparetime Money Handbook contains 100 Pages, of the large magazine size, 9 x 12 inches—with handsome colored covers, over 100 illustrations.

NEW EDITION JUST OFF THE PRESSES

PRICE 50c

If your dealer cannot supply you use Coupon below

THE CONSRAD CO., Inc.,  
230 Fifth Ave., N. Y.

Gentlemen: I enclose 50c for one copy of "Sparetime Money Handbook."

Name .....

Address .....

City, State .....

**PRINCIPLES OF MODERN RADIO RECEIVING**, by L. Grant Hector, Ph.D., assistant professor of physics, University of Buffalo. Burton Publishing Company, Buffalo, N. Y. 5 3/4 x 9 inches, 305 pages, cloth, illustrated. Price, \$5.00.

Just before the broadcast boom descended on an unsuspecting public, it was pretty generally agreed in radio circles that the best all-round radio book for the amateur enthusiast, possessed of a limited technical education and a fair amount of intelligence, was *Principles Underlying Radio Communication*, the Signal Corps manual prepared by several experts of the Bureau of Standards, in Washington. Written in a clear, unpretentious manner, by men who tried merely to explain complex actions rather than to establish a literary masterpiece, it became known as a complete radio education in itself, covering the fundamental facts of direct- and alternating-current practice and the theory and practice of transmitters of the spark, arc, alternator and tube types, as well as of the corresponding kinds of receivers.

With the advent of broadcasting, however, and the rapid development of circuits intended for the reception of broadcast stations, the book has become somewhat inadequate. A man finishing his reading of it is brought right up to the broadcast era and then confronted with the back cover; he is led to ask the natural question: "Well, what about our modern radio circuits and practices?"

It is rather difficult to select a book that is fit to supplement and accompany the Signal Corps' monumental 619-page "pamphlet." However, we think that in Dr. Hector's work, *Principles of Modern Radio Receiving*, we have found such a volume. Its first few chapters are devoted to the inevitable review of fundamental electrical theory, but once it approaches the subject of the three-electrode tube and its use in radio circuits, its value to the man already prepared by the government book becomes evident.

The most important subject of broadcast practice, radio-frequency amplification, is discussed in great detail. Many of the puzzling features of R.F. circuits (particularly those of the various "bridge" types), are explained in such understandable language that radio fans reading the book will probably wonder why they were ever stumped by them. We also suspect that many alleged radio "experts" who discourse glibly on the ramifications of R.F. will secretly bury their noses in the book and really learn, for the first time, what they are talking about.

Superheterodynes and combined circuits, audio amplifiers and battery chargers and battery eliminators are treated in the same clear fashion. The author, being a college professor, has presumably no commercial axe to grind; so his specifications of the advantages and disadvantages of the numerous electrical systems, methods and instruments he describes may be accepted as a valuable presentation of the entire subject.

Dr. Hector's candid language is amusing in places. For instance, when discussing radiating receivers (page 135), he shows a diagram of a typical blooper, with a double border of heavy black and the caption: "In Memoriam. A single-circuit receiver which is a pernicious radiator." In the text he says: "Figure 83, properly draped in mourning to show that the circuit should be (whether it is or not) dead and buried, illustrates the general principle involved."

**PRACTICAL RADIO CONSTRUCTION AND REPAIRING**, by James A. Moyer and John F. Wostrel. McGraw-Hill Book Company, Inc., New York City. 5x7 1/2 inches, 319 pages, cloth, illustrated. Price, \$2.00.

This book is aimed to be of service to the amateur constructor who makes his own set, to the purchaser of a complete radio receiving outfit who wants to know how it works and how to make minor adjustments and repairs when unsatisfactory conditions begin to appear, and to the radio dealer and his assistants who are called upon to test and repair radio receiving sets.

Radio troubles, common and uncommon, are discussed in sufficient detail to enable a radio "troubleshooter" to go about his work intelligently, systematically and efficiently.

The authors would do well to apply some of their own advice, and check over the diagram of a three-stage resistance-coupled amplifier printed on page 141. In this hook-up a very small line, which would not be more than a sixteenth of an inch

before you  
**BUY**  
a radio set  
consult

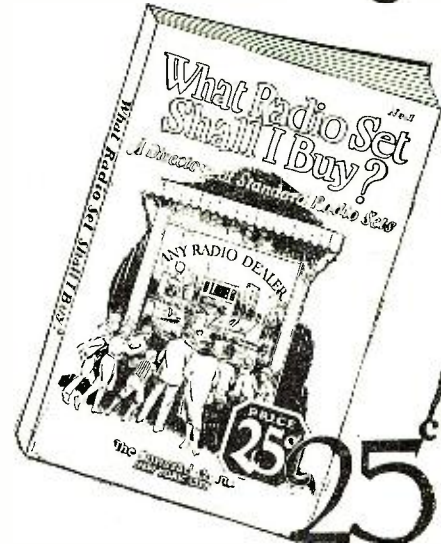

## The first and only complete manufacturers' directory of all standard Radio Receivers—

We all want to know what kind of a set is best to Buy. Here is a book that describes all standard manufactured sets from authentic descriptions furnished by the *manufacturers themselves*.

It gives you all the information you need to take your choice, saves you from "blind" buying, and vain regrets.

GIVES PRICES, TECHNICAL DESCRIPTIONS — ILLUSTRATIONS

Receivers are illustrated, prices are given, manufacturers' names and addresses supplied. General characteristics of sets are described, number of tubes, "Electrified" Receivers, etc., etc. All you need to know—Just like a permanent "Show."

The only book of its kind—absolutely unprejudiced, 40 pages—size 6 x 9 inches profusely illustrated.

DON'T BUY IN THE DARK—AVOID MAKING THE WRONG CHOICE.

USE "The Directory of Standard Radio Sets."

**ONLY 25c**

If your dealer cannot supply you Write direct

The Consrad Company, Inc.  
230 Fifth Ave. New York, N. Y.

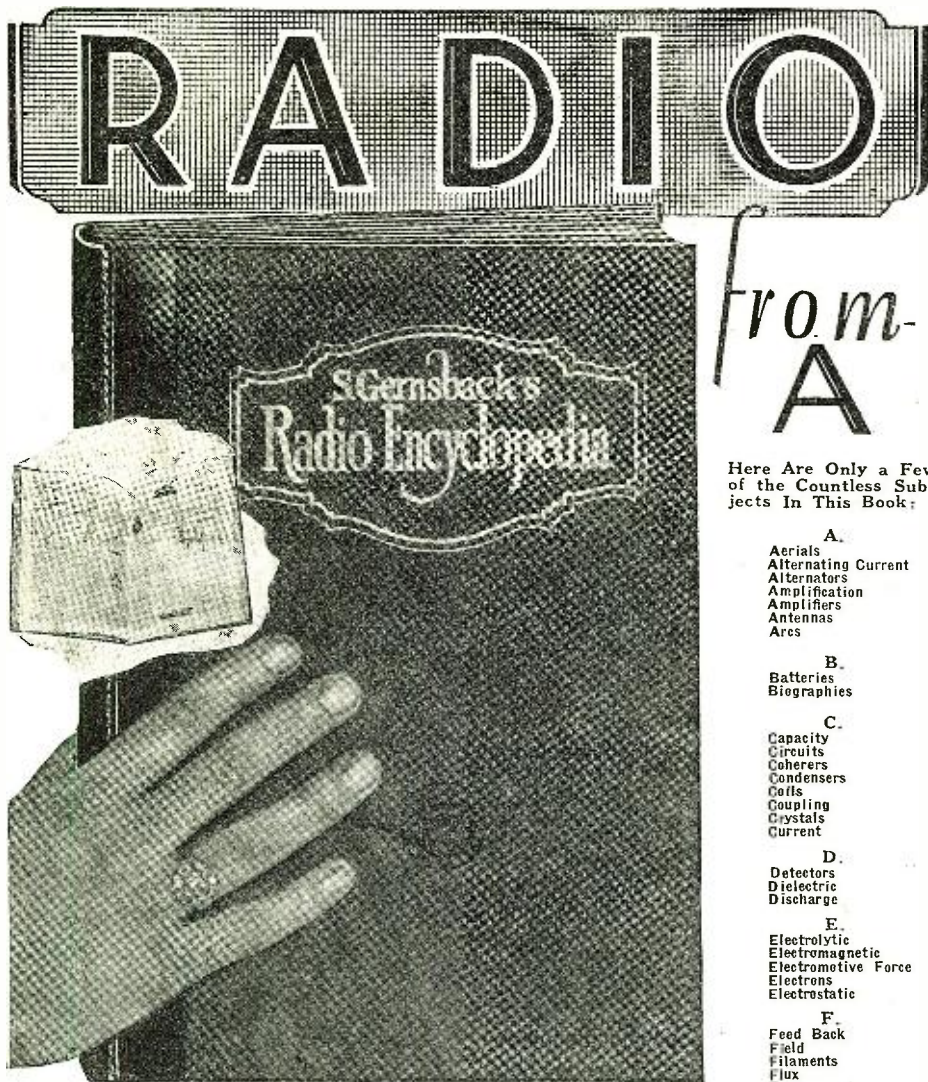

NOT A DICTIONARY—A REAL ENCYCLOPEDIA OF RADIO

# ONE THOUSAND BOOKS—IN ONE

The First Classification and Explanation of the Countless Words Used in the Specialized Science of Radio

Edited by **SIDNEY GERNSBACK**

Editor of *Radio Listeners' Guide* and *Spare Time Money Making*. Author of *Wireless Course* in 20 Lessons, *Practical Electricity Course*, etc.

S. GERNSBACK'S RADIO ENCYCLOPEDIA is the only standard work ever published in America attempting to classify alphabetically the countless words used in the highly specialized science of RADIO.

The ENCYCLOPEDIA is written in plain English so that everybody can understand the definition and descriptions.

No expense has been spared covering over two years in compilation, to make it worthy a place in your library.

It is published in one volume—168 pages—size 9x12 inches, nearly an inch thick and nicely accommodates the beautiful illustrations and the large, easy to read type.

Every page is replete with illustrations—to make the text easily understandable.

**REMEMBER THIS IS A REAL ENCYCLOPEDIA—NOT A DICTIONARY—** and very few of the things described and illustrated in this volume can be found in any dictionary, or any other encyclopedia.

The book contains as a supplement a classified cross-index designed to bring together radio references under one heading having relations in common.

All circuits new and old are described by word and picture and every part and apparatus used in Radio is explained and made understandable by means of photographs and drawings.

The work contains 1,930 definitions, 549 photographs, drawings and diagrams.

The volume is printed upon fine paper—bound in full black Karatol, marbled paper fly leaves and end sheets, with the title stamped in gold.

This volume should find a place in every library, and will be a veritable boon to you who are interested in Radio, from any angle.

The advance sale was so tremendous that a very large edition has been printed, effecting a very considerable saving in printing, etc. This saving is being passed on to present purchasers, and you may obtain the encyclopedia for the present at only \$2.00.

**Price \$2.00** POSTAGE PAID

If Your Dealer Cannot Supply You SEND ALL ORDERS DIRECT TO **SIDNEY GERNSBACK**

230 5th Ave., New York, N. Y.

Money Refunded If Not Absolutely Satisfactory.

# from A

Here Are Only a Few of the Countless Subjects In This Book:

**A.**  
Aerials  
Alternating Current  
Alternators  
Amplification  
Amplifiers  
Antennas  
Arcs

**B.**  
Batteries  
Biographies

**C.**  
Capacity  
Circuits  
Coherers  
Condensers  
Coils  
Coupling  
Crystals  
Current

**D.**  
Detectors  
Dielectric  
Discharge

**E.**  
Electrolytic  
Electromagnetic  
Electromotive Force  
Electrons  
Electrostatic

**F.**  
Feed Back  
Field  
Filaments  
Flux  
Frequency

**G.**  
Galvanometers  
Grids  
Grounds

**H.**  
Heterodyne  
High Frequency

**I.**  
Impedance  
Inductances  
Inductance Coils  
Induction  
Inductive  
Insulating Materials

**K.**  
Keys

**M.**  
Magnets  
Magnetic

**O.**  
Oscillations  
Oscillators

**P.**  
Plates

**R.**  
Radiations  
Radio  
Radio Frequency  
Reactances  
Rectifiers  
Resistances  
Resonance

**S.**  
Switches

**T.**  
Theory of Current Flow  
Transformers  
Transmission  
Tuning

**U.**  
Units

**V.**  
Vacuum Tubes

**W.**  
Wave  
Wires  
Etc., etc.

long, has been omitted; and as a result the detector tube is isolated from the A.F. circuit and its own plate receives no direct current from the "B" battery. Maybe the hook-up in this form was inserted deliberately to give the readers of the book something to practice on, but we don't know.

Otherwise, the book is quite a handy volume. It also gives easily-understood information and directions about the construction, testing and repairing of the important types of receiving sets and commonly-used radio equipment; such as wave traps, trickle chargers for "A" and "B" batteries, cone-type loud speakers, apparatus for directional reception, etc.

Special attention is given to the superheterodyne, short-wave sets, and impedance- and resistance-coupled receivers. "Trouble shooting" is explained fully with the aid of illustrations and diagrams, and such matters as fading and interference are also discussed.

The book is intended as a companion volume to the same authors' *Practical Radio*, and like the latter, furnishes concise, practical information for the man who does not wish to go deeply into the intricacies of radio engineering, but who does want to know how to test, repair and improve his radio receiver. Details of theory are given little space, the book being composed almost entirely of how and why-to-do-it explanations. Amateurs who are not thoroughly familiar with the tools and other mechanical contrivances necessary for radio work can read the volume with profit.

**THE AMERICAN ANNOUNCER AND RADIO LOG**, published by the American Announcer, Buffalo, N. Y. 9x11 inches, 154 pages, flexible covers, illustrated. Price, \$2.50.

This loose-leaf volume is the answer to a question voiced on innumerable occasions by exasperated listeners who have waited anywhere from fifteen to fifty minutes to hear some strange voice announce the identity of a station to which they have been listening: "WHY is a radio announcer?" Each of its pages contains a short biography and a large photograph of a man (there are also a few women) dressed in his Tuxedo and smiling sweetly at the camera or posed in front of the ubiquitous microphone.

The variety of the occupations from which radio announcers have emerged is truly amazing; but one is struck by the fact that comparatively few of these men have had any formal training in either music or public speaking. The majority of them seem to have been deposited before the microphone by accident, and, finding the work interesting and the limelight of public attention satisfying, they have stuck to their new-found posts. It is worthy of note that the few really distinguished announcers, like Milton J. Cross of WJZ and Kolin Hager of WGY, may boast of truly adequate background and training, which is evident in their dignified and thoroughly unobtrusive conduct before the "mike."

Cross, for instance, who was born in New York City in 1897, graduated from the DeWitt Clinton High School and later completed the music supervisors' course of the Danrosch Institute of Musical Art. Afterward he became a member of the Paulist Choristers and devoted much time to church and concert work. Hager, a native of Gloversville, N. Y., started studying for grand opera at the age of eighteen, after having been a noted boy soprano for four years. He has had a varied musical experience, and once toured the country as the director of a light opera entitled "The Isle of Azuwer."

The newspaper profession seems to have furnished the greatest number of announcers, although it stands out only because the other professions are so varied. One individual, at one time well known on the air, but now reduced to the comparative insignificance of vaudeville, is chiefly distinguished as the first man to drive an automobile across the Everglades of Florida. Another was at various times an instructor of aviation in the Police Reserve Flying Corps of New York City, a professional football player and a real estate salesman, thereafter landing a job as radio announcer. Ver-satile, if anything!

## CURRENT RADIO ARTICLES

**RADIO BROADCAST**, March, 1927.

Although, in these days of cheap tubes, the value of reflex systems is open to question, amateur set constructors will be interested in the instructions for building the R.G.S. Inverse-Duplex Receiver, designed by David Grimes, which are contained in the March number of *Radio Broadcast*. To many experimenters who took up the fascinating hobby of radio after the reflex circuit had had its little spurge of glory in the newspaper radio tabloids, the set will appear as a novel one—something different from the usual two- or three-stage tuned R.F. outfits with their imposing metal cans. It is a carefully designed receiver using good components, and undoubtedly will reward with excellent results the person who builds it.

In another article, Edgar H. Felix tells "What You Should Know About 'B' Power-Supply Devices." He gives some extremely practical and valuable suggestions about the selection and opera-

# to Z

MR. S. GERNSBACK,  
230 Fifth Avenue,  
New York, N. Y.

Dear Sir: I enclose \$2.00. Kindly send me "postpaid" one copy of your Encyclopedia!

Name .....

Address .....

City..... State.....

Second call to this wonderful Magazine offer

# Free

You save \$1.00 and get 100 page books free



**WE GIVE YOU THIS VALUABLE BOOK**

It tells you how to make furniture, home appliances, tools, sport devices, hundreds of things that cost hundreds of dollars otherwise. It is full of drawings—pictures—constructional plans. Everything is explained fully—ready for you. Regular Price of this Book is \$5.00. We are giving it free with every subscription to—

## SCIENCE & INVENTION

To tell you how tremendously and intensely interesting is this great magazine is to tell you that exactly 30,405 men, from every country in this wide world of ours, are regular listed reporters of SCIENCE & INVENTION. The world is combed for big and small events in this marvelous scientific era—

Radio, Electricity, Chemistry, Mechanics—

All Scientific fields of endeavor are covered fully.

Here is a list of the major articles in the brand new May issue just out:

- Can I Study Engineering at Home?
- How to Make a Welsh Cabinet
- Hints for the Mechanic
- How to Make a Radio Console Cabinet
- Camouflaging the Radio Loud Speaker

Fill out the coupon below — Enclose \$2.50—and you get SCIENCE & INVENTION for 12 consecutive months — and absolutely Free, one copy of "How to Make It".

**ACT NOW** — this offer may never be repeated.

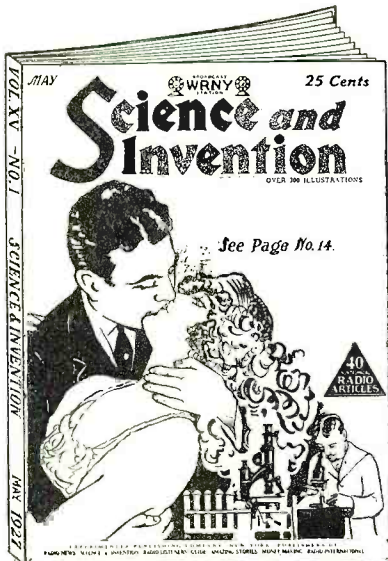

**IT COSTS NOTHING TO OWN THIS BOOK**

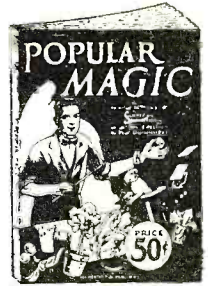

POPULAR MAGIC is a book for you, for everybody, young and old. But especially for those who want popularity, those who want to realize how much the admiration of friends help toward making life worth more.

POPULAR MAGIC contains thousands of simple, entertaining parlor tricks, as many puzzling magical stunts and a whole book full of mystic spirit novelties. A new set of tricks for every day in the year.

You get this book absolutely FREE by subscribing now

## AMAZING STORIES

A new kind of magazine. Scientifiction by world-famed writers. Marvelous, Amazing Stories by great men such as Jules Verne, H. G. Wells, etc., appear in this new magazine AMAZING STORIES every month.

Stories of flying into space at dazzling speed on a comet; Mesmerizing the dead; remarkable situations of all kinds. Tremendously interesting—yet instructive.

Keeps you in touch with the writings of the men of the greatest imaginations in the world. A magazine for young and old.

Some of the big features for the May issue just out are:

- The Moon Pool by A. Merritt
- The Time Machine by H. G. Wells
- The Man Who Was by Walter Burch
- The Star of Dead Love by Will Gray

Price \$2.50 the Year. Think of it for only \$2.50 you get one copy free of POPULAR MAGIC and AMAZING STORIES for 12 consecutive months delivered to your door. Fill out and mail the coupon now.

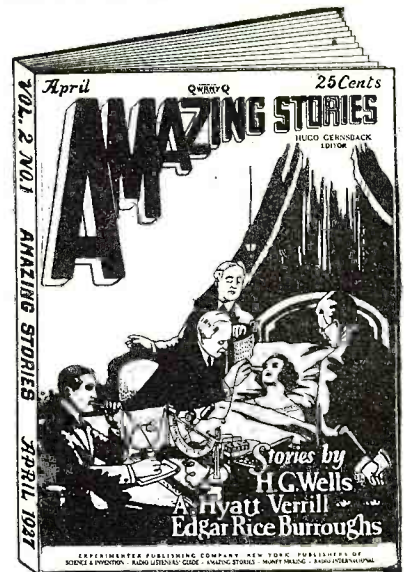

**Experimenter Publishing Company, Inc.**

230 Fifth Avenue  
New York, N. Y.

EXPERIMENTER PUBLISHING CO., Inc.,  
230 Fifth Avenue, New York, N. Y.

Gentlemen: I enclose \$.....for one year's subscription to....., you are also to send me free one copy of.....

Name .....

Address .....

City..... State.....

**Experimenter Publishing Company, Inc.**

230 Fifth Avenue  
New York, N. Y.



# Party Manners

**R**ADIO RECEIVERS know no rules of etiquette—they cannot be taught to act on best behavior when company and friends are judging them—but they can be made to act properly if the operator understands the few simple factors that effect tuning or the proper adjustment of the Receiver's controls.

Be one of those on the safe side. Don't be afraid to invite friends and show them that good tuning means good reception and enjoyable programs.

The 64 page, illustrated book on How to Tune Your Radio Set (Consrad—25c) is a carefully prepared, yet simplified, instruction book on tuning alone.

Receivers, of different types, individual characteristics are handled separately. All there is to know, all that must be known before one can really say to understand the tuning of a set—is given in this book.

It will surprise you—Buy a copy today—at the nearest Radio Shop. Only 25c. You'll get three times that value out of it.

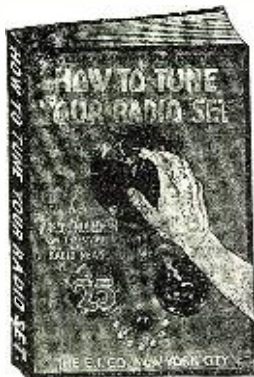

**25c**

**SOLD EVERYWHERE**

*If Your Dealer Has None in Stock Write Us Direct*

The Consrad Company, Inc.  
230 Fifth Ave. New York, N. Y.

tion of these important instruments, and describes their theoretical action briefly, for the benefit of the man not entirely familiar with it.

Other articles in *Radio Broadcast* for March are as follows: "Television: Europe or America First?," by Edgar H. Felix; "A High Quality Amplifier for the R.B. Lab Receiver," by John B. Brennan; "A Five-Tube, Non-Oscillating Receiver," by T. H. Nakken; "Constructing an Amplifier-Power Supply Device," by James Millen; and "A.C. As Filament Supply Source," by B. F. Miessner.

### POPULAR RADIO, March, 1927.

"How to Build a One-Tube Receiver for Use With a Loud Speaker" is the announcement on the cover of *Popular Radio* for March. Turning quickly to the inside of the magazine, we find that the single tube which will perform this extraordinary work is a multivalve actually containing three sets of elements and therefore performing the duties of three separate tubes. This device (described briefly in *RADIO NEWS* for February as the heart of a different set) is connected in an unusual shunt reflex circuit, which, it is claimed, eliminates the howls and squeaks that accompany the more common forms of reflex receivers.

In the lead article, entitled "Radio in 1950 A.D." Dr. Lee de Forest indulges in a little scientific speculation and predicts that some day we may be able to eliminate static; to "see" by radio; to run the clocks of the world by radio impulses; to draw electricity from the atmosphere and put this power to work for man; and to direct streams of radiant energy that will drive airplanes at tremendous speed.

Other articles are: "The Coming Reformation of Third-Degree Methods by the 'Radio Detective,'" by Thomas Elway; "How to Increase the Range of Ammeters and Voltmeters," by K. B. Humphrey; "Popular Delusions About Radio," by Charles Magee Adams; "What Every Fan Should Know About Audio Amplifiers," by Professor E. L. Bowles; and "A Real Radio 'Interference Parol,'" by James Montagnes.

### RADIO, March, 1927.

Amateur radio, according to Don C. Wallace, one-time Hoover Cup winner, writing in *Radio*, was the medium by which the now famous Wrigley marathon swim across the Catalina channel was reported to an eagerly waiting world. The Associated Press installed a short-wave station on a sea-going tug, and transmitted its dispatches to Mr. Wallace's station, 6AM, one of the best known "ham" outfits in the country, at Long Beach, Cal., from where the news was telephoned to the A.P. "swim" headquarters at Wilmington, Cal. Wallace describes the adventures of the operators on the boat, which, like the swimmers themselves, was badly buffeted by the waves, and tells in detail how the minute-by-minute reports of the thrilling race were handled by radio. It is an interesting account.

The rest of the magazine contains much technical and constructional matter, and also departments devoted to the interests of both amateur and commercial radio operators. A few of the titles are: "A Socket Power Oscillator," by Boris S. Naimark; "Tracing Superheterodyne Diagrams," by Lester I. Wiltze; "A Phonograph Cabinet Receiver," by Perry S. Graffam; "Trickle Chargers," by G. M. Best, and "The Ultimax Receiver," by C. W. Morris.

### WIRELESS MAGAZINE, February, 1927. London, England.

The push-pull idea of amplification as applied to audio circuits is nothing new, but it has remained for a British experimenter, J. H. Reyner, to adopt it to radio-frequency circuits. He connects two tubes in a split-coil arrangement, greatly resembling the familiar A.F. push-pull amplifiers used in this country, tunes them both by a single variable condenser and neutralizes them by another. It is his claim that the over-all amplification provided by this scheme is fully equivalent to that furnished by a straightforward amplifier, if not even better. The system is fully explained in the February number of *Wireless Magazine*.

Another interesting set is the "Gloria Four," especially designed for purity of reproduction for loud-speaker work. It consists of one stage of tuned R.F., neutralized with the aid of a tap on the secondary of the R.F. coupler (between the first tube and the detector) and a small balancing condenser connected back to the R.F. tube grid, and two stages of straight resistance-capacity-coupled amplification with an output filter choke and condenser of the latest approved design. The detector is non-regenerative.

### THE WIRELESS WORLD AND RADIO REVIEW, February 2, 1927. London, England.

An interesting short-wave unit, which can be connected directly to the detector tube of an existing detector and audio-amplifier combination, is described in the first February number of the *Wireless World*, one of the brightest of the British radio papers. The unit contains a single tube, a double-winding coil and a variable condenser, the three instruments being connected in an oscillating circuit of the shunt tickler-condenser control type. The secondary portion of this same coil is bridged across the grid and grid tuning condenser of the detector unit, and thus serves also as the inductance for the actual tuning circuit connected to the aerial and ground in the usual manner.

# AMAZING

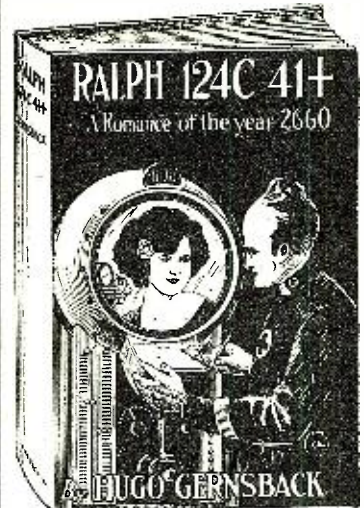

## WORLD SCIENCE and ROMANCE IN THE "YEAR 2660"

from the pen of the renowned editor and Scientific Experimenter HUGO GERNSBACK

Against an amazing background of mechanical, electrical and chemically altered life of mankind there is set a brilliant and colorful romance in the life of the greatest living scientist of that age.

Ralph's love for the beautiful stranger, his conquest of his rival and the working of the great saturnine Martian, culminating in a running fight in space with tragedy and terror conquered by almost unbelievable and incredible weapons, make one of the most interesting and gripping stories ever told.

**\$2.15 POSTPAID**

Experimenter Publishing Co.,  
230 FIFTH AVENUE  
NEW YORK, N. Y.

## AMATEURS! EXPERIMENTERS! BEGINNERS!

ALL USE

Hugo Gernsback's

## "RADIO FOR ALL"

A permanent, comprehensive Reference Book on Radio. A Thousand Textbooks and pamphlets combined in one. For everyone interested in the art of Radio.

Price \$2.00 Postpaid

EXPERIMENTER PUB. CO., INC.,  
230 FIFTH AVE., NEW YORK, N. Y.

## 116 - pages of MODERN MAGIC

by Dunninger

116 PAGE BOOK ON MAGIC "POPULAR MAGIC"

Thousands of Parlor and Stage Tricks used by America's foremost magician. Big second edition fresh from press. Illustrated. Size 9x12 inches.

**50c**

NOVELTIES! FUN! MYSTERY!  
SOLD ON ALL NEWSSTANDS  
EXPERIMENTER PUBLISHING CO.,  
230 Fifth Avenue New York City



# Announcing—A New Size and a Reduced Rate

*Spare-Time Money Making Has Increased In Size From 6 x 9 to 9 x 12 Inches—And It Now Costs Only*

**15c the Copy**

**MORE ARTICLES      MORE OPPORTUNITIES      AT LESS COST**

Spare-Time Money Making, the popular magazine of opportunities, has grown up.

From the small size of 6 x 9 inches it has been increased to 9 x 12 inches—and at the same time its price has been reduced from \$2.50 to \$1.50.

There will be absolutely no change in the high quality of the articles, except that there will be more articles—more

illustrations—more data—everything bigger than ever before.

Our special printing process enables us to give you more at a lower price.

If you enjoyed Money Making before you'll get double value now.

Ask your newsdealer for the new issue NOW.

**ASK YOUR NEWSDEALER FOR THE MAY ISSUE**

**SINGLE COPIES 15c**

**SUBSCRIPTIONS \$1.50**

*If you prefer a year's subscription use the Coupon below*

**THE CONSRAD CO., Inc.**

**230 FIFTH AVE., N. Y.**

# The Big New Spring Edition Is Here

## Latest List of Broadcast Stations

### New Circuits—Data—Information



196 Pages  
Size: 9x12 Inches  
Illustrated

More Radio data, information and constructional articles than ever before—Radio's greatest array of valuable data ever published in any quarterly.

Full to the brim with page after page of illustrated articles.

Spring Edition contains latest list of Broadcast Stations, several complete latest circuits with full constructional data—also many illustrated general Radio articles.

See your newsdealer to-day or write direct.

**Copies 50c -- Sold Everywhere**

Subscriptions \$1.75 the Year—If your dealer cannot supply you use the coupon below.

## USE THIS COUPON

**The Consrad Co., Inc.**  
230 FIFTH AVE., NEW YORK CITY

THE CONSRAD CO., INC.  
230 Fifth Avenue., New York, N. Y.

R.N.-5

Gentlemen: I enclose \$.....for one year's subscription to .....

Name .....

Address .....

City ..... State .....

# D. X. ON A LOOP WITH THE TROPADYNE



## SUPER-HETERODYNE

THE World famous Tropadyne has never been surpassed.

It gets volume, clarity and marvelous D.X. reception, all on a loop antenna—No outdoor cumbersome aerial necessary.

It's a powerful Super-Heterodyne simplified, which makes it possible for anyone to construct it.

Conrad Pattern No. 16 shows you how to build this Receiver at home. New system blueprints of Wiring and Panel layout take the mystery out of blueprints. A child could understand them.

Blueprints are 19 x 44 inches.

There is also a 14-page instruction booklet, illustrated, that gives in full, all steps in the construction.

20,000 have used this Pattern

ORDER THIS PATTERN TODAY

PRICE 50c

THE CONSRAD COMPANY  
230 Fifth Ave. New York City

**\$35 builds this set**  
in your spare time!

## The World Famous "NEUTRODYNE"

There are reasons why the "Neutrodyne" has been the leading Circuit for years. It gives quiet operation, non-oscillating and good power.

It's easy to tune—and easy to build. You can save many dollars by building your own Neutrodyne, using the famous Conrad Pattern.



Use This  
Conrad  
Pattern  
**50c**

This Pattern gives 2 full sized blueprints 16x30 inches of the Panel layout and Wiring diagram, also a 4-page, illustrated, instruction Booklet. The Conrad method of building is the simplest ever devised. Anyone can build from it.

THE CONSRAD CO., Inc.  
230 Fifth Ave., New York City  
Enclosed send 50c for one copy of your "Neutrodyne Pattern."

Name .....  
Address .....  
City ..... State.....

It can therefore be seen that the first tube acts as the local oscillator, supplying the local current which heterodynes the incoming continuous-wave signal. The resultant beat note is detected in the second tube, acting as a straight detector, and may then be amplified with a standard A. F. amplifier. This system differs from the usual oscillating-detector arrangement, wherein the same tube functions as both local oscillator and detector.

The magazine also includes a description of a British Post Office radio patrol van, designed for the purpose of locating radiating receiving sets, which are illegal in Great Britain. The apparatus consists of the usual direction-finder employing a loop aerial. American radio fans who suffer from the nightly squeals of "bloopers" would probably welcome the official operation of such a car in some sections of the United States.

### MODERN WIRELESS, February, 1927. London, England.

A two-dial receiver labelled the "Wanderer Five" is described in the feature article in the February number of this monthly. The set incorporates two stages of tuned-R.F. amplification, regenerative detector, one stage of resistance-capacity-coupled A.F. and one stage of transformer A.F. in the order outlined. Neutralization of the R.F. stages is accomplished by means of split primary windings on the interstage couplers and the usual small balancing condensers. The regenerative action in the detector circuit is provided by a fixed tickler coil and a variable condenser in the Weagant (so-called "Reinartz") hook-up.

Either a regular outside aerial or an indoor loop aerial (the British call the latter a "frame" aerial) may be used with the receiver, the former giving the greatest volume and distance and the latter the greatest selectivity.

### DER DEUTSCHE RUNDFUNK, February 13, 1927, Berlin, Germany.

Except for a half dozen pages containing a few constructional "wrinkles" and a rather crude description of a crystal receiver, this magazine is devoted entirely to the broadcast fan. About half its contents consists of advance programs of the various European stations, while the rest is mostly publicity regarding popular radio performers.

The crystal set is a simple affair, and reminds an American of the good old "ham" outfits of the vintage of 1914.

### FUNK, February 11, 1927, Berlin, Germany.

This weekly is divided into two sections of equal size, one, printed on blue paper, containing the weekly radio programs of the British and Continental broadcasters, and the other, on white paper, containing general technical material for the experimenter.

The German fans evidently like their technical articles to be truly technical. This number of *Funk*, for instance, contains a treatise on the coefficient of self-induction, so full of mathematical formulae that no one but an engineer with a slide rule and a table of logarithms could possibly decipher it.

The constructional material is less formidable. The featured set article deals with the making of a cheap two-tube outfit, consisting of a regenerative detector (in the common "three-circuit" hook-up), and a simple one-stage transformer-coupled audio amplifier. Another article gives the details of a wavemeter, with tapped coils, which covers the wide range between 10 to 18,000 meters.

### RADIO UMSCHAU, February 13, 1927. Frankfurt am Main, Germany.

This weekly, like *Funk*, is also split into technical and program sections of approximately equal size. In the technical section, which is well prepared, the lead story is a discussion of the possibilities of interplanetary communication. Mr. H. Gernsback's contribution to the subject, contained in the February, 1927, number of *Radio News*, is acknowledged, and illustrations used in this magazine are reproduced.

Other articles are: "What Goes On in a Radio Receiver," "Practical Wrinkles for the Radio Amateur," and "What Qualities Must 'B' Batteries Possess?"

### QST FRANCAIS ET RADIOELECTRICITE REUNIS, February, 1927, Paris, France.

A perusal of the February number of this healthy-looking magazine, which is easily the leading radio journal of France, confirms our former observation; namely, that French radio fans are not satisfied with their radio articles unless they are stuffed to the brim with mathematical formulae and references of the most appalling complexity. It is doubtful whether anyone but a professor of college mathematics or an engineer of considerable training can read these articles and really understand them. Beside a copy of *QST Français*, the proceedings of the American Institute of Radio Engineers look like extracts from a high-school book on physics.

Some of the subjects discussed are: "The Radiophone and Its Propagation Phenomena," by General Carrière, "The Path of Electromagnetic Rays," "Crystals in Radio Work," "Directions for the Installation of a Short-Wave Oscillator," "Study of Oscillating Systems," "Electromagnetic Waves," "Tuned R.F. Amplification by Double-Grid Tubes," and "The Double-Grid Tube."

~ ~ only \$35.  
to build this  
five tube  
**COCKADAY**

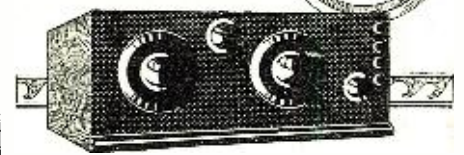

## Invest 50c in the Popular CONSRAD PATTERN and Save 1/2 on Your Set

Radio's most popular "Home Built" circuit, Powerful and easily built. Used by the thousands everywhere. Parts cost only \$35 if you use the Conrad Pattern. Two full sized blueprints given with fully illustrated instruction booklet. All measurements full size.

Panel layout and Wiring diagram simplified so that anyone can understand them. Save NOW on your Radio—Buy one of these patterns.



Price 50c

Conrad Co., Inc.  
230 Fifth Ave., New York City, N. Y.

Enclosed 50c for one copy of your pattern, "How to build the 5-tube 'COCKADAY'."

Name .....  
Address .....  
City ..... State.....

## SAVE \$100. CLEAR! build your own SUPER-HETERODYNE

We all want a big, powerful, D.X. Super-Heterodyne—but few of us can afford one.



You can build one—at 1/2 the price of a ready-made receiver with Conrad Pattern No. 14; takes only a few nights, easy to understand.

Pattern contains two blueprints 19 1/2 x 44"; of Panel layout and Wiring diagram, all in special Heavy cardboard folder. Enjoy a powerful set this week.

Send for Conrad Pattern No. 14

PRICE \$1.00

THE CONSRAD COMPANY, INC.,  
230 FIFTH AVENUE NEW YORK CITY

# \$ M O N E Y \$

## Real Money

May be earned during your spare time taking subscriptions to—

**RADIO NEWS  
SCIENCE & INVENTION**

**AMAZING STORIES**

**SPARE-TIME MONEY**

**MAKING**

For full details write  
AGENCY DIVISION

Experimenter Publishing Company  
230 Fifth Ave. New York, N. Y.



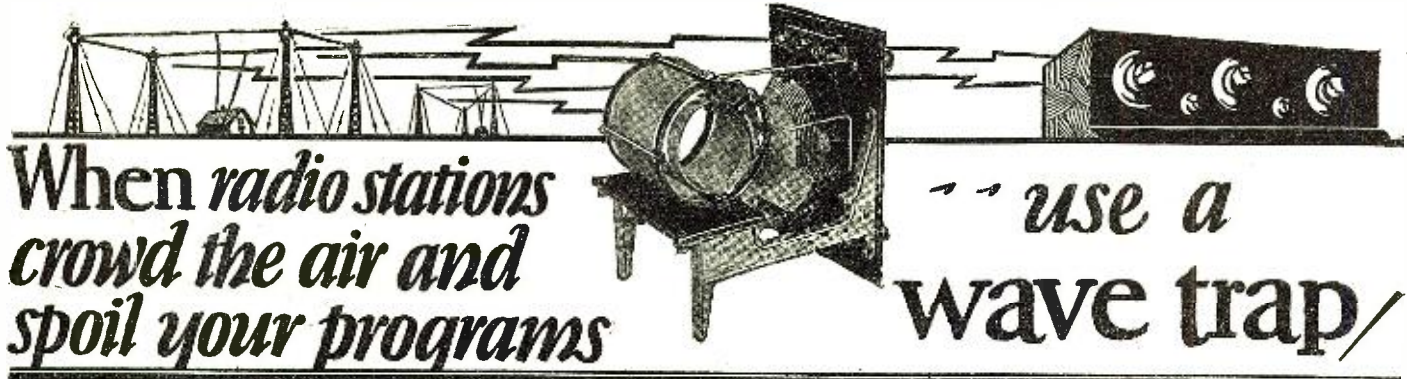

**When radio stations crowd the air and spoil your programs**

**use a wave trap**

**How to make a SIMPLE WAVE TRAP and CLARIFIER**

THE NEW WAVE TRAP PATTERN

BRAND NEW CONSRAD PATTERN ENABLES YOU TO BUILD ONE AT HOME

This new pattern contains a gigantic blueprint, size 27 3/4 inches by 20 1/2 inches, containing simplified Panel layout, Front View, Top View, Side View and Picture Wiring diagram. All measurements are shown actual size. Also a complete Illustrated Pamphlet is enclosed that shows you exactly how to proceed throughout the entire construction; these are enclosed in a heavy folder envelope size 9 1/4 x 9 1/2 inches.

Note: This Wave Trap can be installed in a few seconds. It does not have to be put inside your set.

NO matter how large or small, how expensive or inexpensive a Radio Set may be, it can be decidedly improved with a good WAVE TRAP.

The Receivers of today are not built incorrectly—They are as efficient as Radio Engineering skill can make them.

The fault lies in the fact that there are so many stations on the air that receivers cannot separate them properly.

The simple WAVE TRAP solves this problem—It brings order out of Chaos. It helps separate the Wave-lengths.

A WAVE TRAP does not have to be installed in your set. The New Consrad Pattern shows you how to build a simple WAVE TRAP—By building at home you save 1/3 to 1/2 the cost of a ready made instrument.

And the simplified Consrad system that has been used to construct over 500,000 home-made Receivers is understandable by a child.

Anyone with a Screwdriver, a Scissor, a Pen knife, and a few other household tools can build from a Consrad Pattern in a few nights.

The contents of the CONSRAD WAVE TRAP Pattern are shown on the left.

ORDER YOUR PATTERN NOW. BEFORE MORE PROGRAMS ARE SPOILED BY CROWDING OF STATIONS

**25c** COMPLETE PATTERN **25c** AT ALL DEALERS

*If your dealer cannot supply you write direct*

EVERYWHERE The Consrad Co., Inc., 230 Fifth Ave., New York City

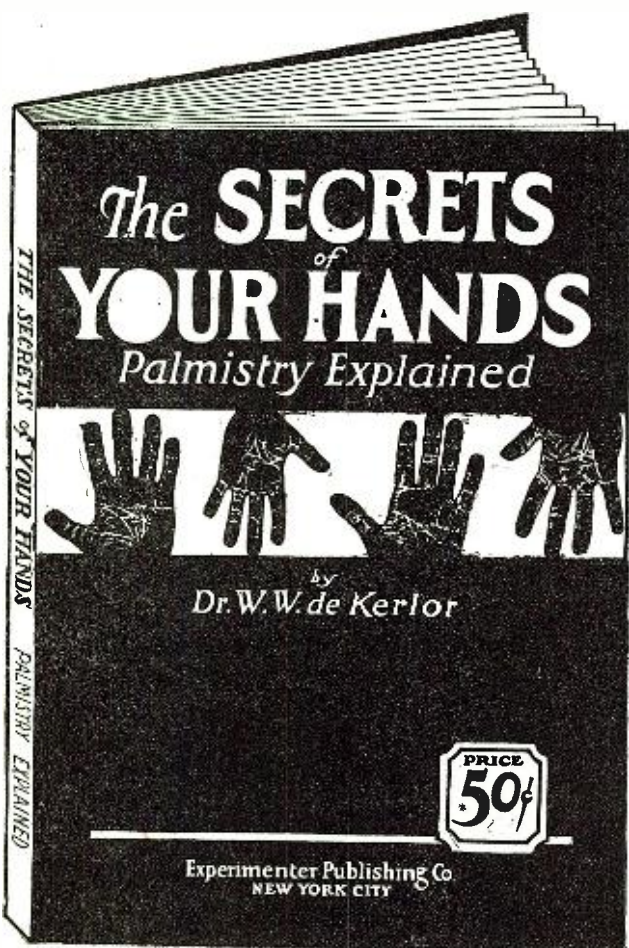

**100,000 Copies fresh from giant presses!**

**A BRAND NEW BOOK ON "THE SECRETS OF YOUR HANDS" PALMISTRY EXPLAINED**

Learn the Secrets, in your palm, your friends palm. The most amazing Science in the world.

Palmistry is within everyone's grasp. Everyone's palm is like an open book, their character, habits, life lines and fortune are indelibly imprinted there.

Learn how the professionals read your palm and then go out and mystify your friends—you can expose their innermost secrets at their expense.

This brand new 116 page, illustrated book is as up-to-date as the art has progressed. It's more thorough than any on the market.

Palm Reading is simplified. With this book you can become proficient in a few days.

Buy your copy today—you're in for a big surprise and plenty of fun.

116 PAGES :: 9 x 12 INCHES

PRICE 50c

SOLD AT ALL NEWSDEALERS

*If your dealer cannot supply you write direct to*

**EXPERIMENTER PUB. CO., Inc.**  
230 FIFTH AVENUE NEW YORK, N. Y.

Issued every month in leading magazines.

# CONSRAD NEWS

ADVERTISEMENT

World's largest Radio Book publishers.

## Radio Waves— What Are They?

Waves we cannot feel, see or hear, yet they are everywhere.

Waves in a body of water are clearly visible, but Radio Waves can neither be seen, heard nor felt. Yet these same Radio Waves have length, frequency, velocity, height and form.

Radio Waves travel with a velocity of about 186,000 miles a second. The distance to which a Radio Wave will travel before dying out depends to a certain extent on its frequency.

The sound waves at the broadcast station are impressed upon a Radio Wave and this carried to a receiving set which in turn transforms them back to sound waves.

How this remarkable transposition is made and all about Radio Reception is thoroughly and simply explained in the Consrad Book, No. 11, "HOW RADIO IS RECEIVED."

The book can be bought at your Radio Dealers or you can buy a copy direct, the price is 25c—use the coupon below for ordering.

### The Fun of Building a Radio Set—and the Thrill of Saving.

A good, carefully built Radio Receiver can equal, even surpass, in some cases, the finest factory made sets.

There is no special difficulty in constructing a good set if one starts with a good circuit and the proper instructions.

To help home set builders in achieving the best results, the Consrad Book No. 2 "HOW TO BUILD PRACTICAL RADIO SETS" is published.

The 64-page book contains many circuits of the most practical and efficient types—complete circuits are shown in all cases. The price of this book is only 25c—you can buy it at most Radio Stores or order direct by the coupon below.



Latest, finest collection of hook-ups obtainable—64-page book, illustrated. Price 25c.—Order Below

## RADIO SETS NEED NOT CAUSE YOU TROUBLE OR WORRY.

You Can Repair Your Set Yourself

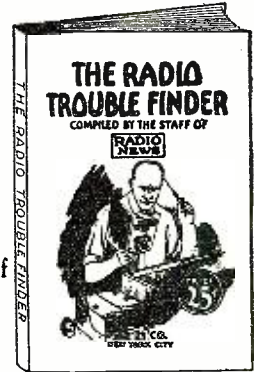

64 Page Book — Illustrated

Simplified chart system locates trouble when your set goes wrong.

Radio Sets can be repaired far more easily than you imagine, if you know where to look for trouble and just how to correct it.

Here's a 64-page book on trouble finding and set repairing—all charted so that you can systematically check all parts of the set.

Size 6 x 9 inches—fully illustrated—"THE RADIO TROUBLE FINDER."

PRICE 25c  
SOLD EVERYWHERE

If your dealer cannot supply you use coupon below.



## "A Chain is only as strong as its weakest link---!"

A Radio Set as strong as its weakest part.

Each and every part of a Radio Set must function properly, if you will get good reception.

There are many hints used by Radio Experts that make for perfect set building and perfect operation of all parts. These hints are combined into a 64-page illustrated book of great value to every set builder.

"Tips for the Radio Constructor Book No. 1."

64 Pages, 5x8—illustrated.  
Price 25c—Order now.

## THE CONSRAD RADIO LIBRARY

- Book 1—Tips for the Radio Amateur Constructor.
- Book 2—How to Make Practical Radio Receiving Sets.
- Book 3—Radio Questions Answered.
- Book 4—Radio Frequency Amplification.
- Book 5—Loud Talkers and How to Build Them.
- Book 6—How to Tune Your Radio Set.
- Book 7—One Hundred Radio Hook-ups.
- Book 8—One Hundred and Fifty Radio Hook-ups.
- Book 9—All About Radio Parts.
- Book 10—History and Operation of the Vacuum Tube.
- Book 11—The Neutrodyne, All About It.
- Book 12—How Radio Is Received.
- Book 13—The Radio Trouble Finder.
- Book 14—Reflex Radio Receivers.
- Book 15—The Super-Heterodyne, Theory and Construction.

These books are sold by all Radio Dealers—or you can use coupon here.

THE CONSRAD CO., INC.

230 Fifth Avenue, New York, N. Y.

Gentlemen—I enclose \$.....for 1 copy of Books Number.....

.....  The Radio Trouble Finder

Name .....

Address .....

City ..... State .....

# SUBANTENNA

## AMAZING NEW Underground Antenna System

# Reduces Static

## Eliminates Most Interference--- Power Line Crackles, Etc.

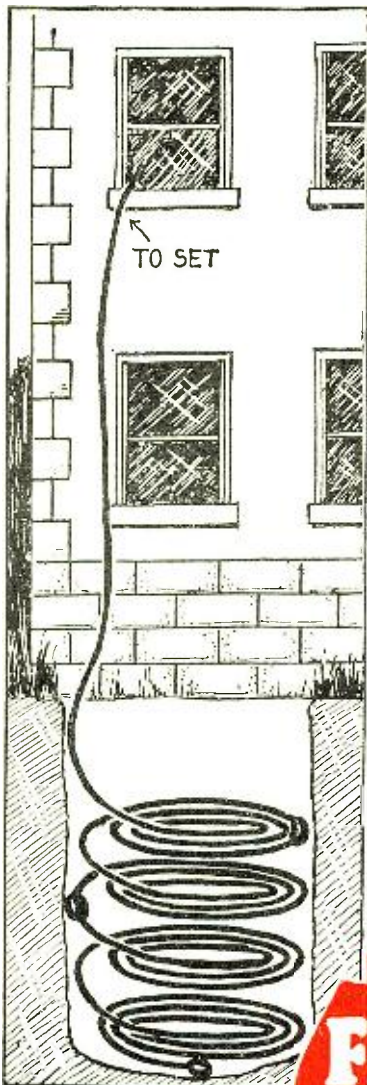

Unless you have spent a radio evening with SUBANTENNA, you positively have no idea of how wonderful Radio really is. There is such an amazing difference in the performance of any set when connected to SUBANTENNA that no user would ever go back to the old style aerial again.

### Real Clarity and Big Volume On DX Now Possible!

Imagine listening to beautiful music, thinking it is from a local station, then hearing the announcer clearly speak the call letters of a station a thousand miles away. Imagine the pleasure of getting real DX crystal clear on bad nights when STATIC is raging all around you. Imagine being able to bring in distant stations with tremendous volume on the same set which with an ordinary aerial gets only "air noises" and static crashes! Because the filtering action of SUBANTENNA delivers such a clean, clear signal to your set, you can turn the power full on when listening to DX. This means you can get bigger volume and more distance with your present set if you use a SUBANTENNA.

### SUBANTENNA Uses Filtered Ground Waves

Instead of using noisy air waves, SUBANTENNA uses *filtered ground waves*. This means that much STATIC, arc light sputters, power line crashes and other disturbing interferences are grounded and removed from the reception before it reaches your set. Read in the lower left corner of this announcement what a few of the thousands of enthusiastic SUBANTENNA users say about this new wonder device.

### Nothing Else Like It

SUBANTENNA is *not* just a wire. It is a specially constructed, specially treated alloy wire differently insulated and sheathed in a lead jacket. At the far end of SUBANTENNA and at an electrically calculated correct location near its center are "building-up" coils which play an important part in SUBANTENNA'S startling performance.

# Make this TEST

Install SUBANTENNA. Leave your old aerial up. Select a bad night when DX is almost impossible with the ordinary aerial. Make a comparison station for station, connecting first your aerial, then SUBANTENNA. From stations that are just a mess of jumbled noise with the old aerial, you'll get reception that parallels local in sweetness and clarity. Send coupon at once for scientific explanation of SUBANTENNA and for particulars of GUARANTEE and FREE TRIAL OFFER. Send COUPON NOW!

### Read PROOF that SUBANTENNA is the Greatest New Thing in Radio

"Subantenna you shipped me now working and results are good. Had WJZ, WLS, KDKA, WTAX, WSM, and others during thunder-storm." Signed,  
L. T. DONALDSON, M. D., Louisiana.

"I have a six-tube set and after installing Subantenna I received greater distance than ever before. On January 18th, I received a program on my set broadcasted from Buenos Aires, South America, at 10:15 in the evening. I never could receive such distance on my outside antenna." Signed,  
W. C. FREYMUTH, River Forest, Illinois.

"I am able to report that static which was a source of much annoyance before, has been entirely eliminated so far as I am able to observe. For clarity and for its contribution to selectivity I think the Subantenna is the best device I have ever had any experience with. Signed,  
REED L. PARKER, Chicago.

"I am glad to report to you the wonderful reception that I am receiving without interference or static of any kind. It is, indeed, a wonderful thing for radio and my opinion is that it will revolutionize the industry." Signed,  
CARL DESSAUBER, Kansas.

"My greatest pleasure with the Subantenna, however, comes through the clarity of tone and perfect reception of the programs. Since using the Subantenna, I am unable to understand how I got any pleasure at all out of my radio, using the old aerial, with its rasping, grating noises, and constant interference." Signed,  
HERMAN SLESCHER, Chicago.

**FREE TRIAL OFFER!**

### MAIL THIS COUPON NOW!

CLOVERLEAF MFG. CO.,  
2714-K Canal St.  
Chicago.

Tell me all about SUBANTENNA and your FREE TRIAL OFFER.

Name .....

Address .....

CLOVERLEAF MANUFACTURING CO., 2714-K Canal St., Chicago

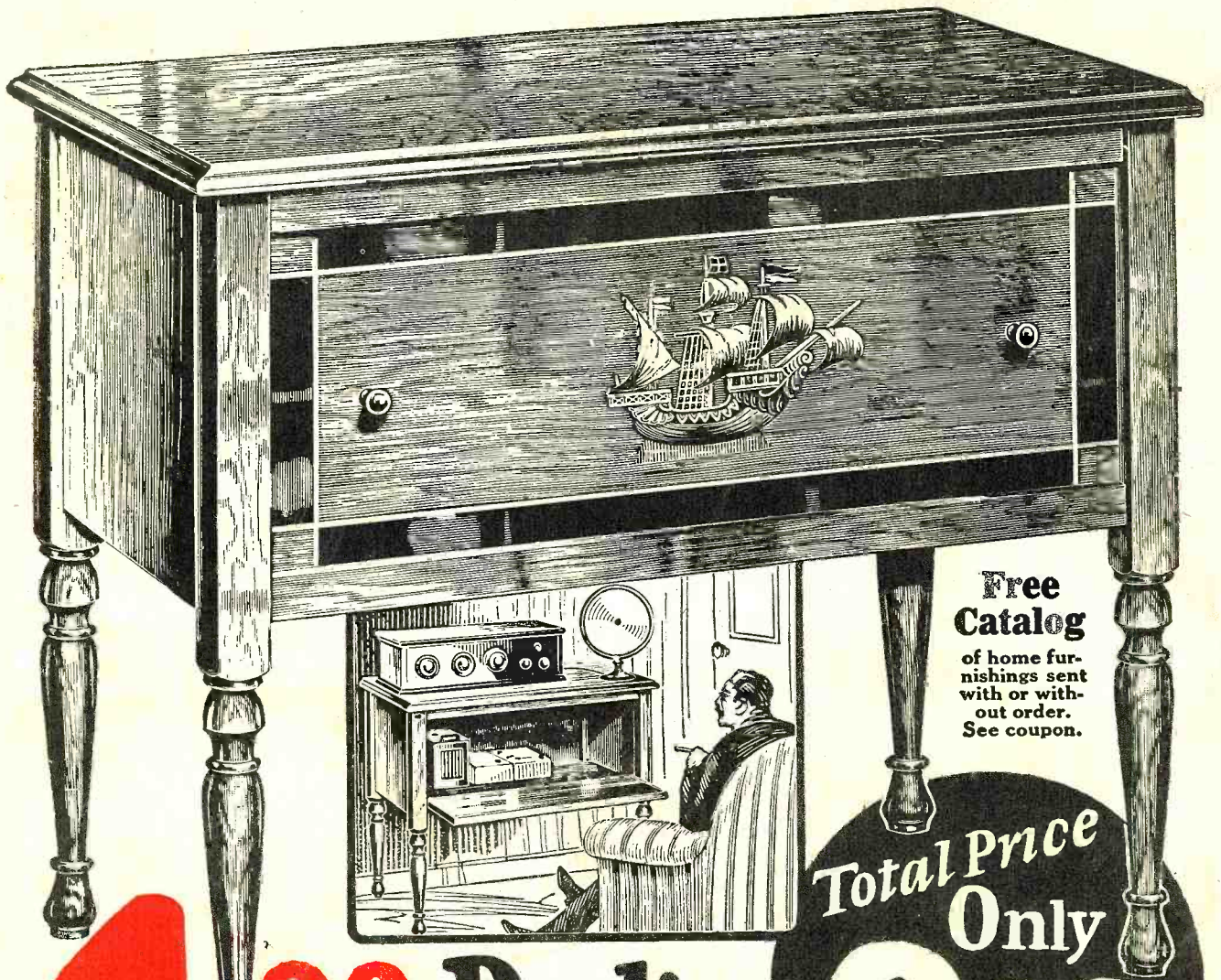

**Free Catalog**  
of home furnishings sent with or without order. See coupon.

Total Price Only

**\$1.00**  
down  
brings this

**Radio Cabinet**

**\$9.90**

**Free Trial** Yes, only \$1.00 with coupon brings this stupendous cut price bargain to your home on 30 days' trial. A handsome radio cabinet with ample room inside for all batteries, charger and eliminators. All unsightly accessories out of sight in a splendid piece of furniture. Made of beautifully grained, thoroughly seasoned selected hard wood. **Elegant Walnut Finish** Will not warp. Highly polished outside surfaces; front panel in popular two-tone effect, ornamented with Galleon Ship in full colors, giving hand-painted effect. Rich gold border countersunk on front panel, will not wear off. Neatly turned legs and beaded edges. Strongly built; all joints reinforced. Top 30 3/4 inches x 16 3/4 inches, ample for any radio and loud speaker. Height 30 3/4 inches.

**\$1.00 a Month** After 30 days' trial, if not satisfied, send it back at our expense and we'll refund your \$1.00 plus all transportation charges you paid. Or keep it and pay only \$1.00 a month till you've paid our smashed cut price for this sale—only \$9.90. Our credit price beats cash prices anywhere. Order by No. B9859A. Shpg. wgt. about 60 lbs.

**Send Coupon NOW!**

**STRAUS & SCHRAM** Dept. R3925 **Chicago**

**Straus & Schram, Dept. R3925 Chicago**

Enclosed find \$1.00. Ship Walnut Finish Radio Cabinet. I am to have 30 days free trial. If I keep the cabinet I will pay you \$1.00 monthly. If not satisfied, I am to return the cabinet at your expense and you are to refund my money and any freight or express charges I paid.

**Walnut Finish Radio Cabinet, No. B9859A, \$9.90**

Name \_\_\_\_\_

Street, R.F.D. or Box No. \_\_\_\_\_

Shipping Point \_\_\_\_\_

Post Office \_\_\_\_\_ State \_\_\_\_\_

Married or Single \_\_\_\_\_ Nationality or Color \_\_\_\_\_

If you want **ONLY** our free catalog of home furnishings mark X here