

OVER 350,000 COPIES OF THIS ISSUE

JANUARY
25 Cents
1927
Over 200
Illustrations

RADIO NEWS

REG. U.S. PAT. OFF



Edited by HUGO GERNSBACK

SHIELDING NEEDED!



RADIO'S GREATEST MAGAZINE

EXPERIMENTER PUBLISHING COMPANY, NEW YORK, PUBLISHERS OF
SCIENCE & INVENTION • RADIO REVIEW • AMAZING STORIES • MONEY MAKING • RADIO INTERNACIONAL

cash or cash eq
prohibited.

ATIONALLY

ific prof
Mail

Cunningham RADIO TUBES



BETWEEN YOU AND THE MICROPHONE

there can be no factor more vitally important to true tone quality in your receiver than Cunningham Radio Tubes. Ever alert—always on duty—these tubes are the sentinels that guard radio reception from distortion and insure tone quality of the highest order. Install them today in every socket of your receiver. Cunningham Radio Tubes are sold by reliable dealers everywhere in the United States.

All Types in the Orange and Blue Carton
Since 1915—Standard for All Sets

E. J. Cunningham Inc.

NEW YORK

CHICAGO

SAN FRANCISCO

Manufactured and sold under rights, patents and inventions owned and/or controlled by Radio Corporation of America.

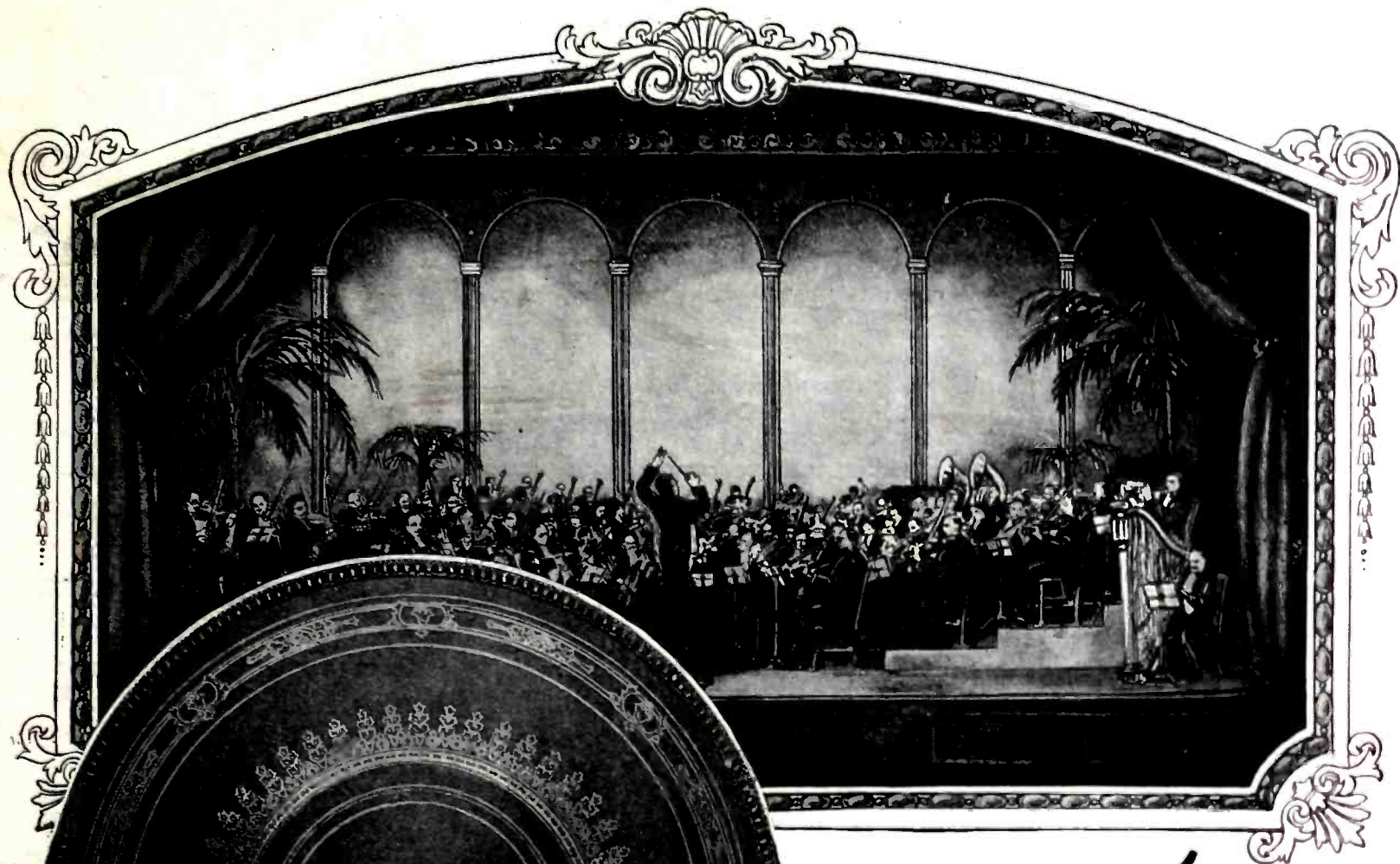

The Tower Cone

\$9.50



Brings to You Every Note of the Symphony

DEEP, rich and clear, the Tower Cone offers a quality of reproduction truly delightful. Acoustically and chromatically perfect (due to scientific design exclusively Tower), this amazing reproducer value is easily in a class by itself. The direct-drive unit, the *eight*

contact points between unit and cone (instead of only one as in most cones), the beauty of design, the non-warping cone, the rugged construction—these are the superior mechanical features that bring to you the best that radio offers—in the manner you most desire.

*The Tower Cone Is Sold From Coast to Coast.
Ask Your Dealer to Demonstrate.*

TOWER MFG. CORP. . . . BOSTON, MASS.



RADIO NEWS

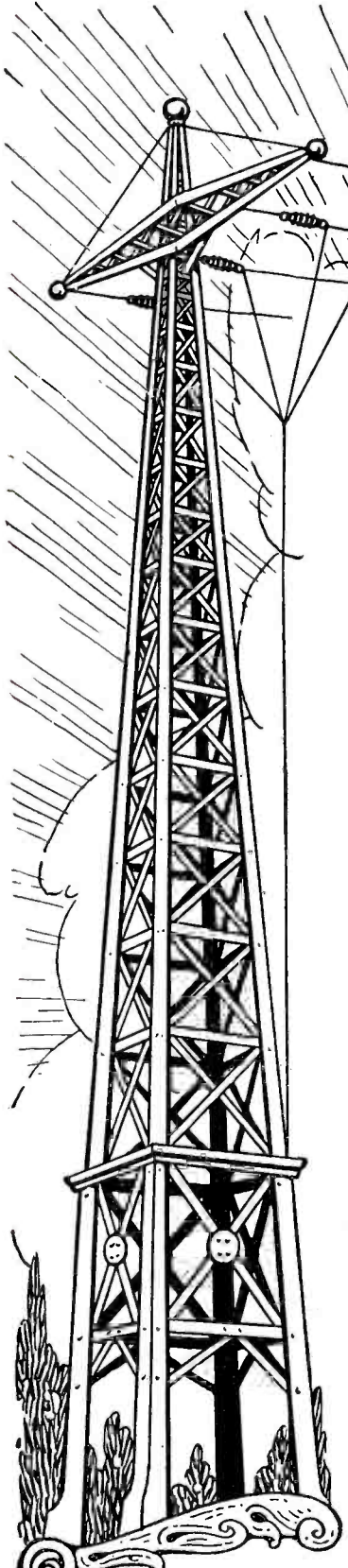

Published by EXPERIMENTER PUBLISHING COMPANY, Inc., Publishers of "Radio News," "Science and Invention," "Radio Internacional," "Radio Review," "Money Making" and "Amazing Stories."
 Editorial and General Offices: 53 Park Pl., New York City
 H. GERNSBACK, President. S. GERNSBACK, Treasurer. R. W. DEMOTT, Secretary.
 Member: Audit Bureau of Circulations Radio Magazine Publishers Association

VOLUME 8

JANUARY, 1927

NUMBER 7

Contents of This Issue:

Radio Progresses, By Hugo Gernsback	787	"Hard" and "Soft" Detector Tubes, By Roger Williams	815B
The "Singing Crystal," By Dr. J. Piesch	788	A Versatile Superheterodyne, Part II, By Leslie Raymond Jones	816
Broadcasting Time Signals		The Powers-Casem Receiver, By David G. Casem and Alvin J. Powers	818
By S. R. Winters	790	Radio Production Has Tripled in Two Years	821
Visible Radio Waves, By Clyde J. Fitch	791	Home Made Coils for the Browning-Drake, Part II, By C. A. Oldroyd	822
The Broadcasting of Weather Maps by Radio Accomplished, By S. R. Winters and B. Francis Dashiell	791A	Testing "B" Eliminators, By Earl Freese	823
What's New in Radio	792	The Carborundum Superheterodyne Receiver, By Dr. M. L. Hartmann and John R. Meagher	824
List of Broadcast Stations in the United States	796	An Improved Audio-Frequency Amplifier, By M. L. Muhleman	828
Automatic Devices in Radio Manufacture, By Herndon Green	797	Permanent Installation of Radio Equipment, By E. R. Pfaff	831
Radio News of the Month	798	How The Primary Affects the Secondary, By Sylvan Harris	832
The Month's News in Radio Illustrated, By George Wall	799	Progress in Radio	833
Results of the \$300 Prize Set Design Contest	800	Radio Wrinkles—Awards of the \$50 Bi-Monthly Prize Contest	834
Where Radio Is Most Needed	801	Correspondence from Readers	836
Just What Is Opera?		Radiotics	837
By Charles D. Isaacson	802	RADIO NEWS LABORATORIES	838
The Invisible Net, By Charles Magee Adams	803	With the Amateurs—A Complete 20-Meter Ham Installation. By A. Binneweg, Jr., 6BX, 6XAA	840
Some Facts About Condensers, By M. L. Muhleman	804	I Want to Know, By Joseph Bernsley	841
"A" and "B" Supply from Direct Current, By H. B. Whiffen	808	QRAs.—Calls Heard	917
Short-Wave Receivers, By L. W. Hatry	811	Book Reviews	926
The New Shielded Ultradyne, By Robert E. Lacault	812	Current Radio Articles	929
Should the Air Waves Be Patrolled? By H. G. Cisin	815B		

In Forthcoming Issues:

THE RADIO NEWS BATTERYLESS RECEIVER By McMurdo Silver Complete constructional details for building a 4-tube receiver, operating entirely on house-current.	THE USE OF RESISTANCES IN RADIO By M. L. Muhleman Another popularly-written educational article which will be of great value to the fan and the home builder, in its explanation of many important things about set construction.	A THREE-TUBE UNIVERSAL RECEIVER By Joseph Riley All the details for the construction of a simple, powerful and selective set, which, by the use of plug-in coils, will draw in the interesting short-wave broadcasts.
---	--	--

RADIO NEWS is published on the 10th of each preceding month. There are 12 numbers per year. Subscription price is \$2.50 a year in U. S. and possessions. Canada and foreign countries, \$3.00 per year. U. S. Coin as well as U. S. Stamps accepted (no foreign coins or stamps). Single copies, 25 cents each. Checks and money orders should be drawn to order of EXPERIMENTER PUBLISHING CO., INC.

All communications and contributions to this journal should be addressed to Editor, RADIO NEWS, 53 Park Place, New York, N. Y. Unaccepted contributions cannot be returned unless full postage has been included. All accepted contributions are paid for on publication. A special rate is paid for novel experiments; good photographs accompanying them are highly desirable.

RADIO NEWS, Monthly. Entered as second class matter, July 12, 1924, at the Post Office at New York, N. Y., under the Act of March 3, 1879. Additional entry at Long Island City, N. Y., and San Francisco, Calif. Title registered U. S. Patent Office. Copyright, 1926, by The Experimenter Publishing Co., Inc., 53 Park Place, New York. The Contents of this magazine are copyrighted and must not be reproduced without giving full credit to the publication. Copyrighted in Germany. Reproduction of articles in Germany is reserved for Radio, Berlin 42. RADIO NEWS is for sale at all newsstands in the United States and Canada,

and at Brentano's, Ave. de L'Opera, Paris, France. European agents: S. J. Wise Et Cie, 40 Place Verte, Antwerp, Belgium.

HOW TO SUBSCRIBE FOR RADIO NEWS. Send your name, address and remittance to Experimenter Publishing Co., 53 Park Place, New York. Mention the name of the magazine you are ordering. We also publish SCIENCE AND INVENTION, RADIO INTERNACIONAL, RADIO REVIEW, MONEY MAKING and AMAZING STORIES. Write clearly.

RATES AND TERMS. The subscription rate for RADIO NEWS is \$2.50 per year. (12 numbers). When remitting do so by check, money order, or registered letter if cash is enclosed. Avoid sending cash through the mail if possible. Subscriptions for less than one year are not accepted. Subscription may be made in combination with SCIENCE & INVENTION, RADIO INTERNACIONAL, RADIO REVIEW, MONEY MAKING and AMAZING STORIES.

POSTAGE. We prepay postage in all parts of the United States, Mexico and island possessions. For foreign or Canadian subscriptions we require 50 cents in addition to the subscription price for additional postage charge.

CHANGE OF ADDRESS. Notify us as far in advance as possible. It requires several weeks to make an address change on our records. Always write clearly. On expiration of your subscription we enclose a renewal blank in our last number to you; we stop our delivery to you on expiration.

General Advertising Dept., 53 Park Place, New York City.

Western Advertising Representatives
Finucan & McClure
720 Cass St., Chicago, Ill.

Pacific Coast Advertising Representatives
A. J. Norris Hill Co.
5 Third St., San Francisco, Calif.
412 West 6th St., Los Angeles, Calif.

Kansas City Advertising Representatives
Davies and Dillon
15 W. Tenth St., Kansas City, Mo.

New England Advertising Representative
T. F. Magrane, Park Square Bldg., Boston, Mass.

Detroit Advertising Representative
Roy Buell, Donovan Bldg., Detroit, Mich.

CROSLLEY

BETTER... COSTS LESS

RADIO

CROSLLEY RADIO INSTRUMENTS

Each item the utmost in radio at its price. All prices slightly higher west of the Rocky Mountains. Prices without accessories.



THE "PUP" \$9.75

This little double-circuit one-tube set has brought happiness to thousands and made records for long distance receiving.



THE "4-29" \$29

A 4-tube receiver of amazing efficiency. Crescendon equipped! Everywhere considered marvelous at its price.



THE "PORTABLE" \$33.00

The 4-29 in portable form, handy, compact, efficient.



THE "5-38" \$38

A five-tube tuned radio frequency set, with two stages of non-oscillating radio frequency amplification. Crescendon controlled two stages of audio frequency amplification.



"RFL-75" \$65

5-tubes. True cascade amplification, non-oscillating, non-radiating even under any mishandling. Its perfect balancing achieved by Wheatstone bridge in each stage of amplification. Exceptional selectivity and tone.



THE "MUSICONSOLE" \$32.00

Embodies the Musicone in a beautiful console of two-tone mahogany finish and provides room for batteries and accessories; 24 1/2 inches long inside.



6-TUBE "RFL-90" CONSOLE \$90

Introducing the double drum station selector! Includes Musicone in exquisite console. Room for batteries and all accessories; 40 inches high by 30 1/2 inches wide.



CROSLLEY 1927 FEATURES

Many exclusive features found only in highest priced radios.

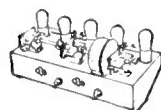

ALL-METAL SHIELDED CHASSIS

This truly great radio achievement, found in several Crosley sets, furnishes a substantial frame for mounting elements, produces excellent alignment of condensers, shields the units from each other, prevents interstage, improves the stability of the circuit, increases selectivity and saves costs by standardizing this phase of manufacture.



"THE ACUMINATORS"

Crosley Acuminators permit tuning in—loud and clear—weak stations passed over and entirely missed by ordinary single dial radios. In tuning high powered and local stations they are not used. They are an exclusive Crosley feature.



THE "CRESCENDON"

When, on ordinary radios ears must strain to catch a station miles away, a turn of the Crescendon on Crosley radios instantly swells reception to room-filling volume. An exclusive Crosley feature.

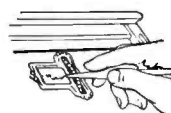

THE SINGLE-DIAL STATION SELECTOR

Nothing in radio equals the joy of the convenience of single dial control. Crosley single drum control enables you to find the stations sought without log book or "tuning."



POWER TUBES

Power tube adaptability marks the Crosley "5-50" "5-75" and "RFL" sets. This feature typifies Crosley provision for best radio reception at moderate cost.

Amazing single dial control and reproduction

THE 5 tube 5-50 THE SUPER MUSICONE THE 5-75 CONSOLE

Such a success! Enthusiastic owners report amazing performance—a drum dial delivering stations loud, clear, sharp; each an almost imperceptible turn of the drum apart. Write station letters on the drum; return to them at will. This marvelous receiver containing these advanced ideas in radio (some of them exclusive to Crosley), including metal shielding and power tube adaptability indicates Powel Crosley, Jr.'s genius in lowering prices by mass production methods.

Listen to this wonder reproducer of broadcasting! Then you'll understand why it is the biggest selling loud speaker on the market EVERYWHERE, and the most imitated. Its shape, however, is NOT the secret of its wonderful performance. Its delightful tone and the fidelity of its reproduction is achieved solely through the Crosley patented actuating unit. Avoid imitations. There is only one genuine MUSICONE. Smaller model, 12-inch cone, \$12.50.

This set includes ideas for radio reception perfection NOT found in any other radio. Marvelous exclusive Crosley "Crescendon" and "Acuminators" increase volume on distant stations and bring in programs entirely passed by and missed on ordinary one dial control radios. Console is 40 inches high with ample room for batteries and a genuine Crosley Musicone is built in. Radio chassis same as in the 5-50 receiver. Beautifully finished two-tone mahogany cabinet, rose gold fittings.

\$50.

\$14.75

\$75.

Prices slightly higher west of the Rocky Mountains

Write Department 22, for Illustrative Literature.

Crosley manufactures radio receiving sets, which are licensed under Armstrong U. S. Patent No. 1,113,149, or under patent applications of Radio Frequency Laboratories, Inc., and other patents issued and pending.

THE CROSLLEY RADIO CORPORATION

CINCINNATI, OHIO. POWEL CROSLLEY, Jr., President

INDEX TO ADVERTISERS



	Page		Page
A			
Acme Apparatus Co.	877	Diva Radio Corp.	865
Acme Electric & Mfg. Co., The.	874	Dodge's Institute	908
Acme Wire Co., The	850	Donle-Bristol Corp., The	884
Aero Products, Inc.	910	Dubilier Condenser & Radio Corp.	894
Aerovox Wireless Corp.	870	Duke Radio Co.	898
Aetna Machine & Mfg. Co.	908	Dyer Radio Manufactory	908
Alden Mfg. Co.	875	E	
All-American Radio Corp.	781	Easton Coil Co.	898
All Radio Co.	860	Electrad, Inc.	901
Allen-Bradley Co.	852, 860, 893, 907, 909, 919	Electrical Research Labs.	918
American Auto & Radio Mfg. Co., Inc.	846, 912	Electric Specialty Co.	900
American Electric Co.	916	Engineers' Service Co.	919
American Hard Rubber Co.	915, 918	Equitable Industries Ass'n.	916
American Radigon Labs.	898	Erie Fixture Supply Co.	880
Amplion Corp. of America, The	876	Everglades, The	920
Amrad Corp.	857	F	
Amsco Products, Inc.	854	Fansteel Products Co.	845
Armo Radio Labs	876	Fenco-Cone	914
AutoStrop Safety Razor Co.	905	Ferbend Electric Co.	861
B			
Barawik Company, The	882, 884, 886, 898, 904, 911, 912, 916, 921, 923	Ferguson, Inc., J. B.	858
Belden Mfg. Co.	891	Ferranti, Inc.	890
Benjamin Electric Mfg. Co.	869	Fishwick Radio Co.	920
Bodine Electric Co.	892	Florentine Art Productions, Inc.	848
Bogue, B. N.	918	Formica Insulation Co.	897
Bolton Co., Arthur	856	Freshman Co., Inc., Chas.	902
Boudette Mfg. Co.	856	G	
Bradley Institute	907	Gardiner & Hepburn, Inc.	870, 917
Brady, John B.	886	Gearhart-Schleuter Radio Corp.	915
Bremer-Tully Mfg. Co.	855	General Electric Co.	917
Buckingham Radio Corp.	921	General Industries Co. The	844
C			
C. E. Mfg. Co., Inc.	866	General Instrument Corp.	916
Carborundum Co., The	867	General Mfg. Co.	912
Carlton Mills, Inc.	882	General Radio Co.	846
Carter Radio Co.	854, 868	George Electric Co.	908
Central Radio Labs.	844, 912	Gerold Co., The	874
Chaslyn Co., The	882	Golden-Leutz, Inc.	885
Chelsea Radio Co.	880	Goodrich Rubber Co., The B. F.	878
Chemical Institute of N. Y., Inc.	896	Gould Storage Battery Co., Inc.	864
Chicago Motor Training Corp.	914	Gray & Danielson Mfg. Co.	859
Chicago Radio Apparatus Co.	910	Grigsby-Grunow-Hinds Co.	907
Chicago Salvage Stock Store	898	Guaranty Radio Goods Co.	886
Chicago Stock Gear Works	872	H	
Clark & Tilson, Inc.	911	Hammarlund Mfg. Co.	913
Condon, Frank	914	Hammarlund-Roberts	911
Conrad Co., Inc., The	926, 928, 930	Hampton Wright	848
Cooper Corp., The	851	Harco Co., The	866, 911
Cornell Electric Mfg. Co.	925	High Frequency Labs.	908
Cornish Wire Co.	900	Hommel & Co., Ludwig	878
Coyne Electrical School	916	I	
Crescent Radio Supply Co.	900	Ideal Products Co.	918
Crosley Radio Corp., The	779	Illinois Stamping & Mfg. Co.	912
Culver Stearns Mfg. Co.	850, 924	In-a-cap Hydrometer Co.	916
Cunningham, Inc., E. T.	Inside Front Cover	J	
Cuno Engineering Corp., The	904	J. M. P. Mfg. Co.	918
D			
Daven Radio Corp.	899	Jefferson Elec. Mfg. Co.	872
Deutschmann Co., Tobe	868	Jewell Electrical Instrument Co.	868
Distantone Radios, Inc.	848	Jones, Howard B.	920
E			
K			
L			
M			
N			
O			
P			
R			
S			
T			
U			
V			
W			
XYZ			

IT Sounds Right!



ALL the tones perfectly — that is the result you want for complete enjoyment of your radio. You secure that result with the All-American Reproducer—pure, *natural* tone of voice or instrument; with clearness of highest treble and mellow richness of lowest bass; in perfect uniformity, at full volume or at a whisper.

You get “the best” out of your receiver with this fine instrument. It combines the best features of the two leading principles of reproduction—cone-type and sounding chamber; which explains its accuracy in preserving the naturalness of all tones at any volume.

ALL-AMERICAN
TRADE MARK
Reproducer

Price \$25.00 Slightly Higher West of the Rockies

Socket Power you can depend on

Operate your set from the handiest light socket with All-American “Constant-B” Battery Eliminator.

With the All-American “B” Eliminator you get socket power from a unit that is tested and proved; recognized as a dependable instrument that can't go wrong.

It is made to meet any voltage requirements; five output taps provide steady uniform plate current; two variable controls permit exact regulation of voltages for R. F. and detector stages. A “High-Low” switch assures proper output for all receivers up to ten tubes.

“Constant-B” is compact, attractive; no acid, no hum. Built complete with Raytheon Tube.



ALL-AMERICAN
TRADE MARK
Battery Eliminator

Price \$37.50 Slightly Higher West of the Rockies

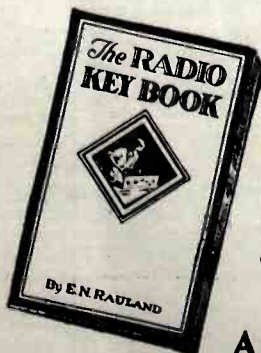

New 1927 Radio Key Book

You'll enjoy reading it—48 pages of interesting, up-to-the-minute facts about radio, simply told. Also full construction details of all leading types of circuits. Send 10 cents (coin or stamps) to cover postage and mailing cost.

ALL-AMERICAN RADIO CORPORATION
 4209 Belmont Avenue, Chicago, Illinois

OWNING AND OPERATING STATION WENR 266 METERS

FREE!



“MEN! Here's the 'dope' you've been looking for-

How TO GET INTO THE RADIO BUSINESS”

J.E.S.

\$50 to \$250 a Week in Work That is Almost Romance

If you're earning a penny less than \$50 a week, clip coupon now for FREE BOOK! New Book, profusely illustrated, tells all about the Radio profession, thousands of openings—in work that is almost romance! YOU can learn quickly and easily at home, through our tested, improved methods, to take advantage of these great opportunities! Why go along at \$25 or \$35 or \$45 a week, when you can pleasantly and in a short time learn to be a Radio Expert, capable of holding the big jobs, paying \$50 to \$250 a week?

Clip Coupon for Free Book

Don't envy the other fellow who's pulling down the big cash! Our proven home-study training methods make it possible for you, too, to get ready for a better job, to earn enough money so you can enjoy all the good things of life. Most amazing book ever written on Radio tells how—thousands of interesting facts about this great field, and how we can prepare you, quickly and easily in your spare time at home, to step into a big-pay Radio job. You can do what thousands of others have done through our training. GET THIS NEW FREE BOOK. SEND COUPON TODAY.

J. E. SMITH, President

NATIONAL RADIO INSTITUTE

Dept. AB-9

WASHINGTON, D. C.

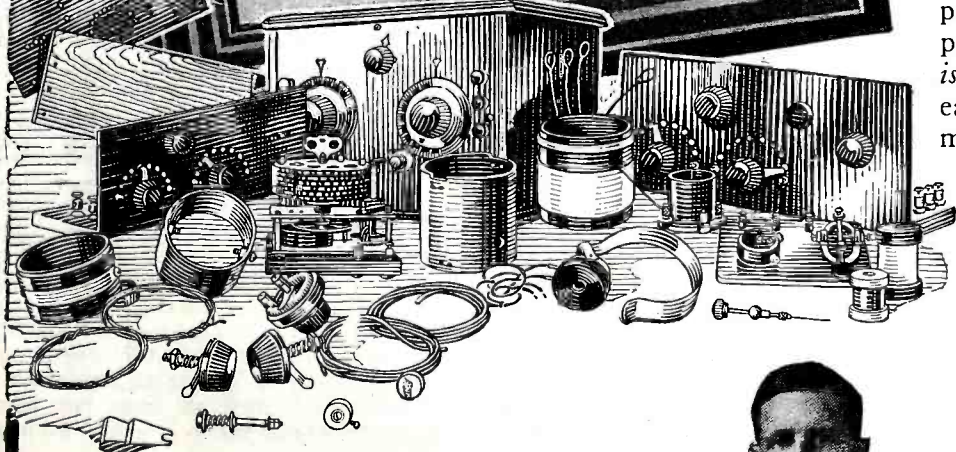

These Instruments FREE of Extra Cost

All instruments shown here and others—SIX BIG OUTFITS—sent to all our students free of extra cost under short-time special offer. Clip coupon now—find out all about this big unequalled offer while you still have time to take advantage of it. Our training is intensely practical—these instruments help you learn to do the practical work. Receiving sets, from simplest kind to thousand-mile receiver. Many other big features.



J. E. SMITH President

My Radio Training Is the Famous “Course That Pays for Itself”

Spare time earnings are easy in Radio when you know it the way we teach you. Increase your income almost from the start of your course thru practical knowledge we give you. We show you how to hold the job, then our big Free Employment Department helps you get one. Free book “Rich Rewards in Radio” tells how.

Howard B. Luce of Friedens, Pa., made \$320 in 7 weeks during his spare time. D. H. Suitt of Newport, Ark., writes, “While taking the course I earned in spare time work approximately \$900.” Earl Wright of Omaha, reports making \$400 in a short time while taking his course—working at Radio in his spare time only! Sylvester Senso, 207 Elm Street, Kaukauna, Wisc., made \$500.

And when your training is completed you're ready to step into a real big Radio job like C. C. Gielow, Chief Operator of the Great Lakes Radio Telegraph Company; E. W. Novy, Chief Operator of Station WRNY; Edward Stanke, Chief Operator of Station WGR; and hundreds of other N. R. I. Trained men. The National Radio Institute, oldest and largest Radio home-study school in the world today offers you the same opportunity these men had, under a bond that guarantees you full satisfaction or money refunded. It's your big chance to get into Radio—mail coupon for FREE Book and proof.

NOW!
Special
Short Time
Offer
6
BIG
OUTFITS

Radio Needs Trained Men

National
Radio Institute
Dept. AB-9
Washington, D. C.

Dear Mr. Smith:
Without obligating me in any way, send me your big FREE BOOK, “Rich Rewards in Radio.” and all information about your practical, home-study, Radio Course.

Name.....

Address.....

Town..... State.....

SEND THIS COUPON TODAY

**30
DAYS
FREE
TRIAL**

7 Tube Set Single Dial Radio



The Metrodyne

ONLY ONE DIAL TO TUNE

Retail Price
\$75
Completely Assembled
Big Discounts
to Agents and Dealers

Wonderful offer direct from the factory! The world's greatest radio. A perfect working, single dial control, 7 tube receiver. And just to prove our claims, we will ship it to your home for **30 days' free trial**. Test it under all conditions. Test it for distance, volume and tonal quality — and if you are not convinced that it is the best single dial set you ever heard, return it to the factory. We don't want your money unless you are completely satisfied.

**BIG PROFITS
TO AGENTS AND DEALERS**
Our Agents and Dealers make big money selling Metrodyne Sets. You can work all or part time. Demonstrate the superiority of Metrodynes right in your home. Metrodyne Radios have no competition. Lowest wholesale prices. Demonstrating set on 30 days' free trial. Greatest money-making opportunity. Send coupon below—or a letter—for our agent's proposition.

Metrodyne Super-Seven Radio

A single dial control, 7 tube, tuned radio frequency set. Approved by America's leading radio engineers. Designed and built by radio experts. Only the highest quality low loss parts are used. Magnificent, two-tone walnut cabinet. Artistically gilded genuine Bakelite panel, nickeled piano hinge and cover support. All exposed metal parts are beautifully finished in 24-k gold.

Easiest set to operate. Only one small knob tunes in all stations. The dial is electrically lighted so that you can log stations in the dark. The volume control regulates the reception from a faint whisper to thunderous volume, 1,000 to 3,000 miles on loud speaker! The Metrodyne Super-Seven is a beautiful and efficient receiver, and we are so sure that you will be delighted with it, that we make this liberal **30 days' free trial offer**. You to be the judge.

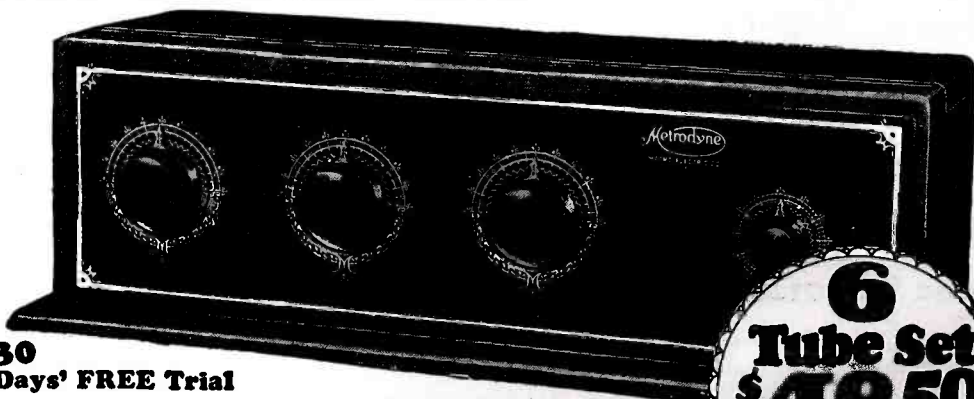

**30
Days' FREE Trial**

Metrodyne Super-Six

Another triumph in radio. Here's the new 1927 model Metrodyne 6 tube long distance tuned radio frequency receiving set. Approved by leading radio engineers of America. Highest grade low loss parts, completely assembled in a beautiful walnut cabinet. Easy to operate. Dials easily logged. Tune in your favorite station instantly on same dial readings every time. No guessing.

Mr. Howard, of Chicago, said: "While five Chicago broadcasting stations were on the air I tuned in seventeen out-of-town stations, including New York and San Francisco, on my loud speaker horn, very loud and clear, as though they were all in Chicago."

We are one of the pioneers of radio. The success of Metrodyne sets is due to our liberal **30 days' free trial offer**, which gives you the opportunity of trying before buying.

**6
Tube Set**
\$48.50
RETAIL PRICE
Completely Assembled

MAIL THIS COUPON
or send a postal or letter. Get our proposition before buying a radio. Deal direct with manufacturer—**Save Money.**

Mail COUPON Below!

Let us send you proof of Metrodyne quality

F. L. Warnock, Greentown, Ind., writes: "I received the Metrodyne in good shape and am more than pleased with it. Got stations 2,000 miles away."

C. J. Walker, Mariposa, Calif., writes: "Received my Metrodyne Single Dial set O. K. I believe that these one-dial sets are going to be excellent sellers. I had no trouble in tuning in stations enough to satisfy anyone, so you will please send me another set."

Roy Bloch, San Francisco, Calif., writes: "Very often we travel from New York to the Hawaiian Islands quickly — from station to station — by means of the little tuning-knob which operates the electrically-lighted dial. The Metrodyne Single Dial Set is much easier to operate than any radio set I've ever seen."

We will send you hundreds of similar letters from owners who acclaim the Metrodyne as the greatest radio set in the world. A postal, letter or the coupon brings complete information, testimonials, wholesale prices, and our liberal **30 days' free trial offer**.

METRO ELECTRIC COMPANY
2161-71 N. California Ave., Dept. 101
Chicago, Illinois

Gentlemen:

Send me full particulars about Metrodyne 6 tube and 7 tube sets and your **30 days' free trial offer**

Name.....

Address.....

If you are interested in AGENT'S proposition, place an "X" in the square

METRO ELECTRIC COMPANY
2161-71 N. California Ave. • Dept. 101 • Chicago, Illinois

APPROVED BY 18 MONTHS OF PUBLIC USE
NO OTHER BATTERY IS LIKE IT

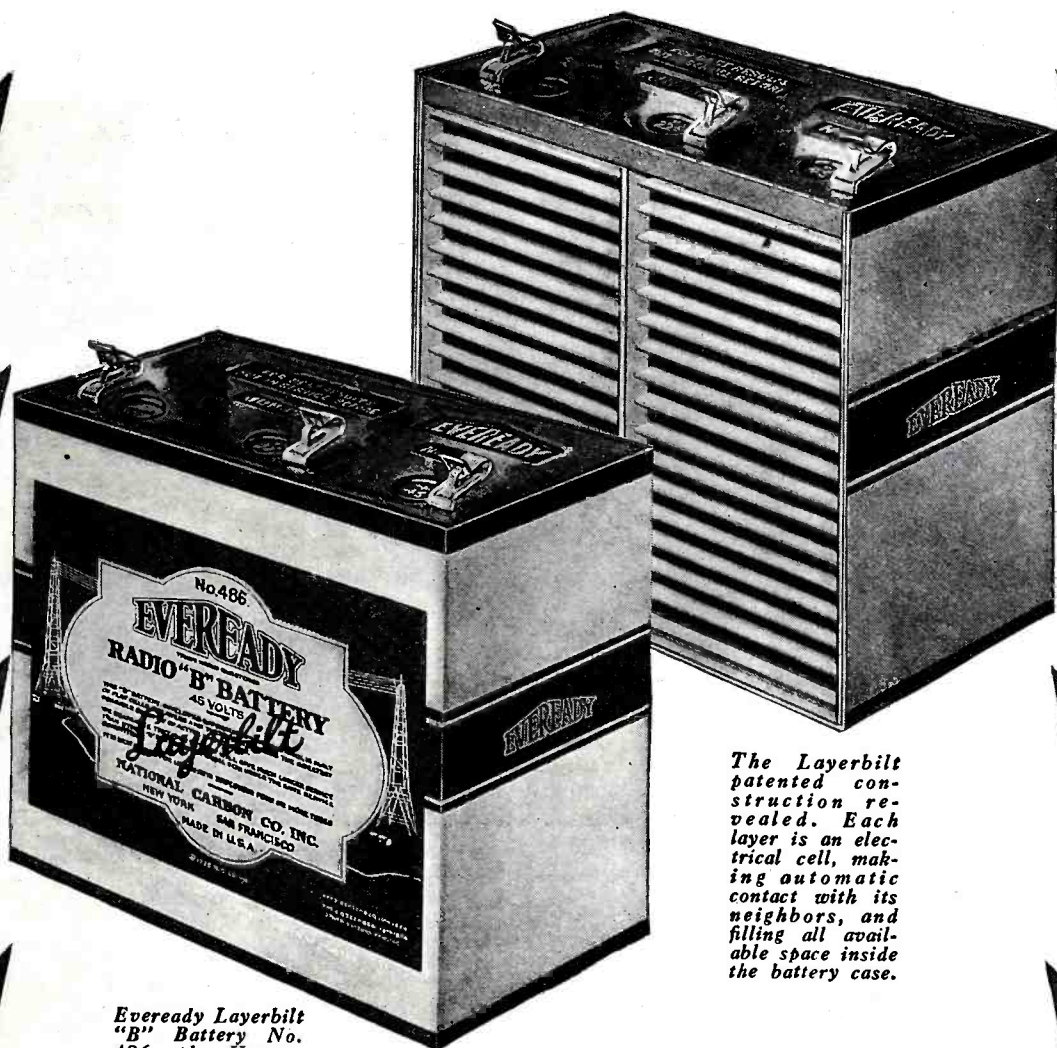

Eveready Layerbilt "B" Battery No. 486, the Heavy-Duty battery that should be specified for all loud-speaker sets. 45 volts.

The Layerbilt patented construction revealed. Each layer is an electrical cell, making automatic contact with its neighbors, and filling all available space inside the battery case.

Practical tests have shown this to be the most economical of "B" Batteries

IN DAILY use in the home, Eveready Layerbilt "B" Battery No. 486 has fulfilled the promises made for it in laboratory tests. After more than a year's study of the performance of this battery in the hands of the public, we believe confidently that it is the most satisfactory and most economical "B" battery ever developed. All loud-speaker sets require Heavy-Duty batteries—and this has proved itself absolutely the best of them all.

If you are now using the smaller, Light-Duty batteries, the Eveready Layerbilts will give you twice the service though they do not cost anything like twice as much. If you are already using Heavy-Duties, the Layerbilt, the longest lasting Heavy-Duty ever built, will run your set at least 25% longer, and again you will save money. Unless Eveready Layerbilts now are

connected to your set, you spend more on "B" batteries than you should, and you can have no idea how good a "B" battery can be. The Layerbilt holds a surprise in store for you.

Eveready Layerbilt's unequaled service is due to its unique construction. All other dry cell "B" batteries are made of cylindrical cells, with many soldered connections, and a great deal of space is wasted between the cells. The Layerbilt is built up of layers of flat current-producing elements, that make connection with each other automatically, and that fill all available space inside the battery case. It is every inch a battery. In it you get more active materials than in any other battery and the Layerbilt construction makes those materials much more efficient current producers.

Those are the convincing reasons why

the Eveready Layerbilt has proved itself the longest lasting, most economical and reliable "B" battery ever built.

Just remember this about "B" batteries—Heavy-Duty batteries are more economical than the smaller Light-Duty batteries on all loud-speaker sets, and the patented exclusive Eveready Layerbilt No. 486 is the most economical of all.

Manufactured and guaranteed by
NATIONAL CARBON CO., INC.
New York San Francisco
Canadian National Carbon Co., Limited
Toronto, Ontario

Tuesday night is Eveready Hour Night—9 P. M., Eastern Standard Time, through the following stations:

WEAF—New York	WTAM—Cleveland
WJAR—Providence	WWJ—Detroit
WEEL—Boston	WGN—Chicago
WTAG—Worcester	WOC—Davenport
WFI—Philadelphia	WCCO—Minneapolis
WCR—Buffalo	WLS—St. Paul
WCAE—Pittsburgh	KSD—St. Louis
WSAI—Cincinnati	WRC—Washington

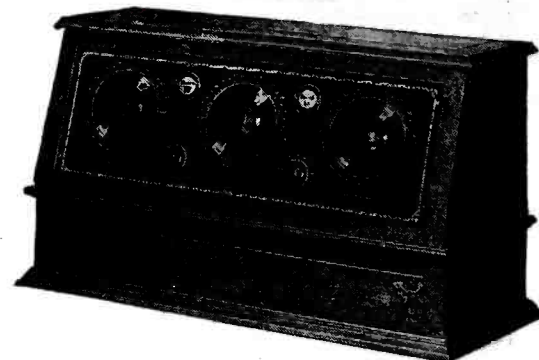

\$13250 F. O. B. Chicago. Ozarka Senior 5 Tube Model complete with Loud Speaker and all accessories. Also built in a 7 Tube Model



\$100 F. O. B. Chicago. Ozarka Junior 5 Tube Model complete with built-in speaker and all accessories.



\$215 F. O. B. Chicago. Ozarka Console 5 Tube Model, solid walnut cabinet, complete with all accessories. Also built in a 7 Tube Model

All Disappointments In Radio Do Not Come Out of the Loud Speaker

RAIN is beyond the control of anyone—sometimes it is a disappointment, but it never can be prevented.

There are many other disappointments in radio which can be prevented—do you know what they are?

In any mechanical device, radio or otherwise, no matter how perfect its construction, no matter what factory make, troubles will come up.

No matter what you do, no matter how careful your selection, this condition is bound to come up.

For any radio manufacturer or salesman to claim that service will never be necessary—may make more sales but not more satisfied customers. Someday the sellers of radio will realize this—someday disappointed customers will make them realize it.

It's little things which generally cause the most provoking radio troubles—things which an experienced service man could fix in a few seconds. But it is these little troubles and the lack of a service man who knows which cause many a disappointment in radio. Many an otherwise good radio is condemned, all because the man who should deliver service has not been trained to do so.

The pleasure or the disappointment which you will derive from your radio will depend largely on the quality of service you can secure when you need it.

When you buy a radio you buy radio service whether you think so or not. Time will prove

this to you just as it has to many other radio users. Whether the service you receive is that of the handy man who can fix anything or the trained factory mechanic depends on your investigation of service.

The value of trained service on automobiles is well known—that day is coming rapidly in radio.

For five years this company has been building and training a service organization who can and will deliver the kind of service which you need. Today there are 4364 men in this organization—many more are studying—many new ones are coming in. These men receive a complete factory training on Ozarka Radio Instruments.

You'll never buy an Ozarka without knowing that a factory trained service man is at your call any time you may need him. You may never need him, but if you ever do, he'll be there. Can you afford to gamble on questionable radio service?

Ozarka instruments are only sold by demonstration in the home. You must do your own tuning—test one by your own operation, try it against all others. It will do its own talking if you give it a chance. Then talk to the Ozarka man about Ozarka Service—you'll find that it will pay.

We have a few Openings for the Right Men

WHILE there are today 4364 Ozarka representatives, some territory is still open. We want men who believe in the future of radio—men who are tired of working for some one else—men who would like to add to their present income by devoting their evenings to Ozarka.

At the start you can keep your present position. Later on, after you have proven what you can do, then you will give us all your time because it will pay far more than your present position.

The man we want may not have much money but he is not broke. He has lived in his community for some time—he has a reputation that his word is good. He may not have made any startling success but he has never "put over something" just to make money. He may know nothing about radio or salesmanship but he will be successful if he is willing to study what we are willing to teach him, without cost.

The field in radio is wide open for the trained man. The success of the 4364 Ozarka representatives proves what men can do. If you are interested, ask for a copy of the Ozarka Plan, a 100 page book which tells a true story of how big money and a permanent business can be built in radio. It is a story of life; of why some men fail while others succeed. This book has shown many men how to start making extra money immediately and within a very short time establish a business of their own.

OZARKA

INCORPORATED

120W Austin Avenue A

CHICAGO, ILL.



RADIO NEWS

HUGO GERNSBACK,
Editor and Publisher

EDITORIAL AND GENERAL OFFICES, 53 PARK PLACE, NEW YORK

Vol. 8

JANUARY, 1927

No. 7

RADIO PROGRESSES

By HUGO GERNSBACK

AS I have pointed out before, when the telephone art was still young it was almost impossible to lift up a telephone receiver and enjoy a conversation. There was usually a background of many other voices, particularly if you were talking over any great distance. Pandemonium seemed to reign on the wires in those days. However, it required no law to rectify this situation, and in a few years the telephone engineers had solved the problem satisfactorily. Today it is a most unusual thing to hear cross-talk on telephone lines. As a matter of fact, we are now using the telephone lines to telegraph several messages simultaneously along with our conversation, but no interference is caused thereby. We are also using the same telephone lines for multiplex telephony, and for the so-called "phantom" circuits, whereby a number of telephone conversations are carried on simultaneously over the same wire—but there is no interference, no cross talk.

Radio is at the stage where the telephone was forty years ago. We are having some interference right now, particularly in our large centers, where there are a great many stations. Every big city seems to have this trouble; but what few people realize is that, when they are located only a few miles from a station, the effects experienced are totally different from those obtained when they are removed some ten or twenty miles from the same station. In some of our large cities it seems impossible to separate the stations at all, and there seems to be a background of one station continuously overlapping its neighbors. Take the same receiver ten miles away and you will find that you can separate the "interfering" stations nicely. The reason is that, so long as you are in the magnetic field of a local station, you will have this condition of interference, particularly if you have an outdoor aerial.

If you use a loop antenna, with a fairly good set, this condition—that is, interference—is done away with almost completely. Even within a few blocks of a station it is possible, with a loop set, to tune out a powerful nearby station and bring in a weak, distant station. I myself performed the curious feat, the other day, of tuning out WRNY on a set located right in the transmitting room of that station, and brought in another local station only twenty kilocycles removed, in the frequency band, from WRNY; this seems incredible, but is a fact. The receiver in question, of course, was a loop set that tuned sharply. It was possible to tune out WRNY's transmitter entirely and bring in the other local station without much trouble.

This suggests several things: first of all, it would seem that, unless great advances are made in radio broadcasting itself, the future receiver for congested districts will have to be a loop set. The loop receiver has the advantage that it is directional and that you can tune in or out wanted or unwanted stations, merely by turning the loop. The heterodyning and interfering station can usually be tuned out nicely.

This is not the case with the aerial-operated set, which is non-directional. In such a case the only recourse is a wave trap; but even this is of no avail if you are located within half a mile of the broadcast station unless, of course, the aerial is a very short one. The longer the aerial, the more the interference, and the harder it becomes to tune out an unwanted station. The sharpest-tuning sets are the ones which employ regeneration. If, on the other hand, you make the set over-sharp, you lose more than you gain. It is possible to have a set extremely sharp; but, in that case, you begin to chop off the "sidebands" of the broadcast station you wish to hear. The result is that the quality begins to suffer and the sounds received will be muffled and not clear.

It would seem that we have about reached the limit of sharp tuning, by means already known; and it also would seem that, dur-

ing the next decade, not many instrumentalities will be invented to make the sets tune sharper than they do now—so that the only remedy would seem to lie in the broadcasting itself.

Already some progress has been made in this direction. Radio physicists have succeeded in chopping off one side of the "modulation envelope," a feat which makes possible, immediately, the accommodation of twice as many broadcast stations as we have now. To elucidate this statement for the non-technical reader, let me make this analogy: the radio wave that a broadcast station sends out may be compared to a river. This is the "carrier wave." Actually its frequency is high above audibility—that is, we cannot hear it, but when no one is speaking or singing into the microphone you can often detect the carrier wave's presence; it sounds like steam escaping slowly through a small vent.

Let us now, in our analogy, place a ship on our river. Usually a ship is narrower than the river itself, but we can imagine a ship on which the upper deck is actually wider than the river. In other words, it would overhang both banks of the river, let us say, ten feet on each side. This is the condition we have in radio broadcasting, where the ship, in our simile, is the voice or sound carried along by the carrier wave. Like our supposed ship, the broadcast carrier-wave has a certain "width." If the music or sound broadcast from the station were the exact "width" of the wave itself, we would have a condition similar to that of a river on which floats a ship of the exact width of the river.

Unfortunately, for technical reasons, we have never been able to accomplish this in radio; and we have an overhang for the "modulated," or sound-bearing part of the wave, of five kilocycles on each side of the carrier wave. This makes a ten-kilocycle band for each broadcast station. It is conceivable that, in time to come, it will be possible to have a carrier wave with a modulation band only one or two kilocycles wide, or even less. When we do arrive at that stage in broadcasting, there will be very little interference between stations, and we will be able to accommodate, without undue interference, many more stations than at present.

Today, such a condition seems impossible of attainment, technically; but greater and seemingly more impossible problems have been solved by our engineers, and I do not doubt, personally, that we shall, sooner or later, accomplish this feat.

The trouble is that we know practically nothing of the radio waves which we impel into space today. We do not even know how the waves are propagated, whether the greater part of them goes through our atmosphere, or whether the greater part goes through the earth. It is not known what happens to the waves after they leave the radio broadcast station and before they strike the receiver aerial. We know that something happens; but our ideas as to just what does occur are mostly vague, and one guess seems to be as good as another.

In the meanwhile, we know we are progressing slowly, but surely; and the time will come, within the next ten years, when interference between radio broadcast stations will be an inconvenience of the past to marvel at, and read of only in antiquated and obsolete textbooks.

Right now one of the most interesting possibilities seems to be underground broadcasting. Dr. J. Harris Rogers, of underground radio fame, has done a great deal along these lines; and it is our belief that much more efficiency can be had by burying the broadcast antenna underground. During the next few months, the RADIO NEWS station, WRNY, will test this theory, whether underground broadcasting is feasible, from its new transmitter at Coytesville, N. J., where preparations are now being made to make underground broadcasting possible.

... In which the Editor recalls the chaotic conditions existing on the wire telephone forty years ago—wherein he recommends loop sets for congested districts—wherein the prediction is made that the next great development in radio will be in the technique of broadcasting itself—and wherein it is predicted that in the future thousands of broadcast stations will be able to operate simultaneously without causing interference . . .

Mr. Hugo Gernsback speaks every Monday night at 9 P. M. from station WRNY on various radio and scientific subjects.

The "Singing Crystal"

The Familiar Zincite Detector As a Speaker and a Microphone

By Dr. J. PIESCH, VIENNA



THE Singing Crystal, which **RADIO NEWS** exclusively presents to its readers in this issue, is an important discovery which may assume unthought-of proportions in the future. While at the present time it is just a laboratory experiment, most great inventions have been in that stage at one time. In the Singing Crystal, Dr. Seidl has produced an instrumentality which may have far-reaching results in future loud speakers and sound producers.

The crystal has been known in radio for a long time; but it has never before been used to reproduce loud sounds at will.

In radio's first magazine, "MODERN ELECTRICS," there was described, many years ago, an instrument whereby an ordinary safety-razor blade was pressed against a piece of silicon. The inventor claimed that faint sounds could be heard from the razor blade, when used as a detector.

Dr. Seidl's discovery, however, far eclipses this, and it is believed that in time this discovery will prove of practical value in the radio art.

—EDITOR.

ONE of the most arresting radio discoveries of recent years has just been made by an Austrian experimenter; that red zinc ore, the familiar "zincite" crystal of early wireless experimenters, is capable of converting electrical oscillations into sound waves and sound waves into electrical oscillations. Small pieces of the mineral have actually been made to operate as both telephone receivers and transmitting microphones, according to a statement from the University of Vienna, where the experiments were performed. The information that the discoverer is a young married woman makes the achievement especially interesting.

Late one evening, in the physics laboratory of the university, one of the assistants was trying to obtain electrical oscillations from a piece of crystal; using the funda-

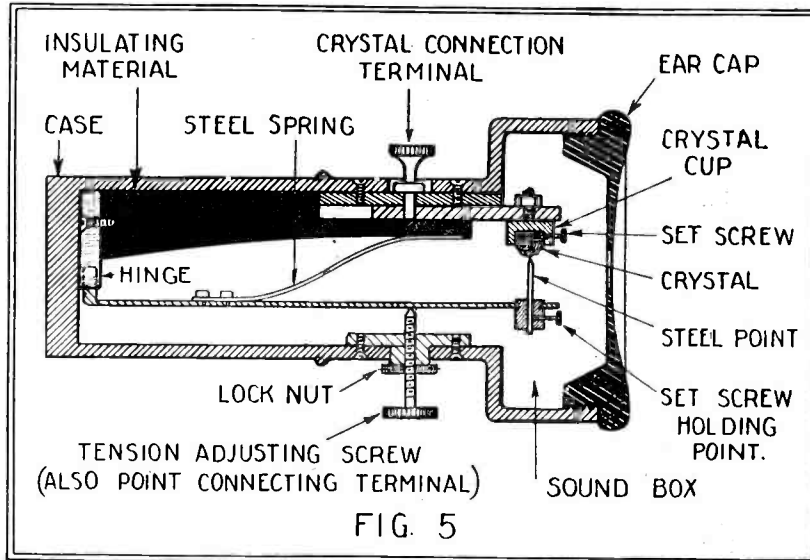

In Fig. 5 is shown the crystal telephone of Dr. Seidl. Instead of a diaphragm, to which we are accustomed, there is merely a crystal such as used in a detector unit. The various parts of the receiver are indicated.

In the illustration on the right is shown the arrangement of the apparatus Dr. Seidl used for testing her singing crystal in a vacuum. The crystal is enclosed in the glass container, A, which can be evacuated.

Dr. Seidl is shown below, in her laboratory, adjusting the voltage on her "singing crystal", which is seen at A. The zinc crystal, Dr. Seidl has discovered, under proper conditions can be used as a microphone or receiver.

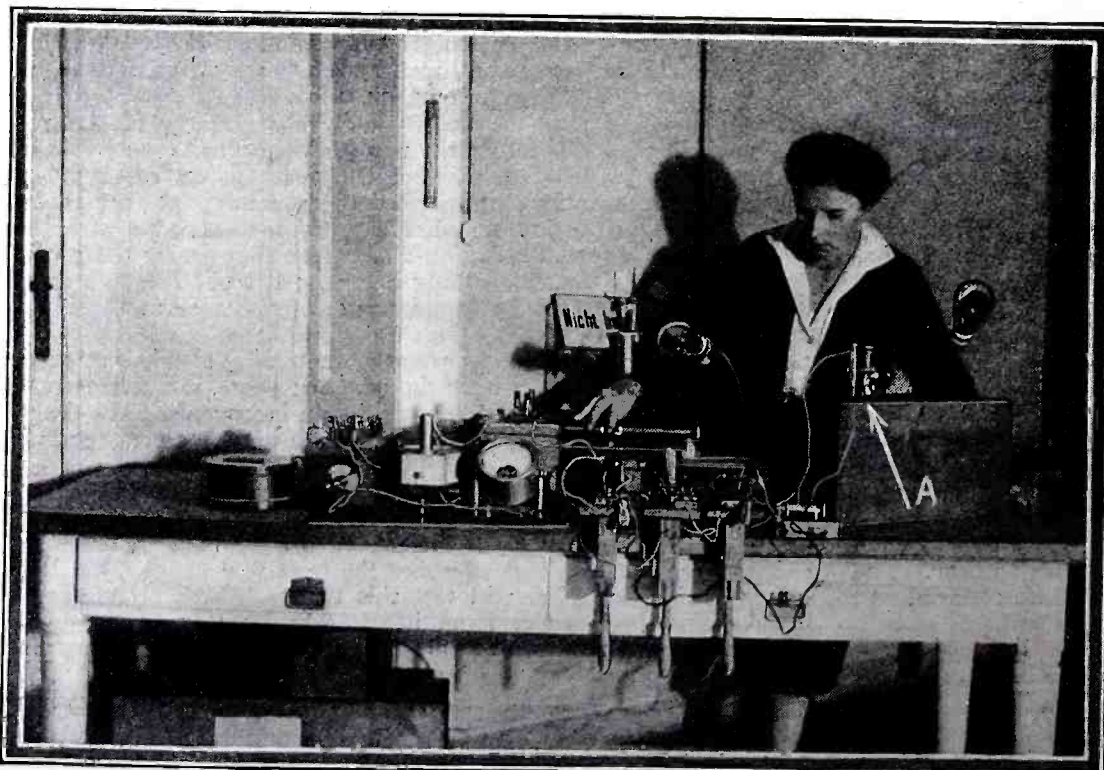
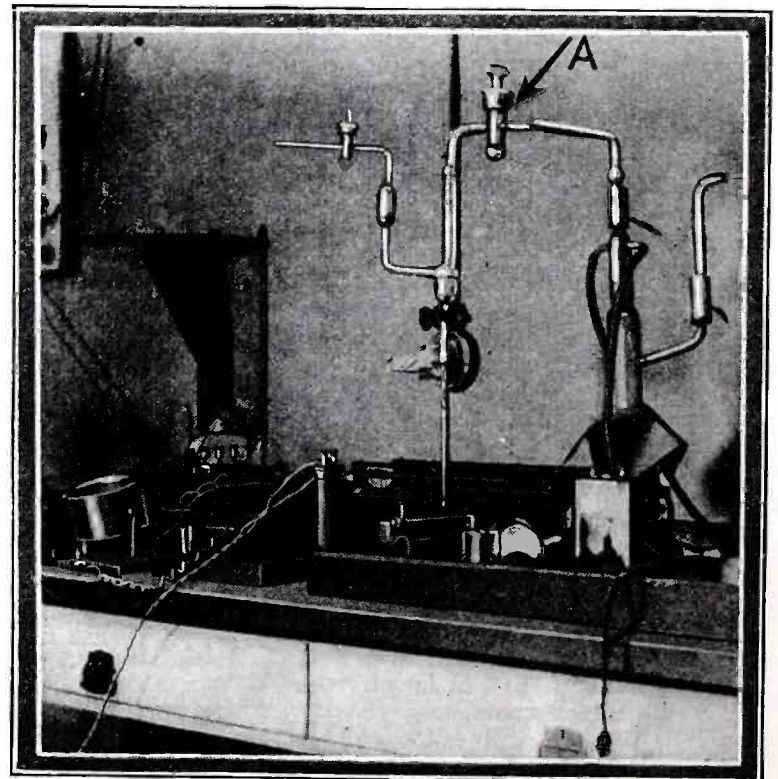

on the crystal itself. Those radio fans who have tried the last-mentioned pastime will know just how the good lady felt. Time after time she almost, but not quite, succeeded in her efforts. Finally she found a good point and an applied voltage that seemed correct, and then turned to make some final adjustment on an oscillograph, with which she wished to study the oscillations produced by the crystal. No sooner did she touch the controls of the instrument than the crystal stopped oscillating, and all her careful work had to be repeated.

At last, after many trials, she lost all patience. She viciously pushed the contact pin hard against the crystal, and with a sweep of her hand pushed the potentiometer slider (P, Fig. 1B) to the high-voltage side. To her surprise the crystal responded to this treatment with a clear, singing tone. "What was this?" she asked herself. Surely it was against all principles to mishandle a crystal in this fashion and yet have it answer with a strength of tone never before heard.

She thought for a moment, and then concluded that the arc of the oscillograph was responsible for the singing sound. However, when she turned the arc off, the singing continued. She then disconnected the phones

(T, Fig. 1B) from the circuit, but the tone was as clear as ever. Nothing but the crystal remained in the circuit to produce that tone.

Although it was a monotone that the crystal gave out, it was sweeter than the music of a symphony to her ears. Surely, here was something new. She rushed from the room to seek through the deserted and gloomy building someone who could hear the singing crystal and witness her discovery. She found a student walking slowly down a flight of stairs, hailed him excitedly, and led him into the laboratory, where she proudly exhibited her bit of musical ore. The student heartily congratulated Dr. Seidl—for that is the discoverer's name.

THE MICROPHONE EFFECT

Before leaving the laboratory that eventful night, she conducted several other tests

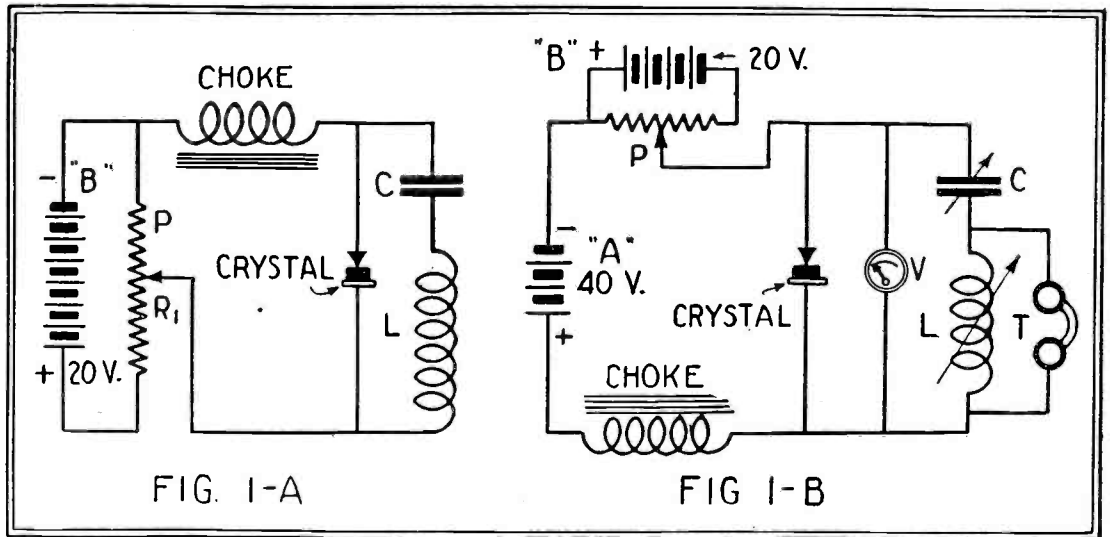

Fig. 1A shows Lossev's original oscillating crystal circuit; and 1B is the diagram of the "singing crystal."

oscillates. In the case of Dr. Seidl's crystal scheme, however, other factors enter into the general equation. The applied voltage affects the frequency markedly, a complete movement of the potentiometer slider from one end of the coil to the other producing a variation of more than one octave. Different points on the crystal itself give different tones, even though the applied voltage and the values of L and C are held constant.

ANALYZING THE RESULTS

The question now naturally arises, "What is the cause of the oscillating-crystal phenomena?" It is a well-known physical fact that sounds in the air are caused by periodic rarefactions and condensations of the medium, the waves so produced traveling at the rate of approximately 1,100 feet per second at normal temperatures. There is a piece of apparatus, the Poulsen "singing arc," which generates both sound and electrical waves at the same time. Dr. Seidl examined her singing crystal under a microscope to see if there were any minute flashes between the contact point and the surface of the crystal, thinking that such sparking might cause the crystal to act as a miniature Poulsen arc; but she could find no trace of light there.

The woman physicist decided to find out if the surrounding medium had any effect on the oscillating crystal. To study this effect
(Continued on page 903)

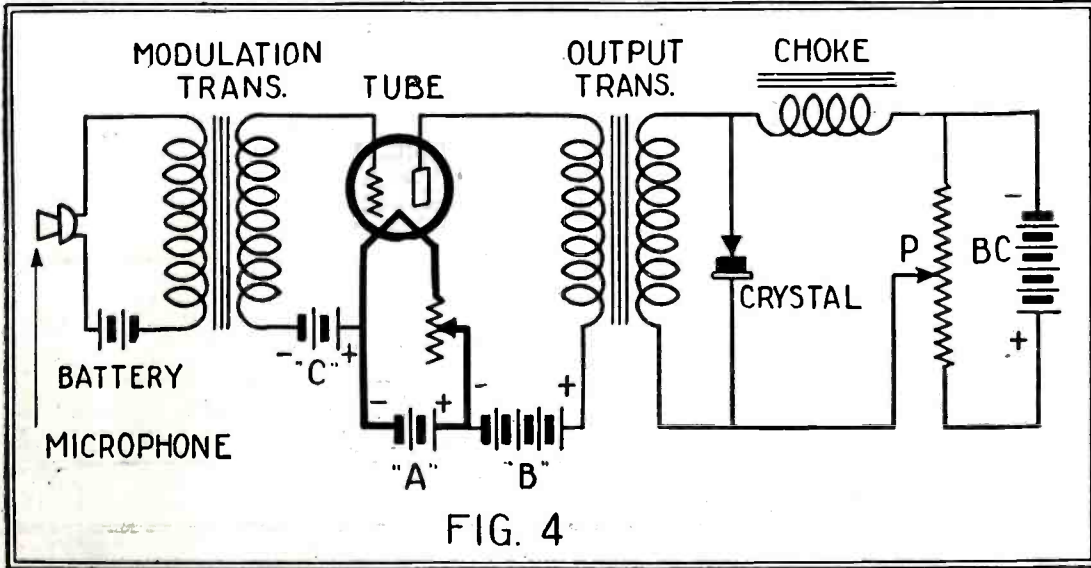

Any radio receiver may be connected to the crystal arrangement, in place of the microphone and amplifier shown, thereby utilizing the reproducing qualities of the crystal.

on the singing crystal. She found that it could also be made to act as a microphone; for when she spoke in close proximity to its surface, it converted the sound waves into electrical impulses. She built up the arrangement pictured schematically in Fig. 2, and discovered that if she shouted loudly at the crystal, her voice could be heard in the telephone receivers connected to the output transformer. This effect has no practical value at the present stage of developments, but it is important from the scientific standpoint.

The next day saw the start of a series of further experiments under Dr. Seidl's direction in the university laboratory. First, the influence of the applied voltage and current were carefully studied. Then contact tips of different kinds of metals were tried, steel tips proving superior to others of silver, tungsten and copper. The crystal employed in all this work was red zinc ore.

Using the same circuit from the start (Fig. 1B), Dr. Seidl strived to maintain the oscillations over as long a period as possible and in one test succeeded in keeping the crystal oscillating continuously for ten hours. The circuit itself is very simple, its components being two batteries, A and B, as sources of current; a potentiometer, P; a choke coil; the crystal; a voltmeter, V, which is optional; a condenser, C and an inductance, L; and a pair of telephone receivers, T. This hook-up is similar to the original one of Lossev, with the receivers added merely as sound detectors. The voltage across the crystal is regulated by the potentiometer, the energy derived from the battery being employed to generate oscillations in the circuit formed by the crystal, the coil and the condenser.

VARYING TONES OBTAINED

The procedure followed by Dr. Seidl in obtaining oscillations is as follows: the con-

tact point is moved over the surface of the crystal until faint scratching sounds are heard in the telephones. The mechanical pressure of the contact point on the mineral is then increased, and the voltage varied at the same time by means of the potentiometer. After the mechanical pressure and electrical voltage reach certain values, the crystal starts oscillating.

Every radio experimenter knows that the values of the inductance and capacity in a circuit determine the frequency at which it

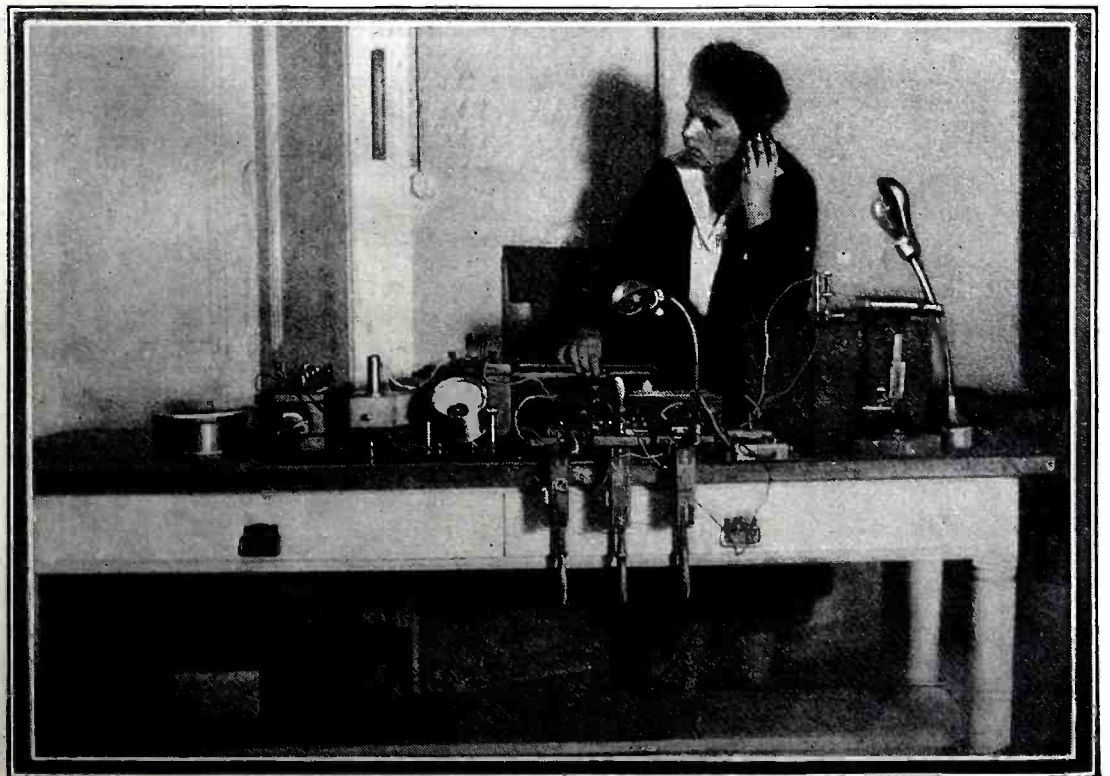

Dr. Seidl is pictured listening to a radio broadcast concert, (receiving set not shown) using one of her crystal telephones.

Broadcasting Time Signals

A Description of Automatic Apparatus for Exact Transmission

By S. R. WINTERS

RADIO as a vehicle for the broadcasting of time signals is a reality to millions of radio fans. Accurate time signals from the Naval Observatory, in Washington, are available daily to approximately 22,000,000 broadcast listeners, these signals being dispersed throughout the United States by a considerable number of broadcasting stations. In this instance, however, radio is but a medium for disseminating the observations of Father Time.

Strangely in contrast with this common achievement is the novel development at the Bureau of Standards, where R. E. Gould, chief of the time section, by an ingenious arrangement of radio apparatus and a photo-electric cell obtains accurate time signals from a swinging pendulum, without the necessity of a mechanical contact. A beam of light falling upon the photo-electric cell is interrupted by a pendulum; the resultant action is to yield a time signal.

There are, of course, several other instruments and accessories necessary to the performance of this feat of coaxing a time signal from a pendulum—in fact, there is a bewildering spectacle of mechanism huddled together on a table in the time section of the Bureau of Standards. This multiplicity of instruments, however, does not detract from the marvels of the achievement—in fact, our wonderment is increased on realizing that the harmonious workings of so many little things contribute to the ultimate objective. Signals, when thus produced, are accurate to approximately 1 part in 1,000 when using a relay, or 1 part in 5,000 when recording the signals on an oscillograph, direct from the electron tubes.

MECHANISM OF THE SIGNAL APPARATUS

The source of illumination is a 6-volt concentrated-filament lamp, of about 100 candle-power, which is connected by means of a transformer to the ordinary 110-volt A.C. lighting circuit. This lamp is mounted in its own little house and provided with a lens, thus focusing the light upon the slot in the black surface of the case containing the clock.

Moreover, the light from this lamp, the slit in the clock case, the end of the clock pendulum (at rest), and the window of the photo-electric cell must be in the same straight line.

The clock, a 30-day movement, is equipped with a half-second pendulum. At the end of the latter is placed a hard rubber tube, about 3 inches long and $\frac{3}{8}$ -inch in diameter, which is sufficiently light to permit the variation from the half second, due to its weight, to be compensated by an adjustment of the pendulum bob. The back glass of the clock case

has been painted with lampblack, with the exception of a tiny slit, about the width of the rubber tube on the end of the pendulum. As the latter swings to and fro this rubber tube cuts off the light passing through this slit. By a careful leveling of the clock, the successive passages of this pendulum are effected at equal intervals.

The light, after penetrating through the slit in the clock case, falls upon the photo-electric cell which is encased in a brass cylinder with a small window, and whose inner wall has been coated electrically with potassium hydride, except for a small section about $1\frac{1}{2}$ inches in diameter on one side. The miniature window of the cylinder must be directly opposite the clear spot in the photo-electric cell.

If the light from the lamp is focused on the pendulum, or to a point of close approximation, the latter, in swinging past the slit, will cut off all of the light from the lamp. The light, falling on the coated or minus side of the photo-electric cell, causes the resistance of the cell to become extremely small. However, as the light is cut off by the pendulum, the electric resistance of the photo-electric cell is increased with surprising suddenness and the current cannot then pass through the cell.

A small platinum electrode, serving as the positive element, is placed in the center of the photo-electric cell. It is the ionic action between the positive and negative elements that causes the cell to act. A 50,000-ohm grid leak has been inserted in the circuit of the negative side of the cell, and the glass surface of the photo-electric cell has been grounded to avoid possible leakage.

The action of the photo-electric cell is amplified by means of two 205-D type radio tubes, these actuating the relay from which

(Continued on page 850)

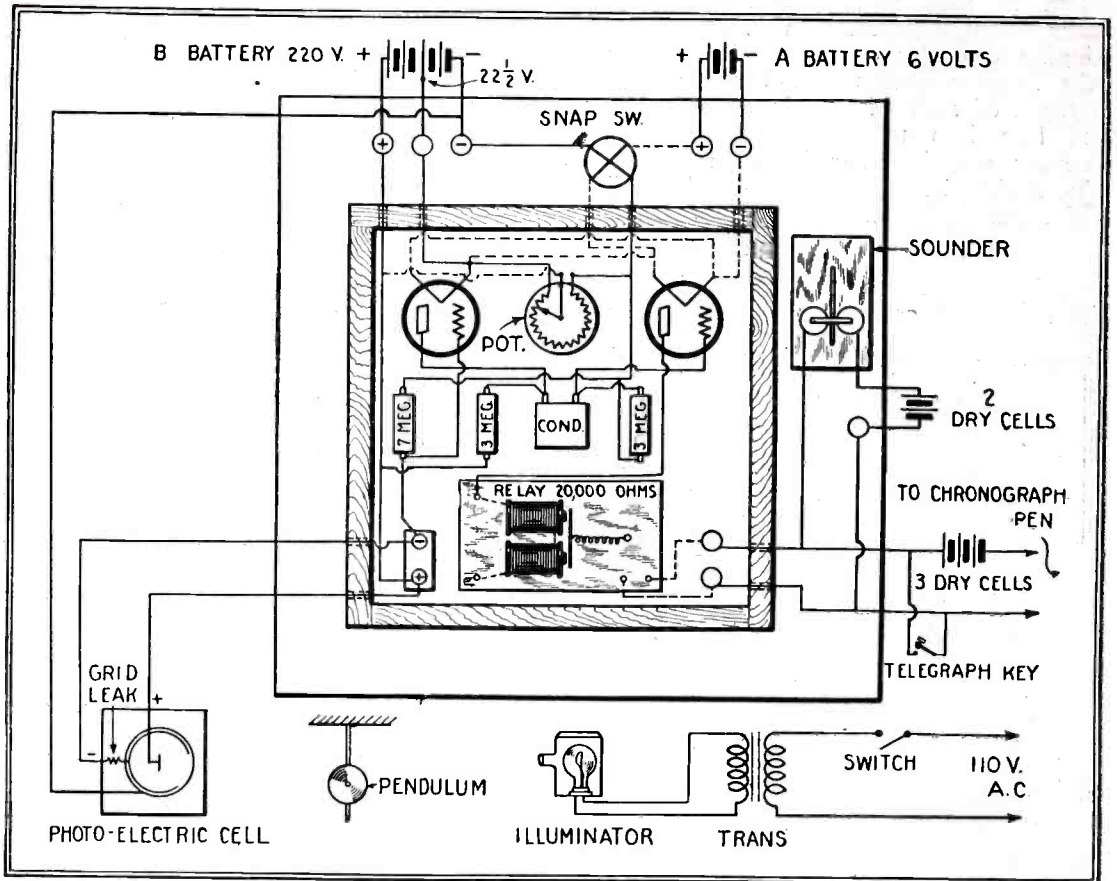

By the use of a photo-electric cell, a pendulum and a beam of light it is now possible to broadcast time signals correct to 0.1 of 1 per cent.

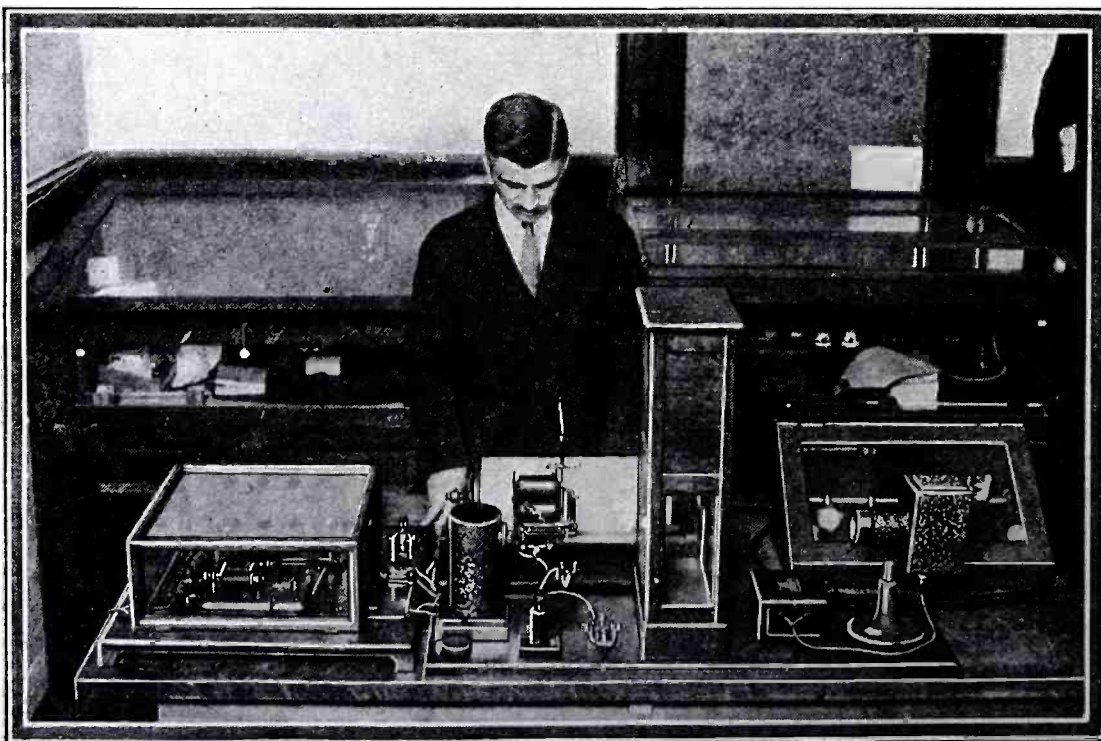

R. E. Gould, chief of the Time Section of the Bureau of Standards, is adjusting his apparatus, which receives the time signal from the swinging pendulum. © Harris & Ewing.

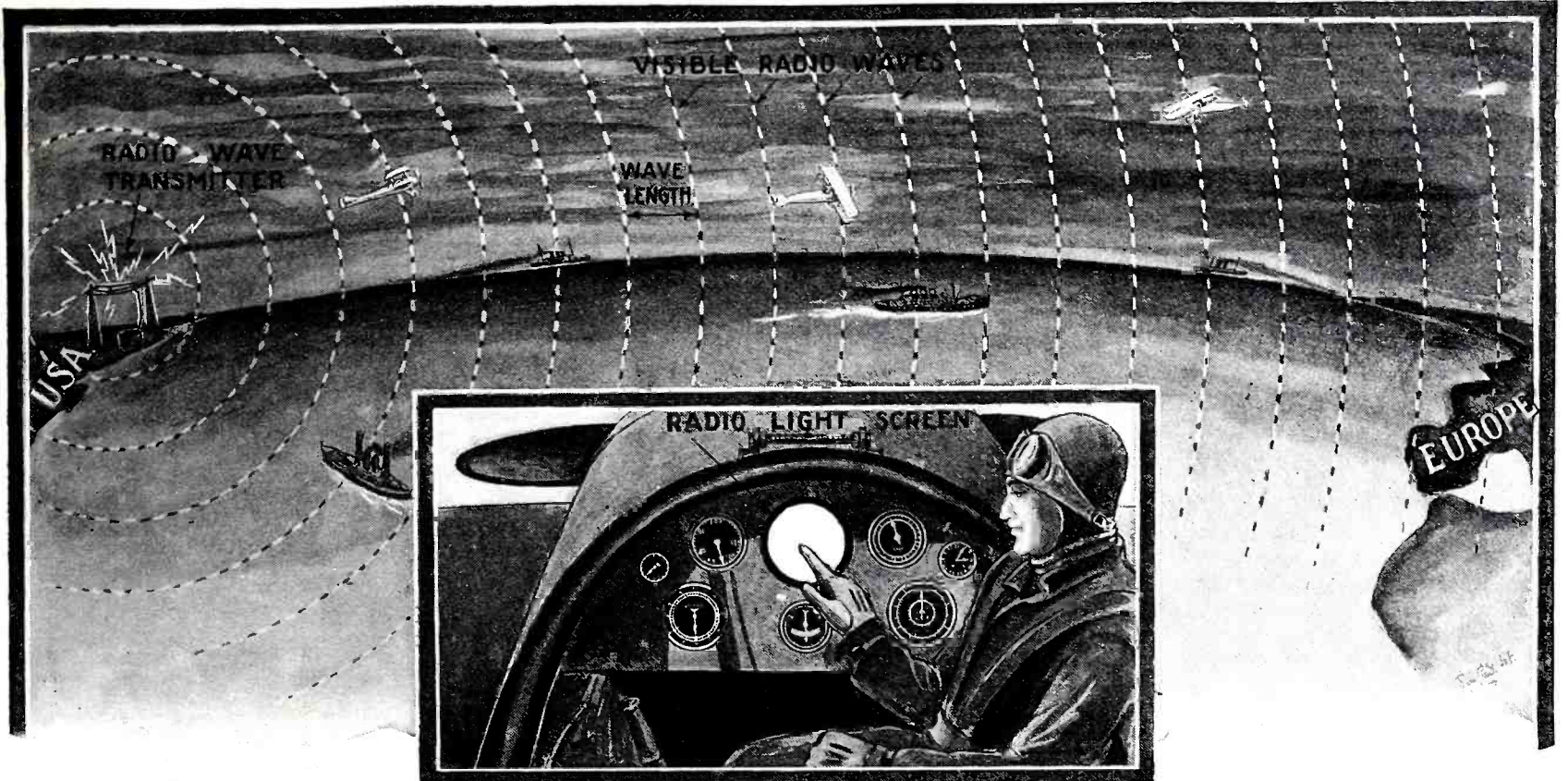
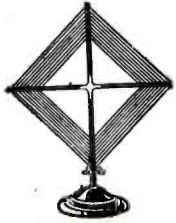

Fig. 2. By using a portable apparatus (as diagramed in Fig. 1), in an airplane the speed of its flight could be measured by means of the flashes on the screen.



Visible Radio Waves

Checking the Velocity of Electromagnetic Waves

By CLYDE J. FITCH

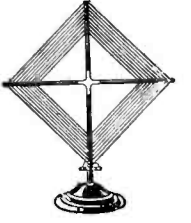

DURING the process of evolution man has acquired a few highly-developed senses, by which his limited knowledge of the external world has been gleaned—those of sight, sound, touch, smell and taste. Obviously, through these five narrow channels little could be learned of the external world and if the sense organs were erratic in translating external impressions to the brain, man's concept of the world would be distorted. Not until the last century, through scientific thinking and investigation, has he acquired a broader and more accurate knowledge of nature's secrets. Even now, man's knowledge is still in the embryo stage. What little is known merely opens the doors to infinite fields of unexplored territory.

For untold thousands of years man has lived on this earth in the midst of powerful

radio waves, from nature's own source, lightning. He had no sense organ to tell him that such waves are present. Only in recent years, through scientific research, has he detected the presence of such waves, learned how to generate them at will, and make use of them for carrying signals, speech and music—broadcasting, in other words. And still he has no sense organ to detect these waves. He cannot hear them; he cannot see them. He uses them merely as carriers of impulses to be converted into mechanical vibrations which affect his sense organs. Eventually he may use them to carry visible impressions. Then he will be able to "see" at a distance, as well as hear; radio vision will be perfected.

While a radio receiver makes it apparently possible to hear radio waves, the apparatus illustrated herewith makes it apparently pos-

sible to see them. A broader knowledge of the nature of radio waves can thereby be obtained. With the apparatus mounted on a moving object, such as an airplane, which is moving directly toward or away from the transmitter, a screen on the apparatus becomes luminous every time a distance of one wavelength is traversed. Knowing the wavelength, the plane can therefore determine its speed. While the apparatus may be of practical value in navigation, it is of even more importance for scientific investigations. The exact velocity of radio waves can be measured. Einstein's theory can be checked; the Michelson-Morley experiment can be repeated with radio instead of light waves. Other interesting experiments will suggest themselves to the reader.

(Continued on page 846)

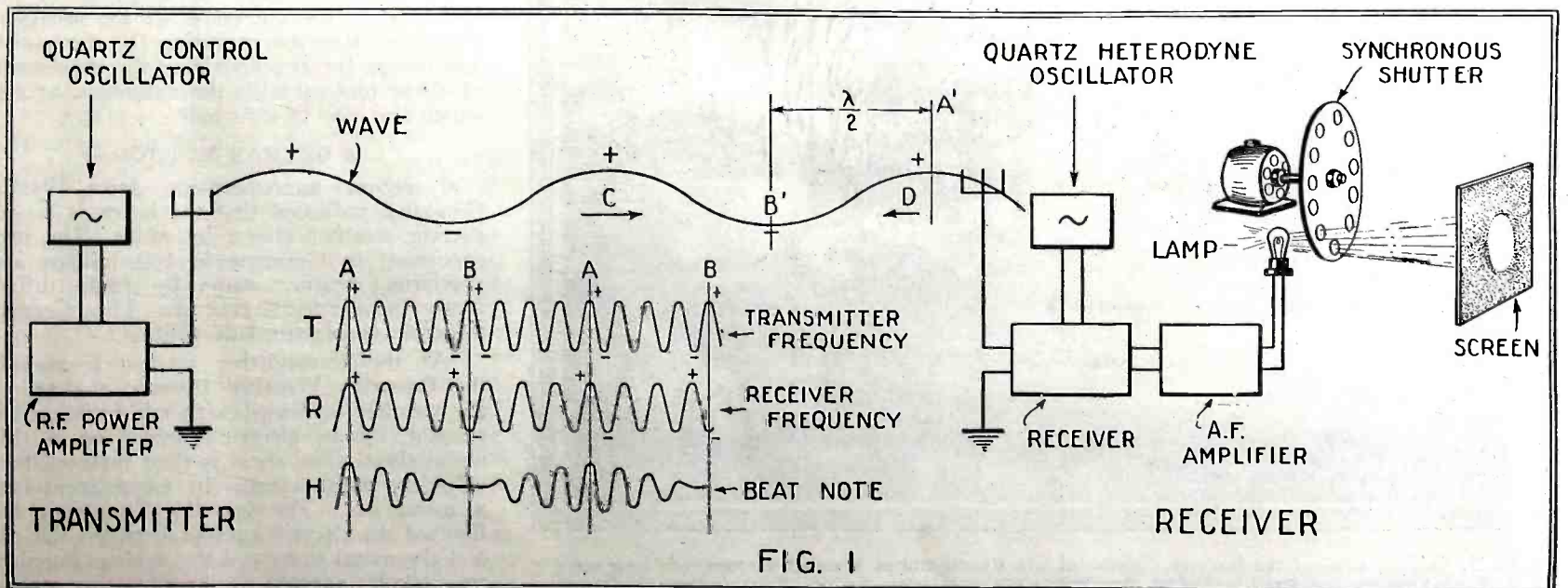

FIG. 1

The receiver at the right has an oscillator differing from the transmitter's frequency. The lamp flashes every time these currents are in phase. The waves are explained in the accompanying text.



The Broadcasting of Weather

New Method of Supplying Mariners with Weather

By S. R. WINTERS

BROADCASTING of complete weather maps by radio to ships at sea, a recent accomplishment, marks a definite step in the realization of radio vision—in that these United States Weather Bureau maps, showing the isobars and the high and low barometric pressures constitute a sort of photograph, whereby the navigator can visualize instantaneously the weather conditions, when hundreds and even thousands of miles at sea.

The Weather Bureau of the United States Department of Agriculture in cooperation with the Bureau of Engineering of the United States Navy Department sponsored this innovation. The actual transmission of the weather maps was effected through NAA, the naval radio station at Arlington, Virginia. The powerful 40-kilowatt transmitting set was employed, and a wavelength of approximately 8,330 meters was used.

The process and instruments developed by C. Francis Jenkins for the transmission and reception of photographs and moving objects by radio, with certain modifications, were employed in flashing weather maps by radio to ships at sea. In previous experiments—for example, in sending and receiving a cartoon by radio—Mr. Jenkins sent and received on flat surfaces. However, in broadcasting these weather maps both the transmitting and receiving were done on cylindrical surfaces.

A photographic film of a weather map, either a positive or a negative, was used. This photographic film was wrapped around the glass cylinder of the picture-sending mechanism. Inside of this glass cylinder is a source of light, which shines through the photographic print of the map as it rotates. The light inside of the glass cylinder shines against or is focused on a photo-electric cell and this light is interrupted by the lines of the weather map as they pass between the light source and the photo-electric cell.

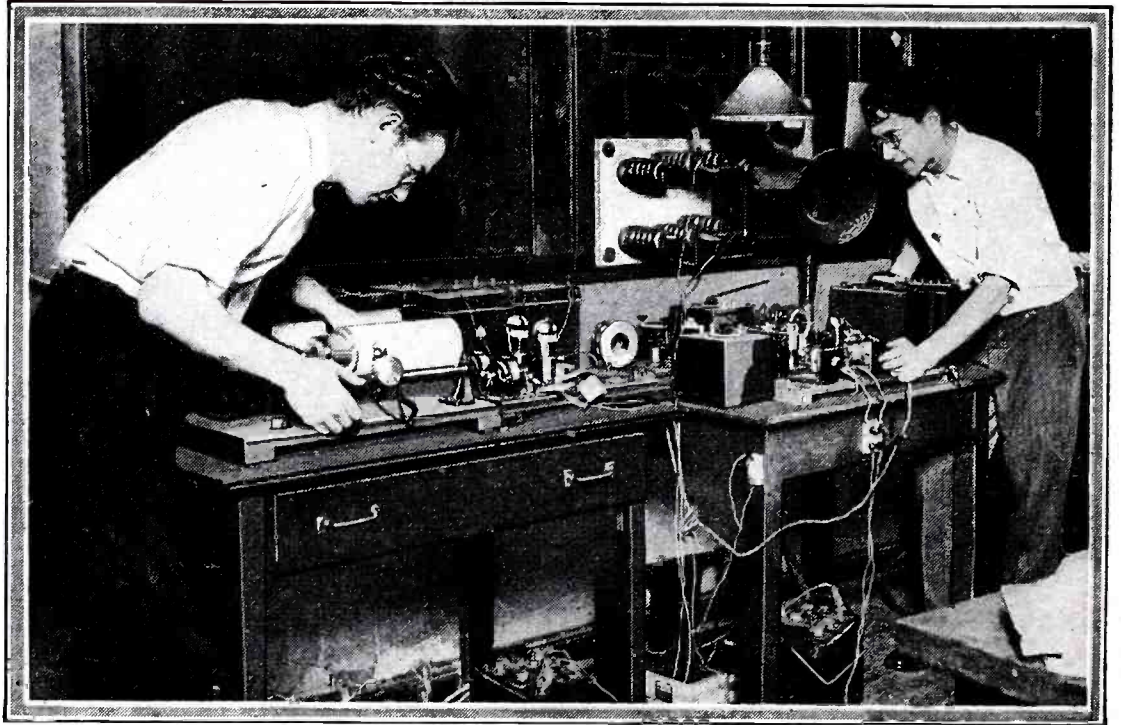

Students at the University of Chicago worked with the Bureau of Standards; they are here shown receiving the weather maps broadcast from Arlington.

© P. & A. Photo.

That is, light impulses are changed into electrical impulses.

The light values, as they fall on the photo-electric cell, are changed into electric values. The current output of the photo-electric cell is amplified and employed to control the output of the broadcasting station. In this instance, it was used in controlling the 40-kilowatt transmitter at Arlington and the weather map, in the guise of electrical values, was then subjected to "key modulation," the map being transmitted in the form of dots, dashes, and spaces, common to the International Morse telegraph code.

In receiving the weather maps on board ships, the method of procedure just outlined was reversed. A conventional radio receiving set—say, for instance, a standard long-wave receiver of the Navy—was tuned to 8,330 meters for picking up the radio signals. In preliminary experiments conducted by Mr. Jenkins, he made use of a radio receiver having a detector, one stage of radio-frequency amplification, and two stages of audio-frequency amplification. The output of the radio receiving set was employed to control a "blocked" electron tube, and the output of the latter was used to operate the stylus or "radio pen" of the weather-map receiving cylinder. Wrapped around this cylinder was a piece of white paper, ordinary typewriter paper serving the purpose. An automatic steel pen, self fed from an ink well containing good fountain pen ink, traced the isobars and the low and high barometric pressures of the weather map being sent from the distant broadcasting station. In addition to the equipment described, there are the necessary electric motors for operating the mechanism and means for synchronizing the movements of these motors with the cylinders, around which the map is wrapped.

A GERMAN METHOD

A recent announcement from Berlin, Germany, indicated that the latter is broadcasting weather charts by radio. The process used in Germany in transmitting and receiving weather maps by radio differs from the Jenkins process. The German principle is described as follows:

"At the transmitting station, located in the Bavarian Weather Bureau, a chart of the weather is drawn with ink resisting the passage of an electric current on a thin metal sheet. The sheet is then fastened to a cylinder, which rotates in spiral form past a metal pin. The ink lines interrupt the flow of an electric current between the pin and the metal sheet and the various impulses are sent by wire to the broadcasting station where they are transmitted into the ether.

(Continued on page 921)

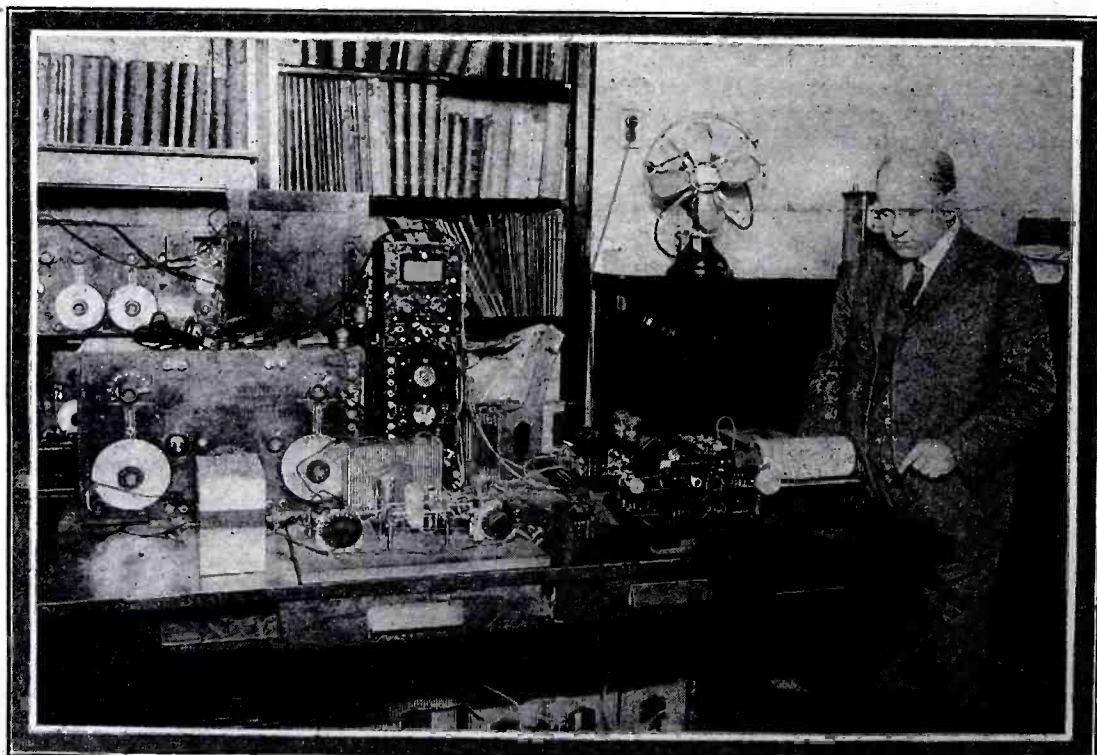

E. B. Calvert, chief of the forecast division of the United States Weather Bureau, can now see how his own weather maps look after they have traveled through the air. This photograph shows Mr. Calvert with the Jenkins radio-weather-map receiving set, which has just been installed in the Weather Bureau.

© Harris & Ewing.

Maps by Radio Accomplished

Information Proves Great Aid to Navigation

By B. FRANCIS DASHIELL



IF you should hear some apparently meaningless jumble of dots and dashes over your radio, that bear no resemblance to the radio code, do not worry because they cannot be decoded. They indicate that a weather map is being broadcast by radio.

The Navy Department is cooperating and has permitted the Weather Bureau and the Jenkins Laboratory to install their transmitter in the powerful naval station NAA at Arlington, Va. The transmission set loaned by the Navy and used for the transmission of the weather maps operates on 8,330 meters and is rated at 40 kilowatts. The Navy is providing not only the transmission facilities, but two warships for special receptions. These ships are the U. S. S. "Kittery" and "Trenton."

Tests which have been conducted between the Weather Bureau and NAA are showing highly pleasing results. An experimental laboratory and receiving equipment have been installed in the Weather Bureau under the direction of C. Francis Jenkins, the inventor; Dr. Charles F. Marvin, Chief of the Weather Bureau, and E. B. Calvert, Chief of Forecasters, and a well known advocate of radio in the work of the Weather Bureau. Dr. Marvin, as well as other officials of the Weather Bureau, who are engaged in these experiments, see in the transmission of weather maps by radio a beginning of a new and important era in meteorological navigation at sea. The Navy Department, realizing the great value to its ships in being able to obtain correct pictures of weather maps immediately after their preparation by the Weather Bureau, is giving its closest cooperation, through Commander Hooper, Chief of Naval Communications, and is watching the outcome of this pioneer adventure into visual radio broadcasting.

A complete weather map adapted to radio transmission and embracing the areas with which navigation is always concerned is prepared daily by the Weather Bureau. The map is then printed on an 8- by 10-inch sheet of photographic film and this negative is used for the actual transmission. The map received is of the same size.

The Jenkins system by which pictures are transmitted by radio is highly interesting. The photographic negative of the weather map is placed about a glass cylinder which revolves at a steady rate while advancing one-fiftieth of an inch with each revolution. A very small beam of light, passing through the cylinder from the inside, is prevented from passing the film by its intense opaque background. But whenever the clear white lines of the map pass the beam, a bit of light will continue on through and falls on a sensitive photo-electric cell. The momentary flicker of light decreases the resistance of the thallium sulphide cell and a slight surge of current passes through. This surge is amplified by power amplifying tubes and in turn operates the giant control relay of the 40-kilowatt transmitter; it is very similar to ordinary key modulation. The wave is broadcast as an irregular series of dots and dashes which is very confusing to ship radio operators who try to decode them, not knowing what they mean.

The wave is received and amplified by an ordinary radio long-wave set and is then passed on to the reproducer. It is further amplified by two UX-171 tubes in parallel. The receiving instrument is similar to the

transmitter except that the operation is reversed, and the photo-electric cell is replaced by a pen or ink stylus. This pen is placed in front of the cylinder upon which is wound the sheet of paper used for producing the map. The radio impulses actuate the pen in the same manner that they operate the diaphragm of a telephone receiver.

The speed of the cylinder and the forward advance of the pen is held in synchronism with the transmitter by a very ingenious device. Proper synchronism was the critical point of development and until the discovery of how to control this, reproduction could not be successfully obtained. The synchronizing mechanism will not permit the receiver to run too fast or slow, but will automatically check the cylinder at each revolution so that it will start off in harmony with each new revolution of the transmitting cylinder. This is accomplished by a synchronizing signal sent out at the beginning of a new revolution by the transmitting station.

Ship radio stations equipped with the

Jenkins system may pick up the map transmission. This will mean much to navigation officers toward the intelligent handling of their vessels in all kinds of weather and providing for coming changes in the weather. The simplicity of the radio weather maps and their clearness of reception are such that they will prove of the utmost value to all navigation.

For many years the Weather Bureau has been broadcasting every day a special weather bulletin, by means of which ship captains have been preparing their own weather maps at sea. The direct reproduction process provides for instant service and the elimination of the old coded method. The long familiar "USWB" weather bulletin, known to all operators since the early days of radio, may soon be a thing of the past. The Weather Bureau is now convinced that the day is not far distant when meteorological advices and information is available to all ships at sea by this direct reproduction method.

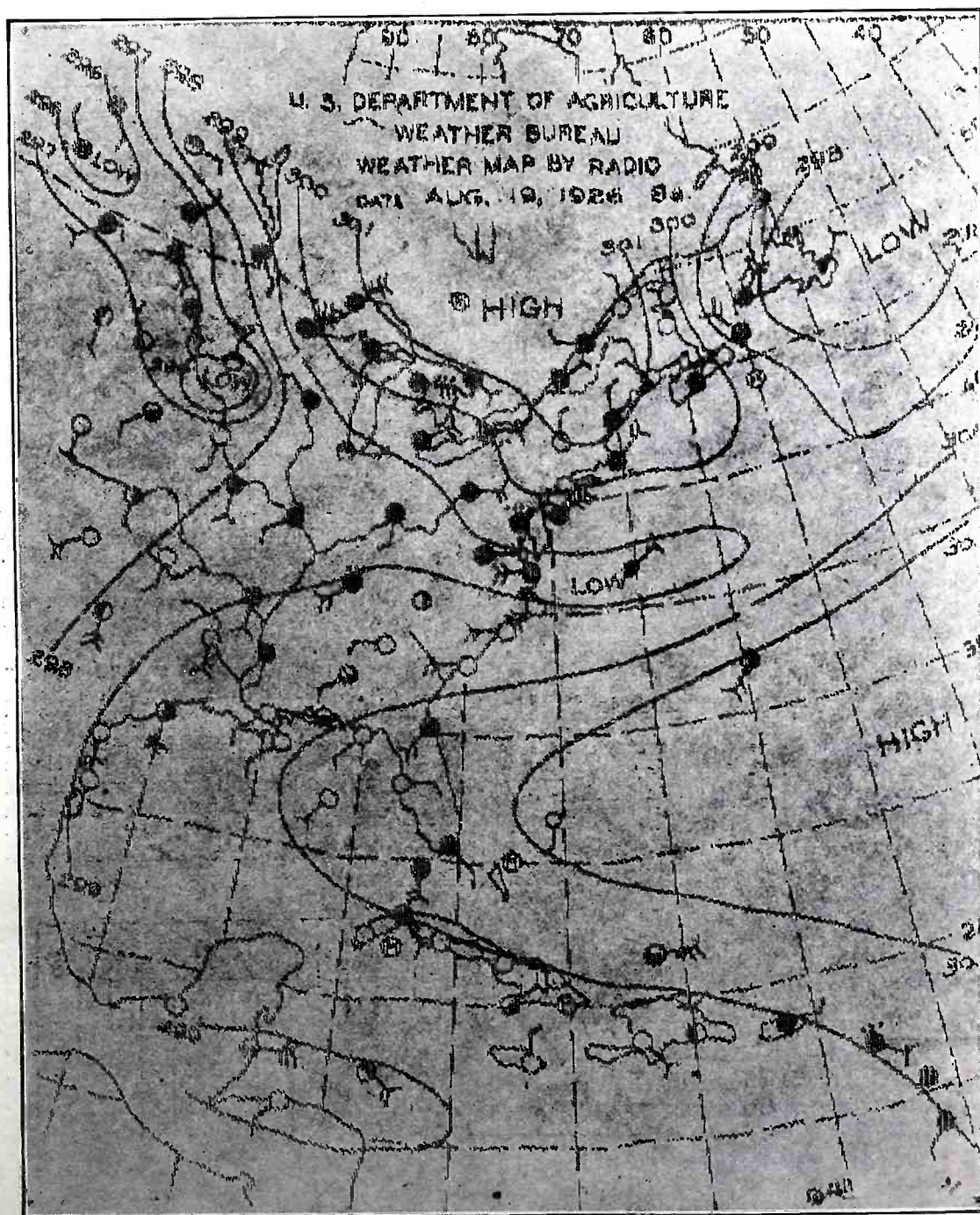

An unretouched reproduction of a weather map, just as it is received on ship-board.



What's New in Radio



UNIQUE SIX-TUBE RECEIVER

Four stages of tuned-radio-frequency amplification are successfully controlled by a single tuning knob in this six-tube receiver. The four tuning condensers are assembled together on one cast aluminum frame of great rigidity, and are not supplemented by any of the usual "trimming", or so-called "vernier" condensers.

Compensation for the different tuning

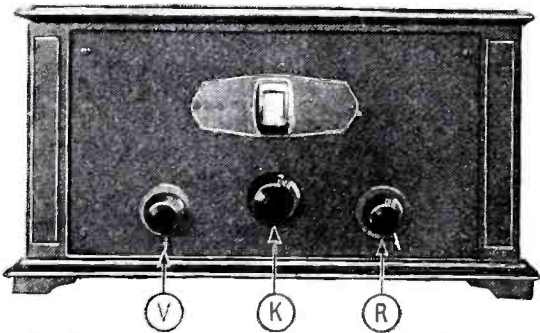

Front view of the complete receiver, showing panel layout. Knob K is the main tuning control, while V is for the antenna variometer and R for the filament rheostat.

Illustrations courtesy Federal-Brandes, Inc.

effects of different antennae is provided by an antenna tuner of unusual design. It is not a coupler of the ordinary semi-aperiodic primary type, but consists of a small variometer, one winding of which is tapped in three places. It is shunted by the first section of the quadruple condenser, and is adjusted in the particular location in which the set is used so that in combination with the inductance of the aerial, it provides just

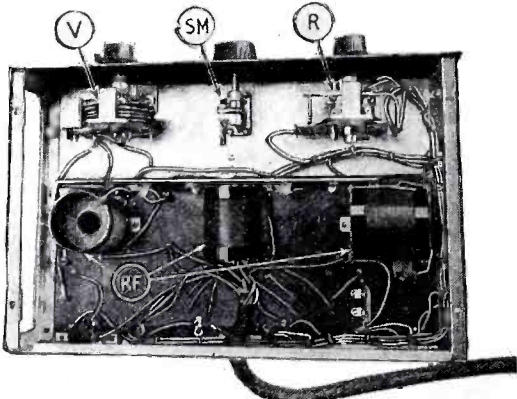

Bottom view of the receiver chassis, showing disposition of the radio-frequency interstage transformers RF, the antenna variometer V, the condenser driving mechanism SM, and the rheostat R.

enough total effective inductance to equal the individual inductance of the three fixed RF. transformers. The four tuning inductances

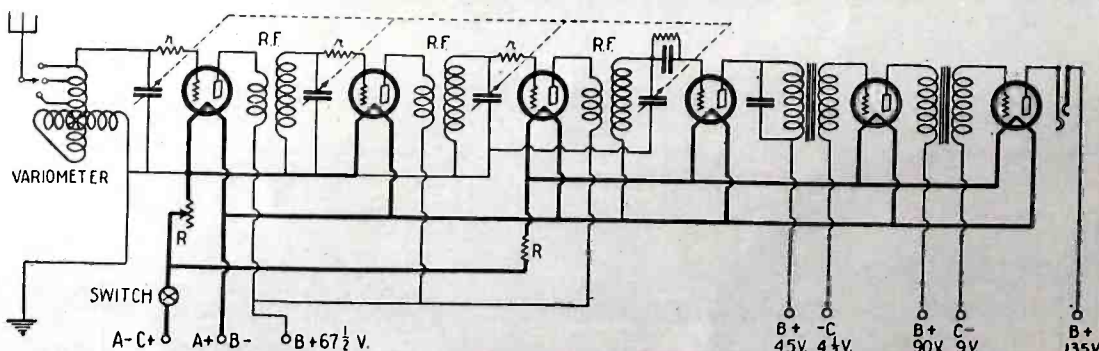

Complete circuit of the four-stage R.F. receiver, showing the position of the antenna variometer. The four tuning condensers are adjusted simultaneously, as indicated by the dotted lines. The fixed resistances, r , in the grid leads of the R.F. amplifier tubes, prevent oscillation. The left-hand rheostat, R, regulates the first two R.F. bulbs; the other is fixed, and controls the other four tubes.

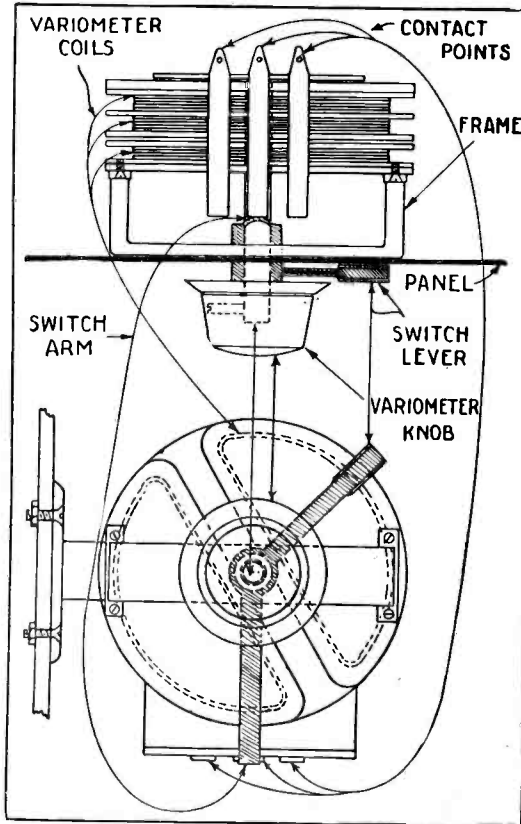

Detailed drawing of the antenna-variometer unit, showing the arrangement of the switch-lever and contact points, by means of which the number of turns of wire in use on the variometer stator is adjusted.

thus being made equal to each other, the quadruple condenser tunes them in perfect step throughout the wavelength range of the receiver. Rough adjustment is furnished by the three taps on the variometer winding.

The radio-frequency stages are of the resistance-stabilized type, and do not betray any signs of oscillation anywhere over the tuning scale. The three interstage couplers are simple solenoids, which are placed in such angular relation that the magnetic feedback between them is at a minimum. A rheostat connected to the first two R.F. tube filaments acts as a volume control.

The set mechanically is very strong, the panel and supporting chassis being made entirely of brass and aluminum.

The front panel holds three knobs and a decorative window through which may be observed an indicating scale graduated in wavelengths. In the accompanying view of the front of the receiver, K is the single main tuning control, V the variometer knob, and R the rheostat. A small lever beneath the variometer knob adjusts the tapped variometer winding, while a similar lever be-

neath the rheostat knob acts as a filament on-off switch.

The audio amplifier is of the standard transformer type, two stages of amplification being employed.

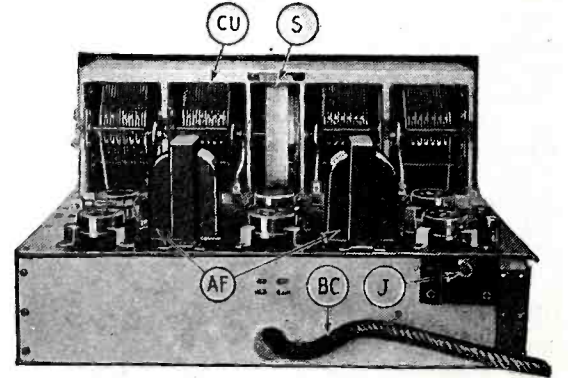

Back view of the receiver: CU is the quadruple condenser unit; S, the condenser indicating scale; AF the audio amplifying transformers; BC the battery cable; and J the loud-speaker jack.

ROSE-BOWL HORNLESS LOUD SPEAKER

In this novel loud speaker from England is incorporated a bowl, covered by a screen in which may be placed flowers, such as roses, pansies, etc., which need support to be kept properly. Beneath this bowl is a hornless loud speaker, the terminals of which may be seen on the side of the base.

This loud speaker comes in different finishes, bronze, or oxidized silver, which enhance its appearance. Not only does it



The loud-speaker unit of this novel instrument is located just beneath the bowl at the section marked "I".

Photo courtesy British Electrical Sales Organization.

serve as an excellent table decoration, but the quality of reproduction is said to be excellent.

TUBE SILENCER

There are in existence many radio receivers equipped with old-style fixed sockets, which, because of their inability to prevent vibrations from affecting the tubes contained in them, are responsible for serious and annoying microphonic disturbances in the loud speakers. To overcome this trouble without making necessary the complete replacement of the receptacles by others of the non-microphonic type, a manufacturer has brought out a silencing device designed for attachment to the individual noisy tubes.

It consists merely of a heavy steel disc, to one face of which are riveted four flexible steel fingers tipped with rubber. When slipped over the top of a noisy bulb it acts as a damping weight, and effectively pre-

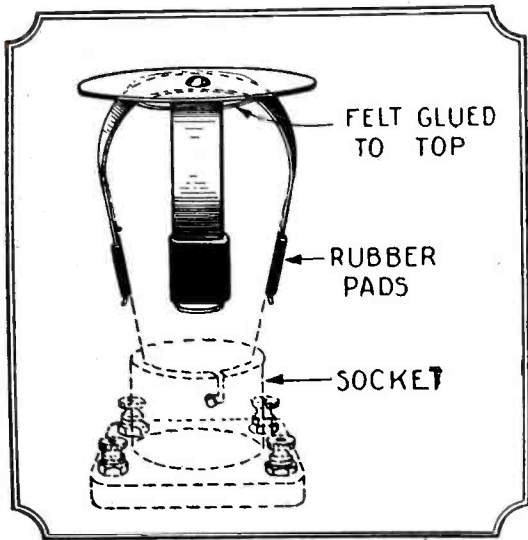

This shows how the silencer fits over a noisy vacuum tube.
Illustration courtesy Day-Fan Electric Co.

vents the tube from responding to transitory vibrations and shocks transmitted to it through the stiff socket.

This attachment is especially valuable to owners of console cabinets which contain both radio sets and loud speakers, as the close proximity of the reproducers to the tubes usually is the cause of strong microphonic effects.

SINGLE-CONTROL 6-TUBE T.R.F.

The six-tube receiver shown herewith has ample space provided on each side of the set itself for the necessary batteries or eliminators; it employs a single-control tuned-radio-frequency circuit, having two



Front view of the single-control 6-tube receiver. The tuning knob is the large one in the center of the panel.
Photos courtesy The Magnavox Company

stages of R.F., a detector and three stages of transformer-coupled A.F. amplification. The three condensers for tuning the R.F. stages are mounted in the bottom of the cabinet, on a sloping platform, and driven by the single control to which is attached

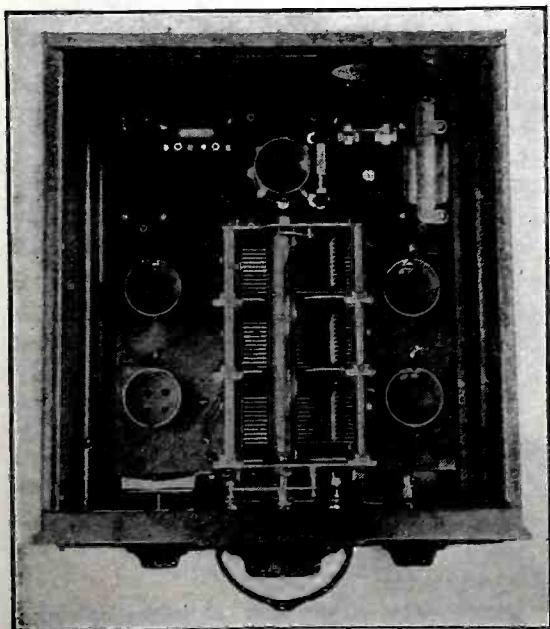

Top view of the single-control set, showing how the tube sockets are arranged around the large triple tuning condenser.

a shaft and gears. These condensers are shielded by a semi-circular plate of metal that extends upwards into the compartment above, in which the six tubes are located. The central panel of the set is set at an angle in order that the dial readings may be more easily seen.

Connections to the batteries are easily made, because of the leads, which go through holes into the battery compartments and are connected permanently to the set. It is claimed that this receiver is capable of very good reproduction due to its well designed audio-frequency amplifier.

STATIONARY HYDROMETER

Consisting of an upright barrel and a flexible nozzle two feet long, this unusual hydrometer permits a radio fan to test all the cells of "A" and "B" storage batteries with-

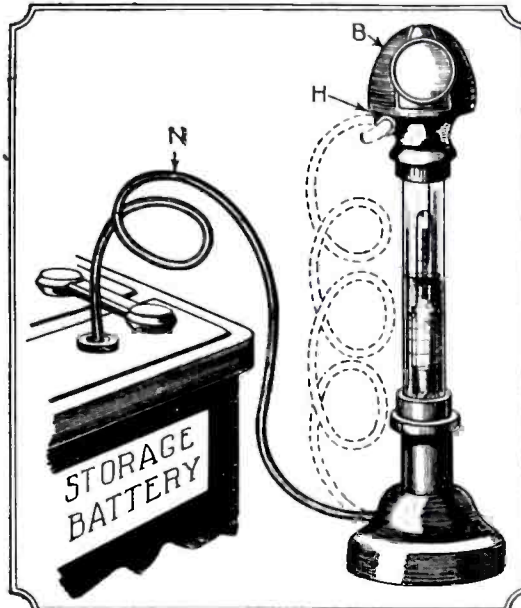

When this hydrometer is not being used, the flexible rubber hose, N, is kept fastened in the hook H, which forms part of the rubber bulb, B.
Illustration courtesy E. Edelman & Co.

out moving either the batteries or the testing instrument. He simply pulls out the hose, N, from its hook, H, in the bottom of the rubber bulb, B, places the end in the battery vent, squeezes the bulb so as to draw some acid into the barrel, and observes the reading. When he is finished, he squeezes the bulb again so as to force the acid back into the battery.

The hydrometer is fitted with a soft rubber base weighted at the bottom so that it cannot be tipped over easily. The glass indicating float cannot stick to the inside of the barrel, being kept away from the latter by means of little projections blown on its surface. The entire device stands only eight inches high.

"A" BATTERY ELIMINATOR

This "A" power unit really eliminates the "A" battery by converting the alternating house current for direct lighting of standard five-volt radio tubes. The action that takes place in it is purely a transformer-and-rectifying one, wherein the 110-volt A.C. is stepped down to a lower voltage, rectified, and its pulsations then ironed out by a filtering system of "brute" dimensions.

No liquids, acids, or other chemicals are used, the rectifiers being two tungar bulbs. The unit does not consume power except when it is actually being used, and then at a rate of about two cents per hour. Once installed, it requires no care, as its components are all fixed and adjusted in the factory.

The maximum output at six volts is 2½ amperes, the eliminator being capable, therefore, of operating any receiving set employing up to ten tubes of the 201A type, or their equivalent. The use of the unit entails no revision of the filament circuit of the receiver.

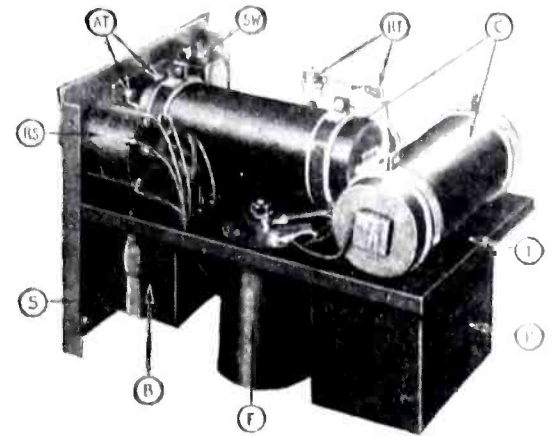

The parts of the "A" eliminator are clearly shown in this illustration: S steel front panel, RS output-regulating switch, AT output terminals; SW on-off switch, RT rectifier tubes, C filter choke coils, T steel assembly tray, P power transformer, F filter condenser; and B ballast unit.
Photos courtesy The Cooper Corporation.

The containing case is made of 16 gauge steel finished in sagebrush green, and is 9 inches wide, 9½ inches high, and 13¼ inches long. It weighs 52 pounds complete.

The two accompanying illustrations give an idea of the external appearance and internal construction. In the photograph of the insides, the letter S indicates the steel front panel; RS the output regulating switch; AT the "A" plus and minus output terminals; SW the on-off switch; RT the rectifier tubes; C the filter choke coils; T the steel assembly tray; P the power trans-

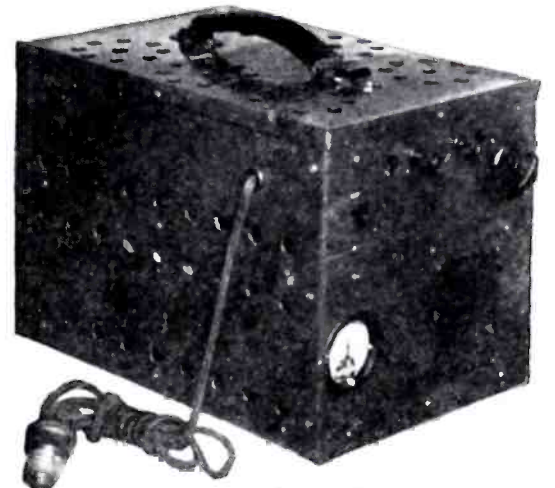

View of the complete "A" eliminator in its case.

former; F the filter condenser; and B the ballast unit for equalizing the output of the two rectifiers.

OVAL SHAPED CONE SPEAKER

The oval shape of this cone speaker is claimed by the manufacturer to strike an agreeable balance in the reproduction of high and low notes. The long side of the oval is



This oval-shaped cone speaker is fitted with a decorative grill which enhances its appearance markedly.

Photo courtesy The Radio Foundation, Inc.

said to stress the low notes, and the short side the high notes, the two rounding out the reproduced tones with great clarity.

The speaker is 20 inches high, 20 inches wide on the long side of the oval and 14 inches on the short side. It uses a single cone, the open side being covered over by a fancy metal grill. The whole instrument stands on a heavy base. The metal work is finished in old gold or statuary bronze, the speaker as a whole presenting a handsome appearance.

NOVEL FIVE-TUBE RECEIVER

A novel combination of two indicating hands traveling over a single semi-circular scale on the front panel is the outstanding feature of this five-tube set. The three variable condensers which tune the two-stage radio-frequency amplifier circuit are mounted on a common frame, the two left-hand ones

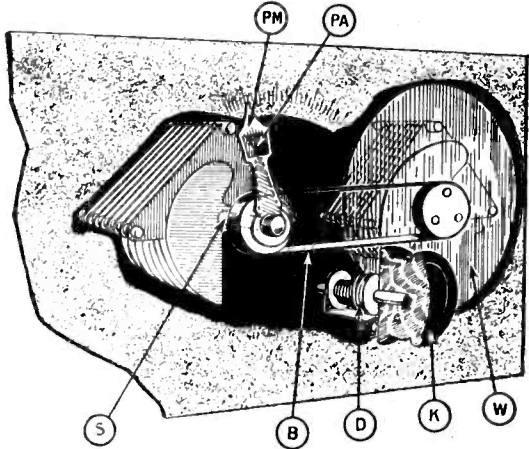

This drawing shows the details of the driving mechanism of the right-hand variable condenser of the five-tube receiver. The large knob K by means of the driving discs D, turns the wheel W, which is attached to the shaft of the right-hand variable condenser. The belt B moves the inside pointer PA, while the pointer PM moves independently on its own shaft S. Illustrations courtesy The Pfanstiehl Radio Co.

being linked together so that their shafts turn together. Their positions are indicated on the panel by the main pointer marked PM in all the accompanying illustrations.

The shaft to which PM is attached revolves inside and independently of a combin-

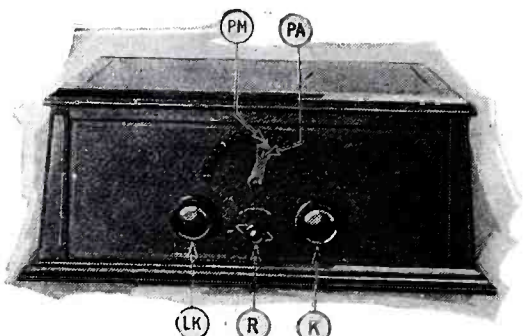

Front view of the complete receiver: PM is the main pointer, PA the auxiliary one, LK controls the two left-hand tuning condensers and PM; K controls the right-hand condensers and PA; R is a rheostat knob.

ation shaft and pulley. To the latter is attached a small pointer, marked PA, moving inside a little square window cut in the main pointer. The pulley is belted to the free right-hand condenser on the large frame.

The operation of the system is obvious

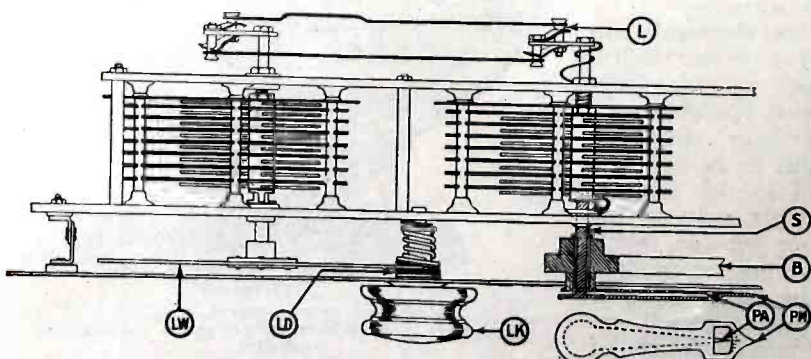

At Left: This shows the details of the left-hand condenser unit. L is the link motion connecting the two condenser shafts; LW is a large wheel, driven by the discs LD and the knob LK; S is the condenser shaft, B the belt to the right-hand condenser, PM the main pointer, and PA the auxiliary.

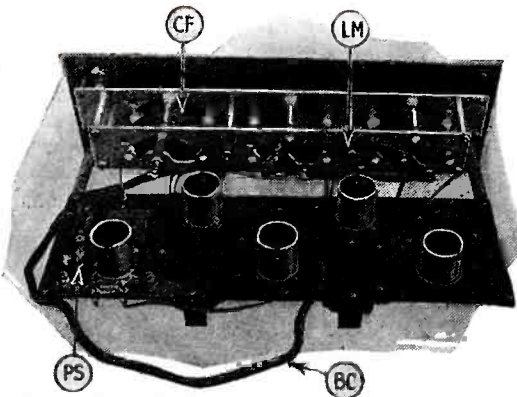

Rear view of the receiver. CF is the triple-condenser unit; LM the link motion connecting the two left-hand condensers (right-hand in this illustration); BC the battery cable; and PS a switch allowing the use of the proper batteries with a power tube.

from the drawings. There are two tuning knobs: LK, below and to the left of the scale on the panel, and K, below and to its right. Knob LK, by means of a pair of friction discs LD (see drawing of top view of condenser and dial assembly), drives a large disc, LW. This disc is fastened to the extreme left-hand condenser on the frame, and through the link motion, L, also turns the second condenser. The shaft of the latter, S, is fixed to the pointer, PM.

A similar driving scheme is used for the single right-hand condenser, which tunes the aerial coupler of the receiver. The knob K, by means of its friction wheels, D, drives the wheel, W, which is attached to the condenser shaft. The wheel also carries a small pulley, S, to the center pulley bearing the auxiliary pointer, PA.

In tuning the set, a person grasps LK in his left hand and K in his right, and turns them so that the small pointer always keeps within the large one. The aerial coupler condenser is rarely more than a few degrees different in setting from the inter-stage condensers, so it is a simple matter to tune the set to perfect resonance with this arrangement.

Electrically the receiver is of more or less orthodox design. The two stages of tuned R.F. feed into a detector tube and a two-stage transformer coupled audio amplifier. Provision is made for the use of a power tube in the last stage.

LOUD SPEAKER

This pear-shaped loud speaker, only 7½ inches high and 6 inches in diameter, em-

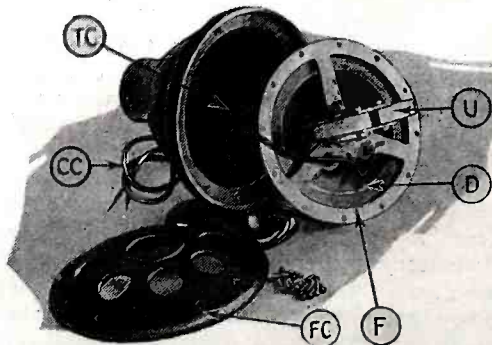

The parts of the pear-shaped loud speaker; the round frame F is fastened against the face of the tone chamber TC when the speaker is assembled.

loys a balanced speaker unit, U, driving a stiff impregnated linen diaphragm, D, set in the cast aluminum frame F.

The case is molded brown bakelite, and consists of two sections, the pear-shaped tone chamber, TC, and the face cap, FC. Twelve screws passing through the cap and the edge of the aluminum frame hold the



The pear-shaped loud speaker ready for use. Photos courtesy The Tectron Radio Corp.

latter in an upright position against the edge of the tone chamber.

COMBINATION POWER AMPLIFIER-"B" ELIMINATOR

A complete "B" eliminator and a stage of power amplification are contained in the

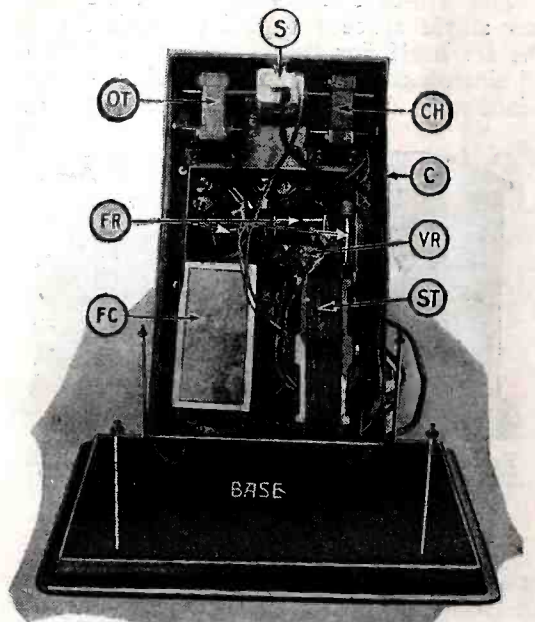

Bottom view of the amplifier-eliminator unit; S is the on-off switch, CH the choke-coil, C the steel case, VR, voltage-output regulating resistance, ST step-up transformer, FC filter-condenser unit, FR fixed resistors to regulate "B" voltages, and OT the output choke for the loud speaker circuit.

Photos courtesy Radio Receptor Company, Inc.

case of this unit, which is intended to replace the second audio tube in any factory-built receiver using transformer coupled audio. It makes use of the second transformer in the

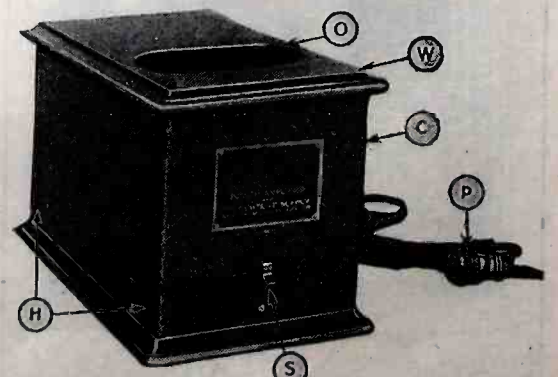

Outside view of the unit. O is the opening through which the amplifier and rectifier tubes are inserted, W wooden cover, C case, P lamp-socket plug, S the on-off switch, H the ventilation holes.

set, and provides the advantages of power tube operation at a minimum of bother.

A power amplifier tube of the 210 type is used. The output circuit includes a choke coil and large fixed condenser to keep the heavy plate current out of the loud speaker.

The "B" section of the unit develops 135 volts, and has sufficient capacity to operate any receiver of six tubes or less. Bias for the grid of the power amplifier tube is furnished by the voltage drop across a fixed resistor in the "B" minus lead.

A MOST UNUSUAL "A" ELIMINATOR

Of radically different design, this "A" eliminator is probably one of the most unusual devices offered so far for the solution of the "A" power problem. It is a filter unit intended for use with battery chargers of either the bulb or chemical type, and serves the purpose of smoothing out the rectified current as it leaves the chargers and of passing it to the radio receiver as smooth direct current free from hum or noise.

Essentially, the unit consists of a large choke coil and a double electrolytic conden-

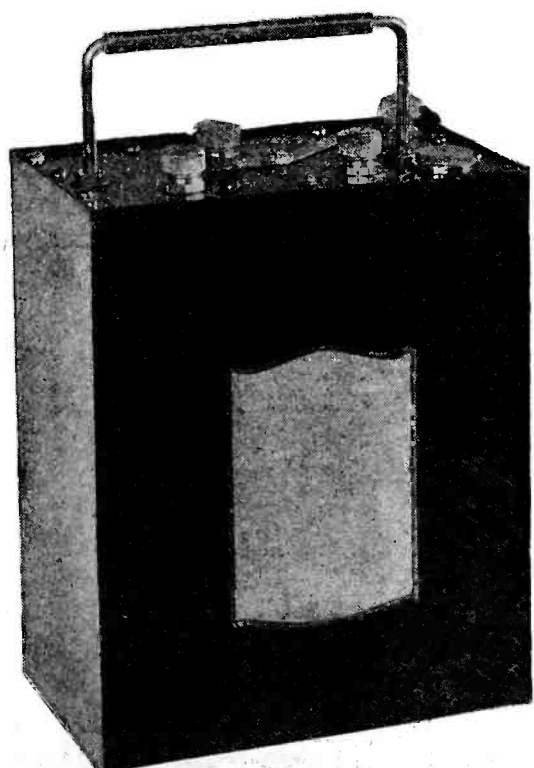

External appearance of the complete "A" battery eliminator.

Photos courtesy The Abox Company

ser of new design. It is wired simply between the output of the charger and the "A" posts on the receiving set, and operates like any other filter system containing inductance and capacity. The secret of this particular filter lies in the condenser, which possesses, according to calculations and measurements made by the inventors, the enormous capacity of ONE QUARTER OF A FARAD. (Note, one quarter of a farad, not microfarad). This capacity is equivalent to 250,000 mf., the condenser undoubtedly being the largest ever made for ordinary radio work.

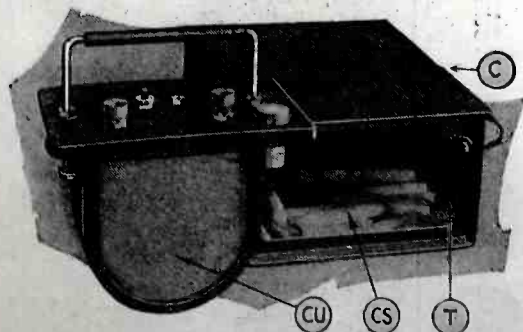

The electrolytic condenser taken apart: C is the outside containing case; T the sealed tank into which the water is poured; CS the sticks of potassium hydroxide before being dissolved; and CV the plate assembly.

Right: The complete neutrodyne receiver, with the power unit at its right.

Photos courtesy The Amrad Corporation

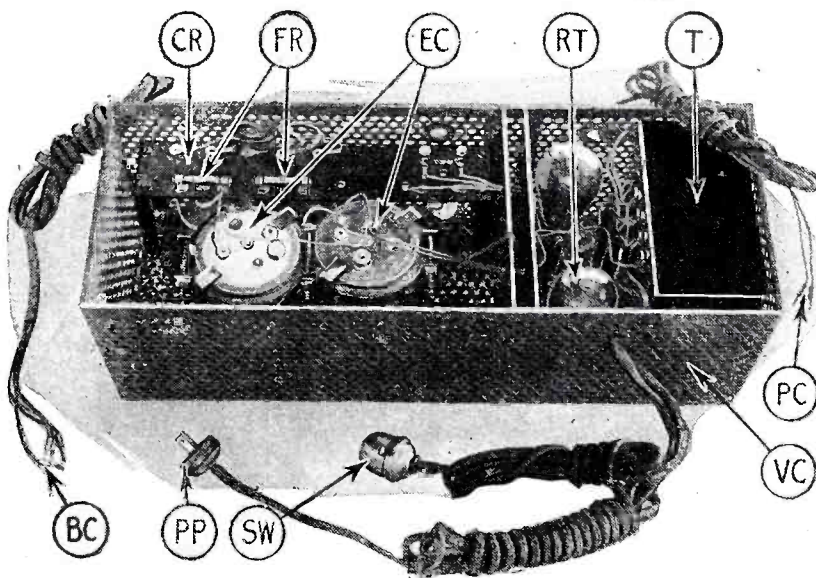
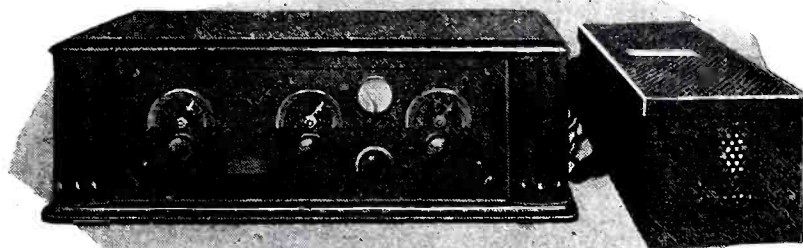

Left: the power unit. CR is the connection rack; FR the fixed resistors; EC the electrolytic filter condensers; RT the rectifier tubes; T the power transformer; PC power-tube connector cord; VC the case; SW the on-off switch; PP the power plug; and BC the battery cable.

Despite its large electrical size, the condenser is surprisingly small mechanically, occupying a space only about three inches wide, six long, and five deep. It operates by reason of a gas concentration on the iron and nickel plates, which are immersed in a strong solution of potassium hydroxide. It is the invention of E. F. Andrews and Laurens Hammond, both of Chicago, Ill., and is covered by a number of patent applications.

The filter may be used with various sizes of bulb and chemical rectifiers to supply either the 199 or 201A types of tubes in any number up to 15. A combination of a 2½-ampere electrolytic charger and the filter makes an ideal source of "A" power direct from the A.C. lamp socket for sets containing six tubes or less.

The unit is extremely flexible, and is adaptable to direct-current service as well as alternating. It may be used with trickle chargers to supply the correct current for 199 tubes, or with heavy five-ampere bulb charg-

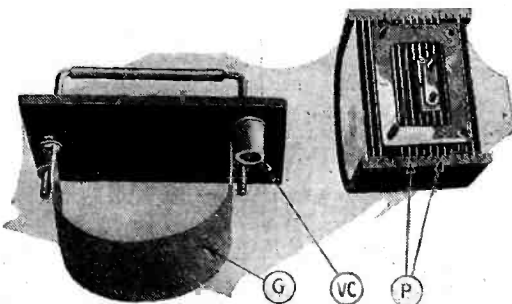

The plate assembly further revealed: G is the girde holding the plates P and VC is the cap through which the water is poured into the tank.

ers for unusually heavy loads. It is only half the size and less than half the weight of the ordinary storage battery, and once filled with water and installed alongside the charger, becomes a permanent power unit that requires no care.

Mr. Andrews personally demonstrated his filter in the RADIO NEWS Laboratories before Mr. Hugo Gernsback and members of the staff, and impressed everyone with its effectiveness. Operating a six-tube set, it produced no audible hum whatsoever in the loud speaker, and only a very faint and hardly discernible hum in a pair of telephone receivers connected to the full output of the receiver.

POWER-OPERATED RECEIVER

A full-wave-rectifier system, employing two 216B tubes and two 15 mf. electrolytic condensers, furnishes complete "A" and "B" power for this receiver, which is a standard five-tube neutrodyne embodying two stages of R.F. and two stages of transformer coupled audio frequency.

The R.F., detector, and first A.F. tubes are of the 199 type, their filaments being wired in series, and fed the necessary .06 ampere by the rectifier system. The last audio tube is a power tube of the 112 type, and is connected directly to a five-volt winding on the power transformer in the eliminator. The grid return from the last audio transformer is made to its filament through a simple split resistance.

The rectifier units, contained in a separate steel case, also supply "B" voltage. A number of fixed resistors of suitable value are connected in the circuit to keep the output voltages at their proper figures.

The receiver and eliminator unit are designed for each other, and cannot be used independently.

"A" CURRENT SUPPLY

This device supplies "A" power for the lighting of standard tubes at six volts and a maximum of 2¼ amperes. After the plug, P, has been inserted in any 110-volt A.C.

(Continued on page 905)

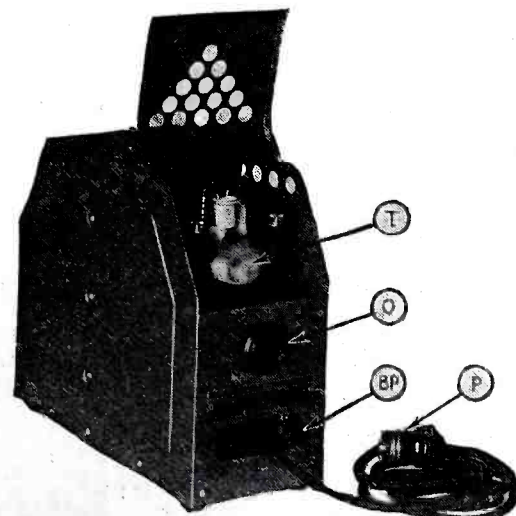

The "A" current-supply unit, with the cover lifted.

Photo courtesy The Crosley Radio Corp.

List of Broadcast Stations in the United States

Radio Call Letter	BROADCAST STA. Location	Wave (Meters)	Power (Watts)	Radio Call Letter	BROADCAST STA. Location	Wave (Meters)	Power (Watts)	Radio Call Letter	BROADCAST STA. Location	Wave (Meters)	Power (Watts)	Radio Call Letter	BROADCAST STA. Location	Wave (Meters)	Power (Watts)
KDKA	East Pittsburgh, Pa.	*309.1	Var.	KGDI	Seattle, Wash.	416.4		WBPP	Petoskey, Mich.	238	200	WGCP	Newark, N. J.	252	500
KDLR	Devils Lake, N. D.	231	5	KGDJ	Cresco, Iowa	202.6		WBRR	Rossville, N. Y.	416.4	500	WGES	Oak Park, Ill.	315.6	500
KDYL	Salt Lake City, Utah	216	200	KGO	Oakland, Calif.	*361.2	5000	WBBW	Norfolk, Va.	222	50	WGHB	Clearwater, Fla.	266	500
KFAB	Lincoln, Neb.	*310.7	5000	KGTT	San Francisco, Calif.	206.8	50	WBBY	Charleston, S. C.	208	100	WGHP	Mt. Clemens, Mich.	270	1500
KFAD	Phoenix, Ariz.	273	100	KGU	Honolulu, Hawaii	270	500	WBBZ	Chicago, Ill. (portable)	215.7	50	WGM	Jettette, Pa.	372	150
KFAF	San Jose, Calif.	217.3	50	KGW	Portland, Ore.	421.5	1000	WBCN	Chicago, Ill.	266	500	WGMU	Richmond Hill, N.Y. (port.)	236	100
KFAU	Boise, Idaho	280.2	2000	KGY	Lacey, Wash.	278.8	50	WBES	Takoma Park, Md.	222	100	WGN	Elgin, Ill.	302.8	1000
KFB	Havre, Mont.	275	50	KHJ	Los Angeles, Calif.	405.2	500	WBNO	New York, N. Y.	322.4	1000	WGR	Buffalo, N. Y.	319	750
KFCB	San Diego, Calif.	380	50	KHQ	Spokane, Wash.	391.5	1000	WBQQ	Richmond Hill, N. Y.	236	100	WGST	Atlanta, Ga.	270	500
KFCB	Sacramento, Calif.	535	100	KHX	Los Angeles, Calif. (port.)	119.9	500	WBRE	Birmingham, Ala.	248	50	WGW	Milwaukee, Wis.	384.4	1000
KFBL	Everett, Wash.	224	100	KICK	Anita, Ia.	273	100	WBRL	Wilkes-Barre, Pa.	231	100	WHA	Schenectady, N. Y.	*379.5	50000
KFBS	Trinidad, Colo.	238	15	KJBS	San Francisco, Calif.	234.2	5	WBRS	Tilton, N. H.	410	500	WHB	Madison, Wis.	535.4	750
KFBV	Laramie, Wyo.	375	500	KJRD	Seattle, Wash.	384.4	1000	WBRS	North Bergen, N. J.	233.7	10	WHAM	Milwaukee, Wis.	275	500
KFCB	Phoenix, Ariz.	238	15	KLDS	Independence, Mo.	*440.9	1000	WBRT	Brooklyn, N. Y.	394	100	WHAP	Lowchester, N. Y.	278	100
KFD	Boise, Idaho	275.1	50	KLX	Oakland, Calif.	508.2	500	WBZ	Charlotte, N. C.	275	250	WHAR	New York, N. Y.	431	500
KFDM	Beaumont, Tex.	315.6	500	KLZ	Denver, Colo.	508.2	500	WBZ	East Springfield, Mass.	*331.1	5000	WHAS	Atlantic City, N. Y.	275	500
KFDX	Shreveport, La.	250	100	KMA	Shenandoah, Iowa	384.4	500	WBZ	Boston, Mass.	*331.1	500	WHAZ	Louisville, Ky.	399.8	500
KFDY	Brookings, S. Dak.	305.9	100	KMJ	Fresno, Calif.	461	500	WCAD	Storrs, Conn.	275	500	WHB	Troy, N. Y.	379.5	500
KFDZ	Minneapolis, Minn.	252	10	KMJP	Kansas City, Mo.	410.9	1000	WCAE	Canton, N. Y.	*263	250	WHB	Kansas City, Mo.	365.6	500
KFC	Portland, Ore.	232	50	KMMJ	Clay Center, Neb.	228.9	1000	WCAH	Pittsburgh, Pa.	461.3	500	WHB	Oil City, Pa.	250	10
KFEL	Denver, Colo.	254	250	KMO	Tacoma, Wash.	250	100	WCAJ	Columbus, O.	265.3	500	WHB	Canton, Ohio	254	10
KFEQ	Oak, Nebr.	268	500	KMOX	Kirkwood, (St. Lo.) Mo.	280.2	5000	WCAJ	University Place, Neb.	254	500	WHB	Bellefontaine, Ohio	222	100
KFEY	Kellogg, Idaho	233	10	KMTR	Hollywood, Calif.	272.2	500	WCAJ	Northfield, Minn.	336.9	500	WHB	Rock Island, Ill.	222	100
KFFP	Moberly, Mo.	212	50	KNRC	Santa Monica, Calif.	238	500	WCAM	Baldwin, N. J.	336.9	1000	WHB	Harrisburg, Pa.	231	20
KFGQ	Boone, Iowa	226	10	KNX	Los Angeles, Calif.	336.9	500	WCAR	Baltimore, Md.	275	100	WHB	Chicago, Ill. (port.)	215.7	50
KFH	Wichita, Kans.	*267.7	500	KOA	Denver, Colo.	*322.4	5000	WCAT	San Antonio, Texas	263	5000	WHB	Chicago, Ill. (port.)	215.7	20
KFHA	Gunnison, Colo.	252	50	KOAC	Corvallis, Ore.	280.2	500	WCAU	Rapid City, S. D.	240	50	WHB	St. Petersburg, Fla.	238	10
KFHL	Oskaloosa, Iowa	240	10	KOB	State College, N. M.	318.6	5000	WCAU	Philadelphia, Pa.	277.6	500	WHB	Johnstown, Pa.	256	100
KFI	Los Angeles, Calif.	467	5000	KOCH	Omaha, Neb.	258	500	WCAZ	Burlington, Vt.	252	100	WHB	Memphis, Tenn.	253	50
KFIF	Portland, Ore.	218	100	KOCW	Chickasha, Okla.	252	200	WCB	Carthage, Ill.	245.8	50	WHB	Cincinnati, O.	215.7	300
KFIO	Spokane, Washington	273	500	KOIL	Council Bluffs, Iowa	305.9	500	WCB	Allentown, Pa.	254	125	WHB	Anderson, Ind.	218.8	10
KFIQ	Yakima, Wash.	256	500	KOIN	Sylva, Ore.	319	1000	WCB	Zion, Ill.	344.6	5000	WHB	Philadelphia, Pa.	215.7	100
KFIU	Juneau, Alaska	226	10	KOMO	Seattle, Wash.	305.9	1000	WCB	New Orleans, La.	263	5	WHB	West De Pere, Wis.	250	50
KFIZ	Fond du Lac, Wis.	273	100	KOWW	Walla Walla, Wash.	285.5	500	WCB	University, Miss.	242	50	WHB	Minneapolis, Minn.	278	500
KFJB	Marshalltown, Iowa	248	10	KPJM	Prescott, Ariz.	215	500	WCB	Baltimore, Md.	229	100	WHB	Rochester, N. Y.	258	100
KFJC	Junction City, Kansas	218.8	10	KPO	San Francisco, Calif.	428.3	1000	WCB	Providence, R.I. (port.)	234	100	WHB	Chicago, Ill.	258.5	150
KFJD	Oklahoma City, Okla.	261	500	KPPC	Pasadena, Calif.	229.9	500	WCB	Providence, R.I. (port.)	242.5	250	WHB	Cleveland, Ohio	272.6	1000
KFJJ	Astoria, Ore.	246	10	KPRC	Houston, Texas	296.9	500	WCCF	Minn.-St. Paul, Minn.	*416.4	5000	WHB	New York, N. Y.	361.2	5000
KFJM	Grand Forks, N. Dak.	278	100	KPSN	Pasadena, Calif.	315.6	1000	WCFI	Chicago, Ill.	491.5	500	WHB	Des Moines, Iowa	526	5000
KFJR	Portland, Ore.	263	120	KQV	Pittsburgh, Pa.	275	500	WCFI	Tulahoma, Tenn.	252	10	WHB	Huntington, Ind.	241.8	15
KFJY	Fort Dodge, Iowa	246	50					WCGU	Lakewood, N. J.	350.6	500	WHB	Deerfield, Ill.	399.8	3500
KFJZ	Fort Worth, Tex.	254	50									WIAD	Philadelphia, Pa.	250	100
KFKA	Greeley, Colo.	*272.6	50									WIAD	Durlington, Iowa	254	100
KFKB	Milford, Kas.	431.4	1000									WIBA	Madison, Wis.	236	100
KFKU	Lawrence, Kans.	275	500									WIB	Elkins Park, Pa.	222	50
KFKX	Hastings, Nebr.	288.3	5000									WIB	New Bedford, Mass.	209.7	30
KFKZ	Kirksville, Mo.	225.4	50									WIB	Fushing, N. Y.	218.8	50
KFLR	Albuquerque, N. Mex.	254	100									WIB	Chicago, Ill. (port.)	215.7	50
KFLU	San Benito, Tex.	236	20									WIB	Chicago, Ill. (port.)	215.7	10
KFLV	Rockford, Ill.	229	100									WIB	Chicago, Ill.	226	1000
KFLX	Galveston, Tex.	240	250									WIB	Steuenville, Ohio	246	50
KFLZ	Anita, Iowa	273	100									WIB	Elizabeth, N. J.	202.6	10
KFMR	Sioux City, Iowa	261	100									WIB	Poyntette, Wis.	222	20
KFMY	Northfield, Minn.	336.9	500									WIB	Logansport, Ind.	220	100
KFNF	Shenandoah, Iowa	461.3	2500									WIB	Utica, N. Y.	234.2	150
KFOA	Seattle, Wash.	454.3	1000									WIB	Montgomery, Ala.	230.6	10
KFOB	Burlingame, Calif.	226	50									WIB	Bridgeport, Conn.	285	
KFON	Long Beach, Calif.	233	500									WIB	St. Louis, Mo.	258	250
KFOR	David City, Nebr.	226	100									WIB	Urbana-Champaign, Ill.	260	1000
KFOT	Wichita, Kans.	241	50									WIB	Miami Beach, Fla.	247.8	1000
KFOX	Omaha, Nebr.	218	100									WIB	Philadelphia, Pa.	508.2	500
KFOY	St. Paul, Minn.	252	50									WIB	Waco, Texas	*352.7	500
KFPL	Dublin, Texas	252	20									WIB	Ferndale, Mich.	407	500
KFPM	Greenville, Texas	212	10									WIB	Norfolk, Nebr.	270	200
KFPR	Los Angeles, Calif.	230.6	500									WIB	Kokomo, Ind.	254	50
KFPW	Cartersville, Mo.	258	20									WIB	Cedar Rapids, Iowa	268	100
KFPY	Spokane, Wash.	273	100									WIB	Princeton, R. I.	305.9	500
KFQA	St. Louis, Mo.	280.2	5000									WIB	Pittsburgh, Pa.	275.1	500
KFQB	Fort Worth, Texas	508.2	2500									WIB	Jacksonville, Fla.	336.9	1000
KFQD	Anchorage, Alaska	227.1	100									WIB	Mount Prospect, Ill.	329.8	1000
KFQP	Iowa City, Iowa	224	10									WIB	Joliet, Ill.	206.8	50
KFQU	Alma (Holy City) Calif.	231	250									WIB	St. Petersburg, Fla.	254	250
KFQW	Seattle, Wash.	215.7	50									WIB	La Salle, Ill.	234	100
KFQZ	Hollywood, Calif.	225.4	500									WIB	Red Bank, N. J.	218.8	250
KFRB	Beville, Tex.	218	250									WIB	Ypsilanti, Mich.	233	10
KFRD	San Francisco, Calif.	267.7	50									WIB	Decatur, Ill.	270	500
KFRU	Columbia, Mo.	*499.7	500									WIB	New Orleans, La.	268	100
KFRW	Olympia, Wash.	218.8	50									WIB	Omro, Wis.	227.1	50
KFSD	San Diego, Calif.	245.8	1000									WIB	Chicago, Ill.	468.5	500
KFSG	Los Angeles, Calif.	275	500									WIB	Lewisburg, Pa.	211.1	100
KFUL	Galveston, Tex.	258	500									WIB	Woodhaven, N. Y.	469.9	50
KFUM	Colorado Springs, Colo.	239.9	100									WIB	New Orleans, La.	270	20
KFUP	St. Louis, Mo.	545.1	500									WIB	Gadsden, Mass.	280	100
KFUR	Denver, Colo.	234	50									WIB	Jacksonville, Fla.	260	90
KFUS	Oakland, Calif.	256	50									WIB	Ypsilanti, Mich.	*370.2	1000
KFUT	Salt Lake City, Utah	263	100									WIB	Ypsilanti, Mich.	518.9	5000
KFUU	Oakland, Calif.	220	100									WIB	Ypsilanti, Mich.	518.9	250
KFV	Venice, Calif.	205.4	50									WIB			

Automatic Devices in Radio Manufacture

How Ingenious Mechanism Does the Work of Human Fingers

By HERNDON GREEN

HOW it has been necessary to devise new methods of manufacture and new machinery, to meet the peculiar demands of radio mass production, is well illustrated in these views of a large Eastern factory.

One of the best examples is shown in the assembly of a recently-developed type of audio amplifier unit, for which the division of labor is facilitated by the use of a conveyor, invented and built for the especial purpose. From the time the stamped laminations for the core of the unit fall from the press, the operation of assembly does not stop until the completed and tested instrument is ready for shipment. (Fig. 1).

The conveyor belt is only four inches wide, this limited working space making accumulation of parts at any point impossible. The motion of the belt is carefully timed, and each operator performs her particular task once each time the belt moves. This means synchronized production, with sufficient time allowance for each operation. Lost motion is eliminated, and the labor cost kept down to the absolute minimum.

To make complete synchronism of manufacture effective, it is necessary that every part going into the assembly process be perfect. In order to insure this, a thorough inspection of all material is maintained, and the possibility of interference with the production line caused by misfit parts therefore prevented. If any defective parts should be found, they are simply left on the belt by the operator, and eventually drop off at the end into a receptacle provided for this purpose.

(Continued on page 913)

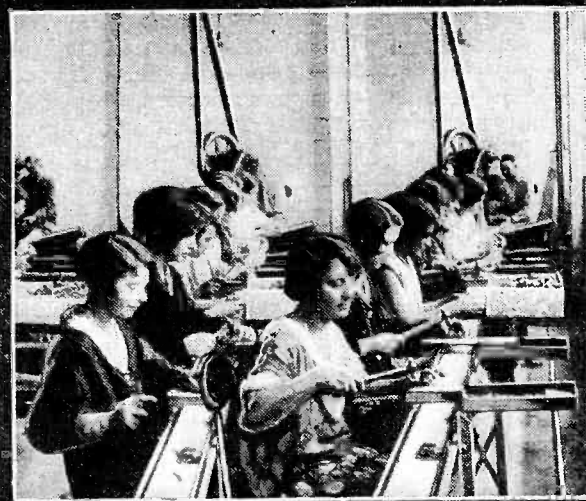
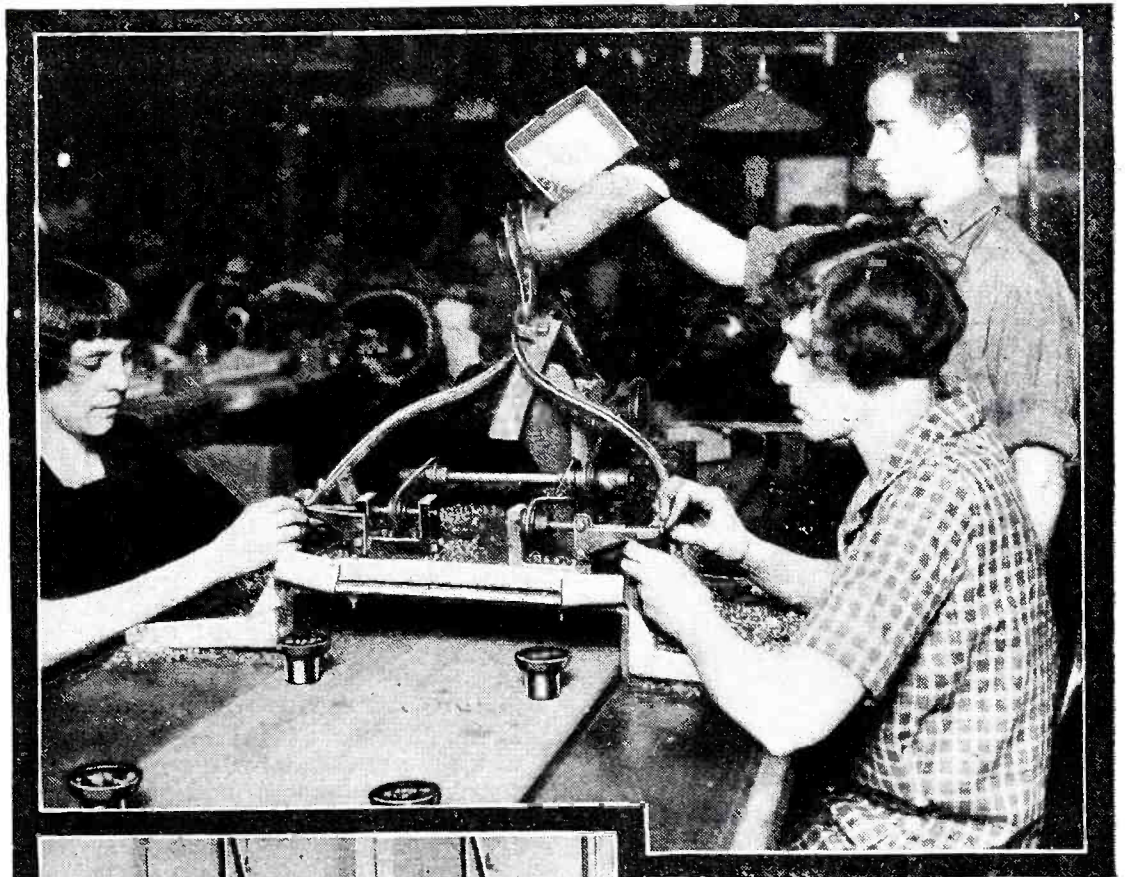

In Fig. 3 (above) is shown the hopper-feed and the automatic machine which threads the terminal-nuts on vacuum-tube sockets, applied by the operator. No fumbling or twisting delays the speed of the assembly. Below are the automatic bakelite-molding presses which turn out insulating parts for radio apparatus.

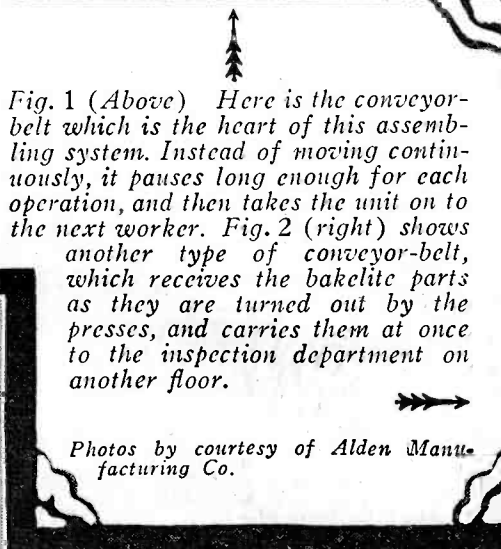

Fig. 1 (Above) Here is the conveyor-belt which is the heart of this assembling system. Instead of moving continuously, it pauses long enough for each operation, and then takes the unit on to the next worker. Fig. 2 (right) shows another type of conveyor-belt, which receives the bakelite parts as they are turned out by the presses, and carries them at once to the inspection department on another floor.

Photos by courtesy of Alden Manufacturing Co.

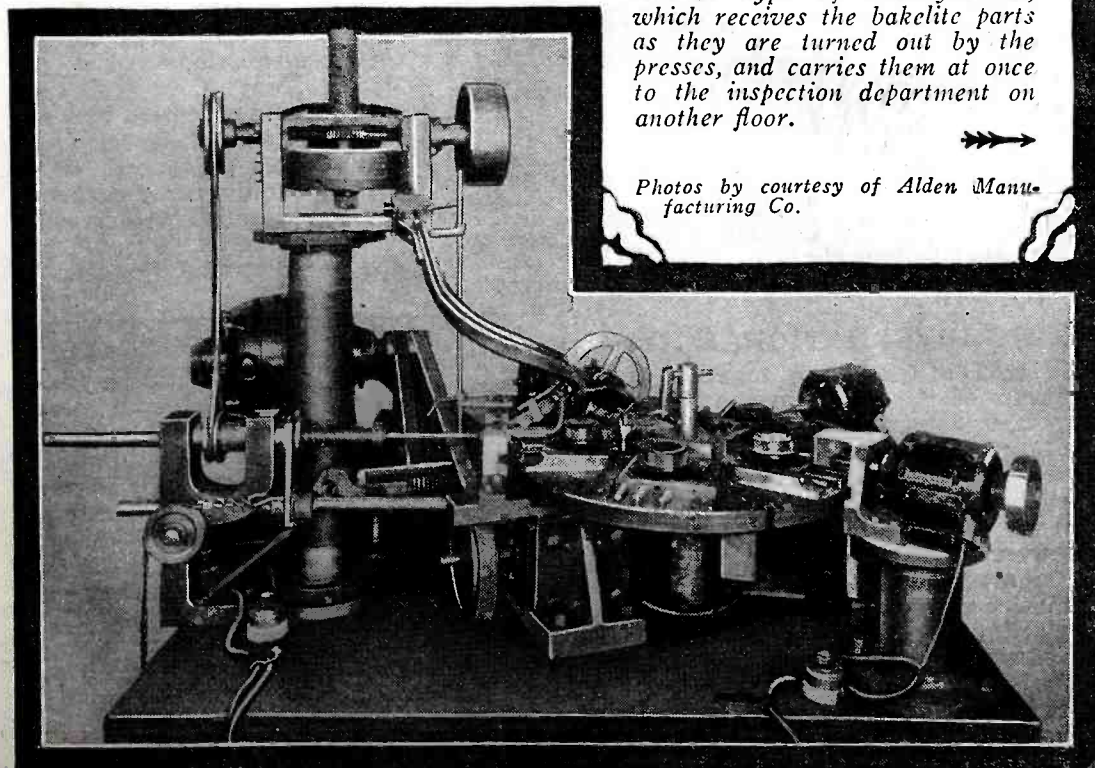
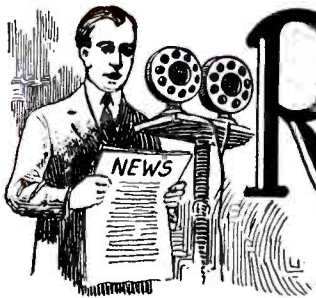

Fig. 4. At the left we have a machine which performs the numerous operations necessary on a composition knob. The revolving turret presents to the knob successively tools for drilling and tapping, and finally threads into it the set screws.



Radio News of the Month



MARCONI PREDICTS RADIO POWER

ADDRESSING the Institute of Civil Engineers at London, during the week of opening the new directional short-wave stations at Bodmin and Bridgewater, England, Senatore Marconi predicted that the beam-transmission principle will yet be perfected to make possible transmission of power, from generators to motors, without the need of cables. The discoveries of the past five years, he said, have left engineers in a more open-minded mood to the possibility of further progress than ever before. The new stations, with their huge reflectors, communicate directly with Canada by short waves on comparatively low power, in contrast to previous telegraphic stations whose waves are radiated in all directions. Great economy, as well as unusual speed (1250 letters a minute each way), is thus obtained. Other stations are under construction to communicate with Africa, Asia and Australia; and South American service is planned.

CHANGE OF WAVE-LENGTH

THE recently - announced measurement of the velocity of light, made by Prof. Albert A. Michelson, may slightly shake the confidence of exacting readers, in published wavelengths of broadcast stations. The calculation of the length of radio waves in meters is based on a division of the velocity of light, (roughly 300,000,000 meters per second), which is assumed to be that of all electromagnetic waves, by the frequency, which may be determined by methods described in December RADIO NEWS. Dr. Michelson now announces that the velocity is really 299,796,000 meters, not 299,823,000, previously accepted. This will take a tenth of a meter off the previously-accepted figures for some of the longer-wave stations, if approximate exactness is to be maintained.

THE RADIO ALTIMETER

THE same capacity effect which operates the burglar alarm described in RADIO NEWS for October will be employed to warn aviators of the approach of a highly-dangerous body—the earth—by the new high-measuring device being constructed by Dr. J. H. Dellinger, of the Bureau of Standards, for airplane use. It will be valuable when a landing is being made on a field, where it will be especially sensitive in the last few feet of descent—which are the most critical. The device is illustrated in the January issue of SCIENCE AND INVENTION Magazine.

EDISON LISTENS IN!

THE dean of inventors, Thomas A. Edison, notwithstanding his recent criticism of the radio as a means of entertainment, was one of the most interested of B.C.L.'s on the occasion of the chain broadcast of "Electric Night" over a large number of stations. The inventor's son, Charles Edison, spoke into the microphone on the forty-seventh anniversary of the construction of the first incandescent electric light by the famous discoverer.

RADIO DIRECTION OF PICTURES

IN the direction of the great spectacles which are produced for the super-movies of today, the well-known megaphone of the director has become inadequate. The production of one naval scene in "Old Ironsides" required the coordination of fifty-two vessels and a distant shore battery. To solve the problem of communication, a portable broadcasting set was obtained, with numerous receivers for each group of participants; and the battle of Tripoli was repeated in Catalina Harbor with all its constituents under uniform control of the director, James Cruze, who held the microphone.

BROADCAST STATIONS CROWD IN

A RECENT survey of the Department of Commerce revealed that 595 broadcast stations, more than ever before, were in operation in the United States, and that others were being installed daily—the total was 605 on Nov. 5. There were 112 preparing to begin operations, some of which have since done so. In the ninth district, with headquarters at Chicago, already a nucleus of radio congestion, 20 new stations were under construction and 21 more planned. Of the older stations in the U. S., 65 had changed their wavelengths, principally going higher in the band, and crossing the division (280 meters) formerly existing between Classes A and B. Over a hundred had increased their power or were planning to do so in the near future. The greatest number of new stations are in the Chicago, New York and New Orleans districts, respectively, Atlanta and Baltimore reporting none. All the new licenses granted last year have been valid for periods of only ninety days, in expectation of congressional action.

AIRPLANE RADIO REQUIRED

THE French Government has just put into force a requirement that all commercial planes carrying ten passengers must be equipped with radiotelegraphic equipment; and others with radiotelephone transmitters if they are to fly more than 100 miles or over the sea. Operators for these sets must be carried, in addition to the pilot. The listening wave is to be 900 meters and transmission (C.W.) on 600 meters and 850-900 meters. The larger planes are also to be capable of transmissions over the band from 1,500 to 1,550 meters, and reception between 850 to 1,800; their telephone equipment, if carried, is to be used only for emergency transmission. The increasing vogue of aerial "busses" has led to these requirements.

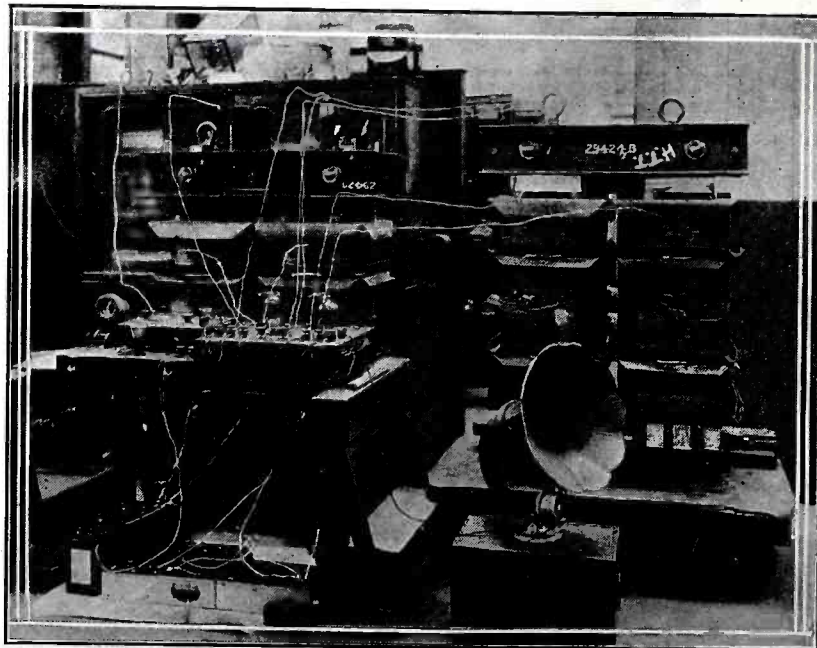

WORLD'S LARGEST AUDIO FREQUENCY TRANSFORMERS. These power transformers together weigh a ton and a half. An enterprising experimenter connected them in the audio stages of a receiver, and obtained high amplification and wonderful quality, especially on low notes. Alas, the combination lacks portability!—C. A. OLDROYD.

Photo courtesy Ferranti, Ltd. (England)

A RADIO INTERNATIONAL HYMN

TYPICAL of the linking together of all nations of the world in the bands of common understanding is the "internationally patriotic" hymn which will be adopted for international broadcasts under the auspices of the League of Nations. The Parisian newspaper, "L'Oeuvre," has instituted a competition for the most suitable song, both words and music; all entries are to be broadcast for selection. Previous compositions submitted have been in French, which is the international language of diplomacy; but entries in this contest may be in any tongue known to radio.

(Continued on page 895)

A RADIO MESSAGE TO MARS!

AT the recent "opposition" of the war-like planet special interest was shown by radio enthusiasts in England. Special receivers were constructed, with which the wavebands were combed for unearthly signals. One "psychic" enthusiast, however, went further and sent a radiogram from the Rugby station, on an 18,240-meter wavelength, addressing the message to a Martian friend. The British post office was somewhat perplexed, but finally agreed to accept it at the highest toll rate (35 cents a word) for terrestrial communication, with a refusal to guarantee delivery.

The Month's News In Radio Illustrated

By GEORGE WALL

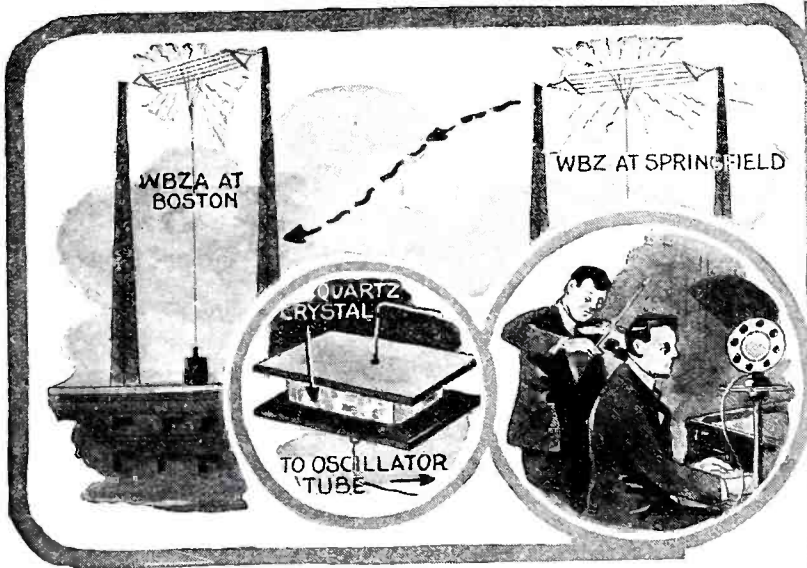

These two stations now broadcast the same program on the same frequency—900 kc. (333.1 meters). If this frequency was not maintained exactly by each transmitter, the interference would be fatal to reception. The tiny quartz crystal regulates both and prevents the slightest variation.

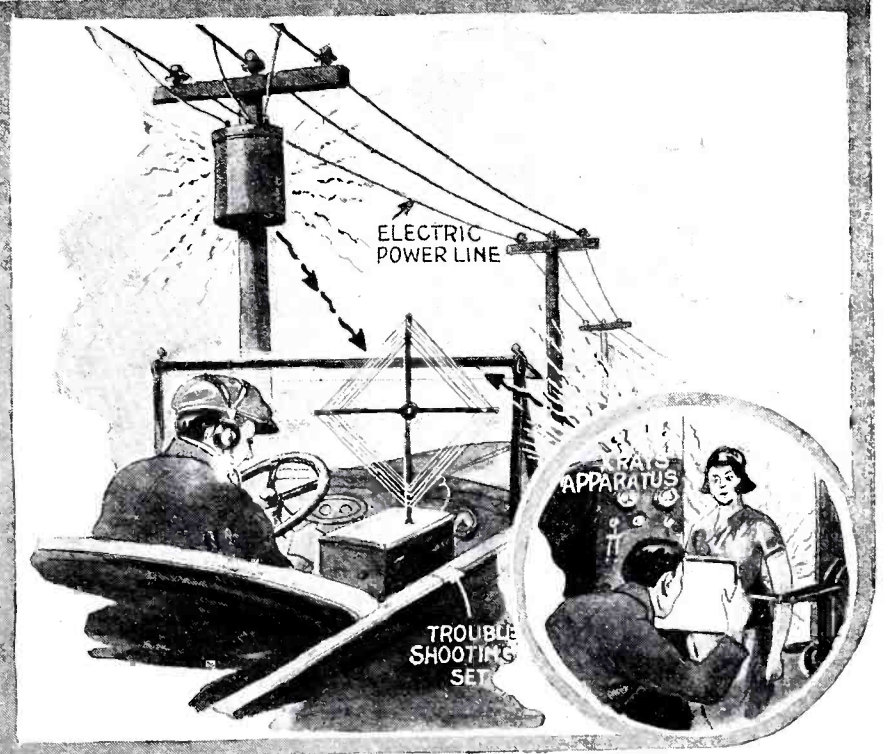

An enterprising radio dealer in Johnstown, N. Y., was told by prospective customers "Too much interference." He rigged up a "trouble car" and hired a "shooter." With the co-operation of the public utilities, interference was banished, and business is now better than ever.



Consternation was created among a group of western Indians by their newly-acquired radio, when an old chief attributed mysterious sounds to one of their ancestral bogies. The younger generation, however are more familiar with the white man's medicine, and not in the least alarmed.



The wicked scofflaws are not beyond attempting to use radio for their own ends. The police of Los Angeles detected a shipment of "radio sets" which were "wireless", but not rumless.

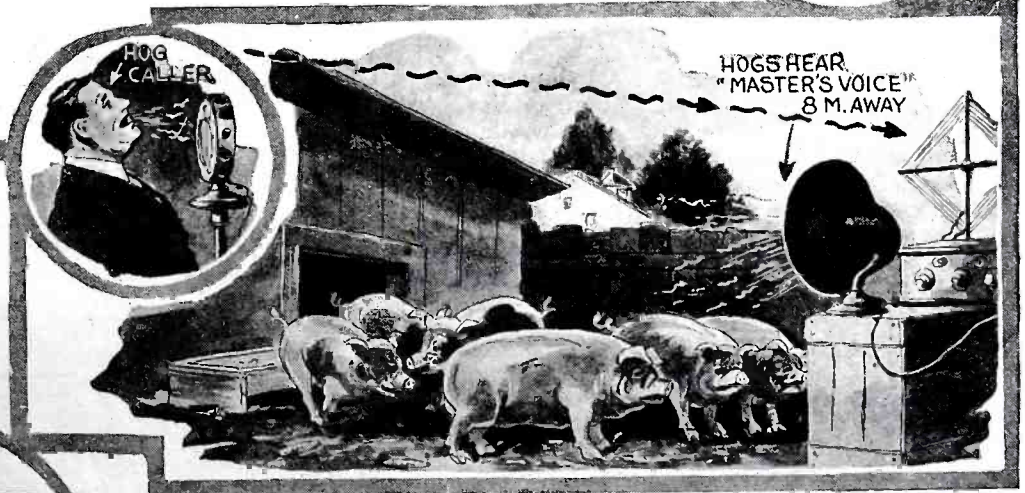
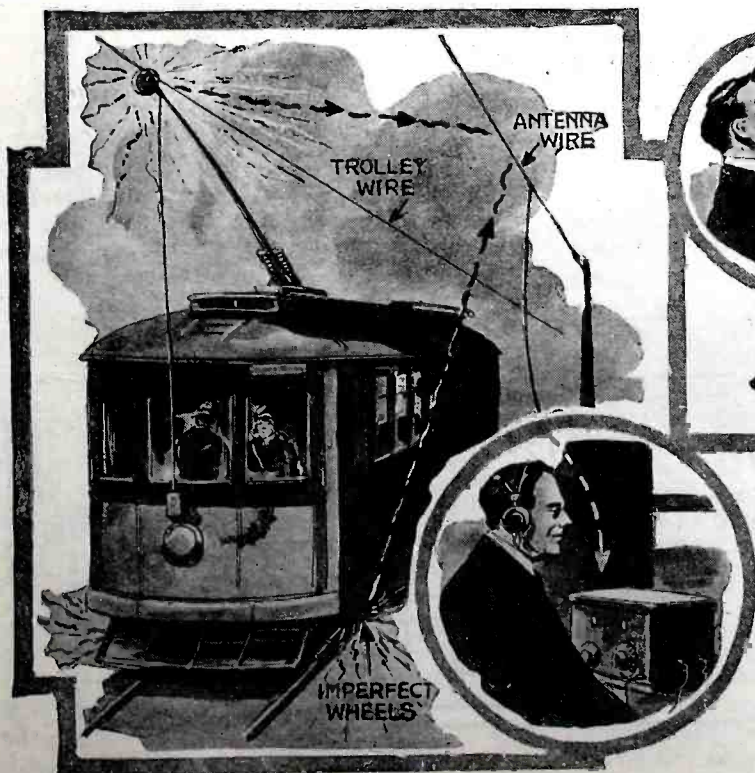

A hog-calling radio contest was submitted to the most practical test at Omaha. The porkers who listened in betrayed the greatest interest in the proceedings.

The fact, that street cars cause more interference with radio reception when they are not in good order, has been a money-saver to a South Carolina traction company. The use of a radio receiver makes it possible for the repair department to detect defects long before they are otherwise apparent.

Results of the \$300.00 Prize Set Design Contest

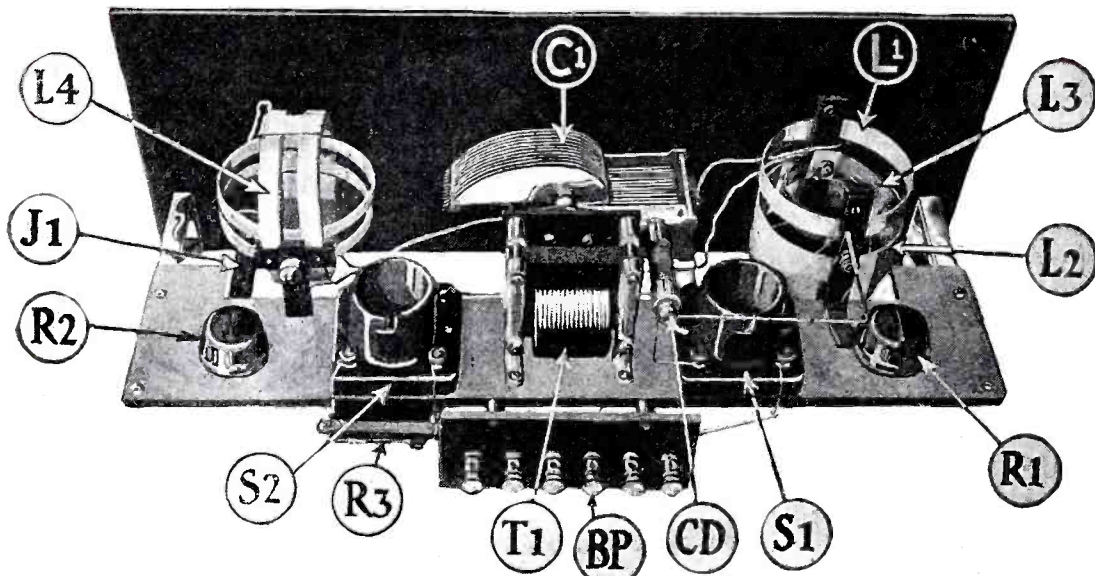

A rear view of Mr. Bond's reflex set, which employs two tubes and a crystal detector. The first tube functions as both R.F. and A.F. amplifier; the second tube as an A.F. amplifier only.

THE August, 1926, issue of RADIO NEWS announced a Set-Design Contest, primarily for the purpose of determining what progress is being made throughout the country by experimenters in the design of receiving circuits. There was given in that article a restricted list of parts which could be used in the make-up of the circuit; for it was decided that they were the essential components of any hook-up, and that no unnecessary complications should be introduced.

The results of this contest were, in the most part, disappointing to the judges; as the majority of the contestants submitted sets from which all the "bugs" had not been extracted. By this we mean that, if a receiver had quality of reproduction, the tuning was broad; if the tuning was sharp, then perhaps the volume would be at fault. Also, in the rules of the contest, it was strongly stressed that sets submitted should be designed so that they would not radiate; this was another point evidently overlooked by the builders. Many of the receivers were bad offenders in respect to radiation.

It was also stated, in the contest rules, that if, in the opinion of the judges, any circuit showed sufficient promise, RADIO NEWS would take out a patent on it in the inventor's name and pay all the Patent Office fees. Unfortunately not one of the receivers submitted was deemed patentable.

Although, as said before, no startling or unusual circuits were submitted, there yet is a chance that something really worthwhile will be evolved. For this reason RADIO NEWS publishes the circuits of the winners of the first and second prizes. The circuits of the other prize winners will appear in subsequent issues.

First Prize

"A DX REFLEX"
By George F. Bond

The circuit described is of the regenerative-reflex type, and uses a special method of coupling between the reflexed tube and the crystal detector. A specially wound radio-frequency coil is required.

DESCRIPTION OF PARTS

The Three-circuit-tuner (L1, L2, L3) is constructed as follows: the primary (L1) consists of 15 turns No. 24 D.C.C. wire on a 3-inch tube. Leave 3/4-inch space and wind the secondary (L2) consisting of 50 turns of No. 24 D.C.C. wire. The tickler (L3) con-

WINNERS IN THE \$300.00 SET DESIGN CONTEST

- First Prize, \$100.00—George F. Bond, 2011 W. Ontario St., Philadelphia, Pa.
- Second Prize, \$75.00—R. Weston, 6 Hermitage Lane, Worcester, Mass.
- Third Prize, \$50.00—W. E. Bemis, 1030 Vallejo St., San Francisco, Cal.
- Fourth Prize, \$25.00—Wm. O'Neill, 123 Summit St., Downer's Grove, Ill.
- Fifth Prize, \$15.00—H. P. Trambley, 2437 Polk St., San Francisco, Cal.
- Sixth Prize, \$10.00—Frank C. Jones, 2037 Durant Ave., Berkeley, Cal.
- Seventh Prize, \$5.00—Charles White, 101 S. 21st St., Terre Haute, Ind.
- Eighth Prize, \$5.00—A. P. Nielson, 1521 W. 52nd St., Seattle, Wash.
- Ninth Prize, \$5.00—J. F. Frank, 717 N. Arch St., Aberdeen, S. D.
- Tenth Prize, \$5.00—O. F. Haylor, 318 Sherwood Ave., Syracuse, N. Y.
- Eleventh Prize, \$5.00—H. H. Wigglesworth, 234 W. Mt. Pleasant Ave., Philadelphia, Pa.

sists of 20 turns of No. 26 D.S.C. wire on a 2-inch tube, mounted to rotate within the 3-inch tube.

Special radio-frequency coil (L4): Wind 13 turns of No. 24 D.C.C. wire on a 3 1/2-inch tube, leave 1/2-inch space and wind 13 more

turns; this is the stator. Wind 15 turns of No. 26 D.S.C. wire on a 3-inch tube, leave 1/2-inch space and wind 15 more turns; this is the rotor. Wind the rotor coil in the opposite direction from that on the stator.

Condensers:

One .0005-mf. S.L.F. variable condenser (C1).

One .001-mf. fixed condenser (C2).

One .005-mf. fixed condenser (C3).

One 1.0-mf. fixed condenser (C4).

Sockets (S1 and S2):

Two UV-type sockets.

Resistances:

Two 30-ohm rheostats (R1, R2).

One 0.1 meg. fixed resistance (R3).

One 1.0 meg. fixed resistance (R4).

Miscellaneous:

One audio transformer (T1).

One battery switch.

One fixed crystal detector (CD).

One jack, S.O.C. (J1).

Two 201-A type tubes.

Batteries, binding posts, dials, panel, cabinet, phones, etc.

OPERATION

Stations are tuned in by means of the variable condenser (C1). Volume is controlled by the special R.F. coil (L4). Re-



A panel view of Mr. Bond's reflex set. The tuning control is exactly in the center.

generation is controlled by the tickler, (L3), of the three-circuit tuner. To operate the set, advance the tickler (L3) until the point of oscillation is reached. Rotate variable condenser (C1) slowly, (the set is very selective), until a station is heard; then adjust R.F. coil (L4) for greatest volume and readjust tickler (L3). Note the condenser readings, as stations will always come in at the same points on this instrument.

Second Prize

THE "TANDEM" CIRCUIT
By Ralph Weston

This circuit was named from the fact that the two sections of the circuit follow each other in tandem fashion. In these two circuits both inductive and capacitive coupling

Circuit diagram of the first prize set. With two tubes it offers a stage of regenerative radio-frequency amplification, one stage of transformer-coupled audio, and one stage of resistance-coupled A.F. amplification.

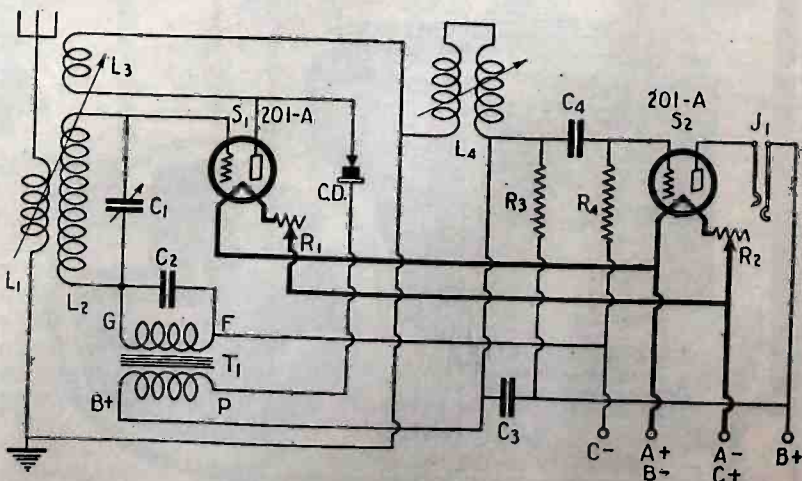

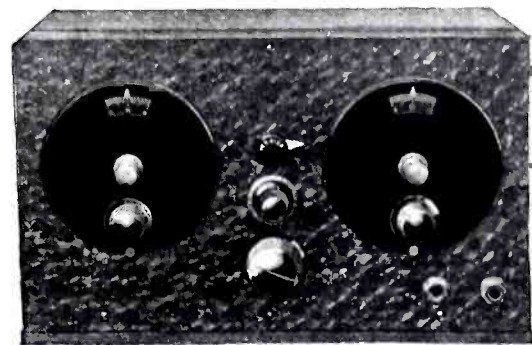
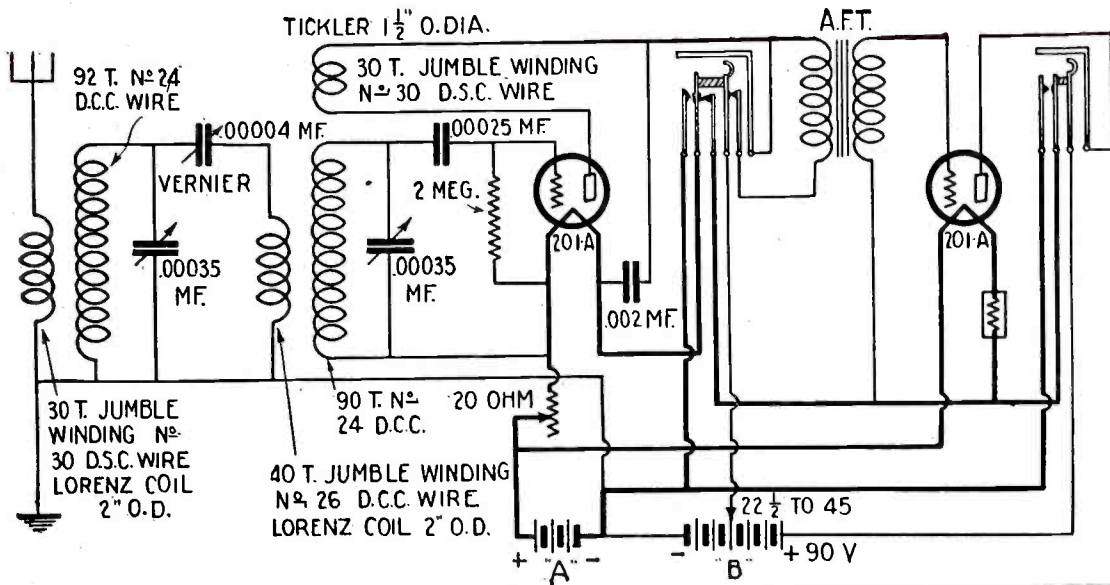

Above: A front view of Mr. Weston's receiver, the second prize winner. Left: The circuit diagram of this set. It will be noted that both inductive and capacitive coupling are employed. There is no reflexing in this circuit; it comprises a regenerative detector and a single A.F. amplifier.

Right: A rear view of Mr. Weston's set, which employs the Tandem circuit. The parts are; L, fixed aerial coupler; L1, tandem coupler; L2, tickler coil; C and C1, tuning condensers; C2, vernier condenser; C3, by-pass condenser (.002 mf.); C4, grid condenser (.00025 mf.); R, grid leak; R1, rheostat; and T, the A.F. transformer. While the condenser C2 is shown variable, this capacity normally assumes a fixed value and may be a fixed condenser of .00004-mf. capacity.

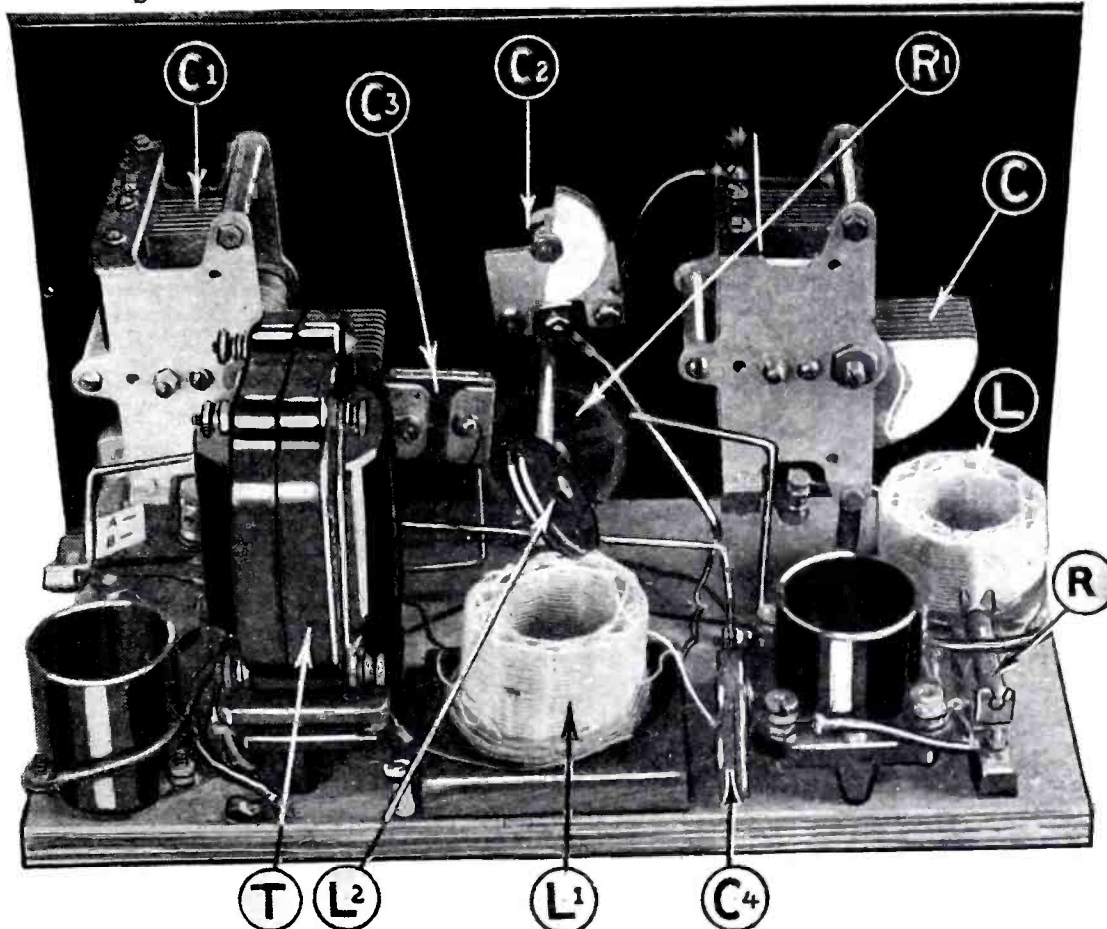

are used. They are connected to a single vacuum tube.

In the accompanying diagram it will be seen that two tubes are used, the second one being employed as an ordinary audio-frequency amplifier. It is possible to use a loud-speaker when local stations are being received, and even on powerful distant ones, if the plate voltage of the detector tube is increased to 45 volts.

Tuning is simple, being accomplished by the two dials and slight adjustments of the center knob. The vernier condenser usually functions best with the variable plates nearly meshed; once adjusted, it can be left untouched until a new tube is inserted. The dials can be made to have the same readings if the number of turns on the coils is varied.

The circuit shown is flexible, being adaptable to any style of condenser or coils. The coils should be placed at least five inches apart, and the condensers at about the same distance. An antenna about 100 feet in length is recommended.

Where Radio Is Most Needed

An Appeal in Behalf of Those Who Will Welcome Your Gift

AS this issue of RADIO NEWS makes its bow to its readers, the holiday spirit, in all its generosity, is abroad everywhere. This is a time of generous giving, when the pleasure of making others happy is brightened by a realization of our own good fortune. We have the opportunity to see the delighted faces of family and friends as they open and appreciate their gifts; but, if we could see also the happiness of those who had thought themselves forgotten, we would be more lavish in our kindness to the neglected neighbors whom we have, perhaps, too long neglected.

In the two previous issues of RADIO NEWS an appeal was made for the "shut-ins," those who are confined to bleak, poverty-stricken homes by age and illness. To them there is no gift, after the simplest of food and shelter has been provided, that can exceed the value of radio as a comforter. We have asked from our readers their co-operation, in the form of radio sets or accessories which are still serviceable—these need not be stylish—to be given to such unfortunates. They

will receive the gift with heartfelt gratitude, for it will mean a new interest in life.

Radio, so doctors have learned, is a companion whose cheering presence is better than drugs to bring back patients to health. It is now a panacea available in almost every hospital. We are endeavoring to help in bringing its blessings into the homes where childhood and old age alike are deprived of the fellowship of their kind during long hours of loneliness and suffering.

The stories of many worthy people have been related in brief form in these preceding issues; we have on hand many more, a few of which appear below, typical of the rest. If you can help out in this work, let us know what radio apparatus you can willingly spare to one whose need is greater than yours; and we will give you directions where it is to be sent. The cases which have been reported are from many parts of the United States, and only the gifts from this vicinity should be directed to the office of RADIO NEWS. All contributions will be acknowledged here, and their disposition reported to the donor.

Case No. 38

John F. is seventy-four years old. He was a hard worker up to a few years ago when an accident to his eyes resulted in total blindness. There is an old lady, eighty-seven years old, who takes care of John; and they get very little from the outside world, as most of their money goes for the necessities of life. Lately John's ears have gone back on him and the pleasures of ordinary conversation is denied him. As often is the case with deaf people, he can understand programs over a radio set as well as he could hear a few years ago. A radio receiver would indeed be a great help to these old folks to brighten the days and evenings. (New York City.)

Case No. 39

John and Margaret are two dear old souls, brother and sister, who live on the top floor of a tenement house in a crowded part of the city. The house is immaculately neat, but John can see only a little and Margaret's eye-sight has nearly gone. John
(Continued on page 897)

Just What Is Opera?

By CHARLES D. ISAACSON

Program Director WRNY.



HELEN YORKE
Charming Coloratura
Soprano.



MISCHA VIOLIN
Whose Name is Fitting.



DAGMAR NORD-
STROM
Of the Facile, Jazzy
Fingers.



DOROTHY SEEGAR
Prima Donna of "Rose
Marie."



PRINCESSE MURAT
In Native Annamite Cos-
tume.

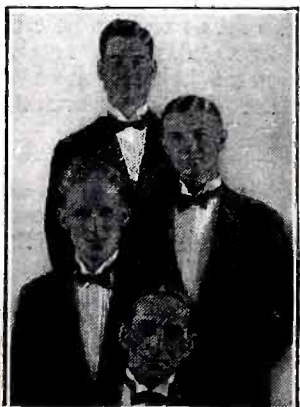

THE LYMAN SINGERS
(Left) A Columbia College
Quartette.

I AM in receipt of a letter this month, along with many queries about music: "What is Opera?" So I shall try to define the form of art which attracts so much attention from its lovers, and frightens so many others away for no legitimate reason.

Opera is a combination of drama and music, in which neither is distinct and true to itself, but instead each defers to the other. The actors who play the characters are singers, and the singers are also representing characters. If the artists were just actors, they could be more nearly the characters in the flesh; if the artists were merely singers, they could be more ideal musicians. So opera is, as you will observe, a mixed art.

And it is in this, that opera attains its virtue and its fault. The public at first see incongruities, because the action of the plot does not move along as smoothly as in a play. The musicians find that the artists are not singing with the same purity as they might in the concert hall. But color, action, movement, drama, are added to the music.

WHY THEY LOVE IT

And there is the huge chorus, the great symphonic orchestra, the graceful ballets, the magnificent scenery. In the Metropolitan Opera I have counted a hundred on the stage. In "Coq d'Or" there was a veritable circus procession. A half million dollars have been spent on a single opera, before it sees its first performance.

Grand opera is what its name signifies—it is spectacle, it is pageantry. It is the most elaborate entertainment in the world. And when once the taste has been incul-

cated in the hearer—it is impossible ever to lose it.

So many are afraid of grand opera, because it has been presented so often by society and in wealth.

Yet those who stand at the top rail of the Metropolitan or the Auditorium in Chicago because they are filled with a great joy in the listening—these people prove the truth that grand opera is an entertainment for everybody in America.

That opera is changing, and that America will produce its own opera, are facts, beyond contradiction. J. Frank Harling, in "Deep River," in my opinion has made the greatest contribution to American opera. It is criminal that it went off the stage. We said so at WRNY. But more of that another time.

THE ROOSEVELT DAY PROGRAM

October will be difficult to beat in our records of the future. It was not all politics, though WRNY broadcast impartially the rallies and speakers of every party.

There was October 27, Theodore Roosevelt's birthday. Of course with our home in The Roosevelt, we feel closer to the great President than most folks. In the morning, the women paid tribute—Miss Butler, Miss Boswell, Mabel McKinley, Mrs. Whitney, Mrs. Roosevelt, Mrs. Robinson and others. In the evening, Rear Admiral Fiske, Dr. Butler, and many celebrities voiced their love of "Teddy." A special musical program, consisting entirely of music Roosevelt especially loved, was rendered.

And speaking of Roosevelt, WRNY is quite proud of the fact, that arrangements

(Continued on page 899)

WRNY's special studio at the recent Electrical Exposition in New York City. In the circle below are shown, from left to right:

Arthur Williams, John Cromwell, Princesse Murat, Charles D. Isaacson, Fannie Brice, and Wallace Edginger.

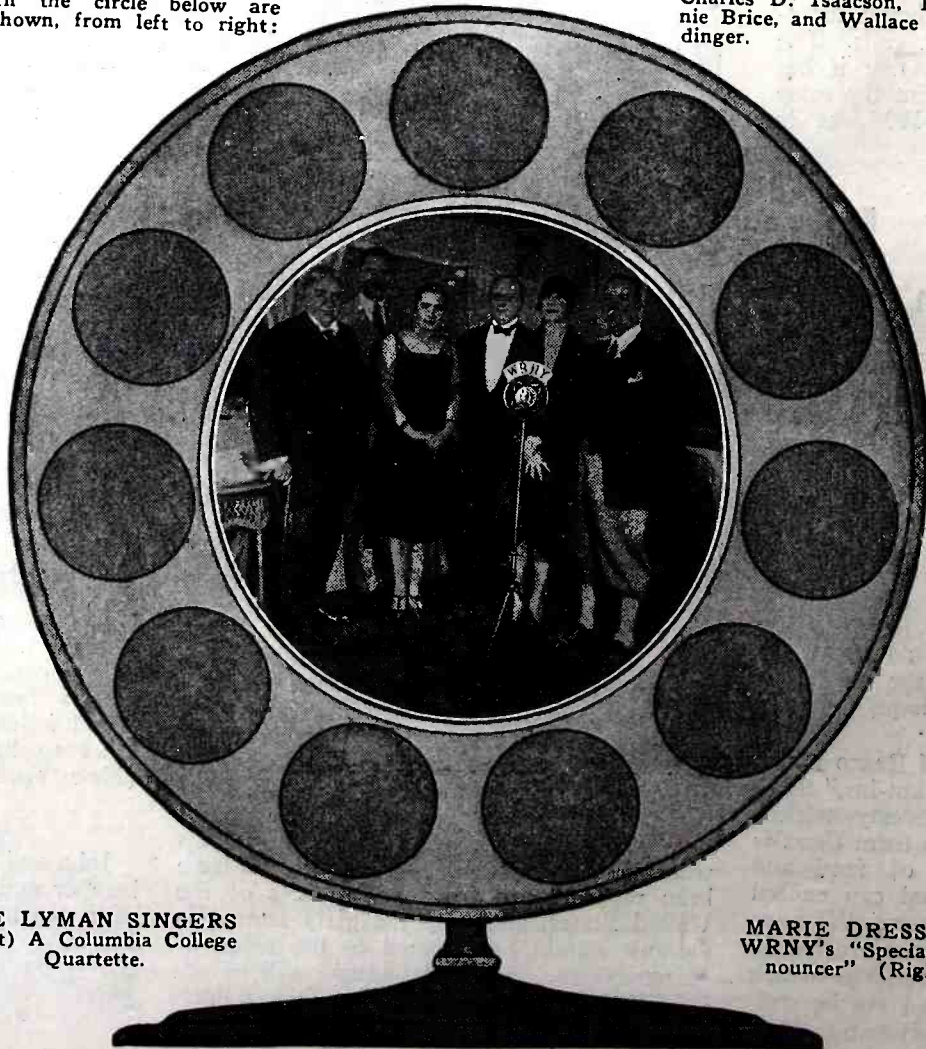

MARGARET WIDDE-
MER
Author and Reader.



ALEXANDER MAL-
OOF
Conductor of Oriental
Hours.

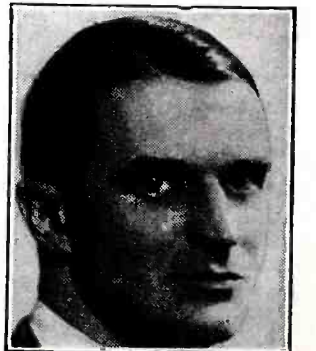

ROBERT CRAIK
Star of "The Vagabond
King."



MARTIN ADOLPH
Cantor.



HENRY MORGEN-
THAU
Formerly Ambassador to
Turkey.



MARIE DRESSLER
WRNY's "Special An-
nouncer" (Right)

The Invisible Net

By CHARLES MAGEE ADAMS

THE flivver swung easily out of the double stream of traffic into the drive that led to the roadside filling station, and came to a stop with a thwarted moan of brake bands. It was a last year's touring model—yellow and black Ohio license tags showing through a layer of dust—with nothing to set it apart from a thousand other flivvers on that well traveled pike.

Two men occupied the front seat. The one at the wheel, the smaller, a little over five feet six inches in height and weighing something less than a hundred and thirty pounds, had light wavy hair under a gray cap pushed back jauntily, blue eyes, and an animated face clean-shaven without a blemish. He wore a smart suit of gray flannel. His companion, a shade less than six feet one and weighing well over a hundred and ninety, had a face also clean-shaven and without a blemish, though stolid, gray eyes, and dark, straight hair at the edge of a brown cap pulled low; and wore serviceable blue stuff.

"Gas, brother," Jack Winkler, the smaller, called briskly as the station attendant appeared in the door.

His eyes fell on a loud-speaker horn protruding through a window, and were lighted with interest. "Well! You've got a radio."

The attendant nodded. "I'll say we have," he replied, dragging up his hose.

Sim McCartney, the bigger man, stopped in the act of unfolding his long legs, and looked from his companion to the horn with a furtive dread.

"Always thought I'd like to have one," Jack went on, sliding nimbly over the side, "But I don't seem to know enough about the stuff to pick a good one. Have much luck with yours?"

"I get 'em all," the attendant declared, face brightening with the zeal of the fan: "Had Los Angeles clear as a bell last night."

Jack whistled. "That's fair enough," he conceded: "Then you ought to get Pittsburgh plenty strong here?"

The attendant grinned. "Strong?" He stopped cranking. "They ought to be on now. I'll show you." He stepped inside, Jack following, and twirled the dials of the long cabinet against the wall skillfully.

A stentorian voice broke from the horn: "Made at the request of the police department of Mortonsville, Ohio. Two thousand dollars reward is offered for information leading to the arrest or apprehension of two men who held up and robbed the First National Bank of that city on the afternoon of September 17th. Their descriptions and that of the car in which they made their escape are as follows:

"Car—Ford touring, 1924 model, Illinois license and hood painted gray. First man—height six feet three inches, weight about one hundred and sixty pounds, dark eyes, jagged scar from eye to mouth, brown suit, and gray hat. Second man—height about five feet eight inches, weight about one hundred and seventy pounds, blue eyes, mole on chin, light palm beach suit, and straw hat.

"Anyone having information regarding the present whereabouts of these men is requested to communicate at once with this station or the Mortonsville police department."

The voice ceased, and Jack beamed with admiration. "That's some sweet little set you've got," he approved enthusiastically. "Clear as a bell, and in daylight too." He cast a quick sidelong glance through the door. But beside the flivver Sim was standing, back turned to the stentorian voice, heavy shoulders hunched defensively; and metallic points of anger showed deep in Jack's eyes.

Five minutes later, when he nosed the flivver back in the northbound stream of traffic between a truckful of calves and a shiny sedan, he turned on the big man beside him, the glint in his eyes hard and blue. "Well!" he snapped. "Do you want me to make a sign 'I'm one of the birds that stuck up the Mortonsville bank' so you can hang it out every time you hear that stuff?"

McCartney winced and turned a drawn face. "You don't understand, Jack," he protested huskily. "You don't understand. I tell y' it gets me."

The muscles around Winkler's mouth, always a little tight, stood out in inflexible lines. "I'll tell you what I do understand," he retorted. "If you don't snap out of this and do it sudden, I'm going to take time off and do it for you. Get that?"

Sim shifted, cast a furtive glance over his

(Continued on page 862)

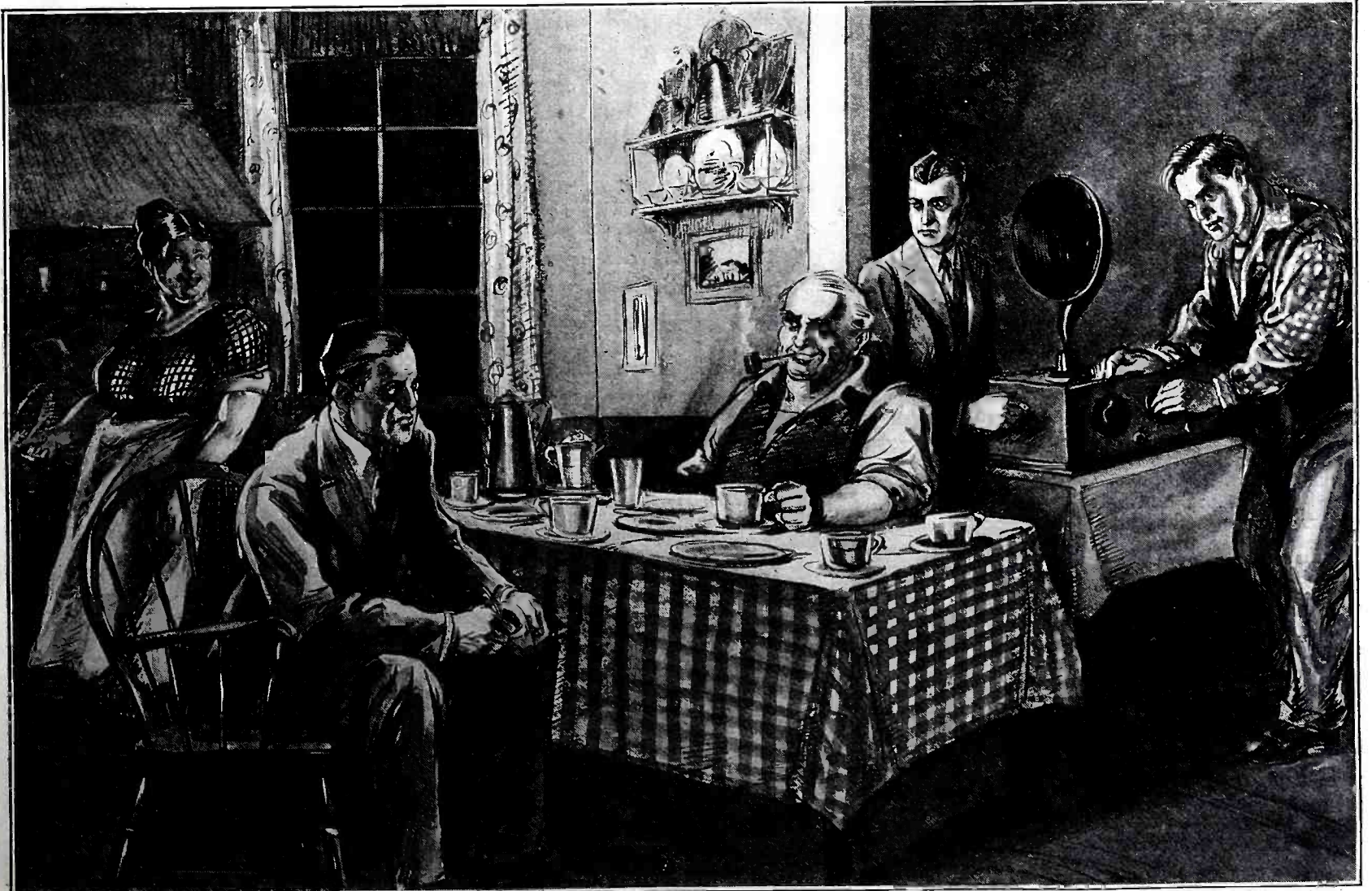

Sim lagged behind as the two of them crossed to the living room, getting out his pipe and trying to occupy himself with filling it. But the same smoothly-controlled voice reached him from the loud speaker.

Some Facts About Condensers

The Ins and Outs of Condensers and Their Uses in Radio

By M. L. MUHLEMAN

THERE are more different types and designs of condensers than one can easily keep in mind; but they are all the same elementally, irrespective of their outward appearance. Likewise, in a sense they all serve the same purpose: namely, to accumulate ("condense") and release electrical energy, but the ends to which they serve differ greatly. In any standard receiving set there are *fixed* and *variable* condensers. Some are used for *tuning*, some to *by-pass* electrical energy and others to *block* electrical energy. There are many other purposes which they can serve in a receiving set and its attendant devices.

The importance of condensers is not fully appreciated by the average radio fan. Without them, radio would be a hopeless affair. Many of the successful radio circuits and many of the new radio devices recently placed on the market, such as "B" eliminators, are reliant more on condensers than on any other part.

In order to gain a satisfactory conception of the value of condensers and the ways in which they can be used, one must have some understanding as to how they function.

FUNDAMENTAL PRINCIPLES

Basically, a condenser consists of nothing more than two electrical conductors insulated from each other. If we take two metal plates and bring them close to each other, we have formed an electrical condenser. If we move the two plates towards or away from each other the *capacity* of the unit is altered. The nearer the plates are to each other, the greater is the capacity, and vice versa.

The unit of capacity is the *farad*. Since this value is too large for practical purposes we employ the more convenient terms *microfarad* (abbreviated as mf. or mfd.) and *micro-microfarad* (abbreviated as mmf. or

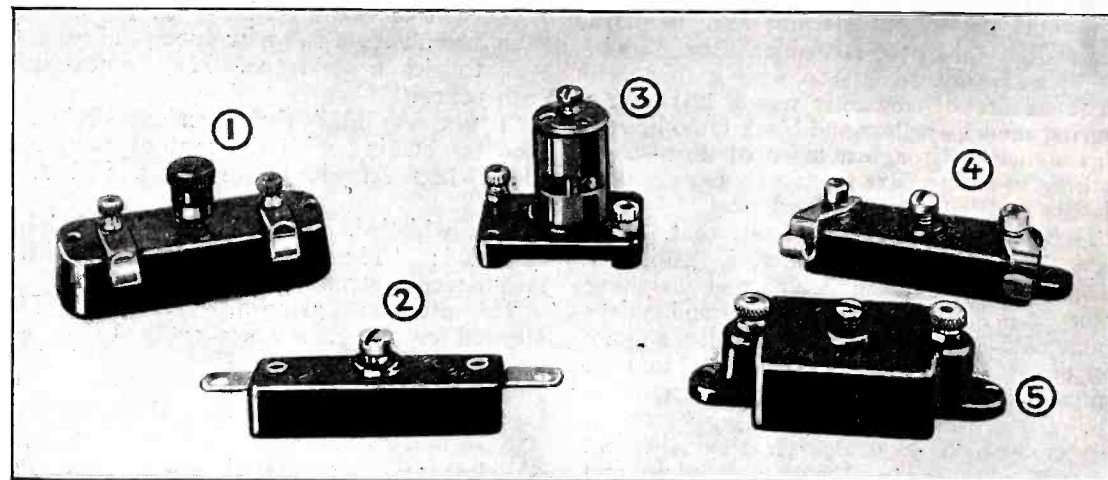

Fig. 6. A group of adjustable condensers. No. 1 is designed expressly for use as a grid condenser and has clips for the grid leak. No. 2 may be employed in any circuit where a neutralizing or stabilizing condenser is required. The capacity is varied by turning the screw on the top. No. 3 is particularly adaptable to sets controlled by gang condensers, and functions as a compensator. No. 4 is another variable grid condenser, with clips for a grid leak. No. 5, similar to 2, can be used for many purposes.

(Courtesy: 1, Amplex Instrument Laboratories; 2, X-L Radio Laboratories; 3, Bremer-Tully Mfg. Co.; 4, X-L Radio Laboratories; 5, Leslie F. Muter Co.)

changed. If instead of air as the dielectric, we use, say, castor oil so that it fills up all the space between the two conductors, the capacity of the condenser will have increased nearly five times. The amount of increase in capacity in this instance is dependent on the *dielectric constant* of the medium employed, which is expressed on a comparative basis. Air is the standard, and is considered to have a dielectric constant of 1. The constant of castor oil is 4.7, of good mica 5.7 and of paraffin, 2. If paraffin was used in place of air the capacity would be exactly doubled.

In order to produce the necessary capacities for radio work, series of small metal plates or sheets, spaced one above the other, are used so that the size of the condenser

substitute one conductor; and the second, fourth and sixth sheets, also connected together, the other, the five sections of mica being the dielectric.

Dry air is the most satisfactory dielectric, as it introduces no serious losses. Other

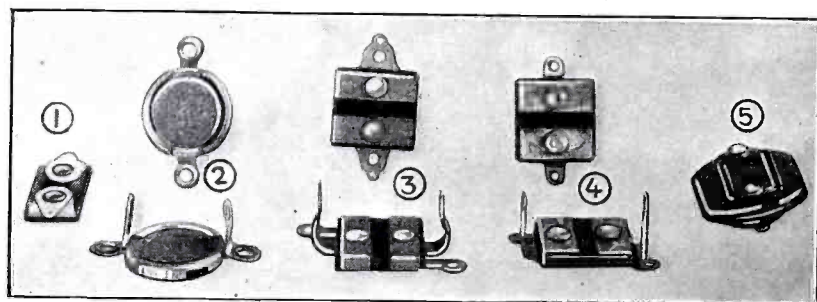

Fig. 2. A group of standard-type low-capacity fixed condensers. Those in the lower part of the illustration are grid condensers and have clips for the grid leak.

(Courtesy: 1, Wizard Co.; 2, Atlanta Hilco Corp.; 3, Electrad, Inc.; 4, Electrodyne Co.; 5, Sangamo Electric Co.)

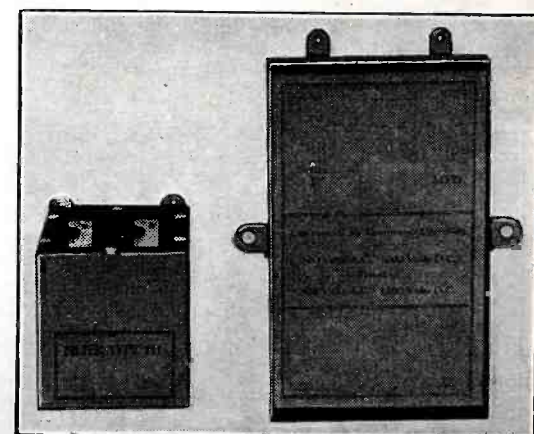

Fig. 4. Two high-voltage fixed condensers, which may be used in filters or as by-pass condensers.

(Photos courtesy Tobe Deutschmann Co. and Sangamo Electric Co.)

mmfd.) The first is one thousandth of a farad, and the second the thousandth part of a microfarad. All condensers employed in radio have capacities which can be stated conveniently in one or the other of the above units.

The capacity of a condenser is determined by a number of factors. These factors are: the total surface area of the two conductors, the distance between the two conductors, and the nature of the insulation between the conductors, which is called the *dielectric*. Let us take an example: assume a condenser of two plates, each three square inches in area, with an air space between them of $\frac{1}{4}$ -inch. If we increase the area of both plates to six square inches, the capacity of the condenser is doubled. If we decrease the air space between the plates to $\frac{1}{8}$ -inch the capacity takes a big jump—four times; for the capacity of any condenser varies *inversely* with the *square* of the distance between the two conductors.

The capacity can be further increased if the nature of the dielectric or insulation is

will not be too large. In other words, instead of using two very large plates to get the required surface we pile up a batch of small ones, the alternate plates being connected together. Thus, a fixed condenser might consist of six small sheets of foil with mica between sheets. The first, third and fifth sheets, connected together, would con-

forms of dielectric, such as hard-rubber, mica, paraffin, paper, etc., present higher leakage paths than air, and also introduce "hysteresis" losses. It is for this reason that air is employed as the dielectric in most variable condensers designed for use in receiving circuits. Fixed condensers employ either mica or paraffin paper, as the losses brought about by their use are not very high, comparatively. The main point, however, is

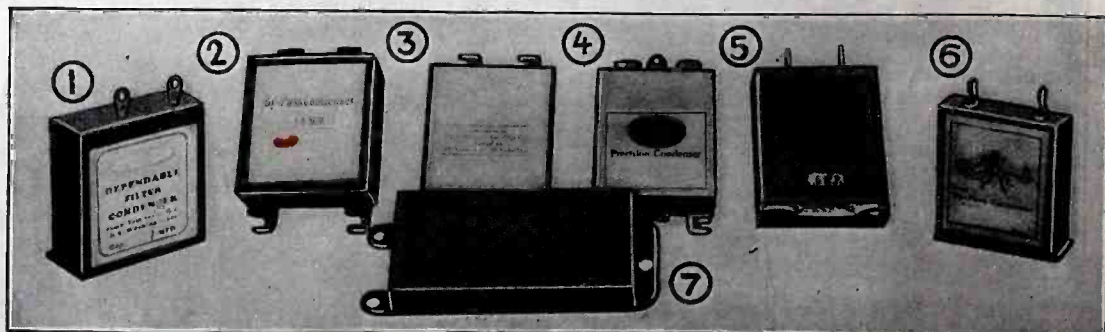

Fig. 3. A group of fixed condensers of the type principally employed as blocking, filter or by-pass condensers. These are not designed to withstand voltages as high as will those shown in Fig. 4.

(Courtesy: 1, Leslie F. Muter Co.; 2, Polymet Mfg. Corp.; 3, Sangamo Electric Co.; 4, Tobe Deutschmann Co.; 5, Electrad, Inc.; 6, Electrodyne Co.; 7, Potter Mfg. Co.)

the reduction in size made possible by the use of a dielectric with a high constant, which allows *extremely small spacing* between conductors. Furthermore, it is not so important to keep down the losses in fixed condensers as it is in variable condensers. In most cases fixed condensers are not connected in the "vital points" of a receiving circuit.

WHAT CAPACITY IS

A condenser can be likened to a water tank. We can charge a condenser with electricity, just as we can pour water into a tank. The amount of electricity a condenser can hold is dependent on its capacity. The amount of water a tank can hold depends on its size. When a condenser is connected in a working circuit and becomes fully charged, that is, filled to capacity, it will automatically discharge its entire contents through an attached circuit. When it is empty it will start charging again. The number of times a condenser will charge and discharge each second depends on its capacity and on the frequency of the current flowing in the circuit containing it. It is obvious that it takes a condenser of

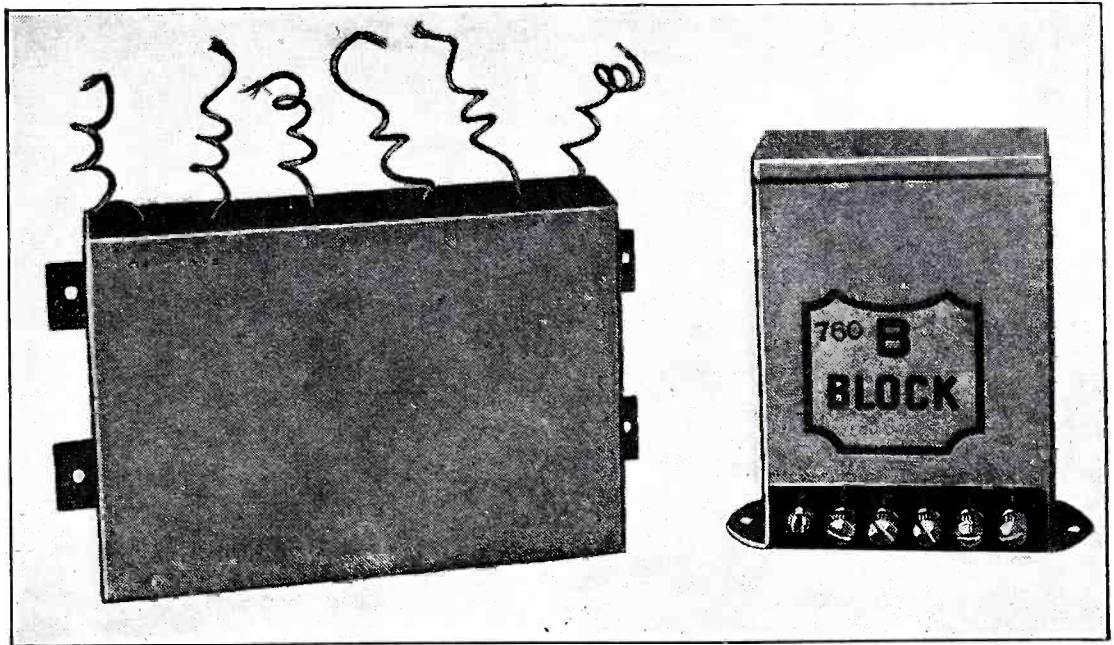

Fig. 5. Two condenser blocks, each of which contains all the condensers necessary for a "B"-eliminator filter circuit. These units are capable of withstanding the high voltages used in "B" eliminators and power amplifiers.

(Photo courtesy of Polymet Mfg. Corp. and Tobe Deutschmann Co.)

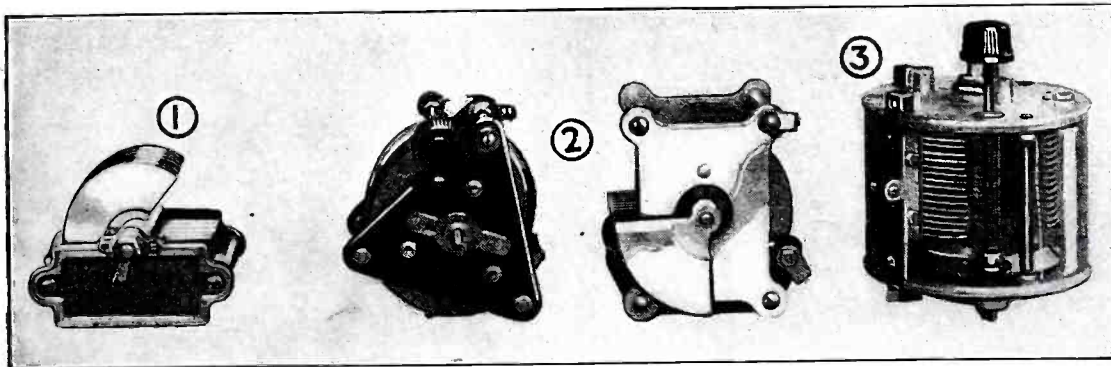

Fig. 8. A group of variable "air" (air-dielectric) condensers of the straight-line-wavelength (S.L.W.) type. No. 1 is made entirely of aluminum and is exceptionally light. The next two condensers, No. 2, are alike in design except that one has insulation end plates, or supports, while the other has end plates of metal. Note the counter-weight. No. 3 is enclosed in a celluloid case which protects it from dust.

(Courtesy: 1, The Fett & Kimmel Co.; 2, General Radio Co.; 3, Acme Apparatus Co.)

large capacity longer to charge than one of small capacity. Consequently, it will discharge at a slower rate than a small one. The capacity of a condenser has a great deal to do with its *reactance*, or resistance to currents. A condenser of small capacity offers high resistance or *reactance* to alternating currents of low frequency, but as the *frequency of the current increases the reactance of the condenser decreases*.

Right here is supplied the missing link in the explanation. It will be noted that the reactance of any condenser increases as the frequency of the alternating current is lowered. If we continue to lower the frequency, until it alternates only once every minute or so, the reactance of the condenser to it is practically infinite. When the current ceases to alternate, or becomes *direct current*, the reactance of the condenser is *infinite* and no current can flow through it. It becomes a *blocking device*. The answer is, then,

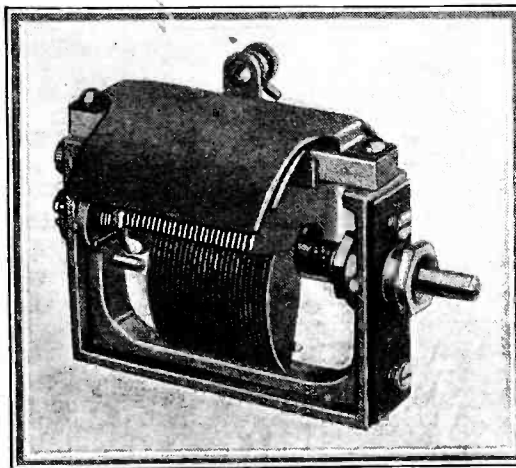

Fig. 10. A variable air condenser of the straight-line-frequency (S.L.F.) type. The plates and the two curved shields are made of copper, the frame of aluminum and the insulating strip of isolantite. The condenser, though of standard capacity, is exceptionally small.

(Photo courtesy of Samson Electric Co.)

that a direct current cannot pass through a condenser, but an alternating current can. The amount of alternating current that can pass depends on its own frequency and the capacity of the condenser. These characteristics of a condenser are important.

CAPACITY AND INDUCTANCE

It might be well to explain here just how important variable condensers are in a radio circuit. The chief property of a coil used in a receiver is *inductance* and it is this property together with the *capacity* of the condenser that makes it possible for us to vary the *frequency* of our receiving circuits and so "tune-in" one station after another.

In order to change the point of resonance of a circuit (at which it responds to a station's carrier wave) from one frequency to another, if the inductance is fixed, then the capacity must be capable of being varied. It is thus that turning the dials of the tuning condensers in our sets adjusts them to receive the desired signals; each variation in the capacity of the condenser "tuning" its coil to a different frequency, or wavelength.

LEAKAGE EFFECTS

The losses in condensers do not amount to a great deal at low frequencies; but they can be extremely high at radio frequencies if the instruments are not well designed. It is very important to keep down the losses in variable condensers, for instance, as these are connected directly in the tuned circuits through which the radio-frequency current flow. There will be leakage and "hysteresis" (electric strain) losses through the dielectric, hysteresis losses in the insulation of the condenser itself, leakage through the insulation and leakage into adjacent apparatus through stray electrostatic fields. The dielectric losses do not amount to much, but great losses can take place in the insulation on the condenser if the insulating material is

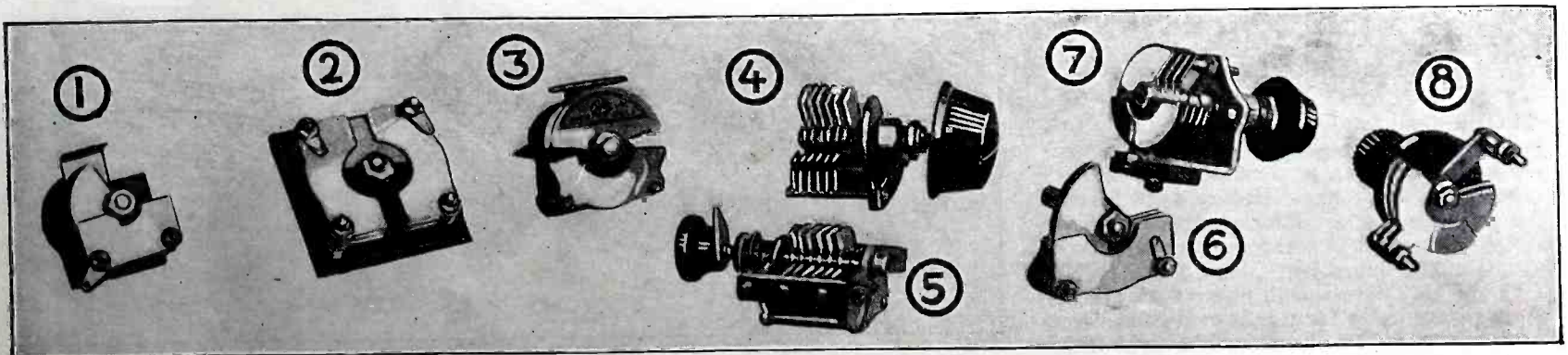

Fig. 7. A group of variable "vernier" condensers which are employed as compensators, balancers, neutralizers and stabilizers. They are, in most cases, small editions of their big brothers. The capacities of these condensers very seldom run higher than 50-mmf. (.00005-mf.)

(Courtesy: 1, Silver-Marshall, Inc.; 2, and 6, Daven Radio Corp.; 3, General Radio Co.; 4, Precise Mfg. Corp.; 5, Gardiner & Hepburn, Inc.; 7, Hammarlund Mfg. Co., Inc.; 8, Martin-Copeland Co.)

"A" and "B" Supply from Direct Current★

Eliminators to Work With D. C. Lighting Are Easily Constructed

By H. B. WHIFFEN

WE are pleased to have the opportunity of presenting this excellent direct-current "A-and-B" eliminator to our readers; it is unlike any types heretofore introduced. Its outstanding features are simplicity, economy in construction and operation, and its perfect output of current relieved of all distressing ripples and other line variations.

The "B" supply end of the eliminator will supply as much current as one could possibly use in a receiver or amplifier and yet remain constant in voltage. The "A" unit will supply current for any number of tubes, from one up, and can be varied at any time by increasing or decreasing the number of resistance units employed.

—EDITOR.

A WEALTH of information has been published on "A" and "B" battery eliminators designed for use on alternating-current lines, and very few radio fans nowadays are not acquainted with the systems employed. However, very few data relative to eliminators for use on direct-current light lines have been available to them.

A direct-current "B" eliminator is a comparatively simple affair, as there is no need for a step-up transformer, a rectifier and a large filter network, all of which are required in an alternating-current "B" eliminator.

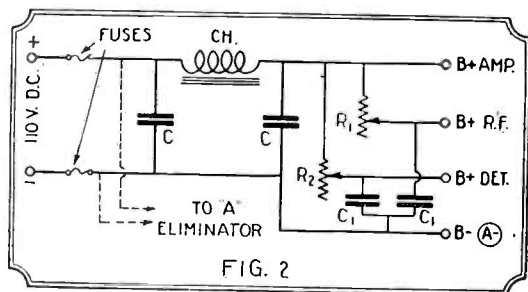

FIG. 2
Circuit diagram of the "B" supply unit of the eliminator. The dotted lines show the wires which lead to the "A" supply unit.

A small filter, comprising two fixed condensers and a single choke coil, is sufficient for suppressing the "ripple," which is created in the D.C. generator at the power house as the brushes pass from one segment of the commutator to the next. The 60-

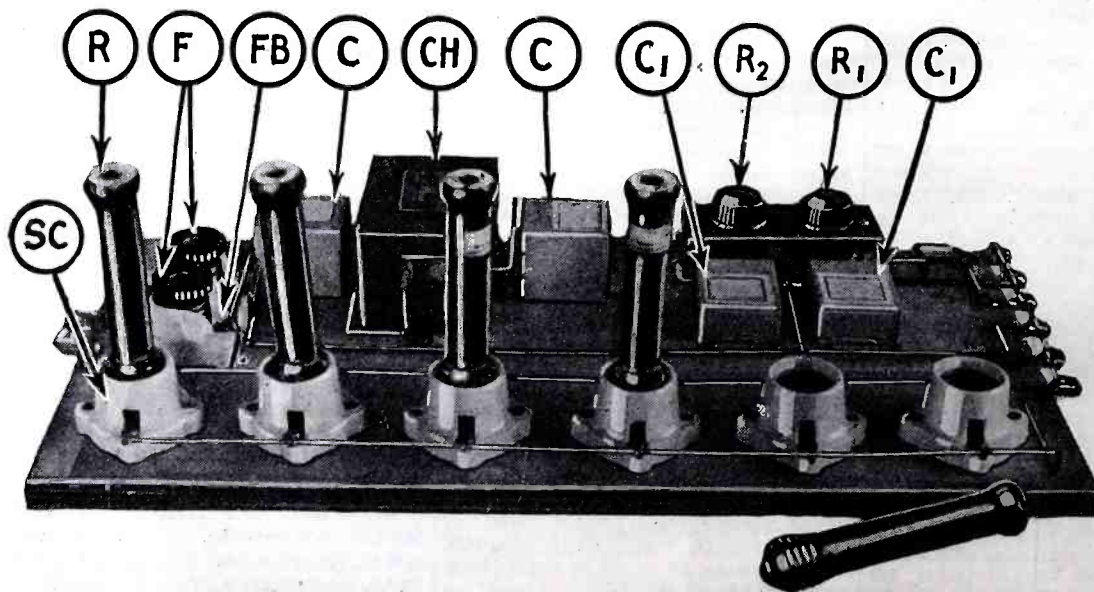

Fig. 1. A view of the completed eliminator. F are the fuses, FB the fuse block, C the filter condensers, CH the filter choke, R1 and R2 the variable voltage controls, C1 the by-pass condensers, SC the lamp sockets and R the special resistances.

* Radio News Blueprint Constructional Article, No. 1.

cycle hum in an A.C. light line is far more difficult to weed out.

STEP-UP NOT POSSIBLE

The one disadvantage of a D.C. "B" eliminator is that the higher voltages, required for operating a power amplifier, cannot be had from the light mains. The usual voltage of a D.C. line is 110. Since there is a voltage drop through the filter system the maximum voltage obtainable, with the eliminator on load, is about 95 to 100. If a higher voltage is required, it is necessary to connect dry-cell or storage "B" batteries in series with the eliminator; that is, the user must connect the negative post of the "B" battery to the highest-voltage positive post on

NOTICE

BEGINNING with this issue, all constructional articles of importance, which have been selected by RADIO NEWS for their standard of excellence, will be made up in blueprint form. All such articles will be distinguished by a special star; and a complete set of working blueprints can be supplied to readers of this publication. The blueprints give exact constructional data and are, moreover, made in full size; so that, for instance, by laying the blueprint on top of the panel it is possible to drill right through the indicated holes on the blueprint into the panel. We are confident that this new device will be of great interest to radio constructors.

—THE EDITORS.

the eliminator and use the free positive post of the "B" battery as the high-voltage terminal for the power amplifier. Obviously, any number of "B" batteries may be added to the eliminator to obtain the desired extra voltage.

An important point relative to D.C. "B" eliminators is that, whatever the output voltage is, it will remain constant. In some A.C. eliminators the output voltage varies considerably with changes in the amount of current drawn by the vacuum tubes. On certain musical frequencies, and when the signals are very loud, the amplifier tubes will draw more than the usual amount of current. If the "B" voltage does not remain fairly constant, distortion will occur. In many

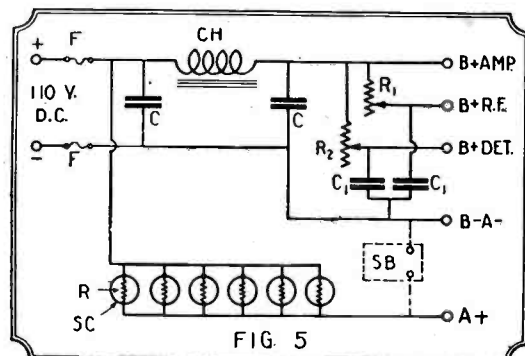

FIG. 5
Schematic circuit diagram of the complete direct-current "A-and-B" eliminator. SB is a storage battery, which is not essential, but may be connected in as shown and employed as a filter.

cases, poor reproduction of low notes or "blasting" in the loud speaker is due to a drop in the output voltage of the A.C. eliminator because the rectifier is not capable of handling the excess load. Though the output voltage of a D.C. eliminator is very seldom greater than 100 volts, one can be assured that under normal conditions it will remain 100 volts, even when the amount of current being drawn is comparatively excessive.

"A" ELIMINATORS

"A" eliminators for use on A.C. lines are necessarily more expensive devices, if they are to be at all satisfactory. An "A" eliminator of this type, in order to operate vacuum tubes with their filaments connected in parallel, must be able to deliver high amperage, anywhere from 3/4 ampere to 2 or 3 amperes. To accomplish this, it is necessary to employ one or more large rectifier tubes, capable of passing a great amount of current, or else use the system commonly referred to as an "A" power unit, which comprises a low-capacity storage "A" battery and a "trickle charger." The prob-

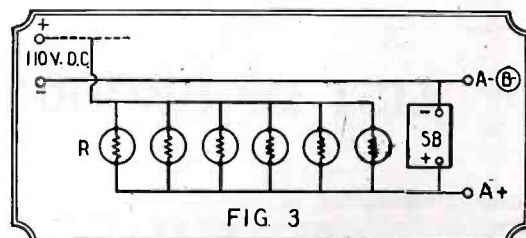
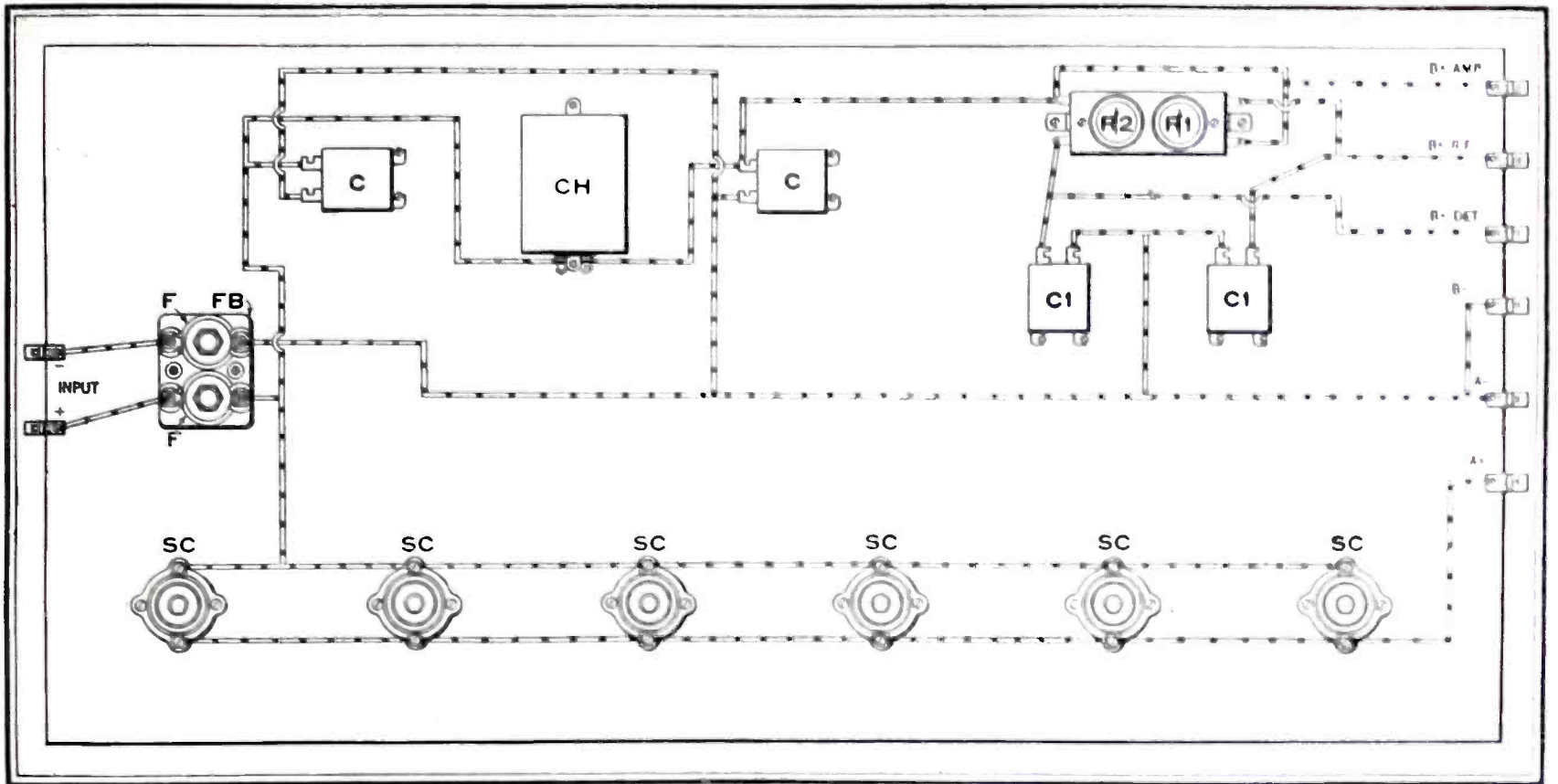

FIG. 3
Circuit diagram of the "A" supply unit of the eliminator, showing a storage battery on "floating charge." The battery is used as the filter.

lem is greatly simplified when the filaments of the vacuum tubes in the receiver are connected in series; for in such a case (assuming that all of them are 201A's) only 1/4 ampere of current is required. But as soon as a power tube is added, the size of the rectifier must be increased.

An "A" battery eliminator for use on D.C. is an entirely different proposition. One of this type is very inexpensive, causes no bother, has no parts to wear out, and operates extremely well with any type of set employing any combination of vacuum tubes with their filaments connected in parallel. The only requisites for its construction are a few lamp sockets and some heavy-duty fixed resistances.

Some of the D.C. "A" eliminators, which we have described in the past, employ a choke in the positive lead for filtering out the commutator ripple. Though this method of eliminating the noise of the generator is fairly satisfactory, the chokes usually do not have sufficient inductance to act as perfect filters. The reason is simple; the wire



Layout wiring diagram of the complete direct-current "A-and-B" eliminator. This is comparatively simple to follow, as all the wiring is made on the top of the baseboard. F are the fuses, FB the fuse block, C the filter condensers, CH the filter choke, R1 and R2 the variable voltage controls, C1 the by-pass condensers, and SC the lamp sockets. All of the binding posts are marked. The parts are shown on a reduced scale for clearness in illustrating the wiring, which may be traced with a colored pencil, as completed.

used in the choke must be very large in order to handle the high currents delivered to the vacuum tubes; and consequently a choke of sufficient inductance would be too large and too costly to be practical. The method employed in the eliminator to be described is far more effective, and yet is not expensive.

HOW TO BUILD THE "A-AND-B" ELIMINATOR

The D.C. "A-and-B" eliminator shown in the illustration (Fig. 1) was found to be perfectly satisfactory from all standpoints. Being quite an inexpensive and practical affair, it is well worth building, if you have the advantage of a D.C. lighting system. As can be seen in Fig. 1, the "B" portion of the device is mounted on the back of the board. It comprises two 2-mf. filter condensers C, a single "B"-eliminator-type choke

coil CH, two variable resistances R1 and R2, two 0.5-mf. by-pass condensers C1, and a double fuse block. The two resistances R1



Fig. 6. A direct-current trickle charger which will deliver three-tenths 0.3 of an ampere to any six-volt storage battery. Incidentally, it can also be used for charging storage "B" batteries.

(Photo courtesy of Ward Leonard Electric Co.) and R2 supply two variable voltage taps which can be used for the R.F. and detector tubes in the set. From 20 volts to maximum

can be had on the first tap, and from 40 volts to maximum on the second. It is understood that these two taps will show a difference in voltage from the high-voltage tap only when the eliminator is connected to the receiver and in operation. In other words, until a load is placed on these two taps, the voltage of both will be practically equal to that of the third, irrespective of the position of the knobs R1 and R2. This is mentioned only as a reminder that, if you wish to measure the voltage at each of the three taps with a voltmeter, you should do so while the set is operating.

The two fixed condensers C1 serve to by-pass the radio frequency currents around the variable resistances R1 and R2.

Nothing need be said relative to the assembling and wiring of this part of the eliminator, as the circuit diagram (Fig. 2)

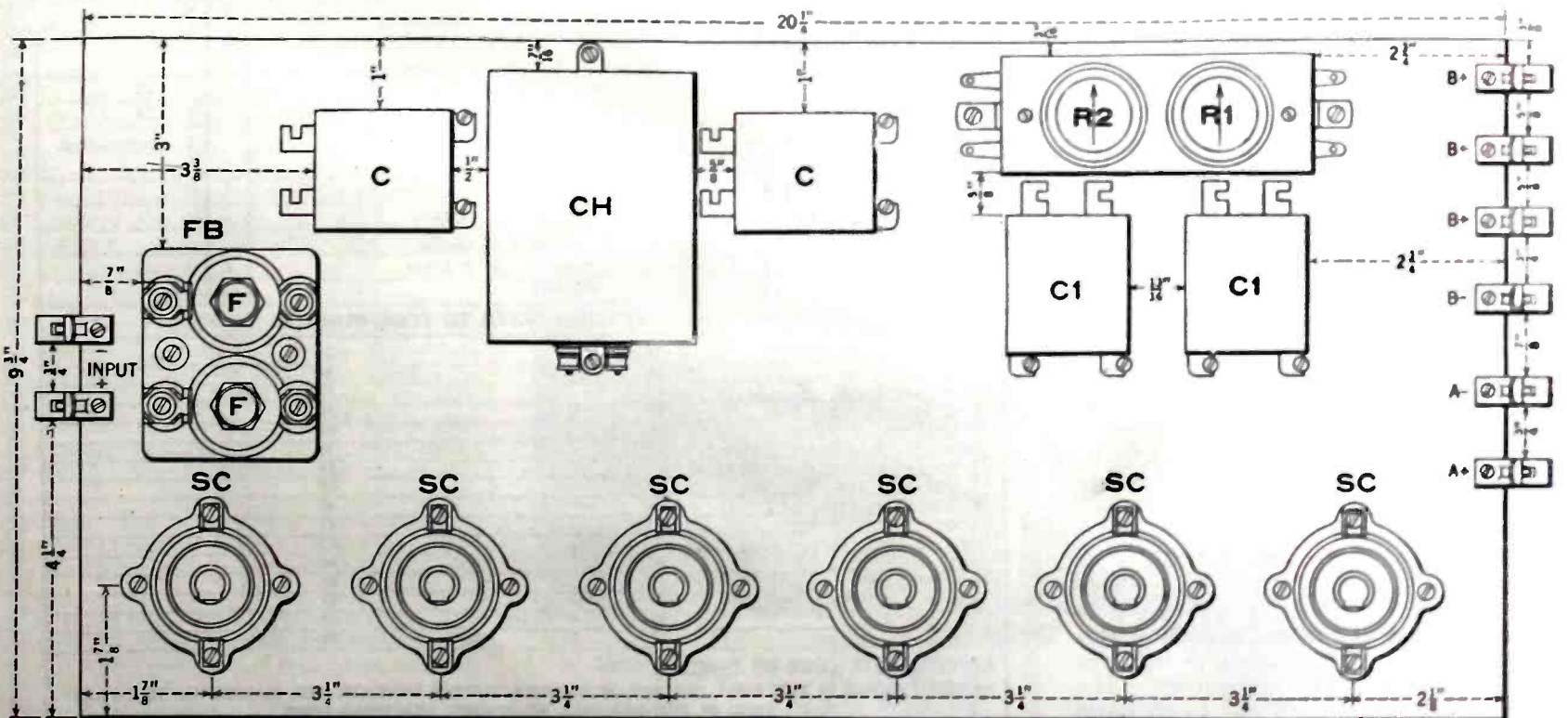

Constructional and layout details of the D.C. eliminator. All the necessary dimensions are given. The parts may be mounted as shown and then wired as indicated in the large sketch above. The apparatus is lettered to correspond with the other illustrations and list of parts.

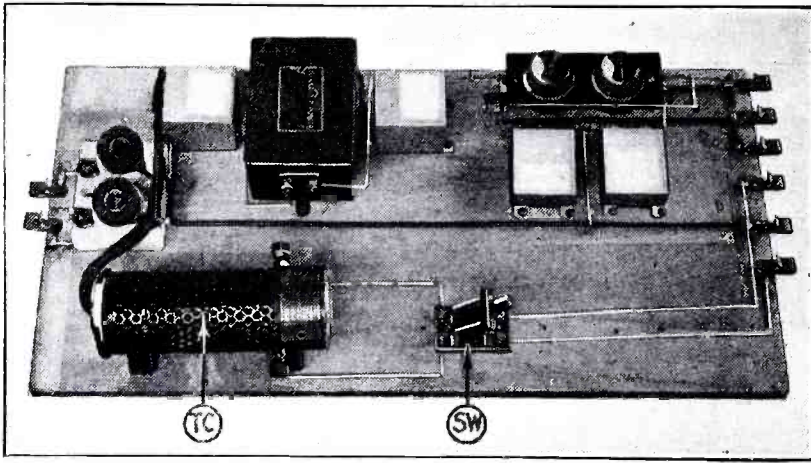

Fig. 7. A view of a slightly different type of eliminator. The "B" unit remains the same, but the "A" unit in this case comprises a trickle charger and a double-pole, double-throw switch which is used in conjunction with a regular storage battery. This arrangement is the same as in the now well-known "A" Power Units.

and the two detailed layouts shown give all the necessary information.

Now let us consider the "A" eliminator part of the unit. It can be seen, from Fig. 1 and the constructional layouts, that it consists of merely six ordinary porcelain lamp sockets and a number of fixed resistance units R. The wiring diagram is Fig. 3.

USE OF RESISTANCES

The idea is very simple. In the combination shown there are two 440-ohm resistances, three 220-ohm resistances and one 700-ohm resistance. The first type will pass 1/4-ampere, the second type 1/2-ampere, and the 700-ohm resistance approximately 1/8-ampere.

Let us see how they are used. For a single 5-volt, 1/4-ampere tube, one 440-ohm resistance is inserted into any one of the sockets; this will pass the required 1/4-ampere. For two tubes of the 1/4-ampere type, two 440-ohm resistances, or one 220-ohm resistance are employed, and so on. The number of resistances required depends upon the number and type of vacuum tubes in your set. As an example, suppose four 5-volt, 1/4-ampere tubes and one 5-volt, 1/2-ampere (power amplifier) tube are used. The total current drain will then be 1 1/2-amperes. To supply this, three 220-ohm resistances are inserted in the sockets, or two 220-ohm resistances and two 440-ohm resistances, or six 440-ohm resistances.

PRECAUTIONS

It is very important to remember that no vacuum tube should be taken out of its socket or the filament turned off while the "A" eliminator is working, unless one of the resistances R has been first removed. If a 1/4-ampere tube is to be disconnected, one of the 440-ohm resistances should first be unscrewed from its socket. If a 1/2-ampere tube is to be disconnected, first remove one 220-ohm resistance. Failure to heed this may mean serious damage to the tubes; as they would, under such circumstances, be receiving too much current and an abnormal voltage. The 220-ohm and 440-ohm resistances are specified for the reason that it is often desirable to turn off one or both stages of audio-frequency amplification. The use of separate resistances makes this possible. At any rate, never have more resistances screwed into the lamp sockets than are required for the number of tubes in operation.

It is obvious that six lamp sockets will not be required in all cases; the number depends on that of the resistances employed. The table (Fig. 4) gives the type and number of resistances suggested for different tube combinations.

FILTERING OUT THE RIPPLE

On most D.C. lines, the generator ripple is not troublesome, or so intense that it is noticeable, during the reception of local stations. However, it is sufficient to interfere with the reception of distant stations. The simplest and most effective way to eliminate this ripple is to "float" a storage "A" battery on the line, as explained below. This

may sound like a contradiction of the purpose of the eliminator, but such is not the case; in this instance the storage battery acts merely as a "floating balance" and not as a supply, therefore a 6-volt storage battery of any capacity within a reasonable range may

motorcycle storage battery will do very nicely, or three cells out of a storage "B" battery connected in series; but most of the readers have already some form of storage battery which they can use to advantage.

The battery is connected directly across the output of the "A" eliminator (see SB in Fig. 3) and should be in a fully-charged condition. Since enough parallel resistances are employed to deliver the exact amount of current required by the tubes, the storage battery is neither charged nor discharged. When employing a storage battery as a ballast in this manner, there is little need to worry about the number of resistances screwed into the sockets; as the battery will take up the excess current, if any. As a matter of fact, an extra 440-ohm resistance inserted into one of the sockets will provide a trickle charge for the battery while the set is operating. More of this later.

USE OF BATTERY

This makes a very flexible combination. If, for some reason, one wishes to use the storage battery alone for lighting the tubes, assuming that it has sufficient capacity for the purpose, all that is necessary is to unscrew all the resistance units from the sockets; a turn or so will disconnect them. After use, the battery may be replenished; the set is turned off and one or more of the resistances screwed in. The charging rate can be regulated from 1/4-ampere, with one resistance in circuit, up to an amount equal to the current drawn by all the tubes in the set, with all the resistances in use. The battery may be also put on trickle charge while the set is operating if another 440- or 220-ohm resistance is added.

Since, in most cases, the storage battery functions only as a form of filter, and does not discharge, there is no need of taking voltage readings or checking the specific gravity of the electrolyte. It will be enough that water is added when required. It should be pointed out, though, that if the battery is undercharged it will rob the tube filaments of a part of their rightful current. Here is where the 700-ohm resistance is useful. This unit will pass about 1/8-ampere, enough to

(Continued on page 901)

RESISTANCE TABLE						
TOTAL NO OF TUBES	5 VOLT 1/4 AMP TYPE	5 VOLT 1/2 AMP TYPE	TOTAL CURRENT CONSUMPTION IN AMPS.	NO OF 440 OHM RESISTANCES	NO OF 220 OHM RESISTANCES	TOTAL NUMBER OF RESISTANCES
1	1		1/4	1		1
3	1	2	1 1/4	1	2	3
3	3		3/4	1	1	2
3	2	1	1.0	2	1	3
5	5		1 1/4	1	2	3
5	4	1	1 1/2	2	2	4
6	6		1 1/2	2	2	4
6	5	1	1 3/4	1	3	4
8	8		2	2	3	5
8	7	1	2 1/4	1	4	5

FIG 4

The most suitable combination of resistances to employ for a given number of tubes may be determined from the above table.

be used, or even four 1 1/2-volt dry cells connected in series, though we do not advise the latter for general operation. A small 6-volt

SYMBOL	Quantity	NAME OF PART	VALUE OF PART	REMARKS	MANUFACTURER ★
CH	1	Filter choke	30 or 60 H.	"B" Eliminator type	1 7, 8
C	2	Fixed condenser	2 mf.	Filter	2 3, 9, 10
C1	2	Fixed condenser	.5 mf.	By-pass	2 3, 9, 10
C2	1	" "	.006 mf.	Protective (See Fig.9)	2 9, 10
R	6	" resistance	(See table)	To fit lamp sockets	4
R1	1	Var. resistance	10,000 ohms	Variable voltage control	3 11, 12
R2	1	" "	50,000 ohms	" " "	3 11, 12
FB	1	Fuse block		Double	Electrical Sup.
F	2	Fuse	10 amp.		" "
SC	6	Lamp socket		Standard size Porcelain	" "
	8	Binding posts			5 13
	1	Mounting board		20 1/2 X 9 1/2 inches	
	1	Insulating strip		1 1/2" X 1 1/2" X 3/16"	6 14

NUMBERS IN LAST COLUMN REFER TO CODE NUMBERS BELOW.

1 Dongan Elec. Mfg. Co.	17
2 Tobe Deutschmann	18
3 Electrad, Inc.	19
4 Ward Leonard Elec. Co.	20
5 Fahnestock Elec. Co.	21
6 Amer. Hd. Rubber Co. (Radion)	22
7 Amer. Transformer Co. (Amertran)	23
8 Thordarson Elec. Mfg. Co.	24
9 Polynet Mfg. Corp.	25
10 Aerovox Wireless Corp.	26
11 Central Radio Labs. (Centralab)	27
12 H. H. Frost, Inc.	28
13 X-L Radio Lab.	29
14 Ins. Co. of America (Insuline)	30
15	31
16	32
	33
	34
	35
	36
	37
	38
	39
	40
	41
	42
	43
	44
	45
	46
	47
	48

APPROXIMATE COST OF PARTS \$ 20.00

★ THE FIGURES IN THE FIRST COLUMN OF MANUFACTURERS INDICATE THE MAKERS OF THE PARTS USED IN THE ORIGINAL EQUIPMENT DESCRIBED HERE.



Short-Wave Receivers

A Description of How These Interesting Sets Are Constructed

By L. W. HATRY



THE average concert fan does not clearly understand the reason why short-wave receiving sets are different from those to which he has been used. He can not understand why it is not possible to build a set to cover from 1 to 200 meters, if another can easily be built to tune from 200 to 600 meters, a greater wave-length range. It is hoped that this will help to reduce the mystery of the matter.

We have learned, in general, that the frequency range and how it is dealt with in tuning determine to a great extent how difficult it is going to be to handle the receiver. The result of this knowledge has been the designing of straight-line-frequency condensers, and others of different calibration, to distribute the allocation of stations along the scale more equally, according to frequency. One of the problems the amateur short-wave bug fights is this same, or very nearly same, one of frequency.

control the tuning of the secondary circuit. The antenna circuit is coupled to the set through a loose coupler with a very few turns, or else through a very small fixed condenser. Either way works very satisfactorily and, as usual with differing ways of doing the same thing, both have their supporters claiming that their own way is better than the other. Strictly speaking, that should not be; practically it is, since the user must fit conditions to his own satisfaction. The general idea of these two methods is shown in Figs. 1 and 2.

WHY PLUG-IN COILS?

The subject of plug-in coils is wrapped up with a couple of explanations that will be better handled by starting further back than the coils themselves.

Half the difficulty of tuning is settled if the frequency range is not too great; and if its calibration curve is a straight line in re-

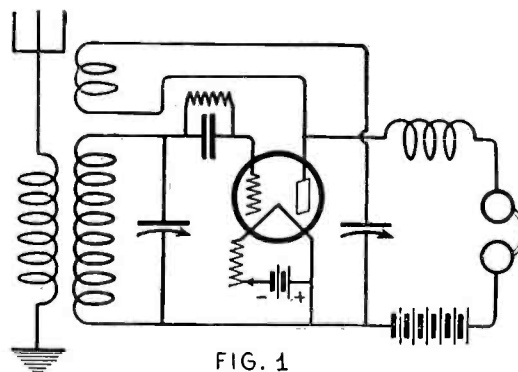

FIG. 1
The antenna is coupled to the receiver through a loose coupler in this circuit.

slows the condenser down at the low end and rotates it much faster at the higher; such as the converting dials now offered for sale. The reduction ratio starts off, say, at sixteen to one, and accelerates to two to one. Yet with a condenser of the straight-line type, a good vernier (reduction-gear type) dial of six-to-one ratio, or thereabouts, is satisfactory enough. In fact it is unsatisfactory to handle a reduction ratio much higher than that; so there is one more thing for the amateur short-wave man to keep in mind. He must have a frequency range not much more than 1,000 kc. in extent.

PROBLEMS IN CAPACITY

Now his problem becomes complicated. There are four amateur wave-length bands in which to listen for the licensed short-wave transmitters. On either side of these bands can be found, as well, foreign amateurs, commercial transmissions, and experimental transmissions. His set should be able to get all these things. The 75-85.6-meter amateur band includes a frequency range of slightly over 500 kc. The 37.5-42.8 meter band includes a frequency range of nearly 1,000 kc.; and the 18.75-21.4 meter band includes a frequency range of 2,000 kc., in round numbers. Then the 150-200-meter band is 500 kc. Three of the bands are quite satisfactorily covered if the variable condenser spreads over the 1,000 kc. band figured from.

(Continued on page 856)

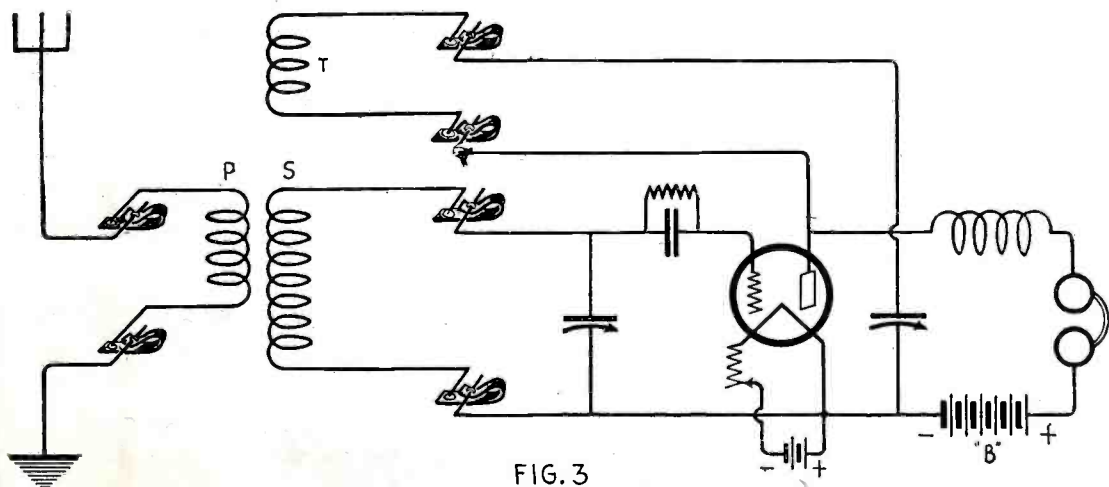

FIG. 3
Schematic diagram of the S. W. receiver illustrated. As shown, spring clips are used for connecting in the different sets of inductances.

First, multi-tube sets using R.F. amplification are marked from his list of possibilities. The only thing that is approximately feasible along this line is the superheterodyne; and the reason for this is obvious from its theory. The super-regenerative circuit appeals to many, but it has proved impractical for short-wave work. The only thing left, then, is the straight regenerative circuit, arranged in some way to permit convenient change of wave-length, with simplified control. R. F. amplification fails to amplify, so the short-wave enthusiast turns to audio amplification; and here he uses transformers the concert fan would abhor, transformers which distort. This for a very good reason.

AMPLIFICATION AT ANY PRICE

The whistles that the BC fan detests are the means of communication on the short-wave lengths. This whistle can always be adjusted to the sound that suits the ear best. If an audio transformer is used which distorts along the frequency or frequencies that satisfy the ear, the received signal will get excessive amplification, due to that same distortion. For this purpose the amplifier tubes are generally used with but 45 or 22 volts of "B" battery; because then the tube impedances fail to match the transformer in any worth-while fashion and the lower frequencies are nearly abandoned, making static and other odd noises remain at a satisfactory minimum.

Simplified control is generally obtained satisfactorily with two dials, one to control regeneration or oscillation and the other to

lation to the scale used on the tuning dial. The broadcast frequency band is not quite a million cycles, or 1,000 kilocycles, wide. When the greater portion of this band is confined, as in the case of the semicircular-plate old-style condenser, to the lower portion of the tuning dial, the trouble in tuning thus caused can be overcome only with a dial which

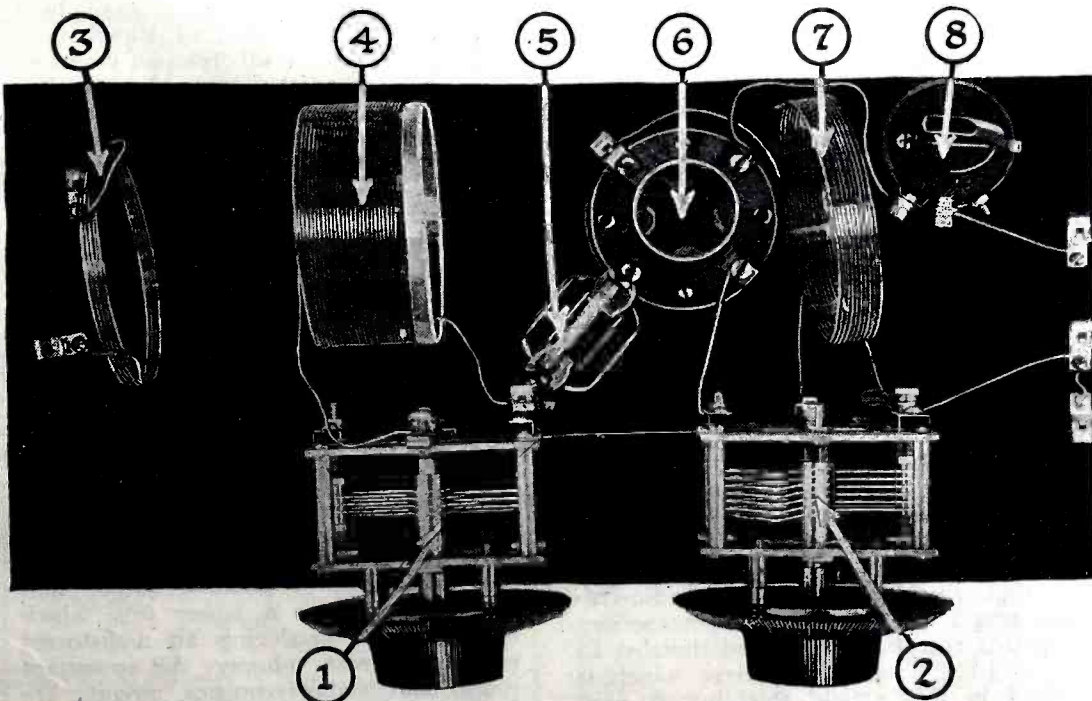

Layout of short-wave receiver: Nos. 1 and 2 are the variable condensers; 3, the primary coil; 4, the secondary; 5, grid leak and condenser; 6, tube socket; 7, tickler coil; and 8, rheostat.

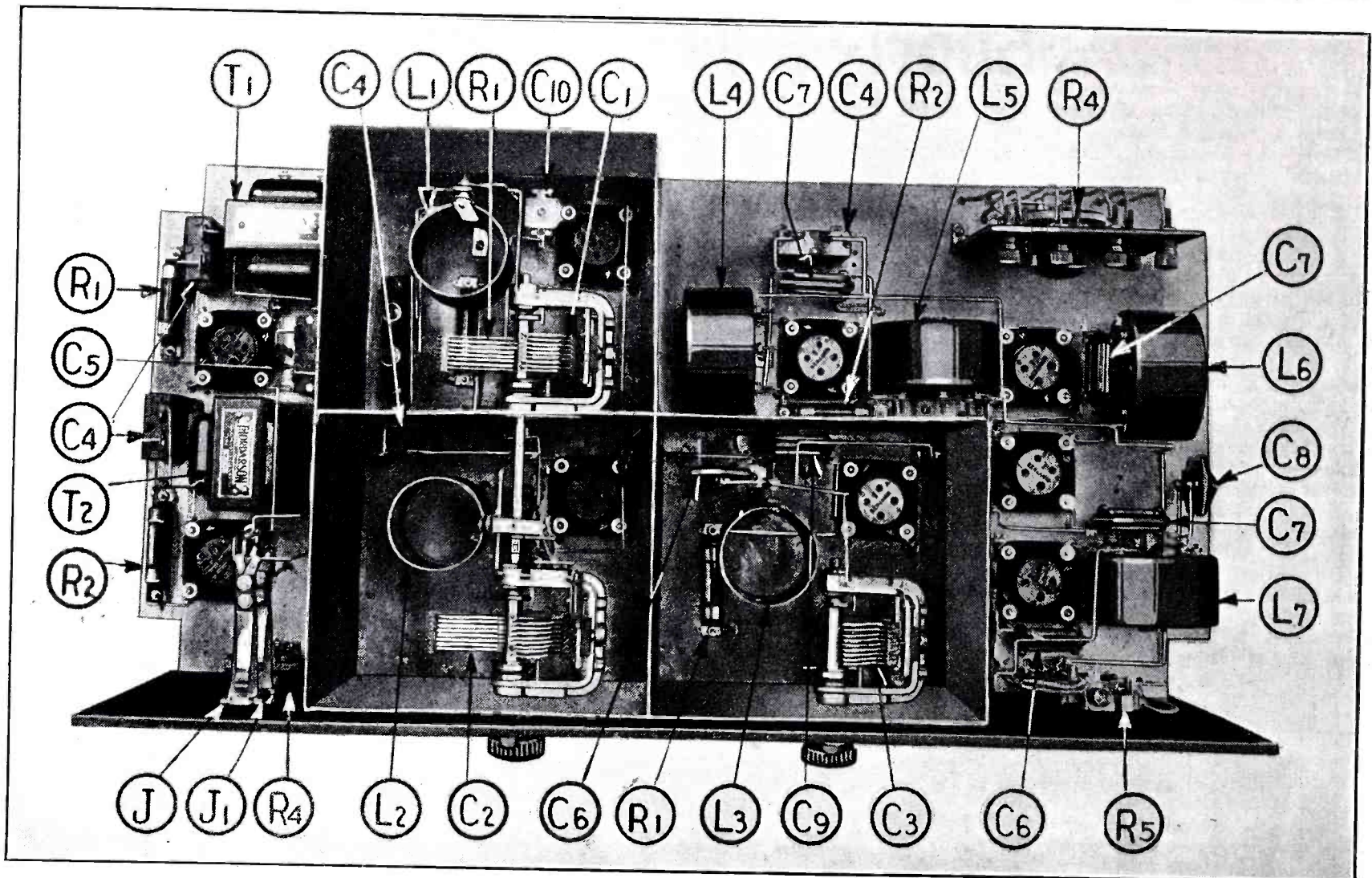

A top view of the new shielded Ultradyne LR4 receiver, which is very compact in form. The two-stage transformer-coupled audio amplifier can be seen at the extreme left of the base. The left rear shield contains the single stage of constant-coupled tuned-radio-frequency amplification which precedes the modulator circuit contained in the left front shield. The right-hand shield encloses the oscillator circuit. The three intermediate-frequency amplifier stages and the detector are grouped around the oscillator shield. Note that the condensers which tune the radio-frequency and the modulator circuits are on the same shaft, making a single control.

The New Shielded Ultradyne*

A Simplified 9-Tube Set Using Standard Parts

By R. E. LACAULT

ALTHOUGH the majority of the receivers that have appeared on the market within the past few months have, on an average, six tubes, there is a great deal of interest displayed in sets having many more. It is true that the five- or six-tube receiver is good for reception up to about one thousand miles—of course in some cases this is exceeded—but when the experimenter goes after really distant stations he turns to a receiver having eight, nine or ten tubes.

On stations within the radius of a few hundred miles the set having five or six tubes will give every bit as good reproduction as will a receiver having a greater number; but, as pointed out numerous times, if distance is wanted there must be sufficient amplification; and this means more tubes, in the radio-frequency end of the set.

CONVENIENT SHIELDING AVAILABLE

When more than two stages of amplification are employed before the detector tube, there is likely to be trouble unless suitable precautions are taken. In the past few months radio engineers have incorporated in set design shielding about the radio-frequency stages to reduce interstage coupling, finding that reception is bettered thereby. In the new LR4 Ultradyne receiver which is described in this article shielding is used around the stage of tuned radio-frequency

ONE of the earliest, and at the same time most popular, superheterodynes was the Lacault Ultradyne. We believe we shall not be contradicted if we say that more Ultradynes were built than of any other type of superheterodyne—certainly in all foreign countries the Ultradyne enjoyed a greater popularity than any other superheterodyne.

The new shielded Ultradyne presents some new features and many refinements. Mr. Lacault has been working on it for a long time; and we believe that it spells the last word in superheterodyne construction for the builder.

The single stage of shielded tuned-radio-frequency amplification preceding the "modulator" circuit, the most sensitive form of input, employs an automatic-constant coupling system which provides equal transfer of energy on all wavelengths. The "Uni-chokes," employed as intermediate-frequency transformers, are surprisingly efficient and have a frequency-response curve far superior to that of most long-wave transformers. The last stage of audio-frequency amplification employs a power tube which is capable of producing an undistorted output of great volume. All important radio- and audio-frequency circuits are by-passed by large fixed condensers.

amplification, the modulator and the oscillator circuits.

In the "old" days of radio—four or five years ago—when an experimenter wanted to build a new receiver it was necessary for him to make the greater part of the apparatus at his own work-bench. Today this condition has been changed, for there are very few accessories that are not manufactured. This is true particularly of the shields, which formerly had to be laboriously cut from sheet metal, but which now can be obtained all ready to install in a receiver.

The LR4 receiver is one designed for assembly with a minimum of effort on the part of the builder. By this is meant that everything that is installed in the set may be purchased; nothing having to be made by the builder unless he so chooses.

WHAT THE LR4 IS

It is impossible to say what a set will do in a given location, especially in cities, there being too many factors involved to permit any broad and sweeping claims to be made. However, if a set such as described in this article is properly assembled and adjusted, it will give excellent results. On a short indoor antenna many distant stations have been tuned-in, the amplification being such that most of them were heard on the loud speaker. The selectivity is sufficient to permit the separation of stations very close in fre-

* Radio News Blueprint Article No. 2.

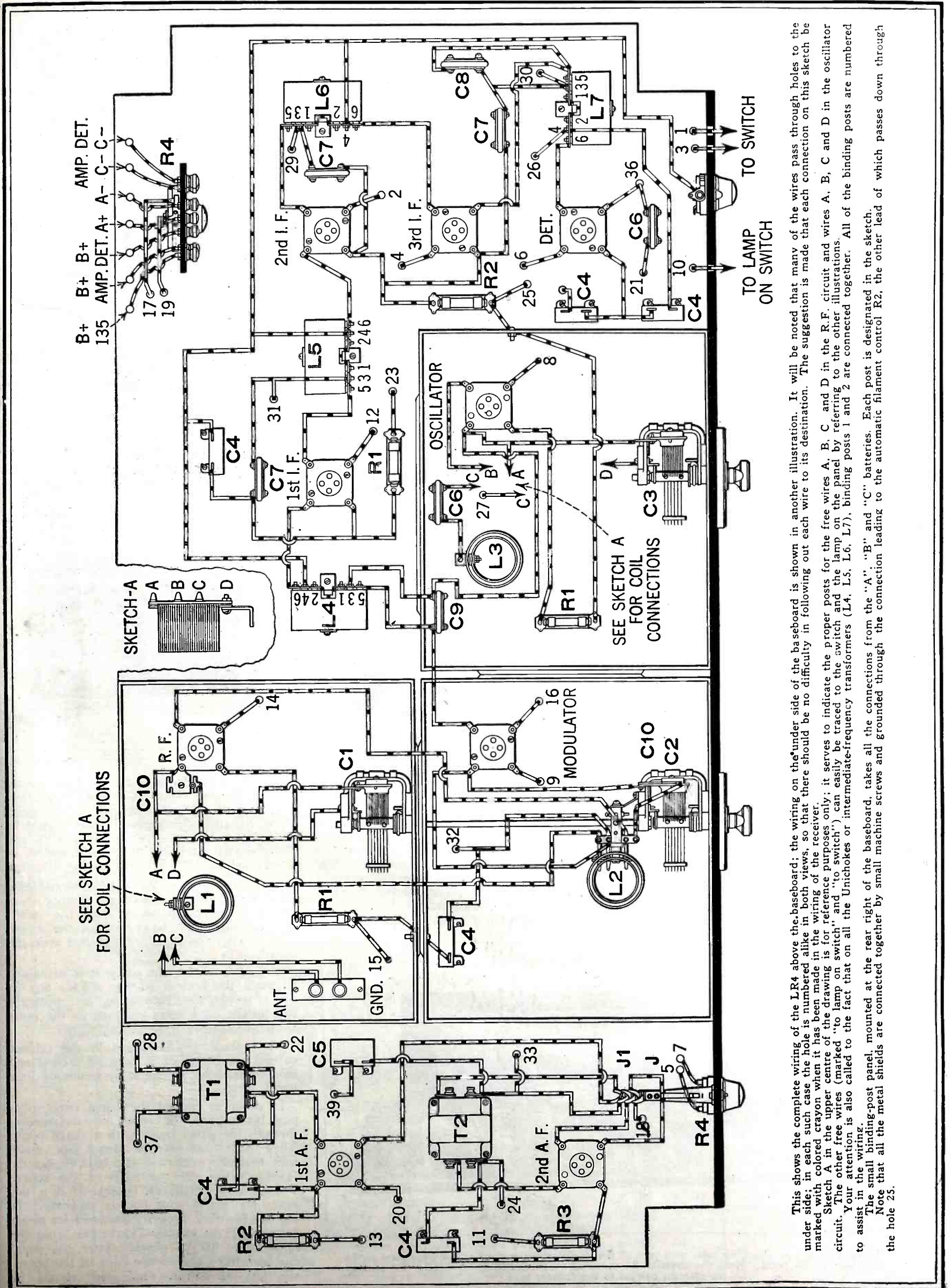

This shows the complete wiring of the LR4 above the baseboard; the wiring on the under side of the baseboard is shown in another illustration. It will be noted that many of the wires pass through holes to the under side; in each such case the hole is numbered alike in both views, so that there should be no difficulty in following out each wire to its destination. The suggestion is made that each connection on this sketch be marked with colored crayon when it has been made in the wiring of the receiver.

Sketch A in the upper centre of the drawing is for reference purposes only; it serves to indicate the proper posts for the free wires A, B, C and D in the R.F. circuit and wires A, B, C and D in the oscillator circuit. The other free wires (marked "to lamp on switch" and "to switch") can easily be traced to the switch and the lamp on the panel by referring to the other illustrations. Your attention is also called to the fact that on all the Unichokes or intermediate-frequency transformers (L4, L5, L6, L7), binding posts 1 and 2 are connected together. All of the binding posts are numbered to assist in the wiring.

The small binding-post panel, mounted at the rear right of the baseboard, takes all the connections from the "A", "B" and "C" batteries. Each post is designated in the sketch. Note that all the metal shields are connected together by small machine screws and grounded through the connection leading to the automatic filament control R2, the other lead of which passes down through the hole 25.

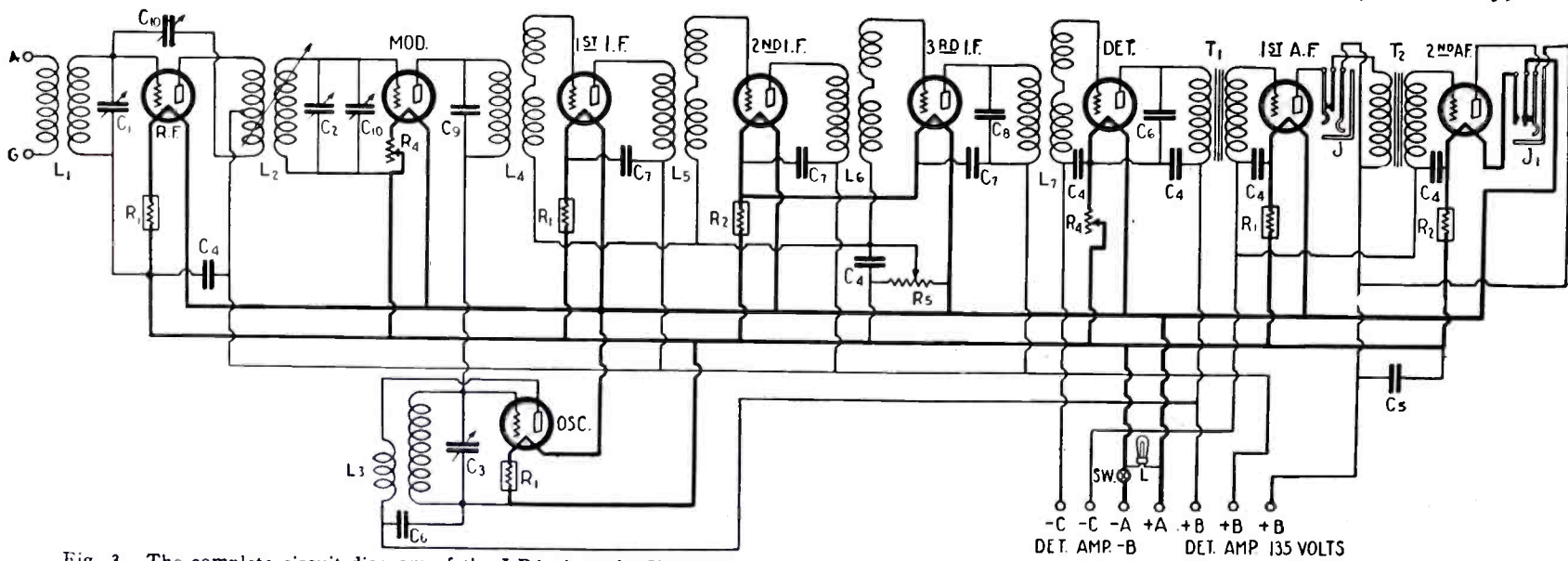

Fig. 3. The complete circuit diagram of the LR4 nine-tube Ultradyne. Note that the last or power stage of audio-frequency amplification employs a filament-control jack; so that this stage is in operation only when the loud-speaker plug is inserted in the jack referred to.

quency; the radio-frequency stage and the shielding preventing much interference and noise from getting through the set.

As can be seen from an inspection of the wiring diagram of the receiver, it consists of a stage of tuned radio-frequency amplification, an oscillator, a modulator, three stages of long-wave radio-frequency amplification, a detector, and two stages of transformer-coupled audio-frequency amplification.

The stage of radio-frequency amplification is *auto-coupled*. By this is meant that the primary of the radio-frequency transformer is automatically varied in its inductive relation to the secondary merely by a rotation of the dial of the variable condenser. (This type of auto-coupling was described in the December, 1926, issue of RADIO NEWS.) As mentioned previously, this stage of amplification is shielded, and is thereby isolated from the rest of the receiver.

The audio-amplifier is designed to produce volume and good quality and, when used with a good loud speaker, will reproduce all audio frequencies with fidelity.

The detector circuit is so wired that it may be employed with a "C" battery, if use is made of the bend in the "characteristic curve" of the tube. The grid return is connected to a binding post, which, in turn, may be connected to the "C" battery or the plus or minus of the "A", as the case may be.

A rheostat also is provided to control the detector filament; it is mounted on the binding-post panel inside of the set; because, once adjusted for the particular tube used, it need not be re-set.

In order to produce the results of which it is capable, this receiver should be built with the best parts obtainable. This has

been said and repeated a great many times by designers of good sets, and will never be emphasized too strongly. The amount of energy received from distant stations is so small that it is of the utmost importance to avoid bad contacts and high-loss parts which absorb energy; otherwise the signals are so weak they are not heard at all.

The construction of the LR4 receiver is comparatively simple because the shielded

The panel should be first traced and drilled with the aid of a square, center punch and hammer. All dimensions should be taken from the left and lower edges of the panel, as shown.

ASSEMBLY WORK

After the panel is completely drilled, the switch, rheostat and potentiometer may be mounted on it. Turn them so that when

A front view of the completed receiver: J and J1 are the two jacks in the audio-frequency stages; R4 is a rheostat which controls the current to the filament of the modulator tube; C1, C2 the radio-frequency-modulator tuning dial; C3 the oscillator dial; SW the filament switch; and R5 the potentiometer.

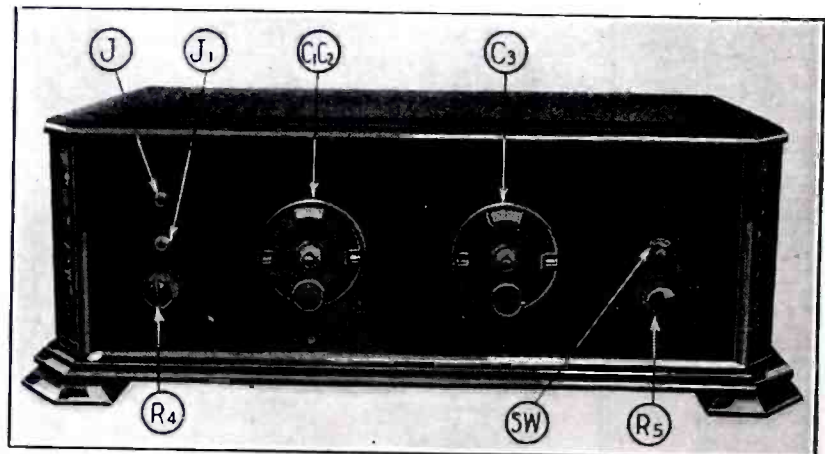

stages, which are the most delicate parts of the receiver, may be built with standard parts which are all ready for assembling and designed to fit without further adjustment. The radio-frequency coils and auto-couple coil are designed to be mounted directly on the condenser or on small brackets. The shields are all drilled for the mounting of the condensers and sockets, so that a screw driver is all that is necessary for the work of assembling these units.

you look at the front of the panel the center lug of the left rheostat points to the left and that of the potentiometer to the right. Next the small binding-post panel should be traced and drilled, as shown in Fig. 2, and the rheostats and binding posts mounted, as illustrated in the baseboard wiring diagram.

The partitions of the shields should also be drilled for the connections running from one shielded compartment into the other. The drilling of the baseboard for the wiring is done after the parts are mounted upon the board.

Before mounting the parts, it is necessary to place the bottom of the shields and in order to do this accurately, and properly line up the condensers mounted on the same shaft, one should proceed as follows:

First place the baseboard in the cabinet so that the clearance is even all around and mount the panel against it by means of four wood screws.

In order to prevent the board from splitting, first mark the spots for the screws through the panel holes with a sharp point. Then drill, but before doing so, make sure that the center of the hole is exactly 1/4-inch below the top edge of the board. This is very important, because if it is not exact the shield may not fit properly. If the baseboard is properly fastened its upper face should be exactly 7/8 inches from the upper edge of the panel. After the panel has been fixed against the edge of the board, the left .00035-mf. condensers should be

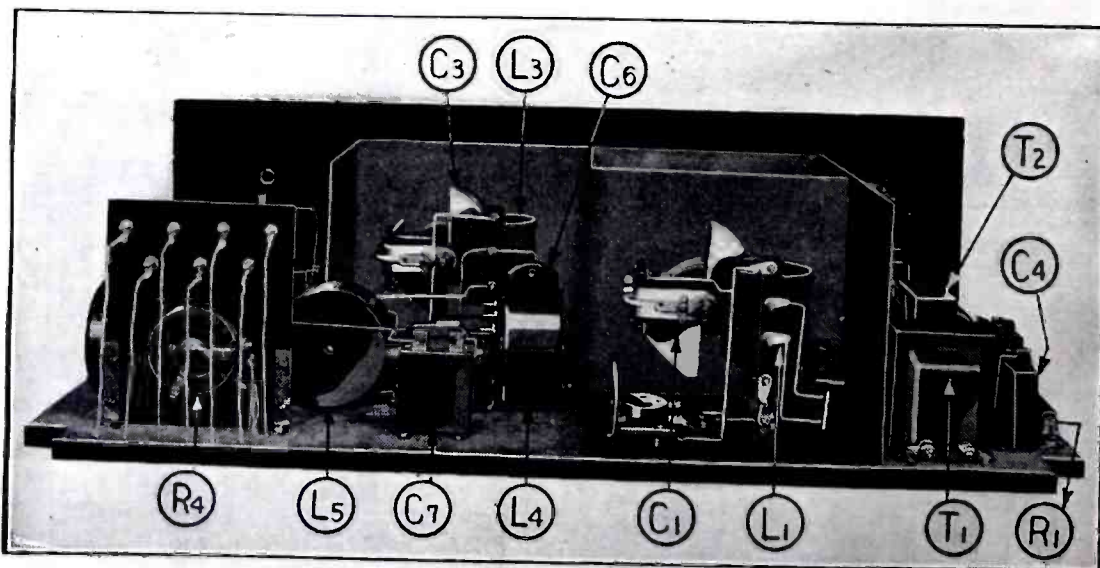

The receiver as seen from the rear, with part of the shielding removed to give a clear view of the placement of the parts. Note the rheostat R4 mounted on the binding-post panel; this controls the filament current to the detector tube.

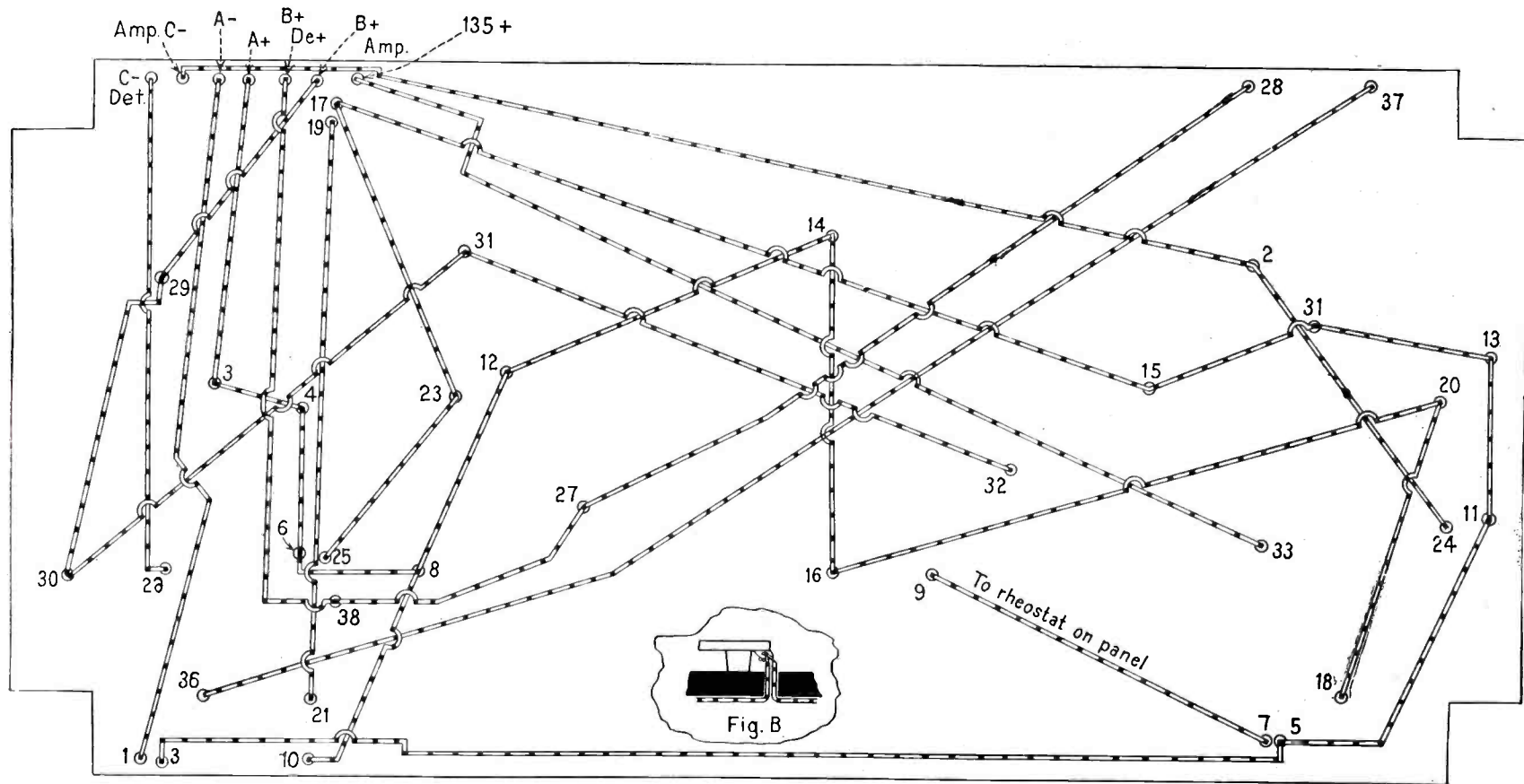

The "golf wiring" on the under side of baseboard. This is comparatively easy to follow; as all of the holes on both sides of the baseboard are similarly numbered.

mounted against the shield and panel so that the screws pass through both of these, as shown. Next, the bottom of the shielded compartment should be placed under the bent edge of the front section of the shield; so that the holes come just under those punched in the bent lower edge of the shield mounted against the panel.

Take care in placing this bottom section to have the two holes punched for the socket mounting screws on the right and back of the condenser when you look from above. Two wood screws may then be inserted through the holes to fasten the bottom of the front compartment on the baseboard, and the socket may also be screwed down.

The next step is the mounting of the other variable condenser on the front section of the back shield and back partition of the front shield. These two sections are mounted back to back, as shown, and maintained by the mounting screws of the condenser. This ensemble should then be placed on the baseboard, and the double-length shaft pushed through both condensers after the individual shafts have been removed.

The long shaft provides the proper alignment for the condensers, which should both turn freely without binding at any point.

The double partition supporting the back condenser may then be screwed down on the board. The holes on the lower edge should correspond exactly with those in the bottom of the front shield.

The bottom of the back shield is screwed down exactly like the front one. Turn it so that the mounting holes for the sockets are on the right of the condenser.

The other partitions of the shield are mounted later and held in the corners by means of the slides provided for this purpose.

The other variable condenser is mounted in the other shield and fastened against the panel and baseboard in the same manner. After the condensers are properly aligned, and the shield screwed down, the condensers should be removed, automatic-filament-control base, coils, binding post and by-pass condensers mounted upon the bottom of the shields, and the holes for the wiring drilled as shown, through both shield and baseboard. Then screw down all the sockets, bases, audio-frequency transformers, multichokes, by-pass condensers and the binding post panel. Mount also the auto-couple coil on the left forward condenser and remount the three variable condensers.

WIRING

The wiring operation, which might be called "golf wiring," because the underboard wires run directly from one hole to the next, is very easy if done as explained further. One may use wires of different colors for each circuit, although this is not essential. Pliable wire rather than bus bar is recommended for the underboard wiring.

If this type of wire is used it may be bent double where it passes through a hole in the board and a loop left long enough to reach the soldering lug. The loop is then cut, the two ends scraped clean and soldered to the lug. (See Fig. B). The wiring is best done in the following order:

Start at "A—" binding post and run the wire through hole 1 to switch, then back through 3 to 5, 11, 13, 39, 15, 17, 23 and 25, also from the left rheostat through 7 to 9, and from the back rheostat through 19 to 21.

Starting at "A+" binding post run the wire through 2, 4, 6, 8, 12, 14, 16, 18 and 20, also from 8 to 10.

From "B+Det" run the wire directly to 38, 27 and 28.

From "B+Amp" to 29, 30, 31 and 32.

From "135v" to 33.

From "C—" for the audio amplifier to 22 and 24 and from "C—" for the detector to 26.

After all the connections are made and soldered, the jacks may be mounted and the wiring above the baseboard done with either the same wire or bus bar. Care should be taken, when wiring the parts inside the shields, not to run the grid and plate leads too close to the shield. Insulate all the wires or bus bars passing through the partitions with spaghetti tubing, even if insulated wire is used. During the wiring operation check each lead often. Be sure to make good soldered joints as this operation is very important. Use a properly-tinned soldering iron and not too much flux. Also be sure to have the wires or lugs clean before you try to solder them.

The wiring diagrams given here show all the connections, which should be carefully checked after the wiring is completed.

To make sure that everything is connected correctly, insert all the tubes in the sockets, turn the rheostats up full and connect the "A" battery only to the "A+" and

(Continued on page 892)

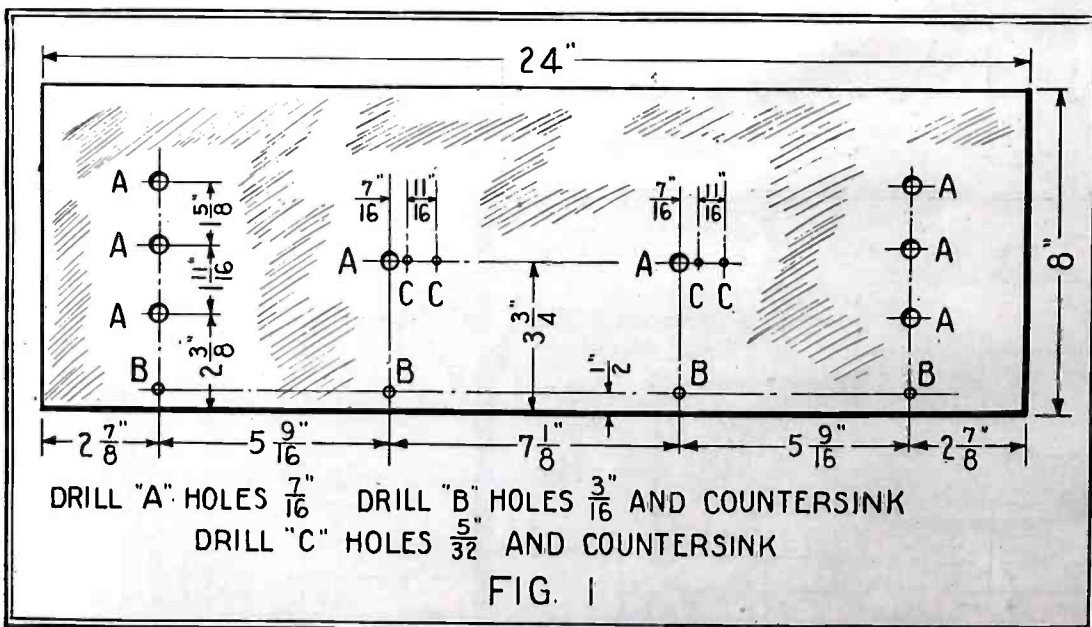

Details for drilling the panel of the receiver. There are very few holes as most of the apparatus is mounted on the baseboard.

Should the Air Waves Be Patrolled?

With Constructional Details of An Oscillator for Use With a Wavemeter

By H. G. CISIN

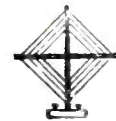

WHAT would happen to traffic at Fifth Avenue and Forty-second Street, New York City, if the traffic towers were dispensed with and the traffic officers were given an indefinite leave of absence? Undoubtedly, your imagination will picture a worse condition than that which would actually take place. Of course, there would be long tie-ups and traffic snarls, but common sense would finally prevail and by mutual consent, traffic would move first across the Avenue for awhile and then across the street. This would only be a makeshift and the resumption of official control by lights and traffic officers would meet with the approval of all concerned.

In a recent interview, Mr. Arthur Batcheller, United States Radio Supervisor for the Second District, disclosed some of the methods which the government is prepared to put into effect in patrolling the air waves, as soon as the expected and hoped-for legislation goes into effect. Mr. Batcheller stated that under existing laws there was nothing to prevent the amateur, or for that matter the commercial code stations, from breaking into the wavelengths assigned to the broadcasters. Under the circumstances, he declared, it was useless for the government to check up on the wavelengths being used. However, just as soon as the necessary legislation is passed, Mr. Batcheller will keep a force of "traffic officers" continuously on duty, checking up amateurs, broadcasters and commercial stations. Accurate measurements will be made by the "zero beat" method, which requires the use of a receiving set, a frequency meter (wavemeter) and a radio-frequency generator.

During the interview Mr. Batcheller showed the apparatus, which will be used and put this into operation, checking up on station WEAJ, which happened to be broadcasting at the time. A standard radio receiving set was used to tune in the station, using a loud speaker instead of a head set. The rheostats controlling the filament current were turned back until the broadcasting was just discernible, thus insuring sharpness in tuning the set. A small vacuum-tube generator was next tuned to the same frequency as the incoming wave. This tuning was performed by means of the beats between the output of the generator and that of the

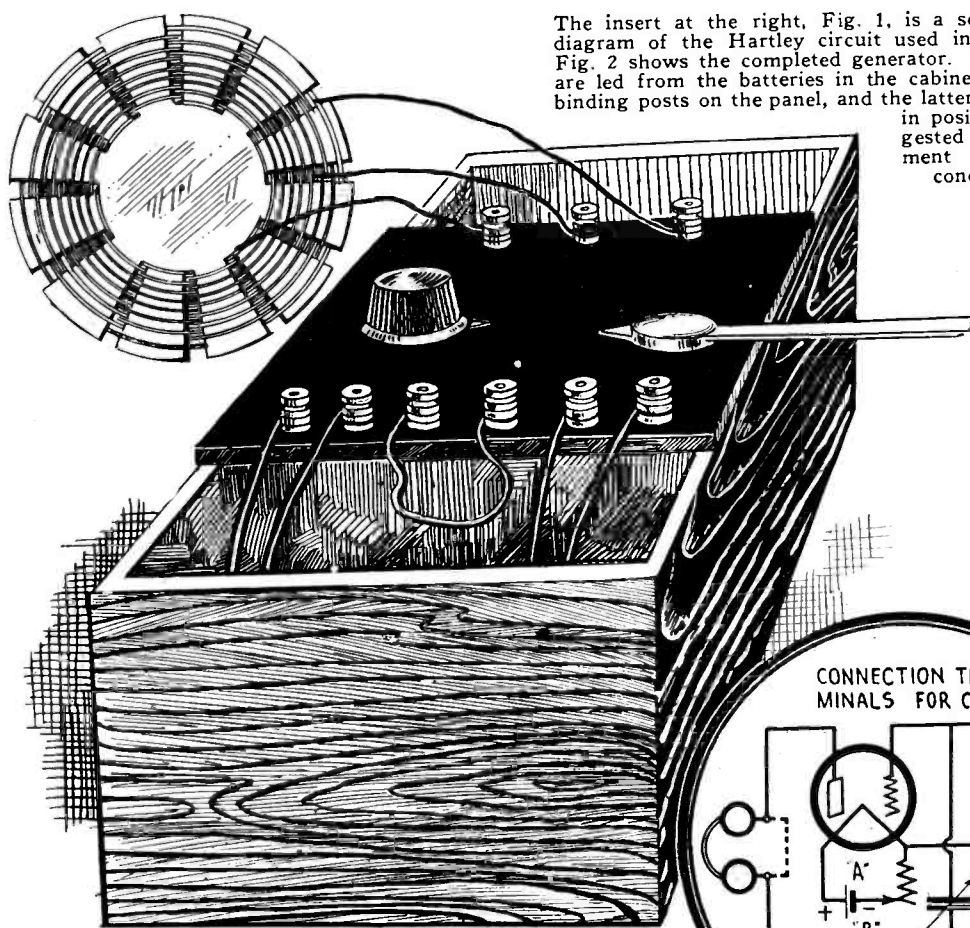
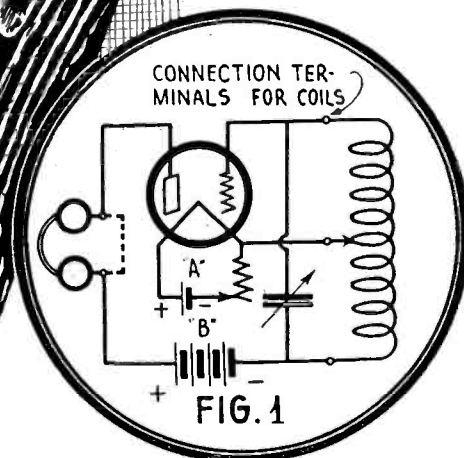

FIG. 2

The insert at the right, Fig. 1, is a schematic wiring diagram of the Hartley circuit used in the generator. Fig. 2 shows the completed generator. Insulated wires are led from the batteries in the cabinet to the correct binding posts on the panel, and the latter is then secured in position. The suggested panel arrangement permits short connecting wires.



incoming wave. The frequency of the generator was regulated until the sounds produced by the beats in the receiving set loud speaker were entirely eliminated. In other words, the frequency of the beat note was reduced to zero, and hence the generator had exactly the same frequency as the incoming wave. A wave meter was then brought near the generator so as to be in inductive relationship to it and the wave meter was tuned until it indicated resonance. A reading was then taken and from a curve the exact wavelength of the broadcast wave was determined.

A fundamental requirement of the generator used in conjunction with a frequency meter and radio receiving set is that it be of sufficient power to permit precise adjustments of the frequency meter. When the latter device is equipped with a certain type of resonance indicator, a low power generator such as an electron tube operated by dry batteries can be used. However, with the usual type of resonance indicator, a generator of about 5 watts is required. The schematic wiring diagram of the well-known Hartley circuit is shown in (Continued on page 924)

"Hard" and "Soft" Detector Tubes

A Comparison of Their Characteristics and Respective Merit

By ROGER WILLIAMS*

THE gas-filled, or "soft," tube, used as a detector, is undoubtedly the most sensitive for this purpose: but, for ordinary receiver operation, this sensitivity is more than outweighed by the following serious disadvantages:

The gas-filled detector tube is always more or less critical in the adjustment of filament current and plate voltage. The older types were extremely critical in these respects; so much so that only a well-trained radio technician was able to employ them to advantage. The later types, developed from these earlier tubes, while doubtless constituting a great improvement, have by no means overcome this defect. Filament

adjustment will be found more critical than with the "hard", or high-vacuum, type of tube. The plate battery adjustment, likewise, will be found quite critical, especially with regard to the residual, or "background" noise.

TEST BY REPRODUCED SPEECH

All soft detector tubes have a "background," which is extremely noisy compared with that of a hard tube. This background is not usually disturbing during the reception of rather loud speech or music, but shows its disagreeable affect as the received signal grows weaker. This is just the time when we wish the detector tube to function

at its best, as we do not need an especially sensitive detector for local reception. A careful comparison of a hard tube with a soft one, made when one is listening to voice which is just understandable, will show that it is much easier to follow the speech when the hard tube is used. Since what we desire is to understand and enjoy our broadcast reception, it is of no avail to make an extremely loud noise in our receiver or loud speaker, if this noise does not consist of intelligible speech or music.

All gas-filled tubes are unstable in operation. They require a considerable period of (Continued on page 898)

*C. E. Mfg. Co.

A Versatile Super-Heterodyne

Optional Hook-ups of the Receiver Illustrated In December RADIO NEWS

By LESLIE RAYMOND JONES

PART II.

PRECAUTIONS IN BUILDING

Be extremely careful to have none of the grid wires parallel to any plate wires. This

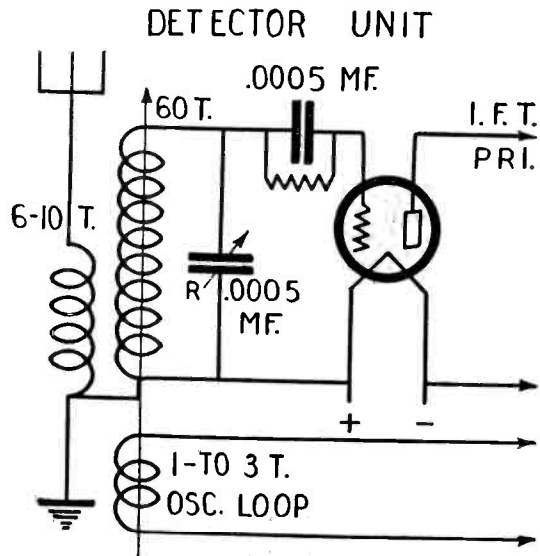

FIG. 1

Circuit diagram of first-detector unit employing a grid leak and condenser for obtaining grid bias.

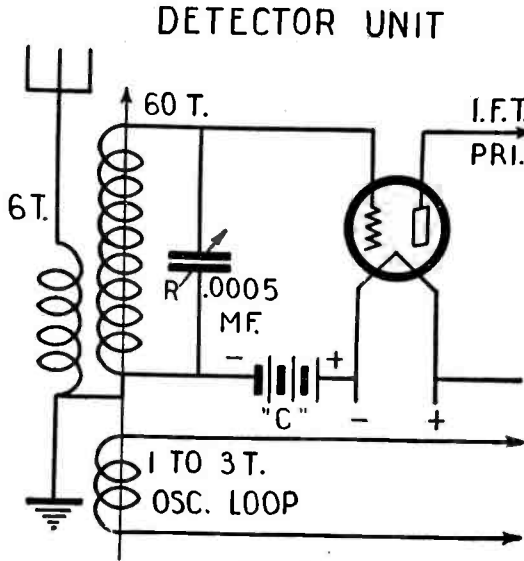

FIG. 2

A first-detector unit employing a "C" battery, instead of a grid leak and condenser, for the grid bias.

Keep all the wires as short as consistent with the layout.

Use the best tubes you can buy. Poor tubes are of no use when results are the

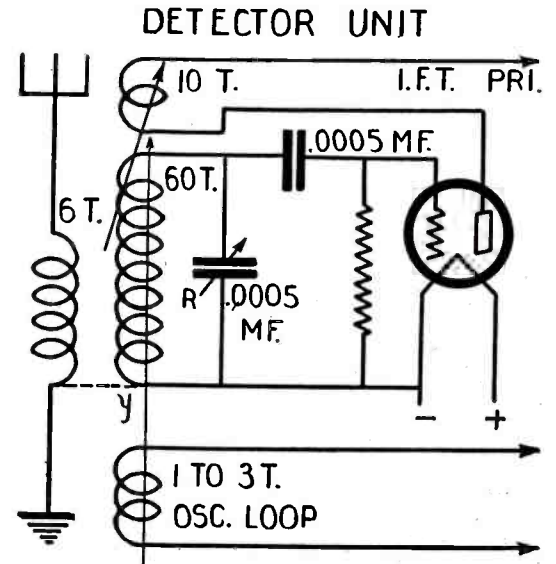

FIG. 3

A first-detector unit wherein regeneration is employed through the use of the ten-turn tickler coil.

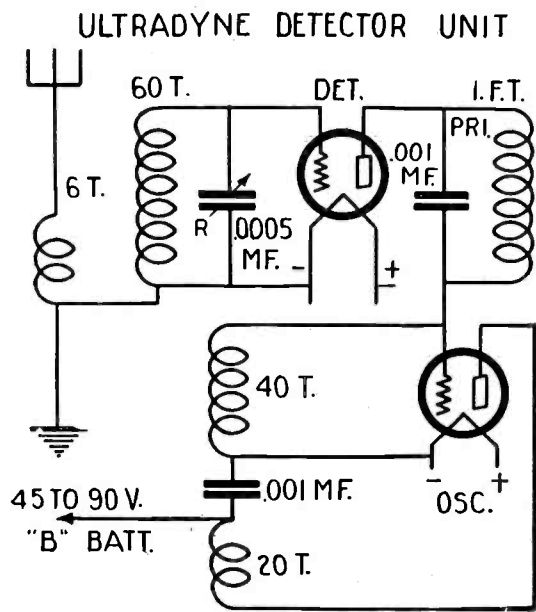

FIG. 4

In the detector unit or "Modulator", there is no "B" voltage on the plate of the tube.

is probably the most important "don't" in the radio catechism. Parallel plate and grid wires will cause whining or howling, undesirable oscillations, and seriously interfere with selectivity and calibration. Because a "super" has lots of power, don't think good results can be had if all kinds of liberties are taken with the construction. Good parts must be used throughout, and precaution taken against poor joints, both mechanical and soldered, on all pieces of apparatus used.

The detectors must be kept below the oscillating point; in fact all tubes must be for that matter, except the oscillator tube, which must oscillate to function as a frequency changer.

Be careful of grid leaks. Adjust their value carefully where and when they are used. Grid leaks have an important function; although they might seem only trivial, they are most important to clear-cut reception.

Keep all batteries up as nearly to full rating as possible. Good, clear reception can't be had with poor, run-down "A", "B", or "C" batteries. Use a tester frequently and know their condition. Don't guess at it.

Keep all coupling coils loosely coupled. The antenna coupling should be especially loose. Many foreign noises and much so-called static can be eliminated by doing this, while at the same time increasing selectivity to a remarkable degree.

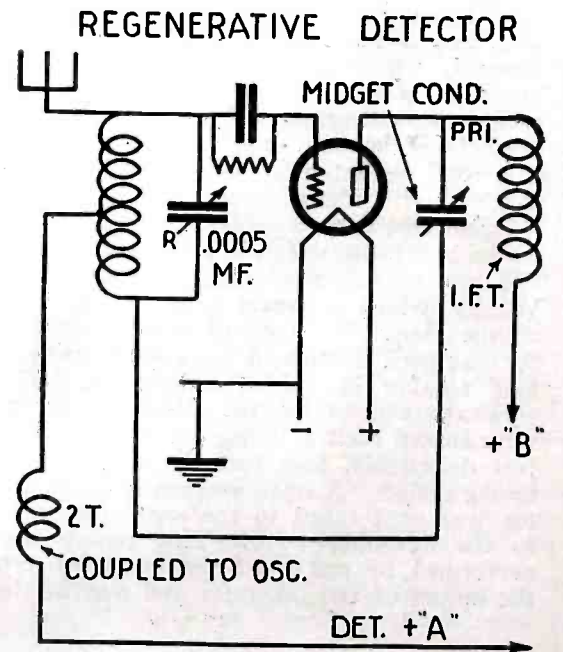

FIG. 5

Another regenerative first-detector unit, employing capacity feedback instead of inductive plate-to-grid coupling.

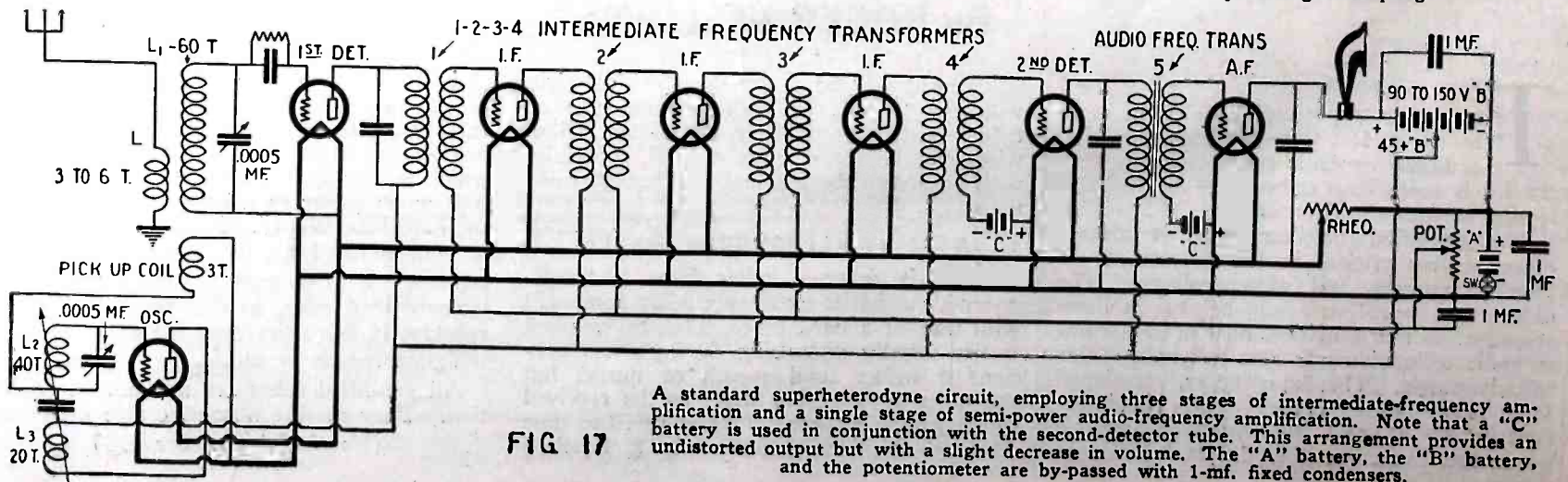

FIG. 17

A standard superheterodyne circuit, employing three stages of intermediate-frequency amplification and a single stage of semi-power audio-frequency amplification. Note that a "C" battery is used in conjunction with the second-detector tube. This arrangement provides an undistorted output but with a slight decrease in volume. The "A" battery, the "B" battery, and the potentiometer are by-passed with 1-mf. fixed condensers.

OSCILLATOR CIRCUIT

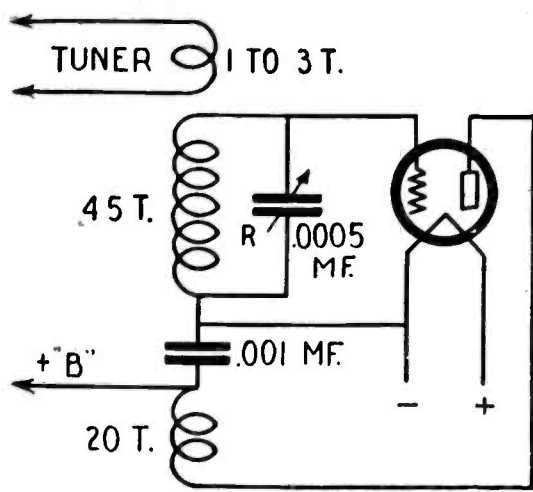

FIG. 7

A typical oscillator circuit. Note that the variable condenser is connected across the grid coil only. A small pick-up coil induces the oscillations in the first detector circuit.

PUSH PULL DETECTOR

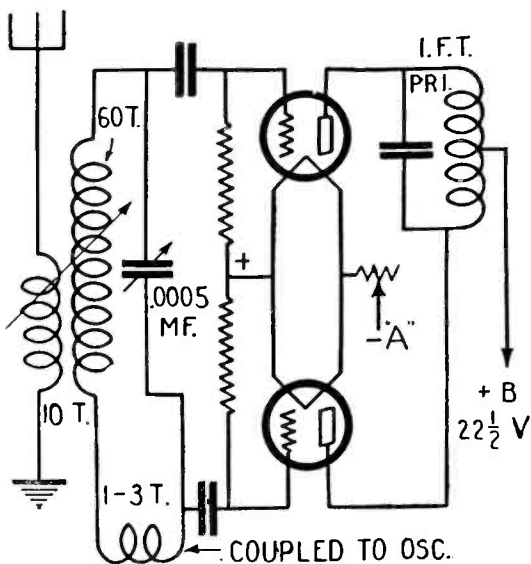

FIG. 6

This push-pull arrangement can be used in the second detector as well. It is capable of handling excessive energy without overloading.

OSCILLATOR CIRCUIT

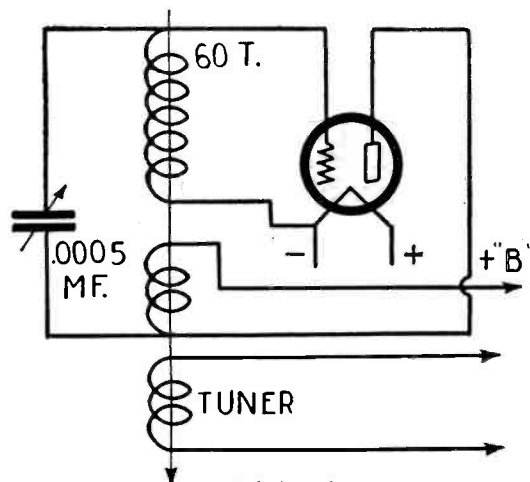

FIG. 9

An oscillator circuit wherein the variable condenser shunts both the grid and plate coils. A pick-up coil is employed, instead of direct coupling, and is more satisfactory, particularly if the coupling is variable.

objective. Have them tested occasionally to check up on their condition.

Use as small a collecting agency as is consistent with the distance desired. Long antennae collect more than the desired signals, so be careful here.

Use a loud-speaker that you know will reproduce notes over the entire range of audio frequencies with faithfulness. Don't economize here if you want music.

And lastly, don't force the tubes beyond their reasonable capacity. When all circuits are tuned to their maximum sensitivity, even though the set does get the distance, it may be found that the tone has been sacrificed.

SOME SUGGESTED COMBINATIONS

Some different circuits that may be tried are shown and will be more or less self-explanatory to the experimenter. All of these have been tested by the author and while they all "work," different combinations can

SECOND DETECTOR UNIT

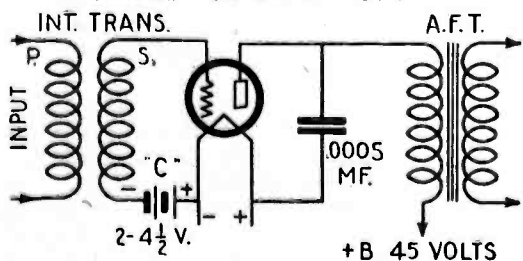

FIG. 10

A second-detector unit employing a "C" battery for obtaining the necessary grid bias. The "C" voltage should be adjusted while the set is in operation.

OSCILLATOR CIRCUIT

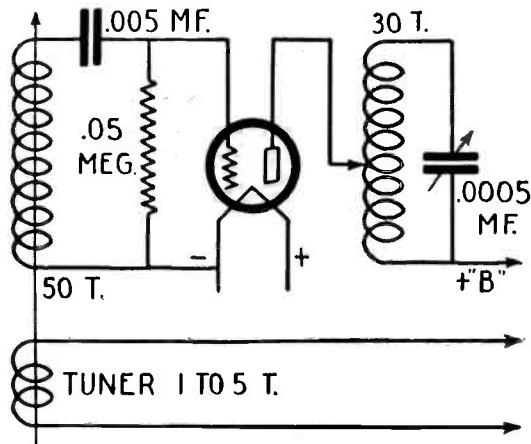

FIG. 8

An oscillator circuit of novel type. The grid leak should be adjusted carefully. This is fairly critical but the arrangement functions very well.

much to the experimenter's radio and electrical education, as well as afford an extremely fascinating pastime.

The use of regeneration in the first detector by the method shown in Fig. 5, is more efficient, the writer finds, when a loop is employed. From experiments he determined that the tonal quality was also much affected by the use of so-called fixed regeneration and, therefore, discarded its use. Sensitivity gained by the sacrifice of tone in the output is not particularly advantageous, ex-

THE ULTRADYNE

Another interesting first detector circuit that may be used is the "Ultradyn" modulation system. (See Fig. 4.) From tests on the writer's receiver this method was by far more sensitive on weak signals. In fact, according to the theory of the circuit as explained by Mr. Lacault, its inventor, a signal response is effected, no matter how small the amount of received energy from the collecting system. From practical audibility tests the writer has, to his own satisfaction, proved this to be true; and furthermore, the tonal quality is of the best.

SECOND DETECTOR UNIT

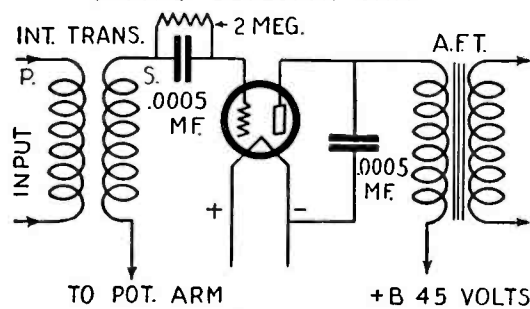

FIG. 11

A second-detector unit employing a grid leak and condenser to obtain the grid bias.

Excellent results are obtained using only 45 volts on the oscillator tube; and although higher voltages may be used and recommended, this seemed sufficient for all practical purposes. Keeping the "B" voltage as low

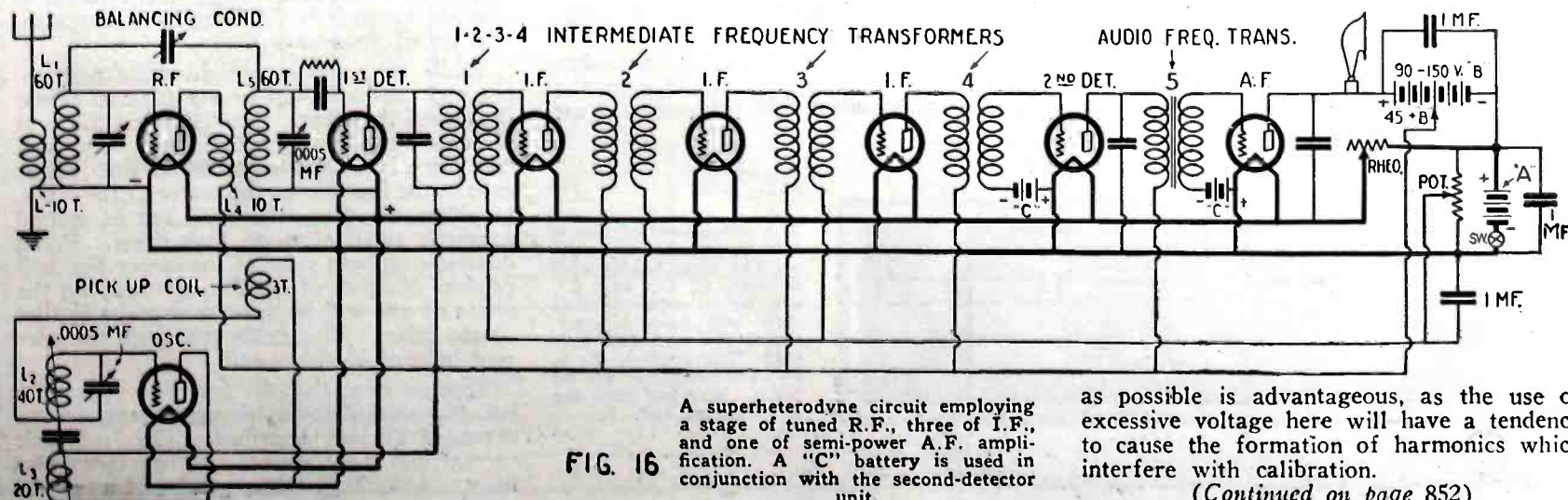
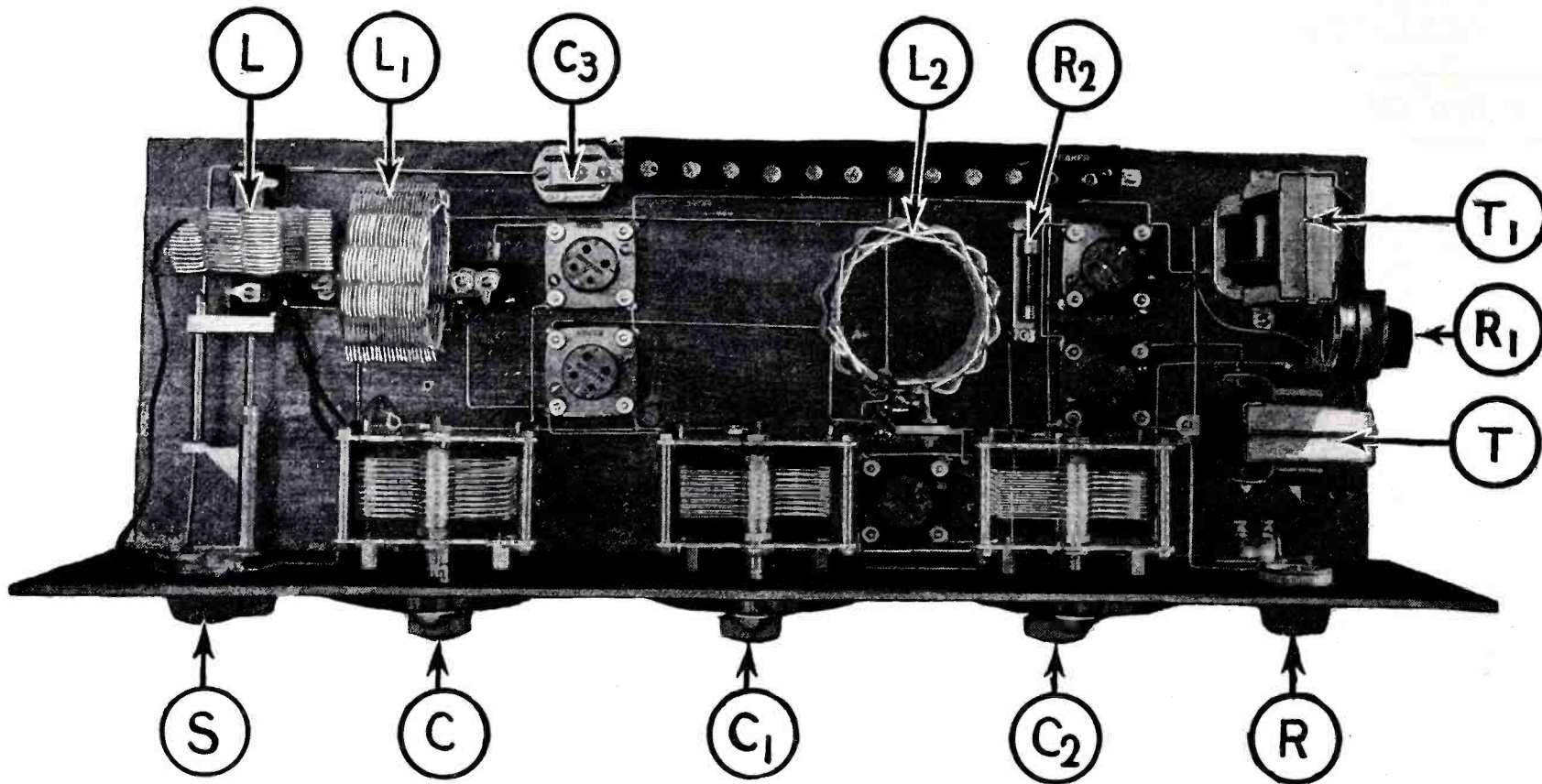

FIG. 16

A superheterodyne circuit employing a stage of tuned R.F., three of I.F., and one of semi-power A.F. amplification. A "C" battery is used in conjunction with the second-detector unit.

as possible is advantageous, as the use of excessive voltage here will have a tendency to cause the formation of harmonics which interfere with calibration.

(Continued on page 852)



The top view of the Powers-Casem 5-tube receiver. L, L1, and L2 are the antenna coil, and the radio-frequency transformers respectively; C, C1, and C2 are three tuning condensers; R is a 30-ohm rheostat; R1, a 200,000-ohm variable resistance; R2, automatic filament control; T and T1, A.F. transformers; and C3, a .0001-mf. fixed condenser.

The Powers-Casem Receiver*

A Five-Tube Set Employing a New System of Variable Neutralization

By DAVID G. CASEM and ALVIN J. POWERS

TO be adopted in more than a thousand receivers, made in the homes of as many radio fans in less than one month, is a record for any circuit. It would have been so even in the days when uncritical credulity was the outstanding characteristic of said fans. Today a designer must have a real circuit, and it must include some meritorious idea, to appeal to the average "bug;" or it will be just another of "those things."

When the Powers-Casem receiver (which was designed to appeal only to those who make their own) was made public, it had the advantage of being previously heard by more than 3,000 fans, who were so struck by its sensitivity, selectivity, volume and quality, that they were impatient to get it going.

Its designers began the set about two years ago, first drawing up a working program with a view to seeing that it should be cheaper, as well as better in quality and in all-around general performance, than any other five-tube receiver we had seen or heard. That meant we had to throw out apparatus for which many claims of "efficiency" had been made. We even took the grid condenser and leak out of the circuit, and made the set so simple that any novice could put it together.

THE Powers-Casem receiver, which is described on the following pages, is one to which our readers will do well to give careful consideration. It has five tubes, two of which are of the 199 type, these being used in the radio-frequency amplifier. The other three are of the 201-A type; or, if desired, the last tube may be a power amplifier.

The set is comparatively easy of construction; it has excellent distance-getting possibilities and if it is correctly constructed, the quality of its reproduction should be of the finest. It also has a new feature in a device for the controlling of oscillations, which makes it a non-radiating receiver.

THEORY OF BALANCING

The efficiency of this receiver is due to two novel arrangements. One is the method used to balance the radio-frequency amplifier tubes, and the other is the detector circuit used.

Balancing is accomplished through the use

of the magnetic fields of the transformers. Ordinarily the stray magnetic fields are the chief source of trouble in a radio receiver. The coils must be placed in exactly the right relationship, so there is no transfer of energy from one to the other, or the set cannot be neutralized.

However, in the set under discussion, the magnetic fields are used to balance out the capacity feed-back due to the internal elements of the radio-frequency amplifiers. In order to eliminate an undesirable current it is necessary to oppose it with another of equal strength but of opposite phase, which can be produced by placing the radio-frequency transformers in the right relationship to each other. An arrangement that can be readjusted at will is also necessary, since the current to be overcome varies with the frequency of the amplified signal.

The antenna inductance and the two R.F. transformers L, L1 and L2 (See illustration) are placed at right angles to each other; the first is attached to a device which makes it possible to vary its relationship to the adjacent transformer at will.

While they are in a right-angle position, one coil can be moved to any position across the end of the other. When the first coil is at the center position no transfer of energy will take place from one to the other. But just as soon as the first passes the center of the other, in either direction, the coils are in mutual magnetic relationship to each other. Equal distances on both sides of the center line will produce currents of equal magnitude, but the phase of one will be directly opposite to that of the other. This holds true with the current induced in either coil.

Suppose now, that the first two coils of a two-stage tuned-radio-frequency receiver are arranged as just described. The feed-back current, due to the capacity of the internal elements of the R.F. tubes, will be of a certain

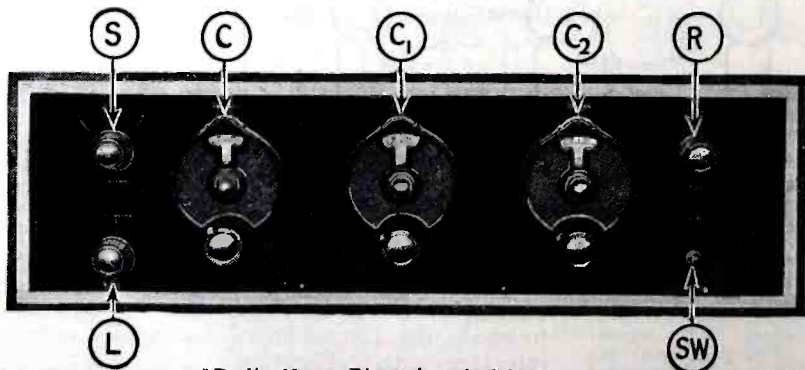

The panel view of the 5-tube Powers-Casem receiver. The three tuning condensers, C, C1, and C2, can be so adjusted that they will have approximately the same dial readings. The control, L, is for balancing the set by sliding back and forth the antenna coil. L.

*Radio News Blueprint Article No. 3.

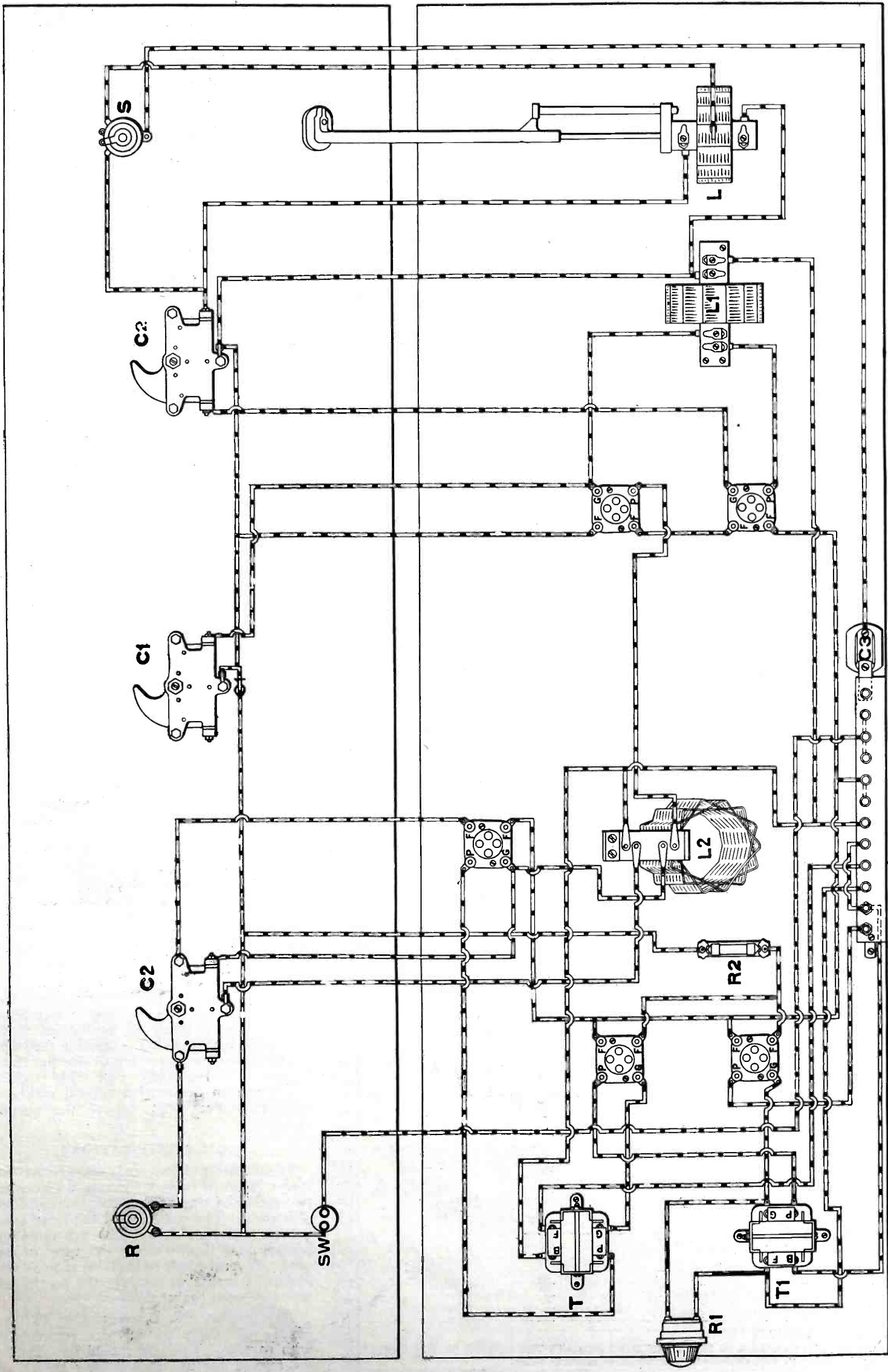

T.J. C-C-B+B-A+ C+A-Gnd. Ant.
9 4 1 135 90

Above is shown, in easily-followed picture form, the complete wiring of the Powers-Casem receiver. As you solder each wire in place, run a pencil line through the dotted line representing that wire on the diagram: when you have blocked out all the lines you know that you have completed the set. The component parts shown herewith have been purposely drawn small, in order to make the connecting wires stand out. For accurate-scale drawings of the receiver panel and baseboard, see the other plates accompanying this article.

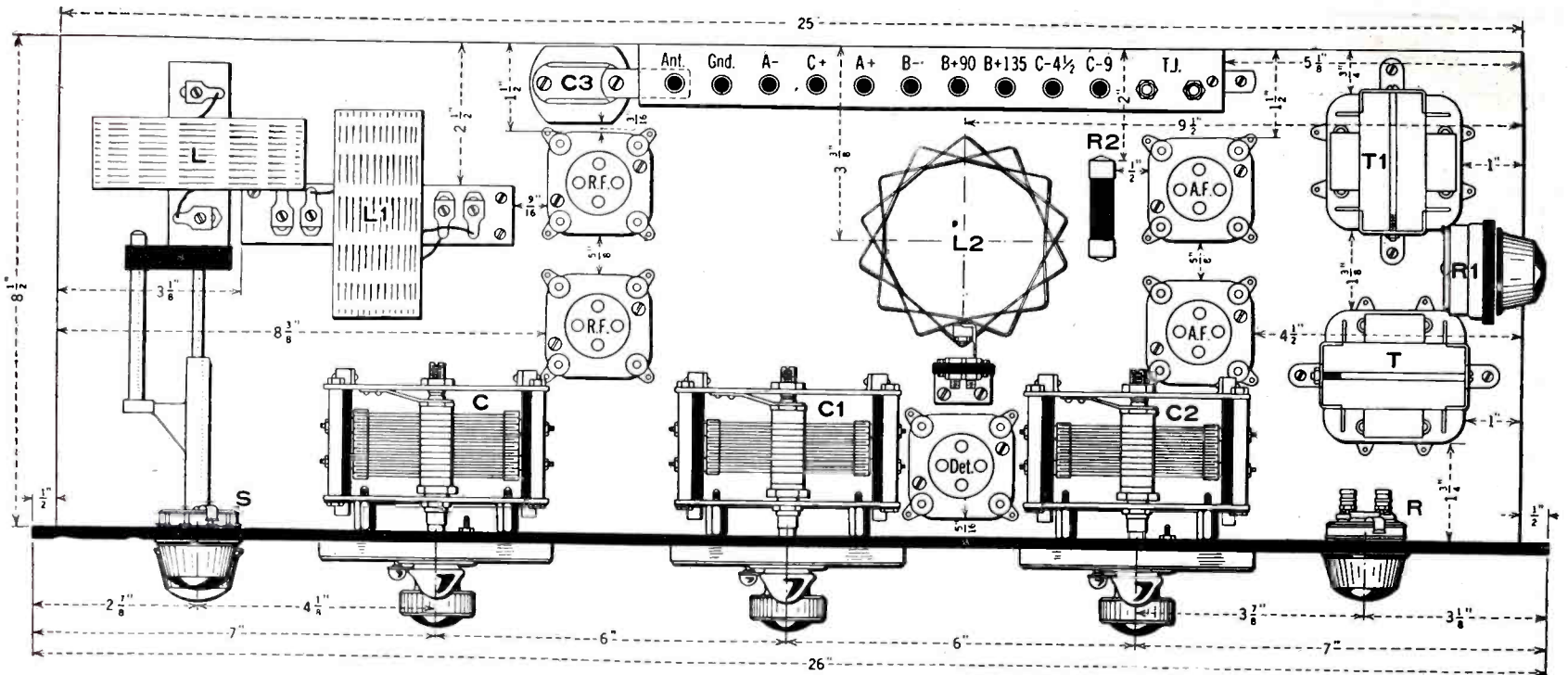

By means of this working drawing, the apparatus can be correctly located on the panel and baseboard. A drawing of this type will be found to be a great aid in construction.

strength, depending upon the type of tube used, the frequency of the signal and the characteristic lay-out of the set. If the first coil is moved in one direction, the induced current in both coils will add to the strength of the feed-back current; but if it is moved in the other direction a current of opposite phase will be produced and the undesirable current will be eliminated. The coil should be moved to the point where the tubes are neutralized, and left in this position until a different station is tuned in.

There is a limit to the amount of current that can be produced with the arrangement

just described. Some tubes have such a high internal capacity that they cannot be neutralized in this manner. One stage of radio frequency, using the 201A type tube, can be neutralized very easily; but the current becomes so great when two stages are used that it is unmanageable. Two stages can be employed, however, when the 199-type tubes are used.

Many radio fans will be interested in the theoretical explanation of the phenomena just described. The same principles of magnetic induction are used here that we find in the case of electric motors and generators. Each coil acts exactly like a bar magnet in

its effect upon the other coil. When one end of an inductance is turned toward the other coil, a current will flow in a certain direction; and when the other end of the first coil is closest the current will flow in the opposite direction. Of course, the polarity of the coils alternates with each oscillation of the signal. The effect is the same as though a bar magnet were rotated, end for end, in the field of the coil.

HIGH DETECTOR VOLTAGE

Such a tremendous signal can be built up, with the radio-frequency amplifier just described, that the conventional detector circuit cannot handle it without a great deal of distortion. The detector would also break into violent oscillation, especially when the higher-frequency signals were detected. This led to a number of experiments in search of a better detector system.

Almost everyone is familiar with the distortion caused in audio-frequency amplifiers when the bias of the grid is not sufficiently negative, or when the plate voltage is not great enough. Experiments proved a similar condition to be the cause of distortion in the detector; so an arrangement was made whereby the negative bias of the detector grid was controlled by the rheostat. It was found that the best plate voltage was 90; but as high as 135 volts can be used on the detector plate.

The remainder of the circuit follows along conventional lines. Some trouble may be encountered as a result of oscillations in the last audio amplifier, but a variable resistance placed across the secondary of the last transformer will generally cure this trouble. There are on the market several makes of high resistances that answer the purpose very well.

COIL SPECIFICATIONS

The receiver illustrated consists of two stages of tuned radio frequency, detector and two stages of transformer-coupled audio amplification. The constants of the three tuned inductances (L, L1 and L2) are quite important and depend upon the type of coil used. Several kinds of coils were used with success, but that which gave the best results was the loose basket weave.

The antenna coil, L, consists of 48 turns of No. 20 triple cotton wire impregnated with paraffin. The coil should be tapped in the middle for use with a long aerial, and for tuning on the shorter waves. This coil is tuned by condenser, C, which has a capac-

SYMBOL	Quantity	NAME OF PART	VALUE OF PART	REMARKS	MANUFACTURER ★
C1, C2	2	Variable cond.	.00035 Mf.		1 23, 19, 27, 31, 32, 33, 40
C	1	Variable cond.	.0005 Mf.		1 2, 3, 19, 27, 31, 32, 33, 40
L, L1, L2	3	Coils		Set covering 220 to 570 meters	4
	5	Sockets		UX type	5 6, 10, 28, 31
C3	1	Fixed cond.	.0001 Mf.		7 13, 14, 31
S	1	Switch		2 point inductance	8 18, 5
R	1	Rheostat	30 ohms		8 14, 13, 17, 15, 31
SW	1	Switch		Filament	8 18, 5, 17, 14
	3	Dials		Vernier	9 16, 32, 33, 34, 31
TJ	2	Tip Jacks		For loud speaker	8 17, 18, 29
	9	Binding posts			10 19, 24, 31
T, T1	2	A. F. Trans.			5 20, 21, 22, 32, 33
	1	Panel		7" x 26"	11 23, 24, 35, 36
	1	Baseboard		8 1/2" x 25" x 5/8"	11 23, 24, 35, 36
	3	Tubes	6V. 1/2 amp.	Standard type	12 25, 26, 30
	2	Tubes	3V. 50W.-A.	Dry cell type	12 25, 26, 30
	1	Binding post strip		1" x 10" x 3/16"	11 19, 23, 24, 35, 31
	1	Neutralizer		Part of coil	4
R1	1	Var. Resis.	200,000 ohms		14 18,
R2	1	Auto. Fil. Control	1/2 amp.		37 38, 39

NUMBERS IN LAST COLUMN REFER TO CODE NUMBERS BELOW.

1 A. D. Cardwell Mfg. Corp.	17 H. H. Frost, Inc.	33 Kares Elec. Co.
2 General Instrument Corp.	18 Yaxley Mfg. Co.	34 Kurz-Kasch Co.
3 Hammarlund Mfg. Co. Inc.	19 X-L Radio Labs.	35 DuPont Viacoloid Co. Inc.
4 Radio Eng. Labs.	20 American Trans. Co. (Amertran)	36 Formica Insulation Co.
5 Pacent Elec. Co. Inc.	21 Thorndarson Elec. Mfg. Co.	37 Radiall Co. (Asperits)
6 Benjamin Elec. Mfg. Co.	22 Bremer-Tully Mfg. Co.	38 Langbein Kaufmann Radio Co.
7 Sangamo Elec. Co.	23 Diamond State Fibre Co. (Celaron)	39 Daven Radio Corp.
8 Carter Radio Co.	24 Ins. Co. of Amer. (Insuline)	40 National Co. Inc.
9 National Co. Inc.	25 E. T. Cunningham, Inc.	41
10 H. H. Eby Mfg. Co.	26 C. E. Mfg. Co. (Ceco)	42
11 Amer. Hard Rubber Co. (Radion)	27 Gardiner & Hepburn, Inc.	43
12 Radio Corp. of America	28 Allen Mfg. Co.	44
13 Polymot Mfg. Corp.	29 Union Radio Cor.	45
14 Electrad, Inc.	30 Van Horne Co. Inc.	46
15 Central Radio Lab. (Centralab)	31 Ameco Products Inc.	47
16 Martin-Copeland Co. (Marco)	32 Samson Elec. Co.	48

APPROXIMATE COST OF PARTS \$ 35.00

★ THE FIGURES IN THE FIRST COLUMN OF MANUFACTURERS INDICATE THE MAKERS OF THE PARTS USED IN THE ORIGINAL EQUIPMENT DESCRIBED HERE.

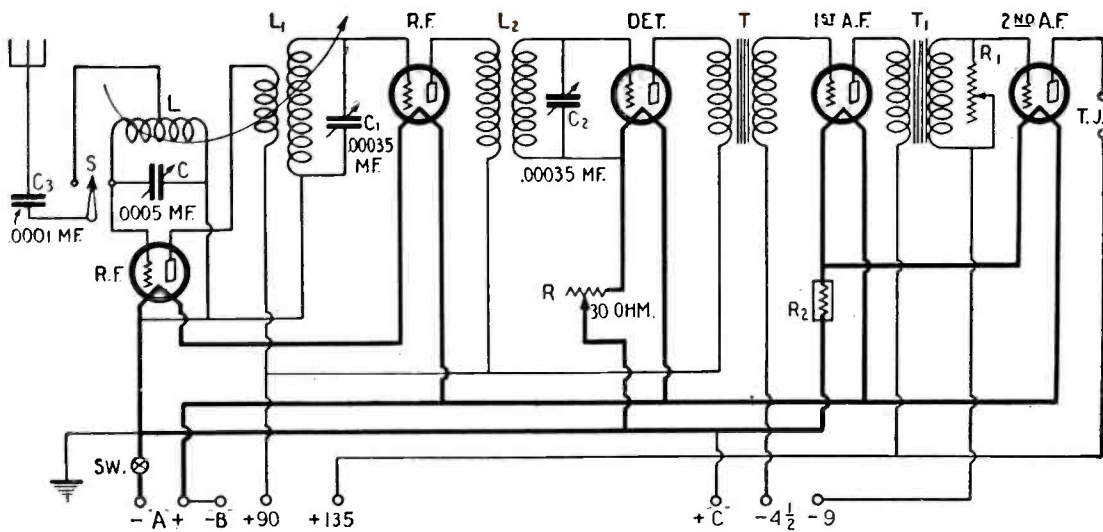

Schematic diagram of the Powers-Casem receiver. It will be noticed that there are comparatively few connecting wires (see diagram page 819) thus making the construction of the set easy.

ity of .0005-mf. The first radio-frequency transformer, L1, has a secondary of 60 turns of No. 20 wire similar to that just described, while the primary consists of 26 turns of No. 30 wire, also triple cotton covered, and impregnated with paraffin. This transformer is tuned by condenser, C1, which has a capacity of .00035-mf. The second R.F. transformer, L2, is similar to the first, except that its primary consists of but 12 turns. The capacity of its tuning condenser, C2, is .00035-mf.

The primaries are wound with the secondaries at the filament ends of the latter coils. The 90-volt battery leads should be made to the outer terminals of the primary windings, with the plate leads going to the inside ends.

If ordinary solenoids are used, the number of turns in the primaries will have to be increased about ten in each case. This is because the exceptionally close coupling in the basket-weave type of coil requires fewer turns.

A 199-type tube should be used in each of the radio-frequency stages. The internal capacity of the 201A is too great to permit it to be used in this receiver. One stage of R.F., using a 201A can be controlled very easily; but when another stage is added it becomes uncontrollable.

It is not absolutely necessary that the apparatus be placed as shown in the diagrams. There are any number of ways in which the apparatus may be mounted in the set,

yet no difficulty encountered. The set has been placed successfully in an ordinary phonograph cabinet, the panel being only fifteen inches in length. Of course, in this case, the audio amplifiers were placed behind the other apparatus.

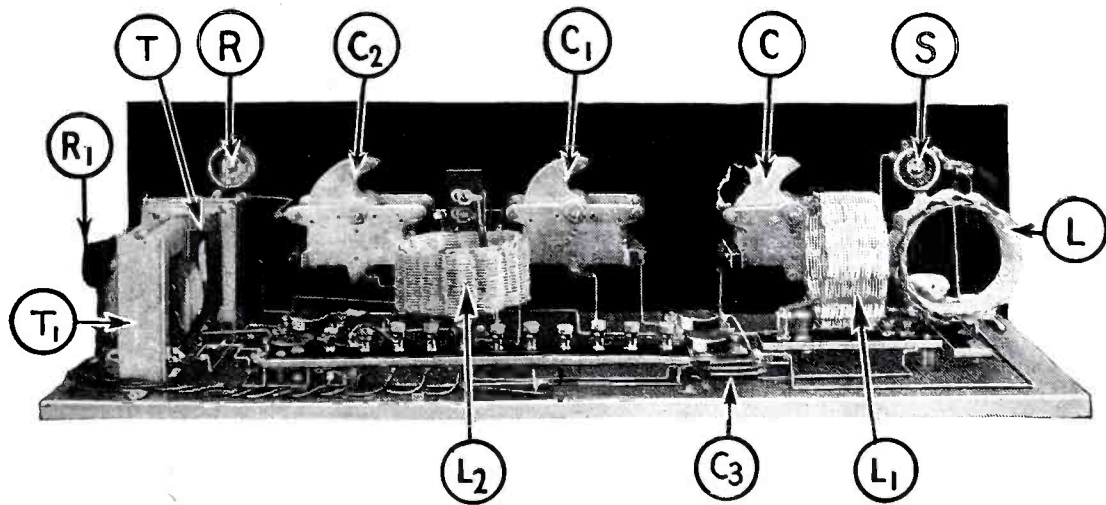

Rear view of the Powers-Casem receiver. The antenna coil, L, slides back and forth before L1; this being the manner of controlling oscillations.

ASSEMBLING THE SET

The panel should be drilled and all its apparatus mounted before it is placed on the baseboard. The mounting for the first radio-frequency coil L1 should be the first thing

after the panel has been secured to the baseboard. It is important to get this device in exactly the right place. The neutralizer plunger should be pushed to the half-way position and the antenna coil L placed in its mounting. Coil L1, in its mounting should now be placed so that the center of L is exactly in front of the center of the open end of L1; the coils are then removed and the mounting for L1 secured to the baseboard.

Mount the binding-post strip in a central position at the rear of the baseboard. Place the sockets for the two radio-frequency tubes between the first and second R.F. transformers. The filament posts should be at the right and the grid and plate lugs at the left; this arrangement shortens a great many leads. The second R.F. transformer coil should be mounted at least five or six inches to the right of the other. If home-made coils are used, care should be taken to get the coils at the right height from the baseboard; their center points should be at the same distance above the baseboard.

The detector socket may be placed between the second and third tuning condensers and the two A.F. sockets just to the right of the last coil, with the two audio transformers at the extreme right end of the baseboard. This is a particularly good position for the audio

transformers, since they are entirely out of the field of the coil. If they are placed too near the R.F. coils the efficiency of the receiver will be lowered, and the tuning dials (Continued on page 897)

Radio Production Has Tripled In Two Years

THE census of manufactures for 1925, now in process of tabulation, has been totaled as regards the radio industry; and is rather expressive in its showing of the changes taking place. The number of receivers commercially manufactured increased over five times; but dividing these products into crystal and tube sets, we find that the number of the latter produced decreased by one half between the two years—from 223,303 to 112,656. On the other hand, the factory-built tube sets increased in number from 190,374 to 2,180,622, or more than eleven times; their value (factory cost) from \$13,326,116 to \$88,800,538, or about six times.

It will be noted that the result of the greater mass production was to cut the factory cost of the average receiver from \$70 in 1923 to \$40 in 1925, while improvements in mechanical and electrical design have been constant. The production of tubes also increased more than five times—from 4,687,400 in 1923 to 23,934,658 in 1925—while the production cost of the average tube was lowered from \$2.10 to 86 cents.

On the other hand, the trend toward higher power in transmission is shown by the fact that the number of transmitters commercially built in 1925 was but 1,076, six less than in 1923; while the average cost was nearly 50% higher. The total value was \$1,355,430, or an average of \$1,260 apiece, last year.

While loud-speaker production was multiplied by four—from 623,146 to 2,606,866—in the two years, the average production cost fell from \$9.00 to \$7.35. The growing preference for loud-speaker reception is indicated in a decrease of 21.6% in the number of headsets produced—from 1,781,793 to 1,397,443.

The total value of the manufactured products of the industry in 1925 (subject to minor corrections) was \$170,390,572, an increase of 215.5% over the \$54,000,470 recorded at the preceding census. These figures, however, do not include numerous accessories, such as batteries, nor much material used with component parts assembled outside of the factories. They indicate production costs, and consequently the selling costs of manufacturers, jobbers and dealers,

together with labor of installation, etc., should be added to arrive at an estimate of the public's investment in radio. From other sources it may be reliably stated that new investment in radio apparatus and maintenance of that in use amounted to over half a billion dollars in 1925, and more than that sum in 1926.

The details of the census of 1925 show the following production:

Apparatus Manufactured	\$ Value	Number Pieces	% Inc. in No.
Loud Speakers.....	19,162,591	2,606,866	318.3
Headsets	2,264,527	1,397,443	-21.6
Receivers:			
Tube type	88,800,538	2,180,622	1045.4
Crystal type	344,079	112,656	-49.6
Transmitters	1,355,430	1,076	-0.6
Transformers	7,457,805	3,413,993	117.2
Rheostats	2,084,188	3,531,871	225.5
Lightning Arresters	506,034	2,971,379	69.0
Tubes	20,437,283	23,934,658	410.6
Misc. Parts	27,978,097		*115.2
TOTAL	170,390,572		*215.5
-Loss			
* In Value			

Home-Made Coils for the Browning-Drake and Similar Circuits

Concluding A Description of Easily-Constructed Coils and Their Forms

By C. A. Oldroyd

PART II

The keen experimenter and the "Doubting Thomas" cannot do better than begin with a modest two-tube set, consisting of R.F. stage and detector. When this is working properly, the fan has mastered the most tricky part of the set and the final set will give no trouble. The addition of an audio-frequency amplifier should not be a difficult matter.

Whether you will use home-made or commercial coils, for the "final" set, depends entirely upon your skill and the time you are prepared to sacrifice to experiments. With commercial coils you can be sure of good results with least effort.

The patient and skillful worker will be able to turn out splendid home-made coils for the finished set; particularly if he has gained experience by constructing a small two-tuber to begin with. This personal ex-

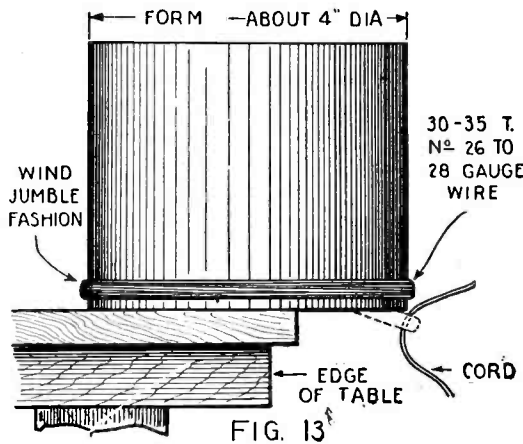

FIG. 13
Illustrating the initial step in the preparation of the "figure-8" coils; the "jumble" winding on a 4-inch cylinder.

FIELDLESS (FIGURE-8) COILS

To eliminate the necessity for lining up the coils, and to make the set more compact, various types of fieldless coils were tried as antenna coils. Some of them proved remarkably successful.

If we wish to retain the high efficiency of the Browning-Drake R.F. transformer coil, with its solenoid winding and the slot-wound primary, we must leave it as it stands at present. But the antenna coil can advantageously be a fieldless coil.

Such coils can be made very small, and it becomes possible to mount them underneath the sub-panel, leaving the top free for tubes and other parts. Toroid coils are "big fellows," consequently unsuitable for our purpose. But the simple "figure-8" coil fills the bill.

Figs 13 to 15 show the gradual steps when constructing a "figure-8" coil which is perhaps the easiest to make. First of all, we need a winding form about 4 inches diameter; the writer used a tobacco jar that happens to be of the right size. It has a wide opening and a very good grip can be obtained on it when winding the coil; a point of some importance when working single-handed.

The experimental coils are wound with D.C.C. wire of No. 26 gauge and enameled wire of No. 28 gauge; other sizes may prove as good or even better. Leave sufficient wire for the connections, and hold the beginning of the winding against the outside of the form with your thumb. Now wind on about thirty to thirty-five turns of the wire; this is the secondary.

Without cutting the wire, make a long loop and continue winding for another ten or twelve turns, and we have the primary. The latter is of course needed only if we decide to use a semi-aperiodic primary.

FINISHING THE COIL

Twist beginning and end of winding together to hold the wire in position and place the form with the coil on it on the table, the front edge of the form projecting about two inches. (See Fig. 13). Gently work down the winding till it is clear of the form, and pass a short piece of cord through the gap. Replace the wire on the form and secure the ends of the cord with a knot. Repeat this in three other places; the coil can then be slipped off the form and we have a ring-shaped self-supporting coil.

It is not exactly a low-loss coil, as the turns are close together, but still it proved very efficient on test. When winding, two points should be watched; the wire must not be wound on too tightly, and an effort should be made to produce a "jumble" winding by varying the angles of its windings. Then the wires cross and re-cross at a slight angle, and the self-capacity will be kept reasonably low.

To form the "figure-8" coil, twist the coil into this shape while holding it at opposite ends. (Fig. 14). The completed coil will resemble that shown in Fig. 15. Where the winding crosses over the coil should be bound with thin cord or tape to prevent it springing back again.

The result is a self-supporting coil of the fieldless type. Such coils could be fixed to the under-side of the sub-panel by placing a narrow strip of hard rubber or thin wood across it; two wood screws passing through

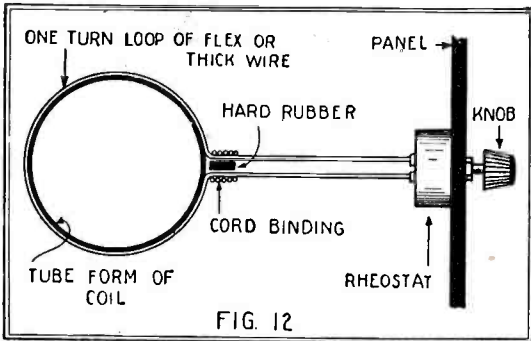
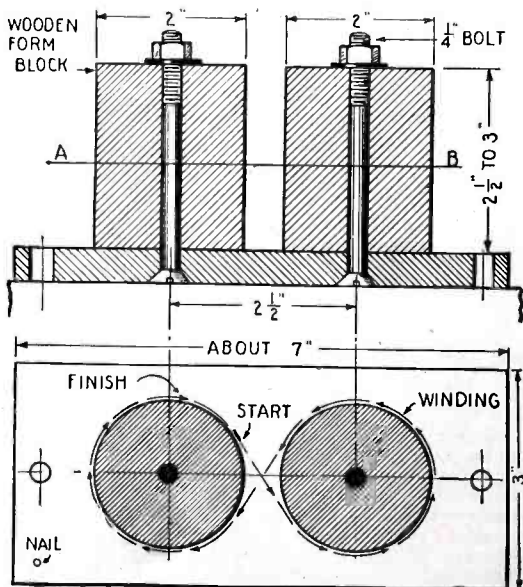

FIG. 12

This illustrates the method of rheostat-regeneration-control, described in Part I (December, 1926, RADIO NEWS).

perience will stand him in good stead when building other sets, of whatever type they may be. Best of all, he has the feeling that he is working on his own and getting away from the beaten track; and there are many of us who prefer to do some pioneering in our own little way.

During the past six months, the writer has built many experimental Browning-Drake sets, and he has come across some possible improvements—as yet not fully developed—which may be of interest to brother fans.



SECTIONAL PLAN ALONG LINE "A B"

FIG. 16

Above is illustrated a form for winding "figure-8" coils, which is easily constructed and handy to use.

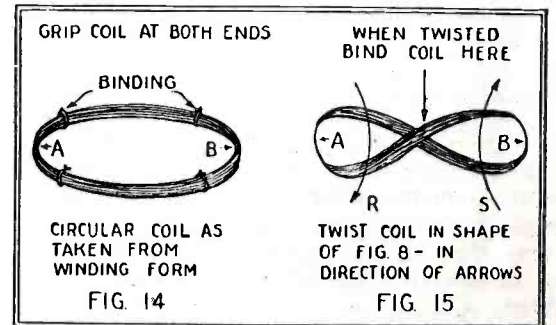

FIG. 14

FIG. 15

When the wire has been taken from the form (Fig. 13) it is twisted, as shown here, to form the fieldless coil.

clearance holes in the ends of the strip will hold a coil securely in position. If a hard-rubber strip is used, small terminals can be fitted to it to facilitate connections.

"DOUBLE PICKLE-BOTTLE" COILS

Another excellent fieldless coil that can be readily made is the "double pickle bottle" coil. It is wound over a double form of either circular or hexagonal cross-section. Fig. 16 shows the double form in detail; the form blocks have here a circular cross-section.

Two short round pieces of wood are bolted to a small baseboard, and long bolts pass through clearance holes in the forms and hold them firmly. The winding direction is indicated by the arrows in the plan view. Winding can be carried out with more com-

(Continued on page 844)

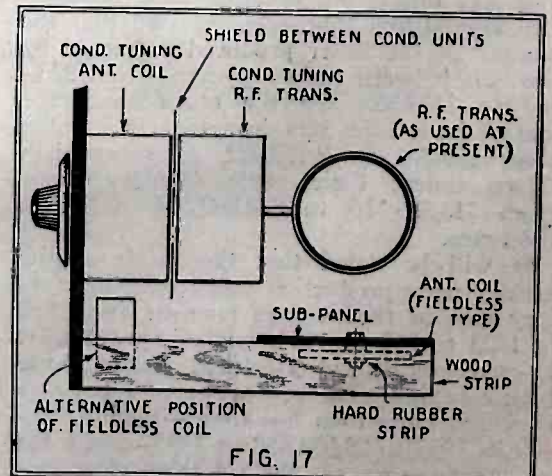

FIG. 17

Arrangement of apparatus for a Browning-Drake receiver employing tandem condensers.

Testing "B" Eliminators

A Description of the Step-by-Step Check in Their Manufacture

By EARL FREESE

IN preparing to place "B" battery eliminators on the market, radio manufacturers have been confronted with a number of serious problems. Their engineers have found that each unit must be working perfectly, according to a definite high standard, in order to produce the desired results; and that, to insure such uniformity, they must observe unusual precautions in the assembly and particularly in the testing processes. If an eliminator delivers a voltage considerably higher than that required by ordinary amplifying tubes, it tends to paralyze them; while if it fails to deliver a voltage high enough for regular service it is equally troublesome. Slight deficiencies in internal parts invariably betray themselves by the production of a hum in the loud speaker, and often they are responsible for distorted signals.

The testing procedure followed in the factory of a large Chicago radio manufacturer is an example of the care which must be exercised in the commercial manufacture of successful eliminators. It is not merely a single move, but comprises a whole series of tests made coincidentally with the construction of an eliminator, as the latter moves along the assembly benches and grows from a blank frame to a completed instrument.

ELEMENTS OF THE ELIMINATOR

As most radio fans are aware, a "B" eliminator consists fundamentally of a transformer which steps up the standard 110-volt house current, a rectifier which converts the high-voltage alternating current into "pulsating" direct current, and a filter (or reservoir) system which "irons out" the pulsations and feeds power to the radio receiver in the form of comparatively smooth direct current. As a majority of the components entering into this construction are under the constant strain of high voltage when in service, it is highly important that defects

in them should be discovered, and the defective parts entirely discarded, before an eliminator is assembled.

In the factory illustrated, the step-up transformers are tested immediately after they have been wound. A skilled operator, with the aid of four meters, examines them for short-circuited and grounded windings and for proper ratio of voltage step-up. The voltage applied between the iron cores and the individual ends of the coils is 500, about four times as high as that to which an eliminator is exposed in ordinary operation. The voltage step-up tests are made with meters directly across the secondaries.

A similar operation is performed on the heavy choke coil, which is part of the filter system. This test is made only for short-circuits in the winding itself and for "grounds" against the iron core. High-reading voltmeters are employed in all this work, with a voltage of definite value as the feed, the electrical circuit being made through the meter and the coil winding under test. The operator knows that the meter needle must deflect a certain pre-established distance for each type of winding, and that any marked variations from this setting indicate a defective coil.

The blocks of filter condensers which, with the choke coils, constitute the filter system, are likewise submitted to voltage tests. The meter readings observed by the test men have a reverse significance in this operation; for condensers are defective if they let the least direct current pass through them. The condensers, which appear like flat rolls of paper with tinfoil ends when they leave their own assembly benches, are actually tested twice; once before they are placed in tin containers, and again after they have been sealed in the latter with black pitch. The test operators must be particularly on the watch for short circuits

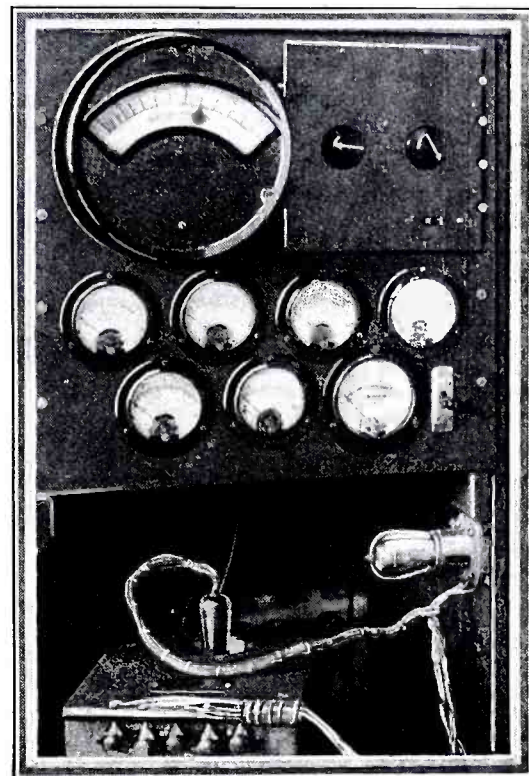

A close-up of the instrument board used for the testing of "B" battery eliminators. The top five meters and the center one of the lower line are voltmeters; the other two milliammeters.

Photos courtesy of All-American Radio Corporation

against the cans; for trouble of this kind multiplies itself later when the cans are placed inside the eliminator case proper.

A BANK OF METERS

After the individual parts have been finally passed by the inspectors, they are assembled in strong stamped-steel cases, which hold, in addition, two variable resistances for adjustment of the output voltages, a high-low switch, a binding-post strip, and a socket for the rectifier tube. The complete eliminators are then passed to the company's laboratory, where they undergo a final and complete examination at the hands of a competent engineer, who checks all their characteristics on a test board containing light sensitive meters. They are also given practical operating tests on two standard receiving sets, one of five tubes and the other of seven, working on an outside aerial and tuned to pick up regular broadcasting signals.

As can be seen from the accompanying close-up of the instrument board, a single rectifier tube is kept in a socket fastened to the wall, its four posts being connected to a plug which can be slipped quickly into the eliminator socket. Not being handled directly by the testing engineer, the tube is thus protected from mechanical injury.

The large meter at the top is connected across the 110-volt A.C. line, the voltage being maintained at 110 by means of the two rheostats at the right. The output posts of the eliminator are connected to the input posts of either the five- or seven-tube set, the line switch turned on, and the meter readings observed. There is one meter to measure each of the developed voltages in the eliminator, or four altogether, as the eliminator is designed to supply 45, 67½, 90 and 135 volts; the last is raised to 150 when the special switch on the case is thrown from "low" to "high." This high voltage is

(Continued on page 880)

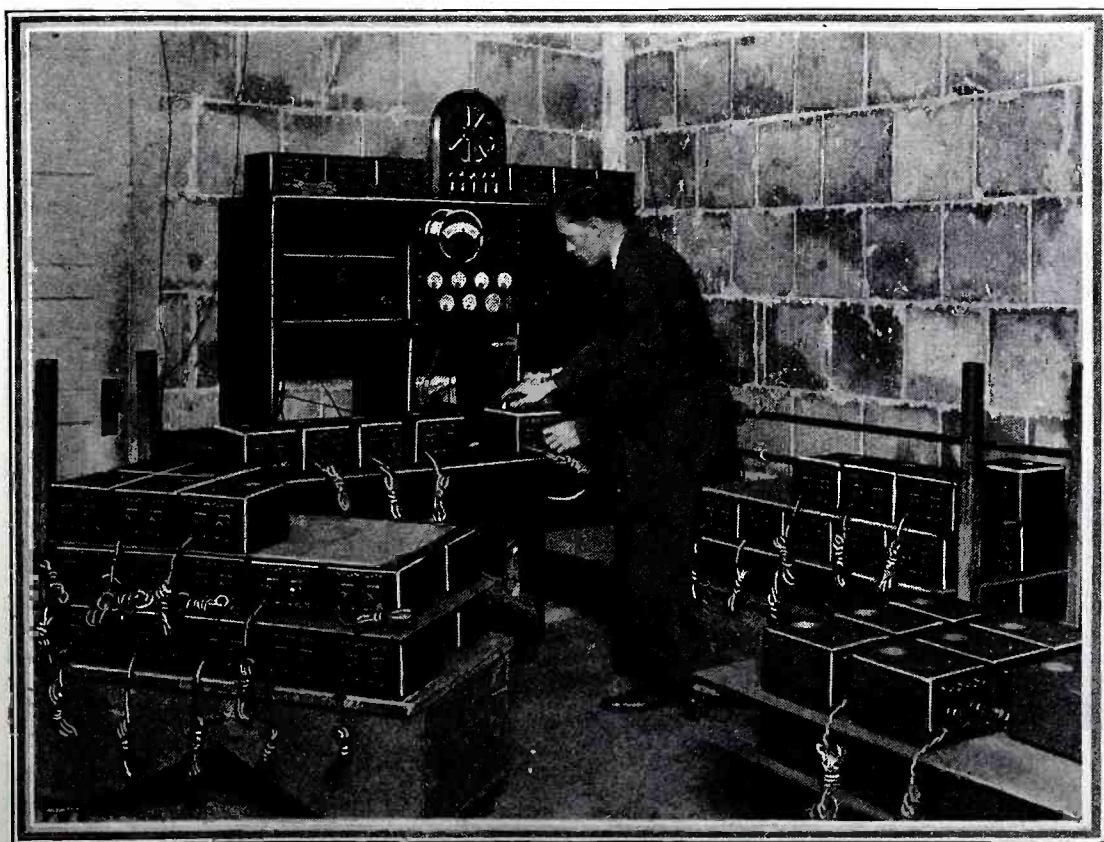

A general view of the eliminator test bench, showing an engineer checking the output characteristics of a number of eliminators.

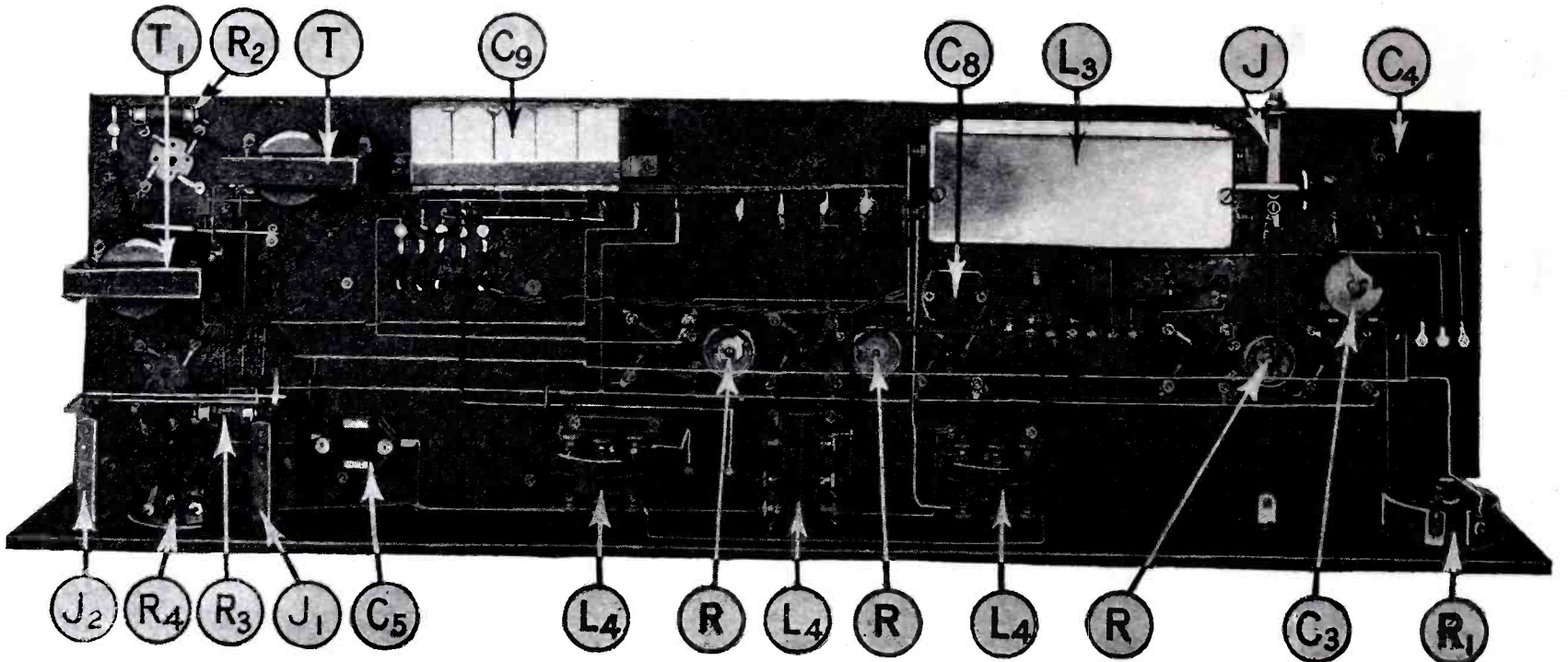

A view of the completed Carborundum superheterodyne receiver from directly beneath the sub-base. The metal case at the right rear contains the input filter I.F. transformer L3. C9 is a bank of five by-pass condensers connected into branch circuits. No difficulty should be experienced in recognizing and definitely locating all the parts, as each instrument is lettered to correspond with the rest of the illustrations.

The Carborundum Superheterodyne Receiver*

An Ultra-Sensitive Long-Distance Circuit Using a Crystal Second Detector

By DR. M. L. HARTMANN,** and JOHN R. MEAGHER***

THE receiver described in this article has some remarkable qualities which place it above the average type of superheterodyne. It comprises the well known sensitive Hammarlund-Roberts circuit (which is a stage of tuned-radio-frequency amplification and a regenerative detector) an oscillator tube, three stages of intermediate-frequency amplification, a carborundum stabilizing unit as second detector, and two stages of transformer-coupled audio-frequency amplification, the last of which employs a power tube. This set has a remarkable degree of sensitivity due, of course, to the successful combination of the Roberts circuit and the superheterodyne, and will rival the best of sets in quality of reproduction.

THIS superheterodyne circuit has given better results in tone, volume and distance than any receiver which the writers have previously investigated. Without aerial, loop or ground, it brings in distant stations with more volume than an exceptionally good five-tube radio-frequency receiver working on an aerial in the same location. With either a loop or aerial the sensitivity and volume are almost unbelievable; so that its sponsors have no hesitancy in recommending this circuit to radio set-builders who want to get distant sta-

tions with excellent quality and volume to spare.

The circuit is the culmination of experiments extending over the past two years; it incorporates tuned-radio-frequency amplification, neutralization, regeneration, the superheterodyne principle and a crystal second detector. It adds the receiving range of a good superheterodyne to the receiving range of a "Roberts"-type circuit. The circuit has been made up in two different forms. One of these is completely shielded, while in the other this feature is applied only to the oscillator. Both sets are practically non-radiating and hence do not interfere with neighboring receivers. Construction of the unshielded model is relatively simple; so this form is recommended to the average set-builder and described here.

THE CIRCUIT

The circuit has eight tubes and a crystal second detector; there are one stage of neutralized tuned-radio-frequency amplification, a regenerative vacuum-tube first detector, an oscillator, three stages of intermediate-frequency amplification (at 2000 meters—150 kilocycles), a carborundum detector unit as second detector, and two stages of trans-

former-coupled audio-frequency amplification.

The neutralized T.R.F. stage is of standard design, a split plate coil and balancing condenser being used for neutralization. A rheostat is included in the filament circuit to afford a check on regeneration and self-oscillation of this first tube; this is a much smoother and less critical control than the neutralizing condenser, which is mounted on the sub-panel and used only for rough adjustment. A jack is arranged in the grid circuit for connection to a loop, while an antenna coupler is provided with suitable primary connections to accommodate aerials of different lengths.

The first detector does not utilize a grid condenser and leak. The grid return is brought through a "C" battery to the "A—." The pick-up coil is connected directly in the grid lead; actual test and comparison have proved this to be the best of a number of possible arrangements. It minimizes overloading of the first detector, as the grid-voltage operating range is appreciably extended. This is an important consideration, as the first detector must handle both the received and the locally-generated (oscillator) energy.

It will be noted that the "pick-up" coil leads are twisted; this makes them partially "non-inductive," so that they have less influence on other connections.

The regenerative feature of the first detector is very desirable, as it increases the receiving range. The regenerative control is used only on very distant stations; it need not be adjusted on locals or stations up to about 1500 miles.

INTERMEDIATE-FREQUENCY STAGES

The input I.F. transformer is designed with a small primary winding, so that a large fixed tuning condenser may be used; its secondary is also tuned and the over-all selectivity (when the I.F. amplifier is ad-

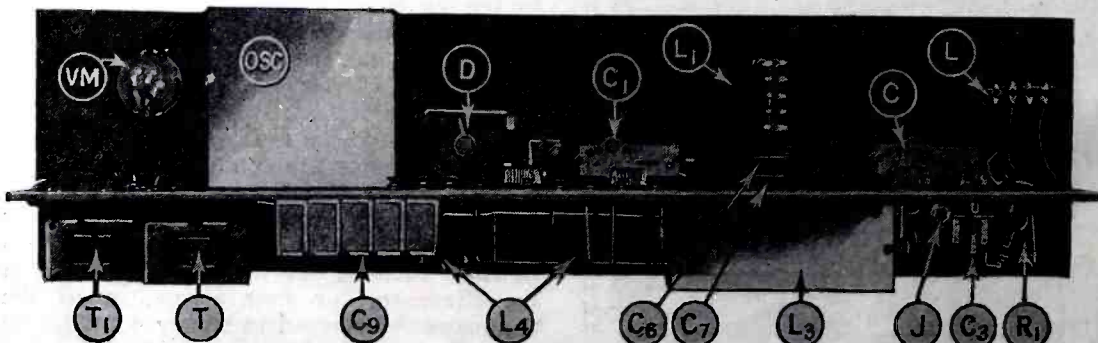

The rear of the set. This provides an excellent view of the instruments on the panel and both the under and upper sides of the sub-base. The small square condenser at the right of the Carborundum detector D, should be disregarded.

* Radio News Blueprint Article, No. 4 **Research Director, Carborundum Co. ***Radio Research Engineer, Carborundum Co.

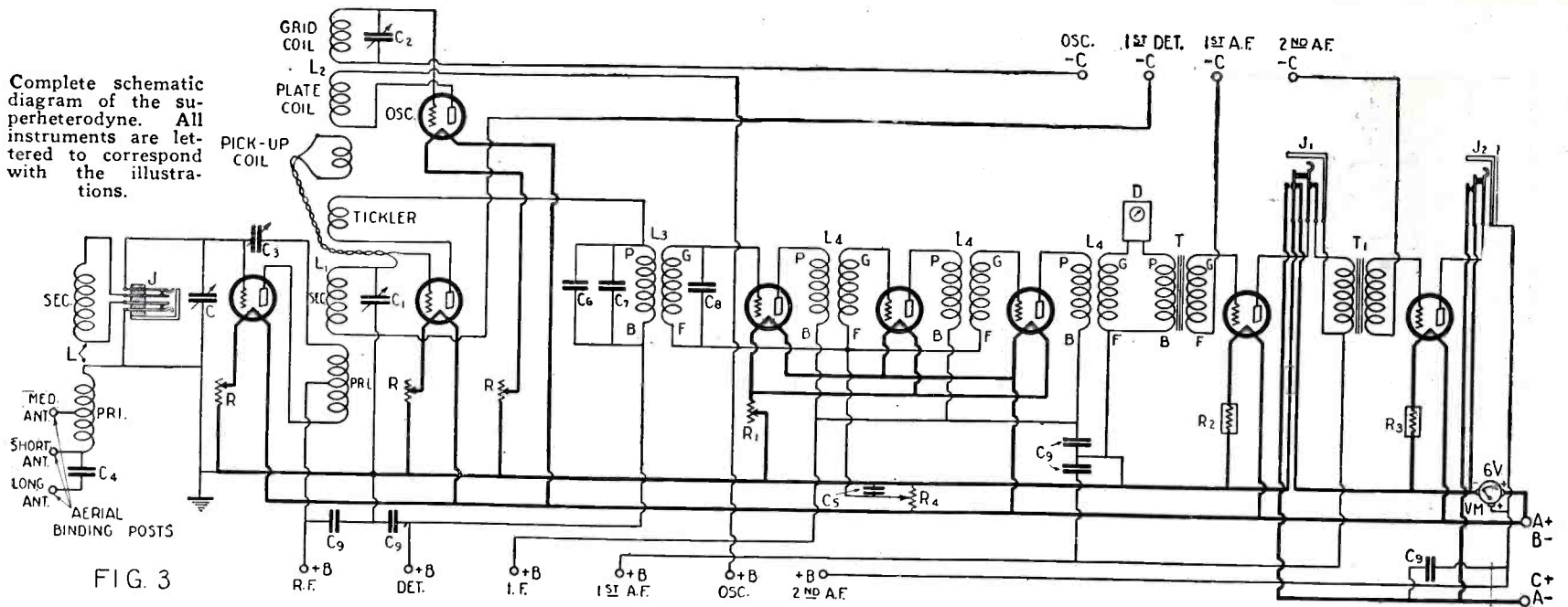

FIG. 3

justed slightly below the point of self-oscillation) is such as to cut off only those frequencies differing by about 10% or more from the intermediate frequency. As a result, all the audio-modulated frequencies ("side-band" components of the intermediate frequency) are passed through the amplifier without suppression; therefore no distortion takes place.

This transformer was built in a long brass case, with provisions for adjustment of the coupling between primary and secondary, in order to determine whether such adjustment is of any value. Subsequent tests showed that decrease in coupling decreased the volume without proportionately increasing selectivity; consequently, this idea has been

then endeavoring to pick the desired frequency from the amplified interference.

The intermediate frequency of 2000 meters was selected because it separates the oscillator frequency sufficiently from the signal frequency to eliminate detuning and erratic operating effects.

The intermediate-frequency amplifier itself is of standard design and employs potentiometer grid-bias for control of self-oscillation and regeneration.

THE CRYSTAL SECOND DETECTOR

The second detector circuit includes the secondary of the last I.F. transformer, a carborundum detector unit and the primary

I.F. transformer, a portion of the biasing voltage is impressed across the detector. Adjustment of this bias serves to regulate the normal resistance or impedance of the detector over wide limits. The proper value may be selected for best results while a distant station is being received.

In this superheterodyne circuit the unit adjustment is not at all critical; in fact the carborundum detector alone may be used if so desired, or if space is limited. The particular advantage of the entire unit is that it makes this portion of the circuit fool-proof. It also prevents self-oscillation of the A.F. amplifier which might be caused by an open circuit across the primary of the first audio transformer. Some readers may have noticed that the removal of the detector tube preceding an A.F. amplifier frequently causes the amplifier to oscillate. Replacement of the tube puts the plate-filament resistance across the transformer primary; and this tends to absorb energy, or form a load on the amplifier, which prevents self-oscillation of the amplifier. Similarly, an ordinary fixed crystal detector followed by an A.F. amplifier may have resistance so high that it does not form a sufficiently high load on the amplifier, and thus be unable to prevent the amplifier from oscillating. However, with the bias provided in the detector unit, the resistance of the detector may be decreased until it produces the desired action.

The audio-frequency amplifier is of the usual transformer coupled design. Automatic filament controls are used on the two amplifier tubes. Adjustable rheostats are used on the other six tubes.

Separate "B" and "C" battery connections are provided wherever necessary. This affords great flexibility in the choice of tubes,

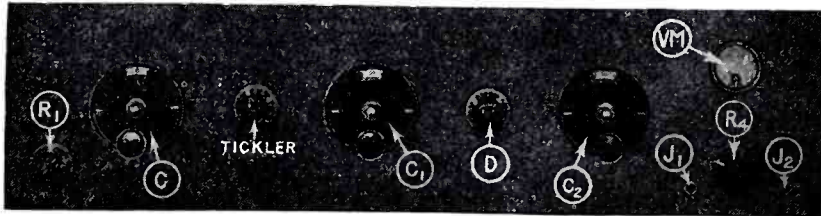

Panel view of the completed receiver; C, C1, and C2 are the principal controls.

abandoned and fixed coupling adopted between the primary and secondary of this transformer. Furthermore, the brass case is not absolutely necessary.

The input (instead of the output) of the amplifier is tuned for two reasons: first, so that the primary of the input I.F. transformer may be shunted with a sufficiently large tuning condenser to "by-pass" both the oscillator and received frequencies; second, because it is possible to secure better selectivity, by first selecting the desired frequency and amplifying only this frequency, than by amplifying the desired frequency together with interfering frequencies and

of the first A.F. transformer; its low-voltage side is grounded to the "A—" lead.

The effective capacity of the detector unit is such that the instrument may be connected to the same type of intermediate frequency transformer as is connected between the intermediate-frequency amplifying tubes. Therefore, all three intermediate-frequency transformers are of the same make.

The fixed carborundum detector is in series with an adjustable bias, the value of which is controlled by the potentiometer. When the external detector circuit is completed through the primary of the first A.F. transformer and the secondary of the third

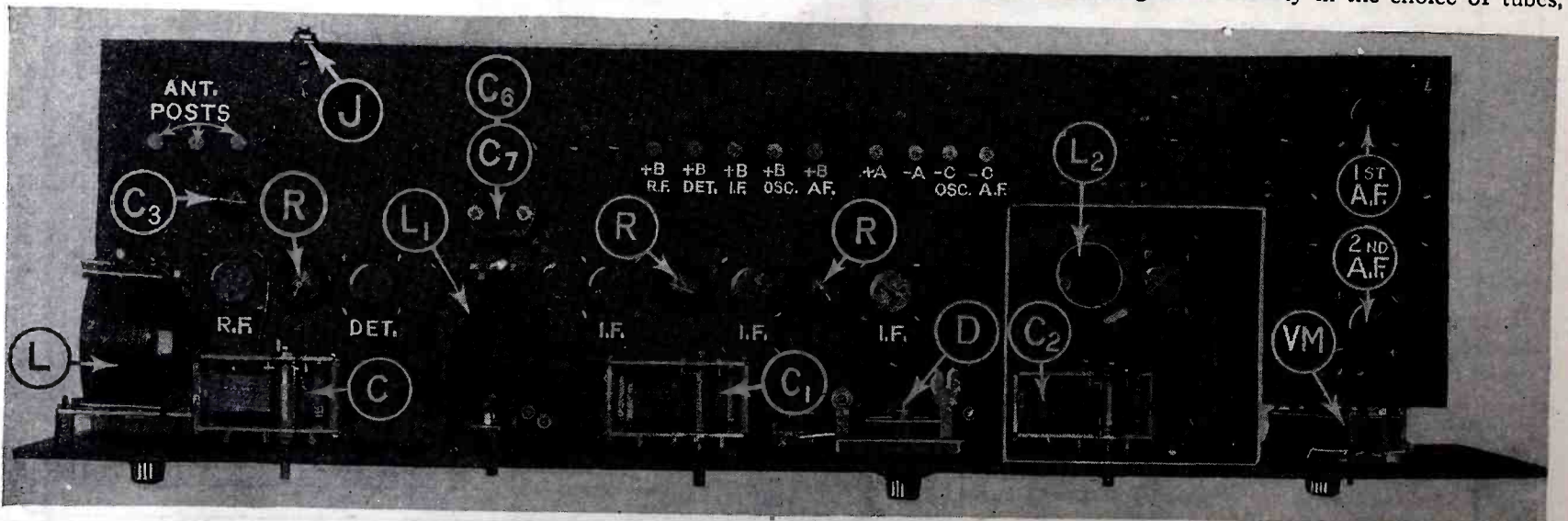

A top view of the receiver with the cover removed from the shield to show the disposition of the instruments comprising the oscillator. Note that all the binding posts are lined up immediately behind the I.F. tube sockets.

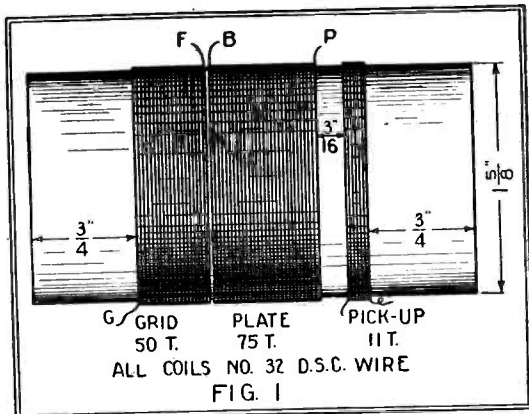

Constructional details of the oscillator coupler (L2) which is housed within the metal shield.

and allows maximum efficiency to be secured from each section of the circuit.

THE TRANSFORMERS

The antenna circuit and regenerative T.R.F. transformers are similar to those used in the "Roberts" circuit. These transformers may be constructed from the specifications given below, or, if desired, regular Roberts-circuit transformers may be purchased.

Antenna circuit transformer: Form 3-inch tube, 3 inches long; secondary, 45 turns No. 24 D.C.C. wire; primary, 20 turns No. 30 D.C.C., tapped at center and wound over filament end of secondary. The primary should be separated from the secondary by a few layers of paper or strips of cardboard.

Regenerative transformer: Form 3-inch tube, 3 inches long; secondary, 45 turns No. 24 D.C.C.; plate coil, 30 turns No. 30 D.C.C., tapped at center and wound over filament end of secondary. (The plate coil should be separated from the secondary by a few layers of paper or strips of cardboard). Tickler, 30 turns No. 30 D.C.C. on a 1-inch tube, 1 inch long. The tickler should be mounted in adjustable inductive relationship to the grid side of the secondary. (Its small size obviates detuning effects). Flexible leads, preferably tinsel braid, should be provided for connection to the tickler.

Oscillator coupler: The oscillator in this circuit must cover a range from about 222 to 431 meters (200 meters minus the intermediate frequency, or 1500 kc. minus 150 kc., to 550 meters plus the intermediate frequency of 545 kc. plus 150 kc. It is better, however, to have the range extend from about 180 to 431 meters, so that a different setting of the oscillator condenser may be used for each received wavelength. This extended range is secured with the oscillator coupler specified in Fig. 1.

Input intermediate-frequency transformer: The constants given in Fig. 2 enable this transformer to be tuned to 2000 meters with fixed condensers of approximately the capacity indicated (see list of parts). The method of tuning this transformer will be described later.

The form for the input transformer may be built up from alternate wooden discs, 1-inch and 1/2-inch in diameter and 1/4-inch thick; or it may be turned out of a solid block of wood or hard rubber.

The coils should be wound haphazard; that is, with no effort to place the turns side by side. The coils may be dried out in a warm open oven and given a light coat of collodion, which should, however, be used sparingly, as it has comparatively low resistance.

All of the home-made transformers should be provided with terminals consisting of short round-head 6/32 machine screws, nuts and soldering lugs.

The intermediate-frequency transformers: Fixed T.R.F. transformers (500-5000 meters) were used in this circuit. Other makes of transformers may be used if they cover the 2000-meter range.

Bear in mind that the amplifying peak of

a fixed broadly-tuned transformer, as usually rated on the manufacturer's test, is not necessarily the best wavelength for an amplifier using these transformers. The best wavelength is that at which the amplifier tends to oscillate; and this wavelength may be quite different from the rated transformer peak.

Actually the wavelength at which the amplifier tends to oscillate, when fixed broadly-tuned transformers are used, is dependent to a great extent upon the tuning of the input transformer. The amplifier generally oscillates at the wavelength to which the secondary of the input I.F. transformers is tuned.

If I.F. transformers having a wavelength including the 2000-meter range are not available, any good transformers with a wavelength between 1000 and 3000 meters may be used. In this event it is necessary: first, to tune the input I.F. transformer to the rated wavelength of the other transformers; second, either to remove a few turns from the grid coil of the oscillator coupler, if the intermediate frequency is below 2000 meters, or to add a few turns to the grid coil, if the intermediate frequency is above 2000 meters. In general, we recommend an intermediate frequency below, rather than above, 2000 meters. When the superheterodyne is not shielded the I.F.

transformers themselves should be shielded or else have a partially-closed iron core. If the superheterodyne is shielded, the I.F. transformers may be of any suitable make, iron- or air-core, shielded or not shielded.

The I.F. transformers may be constructed if desired, according to the specifications given here for the input transformer. The secondary condenser should be omitted, though primary condensers of the same value as used on the primary of the input transformer should be employed.

The front panel of the receiver is 9x36 inches; the sub-panel is 10x35 inches.

The disposition of parts is clearly shown in the illustrations. The metal case shown in the top view encloses the oscillator coupler, oscillator variable condenser and oscillator tube. It has a removable cover and is 6x6x6 inches. The knobs of the I.F., oscillator and first detector filament rheostats, and of the neutralizing condenser, are also shown in this top view.

The long metal case enclosing the input I.F. transformer is shown in the bottom view. As mentioned previously, the adjustable-coupling feature of this transformer has been found of no advantage. In this same view may be noted the holes through which connections are brought from the oscillator, and the long twisted leads connect-

(Continued on page 894)

SYMBOL	Quantity	NAME OF PART	VALUE OF PART	REMARKS	MANUFACTURER *
C, C1	2	Variable cond.	.0005 mf.	SIF type	2 5, 11, 17, 19, 23, 48
C2	1	"	.00035 mf.	SIF type	2 5, 11, 17, 19, 23, 48
C3	1	"	32 mmf.	Neutralizing	5 11, 17, 19, 20
C5	1	Fixed "	0.1 mf.	By-pass	3 4, 21, 22, 24, 25
C9	5	"	1.0 mf.	"	3 4, 21, 22, 24, 25
C4	1	"	.0001 mf.	"	4 21, 22, 24, 25
C6	1	"	.0005 mf.	Filter condenser	4 21, 22, 24, 25
C8	1	"	Approx. .0001 mf.	Capacity determined by trial	4 21, 22, 24, 25
C7	1	"	.00025 mf.	Input filter	4 21, 22, 24, 25
L	1	Ant. coupler		T.R.F. trans. type	5 26, 27, 12
L1	1	R.F. Trans.		With tickler coil	5
L2	1	Oscillator coup-		Special	Hand-made
L3	1	I. F. Trans.	150 K.C.	Input filter	6 28, 29
L4	3	I.F. Trans.	150 K.C.	Tuned, fixed	6 28, 29
T, T1	2	A. F. Trans.			40 9, 18, 19, 23
D	1	Crystal detec.		Carborundum unit	1
VM	1	Voltmeter	0-7,0-140	"A" "B" readings 3 post type	7 31, 32, 33
R	3	Rheostats	20-ohms		8 2, 9, 21, 24, 34, 35
R1	1	Rheostat	10-ohms		8 2, 9, 21, 24, 34, 35
R2	1	Auto.Fil. Cont.	6v. 1/2 amp.	For first A.F. tube	10 36, 37, 2
R3	1	"	6v. 1/2 amp.	For Semi-Power tube	10 36, 37, 2
R4	1	Potentiometer	400-ohms		9 2, 21, 24, 34, 35
J	1	Jack		Double circuit type	11 8, 9, 34, 38
J1	1	"		Double cir. fil. control	11 8, 9, 34, 38
J2	1	"		Single " " "	11 8, 9, 34, 38
	8	Sockets		UX type without base	12 9, 11, 18, 39
	12	Binding posts			13 2, 39, 41
	1	Panel		36 X 9 X 1/4 inches	14 41, 42, 43
	1	Sub-Panel		35 X 10 X 1/4 "	14 41, 42, 43
	1	Metal case		6 X 7 X 7 " Aluminum	5
	3	Dials		Vernier	16 11, 18, 19, 15, 48
	1	Vacuum tube	6v. 1/2 amp.	Semi-Power Amplifier	6 36, 44, 45
	7	Vacuum tubes	6v. 1/4 "	Standard type	6 44, 45, 46
	1	Loop		Optional for .0005 mf. cond.	8 47

NUMBERS IN LAST COLUMN REFER TO CODE NUMBERS BELOW.

1 Carborundum Company	17 Gardiner & Hepburn, Inc.	33 Burton Rogers Co.
2 Ameco Products, Inc.	18 Bremer-Tully Mfg. Co.	34 H.H. Frost, Inc.
3 Tobe Deutschmann Co.	19 Samson Elec. Co.	35 Central Radio Labs (Centralab)
4 Sengamo Elec. Co.	20 Allen D. Cardwell Mfg. Corp.	36 Daven Radio Corp.
5 Hammarlund Mfg. Co.	21 Aerovox Wireless Corp.	37 Langbein-Kaufman Radio Co.
6 Radio Corp. of America	22 Leslie F. Muter Co.	38 Millimeter Mach. Wks.
7 Weston Elec. Inst. Co.	23 All American Radio Corp.	39 H. H. Eby Mfg. Co.
8 Carter Radio Co.	24 Polymet Mfg. Corp.	40 Federal Radio Corp.
9 General Radio Co.	25 Electrad, Inc.	41 Ins. Co. of America (Insuline)
10 Radiall Co. (Amperite)	26 Aero Prods., Inc.	42 Amer. Hard Rubber Co (Racion)
11 Pacent Elec. Co.	27 University Radio Co.	43 Diamond State Fibre Co. (Celaron)
12 Benjamin Elec. Mfg. Co.	28 Madison Radio Corp.	44 E.T. Cunningham, Inc.
13 X-L Radio Labs.	29 Geo. W. Walker Co.	45 C.E. Mfg. Co. (Caco)
14 Formica Insulation Co.	30 Silver-Marshall Co.	46 Sonatron Tube Co.
15 Kurz-Kasch Co.	31 Jewell Elec. Inst. Co.	47 English Whitman Prods.
16 Martin Copeland Co. (Marco)	32 Beede Elec. Inst. Co.	48 National Co., Inc.

APPROXIMATE COST OF PARTS \$ 80.00

* THE FIGURES IN THE FIRST COLUMN OF MANUFACTURERS INDICATE THE MAKERS OF THE PARTS USED IN THE ORIGINAL EQUIPMENT DESCRIBED HERE.

An Improved Audio-Frequency Amplifier*

A Two-Stage Transformer-Coupled Audio Unit with Some New Features

By M. L. MUHLEMAN



THIS two-stage transformer-coupled audio-frequency amplifier has a number of new features which give particular interest and value to the unit. Though it is a technical irregularity to say that each circuit is independent of the next, or virtually "floating", the description fits the occasion. Through the judicious use of both R.F. and A.F. choke coils and an output filter, all of the important "working currents" are kept in their respective circuits, and the coupling of successive circuits through the medium of the common "B" battery has been eliminated. Any type of vacuum tube may be used in this amplifier.

EDITOR.

At the right is top view of the transformer-coupled amplifier, showing the two A.F. transformers T and T₁; the R.F. choke, L; the R.F. by-pass condenser C; the volume control R; the output filter L₂-C₂; and the automatic filament controls R₁. The input binding posts are indicated by the numbers 2, 1 and 3.

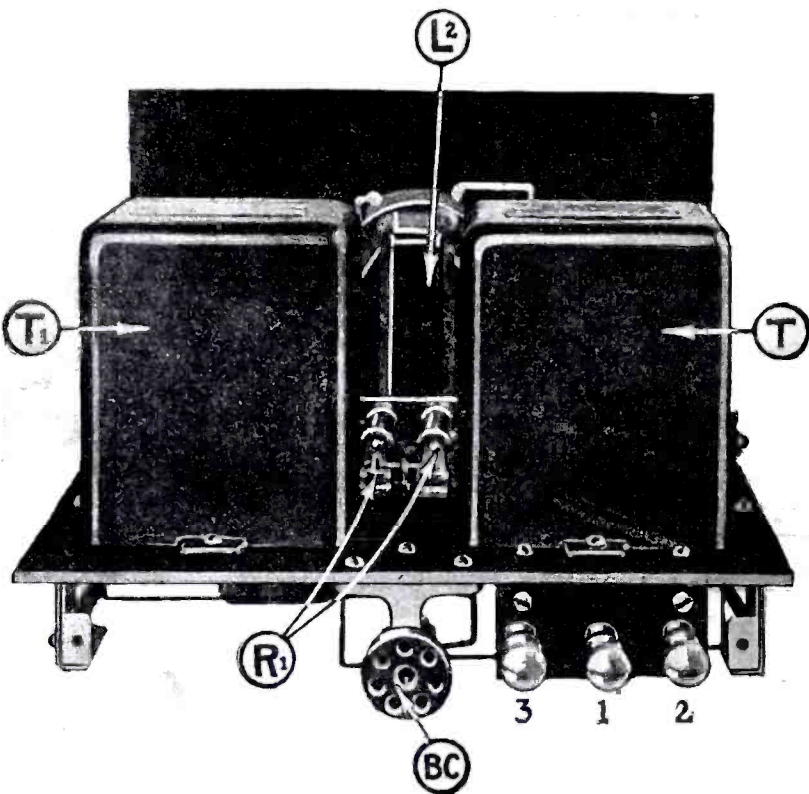

At the left, a rear view of the amplifier. BC is the battery-cable receptacle. All of the connections to the amplifier, with the exception of the input wires from the set, are made through the battery cable. L₂ is the plate impedance, a part of the output filter.

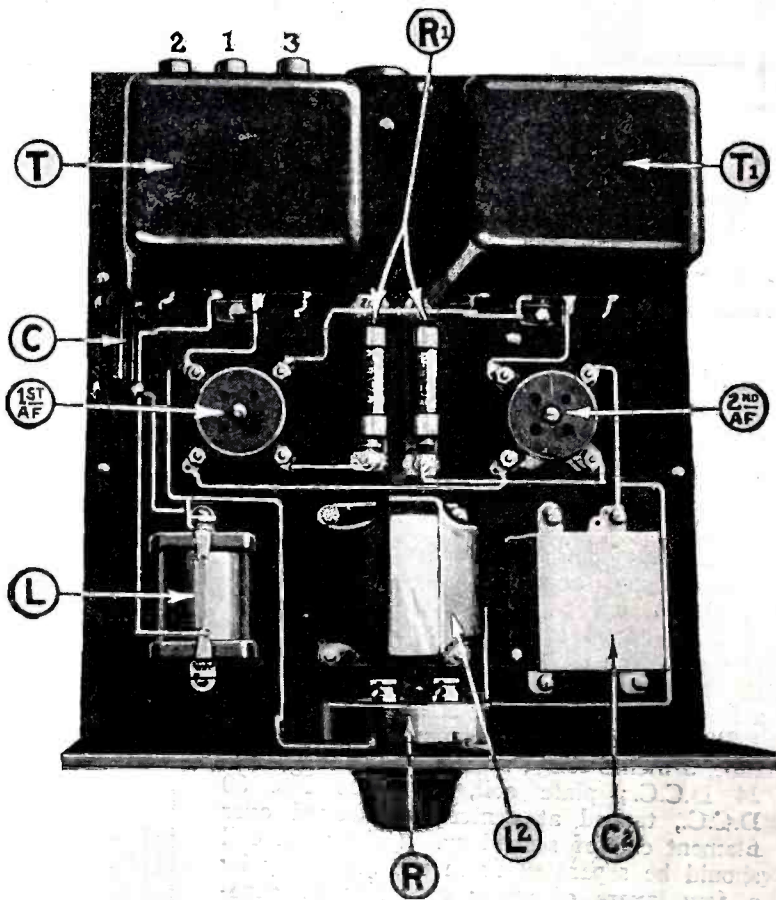

impression of distortion, distorted in itself, being conveyed to the imagination. All audio amplifier curves, though they may be electrically accurate, are decidedly unfair. They can never hope to serve as anything but comparisons between audio coupling units of different design or type, which do not necessarily mean a great deal. They do not inform the observer what the reproduction will sound like, because they are not plotted against the normal perceptibility curve or "response curve" of the human ear. The ear does not respond equally to all musical frequencies. Take special note of the fact that the average ear cannot distinguish a change in the amplitude of sound less than 10 per cent. Therefore, transformer distortion curves are not as formidable as they appear on paper.

The majority of high-class sets on the market today employ audio-frequency am-

CURVES ARE DECEPTIVE

Many fans have received a false impression of the distortion characteristics of transformer-coupled audio amplifiers by placing too much faith in the comparative curves "revealed" from time to time. These curves are distressing to the eye, a visual

THERE is little doubt that most radio fans are very much undecided on the subject of audio-frequency amplifiers; the question as to which type is the best is a catchy one. If the inquiry is confined to the relative merits of the three principal types of audio amplifiers from the standpoint of the *distortion characteristics* of each, all honors go to the resistance-capacity-coupled amplifier. The impedance-coupled amplifier is a close second, and the transformer-coupled amplifier is third. However, if we rearrange our question and ask, "What is the most suitable audio-frequency amplifier for most purposes?" the transformer-coupled type takes first place.

Actually, there are too many factors to be taken into consideration and no one can say that any one form of audio amplifier is superior to all others from every standpoint. Three stages of resistance- or impedance-coupled audio amplification are required to approximate the volume that can be had from a two-stage transformer-coupled audio amplifier. Consequently, the original expense is greater. However, the transformer-coupled amplifier uses more "B" battery current than a resistance or impedance amplifier; but this disadvantage is offset by the increased amount of "A" battery current consumed by the two latter types and the higher "B" voltages required for their efficient operation.

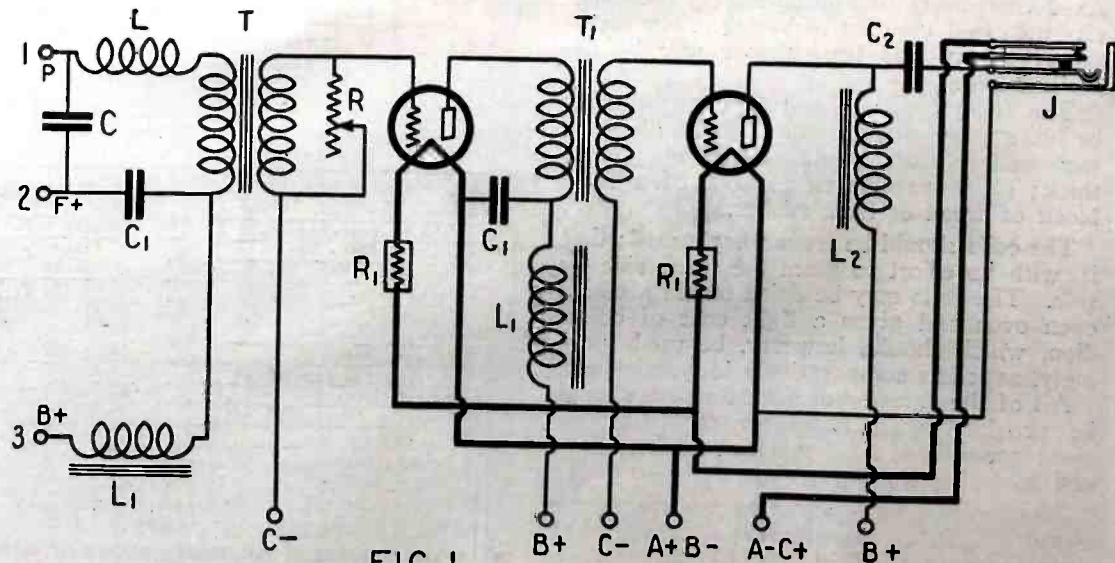
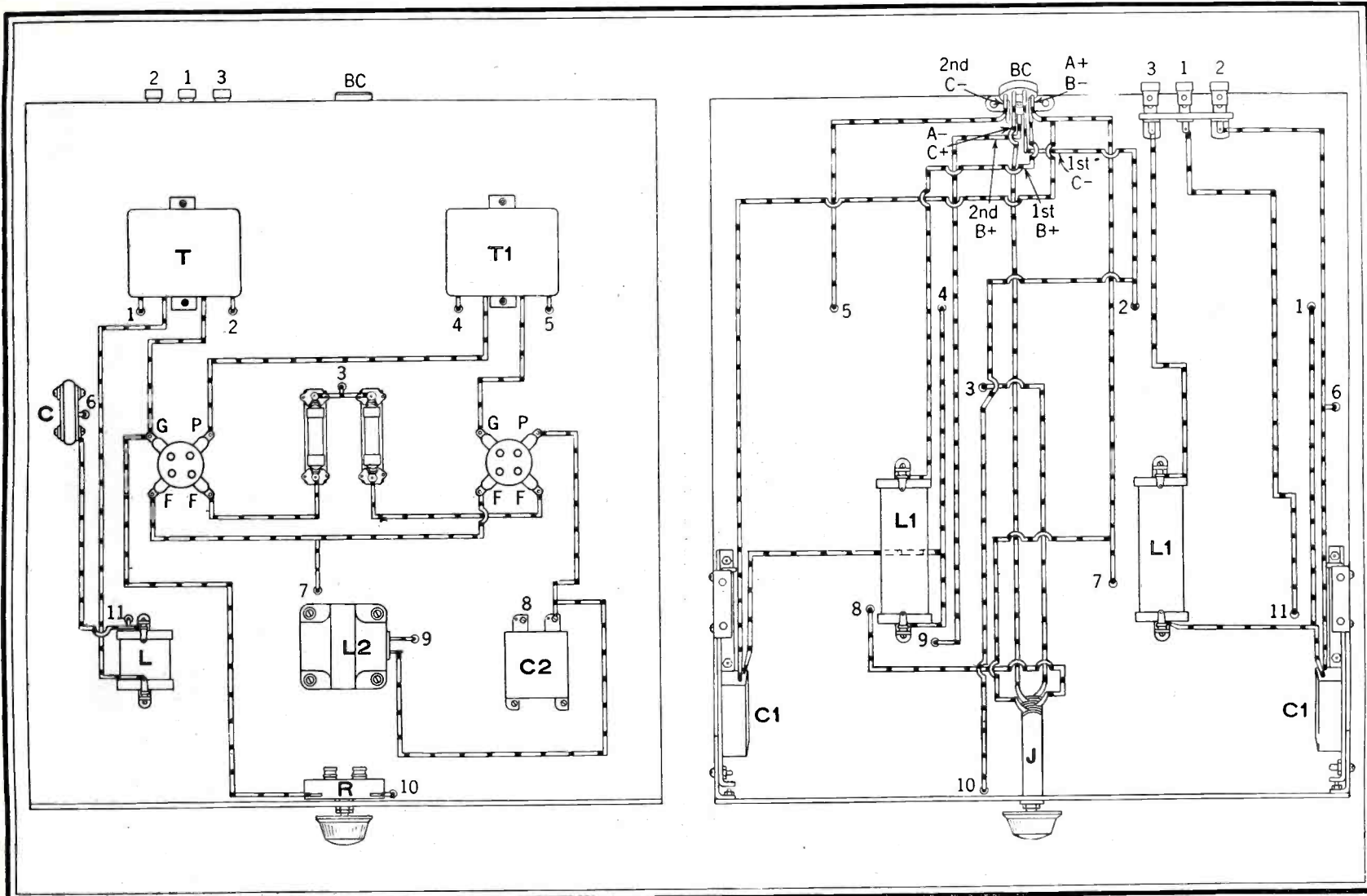

FIG. 1

The complete circuit diagram of the two-stage audio amplifier. The post marked 1 connects to the plate of the detector tube in the receiving set; post 2 to the "F+" post on the detector-tube socket; and post 3 to the detector "B" battery lead.

*Radio News Blueprint Article No. 5.



The layout wiring diagram of the amplifier. The wiring above the sub-base is shown at the left, and that under the sub-base to the right. All of the connections which pass from the top side to the under side, through holes, are numbered. Thus, the first connection on the transformer T passes through a hole which is marked 1 at the upper left. It is also marked 1 at the point where it comes through on the under side of the sub-base; at the upper right.

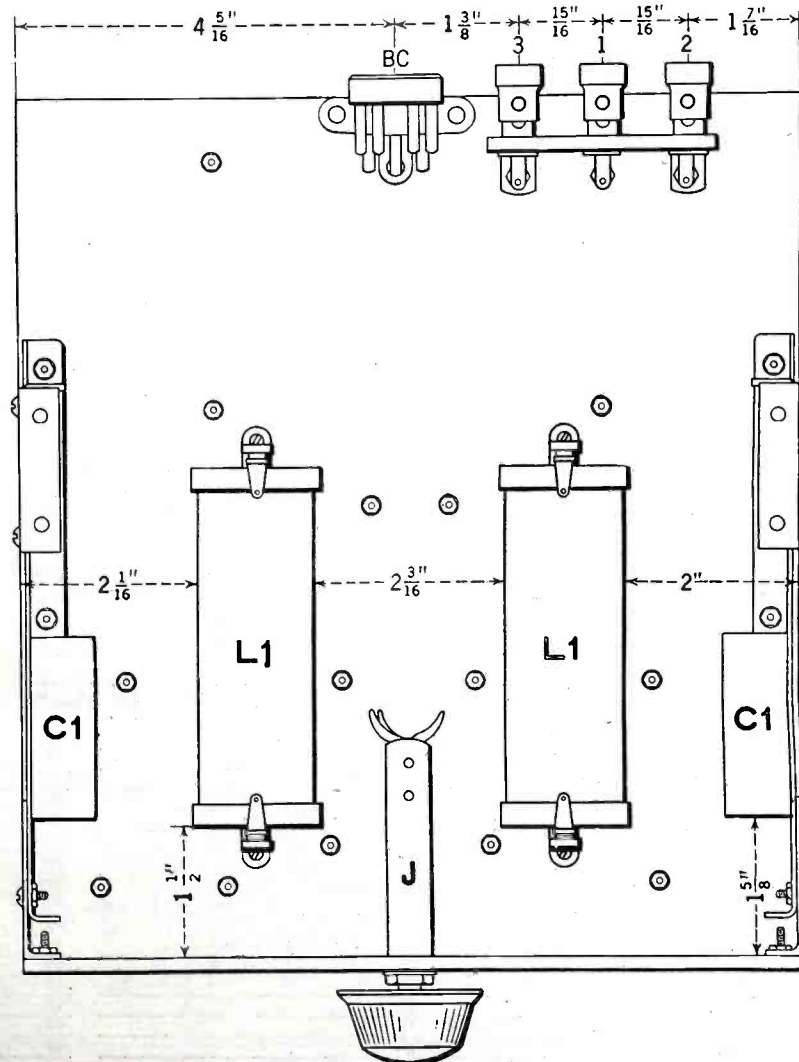
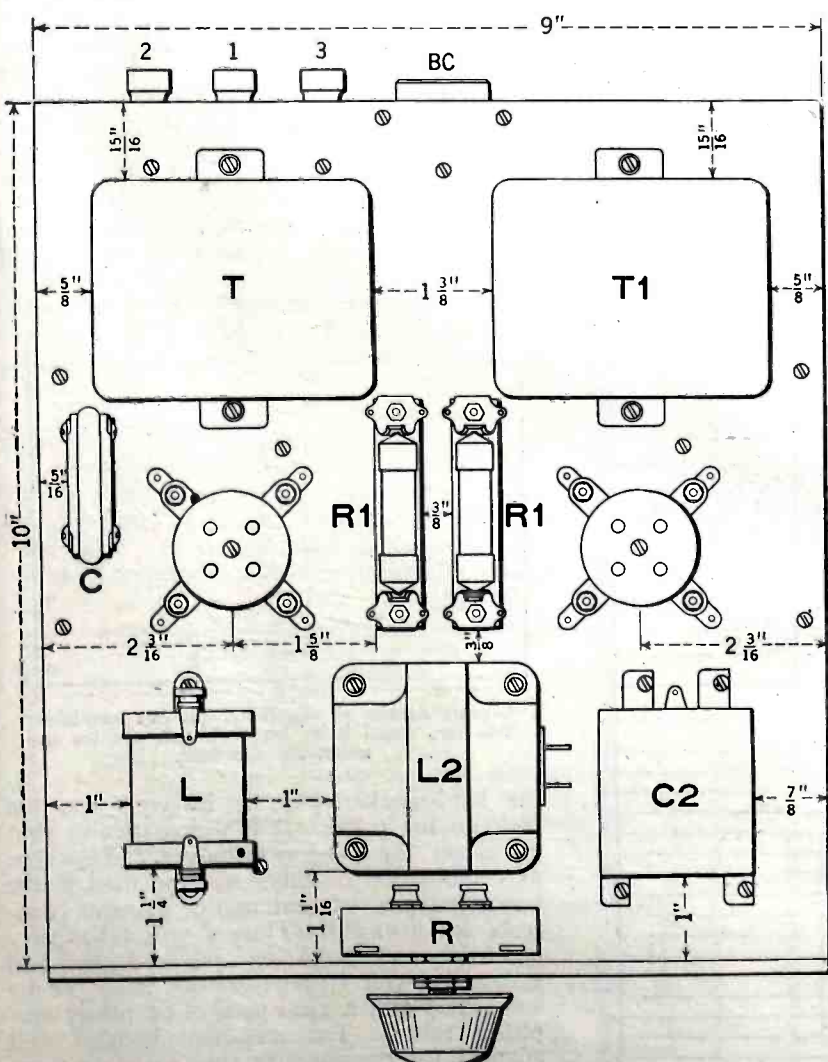

The complete working-plan of the amplifier. All of the necessary constructional details are given here. These specifications, particularly the spacing of the parts, may be departed from if desired; but it is recommended that the same layout or placement of parts be followed. All of the apparatus in these drawings is lettered to correspond with the illustrations and diagrams.

plifiers of the transformer-coupled type, and it cannot be said that they suffer from serious distortion. Most of these sets provide excellent reproduction, the secret of their success, if we may call it that, being in their careful design and construction. The men who design the sets know their business (usually) and are well acquainted with all the inherent characteristics of audio-frequency amplifiers. They are equipped with the necessary knowledge and are therefore in a position to employ transformer-coupled audio-frequency amplifiers in the sets they design, with the assurance that these will work as good amplifiers should. This intimates that the success of a transformer-coupled audio-frequency amplifier is greatly dependent upon electrical accuracy.

There are, however, in operation today too

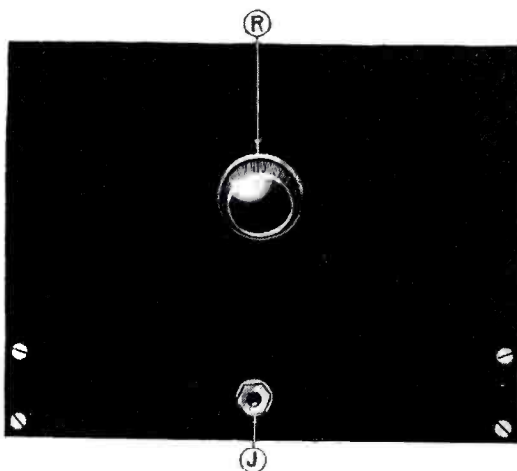

Left: A panel view of the audio amplifier, showing the placement of the volume-control knob R and the combination output-and-filament-control jack J. Right: A view of the apparatus mounted on the under side of the sub-base. L1 indicates the two audio-frequency chokes, one of which is in the plate circuit of the detector tube when the amplifier is hooked up, and the other in the plate circuit of the first amplifier tube. The output filter takes care of the last audio tube. C1 are the audio-frequency by-pass condensers, which are used in conjunction with the A.F. chokes. J is the jack, BC the battery cable connector and 3, 1 and 2 are the input binding posts.

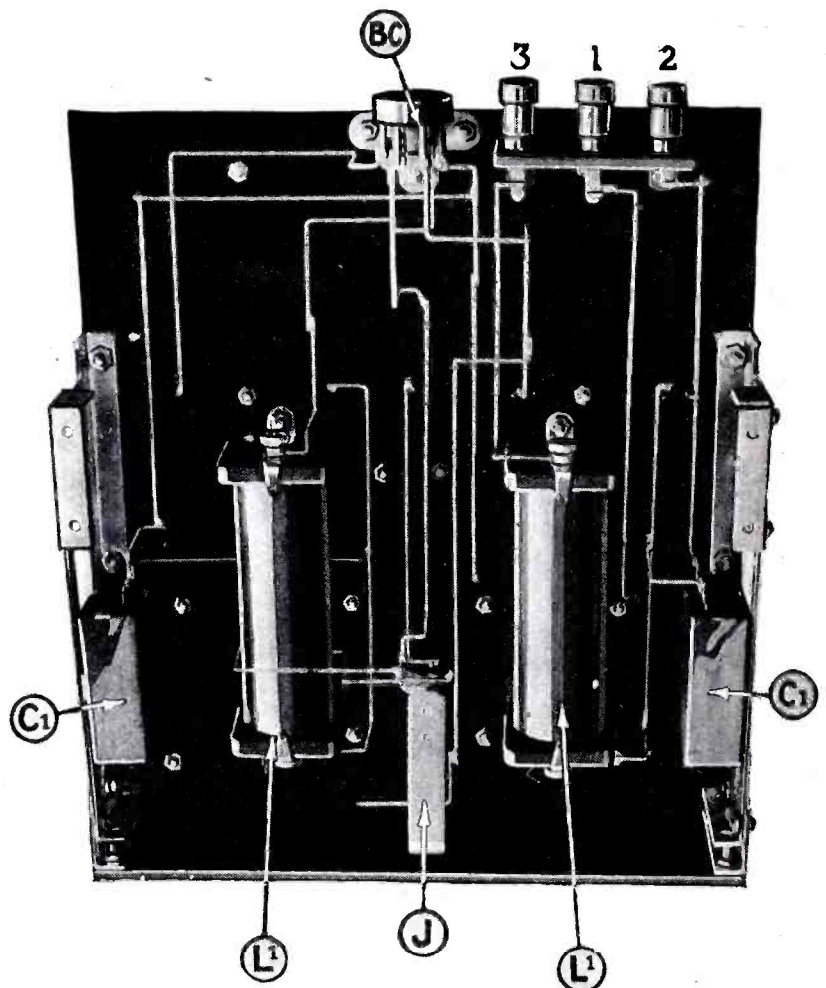

many audio-amplifiers of this type that are an insult to the transformers composing them. Their inefficient operation, or better said, unsatisfactory operation, is due in most part to undesirable coupling effects or overloaded tubes. Not until recently have fans realized that an audio-frequency amplifier of any type can be as petulant as a child. It can be just as erratic and unstable as its sister, the radio-frequency amplifier.

THE TECHNICAL ASPECTS

To obtain really good results from a

transformer-coupled audio-frequency amplifier—and excellent results certainly can be had—it is quite necessary to give serious thought to the technical aspects. The amplifier should be designed to be fool-proof. It should contain apparatus capable of preventing coupling between the various components. Means should be provided to keep any stray radio-frequency currents from entering the amplifier circuit, and a filter should be used between the output of the amplifier and the loud speaker. In other words, all components should be free to

operate independently of each other, and great care taken that one unit does not influence the operation of another.

The two-stage transformer-coupled audio-frequency amplifier to be described has all these qualifications. It is built in one unit and may be used in conjunction with any type of receiver without the necessity of adjustments or alterations on the latter. Of course, with a few minor changes in construction, it can be built as a part of the receiving set and housed in the same cabinet; but as it stands it makes a very convenient unit which can be placed in an out-of-the-way corner where it cannot affect or be affected by the receiving set. It may be permanently connected to the batteries and then forgotten; as it does not operate until

SYMBOL	Quantity	NAME OF PART	VALUE OF PART	REMARKS	MANUFACTURER ★
T, T1	2	A. F. Trans.	3 to 1		1 2, 8, 13, 14
L2	1	Impedance		Output Filter	2 1, 13, 15, 16
L1	2	A. F. Chokes			2 1,
L	1	R. F. Choke	85 MH.		2 1, 17
C1	2	Fixed cond.	1. Mf.	By-Pass	3 4, 5, 18, 19
C2	1	" "	2. Mf.	Blocking	4 3, 5, 18, 19
C	1	" "	.001 Mf.	By-Pass	5 3, 4, 18, 19
R	1	Var. Resis.	0-500,000		6 18, 20, 21
R1	2	Auto. Fil. Controls		Type subject to tube used	7
	2	Sockets		UX type	1 8, 12, 15, 22
J	1	Jack		Open-circuit filament control	8 18, 20, 21, 22, 24
1, 2, 3	3	Binding posts			9 15, 22, 23
BC	1	Battery Cable		For battery leads	10 24
	1	Panel		7" x 9" x 3/16"	11 23, 25, 26
	1	Sub-Panel		9" x 10" x 3/16"	11 23, 25, 26
	2	Brackets			12 1, 26, 27

NUMBERS IN LAST COLUMN REFER TO CODE NUMBERS BELOW.

1 Silver Marshall, Inc.	17 Radio Engineering Labs.	33
2 Sanson Elec. Co.	18 Electrad, Inc.	34
3 Polymet Mfg. Corp.	19 Aerovox Wireless Corp.	35
4 Tobe Deutschmann Co.	20 H. H. Frost, Inc.	36
5 Sangamo Elec. Co.	21 Carter Radio Co.	37
6 Central Radio Labs.	22 Ameco Products, Inc.	38
7 Radiall Co. (Amperite)	23 Ins. Co. of Amer. (Insulac)	39
8 Pacent Elec. Co.	24 Yaxley Mfg. Co.	40
9 X-L Radio Labs.	25 Diamond State Fibre Co. (Celaron)	41
10 Howard B. Jones	26 Amer. Hard Rubber Co. (Radion)	42
11 Formica Insulation Co.	27 American Radio Haws Co.	43
12 Benjamin Elec. Mfg. Co.	28	44
13 American Trans. Co.	29	45
14 Ferranti, Inc.	30	46
15 General Radio Co.	31	47
16 National Co., Inc.	32	48

APPROXIMATE COST OF PARTS \$ 32.00

★ THE FIGURES IN THE FIRST COLUMN OF MANUFACTURERS INDICATE THE MAKERS OF THE PARTS USED IN THE ORIGINAL EQUIPMENT DESCRIBED HERE.

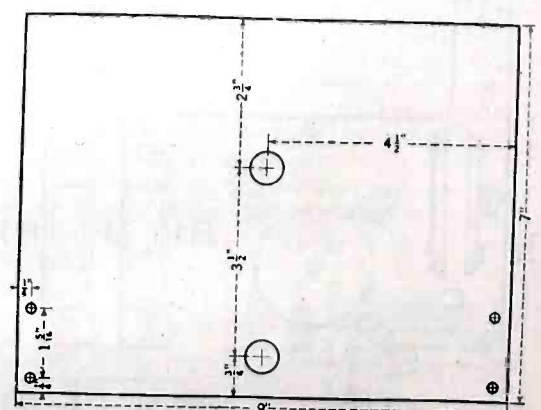

Layout details of the panel for the amplifier. The two small holes on each side are for the mounting brackets.

the loud-speaker plug is inserted into the jack on the panel. It is automatically shut off when the plug is removed. Any type or combination of tubes may be used if the correct types of automatic filament controls are installed. Thus, 3-volt tubes may be used and later on replaced by two standard 6-volt storage-battery tubes, or by one 6-volt and a semi-power- or power-amplifier tubes. The amplifier is also well adapted for comparative tube tests, as there are separate "B" and "C" leads, which permit variation of the negative grid and positive plate voltages on each of the two amplifier tubes.

(Continued on page 919)

Permanent Installation of Radio Equipment

Loud-Speaker Outlets Make Radio Service Now Available In Every Room

By E. R. PFAFF*

RADIO is rapidly taking a more prominent part in the American home. It is no longer regarded as a toy, but is made instead a chief source of entertainment and enlightenment. Just as the necessity of having the family grouped around a receiver to "listen in" by means of head sets has been overcome by the general use of the loud speaker, so has the confinement of radio entertainment to one room been ended. The more enterprising radio fans have enlisted the aid of extension cords and portable jacks to enable them to carry a loud speaker to a porch or adjoining room. Many progressive and far-sighted contractors and architects, however, are establishing practical, permanent installations, in new homes, apartments, hotels, hospitals and office structures, which will furnish radio service to any room in the building.

The home that is wired for radio service in its principal rooms should be most pleasant for every member of the family, and especially the housewife, for the reason that she spends a greater portion of her time in the house. It is now possible for her to hear her favorite programs at all times, regardless of what part of the house she may be led to by her occupation.

The following description of some of the more practical applications will be found in sufficient detail to use for installation purposes.

CONVENIENCE OF VOLUME CONTROLS

The receptacle jack in the bedroom may or may not be equipped with a volume control. It is preferable, however, to have this; in case of sickness or confinement a loud speaker or headset may be used by the patient, and the volume easily and immediately adjusted for maximum comfort.

Any desired volume, from a barely audible signal to that suitable for a loud speaker, may be obtained by turning the volume knob. This does not noticeably affect the volume of any other speaker which may be operating simultaneously in another part of the house.

The "Radio-Equipped" house in Fig. 1 shows a volume-control receptacle jack on the porch also. In summer, when the living room is too warm for comfort, the speaker may be carried to the porch and plugged into the jack. It is desirable to use a volume-control receptacle jack here so that the volume

may be reduced to avoid disturbing the neighbors.

An antenna-and-ground outlet jack (shown in Fig. 1 near the receiver), will furnish a neat and convenient connection for concealed antenna and ground wires. The outlet jack should be placed near the antenna lead-in, although reasonable distances will have no appreciable effect upon the operation of the receiver. The porcelain tube in the outside wall, through which the lead-

jacks are mounted on the wall or baseboard, either with or without a standard wall box; the latter is not indispensable, but it is an effective protection against falling plaster and dirt. Fig. 2B illustrates both methods of mounting this equipment.

It is important that parallel wires be kept at least one foot apart. The method of wiring shown in Fig. 2A allows approximately 18 inches of space between wires, keeping capacity between leads at a minimum.

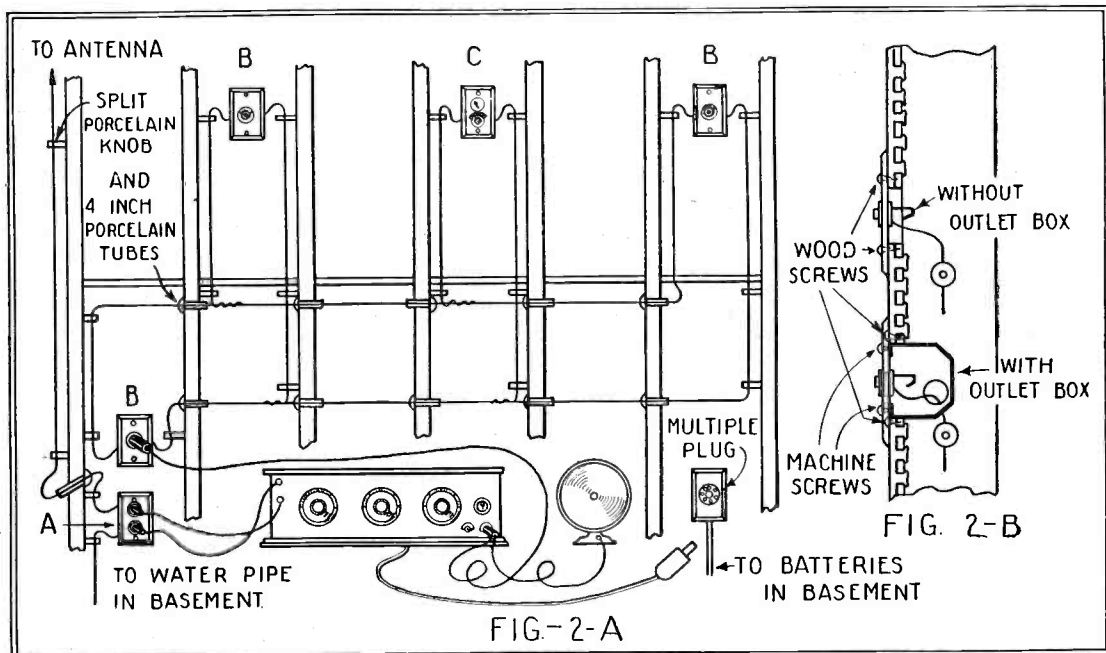

The method of running wires about 18 inches apart between walls to reduce capacity effects is indicated in Fig. 2A, at the left. Fig. 2B shows the methods of outlet mountings.

in wire is brought, should slant down and the lead-in wire be allowed to sag, as shown, in order to prevent water from running down the wire through the tube and into the building. The aerial lead-in and ground wires may be run through porcelain tubes in the studding or joists.

WIRING RECOMMENDATIONS

Fig. 1 shows also the method of wiring the receptacle jacks in the various rooms, which is best done at the time the electricians are installing the lighting circuit. Any wiring contractor will be able to do this, as only a few simple rules need be followed. The current carried by this circuit does not exceed 10 or 15 milliamperes. The receptacle

When wires are run from one floor to another they should be supported on split porcelain knobs, as shown in the drawing. Leads running in horizontal directions should pass through porcelain tubes, which are set in holes drilled in the joists or studding of the building.

The standard practice for open-circuit wiring should be followed as much as possible. The wire should be No. 18 to No. 14, rubber-and-cotton covered. Wires should be allowed to hang loose enough to permit convenient connection to the receptacle jacks. Fig. 2A is a detailed sketch to illustrate the method of running the wires.

In case a building is of fireproof construction
(Continued on page 880)

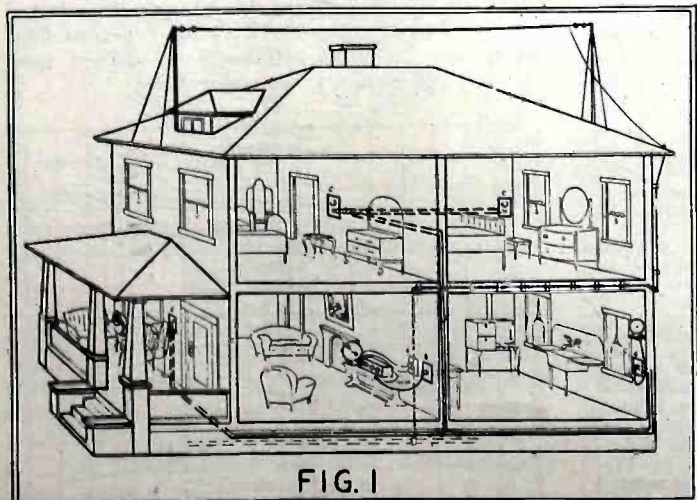

Above is shown how an entire house may be wired especially for radio, providing loud-speaker outlets in the principal rooms, and on the porch for summer comfort in reception.

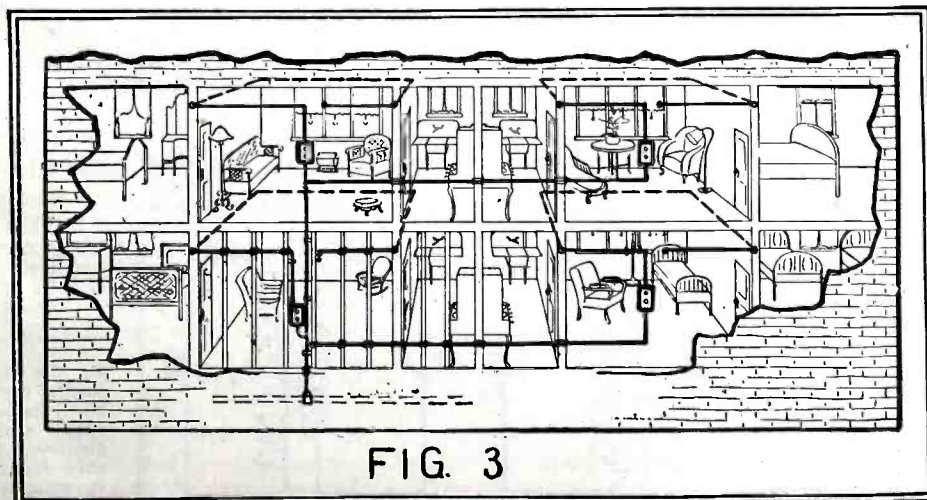

An installation of antenna and ground, such as shown above, will end trouble in apartment houses, where each tenant desires his own aerial. By using outlet jacks every apartment is provided with its own antenna and ground.

* Carter Radio Co.

How the Primary Affects the Secondary

Effects of Coupling In Transformers and Why Inductance Values Are Altered

By SYLVAN HARRIS

IN the design of radio receivers, by not only those who are so-called "fans," but also nearly all radio engineers, the "cut and try" method is very popular and useful; and especially with "resonance transformers." *Resonance transformer* is the technical name given to the antenna coupling coil, or the interstage coupling coil, wherein a primary coil is electromagnetically coupled to a secondary tuned by a variable condenser.

It is very true that in many cases the cut-and-try method is the only one that is satisfactory; especially with resonance transformers, where the *capacity* between the primary and secondary coils introduces complications which cannot be anticipated

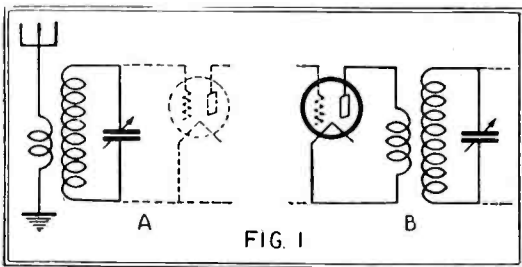

How "resonance transformers" are used: A, to couple the antenna circuit to the tuned secondary; B, to couple the output circuit of a R.F. amplifier to the input of another or of a detector tube.

analytically. But there is no doubt that an understanding of the magnetic phenomena, even omitting the effect of coil capacity, will act as a guide in the design, and save a great many hours of cutting and trying, with the attendant expense and delay.

The purpose of this article is to explain some things in connection with resonance transformers that are not generally known, but which seriously influence the operation of the radio receiver in which they are incorporated, especially in connection with the wavelength range over which they operate. The phenomena will first be considered without taking into account the capacity between the coils; and later the effect which the coil capacity has, in coupling the two circuits together, will be explained.

ANALYZING THE CIRCUITS

As defined before, a resonance transformer, of the type used in radio receivers of today, consists of an *untuned primary* circuit—that is, a circuit not containing a variable element—coupled electromagnetically, by mutual inductance, to a secondary circuit *which does contain a variable element*, usually a variable condenser. There are two cases, as shown in Fig. 1. In the one case (A) the primary is a part of an antenna circuit, which possesses a small amount of inductance, considerable capacity, and a certain amount of resistance. The value of the

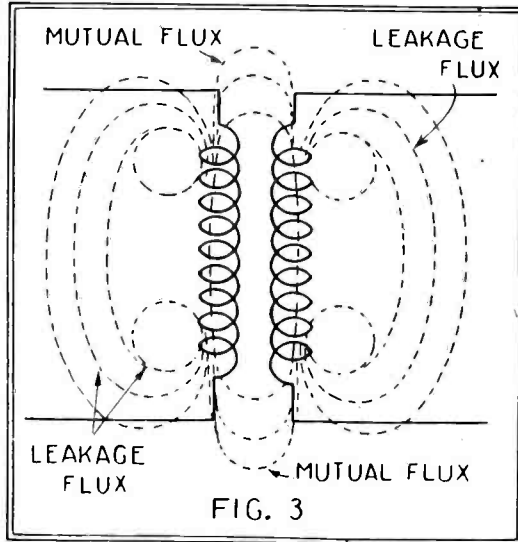

The total flux of a "resonance transformer" is composed of a mutual flux, linking both windings, and a leakage flux, which links only the winding which establishes it, and does not contribute to the transfer of energy from the primary to the secondary.

resistance in the primary circuit depends upon the characteristics of the antenna circuit, and is not very high when compared with the primary resistance in the other case we are going to discuss; it is, however, much higher than the resistance in the secondary circuit. In the secondary circuit we have an inductance (that of the secondary coil), a variable condenser, and a small amount of resistance, the latter varying between about 10 and 50 ohms.

In the other case, shown at B (Fig. 1), we have the primary coil connected to the output of an electron tube, which possesses a rather high resistance (in the neighborhood of 10,000 ohms) and no condenser. The secondary circuit of the resonance transformer is similar to that described in the last paragraph.

In both of these cases the condenser in the secondary circuit is connected to the input (or grid) of an electron tube, which may be a radio-frequency amplifier or a detector. In actual practice, the input circuit of this tube takes a small current, known as the "grid current," because there is only a finite impedance between the grid and filament, and this influences the phenomena of the system. For the purpose of studying the action, we will forget this grid current exists; at any rate it is exceedingly small, and it is to our advantage to keep it as small as possible.

The equivalent circuits of the two cases are shown in Fig. 2. In both cases, C_2 , r_2 and L_2 are, respectively the capacity of the variable condenser in the secondary, the total resistance of the secondary circuit, and the self-inductance of the secondary coil. It is important to remember that L_2 represents the

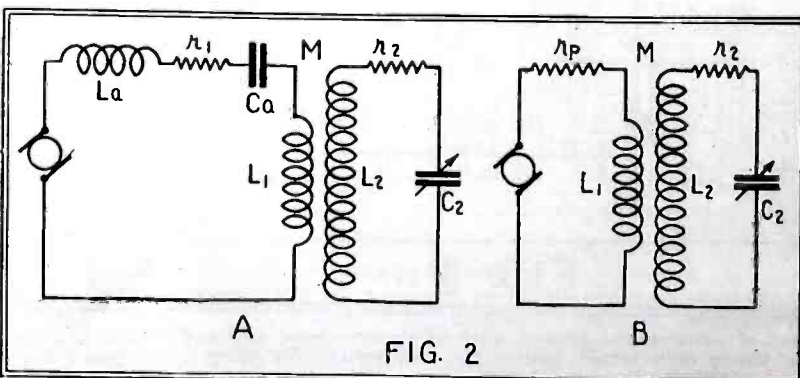

FIG. 2

Left, A and B are respectively the equivalent circuits of the two shown in Fig. 1.

At the right are experimental curves which show how the effective inductance varies with frequency. Note the difference from those in Fig. 4, which were computed without considering the coil capacity.

self-inductance of the secondary *by itself*; that is, as it would be measured if the primary were removed.

In case A, (Fig. 2) L_a and C_a are the inductance and capacity in the antenna, L_1 is the self-inductance of the primary, *by itself* (as if the secondary were removed), and r_1 represents the total resistance of the primary circuit, including the coil resistance, and both the ohmic resistance and the radiation resistance of the antenna. The generator indicated in the figure represents the electromotive force induced in the antenna by the radio waves ("signal").

In case B, (Fig. 2) in the primary cir-

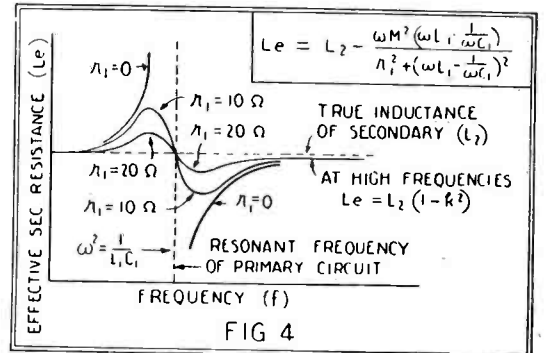

How the effective secondary inductance varies with the frequency. The inductance of the secondary coil alone is the broken horizontal line. The vertical broken line is the natural frequency of the primary and that at which both circuits are separately tuned alike. These curves do not consider the effect of coil capacity.

cuit we have indicated the plate resistance of the vacuum tube, r_p . The other symbols have the same meaning as in case A. The generator symbol represents the electromotive force developed in the plate circuit through the action of the alternating signal-voltage on the grid of the tube connected to the primary coil. The two cases are very similar except in two respects; in the first case (A) there is a capacity in the primary circuit, and resistance in this circuit is relatively low. In the second case (B) there is no capacity in the primary, and the resistance of the latter circuit is relatively very high. These differences cause the circuits to act in markedly different manners, as we shall see.

THE MAGNETIC COUPLING

Now, it is easily understood that the secondary circuit has an effect on the primary, and vice-versa. That this must be so is made clear by the fact that there is energy transferred from one circuit to the other. There is no such thing as having the coupling so "loose" that there is no reaction between the circuits, although we often use

(Continued on page 909)

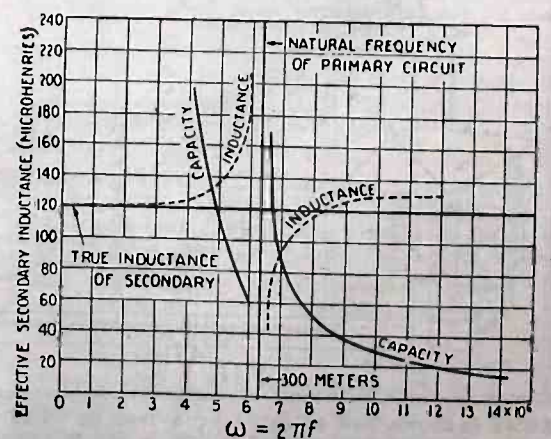
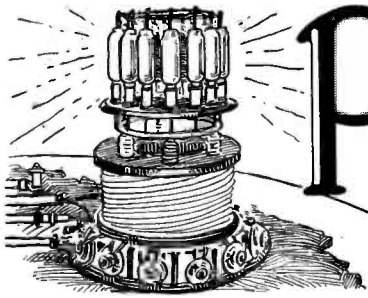
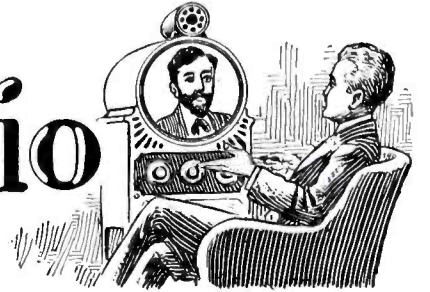

FIG. 5



Progress in Radio



A PERFORATED CONDUCTOR

The construction and use of a perforated conductor, particularly applicable to the internal wiring of wireless sets, is described in British patent, No. 255,512, by A. Edwards. The invention covers the making of an electrical conductor in the form of a flat strip S of thin metal, provided with a number of equally spaced longitudinal slots M. It is claimed that a conductor of this de-

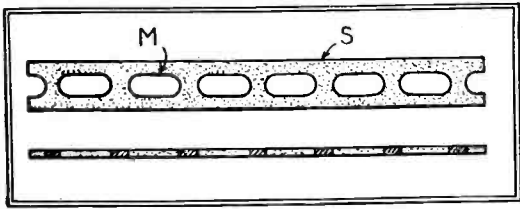

A perforated conductor strip, or "bus wire," which proves very handy in wiring sets. Since the conductor is flat it may be either bent or twisted; an obvious advantage.

scription is very convenient for the internal wiring of a set, since it can simply be locked into position by means of the various terminals or connecting nuts on the various components comprising the receiver. In addition, the strip is capable of being easily bent at right angles, or given a twist through any particular number of degrees, so as to vary the plane of the surface of the strip. Again, if desired, the strip may be soldered to the shank of a terminal, or to the screw to which it is to be connected.

—Wireless World.

A MULTIPLE-SURFACE DIAPHRAGM

The object of this invention is to provide a diaphragm in which the area of the vibrating medium is increased. According to the inventor, Albert Moulton Foweraker, of

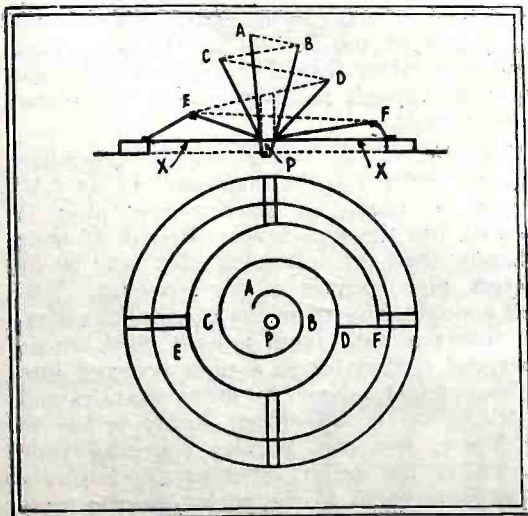

Something new in loud-speaker diaphragms. It is all one piece, and takes on the appearance of a pleated roll.

Carbis, Northbrook Road, Swanage, Dorset, to whom British patent No. 250,692 has been granted, this construction improves the tone and augments the volume of the sound reproduced. The invention consists in a multiple diaphragm, comprising a number of superimposed surfaces or members, fastened together so that they vibrate in unison. These surfaces or members may be of any number and be composed of any suitable

resilient material. They are V-shaped in vertical section, the angles of expansion successively diminishing to form a continuous cavity between them, which provides additional air impedance.

Referring to the diagrams, a spiral, A, B, C, D, E, F, is formed by fastening together two or more circular pieces of paper, or other suitable material, along radii which are cut; these being overlapped slightly at the circumferences so as to form a joint. The discs are then twisted about their common center until they take up a form such as that illustrated. The multiple diaphragm may be mounted upon a shallow cone or a flat diaphragm as shown at X, X, and its apex reinforced by a small wooden plug P glued and fitted inside the apex and projecting through the flat diaphragm so as to receive the applied vibrations. These are conveyed either by contact with or coupling to a connecting rod attached to the diaphragm or armature of a loud-speaker unit.

—Wireless Trader.

A NOVEL LOUD SPEAKER

This invention, which is the property of the "Ira" Company of Berlin, forms the subject matter of a recently granted British

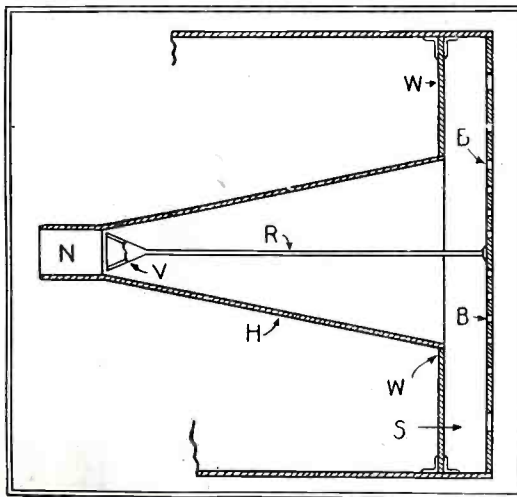

A new loud-speaker horn of novel design. Aside from the horn proper, there is a resonating chamber and a sounding board.

patent (No. 247,902) relating to a device for reproducing sound by means of a vibrating diaphragm, which may be fitted with a horn. The present invention claims to do away with many of the drawbacks encountered in reproduction under usual conditions.

The accompanying drawing represents a section of the device. In the horn, H, connected by its neck, N, in the sound-producing diaphragm, there is raised a vibrating body, V, in the form of a hollow cone, at one end of the neck. The vibrating body is carried by a rod, R, and the latter is inserted in the sounding board, B, in a suitable way. The wall, W, is connected to the horn. Between this wall and the sounding board is left a space, S. As the diaphragm vibrates the body, V, is also made to vibrate, and it transmits its vibrations by means of the rod, R, directly to the sounding board, B, which is arranged at the front end of the instrument. The diaphragm may be connected by the rod, R, to a suitable electro-magnetic unit, or to the sound box of a phonograph.

—The Wireless Trader.

A DOUBLE-DIAPHRAGM LOUD-SPEAKER

The illustration shows a loud-speaker which was invented, and made, by Mr. N. D. Blagdon-Phillips of Vancouver, B. C. (Canada). The principle of this instrument is the proximity of two diaphragms, vibrating in unison, but in opposite directions.

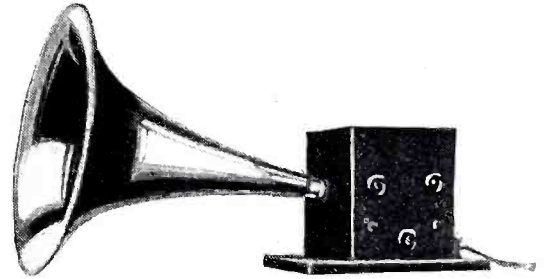

From a photo of the Blagdon-Phillips double-diaphragm loud speaker. The diaphragms are parallel to the axis of the horn.

Reference to the line drawing will make clear its construction and operation. Fig. 2 is a sectional elevation, showing the two diaphragms, d, d, which are separated by a paper ring, c; these then are clamped tightly together by two brass rings, r, r, with a number of small bolts and nuts. (For the sake of clearness the paper ring is shown as if it were thick.) This unit is then screwed to the three wooden pillars, p, p, p.

The electro-magnets, m, m, are of the watch-receiver pattern, and mounted on wood bases, w, w.; each has three slots in which ride the shouldered adjusting screws, s, s, which enables the magnet poles to be adjusted to a nicety in relation to their respective diaphragms.

Fig. 3 shows the attachment, t, for the horn, at which point there is a small gap, g,

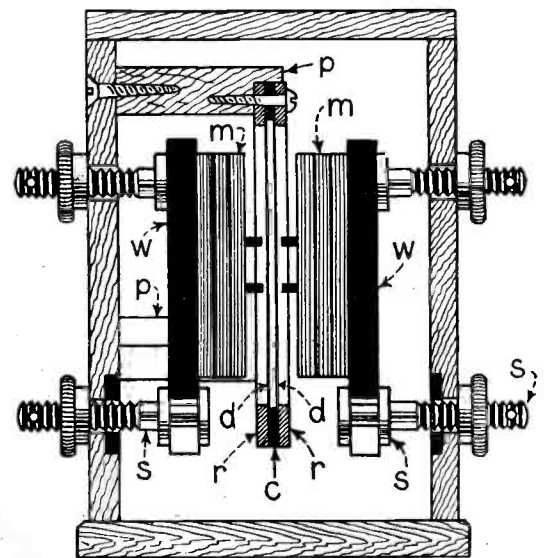

FIG. 2

A detailed sketch of the parts comprising the Blagdon-Phillips loud speaker; d, d are the two diaphragms.

in the continuity of the paper ring, through which the "tidal air" passes to the horn.

The action of the diaphragms in the manner first described may be likened to that of a pair of bellows, bearing in mind, of course,

(Continued on page 891)



First Prize

"A-AND-B"-BATTERY CHARGER

By ARTHUR A. SINISCAL

The writer of this article has in mind to describe a simple, inexpensive, easily-made chemical rectifier which will recharge both "A" and "B" batteries conveniently at home.

Having obtained four one-pint Mason jars, you will need eight electrodes for these cells, one pair for each. These electrodes consist of four aluminum and four lead plates, whose dimensions are each $1\frac{5}{8} \times 5$ inches (Fig. 1). Four aluminum plates cut from an ordinary kitchen casserole are excellent for this purpose. A strip of sheet lead, $5 \times 6\frac{1}{2}$ inches, obtained at a plumber's shop and cut into four pieces of the same size, will serve for the other set of plates. Scrape all eight plates well with emery paper to bring out a clean surface.

The plates are suspended in the cells, in pairs, by means of wood supports, the size of each of which is $\frac{3}{4} \times \frac{7}{8} \times 3$ inches. Both plates and supports and the method of attaching them are sketched in Figs. 1 and 2. Two holes drilled in each plate will allow two small screws to attach it to its support, a 10-in. length of copper wire being firmly entwined between the screws and wood sup-

Prize Winners

First Prize \$25

"A-and-B"-BATTERY CHARGER

By ARTHUR A. SINISCAL

284 So. 8th Street, Newark, N. J.

Second Prize \$15

IMPEDANCE-COUPLING KINK

By D. C. DUNCAN

804 So. Prospect Ave., Champaign, Ill.

Third Prize \$10

AN EASILY-MADE DRUM-TYPE DIAL

By H. R. WALLIN

203 Tompkins Ave., Brooklyn, N. Y.

All published Wrinkles, not winning prizes, will be paid for at the rate of two dollars each.

The next list of prize winners will be published in the March issue.

port for connection later. The supports should be boiled in a hot paraffin bath for an hour or so before final use. The four cells are then placed upon a base of wood (8 by 10 inches), arranging the plates in the manner shown in Fig. 4. Two hard rubber strips are fastened to the base, having binding posts with which external connections are made. The receptacle (S) is an ordinary porcelain lamp socket, placed where shown, and used for inserting the resistances (R), as a lamp, electric iron, etc.

For the electrolyte, first make a saturated solution of sodium bicarbonate (common baking-soda) in two quarts of distilled or rain water. Be sure you use distilled and not tap water, as the latter contains mineral compounds that interfere with the chemical action of the cell. When this solution is made, obtain 10 grams (one-third ounce) of ammonium phosphate (at any drug store) and dissolve this in a beaker of distilled water, adding the whole, when entirely dissolved, to the first solution. When the final mixture is completed, fill each cell with it to about an inch from the top and then connect your apparatus as indicated in Fig. 3.

For those who do not readily understand the wiring diagram of Fig. 4, the complete view of the apparatus in Fig. 3 will help illustrate more clearly the method of connections. Thus an aluminum from one jar is connected with a lead from another jar to one side of the house current line. Then the other side of the line is connected to an aluminum and a lead plate from the other two jars, as in the first case, but in series with a resistance (R) placed at S. This leaves two aluminums and two leads free, the two lead plates connected together forming the negative (-) terminal of the charging side, while the two aluminum plates are likewise connected and form the positive (+) terminal of the D.C. side.

In time, if any of the salts separate out and collect at the bottom of the jars, care should be taken that the sediment does not rise high enough to short-circuit the plates of your cells.

The size of the resistance is dependent upon the battery to be charged. If an "A" battery is used, an electric-iron plug is screwed into the socket (S), Fig. 3. If none is handy, then the following idea may be of interest, also because of its economy. Extract a single fuse from the box in the cellar, and insert a plug from a light cord whose other end terminates in a plug screwed into the socket (S). Now, by going upstairs and switching on a half-dozen lights or so in the house, you can, besides charging your battery in the cellar, also peruse leisurely the evening paper in the parlor, on the same electric bill.

If a "B" battery is to be charged, simply insert a 75-watt bulb into the socket, S, and leave it so until the battery is fully charged, which is determined with a voltmeter, or hydrometer in the case of an acid battery. If you are fortunate enough to possess a step-down transformer whose secondary voltage is around 20 to 50 volts or so, you can connect the A.C. side of your rectifier directly to the secondary terminals, placing a 5-ampere fuse into the receptacle (S) for either battery.

In practice, just before using the charger

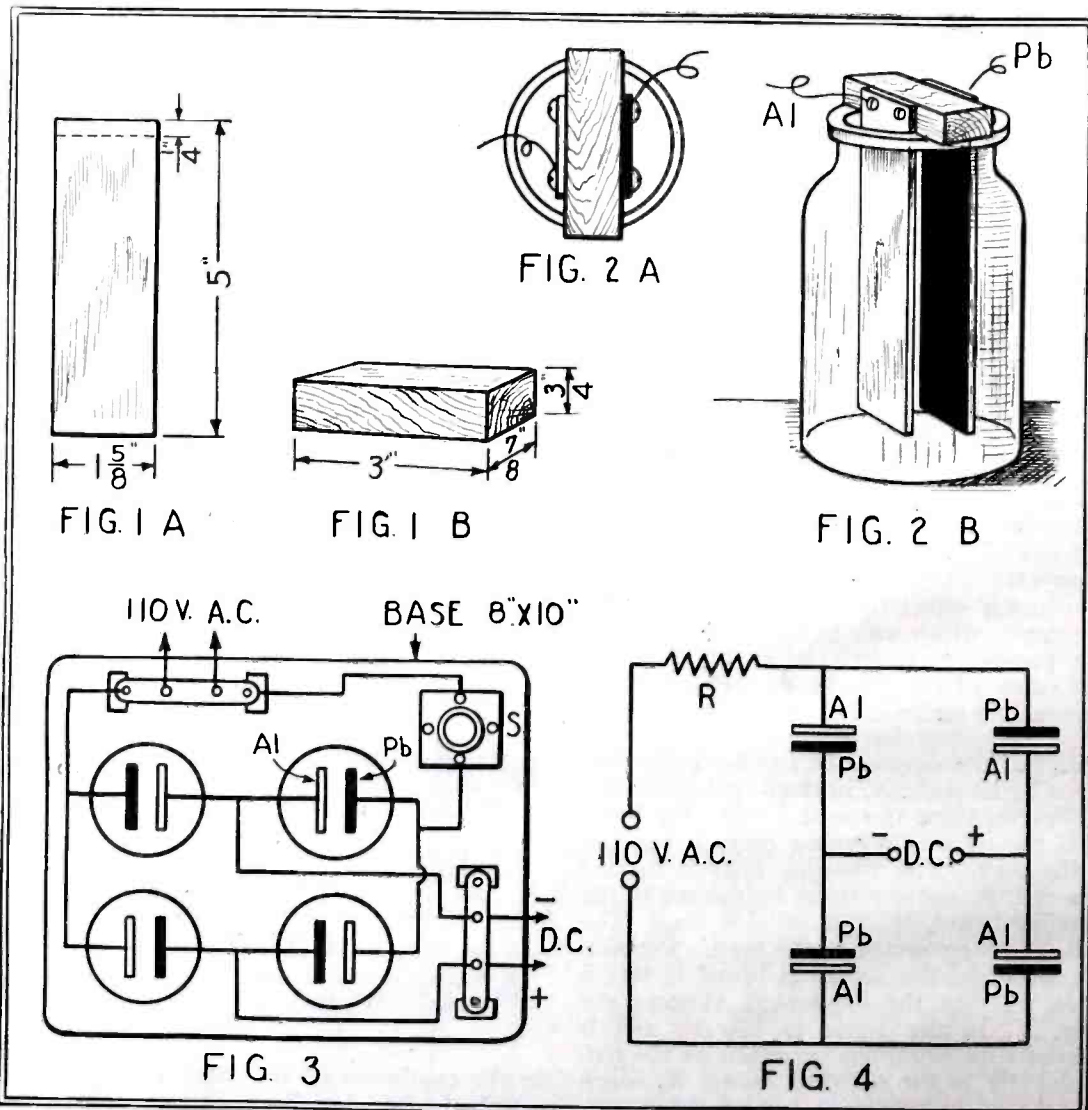

Constructional details and wiring diagram of the "A-and-B"-battery charger. The rectifier is of the electrolytic type, employing aluminum and lead plates. The amount of current delivered is dependent on the size of the lamp, or other form of resistance inserted into the socket S shown in Fig. 3. R in Fig. 4 represents the resistance placed in series with the circuit to control the current flow. This corresponds to S in Fig. 3.

for the first time in any case above stated, you must "form" the plates of the cells. This is done by directly short-circuiting the D.C. side with a thick wire and letting it stand thus for one-half hour or more with the current on. Of course, a low resistance, as an electric iron (if the house current is not stepped-down) must be connected to (S), or a fuse if a transformer is used. The plates are thoroughly "formed" when on disconnecting this wire, a bulb placed in the socket at (S) burns very dimly, if at all. This test can also be applied at some other time during the use of the apparatus, if it is suspected to be functioning improperly. Should the lamp thus tested burn brightly, the electrodes are not rectifying at all, and the trouble is usually found to be in the electrolyte, which will weaken in time. A fresh solution ordinarily removes the trouble, unless it happens to be in the external circuit. Other details, as the use of a switch control, are left to the will of the experimenter, but the apparatus is absolutely complete as hitherto described.

Second Prize IMPEDANCE COUPLING KINK

By D. C. DUNCAN

Impedance and resistance coupled audio amplifiers are quite popular. The circuits used lend themselves admirably for speaker filter circuits without any additional apparatus. By connecting the jacks as shown in the illustration, the loud-speaker may be

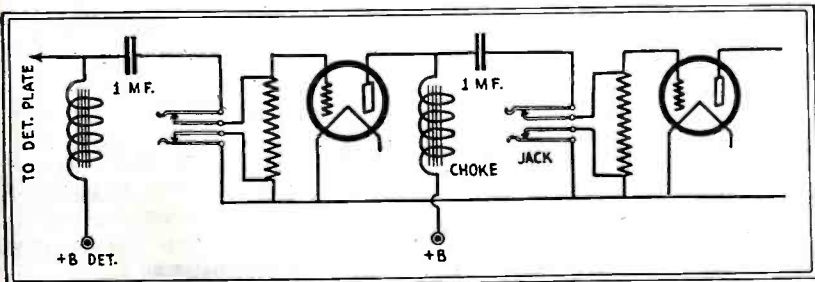

connected to the first, second, or third stage and the choke coil and condenser of the stage in which the speaker is connected forms the speaker filter circuit. You will note that with this arrangement the "B" battery current does not pass through the speaker.

Third Prize AN EASILY-MADE DRUM-TYPE DIAL

By H. R. WALLIN

One of the new drum-type rotary dials, such as are used in the higher grade of radio sets today, can be easily made with two ordinary three- or four-inch bakelite dials. Holes are drilled through the knobs to fit the shafts as shown in the illustration and the two dials are glued together with the degree markings coinciding. A small window

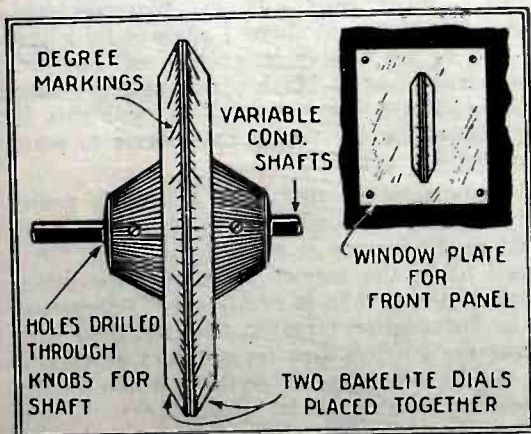

An excellent drum-type dial, made from two ordinary composition dials. The arrangement may be adapted to either single or double control.

plate made of brass, with the opening made to fit the dials, is placed on the front of the panel as shown. Small brackets hold the shafts securely.

The dial can be used on a single control set operating several condensers in tandem or two or three of the dials can be placed in the set.

(By using one dial for each condenser and by placing the two close together but without glueing them, the two condensers may be turned with one hand simultaneously or each one may be turned individually.—*Editor.*)

A SIMPLE VARIABLE GRID LEAK

Procure a thin piece of glass tubing 1 1/2 inches in length and having an inside diameter of about 1/16 inch. Place a piece

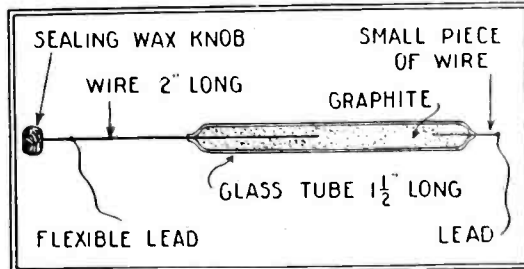

A variable grid leak, made from powdered graphite sealed into a glass tube.

of wire in one end as shown in the illustration and seal the end by heating the glass. Next fill the tube with graphite from a lead pencil. Now get a piece of wire

A very clever arrangement for impedance-coupled audio amplifier. When the loud speaker is plugged into either of the jacks, the impedance and condenser of the preceding stage form an output filter.

about 2 inches long, that fits in the tube, and make a knob of sealing wax on one end of it. This is placed in the tube and the end of the tube sealed just enough so that the plunger can move freely. This makes a very good variable grid leak. It is connected in the circuit by means of two connections soldered to the small wires.

Contributed by V. Sia, Shanghai, China.

SIMPLE COUPLING ARRANGEMENT

It is of considerable advantage to have some means whereby the coupling of the primary coil of a three-circuit tuner can be

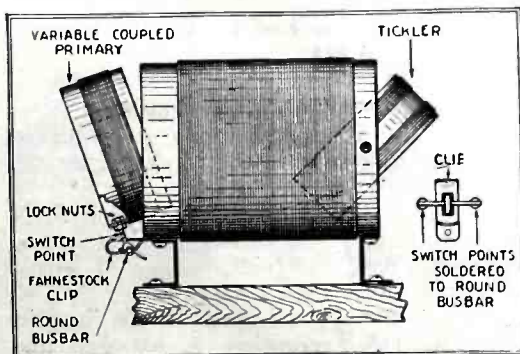

Details of a very simple arrangement providing flexible coil-coupling.

varied easily and effectively, and still be able to maintain any position in which it is placed.

A very good method for varying the primary coupling is shown in the accompanying illustration. The tuner itself is of usual construction. At the end of the tube upon which the secondary coil is wound is fastened a common form of spring clip.

Through this clip is passed a piece of heavy round copper wire (No. 12) about one inch long; this section of wire acts as a hinge. The ends of the wire are soldered to two machine screws which in turn are fastened to the tube containing the primary coil, as shown. The spring clip exerts sufficient pressure on the section of wire, so that the primary coil, though it can be easily moved, will hold its position.

Contributed by J. L. Rochester.

PREVENTING CORROSION OF BATTERY LEADS

The leads from the storage battery, whether it be "A" or "B", will soon lay across the vents and become impregnated with the electrolyte and become eaten away. When the battery is on charge, the spray rapidly eats into the battery leads.

One method of preventing such corrosion is to soak the leads for about a foot or two of their length in melted paraffin. For this operation a coffee can (see the illustration) placed upon the kitchen stove is very satisfactory in impregnating the leads. The first one or two feet of the wire is simply crum-

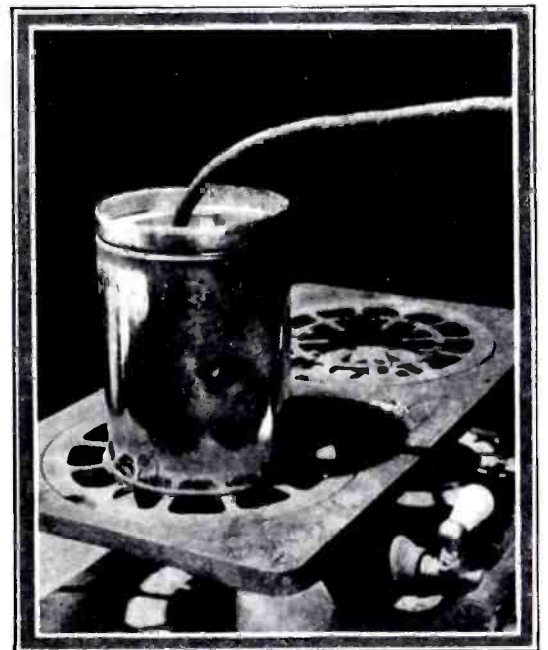

By impregnating all battery leads with paraffin, in the manner shown, they will be fully protected from the effects of corrosion thereafter.

med into the can of melted wax and allowed to remain for several minutes for sufficient penetration.

Contributed by Raymond B. Wailes.

A NON-MICROPHONIC SET

An inexpensive way of reducing the microphonic tube noises in a radio set is clearly illustrated in the accompanying drawing. Two rubber stair mats, which may be ob-

(Continued on page 856)

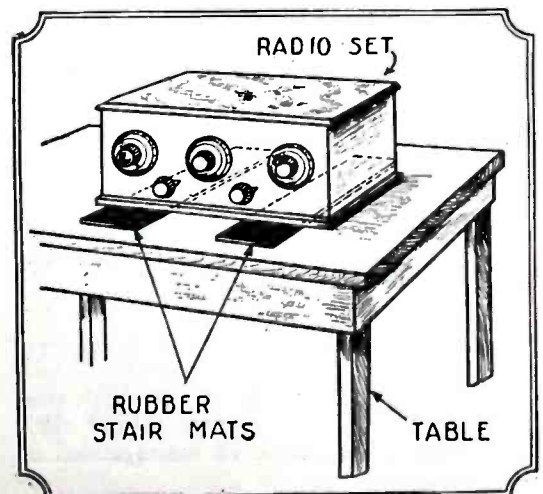

Microphonic noises in a receiving set can be eliminated by placing the set on rubber mats, as shown.



Correspondence from Readers



RADIO AS A "RAIN-MAKER"

Editor, RADIO NEWS:

This letter is written from a "dry" district—dry in the sense that there is not an abundance of moisture. It is the belief of some of the farmers of the district that broadcasting has a direct influence on rainfall. Some claim that Calgary and Saskatoon (cities about 200 miles distant from this village) have been benefited by their broadcasting, so far as rainfall is concerned. These cities, in their opinion, were heretofore dry, and are now wet. The farmers of this district do not believe that radio waves will gather clouds, but they do think that, given clouds (which have passed over us frequently during the summer) the effect of broadcasting would be to cause them to be condensed and so precipitate rain.

Some of these men are quite enthusiastic about the idea of building a station. If there is any connection between rainfall and broadcasting, would you kindly advise me? This is not an idle query written by some curious radio fan, but a letter asking for advice. The men back of the scheme are quite serious about it. The number of dry years has made them quite willing to try anything that will bring moisture. A letter has been sent to Montreal, but there has been no reply. I felt sure that an eminent authority on matters pertaining to radio, such as yourself, could give us some authentic information.

L. Goffman.
(Address not given)

There are no recorded facts tending to show that radio waves have the slightest effect on clouds. Extremely high voltages are required to bring about the precipitation of fog in a very limited area. The erection of a broadcast station in your district, for the purpose only of "making rain," would be a waste of money.—EDITOR.

SUPER-DX RECEPTION

Editor, RADIO NEWS:

For a long time I have been wanting to write and tell you about my DX work, but have been pretty busy answering letters from radio fans from all parts of the country.

I have been fairly successful for the past year in picking up a number of foreign stations; my log looks like the new Webster's dictionary. I always have my watch in front of me and jot down every item and the exact time (noting fading, modulation, etc.) that is being broadcast from the foreign stations.

My best reception of any foreign station is from station 4QG, Brisbane, Queensland, Australia, on 385 meters, 5,000 watts. On Friday morning, July 16, 1926, I heard the station's complete program from 2:02 A. M. until it signed off at 4:12 A. M., P.S.T., which corresponds to 8:02 P. M. to 10:12 P. M., same day, Brisbane time, as they are 18 hours ahead of P.S.T. I heard 31 different items, also set my watch that morning by Australian time. When the announcer said it was just 12 minutes past 10 o'clock—"Good Night Everybody,"—my watch read 4.11 a.m. I was one minute behind their time although they were 18 hours ahead of P. S. T.

The Australian and Japanese stations have been coming in fine for the past two weeks: namely, 3LO, Melbourne, 371 meters, 5000

watts; 2BL, Sydney, 353 meters, 5000 watts; 5CL, Adelaide, 395 meters, 5000 watts; 4QG, Brisbane, 385 meters, 5000 watts; JOAK, Tokyo, (Japan) 375 meters, 1000 watts; JOCK, Nagoya, 360 meters, 1000 watts; and JOBK, Osaka, 385 meters, 1000 watts. I can tune in the above-named stations every morning on the loud speaker, using two stages of audio, or 5 tubes, on my Super Zenith set.

I have tuned in 4QG Brisbane, Australia, for 27 consecutive mornings, and it is the most consistent of any foreign station.

My log now stands 287 stations, since Feb. 21, 1925, all confirmed; and 66 are out of U. S. A. Practically all of this year I



The new aerial, erected by Mr. Moskovita, which he uses for DX reception.

have worked only on foreign stations. Several of these foreign stations were picked up for the first time in the U. S. A. by me, I am informed.

I believe my best record is station 5DN Adelaide, South Australia, 140 watts, and Capetown, South Africa, which I have heard four times this year.

I have learned that one of the biggest secrets in DX. reception is patience and plenty of it. Often I wrestle with an elusive carrier wave for two hours or more, but I never give up until I hear a song or some other number by which I can have the reception confirmed.

The best DX. months of this year for foreign stations were February, March, the first half of April, and July, which was the best month for Australian and Japanese stations.

Jack Moskovita,
1121 So. Meyler St., San Pedro, Calif.

PRANKS OF THE AURORA BOREALIS

Editor, RADIO NEWS:

In a very recent newspaper I noticed the statement that the aurora which brightened the north a few nights since, and which was of most peculiar color, did *not* seem to make any difference in signal strength, cause fading, or other similar phenomena in radio.

But in a later issue of the paper we were told that telegraphic communication suffered some inconvenience, and that there was induction enough to energize telegraph wires so that batteries were shut off.

But a more peculiar fact was that there was a "change of direction every few minutes."

It would be interesting to know how much power is applied to the wires of the Western Union in order to energize the system. This being known, is it not within the realm of mathematics to estimate the probable energy of the auroral "light" in order to furnish this power by induction?

The statement "every few minutes the direction changed" is intriguing. It is rather evident that we have actual alternating "current" of very low frequency, provided we are willing to forego application of the literal term and take it as we know it in the "frequencies" understood in radiant energy.

If we have some writer who is interested in these things it would seem that he could furnish a most interesting and instructive paper to readers of your magazine.

Dr. F. McFadden,
Athol, Mass.

MORE ABOUT RADIO GRAFTERS

Editor, RADIO NEWS:

Your article in the November, 1926, issue of RADIO NEWS, entitled "Confessions of an Installation Grafter," has just been read by me. I was extremely surprised that such a magazine as RADIO NEWS would publish such a fictitious article as the above.

I have made quite a study of radio during the past six and a half years and have built radio sets of most every description; and I also happen to follow up radio to the extent of being a service man, doing service work in the evenings after I am through working for my employer. I have always been honest in every service job that I have undertaken. I have always given \$1.00 worth of service for \$1.00. If a man's tubes in his set checked good, I always pronounced them good. If his batteries had sufficient voltage in them I always told him so, and as yet I have never "gyped" anyone. Your article puts a black mark on every man who installs or services radios, and this is the reason for my taking exceptions to your uncalled-for article.

It seems to me that your article is probably fiction, in order to warn people of what might happen if some "gy." artist happened to be the service man. On the other hand, if the article is really the Confessions of an Installation Grafter, then the man who wrote the story is just an ordinary thief and he would not stop at anything when in his thieving mood. If he stole, grafted, and cheated people for whom he installed sets, then he would steal from anyone. In all probability if he stole, he also is a very good

(Continued on page 914)

Radiotics

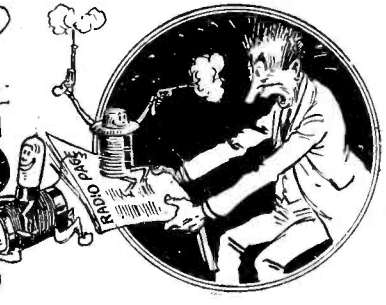
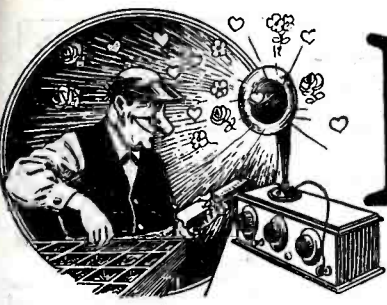

HOW MUCH A KARAT?



Influence of the Roumanian visit on resistances, as seen by *Popular Science Monthly* (November issue): "Makers of a line of VALUABLE resistances." We sent Mike of the Investigation Department out on this and he found out that someone is using pearls, diamonds, and rubies in these grid-leaks. And with all these robbers about, too!

Contributed by E. F. Winther

THIS SOUNDS EFFICIENT



"Take no chances" must be the motto of the *Cincinnati Enquirer*, as evidenced in its issue of Oct. 10 by the following: "The shield is SHIELDED." Now, if you shield the shield, how are you going to shield the shield that shields the shield? We give up!

Contributed by B. J. Nieberding

THE POOR COIL!



In the *Philadelphia Evening Public Ledger* of Oct. 9 we have the following: "The grid connection to the secondary should be next to the TICKLED coil." We throw back our head and yell to the universe, "WHY, OH WHY?" What is the idea of tickling the coil? Ain't there howls enough in the average set?

Contributed by Albert Flurry

EVIDENTLY AN ANTIQUE

Ghoulish gesture from the *Providence, Evening Bulletin* of Oct. 19: "This handsome BURIED walnut finished console." Perhaps a treasure from King Tut's lumber room. It is hard to tell what our enterprising excavators will dig up next.

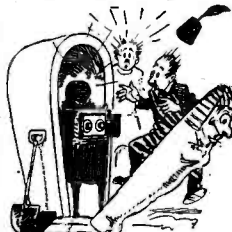

Contributed by Mrs. G. E. Sunderland

AIN'T SCIENCE WONDERFUL?

Twentieth century method of transportation, as reported on Oct. 10 by the *Chicago Tribune*: "At present there are several means of transmitting PHOTOGRAPHERS from one point to another by wire, cable or radio." We wonder why only photographers? What have they done to monopolize so excellent a means of travelling?

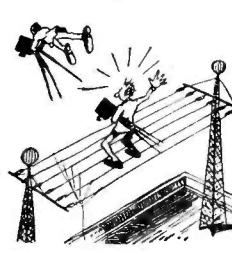

Contributed by Leo Cross

LAFF THIS OFF

Advertisement in the *London (Ont.) Free Press* of Oct. 5: "Radio battery, 6 volts, 100 ap. hours. 1 1/2 H. P. VARIABLE SPEED." Oh, Grandma, how come the battery has to have variable speed? Where does it go? Does it run after the stations and drag them in to the receiver? Please tell your little boy.



Contributed by Loyd Frank

'RAY FOR THE WETS!

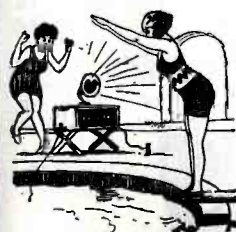

Anti-prohibition note from the *Farm and Ranch Review* of Sept. 25: "Static Minimized with POOL aerial." This is new apparatus, says the Review, and we believe it. We have heard of goldfish bowls being used; but the use of a whole pool of something or other in place of an antenna is sure new to us.

Contributed by Harry McCreight

IF you happen to see any humorous misprints in the press we shall be glad to have you clip them out and send to us. No RADIOTIC will be accepted unless the printed original giving the name of the newspaper or magazine is submitted with date and page on which it appeared. We will pay \$1.00 for each RADIOTIC accepted and printed here. A few humorous lines from each correspondent should accompany each RADIOTIC. The most humorous ones will be printed. Address all RADIOTICS to

Editor RADIOTIC DEPARTMENT, c/o Radio News.

THEY STAY OUT ALL NIGHT

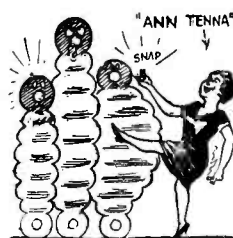

Reforming gesture from the *Pittsburgh Press* of Oct. 3: "Glass insulators PROTEST antennae." Now that everything else is being reformed the glass insulators are taking their turn at deploring the looseness of antennae. Use your own judgment about the type of looseness.

Contributed by Paul H. Shafer

FOR THE LADIES' PORTABLE

Feminist movement, as indicated in the *Springfield (Ohio) News* of Oct. 15: "Ask your dealer about Philco LOCKET powers." Now that the girls are getting so interested in radio, the manufacturers are putting out equipment that they can carry the powder puff in. Great stuff, boys, eh?



Contributed by John Simons

MORE REMOTE CONTROL

News item from the *Milwaukee Journal* of Oct. 10, about our Army airplanes. "The distance between the airplane and A SET, however, rarely exceeds 75 or 80 miles." Believe me, boys, they must have some almighty powerful loud speakers in the army, if they can be heard 75 or 80 miles over the roar of the 'plane's engine.

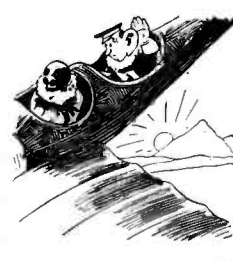

Contributed by Arthur Russell

SOME TUBES!!

The latest word in multi-tube receivers, as advertised in the *Vancouver (B.C.) Star* of Sept. 17: "Radiola 93A with phones and 30 BY 199 tubes. \$42.50." We don't quite get what sort of tubes these are, whether we should multiply 30 by 199, or whether they are 30 by 199 inches or feet. Does anybody know?

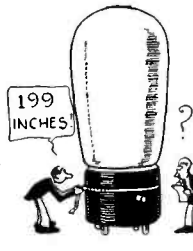

Contributed by A. R. Cann

SOME LOUD SPEAKER

The *Tulsa (Okla.) World* of Oct. 3 gets at the root of the matter of loud speakers in the following advertisement: "Receiver equipped with Western Electric CORE—" We suppose that this means that the Western Electric is getting big hearted and is putting the main part of its plant into a speaker.

Contributed by John Ecton



HOW ABOUT SPONGES?

This from the *Memphis Commercial Appeal* of Oct. 10: "Elimination of BOWLS and dials being sought." Did any of you folks ever use bowls to put under the grid leaks? Now that bowls are out, we humbly suggest that sponges be used in their stead. Think it over.

Contributed by N. G. Scott



BOOM! BOOM!!

Explosive item in the *Baltimore Post* of Oct. 1: "some means must be provided for securing a close adjustment of the grid BLASTING potential." All of which means, Oscar, that there isn't enough power in the tubes for some folks, and they have to add a little dynamite to get the necessary pep.

Contributed by A. R. Keuchen



BOILED OWLS, BEWARE!

Startling news on marriages and divorces in the *Asheville (N.C.) Citizen* of Oct. 14: "In the nation at large there is now one divorce for every seven marriages—the RADIO increases." Now, you DX hounds who sit up all night had better watch your step. When friend wife rings the curfew you might just as well sign off. No more of this "Just a minute, honey" stuff.

Contributed by I. N. Harris



OF THE RED-HOT KIND?

Trend of the times as seen in the *Ashtabula (Ohio) Star-Beacon* of Oct. 13: "FRESHMA Masterpiece." We would naturally assume that this masterpiece hasn't a great deal to do with radio, although there might be a loud speaker somewhere around. Have you a little masterpiece like this in your home?

Contributed by A. Klingbeil



MAKING A SET SELECTIVE

Advertisement in *RADIO NEWS* for December informs us that we can get a "30H, 50MA, Raytheon FILER, \$1.75." Cheap at double the price; this is evidently the kind of attachment that you put on the receiver to sharpen the tuning. But just how do we hook it up? Diagram, please.

Contributed by F. L. Erickson



APPROVED RADIO NEWS LABORATORIES 1922

RADIO NEWS LABORATORIES



RADIO manufacturers are invited to send to RADIO NEWS LABORATORIES, samples of their products for test. It does not matter whether or not they advertise in RADIO NEWS, the RADIO NEWS LABORATORIES being an independent organization, with the improvement of radio apparatus as its aim. If, after being tested, the instruments submitted prove to be built according to modern radio engineering practice, they will each be awarded a certificate of merit, and a "write-up" such as those given below will appear in this department of RADIO NEWS. If the apparatus does not pass the Laboratory tests, it will be returned to the manufacturer with suggestions for improvements. No "write-ups" sent by manufacturers are published on these pages, and only apparatus which has been tested by the Laboratories and found to be of good mechanical and electrical construction is described. Inasmuch as the service of the RADIO NEWS LABORATORIES is free to all manufacturers whether they are advertisers or not, it is necessary that all goods to be tested be forwarded prepaid, otherwise they cannot be accepted by the Laboratories. Apparatus ready for the market or already on the market will be tested for manufacturers, as heretofore, free of charge. Apparatus in process of development will be tested at a charge of \$2.00 per hour required to do the work. Address all communications and all parcels to RADIO NEWS LABORATORIES, 53 Park Place, New York City.

CORRECTION

The Tapped Inductance submitted by Heintz & Kohlmoos, Inc., 221 Natoma Street, San Francisco, Calif., was by error listed on page 373 of the October, 1926, issue of RADIO NEWS as having been submitted by the Remler Division of Gray & Danielson Mfg. Co., 260 First St., San Francisco, Calif., instead of as above.

This inductance is designed for use in the Infradyne circuit and was found to be of excellent construction.

AWARDED THE RADIO NEWS LABORATORIES CERTIFICATE OF MERIT NO. 1710.

BATTERY CABLE

The "Alpstrand" silk covered battery cable shown, submitted by the Alpha Radio Supply Co., Inc., New York City, N. Y., consists of five



differently-colored flexible wires. Upon each wire is placed a number of layers of insulation, which enhance the insulating value of the cable. The wires are held together by a silk sleeve.

AWARDED THE RADIO NEWS LABORATORY CERTIFICATE OF MERIT NO. 1647.

RESISTANCE HOLDER

The Single "Durham" grid resistor mounting and condenser mounting shown, submitted by the International Resistance Co., Perry Bldg., 16th and Chestnut St., Philadelphia,

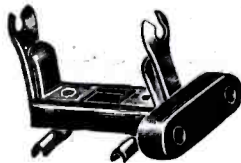

Pa., is of unique construction. Its main feature is the molded bakelite base, which is made so that the holder may be mounted in an upright or vertical position. Firm contact is made by two spring-brass nickle plated clips, to which are attached terminals for connection.

AWARDED THE RADIO NEWS LABORATORY CERTIFICATE OF MERIT NO. 1660.

WAVE TRAP

The "Station Rejector," or wave



trap shown, submitted by Hart and Hegeman, 342 Capitol Ave., Hartford, Conn., was found to be very efficient, when used with general types of radio receivers, for eliminating interference. It is of considerable aid in solving selectivity problems, with receivers of the broad-tuning type.

AWARDED THE RADIO NEWS LABORATORY CERTIFICATE OF MERIT NO. 1670.

ADJUSTABLE CONDENSER

The "Mikro-Mike" condenser shown was submitted by Bremer-Tully Mfg. Co., 532-536 So. Canal St., Chicago, Ill.; micrometer adjustment is obtained with its use. It is used mainly as a neutralizing

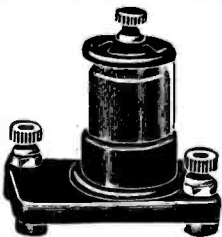

condenser, because of its very small minimum capacity. The principle is that of a brass tube sliding in and out of a larger one, with a glass cylinder as the dielectric.

AWARDED THE RADIO NEWS LABORATORY CERTIFICATE OF MERIT NO. 1676.

INDUCTANCE COIL

The diamond-weave "Sickles" inductance coil shown, submitted by F. W. Sickles Co., 130-140 Union St., Springfield, Mass., is enclosed in a

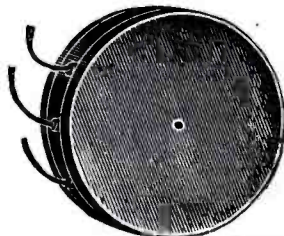

metal case which acts as a shield. It will tune from 200 to 550 meters in conjunction with a .00035-mf. variable condenser. This type of coil is commonly used in tuned-radio-frequency receivers.

AWARDED THE RADIO NEWS LABORATORY CERTIFICATE OF MERIT NO. 1677.

EXTENSION CORD CONNECTOR

The extension cord connector shown was submitted by Frank W. Morse Co., 289-291 Congress St.,



Boston, Mass. Quite often it is desirable to operate a loud speaker at some point remote from the set, in which case an extension cord is employed. This connector is a simple device for connecting the loud-speaker-cord tips to those of the extension cord. It is well constructed, and highly suitable for its purpose.

AWARDED THE RADIO NEWS LABORATORY CERTIFICATE OF MERIT NO. 1682.

VARIABLE RESISTANCE

The "Resist-o-meter" shown was submitted by Scholes Radio & Mfg.



Corp., 32 West 18th St., New York City, N. Y. This variable resistance is employed especially for grid-leak purposes, when the adjustment of the grid resistance is more or less critical. Exceedingly fine adjustment may be obtained because of the finely threaded rod, the rotation of which varies the resistance of the unit.

AWARDED THE RADIO NEWS LABORATORY CERTIFICATE OF MERIT NO. 1684.

SET TESTER

The "Superunit" set tester shown, submitted by the Hanscom Radio Devices, Woonsocket, R. I., operates from the light socket, on either alternating or direct current. A 25-watt

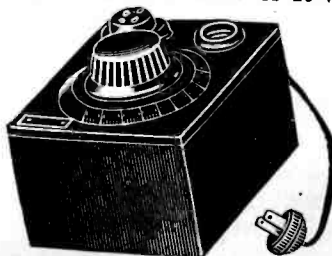

lamp is employed as a resistance, which reduces the current to the value required for vacuum-tube operation. The oscillator frequency is varied by the dial.

AWARDED THE RADIO NEWS LABORATORY CERTIFICATE OF MERIT NO. 1685.

LOUD SPEAKER

The "Resonata" reproducer shown, submitted by the Resonata Corp. of America, 1270 Broadway, New York City, N. Y., is entirely new in prin-

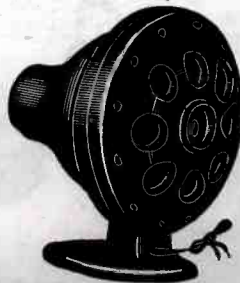

ciple and strikingly efficient. Its resonance chamber is somewhat similar in form to the human mouth. In appearance the Resonata is small, compact and beautiful in construction.

AWARDED THE RADIO NEWS LABORATORY CERTIFICATE OF MERIT NO. 1686.

BY-PASS CONDENSER

The by-pass condenser shown, submitted by the Polymet Mfg. Corp., 599-601 Broadway, New York City, is employed in the construction of radio receivers and units when rela-

tively high capacities are required. The container of the condenser is of metal and provision is made for the fastening the unit to either the base-board or sub-panel of a set. Different sizes from 0.1 to 5 mf. in capacity, are available.



AWARDED THE RADIO NEWS LABORATORY CERTIFICATE OF MERIT NO. 1687.

INDUCTANCE COIL

The interchangeable low-loss coil shown, submitted by the Washburn Mfg. Co., Kokomo, Ind., is of the plug-in type and has the desirable feature of variable coupling between the primary and the secondary windings. A receiver having a high de-



gree of selectivity may be constructed with this type of coil. The coils are constructed in various sizes to cover various wavelength ranges. The base plugs into an ordinary VT or UX socket.

AWARDED THE RADIO NEWS LABORATORY CERTIFICATE OF MERIT NO. 1689.

ASSEMBLED KIT

The assembled kit No. 395 shown, was submitted by the General Radio

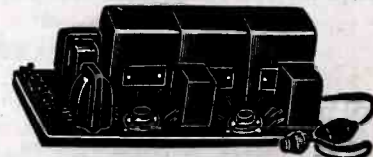

Co., 30 State St., Cambridge, Mass.; a power amplifier and "B" battery eliminator is incorporated into one unit. The eliminator is of the full-wave rectifying type, employing a Raytheon tube; the current output is rated at 80 milliamperes. The power amplifier uses one UX171 type tube. The unit operates from an alternating current source, and performs very efficiently.

AWARDED THE RADIO NEWS LABORATORY CERTIFICATE OF MERIT NO. 1690.

LOUD SPEAKER

The "Utah Book Loud Speaker" shown was submitted by the Utah Radio Products Co., 1421 So. Michi-



gan Ave., Chicago, Ill. The design resembles the two open pages of a book, each page being caused to vibrate by the speaker unit, which connects at the intersection of the two pages. The quality of the reception is excellent.

AWARDED THE RADIO NEWS LABORATORY CERTIFICATE OF MERIT NO. 1691.

LIGHTNING ARRESTER

The "Fil-Ko radio lightning arrester" shown, submitted by S. R. Hipple, Williamsport, Pa., may be

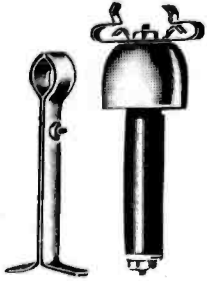

easily installed indoors or outdoors. The directions for the installation are included in the carton. It is well constructed and easily passes the requirements of fire underwriters.

AWARDED THE RADIO NEWS LABORATORY CERTIFICATE OF MERIT NO. 1692.

EXTENSION CORD

The "Radio Reel" loud speaker extension cord shown, submitted by the Cuno Engineering Corp., Meriden, Conn., contains a spring

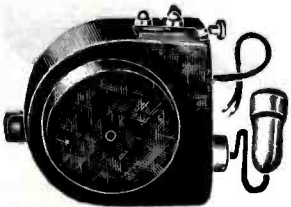

ratchet whereby slack in the cord is automatically taken up. It is used in conjunction with a receiver, with a loud speaker at a remote point.

AWARDED THE RADIO NEWS LABORATORY CERTIFICATE OF MERIT NO. 1693.

COIL

The coil shown, submitted by Feri Radio Mfg. Co., 1167 Bedford Ave., Brooklyn, N. Y., is a self-supporting solenoid of the type used in or-

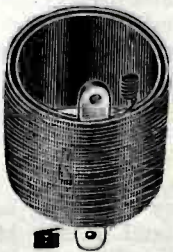

inary tuned-radio-frequency receivers. The wires are space-wound. Besides the celluloid material which supports the winding, green silk insulation is used.

AWARDED THE RADIO NEWS LABORATORY CERTIFICATE OF MERIT NO. 1694

COIL

The coil shown, submitted by the Feri Radio Mfg. Co., 1167 Bedford Ave., Brooklyn, N. Y., is of unique construction, being encased in a cop-



per casing with a crystalline finish. The casing serves as a shield, as well as a connection for the "F minus" terminal of the coil, which may be used in a standard T. R. F. receiver,

where suppressed oscillation is desired.

AWARDED THE RADIO NEWS LABORATORY CERTIFICATE OF MERIT NO. 1694.

CONNECTOR CLIP

The "Hartung" clip shown, submitted by the Charles F. Hartung



Co., 728-30 E. 61st St., Los Angeles, Calif., is made of spring steel and has an outside coating to prevent acid corrosion. It is made in various sizes.

AWARDED THE RADIO NEWS LABORATORY CERTIFICATE OF MERIT NO. 1695.

LOUD SPEAKER

The "Fine Arts" reproducer shown, submitted by the Plaza Radio Corp., 10 West 20th St., New York City, N. Y., is of the cone type and has a beautiful appearance. It is capable of clear reproduction without "blasting."



AWARDED THE RADIO NEWS LABORATORY CERTIFICATE OF MERIT NO. 1696.

EXTENSION CONNECTOR

The "E-Z" extension connector shown, submitted by the Polymet Mfg. Corp., 599-601 Broadway, New York City, is employed for extension purposes and is designed specifically for connecting a remote speaker.

AWARDED THE RADIO

NEWS LABORATORY CERTIFICATE OF MERIT NO. 1698.

RESISTANCE-AMPLIFIER UNIT

The resistance-coupled amplifier shown, submitted by the Polymet

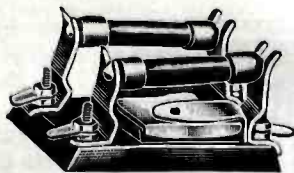

Mfg. Corp., 599-601 Broadway, New York City, was found to be accurate and as specified. The resistances employed in this unit will remain practically constant in value for a long period of time. The base of the resistance unit is of molded bakelite and is equipped with spring clips for the resistors.

AWARDED THE RADIO NEWS LABORATORY CERTIFICATE OF MERIT NO. 1699.

SOCKET "A" CHARGER

The "Harvard" socket "A"

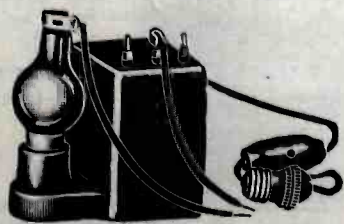

Charger shown was submitted by the American Storage Battery Co., 326

Newberry St., Boston, Mass. This battery charging device, of the half-wave-rectifier type, employs a two-ampere Tungar or similar type tube; the charging rate is low. The device operates from an alternating-current socket only.

AWARDED THE RADIO NEWS LABORATORY CERTIFICATE OF MERIT NO. 1700.

IMPEDANCE-AMPLIFIER UNIT

The "Impedaformer" shown, submitted by the National Company, Inc., 110 Brookline St., Cambridge, Mass., may be used in the construction of audio-frequency amplifiers. It is designed to give satisfactory amplification over the entire range of audio frequency. It gives reproduction which is most pleasant to the ear.

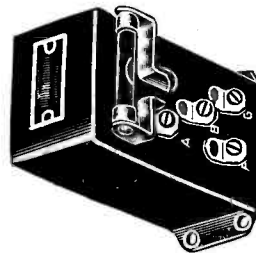

AWARDED THE RADIO NEWS LABORATORY CERTIFICATE OF MERIT NO. 1701.

RHEOSTAT

The "Tom Thumb" Rheostat shown, submitted by the Amsco Products, Inc., 416 Broome St., New York City, is of unique design and compactly constructed. The

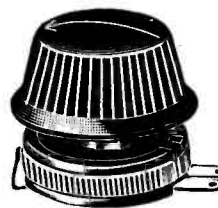

terminals are stamped and soldered, instead of being bolted.

AWARDED THE RADIO NEWS LABORATORY CERTIFICATE OF MERIT NO. 1702.

BINDING-POST STRIP

The assembled binding-post strip



shown, submitted by the Amsco Products, Inc., 416 Broome St., New York City, is made of molded bakelite, and is very strong. It contains enough binding posts for the ordinary receiver. The binding-post tops are engraved, with suitable markings.

AWARDED THE RADIO NEWS LABORATORY CERTIFICATE OF MERIT NO. 1703.

SHIELDED DIALS

The "Eby" shielded dials shown, submitted by the H. H. Eby Mfg. Co., Philadelphia, Pa., are neat in appearance and may be used as tuning controls on any radio receiver. A single set screw is employed for locking a dial in place. The dials have a vernier action with a ratio of 10 to 1, and both clockwise and counter-clockwise readings.

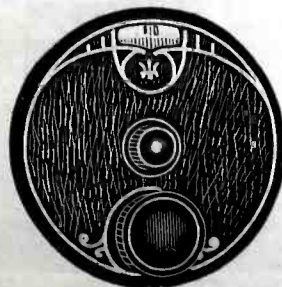

AWARDED THE RADIO NEWS LABORATORY CERTIFICATE OF MERIT NO. 1704.

VERNIER DIAL

The "Cornell" Vernier dial shown, submitted by the Cornell Elec. Mfg. Co., 135 East 58th St., New York



City, has a beautiful bronze finish and is engraved in a most pleasing style; it is made of metal and has a ratio of 10 to 1. It is fastened to the panel by means of a bolt and screw.

AWARDED THE RADIO NEWS LABORATORY CERTIFICATE OF MERIT NO. 1705.

LOUD SPEAKER

The "Trutone" loud speaker shown, submitted by the Gemco Mfg. Co., Milwaukee, Wis., is mounted on a beautiful platform or base. Despite its appearance, it op-

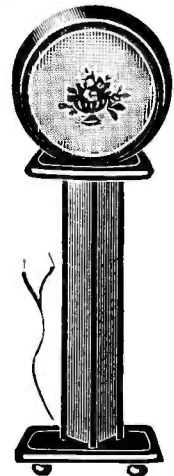

erates on the horn principle, the unit being mounted at the bottom of the platform.

AWARDED THE RADIO NEWS LABORATORY CERTIFICATE OF MERIT NO. 1706.

RADIO RECEIVERS

The "Pfanstiehl Overtone" receiver (Model 20) shown, submitted by the Pfanstiehl Radio Co., Waukegan, Ill., was found to be very selective and efficient. It employs only one con-

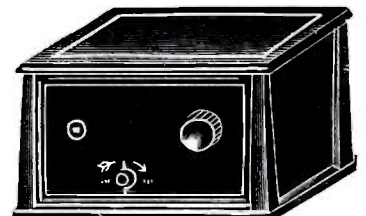

trol for tuning; the dial is calibrated in meters instead of degrees, thereby making tuning very simple. The cabinet is highly finished and decorative.

AWARDED THE RADIO NEWS LABORATORY CERTIFICATE OF MERIT NO. 1707.

The "Pfanstiehl Overtone" receiver (Model 18) shown, submitted by the Pfanstiehl Radio Co., Waukegan, Ill., was found to be very efficient and selective. It incorporates two stages of

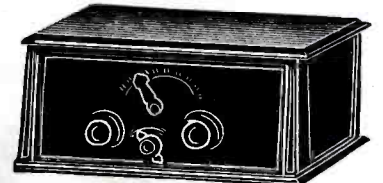

tuned-radio-frequency, detector, and two audio stages. The panel-dial readings are calibrated in meters. The receiver as a whole is very neat in appearance.

AWARDED THE RADIO NEWS LABORATORY CERTIFICATE OF MERIT NO. 1707.

(Continued on page 906)



With the Amateurs

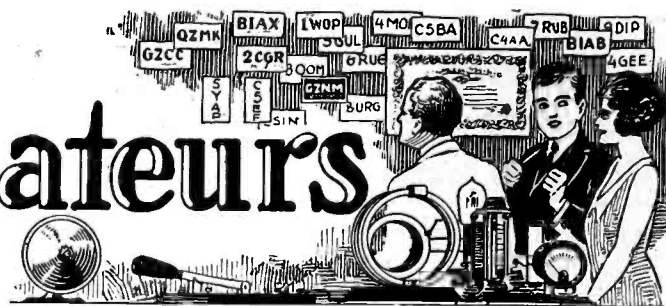

A Complete 20-Meter Ham Installation

Constructional Data for Modern Short-Wave Transmitter and Receiver

By A. BINNEWEG, Jr., 6BX, 6XAA

THAT the short waves are the best is now an established fact; so why waste time and power on a long wave-length that sooner or later will be completely abandoned, at least by the DX-shooters, in favor of shorter waves? Amazing results with low-powered transmitters have been secured on 40 meters and very amazing results may be secured on 20 meters in daylight. For the experimenter and low-powered DX-man, 20 meters offers wonderful possibilities for distant communication. Certain hours of the day favor transmission in certain directions, and by merely choosing the right time, there is practically no limit to the DX that may be attained. True it is, that real, consistent long-distance work usually cannot be accomplished by any low-powered transmitter, but the short waves offer greater possibilities. The dropping of a signal, now and then, into some distant land is all that the average fan desires and the following constructional data should prove of more than ordinary interest to those considering the construction of short wave transmitters and receivers.

THE RECEIVER

The receiver, although originally designed for 20-meter reception, is of the interchangeable-coil type and hence may be readily adapted to receive on any wave-length below 100 meters. The famous circuit employed by Schnell in his wonderful DX work, with the navy in the Pacific, is shown in Fig. 1. It is important to have the throttling, or variable by-pass condenser, connected exactly as

shown; good oscillation control is very important when dealing with long-distant C.W. reception. The leads in the receiver are as short as possible, consistent with other requirements, and are all well spaced. As much of the wiring as possible has been shifted to the amplifier, leaving coils well in the open. The filament leads are of heavy, paraffined house-wire and are kept away from surrounding apparatus by being run directly on the baseboard. All wiring is done with No. 12 D.C.C. wire and all joints are securely soldered with resin-core solder so that corrosion cannot set in. The phones are attached directly to one post of the amplifier socket and to the head of another binding post soldered directly to the back of one of the battery screws. The posts for the coils are mounted on a small, very thin strip of insulating material and sufficient distance is left between them. The nearest object to the coils, the detector tube, is about 5 inches away. Heavy leads are run directly from the coil posts to the tube-socket. The grid-leak and condenser are mounted at the socket. The coils are all well in the open and are of the popular low-loss, space-wound construction.

The small porcelain switch seen in the picture is used to switch to different antennae; either a long antenna, a short one or none at all may be used; a very convenient feature. A long antenna should be used on the receiver wherever possible. Better results on distance work are always secured. The horizontal antenna is always a big advan-

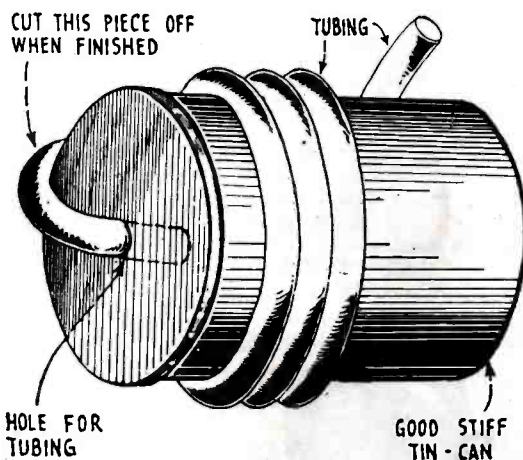

FIG. 4
Method of winding the inductances of copper tubing for the transmitter. If directions are followed this will not prove a difficult task.

tage, too, so make the antenna long and part of it horizontal.

The vernier shown on the secondary condenser, although not absolutely necessary, is quite a convenience in tuning-in long-distant stations. One should be used wherever possible.

The grid-leak should be a variable one: the correct adjustment of the leak often gives better signal strength and always allows correct adjustment for oscillation.

Although any ordinary binding posts will serve, some very good screws may be secured from the old wooden-case type "B" batteries.

Detector tubes have a habit of making ringing noises in the receiver every time the table is jarred. This is especially noticeable on short wave-lengths and is very objectionable. Either buy a "cushioned" socket or mount the one you have on a pile of small felt clippings and replace the heavy leads to the socket by small copper foil pieces for a short distance. This will prevent vibrations reaching the tube through the connecting wires. If you do not intend removing the tube from its socket it might be well to solder the leads directly to its base and do away with the socket entirely. This is by far the best procedure but is seldom done because changing tubes then becomes rather troublesome.

THE TRANSMITTER

The transmitter employs the coupled Hartley circuit, which will oscillate and put power into an antenna on practically any wave-length. It is, perhaps, the most popular circuit, in use by the amateur, for its simplicity and flexibility. The circuit is shown in Fig. 2.

The arrangement of parts is the most efficient that the writer has seen. All high-frequency parts are well insulated, the inductances are out in the open, the leads are

(Continued on page 887)

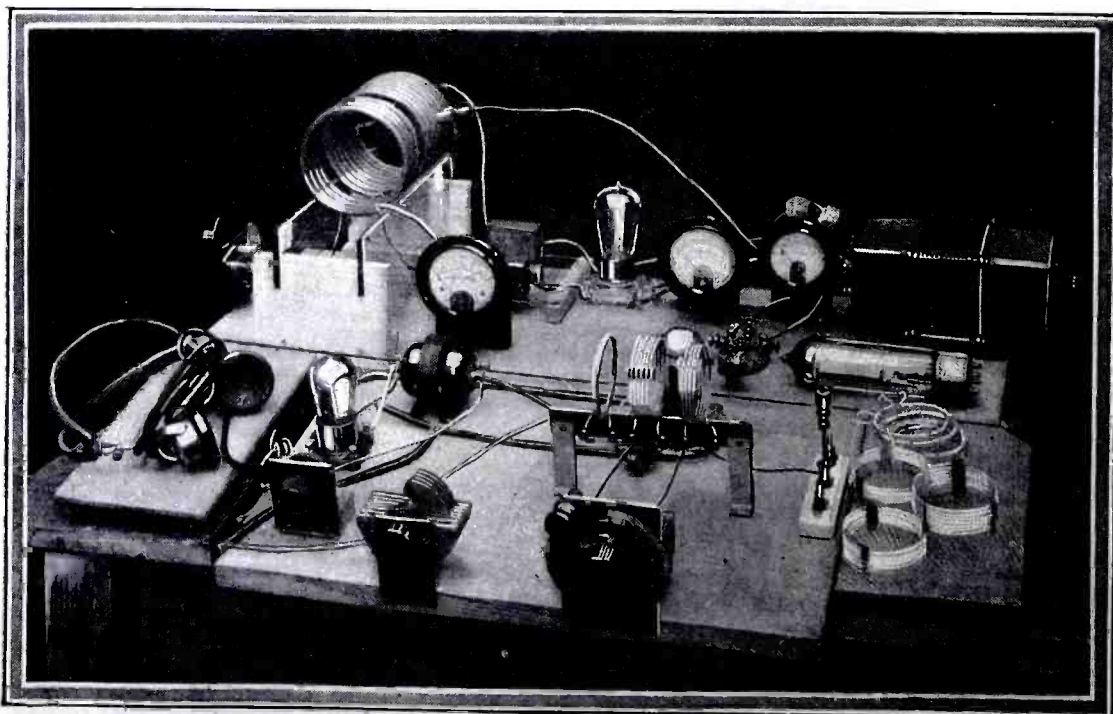

Usually the receiver (in front) is placed at the right of the transmitter, which may be seen in the background of the illustration. Separate antennae are used.

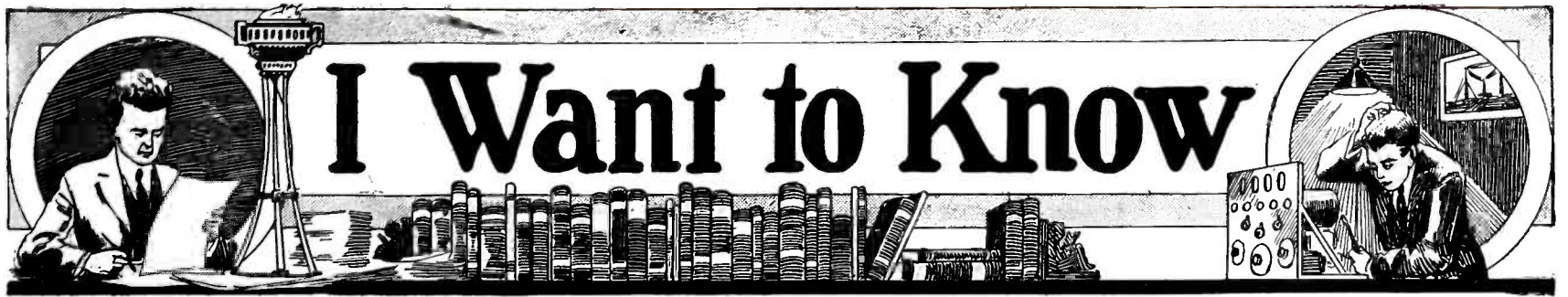

Conducted by Joseph Bernsley

THIS Department is conducted for the benefit of our Radio Experimenters. We shall be glad to answer here questions for the benefit of all, but we can publish only such matter as is of sufficient interest to all.

1. This Department cannot answer more than three questions for each correspondent. Please make these questions brief.
2. Only one side of the sheet should be written upon; all matter should be typewritten or else written in ink. No attention paid to penciled matter.
3. Sketches, diagrams, etc., must be on separate sheets. This Department does not answer questions by mail free of charge.
4. Our Editors will be glad to answer any letter, at the rate of 25c. for each question. If, however, questions entail considerable research work, intricate calculations, patent research, etc., a special charge will be made. Before we answer such questions, correspondents will be informed as to the price charge.

Mr. Bernsley answers radio questions from WRNY every Thursday at 8:15 P. M.

FRESHMAN MASTERPIECE

(Q. 2198) Mr. J. Lyons, Roxbury, Mass., asks:
Q. 1. Can you furnish me with a wiring diagram of the new Freshman Masterpiece receiver, and the circuit diagram of the firm's power amplifier, which operates directly from the 110-volt alternating current line?

A. 1. The two circuits requested are illustrated in Figs. 2198-A and 2198-B.

A UX-210 power tube is employed in the power amplifier and a UX-216B for the rectification, the latter tube being of the half-wave rectifier type. Constructors may easily assemble an amplifier of this type with apparatus obtainable in any radio store.

The receiver consists of two stages of radio-frequency amplification, detector stage, and two stages of transformer-coupled audio-frequency amplification. This combination produces sufficient loud-speaker volume for ordinary operation. Those desiring extreme volume can easily obtain this additional factor by simply connecting the power amplifier to the receiver.

ELIMINATING OSCILLATOR DOUBLE-READING EFFECT

(Q. 2199) Mr. L. Miller, Brooklyn, N. Y., asks as follows:

Q. 1. I have a superheterodyne receiver which I feel sure would be very efficient and satisfactory, if it were not for the double-reading effect obtained on the oscillator dial. This, of course, I understand, is common with superheterodyne receivers. Nevertheless, I wonder if there is some conventional means of installing a wave trap, or some other absorbing system, by which the second reading could be eliminated. This would allow me to obtain other stations, as the present dial reading on the oscillator condenser for various stations leaves me no room to obtain distant reception.

A. 1. A means for eliminating the double reading on the oscillator dial obtained on all superheterodyne receivers has been completely described in the Saturday Radio Section of the *New York Sun*. We are reprinting below the description of this

device, and feel sure that the information will be of much value to superheterodyne set users who experience the same difficulty as Mr. Miller.

"The floating-beat-note hook-up, an automatic frequency-changing system, is put forward as a cure for the one fault of that king of all receiving sets, the superheterodyne. It does away with the double-beat note, that inherent and annoying habit of the super in bringing in a station at two different points on the oscillator dial.

"Like Venus, the superheterodyne was born into this world all but perfect. Either by accident or a *tour de force* on the part of its inventor, Major E. H. Armstrong, it emerged from his laboratory in Paris in 1918 in so mature a form that it has been susceptible to little improvement since. Unlike other receiving circuits of note in this rapidly changing period of radio art, it continues to increase in vogue. Of the true super, it can be said it will do anything any other set will do, and throw away the antenna to boot. That is, it will do anything on a small loop that any other set can do on a good antenna. And, in addition, it possesses an inherent degree of selectivity never attained by any other combination of tuned circuits.

"But—there is the fly in the ointment—the double-beat note. A station will come in equally well at two points on the oscillator dial. And the upper beat note of one station will very frequently collide with the lower beat note of another station, or vice versa, and very seriously upset, by this interference factor within the receiver, the much-prized selectivity. So serious may this double-beat-note trouble become that different wavelength transformers are recommended for different locations.

"Prof. Walker Van B. Roberts of Princeton, originator of the popular Roberts set, said in one of his writings how nice it would be if all broadcasting stations in the country were on the same wavelength and at the same time couldn't interfere with each other! In such a radio paradise one could design a receiver for a single frequency without any compromises and it would always work at its best. Having said so much, Prof. Roberts went on to say that this is just what the superheterodyne does—it reduces the signals of all stations to a single fre-

quency and then passes them on to a detector and amplifier built to handle only that frequency. It is the 'frequency changer' of the super that accomplishes this miracle; the rest of the super is merely a fine receiver, with two, three or four stages of fixed radio frequency, a detector and one or two stages of audio. Taken from this point of view, the super is not such a complicated animal.

Function of "Super"

"How the frequency changer works is shown schematically in Fig. Q. 2199-B. First, let us say the receiver is designed to function at 6,000 meters, or 50 kilocycles. Properly designed, it will respond to this wavelength and no other, within easily-controllable limits. That is where the selectivity of the super comes in.

"The frequency changer, which is to change all wavelengths within its tuning range into one (that of 6,000 meters or 50 kilocycles), consists of a so-called 'first detector' and a 'heterodyne,' or oscillator. The first detector receives the tuned signal from the loop, like any other single-circuit tuner, being tuned by C1. The 'heterodyne' is merely a second tube in an oscillating condition, like an ordinary regenerator that has spilled over. This tube is tuned by C2, not to the signal itself, but to 50 kilocycles above or below the signal. Let us say that C1 is tuned to 600 kilocycles (500 meters), then C2 would be tuned to 550 or 650 kilocycles. These signals are mixed together on the grid of the first detector tube through the coupler X, the oscillations cancelling each other out until there are only 50-kilocycle frequencies left; the output of this tube thus becomes 50 kilocycles. Thus we have taken a signal of 500 meters and, by a simple process of subtraction, we have changed it into a signal of 6,000 meters to pass on to our one-wavelength receiver.

"These are the only tuning controls there are on a super: one for wavelength and one for the heterodyne. The first dial is very broad, like any other single-circuit tuner; the second is as sharp as a razor, unlike any other tuner known. The heterodyne dial has, as we have stated, the single

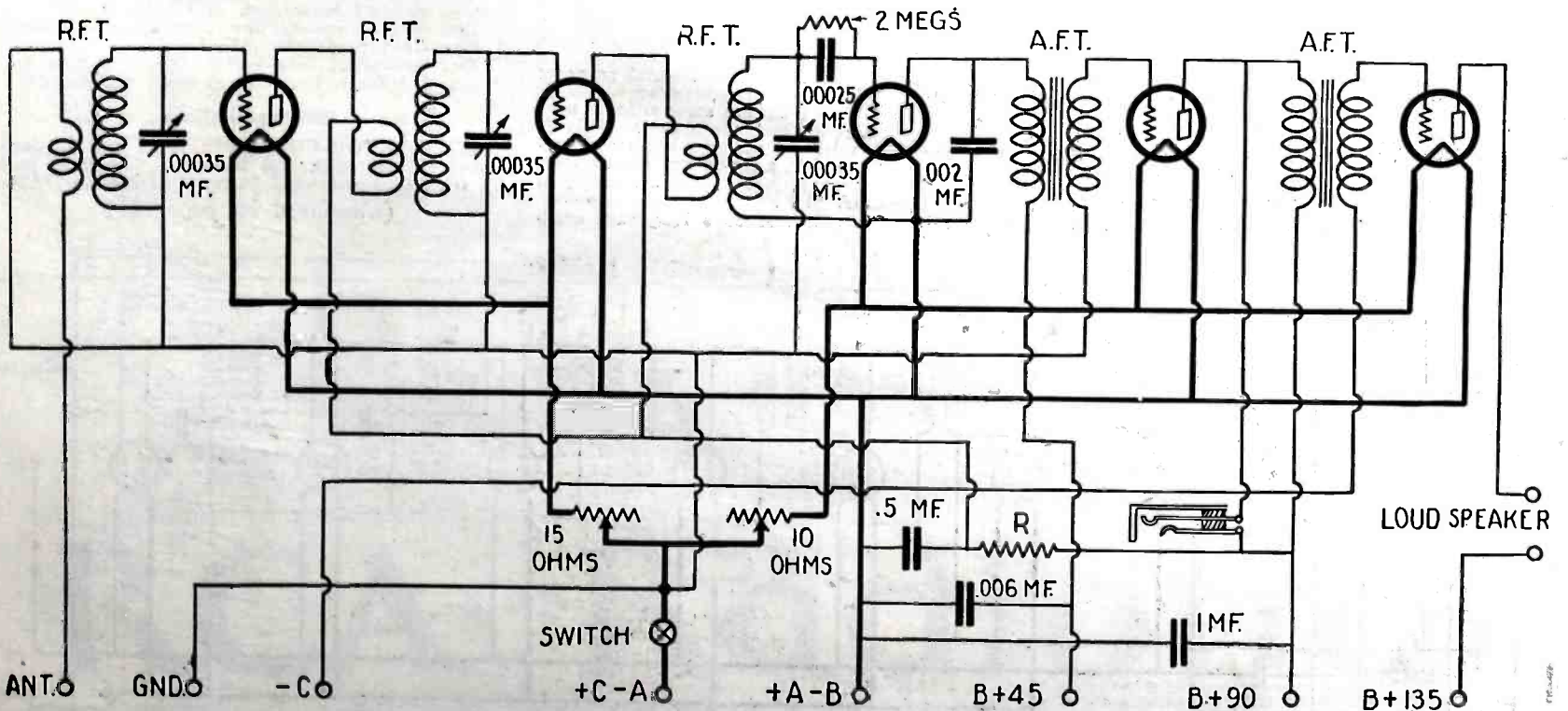

Q. 2198-A

The wiring diagram of the Freshman receiver, comprising two stages of tuned-radio-frequency amplification, detector and two stages of transformer-coupled audio-frequency amplification. The receiver is well shielded, and the cable scheme of wiring is employed.

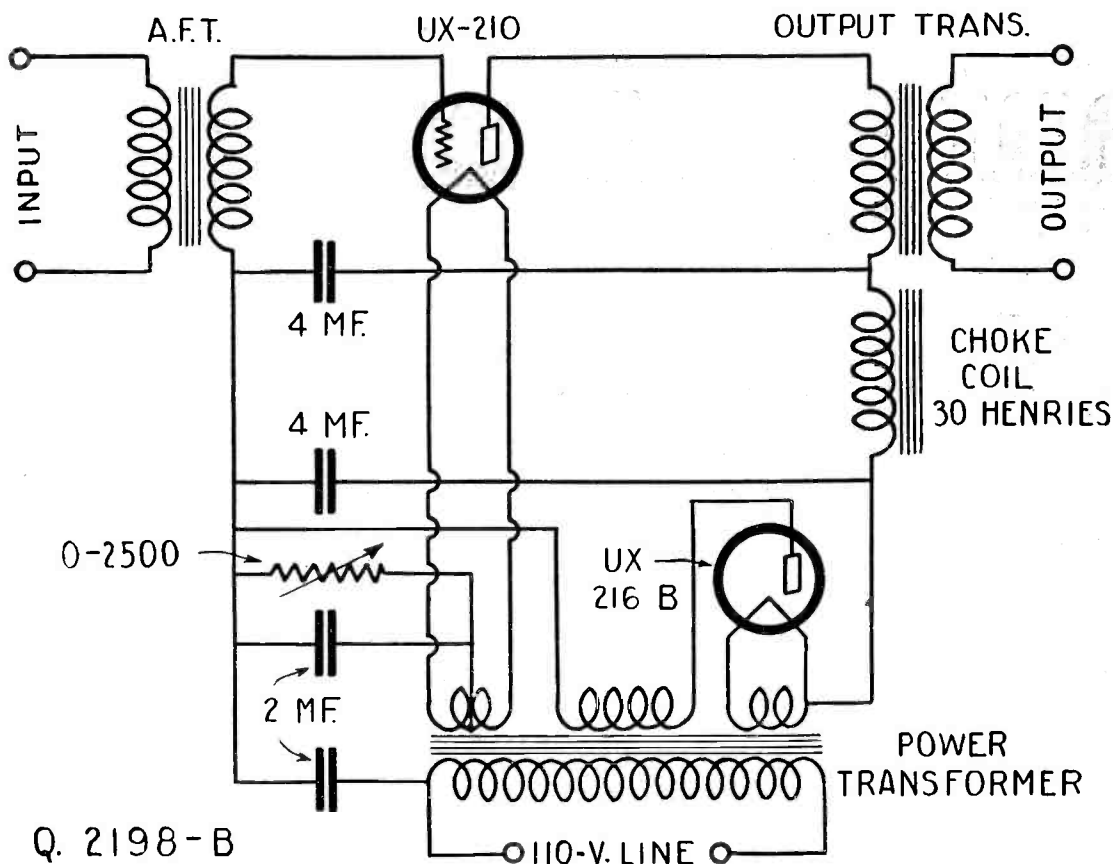

Q. 2198-B

A "B" eliminator and power audio-stage unit, the circuit of which is exactly similar to that employed by the Freshman Amplifier. It is possible to tap off from this device and obtain "B" current for the receiver.

weakness of a double-beat note; that is, it can be tuned either above or below the frequency of the signal, so long as the difference between the two frequencies remains 50 kilocycles.—or whatever wavelength the receiver is designed for.

What the New System Does

"The floating-beat-note system is suggested as a means of doing away, not only with the heterodyne dial itself, but also with the troublesome double-beat note. It accomplishes this at a sacrifice of the inherent selectivity of the standard superheterodyne.

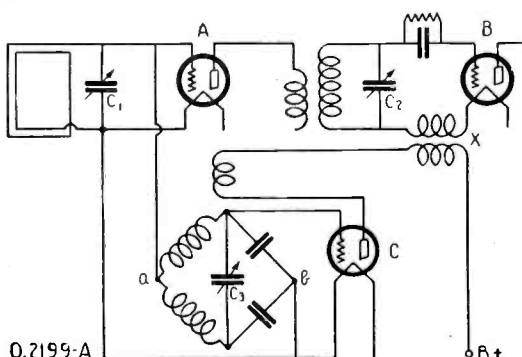

Q. 2199-A
The wiring diagram of the "floating-beat" device, which eliminates the second-dial-reading effect obtained when tuning the oscillator dial of a superheterodyne receiver.

It is therefore necessary to add selectivity to the tuned signal itself, which may be done by using a stage of tuned radio frequency before the 'first detector.'

"A schematic diagram of the floating-beat-note device is shown in Fig. Q. 2199-A. Tube A is a

radio-frequency stage, B is the 'first detector,' and C is a fixed oscillator (heterodyne), oscillating at the exact frequency for which the receiver is designed. Thus, in the above instance, tube C would be tuned to oscillate permanently at 50 kilocycles.

"Tubes A and C are connected in parallel across the tuned loop. The operation is as follows: the incoming signal, say of 600 kilocycles, is tuned by C1; this signal divides between tubes A and C equally. The half signal passing through tube A is amplified at radio frequency and rendered highly selective by C2, and passed on to the grid of tube B. The half signal passing through tube C is mixed with the fixed oscillations of this tube, 50 kilocycles in this instance. The output of this tube thus becomes automatically 600 minus 50, or 550 kilocycles, the same heterodyne value which would be achieved in a conventional super by manual tuning. The output, 550 kilocycles, is mixed up with the 600 kilocycles signal on the grid of tube B, through the coupler X, in the same manner as in Fig. Q. 2199-B.

Many Forms Possible

"Since this is accomplished by the use of a fixed oscillator, instead of the tuned oscillator, several interesting schemes for this fixed oscillator immediately suggest themselves to the experimenter. The fixed oscillations may be generated by: a separate local oscillator tube, as in the super, or an oscillating crystal. The latter method (*i.e.*, the quartz crystal) suggests the most interesting possibilities, though it also injects technical difficulties to tax any but the advanced amateur.

"The simplest method for experimental purposes is the one shown in the diagram, the 'autodyne' or feed-back method, in which the same tube is used for the fixed oscillator and the mixer. This is accomplished by means of the capacity-impedance-bridge method of coupling, a superheterodyne system brought out a year or two ago by Capt. Pressley of the Signal Corps, U. S. A.

"The tube C is connected as a long-wave oscil-

lator. The inductance of the bridge consists of two 250-turn honeycomb coils, with tap at (a). The capacity of the bridge is obtained from midjet condensers to balance the two arms, and the feedback may be a honeycomb coil of 250 turns or less. The parallel circuit feeding into the tube is connected at (a) and (b). C3 is semi-variable and need not be touched after it is once adjusted. This fixed oscillator may be attached to any tuning circuit as a frequency changer."

MODEL C-7 SUPERHETERODYNE

(Q. 2200) Mr. J. Hathaway, Weirsdale, Florida, asks as follows:

Q. 1. I would like to construct the C-7 type superheterodyne receiver which I am informed, has a high degree of efficiency and is very sensitive to weak signals. Any particulars regarding the construction of this receiver, also a list of parts which

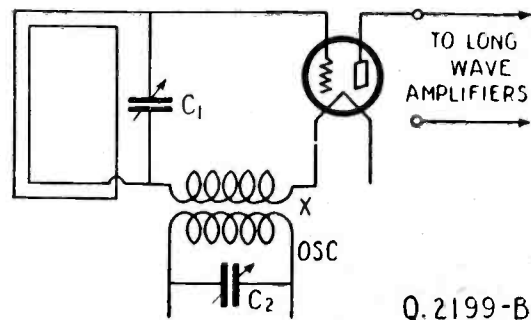

Q. 2199-B
The conventional method of coupling an oscillator to the first detector in a superheterodyne receiver.

I could use in the construction of this set, wherever it is impossible to make the instruments, will be greatly appreciated.

A. 1. The Model C-7 receiver was at one time manufactured by the Norden-Hauk Co., 1617 Chestnut St., Philadelphia, Pa. All information on this receiver published in these columns was kindly furnished by this company. The schematic wiring diagram will be found in Fig. Q 2200.

List of Parts

- One cabinet, 40x8x8 inches;
- One panel, 40x8x1/4 inches;
- Eight binding posts;
- One heterodyne condenser, .0005-mf.;
- One wavelength condenser, .00025-mf.;
- Three midjet condensers, .00045-mf.;
- One oscillator coupler, as per specifications below;
- One output transformer, as per specifications;
- Two radio-frequency transformers, Type "C" only—E.I.S. special (or 1716's);
- Two audio-frequency transformers;
- Three "C" batteries, 4 1/2 volts;
- Three by-pass condensers, one .005-mf., and two .001-mf.;
- One open jack;
- One grid leak, 2-megohm; and grid condenser, .00025-mf., with mounting;
- Three by-pass condensers, 1.0-mf.;
- Seven sockets;
- 60 ft. each No. 12 bus wire soft drawn tinned copper and No. 12 spaghetti, with necessary screws and nuts.
- One filament switch;
- Two 4-inch dials, and knobs;
- One antenna inductance (see below);
- Two master rheostats, one 7-ohm and one 20-ohm;
- One fixed condenser, .01-mf.;
- One voltmeter, 0-7, 0-140 scale, and one ammeter, 0-3 amps. (optional as extra equipment).

Coil Specifications

OSCILLATOR COUPLER: form is a 3 1/2-inch tube, 1/8 inch thick, 2 3/8 inch long. Start 1/4 inch in from edge and wind 26 turns of No. 20 D.C.C.

(Continued on page 915)

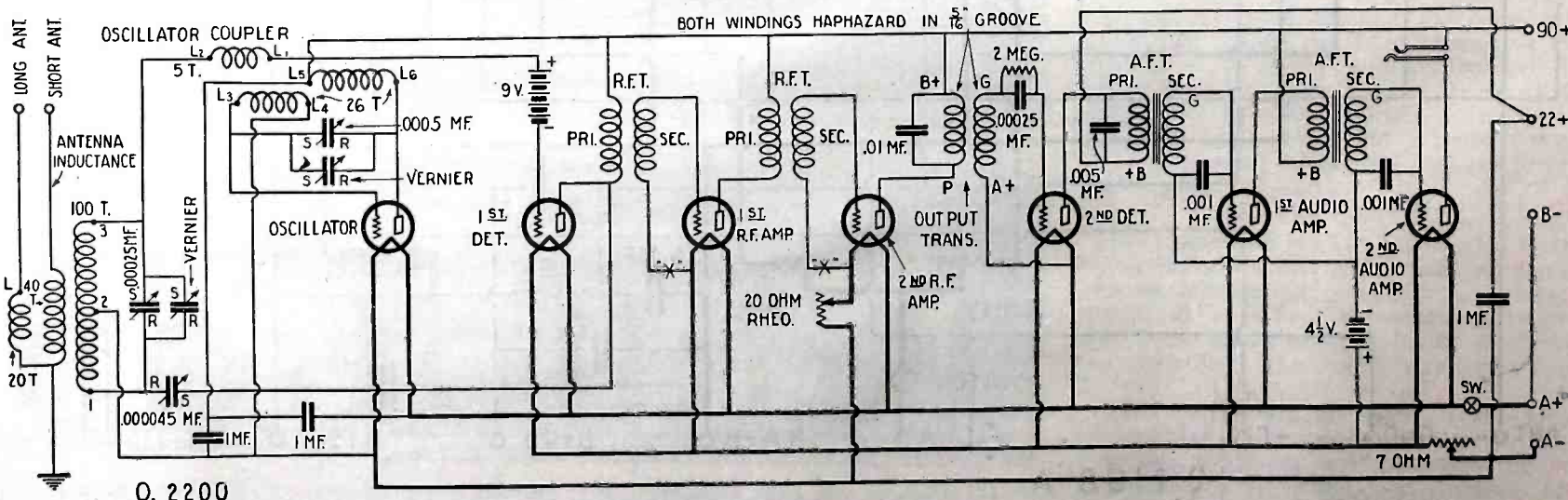

Q. 2200

The E. I. S. model "C-7" superheterodyne receiver; constructional details of the various parts will be found in the text. Intermediate-frequency transformers, whose characteristic peaks are around 10,000 meters (R. C. A. 1716 will be satisfactory), may be employed.



look inside that Christmas Radio Set

THE equipment is as important as the set. The distance reach of a set depends a great deal on the tube in the detector socket. The over-all performance of a set depends very much on the tubes in every socket. The volume and tone quality you will get are dependent upon the tube in the last audio stage. In every point, the tubes are as important as the set. And everyone who realizes this insists on genuine RCA Radiotrons.

The research laboratories of RCA, General Electric and Westinghouse have developed Radiotrons to new accomplishment, year by year. And the manufacturing skill of these same companies keeps RCA Radiotrons far in the lead in accurate making.

Be sure, when you buy a Christmas radio set, that you are getting genuine RCA Radiotrons with it. You can tell by the RCA mark inside the glass at the top. Or take out the tube, and look at its base.



Extra! Extra! Gift Ideas for Radio fans

A "spare" Radiotron—genuine RCA Radiotron, of course—of the type he uses.

A *power* Radiotron UX-112, UX-171 or UX-210 for bigger volume and finer tone.

A special *detector* Radiotron UX-200-A for storage battery sets—for longer distance reach.

Ask any dealer all about these Radiotrons—he'll tell you which to get. But be sure it's a genuine RCA Radiotron, if it's to be worthy of gift giving.

RADIO CORPORATION
OF AMERICA
New York Chicago
San Francisco

RCA Radiotron

MADE BY THE MAKERS OF THE RADIOLA



ONLY
\$24.75
COMPLETE

Years of Christmas Gift Joy!

Buy this for all the family—a "B" eliminator that does away with All "B" batteries and gives constant, unvarying power to any set up to 10 tubes using resistance, transformer or impedance coupling; one that will operate power tubes, too.

Warren "B" Eliminator

150, 90, 67½, 45 and 22½ volt taps give correct voltage with no variable resistances to worry you. Simple, compact. Free from distortion. No expensive tubes to burn out; no dangerous acids. Can not blow out receiver tubes from short circuit. Needs little more attention than your loud speaker; costs less than \$1 per year to use; easier to hook up than a set of "B's". Just plug into light socket and turn on the switch—get full tone, humless reception without fuss, worry or "B" battery expense.

J. M. Smithson, Lacon, Ill., says—"Have put my WARREN 'B' to every test; find it more than claimed. Tried cheaper and more expensive eliminators—yours is the one to buy. Price is right; quality can't be surpassed."

Why Pay More Than \$24.75

\$35 and up cannot buy more; less than \$24.75 cannot buy near as much. WARREN "B" costs about the same as two sets of "B's" and is built to last indefinitely; wonderfully well made of finest materials; beautifully finished in old gold—an eliminator you will boast about and proudly show to your friends. Shipped complete, all ready to use; no extras to buy. 110V; 60 cycle; A.C. Unconditionally guaranteed to do more than claimed or money back. If dealer can't supply send coupon for immediate shipment. Reference; Central National Bank, Peoria, Ill.

WARREN ELECTRIC CO.,
Dept. M, Peoria, Ill.

- Warren Electric Co.
Peoria, Illinois.
- Ship at once, express paid, \$24.75 (check enclosed.)
 - Ship at once, C. O. D. for \$24.75, plus slight express charges.
 - Send free literature.

Name

Address

City State

Dealers — Write for proposition.

Home-Made Coils for the Browning-Drake

(Continued from page 822)

fort if the form is screwed to the work table or bench; for this purpose two clearance holes for wood screws are provided at the ends of the wooden base. If the constructor has a large vise, he may clamp the base supporting the form in it while carrying out the winding.

Before starting the winding, two or three strips of surgical plaster, or paper strips coated with common glue, are placed, evenly spaced, over each form, just as in the case of a "pickle-bottle" coil. These strips may be held in position by rubber bands slipped over their ends, or still better by push-pins pressed into the form. The latter method is preferable, since the pins locate the strips definitely, and no slipping is possible.

To hold one end of the wire while the winding proceeds, a short nail or small wood screw is driven into the wooden base. A few turns of wire are taken around this, and when the winding is completed, the other end of the wire is fastened in a similar manner.

The strips of tape are bent over the finished layer of wire, after the drawing pins or rubber bands have been removed. The strips should be long enough to overlap about ½-inch. Finally, the plaster strips are pressed down upon the wire, to bind well.

The nuts are now taken off the bolts, and the coil, with the form blocks still in position, can be withdrawn from the base, which is clamped to the work-bench. The forms are freed and taken out by twisting them gently; if the wire has been wound with the right tension, and not too tightly, they will come out quite easily. The center of the coil, where the wires cross over, is bound with a few turns of thin cord, or tape, as before.

The number of turns required for a given variable condenser must be determined by experiment; for a start, thirty to forty turns of No. 26 D.C.C. wire may be tried. Care must be taken when winding these coils to space the wires slightly on their forms, else the coil will bulge out at the center.

This brings us to the final development the writer has in mind; a Browning-Drake equipped with tandem condensers. At the end of the rear condenser a R.F. transformer of the present-day type is carried (Fig. 17). Under the sub-panel, or anywhere else out of the way, lies the fieldless antenna coil.

With one stroke, we have single-control, no more interference between coils, and a far more compact set: in short—the ideal Browning-Drake! It may yet prove the four-tuber of the future!

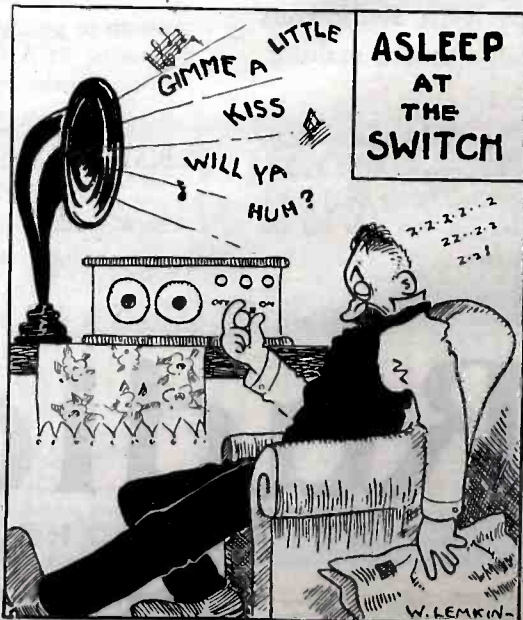

\$10 Loud Speaker

For \$10 you can get the finest loud speaker that money can buy—the new, perfected Dulce-Tone, the unit that utilizes all the scientifically developed, time-tested reproducing elements of your phonograph.

Dulce-Tone and your phonograph will improve the reception from any set. Greater volume, clearer tone, entire freedom from blare and distortion.

Nothing to install. Simple to use. Fully guaranteed. \$10 at your dealer's or with the coupon.



THE GENERAL INDUSTRIES CO.
Formerly named
THE GENERAL PHONOGRAPH MFG. CO.
253 Taylor St., Elyria, Ohio

Enclosed is \$10 for my Dulce-Tone. If I'm not satisfied after 10 days' trial, I'll return it and get my money back.
Name

Street

City State

Heavy-Duty RADIOHM

for Simple Control of B-Battery Eliminator



A single turn of the knob gives full resistance variation to control eliminator's output voltages. Permanent resistance as adjusted. Insulated for 1,500 volts. Approved by Raytheon Laboratories. Outlasts eliminator, giving full efficiency from it.

\$2 at dealers, or from us.

Central Radio Laboratories

19 Keefe Ave., Milwaukee, Wis.
Canadian Representative—Irving W. Levine, Montreal.
Great Britain Representative—R. A. Rothermel Ltd., London.
Australian Representative—United Distributors, Ltd., Sydney.
69 standard set makers use Centralab variable resistances.

Centralab

FREE — OUR 84-PAGE CATALOGUE. FILLED WITH RADIO BARGAINS. WRITE TODAY!

RANDOLPH RADIO CORP.
180 N. UNION AV. Dept. 2 CHICAGO, ILL.

The new Balkite "B" at \$27.50 and the Balkite Trickle Charger furnish all radio power from the light socket

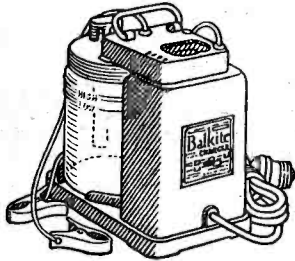
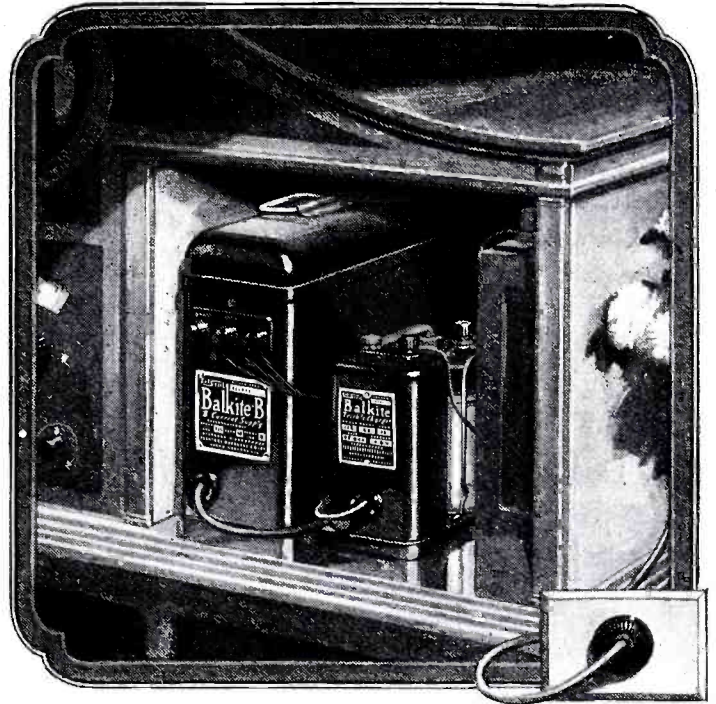

The New Balkite Charger

MODEL J. Has a low trickle charge rate and a high rate for rapid charging and heavy duty use. Can thus be used either as a trickle or as a high rate charger and combines their advantages. Noiseless. Large water capacity. Visible electrolyte level. Rates: with 6-volt battery, 2.5 and .5 amperes; with 4-volt battery, .8 and .2 amperes. Special model for 25-40 cycles with 1.5 amperes high rate. Price \$19.50. West of Rockies \$20. (In Canada \$27.50.)

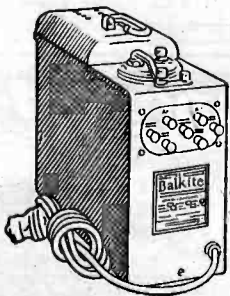

Balkite Combination

When connected to the "A" battery this new Balkite Combination Radio Power Unit supplies automatic power to both "A" and "B" circuits. Controlled by the filament switch already on your set. Entirely automatic in operation. Can be put either near the set or in a remote location. Will serve any set now using either 4 or 6-volt "A" batteries and requiring not more than 30 milliamperes at 135 volts of "B" current—practically all sets of up to 8 tubes. Price \$59.50. (In Canada \$83.)

All Balkite Radio Power Units operate from 110-120 volts AC current with models for both 60 and 50 cycles. The new Balkite Charger is also made in a special model for 25-40 cycles.

The light socket is your most convenient source of radio power. Use it by adding the new Balkite "B" and the Balkite Trickle Charger to your radio set.

Balkite "B"—the unique "B" power supply—eliminates "B" batteries entirely and supplies "B" current from the light socket. The new Balkite "B"-W at \$27.50 serves sets of 5 tubes or less requiring 67 to 90 volts, Balkite "B"-X sets of up to 135 volts and 8 tubes and Balkite "B"-Y any standard set.

The Balkite Trickle Charger at \$10 is probably the most popular of all chargers. Over 200,000 were purchased during one season and are now in service. Instead of operating intermittently at a high rate, it operates continuously at a low rate, thus automatically keeping the battery at full charge. In effect it converts your "A" battery

into a light socket "A" power supply. With 4-volt batteries it can be used as an intermittent charger, or as a trickle charger if a resistance is added.

Both Balkite "B" and the Balkite Trickle Charger are noiseless in operation. Both are permanent pieces of equipment, with nothing to renew or replace. Other than a slight consumption of household current, their first cost is the last. Both are built to conform with standards set by the Underwriters' Laboratories.

Over 700,000 radio sets are already Balkite equipped. Make yours a light socket receiver too by adding these Balkite Units. Enjoy the pleasure of owning a radio set always ready to operate at its best.

*The Balkite
Radio Symphony Concerts
with WALTER DAMROSCH
and the New York Symphony*

These concerts are broadcast every other Saturday Evening. On intervening Saturdays, Mr. Damrosch gives one of his famous piano recitals on Wagner's great Music Dramas. At 9 P.M. Eastern Standard Time, over a group of 13 stations: WEAf, WEEL, WGR, WEI, WCAE, WSAI, WTAM, WWJ, WGN, WCCO, KSD, WDAF, WOC.

[Balkite "B"-W \$27.50; "B"-X \$42; "B"-Y \$69; Trickle Charger \$10; West of Rockies \$10.50. In Canada, "B"-W \$39; "B"-X \$59.50; "B"-Y \$69; Trickle Charger \$15.]

Fansteel Products Co., Inc., North Chicago, Ill.

FAN STEEL

Balkite

Radio Power Units



A Brief Study of Audio Amplification



In the design of any amplifying device for use at audio frequencies, it should be kept in mind that the curve of voltage amplification against frequency should approximate as closely as possible a horizontal line, if true tone quality is to be preserved in the process of intensifying the audible notes.

Since the purpose of amplification is to effect a considerable increase in volume, the curve representing the character of amplification should be as high as possible as well as a straight line running in a horizontal direction.

While it is a comparatively simple task to design a transformer to have a high and even amplification curve over any narrow frequency band, it is considerably more difficult to maintain the same degree of amplification at very low and very high frequencies as in the middle of the range.

In order that a transformer may function efficiently at low frequencies, its input impedance must be high—several times the plate impedance of the tube at 100 cycles. This is accomplished in the General Radio Type 285 transformers by means of a core of large cross-section of high permeability steel and a primary coil of many turns. Proper coil design, avoiding excessive coil capacity and magnetic leakage prevents loss of notes above the middle register.

Careful laboratory measurements of all General Radio Type 285 Audio Transformers show a high and comparatively flat curve over practically the entire section of the audio range covered by the human voice and musical instruments.

It will be remembered by radio experimenters whose interest in the science dates back to the early days of broadcasting, that in 1917 the General Radio Company brought out the first closed core transformer to be sold commercially. This instrument was the type 166. It established a new and higher standard of audio frequency transformer design. Since that time the subject of amplification has been exhaustively studied in the laboratories of the General Radio Company with the result that transformer design has been constantly improved and today the General Radio Company is universally recognized as an outstanding manufacturer of quality transformers.

Type	Ratio	Price
285	1 to 6	\$6.00
285-D	1 to 2.7	\$6.00
285-L	1 to 2.1	\$6.00

Write for Catalog 925

GENERAL RADIO CO.
Cambridge, Mass.

Standardize on
GENERAL RADIO
Parts and Accessories

Visible Radio Waves

(Continued from page 791)

DESCRIPTION OF APPARATUS

The apparatus itself is very simple. The action can be explained with reference to Fig. 1. At the left is shown a stationary radio transmitter, sending out waves of a known frequency, which is maintained virtually constant by means of a quartz-crystal-controlled master oscillator. Radio listeners are already familiar with crystal-controlled transmitters, as many broadcasting stations are now using them. The characteristic of the quartz oscillator is that its frequency of vibration is constant. In Fig. 1, therefore we have a constant-frequency transmitter with a known frequency previously determined by oscillograph measurements. So much for the transmitter.

At the right of Fig. 1 is shown the receiver. A quartz-oscillator is employed in the receiver also for heterodyne purposes. The crystal at the receiver is ground to produce a frequency slightly different from that at the transmitter. Let us say that the difference is 1000 cycles per second. A heterodyne or beat note having a frequency of 1000 cycles will therefore be produced at the receiver. The heterodyne action has so often been explained in connection with superheterodyne receivers that it seems unnecessary to explain it here.

The 1000-cycle beat note is amplified by an A.F. amplifier, the output of which is connected to a lamp, such as the telorama gas lamp used in radio-vision apparatus. The lamp, therefore, flashes 1000 times per second, once for each time that the transmitted wave is in phase with the wave produced at the receiver.

In front of the lamp is placed a synchronous shutter, driven by a motor and adjusted so that every time the lamp flashes light passes through a hole in the shutter and illuminates the screen. The shutter is maintained in synchronism by means similar to those employed in radio-picture transmission, or radio-vision apparatus.

Now everything is working fine. The oscillations from the transmitter interfere with those of the heterodyning oscillator at the receiver, setting up a 1000-cycle beat note, which causes the lamp to flash 1000 times per second. Each flash of light passes through an opening in the shutter and illuminates the screen. Therefore, while all things remain constant, the screen remains illuminated. What happens when the entire receiver is moved toward or away from the transmitter? We can answer this with reference to the curves, T, R, and H of Fig. 1.

EFFECT OF VARYING DISTANCE

T represents the transmitted frequency, and R the local frequency generated at the receiver. As stated before, every time the two are in phase, a beat is produced and the lamp flashes. The two points A indicate where the two waves are in phase, and the curve H (obtained by combining curves T and R) shows the beat produced. Similarly the two points B indicate where the waves are out of phase, at which instants the lamp is dark.

With the apparatus adjusted so that the screen is illuminated, and with the receiver located at the point A', with respect to the transmitted wave, let it be assumed that at the instant shown the two currents are in phase, the lamp is lit, and a shutter opening is in front of the lamp. Now suppose the receiver is instantly shifted to B', one-half-wavelength nearer to the transmitter. The two currents would no longer be in phase, and the lamp would be dark. Of course, the heterodyne action would bring the two currents around in phase again and

Choose Your Cone Materials Carefully

In Building Your Own

3 Foot Cone



MADE especially for cone type speakers, ALHAMBRA FON-O-TEX is used by practically all leading cone type speakers manufacturers. This remarkable material has no grain, hence no resonance point of its own; but resonates uniformly at all frequencies.

Price 75c for a sheet 38 x 38 inches, large enough for a 3 foot cone. Ask your dealer. If he hasn't Alhambra FON-O-TEX we will supply you. To the cost of the number of sheets you need, add \$1 for packing and delivery charges.

The SEYMOUR Co., Desk 100
125 West 16th St. New York City

ALHAMBRA
FONOTEX
PRODUCT AND PROCESS PATENTED
FOR CONE TYPE LOUD SPEAKERS

Build It Yourself

Parts Complete \$14.15
Including Unit



In one evening and for 1/5 retail cost you can build the finest 3 foot Cone Speaker. Marvellous tone quality; every instrument in an entire symphony orchestra is clear, musical and distinct, even the very lowest. And the cost for ALL the parts—2 sheets Alhambra FON-O-TEX, Penn Back Rings, Unit Mountings, special Ambroid Cement and genuine

Penn Cone Speaker UNIT

designed especially for 3 foot Cone Speaker—is but \$14.15.

PENN Cone Speaker Unit is adjustable to the audio output of any set. Unit alone, \$9.50.

If your dealer cannot or will not get the parts for you, we will ship on receipt of price. Pamphlet, "How to Build a 3 foot Cone Speaker for \$14.15," sent for 10c., stamps or coin.

PENN RADIO SALES CO.

104 Fifth Ave., Suite 2013 New York City
Exclusive Selling Agents for G. R. Penn Mfg. Co., New York

BROADCAST!
Get Big Pay

Mingle with Statesmen, Financiers, famous actresses, authors, world-renowned athletes, all the world's great. Attend World's Series ball games, National political conventions, mammoth prize fights, all as a part of your day's work! Be a BROADCASTER. A single large broadcast station of today employs 50 to 80 persons—some of the fine broadcasting jobs pay \$250 and \$300 a week. Radio easy to learn—I'll train you quickly in your spare time at home to hold any broadcast station position. FREE Employment Service. Write today for Free Book giving details, no obligation. Address, J. E. Smith, President, National Radio Institute, Dept. AB-99 Washington, D. C.

American RADIO Now—
Lowest Wholesale Prices on **RADIO!**

BIG NEW 1927 CATALOG-FREE

Dealers, Agents, Set Builders—get our big 1927 Catalog—225 nationally advertised lines. Low money-saving prices! Largest, most complete stock. Radio's latest developments. It's FREE—send for your copy now.

AMERICAN AUTO & RADIO MFG. CO., Inc.
1434 McGee Street, Kansas City, Mo.

**Windsor Wall or Table
Type Cone Speaker
Amazes Radio World**



Model 210
(Pat. Applied For)

The latest model Windsor Cone Loudspeaker has astonished the world of radio. In convenience, quality of reception, and extremely low price, it far surpasses anything yet offered. The cone is 22 inches in diameter and is mounted on a sounding board which, in turn, is supported by an easel back. It can be hung up on the wall, as in the picture above, or stood upon any flat surface as shown in the picture below. It contains the famous Windsor loudspeaker unit noted for the extreme clarity and fidelity of reproduction.



Model 210
22-inch Cone Loudspeaker with sounding board and easel back.

\$15.00

(West of Rockies \$18)
(Pat. Applied For)

Model 302 (Shown below)
With Moulded Composition Horn Loudspeaker and 18-inch Cone Loudspeaker.



(Pat. Applied For)

In this Windsor Console is combined both the Windsor Moulded Composition Horn Loudspeaker and the 18-in. Windsor Cone Loudspeaker. The top is 30 in. x 17 in. and stands 29 in. high. Plenty of battery and equipment space is provided by large shelf in rear. Price, finished in Mahogany or Walnut **\$48.00**
(West of Rockies, \$55)

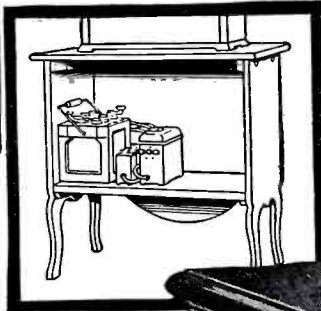

Rear view at left shows large compartment with ample space for batteries, battery charger, or battery eliminator, which are entirely concealed from view. Back is open for ventilation of batteries.

At right is shown the Cone Loudspeaker, with its sounding board, which is quickly and easily removable, allowing instant access to all batteries, battery charger, battery eliminator or other equipment and wiring.

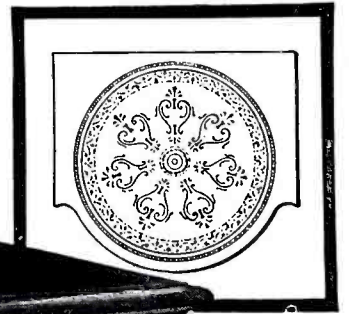

(Pat. Applied For)

Model 200—with 22-inch Cone Loudspeaker

This Windsor Cone Loudspeaker Console is equipped with a 22-inch Windsor Cone Loudspeaker. Its top is 30" x 17" and is 29" high. The battery shelf provides ample space for batteries, charger, battery eliminator and other equipment. Beautifully finished in either Mahogany or Walnut.

Model 200

\$29

Console with Cone Loudspeaker Ready for Set and Batteries
(West of Rockies, \$35)

This is the Fastest Selling Line of Loudspeakers and Loudspeaker Consoles in the Radio World Today



Model 100
with Moulded Composition Horn Loudspeaker or 16-inch Cone Loudspeaker
(Pat. Nov. 18, 1924)

Above is shown a beautiful Windsor Loudspeaker Console, finished in either Walnut or Mahogany, which provides ample space on top for any radio set. The battery shelf beneath will accommodate all necessary equipment. Equipped with either Moulded Composition Horn or 16-inch Cone Loudspeaker. Size: 38 in. x 18 in., and 29 in. high. Price **\$40.00**
(West of Rockies, \$42.50)

To the right is shown the newest Windsor Loudspeaker Console. It is equipped with a 22-inch Cone Loudspeaker and cabinet suitable for 7-inch radio panels up to 26 inches in length. Battery shelf provides ample space for all equipment. Beautifully finished in either Walnut or Mahogany. Price (without receiving set) **\$44.00**
(West of Rockies, \$52.00)

Note to Dealers: Write or wire today for details of the highly profitable Windsor line.

The quality of radio reception made possible by Windsor Cone and Horn Loudspeakers and Loudspeaker Consoles so far surpasses anything heard heretofore that it amazes and delights every radio enthusiast. The Windsor Line is so complete that everyone can find in it a loudspeaker, loudspeaker table, or loudspeaker console exactly to fit their particular needs.

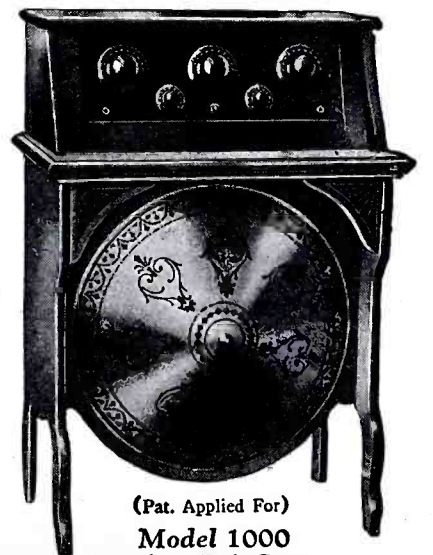

(Pat. Applied For)

Model 1000
with 22-inch Cone Loudspeaker

Electrical Department

WINDSOR FURNITURE COMPANY

1410 Carroll Avenue • CHICAGO, ILLINOIS

Los Angeles Branch—917 Maple Avenue

Distantone

"Built By Craftsmen"



ELECTRICALLY OPERATED!

All batteries eliminated. Simply plug into your AC light socket. Beautiful duo-tone solid walnut cabinet, highly finished. Panel control board is of metal, artistically decorated in duo-tone effect. Equipped with built-in speaker of great volume and tone clarity. Five tubes. Two dial control.

List Price Without Tubes
 Model E Console with Power Unit \$325.00
 Model E Console without Power Unit \$165.00

THE DISTANTONE LINE

In addition to the two models shown here, the Distantone line includes five-tube receivers of two and three dial control and five- and six-tube sets with single dial control, all tuned radio frequency.

DISTRIBUTORS

Write or wire us today for the Distantone proposition.

DISTANTONE RADIOS, Inc.

Lynbrook, Long Island, N. Y.

TABLE MODEL E \$60

5 Tubes — 2 Dials

Richly finished duo-tone cabinet and harmonizing panel. It is a receiver of great volume, superb tone and long distance. Over-all dimensions 20x10x9 inches. Wave length range 180 to 550 meters.

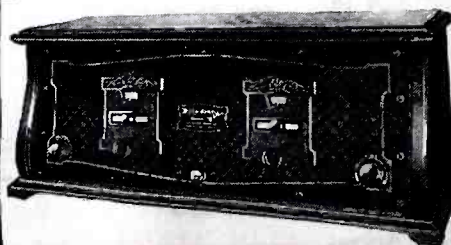

the lamp would light; but the shutter also is rotating, and the lamp would flash at a point midway between the shutter openings, and the screen would be dark. In other words, at the point A' the screen would be illuminated, and at the point B' it would be dark. As the receiver is slowly moved toward B' the screen would gradually become dark, and would gradually light up again as the receiver was moved another half-wavelength toward the transmitter.

A mechanical analogy of the action is illustrated in Fig. 1A. The rack C' represents the transmitted wave C of Fig. 1; it is moving from left to right. The gear wheel W represents the local oscillation generated at the receiver; it rotates as the rack moves and its teeth are in phase or in mesh with those of the rack. Now suppose the wheel W is moved one-half-tooth (one-half-wavelength) to the left, without changing its speed of revolution. What happens? The teeth are no longer in mesh; they ride on top of each other. They are out of phase,

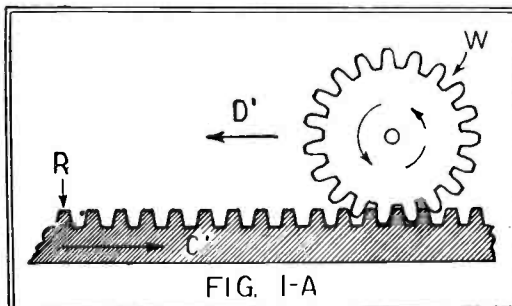

In this mechanical analogy C1 represents the transmitter wave and W, the local oscillations as shown in Fig. 1 on page 791.

in other words. Moving another distance of one-half-tooth to the left brings them in phase again. One "wavelength" is jumped.

The same is true in the radio apparatus; moving the receiver nearer to the transmitter has the same effect as though the transmitter-frequency were being increased. Moving away has the effect of decreasing the transmitter-frequency. The screen indicates a cycle of light and darkness every time a distance of one wavelength is passed.

PRACTICAL APPLICATIONS

Suppose the receiver to be carried in an airplane or ship, as illustrated in Fig. 2. Every time the plane travels a distance of one wavelength the screen passes through one cycle of light and darkness; and by recording the number of cycles on suitable apparatus, the aviator can determine his speed and location with respect to the transmitter. In radio-controlled apparatus, the transmitter may be placed on the controlled device, and the receiver remain stationary. The effect would be the same. In this way the device under control can be sent out and its speed and location can be determined at the receiver.

By traveling in a circle around the transmitter, in such a way that the screen remains illuminated, the exact shape of the wave front might be plotted. It would be interesting to note what effect obstructions have on the wave front.

WAVE-PROPAGATION MEASUREMENTS

By traveling directly toward, or away from, the transmitter a distance of, say, 1000 wavelengths, as indicated by the light and dark cycles on the screen, measuring the distance and dividing by 1000, the wavelength can be very accurately determined. Knowing the frequency, the speed of propagation of radio waves can be determined. Methods now in use for measuring wavelengths employ some kind of standing-wave system on metallic conductors, which may not give the true length of the waves in open space.

It would be interesting to note if the velocity of the waves travelling east and west is the same as it is north and south;

"The Voice from the Sky" Loud Speaker



"THE MOST BEAUTIFUL SPEAKER IN THE MARKET." —different from any other.

The "Voice From the Sky" speaker is scientifically constructed, cast in one solid piece, of materials which have the property to eliminate useless noises. It produces a clear, soft, and pleasant acoustical rendition in a manner not yet attained by any other loud speaker. Overall height 24". Bell diameter 12". Finished in walnut, mahogany.

List Price, \$30 "No Vibration"

Write for further information and discounts

MANUFACTURED BY

Florentine Art Productions, Inc.,
 838 W. Austin Avenue Chicago, Ill.

Write For Hampton Wright's Radio Economy Catalog

Hampton-Wright Makes Fine Radio Reception Possible These Cold Nights

The Thousands of efficient parts and sets listed in the great catalog mean BETTER RADIO. Write for this free book—see for yourself how easy it is to have fine radio.

SPECIFY CATALOG No. B-8

Hampton Wright
 P. O. Box 181
 Indianapolis, Ind.

6 Volt

Most amazing battery value ever offered! A genuine World 6-volt Radio "A" Battery with 25 ampere capacity for only \$5! It is just the thing for Trickle charger. Famous World Quality assured. Equipped with

STORAGE RADIO "A" BATTERY

\$5.00

C. O. D. Send No Money

Solid Rubber Case

An assurance against acid and leakage. Order shipped same day—subject to your examination on arrival. Extra offer: 5% discount for cash in full with order. ACT TODAY!



WORLD BATTERY COMPANY
 1219 S. Wabash Ave. Dept. 110 Chicago, Ill.

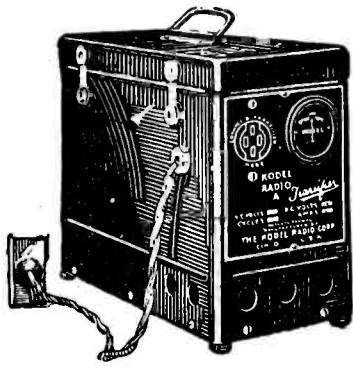

A-B & C Socket Power

Kodol Transformers operate any receiver direct from the light socket. Eliminate all batteries. Give increased volume, a purer richer tone. Last indefinitely. Five models for all sets and all currents.

- Model 15 "A & B"—4 or 6 volts "A" current, 22½ to 180 volts "B" **\$65.00**
- Model 10 "A"—4 or 6 volts "A" current for sets up to 8 tubes. . . . **42.50**
- Model 61 "B" — The most popular eliminator for 5 and 6 tube sets. . . . **28.50**
- Model 10 "B"—22½ to 180 volts "B" current; 4 to 12 volts "C" current—for any size set. **42.50**
- Model 63 "B"—for use on 110 or 220 volt direct current circuits— **25.00**

Prices Do Not Include Tubes



The New Triple Duty GOLD SEAL HOMCHARGER

Fast 5-ampere charging rate. Rejuvenates radio tubes. Supplies A. C. filament current. Fully charges the average "A" battery overnight, also charges "B" batteries. Several new exclusive features make it radio's most efficient battery charger. The World's Most Popular Battery Charger. More than 500,000 already in use. Price, complete **\$19.50**

Make a Power Unit of your radio battery

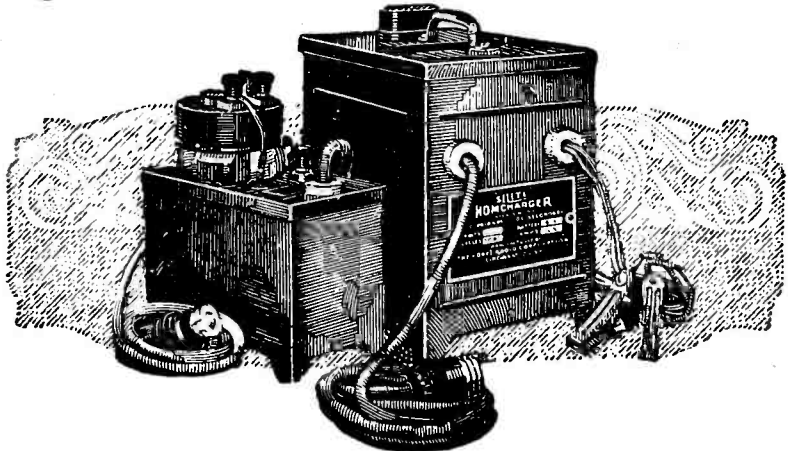

SILITE TRICKLE CHARGERS



You can make an efficient light socket "A" power unit of your present radio battery. Merely connect either of the Silite Trickle Chargers to your battery and plug it into the light socket. That's all there is to it. Left permanently on charge, your battery remains always at peak power, ready to deliver a full charge of live, powerful current to the set. You may obtain either of the two models from your nearest radio dealer, or write direct for full information.

- Silite Trickle Charger, gives .6 ampere charging rate. For any average size set. Absolutely noiseless. Complete. **\$10.00**
- Silite Homcharger. In addition to .6 ampere rate, gives booster charge of 2½-3 amperes. For very large sets. Absolutely noiseless. Price complete. **\$19.50**

The Kodol Radio Corporation
CINCINNATI ~ OHIO

KODEL

POWER SPECIALISTS SINCE 1912

SM

630

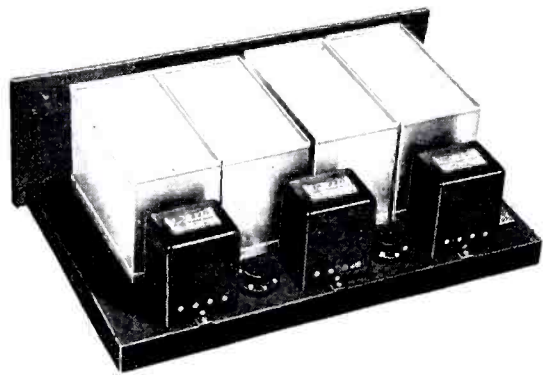

'Ever heard a real receiver?

Have YOU ever heard a radio set that made you lie back, light up your favorite pipe, and say "This is the life"? When you've listened to a symphony over the radio, haven't you always felt that it would be just a bit clearer if you were in the concert hall?

Have you ever heard a Silver-Marshall Shielded Six "doing its stuff"? It is guaranteed to give you better reproduction than you've ever heard. With the Six, you actually feel the vibration when you hear a cello or an organ—the timbre of a violin is true—a piano sounds as it should. And on a full orchestra—well, just ask the man who's built one about tone quality—he'll probably overwhelm you with enthusiasm.

You can put it together on the living-room table with three tools in three hours, and the same evening bring in stations local and distant with uncanny ease—with only two dials. You can buy every part needed for the Shielded Six solidly packed in a wooden kit-box—everything necessary except cabinet and accessories. Just ask for the 630 kit—it costs \$95.00—and it will build a set you can't duplicate for \$200, factory built. Or if you have some parts, you can get the Essential Kit, No. 633, for \$45.00.

And remember—when you build a Shielded Six you're getting a set with years of research work behind its design, with every part laboratory tested. You're getting a guarantee that its tone quality is beyond compare. Radio Broadcast, Radio Age, Radio News, The Citizen's Radio Call Book, all and more, have verified these claims—have endorsed the Shielded Six unqualifiedly.

Do You Know the Secret of Quality Reproduction?

Have you your copy of "The Secret of Quality"? This book tells you simply and concisely how to get the most out of your audio amplifier—how to get real quality. It contains laboratory data never before available even to many manufacturers. It is the only authoritative treatise on all types of audio amplification written in non-technical language ever published.

It's free! Ask your dealer for a copy.

Prices 10% higher west of the Rockies.

SILVER-MARSHALL, Inc.
848 W. Jackson Blvd.
Chicago, U. S. A.

and if the earth's motion through space has any effect on radio wave propagation.

By the way, has it occurred to you that static will have little effect on this apparatus? Only the static waves that are in phase with the transmitted wave will get through the shutter in the form of light; static out of phase with the signal will cause the lamp to flash midway between the shutter openings, and will not affect the screen. The effect of static is therefore reduced fully 50%. Interesting possibilities!

Technical details of the apparatus, such as the quartz-oscillators and the synchronous shutters, have been purposely left out to avoid confusion in the reader's mind. Both have been fully described in previous issues of RADIO NEWS.

Broadcasting Time Signals

(Continued from page 790)

the time signal is received. This radio amplifier is connected in the manner illustrated in the accompanying diagram.

The 220-volt "B" circuit records the behavior of the photo-electric cell which, under strong light, consumes only 10 milliamperes of current. On the other hand, when the electrical resistance of the cell is multiplied, due to darkness when the pendulum swings across the slit, the current follows the path of least resistance—through the grid leak. This produces an increased current through the 20,000-ohm relay, with the result that the magnet draws over the armature. When the cell again is illuminated, the current flows through it, thus releasing the armature of the relay.

The circuit from the points of the relay may then pass through a recording device. A sounder is employed for increasing the audibility of the action of the relay. Also a circuit from these points passes through the pen magnet of the chronograph, thus permitting the making of records, on the sheet of the time-recording device, showing the variations of the pendulum. The telegraph key (when depressed) inserted in this circuit, affords extra signals for the pen, required in testing timepieces in the laboratory. A special push-switch operates the chronograph drum through a 1/10-horsepower induction motor.

"The object of this apparatus," states Mr. Gould, the inventor, "is to demonstrate a method of obtaining regular time signals from a pendulum without actual mechanical contact. The action of the photo-electric cell and of the amplifying electron tubes is practically instantaneous; such variations as may occur probably being due to the irregular action of the relay. This relay is of a sensitive type, having 20,000 ohms resistance, so that at 200 volts it requires only 10 milliamperes to operate it."

PICKING UP DISTANCE

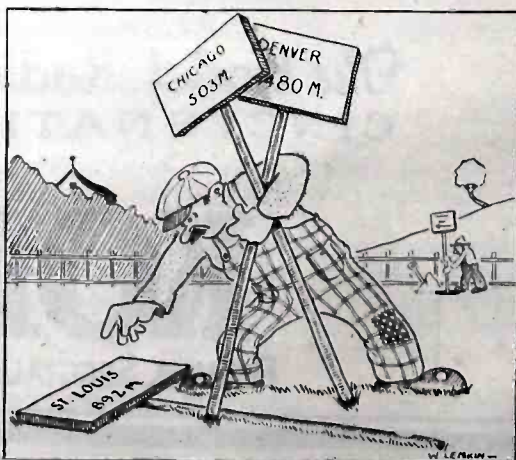

ACME FLEXIBLE CELATSITE

Flexible, stranded wire for point-to-point and sub-panel wiring. Non-inflammable "spaghetti" covering. In black, yellow, green, red and brown; a color for each circuit. Put up in 25-foot coils.



The Original Celatsite
—a tinned, copper bus bar wire with non-inflammable "spaghetti" covering, for hook-ups. 5 colors; 30-inch lengths.

Celatsite Battery Cable

—a silk-covered cable of vari-colored Flexible Celatsite wires, for connecting batteries to set. Prevents

"blowing" of tubes; gives your set an orderly appearance.



We also offer the highest grade of "spaghetti" tubing for Nos. 10 to 18 wires. 5 colors; 30-inch lengths.

Stranded Enameled Antenna

Best outdoor antenna you can buy. 7 strands of enameled copper wire; maximum surface for reception. Prevents corrosion and consequent weak signals.



Send for folder

THE ACME WIRE CO., DEPT. D
NEW HAVEN, CONN.

ACME WIRE MAKES BETTER RADIO

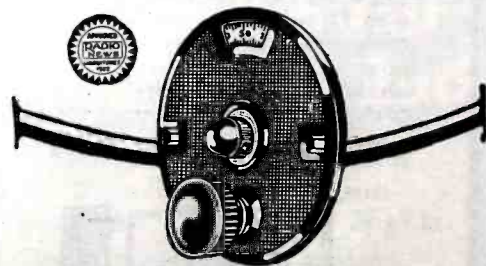

to put

MAR-CO Dials on your set, is to add supreme accuracy and responsive tuning. to put it off, is to miss the best your set can give.

MAR-CO DIALS

Rubber Covered Insulators



Actual Size

Neat and efficient. For antenna, ground and for lead in wires. Small screw starts readily and makes finished job. Great improvement over ordinary large, unsightly insulators. They keep the wires in place and out of the way. Packed 10 in a box, 25c at your dealers or direct from us.

CULVER-STEARN'S MFG. CO.
Worcester, Mass., U. S. A.

Insure your copy reaching you each month. Subscribe to RADIO NEWS — \$2.50 a year. Experimenter Publishing Co., 53 Park Pl., N. Y. C.

Cooper **A** Eliminator

The "A" Battery is gone - - -
- - - forever!

*N*OW you can enjoy radio without having to put up with the inconveniences caused by the storage "A" battery, for the "A" battery has been totally eliminated as a radio necessity.

The Cooper "A" Eliminator actually eliminates the "A" battery with all its messy watering and charging. Just plug the Cooper "A" Eliminator into the light socket and turn on the set . . . a simple throw of a switch and the current is on . . . tumble back the switch and the

current is off . . . supplies up to 2½ amperes of current, enough to operate any make of receiver using up to ten six-volt tubes.

The Cooper "A" Eliminator is not a power unit. It employs no trickle charger. It needs no attention of any kind . . . no batteries to water . . . no acids or liquids to replace . . . operates purely on a rectification and filtration principle . . . creates noiseless, distortionless filament current direct from the house lighting system.



Good radio dealers in most cities have the Cooper "A" Eliminator on display, \$87.50 (tubes extra); slightly higher West of the Rockies.

This Free Booklet Tells the Story

We have prepared a very complete folder describing the Cooper "A" Eliminator and the principle upon which it is built. May we send it to you?

DEALERS—JOBBER

The Cooper "A" Eliminator is the only device of its kind on the market. It is new in principle—has no competition. Limited distribution and full protection to trade outlets insure legitimate profit. Write for full particulars of our exclusive proposition

THE COOPER CORPORATION

Radio Division—Dep't N

CINCINNATI, OHIO

Founded 1904—Factories, Cincinnati and Findlay, O

Radio Ops See Foreign Lands

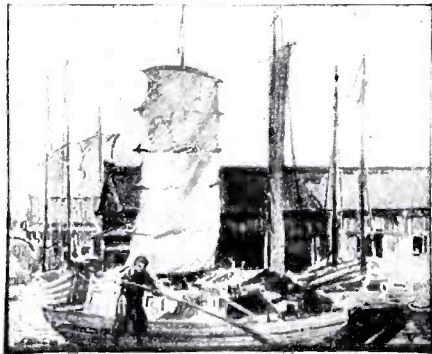

Radio operators on ships have marvelous opportunity for travel and adventure. They earn good pay—in addition to board and sleeping quarters.

Study at home now for a voyage next summer.



Radio Institute of America—world's oldest radio school—offers Home Study Courses that qualify you to pass the U. S. Government Commercial or Amateur License examinations.



Radio Institute conducts a special technicians' course for radio dealers, jobbers and service men. Write for booklet.



RADIO INSTITUTE OF AMERICA

formerly Marconi Institute
Established in 1909
324 Broadway, New York City



Mail coupon for complete description of course.

CUT HERE

Radio Institute of America
324 Broadway, New York City

Please send me your free booklet.

I am interested in the radio course which prepares for the Government Commercial, Broadcast or Amateur License.

I am interested in the technicians' course for jobbers, dealers and service men.

Name _____

Address _____

A Versatile Superheterodyne

(Continued from page 817)

If higher voltages are used on the Ultradyne oscillator, the employment of a larger tube and the use of a "C" battery to bias the grid will overcome this difficulty. A thorough try-out of this "Ultradyne modulation" system will well repay the builder; for the circuit has wonderful possibilities and, as here developed, represents one of the best methods of reception in use at the present time, especially on weak signals.

The detector circuit used for the first tube can be the usual one, employing a condenser and leak for rectification, or it may incorporate the use of a "C" battery.

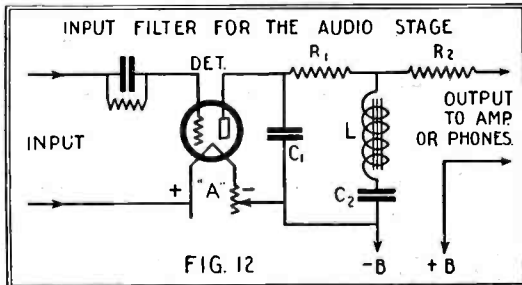

FIG. 12
A filter for the input of the audio power stage. The values are: C1, .001-mf. to .006-mf.; C2, .0001-mf. to .0002-mf.; L, 100 millihenrys; R1 and R2, 12,000 ohms fixed, C1 should be adjusted carefully.

Either system will produce probably equal results if handled properly. It will be noticed that the Ultradyne does not employ either.

INTERMEDIATE-FREQUENCY TRANSFORMERS

The intermediate amplifier may be any standard make or construction. However, care should be taken to select transformers having charted curves so there will be no guesswork in their use. Those made to work on between 3000 and 5000 meters wavelength (100 to 60 kilocycles) are recommended. They may be either iron or air-core: the writer is inclined to believe that air-core transformers, properly designed to allow a sufficiently wide wave band to pass, are less liable to produce distortion.

If the Ultradyne circuit is used, the input transformer should be shunted by a fixed condenser. Satisfactory results will probably not be obtained without it.

About 45 volts will be found most practical for the intermediate amplifiers in general use. Higher voltages require much care and discretion, so keep them as low as consistent with good volume and amplification.

The second detector circuit (Figs. 10 and 11) may be any of the conventional arrangements. Take caution to have it properly biased, by the use of either a "C" battery or a proper leak. For this second detector the writer favors the "C" battery method for better tonal quality, and for handling large amounts of current.

OSCILLATOR UNIT

The oscillator circuits (Figs. 7, 8, and 9) are typical and, whatever circuit is chosen, tests should be made to determine whether

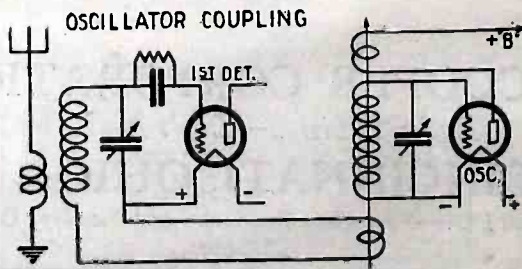

FIG. 13

Showing one method of coupling the first detector to the oscillator.



Radio Troubles gone forever!

FULLY 90% of all radio trouble is battery trouble. Don't buy any more bothersome, mussy, expensive "B" batteries. Use a VELVETONE—operate your set from the light socket, and enjoy better radio reception.

VELVETONE is the new improved "B" battery eliminator. It employs an exclusive principle which positively insures a maximum of smooth "B" current at all times—free from hum or distortion. VELVETONE gives more volume and improves the tonal quality of all reception. It never runs down—always operating at peak efficiency to bring in weak and distant stations without strain on tubes.

VELVETONE is designed to give any voltage desired. It is guaranteed to operate any receiving set satisfactorily—no matter what style or number of tubes—or money refunded. Will last indefinitely—no working parts to get out of order, wear or be replaced. Price \$31.95, installed complete. Write today for descriptive literature, giving name of your radio dealer.

OUTPUT

LINE 115V. A.C.
10 mils. - 175
20 mils. - 163
30 mils. - 153
40 mils. - 143
50 mils. - 132
60 mils. - 123
70 mils. - 114
80 mils. - 106

DEALERS:
Write or wire for our attractive selling offer for your territory.

General Distributors
VELVETONE COMPANY
3729 Avalon Blvd., Los Angeles, Calif.



Bradleystat

PERFECT FILAMENT CONTROL

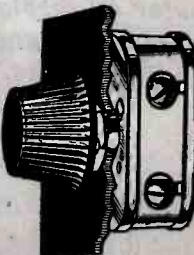

Provides complete noiseless filament control for all radio tubes without change of connections. Metal parts are nickel plated. One hole mounting. Self contained switch opens battery circuit when desired.

Allen-Bradley Co.
Electric Controlling Apparatus

287 Greenfield Avenue Milwaukee, Wis.

Only Karas has been able to solve the vital problem of automatic tuning at every dial setting through the marvelously efficient Karas Equamatic 5-Tube Sensation.

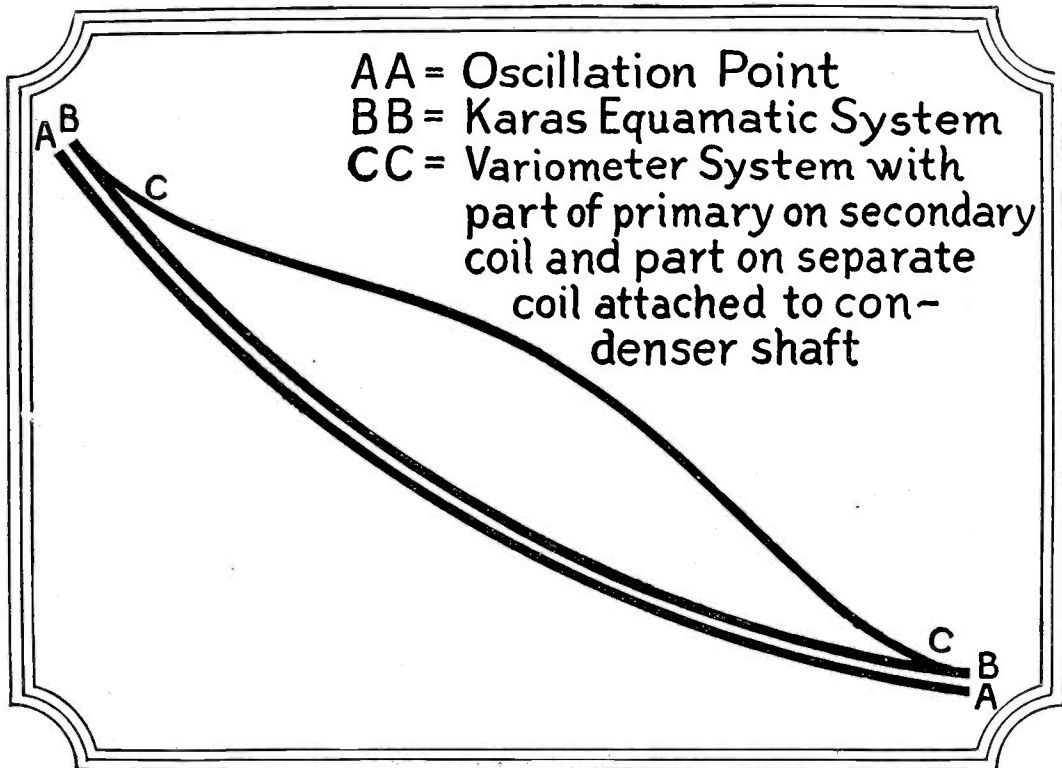

Equamatic System Licensed Under King Patents Pending.

THE Karas Equamatic 5 Tube Sensation—the talk of all of the great national radio exhibitions—the most discussed set in the pages of leading radio publications—is the only receiver which accomplishes automatic tuning at every wave length setting of the dials. Only Karas has been able to solve the problem in a simple, practical, automatic manner.

What does the Equamatic Receiver Accomplish?

The Equamatic System provides a CONTINUOUS MAXIMUM and an absolutely EQUAL TRANSFER OF ENERGY between primary and secondary inductances AT ALL WAVE LENGTHS. It utilizes a coupling system that is absolutely unique in the entire field of radio engineering. Because of this feature the Karas Equamatic actually delivers from five tubes results that heretofore have only been possible with six or seven tubes. Its volume is tremendous. Its selectivity is sensational. Its clear, pure, rich, sonorous tones are a revelation. And all because the Equamatic System, utilizing Karas precision-built parts, has been brought to a peak of operating efficiency that will not be found in any other receiver regardless of price, type of circuit or number of tubes.

What is Meant by High Efficiency in the Equamatic?

Other circuits have been called highly efficient in the past, and even today remarkable claims are made for the operating efficiency of certain receivers. What constitutes this much to be desired peak point in receiver operation?

Radio engineers are agreed that the radio frequency tubes in a tuned radio frequency receiver are at highest efficiency when just below their oscillation point. The problem in such receivers always has been to keep the R.F. tubes at this point by continuously maintaining an equal transfer of energy between primary and secondary coils. Until the Equamatic System was invented no one had ever done this, although there had been several makeshift attempts to reach the desired goal.

The Story Told in Graphic Form

Study the curve chart reproduced above. It is a graphic picture of the oscillation curve of a radio frequency tube, designated by the line AA. Naturally you will find the highest operating efficiency of radio frequency tubes indicated by a line, BB, exactly parallel to it, and directly above the line AA. Tests have shown that this line, BB, also indicates the exact efficiency of the radio frequency tubes in the Karas Equamatic Sensation—just below the oscillation point, WHERE EVERY TUBE IS MOST EFFICIENT. And the Karas Equamatic maintains this peak efficiency at every wave length setting of the dials—not at certain points in the broadcast waveband, BUT AT EVERY DIAL SETTING BETWEEN 200 and 600 METERS.

Other Sets Vastly Less Efficient

To give you a graphic idea how much less efficient are other types of receivers we have plotted the curve of a typical set using the variometer system. In these sets part of the primary coil is carried on the secondary, where it cannot possibly be varied, and part of it is carried on a separate coil mounted on the condenser shaft. The curve of operating efficiency of the radio frequency tubes in such sets is shown by the variable curved line CC. Note how far from peak efficiency such sets must be except at one or two points!

The variometer type of design cannot possibly offer the efficiency of the Karas Equamatic System because it does not provide a continuously equal and constantly maintained transfer of energy between primary and secondary inductances at every wave length setting of the dials—a thing absolutely essential if highest efficiency is to be secured.

The Problem Solved Only by the Equamatic
In the Equamatic System the primary coils are entirely separate from the secondaries. They are attached to the shafts of the condensers, in a way to make them adjustable in their relation both to the condenser shafts and to the secondary coils. The secondaries are adjustable to any desired angle in relation to the primaries and also as to their degree of coupling with the primaries. By means of this method of mounting the inductances, the primaries are AUTOMATICALLY, CONSTANTLY and CONTINUOUSLY VARIED at a definite, ever-changing rate of variation, with the turning of the condenser dials. This is the means by which an absolutely exact amount of coupling at every wave length setting is provided—the precise amount necessary to deliver to the secondary coils exactly the quantity of energy required to cause the radio frequency tubes to operate constantly at their very peak of efficiency—as shown by the line BB, just above the oscillation curve AA. So efficient is the Karas Equamatic that when once correctly adjusted it positively cannot and will not oscillate in the slightest at any frequency between 200 and 600 meters, yet the slightest increase in filament voltage will throw the tubes into instant oscillation.

Not only is the Karas Equamatic the most efficient receiver you can possibly build, but it has also a selectivity, purity of tone and a volume that you can get with no other receiver. It is extremely simple to operate. You will be able to spend far more time listening to the programs with your Karas Equamatic and far less in locating the stations you wish to hear than with any other receiver. And last, but not least, the Equamatic is extremely easy to build.

Easy to Build with Karas Parts

Karas has taken all of the bother out of building this powerful, full-toned, sensitive receiver by making its assembly a pleasant job for some convenient evening when you have an hour or so. We furnish complete layouts for panel and subpanel—simple, easily understood instructions for the placing of every part and the wiring of the receiver. A complete manual of simple wiring diagrams and full directions for building the Equamatic is packed with each set of three Karas Inductance Coils, together with all necessary nuts, screws and binding posts for building the complete receiver. You should use Karas parts in building the Equamatic wherever they are specified because this remarkable receiver was designed especially for these famous parts, and will operate at its highest efficiency only when they are used.

To build the Equamatic you will need the Karas parts listed in the coupon, plus certain other standard parts easily obtainable anywhere. If your dealer cannot supply you with Karas parts for your Equamatic you may order direct from us by filling out and mailing the coupon below. SEND NO MONEY. Just hand the postman the price of the parts plus a few cents postage. Then build the set and have the receiver you have always wished you might own! Order the Karas parts today from your dealer or from us. Act now, while this page is before you. Learn for yourself how marvelously better the Karas Equamatic Receiver really is.

KARAS ELECTRIC CO.
1121 ASSOCIATION BUILDING, CHICAGO

Essential Parts of the Karas Equamatic Sensation



KARAS EQUAMATIC INDUCTANCE COILS are packed three in a carton, and come to you with complete manual of simple diagrams and instructions, all necessary nuts, screws and binding posts, ready for mounting in your receiver. Price, set of three coils, \$12.

KARAS SPECIAL 17 PLATE ORTHOMETRIC CONDENSERS

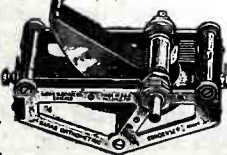

three of which are used in the Equamatic Receiver, have special extended shafts upon which to mount the primary coils of the Inductances. Price, each,\$7.00

KARAS HARMONIK AUDIO FREQUENCY AMPLIFYING TRANSFORMERS



are essential to the tone quality success of the Equamatic Receiver. Two of these are used for the two stages of audio frequency amplification. Price, each,\$7.00

KARAS EQUAMATIC RETARD COILS, two of which are used, were designed especially for the Equamatic System. Price, each, \$1.00

KARAS EQUAMATIC SUB-PANEL BRACKETS. To insure the necessary exact positions of primary and secondary coils these brackets are essential. Price, set of three, 70c.



KARAS MICROMETRIC DIAL. It has a 63 to 1 vernier and tunes to 1/1000 of an inch. The gear arrangement by which this is accomplished is a real achievement—there are no friction gears or cams to work loose—yet Micrometrics turn easily with a liquid-like smoothness that is brand new and is a surprise to even the most experienced fan. Supplied in 180 or 360 degree types. Gold inlay markings. Genuine Bakelite. Price, 3.50.

KARAS ELECTRIC CO.
1121 Association Building, Chicago, Illinois

Please send me set of 3 Equamatic Inductance Coils, \$12.00; 3 special Orthometric Condensers with extended shafts, \$7.00 each; 3 Micrometric Vernier Dials, \$3.50 each; 2 Harmonik Audio Transformers, \$7.00 each; 2 Equamatic Retard Coils, \$1.00 each; and 3 sub-panel brackets, 70c. for which I will pay postman \$60.20, plus postage, upon delivery. It is understood that I have the privilege of returning any of this apparatus for full refund any time within 30 days if it does not prove entirely satisfactory.

NAME.....
ADDRESS.....
CITY..... STATE.....
(If cash accompanies order we will ship postpaid)

AMSCO METALOID

GRID GATES & RESISTORS

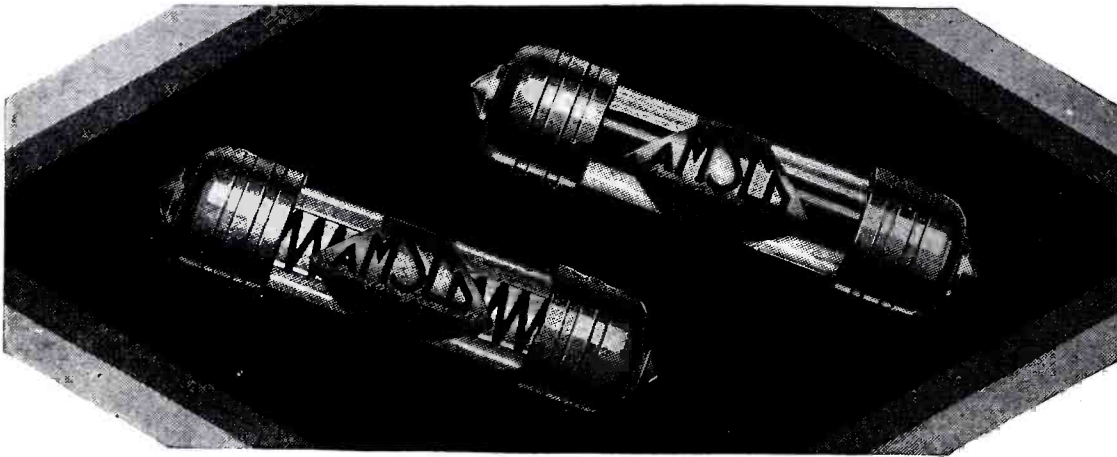

SILENT ACCURATE PERMANENT

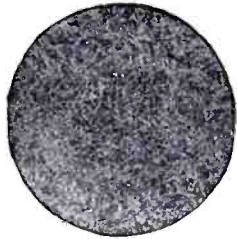

Microphotogram of Colloidal AMSCO metaloid element. "Smooth, unbroken and silent."

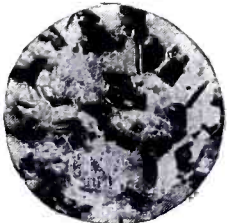

Microphotogram of typical crystalline metallic element. "Jagged and noisy."

THE secret of AMSCO excellence is in the changeless AMSCO METALOID resistance element. It is COLLOIDAL—smooth, stable, never varying with age, moisture or usage—superseding crystalline forms, with their jagged, noisy pathway to the current.

The element is fused into glass, and contact made by a welded joint, spun to the exterior cap. The large element, many times the size of inferior metallic resistors, will dissipate two watts of power with a 500 per cent margin of safe overload.

AMSCO Metallic Grid Gates and Resistors are standard specification for fine Radio Receivers, and Battery Eliminators requiring high watt dissipation.

AMSCO Accuracy is guaranteed within five per cent of rated value—Silent operation guaranteed without qualification. Insist upon AMSCO Metaloids.

AMSCO PRODUCTS, INC.
Broome and Lafayette Streets, N. Y. C.



Write for Zeh Bouck's monograph on R. C. Amplification. Also leaflets describing AMSCO Allocating Condensers, single, siamese, and three-gang—allocating by frequencies, wavelengths or capacity variations.



or not it oscillates vigorously over the entire scale of wavelengths used. Some of the circuits are bad for hand capacity; especially those having no ground or zero potential connection to the rotor plates of the variable condenser. Circuits with the "A—" going to the rotor will generally be free from this effect. Figs. 13 and 14 show two methods of effecting a coupling between the oscillator and tuner for the superheterodyne. It does not particularly matter whether a loop is pulled out of the tuner and carried over to the oscillator or whether a loop is taken out of the oscillator and carried over to the tuner.

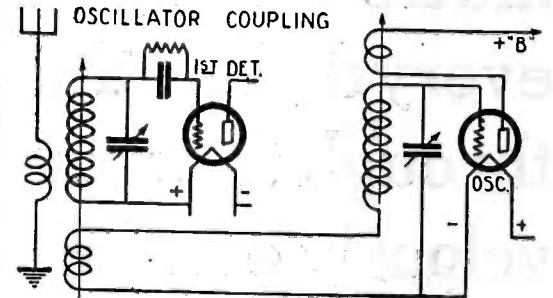

FIG. 14
Another method of coupling the first detector to the oscillator.

However, the method shown in Fig. 14, is preferable, as it increases the efficiency of the tuner. Whatever method is used, keep the coupling loose, using only a few turns. Care should be taken in selecting a good oscillator tube for this unit.

MODERATE SELECTIVITY DESIRABLE

The tuner circuits available are numerous, but a few stand out as most practical for the superheterodyne. Of course, nothing can be amplified that doesn't get into the first detector; so construct the tuner with the best materials and design, as laxity here will certainly destroy its value as a distance-getter.

However, one usually must choose between extreme efficiency and ease of operation, and this is no exception. Perhaps a moderately selective tuner is the most practical for general use, as the tuning is usually more easily accomplished. For this reason no circuits have been shown using more than one control; which, with the oscillator control, gives two-dial tuning.

In regard to tubes, the 201-A type are the best all-around ones to use. They are rugged, powerful, and flexible. Wherever smaller tubes like the 199 type are used,

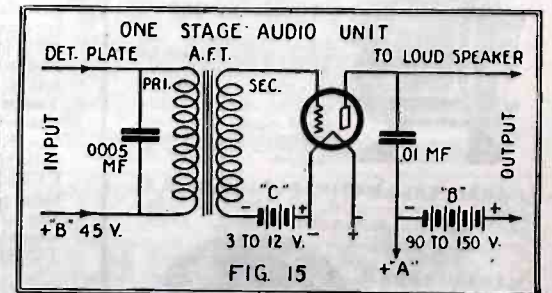

FIG. 15
Circuit diagram of the one-stage semi-power audio amplifier. Note that high "B" and "C" voltages are employed.

great care should be taken in checking filament voltages; otherwise short life must be expected. Tests should be made while the set is in actual use to ascertain the best position for the respective tubes. Some tubes perform much better as detectors than others, and the same is true of amplifiers.

SHIELDING?

The subject of shielding has been purposely neglected. Shielding practice is complicated; and as generally used it is more of a "losser" than a shield. During experiments on "supers" the writer has tried sev-

CARTER "Midget" Rheostat with Filament Switch



\$1

- | | |
|---------|----------|
| 2 ohm* | 20 ohm* |
| 3 ohm* | 25 ohm |
| 6 ohm* | 30 ohm* |
| 10 ohm* | 40 ohm |
| 15 ohm | 50 ohm* |
| | 75 ohm* |
| *R.M.A. | Standard |

First and ONLY battery, switch and rheostat in one. As soon as knob is turned from "off"—the filament circuit is closed. Eliminates one knob from panel, simplifying operation and conserving space. A big advance in radio construction. Made in all resistances including all R. M. A. Standards. Specified in Hammarlund-Roberts and other circuits.

Any dealer can supply

In Canada: Carter Radio Co., Limited, Toronto



Insure your copy reaching you each month. Subscribe to Radio News—\$2.50 a year
Experimenter Publishing Co., 53 Park Place, N. Y. C.

SUPERIOR QUALITY IS ONLY ONE OF MANY REASONS

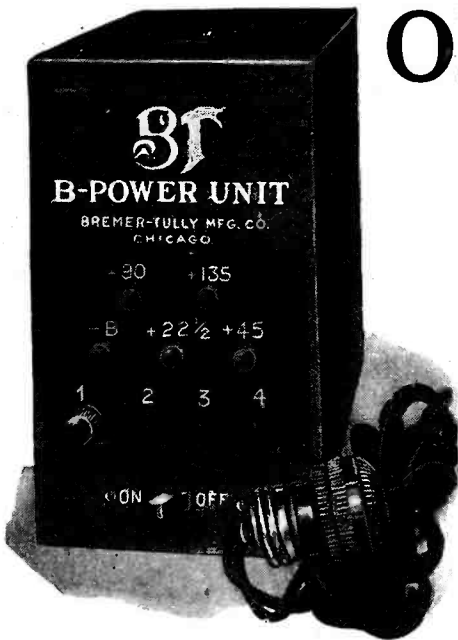

Capacity 150 volts at 60 milliams.
Equally satisfactory on smaller sets.
Price ready to operate \$49.50—
(slightly higher west of Rockies)

Why you should choose the B-T B-Power Unit.

Better design is another. You set the B-T once and you are thru unless you should change to a different type of set. There is no guess-work—no knobs to turn.

But the extra convenience isn't the chief point,—it's the fact that you know you're giving your tubes the voltage they require to produce the results you can't secure without it.

When you buy a B-T product you know what you're getting,—and there is no greater economy in radio than buying a good B-Power Unit.

Designed by the same engineers whose record on parts and circuits is unparalleled and manufactured by an organization that has given B-T a reputation for never having put out anything not highly successful.

What greater assurance can you find?

In the B-T Power-Six Bremer-Tully present the best you can build

The full size diagram in colors leaves no room for errors in wiring.

Price of P-6 Kit containing essential parts—\$41.50.

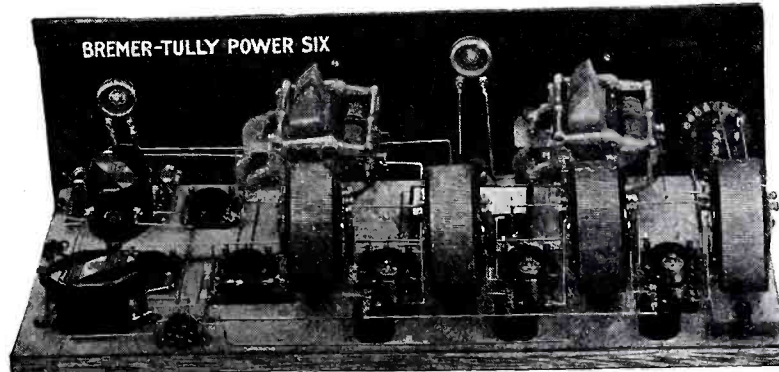

It uses the power tube — up-to-date in every respect.

Two controls — four tuned stages power output.

Gerald M. Best, Superheterodyne expert, Tech. Ed., etc, says:

"The new Bremer-Tully Power Six is by far the best Bremer-Tully receiver yet developed.

Its remarkable selectivity and simplicity of operation leads me to believe it will be one of the season's most popular circuits.

It is one of the easiest circuits to wire of any I have seen. Its engineering principle is sound.

Congratulations to Bremer-Tully on this new development."

Louisville, Ky.,
Oct. 28th, 1926.

After reading "Better Tuning" tenth edition, I revamped my six tube Counterphase with Power Tube and would like to report to you that unquestionably I am having the best radio reception I have ever heard, and incidentally I believe better than any eight tube receiving set at the present time. The B-T Counterphase Circuit is beyond an equal.—G. C. M.

Better Tuning

A booklet discussing many radio subjects in a way not found elsewhere.

Audio amplification methods, —B-Eliminators, tubes, circuits, fads and fallacies explained and exploded. Equally interesting whether you intend to buy or build a set. Postpaid 10c.

Washington, D. C.
Oct. 29th, 1926

I had previously thought it was impossible to improve on the Counterphase Six and up to the time I changed to the Power-Six it was the best I had heard. Now that I have changed to the Power Six the difference is really wonderful. It is unquestionably the finest set on the market today.—H. H.

London, Eng.,
Oct. 16, 1926

The Counterphase Six I built here some nine months ago has been very good and greatly admired. A friend of mine from Paris has just heard it and gave me no peace until I sold it to him.—S. H.

BREMER-TULLY MFG. CO., 520 SO. CANAL STREET
CHICAGO, ILL.



Beauty of appearance—yes. No other speaker offers so many quality refinements as Sonochorde, such as the rich wine-colored front of silk—the graceful, non-breakable frame finished in deep mahogany with oversized felt-padded base to match—the highly developed unit capable of handling the new power tubes—the ease of adjustment.

Quality of performance? *Just hear it!* Such wealth of tone! Floods the largest room or it may be tuned down to lowest pitch without slightest impairment. Compare it with ANY speaker you previously considered good. That's all we ask.

Sonochorde is also available in the new vogueish Floor Standard and Wall Designs.

Write for the Sonochorde Story

BOUDETTE MFG. Co., Chelsea, Mass.

Factory Sales Agents

Hastings Elec. Sales Co.
42 Binford St., Boston



Open a Radio Store

OPEN a RADIO STORE! Big business opportunity of the day—no capital necessary under our plan. Snap your fingers at the time clock—boss a good business of your very own. No other line offers you such a chance to start small—without capital—and grow big and firmly established in a very short time. Our **FREE BOOK** explains our plan—how we teach you all you need to know about Radio and help you start up in your spare time if you like—how our Business-Building Aid guides you and helps you grow FAST and make good money. Write today for Free Book giving details—no obligation. Address, J. E. Smith, President, National Radio Institute, Dept. AB-99, Washington, D. C.

NOT A LOUDSPEAKER But a QUALITY REPRODUCER



Our patented tonal chambers reproduce microfonic vocals and orchestral vibrations with mellowness, clarity and perfect resonance. A new principle invented by a master craftsman of acoustics, the science of sound.

\$18.00 WALNUT and MAHOGANY FINISH
Write us direct
ARTHUR BOLTON CO., 1924 19th St., Santa Monica, Cal.

eral types; but unless the reader is going into it for a scientific proposition, and is absolutely sure of the methods and technique of shielding, he should be advised against its use—at least, until he becomes familiar with "super" construction.

The experimenter who wants to build a superheterodyne that will permit further experimenting to advantage will be well satisfied with the results he will get from a thorough tryout and investigation of the wealth of experimental information herewith presented.

Radio Wrinkle Contest

(Continued from page 835)

tained for about ten cents each or for nothing at all if filched from the stairs as were the writer's, are used. By placing these mats under the set, as shown, the microphonic noises are reduced to a minimum. They may be completely hidden from view by covering them with a table cover.

Contributed by James A. Lynch.

Short-Wave Receivers

(Continued from page 811)

Then figuring from the 150—200-meter band we get a necessary wave-length range of 1.33 to 1, a capacity range of practically 2-1; for the square-root of the added capacity to a given inductance gives the added wave-length. Dropping down to what we ought to cover in the 40-meter region if we want to take care of foreigners, we need a capacity range only about 1.6 to 1 for 35 to 45 meters; and the frequency range is quite enormous, it's getting outside our 1000-kc. limit. Yet, there's no avoiding this. There

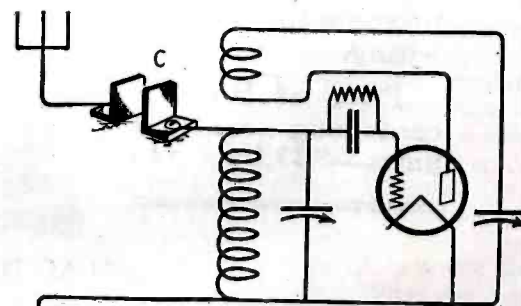

FIG. 2

The antenna is here coupled through a small condenser, C, to the receiver.

is no difficulty in getting a two-to-one capacity range, since the average condenser minimum is in the order of .00001 μ f. in the amateur size of condenser, and the circuit capacity is along the same order. (The circuit capacity includes the distributed capacity of the coil plus the tube and wiring capacity.) This gives us a minimum of .00002 μ f., or 20 μ f., so that we see our maximum need not be more than double that. However, when we start to vary the condenser, the minimum of the condenser changes and the fixed minimum of the circuit capacity remains; so that

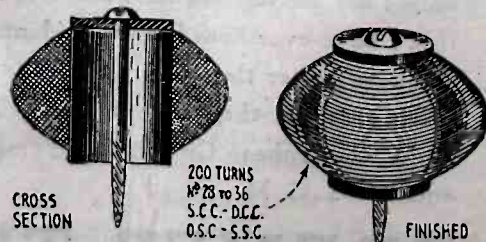

FIG. 4

A choke coil of special design is unnecessary. One may be made according to the above specifications.

Insure your copy reaching you each month. Subscribe to Radio News—\$2.50 a year. Experimenter Publishing Co., 53 Park Place, New York City.

Mass Production methods and tremendous purchasing power brought to Amrad and applied to building Neutrodyne a year ago by Powel Crosley Jr. make available to the public a 5 tube Neutrodyne at \$60

In this 5-tube battery type Neutrodyne at \$60 great engineering skill is manifest in the splendid performance of the set. Cabinet and trimmings are all any purchaser could ask—beautifully finished and appointed. Recessed dials behind windows and delicately adjusted vernier controls are distinctive features

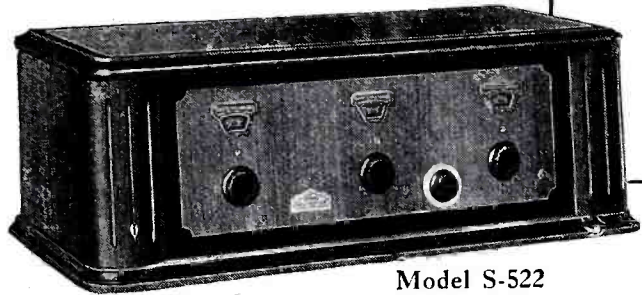

Model S-522



Cone Table for table models S-522 and AC-5 with Crosley Musicone Built in. Ample room for batteries or power unit. \$32

—and a light socket operated Neutrodyne at \$150

This is Amrad's crowning achievement. A power unit, using a current direct from your light socket on wall or from table lamp furnishes A, B and C current direct to the 5-tube Neutrodyne pictured at the right. This power unit is pictured directly behind the set.

No batteries—nothing to charge. An entirely new development in power supply. Amazing Mershon Condensers contribute to its great efficiency and compactness. TESTED BY CONSTANT USE IN HOMES FOR OVER A YEAR. Price of receiver \$65. Price of power unit separately \$85.

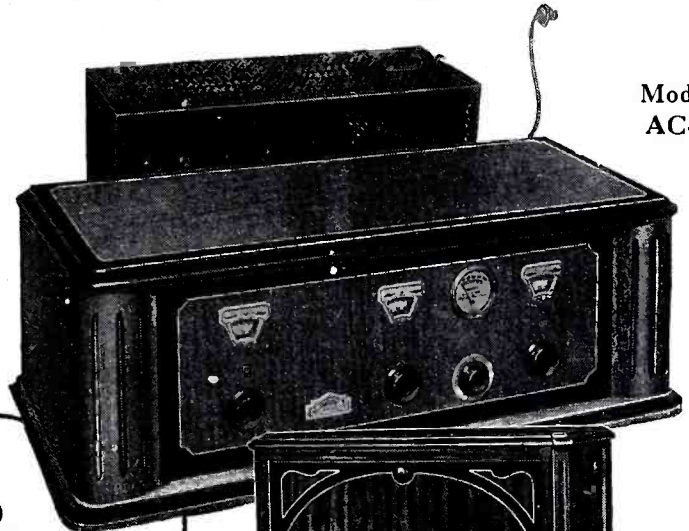

Model AC-5



Add a Mershon Condenser to your B eliminator for super-B current supply

30 MFD DUOTYPE



Filtering out light socket current hum is but part of the job. Eliminators must have STORAGE capacity to prevent "chopping off" of loud or sustained notes. The Mershon Condenser acts as a reservoir and STORES energy for sudden heavy drains on plate current. Does the work of expensive storage battery electrically rather than chemically. B eliminator connected with this condenser gives the excellent tone reproduction of fresh B batteries.

Mershon Electric Condenser 15 mfd's capacity each half, 30 mfd's total capacity. Type D-15-30. Maximum rating 300 volts D.C. If punctured can be repaired and need not be thrown away.

\$8



Model AC-5-C

Light Socket Operated 5 tube console

A beautiful cabinet in two-tone finished mahogany. Stands 40 inches high. Genuine Crosley Musicone built-in. Equipped with 5 tube battery type set \$110 —with lamp socket set and power unit \$200.

AMRAD

AMRAD CORPORATION
Medford Hillside, Mass.

HAROLD J. POWER, Pres.

Write Dept. 1A7 for descriptive literature

NEUTRODYNES

Ferguson

IN MANY receivers one may experience excellent "tone quality." With FERGUSON you are conscious of something more: a degree of fullness that gives you each note from every instrument in perfect timbre. Not mere music, but the soul of the artist seems to come into your living room.

One Tuning Control—Calibrated in Meters gives you, in a moment, the program to suit your mood.

Complete shielding of all tuning elements gives this 6-tube Receiver its marked selectivity.

See, hear, compare!

J. B. FERGUSON, INC.

225 West 57th Street
New York, N.Y.

The FERGUSON
Model Ten \$110.00
With table, as shown, 147.50
(Ten per cent increase west
of the Rockies)

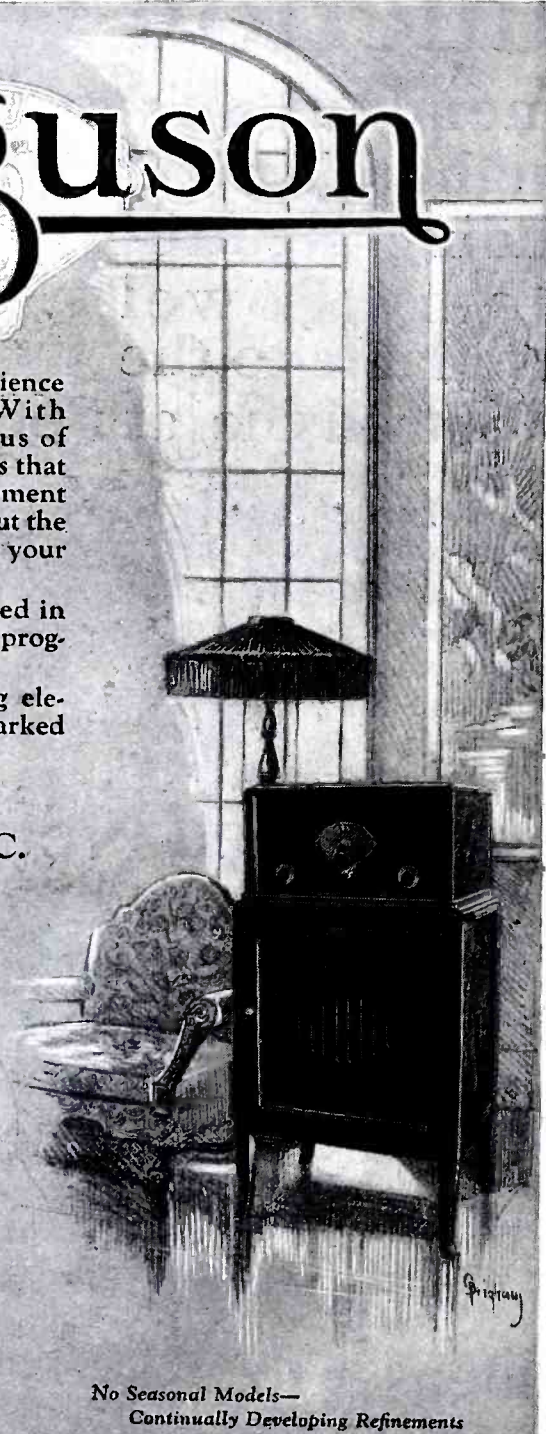

No Seasonal Models—
Continually Developing Refinements

The Gold Standard of Radio Receivers

our top capacity is necessarily, for the condenser, 40 less 10 or 30 micromikes (.00003 μ f.). This is close figuring. If anything should go wrong in our wiring and calculations we would be way off. We must allow something. So, the maximum capacity of the variable condenser we need ought to be in the order of .00004- μ f. for safety's sake. A condenser of this sort may be, satisfactorily, a baby midget variable, or else a three-plater of the usual dimensions.

ADAPTING A COMMON CONDENSER

To get a sufficiently low capacity, it is also possible to cut down a large condenser. Many variable condensers have their rotor plates bound together on the shaft with a nut only. It is easy in that case to loosen the nut, remove the useless plates and leave

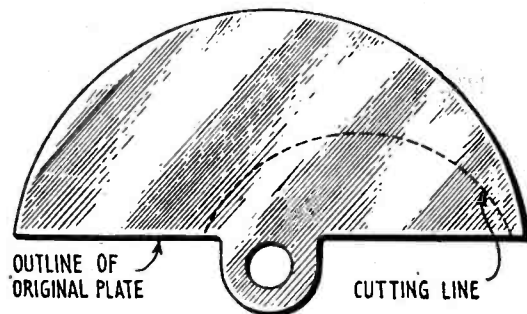

FIG. 5

If the experimenter wishes to retain the same number of plates in the condenser, this may be done by cutting down their size, as shown.

only those needed to get the right capacity. The stator plates need not be changed since only those plates interleaved will be effective. Of course, the stunt can be reversed and stator plates removed instead of rotor ones.

To get the right capacity calculate this way: count the number of rotor plates; notice whether or not they all interleave between two stator plates; if they do then each rotor plate has two active surfaces. A condenser of this sort has 16 active surfaces for .00025 μ f. capacity (250 μ mf.). Dividing by sixteen to get the capacity of one active surface gives .0000156; and we only wanted .00003, so that a single rotor plate with two active surfaces did the trick nicely. (See Fig. 6). This condenser was rated with a minimum capacity of .000007 μ f., which is unusually small, .00001 to .00002 being more often the case.

The general troubles of the amateur are perhaps more clear to your mind now than they were. It is obvious that a set designed with such a small tuning condenser will not do on the BC range of wave-lengths with the sizes of coils required. Often enough builders find a .00025- μ f. maximum condenser too small; and that has nearly ten times the capacity of our one-plate condenser. The 200- to 500-meter wave-length range requires a capacity range of nine-to-one, whereas two-to-one is enough for the amateur short-wave receiver.

The illustration shows one baseboard, or "bread board" set used by the writer in experimental work. The antenna coil was permanently fixed at 5 turns, well separated from a secondary with the number of turns necessary for the wave-length range used. The coils illustrated are rather difficult to make; however their dimensions for various wave-length bands are given. Spring-clip binding posts were used to connect in the coils. The tickler coil was allowed to be on the other side of the tube from the secondary. The secondary condenser is a variable one with plates shaped to give some sort of a frequency-spreading curve, similar to the straight-lines now so touted. Because the plates were shaped and small, several were necessary. The regeneration condenser, to the right, is an ordinary semi-circular-plate affair.

In Fig. 3 is shown the circuit of this set. Since the coils hang by their leads it is



give

your set the responsive tuning today's conditions call for—equip your set with MAR-CO Dials tonight—enjoy, from then on, air-searching dial action.

MAR-CO DIALS

TRADE IN YOUR OLD LOUD SPEAKER

Liberal cash allowance for any antiquated goose-neck or ear-trumpet type of loud speaker, regardless of age, make or condition, in part payment of the new, glorious-toned

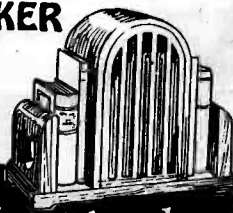

PREMIER "Library Grand" Speaker

Bass to Soprano
Organ to Violin

FREE TRIAL, right in your own home to prove the Premier surpasses all earlier types in quality, range, and volume of tone. A handsome piece of furniture, besides. For library or occasional table or mantel. Walnut finish. Treat your Radio to this amazing and beautiful reproducer.

Demonstrators Wanted in every neighborhood, to take orders. \$14 profit for you on every sale. No stock to carry. Trade-in offer gets 'em all! Write quick for special demonstrator offer!

You sell for \$35.00
Net price to Agents after trade-in:

\$16.00

PREMIER ELECTRIC COMPANY
Dept. 199, Grace at Ravenswood, Chicago

Insure your copy reaching you each month. Subscribe to RADIO NEWS—\$2.50 a year. Experimenter Publishing Co., 53 Park Place, N. Y. C.

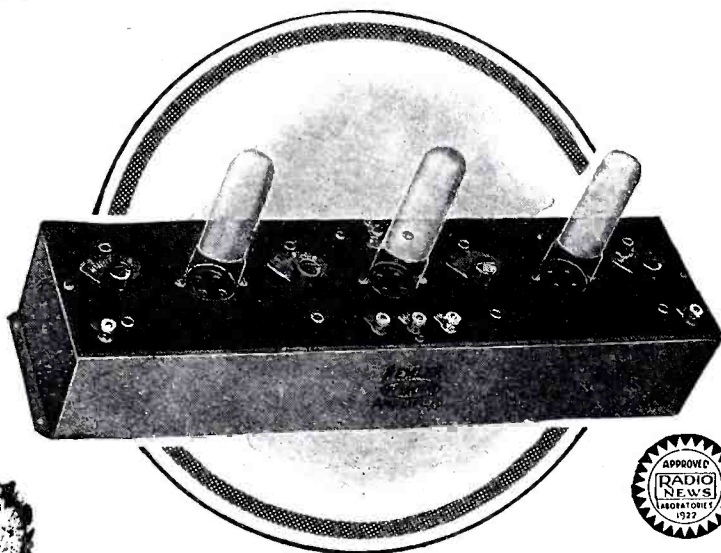

REMLER
INFRA-DYNE
AMPLIFIER

Smashing all Barriers

that stand between your set and the kind of radio reception that you want and need. That is exactly what the Remler Infradyne Amplifier is doing for thousands of radio owners and that is exactly what it can do for you.

Perhaps right now you are thinking of buying a new receiver. How much better to keep the old reliable neutrodyne or tuned radio frequency set and add the Remler Infradyne Amplifier with associated parts. Then you will have a circuit that gives you all—and more—than you can reasonably ask.

Most progressive dealers already know the Infradyne story and what it means in improved reception. Ask your favorite retailer for full details. If he can't tell you all you want to know, write us for 2-color folder and complete instructions for building the complete Infradyne circuit and the Adaptor.

This is an Infradyne year—why drift along with the "also-rans" when it's so easy to lead the procession.

Price \$25.00

REMLER

DIVISION OF

GRAY & DANIELSON MANUFACTURING COMPANY

CHICAGO

260 FIRST STREET • SAN FRANCISCO

NEW YORK

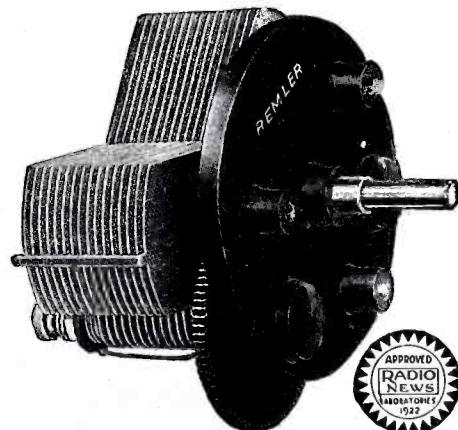

REMLER
TWIN-ROTOR
CONDENSER

Straight-Line Frequency Straight-Line Wave Length

So good—that your set certainly deserves it— This Condenser has won national popularity on its sheer outstanding merits. Rotation is thru a full 360°, and stations are widely spaced. Brass and Bakelite construction thruout. Both sets of embossed plates rotate and are rigidly soldered into position.

Capacities .00035 and .0005.
 Price \$4.50 less dial



only
\$7.95
 \$1.00 Down
 Balance
 C.O.D.

**READ
 this Proof!**

**MONEY
 BACK ~ if Not Delighted**

"I received the Eliminator and I am greatly pleased with it. We did not know we had a good radio till we hooked up your Eliminator."

"The Eliminator's performance is all I could ask."

"I have your B Eliminator. It has given very good service."

"Received 'B' Eliminator. Works fine."

"Eliminator is working perfectly."

"'B' Battery Eliminator working satisfactorily. I can sell several here."

"Originals of above letters in our files. Just a few of hundreds."

"Marvelous!" "Unbelievable!" "What a Bargain!" Every day we receive scores of enthusiastic letters from users of this amazing new Roll-O "B" Battery Eliminator.

Forgot Battery Troubles Forever

All you do is hook up this Roll-O Eliminator to your set and sit back to the greatest radio pleasure of your life. No more batteries to worry about. Enjoy better reception, sharper tuning. Don't worry because "B" batteries run down and spoil the reception.

Operates On All Sets

Works perfectly on any direct or alternating current giving up to 90 volts current and using full wave of power supply. Hooks up in a moment to any set up to six tubes. Constant voltage assures more power.

Completely Equipped—No Extras to Buy
 Five minutes after you receive this Eliminator you can be enjoying its use. Comes to you completely equipped, together with simple, easy instructions. Solidly built in beautifully finished metal case with genuine Bakelite top.

Order Today—10 Days Trial

Now, for no more than the cost of good "B" Batteries, you can own a Roll-O Eliminator that will make batteries unnecessary forever. Pin a dollar bill to coupon and mail today. Postman will deliver Eliminator to you. Deposit \$6.95 (plus few cents postage) with him. Use Eliminator 10 days. If not delighted with results, return it within ten days and receive your money. Don't delay. Act quick to become one of the thousands of enthusiastic users.

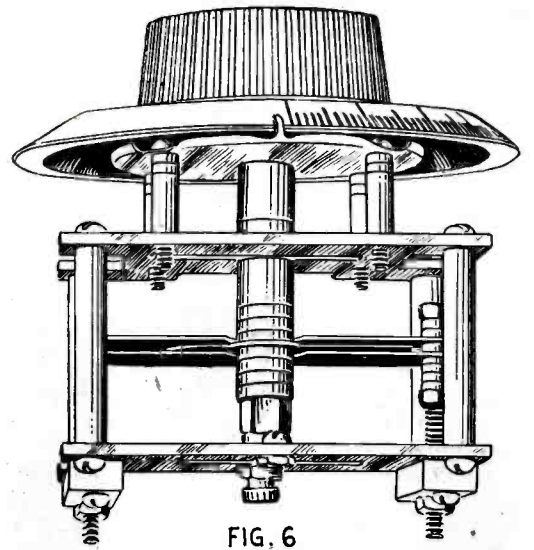

FIG. 6

A variable condenser of many plates can be easily converted to capacity suitable for S.W. work, as shown above.

possible to vary the coupling between them to any satisfactory point in the case that the tickler or antenna coil should have too many turns, rather than have to remove turns.

The primary coil (No. 3 in the illustration) consists of five turns of No. 22 enameled wire, space wound, 3 1/2 inches in diameter. The other coils, the secondary (No. 4) and tickler (No. 7) are wound similarly, with the same wire; but the number of turns is altered, as follows, for the three short-wave bands:

Bands Meters	Secondary Turns	Tickler Turns
75-85.6	21	8
37.5-42.8	12	6
18.75-21.4	7	4

The choke coil used is not very critical. The writer usually grabbed any coil had for the purpose: some times it was a spider web of 60 turns ordinarily used in the sort of receiver and other times it was the secondary of a loose R.F. transformer of the sort styled "neutroformer," or else a coil in some spare and otherwise unused form. The important point was a choke coil of some sort rather than merely a special form of coil for the purpose. A good choke coil for the job can be made according to Fig. 4.

If you possess a semicircular plate condenser of the .00025 microfarad size whose plates can be removed and you have a desire to build a short-wave affair, it is only necessary to take the plates out, cut them down according to the general shape of Fig. 5 and reassemble the condenser with the original number of plates. If sufficient area is removed the maximum capacity of the new condenser will be on the general order of .00008 to .0001 microfarad and that is not particularly excessive after all for the shorter wave-lengths. The new shape of the plates will give an approximately equal frequency separation over the scale and will make the tuning consequently smoother and easier. A heavy pair of tinsmith shears, which can be purchased in an inferior but satisfactory grade at the ten cent store, can be used to cut the plates well enough. In cutting, small bites should be taken one at a time to avoid bending or curling the plates of the condenser.

There is no merit in having the feed-back condenser one with specially shaped plates. With proper coupling between plate and grid circuits this method of regeneration control has practically no tuning effect. However, for the telegraph man, there is a value in having a large size of variable regeneration condenser. He is then able to dive deeply into oscillation to muffle interference and noises somewhat, and often to his entire satisfaction.

TRICKLE CHARGER, \$3.95

Charges "A" or "B" batteries using ordinary house current. Hooked to your "A" battery gives complete "A" power unit. Send \$1 with order, pay \$2.95, plus few cents postage to postman when he delivers your charger, balance C.O.D. Use for ten days. If not more than satisfied, return it and get your money back.

THE ROLL-O RADIO CO.

Dept. Q-8, 3rd and Sycamore Streets
 CINCINNATI, OHIO

**Send \$1 with this Coupon
 only!**

The Roll-O Radio Co.,
 Dept. Q-8, 3rd & Sycamore Sts.,
 Cincinnati, Ohio.
 Gentlemen: I attach \$1.00. Please send Roll-O Eliminator to me C. O. D. for \$6.95 (plus postage) on special 10-day trial guarantee.

Name
 Address
 Town State

**Yale GROUND HOG
 INCREASES POWER AND
 DISTANCE**

Marvelous newly-invented ground gives incredibly improved reception. Doubles power and distance users say. Reduces leakage. Stops jangling even in midsummer. Results never before equalled. Satisfaction guaranteed or money back at once. Proven absolutely essential to clear, powerful distance reception. Draws and holds moisture indefinitely. Highly sensitive to radio energy.

HIGHEST APPROVAL

Approved by Radio News exhaustive laboratory test and endorsed by other high scientific radio authorities.

SEND NO MONEY—To introduce, we offer to those who act at once, regular \$5.00 size for only \$2.00. Send name today and pay \$2.00 plus 17c postage on delivery. Or send only \$2.00 with order and save postage. **FREE**—Full description of Ground Hog and details of amazing special low priced battery offer on request—write today.

Yale Specialty Supply Co.
 125 W. 5th St., Kan. City



**Bradley-Amplifier
 Resistance-Coupled
 PERFECT AUDIO AMPLIFIER**

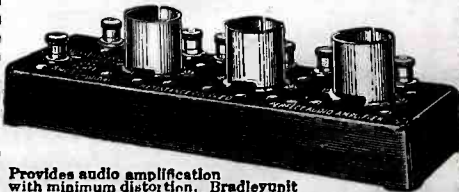

Provides audio amplification with minimum distortion. Bradleyunit molded resistors used in the Bradley-Amplifier do not vary with age and are not affected by atmospheric conditions. Can be used to replace transformer amplifiers in standard radio sets with decided increase in tone quality.

Allen-Bradley Co.

Electric Controlling Apparatus

287 Greenfield Avenue Milwaukee, Wis.

EVERYTHING IN RADIO

AT ATTRACTIVE PRICES. SETS OR PARTS. Orders shipped exactly as ordered. Prompt Service. Write for Prices. Mail Order Only.

ALL RADIO COMPANY, 417 North Clark St., Chicago

Print Your Own

Cards, Stationery, Circulars, Paper, etc. Save money. Print for others, big profit. Complete outfits \$8.85. Job press \$11.29. Rotary \$149. All easy, rules sent. Write for catalog presses type etc. **THE KELSEY CO., P-72, Meriden, Conn.**

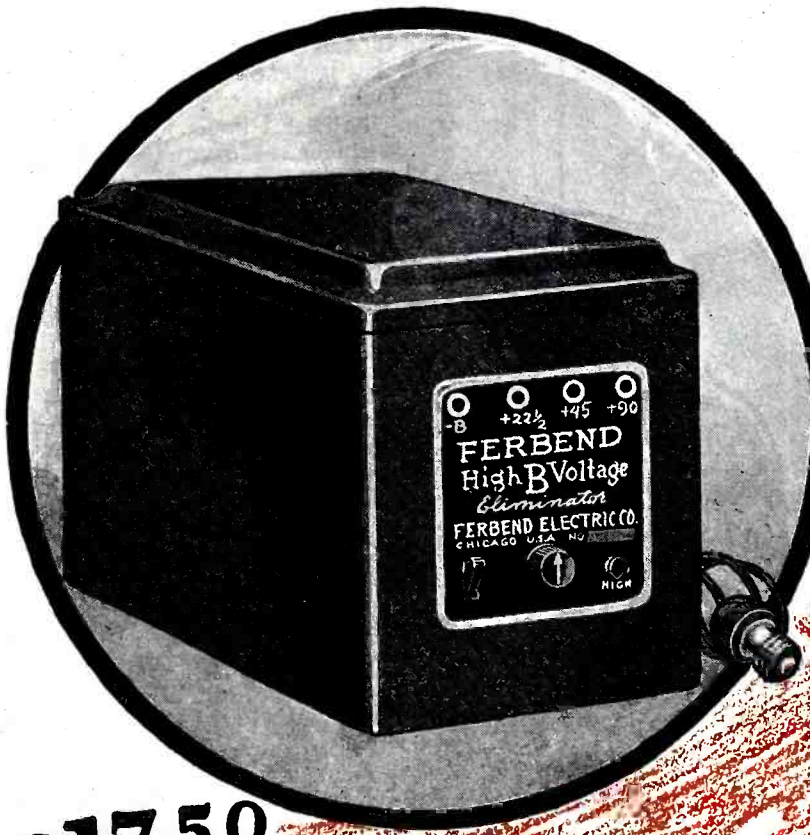

\$17.50

New High Voltage Model
Complete: Delivers
up to 180 Volts



\$12.50

COMPLETE
Nothing else to buy. Replaces
"B" Batteries. Operates direct
from Electric Light Socket on
110-120 volt A. C. Lighting Cir-
cuit. Delivers up to 100 volts.



**Not only
the most reasonable**

but proved by 40,000 users to be also the most convenient,
unfailing and satisfactory "B" Eliminator

New High Voltage Model

for extremely large sets, or sets using power tubes, now per-
fected. Delivers up to 180 volts. One control adjusts voltages
on all taps.

**Equal to any "B" Eliminator regardless of price—not only
in operation, but in workmanship, quality,
durability and appearance**

Money Back Guarantee

Stop paying out money for costly, unreliable battery service and repairs.
Permanent excellence can be built into economical "B" service. 40,000
users of the good Ferbend "B" Eliminator agree. That is why during the
slack summer season we worked at full capacity to meet orders. That is
why hundreds of unsolicited testimonials prove beyond the shadow of a
doubt its splendid, enduring performance.

Ask Your Dealer—or Send Direct

Shipment made direct on receipt of price, or C. O. D. if preferred. Use
for 10 days to convince yourself—if unsatisfactory write us within that
time and purchase price will be refunded. Use Coupon NOW.

**FERBEND ELECTRIC COMPANY
425 W. Superior St., Chicago, Ill.**



They Want YOU to Know

Montreal, Canada
I am pleased to state that the
Ferbend "B" Eliminator pur-
chased from you is a wonder
and is giving results far beyond
my expectations. The tone and
volume would satisfy the most
critical.
James Stroud,
Electrical Engineer.

Youngstown, Ohio
Your Eliminator is the best
buy I have made in a long time.
It has already more than paid
for itself in saving on "B" bat-
teries.
R. L. Welsh.

Springville, N. Y.
Having had perfect results
with the seven Eliminators re-
cently purchased you may send
me six more by express at once.
Leonard J. Cooper.

Burbank, Calif.
I am more than pleased with
your Eliminator. I am getting
several Eastern stations
through about 15 locals using
the Eliminator.
Jean Barnard.

St. Peter-burg, Fla.
I used your Eliminator all last
winter, and it was as good, if
not better than several I tried
of much higher price. I am
more than satisfied.
Ben M. Pyatt.

Trenton, N. J.
I have used your Eliminator
for several months and unhesi-
tatingly recommend it. It has
added 25 per cent to the vol-
ume of my set and always has
full voltage.
J. M. Starger

New Orleans, La.
The "B" Eliminator which I
purchased from you some three
or four months ago has given
entire satisfaction and I am
well pleased with its perfor-
mance.
G. J. Murphy

Wilmington, N. C.
I am well pleased with the
Eliminator I purchased some
time ago. It is all you claim and
more. It brings in signals loud-
er and clearer than any set of
dry batteries I ever used.
T. E. Lyon.

Amsterdam, N. Y.
I have compared your Elim-
inator with other makes and it
cannot be beat. My reception
has easily increased 60 per cent.
It gives me much better results
than I was ever able to get with
dry batteries. William Davis.

Wheeling, W. Va.
The Eliminator purchased
some time ago is giving re-
markable results.
William A. Raper, Jr.

Des Moines, Ia.
Your Eliminator is just what
I needed.
Rev. F. A. Case.

Louisville, Ky.
Your Eliminator is all you
claim it to be. Am very much
pleased with it.
Alonzo G. Smith.

OH City, La.
Your Eliminator has given me
good service for over a year.
George May.

St. Louis, Mo.
After giving your "B" Elim-
inator a thorough trial wish to
state that I am thoroughly sat-
isfied. It's performance is per-
fect—absolutely no hum what-
ever.
Frank Kolar.

Mattapan, Mass.
I have used your Eliminator
for six months and am satisfied
with it in every way. It has in-
creased the volume of my 6-
tube Neutrodyne fully 60 per
cent and there is absolutely no
hum from the 60-cycle line.
John W. Purcell, Jr.

Second Successful Year

**FERBEND
"B" ELIMINATOR**

Approved and passed by the rigid Laboratory Tests
of the two foremost Radio Laboratories in America
—Radio News and Popular Radio

**FERBEND ELECTRIC CO.
425 W. Superior St., Chicago, Ill.**

- Send \$12.50 model. Send \$17.50 model.
- Send at once. Payment enclosed.
- Send C. O. D. Send literature.

Name

Address

City.....State.....



All in One!

**THORDARSON
POWER
COMPACT**

TYPE R-171 For Raytheon BH rectifier and power tube UX 171. Includes buffer condensers \$15.00
TYPE R-210 For UX 216-B rectifier and power tube UX 210. No condensers included. \$20.00

**The Complete Foundation Unit
for power amplification and B-supply**

Simplified Assembly. Only 14 leads are necessary to complete the Raytheon assembly. All terminals are carefully located for the greatest ease of connection.

Compactness. The only additional apparatus required to build the B-supply are the condenser block (Raytheon type), a Raytheon tube BH, and the resistance units.

High Efficiency. The power supply of either Power Compact furnishes the proper current for maximum efficiency of the rectifiers used; the chokes are of sufficient capacity to carry the maximum output. Conservatively rated; will not heat up in continuous service.

High Voltage Output. The R-171 Power Compact assembly will deliver a maximum plate voltage of 300 v. at 30 MA., or 275 v. at 40 MA.

- A power supply transformer.
- Two filter chokes.
- Two buffer condensers.
- A power filament supply.
- All in One Case

The R-210 type assembly will deliver 400 volts to the plate of the power tube, and, in addition, will supply a constant 90 volts to the receiver at any current drain up to 40 MA.

Silent in Operation. There is no traceable hum, either mechanical in the compact itself, or electrical through the loud speaker.

Complete Supply for Power Amplification. The Power Compact provides for the complete A-B-C supply for the power stage. Makes it possible to use power amplification, even on sets designed for dry battery operation.

Electrically Centered Filament Supply. The power tube filament supply is tapped at the exact electrical center for grid return. The center tap is taken from the common lead of two perfectly balanced windings — completely obliterating the A.C. hum. (An exclusive Thordarson Feature.)

Write for instruction booklet SD-49 and SD-50
If your dealer cannot supply, order direct from the factory.

THORDARSON ELECTRIC MANUFACTURING CO.
Transformer Specialists Since 1895
WORLD'S OLDEST AND LARGEST EXCLUSIVE TRANSFORMER MAKERS
Huron and Kingsbury Streets — Chicago, Ill. U.S.A.

3446-A

LEARN THE CODE AT HOME

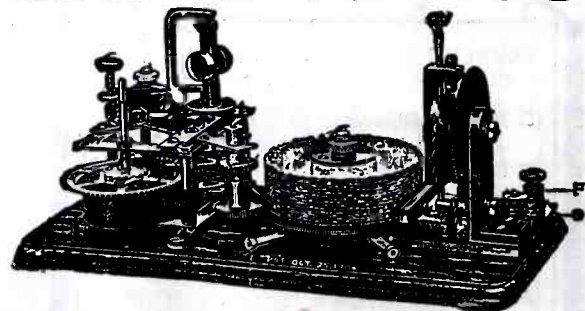

WITH THE OMNIGRAPH

THE OMNIGRAPH Automatic Transmitter will teach you both the Wireless and Morse Codes—right in your own home—quickly, easily and inexpensively. Connected with Buzzer, Buzzer and Phone or to Sounder, it will send you unlimited messages at any speed, from 5 to 50 words a minute.

THE OMNIGRAPH is not an experiment. For more than 15 years, it has been sold all over the world with a money back guarantee. The OMNIGRAPH is used by several Depts. of the U.S. Govt.—in fact, the Dept. of Commerce uses the OMNIGRAPH to test all applicants applying for a Radio license. The OMNIGRAPH has been successfully adopted by the leading Universities, Colleges and Radio Schools.

Send for FREE Catalog. **DO IT TODAY.**
THE OMNIGRAPH MFG. CO., 15 HUDSON STREET, NEW YORK CITY
If you own a Radio Phone set and don't know the code—you are missing most of the fun

Insure your copy reaching you each month. Subscribe to Radio News—\$2.50 a year.
Experimenter Publishing Co., 53 Park Place, N. Y. C.

The Invisible Net

(Continued from page 803)

shoulder at the disappearing loud-speaker horn, and straightened a little. "I've been tryin' to, Jack," he defended uneasily. "I've been tryin' the best I know how, but it ain't no use." A shiver ran over his big body and dread showed in his eyes. "I tell y' there's something spooky about this radio. Y'can't see it or tell what it's doin'; and just the same it keeps followin' us and followin' us."

Jack snorted with contempt. "Plain damned fool!" he burst out. "That's all you are, a plain damned fool! Spooky! You make me sick. I don't know how it works, either, but it don't throw any scare into me. I've been easing you and your crazy notions along all the time, but I'm through now. See?" He held the bigger man with his blue metallic eyes, and his voice rasped curtly. "Snap out of it. Snap out of it! We've pulled this job too well to have you spill it this late. Do you hear?"

Sim drew his heavily muscled shoulders erect with an effort. "I—I'll try, Jack," he promised wearily. "Honest, I'll try."

They had been through all this perhaps a dozen times now. Three days before, the two of them—Sim in a tight brown suit, a jagged scar from eye to mouth; Jack in an ample palm beach, a mole on his chin—had parked their flivver at the curb and walked briskly into a small door beside the impressive entrance of the First National Bank of Mortonsville, Ohio, four hundred miles away, a few minutes after the institution had closed for business.

They had been here before, as salesmen for a compound for cleaning marble floors; and the janitor, a little inoffensive man, eyed them with blank terror when he looked into the muzzle of Jack's automatic. He was still looking at them like that as they locked him in the mop closet and returned to the employees' door with his keys. The men and girls balancing the day's business in the shelter of the bronze grill looked up with varying degrees of fright and amazement as they stepped in with drawn weapons; and at four o'clock, when the janitor finally broke down the door and released the staff from the musty file vault in the basement, the flivver, with \$242,000 in a stout cowhide bag, was thirty miles away in a secluded glade. The gray water color had been washed from its hood, the license plates changed; and Jack and Sim, clad in smart gray and serviceable blue, the make-up washed from their faces, were grinning with relieved triumph.

It was an "air-tight" job. Nobody had looked twice at a mere flivver heading out of town at fifteen miles an hour; and by the time the bank employees were able to supply descriptions there was no pair with a scar and mole, in a brown suit and palm beach, to be trailed. Big Sim had carried out his part flawlessly too, steady and impassive as a machine. But this was before the first radio announcement came through.

They were eating supper at a small-town lunch and pool room fifty miles from Mortonsville. Jack was talking across the counter to the stout proprietor, and Sim giving methodical attention to a second piece of cherry pie; when a youth in a game at one of the green tables turned to a cabinet against the wall and began twirling its dials idly. Orchestral music came from the loud speaker beside it, stopped, and a deliberate voice began speaking:

"This is station KDKA at East Pittsburgh," it said. "We are making the following announcement at the request of the police department of Mortonsville, Ohio.

For an Ideal Radio Christmas

Willard Radio Power Units



The Willard "A" Unit and "B" Battery Charger

Gives you full convenience of lamp-socket reception with steady, non-fluctuating battery power. Two-speed selective charging—a trickle charge for regular use, and a 2-ampere rate for emergencies. Insures full "A" battery power for sets up to 11 tubes. Charges storage "B" batteries, too, if desired, without changing a single connection.

The Willard "B" Power Unit

Rectifies the full wave of A. C. house-lighting current. Uses harmless, non-acid solution. No tubes. Will give ample, steady power in all types of radio sets up to 10 tubes, including sets using power tubes in audio stages. Voltage can be varied at will as follows: detectors, 18 to 60 volts—amplifiers, 90 to 110 volts—power tubes, 120 to 160 volts. And there is no hum.

WILLARD STORAGE BATTERY CO.
CLEVELAND, OHIO, U. S. A.

The Willard Selling Plan for Radio Dealers

Your local Willard Service Station will act as your jobber on Willard Radio Products.

This means a quick source of supply for strictly fresh material which you can turn over to your customers in the pink of condition.

Your local Willard Service Station will also assume the responsibility for service, if needed.

Months of operation have proved that this plan is effective, and profitable for all concerned.

Willard Radio Products are advertised extensively. Doubles and full-pages in The Saturday Evening Post and other leading publications.

Have your local Willard Service Station explain the details of this practical plan for advertising and selling radio products. The advertisements are signed:

The Willard Battery men
and their
Authorized Radio Dealers

Appropriate signs and window cards will identify you as an Authorized Dealer. Booklets and other valuable selling helps will be furnished.

**Your Nearest Willard
Service Station is Your
Nearest Willard Jobber**

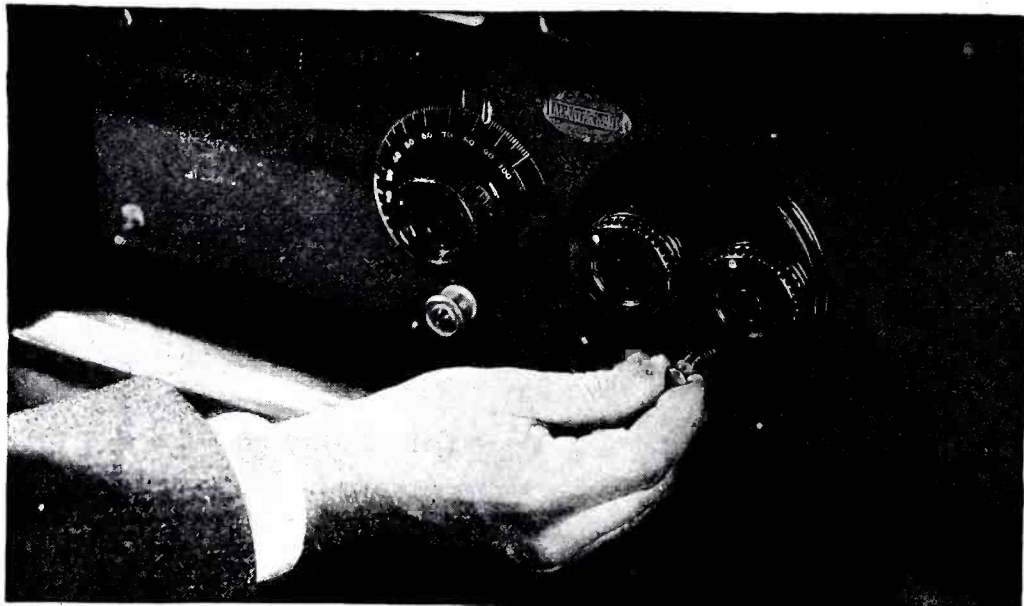

At a click of your set switch

- AUTOMATIC radio operation
- NEVER-FAILING power
- UNDISTURBED reception

AT one click of the set switch—Unipower supplies even, unfailing "A" power, and controls "B" power automatically! No matter what set or "B" power you use—Unipower enables complete radio operation under one control.

Unipower does far more, in fact. It furnishes the exact amount of "A" power required by your particular set,—at any time—under any condition. Your reception is saved from the crashing and grating of over-charge—and the sickly fading of insufficient power.

Never, as before, need you be without the use of your set for days, even hours at a time. Unipower's

full current assures permanent, continuous reception—always of clearest tone and finest quality.

Time-tested, proven again and again, Unipower cannot fail. It is built by the same skilled experts who, for 30 years, have made Gould quality renowned everywhere. And its trouble-proof construction and everlasting performance have earned it the highest praise of radio engineers and manufacturers. Ask your dealer how easily and cheaply Unipower can be yours. [Unipower contains a Balkite charging unit of Gould design]. The Gould Storage Battery Co., Inc., 250 Park Avenue, New York.

Unipower

A GOULD PRODUCT

AUTOMATIC "A" POWER THAT CANNOT FAIL

LAUREL RADIO RECEIVER

COAST TO COAST RECEPTION

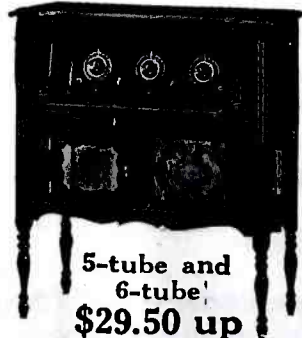

5-tube and
6-tube
\$29.50 up

The lowest-priced high quality radio receiving sets on the market. Extraordinary selectivity. Five-tube and six-tube sets from \$29.50 up. Many superior features of design and construction to bring better, stronger, clearer reception. Beautifully finished console cabinet designs if desired. Console cabinets only, \$17.50 to \$35. Write for free booklet and confidential discount sheet for dealers and salesmen.

LAUREL RADIO COMPANY, Manufacturers
Dept. R Anderson, Indiana

Insure your copy reaching you each month. Subscribe to Radio News—
\$2.50 a year. Experimenter Publishing Co., 53 Park Place, N. Y. C.

Two thousand dollars reward is being offered for information leading to the arrest or apprehension of two men, who held up and robbed the First National Bank of that city this afternoon."

Sim put down his fork and faced the horn, shoulders hunched defensively. Jack stopped talking and turned toward it too, with sprightly attention. The voice went on, described them and their car as they had appeared at the time of the robbery. "One more, eh?" Jack remarked cheerfully when it finished. But Sim said nothing, did not finish his pie—and Sim liked pie.

Not that this mere announcement made him suddenly uneasy. Make-up and camouflage had done their work too well to let identification be even a possibility. It was simply that he had an unaccountable dread of radio.

A fine prickling chill had run up and down his spine, and sweat had come out on his palms, the time he first came in contact with it; a crude loud speaker in front of an electric shop, blaring speeches and music. The demonstrator had explained it glibly enough, of course—electrons, high frequency, tuned circuits. But that missed Sim. The sheer mystery of the thing overwhelmed him, got under his calloused skin: these voices and songs winging their way hundreds of miles unseen—not even felt—through buildings and trees and mountains—even through his very body—without wires—without anything to betray their teeming presence till these black boxes with the bright wires overhead snatched them out of the air and let them be heard!

There was an uncanny quality about it that gave him the crawling sense of confronting something beyond mere human power; and his baffled uneasiness only grew the stronger as more shop windows bristled with yawning horns and the pool rooms and gambling places he frequented installed them. There were times when he had to put down his cue or cards and get away from the reminder that voices no ear could hear teemed about him; and that was what he wanted to do when the loud speaker in the little lunch room boomed out its announcement. But Jack felt differently about it.

"Fine! Never counted on a break like that!" he exclaimed exultantly, back in the fivver. He pointed to a paragraph under a four-column head on the first page of a Youngstown paper he had bought, and Sim read. "Science's most modern dragnet was enlisted by police when they arranged with the powerful radio station KDKA at East Pittsburgh to broadcast descriptions of the two bandits at hourly intervals, and it is expected that their whereabouts will soon be reported through this means."

Jack saw the dread in Sim's eyes when he looked up. "Well! Now what?" he demanded curtly.

Sim made a baffled gesture. "It gets me," he confessed miserably, his big shoulders hunched. "There's something spooky about it I tell y', Jack. Nothing y'can see. No wires, and everything. I wish they hadn't done it."

Jack burst into shrill, amused laughter. "Spooky? Spooky? Radio? Say, that's a wow!" He sobered and made quick elated gestures. "They can't touch us. Don't you see? All they've got's those bum descriptions, and if the flatties do stumble on anything this broadcasting'll give it to us. See?" He beamed. "Why it's just about the best break we could have had, and believe me we're going to edge in some place every time that stuff's on and listen to 'em tell us the latest they've got. See?"

And that was precisely what they had done. An hour later in a garage, an hour after that in a confectionery, the next day at filling stations, hotels, lunch rooms, tour-

The most Amazing Radio Bargain of the Year



Brand-new, perfect-working, popular Diva 5 tube model. Clarity, mellowness and positive power and selectivity. Easy to operate. Only highest quality parts used. Riveted set, no solder. Power and tone leaks prevented. Marvelous reception. Let us prove its good points to you.

Direct to You
from Factory Saving 60%
5 tube-leakless
powerful-handsome
\$23.50!

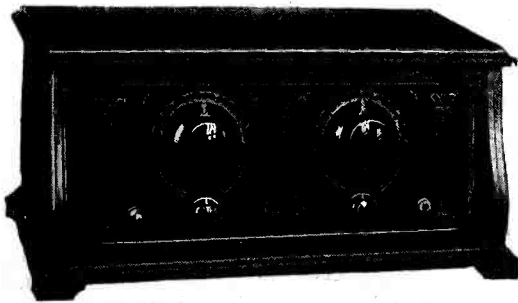

\$37.50 A superior Diva 5 tube set. A beautiful and efficient receiver. Transformer coupling and interchangeable coils. You solve the peculiar local atmospheric conditions. Operation on all wave lengths. Slight tuning changes tone from a whispered drama to a thundering chorus. You will be delighted.

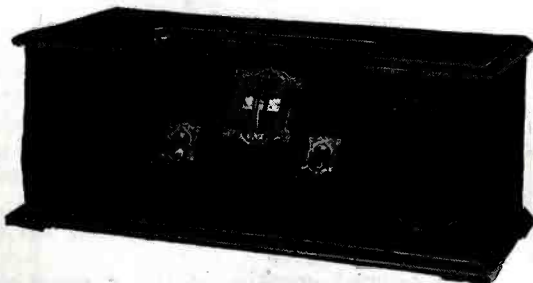

\$47.50 This 6 tube de Luxe Diva Receiver is our pet model. Simplicity of single control. Minutest adjustment on both wave and station. Shielded coils and transformer couplings. Cabinet contains space for oversize "B" batteries. Marvel set of modern radio. Magnificently designed, handsome and dignified as well as being THE Super-Receiving set.

To all who act quickly, we offer the greatest radio bargain of 1927. Brand-new Diva Radio Receiver is *really amazing* in performance. Nowhere will you find such a high-class model as this 5-tube Diva Radio at the price. Has all the most modern improvements. Diva Radio is riveted, eliminating all soldered parts. No leakage of power. No loss of tone. Fullest possible reception always. Easy to operate. Dials log in the easiest way. Has been approved by thousands of radio fans and the leading radio engineers in the country. Clear, natural, well-rounded tones. Reproduces song, speech and music, from the faintest whisper to the mightiest orchestra. Finished in smart cabinet. Artistically designed. Distinctive in appearance. A piece of furniture as well as a first-rate radio. Acquisition to any home. You couldn't build one half as cheap, nor nearly as fine. Cut out the coupon below, and send today.

30 DAYS FREE TRIAL IS YOUR RIGID GUARANTEE!

You are fully protected. To prove our claims for the Diva Radio we will allow you to make a full month's test, free! If at the end of this month's free test, the set does not operate to your entire satisfaction, send it back at our expense. We will return your money in full, without hesitation. We can afford to make this offer, as we have never had a set returned. You will be more pleased with your Diva set at the end of the thirty days than you were the day it was installed.

SELLING TO YOU DIRECT SAVES YOU 60%

Under our plan, the dealers, jobbers and distributors discounts—usually about 60% of the cost of the set—GOES TO YOU. By cutting out these handling charges and selling the Diva Radio to you DIRECT. We save you fully 60% of the profits. Ordinarily, you would have to pay 50%, 10% and 7% in commissions before you got your set.

With this special Diva offer, not even an agent makes a cent in discount or commission. That is why the Diva Radios come to you at such amazing figures of \$23.50, \$37.50 and \$47.50, respectively, for the three models. That is why the Diva Radio is the greatest Value of the Year.

Full equipment including: tubes, cone speaker, batteries, aerial and ground wires—\$20. for two less expensive sets—\$25. for \$47.50 set. To operate from 110 v. 120 v. A.C. any cycle add \$25 to price equipment—B eliminator to operate any set from 110-120 v. A.C. any cycle giving 150 v. with variable control \$22.50. Combination A and B eliminator \$42.50. Big special catalogue furnished on request. Send for it NOW.

YOU PAY ONLY 1/4 WITH ORDER

You need only send 25% of the cost of the model you want, if you act NOW. Pay the rest on delivery of set. It is your chance of the season. Get one for Christmas. Orders will be filled as they come in, and will be shipped from our nearest branch to save charges. Get yours in now and take advantage of this special offer.

Mail this coupon →



DIVA RADIO CORPORATION,
 294 East 137th Street, New York, N. Y.

Gentlemen: I am sending you \$..... which is 25% of the cost of the \$..... Diva Radio. I agree to pay the balance upon delivery. If for any reason, the set is unsatisfactory, it is agreed that I can return the set—at your expense—and that my money will be returned in full.

Name

Address

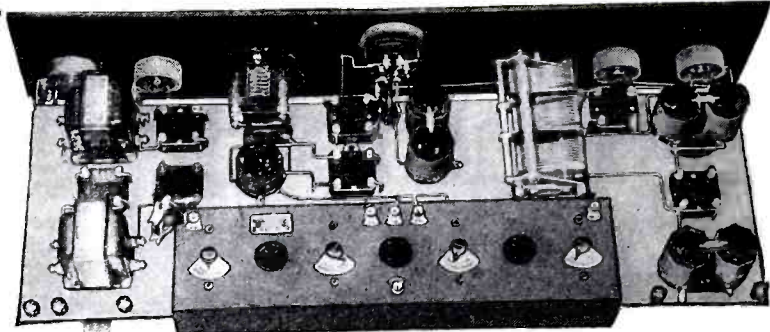

INFRADYNE

INFRADYNE RECEIVER

1 Remler Infradyne Amplifier.....	\$25.00	1 Carter Single circuit closed jack No. 102A80
1 Hammarlund 3 Gang .00035 Condenser	12.00	1 Carter Single circuit open jack No. 10170
3 Hammarlund midget condensers 5 plate at \$1.80	5.40	1 Jewell No. 135 0-5 Volts	7.00
1 Remler .00035 Condenser	5.00	1 Lynch 2 meg grid leak50
1 Frost No. 886 50,000-ohm variable resistance	1.25	1 Dubilier .0001 Fixed Con.35
1 Camfield Set Coils	10.00	2 Dubilier .00025 Fixed Con.70
2 National Dials C.C.W., at \$2.50 ...	5.00	1 Dubilier .00025 Fixed Con.35
7 Benjamin UX sockets, at \$.75	5.25	2 Thordarson R-200 Audio Transformers, at \$8.00	16.00
1 No. 112 Amperite	1.10	1 Panel 7x30 Drilled and Engraved...	6.85
1 No. 1A Amperite	1.10	1 Baseboard, 7x3085
1 Centralab 200,000 ohm var. resistor	2.00	1 Jones Multiplug Basemounting ...	4.50
3 2-inch dials, at \$.50	1.50	2 Eby Posts, at \$.1530
1 Carter filament switch65	1 Camfield No. 23 oscillator	1.50
		1 GR Rheostat 25 Ohm, baseboard type	1.25
			\$116.90

CARBORUNDUM 8-TUBE SEMI-SHIELDED SET 2 STAGE AUDIO AMPLIFIER

ST. JAMES — SHORT WAVE — SAMSON T. C. — NINE IN LINE
BROWNING-DRAKE — VICTOREEN — AERODYNE

Dealers writing us specify just what hookup you are especially interested in.

NEWARK ELECTRIC CO.

"Nothing but Radio"

226 WEST MADISON STREET
CHICAGO,
ILL.



ist camps, any place with a tell-tale aerial or loud-speaker maw, they had stopped while an evenly-modulated voice repeated the familiar formula.

It had been three days of torture for Sim. He tried to tell Jack in his groping inarticulate way; strove desperately to make him see this really was an eerie, uncanny web the police were spreading for them—something elusive they could not reckon with or guard against, that followed them relentless and invisible no matter where they went or how they detoured or doubled. But Jack only laughed at him, then fell to rebuking him sharply as his dread showed more plainly; and this was why a strained silence lay between them, late the third day, as they turned off the main highway.

It was not a very good road, a mechanic at a garage a few miles back had told them, and he was well within the truth—considerably within the truth, as they discovered before they covered a half-dozen miles. There was a yawning succession of holes that even Jack's agile driving could not avoid, and hills that proved to be not only frequent but formidable. The little car racked and jounced from hole to hole when it was not churning laboriously up grade; and at half-past six, with heavy clouds that threatened an all-night's rain bringing on premature dusk, the speedometer showed they had negotiated only fifteen miles of the twenty-five between them and the little town they had planned to make.

This did not include the distance they had traveled up and down, Jack pointed out sardonically. "What do you say we pick out some open-hearted hick, if there is any along this cowtrack, and see if we can get a bunk?" he suggested, twisting the flivver out of another hole. "I'd as soon sleep in a barn as do five miles more of this."

"Suits me," Sim agreed dully; "place on this side about half a mile back looked pretty good."

Jack nodded ahead to the left. "Better give this one the once-over first," he decided. "No chance to turn around here."

The little car chugged ahead, in and out of more holes, and the house Jack had caught sight of through the trees came into view. It was larger than any they had passed, with well-kept barns and broad porches that gave it an air of prosperous hospitality. But Sim was eyeing the house with furtive intentness. "No, Jack! Look!" he protested, leaning forward. "They got a radio! See?" His big forefinger was pointing to a tell-tale aerial, shimmering in the failing light, high up between house and barn.

Jack frowned; then curtly, "And I'll say I'm glad they have."

Sim hitched uneasily in the narrow seat, dread showing in his eyes. "It looked to me like they got more room back there'n they got here," he offered, jerking a thumb over his shoulder.

The muscles around Winkler's mouth tightened. "I saw they didn't have a radio, if that's what you're driving at," he countered sharply. "And the reason I'm stopping here's because they have. See?"

Sim's impassive face twitched. The drive that led into the house with the aerial was only seventy-five yards away, and he seized Jack's arm. "But, Jack!" he protested, his voice husky. "Don't! Don't go in there! Y'know how't gets me. I couldn't stand t'hear that stuff about us again t'night!"

Jack freed his arm with an oath. "You fool!" he snapped. But Sim clutched it again more tightly. The drive was only fifty yards away now. "Go back, Jack!" he begged. "Back t' that other place!" There was fear in his eyes. "Don't go in here, Jack!"

Winkler shook him off again with a cold, metallic fury. "You fool!" he flared.

(Continued on page 872)

Three New **CC** TUBES

Endorsed by Radio Authorities



TYPE G
HIGH MU

For use in impedance and resistance coupled receivers.

"CeCo" Type "G" tube will carry more power without overloading than any other available High-Mu.

Average voltage amplification 20—Average Output Impedance 25,000.

PRICE \$2.50



TYPE H
SPECIAL DETECTOR

Will give improved reproduction and avoid the usual rushing and hissing sounds of the "soft" detectors.

Using a higher plate voltage than previous types, it will handle powerful signals with less overloading. Average mutual conductance 940. Voltage Amplification factor 14.4.

PRICE \$2.50



TYPE J-71
OUTPUT TUBE

Will handle sufficient power to operate the largest loud speakers at full volume. Does not require high voltage plate supply. At 90 v. it will give twelve times the undistorted power of the ordinary "A" type. To be used in receivers where a separate "C" Battery connection for the last tube is furnished. Can be used on voltages up to 180 with enormous volume output, provided a special output circuit is used to protect the loud speaker. Filament 5 v.—½ A.

PRICE \$4.50

Write for complete data sheet.

Insist on Genuine CeCo Tubes. There's a type for every radio need.

C. E. MFG. CO., Inc., PROVIDENCE, R. I.

The Largest Plant in the World Making Radio Tubes Exclusively.



The Carborundum 8-Tube semi-shielded Set

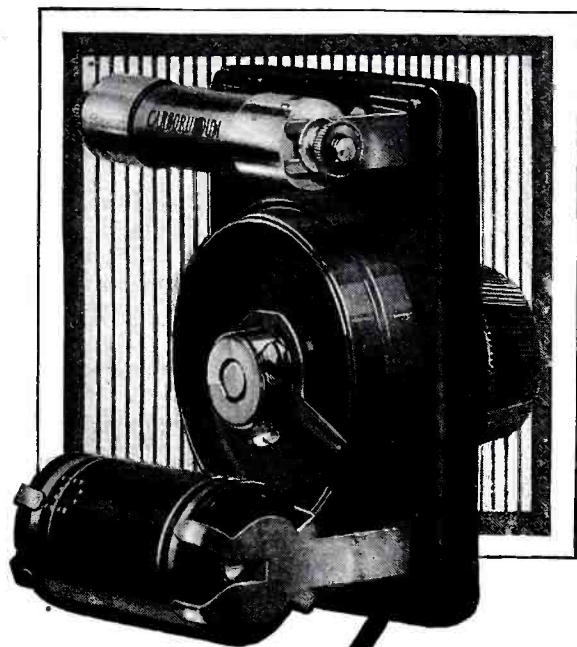

\$3.50 ^{IN} U.S.A.

WITHOUT
DRY CELL

Featuring

CARBORUNDUM

REG. U. S. PAT. OFF.

STABILIZING DETECTOR UNIT

THEY say that even hardened laboratory engineers are enthused over the new Carborundum Eight-Tube Super Set described in this issue.

It is an absolute revelation and one of its great features is the Carborundum Stabilizing Detector Unit employed as a second detector.

With this marvelous set you will get crystal clear tones at super-hot volume to spare—greater distance—increased sensitivity.

And one of the great reasons for its remarkable success is the

CARBORUNDUM STABILIZING DETECTOR UNIT

Improves Any Set

CARBORUNDUM GRID LEAKS · CARBORUNDUM COUPLING RESISTORS

SEND FOR NEW HOOK-UP BOOK D-1

THE CARBORUNDUM COMPANY, NIAGARA FALLS, N. Y.

SALES OFFICES AND WAREHOUSES IN

New York : Pittsburgh : Chicago : Philadelphia : Cleveland : Detroit : Cincinnati : Boston : Grand Rapids : Milwaukee
The Carborundum Co., Ltd., Manchester, Eng.

{ Carborundum is the Registered Trade Name used by The Carborundum Company for Billion Carbide. This Trade Mark is the exclusive property of The Carborundum Company. }

The Carborundum 8-Tube semi-shielded Set

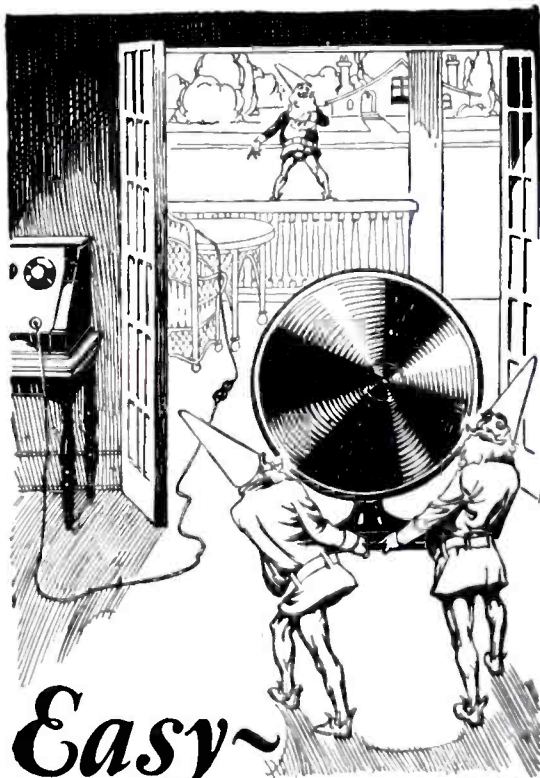

Easy with the E-Z

Now you can have radio entertainment in any room, porch or lawn without disturbing your set! The E-Z Extension Connector hooks up to your set easily and quickly, enabling you to carry the loud speaker anywhere. Exclusive tension slot construction assures positive contact.

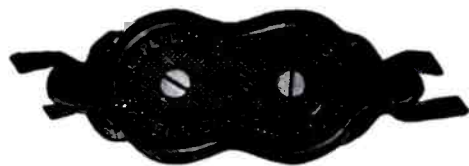

Connector only - 35c
with 20 ft. cord - \$1.25 with 35 ft. cord - \$1.75
" 25 ft. cord - 1.50 " 50 ft. cord - 2.00

Raytheon Block Condensers

Guaranteed 1000 volt breakdown test. Finest materials and special impregnating compounds embodied in Polymet Block Condensers assure the lasting success of your construction job. Specify Polymet Condensers!



Type 1000-14 Mfd. tapped at 1, 1, 2, 2, 8 . . . \$9.50
Type 1001-1-C-1 Mfd. . . . 2.00

Poly Claro-Plug

Every set deserves one—turns old set into new—improves tone—broadens the range—eliminates scrapes, rasps, hissing. Reduces static.

Over 125 manufacturers of receivers and power units use Polymer Products. THEY KNOW. Follow their lead—specify Polymer Products for best results. At all good dealers everywhere or send direct. Send for illustrated descriptions of all products. FREE on request.

Polymet Manufacturing Corporation
599A Broadway - New York City

"World's Largest Manufacturers of Radio Essentials"

POLYMET PRODUCTS



A Voltmeter

for filament control and battery checking enables the set builder and owner to regulate the filament voltage and maintain just the proper battery condition. It gives that nicety of adjustment that brings in distant stations with quality. Security of operation comes only with voltmeter control.

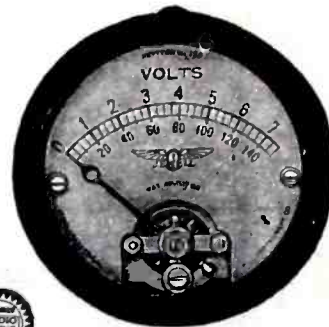

Pattern No. 135-B Voltmeter

The instrument illustrated is well adapted to the Carborundum 8-tube semi-shielded set—It is a double scale, two-inch round panel mounting instrument operating on the D'Arsonval principle. The low scale is 0-7.5, for checking A-battery and filament voltages and the high scale, 0-150 volts is for checking B-batteries. The movement parts are all silvered and it is provided with a zero adjuster. It is a quality instrument.

See this instrument at your dealers or send for our Radio Catalog No. 15-C

Jewell Electrical Instrument Co.

1650 Walnut Street - - Chicago

"26 Years Making Good Instruments"



Tobe Deutschmann Company announces a new line of quality Fixed Condensers, for continuous operation on 400 volts,—known as the TOBE 400 Condenser.

With the continual rise in plate voltages employed in order to secure the very best quality of audio amplification and the very much increased voltages now available from such plate-supply units,—as these now using the Raytheon BH Tube,—this TOBE 400 becomes necessary.

Cased in the characteristic silver finished case, of a shape taking up minimum floor space in the set or plate-supply unit, with strong fastening lugs for attachment, and equipped with the special TOBE Safety Terminals at base of condenser. These terminals permit arrangement of a number of con-

densers in a bank with minimum wiring,—keep the connections out of the reach of chance contacts as they should be for high voltages, and greatly simplify constructions.



PRICES:

- No. 401—1 Mfd. \$2.00
- No. 402—2 Mid. \$2.75
- No. 404—especially made for the L.C.-27, but adaptable to all similar purposes \$4.50

(Write us for particulars of our full line of Condensers for all set and plate supply unit construction, the TOBE B BLOCKS, including new TOBE BH BLOCK, the TOBE VACUUM "TIPON" the TOBE "VERITAS" HI-CURRENT RESISTOR.

TOBE CONDENSERS ARE SPECIFIED IN THE CARBORUNDUM COMPANY SET

Tobe Deutschmann Co.

Engineers and Manufacturers of Technical Apparatus

CAMBRIDGE

MASS.

New "Midget" Rheostat All metal.



50c (Half Size) (all resistances)
Any dealer can supply

CARTER

Parts As Specified In CARBORUNDUM 8 Tube Semi-Shielded Set

Also Carter Potentiometers and Jacks. Make sure the successful working of your set by refusing substitutes.



"IMP" Loop Aerial



Only 16 in. Dia.

\$7.50

In Canada Carter Radio Co. Limited, Toronto.

The Carborundum 8-Tube semi-shielded Set

Excels in Every Valuable Characteristic

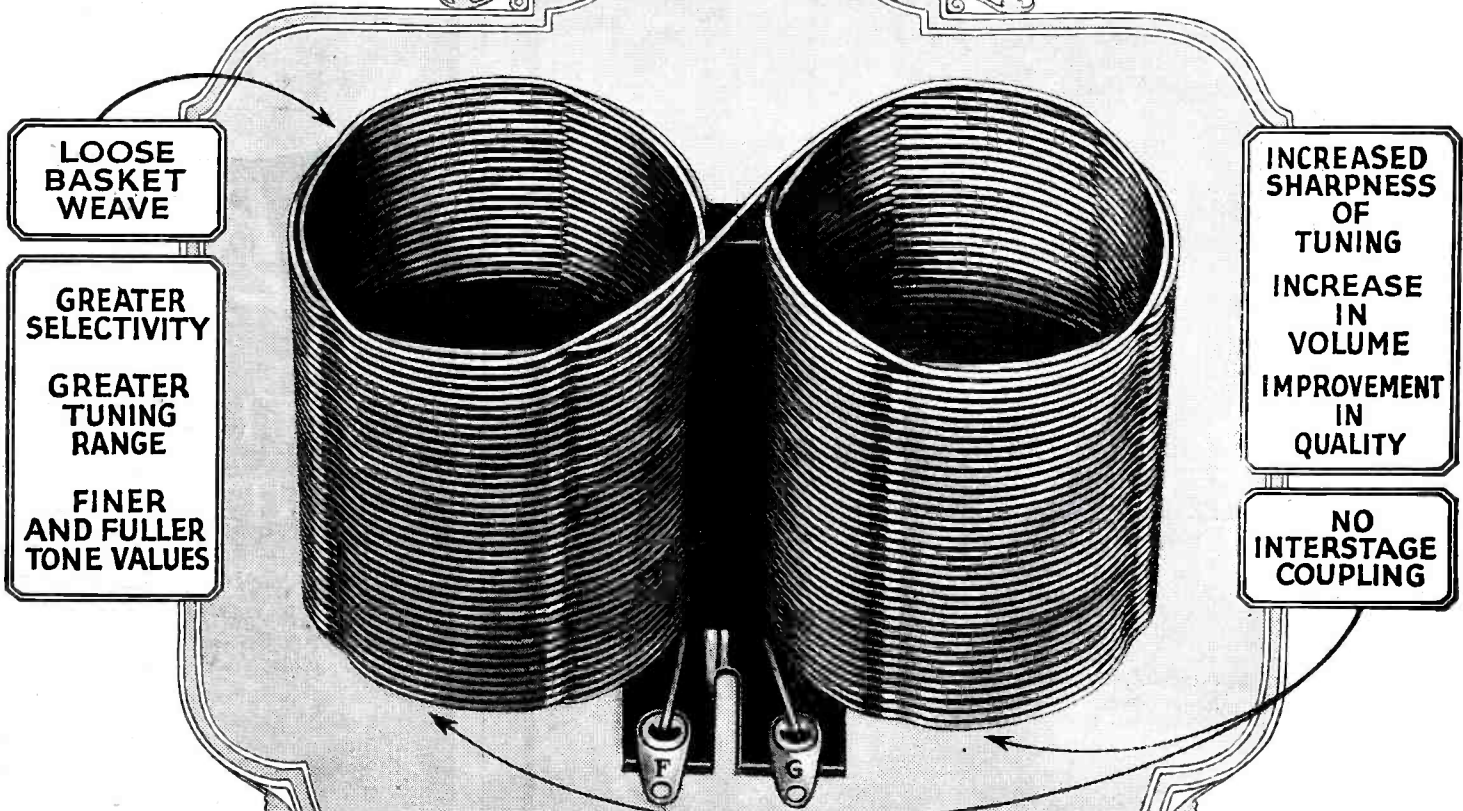

The "Lekeless" Radio Frequency Transformer 170 TO 574 METERS - FOR .00035 MFD. CONDENSER

Five Big Features

- 1—Low apparent resistance at broadcasting frequencies.
- 2—Highest ratio of inductance over apparent resistance.
- 3—Lowest percentage of comparative increase of radio frequency resistance to direct current resistance.
- 4—Lowest apparent inductance at broadcasting frequencies compared to inductance at 1 Kc.

- 5—Lowest rate of decrease in ratio of inductance over apparent resistance at radio frequencies to the same values at audio frequencies.

Superiority Shown in Every Test Applied

These separate items of superiority are cumulative, and not only from the laboratory tests but from actual experience of amateurs and manufacturers this coil has proved to give the best results.

At your radio dealer's for \$2.50, or send his name with your remittance direct to us and we will see that you are supplied promptly.

Ask your dealer or send to us for free booklets of instruction, giving full information and working drawings for building:

- Improved Controlodyne 5-Tube Receiver
- General Utility Portable and Home 5-Tube Receiver
- De-Luxe Cle-Ra-Tone 3-Tube Receiver



Benjamin Electric Mfg. Co.

New York: 247 W. 17th Street

120-128 S. Sangamon Street, Chicago

San Francisco: 448 Bryant Street

Manufactured in Canada by Benjamin Electric Mfg. Co. of Canada, Ltd., Toronto, Ontario



Tuned Radio Frequency Transformers

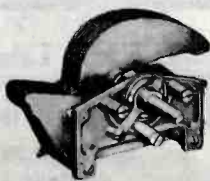

Straight Line Frequency Condensers



All Benjamin Radio Products are of the same high standard as the far-famed Cle-Ra-Tone Sockets~

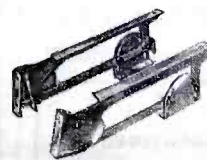

Adjustable Brackets



Battery Switch

The Carborundum 8-Tube semi-shielded Set



Dependable Products

make your set
operate better

Endorsed and used by
leading set builders

Quality at
Popular
Prices

*May we send you our
complete catalog?
Write Dept. R.N.*

LESLIE F. MUTER COMPANY

76th & Greenwood Avenue
CHICAGO, ILL.

MEMBER
RMA



Variable High Resistance



Single Pole Double Throw



Double Pole Double Throw



Triple Pole Double Throw



Antenna Plug



Resistance Amplifier Unit



Fixed Grid Leaks



Resistance Amplifiers



Interference and Static Eliminator



Audio Frequency Transformers



Push-Pull Panel Switch



Automatic Shock-Proof Phone Plug



Fixed Condensers



Fixed Rheostats



Lightning Arrester



Antenna Lead-In Insulator



Standard Complete Aerial Kit



Variable Condensers



Adjustable Ground Clamp

—used in the LC-27



As recommended by S. I. Cole
for use in the
CARBORUNDUM
8-Tube Semishielded Receiver

AEROVOX

“Built Better”

FIXED CONDENSERS

are Specified in

<p>LC-27 Diamond of the Air To be announced soon(?) Ultradyn To be announced soon(?)</p>	<p>by L. M. Cockaday Herman Bernard John Rider Raytheon “B” Eliminator Raytheon Mfg. Co. R. E. Lacault R. E. Lacault</p>
--	--

AEROVOX fixed condensers have been approved
by M. I. T. and Yale Universities.

AEROVOX WIRELESS CORP.

489-491-493 Broome Street
New York



In Your Set

Tube life and efficiency, tone clarity and accurate tuning—all depend on filament control.

AMPERITE, the only self-adjusting filament control, regulates the tube current that governs these vital points. Eliminates hand-rheostats, simplifies set-wiring.

Accepted as standard equipment by every leading engineer, AMPERITE is specified for these circuits—CARBORUNDUM, L-R 4, POWERS-CASEM, TWO-STAGE AUDIO AMPLIFIER.

Write for FREE COPY of “The Radiall Book” to Dept. R.N.1.

Radiall Company

50 FRANKLIN ST., NEW YORK

AMPERITE

REG. U.S. PAT. OFF.

The “SELF-ADJUSTING” Rheostat

Capacity .00035



PRICE \$2.50

CONTINENTAL Lo Loss CONDENSERS

The low dielectric losses, exact capacities and mechanical perfection of Continental Condensers make them the logical choice where fine reception is appreciated.

Continental (Single) .0005	\$2.50
Continental (Single) .00035	2.50

Continental Jr. Neutralizing Condenser \$1.25
(Specified in the Carborundum Receiver)

If not at your dealer's, write Condenser Headquarters.
GARDINER & HEPBURN, Inc.
611 Widener Bldg., Philadelphia

ELKAY EQUALIZORS



specified as “ballast” for the Carborundum “B” and LR-4 receivers are made by The Langbein-Kaufman Radio Co. (Dept. N), 62 Franklin St., New Haven, Conn. Write for prices and tables of values.

WINTER EDITION
of the
**RADIO LISTENERS GUIDE
and CALL BOOK**
JUST OUT

Latest Revised List of U. S., Canadian and Foreign Broadcast Stations.

50C ON ALL NEWSSTANDS

See that screw

A SCREW DRIVER ADJUSTS AN XL IN CROWDED PLACES



XL VARIO CONDENSER

RESULTS in easier tuning, more distance, volume and clarity—greater stability. Indorsed by leading authorities.

MODEL “N”—A slight turn obtains correct tube oscillation on all tuned radio frequency circuits. Neutrodyne, Robert's two tube, Browning-Drake, McMurdo Silver's Knock-out, etc. Capacity range 1.8 to 20 micro-micro farads. PRICE \$1.00

MODEL “G”—with grid clips obtains the proper grid capacity on Cockaday circuits, filter and intermediate frequency tuning in heterodyne and positive grid bias in all sets.

CAPACITY RANGE

Model G-1—0.0002 to .0001 MFD
Model G-5—0.001 to .0005 MFD
Model G-10—0.003 to .001 MFD

PRICE \$1.50

X-L PUSH POST—Push it down with your thumb, insert wire, remove pressure and wire is firmly held, releases instantly. PRICE 15c

PUSH POST PANEL—permanently marked in white on black insulating panel. In box including soldering lugs, raising bushings and screws for mounting, etc. PRICE \$1.50



X-L Radio Laboratories, 2426 LINCOLN AVE., CHICAGO, ILL.

\$3000 IN CASH PRIZES
SEE SCIENCE AND INVENTION
25C ON ALL NEWSSTANDS

The Carborundum 8-Tube semi-shielded Set

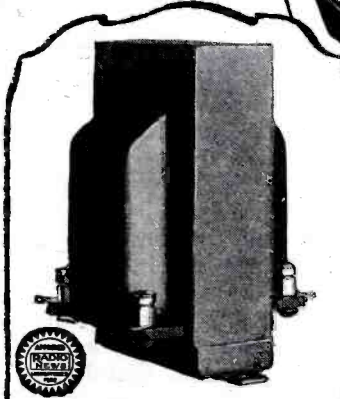

Super Audioformer

This is a big husky transformer developed to meet the demand for finer musical and tonal values in broadcast reception. Satisfactory for use in any amplifier circuit, singly or in pairs. Designed with modern power amplification requirements in mind. Cat. No. 27. Unshielded \$6.00. Shielded \$7.50



"Cushion" Socket

A new Pacent achievement, a genuine bakelite socket, with real spring suspensions. The phosphor bronze solder tab and spring members are all in one piece. Push contact seats tube prongs properly and effects reliable positive contact. It is "Universal", accommodating all UX or CX type of tubes as well as standard UV or CV types. PRICE 65c

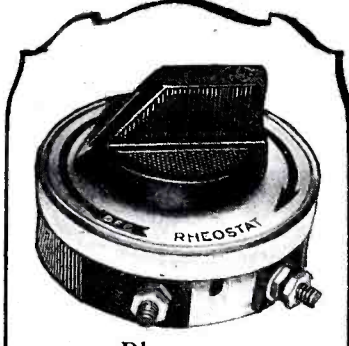

Rheostats

Supplied with Porcelain or Bakelite Base. Pacent type moulded knob. Gold or silver finished dial. Two-unit construction. Elongated holes accommodate varying spaced mounting holes on panel. Various resistances with corresponding capacities. PRICE. 6, 10, 20, 30 Ohm. Porcelain Type 65c. Bakelite type \$1.00



Jack

The most complete line of jacks in the world. "Splitab" feature for easy soldering. Regular types have high percentage German silver spring member, sturdy washers and extra commode to accommodate varying thicknesses of panels. Special types are sturdy but of lighter construction. Eleven Standard Regular types for various use—prices from 50c to 90c. Five Special types—Prices from 40c to 50c.

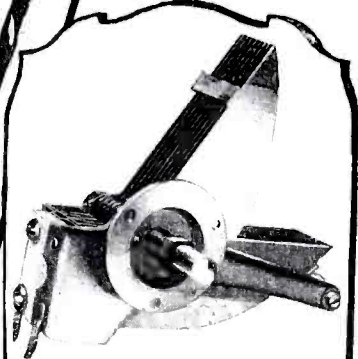

Condenser

Stations can be equi-spaced according to frequencies. Grounded rotor in continuous connection with metal end-plate—meets all requirements of low loss design. Perfect insulation—Isolantite properly placed. Special brass plates. Riveted and soldered. Rigid channel frame construction. Permanent plate alignment. Extra tie bars. Over-size, dust-proof, uni-bearing. Positive enclosed stop. Optional one-hole mounting. Design provides for uni-control tandem mounting. Cat. No. 250B (17 Plates) Price \$3.50. Cat. No. 250C (23 Plates) Price \$4.50



Up-To-Date Designers Prefer PACENT

Wherever you turn in the field of new and outstanding circuits, you will find leading designers using Pacent Parts because they prefer them. Loftin and White, Powers-Casem, Siegmann in The New Ultimax, not to mention a dozen others have chosen Pacent Parts.

There must be a reason. It is simply this: Pacent Parts are of that high standard of efficiency and engineering design that modern circuit calls for. That is why designer after designer is using and specifying Pacent equipment for the latest and best circuits and kits in radio.

Don't forget, many of the outstanding set manufacturers use Pacent Parts as standard equipment.

PACENT ELECTRIC CO.

91 SEVENTH AVE., NEW YORK, N. Y.

Sales Agents: Chicago, Minneapolis, Buffalo, Boston, Philadelphia, Washington, D. C., Pittsburgh, San Francisco, St. Louis, Jacksonville, Cleveland. Canadian Licensed Manufacturer: White Radio, Ltd., Hamilton, Ont. Licensed Manufacturer for Gr. Britain and Ireland: Igranic Elec. Co., Ltd., London and Bedford, England.

PACENT
Radio Essentials are recommended for use in these modern circuits.

—
ULTIMAX

—
POWERS-CASEM

—
INFRADYNE

—
CARBORUNDUM 8 TUBE SET

—
BASS NOTE CIRCUIT

—
L. R. 4

—
2 STAGE AMPLIFIER

PACENT
Radio Essentials are recommended for use in these modern circuits.

—
LOFTIN-WHITE

—
UNIVERSAL ALL-CIRCUIT SET

—
SUPER-HET TRAVELING COMPANION

—
ROGERS-SCHUTE

—
SHIELDED HAMMARLUND-ROBERTS

—
ALDEN SOMERBRIDGE

DON'T IMPROVISE - PACENTIZE

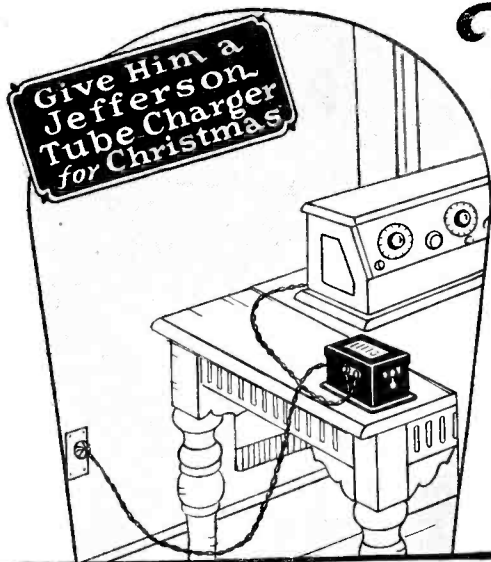

Tubes weaken as do batteries

DOES your set bring in the distant stations you got when it was new? Is your volume as great as then? If not, look to your tubes.

To keep large or small type tubes at highest efficiency, attach a Jefferson No. 275 Tube Charger to the light socket and connect it for 10 minutes, once a month. Improved reception—plus longer life of tubes and batteries—will be worth many times the price to you. Guaranteed and made only by Jefferson. Get one today. Ideal Christmas Gift!

JEFFERSON ELECTRIC MFG. CO.
Largest manufacturers of small transformers
541 So. Green Street • • • Chicago

KEEP TUBES LIKE NEW—CHARGE THEM MONTHLY and ALL AT ONCE

\$3.50 at your dealers

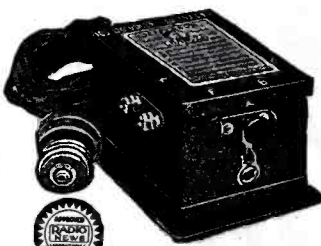

Jefferson No. 275 Tube Charger



Fred W. Stein.

Steinite Greatest \$1 Value in Radio Today

INTERFERENCE ELIMINATOR NO RADIO SET COMPLETE WITHOUT IT

Select stations at will. Especially necessary for 1 and 2 dial controlled sets. Under present conditions the average set fails to bring in the desired stations properly. The Steinite Interference Eliminator shuts out local and other interference. You get one station at a time, the one you want, and tune in loud and clear. Operates on any set—attach to aerial wire and to set—no changes—no extra tubes or batteries.

Over 400,000 Sold

New 1927 Model

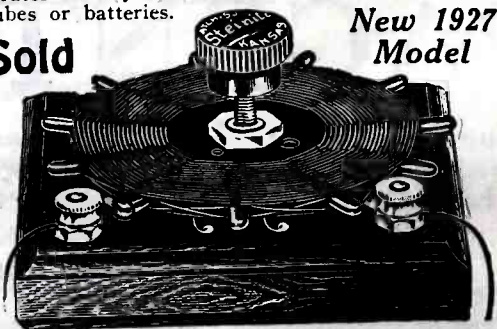

Improved Results with Tube or Crystal
Try entirely at my risk the wonderful improvement this inexpensive little device will make in the reception of your set. Improves results on both crystal and tube sets that use any kind of aerial except loop antenna. Clears up reception wonderfully, increases volume and partially absorbs static. Money-Back Guarantee.

MONEY BACK GUARANTEE Put this interference eliminator on your set and note amazing improvement. No tools needed—install in a moment's time. Connect with set and follow simple instructions. Money back promptly if not delighted. \$1 postpaid when cash with order. ORDER TODAY—a dollar bill will do. References: Exchange National Bank; Atchison Savings Bank.

\$1 Postpaid If you are not delighted with results you get your dollar back

The New Steinite 7-Tube Radio uses no batteries of any kind—only \$125. Loud Speaker Built In. Complete with tubes \$151 with nothing to buy. Operates from light socket 1c an hour. Write for descriptive literature before buying an expensive Battery Set. Also Steinite Long Distance Crystal Set \$6—6-Tube Battery Set \$45. WRITE TODAY.

STEINITE LABORATORIES, 402 Radio Bldg., Atchison, Kansas

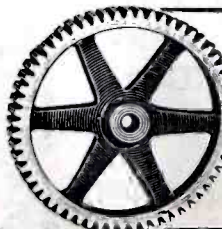

GEARS All Kinds—Small

The most accurate made and prices reasonable. We carry a complete line of gears in stock for immediate shipment. Can also quote on special gears of all kinds. Send us your inquiries.

Write for Catalogue 40
Chicago Stock Gear Works
105 South Jefferson St., Chicago

Write Today for Our 84-Page Catalog of RADIO BARGAINS

RANDOLPH RADIO CORP.
180 N. UNION AV. Dept. 2 CHICAGO, ILL.

The Invisible Net

(Continued from page 866)

"Come out of it! Do you hear? Come out of it!"

They were at the mouth of the drive, and with a sudden movement Sim clutched desperately for the wheel. Jack struck his hand aside viciously. "Keep your mouth shut now," he ordered, a rasping intensity in his voice. "If you don't I'll shut it for you! I'm getting sick of this monkey-business. Understand?" And with a twist he swung the little car out of the road.

George Whipple—that was the name on the mailbox—came out on the porch as they stopped; a stout man with a round, good-humored face. Jack did the talking; and the results followed, that all but inevitably did, whenever he put his heart into it.

Only too glad to have Mr. Walker and Mr. Melvin stay all night. It was going to rain any minute and the road from here into the Falls was even worse than that they had come over. Had they had any supper? Mrs. Whipple, plump and energetic, asked them this in the wide hall; and George, Jr., the lanky seventeen-year-old son, carried the baggage briskly upstairs.

Sim was aware of this hospitable stir in a blurred way, while he tried as best he could to get a grip on himself. The wire overhead might not be an aerial after all. It might be for lights or a telephone. Farmers had such things these days. But as they came into a comfortable living room, a long cabinet with many shiny controls, topped by a huge loud speaker, confronted him; and he mustered what strength he had for the ordeal he knew must follow.

It was not long delayed. Jack's eyes brightened as they fell on the cabinet. "Well, you've got a radio," he remarked, all interest, walking across to the thing.

"Yes, sir, George made it for us," the elder Whipple replied proudly. "Every bit himself."

Jack turned to the boy. "You made it yourself?" he demanded.

George, Jr., flushed. "It wasn't so hard," he explained.

Jack eyed his handiwork. "Well, I'll say you did a mighty good job," he declared admiringly: "I suppose Pittsburgh comes in strong here."

He was at it again—the same suave tactics he had been using for three days. The clock on the mantel had just struck seven, and George Jr., began to twirl the dials eagerly. "Descriptions and that of the car in which they made their escape are as follows," the relentless announcement rolled from the loud speaker. "Car—Ford touring, 1924 model, Illinois licenses—"

Sim walked over to the window and looked out without seeing that it had begun to rain, big fingers clenched against palms that were wet and a fine prickling chill playing up and down his spine. If Jack had only stopped at that other place or if he would even give up deliberately courting this uncanny thing! He would have to endure the torture of feeling that invisible net tighten about them three or more times tonight—four if the station signed off later than usual; and he was not at all sure he could.

The voice finished at last and a quartet began to sing. "Some little old station," Jack approved enthusiastically. "Always sure of getting a class A program, and I'll say this set of yours does bring it in sweet."

Mrs. Whipple called briskly from the door that supper was ready, and Sim followed Jack out to the table heavily. There would be an hour before that unrelenting announcement would boom out again, and it

Your program starts with a snap—

It does if your "snap" judgment is good! Because good reception demands lively batteries. And that's what you get when you snap on your Rectigon to do your charging. The time to start bringing in tomorrow's snappy program is tonight—after the last station signs off. You just plug into the light socket and attach the terminals. That keeps your batteries at their peppy best. That saves service station bother. And you'll never be caught with batteries run down, or absent for charging when the week's best program is on the air.



when you charge 'em at home with

The Westinghouse Rectigon Battery Charger

©, 1927, W. E. & M. Co.

No noise as it charges—not a bit of fuss. Not even a murmur that would disturb the mildest slumber.



No acids, no chemicals—no moving parts—nothing to spill or burn. No muss, no worry. You'll have no spoiled rugs, no ruined clothing.



Saves its cost in short order—Count the dollars spent in a few trips to the service station and you'll hotfoot it for a Rectigon, for the good it does your pocketbook as well as your batteries.



Charges both "A" and "B" batteries—Keeps both packed with power. Bulb is used for "B" battery charging and is enclosed, like all other parts, in metal, safe from accident. (Rectigon charges automobile batteries, too.)



Perfect safety for your set—If you tune in while you're charging there'll be no harm either to set or batteries. Nor will batteries be discharged if anything happens to the current while your Rectigon's attached.



No Storage Battery Radio is Complete Without a Rectigon



THE RECTIGON is a superb Westinghouse product. Things you *can't* see, like extra heavy insulation, things you *can* see, like the durably enameled case—all are of highest quality. Westinghouse also manufactures a complete line of radio instruments, and Micarta panels and tubes.

WESTINGHOUSE ELECTRIC & MANUFACTURING CO.
Tune in on KDKA · KYW · WBZ · KFKX

90 VOLT "B" POWER UNIT \$12.75

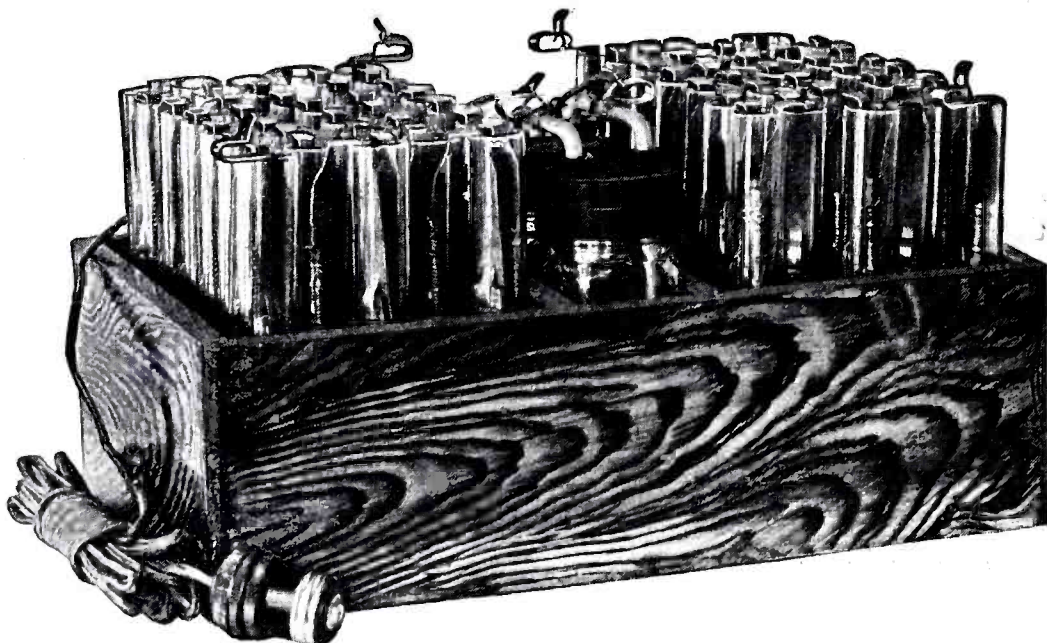

RUMOR has had it this NEW HAWLEY ADVANCED POWER UNIT was coming—and here it is. Hawley Storage "B" batteries have been standard for over 5 years and the same quality—the same standard of workmanship comprise this unit with its new ingenious hook-up and built-in-charger giving the utmost in B-Eliminator simplicity. Positively guaranteed not to give the slightest kind or trace of a hum or line noises. Simply plug into your electric socket and forget it. Any inexperienced person can hook it up in 2 minutes as all voltages including those for any kind of detector are all plainly marked. Operates any 1- to 10-tube set. Does not contain any acid.

It's so good—such true smashing value—that my 5-year-old 30-day trial offer refund applies. You've got to see it—hear its operation to fully appreciate this statement.

The prices—only slightly more than ordinary dry cells, 90 volts, \$12.75; 112½ volts, \$15.25; 135 volts, \$17.50. For 105 to 120 volts, 25- to 130-cycle alternating current only. Special sizes to order of any voltage. Knockdown kits at still greater savings. All complete as above—nothing to purchase extra. Further covered in my regular 2-year guarantee. Ample stocks—all packed—same day shipments and your order is all I need to speed it on its way to you. Simply say: ship C.O.D.—pay expressman its cost plus small transportation charges—and you'll thank me later—or write for my free literature, testimonials, etc.

B. HAWLEY SMITH, 321 Washington Ave, Danbury, Conn., U.S.A.

Mfr. of "A" Power Units, "B" Power Units, "A" Storage Batteries, "B" Storage Batteries and A & B Chargers including Tricklechargers

YOU NEED THIS



RADIO CONTROL SWITCH

ENTIRELY AUTOMATIC IN ITS OPERATION

When the receiving set is turned on, the Trickle Charger is automatically disconnected from A Battery and B Power Unit is connected to set. When set is turned off, it automatically connects the Trickle Charger to the storage battery and starts the charge, disconnecting the B Eliminator from the set and line.

The ACME TRICKLE CHARGER

An exceptionally fine economical product. Has a specially designed transformer with independent windings. Delivers ½ to ¾ amp. and consumes 25 to 40 watts. Attractive. Efficient. East of the Rockies. . . . **\$6**
2 ampere bulb, \$4



This switch may be used with any set regardless of type of charging equipment. Attractive in appearance. Guaranteed.

\$5

complete, East of the Rockies
Acme Battery Charging Equipment is nationally known for its excellent performance.

Manufactured for 10 years by

THE ACME ELECTRIC AND MANUFACTURING COMPANY
1412 HAMILTON AVENUE CLEVELAND, OHIO

W E P A Y	Liquidate Your Surplus	C A S H
	Radio Stock	
	Highest prices paid for surplus radio cabinets, sets and parts. Any quantity.	
	What have you to sell?	
	ROYAL SURPLUS COMPANY 228 Jelliff Ave., Newark, N. J.	

WADE BENCH LATHE	
Cap: 4" dia. x 12" length. Silderest has travel entire length of bed. Lead-screw inside bed. Hollow spindle. Turning, facing, boring, drilling, winding, thread-cutting. No. 1 Lathe, plain headstock \$28.00. No. 2 Lathe back-gear headstock \$58.00. Either lathe, 4"x18" \$7.00 extra. Complete line of accessories at equally low prices. Catalog sent free. THE GEROLD COMPANY Dept. R-1 120 Liberty Street New York	

Insure your copy reaching you each month. Subscribe to Radio News—\$2.50 a year. Experimenter Publishing Co., 53 Park Place, New York City.

was a good supper the plump little woman set before them. But a tight band seemed wound about Sim's throat. It was only a respite. He would have to fight off that sense of an inexorable web closing in about them again, without letting these people see the crawling dread that gripped him.

Jack did the meal justice, of course; and Sim resented this dully. He resented the younger George: his vivid "lumberjack" shirt and orange corduroy trousers. If this kid had paid more attention to his father's hogs, and less to radio, there would have been nothing to torture him in this big house.

It was a little before eight when they finished, and Jack turned to George Jr., as he rose. "Well, old timer," he suggested. "Suppose we see what our old friend KDKA's got on by this time."

Sim lagged behind as the two of them crossed to the living room, getting out his pipe and trying to occupy himself with filling it. But the same smoothly-controlled voice reached him from the loud speaker. "We are making the following announcement at the request of the police department of Mortonsville, Ohio."

He was sure Whipple must see his hands trembling, but there was not the slightest trace of suspicion in the farmer's open face. These descriptions were too far from the truth to be of any possible consequence, he tried to tell himself. But it was no use. There was an unseen, eerie web they were powerless to break or elude, drawing tighter and tighter about them; and he hitched his chair into a shadowy corner when he finally went into the living room, utter weariness pressing down his broad shoulders. He had gone through it again, but he doubted if he could once more without breaking.

Mrs. Whipple, the dishes finished, came in and Jack talked glibly to her and her husband, while George Jr., manipulated the dials. The minutes that stood between Sim and his next ordeal seemed fairly to melt away. The voice, tuned in by Jack's guileless manoeuvring, made its relentless announcement again, and when it finished Sim's big muscles were quivering. He could not go through it once more. He would have to get away—down the rutted road through the rain—anywhere, away from these invisible meshes the police had spread, before they tightened again.

He smoked out his pipe in jerky puffs, filled it again, smoked it out again; his mind occupied feverishly with the idea. He would have to get away—even upstairs if nothing else offered. He looked furtively at the clock. It was twenty minutes after nine. Upstairs. That could be managed. He would go there before that voice boomed out at him again, no matter what Jack said.

He waited, tense, watching. His chance came at five minutes of ten. There was a moment's lull in the talk as Jack, handling the dials himself now, turned back to KDKA, and he made himself look up. "Jack," he said, dry and forced, "I—I'm sleepy, and if it's all the same to you I—I'll go up and turn in."

Winkler's eyes flicked at him in an instant's glance, then his face wreathed itself in a smile. "Exactly what I was going to say, old top. After our little ride I have a hunch that bed'll feel mighty good."

"Oh, we'd like to have you stay and talk," Mrs. Whipple protested: "But," maternally, "I know you must be tired. Take them up and see if there's anything they need, George," she directed, turning to her husband.

They rose, except George Jr. "This is just when the DX begins to get good," he remarked, taking his place at the dials.

A lifting relief took possession of Sim. He was escaping after all—escaping that eerie, inexorable web. His big shoulders

Which do you want Radio or Music?

WHEN you have read this advertisement you will realize that an important forward stride has been made in radio reproduction and you will be glad to have learned that, *no matter what kind, make or age of set you have, you can now convert it in a few minutes' time and at small expense into the most perfect reproduction known to radio.*

In test after test under all conditions, before laboratory experts, set manufacturers, broadcasting artists of national fame, musical critics, and in tests by the radio public itself, the new Truphonic amplifying principle has definitely proved itself to be superior to all other methods of reproduction—barring none. And the Truphonic furthermore has the unique feature that it can be instantly attached to *any* set.

What the Truphonic Is

The Truphonic is simply this: A compact instrument containing three stages of Truphonic coupling and an output unit to protect the loud speaker from the powerful Truphonic output. A 6-foot battery cord contains all wires to the "A" and "B" batteries (including wires for "C" battery and additional "B" battery if power tube is used). A single wire with clip attached slips over the plate prong of the detector tube which is then reinserted in the socket of the set. It is as simple as ABC and can be attached by anyone in less than 5 minutes, without any knowledge of radio.

Used in Commercial Sets

Although Truphonic amplification has been on the market only a short time it is now used in the sets of 22 radio manufacturers. Unfortunately it was not perfected in time for general use by manufacturers of large production this year. Next year the trend will be toward Truphonic amplification.

But if you want the most beautiful reproduction of music and speech in your home *right now*, get the Truphonic at your dealer's, attach it, and *know* that you have the finest reproduction obtainable—no matter how much you can afford to pay.

If your dealer has not stocked the Truphonic we will send you one C. O. D. on 5-day money-back trial. No Truphonic sent unless you give your dealer's name and address.

ALDEN MANUFACTURING COMPANY
Dept. K 24, Springfield, Mass.



TRUPHONIC Power Amplifier

Reg. U. S. Pat. Off.



\$20
Ready to Attach



From the highest musical note
in nature, to the deepest—

Amplion reproduces the whole range—perfectly

TO the world-famous Amplion line of radio reproducers is added the Amplion Cone—time-perfected—clear and mel-

low in tone—strikingly distinct in the enunciation of the spoken word. In a graceful, two-tone mahogany cabinet, 14" x 14" x 9".

AMPLION Reproducers, \$12 to \$45

Ask your dealer for a demonstration or write to us for interesting Amplion Booklet

AMPLION

THE AMPLION CORPORATION OF AMERICA
Suite S, 280 Madison Ave., New York City



PRICE
\$4.50

CAPACITY
.00035
.00045

MICROMETER ADJUSTMENT DEFINED

No other manufactured condenser allows accurate matching of capacities and inductances without the aid of balancing condensers or compensating devices. ARMO, on the contrary, uses a micrometer adjustment allowing a change in capacity of 30%, thereby eliminating the use of precision instruments or special equipment to balance coils. This is done by a simple adjustment on the rotor shaft—

A new principle of S. L. F. and S. L. W. L.—A method giving most desirable spacing on all broadcast wavelengths.—

Another feature—The plates are soldered, not assembled, thereby offering a free electrical surface reducing resistance very materially.

Being an unusually small condenser for its capacity, it has a very concentrated field. This, along with its small amount of insulation, well out of the way of the field, gives improved selectivity and its value is obvious, especially on short wave.

This angle, however, is taken care of by our manufactured range of capacities from .00015 to .00045.

WRITE US DIRECT GIVING THE NAME OF YOUR DEALER.

ARMO RADIO LABORATORIES
1666 Tarleton St., Los Angeles,
CALIFORNIA

HAVE YOU SEEN THE NEW MAGAZINE? MONEY MAKING

The Magazine of Opportunities — Earn a Second Income
For Men and Women who want to become Independent

25¢ ON ALL NEWSSTANDS

had begun to straighten, his big body to expand again as they reached the airy guest chamber at the opposite side of the house from the other bedrooms. He could rest up here—rest without that relentless announcement dinning at him.

Whipple and Winkler paused at the door to talk, and Sim moved across to the oak dresser to arrange his few toilet articles: then halted heavily. On its top, among the embroidered flowers of a scarf, lay a pair of head-phones, their cords running down to wires along the baseboard.

"If you want to listen in some more," Whipple was saying, "there's a head-set connected to the loud speaker downstairs." The proud father was expressed in his voice again. "George fixed it up last winter while my sister was here so she could hear in bed. He always sits up late listening."

Jack made an easy reply, and the farmer, with another remark or two, wished them a good night and closed the heavy door. Jack's hand gripped Sim's shoulder and jerked him about the moment it shut. "You poor thick-headed fool!" he snapped, his voice low but savage. "Why don't you tell them? Why don't you tell them all about us? Sit there and squirm, and get blue around the gills!"

"But, Jack! Jack!" There was stricken lines in Sim's big face, and his voice was husky: "I can't! I can't, Jack! Honest to—"

Winkler's eyes blazed. "Can't"—he shot back. "I'll show you if you can't!" He caught up the phones. "Here! Put these on! Do you hear?"

He thrust the receivers out, and Sim jerked back. An inexorably even voice was coming from them. "Of the car in which they made their escape are as follows." "No, Jack! No!" Sim burst out, face white and stark fear in his eyes. "I can't stand it, I tell y'! Don't! Don't!"

Winkler only tightened the grip on his shoulder. "I said put 'em on," he repeated mercilessly, crowding the phones and that relentless voice closer. "After we've got this far, do you think I'm going to stand by like a fool and let you tell the world we stuck up the Mortonsville Bank just because you've got a crazy notion there's something spooky about radio?"

They confronted each other, only the phones between them; and a fear-born rebellion flared up in Sim. Jack had no right to do this—no right. He wrenched free, swung a huge fist at the phones and Jack's face; then checked it with frozen suddenness.

The familiar voice had stopped, and a new announcer was speaking—eagerly. "The police department of Mortonsville, Ohio, has just received information that the correct descriptions of the two men who robbed the First National Bank are as follows," it said:

"First man—about five feet six inches in height, a hundred and thirty-five pounds, light hair, blue eyes, smooth face, snappy gray suit, and gray cap; answers to the name of Walker. Second man—about six feet one, a hundred and ninety-five pounds, gray eyes, brown hair, smooth face, wearing blue suit and dark cap; and answers to the name of Melvin.

"They were last seen in a Ford touring car, with Ohio licenses, this evening, heading toward Taylor's Falls, Pa., along the cut-off road. A reward of two thousand dollars is offered for their arrest or apprehension."

The voice ceased. There was a click, and an orchestra broke in with a rollicking fox-trot. But Sim McCartney and Jack Winkler stood—bodies rigid, faces drawn—for a long tight moment. Then Winkler cursed harshly and flung the phones to the floor, the muscles along his jaw knotting. "They haven't got us yet, damn 'em!" he blazed.

“Every note -
high and low -
perfectly clear”

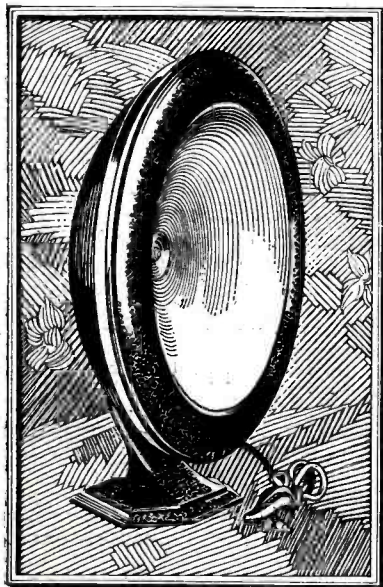

Acme K-3 Enclosed Single Free Edge Cone Speaker, (shown above). Diameter of cone, 11 ins. Green bronze metal case. Price: \$18.50

Acme K-1 Enclosed Double Free Edge Cone Speaker. Diameter of Cone, 14 ins. Tan metal case. Price: \$25.00

♣ ♣ ♣

Acme Enclosed Free Edge Cones and Acme Reproducing Units, (Designed for use exclusively with the free edge cone) eliminate resonance and preserve the tones, pure, round and clear. A fixed edge cone, to produce the same results, would have to be three times the diameter, too clumsy for your living-room. High notes are reproduced toward the center of the cone; low notes, toward the edge. The laws of vibration make it possible to produce low notes with a small cone, provided the edge is free and enclosed, and provided the reproducing unit is especially designed for use with a free edge cone.

Write us for circular describing full line of Acme products.



“We listen to
our new Acme
perfectly fascinated!”

“...With our new Acme Speaker, the voices and music that come in are so clear and beautiful that we just love to listen. It seems as if what we hear are the actual voices and music themselves...”

The wonderful new Acme Loud Speaker successfully reproduces voices and music, in your own home as clearly as they were originally created in the broadcasting studio. It reproduces the voice of the singer in all its thrilling, tender beauty. It brings out the different personality in each voice, so that you can tell one voice from another. It recreates orchestral music so clearly that you can hear each instrument playing. It reproduces low notes and tones as clearly as high notes and tones. You hear the bass and treble, harmony and melody.

All this was not done in a moment, Acme engineers worked five years and made 256 experimental speakers, before they arrived at the new Acme Enclosed Free Edge

Cone and Acme Reproducing Unit, which together are responsible for this great increase in radio enjoyment.

See this new Acme at your dealer's

Try out this new Acme for yourself. See if all we have said about it is not true. Compare it with others in the dealer's store. Drop in at your dealer's today and hear this remarkable new speaker. Made by Acme Apparatus Co., Pioneer Radio and Transformer Engineers and Manufacturers, Cambridge, Mass., U.S.A.

Send for this Acme Book

“Amplification Without Distortion”, now in its 13th edition. Written by a prominent radio engineer in a non-technical and interesting manner. It gives you a clear picture of radio reception, and shows exactly how you can eliminate distortion and improve the operation of your set. It also describes fully these wonderful new Acme loud speakers—and includes details of the complete Acme line of transformers, impedances, condensers, potrehos, choke coils, etc. Send coupon below.

Mail this Coupon for
“Amplification Without Distortion”

ACME
for amplification

ACME APPARATUS CO.,
Dept. K-21, Cambridge, Mass.

Enclosed find 10 cents (stamps or coin) to cover cost of sending me one copy of “Amplification Without Distortion”, 13th edition.

Name.....

Street.....

City..... State.....

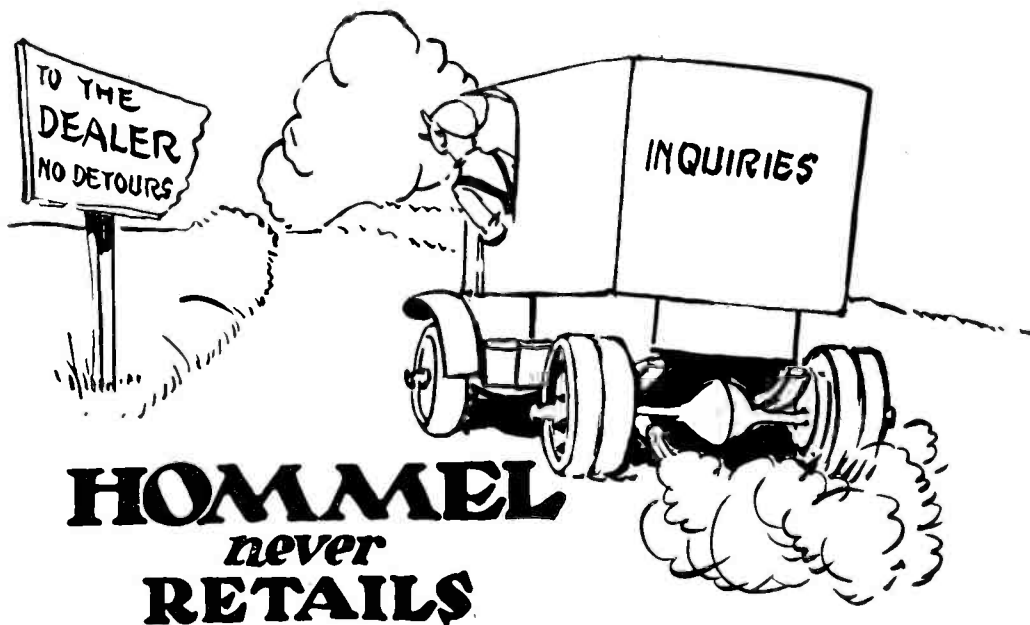

Strict adherence to this fundamental Hommel policy over a period of many years has established the "House of Hommel" into the abiding confidence of thousands of radio dealers all over the country. Hommel's liberal and consistent national advertising acts as a constant sales stimulant that keeps dealers' stocks constantly on the move. All inquiries, resulting from Hommel's national advertising, are promptly turned over to Hommel dealers—exemplifying the highest type of jobber loyalty and co-operation a dealer can enjoy. If you like a fair and square jobber connection—tie up with Hommel—the wholesaler who never retails. Write to-day for the Hommel Catalogue—27-S.

Five Big Reasons Why You Should Tie Up with—"THE HOUSE OF HOMMEL"

1. Unexcelled Dealer co-operation
2. Ample Stocks at all times
3. Wholesales Exclusively
4. Dealers' Repair and Inspection Department
5. Modern Display Room Facilities

WHOLESALE EXCLUSIVELY
LUDWIG HOMMEL & CO
 929 PENN AVENUE PITTSBURGH, PA.

Goodrich Silvertown Radio Panels



For greatest range and selectivity

- 1 Easier to drill and machine.
- 2 Better color, lasting lustre.
- 3 Lower free sulphur—no discoloration.
- 4 Higher softening point—no warping.

Goodrich V. T. Sockets
Spaghetti Tubing

Radiophone Ear Cushions
Battery Mats

Hard Rubber Tubes for Coils

The B. F. Goodrich Rubber Company
 Established 1870 Akron, Ohio

Have You Seen "MONEY MAKING"?

The new magazine that tells of hundreds of ways to make
EXTRA MONEY

DON'T MISS IT—25c ON ALL NEWSSTANDS

THE CONSRAD CO., Inc.
53 Park Place
New York City

He jerked along his head toward their belongings. "Throw that stuff in a suitcase. We're going to get out of here."

Sim only gazed at him with fixed dullness. Those eerie invisible meshes had tightened at last—were ready to smother them in an inescapable grip. Jack struck him a stinging blow across the face. "Do you hear? Come out of it!" Sim stooped mechanically for the suitcase, and a voice curt with command, barked behind them. "Hands up!" it ordered: "Up!"

* * * *

Sim, tied snugly with hay rope in a straight-backed chair, did not raise his eyes from the rug or straighten his slumped body. Jack, likewise bound but defiantly erect, stirred and his eyes flicked over their captors with contempt. "I'll say you make two thousand easy," he snapped. "Any dumb-bell could pull your stuff after the radio gives you all the dope."

George Jr. only grinned, and he and his father looked at each other. "Think so?" the youth inquired. He stepped to the long cabinet against the wall, and pushed a switch.

"Made at the request of the police department of Mortonsville, Ohio, before signing off," a relentlessly familiar voice announced in the loud speaker. "Their descriptions and that of the car in which they made their escape are as follows: car—Ford touring, 1924 model, Illinois licenses—"

Jack twisted about, frowning abruptly. George Jr. made an adjustment, and the voice ceased. "We'll see," he prophesied, his eyes dancing, and ran out into the hall and upstairs; while Jack regarded the cabinet warily, and Sim did not stir.

There was silence for a moment, then a voice boomed out of the loud speaker again. "I'm up in the spare room," it said. Jack's eyes narrowed. It was not the voice that had just ceased. It was another voice—a voice he had heard before—George Jr.'s. "I'm talking into the head phones here, like you were a while ago," it went on. "Speaking of dumb-bells, maybe you see now how I heard every thing you said and faked that announcement back." He broke into triumphant laughter, that made the speaker's diaphragm chatter, and his father joined him.

"It sure takes a mighty smart one to get ahead of that boy of mine on this radio business," he declared proudly.

Jack glared at him a moment with malevolent chagrin, then cursed throatily. But Sim only kept on staring at the rug, eyes dull and shoulders sagging wearily. He had tried, from the first, to warn Jack about this baffling, uncanny net.

Station
WRNY
NEW YORK

373.8 Meters - 802 kilocycles

is owned and operated by the publishers of this magazine

Our Editors will talk to you several times every week—

See your Newspaper for details

TUNE IN ON
WRNY

**NO BATTERIES
 NO CHARGERS
 NO WORRY
 NO ACIDS**

ZENITH
TRADE MARK REG.
→ LONG DISTANCE ← RADIO
TRADE MARK REG.



Super Zenith mounted on spinet base.

Zenith has again demonstrated its superiority in radio; this time you are relieved of constant worry and attention required by storage battery radio sets. The new super Zenith plugs into your light socket, there are no small storage batteries, water, acids nor chargers. Always full power. Amazing selectivity and tone quality.

Super Zeniths in three distinct models—
 \$280.00—\$300.00—\$395.00.

Write for literature and demonstration appointment.

ZENITH RADIO CORPORATION, 3620 Iron St., Chicago

MANUFACTURERS OF

- Zenith ten tube DeLuxe models (no aerial or loop)..... \$650.00 to \$2500.00
- Zenith "B" eliminator, a durable, dependable eliminator..... \$60.00
- Battery operated super Zeniths (where no electric current is available)..... \$240.00, \$260.00, \$355.00

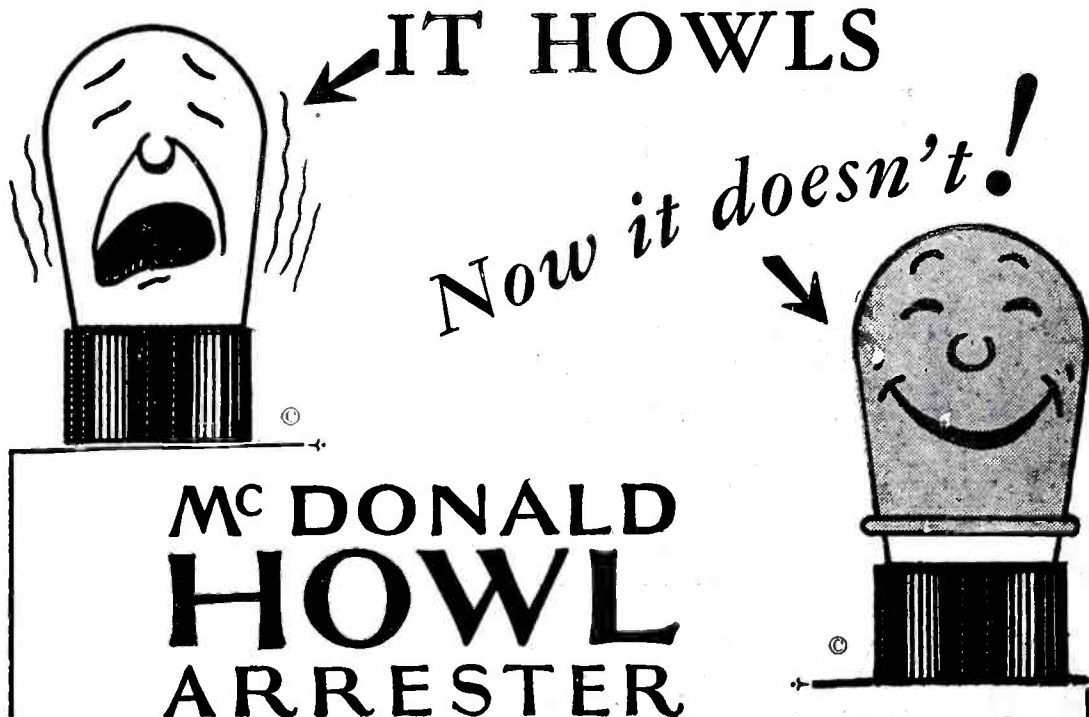

Mc DONALD HOWL ARRESTER

TRADE-MARK

"It Stops that Howl!"

Slip one of these live rubber jackets over each trouble-making tube . . . and the Howl stops.

Remember the name! You can get it for every size tube. It sells for 75c each. Just ask your dealer, or write.

Sole Selling Agents for the U. S. A.

SPARTAN ELECTRIC CORPORATION
350 West 34th Street, New York City

Manufactured in the U. S. A., by the
SCIENTIFIC PRODUCTS CANADA, LTD.

"It Stops that Howl!"

Testing "B" Eliminators

(Continued from page 823)

made available for power-tube operation. The sixth meter indicates the total current drain of the eliminator in milliamperes, the seventh the voltage of the "A" battery feeding the receiver. The eighth meter, which reads 5 milliamperes at full-scale deflection, is used to check the transformer windings for short-circuits against the frames. A transformer developing 500 volts is connected to the steel case and to each of the output posts, in turn, the sensitive meter immediately disclosing leakage if any is taking place.

Such exhaustive tests insure dependable "B" power supply units for radio set owners. Although they are expensive to perform, the manufacturer finds them well worth while; for few eliminators so tested will be returned for repairs.

Permanent Installation of Radio Equipment

(Continued from page 831)

tion, there is no space between the floors and walls to run open-circuit wiring. It is impracticable to run the wires in metal conduit, as done with power wires, because of the choking effect of metal pipes. The electrostatic capacity between wires in the conduit is also responsible for a large portion of this absorption.

Some time ago an installation of this nature was made in a large Chicago apartment building; but, of course, the system would not operate. While an attempt to locate the trouble was being made, one of the wires connected to the jack terminals broke off and the jack terminal was accidentally grounded on the conduit. To the surprise of all, it was found possible to operate a loud speaker from this receptacle jack. The broken wire was taped, and the jack terminal permanently grounded on the conduit. This change was made in each room, thereby making the entire system operative.

The action of this circuit will be more readily understood when attention is called to the fact that the conduit acts as one plate of a fixed condenser and the dead-ended wire as the other plate, thus placing a capacity in series with the loud-speaker circuit. This method may be successfully used; but it is not recommended, since the open-circuit wiring is less expensive and produces better results.

BURIED WIRING

There have been many installations where No. 14 rubber covered wire was encased in loom and buried in concrete floors and walls. When making an installation of this kind it is necessary to maintain the spacing specified for open-circuit wiring. The loom should be run between outlet boxes without a break. Several layers of tape wrapped on the end of the loom, inside the box, will prevent it from slipping out when the concrete is being poured.

Fiber conduit may be used instead of loom, affording better protection to the wires and permitting rigid construction similar to metal conduit. The conduit should be threaded at the ends and fastened to metal or fiber outlet boxes with metal nuts in the conventional manner. This material does not bend readily; so it will be necessary to use elbows or condulets when a turn is made. These may be made of either fiber

CHELSEA

Why Pay More!

You cannot buy more radio enjoyment than you get with the Chelsea Super Six. Employs the revolutionary Tru-tone Circuit, fully shielded; and is specially recommended for power tube operation. Includes many quality features found only in the most expensive sets. Ask your dealer to demonstrate.

Write for New Folders.

Other Chelsea Receivers—Regeno-3, \$26; Super Five, \$50. Send for details.

CHELSEA RADIO CO., Chelsea, Mass.

The New **\$60**
Super-Six



Specifications

Six tubes, Tru-tone construction. New system of audio and radio amplification. Beautiful two-tone mahogany finished cabinet with dust-proof, fool-proof inside panel protecting chassis. Rugged bus-wiring, hand-soldered connections, cord leads for making all connections.



"Lighting Fixtures"

READY TO HANG

(Direct from Manufacturer)
Completely wired including glassware
Send for new Catalogue No. 27
(Just reduced prices)

Special Proposition to Dealers
ERIE FIXTURE SUPPLY CO.
STATION R ERIE, PA.

1927 CATALOG JUST OUT!

SEND FOR YOUR COPY
RANDOLPH RADIO CORP.
180 N. UNION AV. Dept. 2 CHICAGO, ILL.

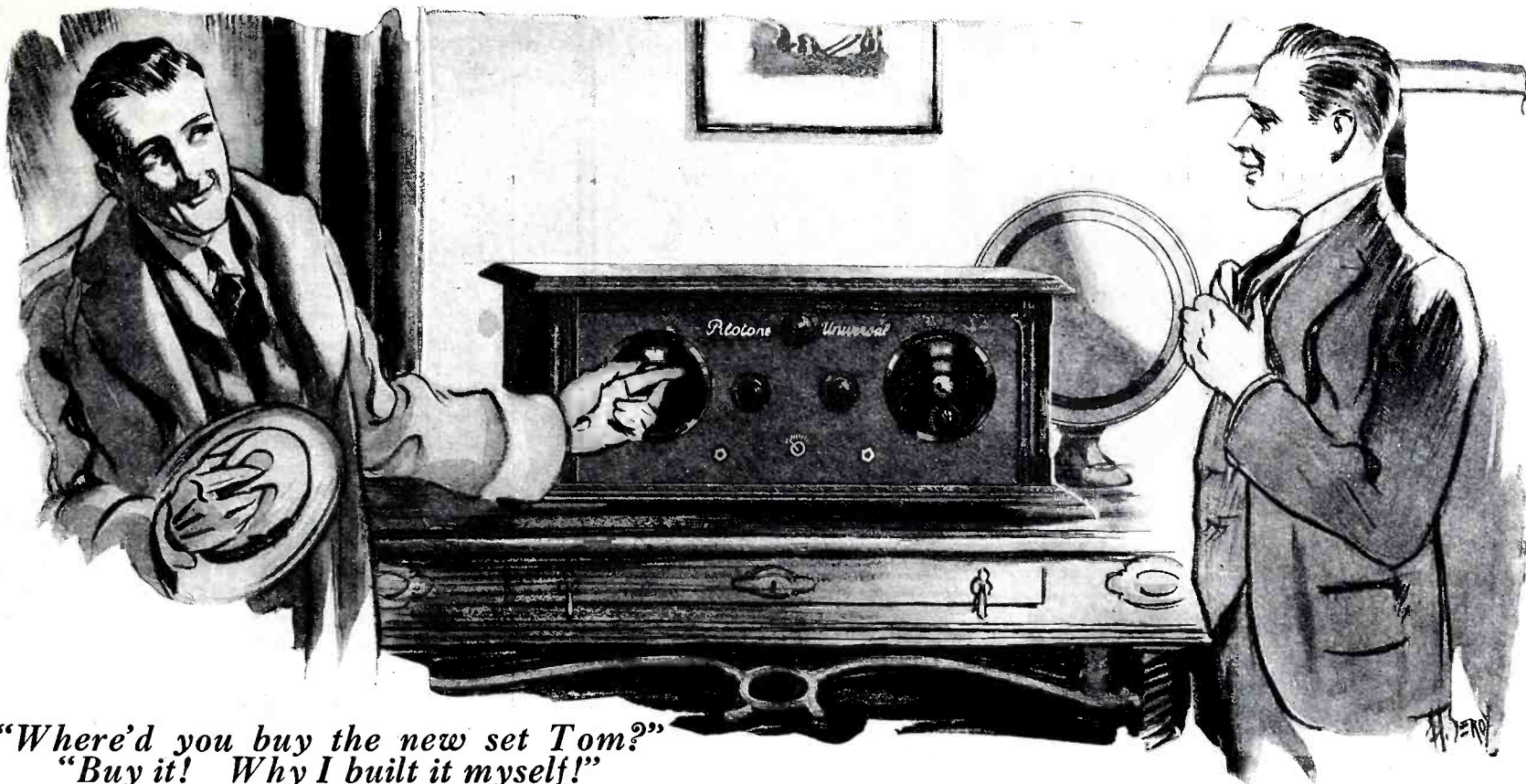

"Where'd you buy the new set Tom?"
 "Buy it! Why I built it myself!"

At Last! A Real Radio Set You Can Build Yourself with the "Professional Air" of the high class Factory-Built Product!

\$ 17⁹⁰

—What You Get For Your Money in The Pilotone Universal Kit

- 1 Drilled and Lithographed Front Panel (7 x 18)
 - 1 Drilled Sub-Panel (7 x 17)
 - 1 Pilot Light
 - 2 2" Bakelite Sub-panel Brackets
 - 2 700-ohm Resistances (Dampers)
 - 1 .006 By-Pass Condenser
 - 1 .002 By-Pass Condenser
 - 2 Vernier Dials
 - 5 Universal Sockets
 - 1 Filament Switch
 - 1 Pkg. Washers—1 Pkg. Nuts—2 Pkgs. Asst. Screws
 - 38 Flexible Leads
 - 1 .00025 Grid Condenser
 - 1 Grid Leak
 - 9 Marked Binding Posts
 - 2 Audio Frequency Transformers
 - 1 10-ohm Rheostat w/knob
 - 1 20-ohm Rheostat w/knob
 - 1 3-Point Jack—1 4-Point Jack
- Massive Walnut Finish Cabinet \$7.50 additional

Build it Yourself with the

PILOTONE UNIVERSAL KIT

Do you want a 5-tube radio frequency receiver?—A 3-tube three circuit?—A 2- or 3-tube reflex?—A 3-tube short wave?—Build any or all these circuits with this amazing Pilotone Kit. Contains complete parts, except tuning coils and variable condensers—Every hook-up operates with two dial control—You turn out a job every bit as good, if not better, in performance and appearance than most factory built receivers—Just the kit for inventive men who like to experiment—Especially popular among small manufacturers who know the Pilot reputation for precision parts!

What Greater Gift—?

What greater gift to the family than the wonderful flow of music and entertainment waiting to be plucked from the air with a PILOTONE?

What greater gift for Mother than PILOTONE'S extreme simplicity—only two dials regardless which of the five circuits you build!

What greater gift for yourself than that glow of pardonable pride which is yours when the PILOTONE, built with your own hands, brings in loud and clear and true the music of stations hundreds of miles away!

The building of the PILOTONE is perfectly simple; the results—simply perfect! A screw driver, a pair of pliers, a few pleasant hours and you have built for yourself a better Radio Receiver than any at triple the price!

ENGLAND
 R. A. Rothmel, Ltd.,
 24 & 26 Maddox Street,
 Regent St., London, W.1.
 AUSTRALIA
 United Distributors, Ltd.,
 72 Clarence St., Sydney
 BRAZIL
 Samuel Meyer,
 41 Rua Buenos Ayres,
 Rio Janeiro
 ARGENTINE
 Samuel Meyer,
 367 Bartolome Mitre,
 Buenos Aires



PILOT
 ELECTRIC M'FG. CO., INC.
 323 BERRY ST., BROOKLYN, N.Y.

Get the Pilotone Kit at S. S. Kresge Radio Depts. If none nearby, order through local dealer. Otherwise send \$17.90 via postoffice or express money order for complete kit; also condenser and coil catalogs. Massive walnut finish cabinet \$7.50 extra. Department 127.

Good Radio Isn't Just Luck



If you keep your radio tubes in good condition, much of the discomfort you attribute to unruly static reception can be eliminated.

Just give them a few minutes' treatment now and then with the Sterling Reactivator. The meter shows the condition of tubes *before*, and also indicates how much improved they are *after treatment*.

For large or small tubes. Price \$12.50

Midget Model (without meter).

Price \$3.75

Sterling Tube Reactivator

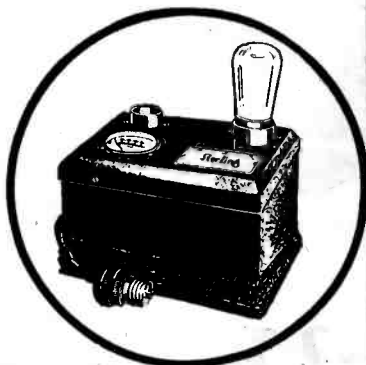

See your dealer and insist on "Sterling" protection. Write for 32 page, instructive, illustrated booklet on care and upkeep of radio.

The Sterling Manufacturing Company
Cleveland, Ohio



See the World FREE!



Snap out of that rut! Be ALIVE while you CAN. Travel, taste adventure, SEE THE WORLD. Let me show you how to do it FREE—more than that, get paid for your trouble. Radio operators for ocean steamers are urgently needed. I'll teach you in few short months of your spare time at home to be one—then as soon as you qualify the whole world lies open before you. Radio operators are ship's officers, draw a good salary, travel free with all living expenses paid. U. S. Government controls all Radio operators, recognizes and accredits my quick training methods. Write for Free Book—no obligation. Address, J.E. Smith, President, National Radio Institute, Dept. AB-97, Washington, D. C.



TEST YOUR BATTERY WITH AN S O S HYDROMETER

Without withdrawing the Hydrometer Balls make reading simple and easy. Swim all three charged fully. Sinks the white, charge still right. Sinks the green, charge is near. Sinks the red, charge is dead. Accurate—durable—no float to read or break. Over five million patented Chaslyn Balls used by leading Battery Manufacturers as standard equipment in Glass-Cased Batteries and Power Units. Ask your dealer. If he can't supply, send seventy-five cents to

THE CHASLYN COMPANY
4617 Ravenswood Ave., Chicago

FREE RADIO GUIDE

164-PAGE (1927) GUIDE Gives special hook-ups with illustrations. Shows big savings on standard radio parts, complete sets, kits. Be sure to get this thrifty book before you buy. Write letter or postal NOW. Also include name of another fan.

BARAWIK CO., 542C Monroe St., CHICAGO, U. S. A.



\$100 a week Selling Shirts

Fred Frankel, III., writes: "I earned \$110 first week selling Carlton Shirts direct to consumer." You can too. No capital or experience required. We pay 25 per cent. cash commissions daily and big extra bonuses. WRITE FOR FREE SAMPLES CARLTON MILLS, Inc., Shirt Mfrs. 114 Fifth Ave., Dept. 169A New York

or metal. It is rather unusual to run two separate lengths of conduit between two outlet boxes, but it is necessary in order to maintain the proper spacing between wires.

A radio-wired home would not be complete without some method of concealing unsightly batteries. Of course if a console cabinet is used, the batteries may be kept in it. When this is not the case, however, the batteries may be kept in the basement and connected to the set by means of a multiple plug (see Fig. 2A).

APARTMENT SERVICE

During the past few years there have been numerous radio installations in apartments, hotels and hospitals. If a radio-equipped hotel or apartment has a private telephone switchboard, the radio receiver should be in the care of the switchboard operator.

One receptacle is usually placed in each apartment or hotel room. When a tenant or guest, as the case may be, desires to hear a program, it is necessary only for him to plug in the jack. Of course, this does not allow individual selection; but in special cases it may be possible to phone the operator and make a request for a definite program.

A modification of this system, which is somewhat more expensive to install and operate but allows greater flexibility, was used in the Hudson View Gardens, a newly-constructed group of large apartment buildings, in New York. Each apartment is provided with four receptacle jacks, each of which is connected to a different set in the operating room. Each tenant may thus choose one of four different simultaneous programs.

FOR HOSPITAL BEDS

There is also a great demand for radio service in hospitals. The same method of wiring as in apartment houses can be used, but receptacle jacks with volume controls should be furnished. A receptacle jack should be placed at the head of each bed to enable the patient to listen in, with a headset, without disturbing those around him. The headset may be equipped with soft-rubber ear cushions to make possible its use for a long period without discomfort. Here again, the receiver may be placed in the hands of the switchboard operator. In large institutions, where there are many rooms, it is recommended that a receiver be installed on each floor and that it be operated by the nurses.

BUILT-IN ANTENNA

There is still another type of radio apartment to be considered.

It is often desirable to add special features to a building to contribute to the convenience of the tenants and add rental value to the apartments. Fig. 3 shows a method of installing concealed antennae, together with ground connections, each pair terminating in an outlet jack, thus providing a separate individual antenna for each apartment. The wiring should consist of No. 18 to No. 14 rubber-and-cotton-covered wire. The antenna may be concealed behind the picture moulding, or run through porcelain tubes in the wall. The "lead-in" should be supported on knobs between the walls and terminated at the jack. It is advisable to tape the free end of the antenna with friction tape, in order to prevent the copper wire from touching the wall. This is a very inexpensive installation and, in addition to the above mentioned advantages, keeps the roof free from unsightly make-shift antennae. It also completely eliminates damage to the roof and leaks occasioned by the erection of antenna supports and by undesirable walking on the roofs. An apartment owner will readily and keenly appreciate this feature.

In conclusion, it will be in order to give a few suggestions regarding the receiving set (Continued on page 887)

Insure your copy reaching you each month. Subscribe to Radio News—\$2.50 a year. Experimenter Publishing Co., 53 Park Place, N. Y. C.

Largest variety of Radio Parts!

1926 EDITION
No. 16
300 Illustrations
32-Page Log book of all U. S. Broadcast Stations

RASCO RADIO PARTS CATALOG No 16

RASCO HAS IT

THIS 68 PAGE RADIO CATALOGUE FREE

75 HOOKUPS

Radio Specialty Co.

96-98 Park Place New York

"ALL GOODS SENT PREPAID IN U.S.A."

BUY FROM RADIO'S OLDEST MAIL ORDER HOUSE

WE are the oldest established, exclusive radio mail order house in the country. Our motto is "Quick Shipment." All orders are shipped within 24 hours. Quick, prompt, courteous service. We carry a larger variety of radio parts and findings than any other radio house in the country.

"RASCO HAS IT"

If you are in need of certain small radio parts that other radio and mail order houses do not bother to carry, get the Rasco parts catalog, and you will find them there, anything from a screw to copper ribbon and telephone diaphragms, as well as thousands of other small radio findings. Just to mention a few:

Lugs, nuts, dials, vernier dial, jacks, plugs, every kind of knob, cords, panels, screws, sliders, washers, selenium, tinfoil, switches, crystals, cap nuts, Litz wire, cord tips, brass rods, resistances, name plates, spring binding posts, switch parts, metal ribbon, carbon balls, binding posts, all types, switch points, switch levers, lock washers, carbon grains, ground clamps, metal pointers, insulated tubing, low melting metal, antenna connectors, bus bar wire, as well as thousands of other articles.

We carry the Largest Variety of Small Radio Parts in the World.



THE NEW RASCO CATALOG No. 16

Contains the Following Hookups
All Armstrong Circuits: These important circuits are explained clearly, all values having been given. Just to name a few of the Vacuum Tube circuits: The V.T. as a detector and one-step amplifier; Super Regenerator; one-step radio frequency amplifier and detector; three-stage audio frequency amplifier; short wave regenerative circuits; 4-stage radio frequency amplifier; radio and audio frequency amplifier; inductively coupled amplifier; all Reflex Circuits. This catalog is crammed full of small parts and radio findings, literally thousands of them. In addition there is much useful information contained herein.

If you will paste this coupon on a post card and mail today, we will be pleased to send you our new Catalog at once.

RADIO SPECIALTY CO.
98 Park Place New York, N. Y.

RADIO SPECIALTY CO., 98 Park Place, New York R.N.-1-'27
You may send me, without charge or obligation, your NEW CATALOG No. 16. (Write on margin if you desire.)
Name
Street
P. O. State



A New and Advanced Model

Norden-Hauck Super-10

Highest Class Receiver in the World

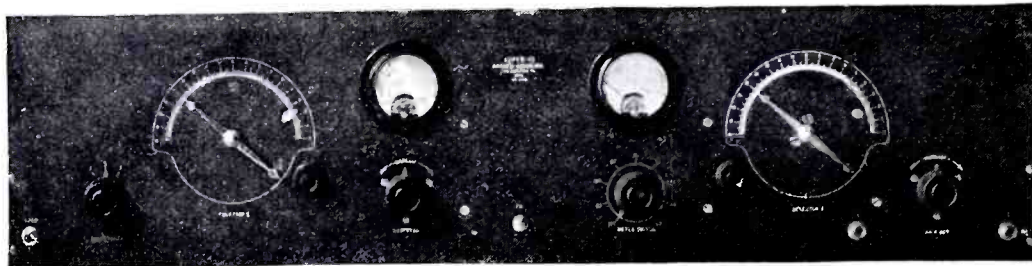

Panel Size: 36" x 9" x 1-4"

Weight: 55 lbs.

THE NORDEN-HAUCK SUPER-10 is an entirely new and advanced design of Receiver, representing what we believe to be the finest expression of Modern Radio Research Engineering. It is the product of years of experience devoted exclusively to the attainment of an ideal Broadcast Receiver—regardless of cost. Results obtained in every respect will upset all your previous ideas of good radio reception. Here are only a few of the host of features that place the NORDEN-HAUCK SUPER-10 far in advance of competition.

- 10 tubes employed to give perfect reproduction with unlimited range and volume power.
- Super selectivity on all wave lengths.
- Built to Navy Standards.
- Wide wave length range—with removable coils. Adaptable 35 meters to 3600 meters if desired.
- Use Loop or Antenna.
- Simple to operate, having only two major tuning controls.
- No Harmonics. Signals are received only at one point.
- Special Power Audio Amplifier, operating any loud-speaker and eliminates necessity of external amplifier.

The NORDEN-HAUCK SUPER-10 is available completely constructed and laboratory tested, or we shall be glad to supply the complete engineering data, construction blue prints, etc., for those desiring to build their own receiver.

Upon Request Complete literature, attractively illustrated, will be gladly mailed without charge, or full size constructional blue prints, showing all electrical and mechanical data, will be promptly mailed postpaid upon receipt of \$2.00.

Write, Telegraph or Cable Direct to
NORDEN-HAUCK
 Incorporated
 ENGINEERS—MARINE BUILDING
 Philadelphia, U. S. A.

TEAR OFF AND MAIL TODAY

NORDEN-HAUCK, Inc., Philadelphia, U. S. A.

Gentlemen:
 Please send me without cost or obligation on my part, attractive illustrated literature describing the new Norden-Hauck Super-10.
 I enclose \$2.00 for which please send me, postpaid, complete full size constructional drawings and all data for building the Super-10.

Name
 Address



You don't know

how to get the most from a sensitive detector until you have read this booklet and a new bulletin, just prepared, which describes a special circuit for the tube and the kits to build it.

THE
DONLE-BRISTOL CORP.,
 Meriden, Conn.

Thousands Use These Ingenious TRANSMITTER UNITS

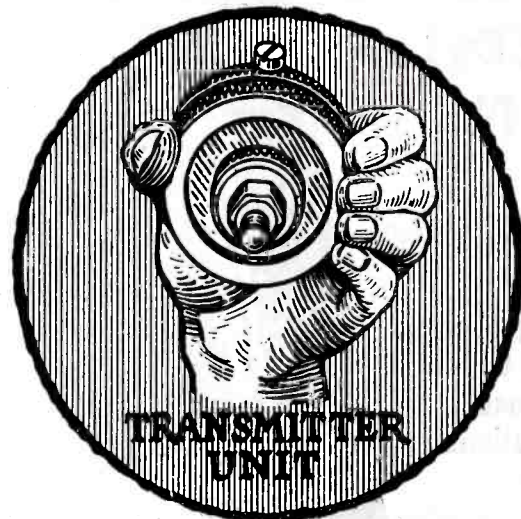

Here's a marvel of Engineering design—a practical miniature transmitter, used by thousands of radio fans and experimenters for amplification purposes.

It is a most novel unit, having hundreds of uses. Every amateur should have two or three of these amplifiers in his laboratory.

A FEW USES FOR THESE UNITS

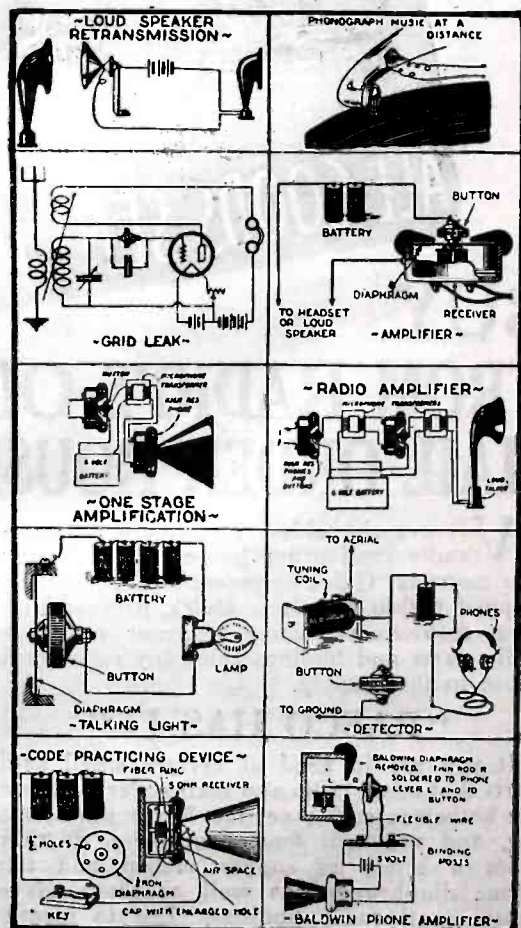

With each unit is mailed an eight-page instruction pamphlet containing suggestions for innumerable uses. Our supply is limited; avoid disappointment by ordering today. The coupon below is for your special convenience.

SPECIALLY PRICED
 While they last— **95c**
 (or Two for \$1.75) per unit

THE PRESS GUILD,
 66-R West Broadway, New York, N. Y.
 Enclosed find 95c/\$1.75 for which send me postpaid one/two amplifier units as advertised.
 Name
 Address
 City, State

FREE RADIO GUIDE
164-PAGE (1927) GUIDE
 Gives special hook-ups with illustrations. Shows big savings on standard radio parts, complete sets, kits. Be sure to get this thrifty book before you buy. Write letter or postal NOW. Also include name of another fan.
BARAWIK CO., 542C Monroe St., CHICAGO, U. S. A.

RADIO PANELS
 OF GENUINE BAKELITE
 Cut, drilled and engraved to order. Send rough sketch for estimate. Our New Catalog on Panels, Tubes and Rods—all of genuine Bakelite—mailed on request.
STARRETT MFG. CO.
 520 S. GREEN ST. CHICAGO

UNIVERSAL TRANSOCEANIC

A NEW COMPANION TO THE "SILVER GHOST"

TRANSOCEANIC "PHANTOM"

NINE TUBES--100% SHIELDING--TUNES 35 METERS to 3600 METERS

\$250 (NO ACCESSORIES)

We are now ready to demonstrate that the Phantom Model has a far greater range, greater degree of selectivity, easiest means of operation, finest electrical design and construction and the best quality of musical reproduction as compared with any radio broadcast receiver in the world.

**MOST POWERFUL
IN THE
WORLD**

Phantom models are now in use on the U. S. S. Vaga and U. S. S. Utah

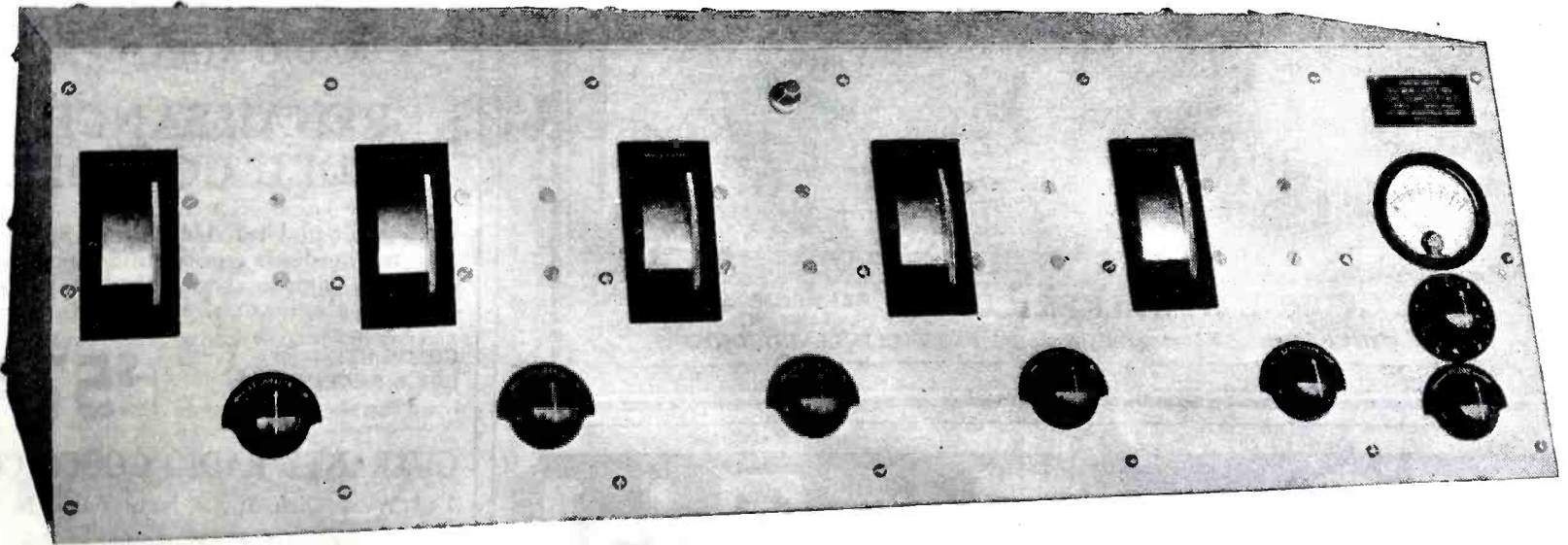

COMPARE THESE FEATURES WITH ANY RADIO

* INDICATES ORIGINAL GOLDEN-LEUTZ FEATURE AS APPLIED TO BROADCAST RECEIVERS, # EXCLUSIVE FEATURE

		Golden-Leutz Transoceanic	Any Other Radio
1.	100% shielding - Interstage shielding - Complete external shielding against extraneous disturbances*	✓	✓
2.	Totally shielded low loss variable condensers to prevent interaction between condenser and transformer fields* #	✓	✓
3.	Complete shielding between stators (grid circuit) of multiple condensers*	✓	✓
4.	Use of Indicating Meters and special switch to read "A," "B" and "C" battery voltages*	✓	✓
5.	Licensed under Hogan Patent 1,014,002 for single control (first licensee)*	✓	✓
6.	Optional individual control or simultaneous control of all tuning controls*	✓	✓
7.	Use of interchangeable tuned radio frequency transformers to tune all broadcast wavelengths in the world, viz. 35 to 3600 meters* #	✓	✓
8.	A special filter circuit in the output to exclude detrimental plate current from the Loud Speaker	✓	✓
9.	Use of Resistance Coupling in the Audio Amplifier, combined with impedance and transformer coupling for perfect reproduction* #	✓	✓
10.	Adjustable Antennae Coupling to adapt set to all various types and sizes of broadcast antennae* #	✓	✓
11.	Antennae Series Condenser for Extreme Selectivity in congested districts* #	✓	✓
12.	Sealed Chassis to exclude moisture and dust* #	✓	✓
13.	Last stage, power audio, adaptable to 201A, 112, 171 or 210 tubes, 350 volts maximum capacity for great volume* #	✓	✓
14.	Separate B Voltage Taps for Detector, Radio Amplifiers, Audio Amplifiers and Power Amplifiers*	✓	✓
15.	Separate Bias Voltage Taps for Radio Amplifier, Audio Amplifiers and Power Amplifiers*	✓	✓
16.	Power Audio Tube Filament arranged for heating by either battery or alternative current*	✓	✓
17.	No rivets to corrode, all connections soldered in accordance with Navy Specifications*	✓	✓
18.	Only piece of steel used is in condenser shafts, detrimental steel supports purposely omitted	✓	✓
19.	Metallized heavy current carrying, permanent value grid leaks and resistors	✓	✓
20.	Direct Disc Varner Adjustments	✓	✓
21.	Indicating rotors upon which calibrations can be recorded for reference	✓	✓
22.	All insulating material Genuine Bakelite include sub-panels - coil bases - coil forms - sockets	✓	✓
23.	All Screws, Bolts and Nuts securely fastened by bronze lock washers* #	✓	✓
24.	Most Compact Multiple Tube Sets made, 9 tube less than 2 cubic feet; 7 tube less than 1 cubic foot	✓	✓
25.	Scientifically determined distance between transformers and shield, not detrimentally close* #	✓	✓
26.	Volume Control device to regulate volume to any desired value without affecting quality	✓	✓
27.	Can be used with "B" and "C" Eliminators, special Golden-Leutz Eliminator made to match	✓	✓
28.	Practically all parts, except the meter and a few small parts, are manufactured in our factory	✓	✓
29.	Each receiver tested at night and calibrated to a station at least 2000 miles distant	✓	✓
30.	Designed by Charles R. Leutz.	✓	✓

Universal Transoceanic "Phantom"

Item	Quan.	DESCRIPTION	Price
1	1	Universal Transoceanic "Phantom" Broadcast Receiver, 9 tubes, 4 tuned radio, detector, three audio and power audio amplifier. Including "A" Transformers for 200 to 560 meters tuning range. (No accessories included.)	\$250.00
EXTRAS			
2	1	Set selected tubes including detector and 210 power amplifier	25.50
3	1	Set "B" Transformers for tuning 80 to 210 meters	25.00
4	1	Set "C" Transformers for tuning 35 to 90 meters	25.00
5	1	Set "AA" Transformers for tuning 500 to 1500 meters	25.00
6	1	Set "BB" Transformers for tuning 1200 to 3600 meters	25.00
7	1	6 volt 120 A.H. Storage Battery	24.00
8	1	New Type Farrand Senior Loud Speaker, Cone Type	32.50
9	1	Golden-Leutz Special Current Supply for 110 volts 50/60 cycle A.C.	135.00
10	1	Antennae Equipment	4.00
		Total all accessories	\$571.00
11	1	Complete Knocked down Kit of all Transoceanic "Phantom" Parts, ready for assembly including constructional drawings (no accessories). "A" Transformers for 200 to 560 meters included	\$220.00
12	1	Complete set of Constructional Drawings and Operating Data for Transoceanic "Phantom" only	2.00

Special Quotation for Dry "B" Battery Operation Will Be Made on Request

GOLDEN-LEUTZ, Inc.

"Manufacturers of the Highest Class Radio Apparatus in the World"

MAIN OFFICE AND WORKS:

SIXTH and WASHINGTON AVENUES, LONG ISLAND CITY, NEW YORK, U. S. A.

Cables: "Experinfo" New York—All Codes

DEALERS OR JOBBERS WIRE ORDER FOR SAMPLE TODAY. CUSTOMERS MAY ORDER DIRECT IF DESIRED.

VICTOREEN SUPER COILS



Guaranteed Precision to 1/3 of 1%

That's why Victoreen Coils are so sharp tuning—that's why a Victoreen Super set is without a peer among radios. Victoreen Super sets are free from oscillations, howls or squeals—no matching of tubes is necessary. Range, clarity, volume, selectivity and ease of operation are all Victoreen features. Build a Victoreen.

USE THESE PARTS IN YOUR SET:

- 4 Victoreen No. 170 R.F. Transformers.
- 1 Victoreen No. 150 Coupling Unit.
- 1 Victoreen No. 160 Antenna Coupler.
- (For use with outside aerial only)
- 2 6-ohm Victoreen Rheostats.
- 2 30-ohm Victoreen Rheostats.
- 1 400-ohm Victoreen Potentiometer.
- 1 Victoreen Master Control Unit.
- 1 Victoreen Audio Control.

Free Victoreen folder and hook-up answers all questions about Victoreen circuit.

VICTOREEN MASTER CONTROL UNIT



A completely assembled unit with one dial reading controlled by a compensator on the Vernier dial which compensates for any difference in the capacities of your condensers with 20 points on the dial. Used in circuits employing two or more condensers of the same capacity. Easy to mount—no change of wire necessary.

Victoreen Rheostat

Has zero temperature coefficient. The resistance remains absolutely constant. Double the number of turns of wire—that means twice as fine adjustment. 3 terminals simplify wiring. 5 resistances—2, 5, 10, 20, 30 ohms—\$1.20 each

THE GEORGE W. WALKER CO. 6528 CARNEGIE AVENUE
DEPT. H.
CLEVELAND, OHIO

Merchandisers of Victoreen Products

You may test it out for
10 DAYS IN YOUR OWN HOME

A test in your own home is worth two in a dealer store.

BST-5 Set

Direct from factory \$40

Sets like this bought in a store
Cost \$75.

GUARANTEED

Satisfaction Or Money Back

If it is not absolutely satisfactory in every way return it and get your money back without question.

This B.S.T.-5 has received Certificates of Merit from the testing laboratories of

RADIO NEWS
and
RADIO WORLD



RENAISSANCE MODEL CONSOLE

With built-in Utah Unit Loud Speaker and commodious compartment in which there is ample room for batteries, charger, eliminators, etc.

COMPLETE—
BST-5 RECEIVER,
Loud Speaker and Console

\$57⁰⁰

GUARANTY RADIO GOODS CO.
141 West 45th St., New York, N. Y.
Immediate Shipment on Receipt of Price

30 Days Free Trial

*Just Out—
1927
Model*

Yes Sir!
You can put a new 1927 Westingale Radio in your home and use it to your heart's content on **30 Days' Trial**. Listen to music, concerts, news, sports, market reports from stations all over the country. Compare it with old style 3 or 4 dial sets costing more, then if not convinced that Westingale gives you the greatest Radio satisfaction and the best value for your money, **you don't have to keep it.**

NOW! Westingale offers the last word in Radio. Either 1 or 2-Dial Control — easiest to tune and years ahead in powerful reception and tone. Newest period type cabinets, two-tone walnut finish. The front panel embossed in dull gold with artistic Spanish Galleon design. Unbeatable for performance, appearance or price.

2-Dial, 5 tubes \$47⁰⁰
1-Dial, 5 tubes \$57⁰⁰

Where else can you get so much for the money on 30 days trial? Why pay more? Why take chances? Why not have the **NEWEST** Radio when you can try them at our risk. Before you buy get our Free Catalog and 30 Day Trial Offer

Westingale Electric Co.
Department 128
1751 Belmont Av., Chicago, Ill.

New ONE Dial Radio

\$57⁰⁰

Retail Price

Big Discounts to Agents



AGENTS WANTED

Your own Radio Free. Get demonstrator set on 30 Days' Trial—make \$100 a week easy. Full or spare time. Big discount on first set placed in each locality. Be first—write today for dealers' discount and full details.

Special Library of Information on

RADIO PATENTS and TRADE MARKS

JOHN B. BRADY
Patent Lawyer

Ouray Building Washington, D. C.

Cable address: **RADIOPAT** Telephone: **Main 4806**

Big FREE RADIO

Catalog & Guide

PARTS, HOOK-UPS, SETS and KITS

Send now for this valuable FREE Radio book. 164 pages of newest hook-ups, parts and kits at big savings. A real guide. Shows factory built sets and new ideas in radio. Send at once. No obligation. Please include name of radio fan.

BARAWIR CO., 542-C Monroe St., CHICAGO, U. S. A.

KARAS EQUAMATIC

ALL GENUINE PARTS IN STOCK NOW!
WHOLESALE CATALOG

FREE

Listing thousands of new radio parts, kits, furniture, accessories and complete radio sets, at prices that save you money. Write for your copy now. It's free.

THE HARGO CO., 1253 S. Wabash Ave., Chicago, Ill.

Insure your copy reaching you each month. Subscribe to Radio News—
\$2.50 a year. Experimenter Publishing Co., 53 Park Place, N. Y. C.

Permanent Radio Installation

(Continued from page 882)

to be used with an elaborate system, such as described in the beginning of this article. It is obvious that the ordinary vacuum tube would be badly overloaded if it furnished power to a great number of speakers. It is generally known that this would impair the tone quality of the entire system. A simple remedy is to use a power tube in the last audio stage. Many sets are now available equipped and wired for such tubes, or can readily be adapted to their use. Another method is to use a separate power amplifier with a standard receiver. Of course, if a standard receiver is modified for use with a power tube, only a few changes are necessary. Many descriptions of this procedure have already been published in RADIO NEWS.

Thus radio, which yesterday was considered a mere novelty, is today counted among the necessities by far-visioned builders and those who wish to add still greater convenience and pleasure to homes already built.

The Commonwealth of Australia has equipped several isolated lighthouses with radio-telephone transmitters and receivers, in order that they may keep in communication with the land. Each set will have a 250-watt gasoline-driven motor generator. The distances to be spanned are as high as fifty miles. The island lighthouses will transmit messages for distant points through a station on land which has telegraphic service.

20-Meter Installation

(Continued from page 840)

comparatively short; and yet the whole arrangement is pleasing to the eye. Normally the outfit is set to the left of the receiver and employs a separate antenna. Both the antenna and counterpoise are vertical and are connected directly to the ammeter and series condenser respectively. They should be each about 12 feet long, for operation on a wave-length of 20 meters.

The inductances are of heavy copper-tubing, space wound, and mounted on plate-glass supports as shown.

The R.F. chokes are small Lorenz coils, supported by heavier leads soldered to them, and placed so that their fields are at right angles to that of the main inductance.

The grid leak is of the ordinary 5,000-ohm variety. The resistance of the leak has been found not critical.

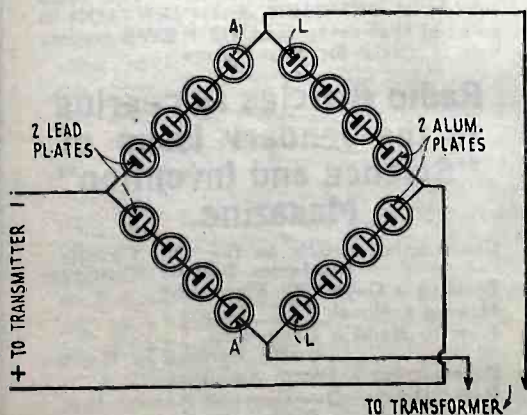

FIG. 5

Showing how the rectifier is connected. It is well to design this for a current around 150 milliamperes.

These Automatic Switches at \$2.00 to \$3.75

WITH the completion of the "Convenience Model" of the Reliable Automatic Control Switch, set owners may now have their choice of two types of automatic switches at prices ranging from \$2.00 to \$3.75. It is no longer necessary to pay more for this new radio necessity.

Either type switch will make the A Battery switch on your receiving set, automatically turn on and off, either or both the Trickle Charger and B Eliminator as required.

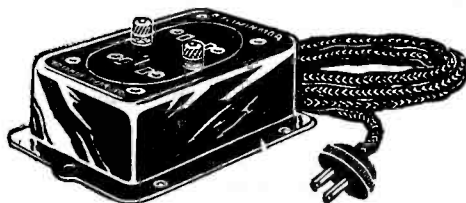

\$3.50

Convenience Types

Model 23—Complete with cord and plug and receptacles for connection with Trickle Charger and B Eliminator. This model is for receiving sets using 3 to 8 type 201-A tubes or their

equivalent in amperage drain. Retail at \$3.50.

Model 24—Same construction as Model 23 but is intended for use with sets using from 5 to 10 type 199 tubes or their equivalent in amperage drain. Retail at \$3.75.

Utility Types

Model 13—This model is identical electrically with Model 23 except that it is without cord and plug. Connections are easily made to binding posts. Retail at \$2.00.

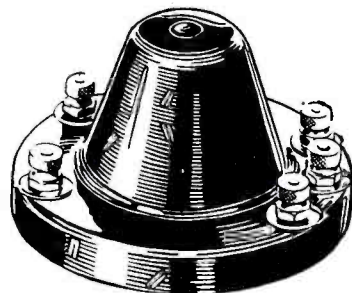

\$2.00

Model 14—This model is identical electrically with Model 24 except that it is without cord and plug. Connections easily made to binding posts. Intended for use with sets using from 5 to 10 type 199 tubes or their equivalent. Retail at \$2.50.

Ask the nearest radio dealer to show you these newest necessities of radio, or if he cannot take care of you, order direct, giving dealer's name on the coupon below.

THE RELIABLE PARTS MANUFACTURING CO.
2831 Prospect Avenue Cleveland, Ohio

Reliable Automatic Power Control Switch

Reliable Parts Mfg. Co.
Cleveland, Ohio

I would like to have one of your Reliable Automatic Switches.

\$2.00	\$2.50	\$3.50	\$3.75
<input type="checkbox"/>	<input type="checkbox"/>	<input type="checkbox"/>	<input type="checkbox"/>
No. 13	No. 14	No. 23	No. 24

My Dealer is _____

My Name _____ My Address _____

Fully guaranteed. Money returned if unsatisfactory for any reason. Sent C. O. D. if desired.

New Kodel Silite Battery Charger

For Radio or Automobile Batteries



The new, silent Kodel Silite Battery Charger—the most efficient and trouble-free of home chargers for "A" and "B" radio and automobile batteries—now on *easy monthly payments* at the cash price! This charger uses Silite, the new metallic glass element which has such marvelous charging efficiency. *Entirely noiseless*; can be used while set is in operation without interfering with reception. Insures a *fully charged battery* at all times.

\$ 1⁰⁰ Down

Brings It On Free Trial

Only \$1.00 deposit with coupon below brings this Kodel Silite Battery Charger on 30 days free trial. Comes complete and ready for use. Attach to any light socket. Charges at 2½ ampere rate. Has no moving or wearing parts. Needs no fuses, no adjustment or care except water. Cannot deteriorate. Cannot overcharge. Try it 30 days; if not satisfied send it back at our expense and your \$1.00 plus transportation charges refunded at once.

\$3⁵⁰ a Month

If satisfied, pay our special sale price at the rate of only \$3.50 a month. Total rock bottom price only \$19.50. (The cash price on easy payments!)

Order by No. Y8922A; Send \$1.00 with coupon; \$3.50 monthly; price, \$19.50.

Straus & Schram
Dept. R-3921 Chicago, Ill

STRAUS & SCHRAM, Dept. R-3921 Chicago

Enclosed find \$1.00. Ship special advertised Kodel Silite Home Battery Charger. I am to have 30 days free trial. If I keep it, I will pay you \$3.50 monthly. If not satisfied, I am to return it within 30 days and you are to refund my money and any freight or express charges I paid.
Kodel Silite Battery Charger, No. Y8922A, \$19.50.

Name.....
Street, R. F. D. or Box No.....
Shipping Point.....
Post Office..... State.....
Married or Single..... Nationality or Color.....

Those acquainted with the Hartley circuit as employed on the longer wave lengths will notice that no shunt condenser is used across any part of the primary inductance. It has been found that the distributed capacity of ordinary inductances below 70 meters is sufficient to make the circuit oscillatory without it. In fact this distributed capacity is so high that around 5 meters the plate-stopping and grid condensers must be made variable to reduce the total circuit capacity sufficiently.

All the meters, as well as the condensers on the receiver, are mounted on small pieces of scrap insulating material screwed to small pieces of wood mounted on the baseboards.

The clips have small points in the jaws. The jaws should be widened out somewhat, so as to fit around the heavy tubing, and the points cut half-way off. Very good contact can then be made with the inductance.

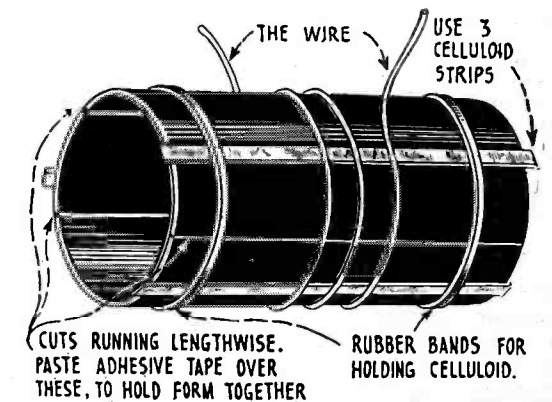

FIG. 3
The cardboard covers of old dry cells furnished these forms. The coils are doped with collodion to make them self-supporting.

THE COILS

The coils are, perhaps, the most important parts of a short-wave receiver. Extreme care should be taken in their construction to see that they are made as good, electrically, as possible. The coils with the least losses are probably the single-layer, space-wound variety employed here. The coils are comparatively easy to make and are very good electrically. While you are at it make enough to cover the 20- and 40-meter bands at least. Some very good sizes to have lying about are 2, 3, 4, 5, 7, 9 and 11 turns. For the 80-meter band you will need coils larger than

40 Non-Technical Radio Articles

every month for the beginner, the layman and those who like radio from the non-technical side.

SCIENCE & INVENTION, which can be bought at any newsstand, contains the largest and most interesting section of radio articles of any non-radio magazine in existence.

Plenty of "How To Make It" radio articles and plenty of simplified hook-ups for the layman and experimenter. The radio section of SCIENCE & INVENTION is so good that many RADIO NEWS readers buy it solely for this feature.

Radio Articles Appearing in the January Issue of "Science and Invention" Magazine.

- Construction Article on the "N" Circuit, By James Francis Clemenger
- Building a Good "B" Eliminator
- Making a Novel V. T. Socket
- How to Build a Drum Dial, By Herbert E. Hayden
- Constructing a Power Amplifier
- Radio Oracle—Question and Answer Box
- "Latest News in Radio" Photos
- Radio Wrinkles Illustrated.

100 Volt Storage "B" Battery \$10



Everybody can now enjoy the benefits of Storage "B" Batteries—more power, quieter reception, greater economy. Rubber case prevents leakage or shorting. Easy to recharge. Will last for years with ordinary care.

SERVICE Rechargeable "B" Batteries
in all-rubber cases
50 VOLT \$5.50
100 VOLTS \$10.00
125 VOLT \$12.50

SERVICE "A" Batteries
Indestructible rubber case, 2 year guarantee.
6 Volt. 100 amp. hr. \$14.00
6 Volt. 120 amp. hr. \$16.00

Prices in Canada:

50 Volt . . \$7.75
100 Volt . . \$14.50
125 Volt . . \$17.00

SERVICE BATTERY CO. of Canada, 137 Roncesvalles Ave. Toronto, Ontario
SERVICE BATTERY CO.
704 East 102nd Street Cleveland, Ohio

SERVICE "A" POWER

Just plug into your light socket and forget battery troubles.

Eliminates the most troublesome feature of Radio reception—battery charging. You always have full "A" power, without worry.

Write for full information. If your dealer can't supply you with Service "A" Power Supply Unit, order direct.

Price \$32
F.O.B. Cleveland

VALET "AutoStrop" RAZOR FREE

Send \$1 for 5 months' subscription to SCIENCE & INVENTION and receive one genuine VALET RAZOR FREE

EXPERIMENTER PUB. CO., Inc., 53 Park Place, New York City

this but these sizes will serve you well on the shorter waves.

The tickler coils are wound "haywire," and tied together with twine. These coils take very little time to construct; it is a good idea to construct several starting with a 2-turn size. The coils illustrated are the same diameter as the other coils; it might be better to make them slightly smaller in diameter, although this makes little difference.

CONDENSER

The secondary condenser should be the best condenser that you can buy. It should run smoothly, have 3-5 plates, as desired, be S.L.W. or S.L.F. and have very low losses.

The by-pass condenser may be any one at hand. The one pictured was originally a 23-plate but has been reduced to a 10-plate by double-spacing the remaining plates. This may also be done for the secondary condenser if a good one is on hand, but it is usually better to buy one; it don't pay to fool with good condensers anyway.

The R.F. choke is composed of two small Lorenz coils, of about 50 turns each, connected in series. One coil of 100 turns would do just as well but such a long coil usually is difficult to handle especially when the wire is small. They are wound on 7 nails, spaced equally around a one-inch circle, and the finished windings are tied together with heavy thread.

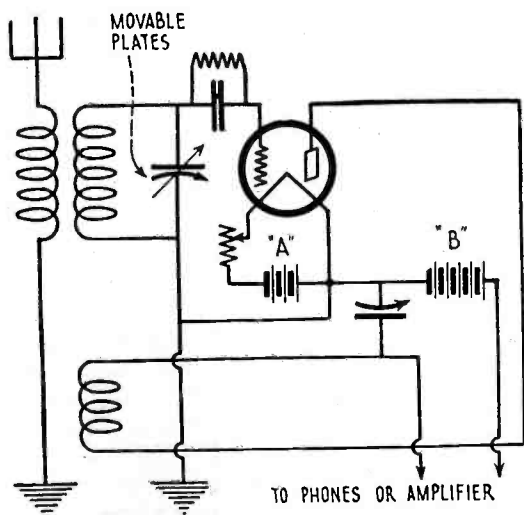

FIG. 1

The coils of this receiver for work on 20 meters are of the plug-in type, so that different wavebands may be heard with different coils.

OSCILLATOR INDUCTANCES

The oscillator inductances are made from some 5/16-inch copper tubing wound upon a four-inch form. Ordinarily the winding of such stiff tubing presents certain difficulties but these difficulties may be overcome by employing the method illustrated in Fig. 4. A hole that will accommodate the tubing is made near the edge of a good, stiff tin-can and the tube inserted for about an inch. This part of the can is then held firmly against the bench while the tubing is bent securely around the circumference of the can. Gradually rotate the can as the tubing is wound on with each successive turn securely against the preceding one. Wind both coils in one operation and cut them apart later. When the required number of turns is wound on, slip the tubing off. You will find that the final inside diameter of the turns is slightly over 4 inches, due to the spring in the copper. The small piece that was inserted in the hole in the can may be straightened out or cut off as desired. If the tubing is rolled up, as it usually is when purchased, it should be straightened out before winding; otherwise small bends in the final winding will be noticed. To make the coils space-wound, each turn should now be separated from its neighbor by about 1/8- to 3/16-inch. Start at one end and gently pull each turn out till



Aristocrat E-Z TOON Vernier Pointer



The NEW "Aristocrat" Vernier Port Dial

THE new, improved Aristocrat Vernier Port Dial is the greatest dial value on the market. Despite its many outstanding advantages, the Aristocrat costs no more than ordinary vernier dials.

If you want the finest-looking, finest-tuning vernier dial, be sure you get the Aristocrat. Made of Bakelite. All mechanism and shaft ends are concealed. Calibrations appear in a beveled port with a peaked indicator that makes misreading impossible.

Simple friction action is smooth, sure and quick. No gears, chains or cogs to backlash, wear out or get out of order. It may be installed in a few minutes. The famous Kurz-Kasch Split Bushing fits all condenser shafts—aligns rite, holds tite!

You'll be surprised at the difference a set of Aristocrat Vernier Port Dials will make. In appearance your radio will look better than the season's prettiest models. And, due to the fine, 14 to 1 vernier ratio, you'll enjoy better and clearer tones, more volume, and countless stations you've never before logged.

The Aristocrat Vernier Port Dial is supplied in three attractive finishes to match any radio—black with white markings, mahogany and walnut with gold markings. The price is \$2 each—in the finish you prefer. With a complete set of three Aristocrats, we are making a special limited offer. We are giving away the beautiful, 48-page, authentic Log Book illustrated here. You'll appreciate this gift when you see it. Ask the better radio dealer near you to show it to you.



free!

This marvelous, recently compiled, 48-page Log Book (worth \$1) is given FREE with every set of three Aristocrat Vernier Port Dials. Bound in beautiful, two-tone, Mocotan Leather with embossed cover. Lists every United States and Canadian Radiocast Station of record June 1st, using power of 250 watts or more. Indexed by call letters, wavelengths and location. Also includes the principal foreign stations. Ask your dealer to show you a copy.



THE KURZ-KASCH COMPANY, DAYTON, OHIO

Moulders of Plastics

OFFICES: New York, Chicago, San Francisco, Los Angeles, Portland, Spokane, Denver, Toronto

KURZ  KASCH
Aristocrat Dials and Knobs

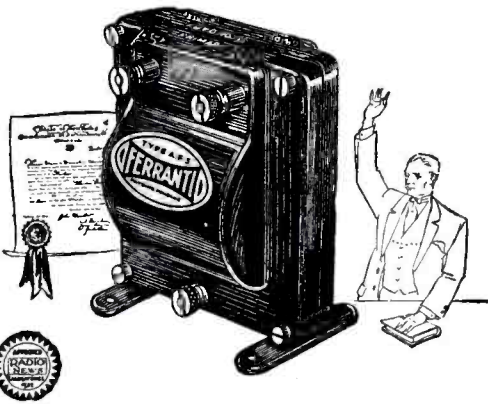

All the Truth and nothing but the Truth!

If your set gives you poor quality, it is telling lies about the sending station. If it fails to transmit those low bass notes, it is concealing part of the truth.

You want true reception. You are entitled to it. So is your family. There is a way to get the truth in radio:—



Ferranti Transformers can probably modernize that old set of yours or improve the reception of even a new one. Your dealer can help you install one or two.

If you want to make the best of the power tube feeding the loud speaker, use Ferranti. If your dealer does not carry Ferranti, write us and we shall tell you where you can get one.

HIGHSPOTS

High amplification ratio with flat curve.

Ferranti brings out the fundamental frequency of low tones—none are heard merely by inference from higher harmonics.

Every transformer tested ten times—all short-circuit turns eliminated.

Windings have high impedance.

Built by an established manufacturing company with forty years' experience in the winding of coils of fine wire for electrical instruments and meters. Primary shunted with built-in condensers of correct capacity.

Tested to 1000 volts between primary and secondary and between primary and secondary and ground.

For the best available transformer results—Ferranti Audio Frequency Transformer A.F. 3—ratio 3½ to 1—\$12.

For a transformer far superior to the average, use Ferranti A.F. 4—ratio 3½ to 1—\$8.50.

FERRANTI, Inc.

130 W. 42nd Street
New York, N. Y.

No Better Transformer Is Available At Any Price

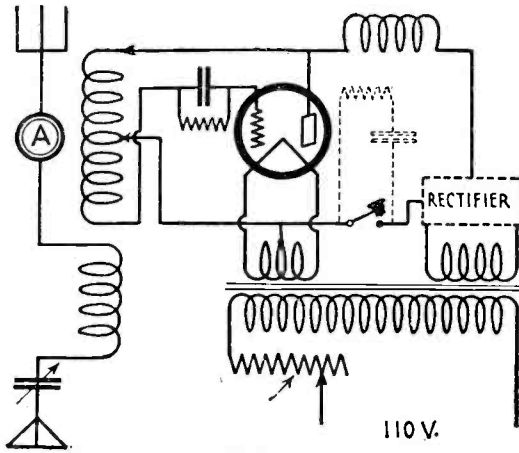

FIG. 2
The circuit diagram of a transmitter designed especially for operation on a wavelength of 20 meters.

it remains at the required distance. Quite a neat job may be done if reasonable care is taken; certainly very much easier than winding rope, etc., between turns. The completed coils will be found to be very good electrically and very rigid, an important item on the short waves.

THE RECTIFIER

The rectifier is constructed of pure aluminum and lead plates cut to the proper size. It will be best to design the rectifier, originally, for higher powers so that it need not be redesigned later. Three square inches of plate surface underneath the solution will serve for all ordinary purposes; that is, up

to a plate current of 150 milliamperes. Allow one square inch for each additional 50 milliamperes. Many different chemicals are used for the electrolyte; but sodium phosphate is as good as any, and seems to be slightly better than ordinary "borax." A few drops of ammonia per jar will greatly strengthen the film that forms on the aluminum plate. For efficient rectification you need sufficient jars so that the voltage across any jar is not excessive; thirty volts per jar is about the right value; that is, if your plate voltage is 300 volts you will need 10 jars on each side of the cycle. Connect them in the usual manner, a lead and aluminum plate in each jar, as shown in Fig. 5.

The rectifier is attached to large binding posts at the rear of the milliammeter and the primary rheostat is inserted in the 110-volt lead to the transformer (they are not shown in the illustration). If no rectifier is desired, for the time being, the set will operate fairly well on "raw" A.C.; although such procedure is ordinarily not recommended. The wave-length is so short that practically no interference will result. The range of the outfit using A.C. is very much less and, in general, the set should not be so operated.

RECEIVER ADJUSTMENT

After you have constructed the receiver and have made sure that your wiring is all right you are ready to bring it into operation on the proper wave. Perhaps the simplest method of doing this is to make use of a wave-meter, but few are available that cover this band. Usually the 40-meter band can
(Continued on page 915)

SYMBOL	Quantity	NAME OF PART	VALUE OF PART	REMARKS	MANUFACTURER ★
RECEIVER					
	1	Variable cond.	.000125 mf.	7 Plates	1 4, 31, 32
	1	" "	.00025 mf.	10 Plates	1 4, 31, 32
	1	Rheostat	30-ohms		2 4, 8, 32
	1	Socket		For detector	3 17
	1	" "		UX Type	4 2, 3, 17
	1	A.F. Trans.	High Ratio		5 4, 26, 28, 29, 32
	1	Var. grid leak			6 16, 33, 34
	1	Grid condenser	.00025 mf.		7 18, 35
	1	Switch		S. P. D. T.	8 4, 19
	1	Dial		Vernier	9 20, 36
		Wire	No. 20	For coils	10 21
TRANSMITTER					
	13 ft.	Copper tubing			22 23
	2	Fixed condenser	.02 mf.	Working voltage 6,000	11 37, 38
	1	Socket			3 2, 17
	1	Grid leak	5000-ohms		5 30
	1	Ammeter	0-1 amp.	Antenna	12 24, 25
	1	Voltmeter	0-15v.	Filament	12 24, 25
	1	Milliammeter	0-200 MA	Plate	12 24, 25
	1	Power Trans.	550-1100v.		5 28, 29
	1	Trans. key			13 27
	1	Variable cond.	.000125 mf.	7 Plate	1 31, 32
	1	Rheostat		For primary	14
	2	Strips plate glass		2½" X ¼" X 12"	15
	1	pc. window glass		6" X 6"	15
		Wire	No. 26	For chokes	10 21

NUMBERS IN LAST COLUMN REFER TO CODE NUMBERS BELOW.

1 Bremer-Tully Mfg. Co.	17 Airgap Products	33 North Amer. Bretwood Co.
2 Klosner Radio Corp.	18 Electrad, Inc.	34 Central Radio Labs. (Centralab)
3 Garod Corporation	19 Leslie F. Muter Co.	35 Sangamo Elec. Co.
4 Pacent Elec. Co., Inc.	20 Martin Copeland Co. (Marco)	36 Kurz-Kasch Co.
5 Radio Corp. of America	21 Acme Wire Co.	37 Tobe Deutschmann Co.
6 Durham & Co., Inc.	22 Radio Eng. Labs.	38 Dubilier Cond. & Radio Co.
7 N.Y. Coil Co.	23 J. Gross	39
8 H.H. Frost, Inc.	24 Weston Elec. Inst. Co.	40
9 National Co., Inc.	25 Nagel Elec. Co.	41
10 Cornish Wire Co.	26 American Trans. Co. (Amertran)	42
11 Wireless Spec. Apparatus Co.	27 Bunnell & Co., Inc.	43
12 Jewell Elec. Inst. Co.	28 Acme Apparatus Co.	44
13 Manhattan Elec. Supply Co.	29 Thordarson Elec. Mfg. Co.	45
14 Allen-Bradley Co.	30 Crescent Radio Supply Co.	46
15 Pittsburgh Plate Glass Co.	31 A. D. Cardwell	47
16 Eagle Elec. Mfg. Co.	32 General Radio Co.	48

APPROXIMATE COST OF PARTS \$ Receiver \$11.00 - Transmitter \$40.00

★ THE FIGURES IN THE FIRST COLUMN OF MANUFACTURERS INDICATE THE MAKERS OF THE PARTS USED IN THE ORIGINAL EQUIPMENT DESCRIBED HERE.

Form copyright 1926, E.P.Co.

Progress In Radio

(Continued from page 833)

that their movements are very minute. The results obtained from this instrument were excellent, speech and music being received very clearly, and audible over a large room; the articulation, too, being very good.

While an apprentice, Mr. Phillips made a

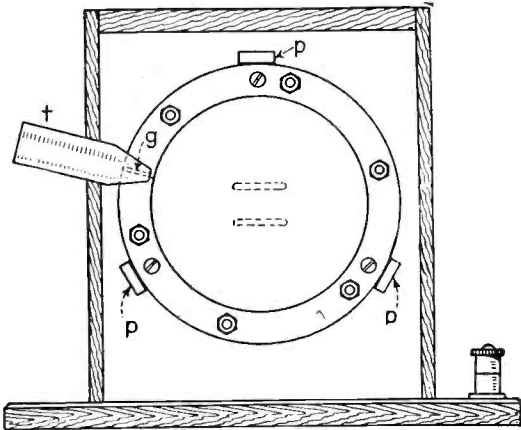

FIG. 3

A side view of the double-displacement loud speaker.

receiver in which increased movement of a diaphragm was provided for by a system of light levers, and this principle has since been applied with success to talking apparatus.

Unfortunately at those early dates no general interest could be aroused, until Radio came upon the scene.

Some Facts About Condensers

(Continued from page 807)

still be able to cover a fairly wide wave-length band without crowding stations. A good many condensers of this type employ double spacing between the plates, or are changed slightly in design from the regular type. Most of these short-wave condensers are also adaptable to short-wave transmitting circuits of low and medium power.

GANG OR TANDEM CONDENSERS

Gang or tandem condensers (See Fig. 15) are designed for use in receiving circuits where it is desirable to group two or more stages of tuned-radio-frequency amplification under a single control. Manufacturing developments have made possible producing accurately-graded condensers of this type. The discrepancy in capacity between the units, from zero to maximum, is usually so small that it can be disregarded in most cases.

Another type of gang condenser is shown in Fig. 16. With the units illustrated it is possible to vary all of the condensers at once or each one separately.

CHASING WHALES BY WIRELESS

The radio compass is invaluable to the fleet of Antarctic whalers which makes constant use of radio bearings while fishing in the vicinity of the southern ice barrier. The fleet consists of a mother ship which is equipped with a spark transmitter, and five whale chasers, each having a radio direction finder. The radio compass is of particular value to these vessels, since there are constant fogs, and in the vicinity of the south magnetic pole but little reliance can be placed on the magnetic compass.

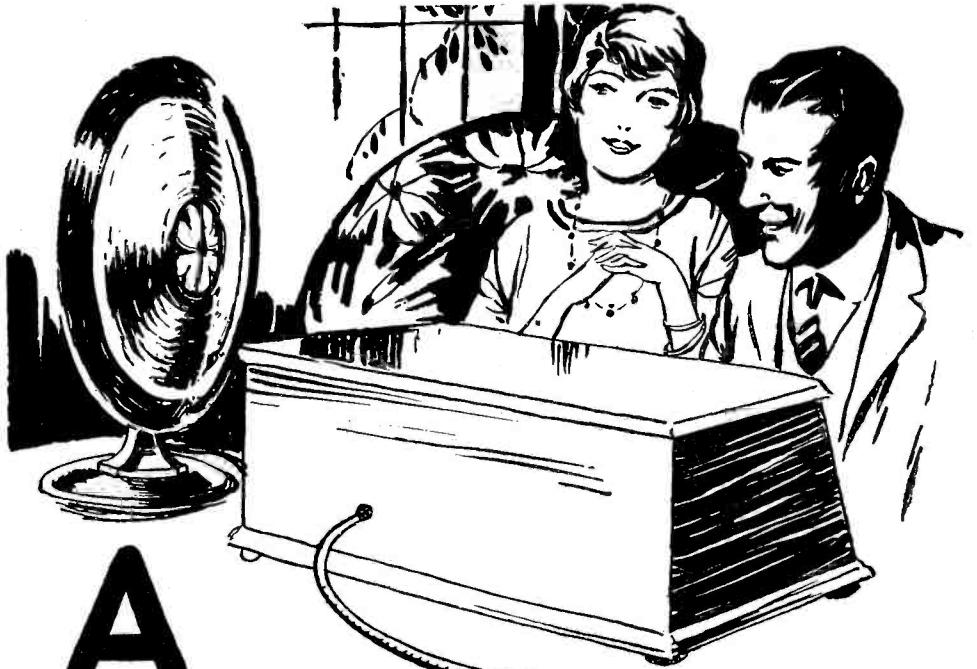

A Safety Valve for Your Radio

SUPPOSE the battery wires to your radio set became crossed, accidentally, what would happen? Almost anything from a serious fire, due to overheated wires, to a ruined B-Battery or a burned-out tube. The consequences are serious enough to warrant some careful thought right now!

The cheapest insurance against the dangers of crossed wires is to protect your radio set with a Belden Fused Radio Battery Cord. It provides

- 1—An A-battery fuse.
- 2—A B-battery fuse.
- 3—A polished bakelite cover for the battery fuses.
- 4—A compact connecting cable that dispenses with loose wires.
- 5—A color-code on each wire for identifying each circuit.
- 6—A time-saver, because the cord is quickly connected and easily concealed.

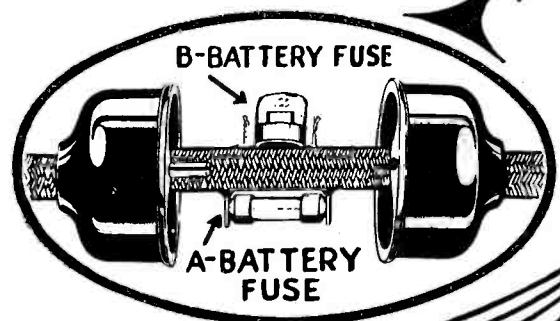

Eliminate fire hazard, ruined or discharged batteries, and burned-out tubes. Ask your nearest dealer for a Belden Fused Radio Battery Cord, today!

Belden Manufacturing Co.
2314A South Western Avenue.
Chicago, Illinois

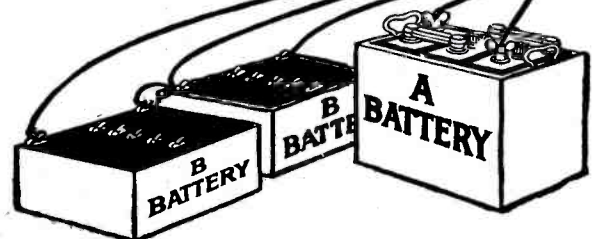

use a

Belden Fused Radio Battery Cord

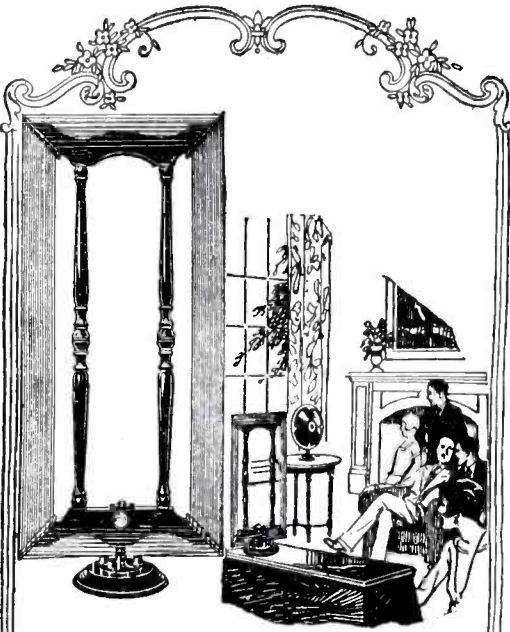

An Efficient Loop of Surpassing Beauty

The Bodine De Luxe Loop fulfills perfectly the long felt need for a compact beautiful loop—outstandingly efficient. The symmetrical frame of solid walnut, handrubbed to a beautiful finish, black bakelite mountings, and attractive silk covered windings combine in producing a loop of outstanding beauty.

Despite its compact size the De Luxe Loop brings in stations with amazing power. Sharper selectivity due to directional tuning improves tone quality.

Designed for standard loop sets but can be used effectively with most aerial sets. Write for free illustrated booklet that tells how. Price, Bodine De Luxe Loop, all models, \$12.00.

Bodine Folding Loop

Exceptionally directional, remarkably efficient. Because of the Basket-weave method of winding the Bodine Folding Loop brings in the long distance stations. Sliding sleeves

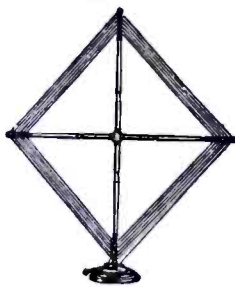

conceal the hinges of the English Mahogany frame in operation. Folded it fits a box only 3 1/2" x 6" x 18". Ideal for camping too! Holds shape under long service. Price, Bodine Folding Loop, \$8.50 to \$10.00.

Bodine Twin-Eight R. F. Transformers



Greater amplification, less interference with other parts, sharper selectivity, are features of these improved coils that amaze manufacturers and set builders alike.

No type of torodial or doughnut coil can compare with Twin-Eights. Improves all tuned radio frequency hookups. Compact and small, easy to install. The boon of amateur set builders. Write for hookup of the Bodine Twin-Eight Receiver which uses Twin-Eight Coils. Buy Twin-Eight Coils from your dealer today. Price \$2.00 per coil, three matched coils \$6.00.

Mail the Coupon

BODINE ELECTRIC COMPANY
2264 West Ohio Street
Chicago, Illinois
Kindly mail FREE circular describing:
Bodine Radio Loops
How to use a loop with aerial receiver.
How to build the Bodine Twin-Eight Receiver.

Name _____
Address _____

The New Shielded Ultradyne

(Continued from page 815A)

"A—" posts. If the filament wiring is correct, all the tubes will light.

To check the "B" battery circuits, leave the "A—" connected as before; but connect the plus terminal of the 6-volt storage battery to the "B+Det" binding post. If this circuit is O.K., none of the tubes should light.

Repeat the test by connecting the plus "A+" lead to the "B+Ampl" and the "B+" 135v. If during these tests one or more tubes should light, it is because there is a wrong connection somewhere.

If dry-cell "B" batteries are used, the large size or heavy-duty types should be selected because they last much longer. Storage "B" batteries may be re-charged and can deliver more current; or a good eliminator may be used.

ACCESSORIES

In the binding-post arrangement of the LR4 a binding post is provided for the detector voltage so that 45 volts or more may be used on the plate of the detector tube. With 201-A bulbs 90 volts should be used in the radio-frequency tubes and 135 or more on the audio tubes. The "C" battery voltage depends upon the audio "B" voltage and is given by the tube manufacturer in the sheet of instructions furnished with each tube. The "C" battery voltage on the detector should be adjusted experimentally, because it varies with the plate voltage and the type of tube used. The rheostat provided for the control of the detector filament

permits the use of various types of tubes, and after being set may be left fixed.

An aerial is used with the LR4 receiver because of the necessity of matching the input and radio-frequency stage accurately. Another reason for using an antenna is that it picks up more energy than a loop. If installed indoors it may be fastened around the picture moulding in the room and thus be invisible, while a loop is always more or less bulky and sometimes unsightly.

It is possible to use a loop with the LR4 receiver, but if this is done a midget condenser connected in parallel with the second variable condenser is required for balancing the inductance between the loop and auto-couple coil.

The ground connection may be taken on the radiator or water pipe, previously scraped clean. In some locations, where the set is installed high above the ground, it is possible to use the ground alone as an antenna. In this case the ground lead is connected to the antenna binding post and nothing is connected to the ground post.

Although the receiver will work satisfactorily with any good tubes, we recommend the use of the 201-A type. It may be employed throughout the set; but it is of advantage to use a 112 tube in the last stage of the audio amplifier. If 135 volts or more are used on the plate of the audio tubes, it would even be preferable to use two of these tubes in the two stages of audio-frequency amplification.

TUNING

Once the batteries, antenna and ground are connected, the set should be adjusted as follows: Turn the rheostats on almost full; then turn the dials until some station is heard.

SYMBOL	Quantity	NAME OF PART	VALUE OF PART	REMARKS	MANUFACTURER ★
C1, C2, C3	3	Variable cond.	.00035 mf.	Straight-line-tuning type	1
C10	2	" "	3 to 50mmf.	Equalizing	1
C4	6	Fixed "	.5 mf.	By-pass	2 12, 13, 14
C5	1	" "	1.0 mf.	" "	2 12, 13, 14
C7, C8	3	" "	.005 mf.	" "	2 12, 13, 14, 15
C6	2	" "	.001 mf.	By-pass and blocking	2 12, 13, 14, 15
C9	1	" "	.00025 mf.	By-pass	2 12, 13, 14, 15
L1, L3	2	R. F. Trans.		For .00035 mf. variable condenser	1 16, 17, 18
L2	1	R. F. Trans.		Auto. Var. Coupling	1
T1, T2	2	A. F. Trans.	3 to 1	Large size	3 19, 20, 21, 22
	9	Sockets		Spring supporting type	4 8, 23, 24
	2	Dials		Vernier	5 20, 24, 25, 42
R4	2	Rheostats	20-ohms		6 12, 14, 23, 26, 30, 41
R5	1	Potentiometer	400-ohms		6 12, 14, 23, 26, 30, 41
R1	4	Auto. Fil. Cont.	6v. 1/2 amp.	For standard type tube	7 16, 27
R2	2	" " "	6v. 1/2 amp.	For Semi-power tube	7 16, 27
	9	Binding posts			8 24, 28, 29, 31
L4, 5, 6 & 7	4	Chokes		Special (used as trans.)	9
J	1	Jack		Double Circuit	6 23, 30, 32
J1	1	"		Single " Fil. Control	6 23, 30, 32
SW	1	Switch		With pilot light	6 30, 31, 33
	1	Panel		8X24X3/16 inches	10 34, 35, 36
	1	Cabinet		8X25 1/2 X 12 1/8 " (inside diameter)	11 37, 38, 39
	1	Baseboard		8X25 1/2 X 12 inches (wood)	
	3	Shields	6X6X7	Aluminum	1 40

NUMBERS IN LAST COLUMN REFER TO CODE NUMBERS BELOW.

1 Hammarlund Mfg. Co.	17 Feri Radio Mfg. Co.	33 Pilot Elec. Mfg. Corp.
2 Sengamo Elec. Co.	18 Heintz & Kohl Moos, Inc.	34 Diamond State Fibre Co. (Celoron)
3 Thorjerson Elec. Mfg. Co.	19 American Trans. Co.	35 Ins. Co. of Amer. (Insuline)
4 Benjamin Elec. Mfg. Co.	20 Sanson Elec. Co.	36 Amer. Hd. Rubber Co. (Radion)
5 Martin-Copeland Co. (Marco)	21 All American Radio Corp.	37 Electrotube Blocking Co.
6 Yalkey Mfg. Co.	22 Jefferson Elec. Mfg. Co.	38 Baker Yacht Basin, Inc.
7 Radioll Co. (Amperite)	23 Pacent Elec. Co., Inc.	39 Southern Toy Co.
8 H. H. Eby Mfg. Co.	24 Amco Prods, Inc.	40 Aluminum Co. of America
9 Madison Radio Corp.	25 Kurz-Kasch Co.	41 Central Radio Labs (Centralab)
10 Formica Insulation Co.	26 H. H. Frost, Inc.	42 National Co., Inc.
11 Fritts Cabinet Co.	27 Langbein Kaufmann Radio Co.	43
12 Electrud, Inc.	28 X-L Radio Labs.	44
13 Aerovox Wireless Corp.	29 Waterbury Button Co.	45
14 Polymet Mfg. Co.	30 Carter Radio Co.	46
15 Micamold Radio Corp.	31 Bruno Radio Corp.	47
16 Daven Radio Corp.	32 Hillimeter Machine Works	48

APPROXIMATE COST OF PARTS \$ 60.00

★ THE FIGURES IN THE FIRST COLUMN OF MANUFACTURERS INDICATE THE MAKERS OF THE PARTS USED IN THE ORIGINAL EQUIPMENT DESCRIBED HERE.

Form © 1926, E.P.Co.

Once a signal is tuned in, adjust the potentiometer for maximum signal strength.

If a whistle is heard, it may be that the balancing condenser in the circuit of the first tube is not adjusted correctly. If this is the case, turn the adjusting screw slowly until the whistle stops. To check this adjustment, tune in a short-wave and then a long-wave station. The first tube should not oscillate in either case if the balancing condenser is properly adjusted.

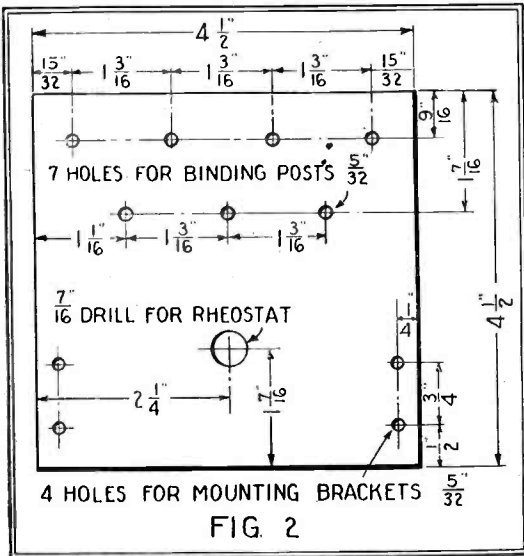

Constructional details of the small binding-post panel, which also takes the detector rheostat.

If everything is properly adjusted the set is now ready to tune on any broadcast frequency. It should be noted that the rheostat on the panel should be re-adjusted when weak signals are being received.

Notice to Readers

A COMPLETE set of full-sized blueprints for this Ultradyne Receiver may be obtained by sending \$1.00 to the Blueprint Department of RADIO NEWS, 53 Park Place, New York, N. Y., specifying Set No. 2. These blueprints may be placed upon the panel and sub-panel, forming templates for drilling and locating the apparatus, as well as wiring guides.

FIFTEEN THOUSAND "HAMS"

This is the number of amateur radio operators in the United States with licenses for short-wave sets. On June 30 there were 14,902, about two hundred fewer than last year; but the difference is ascribed to the period of obtaining license renewals.

About one-twentieth of the entire number are in New York City, with 717; Chicago has 419; Los Angeles 383; Philadelphia 335; Oakland 274; San Francisco 234; Baltimore 136; Detroit 123; Portland (Ore.) 111; and Seattle 107.

In the other large cities the numbers are Washington 98, St. Louis 89, Pittsburgh 81, Minneapolis 80, Milwaukee 67, Cincinnati 66, Rochester 64, and Boston 57. Thousands of amateurs are scattered in small towns, villages, and in the rural districts throughout the country.

The official list, with calls, names and addresses, up to June 30, is now available, and may be secured from the Superintendent of Documents, Government Printing Office, Washington, for 25 cents a copy.

A SHUT-IN SUPPORTER

Governor Al Smith of New York, in the closing days of his gubernatorial campaign, found time to send a telephone message to a faithful follower who has no vote. Thomas J. McGurty of Utica, the constituent in question, has been confined to bed by illness for five years; but has never failed to tune in the governor on his radio when possible.

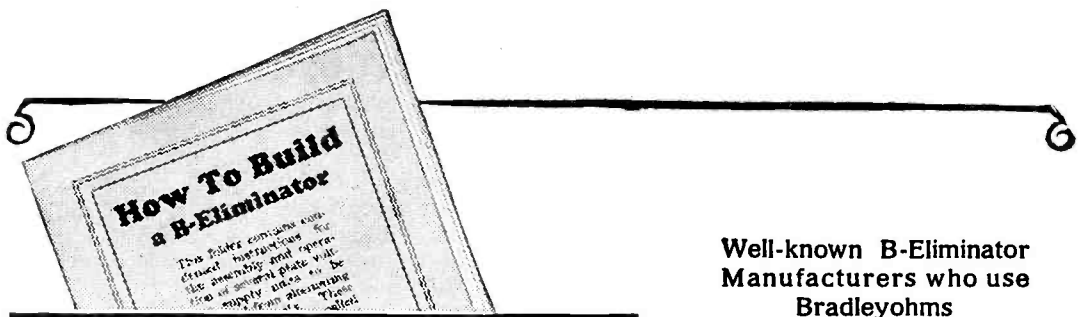

SEND FOR THIS RADIO FOLDER

Contains seven hookups for B-Eliminators published in a prominent radio magazine.

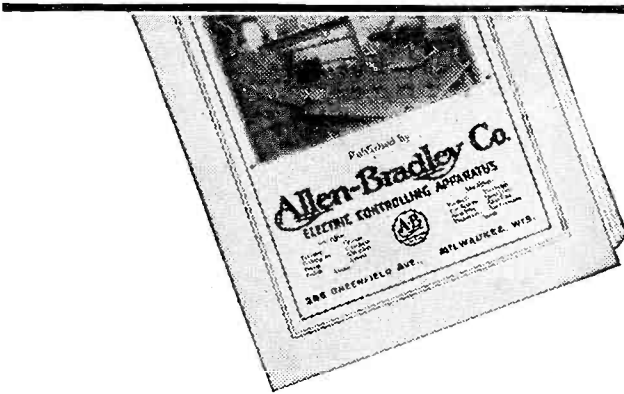

Well-known B-Eliminator Manufacturers who use Bradleyohms

- Acme, All-American, American Bosch, Brown & Green, DeWitt-LaFrance, Farrand, Forest Unitron, Grigsby-Grunow-Hinds (Majestic), Kellogg, Philadelphia Storage Battery (Philco), Precision, Radio Receptor, R. A. Rothermel, London; Spartana, Valley, Willard, Wilson.

When You Build a B-Eliminator

Use Bradleyohm-E for the Variable Resistors and Bradleyunit-A for the Fixed Resistors

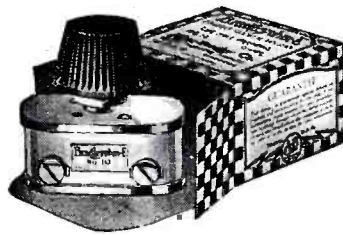

Bradleyohm-E

For B-eliminator service requiring wide voltage control, Bradleyohm-E is essential. It is an oversize Bradleyohm with sufficient capacity to handle all normal B-eliminator requirements. Be sure to ask for Bradleyohm-E in the checkered carton. Your dealer can get them for you



Bradleyunit-A

This solid, molded, fixed resistor has no glass or hermetic sealing in its construction. It is a solid unit with silver-plated end caps and is not affected by temperature, moisture and age. By all means, use Bradleyunit-A when you need a fixed resistor.



ALWAYS insist that Bradleyohm-E and Bradleyunit-A are included with your B-Eliminator kit, if you want to be assured of perfect voltage control. The leading manufacturers of B-Eliminators have long since adopted these Allen-Bradley variable and fixed resistors as standard equipment for their B-Eliminators. In fact, Bradleyohm-E is used almost as universally as the Raytheon tube, itself.

You cannot afford to risk the use of inferior substitutes for the scientifically treated discs used in Bradleyohm-E. This remarkable variable resistor handles the strenuous requirements of B-Eliminator service without the slightest strain. Ask your dealer for Allen-Bradley Perfect Radio Devices, today.

MAIL THE HANDY COUPON

Allen-Bradley Company
287 Greenfield Avenue
Milwaukee, Wisconsin

Please send me, FREE, your radio folder with seven B-Eliminator hook-ups.

Name.....

Address.....

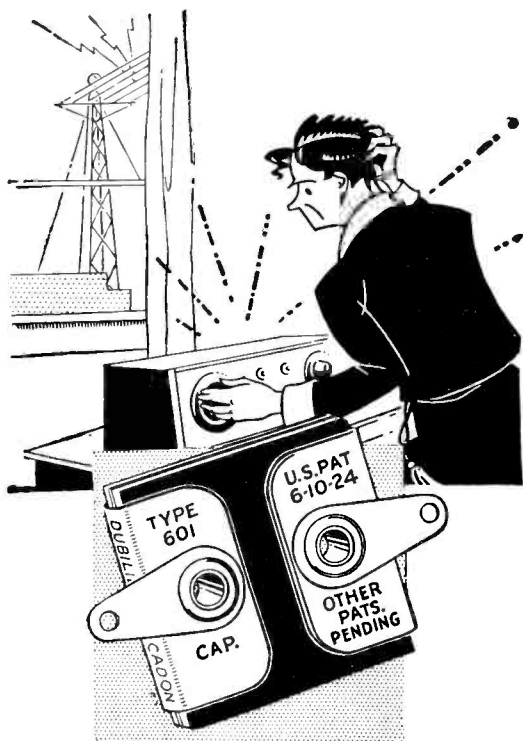

*Can't
tune 'em
out?*

TRY a Micadon 601 in series with the antenna of your set, if you find it hard to "tune out" nearby stations.

The Micadon will have the same effect as "loose coupling," and the selectivity of your set will be greatly improved. Capacities from .0001 to .0005 mfd. may be used—you will find a full explanation in our 32 page booklet, "Seventeen Ways to Improve Your Set."

Micadons, because of the patented principles of low-loss insulation and protection against variation in capacity which they embody, are a vital element in the improved reception of thousands of radio sets. The tone, the efficiency, and the satisfactory operation of your set depend on the quality of the fixed condensers used.

If you want to be sure that your set will do all it was meant to do, be sure that the fixed condensers bear the name of Dubilier.

Send 10c in stamps or coin for your copy of "Seventeen Ways to Improve Your Set"

Dubilier
CONDENSER AND RADIO CORPORATION

4377 Bronx Blvd., New York, N. Y.

The Carborundum Super-heterodyne Receiver

(Continued from page 827)

ing the pick-up coil to the grid circuit of the first detector. The loop circuit jack is mounted at the rear of the sub-panel, so that the loop connections are kept free from the front of the panel and the operator's hands.

This set may be operated without loop, aerial or ground, the antenna and detector-circuit transformers acting as the pick-up medium. The first-R.F. and the first-detector tuning-condenser controls are not critical on nearby stations; the selectivity, however, is excellent.

GENERAL CONSTRUCTION

Before laying out the panels: All the parts should be secured before the panel is laid out. Each part should be carefully tested with a headset and 22½-volt "B" battery to determine whether it is satisfactory. In addition, all bolts and nuts on the parts should be tightened and, if possible, equipped with lock-washers.

The front panel should be rigidly fastened to the sub-panel with radio angle-brackets, extending the full height and depth of the panels.

The filament circuit should be wired first and tested before anything else is done. The grid and plate circuits are next in order. Different-colored wiring may be used for the filament, grid and plate circuits. The oscillator shield should be connected to the "A—"

TUNING

When the set is wired and ready for operation a spare .0005- or .00035-mf. variable condenser should be connected temporarily across the secondary of the input I.F. transformer (in the place indicated for C8) and set at zero, or minimum capacity. When a distant station has been tuned in the capacity of this variable condenser should be increased slightly, and the oscillator condenser and I.F. potentiometer, (R4) readjusted for best results. This action should be repeated in small steps up to the full capacity of the variable condenser. Careful comparison should be made of the volume at different settings, and that adjustment of the variable condenser which gives the best results should be retained. The capacity of the condenser at this setting may be estimated and a fixed condenser of approximately the same value substituted and permanently connected across the secondary, (of the input I.F. transformer.)

This condenser value is *not* critical, because broadly-tuned transformers are used in the rest of the amplifier and because it is practically impossible to detect a difference in audibility of less than 25%. The main idea of this procedure is to tune the secondary to the wavelength of the primary.

In tuning, after the input I.F. transformer has been adjusted as described above, it will be found that the oscillator condenser (C2) is most critical and requires careful adjustment. The two other variable condensers are relatively broad in tuning, but they must be set properly in order to bring in distant stations. We have thus the paradox of a broadly-tuned set that is sharply selective.

After tuning in a distant station, adjust the radio-frequency rheostat to the most sensitive point, and make slight readjustment of the aerial tuning condenser C if necessary.

Likewise, when receiving very weak signals, adjust the tickler of the first detector and retune the R.F. variable condenser C1.

The detector unit may be set for best results, while a distant station is being received, and then left alone. Similarly, the I.F. potentiometer may be set for nearly

maximum sensitivity and then left alone; if its slider is set too closely to the negative side, the I.F. amplifier will oscillate and the set will apparently go dead. In this case, when the trouble is recognized, it is necessary merely to readjust the potentiometer until the I.F. amplifier is operating slightly below the point of self-oscillation.

It should be remembered that there are three self-oscillation controls: the radio-frequency rheostat, the tickler of the first detector and the I.F. potentiometer. Proper results can not be secured if any one of these controls is set above the oscillating point. Yet it is necessary, in order to secure maximum amplification, that each of the three sections (R.F. amplifier, first detector and I.F. amplifier) governed by these controls be capable of regeneration and self-oscillation. Normally each control is smooth and quiet in operation.

TUBES AND BATTERIES

We recommend the use of 201A-type tubes in all except the last audio-frequency stage, where a 112-type tube is best. With this combination the following (approximate) "B" voltages have given good results: 60 volts on the first R.F. and on the I.F. amplifier; 40 to 60 volts on the first detector; 135 volts on the oscillator and on the first audio; 135 or 160 volts on the second audio. The corresponding "C" voltages are: 7½ volts on the oscillator and first audio; 9 or 11 volts on the second audio; 0 to 7½ volts on the first detector.

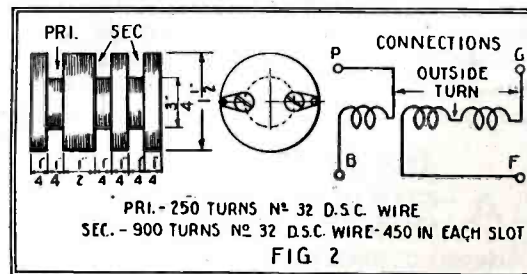

Constructional details of the special input-filter intermediate-frequency transformer. Note that the secondary is wound in two sections.

Increased volume and better reproduction of extremely strong signals are secured with a 112 tube as the first audio amplifier and a 171 tube as the second audio, with 135 or 160 volts on the first and 180 volts on the second. The corresponding "C" voltages are: 9 or 11 on the first and about 40 on the second. However, with this combination it is necessary to use an output transformer, or output impedance and condenser, between the loud speaker and the last tube.

The circuit is so arranged that with *good* tubes there is no necessity for matching or changing them around for best results. However, a spare tube should be available for direct comparison with one that may be thought defective. It is advisable to try different "B" and "C" battery voltages; this should be done only after the builder has thoroughly familiarized himself with the method of operation. The batteries should be kept in good condition and checked frequently with a voltmeter while the set is in actual operation.

MEASURING THE INTERMEDIATE FREQUENCY

If it is so desired, the actual intermediate frequency may be measured by a special method which does not require a wavemeter covering the 2000-meter range. This method is based on the fact that the intermediate frequency is equal to the *difference* between the signal and oscillator frequencies; the received frequency being known, it is necessary only to measure the oscillator frequency. Their difference is the intermediate frequency. In order to make this measurement it is necessary to have either a broadcast-range wavemeter or a broadcast receiving set of any type.

The procedure is as follows:

(1) Tune the superheterodyne accurately to a station whose wavelength is known. Leave the controls in this position and, with the set turned on, remove the first R.F. and the first detector tubes.

(2) Loosely couple the wavemeter or the broadcast receiving set (which also must be in operation) to the oscillator in the superheterodyne and determine the wavelength at which the oscillator is operating. (With a wavemeter this will be indicated by maximum deflection or maximum brilliancy of the resonance indicator. With a broadcast set it will be indicated by the clicking noise heard in the 'phones—connected to the broadcast set—when the wavelength controls of this set are adjusted to the wavelength of the oscillator; from the position of these controls it should be possible roughly to estimate the wavelength of the oscillator).

(3) Convert the wavelength of the oscillator and the wavelength of the signal (as received on the superheterodyne) to their equivalent frequencies, obtained by dividing 300,000,000 by the respective wavelengths. The numerical difference between these two frequencies equals the intermediate frequency and, if desired, this may be converted to wavelengths by division of 300,000,000.

The reason for removing the first R.F. and first detector tubes is to minimize the possibility of errors which might be caused by self-oscillation of either of these tubes. Incidentally, if either of these tubes (especially the first detector) is oscillating, local stations may be received even with the regular oscillator tube removed from the set.

When the intermediate frequency has been measured, the input I.F. transformer may be retuned, if necessary, to bring it to 2000 meters. Of course, when broadly-tuned I.F. transformers are used it is not absolutely necessary to have the input transformer set to this exact wavelength.

If I.F. transformers of the type specified, or others covering the 2000-meter range, are used and if the input I.F. transformer is constructed according to the specifications, there will be no necessity to measure the intermediate frequency.

NOTICE TO READERS

A COMPLETE set of full-sized blueprints for this Carborundum Superheterodyne Receiver may be obtained by sending \$1.00 to the Blueprint Department, RADIO NEWS, 53 Park Place, New York, N. Y., specifying Set No. 4. These blueprints may be placed upon the panel and sub-panel, forming templates for drilling and locating the apparatus, as well as wiring guides.

Radio News of the Month

(Continued from page 798)

WRNY TRIES ANNOUNCERLESS NIGHT
SO many criticisms of the radio announcer, as a superfluous individual, have been current, that WRNY, the RADIO NEWS station, on the evening of Oct. 15 gave a practical demonstration of what a broadcast program would be without the services of that much-maligned individual. It was, however, necessary for duties of his part to be performed; the artists making known their own identity, that of the station broadcasting, and of their successors, when making their farewell. The general criticism of the result was that the need for the personality of an announcer had been proven; as the Editor of RADIO NEWS, Hugo Gernsback, had maintained in his explanatory speech toward the close of the program. The services required of radio's master of ceremonies are real, and cannot be evaded.



Contains the following:—
 Three .1 Meg.
 One .5 "
 One .25 "
 One 2 "
 Complete, \$4.25

METAL long has been recognized as the best of electrical conductors. The Lynch Metallized Resistor has received the unqualified endorsement of leading engineers, experimenters and test laboratories because it is absolutely silent in operation and remains permanently accurate.

Comprising a concentrated metallized deposit one-thousandth of an inch thick upon a glass core and sealed within a glass tube, each LYNCH METALLIZED FIXED RESISTOR wins in the exacting tests of time and service.

Warranted—
Absolutely Noiseless
Permanently Accurate
Dependable!

If your dealer cannot supply you, we will ship by return mail. You take no risk as Lynch products are sold on a money-back guarantee. Use the Convenience Coupon below.

PRICES	.25 to 10 Megohms	.50
	above .01 to .24 "	.75
	.001 to .01 "	1.00
	Single Mounting	.35
	Double Mounting	.50

Write for complete list of ranges.

ARTHUR H. LYNCH, Inc.

Manufacturers of Radio Devices
 Fisk Bldg., B'way & 57th St.
 New York, N. Y.



The NEW LYNCH EQUALIZOR (Automatic filament Control) for any combination of tubes \$1.00 Complete with Mounting.

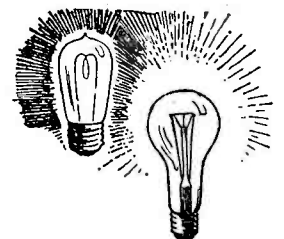

The old carbon lamp consumed more current to give less light. Tungsten, which is metal, proved more efficient, more dependable. The Lynch Metallized Resistor gives non-arcing, conductive resistance. It marks as great an advance as did the tungsten lamp.
 Arthur H. Lynch

Dealers: Get our FREE "Advance Information" Service

ARTHUR H. LYNCH, Inc., Fisk Bldg., New York, N. Y.
 Send me the Lynch Assortment described above (7 Lynch Metallized Resistors) with the understanding that I am to receive my money back if not satisfied. I will pay postman on delivery, \$4.25, plus postage.
 (Name)
 (Address)

Or send check or money order and save postage.

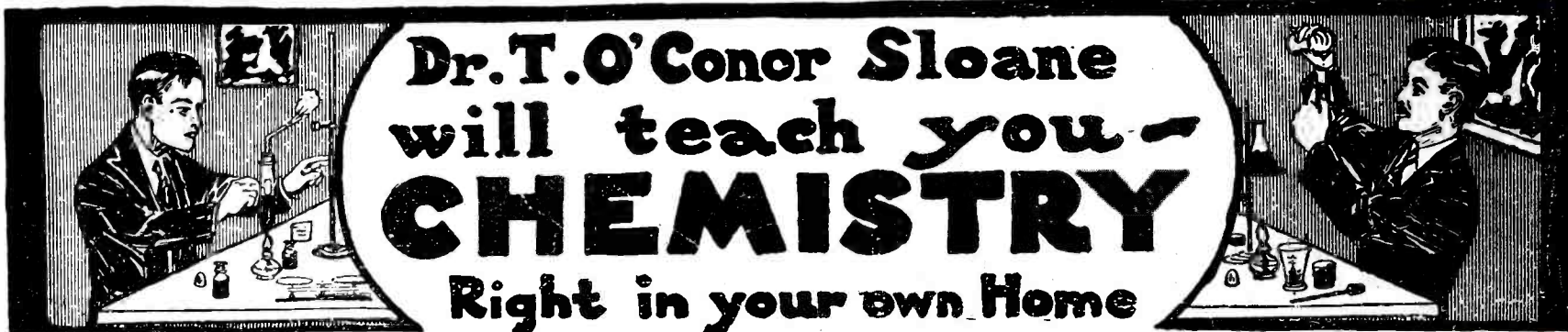

Dr. T.O'Conor Sloane
will teach you -
CHEMISTRY
Right in your own Home

Good Chemists Command High Salaries



T. O'CONOR SLOANE.
A.B., A.M., LL.D., Ph.D.

Noted Instructor, Lecturer and Author. Formerly Treasurer American Chemical Society and a practical chemist with many well known achievements to his credit. Not only has Dr. Sloane taught chemistry in the class-room but he was for many years engaged in commercial chemical work.

Industrial firms of all kinds pay tempting salaries to get the right men. Salaries of \$10,000 to \$12,000 a year are not unusual for chemists of exceptional abilities. Chemistry offers those who are ambitious and willing to apply themselves conscientiously the greatest opportunities of any vocation. Why be satisfied with small pay and hard, thankless work—learn the profession of Chemistry and your salary will depend only upon your own efforts and your own abilities.

The work of the chemist is extremely interesting. If you are fond of experimenting, if you like exciting and fascinating work, take up Chemistry. To the man who is dissatisfied with his present job, to the young man just deciding on his life work, Chemistry holds alluring charms, and countless opportunities. If you want to earn more money, the way is open through our course in Chemistry.

NOW IS THE TIME TO STUDY CHEMISTRY

Never before has the world seen such splendid opportunities for chemists as exist today. The war has awakened the United States to the need of trained chemists and chemical engineers. Everywhere the demand has sprung up. In factories, mills, laboratories, electrical shops, industrial plants of all kinds, chemistry plays a vital part in the continuation and expansion of the business. In every branch of human endeavor the need for chemists has arisen. No profession offers such alluring opportunities and the next

ten years are going to show the greatest development in this science that this country has ever seen. Those who have the foresight and ambition to learn chemistry now will have the added advantages and greater opportunities afforded while the chemical field is growing and expanding.

You Can Learn At Home

NO PREVIOUS SCHOOLING NEEDED

Dr. Sloane will teach you Chemistry in a practical and intensely interesting way. Our home study course written by Dr. Sloane himself is practical, logical and remarkably simple. It is illustrated by so many experiments that are performed right from the start that anyone, no matter how little education he may have, can thoroughly understand every lesson. Dr. Sloane teaches you in your own home with the same individual and painstaking care with which he has already taught thousands in the class room. He will, in addition, give you any individual help you may need in your studies. This personal training will be of inestimable value to you in your future career.

Experimental Equipment Given to Every Student



We give to every student without additional charge, this chemical equipment including fifty pieces of laboratory apparatus and supplies and thirty-nine different chemicals and reagents. The fitted heavy wooden box serves not only as a case for the outfit but also as a laboratory accessory for performing countless experiments. Full particulars about this special feature of our course are contained in our free book "Opportunities for Chemists."

DIPLOMA AWARDED TO EACH GRADUATE

Upon graduation each student is awarded our Diploma in Chemistry, certifying that he has successfully completed his studies. Your name on this certificate will be a source of pride to you all your life, as well as an aid to obtaining a position in Chemistry.

Easy Monthly Payments

You do not have to have even the small price of the course to start. You can pay for it in small monthly amounts or earn it as many others are doing. The cost is very low, and includes even the Chemistry outfit—there are no extras to buy with our course. Write us and let us explain how you can qualify for a trained technical position without even giving up your present employment.

SPECIAL 30 DAY OFFER

Besides furnishing the student with his Experimental Equipment, we are making an additional special offer for a short while only. You owe it to yourself to find out about it. Write today for full information and free book, "Opportunities for Chemists." Send the coupon right now while it is fresh in your mind. Or just write your name and address on a postal and mail it to us.

What Well-Known Authorities Say About Our Course

From Hudson Maxim.
"Dr. Sloane has done a much-needed work in a much better way than anything of the kind has, heretofore, been done."

"Dr. Sloane has a remarkable faculty of presenting Science for self-instruction of the student in such a clear and understandable way as to be most readily grasped and assimilated."

"I, therefore, unreservedly recommend and place my highest indorsement on his work."

From Dr. W. W. de Kerlor,
"I can not recommend your course too highly and I congratulate both you and Dr. Sloane on same."

From John A. Tennant.
"This is something which has long been needed. Your long experience in the teaching of chemistry... assurance that the course will be practical as well as plain to the untrained students."

What the Students Say:

"Your course has been worth \$50,000 to my concern."

"This is just like reading some fascinating fiction story."

"I have just been made Assistant Chemist of my concern."

"Your course is just what a person wants to start in the wonderful science of Chemistry."

"I find that your course is very interesting. I wait patiently for the next lesson."

"I find the study of chemistry more and more interesting at every lesson and you may be sure that I am getting into studying habit even more than I ever did even in my school days."

"I like the lessons so much that I honestly would not sell them for many times their price."

"I am taking this opportunity to express my satisfaction with your chemical lessons."

"I now have a fine position as chemist at the Du Pont Dye Works. It was thru your course alone that I have been so successful."

"I have written to different people about your course and they speak very highly of same."

"If I don't learn it isn't your fault for I find that your lessons contain a whole lot."

(Names and addresses on request.)

Don't Wait -- Mail the Coupon NOW!

CHEMICAL INSTITUTE of NEW YORK, Inc.

66-R WEST BROADWAY Home Extension Division 1 NEW YORK CITY

NAME

ADDRESS

CITY STATE

RN-1-'27

THOSE EDUCATIONAL HOURS

Mrs. Weems: Is your boy well educated?
Mrs. Whaams: Well educated! Well, I should say so. We've sent him through three radio sets.

H. I. Phillips in New York Sun.

RADIO BARGAINS IN PERU

MONOPOLY of radio equipment sales in Peru was until recently enjoyed by the Peruvian Broadcasting Company, which dealt largely in British goods. The new arrangement, under which the Marconi Company takes over broadcasting under government auspices, is accompanied by a lifting of the ban on private importation of parts. Bargain sales of the stocks accumulated under the previous regulations are now being held.

Where Radio Is Most Needed

(Continued from page 801)

gathers odd bits of wood in the neighborhood in the summer, storing up his fuel for the cold days and doing all he can to help his sister. She is troubled with the usual afflictions of old age, can rarely go out to her beloved church, and welcomes any one who can tell her what is going on in the outside world of which she was formerly a part. Only the kindness of others keeps these two from dire poverty. (Boston.)

Case No. 40

Mrs. L. is a little old lady who has lived in one tenement for over twenty-five years, doing her share of the world's work until a malignant growth appeared. After an operation, she became incapacitated for supporting herself. Dizziness, weakening muscles and other old-age troubles keep her confined to the house; and loneliness is often most oppressive. (Boston.)

The Powers-Casem Receiver

(Continued from page 821)

thrown out of alignment. The R.F. coils are so constructed that they should tune exactly alike if proper condensers are used and if the lay-out is right. The tuning of the first dial will depend upon the length of aerial used.

ADJUSTMENT AND OPERATION

The receiver will operate with an aerial of almost any length. For the best results, a good ground should be secured; the cold-water pipe is usually the best. When a short aerial is used, the tuning becomes extremely sharp. The radiator may sometimes be used as an aerial when nothing else is to be had.

When the set is first being tested, the headphones should be used; the detector rheostat should be turned to about the mid-position, and the three tuning condensers set for a loud local station. If the set is functioning at all, some signals will be received. If the set squeals or whistles, move the neutralizer back and forth until a position is found where the set no longer oscillates. If this operation does not properly neutralize the set, try transposing the two radio-frequency tubes. Sometimes when the tubes are new, the filament emission is considerably greater than it will be after the tubes have been used a short time. This will sometimes cause a set to oscillate badly, and as a result, the detector becomes overloaded and cannot handle the signal. This trouble can generally be overcome by an adjustment of

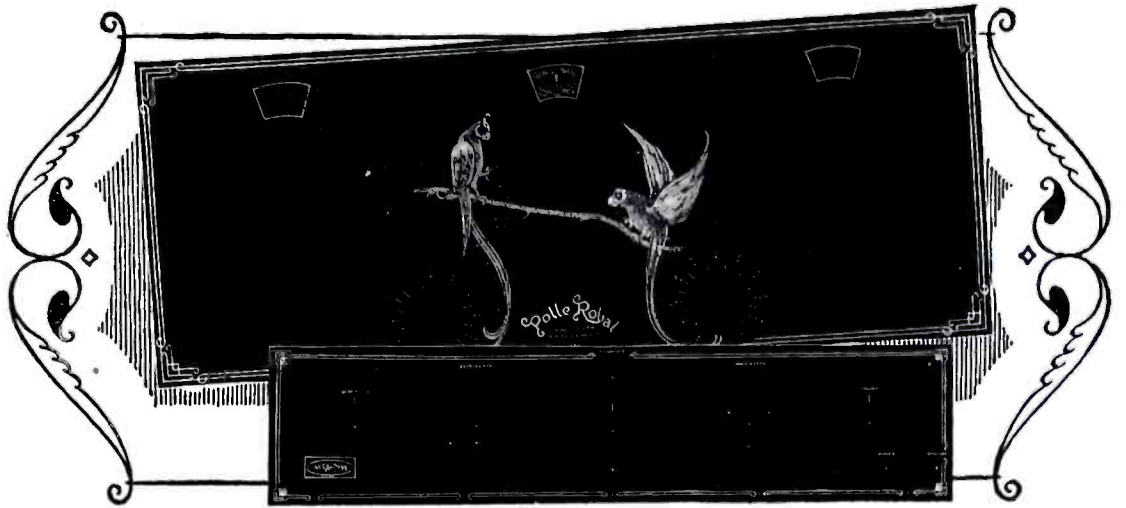

Kit Panels with Gold Decoration

FORMICA is this year providing amateurs through the leading jobbers and dealers with handsomely decorated gloss black panels with gold decoration for the leading kits: Infra-dyne, Aerodyne, Bremer Tully Counterphase and Power Six; Browning Drake National; General Radio Universal; Victoreen Superheterodyne (Two Dial and Universal One Dial) Madison Moore Superheterodyne; Camfield Duoformer; St. James 8 tube; and Karas Equamatic front and sub panels. H. F. L. Superheterodyne front and sub panels.

Formica is offering a very complete service for radio manufacturers. This includes front panels, base panels and terminal strips perforated with all necessary holes and decorated either by Veri Chrome process or stamped.

It includes the threading of tubing for winding radio frequency inductances. This threaded tubing has a positively uniform diameter, the turns are evenly spaced; enameled wire may be used in place of silk insulated; the inductances are much more uniform than those wound on ordinary tubing.

Formica has a very large equipment for these fabricating operations and can give quick service.



The FORMICA INSULATION COMPANY

4618 SPRING GROVE AVENUE

CINCINNATI, OHIO

Hear the FORMICA
Orchestra Tuesday
9 to 10
over WLW

FORMICA

Formica has a
Complete Service on
Insulating Material for
Radio Manufacturers

100 Pages of RADIO BARGAINS

FREE

Our
New
1927
100
Page



RADIO CATALOG

"WRITE TODAY FOR YOUR FREE COPY"

BEFORE you build or buy a radio be sure to consult our new 100 page catalog—sent to you free. All the latest kits, accessories, and parts—a million dollar radio stock to choose from.

We Save You Money

We handle only brand new apparatus—standard makes that are fully guaranteed. QUANTITY sale of QUALITY parts explains our low prices. Compare with others and see why thousands of fans look to us as radio headquarters. Write for your copy of this new catalog today.

CHICAGO SALVAGE STOCK STORE

Dept. RN. 509 S. STATE ST.
CHICAGO, U. S. A.

the detector rheostat. In fact, regeneration in the detector tube can be controlled by the rheostat; in order to produce more regeneration the rheostat is turned toward the off position. This rheostat also makes a good volume control.

The set can be accurately logged, in fact, it is recommended for best results that a log be made of all important stations.

Proper use of the balancer and the detector rheostat, and careful adjustment of the tuning condensers will result in the reception of distant signals. Of course, it takes some practice before the best results on DX stations can be obtained; little trouble, however, should be encountered in the reception of locals.

Plug-in coils have been adopted so that the set may be used on the short waves; with three sets of coils, it has a range from 40 to 550 meters. On the shorter waves a variable condenser of .0005-mf. capacity should be used, in series with the aerial. If an arrangement of this kind is not used, the set will not oscillate on certain wavelengths.

Notice to Readers

A COMPLETE set of full-sized blueprints for this Powers-Casem Receiver may be obtained by sending \$1.00 to the Blueprint Department, RADIO NEWS, 53 Park Pl., New York, N. Y., specifying Set No. 3. These blueprints may be placed upon the panel and sub-panel, forming templates for drilling and locating the apparatus, as well as wiring guides.

Now Try the "RADIGON" "B" Battery Eliminator



SILENT
POWERFUL
NATURAL

The Radigon "B" is absolutely free from "hum" of any kind. It is guaranteed to supply constant, uniform "B" power up to 200 volts. It invariably improves the reception of any receiver. The Radigon will give you years of trouble-free service. Guaranteed against defect for one year.

Get the Best! A "RADIGON"

cycle A.C. Current. A marvelous unit built in master fashion of the finest parts and finished in tasteful crystal brown that harmonizes with any surroundings.

The Ideal Xmas Gift—A "RADIGON"

PROMPT DELIVERY Remit in full with order or we will ship C.O.D. on receipt of part payment with order. 10 Day Trial. Your money back if you wish. Mail your order today. Price \$19.95, F.O.B., Chicago.

AMERICAN RADIGON LABS.

559 W. MONROE ST., CHICAGO

Complete with Tube

\$19.95

Perfection—at Last!

All that you've ever wished for in a "B" Eliminator is found in the Radigon "B". It is the finest "B" supply unit available regardless of make and price. It assures unflinching, unvarying current sufficient for even the largest receiver. The "Radigon" uses a full wave non-filament tube—operates on 105 to 120 volts 50-60

"Hard" and "Soft" Detector Tubes

(Continued from page 815-B)

time to reach a comparatively stable operating condition. That is to say, when the tube is first lighted, it will be found necessary to make frequent adjustment of the rheostat until the tube has thoroughly "warmed up." This "warming" of the tube usually means the vaporization of certain alkaline metals which do not aid the operation of the tube until they are changed into a gaseous state by the heat of the filament; and this operation takes time. Furthermore, any changes of battery voltage, made while the set is operating, will upset the so-called "condition of equilibrium," which had been previously reached, and thus necessitate readjustment of the filament rheostat to restore this condition. This lack of stability is also shown during the reception of strong local signals, which frequently disturb the balanced condition of the soft tube and result in distortion of the signals.

EFFECT OF REDUCED IMPEDANCE

The gaseous tube has a rather low input impedance; that is, it acts like a low resistance in shunt with the circuit connected to it. With the untuned-radio-frequency circuits used in older types of receivers, this effect was not a serious drawback, since these circuits were already of high resistance; but with the modern receiver, employing tuned-radio-frequency amplification, it constitutes one of the most serious disadvantages of the soft tube.

Today, with the multiplication of broadcast stations, an extremely high degree of selectivity is demanded, and anything which tends to lessen a receiver's selectivity constitutes a serious disadvantage for the user. When a gaseous tube is placed in the detector socket of the modern tuned-radio-frequency set, it will be found that a moderately strong station, which perhaps had been heard over only 5 degrees on the tuning dials before the insertion of this tube, will now cover 10 to 20 divisions. The reason is that the connection of the soft tube to the

5-TUBE RADIO SET \$1.00 Down

This wonderful Radio made possible because practically everything is manufactured in our factory. We supply the set completely wired but we do not supply 7 x 18 cabinet. Set is of latest design. Money back guarantee. Send \$1.00 with order, balance \$20 C.O.D. on receipt of set. Total price \$21.00. DUKE RADIO, 326 W. Madison, Chicago, Ill.

COIL WINDINGS

Audio-B Eliminator—Bell Ringing Trans.
TELEPHONE RINGER—CHOKE—
IGNITION—CONTROLLER & SPECIAL
SOLENOID WINDINGS

Easton Coil Co. P. O. Box 237
Easton, Pa.

FREE RADIO GUIDE

164-PAGE (1927) GUIDE

Gives special hook-ups with illustrations. Shows big savings on standard radio parts, complete sets, kits. Be sure to get this thrifty book before you buy. Write letter or postal NOW. Also include name of another fan.

DARAWIK CO., 542B Monroe St., CHICAGO, U. S. A.

84 Illustrated Pages of Radio Bargains!

Write for Catalog Today

RANDOLPH RADIO CORP.
180 N. UNION AV. Dept. 2 CHICAGO, ILL.

preceding tuning circuit has been equivalent to the introduction of a resistance in shunt with it. This causes the circuit to change from a "low-loss" to a comparatively "high-loss" circuit, and accordingly broadens the tuning of the receiver. Therefore, the mere possession of increased sensitivity, by the use of a soft tube, by no means implies superior performance when it is placed in the type of receiver which is most common today. The above explanation gives an idea why the hard tube will usually out-perform the soft type, when used as a detector.

A NEW HARD DETECTOR

There is a tube which not only is free from the above-mentioned disadvantages, which are inherent in the soft tubes, but also possesses distinct improvements over the regular all-purpose type of hard tube; namely, a special internal construction to prevent mechanical vibration of the elements, and a mutual conductance 25% greater.

In this tube we have a special detector built for its task, with the following features: non-microphonic, high input impedance, non-critical, sharp-tuning, quiet background, high mutual conductance, perfect stability, and maximum sensitivity consistent with these requirements.

This special tube may be substituted in any set which uses a 201-A-type tube as a detector, without change in connections. The "B" battery lead marked "B+Det" should be connected to give from 67 to 90 volts, when this tube is used with transformer- or impedance-coupled amplifiers, and from 90 to 135 volts for use with resistance-coupled amplifiers.

The degree of improvement to be expected from a substitution of the new tube for the all-around type will depend upon:

The type of circuit used—especially good results are to be noted with non-regenerative types, such as the standard superheterodyne, tuned-radio-frequency, and various older circuits of this type.

The transformer used to couple the tube to the succeeding audio-frequency stage—the higher its primary impedance the greater the gain noticed. As this same feature, (high primary impedance) is to be found in all good modern transformers, because it is one of the qualities necessary to reduce distortion, the better the transformer used, as a rule, the greater will be the gain noticed on substitution of the new tube; with impedance and resistance couplings, it is very marked.

The plate voltage used—rarely will less than 67 be needed, and values from this upwards should be tried out. With resistance coupling, values from 90 up will usually be found best. *The tube cannot be damaged by voltages below 150.*

The strength of signal received—the weaker the signal, the more improvement will be noticed with this tube. Strong local signals should not be used to determine the sensitivity of a tube, as they may be powerful enough to overload it.

Just What is Opera?

(Continued from page 802)

were finally concluded to broadcast part of the Roosevelt Recitals direct from the Grand Ballroom. The first concert brought Mary Garden and Geza de Krez, the violinist, and WRNY picked up the instrumental portions only. On the future recitals, it is possible that the entire afternoon program may be broadcast.

A big achievement was the B. F. Keith program. You know (if you are acquainted at all with the theatre) that the Keith Circuit has refused to permit their artists to broadcast, and in fact went so far as to

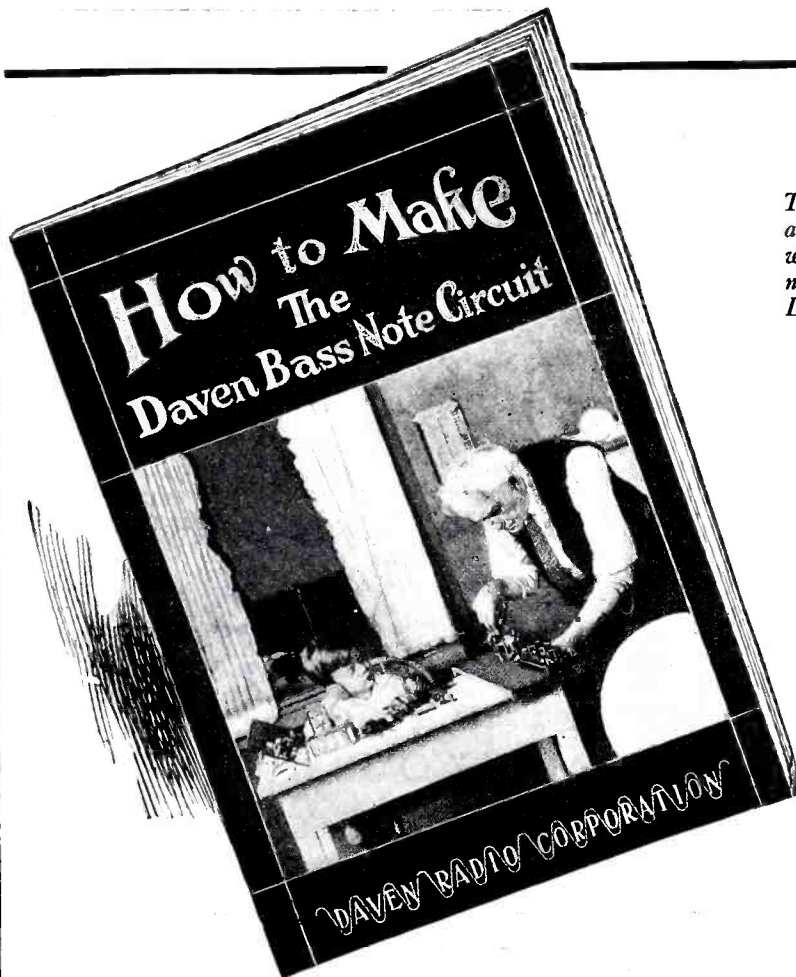

This book tells you in a new, simple, direct way how to build this new radio set. 25c at Daven dealers, or 30c by mail.

We GUARANTEE Your Success

NO matter if you're totally inexperienced in radio—you can build a successful 1928 model Daven Bass Note Set—we guarantee it! A set whose beauty and clearness of reception will be the envy of your friends. A set with a new purity and fullness of Tone. A set that brings in all the deep notes in music, notes that are usually muffled or lost.

Daven Engineers Will Help You

If, after reading "How to Make a Daven Bass Note Circuit, you have the slightest difficulty, write us your problem, and our engineers—the men who perfected this circuit and designed the Daven parts which go into it—will give you personal advice and instruction. Ever hear before of a radio parts manufacturer giving such a guarantee?

Get This Book TODAY

Shows how to assemble a Daven set that is economical of space; has simple two-dial control; equipped with new Daven Balancer and Compensator for sharp easy tuning. Charts of a new kind show every part lifesize, with exact measurements for wiring, etc. With its help you can build a \$150 radio set and save more than half of that. If your dealer hasn't this book send us 30c for a copy.

DAVEN
BASS NOTE CIRCUIT
For Complete Radio Reception

FACTORY BUILT DAVEN BASS NOTE SETS

If you are not interested in set building, but want the new completeness of reception, the easy 2-dial tuning, the sharp selectiveness that the Bass Note Circuit brings, you will be interested to know that we have bought a controlling interest in the Port Manufacturing Co., Newark. Write for Free Folder showing and describing complete Daven Bass Note Sets.

Port Manufacturing Co., Radio Set Division of
Daven Radio Corp., 141 Summit St., Newark, N. J.



NEW 8th EDITION DAVEN MANUAL
Complete Catalog of Daven Parts **FREE**
This valuable book, newly revised, explains Daven Amplification in full detail, and shows how to apply Daven Amplification to any set. Get the Manual at your dealers' 25c—30c by mail.

Complete Daven Catalogue Free
The Sign of Merit
DAVEN RADIO CORPORATION
Trade Mark Resistor Specialists Registered
141 Summit Street Newark, N. J.

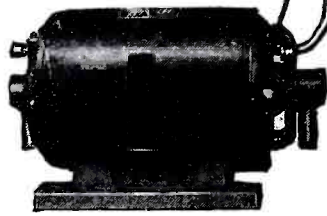
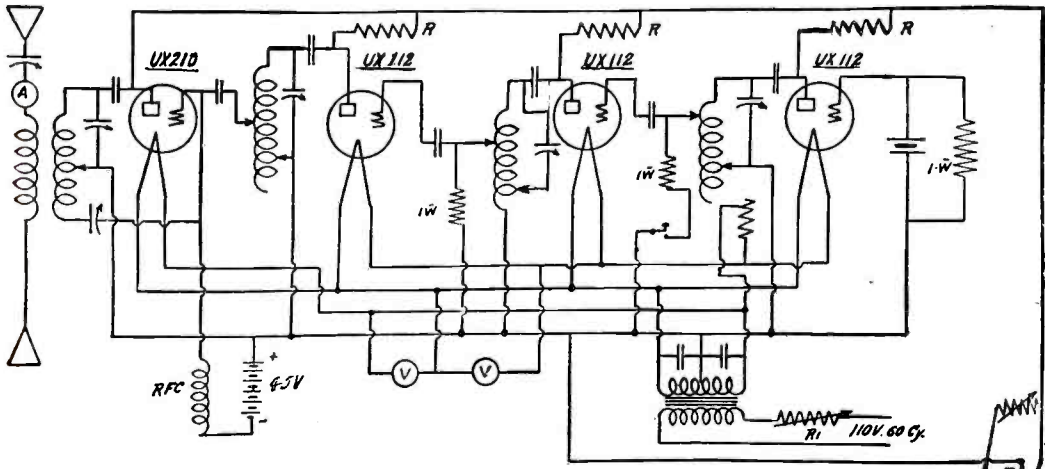

THIS is the third of a series of five "hook-ups" for crystal control transmitters using "ESCO" Maximum miles per watt Power Supply. The crystal oscillator is a UX112 controlled by a 320 meter crystal for 80 meter operation or 160 meter crystal for 40 meter operation. A 320 meter crystal can be used for both 80 and 40 meters, with slightly reduced output in the 40 meter band. Assuming a 320 meter crystal—the first UX112 oscillates at 320 meters. The second UX112 has its plate circuit tuned to the second harmonic of the crystal tube—160 meters. It amplifies at this wave length. The third UX112 has its plate tuned to the second harmonic of the preceding tube or 80 meters. The last amplifier is a UX210 which is tuned to the wave of the last UX112. Neutralization in the last stage is then necessary, as is shown. Plate supply comes from Item 8 operating from DC or AC supply. The filaments are heated by a 110 volt 60 cycle transformer. Plate circuits of all tubes except the 210 have resistance [R] to drop the plate voltage to not over 250 volts. The 210 has the full 500 volts from Item 8.

ELECTRIC SPECIALTY COMPANY

211 South Street

TRADE "ESCO" MARK

Stamford, Conn., U.S.A.

Manufacturers of Motors, Generators, Motor-Generators, Dynamotors and Rotary Converters for Radio and other purposes

CORWICO

RADIO'S BEST WIRE

"From the Ground Up"

USED BY

Mr. JOHN HARRISON HARTLEY

Winner of the World's International Set Building Championship.

Through past experience with all kinds of radio wire, Mr. Hartley proved conclusively that for all around efficient service and for building a neat job that meets the requirements of high-class workmanship, there was no equal for "Corwico". It was quite natural therefore that Mr. Hartley should select "Corwico" wire for the set that later won him the world's international set building championship.

FREE Write for interesting booklet, telling all about the various kinds of radio wire and their uses.

Dealers and Jobbers—Write for the "Corwico" wire proposition.

CORNISH WIRE COMPANY

30 Church Street New York City

insert a clause in their contracts, that failure to abide by this rule meant instant dismissal. For years, I have been trying to persuade my friend, E. F. Albee, to abrogate this rule, and at last we succeeded. Though it was only for a single occasion, and although it was for the charitable purpose of aiding the Florida Relief Drive, nevertheless it happened! And nobody was more surprised than the members of the Keith offices. That afternoon! There were Blossom Seeley, Jack Smith (returned to his first love, in the midst of his successes) Jimmy Hussey, Harold Leonard's Orchestra, and many others. My, how Theatre Row did buzz!

Another great night was Central Park's own. There are eighteen gates in Central Park, New York City, and each bears a name; and each of the gates was represented that evening by a prominent individual or organization. So there came bands, choirs, choruses, individual singers, and stars. Marie Dressler was in charge. The inimitable comedienne kept things moving. She had been heard all evening as special announcer. The telephones kept buzzing to tell WRNY what a scoop that was. Somebody asked "Why not have Marie Dressler for a regular announcer?" I asked "Isn't Marie a regular announcer?" The lady said "I'll say she is!"

That night! There was Kermit Roosevelt, looking so much like his father that he sent the shivers up our backs, Dr. John Finley, Roulstone, and many, many others.

Speaking of announcers—special and otherwise. There was the much discussed Announcerless night of WRNY. I'm going to write you a special article about that another time. But suffice it to say, that it was a huge success—in the sense that it had everybody excited. Here's how we did it; we let each one of the artists do his own announcing. It was rich, but we all had to work harder than we ever do, when we do the job in the regular way.

"CHORUS GIRL" EVENING

And then there was the time we put the Chorus Girls in charge. By the most peculiar coincidence, some of the friends whom I had not seen in ages came in that very evening to ask me how things were going, to inquire about my health, and so on. They asked, all of them, what was on that was interesting! The chorus girls came in a veritable drove, from the front rows of the current attractions; and my friends among the producers generously allowed them to leave the stage some time before the last curtain. Miss Bryant of the Chorus Equity led the aggregation and told of the new Chorus Girl age, when no longer merely looks and the ability to step a little, but real brains are needed now. An epic to the chorus girl who has succeeded, a long list of famous women who grew out of the chorus, was chanted into the proceedings. The hardworking girl of the chorus, the finish of the stage-door Johnny!

THE ELECTRICAL SHOW

Principally I must tell you, however, about the WRNY Studio at the Electrical Exposition and what went on there. If you saw the studio, which was erected on the third floor of Grand Central Palace, you will agree with me that no temporary broadcast room ever equalled it. Three sides were of glass, and always hundreds were outside watching how radio is handled. It is estimated that 200,000 people viewed WRNY's microphone there during the ten days of the exposition.

There were several features which caused the floor to be nearly mobbed. For instance the opening services. And more particularly the "Tableau of Light" on the anniversary of Edison's incandescent light achievement. Then the Edison Ensemble, with H. T. Burleigh, and a story of Light's history dramatically presented from the command

Send for Latest RADIO CATALOG and GUIDE

Radio's Newest at Rock-Bottom Prices

The new 1927 edition of the Barawik Catalog and Guide gives a comprehensive listing of the radio sets, parts, kits, supplies and accessories necessary in radio. This new GUIDE contains over 6,000 items of radio's newest developments, everything that a real fan will need from the complete factory-built set to the smallest screw, including labor-saving devices, tools, power supply units. Send TODAY! Also include name of another fan.

BARAWIK CO., 542-C Monroe St., CHICAGO, U. S. A.

5 TUBE PRMCO RADIO

RADIOS BIGGEST VALUE—5-tube Prmco receiver—low in cost—wonderful reception qualities. Deserve your consideration. Write today for FREE CATALOG No. 1A.

DEALERS-AGENTS—Get Special Offer Some territory still open.

PORTS MFG. CO. 3305 E. BELMONT FRESNO CALIF.

NOW DIRECT from FACTORY

100 VOLTS \$10.95

NON-ACID RECHARGEABLE STORAGE "B" BATTERY

130 VOLTS \$13.95

"B" BATTERY CHARGER \$2.99

ORDER DIRECT TODAY

This everlasting, Non-Deteriorating Improved Alkaline Storage "B" Battery—Use 10 Days—if Not Satisfied Return and Your Money Will Be Refunded.

MARTIN, 706 So. Ashland Blvd., Chicago

A Laboratory Product

CRESCENT LAMPE RESISTANCES

Used in 50 big broadcasting stations 12,000, 48,000, 50,000 and 3,000 ohms. For distortionless amplification. Order a Crescent today at \$1.50. Special sizes made to order. Discounts to dealers.

Crescent Radio Supply Co., 1-5 Liberty St., Jamaica, N. Y.

"Let there be Light" until the present, were seen and heard. The regular Edison Hour program, with Eddy Brown, noted violinist, as guest artist, was brought to the combination audiences. The new Edison play, "Suppose It Should Happen" (it ought to have been good, but whether it was I am in no position to say, for I wrote it), was played. It gave the Electrical Exposition crowd a unique thrill, to see the properties and how sounds are made—the auto horn, motor, the glass to be broken, the electric switch, the toast, the running water, the stairway and the like.

The crowd saw Wallace Eddinger of "Captain Applejack" and "On Approval" fame, petite Agnes Lunbard, Mitzi Salzmann, Al Rigali, and the mob scene; saw me directing it all; saw the peculiar use of the microphones; saw Fannie Brice and Princess Murat and others after the play.

Then there were the nightly microphone tests, in which several hundred participated, and the finals before the judges, the essay contest, and the highlights of the exposition; and celebrated men of the electrical fraternity, Frank W. Smith, of the United Electric Light and Power Co., E. H. Rosenquist of the Westchester Lighting Company, Philip Torchio, of the N. Y. Edison Company, and many others.

Have you heard the Twilight Hours of Sunday, when the Greater N. Y. Federation of Churches brings down its wonderful choruses, instrumental ensembles, and so on? October was a great month.

"A-and-B" D.C. Eliminator

(Continued from page 810)

keep the battery fully charged at all times. As previously explained, there is no actual current taken away from the battery; but a battery will slowly lose its charge if left idle. Use of the 700-ohm resistance will make up for this. Whether it should be left in circuit at all times during the operation of the set can be only determined by trial. Probably it should not, but much is dependent on the condition of the storage battery. Poor operation of the set may indicate that the battery is taking current from the tubes, because it is not fully charged. The use of the 700-ohm resistance should rectify the trouble in short order.

All of the necessary details for the assembling and wiring of the complete "A-and-B" eliminator are given in the accompanying layouts. The diagram of the complete unit is Fig. 5.

DIRECT-CURRENT "A" POWER UNIT

Those experimenters who have storage "A" batteries, and do not desire to use the

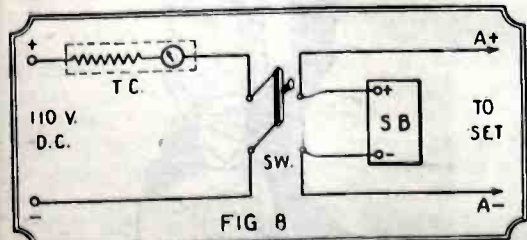
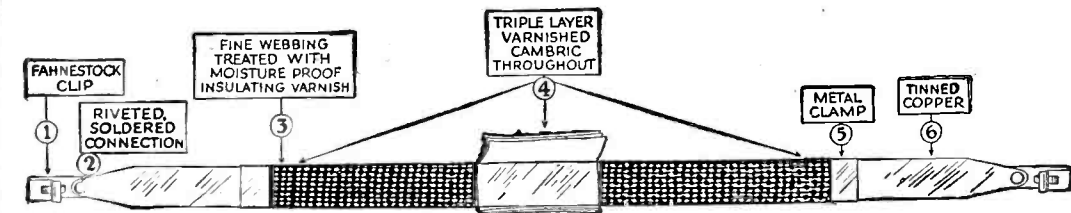

Diagram showing how the trickle charger is connected up with the D.C. line, and the storage battery through the double-pole, double-throw switch.

"A" eliminator previously described, can make a simple "A" Power Unit similar to the A.C. models now on the market. All that is necessary is a direct-current trickle charger (See Fig. 6) and a double-pole single-throw switch.

A photo of this arrangement, in conjunction with the "B" eliminator unit, is reproduced in Fig. 7; the wiring diagram of this "A" power unit is shown in Fig. 8. The set may be operated direct from the storage

ELECTRAD



"THE SIX-POINT LEAD-IN"

STUDY THE SKETCH

Know Why the Electrad Certified Lead-In Is Better—Why You Should Refuse Substitutes

Triple-ply insulation full 10 inches long, covered with waterproof webbing. One-piece copper strip, heavily tinned to prevent corrosion. Fahnestock clips, all connections *riveted* and *soldered*. Imitations may look like the Electrad Lead-In, but that is all.

Here is a lead-in you can trust—that gives you protection and improves reception. Fits under locked doors and windows. No need to bore holes through walls, doors or window trim. Bends to any shape.

Insist on the Electrad Lead-In. All good radio stores carry them or can easily and quickly get one for you. Price 40c, in Canada 60c.

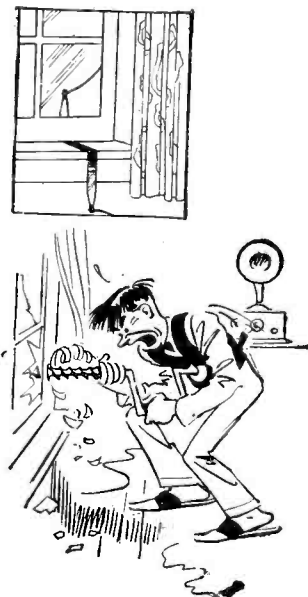

ELECTRAD Metallic Grid Leaks and Resistors

If you know anything about radio then you know why the new Electrad Metallic Grid Leaks and Resistors are necessary on every set to get better reception. The metallic resistance element is fused to the inside of a glass tube. It is noiseless, accurate, non-inductive, non-hygroscopic. Non-varying under any weather or working conditions. Greater current-carrying capacity without overheating or change of resistance. Will give clearer reception with greater signal strength. Try this unit. See what a difference it makes in your set. Size .1 to 10 megohms. Price 60c, in Canada 85c.

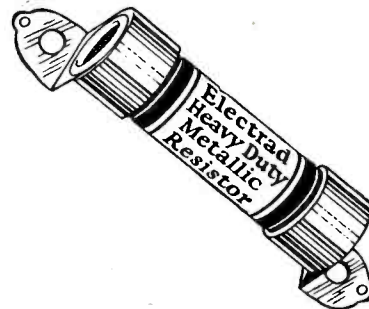

Use ELECTRAD Certified Condensers

Without hesitancy we claim the Electrad Certified Six-Point Fixed Condenser to be without equal. Here is why: Uniform pressure insured by rigid binding at six points. Sheet copper, not tinfoil. Soldering iron can't hurt it. Certified electrically and mechanically. Guaranteed to remain within 10% of calibration. Standard capacities—all types. Price U. S. 30c to 75c, Canada 45c to \$1.50, in sealed packages, at all good radio stores.

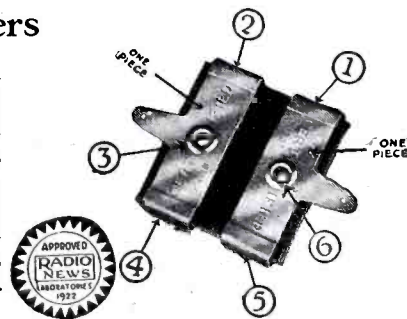

For perfect control of tone and volume use the Electrad 500,000 ohm Compensator. For free hookup write 428 B'way, New York City.



ELECTRAD Inc.

Stop It!



FRESHMAN AUTOMATIC CHARGER

Last quarter—eight minutes to play—score tied—your favorite has the ball on opponent's twenty yard line—first down—ten yards to go—looks like a touchdown—

Broadcasting coming in fine—play by play—and then—it fades away. Tubes are not lit—"A" Battery is out—run down.

This cannot happen to those who use the

FRESHMAN AUTOMATIC CHARGER

This device keeps the "A" Battery fully charged at all times.

AN absolute necessity—fool proof and dependable in every respect. Equipped with a Tungar Rectifying Tube which supplies a steady charging current to the "A" Battery when the set is not in use. When the radio is in operation the charger is disconnected by means of an automatic relay. This Automatic Charger uses no acid whatsoever.

No Attention Required
"B" Eliminator Connection

Write for new 48-page catalogue—it's free.

Sold by Authorized FRESHMAN Dealers Only
CHAS. FRESHMAN CO., INC.—FRESHMAN BLDG.—NEW YORK



battery, or with the switch open, with the switch closed, while the storage battery is on trickle charge. With the switch closed and the set turned off, the battery may be left on trickle charge.

PROTECTIVE CONDENSER

Since one side of a D.C. light line is grounded, it is essential to connect a .006-mf. fixed condenser *in series with the ground wire*

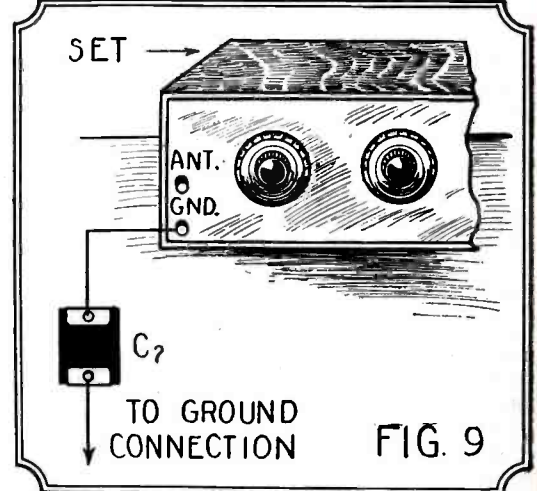

When the D.C. eliminator is used in connection with your set, a small fixed condenser (C2) should be inserted in the ground lead, as shown. This is merely a protective measure.

to the receiving set, so that there will be no possibility of short-circuiting the 110-volt mains. This connection is shown in Fig. 9. As a special safety measure, the double-fuse block, employing 10-ampere fuses, is included in the "A-and-B" eliminator.

NOTICE TO READERS:

A COMPLETE set of full sized blueprints for this D.C. Eliminator may be obtained by sending 75c. to the Blueprint Department, Radio News, 53 Park Place, New York, N. Y., specifying Set No. 1. These blueprints may be placed upon the baseboard, forming templates for drilling and locating the apparatus, as well as wiring guides.

A BALANCED RECEIVER



A BATTERY AND ELIMINATOR B

SOLD DIRECT FROM FACTORY TO YOU
SAVE JOBBERS 50% DISCOUNT
Delivers pure direct current from your light socket

Union Standard-B
works on D.C. or A.C. Any Cycle. 45 mils., at 100 volts. Formerly \$25. Now **\$12.50**

UNION A and B
6-135 Volt for A.C. Any cycle. Works any type receiver. Complete ready for use. Formerly \$75. NOW **\$35.00**

Union Master B
Works A.C. Any cycle. For Radiola 25-28-30 and super heterodynes. Operates power tubes. 60 mils. at 150 volts. Formerly \$42.50. Now **\$21.25**

NO HUM—SUPERIOR TO ANY SOURCE OF POWER
Variable voltage adjustment on every machine to meet the varying conditions of every city and on any set. No acid. Uses Raycathode. No filament to burn out. Will give years of service. Extra replacement Raycathode \$1.00.

GUARANTEE
We guarantee our machines against defective materials for two years. Try it for ten days and if found unsatisfactory you may return it at our expense and an immediate refund will be made. We ship from our nearest factory branch. No waiting. Immediate delivery. If interested in electrified sets send for catalog.

UNION SERVICE COMPANY Box 23, Morris Heights P. O., New York, N. Y.

Insure your copy reaching you each month. Subscribe to Radio News—\$2.50 a year. Experimenter Publishing Co., 53 Park Place, New York City.

The Singing Crystal

(Continued from page 789)

she placed the crystal apparatus under a bell jar, from which the air could be exhausted. She found that the oscillations varied almost directly with the pressure; that is, the less pressure inside the jar, the weaker the oscillating action. At a certain point in the exhausting process the action stopped altogether. She concluded from these experiments that the atmosphere has a direct influence on the oscillations generated by the crystal.

Dr. Seidl undertook numerous other experiments, the results of which strengthened this hypothesis. She immersed the crystal in a bath of paraffin oil, and noted the reactions of the mineral to the oil at different temperatures. When the oil was cold, it was stiff and thick, so it did not flow over the entire surface of the crystal and its contact point, but left portions of them exposed, as diagramed in Fig. 3. With the oil in this chilled condition, the crystal continued oscillating, but when the oil was heated, and started to fill the cracks and crevices of the mineral, oscillation ceased altogether. The crystal would not oscillate again until it had been carefully cleaned of all oil.

Before an explanation can be given of the relation between the oscillatory phenomena and the air surrounding the crystal, it is necessary to study the action of the electricity that circulates through the contact point when the crystal is singing.

It should be mentioned that the metal contact-pin of the crystal unit must be connected to the negative side of the battery. Now steel is a much better conductor of electricity than zinc ore. This is probably why the *electrons* (negative particles) constituting the current flow tend to accumulate at the tip, which is negative in respect to the crystal. This condition of negative charge tends to fling electrons off the point, and they pass through the air to the surface of the crystal, while there is also another flow of current through the steel *directly* to the crystal. Thus, we have what amounts to two circuits; one through the layer of air surrounding the point of contact, and the other through the steel tip directly to the surface of the mineral. The resistances of the circuits seem to be variable in themselves and consequently in relation to each other. It is the belief of the Viennese scientists that these irregularities are responsible for the oscillations.

CAUSE OF THE SOUNDS

When the electrons pass through the air, because of their high velocity they collide with atoms of its gases, and divide the latter into their positive nuclei and attendant groups of electrons, the exact number of the latter depending on the particular gases present. This action spreads around the crystal and the contact point, and causes periodic rarefactions and condensations in the surrounding air. The immediate result of this movement is a series of sound waves; the air vibrates at a frequency determined by

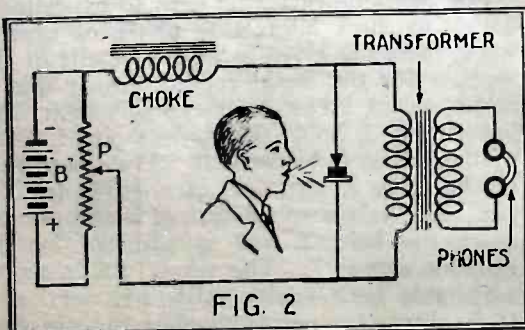
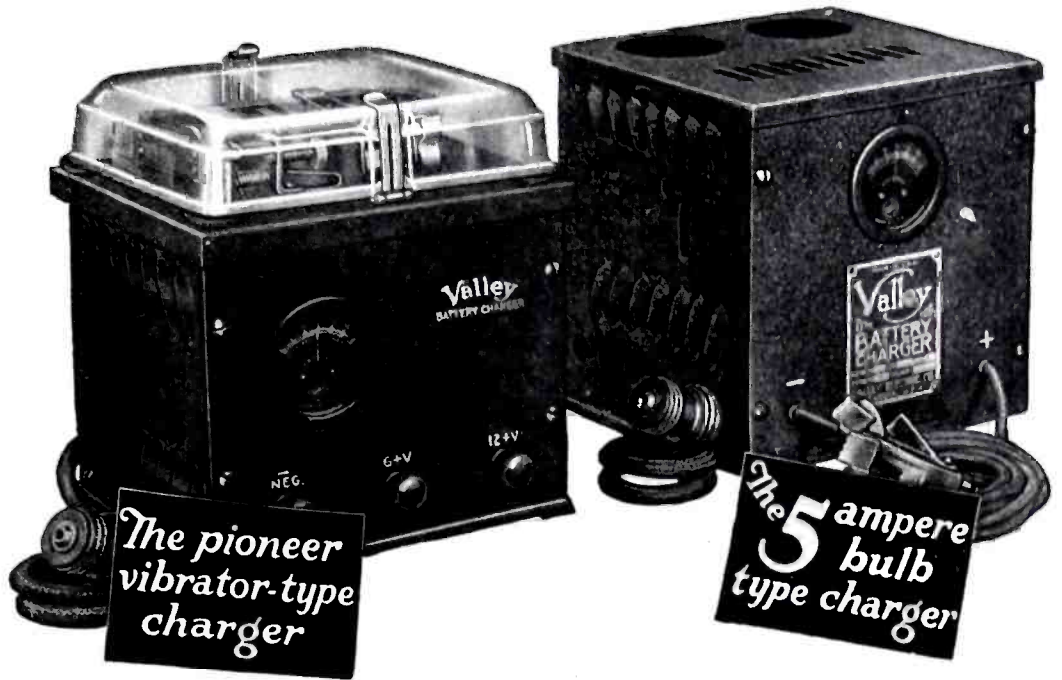

FIG. 2

Merely by speaking to the crystal, as shown, speech will be reproduced in the head-phones.

Valley Electric



Use either one for a dependable source of "A" battery current

You can get the famous Valley Battery Charger in both vibrator and bulb types. Use either one for a dependable source of A battery current.

The Vibrator Type: This is the pioneer of radio battery chargers. Nearly a quarter of a million of this type of Valley Charger has gone into service all over the world.

Charges 6-volt batteries at 6 amperes, 12-volt batteries at 3 amperes, Quiet. Efficient. Cannot harm the battery.

Mounted in black case with bakelite panel and glass top. Pleasing in appearance and will harmonize with finest radio receiver. Complete with cord and plug, and leads and clips.

The Twin Bulb Type: The twin bulb design of this Valley Charger overcomes the only objection to the bulb type charger, i. e., the slow charging rate.

Using both bulbs, you have a 5-ampere charger. Using only one bulb, you have a 2½-ampere charger. Thus the charging rate and the purchase of one bulb or two are entirely optional.

Absolutely noiseless. Built in handsome black grained metal case. Complete with cord and plug, and leads and clips.

Other Valley Radio Units

The two small cuts below show the Valley B Power Unit and the Valley Radio Receiver.

The B Power Unit supplies plate voltage from the house circuit. For sets of 12 tubes or less. May be used with a power tube or unit. Fitted with the Raytheon Tube only—"for reliable reception."

The Valleytone is a 5-tube, tuned radio frequency receiver. Two-dial control. Wired so that use of power tube is optional.

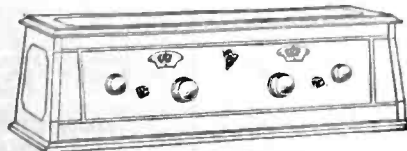
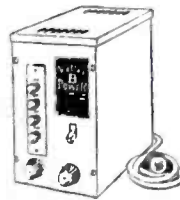

VALLEY ELECTRIC CO. · RADIO DIVISION · ST. LOUIS, MO.

District Offices: Boston, Chicago, Cleveland, Indianapolis, Kansas City, Minneapolis, New York, Philadelphia, San Francisco

New! RADIO CUNO REEL

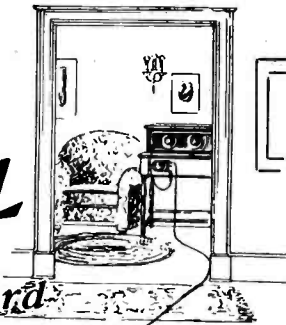

Loud Speaker Extension Cord

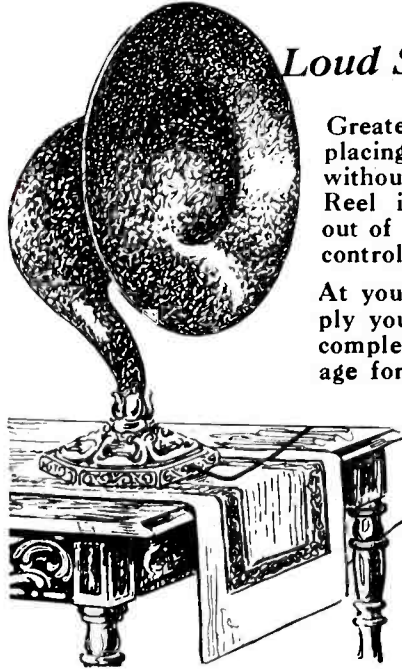

Greatest radio convenience. Permits placing loud speaker where you want it without moving set. The Cuno Radio Reel is self-rewinding, keeping cord out of way and fully protected. Button controls ratchet.

At your dealers, or, if he cannot supply you, direct from us, complete including postage for **\$3.50**

The Cuno Engineering Corp.

80 South Vine St.
Meriden
Conn.



Handsomely finished in brown enamel and nickel, complete with 25 feet of high grade cord. Easy to attach with two screws. Well made and fully guaranteed.



A Christmas Gift for Good Reception!

Guaranteed to remove the battery nuisance and deliver clearer tone and increased volume. Provides three different voltages at the same time. Each tap adjustable over a wide range, making possible any desired voltage from 5 to 150, absolutely harmonizing "B" current supply to your set. Raytheon tube used as rectifier. No noise or vibration. Contains no acid or solution and will not get out of order. Operating cost negligible. A REAL Christmas gift.

At Your Dealer's

Price, Complete with Raytheon Tube - - **\$35.00**

Kokomo Electric Company
Kokomo, Indiana

Kingston "B" Battery Eliminator

The Raytheon Rectifier



Absolutely reliable, requiring no attention. Long life, no filament. Full wave rectification and an abundance of power.



Matchless bargains in radios and accessories. Full line of Bremer Tully, Balkite, All American G. E. Tungar, Thorola, Majestic, Utah, R. C. A. Tubes, nationally advertised parts, batteries, chargers, etc. Big opportunity for live dealer to double sales quick. Tell us about your business as we sell wholesale only. Postcard or letter brings catalog and dealer's proposition. Exclusive territories open. Act-NOW!
NEW ENGLAND MILLS COMPANY
Distributors of Nationally Advertised Radio Lines
Dept. 91H 851-85 Washington Blvd. Chicago, Ill.

FREE RADIO GUIDE

164-PAGE (1927) GUIDE
Gives special hook-ups with illustrations. Shows big savings on standard radio parts, complete sets, kits. Be sure to get this thrifty book before you buy. Write letter or postal NOW. Also include name of another fan.

BARAWIK CO., 542C Monroe St., CHICAGO, U. S. A.

PATENTS

DON'T LOSE YOUR RIGHTS
Before disclosing your invention to anyone send for free blank form "EVIDENCE OF CONCEPTION" to be signed and witnessed.
LANCASTER & ALLWINE
Reg. Pat. Attys. in U. S. and Canada
270 Ouray Bldg., Washington, D. C.
Originators of the form "Evidence of Conception"

the values of the coil inductance and condenser capacity, the voltage applied, and the characteristics of the crystal itself; and the sound waves become distinctly audible.

The pressure of the contact pin on the crystal must be rather heavy, to enable the pin to penetrate the microscopic, but nevertheless appreciable, stratum of air above the surface of the ore. This stratum is not entirely expelled by the comparatively light "feeler" used in ordinary crystal stands.

Although the singing crystal as a transmitting microphone has little practical value, there is a possibility that it will become important as a reproducer for radio receivers. In tests performed on the crystal telephone and a regular magnetic telephone receiver, for the purpose of determining their comparative faithfulness of reproduction, Dr. Seidl noticed very little difference between the oscillograms recorded from the respective devices.

EASY HOME EXPERIMENTING

When the singing crystal is used as a telephonic reproducer, it is connected in a circuit like that shown in Fig. 4. It is wired across the secondary of an ordinary audio-frequency transformer, and is shunted by a choke coil, a regulating potentiometer and a battery. The rest of the circuit represents a laboratory set-up, wherein a microphone (at the left) carries the sound of a speaker's

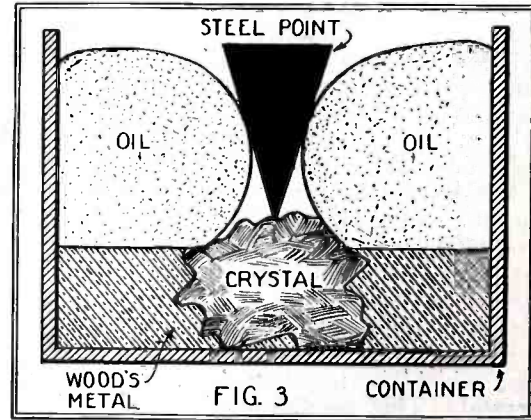

When the oil is cool the viscosity is high and there will be an air pocket at the point's tip, allowing the crystal to oscillate.

voice through a modulation transformer to the grid of a three-element tube. The latter amplifies the audio-modulated current of the microphone battery transferred through the transformer, the audio component of its plate current being carried in turn to the crystal by means of the output transformer. Any radio fan can see that this hook-up is practically a duplicate of the audio-amplifying stages found in scores of broadcast receivers, and that it will be quite a simple matter to experiment with "singing crystals" in connection with the output of such receivers.

An actual sound-reproducing receiver, made by Dr. Seidl, is shown in cross-section in Fig. 5; the details of the construction are obvious and can be easily followed. The instrument is a sort of hybrid detector-telephone; as the containing case is shaped almost exactly like the receiver of a standard desk-set, and the crystal mechanism greatly resembles that of some of the old-time crystal detector stands.

For any amateurs who care to experiment with this most interesting phase of crystal work, there are given in Fig. 6, details of the support for the metal contact point; this is an important factor of the construction. The brass tube, 3, holds the contact pin, 5, fixed by the screw, 6, to the bolt. The lower part of the tube, 3, also acts as a guide for the pin. No. 4 is a spiral spring which presses down the bolt, 2, and is adjusted by the machine screw, 7. The whole unit must be adjustable both horizontally and vertically. It is absolutely necessary that the pin cannot shake in its holder and that the pressure may be varied very precisely.

The condenser C, of the oscillatory circuit (Fig. 1B), may have a capacity between 0.5 and 1.0 mf.; the inductance, L, is between 0.1 and 1.0 henry. The choke coil may be the secondary of an audio-frequency transformer. The inductance is wound on a form cut from a piece of bakelite 1/2-inch thick and 5 1/2 inches in diameter, with a groove about 3/4-inch deep turned in the rim. In this groove is wound the coil, which consists of about 375 turns of No. 26 B. & S. enameled wire. The coil should be immersed in hot paraffin. A number of ordinary fixed condensers, of the by-pass type, may be wired in parallel to obtain the desired capa-

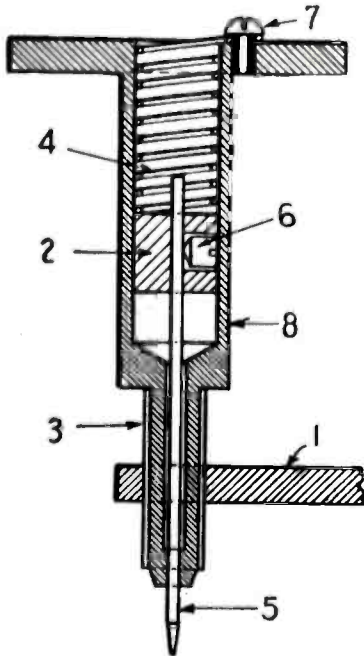

Fig. 6. Details of contact point holder. No. 1 shows support; 2, a sliding bolt; 3, brass tube; 4, spiral spring; 5, contact pin; 6 and 7, set screws for adjustments.

city; and the inductance may be tapped at several points in winding, and the ends brought out, in order that the most suitable values in circuit with a given crystal may be found by experiment.

The interesting facts presented in this article are only the first ones brought out in Dr. Seidl's experiments. The surface of the subject has hardly been scratched, but in a short time RADIO NEWS expects to be able to present to its readers further and more detailed data.

What's New in Radio?

(Continued from page 795)

lamp socket, the two binding posts, BP, on the side of the case may be connected to the set as if they were the posts of an ordinary storage battery.

The unit consists of a rectifier tube, T, feeding a storage battery of the jelly electrolyte type contained within the case. Both tube and battery are in service when the instrument is operating, the battery "floating" on the line. This arrangement is to be distinguished from the "trickle-charger" system, in which the battery is being charged continuously when the set is not in use. On the back side of the case, not visible in the photograph, are an ammeter and rheostat, by means of which the user adjusts the balance of the circuit.

An outlet plug is provided on the front side of the power unit for the convenient connection of a "B" battery eliminator. This plug is wired directly across the input cord connected to the plug, P, and saves the set owner the trouble of running the 110-volt cord of his "B" eliminator to another lamp socket.

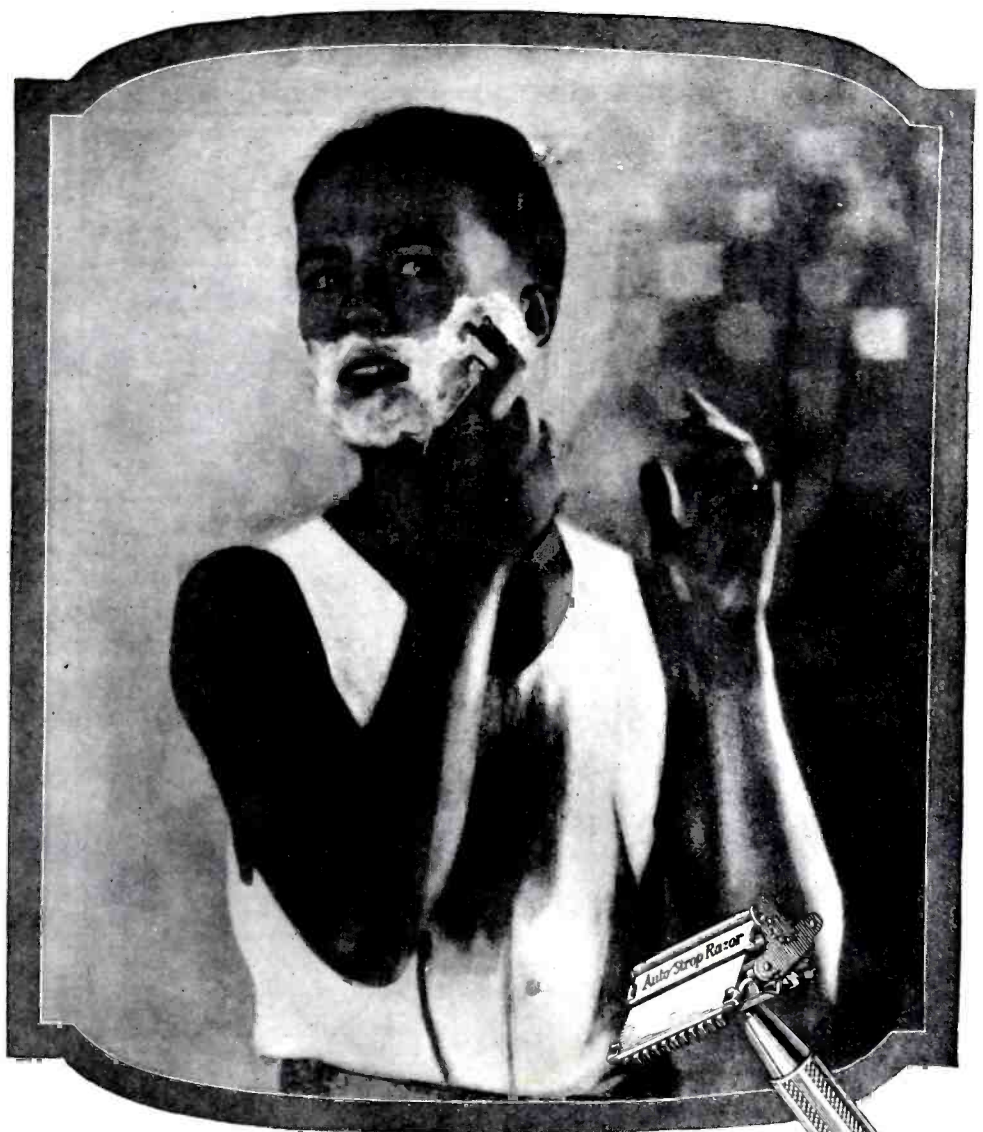

"Lucky Boy"

His father starts him off with the right razor

It's the Valet AutoStrop Razor!

No dull blades—no pull. Every shave with a super-keen blade.

The razor that strops its own blades. A few strokes and a blade is new-like. A smooth, comfortable shave every time.

Shave, clean and strop without removing the blade from the holder.

Valet AutoStrop Razor

REG. U. S. PAT. OFF.

AutoStrop Safety Razor Co., 656 First Avenue, New York City



The Razor That Sharpens Itself



“All sense of listening ceases — you are in the great artist’s presence,”

say the musically critical who have simply added



Samson Chokes

to their radio receiving sets to eliminate howling, “motorboating” and other disturbing noises—for at all times these chokes keep radio and audio frequency currents where they belong.

For this purpose Samson Chokes cannot be approached because their patented helical winding prevents the choke acting as a by-pass condenser at certain frequencies and reduces distributed capacitance effect to a negligible minimum. These chokes have no pronounced self resonant points. Special bulletins on the uses of these chokes are available.



A. F. CHOKE

- No. 85 Samson R.F. Choke (85 millihenries)\$1.50
- No. 125 Samson R.F. Choke (250 millihenries)\$2.00
- No. 3 Samson R.F. Choke (3½ henrys)\$3.00

Our book—“Audio Amplification”—already accepted as a manual of audio design by many radio engineers—contains much original information of greatest practical value to those interested in bettering the quality of their reproduction. Sent upon receipt of 25c.

SAMSON ELECTRIC COMPANY



MAIN OFFICE: **Manufacturers**
CANTON, MASS. Since 1882
Factories at Canton and Watertown, Mass.

Radio News Laboratories

(Continued from page 839)

KIT FOR 5-TUBE SET

The kit shown, submitted by the University Radio Mfg. Co., 50 Park Place, New York City, contains all the parts necessary for the Henry-Lyford receiver. The circuit employed comprises

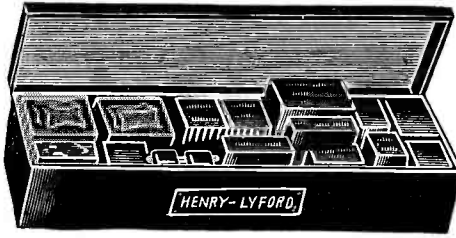

one stage of tuned radio-frequency and one stage of untuned, detector, and two stages of audio-frequency amplification. The parts employed are of high quality.

AWARDED THE RADIO NEWS LABORATORY CERTIFICATE OF MERIT NO. 1613.

RADIO RECEIVER

The radio receiver shown, submitted by the Mu-Rad Radio Corp., 800 Fifth Ave., Asbury Park,

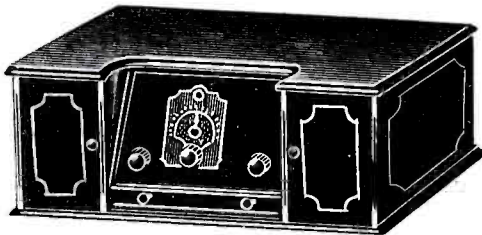

N. J., was tested and found to be entirely satisfactory as regards selectivity, sensitivity and quality of reproduction. The appearance of the set is very pleasing.

AWARDED THE RADIO NEWS LABORATORY CERTIFICATE OF MERIT NO. 1626.

RADIO RECEIVER

The “Kolster” radio receiver shown, submitted by Federal-Brandes, Inc., Woolworth Bldg., New York City, incorporates three stages of tuned-radio-

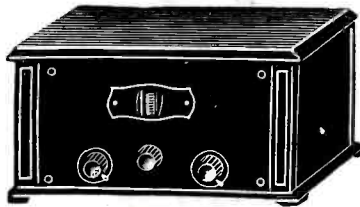

frequency, detector, and two audio. It is very selective and sensitive. It is of the one-dial control type, and, therefore, very simple to handle. The appearance of the receiver is very attractive.

AWARDED THE RADIO NEWS LABORATORY CERTIFICATE OF MERIT NO. 1708.

RADIO RECEIVER

The “Musi-King” radio receiver shown, submitted by Bailey & Co., 324 Peachtree St., Atlanta, Ga., satisfactorily passed all laboratory requirements in regards to sensitivity, selectivity and tone quality. It is a two-dial control type, employing



two stages of tuned-radio-frequency amplification, detector and three stages audio-frequency amplification. The receiver is well constructed and has a neat appearance.

AWARDED THE RADIO NEWS LABORATORY CERTIFICATE OF MERIT NO. 1709.

RADIO RECEIVER

The radio receiver shown, submitted by Westingale Electric Co., Inc., 1751 Belmont Ave., Chicago, Ill., has satisfactorily passed the laboratory



requirements as regards selectivity, sensitivity and quality of reproductions. It is of the one-dial control type, with engraved leatherette covering the panel.

AWARDED THE RADIO NEWS LABORATORY CERTIFICATE OF MERIT NO. 1712.

R. E. LACAULT, E.E., I.R.E.

Originator of the famous

ULTRADYNE

Presents his latest treatise entitled **SUPER HETERODYNE CONSTRUCTION AND OPERATION**

In this book Mr. Lacault gives comprehensive and informative data most valuable to owners of Super Heterodyne and other receivers. In addition to this Mr. Lacault reveals for the first time the diagrams and full constructional details of his latest design—

The new super sensitive 9 tube **LR 4**

Other chapters include:

- The how and why of each part
- Super Heterodyne trouble shooting chart
- How to improve your present set
- How to check and match your tubes
- How to build a power amplifier, etc.

MAIL YOUR ORDER TODAY!

Price \$1.97

FULL SIZE DRAWINGS FOR THE ASSEMBLING AND WIRING OF THE LR4 ARE NOW OBTAINABLE. PRICE \$1.

R. E. LACAULT RADIO ELECTRIC LABORATORIES

Dept. 1A—1931 Broadway
New York City

Radio’s Newest Improvement

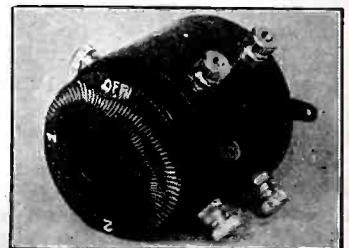

The Rono Multi-Stage Jack and Filament Switch

The Rono eliminates all jacks and push-pull plugs and attendant wiring and soldering. The Rono dial controls the batteries and both audio stages. Each stage a filament control. Recommended by Radio Engineers, Editors and Fans—Single hole mounting—Will outlast the receiver—absolutely efficient—saves time, labor and parts. You will never use another jack after you see the Rono. Get one at your Dealers today.

EACH \$2.50
If your Dealer cannot supply you order direct, enclosing \$2.50 or we will ship C. O. D.

Write for circular describing the Rono and its uses.

DEALERS—Write for Discounts—JOBBERS
Rono Mfg. Co., 428 S. Clinton St., Chicago

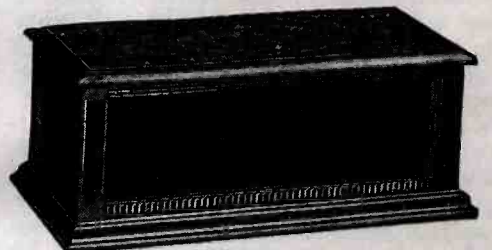

Our Queen Walnut Cabinet.

Also a fine line of Radio Consoles and Desks. Send for catalog and prices.

UTILITY RADIO CABINET CO., 448-27th Street, Milwaukee, Wisconsin

Insure your copy reaching you each month. Sub-Subscribe to RADIO NEWS — \$2.50 a year. Experimenter Publishing Co., 53 Park Pl., N.Y.C.

CONE SPEAKER

The "R F I Balanced Oval-Cone" speaker shown was submitted by the Radio Foundation, Inc., 25 West Broadway, New York City. This loud speaker, instead of being of the conventional



round-cone type, is oval in form. Its reproduction of both speech and music is exceedingly good, and the general appearance of the reproducer is pleasing.

AWARDED THE RADIO NEWS LABORATORY CERTIFICATE OF MERIT NO. 1713.

POWER UNIT

The "Amrad" power unit shown, submitted by the Amrad Corp., Medford Hillside, Mass., was tested in conjunction with the Amrad receiver and

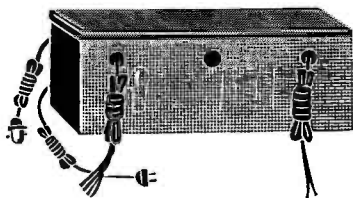

found to be very efficient. The unit incorporates an "A" and "B" battery eliminator, so that no external batteries are necessary to operate the receiver; it operates on A.C. only.

AWARDED THE RADIO NEWS LABORATORY CERTIFICATE OF MERIT NO. 1716.

RADIO RECEIVER

The "Amrad" neutrodyne radio receiver shown, submitted by the Amrad Corp., Medford Hillside, Mass., is of the tuned-radio-frequency type and so



constructed that it must be used with the Amrad power unit; it proved to be efficient. As a whole it is neat in appearance.

AWARDED THE RADIO NEWS LABORATORY CERTIFICATE OF MERIT NO. 1717.

BALANCING CONDENSER

The balancing condenser shown, submitted by L. McMichael, Wexham Road, Slough, Bucks (England), is of extremely small capacity and is used for balancing or neutralizing purposes. The adjustment

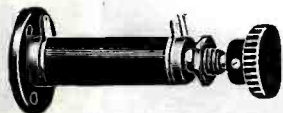

is of the micrometer type and is so calibrated that if the setting should be lost it can be easily found by simple reference to the former position of the knob.

AWARDED THE RADIO NEWS LABORATORY CERTIFICATE OF MERIT NO. 1718.

ANTENNA INDUCTANCE

The "Dimic Plug-In" antenna inductance shown, submitted by L. McMichael, Wexham Road, Slough, Bucks (England), has numerous low-loss features, such as little supporting material, space-

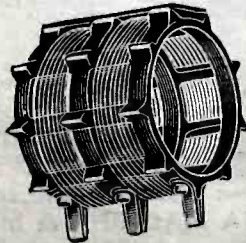

wound turns, low-resistance wire, and a firm plug-in contact; it is made in various sizes to cover various wavelength ranges.

AWARDED THE RADIO NEWS LABORATORY CERTIFICATE OF MERIT NO. 1719.

R.F. COIL

The "Dimic Plug-In" R.F. coil shown, submitted by L. McMichael, Wexham Road, Slough, Bucks (England), is also of the low-loss type. It has very little dielectric support, the turns being space wound. The entire construction is rigid. Three contacts of the plug-in type are mounted on each coil; the center contact connects to the center turn of the winding. This coil is also made in

Better Reception

Majestic "B" Current Supply

delivers pure direct current—from your light socket

Majestic Standard-B
Capacity seven tubes or six plus 1 power tube. 45 milliamperes at 135 volts
\$32.50
West of Rocky Mts., \$35.00

Majestic Super-B
Capacity one to twelve tubes, including the use of power tubes. 45 mls at 150 volts. **\$35.00**
(AS ILLUSTRATED)
West of Rocky Mts., \$37.50

Majestic Master-B
For Radiola 25, 28, 30 and Super heterodynes. Operates power tubes. 60 mls at 150 volts.
\$42.50
West of Rocky Mts., \$45.00

No Hum—Superior to Any Source of Power

The voltage can always be accurately adjusted to meet the varying conditions of every city and on any set. Economical—cost a fraction of a cent per hour. No acid or liquids; Uses Raytheon Tube; No filament to burn out.

See your dealer today. Insist on a demonstration on YOUR set immediately
(Can be purchased on deferred payments)

GRIGSBY - GRUNOW - HINDS - CO. 4572 ARMITAGE AVE CHICAGO-ILL.

WANTED!

Radio Inventions

INVENT some NEW Radio Improvement—there's big money in this line. Many simple little devices make large profits in this practically unlimited field. Send today, for FREE Book telling how you can easily learn the necessary principles of Radio so as to experiment successfully. HUNDREDS OF RADIO INVENTIONS are needed now! We teach you quickly at home in your spare time all the principles of Radio, then give you special training in Radio invention. Every experimenter needs this thorough training for it will enable you to profit by the progress of others. Write today for Free Book—no obligation. J. E. Smith, President, National Radio Institute, Dept. AB-96, Washington, D. C.

Learn Watchwork, Jewelrywork and Engraving A fine trade commanding a good salary, and your services always in demand. Address Horological, Dept. 5, Bradley Institute, PEORIA, ILLINOIS, for our latest catalog.

Bradleyometer

THE PERFECT POTENTIOMETER

Use graphite disc resistors which are noiseless and not affected by atmospheric conditions. Metal parts are nickel plated. One hole mounting. Finish and knob match Bradleystat. Made in 200 and 400 ohm ratings.

Allen-Bradley Co.
Electric Controlling Apparatus
287 Greenfield Avenue Milwaukee, Wis.



Transformers

Give Finest Radio Reception

These improved transformers assure selection of radio programs at choice, regardless of broadcast conditions. They combine tremendous power with an unexcelled purity of tone and amplify the weakest signals to full loud speaker volume. They operate with all types of standard tubes. Unsurpassed for quality, clarity and volume.

Praised — Endorsed — Approved

THE CALL BOOK SAYS: Using H. F. L. Units, we secured hair-line selectivity, tremendous power and highest quality of tone combined with simplicity of tuning and economical cost of operation.

RADIO NEWS SAYS: Using H. F. L. Units, we received 105 stations in United States, 7 Canadian, 1 Mexican, all logged while 23 local broadcast stations were on the air.

PRICES

H. 210 Iron core transformers with an exceptionally high amplification factor. Each unit carries laboratory calibration. Range 32,000 to 42,000 cycles. Price \$8.00

H. 215 Air core transformer, tuned stage, designed to amplify signals at a maximum efficiency of 37,000 cycles. Each unit carries the laboratory calibration. Price \$8.00

F. 320 Audio frequency transformer which will amplify signals to greatest volume with incomparable faithfulness of tone. These units are the result of an entirely new principle in transformer construction. Price \$8.00

L. 425 Radio Frequency Choke Unit. Price \$5.50

L. 430 Low Loss Radio Frequency Transformer. Price \$5.50

Jobbers Write Today Dealers

Try H. F. L. Units for Better Results. If your Dealer cannot supply you order direct.

Write for H.F.L. Circulars

HIGH FREQUENCY LABORATORIES
129 N. Wells Street
Chicago Illinois

Big FREE RADIO PARTS, HOOK-UPS, SETS and KITS Catalog & Guide

Send now for this valuable FREE Radio book. 164 pages of newest hook-ups, parts and kits at big savings. A real guide. Shows factory built sets and new ideas in radio. Send at once. No obligation. Please include name of radio fan.

BARAWIK CO., 542-C Monroe St., CHICAGO, U. S. A.

Radio Pocketbook 15c

A 52-page, Illustrated, Pocket Textbook

Chief Eng. David, of Sterling Mfg. Co., says: "It is the clearest treatise for the amateur radio fan I have seen."

Theory and practice, understandable to the novice, valuable to the technician.

Sent postpaid for 15c, coin at our risk. Publishing Div. of DYER RADIO MANUFACTORY, Quincy, Mass.

various sizes. The center tap is provided, so that a coil may be used in any circuit where neutralizing is required, or in any regenerative circuit similar to the Hartley.

AWARDED THE RADIO NEWS LABORATORY CERTIFICATE OF MERIT NO. 1720.

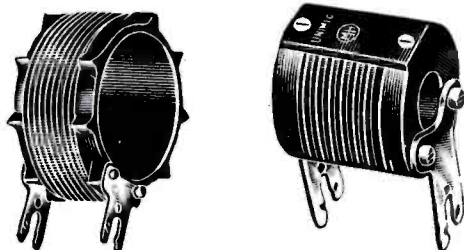

R.F. CHOKE COIL

The "Dimic" R.F. choke coil shown, submitted by L. McMichael, Wexham Road, Slough, Bucks (England), is well constructed, and also of the plug-in type. It consists of several windings, made in layer foundation in six or seven grooves, to reduce the distributed capacity of the entire coil. The particular type submitted measured 2.250 micro-henries.

AWARDED THE RADIO NEWS LABORATORY CERTIFICATE OF MERIT NO. 1721.

SPRING CONTACT MOUNTING

The spring-contact mounting shown, for Dimic Plug-In coils, submitted by L. McMichael, Wexham Road, Slough, Bucks (England), is of interesting design, and incorporates two powerful spring contacts which snap over the mounting of the coil. The coil is thus held rigidly in place. Coils with terminals similar to those shown on the Dimic antenna coil are employed with this device.



AWARDED THE RADIO NEWS LABORATORY CERTIFICATE OF MERIT NO. 1722.

IMPROVED RHEOSTAT

The Improved Rheostat shown, submitted by Electrad, Inc., 428 Broadway, New York City, is very compact and well constructed. The rotating arm makes firm and noiseless contact with the contact wire. The terminals are well placed and easily accessible. The knob and frame are composed of molded bakelite.

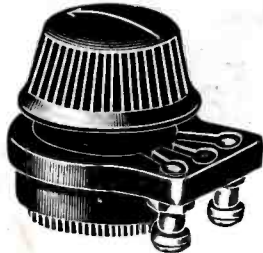

AWARDED THE RADIO NEWS LABORATORY CERTIFICATE OF MERIT NO. 1723.

VERNIER DIAL

The dial shown, submitted by the National Co., Inc., 110 Brookline St., Cambridge, Mass., is of the vernier type, has a very neat appearance and may be very easily attached to any radio receiver panel. The adjustment ratio is variable.

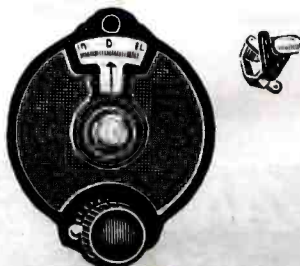

The pilot lamp shown is designed for use in connection with this dial. It is mounted behind the panel, into which an opening is cut so that the lamp extends through. Two terminals on this device connect directly across the "A" battery leads within the receiver. They may be wired so that the pilot lamp lights when the receiver is turned on.

AWARDED THE RADIO NEWS LABORATORY CERTIFICATE OF MERIT NO. 1724.

A CORRECTION

The meaning of a sentence in last month's RADIO NEWS was, by a typographical accident, completely reversed. In the article "The Neutrodyne and Its Position in Radio," by R. M. Klein, general manager of F. A. D. Andrea, Inc., the author wrote: "Neutrodyne, and Neutrodyne alone, stands as the one and only method of definite capacity-coupling without loss of efficiency." As printed, it read "with loss of efficiency"—a palpable error.

GEORGE ELECTRIC

"B POWER UNIT"

type m

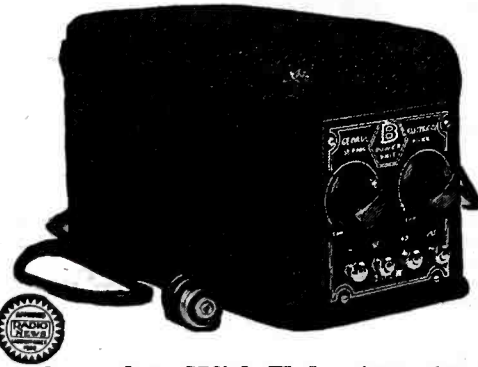

Complete With Tube \$29.50

Our patented filter circuit is most efficient, delivering absolutely pure direct current, free from any hum or distortion. The Type M Unit is sturdily constructed, and will last as long as the best receiving set.

Variable resistances permit the selection of voltages to make your set work efficiently at all times. You can bring in distant stations with more volume, and your locals with purer tone.

This unit operates on 110 volt, 60 cycle A.C. It will deliver 180 volts, with plenty of current for a ten tube set or sets equipped with power tubes.

FULLY GUARANTEED

Our dealer will be glad to give you a demonstration. Write for further information.

GEORGE ELECTRIC COMPANY

753 Carleton Avenue St. Paul, Minn.
Dealers and agents! Write today for attractive agency proposition.

Aetna Tube Reactivator



201-A — 301A

One Model for Both 199 and 299 Tubes

Keeps tubes at their highest efficiency. No radio set owner should be without one. Does away with most of the so-called "summer static."

Aetna Re-Activator Bakes the Tubes

It heats the filament at a slow even temperature and, in addition, bakes the tube externally. This redeposits on the filament some of the thorium that has been driven onto the side of the glass by use. The shell surrounding the tube is essentially a miniature oven, containing a patented element that furnishes the heat for this purpose.

Operates on A.C. or D.C. current.

SEND \$5.00 DIRECT

If not satisfied return in one week and we will return money.

Jobbers & Dealers write for discounts.

AETNA MACHINE & MFG. CO.
426 So. Clinton St., Dept. RN Chicago, Ill.

TELEGRAPHY

(Morse and Wireless) and RAILWAY ACCOUNTING taught thoroughly. Big salaries, great opportunities. Oldest, largest school. Endorsed by Telegraph, Railway, Radio, and Government officials. Expenses low — opportunities to earn large portion. Catalog free. DODGE'S INSTITUTE, Swan Street, Valparaiso, Ind.

Insure your copy reaching you each month. Subscribe to RADIO NEWS — \$2.50 a year. Experimenter Publishing Co., 53 Park Pl., N.Y.C.

How the Primary Affects the Secondary

(Continued from page 832)

such an expression in radio work. This is done when very loose coupling is used, so loose that what reaction does occur affects the work only to a negligible degree. In tuned circuits such as we use in radio receivers, however, we have no right to make such an assumption, although it is often done. The reason will be apparent later on.

To orient our thoughts, let us outline the actions. We have a source of electromotive force in series with the primary coil. This establishes a magnetic field, part of which links the turns of the secondary winding. An electromotive force is established in the secondary, which causes a secondary current to flow. The secondary thus takes energy from the primary. The flow of current in the secondary also sets up a magnetic field, part of which links the primary winding, and is opposed to the primary flux in polarity. Those parts of the primary and secondary fluxes established by the two windings, which do not link the other winding, but link only the winding in which they are generated, are called the *leakage fluxes*; and the parts which do link both windings are called the *mutual fluxes*. The two mutual fluxes are equal and opposite, and thus neutralize each other. The action is represented in a crude way in Fig. 3. The closed paths threading both coils represent the mutual flux, and those which do not thread both coils represent the leakage fluxes.

In the transfer of energy, from one circuit to the other, the leakage flux goes to waste. It is the mutual flux only which determines the energy transfer. It is necessary, therefore, to have this as great as possible. However, there is a limit to the amount of the mutual flux, this being determined by the other constants of the circuits, the size of the coil, and other things. One of the most important of these is that, if the mutual inductance is too great, the circuits will tune to the same wavelength or frequency at *two different settings* of the secondary condenser. It is necessary, therefore to keep the mutual inductance so low that for all practical purposes these two settings of the condenser come together. This phenomenon is well known to experimenters by the expression "double-hump" resonance curve.

We have seen above that part of the secondary flux is neutralized by part of the primary flux. The secondary therefore acts, in conjunction with the condenser, as if it had *less inductance* than it really has. This may not be evident at first, so we will study it more in detail. Suppose we are receiving a signal, having a certain frequency, in a circuit in which the only inductance is the true self-inductance of a coil. A certain setting of the condenser will be required to produce resonance. Remember that the *inductance* of a coil is measured by the magnetic flux it establishes. Now suppose we neutralize part of the flux set up by the coil. The net flux will be less than it was, and the coil will act as if it had *less inductance*; consequently a *larger capacity* will be required in the secondary condenser to produce resonance.

This is exactly what goes on in a resonance transformer, excepting that in some cases the secondary may act as if its inductance has been increased instead of decreased. This seeming contradiction arises from the fact that the reduction of the secondary inductance, as explained above, is an *algebraic* reduction. That is, if more capacity is introduced into the primary circuit, the effect is the same as if we had subtracted a *negative*

Look in the magnifying-glass!

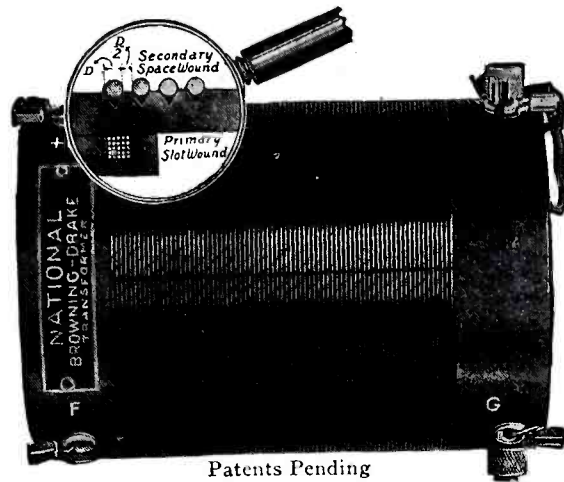

YOU can see two reasons why a radio-set using NATIONAL BROWNING-DRAKE R.F. TRANSFORMERS perform so well.

1 SLOT-wound Primary **2** SPACE-wound Secondary

They were developed mathematically by Glenn H. Browning and F. H. Drake after a year of research at Harvard University and are made under Mr. Browning's supervision.

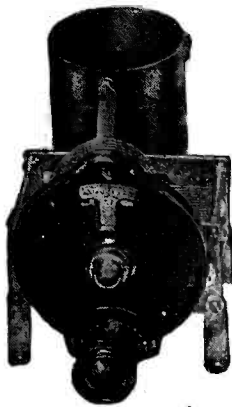

BD-1B

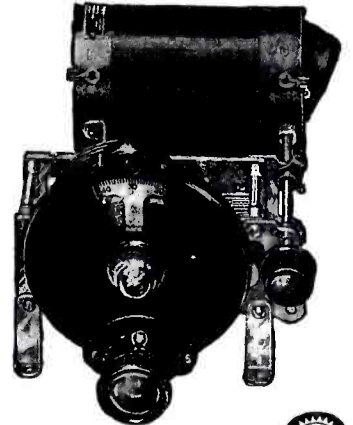

BD-2B

National Tuning-Units

comprise these five coils and the NATIONAL "Equicycle" condensers (plates developed by Prof. R. F. Field of Harvard University, and Carl A. Hellman of Washington, D. C.) and the unexcelled NATIONAL VELVET VERNIER DIALS, Type A, Type B, as shown, or Type C, the ILLUMINATED DIAL.

Price BD-1B, \$10.25
BD-2B, \$14.75

Separate Inductances\$2.00
Separate R.F. Transformers.....\$6.50

NATIONAL Radio set essentials may be easily assembled into a modern receiving set—sensitive, selective, easy to operate and easy to listen to. Send for Bulletin 116-RN.

National Co., Inc., Engineers and Manufacturers, W. A. Ready, Pres., Cambridge Mass.

BE SURE YOU GET THE GENUINE

NATIONAL

RADIO PRODUCTS

LEBNITE

THE POWERFUL NEW
MULTIPOINT FIXT DETECTOR

75c Post Paid 75c Post Paid

The Super-Power Crystal

Double Volume Double Distance
Perfect for Reflex — Great for Crystal Sets
From your dealer or direct. Dealers write for discounts



PALMER & PALMER
404 W. Utica St. Buffalo, N. Y.
Makers of the Famous
MULTIPOINT LINE



Kennedy & Kennedy, 1442 Yonge St., Toronto, Ont., Exclu. Can. Dist

Bradley Leak

THE PERFECT GRID LEAK

Provides a noiseless range of grid leak resistance from 1/4 to 10 megohms. Assures most effective grid leak resistance value for all tubes. Small grid condenser (0.00025) is separate. Metal parts nickel plated. One hole mounting.



Allen-Bradley Co.

Electric Controlling Apparatus
287 Greenfield Avenue Milwaukee, Wis.

YOU need these

AERO COIL SUPER-SENSITIVE INDUCTANCE UNITS



Tuned Radio Frequency Kit

\$12.00

The Aero Coil Tuned Radio Frequency Kit illustrated above will positively improve the performance of any receiver. Patented Aero Coil construction eliminates radio frequency losses and brings tremendous improvement in volume, tone and selectivity.

Kit consists of three matched units. The antenna coupler has variable primary. Uses .00035 condenser. 8 page color circuit, layout and instruction sheet for building the supersensitive 5 tube Aero-Dyne receiver packed FREE with each kit. Extra copies, 75c each.

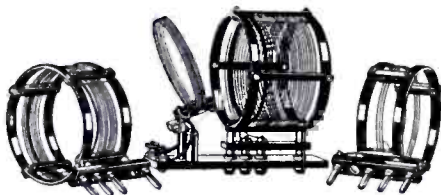

Low Wave Tuner Kit

\$12.50

Completely interchangeable. Adapted by experts and amateurs. Range 15 to 130 meters. Includes three coils and base mounting, covering U. S. bands, 20, 40 and 80 meters. You can increase the range of this short wave tuner by securing coils No. 4 and 5. Combined range of 15 to 550 meters. Both interchangeable coils fit same base supplied with short wave kit and use the same condensers. Coil No. 4 price \$4.00; Coil No. 5 price \$4.00.

These Aero Coils are available at your dealers. Get yours today!

AERO PRODUCTS, INC.

Dept. 105

1772 Wilson Ave.

Chicago, Ill.

DEPENDABLE RADIO EQUIPMENT

Dealers! Set Builders!

Write for FREE

RADIO CATALOG

1. Right Prices
2. Quick Delivery
3. Advertised Lines
4. Complete Stock
5. Dealer Cooperation

Be Sure to Use Business Letterhead When Answering

CHICAGO RADIO APPARATUS CO.,
415 S. Dearborn St., Dept. RN., Chicago

CHIRAD—RADIO—CHIRAD

inductance; which amounts to the same thing as adding to the inductance.

EFFECT OF VARYING FREQUENCIES

Now, keeping all this in mind, let us examine the primary circuit. At frequencies less than the natural frequency of the primary, the net reactance of this circuit is capacitive; that is, as far as the resonance effects are concerned, the complete primary circuit may be regarded as simply a certain capacity, greater than the actual capacity, in series with the resistance of the circuit. At frequencies greater than the natural frequency of the primary circuit, the circuit acts inductively; that is, as far as resonance is concerned, the complete primary circuit may be regarded as simply a certain inductance, less than the true inductance, in series with the circuit resistance.

The result is, that at frequencies lower than the natural frequency of the primary circuit, the capacitive effect of the primary adds to (or "negatively subtracts" from) the effect of the secondary inductance; making the latter act as if it were greater than it really is. At frequencies higher than the natural frequency of the primary circuit, the inductive effect of the primary subtracts from the effect of the secondary inductance, making the latter act as if it were less than it really is. At a frequency exactly the same as the natural frequency of the primary circuit, the latter circuit has no effective reactance—it acts neither inductively or capacitatively—so that its effect on the constants of the secondary circuit, as far as resonance effects are concerned, is nil. Therefore, the effective secondary inductance under these conditions is the same as the true secondary inductance.

All these ideas are shown graphically in the curves of Fig. 4, which were calculated from assumed data, and which are exaggerated for the sake of clearness. The frequency f_0 is the natural frequency of the primary circuit. For frequencies lower than this the effective secondary inductance L_0 is greater than L_2 , the inductance of the secondary coil alone. At the frequency f_0 the primary and secondary circuits are both tuned to the frequency of the impressed signal, and L_0 is the same as L_2 . At zero frequency, likewise, when the reactance of the primary circuit is zero, $L_0=L_2$. At frequencies higher than f_0 , however, the effective inductance of the secondary is always less than L_2 and never equals it, even at infinite frequency. When the frequency is very high, the effective inductance is less than the true inductance, according to the relation $L_0=L_2(1-k^2)$, where k is the coefficient of coupling, and is equal to the mutual inductance divided by the square root of the product of the primary and secondary self-inductances.

The general expression for the effective secondary inductance at any frequency is rather complicated in its entirety, but has the same form as the expression above, excepting that the quantity k is no longer the simple coefficient of coupling of the resonance transformer, but is equal to $2\pi fm^2x_1L_2z_2^2$. F is the impressed frequency, x_1 is the reactance of the primary circuit and z_2 is the impedance of the secondary circuit. Note that the resistance of the secondary does not enter into this expression; this means that the presence of resistance in the secondary has no influence on the adjustments of this circuit to produce resonance. Note, however, that as shown in Fig. 4, the lower the resistance of the primary circuit, the greater is the range over which L_0 varies.

EFFECT OF PRIMARY RESISTANCE

Three curves are shown, one for a primary resistance of 10 ohms, another for $r_1=20$ ohms, and still another for zero primary resistance. Note that the latter curve does not turn back on itself as do the others.



POWERIZER

AMAZING
VOLUME
with
QUALITY!

A "B" Eliminator and power amplifier combined in one unit which employs the new super-power tubes and may be attached to any set. Think of it! Powerizer changes dull, lifeless notes into vibrant mellow tones, full in volume and rich in quality. Gives results not duplicated in sets selling short of \$300 to \$1000. Yet costs no more than a good "B" Battery Eliminator ALONE. Hear Powerizer radio reception. Ask the nearest Powerizer dealer to demonstrate it TODAY.

Price \$49.50

Radio Receptor Co.

106 Seventh Ave., New York



209

"I smoke too much—

and I pass this advice on to other smokers":—

writes a business man

"I talk over the 'phone, sell merchandise, dictate letters and articles, speak over the radio and, in common with many other busy men, I smoke too much. Result—when fatigued my throat feels it first. I get the greatest relief and comfort from Luden's—they soothe and benefit my throat and sweeten the breath after smoking. I keep a box at home, another in my desk, and always carry one in my traveling bag." (Original letter on file)
Luden's will help you, too. In the yellow box—5c—everywhere.

LUDEN'S MENTHOL COUGH DROPS 5¢

BARGAINS!
SAVE 1/3 TO 1/2
WRITE FOR CATALOG
RANDOLPH RADIO CORP.
180 N. UNION AV. Dept. 2 CHICAGO, ILL.

This means that it would be impossible to tune both primary and secondary circuits simultaneously to exactly the frequency of the impressed signal if the primary had no resistance. The minutest change of secondary capacity would seriously affect the whole system.

The writer recently noticed a case like this in a broadcasting transmitter. It happened that the frequency at which it was desired to transmit was very close to the natural frequency of the antenna, and the latter at that frequency had relatively low resistance. When an attempt was made to tune the secondary it was found that, as the natural antenna frequency was approached, the radiation would suddenly jump from a lower to a higher frequency or vice-versa; depending upon whether we started tuning below the natural antenna frequency and tuned up, or above the natural frequency and tuned down. Upon inserting resistance in the antenna circuit it was found possible to tune the circuits; but of course, since this is an inefficient way in which to operate, changes were finally made in the antenna.

This sort of thing happens only when the mutual inductance in the resonance transformer is relatively great. The curves drawn in Fig. 4 have been exaggerated in regard to the variation of L_e ; the actual variation (as calculated) in a radio receiver is very little. On the other hand, the variation found experimentally is quite considerable. The shape of the curves (Fig. 5) was similar to the shape of those drawn for zero primary resistance in Fig. 4 except that the former were much steeper. The great variation of the effective secondary inductance is no doubt due to the capacity existing between the two windings of the resonance transformer. It is interesting to note how rapidly L_e increases as the frequency approaches the natural frequency of the primary circuit.

In connection with this we are led to a better understanding of why so many radio receivers, designed in the past, have been unable to tune to the short end of the broadcasting spectrum. It is difficult to control the capacity in these transformers, and it is doubtful if there is much gain in this respect even when special forms of winding are used; so the difficulty must have arisen mainly from the use of too much mutual inductance. Most of these receivers were constructed to have plenty of resistance in the tuned circuits; and, to counteract the effect of this, rather close coupling was employed in order to get sufficient energy transfer. The closeness of the coupling caused the effective secondary inductance to rise rapidly as the low end of the condenser scale was approached. This effect was not generally foreseen when the coil was designed; for in many cases if the secondary coil, together with the variable condenser, tuned as low as was desired without the primary being connected, it was thought sufficient. Many costly lessons have been learned about resonance transformer coupling; but it is doubtful if many of those designers fully realize the reasons for their mistakes.

INTERSTAGE COUPLING

So far we have considered only the case A of Figs. 1 and 2. We have yet to consider the case B, where the capacity in the primary circuit is missing, and there is instead a high resistance; viz., that of the plate-filament path of the electrons in the tube to which the resonance transformer is connected. There is not much remaining to be said about this case, for much that was said about case A applies to case B also. Let us take the circuit of case A (Fig. 2) and short-circuit the condenser in the primary. In effect the capacity of this condenser has become infinite, and this makes the terms involving C_1 in the general expression for L_e , given above, vanish, or become zero. The resulting expression has the same form as

YOU CAN BUILD THE NEW SHIELDED HI-Q*



The Hammarlund-Roberts Board of Engineers

The Hammarlund-Roberts Hi-Q Receiver is the joint creation of ten of America's leading engineers.

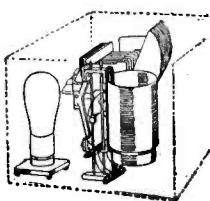

Automatic Variable Coupling

A wonderful new feature which gives maximum and equal amplification and selectivity over entire tuning range.



"How to Build It" Book

Simple A B C language. Every detail described, numbered and diagrammed so that you can easily understand it. 25c.



The Hi-Q Foundation Set

Includes drilled and engraved panel and sub-panel and all the essentials required to start building. Price \$10.50.



\$63⁰⁵

Over 57,000 Built at Home
You Can Do It Too



IF you want radio's greatest value look into this New Shielded Hi-Q Receiver—designed by ten leading American engineers. Even a greater instrument than the famous Hammarlund-Roberts which has been built by over 57,000 novices. Incorporates every modern feature. Highest quality parts are **PERFECTLY MATCHED**. Five tubes equal eight. A new feature eliminates distortion and produces the sensitivity of expensive many-tubed "Supers". And on all stations, tone has that velvet-smooth, crystal-clear quality you have always hoped for.

Ask your dealer for the "How to Build" book and learn how you can build one of the world's finest radios—at a saving of \$50 to \$100 over sets of anything like similar efficiency.



*High ratio of reactance to resistance. High ratio—Great Selectivity—Loud Signals.

HAMMARLUND-ROBERTS

1182-C Broadway, New York

C. L. PARKER

Ex-Examiner U. S. Patent Office
Attorney-at-Law and Solicitor of Patents
McGill Building, Washington, D. C.
Patent, Trade Mark and Copyright Law

KARAS EQUAMATIC

ALL GENUINE PARTS IN STOCK NOW!
FREE WHOLESALE CATALOG
Listing thousands of new radio parts, kits, furniture, accessories and complete radio sets, at prices that save you money. Write for your copy now, it's free.
THE HARCO CO., 1253 S. Wabash Ave., Chicago, Ill.

DEALERS!

Complete stock of nationally known parts and accessories. Send for illustrated catalog and discount sheet.

Radio Exclusively Since 1921
CLARK & TILSON, Inc.
122 CHAMBERS ST. New York
The Nationally Known House

FREE RADIO GUIDE

164-PAGE (1927) GUIDE
Gives special hook-ups with illustrations. Shows big savings on standard radio parts, complete sets, kits. Be sure to get this thrifty book before you buy. Write letter or postal NOW. Also include name of another fan.
BARAWIK CO., 542C Monroe St., CHICAGO, U. S. A.

Insure your copy reaching you each month. Subscribe to Radio News—\$2.50 a year
Experimenter Publishing Co., 53 Park Place, N. Y. C.

Positive Control of Volume all the time

THE U. S. Navy, the Signal Corps and 69 makers of leading standard sets use the variable resistance controls made by Central Radio Laboratories. You need them if you want the last word in fine reception.

Centralab Modulator

In any radio circuit, will control tone volume from a whisper to maximum. Improves tone quality and prevents overloading of tubes or speakers. Recommended by Thorardson, Samson, and other makers of high grade amplifiers. **\$2.00** at your dealer's.

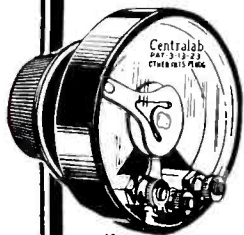

Centralab Rheostat

Where old design rheostats overload, heat and quickly become noisy on new style tubes using increased current, Centralab Rheostats have more current capacity and are smooth and permanently quiet.

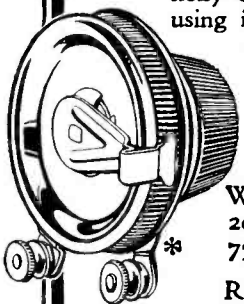

Wire Wound 6, 10, 20, 30 or 75 ohms, **\$1.00**

Ribbon Wound 2 or 3 ohms for 5 to 10 tubes, **\$1.25**

CENTRAL RADIO LABORATORIES
19 KEEFE AVE., MILWAUKEE, WIS.

Makers of Variable Resistances for all circuits. Write for free Hook-ups.



American Radio Now - Lowest Wholesale Prices on RADIO!

BIG NEW 1927 CATALOG-FREE
Dealers, Agents, Set Builders - get our big 1927 Catalog - 225 nationally advertised lines. Low money-saving prices! Largest, most complete stock. Radio's latest developments. It's FREE - send for your copy now. AMERICAN AUTO & RADIO MFG. CO., Inc. 1433 McGee Street, Kansas City, Mo.

Send for Latest RADIO CATALOG and GUIDE

Radio's Newest at Rock-Bottom Prices
The new 1927 edition of the Barawik Catalog and Guide gives a comprehensive listing of the radio sets, parts, kits, supplies and accessories necessary in radio. This new GUIDE contains over 6,000 items of radio's newest developments, everything that a real fan will need from the complete factory-built set to the smallest screw, including labor-saving devices, tools, power supply units. Send TODAY! Also include name of another fan. BARAWIK CO., 542-C Monroe St., CHICAGO, U. S. A.

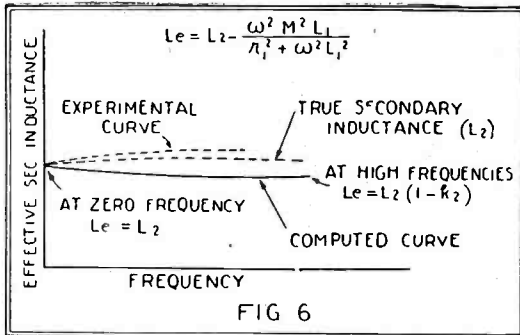

These curves show how the effective inductance in an interstage-coupling coil varies with frequency.

the one given before, but now k has become 1

$4^2 f^2 M^2 L_1 z_1^2 L_2$. Furthermore, the impedance, z_1 , is now composed of only resistance and inductive reactance, the condenser being removed from the primary circuit.

There are several things to notice about this expression: first, that there is no term in it whose algebraic sign changes with frequency, as do the terms in parentheses in the original expression. In other words, for this case, the effective secondary inductance is always less than the true secondary inductance. Also, as in the previous case, the resistance of the secondary plays no rôle in influencing the adjustments for resonance. It is also evident that the fraction in this expression has a very small value in ordinary cases.

In other words, the actual variation of L_e (as calculated) in this case is very small, as in the previous case. At zero frequency L_e is equal to L_2 . At all other frequencies it is less, and at infinite frequency it is given by the same expression that gave the value of L_e at infinite frequency in case A. The computed curve is shown in Fig. 6 (heavy line). On account of the coil capacity the experimental curve not only does not drop with increasing frequency, but actually rises. The curve of Fig. 5 (for case A) acts in exactly the same manner; if it were not for the capacity between the coils the curve would always be below the value L_2 , at frequencies greater than f_0 . But the coil capacity makes it rise above this value, just as in the case of the experimental curve (for case B) given in Fig. 6.

It is thus possible for the interstage coupling transformers to limit the wave range over which the receiver will receive. The rise of secondary inductance with increasing frequency (decreasing wavelength) may make it impossible to tune to wavelengths as short as desired. It is more than likely, however, that most of the trouble mentioned above lay in the antenna coupling coil, as it is here that L_e varies most widely.

There is much to be learned from this study that will be of benefit in the design of radio receivers. Thus far we have not been able to employ resonance transformers designed to be as efficient as they might be. The reason is that, when really efficient transformers are used, the circuits break out into oscillation, and something has to be done to stop this; the expedients we adopt for this purpose cause us to lose elsewhere what we expected to gain in the efficient coupling transformers.

It has been found possible, however, to use very efficient transformers in the bridge types of circuit, especially in that which employs only condensers in the arms of the bridge. It is not possible for such a bridge, when properly balanced, to become unbalanced, as none of the elements in the various bridge arms vary with the frequency. We may expect great things therefore, when properly-designed resonance transformers are used in properly-designed circuits.

IT'S A WONDER! Works So Easy

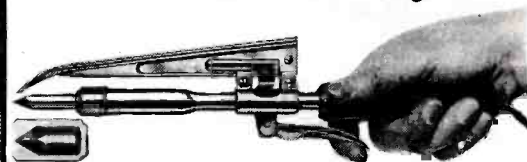

Press-to-Feed Electric Soldering Iron

A great invention. Indispensable for all kinds of soldering work. Convenient, simple, economical. One hand does the work of two. Made with removable tip— $\frac{3}{8}$ " and $\frac{1}{4}$ " round, making it adjustable for light or heavy work. Trigger Press-to-Feed attachment takes all sizes of solder wire. Operates on either D.C. or A.C. 110 to 115 volts, 50 watts. Attachments are made to fit all leading makes of electric soldering irons. Price complete with Press-to-Feed attachment **\$3.50**
Attachment only **1.50**



Radio Work requires this iron. Gets into tight places with ease. Speeds up radio set building.
Agents Press-to-Feed is a necessity for industrial and domestic uses. Big profits selling this wonderful iron to factories, homes, auto mechanics, etc. Order a sample. Quantity discounts on request. Write to
ILLINOIS STAMPING & MFG. CO.
220 N. Jefferson St., Dept. 14 CHICAGO

RADIO BOOK FREE

64 pages full of opportunity. Your guide to what's right and standard in Radio; full explanation of liberal offer paying agents \$60 to \$100 a week and how to get latest radio goods at wholesale.
Big Money In Radio
We want live dealer and agents in every locality. Lifetime opportunity. This Book more than a catalog—shows big profit way to get into world's newest and richest field—make big money—turn full or spare time into cash. **Accept This Offer!**
Write for FREE book. Lowest prices—make 40 to 60% every sale. 5-tube Coast to Coast Receiver \$39.50 Retail. Sells on sight. Hundreds of such money makers. Write for special agent's wholesale prices. Newest sets, parts and accessories—tremendous saving and profit. Write for FREE book and amazing offers.
Standard Radio Company, 1410 Walnut St., Kansas City, Mo.

COILS Special	GEN-RAL	PARTS Regular
For Manufacturers	REGISTERED	For Dealers
WRITE For The Four Tube Hook-up With THE GEN-RAL TEAM		NEW DUO-FOMER Five Tube Circuit Is Ready NOW
Chicago's Favorite	A Special Message	No Charge
GENERAL MANUFACTURING CO. 6637 So. Cottage Grove, Chicago		

SAVE 1/3 TO 1/2!
Everything in Radio
WRITE for CATALOG—FREE
RANDOLPH RADIO CORP.
180 N. UNION AV. Dept. 2 CHICAGO, ILL.

Automatic Devices in Radio Manufacture

(Continued from page 797)

AN AUTOMATIC TEST

This synchronization makes possible a remarkably high standard of quality and quantity. The slightest inaccuracy in parts going into assembly shows up at once, because it becomes difficult for the particular operator affected to keep up with the movement of the belt. If anything does get to the assembly department which is not quite right, it is thus immediately detected and either remedied or replaced.

The mechanism of this belt is unique, there being nothing like it on the market. It is possible to adjust both the speed with which the belt travels and also the distance which it moves at each interval. The motion of the conveyor is intermittent, thus furnishing an automatic standard of time for each operator, her task being to complete her operation before each successive movement of the belt. The most interesting point about this method is that the operators like it, the production units having been set up with particular regard for the girl's comfort. Care was even taken to paint the conveyor frame in attractive colors. Because the synchronous arrangement does not in any way overtax the operators, the job is an attractive one from the workers' angle.

AUTOMATIC MOULDING MACHINES

Another interesting job in the shop is the automatic moulding of bakelite. Here again each machine is right beside a moving conveyor or belt; parts dropped automatically from the machine are immediately carried to the next floor for inspection. Accumulation of parts in the moulding department is absolutely avoided. The moulding machine which is shown in Fig. 2 at the right of the belt conveyor is about as automatic as it is possible to make a mechanical device.

In the first step, the proper amount of bakelite powder is automatically furnished for each mould. The moulding dies go through the presses automatically and the finished parts are ejected in the same way. An immense amount of thought and development has been spent on these processes in order to make possible maximum quality, standardized volume production, low costs, and low selling prices.

The production of the dies which are used in the moulding of these radio parts is interesting. A highly specialized corps of die makers is required for this work. The steel dies are formed under tremendous pressure in a special hydraulic press, the use of which saves an immense amount of hand labor and

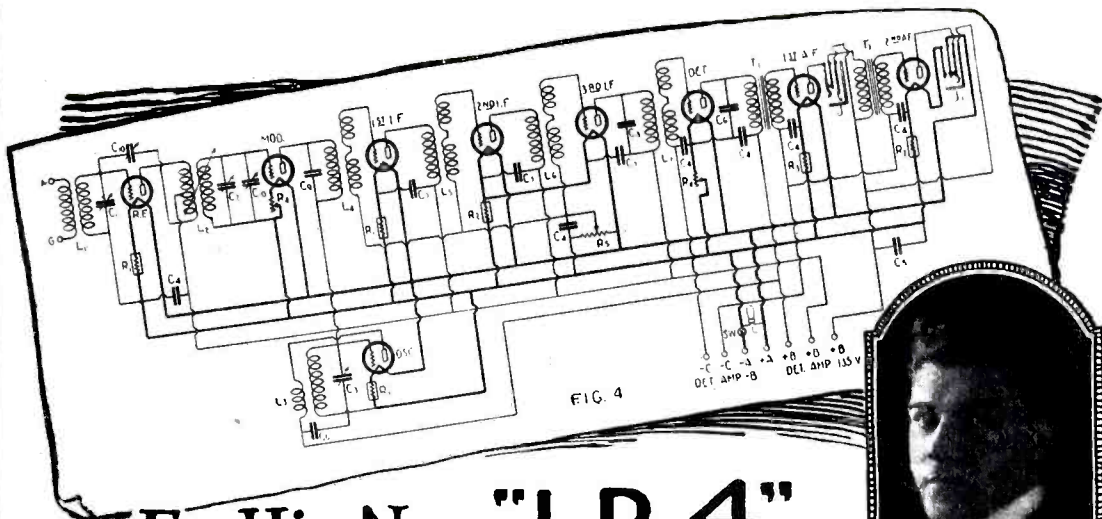

For His New "LR 4"

R. E. Lacault specifies

HAMMARLUND Condensers and Coils



Among the other new circuits of the season for which Hammarlund Products are specified are:—Cockaday's "LC27"; Sargent's "Infra-dyne"; St. James Super; Browning-Drake; the new Harkness; "Henry-Lyford"; Morrison's "Varion"; Victoreen Super; Loftin & White; "Carborundum"; Paent's "Ultimax"; Popular Science Monthly's "Powerful"; Hammarlund-Roberts "Hi-Q".

DESIGNERS of new circuits and construction kits know the danger to both their personal prestige and the success of their product by including any material of other than the highest standing.

Hammarlund has long preached and practised the basic principle that only perfection in each individual radio unit can result in satisfactory performance of the completed receiver over a period of years. This principle is now generally recognized by the better designers, which accounts, we believe, for the use of Hammarlund Products in so many of the season's featured circuits.

The condensers, equalizers and space-wound coils specified by Mr. Lacault for his new "LR4" Receiver are typical of Hammarlund Quality. Use them wherever you require quality results and permanent satisfaction.

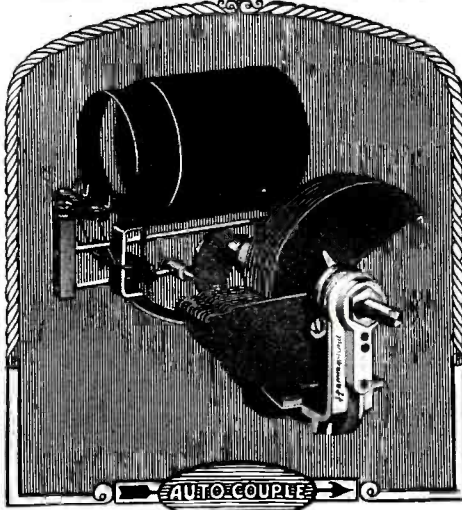

HAMMARLUND MANUFACTURING COMPANY

424-438 W. 33rd Street, New York



We shall be pleased to refer to the proper authorities your inquiries regarding any receiver mentioned above.

For Better Radio
Hammarlund
PRECISION
PRODUCTS

Write for illustrated literature describing Hammarlund Precision Products for all the popular circuits. Dealer inquiries invited.



CABINETS

GET READY FOR CHRISTMAS!

WE HAVE PREPARED A LARGE STOCK—12 HOUR SHIPMENTS

The Southern Toy Co., Hickory, N. C.

Insure your copy reaching you each month. Subscribe to Radio News—
\$2.50 a year. Experimenter Publishing Co., 53 Park Place, N. Y. C.

FREE

BE AN AUTO EXPERT

Earn Up to \$150 a Week!

Clip coupon below for these 3 Auto Lessons. I'll send them absolutely FREE and without any obligation whatever! I'll PROVE that I will train you at home in your spare time for the tremendous money-making opportunities in this gigantic Auto Business! Whether you're young or old—experienced or not—send for these FREE lessons! See for yourself that Common Schooling is all you need to be started on the way to Quick Raises in Pay—extra Spare-Time Money—a Big Auto Job that pays up to \$10,000 a year—or a Business of your own through my "Job-Way" Training. My big new Auto Book also FREE! Tells about my Lifetime Employment and Consultation Service, and the 4 big working outfits I give you free of extra charge. Get all the Facts. Act Quick!

3 AUTO Lessons

CLIP NOW! COUPON

Send lessons and book free

B. W. COOKE
Directing Engineer
CHICAGO MOTOR TRAINING CORPORATION
1916 Sunnyside Ave., Chicago, Dept. 188
Rush Lessons, Book, and Particulars to:

Name _____
Address _____

NEW KLOSNER UNIVERSAL SOCKETS

now 35¢

TYPE "X"

Special Offer By Mail

Improve your circuit. Made of genuine low-loss Bakelite, with double-grip phosphor-bronze contacts, Spring-grip terminal lugs. Also New Type "T" for real sub-panel concealed wiring; you don't have to drill special large holes—40c each.

SPECIAL OFFER BY MAIL—POSTPAID

Type "X" Set of 6 Boxed—	\$1.85
Set of 5 "	\$1.50
Type "T" Set of 6 "	\$2.15
Set of 5 "	\$1.75

Order Your Sockets Now.

KLOSNER RADIO CORPORATION
1022 East 178th Street : New York

what adds so much to radio satisfaction—at so little cost—as MAR-CO Dials? handsome, responsive, supremely accurate—put them on your set tonight.

MAR-CO DIALS

reduces their cost considerably. A mirror finish is put on by hand before the dies are ready for use.

Automatic machines have been devised to take care, wherever possible, of the machining and assembly operations. In the assembling of sockets and knobs a single automatic machine drills, taps, and assembles the set screw in the moulded bakelite knob. Another automatically threads the terminal nuts on the radio tube sockets. (Fig. 3).

Quality is maintained by careful inspection and testing; the sockets, for example, are tested in a special fixture with indicating lights showing every characteristic, so that any variation from the standard is easily detected. These tests, and many others, are made all along the production line, numerous specially-designed testing fixtures being used.

The experimental laboratory is equipped with every kind of instrument for the measuring and testing of radio apparatus. A studio, carefully constructed for proper acoustics, is employed as the scene of comparative tests, carried out with all types of radio apparatus, and particularly audio amplification systems.

Correspondence from Readers

(Continued from page 836)

liar, and the article therefore is filled with lies and is not true. Your article therefore should not have had the title of "Confessions of a Radio Grafter," but should have been entitled "Confessions of a Liar and Thief."

YET HE KNOWS OF ONE

There is no doubt in my mind whatever that there are some crooked service men in the radio field. Only yesterday I was called on a service job. The man who owned the set knew nothing about radio. He told me that he had just had his set to a dealer in Pittsburgh, who took out the screws that held the radio in its cabinet and began smelling the three transformers in the set. After smelling them a little while, he informed the owner that two transformers in his set were "burnt out," and that the two new transformers would cost him \$9.00, installed. The owner left the set for repairs; but after he got it home found that the set was just as bad as ever, in other words, it did not work. Then he called me on the job.

I inspected the radio and found that two of the three transformers had recently been painted, and that the dealer who pretended to put in two new transformers did not do so, but just gave the old ones a coat of black paint in order to make them appear as though they were new. Further evidence of his not putting in two new transformers was evident; for the reason that the manufacturer who made the set sold the transformers (replacements) for \$7.00 each. In other words, the job should have cost \$14.00 plus time for installing the transformers; the set not being worth this amount, as it was being sold here in Pittsburgh at a reduced price of \$10.50. Upon further examination of the set I found that there was one open transformer. I purchased a new one, installed it in the set at the customer's home, and left the old transformer with him.

L. J. Persohn,
1011 Chestnut St.,
N. S. Pittsburgh, Pa.

(The article in question, "Confessions of an Installation Grafter," was bona fide.

It was a combination of experiences by the author and experiences of his fellow installers, during their careers.

The outburst of our correspondent is not

M&H

Radio's largest kit supply house

ESTABLISHED 30 YEARS

POWERS-CASEM Receiver!

BRAND NEW KIT NOW READY. Identical parts used by designer. One of Radio's newest and best Radio Sets..... **Price \$35.00**

CARBORUNDUM

8 TUBE—SEMI-SHIELDED

THE NEW YEAR'S BIG SENSATION ORIGINAL KIT

TONE—VOLUME DISTANCE **Price \$80.00**

LR4

BIG KIT OF ORIGINAL PARTS USED BY THE DESIGNER

R. E. LACAULT

9 TUBES **Price \$60.00**

BIG-POWERFUL

OUR CIRCULAR IS NOW READY

It Will Pay Set Builder to Send for This.

M. & H. SPORTING GOODS CO.

512 Market St., Phila., Pa.

RADIO CATALOG

Dealers! Send for our new 1927 Catalog. Contains nationally advertised high quality sets, kits and parts.

Use your letterhead.

Western Radio Co. MFG

134-136 W. Lake St. Chicago, Ill.

RADIO SET FREE

5 TUBE

AND \$100 A WEEK JUST SHOWING IT TO FRIENDS

The Ambu Institute has perfected the finest 5 tube set ever made. Out-performs all others and sells for half store prices. We need men to represent us in every territory and will give demonstrator set free if you will show it and take orders from your friends.

READ! Your set is certainly a wow! It performs better than any I've heard. Took orders for 6 in 2 nights. My profit \$212. Can sell 50 more this season easy. I'm out for a big profit.

R. MASON Michigan

Coast to Coast Reception. More distance activity, easier tuning, perfect rich reception of great volume. Big demand in your territory. Ordinary All Waves, 40-600 Meters. sets cannot go below 200. Famous Ambu Five gets all stations, local and foreign, 40 to 600 meters. Hundreds want this amazing new kind FREE of set. You can make \$100 to \$200 a week just showing free demonstrator. I set you up in Radio business and give you set free. Write quick for information. Postcard will do.

FRANK CONDON, Dept. 28N 2632 Prairie Ave., Chicago, Ill.

COMPLETE KIT TO BUILD A 36-IN. CONE SPEAKER

\$12.00

Kit consists of Guaranteed adjustable Fenco balanced unit, 2 sheets Alhambra Fonotex paper, cut and ready to glue. Also baffle ring and unit support. One can of Ambroid Glue and instructions for assembling.

If your Dealer Cannot Supply Order Direct From

Fenco-Cone, 57 Murray St., New York

START THAT NEW CIRCUIT with a Genuine RADION PANEL

"The Supreme Insulation"

SUPERIOR insulating characteristics. **EASILY** cut and drilled.

RESISTS warping....
Positively **MOISTURE**
PROOF.

Ready-cut sizes.

From your dealer or order
by mail..... Catalogue of
Radion Panels and parts
on request.

**American Hard Rubber
Company**
11 MERCER ST., NEW YORK

convincing, because, first of all, the public must be protected from grafters of this kind and the more the public knows about the game, the more quickly will these grafters be stopped.

As our correspondent admits, he knows some of the grafters, and, on the other hand, it should not be difficult for an honest installer to make his living in an honest manner, if he so chooses.—EDITOR.)

I Want to Know

(Continued from page 842)

wire, two-layer bank winding (L5, L6); start $\frac{3}{4}$ inch over and wind 26 turns of No. 20 D.C.C. wire, two-layer bank wound in the opposite direction (L3, L4); start $\frac{3}{4}$ inch over and wind 5 turns of No. 20 D.C.C. wire, two-layer bank winding in the same direction as the first coil. Connect as shown in the schematic wiring diagram. (L1, L2).

OUTPUT TRANSFORMER: form is 2 inches inside, 4 inches outside diameter, with a winding space $\frac{5}{16}$ inch wide; the primary is 100 turns of No. 28 D.C.C. wire wound at random; the secondary 300 turns of No. 28 D.C.C. wire, wound in the opposite direction.

ANTENNA INDUCTANCE: primary form, $1\frac{1}{4}$ inch tube, $\frac{1}{16}$ inch thick, $2\frac{5}{8}$ inches long. Wind 20 turns of No. 32 D.C.C. wire, in 2-inch winding space, and equally spaced from ends of tube (L). On top of the first coil, and separated from it by a piece of paper, wind 40 turns of No. 32 D.C.C. wire in same direction; Secondary form—2-inch diameter $\times 1\frac{1}{16}$ -inch wall $\times 2\frac{5}{8}$ -inch long formica tube. Wind 100 turns of 10-strand No. 38 (Litzendraht) with a tap at 50 turns. Wind in opposite direction from the two primary coils and spaced evenly from ends of the tube.

Oscillations and the sensitivity of the receiver may be controlled by the insertion of a 400-ohm potentiometer (in the proper manner) at points marked "X" in the intermediate-frequency stages. One may be used for both stages.

20-Meter Installation

(Continued from page 890)

be found without difficulty; there are so many stations working at this wave. The 9-turn coil will probably cover this. Select a tickler of say, 5 turns; set it into its proper place on the bakelite strip and move the condenser knobs. Set the secondary condenser at about the center of the dial and move the other condenser knob. If the set does not oscillate move the tickler coil up against the secondary and again proceed as before. Then try turning the tickler around; it is unnecessary to remove it from the posts, just twist it around through 180° . If the 5-turn coil doesn't seem to bring the set into oscillation, try a 7-turn.

Usually one has little trouble with the circuit, if connections are properly made, the filament voltage is correct and the plate voltage is sufficient. If the 7-turn works you may find that a 6-turn would perhaps be better. That is, you should be able to bring the receiver into and out of oscillation with a slight hiss by merely moving the throttling-condenser knob. The tickler should be placed at such a distance from the secondary that the set oscillates when the by-pass condenser is at half-scale; and this should be when your secondary condenser is tuned to the center of the particular wave-band.

We have our set on 40 meters and by a little experimentation we have become acquainted with all the tricks of the circuit. Now for 20 meters. This is the most difficult part if a wave-meter is unavailable. One method is to adjust a transmitter to operate at 40 meters; then by gradually reducing the turns in the secondary and tickler, to listen for a strong harmonic. Another way is to



An Amazing New 6-Tube, Two-Dial Receiver That You Can Easily Build at Home.

The perfect tone reproduction of the new Quadraformer can not begin to be approached by any other receiver—not even former Quadraformer models. But this is not all, for the Quadraformer system of radio frequency amplification accomplishes a combination of radio virtues previously thought impossible in one radio receiver. As Mr. W. G. Hopson (address on request) wrote of the Quadraformer V:

I am one of those fans looking for tone quality, selectivity and distance, and I have found the three hard to get at the same time, as it has been generally necessary to sacrifice at least one. Recently I built one of your Quadraformers and it surprised me by qualifying in all three. It has a wonderful tone, is very selective, and is a good distance getter. I have traveled from coast to coast and even ventured down into southern Florida. We live in the heart of Chicago and on a recent Saturday night, when the Chicago stations were doing their best I went through them and brought in ten distant stations, including KFI!

NEW FEATURES: Selective SELECTIVITY and SENSITIVITY

In driving your automobile, you select the gear ratio to suit the need of the moment. If the going is hard, a shift into the powerful low and the car plows right on thru. Second gear is a mixture of power and speed, and high is mostly speed.

The new Quadraformer VI adapts this idea to radio. An arrow knob on the panel has three numbered positions. Set it on "1", and you have maximum selectivity with normal sensitivity. Position "2" is intermediate between selectivity and sensitivity; while "3" gives the set's greatest sensitivity and normal selectivity. For the first time, a radio may be adjusted to work best in any location, and varied from maximum selectivity to maximum sensitivity instantly, at the operator's wish, to suit receiving conditions.

New SHIELDED QUADRAFORMERS

The famous Quadraformer coils have been redesigned and are individually shielded in handsome burnished copper containers. Large wire, specially insulated, is used and the coils are unconditionally guaranteed against burn-outs or other defects. The new shielding makes the set unusually selective, as energy pick-up by the individual circuits is prevented, and the signal energy you desire to amplify is forced thru each tuned circuit successively.

Efficient HIGH WAVE-LENGTH AMPLIFICATION

Many sets amplify satisfactorily the wave-lengths below 400 meters, but fall down miserably on the higher wave-lengths. In the new Quadraformer VI is incorporated the AMPLI-TROL—Gearhart Schlueter's latest invention—which absolutely gives you the same powerful amplification on wave-lengths up to, and above, 600 meters, as it does on those around 200. KSD, KFUD, KYW, WHA, WOAW, WNYC and WHO boom in with a volume that is amazing.

Simplicity of Control:

The set is easy to tune—two dials bring in your stations. No verniers. Logs absolutely. It is easy to build. You need only the new Quadraformer Essential Kit, which contains the three shielded Quadraformers, the Ampli-trol, the Selectivity Control, and complete instructions, which costs \$17.50 prepaid; and some \$50 worth of other standard parts, most of which you probably have.

Send 25c. today for the new QUADRA-FORMER BOOK, which contains complete step-by-step instructions for building this wonder set.

Gearhart-Schlueter Radio Corpn.
P. O. Box 666A Fresno, California

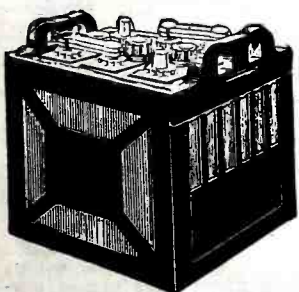

CHICAGO RADIO BATTERIES AUTO

Solid One Piece
Rubber Containers
**GUARANTEED
FOR 2 YEARS**

FAMOUS for unexcelled quality, guaranteed long-lived service and unvarying dependability. Chicago Batteries offer the Radio fan an "A" Power that is backed by years of experience and master workmanship with the finest materials available. Endorsed and approved by leading Radio and Automotive authorities. Chicago Batteries in their new non-leak, solid rubber cases represent an amazing value at lowest cost.

PRICES SOLID RUBBER CASE RADIO BATTERIES

6 volts, 100 amps.\$ 8.79
6 volts, 120 amps. 10.79
6 volts, 140 amps. 13.50

SAVE MONEY—ORDER DIRECT
Buy Chicago Batteries direct from the manufacturer. Batteries shipped same day order is received. Express C.O.D. or 3% discount cash with order.

MOGUL ELEC. LABS.
1210 So. Peoria St. Chicago, Ill.

Potter Condensers

Potter condensers, American made of highest quality materials to full capacity, build the best Socket Power Devices, Power Amplifiers, Impedance Amplifiers. And they are best for Filter Uses, Rectifiers, By Pass, and Blocking D.C. All types and sizes.

POTTER MANUFACTURING CO.
North Chicago, Illinois

Do This - Earn \$100 to \$200 A WEEK

Grasp this surprising opportunity! Insure your future in fascinating work which offers ordinary salaries of \$200 to \$800 a month—with unlimited possibilities for the future. Right now *Electricity* demands young men—and will reward them generously even at the beginning. Vitaly interesting work—clean—and easy to get started. But best of all is the real money it pays 12 months a year!

Free R. R. Fare To Chicago

Qualify now—in the Great Shops of Coyne at Chicago—world's Electrical Center! Free R. R. fare to all who enroll. No higher education or previous experience needed. No books. No dry lessons. All practical work on actual electrical equipment—under personal guidance of experts. We assist you to earn while learning. Free employment service. And (right now) Free course in Radio and Auto Electricity. Write for Free Book today.

COYNE Electrical School
Dept. 17-77
1300 W. Harrison St., Chicago, Ill.

H. C. LEWIS, Pres.,
Coyne Electrical School, Dept. 17-77,
1300 W. Harrison St., Chicago, Ill.
Without obligation, please send me your FREE illustrated Book on opportunities in Electricity and Special Offer.

Name
Address
Town State

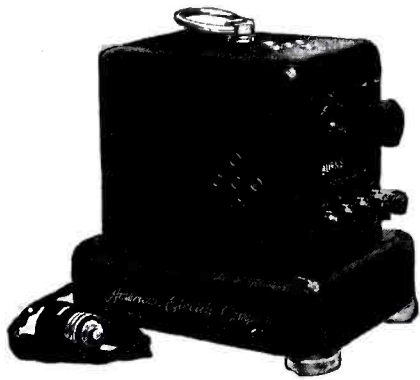

It Delivers FULL "B" VOLTAGE

Burns

B-Battery Eliminator

Operates from lighting current like other household appliances. No hum or vibrations. Smooth constant plate supply. Once connected it requires no further attention or adjustment.

Popular Price—Write for Data.

American Electric Company

State and 64th Streets Chicago, U. S. A.
Makers of Burns Loud Speakers

FREE RADIO GUIDE—SEND FOR IT SETS, PARTS, KITS



164 PAGES OF NEW IDEAS
You need this big FREE book. A practical guide to success in set building. Gives new 1927 hook-ups. Shows the latest parts and kits at prices far below others. Send today. Build the newest sets. Make more money.

BARAWIK CO.

540-542-C Monroe St. Chicago, U. S. A.

We Establish You

Co-operative membership in EIA is establishing an honest man in each locality, regardless of his handicaps. In a successful radio industry of his own. Apply by letter to **EQUITABLE INDUSTRIES ASSOCIATION**, Dent. R. Tenth Ave., New York.

listen with the receiver for the harmonic of some friend's oscillating 40-meter receiver. All this, however, is like working in the dark; a wave-meter is such a simple, inexpensive and important addition that you should not be without one. When your receiver is properly adjusted on the 20-meter band you are ready to adjust your transmitter.

TRANSMITTER ADJUSTMENT

Remove the secondary from the immediate vicinity and set the filament clip at the center of the primary inductance. Set the plate clip at the opposite end to the grid clip, bring the plate voltage to about one-half normal, raise the filament voltage to its proper values and depress the key. Usually little difficulty is experienced in making the set oscillate. Listen in the receiver when pressing the key; you should hear a fairly strong signal; a click doesn't mean anything. Adjust the filament clip until the set oscillates strongly. The correct position is about half-way between the grid and plate clips but perhaps a turn or so nearer the latter.

If the plate current is excessive and the tube heats badly, readjust the filament clip. Moving it toward the grid end of the inductance will usually lower it greatly. If the wave-length is too high, as determined by wave-meter or by listening in the receiver, move the plate clip toward the grid end a turn at a time and again adjust the filament clip.

After the primary is in operation on the proper wave bring up the secondary. All kinds of strange things happen if you are not careful. Do not make the coupling too close—start at say 4-inch and move the counterpoise series condenser until you notice a small kick in the plate milliammeter or you get some radiation. Don't expect to blow the meter; you'll be lucky if you get any at first with a five-watter. All this time you have been listening in the receiver. Now try a little closer coupling, say 3 inches. This would be a fine place to leave the secondary; but you may find, while bringing it into resonance as before, that the oscillator will suddenly stop oscillating. The remedy is to reset the filament clip. or to adjust the series condenser so that the circuits are not exactly in resonance. The



IN OUR JANU-ARY, 1927, ISSUE

"THE RED DUST," by Murray Leinster. You have, of course, read "The Mad Planet." "The Red Dust" is a sequel to this all-absorbing and now famous story.

"THE MAN WHO COULD VANISH," by A. Hyatt Verrill. The author of "Beyond the Pole" and "Through the Crater's Rim" has written what is, to our mind, a real masterpiece. You will read and reread this story.

"THE MAN WITH THE STRANGE HEAD," by Dr. Miles J. Breuer. When a physician turns author, you may be sure that he will write a story that we can all enjoy.

"The FIRST MEN IN THE MOON," by H. G. Wells. Our adventurers are now on the moon, or, rather, inside of it, and are fast getting acquainted with the superhuman insect race which he pictures as reigning on our satellite. The second installment is packed full of weird and exciting incidents that you can never forget.

"THE SECOND DELUGE," by Garret P. Serviss. Cosmo Versal was right. The deluge covered most of the highest mountains of the Himalayas. In this installment we are told of some strange adventures in the submerged cities.

PRICE 25c PER COPY AT ALL NEWSSTANDS

TEST YOUR BATTERY with a BATTERY GA-JIT

REPLACES MESSY HYDROMETERS.

\$1.25

NO RADIO OR AUTO COMPLETE WITHOUT ONE

No more spilling of carpets with acid. Battery Ga-Jit replaces the messy acid spilling hydrometer and tests your battery in a second.

At Your Dealer's
If he can't supply you send price and we will forward one, postpaid.

General Instrument Corporation
477 BROADWAY - NEW YORK, U.S.A.

THE NEW In-a-Cap Hydrometer and Water Gauge Battery Testing Simplified

and safeguarded with combination hydrometer and water gauge. Know when to charge—when to add water, one squeeze of the bulb does both. This is an exclusive IN-A-CAP feature. It extends about 3" above battery, is properly vented so battery can be used and charged with hydrometer in place. It is not necessary to handle the instrument, therefore it cannot drip, be misplaced or broken. Don't ruin your battery when it is so simple to care for. It insures longer battery life, protects rugs, floors, clothes, and makes certain good reception at all times. Tested and approved by leading radio publications. Sold on money back guarantee. 75c each. Set of three \$2.00.

CURVED BATTERY FILLER

Replenish your A Batteries, Wet B Batteries, Trickle Chargers, Eliminators and Power Units without moving them from your cabinet. Also good for your Automobile Battery.

The curve does the trick—fits in the tightest places. No radio fan should be without one.
4 oz. Rubber Bulb 65c; 6 oz. Bulb 75c.
IN-A-CAP HYDROMETER CO.
1341 14th Place - Chicago

dial-action can be smooth, fine, responsive—or it can be rough and jerky. put a set of **MAR-CO Dials** on your set tonight and see the difference.

MAR-CO DIALS

Insure your copy reaching you each month. Subscribe to **RADIO NEWS**—\$2.50 a year. Experimenter Publishing Co., 53 Park Pl., N.Y.C.

latter is good procedure anyhow, if you desire a steady note; a note that will not vary every time the antenna system "constants" vary slightly.

EXPERIMENTATION

Some rather interesting things are noted at this wave-length. A distant station may be heard quite loudly at a certain time of day, then grow fainter and finally not be heard at all; this is especially noticeable at sunset. Sometimes this effect may be made use of in carrying out communication over great distances. If you notice, that in your particular location, stations from a certain distant locality come in particularly well at a certain time of day and certain wave-lengths, you may be practically assured that signals from your own transmitter, if on the same wave-length and with equal power, will arrive at this locality with about equal intensity. The thing to do then is to change your wave-length so that this effect may be made use of.

Changing the wave-length of the transmitter is rather bad practice but if you are the experimenting type of amateur you will probably know how to do this and get away with it. With some experimentation you can readily determine the correct position of the plate clip for the particular wave. The filament clip must also be slightly readjusted and the primary and secondary circuits should be brought into resonance again. It may be well to attach small tags, with the proper wave-lengths marked on them, to the inductances, so that this wave-changing business will not consume much time.

Perhaps after you have experimented with the 20-meter outfit for some time you may become curious enough to try your luck at 5 meters. At this wave-length, all the knowledge you may have gained through experimentation on 20 meters will be of value to you; any slight change in wiring, in capacity values, in fact any change that can be made, almost, will change the wave-length. The experiments that may be performed with reflectors and the like, are innumerable and the work may prove so intensely interesting (this business of measuring waves with a yardstick!), that you may wish that you were in the game for good.

NEW QRAs

2BBA, William Tebben, 4316 Twenty-fifth Ave., Long Island City, N. Y. Cd for cd; will appreciate repts on my sigs as I am using fairly low power—300 volts "B" batteries.

5EP, Arlo R. Eggensperger, RR. 3, Springdale, Ark.; 80 meters on 5 watts. Ans. all cards day rec'd.

7PH and **7ABY** (portable), Leo Sands, 2119 McDougall Ave., Everett, Washington. 5 watts A.C.C.W., 40 meters and 201A tube with 45 volts plate. Will appreciate and QSL card from any ham, nearby or DX. Be a good sport.

9DOD, Donald F. Hunt, Rosedale, Ind.
9QS, Robert E. Williams, Rosedale, Ind.

CALLS HEARD

J-300, K. Yamaguchi, 18, Nakayamate 4-chome, Kobe, Japan.

AUSTRALIA—2cg, 2cm, 2ds, 2gq, 2ij, 2jw, 2lk, 2lz, 2rl, 2tm, 2yh, 2yi, 2hk, 2cs, 2bv, 2mk, 2xa, 2yx, 2ar, 3ad, 3ap, 3hi, 3ef, 3kh, 3wm, 3hs, 3hl, 3al, 3hd, 3tm, 3bl, 3bm, 3bp, 3jk, 3lp, 3qh, 3xo, 3yx, 3ef, 3bq, 3ak, 4an, 4cm, 4rb, 4bg, 4kb, 5ay, 5hr, 5ay, 5wy, 5rg, 5do, 5bg, 5ku, 5lf, 6ag, 6bo, 6kx, 7cw, 7bg, 7pf.

UNITED STATES—1rd, 5tm, 5ah, 5aad, 5acl, 5cs, 5ef, 5ji, 5amd, 5ft, 5jf, 6abg, 6acc, 6ajl, 6alt, 6aon, 6aus, 6awt, 6bav, 6ahp, 6art, 6axu, 6akm, 6ad, 6aid, 6ajj, 6amm, 6ajm, 6ajn, 6akx, 6alz, 6am, 6amn, 6anp, 6aps, 6ael, 6arn, 6aws, 6azq, 6ael, 6ham, 6hgc, 6hhz, 6bbv, 6hls, 6hav, 6hwi, 6hvc, 6hwc, 6huv, 6bil, 6bjd, 6bq, 6htg, 6bpg, 6hav, 6hgc, 6hix, 6hqs, 6btd, 6btm, 6bvo, 6hej, 6hen, 6hgc, 6hcl, 6hes, 6hep, 6hjl, 6hkh, 6hvy, 6hwl, 6hxc, 6hcl, 6hes, 6hep, 6hjl, 6hkh, 6hvg, 6hhq, 6hgv, 6ch, 6chl, 6cgk, 6ckv, 6cmg, 6cmq, 6cof, 6cqa, 6csx, 6ctd, 6cul, 6cvq, 6cvw, 6cto, 6cab, 6crs, 6cho, 6ct, 6cj, 6cm, 6cuv, 6ckv, 6ccv, 6ccl, 6cgw, 6cmg, 6cnc, 6dag, 6dap,

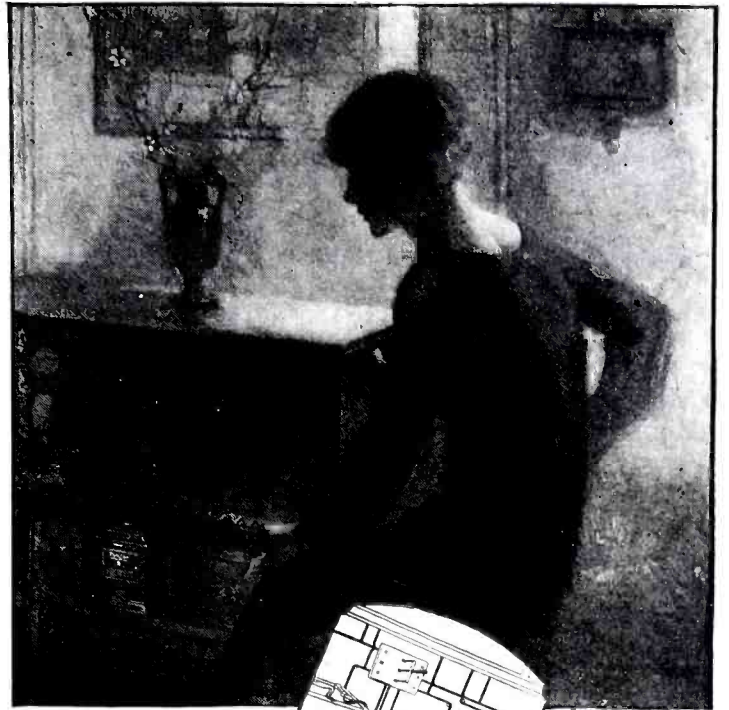

**Throw a switch
and charge
your batteries**

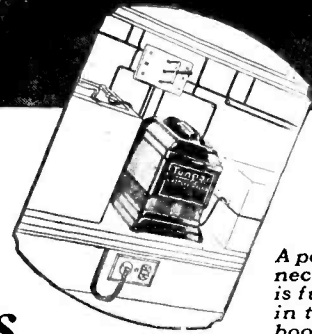

A permanent connection hook-up is fully illustrated in the instruction book accompanying each Tungar.

Nowadays, charging a battery with a Tungar has become as easy as turning on a light. Just throw a switch—and charge your batteries. That's all there is to it if you have a Tungar permanently installed.

The batteries themselves may be placed in a cabinet, or down in the cellar. And, at night, when you sign off, all you have to do is throw a switch—to the right for "A" batteries, to the left for "B." It's no more bother than switching on a light.

Tungar causes no radio interference.

It cannot blow out Radiotrons.

An overnight charge costs about a dime.

Tungar is the original bulb charger. It is a G-E product developed in the Research Laboratories of General Electric.

The 2 or 5 ampere Tungars charge 2, 4 and 6 volt "A" batteries, 24 to 96 volt "B" batteries in series; and auto batteries, too. No extra attachments needed.

East of the Rockies
2 ampere Tungar, \$18
5 ampere Tungar, \$28
Trickle Charger, \$12
(60 cycles—110 volts)

Merchandise Department
General Electric Company
Bridgeport, Connecticut



Tungar—a registered trademark—is found only on the genuine. Look for it on the name plate.

GENERAL ELECTRIC

Capacity .00035



PRICE \$2.50

CONTINENTAL Lo Loss CONDENSERS

The low dielectric losses, exact capacities and mechanical perfection of Continental condensers make them the logical choice where fine reception is appreciated.

Continental (Single) .00035\$2.50

Continental (Double) .00035\$5.00

(Specified in the Daven Bass Note Receiver)

If not at your dealer's, write Condenser Headquarters
GARDINER & HEPBURN, Inc.
611 Widener Bldg., Philadelphia

All Specified Parts FOR THE World's Record Super 9 and 10

Send for free catalog of all the parts needed for these marvelous receivers that have made four world's records. We have in stock complete sets of the exact parts used by the designer in his original receiver. Verification of records sent upon request. Write today!

THOR RADIO CO.,
318 Crilly Bldg. Chicago

Insure your copy reaching you each month. Subscribe to Radio News—\$2.50 a year. Experimenter Publishing Co., 53 Park Place, N. Y. C.



Blue Prints

FREE Write for a complete description of the Peer of all receivers—the World's Record Super 9—the wonder receiver that holds 4 fully verified World's Records for distance. The World's Record Super 9 is one of the few receivers to bring London into Chicago during the last two International Contests. Thousands of testimonials hail the World's Record Super 9 as the marvel of Radio. Write for free list of records and testimonials today!

Easy to Build

You can build an exact duplicate of the original World's Record Super 9 by following our Blue Prints. Building instructions complete in every detail with each set of Blue Prints make it easy for anyone to build this remarkable receiver with perfect success. Complete Building instructions and Blue Prints \$5.00. Remit with order or we will send C. O. D.

Mail the Coupon Today!

M-S SYNDICATE

Box 2131 Cleveland, Ohio

M-S SYNDICATE,
Box 2131, Cleveland, Ohio

- Please send me free literature and verifications of the records made by the World's Record Super 9.
- Am enclosing \$5 for Blue Prints, etc.
- Send me Blue Prints, etc., C.O.D.

NAME

ADDRESS

The Best Loop — At Any Price

Unmatched In Reception and Appearance, Too

For REAL RADIO ENJOYMENT, you can't buy a better loop aerial than the NEW THOMAS.

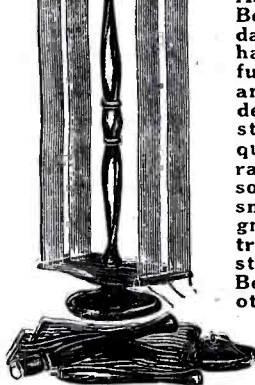

Beautiful hand rubbed, dark walnut finish harmonizing with any furniture. Designed for any set with .0005 condenser (one or more stages of Radio Frequency). Turns on 6" radius. Fine for consoles, fireplaces, and small spaces. 180 degrees directional control. Collapsible. 54 strand, silk covered Belden wire. Many other exceptional quality features. Guaranteed against mechanical or electrical defects.

By actual comparison it leads them all, Exceptionally priced at **\$7.50**

West of Rockies, \$8.50

Ask Your Dealer or Send Money Order Direct. Agents, Jobbers and Dealers, Write.

IDEAL PRODUCTS COMPANY

Manufacturers of Thomas Loops
213 North Deslaines St., Chicago, Ill.

ERLA CRYSTALS still reign supreme for use in any circuit employing a crystal detector. Super-sensitive, permanently adjusted, assuring full volume at all times. Ideal for reflex sets. Buy this better crystal at your dealers. If he cannot supply you we will send it prepaid to any city in the United States for only \$1.00. Electrical Research Laboratories, 2500 Cottage Grove Avenue, Chicago, Ill.

6dcl, 6daa, 6dbl, 6dah, 6dl, 6dcf, 6dat, 6dck, 6dcq, 6eb, 6ex, 6ea, 6fz, 6fg, 6fm, 6goc, 6hv, 6hm, 6hb, 6hna, 6ih, 6if, 6jn, 6js, 6jy, 6jx, 6ji, 6kb, 6km, 6ky, 6lcq, 6lcf, 6mb, 6oi, 6oa, 6pr, 6pm, 6ob, 6qu, 6qr, 6qv, 6rn, 6ts, 6rd, 6rj, 6sq, 6sv, 6rp, 6ta, 7df, 7do, 7gc, 7hh, 7lq, 7tk, 7wu, 7xf, 7cs, 7aa, 7ay, 7em, 7hg, 7ki, 7ab, 7vh, 7tm, 7ge, 7ek, 7pt, 7it, 7lq, 7tk, 7wu, 7la, 9doq, 4ft, 6adt.

HAWAII.—6aff, 6aje, 6axw, 6ajc, 6ajl, 6bdl, 6buc, 6cst, 6clj, 6dcl, 6isa, 6roe, 6abw, kfuh, kio, c3n, fxi, 6oa.

NEW ZEALAND.—1ao, 1ag, 1ac, 1ax, 1fg, 1io, 1aa, 1fu, 2ac, 2ak, 2aq, 2bx, 2cg, 2gj, 2xa, 3ai, 3ad, 3af, 3am, 4aa, 4ac, 4al, 4ax, 4av, 4ag, 4ar 4ak, 4am, 4ai, 4as.

ARGENTINE.—aa8, bai, dh5, fh4, ga2, cb8.

PHILIPPINES.—1ar, 1at, 1au, 1cw, 1fr, 1hr, 1bd, 1dl, 1hr2, 1mo, 3aa, cd8, 8hr, aj2, wuch, 2px.

FRENCH CHINA.—8em, 8ag, 8gg, 8zw, 1ego, 4to, 8fo, 8ir, 8xx.

FRENCH INDIA.—8qq.

BRAZIL.—2ab, 1ab, 1ac.

CANADA.—3go.

STRAIGHTS SETTLEMENTS.—2se; BORN-EO, sk2.

MISCELLANEOUS.—Many U. S. Naval station. NPO, MPM and other commercial stations.

If your call is here, please send a card I will

QSL, QRH, QSB, QRK etc.

SR-FMH, J. FREDERICO MEJIA, 14a Avenida Norte, 21, San Salvador, Rep. of Salvador, C. A.

U. S. A. 1ajm, 1awe, 1bhs, 1ccz; 2amq, 2apv, 2au, 2aw, 2awq, 2ayj, 2ck, 2ih, 2cxl, 2nz, 2fx, 2sc, 2sj, 2uo.

3aig, 3ade, 3asw, 3blz, 3jf, 3kw, 3xg, 3yp.

4lk, 4gi, 4it, 4iz, 4qb, 4qbw, 4sl, 4tkb, 4wb, 4wj.

5aab, 5ash, 5at, 5dh, 5fa, 5gz, 5uk, 5ux, 5ik, 5zq, 5zu.

6ahh, 6asa, 6edu, 6chl, 6ct, 6ul, 6cuw.

8aay, 8az, 8bde, 8boy, 8bzt, 8bfv, 8ccs, 8cro, 8chx, 8cuz, 8dbb, 8dmz, 8dne, 8ex, 8nn, 8szt.

9acx, 9atq, 9auv, 9bfj, 9buj, 9bvp, 9cet, 9cw, 9cyw, 9dez, 9dkg, 9dpw, 9dte, 9dvt, 9eea, 9ei, 9ekn, 9elb, 9elt, 9ft, 9if, 9iun, 9mn, 9qab.

Misc: fw, icc, glq, npg, npl, nem, nxf, ur, wiz.

Crđ for crđ OM; send fr urs.—QRK SR-FMH on 78 meters?

G-6AP, ARTHUR C. PORTER, 1a, Manor Road, Brockley, London S.E. 4, England.

U. S. A. 1ff, 1zk, 1awe, 1bvl, 1aci, 1ae, 1ag, 1aep, 1afw, 1dl, 1mj, 1rf, 1bqt, 1ch, 1aay, 1ala, 1blb, 1cu, 1cib.

2ccx, 2xaf, 2ahm, 2bk, 2cy, 2atc, 2atz, 2bl, 2crb, 2bb, 2apv, 2axq, 2mm, 2ow, 2md, 2ctu, 2cxl, 2cyx.

3afq, 3blc, 3bva, 3fc, 3agc, 3cjn, 3bnf, 3hq, 3lw, 3bur, 3bwt, 3wf.

4at, 4bl, 4hu, 4cl, 4ef, 4sl, 4hr, 4pi, 4uh, 4pk, 4qj, 4wq.

5ni, 5zai.

6cba, 6cqa.

7hl, 7bde.

8ada, 8aly, 8kf, 8bdf, 8bof, 8cug, 8cax.

9wa, 9cxc, 9brg, 9dpj, 9egh, 9ekf, 9za, 9eji.

Canada: leo, ldd, lar, lax, larq.

CHARLES JUSTICE, 433 So. Seventeenth St., Columbus, Ohio

Argentina: raf1.

Australia: a-2tm.

Brazil: bz-1an, bz-1aw, bz-1bi, bz-2ag, bz-2aj, bz-2ao, bz-5ab, bz-5ad, bz-9qa, bz-spc.

Cuba: q-2mk, q-8kp.

Chile: ch-2ah, ch-2ar, ch-2ld, ch-3ij.

Canal Zone: cz-99x, cz-fr5, cz-nba.

Dominican Republic: hik.

Ecuador: gh-lfg.

England: 6-2kf, g-2nm, g-5dh, g-6yd.

France: f-8kf, f-8jf, f-8jn, f-8yor (QRA?)

Hawaii: hu-6buc, hu-fxl.

Italy: i-1co.

Jamaica: jm-2pz.

Mexico: m-1aa, m-1af, m-1g, m-1j, m-1k, m-1n, m-5b, m-5c, m-9a, m-jh, m-xc5i (QRA?) m-xcd, m-xda.

New Zealand: z-1ao, z-1ax, z-2ae, z-2ac, z-2xa, z-3ak, z-3am, z-3ar, z-4ac, z-4am, z-4av.

Porto Rico: pr-4ja, pr-4je, pr-4kt, pr-4sa, pr-4ur.

Uruguay: y-1cd, y-2ak.

Misc.: nitc, niss, rxy, agc, fw, wnp, kgbb, voq.

Any of the above who hv not recd a crđ, pse qsl.

U-8BAD, K. TROST, 10 E. Walnut St., Tippecanoe City, Ohio.

a2cs, a3ef, a3bk, a2bk, a2yi, a2bb, a4cm, a5kw, a2tm, a7aa, a3bd, a4an, a5bg, a3em, a3en, a2sh.

b2lab, b2lac, b2lsq, b2lia, b2lan, b2zws, b2zab, b2lib, b25ab, b2lar, b2lam.

ch3ag, ch9tc, ch2ld, ch3ij.

f8jn, f8ww, f8dk, f8yor, f8cs, f8bx, f8zo, f8rbp, f8tk, f8gm.

f8qq, fm8ma, fm8mb.

g6lj, g6nf, g5hs, g2it, g2nm, g2lz, g2pd.

ilgw, ilno, ilor, iler, ilrm, ilau.

j-jsh.

m1b, m1aa, m-jh, m9a, m1j, m1n, m1g, m1k.

m-cyy, n-0w3, oa3b, q2jt, q8kp.

rth4, raf1, rba1, rcb8, raa8.

z4ar, z2ac, z2xa, z3af, z4ac, z1ao, z2ae, z4xa, z3lf, z4aa, z4am, z1ax, z2gc.

smyy, smzs, ska, sgc.

ntt, gdvb, gh1fg, n-xa, pcj, kft, kegk, kfuh, pr-xyr, voq, wnp, vvg al7kx.

U-7PH, U-7ABV, LEO SANDS, 2119 McDougall Ave., Everett, Wash.

nz2ag, a3hl, oa5m, oa6n, fc8em, tuk, rrp, rdw.

wiz, wddo, au7bh, kel, rxy, bb3, kft.

nads, nkf, npo.

bam, buv, dx7, dm2, ho, och, ma, lp.

New!
Crackle Surface
ACE
HARD RUBBER
PANEL
of highest insulating efficiency with a distinctly attractive surface finish.
In regular ready-cut sizes:
7x10 7x18 7x26
7x12 7x21 7x30
7x14 7x24
Popular prices. All dealers.
Made by the makers of the famous RADION PANELS.
Write for price list.
American Hard Rubber Company
11 MERCER ST., NEW YORK

NOW—ANY SET CAN GET LOW WAVE
Stations—Amateurs
Experience a new radio thrill! Explore the short waves on which super-power stations are experimenting daily and amateurs are talking from all parts of the globe. Enjoy a new radio delight with the

SUBMARINER
Converts Any Set Into a Low Wave Receiver Gets the Short Wave Experiment Stations broadcasting on 41 meters, 83 meters, etc., and a wide band of Amateurs' Stations. Price, \$15. No extras needed. Anyone can attach in one minute, ready to operate.
Everywhere— a Sensation!
No jumble of stations in the low waves—no disagreeable noises. Ideal for summer reception. Hear KDKA talking to Europe. Listen to an A. R. L. operator speaking to Australia! The low-waves abound with new wonders and strange voices from far-off places. The SUBMARINER brings them all to you. Send for this marvelous new instrument today. Sent post-paid upon receipt of \$15, or C.O.D., plus postage. State type of detector tube in your set. Money back if not delighted. Order at once.
ORDER DIRECT MONEY-BACK GUARANTEE
J. M. P. MFG. CO.
Dept. 115-X Milwaukee, Wisc.

You can be quickly cured if you
STAMMER
Send 10 cents for 288-page book on Stammering and Stuttering, "Its Cause and Cure." It tells how I cured myself after stammering 20 yrs. B. W. Bogue, 6963 Bogue Bldg., 1147 N. Ill. St., Indianapolis

Insure your copy reaching you each month. Subscribe to RADIO NEWS — \$2.50 a year. Experimenter Publishing Co., 53 Park Pl., N.Y.C.

An Improved A. F. Amplifier

(Continued from page 830)

USE OF THE CHOKES

The choke coils play a very important rôle in the operation of the amplifier. They are designated in the circuit diagram (Fig. 1.) L is a radio-frequency choke which finds itself in the plate circuit of the detector tube when the amplifier is connected to the receiving set. It offers free passage to audio-frequency currents but obstructs the flow of the radio-frequency currents, which are forced to take the path through the by-pass condenser, C. The radio-frequency currents are thus kept in the plate-filament circuit of the detector tube, where they belong, and cannot enter the amplifier circuits. The audio-frequency currents, however, are not hindered in their passage from the output of the detector tube into the amplifier.

It is as desirable to "tie in" the audio-frequency currents as it is to keep the radio-frequency currents in their own circuits. Consequently, this amplifier employs two audio-frequency chokes in conjunction with two by-pass condensers, so that each circuit is made independent of the next. These chokes do not obstruct the normal flow of plate current nor cause a drop of voltage worth mentioning, but their impedance to audio-frequency currents is high enough to effectively block the passage of the latter. The A.F. choke L1 connected in the detector "B" battery lead, (post 3 in Fig. 1), does not prevent the A.F. currents from passing through the audio amplifier, but it does keep them out of the "B" battery, which is common to all tubes. They are by-passed to the filament of the detector tube through the condenser C1 and post 2.

The other A.F. choke (also L1) is connected in series with the "B" battery lead for the first audio amplifier tube. Its function is the same; the A.F. currents are kept out of the "B" battery circuit and by necessity pass through the condenser C1 to the filament of the amplifier tube. Thus, these currents are confined to the circuit consisting of the plate of the first amplifier tube, the primary winding of the first audio transformer, the condenser, C1, and the filament.

The choke, L2, is known as an output impedance and its combination with the condenser, C2, keeps the audio-frequency currents from the output of the last amplifier tube from getting into the "B" battery circuit and also prevents the normal plate or "B" battery current from passing through the loud speaker. As with the other type of A.F. chokes, the resistance of L2 to a direct current is comparatively small, so the plate current has free passage. The A.F. currents, however, cannot pass through the choke. Instead, they take the path through the condenser, C2, the loud speaker, and back to the filament of the last amplifier tube. The advantages of this combination (L2-C2) are three-fold: It prevents coupling between the amplifier tubes through the common "B" battery; it keeps the plate current out of the loud-speaker windings, where this would have a tendency to place limitations on the movement of the driving unit of the loud speaker; and it protects the windings from "B" current, which if excessive, as it is when a power amplifier tube is used in the last stage, might cause them to burn out.

It is obvious that the use of these different types of chokes has resulted in an amplifier with independent circuits beyond the influence of each other. The detector circuit of the receiving set is isolated from the amplifier, both amplifier stages are isolated

Send for Latest RADIO CATALOG and GUIDE

164 PAGES OF 1927 BARGAINS

The new 164-page 1927 edition of the Barawik Builder's Guide is now ready. This is the book that hundreds of thousands of radio enthusiasts turn to when they want the latest and best in radio at big discounts. It's a handy and most reliable radio reference guide. Keep up to date by utilizing Barawik service. It will help you to solve many a radio problem as well as saving you tremendous sums on the very things you need and use most. You want the latest—We have it—at bargain prices, too.

The new Guide is brimful of the best approved standard radio sets, parts and kits, at savings that will appeal to the thrifty. Profusely illustrated with reliable guaranteed goods at tremendous savings. Be sure to get your copy before you spend another cent for sets, parts and radio supplies.

VALUABLE INFORMATION FREE

Complete Parts for All the Newest Circuits

In every issue of RADIO NEWS and other radio magazines you will find the newest circuits of the world's greatest radio engineers. You will want to build these sets from the parts specified. BARAWIK service keeps up to date on all the new wrinkles. The new BARAWIK Guide is brimful of valuable information. We have the specified parts for all the new circuits, complete, ready to ship you the instant your order arrives. Take advantage of this unequalled service. Get what you want—quick—at a big saving. No order too large or too small for us. 300,000 fans thrive by using BARAWIK service. We can please you, too. Get your free copy of the complete 164-page Guide for 1927 NOW. Delay means loss to you.

Special Amateur Section—Short Wave Equipment

Another new Barawik idea is the Amateur Section under the direction of F. J. Marco, 92A, wherein is presented for the first time a complete line of short wave receivers, transmitters and all the necessary amateur equipment so dear to the amateur experimenter—all at bargain prices. Don't miss the opportunity to look into this inviting field.

Get Your Free Copy To-day—NOW

To everyone mailing the coupon or writing us a letter or postcard we will mail free the new 1927 Barawik Radio Guide, with its 164 pages of everything interesting for the Radio fan. Never in the history of radio has such a tremendous collection of radio supplies been presented to the public. Build the set of your dreams now. Get the things you have always longed for. You can do it, for our low prices will make the most expensive articles reasonable in price.

Mail Coupon Now. Get this Guide into your hands before you buy another part. It will mean money in your pocket. Write today; also please send names of other radio fans.



BARAWIK CO.

510-512C MONROE ST., CHICAGO, U. S. A.

NAME
ADDRESS
FRIEND

WORLD'S FINEST LOUD SPEAKER.

GENUINE "ENSCO" 3" CONE KIT

ONLY \$10
Can be assembled in less than an HOUR.
The Original Three Foot Cone Speaker KIT



NO DISTORTION THE SOLUTION OF THE LOUD-SPEAKER PROBLEM The Choice of Leading Engineers PERFECT FIDELITY

Kit includes famous "ENSCO" cone unit, the only direct-drive, distortionless unit for large cones; Alhambra Fonotex for big cone, with brass apex, two Sepia Prints showing cabinet or simple stand construction. All necessary instructions. Buy this wonderful speaker under our absolute guarantee. Your money back if you are not convinced that it is the finest reproducing medium obtainable at any price. It works on any set, with ordinary Tubes or with Power Output.

MAKE YOUR OWN THREE FOOT CONE SPEAKER IN LESS THAN AN HOUR. Complete parts furnished in kit form. We guarantee this speaker the equal of any manufactured cone speaker at any price.

With this THREE FOOT CONE SPEAKER you hear all the tones. It brings out the true depth and beauty of orchestral and instrumental music. Can be operated softly for Living Room Music or Full Volume for dancing, and without trace of distortion.

SEND NO MONEY!
ENGINEERS' SERVICE CO.,
25 Church St., (Desk N) New York City
Write your name plainly as indicated below, then mail and complete kit will be forwarded to you. Just pay postman \$10.00 upon delivery.
NAME
ADDRESS

KELLOGG Radio

Flawless Reproduction

BLUE PRINTS (3 Full Size)
POWERS-CASEM SET
\$1.00 at Dealers or By Mail.
NATIONAL RADIOPRINT CO.
200 Broadway, New York

Rcom 406



The Everglades

Miami, Florida

NOW OPEN

Miami's Beautiful New Apartment Hotel
on Biscayne Boulevard
Overlooking City Park and Biscayne Bay

A 17-Story Fireproof Structure affording hotel accommodations of the highest character; also housekeeping apartments of 1, 3 and 4 rooms, completely equipped with daily maid service.

A FRED F. FRENCH PROPERTY

WILLIAM M. GALE, Manager

Illustrated Booklet Upon Request

BETTER Reception with EFFARSEE Antennae or Your Money Back!

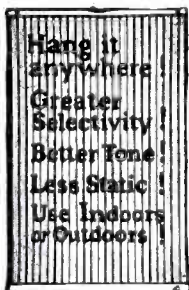

That guarantee shows how certain we are that the wonderful new EFFARSEE Antennae will increase the power, range and selectivity of your set. The scientific design of this marvelous device, built on an entirely new principle with two specially made condensers, practically eliminates static and interference.

Don't Imperil Your Life

Why clutter up your home with ugly outside wires or masts? Why take a chance of death by a fall when erecting or repairing an outside aerial? Why deliberately attract the deadly lightning that may kill your whole family and burn your home? Just buy your EFFARSEE Antennae.

shove it under a rug or put it in the attic, and enjoy perfect safety and get 50% better reception. No trouble—installed in 30 seconds—lasts forever. Radio manufacturers find it ideal for testing sets. Approved by Radio News, Popular Science, Popular Radio and other prominent Radio Magazines. Thousands of enthusiastic users.

Send No Money

Order your EFFARSEE Antennae today, at the special price of \$1.00. If it does not improve the performance of your set at least 50%, return it and we will refund your payment in full. Send no money—just your name and address. We'll send your EFFARSEE Antennae at once, and you can pay \$1.00 to the postman on delivery. Remember, you take ABSOLUTELY NO RISK.

FISHWICK RADIO CO.,
Dept. 51 133 Central Parkway Cincinnati, Ohio

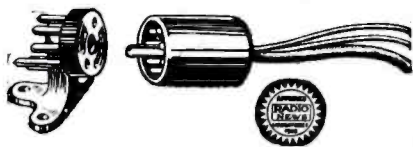

ESPECIALLY RECOMMENDED

Radio set designers are constantly recommending the use of the Type B.M. Jones MULTI-PLUG illustrated above; Radio News hookups feature the Jones MULTI-PLUG. Its use eliminates binding posts, as it is the one master plug for seven connections—two for the A battery, three for the B batteries and the ground and aerial wires.

Complete with 4 ft. Cable.....\$3.50
Complete with 8 ft. Cable.....\$4.50

At your dealer or write to us direct.

Jones
MULTI-PLUG
THE STANDARD SET CONNECTOR

HOWARD B. JONES
618 S. Canal St., Chicago, Ill.



World Radio Storage "B" Battery

12 Cell—24 Volt

275

Proved value. Thousands of users find reception almost magical. Clear, true power—instantly and unendingly. Wise economy. Sturdy construction—Solid Rubber Case protection. Recharged for almost nothing. Endorsed and listed as standard by famous Radio institutions including Pop. Radio Laboratories, Pop. Sci. Inst. Standards, Radio News Lab., Lefax, Inc. and other Radio authorities. What more need be said? Extra Offer: 4 Batteries in series (96 volts) \$10.50.

Send No Money Just state number wanted and we will ship same day order is received, by express C. O. D. Pay expressman after examining batteries, 5% discount for cash with order. Remember—you save 50% on World Batteries.

WORLD BATTERY COMPANY

1219 So. Wabash Ave. Dept. 75 Chicago, Ill.
Makers of the Famous World Radio "A" Storage Battery
Prices: 6-volt, 100 Amp. \$10.00; 120 Amp. \$12.00; 140 Amp. \$13.00.
All equipped with Solid Rubber Case.

Set your radio dials at 288.3 meters for the World Storage Battery Station WSBC. Variety—New Talent—Always Interesting.
JERRY SULLIVAN—Director and Announcer—"Chi-CAW-go"

RADIO DEALERS

Get the New 1926-27 Van-Ashe Catalogue—

Shows all the newest parts, circuits and kits—all the hard-to-get items that set-builders demand. 12-hour shipments—extra-good discounts. Mail the coupon.



Dan-Ashe Radio Co.

210 North 10th St. ST. LOUIS, MO.

Send catalogue.

Name

Address

from each other, and the loud speaker is virtually "floating" in its own condenser-coupled circuit.

USE OF OTHER PARTS

As previously mentioned, the output jack, J, automatically controls the filament circuit of the amplifier. At the same time it forms the output connections for the loud speaker. The automatic filament controls, R1, as explained, should have the correct values for the tubes employed. It is a good idea to have a number of different types on hand, so that vacuum tubes of different voltage and current requirements can be used at any time.

The variable resistance, R, has a range from 0 to 500,000 ohms and constitutes a volume control. However, its variation also alters the "distortion curve" of the first transformer and so is rather effective in obtaining reproduction most satisfactory to the builder's own ears.

Both of the audio transformers used are of the new type, with large iron cores and high-impedance primary windings. These give the best results and therefore should be used.

Earlier in this article it was mentioned that, in most cases, distortion in audio-frequency transformers is due to coupling effects or overloaded tubes. The amplifier described here is so designed that coupling effects are eliminated.

Now let us consider the question of overloaded tubes. Generally speaking, a tube is overloaded when the grid voltage becomes positive. To put it more clearly, we can assume that the grid of the tube has a certain negative voltage impressed on it, either from the negative filament connection or from a "C" battery. If at any time the positive value of the signal voltage exceeds the negative voltage value on the grid of the tube, the grid "goes positive" and is considered overloaded.

At any such time the tube is operating on a very unsatisfactory portion of its characteristic curve, is drawing excessive plate current and is not passing on faithful reproduction of the variations put into it. It is obvious that the most distortion would be evident when the signals are loud or when the signal voltage is of a large value. It is also true that the most distortion will be noticeable at certain definite audible frequencies, and these are generally those most favored by the amplifier.

"C" BATTERY VOLTAGES

The important thing is to keep the negative voltage value on the grid of each amplifier tube high enough so that the grid cannot go positive, even on very loud signals. Naturally the signal voltage impressed on the grid of the second amplifier tube will be greater than the voltage impressed on the first. Therefore, it is necessary to use a higher negative voltage on the second tube. It is usually considered satisfactory to connect the grid return from the first tube directly to the negative side of the filament, and use a "C" battery on the grid of the last tube only; the idea being that sufficient negative voltage is supplied by the "A" battery. This may or may not be so. At any rate, it is a gamble. The output from the second detector in a superheterodyne set can easily be of sufficient voltage to swing the grid of the first audio-amplifier tube to a positive value, unless a "C" battery is used. This is why the separate "C" battery leads are shown in the audio amplifier described.

There is only one good way to determine if the "C" battery voltage is correct, and that is by checking up the output of each amplifier tube by connecting a milliammeter in the plate circuit; it can be inserted between the P post on the tube socket and the wire that normally connects to this post. With the set and amplifier in operation, the milliammeter will indicate the flow of plate

current in the circuit in which it is connected. The loudest local station should be tuned in. If there is any change in the plate current as indicated by the milliammeter, overloading and distortion are taking place. If the milliammeter needle kicks to the left, (shows a decrease in current), more "C" battery is required. If the needle kicks to the right, the "C" battery voltage should be decreased or the "B" battery voltage increased. Carry out this test on both tubes. When the voltage values are correct there should be no perceptible movement of the milliammeter needle from its plate-current reading position.

No specific "B" and "C" battery voltages can be given as these are dependent on the type of tubes employed. One is safe in following the voltages specified by the tube manufacturer.

Another way of determining the approximate "C" voltage is by use of the

B

simple formula $\frac{B}{2\mu} = C$, wherein B is the

2μ

plate voltage and μ ("mu") the amplification factor of the tube employed.

It is always advisable to employ a semi-power or power tube in the last stage. In many cases, particularly if the output energy of the receiver is large, it is an excellent idea to use a semi-power tube in the first stage also. An amplifier utilizing two semi-power tubes, or one semi-power tube and a power tube in the last stage is, not very susceptible to overloading; while it is quite an easy matter to overload a standard 6-volt, 1/4-ampere (storage-battery) tube.

NOTICE TO READERS:

A COMPLETE set of full-sized blueprints for this Amplifier may be obtained by sending \$1.00 to the Blueprint Department, RADIO NEWS, 53 Park Place, New York, N. Y., specifying Set No. 5. These blueprints may be placed upon the panel and sub-panel, forming templates for drilling and locating the apparatus, as well as wiring guides.

Broadcasting Weather Maps

(Continued from page 791A)

"The receiving apparatus, which listeners in may use in the place of a loud-speaker, has a cylinder rotating with the same speed on which is fixed a piece of paper covered by a sheet of carbon paper. The arriving impulses, transformed by a tube from alternating into direct current, move the anchor of a relay that again moves the anchor of a local relay operating a pin. The latter presses through the carbon paper upon a sheet of blank paper on the cylinder according to the electric impulses, thus repeating the drawing transmitted.

"The pressure naturally must not be too strong; otherwise the paper would tear. Difficulties were encountered in the beginning in drawing a continuous line, but by heating the pin electrically from 80 to 100 degrees Centigrade this difficulty was overcome. The chart broadcast in this manner shows the isobars, the regions of high and low pressure, and the height of the barometer.

"The broadcasting station of Hamburg, it is said, is now also planning to broadcast weather charts regularly in this manner, and from the Government station at Norddeich, it is reported that small weather charts have frequently and successfully been transmitted to ships with a minimum of power across distances of 4,000 to 5,000 kilometers."

\$75.00 A WEEK BUILDING RADIO SETS

—in your spare time

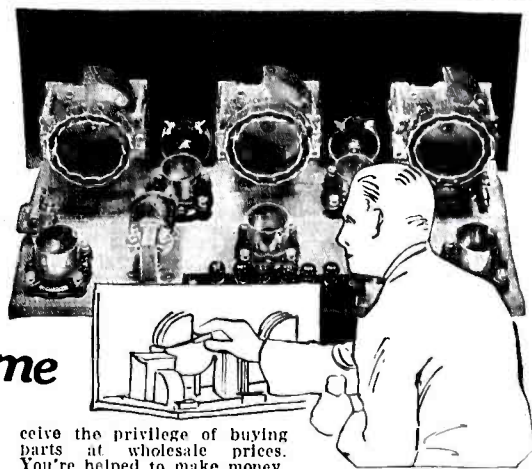

Join the Radio Association of America. Learn how to build and repair radio sets. The Association will train you—start you out in business if you wish. Be the radio "doctor" of your community. \$3 an hour upwards easily made. Radio offers you a big money-making opportunity right now.

ceive the privilege of buying parts at wholesale prices. You're helped to make money.

JOIN THE ASSOCIATION NOW

If you're interested in Radio for either pleasure or profit, join the Association without delay. because we have a plan whereby your membership may not need not—cost you a cent. Only a limited number of these memberships are acceptable. Write now for details. Write before it's too late.

This Association has prepared a beautiful book that gives figure-facts regarding the profit possibilities of the Radio Industry, the purpose of the Association, and the details of the Special Membership Plan.

MAIL THIS COUPON

RADIO ASSOCIATION OF AMERICA
Dept. RN-1—4513 Ravenswood Ave., Chicago

Send me your book and details of your Special Membership Plan.

Name
Address
City State.....

EARN \$500 IN SPARE HOURS

"I have at last found myself," writes Lyle Follick, Lansing, Michigan, "I have already made over \$500 building radio sets after working hours." Werner Eicher, Rochester, N. Y., writes, "I have made over \$50 a week in my spare time."

Our members are starting radio stores, increasing their salaries, securing better positions, passing radio operator examinations, earning big money for the most enjoyable kind of spare-time work.

WHAT A MEMBERSHIP MEANS

A membership in the radio Association of America gives you the most up-to-date and thorough training in the Science of Radio.

You're taught how to build and repair all kinds of sets. You're given the training you need in preparing for a Licensed Radio Operator's examination. You re-

BUY BATTERY CAPACITY

Thomas Battery Combination

BUY BATTERY CAPACITY

THIS "A" BATTERY

100 Amp. hour "A" Battery, standard rate. 6-Volt capacity absolutely guaranteed—will operate Average 5 tube set for a month or more on a single charge. Solid rubber compartment case, lead coated handle. Non-corrosive terminals.

GUARANTEED 2 YEARS
OVER 18,000 SATISFIED CUSTOMERS

AND THESE "B" BATTERIES

Standard, high power, maximum service, 45-Volt. "B" batteries. Seamless cells. Built of best "B" battery materials. None better at any price.

ALL FOR \$13.98

Shipped direct from the factory—promptly. No delays—Every battery fresh. **NO ADVANCE PAYMENT REQUIRED.** Shipment order—and we will ship by express and you examine batteries at express office to your heart's content—pay the expressman \$13.98 plus express charges if you decide to take them. If you prefer to remit with order—deduct 50 cents. These "A" and "B" batteries can be purchased separately. "A" Battery (Same as above) \$10.50. "B" Battery (Same as above) \$2.50 each.



JACK SAGINARIO
Bronx, N. Y. City
I am very glad I was recommended to your battery as I get twice the volume. I will always recommend it to my friends.

JULIUS R. BROWN
New York City
I have used Thomas Batteries for twenty-two months and will always recommend it to the next person as being the "goods."

HIRAM MORGAN
Beloit, Wisconsin
I guess the best appreciation I can show is to enclose check for one of your 100 Amp. hour batteries as advertised in the Radio Magazine. The one I got some time ago from you is Perfect and giving excellent continuous service.

All prices for Domestic Shipments only—Export price 15 percent additional. Prices other sizes and auto batteries on request.

THOMAS BATTERY CORP.
507 West 50th St., N. Y. City

Gentlemen: I am enclosing \$.....for () "A" Batteries () "B" Batteries as advertised in RADIO NEWS.

NAME
ADDRESS
CITY..... STATE.....



A Complete Line of Radio Power Units

From the Webster line of power supply units everyone may find the right type for his set at a price he can afford. "Little Giant B C"—at \$50.00—has five variable voltages—one for C power. "Super B" has three voltages with variable control—price \$39.00. "Popular B" is open type—\$35.00—all equipped with Webster Duo Choke (pat. pending) and Raytheon tube. Write for complete description in folder "Improving Your Radio."
THE WEBSTER CO., 3516 West Lake St., Chicago

DEALERS AND AGENTS

Write for exclusive Franchise on the well known line of Buckingham High Grade Radio Receivers.

Selected Franchise Dealers will receive a special introductory discount under our new plan.

BUCKINGHAM RADIO CORPORATION
25 East Austin Ave., Chicago, Ill.

FREE New 1927 Catalog FREE

Shows photographs and hook-ups of all latest kits, complete line of cabinets and consoles, accessories and parts. We are headquarters for all nationally advertised lines. Dealers and professional set builders write today for your copy of this big FREE CATALOG.

SHURE RADIO CO., 19C-21 S. Wells St., Chicago

FREE RADIO GUIDE

164-PAGE (1927) GUIDE
Gives special hook-ups with illustrations. Shows big savings on standard radio parts, complete sets, kits. Be sure to get this thrifty book before you buy. Write letter or postal NOW. Also include name of another fan.
BARAWIK CO., 542C Monroe St., CHICAGO, U. S. A.

Insure your copy reaching you each month. Subscribe to Radio News—\$2.50 a year. Experimenter Publishing Co., 53 Park Place, New York City.

OPPORTUNITY AD-LETS

Follow these advertisements every month. Reliable advertisers from all over the country offer their most attractive specials in these columns.

Classified advertising rate twenty-two cents a word for each insertion. Ten per cent discount for 6 issues, 20 per cent discount for 12 issues. Name and address must be included at the above rate. Cash should accompany all classified advertisements unless placed by an accredited advertising agency. No advertisement for less than 10 words accepted. Objectionable or misleading advertisements not accepted. Advertisements for the March issue must reach us not later than January 1st.

CIRCULATION LARGER THAN THAT OF ANY OTHER RADIO PUBLICATION

EXPERIMENTER PUBLISHING CO., INC., 53 Park Place, New York, N. Y.

Agents Wanted

Big Money and fast sales. Every owner buys gold initials for his auto. You charge \$1.50; make \$1.35. Ten orders daily easy. Write for particulars and free samples. American Monogram Co., Dept. 133, East Orange, N. J.

We Start You In Business, Furnishing everything. Men and Women, opportunity to earn \$10.00 to \$100.00 weekly operating Ragsdale's original "New System Specialty Candy Factories" anywhere; wholesale or retail. Valuable commercial candy book free. W. Hillyer Ragsdale, Drawer 210, East Orange, N. J.

Earn \$10 daily silvering mirrors, plating, refinishing metalware, headlights, chandeliers, bedsteads. Outfits furnished. Bolanger Dele Laboratories, 1133 Broadway, New York.

Guaranteed Genuine Gold Leaf Letters anyone can put on store windows. Large profits, enormous demand. Free samples. Metallic Letter Co., 422 N. Clark, Chicago.

Agents: 90c an hour to advertise and distribute samples to consumers. Write quick for territory and particulars. American Products Company, 9029 Monmouth, Cincinnati, Ohio.

Business Opportunities

Free Book. Start little Mail Order Business, Pier Company, 72A F Cortland Street, N. Y.

Stocks—Bonds. Domestic—Foreign, bought—sold. Dealers in all marketable securities. Frank Y. Everett & Co., 20 Broad St., New York.

Manufacture Crystals—Big profits, particulars Free. Box 313, Wichita, Kansas.

Manufacture. New. Fast-Selling Novelties, Toys, Auto, Household and Agent's Specialties. Free Bulletin describes reliable plans, patterns, processes commercial information. Manufacturer's Bureau, 1129P, East 31st, Kansas City, Mo.

Chemistry

Learn Chemistry at Home. Dr. T. O'Connor Sloane, noted educator and scientific authority, will teach you. Our home study correspondence course fits you to take a position as chemist. See our full page ad on page 896 of this issue. Chemical Institute of New York, 66 W. Broadway, New York City.

Correspondence Courses

Used correspondence school courses. All kinds. Sold on repurchase basis. Big saving. Money back guarantee. Lists free. (Courses bought). Leo Mountain, Pisgah, Alabama.

Correspondence School Courses bought, sold, exchanged. Catalogue Free. Handling, R-799 Broadway, New York.

For Advertisers

Advertisers International Manual, new edition. Inside information for advertisers and Publishers' Rates. 50c postpaid. Economics Publishing Co., Dept. 56, 1475 Broadway, New York.

For Sale

Two Millikan galvanized steel towers, one 116 feet high, the other 128 feet high. Towers identical with exception of additional lower section to make the taller tower. Price \$750.00, f.o.b., Calhoun, S. C. Electric Specialty Motor generator set consisting of a Type BF24, 6 h.p. 220 volt, 60 cycle, 1750 R.P.M. three phase motor, direct connected to two Type F 23-1000 volt 1.5 amp., compound direct current generators with two spare field coils, as well as starting and control accessories. Price \$350.00 f.o.b., Calhoun, S. C. Director of Extension Ser. Clemson College, S. C.

Health

Herb Doctor Book—10 cents. 250 Receipts for making herb medicine. Hazard Company, Box 1, Vanderveer Branch, Brooklyn, N. Y.

Help Wanted

Detectives Needed Everywhere. Travel. Experience unnecessary. Write, George Wagner, former Government Detective, 1968 Broadway, N. Y.

Earn \$25 weekly, spare time, writing for newspapers, magazines. Experience unnecessary. Details FREE. Press Syndicate, 973, St. Louis, Mo.

Become a Landscape Architect. Uncrowded profession of wonderful opportunity for money-making. Easily mastered by mail. Earn while you learn. Write for book. American Landscape School, 11 Newark, N. Y.

Miscellaneous

Inventors: Use our special service for presenting your invention or patent to manufacturers. Adam Fisher Mfg. Co., 278-A Enright, St. Louis, Mo.

Don't Prepare for any Civil Service Examination without seeing our catalogue. Free. Columbian Correspondence College, Washington, D. C.

Forms to cast Lead Soldiers, Indians, Marines, Trappers, Animals. 151 kinds. Send 10c for illustrated Catalogue. H. C. Schiercke, 103-4 72nd St., Brooklyn, N. Y.

Motorcycles, Bicycles

Don't Buy a Bicycle Motor Attachment until you get our catalog and prices. Shaw Mfg. Co., Dept. 6, Galesburg, Kansas.

Music

Play Piano by Ear. A Sound System. Write for Free Booklet. You'll be glad you did! Boucher's Harmony Studio, 127 Metcalf St., Ottawa, Can.

Old Money Wanted

\$2 to \$500 each paid for hundreds of Old or Odd Coins. Keep all old money, it may be very valuable. Send 10c for New Illustrated Coin Value Book, 4x6. Guaranteed prices. Get posted. We pay Cash. Clarke Coin Company, 14 Street, LeRoy, N. Y.

Patent Attorneys

Inventors—Should write for our Free Guide Books and "Record of Invention Blank" before disclosing inventions. Send model or sketch of your invention for our Free Inspection and Instructions. Radio, Electrical, Chemical, Mechanical and Trademark experts. Terms reasonable. Victor J. Evans & Co., 923 Ninth, Washington, D. C.

Patents—Send for form "Evidence of Conception" to be signed and witnessed. Form, fee schedule, information free. Lancaster and Allwine, Registered Patent Attorneys in United States and Canada, 269 Ouray Bldg., Washington, D. C.

Patents. Send drawing or model for examination and report as to patentability. Advice and booklet free. Highest references. Best results. Promptness assured. Watson E. Coleman, Patent Lawyer, 724 9th Street, N.W., Washington, D. C.

U. S. and Foreign Patents, trademarks, modern rates. 22 years' experience. George C. Helnicke, 32 Union Square, New York; registered in U. S. and Canada.

S. Goldstein, Formerly Examiner United States Patent Office, 256 Broadway, New York.

Patents

Inventions Commercialized. Patented or unpatented. Write Adam Fisher Mfg. Co., 278 Enright, St. Louis, Mo.

Patent Sense valuable book free. See Lacey's ad page 924. Lacey & Lacey, 631 F St., N.W., Washington, D. C.

Personal

Tobacco or Snuff Habit Cured or no pay. \$1.50 if cured. Remedy sent on trial. Superba Co., N12, Baltimore, Md.

Postage Stamps

Stamp Collectors—Phillips Monthly Bulletin (Illustrated) offers over 2000 special bargains, sets, packets, single stamps etc., each issue. Free. Phillips, Box 1012, Hartford, Conn.

Radio

Boys! Don't Overlook This. The "Rasco" Baby Detector. Greatest detector ever brought out with molded base. Fully adjustable. See former advertisements in this publication, or our catalog. Detector with Galena Crystal, complete 50c, the same detector with Radiocite Crystal, 75c pre-paid. Send for yours today. Radio Specialty Company, 96-98 Park Place, New York City.

Attention!—50 Vacuum tube hook-ups. The greatest collection of vacuum tube circuits ever brought under two covers at such insignificant cost. These diagrams will be found in the great "Rasco" catalog, which contains raw materials and parts in a greater profusion than any other catalog. 15c in stamps, or coin will bring the catalog to you. Radio Specialty Co., 96-98 Park Place, New York City.

Build a Lifetime "B" Battery from my better Edison Elements. With Welded connections 7c pair. Sample cell 10c. Paul Mills, Woodburn, Oregon.

Free sample of Ivorylite the new ivory radio panel now in great demand. Its handsome, grained, and polished surface excels them all in beauty; as for its workability, durability, and insulating qualities, complete description and dielectric data will be sent with Free sample. Ivorylite Radio Panel Co. 3121 Ave. G, Fort Worth, Texas.

Save 33 1/3% on all your radio supplies! Order by mail. Eliminate the storekeeper's profit. We handle only guaranteed quality products. Write for price list now. Midwest Engineering Supply Co., Dept. R, 3318 W. Harrison St., Chicago.

Resistance Coupled Amplification. Gets great distance with excellent quality by means of improved method of connecting amplifier to detector circuit. Blueprint showing necessary changes sent on receipt of \$1.00. W. Moses, 9225 Edmunds Ave., Cleveland, Ohio.

Bargain Radio Catalog Free. Write now. Radio Specialty Shop, 525 Park Ave., Kent, Ohio.

275 Volt Transmitting Generator \$8. Microphone \$1.25. R. Wood, 38-102 St., Corona, New York.

Panel Lamp. Rests on top cabinet. Lights dials. \$1.25 pre-paid. Guaranteed satisfactory. Robert Stevenson, Lancaster, Ohio.

We are manufacturers of Radio Receivers and Speakers. Factory at Poughkeepsie, New York, would like catalogues of Radio Parts and general factory supplies and equipment mailed to Algonquin Electric Company, Inc., 120 Broadway, New York City.

Radio trouble finder, log, dictionary, a new illustrated book just off the press. Send for free circular. Patrick-Mahoney Co., P.O. Box 931, Schenectady, N. Y.

Representatives Wanted

Vizeains & Co. Merchants and Commission Agents established in Managua, Rep. of Nicaragua, desire Agency or Representation of Manufacturers of apparatus for radio-telephony and accessories; soliciting price lists, conditions of agency or representation, etc. The Nicaraguan Consul in New York recommends this firm as serious and responsible.

Salesmen Wanted

Salesman: Manufacturer of established line guaranteed tools offers profitable connection to men with mechanical and some sales ability; part time men considered; two average sales daily net \$50.00 weekly; advance against commission. Write for free catalogue and money-making plan. J. G. Woods, Inc., Dept. 208, 37 West 20th St., New York, N. Y.

A Salesman wanted in every town or city within 25 miles of a broadcasting station to sell Radiogem, the complete radio receiving set that retails for \$2.50. With Radiogem there is nothing else to buy—the outfit includes the Radiogem receiving apparatus, 1,000 ohm-phone, and aerial outfit. The cheapest radio outfit on the market—yet as practical as the most expensive. Big money to the right men. Send \$2.00 for sample outfit. The Radiogem Corp., 66-R West Broadway, New York City.

Scenery for Rent

World's Most Beautiful Settings for operas, plays, minstrels. Amelia Grain, Philadelphia.

School of Electricity

Electricity—Short day or evening courses in Electricity, Drafting, Engineering, and Architecture. In Chicago earn while you learn. Part Time positions pay expenses. Faculty of experts. Special short courses. Diplomas in 2 years. B.S. Degree in 3 years. Small classes, individual instruction. 23 year old institution with thousands of successful graduates. Enter any time. Employment bureau. Moderate tuition—monthly payments. New College building—all athletics. All details in 72 page "Blue Book." A copy will be sent to you free. Write today. Chicago Technical College, Dept. 27, 118 E. 26th St., Chicago, Ill.

Song Writers

Song-poem writers. Address Monarch, 1472 Broadway Dept. 122, New York.

Songwriters Substantial Advance Royalty payment essential to publication contract. Expert advice furnished beginners upon receiving poems requiring music and copyrighting for free examination. Send today. Walter Newcomer, 1674 Broadway, N. Y.

Stammering

St-tut-t-tering and stammering cured at home. Instructive booklet free. Walter McDonnell, 121 Arcade, 1126 Granville Avenue, Chicago, Ill.

Stop Stammering. All speech defects successfully corrected. Samuel Robbins, 399 Boylston St., Boston.

Telegraphy

Telegraphy—Both Morse and Wireless taught thoroughly. Big salaries. Wonderful opportunities. Expenses low, chance to earn part. School established fifty years. Catalog free. Dodge's Institute, Cour St., Valparaiso, Ind.

Wanted to Buy

Full Value Paid for Old Gold, Jewelry, Watches, Diamonds, crowns, bridges, dental gold, silver, platinum, gold or silver ore; magneto points, old false teeth. Packages returned if our offer is not satisfactory. United States Smelting Works (The Old Reliable) 39 So. State St., Dept. 16, Chicago, Ill.

\$35100 CLEARED IN ONE DAY

So writes W. H. Adams of Ohio. Letter from V. A. Marini of California reports \$11275 sales in three months. Jacob Gordon of New Jersey \$4000 profits in two months." Alexander of Pennsylvania "\$3000 profits in four months." Ira Shook \$365 sales in one day. Bram bought one outfit April 5 and 7 more by August 28. Iwata, bought one outfit and 10 more within a year. Mrs. Lane of Pittsburg says "sold 8000 packages in one day. J. R. Bert says "only thing I ever bought that equaled advertisement." John Culp says:



WE START YOU IN BUSINESS
Furnish secret formulas, raw material, and equipment. Little capital required; no experience needed.

Build a Business of Your Own
No limit to the sale of Crispettes. Everybody likes them. It's a delicious food confection. Write for facts about a business that will make you independent. Start now, in your own town.
Profits \$1000 a Month Easily Possible
Send postal for illustrated book of facts. It contains enthusiastic letters from others—shows their places of business, tells how and when to start, and all information needed. Free. Write now!

LONG-EAKINS COMPANY
169 High Street Springfield, Ohio

FREE RADIO GUIDE—SEND FOR IT



SETS, PARTS, KITS
164 PAGES OF NEW IDEAS
You need this big FREE book. A practical guide to success in set building. Gives new 1927 hook-ups. Shows the latest parts and kits at prices far below others. Send today. Build the newest sets. Make more money.

BARAWK CO.
540-542-C Monroe St. Chicago, U. S. A.

MADISON MULTI-CHOKES

QUADRI-WOUND

Specified for

"LR-4"

Lacault's Greatest Success!

Madison Multi Chokes (Quadri-Wound) have been specified by R. E. Lacault, originator of the famous Ultradyne in his latest development—the nine-tube Super-Sensitive LR-4 receiver.

For years, set builders have followed Lacault's specifications and guidance, in the successful construction of the most efficient radio receivers. There is no question about his selecting the Madison Multi-Chokes for his latest achievement.

Lacault knows something good when he sees it. Madison Multi-Chokes have met his most exacting requirements and it is for this reason that they are being specified in the new LR-4.

Madison Multi-Chokes can be used in many different combinations. In fact, this choke is the latest development in radio. They can be used for at least thirty different purposes. They are universal coils.

Lacault's LR-4 owes its extreme sensitivity and selectiveness to the Madison Multi-Chokes which are the foundation of his receiver.

Madison Multi-Chokes are made up in two types; Type

"C" and Standard. These Multichokes are special choke coils built in sections of different values, permitting various values of inductances to be obtained by connecting the terminals as shown in the pamphlet furnished with each Multi-Choke.

For example; the various windings may be connected so as to form a radio frequency transformer for the reception of long wave lengths, such as used by European broadcast stations. When used as R.F. transformers, five different ratios are obtainable.

The various values of inductances obtainable make these chokes adaptable to any radio receiver or circuit in which choke

coils are used. A few of the uses are: — Between the detector and audio amplifier. (This is particularly useful when resistance coupled amplifiers are used).

In the B battery leads, in circuits balanced to prevent oscillation, in filters, etc.

Additional values of inductances are obtainable with the type "C" chokes.

Dealers and distributors:
This is your opportunity to cash-in on this money-making proposition. Madison Multi-Chokes will be a consistent money maker. National advertising has been scheduled so send your orders at once. Orders will be filled and shipped in the rotation in which they are received. First come, first served.
Send for free literature.

Price \$6.50 each

MADISON RADIO CORPORATION

114 E. 28th Street

New York, N. Y.

Earn Big Profits in Spare Time

Take subscriptions to RADIO NEWS and four other nationally known magazines.

You can earn a handsome monthly income right in your own home—among your friends.

WRITE FOR PARTICULARS NO OBLIGATION

Dept. R

EXPERIMENTER PUB. CO., Inc.
53 Park Place, New York, N. Y.

Famous **MARWOOD** Now Sold on



Easy Terms

1 Dial 6 Tube \$43.85

Get Agents Price—Save 50%
Great news! Now own a famous Marwood at the world's lowest price for real quality—and pay on easy terms. The only Radio sold direct on easy terms—proof that the Marwood MUST be a wonder. A year ahead with 4 big exclusive improvements—Super-Selectivity, Power-Tube Volume, New Easy-Tuning Principle, New Tone Quality. Save half—and get a Radio that can't be beat at ANY price.

Both Models Shipped **Complete With All Accessories**

30 Days Free Trial
We trust you. Prove the Marwood the best buy in America. Don't buy a Radio till you get our Easy Terms, 30 Days' Free Trial, Agent's Confidential Low Price, Free Radio plan, new Catalog. Agents—Write quick for territory—Make big money.

MARWOOD RADIO CORPORATION
1747-A31 Morse Avenue, Chicago, Ill.

6 Tube 3 Dial \$36.85

YAXLEY

APPROVED RADIO PRODUCTS

for Your LR4 Nine Tube Receiver

When it came to selecting quality products for his new LR4 Nine Tube Receiver Mr. R. E. Lacault chose Yaxley Approved Radio Products. They were selected for use in this new circuit because they meet the most exacting radio requirements and are made to give lasting, reliable service.

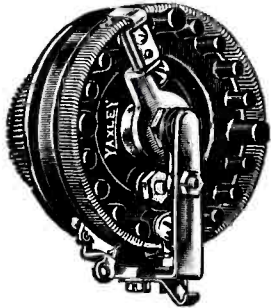

Air-Cooled Rheostat

- No. 120K—Rheostat, 20 ohm (with knob) ...\$1.35
- No. 400—Potentiometer, 400 ohm (with knob and dial plate) 1.75
- No. 3C—Jack (Double Circuit)70
- No. 3—Jack (Single Circuit Filament Control) .70
- No. 210—Pilot Light Switch (without lamp) .75
- Lamp for Pilot Light Switch..... .30

At your dealer's. If he cannot supply you, send his name with your order to

YAXLEY MFG. CO.

Dept. N, 9 So. Clinton Street, Chicago, Ill.

GOLD WAVE AERIAL



- Guaranteed to—**
- 1 Give you stations not previously received.
 - 2 Bring in greater distance.
 - 3 Improve tone and selectivity.
- or Your Money Back**

We make these claims without reservation. This famous Gold Wave Aerial has been put to thousands of tests. Recommended by all radio engineers. Broadcasting stations use it for better results. Can't corrode. Gives remarkable results when used on any make Radio set. 7 strands—gold plated—Aerial 100 feet long. Installed like any other aerial.

10 DAYS, TRIAL—SEND NO MONEY

Get One at Your Dealer's or Mail Coupon

LUXEM & DAVIS MFG. COMPANY
Dept. B 6229 Broadway, Chicago

Dealers and Agents Write for Proposition.

LUXEM & DAVIS MFG. CO.,
6229 Broadway, Dept. B, Chicago, Ill.

Please send me a GOLD WAVE AERIAL as described above. I will pay postman \$3.00 plus a few cents postage. If I am not satisfied after trial, I will return the aerial within ten days and you guarantee to refund my money.

Name

Address

PATENTS As one of the oldest patent firms in America we give inventors at lowest consistent charge, a service noted for results, evidenced by many well known Patents of extraordinary value. Book, Patent-Sense, free.

Lacey & Lacey, 631 F St., Wash., D. C. Established 1869.

Should the Air Waves Be Patrolled?

(Continued from page 815B)

Fig. 1. The general appearance of the completed generator is shown in Fig. 2. Variations in the inductance of the coils and in the capacity of the condenser for a particular setting over any but a short time interval, are of no consequences. The generator cabinet accommodates the dry cell "A" and "B" batteries and provides storage space for the coils. The variable condenser, tube socket and rheostat are mounted on the under side of a wooden panel. The arrangement of the parts on the panel as suggested in Fig. 2 permits short connecting wires and provides space inside the cabinet for the batteries. The generator coils are of the so-called spider-web type. This type of coil is easily wound to an approximate required inductance. Since it does not require the selection of a cylindrical winding form of a given diameter, it also has the advantage of compactness. On the other hand, it is probable that single layer coils wound on cylindrical forms will give slightly better results. The two terminals of each coil are anchored to the cardboard form and allowed to project about six inches. A third terminal is formed by soldering a wire to a point near the center of the coil. The three terminals are connected to binding posts on the generator panel.

The variable condenser used in the generator should have a maximum capacity of .001-mf. This determines the specifications for the coils as given in the table below, in order that the generator may cover the required range of frequencies (approximately 300 to 3000 kilocycles) with sufficient overlap between coils. The coils are wound with No. 20 or No. 22 A.W.G., double cotton covered wire upon cardboard forms having an odd number of projections or spokes.

Coils for Low-Power Radio-Frequency Generator:

	Coil No. 1 (Range 300 to 1,400 kc)	Coil No. 2 (Range 800 to 3,000 kc)
Approximate outside diameter of flat coil form.	6 1/4 inches	6 inches
Inside diameter of flat coil form	3 inches	3 inches
Number of turns	50 No. 20 AWG d.c.c. wire	20 No. 20 d.c.c. wire

The condenser should be provided with a dial and a type of knob to which can be attached a light wooden strip about 14 inches in length, to avoid body-capacity effects.

The schematic wiring diagram of the generator is shown in Fig. 1. Insulated wires are brought out from the batteries and connected to the proper binding posts on the panel, which is then secured in position. The batteries are held in place inside the cabinet by wooden strips. The head phones are connected to the proper binding posts, the rheostats turned on, and the coil terminal, which leads to the grid of the tube, is tapped lightly with a moistened finger, while the condenser is rotated. A succession of clicks indicates that the circuit is oscillating and thus in operating condition.

In measuring the frequency of a distant transmitting station of a frequency within the range of the frequency meter, the operation is essentially the same as locating a point from a transmitting station in calibrating the frequency meter. After the generator is tuned to zero beat with the incoming signal, the frequency meter is tuned to the generator, the setting of the frequency meter is read and the frequency is determined from the calibration curves.

DESIGNED to OUTLAST World Storage "A" Battery

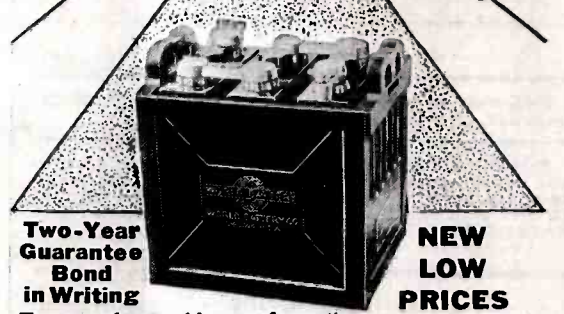

Two-Year Guarantee Bond in Writing

NEW LOW PRICES

Famous the world over for reliable, enduring performance. Solid Rubber Case lasting protection against acid or leakage.

Approved and Listed as Standard by Leading Authorities

including Radio News Laboratories, Popular Sci. Inst. Standards, Pop. Radio Laboratories, Radio Broadcast Laboratories, Radio in the Home and Lefax, Inc.

Send No Money

Just state number wanted and we will ship same day order is received, by express C.O.D. Pay expressman after examining batteries. 5% discount for cash with order. Remember, you save 50% on World Batteries—so send your order today.

WORLD BATTERY COMPANY
Dept. 10
1219 S. Wabash Ave., Chicago, Ill.

- Solid Rubber Case Radio Batteries**
- 6-Volt, 100-Amperes \$10.00
 - 6-Volt, 120-Amperes \$12.00
 - 6-Volt, 140-Amperes \$18.00
- Solid Rubber Case Auto Batteries**
- 6 - Volt, 11 - Plate \$10.00
 - 6 - Volt, 13 - Plate \$12.00
 - 12 - Volt, 7 - Plate \$14.50

Set your radio dials at 288.3 meters for the World Storage Battery Station W5BC. Variety—new talent—always interesting. Jerry Sullivan, Dir. and Announcer "Chi-CAW-go"

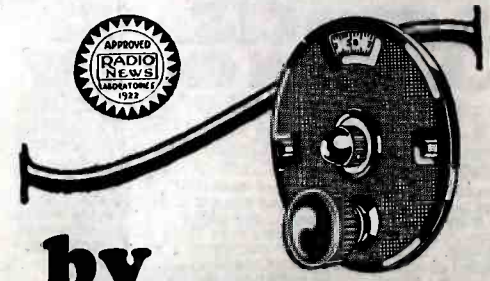

by **splitting a single degree into hair's breadth divisions, MAR-CO Dials respond to stations you now pass over. don't put it off—put them on your set tonight.**

MAR-CO DIALS

A NEW RADIO PLUG

Simple to use, gives perfect electrical contact with any style tip.

Simply push cord tip through plug, loop cord and push tip back into plug.

Sent postpaid on receipt of 50c

CULVER-STEARN'S MFG. CO
Worcester, M. sas

FREE | New 1927 Catalog | FREE

Shows photographs and hook-ups of all latest kits, complete line of cabinets and consoles, accessories and parts. We are headquarters for all nationally advertised lines. Dealers and professional set builders write today for your copy of this big FREE CATALOG.

SHURE RADIO CO., 19B-21, S. Wells St., Chicago



Cornell Dials



ACTUAL SIZE

Bring Your Old Set Up to Date

The most beautiful dial in the world, and mechanically as good as it looks.

Works with velvet-like smoothness without a trace of back-lash. Strong enough to turn a heavy double or triple condenser without slipping.

Send for this very attractive, antique gold-finish, beautifully etched embossing, 9 to 1 Vernier Dial. It will beautify your set and make it a 1927 model.

LIST PRICE - - - \$1.50 a piece.

CORNELL ELECTRIC MFG. CO.,
Rawson & Annabelle Streets, Long Island City, N. Y.

Enclosed please find Money Order for \$..... for
Cornell dials at \$1.50 each, and name of your nearest dealer.

NAME

ADDRESS

BOOK REVIEW

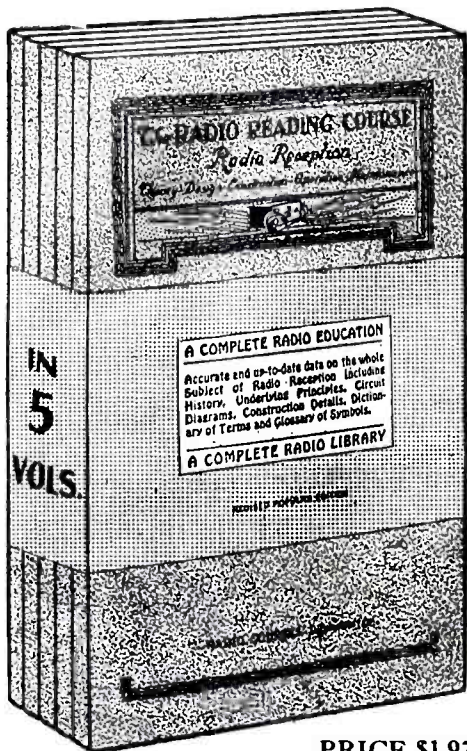

PRICE \$1.97

A RADIO EDUCATION

IN 5 VOLUMES

Theory, Design, Construction
Operation and Maintenance

LEARN AT HOME

These five component parts of a complete Radio Instruction Course are outlined in five volumes that contain not merely the essentials as so many books do, but more, they contain all that any modern up-to-the-minute textbook on any subject would cover. They are in themselves a COMPLETE radio education teaching every possible portion of Radio science.

Size of each book 6 by 9 inches, handsomely bound and illustrated with charts, diagrams, descriptions of equipment, etc.

SEND NO MONEY for these books. Just forward your name and address. We send you the books at once. On receipt of same you pay the postman \$1.97 plus a few cents postage and then they are yours.

Distributed by

The Consrad Co. Inc.
53 Park Place, New York, N. Y.

HOW RADIO RECEIVERS WORK, by Walter Van B. Roberts, B.S., E.E., Ph. D. Doubleday, Page and Company, Garden City, L.I. 6 $\frac{3}{4}$ x10 $\frac{1}{2}$ inches, 53 pp. cloth. Price \$1.00.

This brief but authoritative little book is full of precise information, presented in clearly written language and illustrated with scores of drawings. Although an engineer and skilled mathematician himself, the author shows a fine regard for his readers by not overawing them with formidable mathematical formulae and data, and instead explains various radio phenomena in physical terms. He does not entirely remove mathematics from his explanations, but considerably marks with stars those portions of the book which he thinks are too technical for the average seeker of radio knowledge whom he thereby saves the trouble of trying to decipher the complex equations with their unpronounceable Greek symbols.

The first fifteen pages of the book are devoted to a tabloid treatise on electrical theory, and may serve more to refresh the memory of one who has already studied such things rather than to furnish a beginner with an education in fundamental principles. The rest of the volume, with the exception of a short chapter on essential accessories like loud speakers, batteries, sockets, etc., is occupied by detailed explanations of vacuum-tube characteristics and operation. The subject of feed-back methods of regeneration is covered with comparative thoroughness so that the radio experimenter who has always been puzzled by regeneration may read this chapter with particular benefit.

Modern receiving circuits are also discussed; the reasons for the existence of sets like the neutrodyne and superheterodyne are explained briefly, as are reflex and super-regenerative hook-ups.

In general this book will be most valuable to the radio fan possessing some theoretical knowledge and practical experience. Its paragraphs and chapters are short and to the point, and may be read with profit by the fan during spare minutes after lunch, or on the train on the way home. It is not a complete radio education, but a rather useful supplement to standard engineering volumes.

THE RADIO NEWS SUPERHETERODYNE BOOK, compiled by the staff of Radio News. Experimenter Publishing Company, New York, N.Y. 8 $\frac{1}{2}$ x11 $\frac{3}{4}$ inches, 96 pp. paper bound. Price, \$0.50.

The unchallenged leader of receiving circuits, the superheterodyne is by far the favorite hook-up of the radio experimenter. Every angle of its theory, construction and operation is covered with great thoroughness in this handy book, which should find a place in every radio experimenter's library.

No less than nineteen different receivers embodying the superheterodyne principle are described in the manual. The full details of their construction, with working drawings, circuit diagrams and picture hook-ups, are given, so that even an inexperienced experimenter can assemble a set and make it work successfully.

Among the "supers" described are the Cotton, the Silver, the Hetro Five, the Fenway, the Midget, the Second Harmonic, the Tropadyne, the Best 45,000-cycle, the "Peanut," the Ultradyne and the Pressley.

Special articles are devoted to data on the intermediate amplifier and on the process of matching tubes. The author of the article on the latter subject is S. Young White, who recently came into prominence as co-inventor with E. H. Loftin of the constant-coupling arrangement for R.F. amplifiers which bears their names. Another section, written by Professor Grover Ira Mitchell, deals with the matter of matching intermediate transformers. The importance of such matching is stressed, and directions are given for the benefit of the constructor.

Twenty-six patents dealing with or relating to the superheterodyne are printed in the back of the book in condensed form. These form an interesting and instructive history of the famous circuit, and bring to light the parts played by several men whose names are not usually associated with superheterodyne development.

This Book and Magazine section will appear in each issue of RADIO NEWS, and contain reviews of the new publications of interest to radio students, from the beginner to the most advanced. It will be found a useful guide to intelligent purchasing. For the benefit of our readers, contemporary periodical offerings, both American and foreign, will also be briefly listed.

Over
10,000,000
have used
CONSRAD
PATTERNS

CHOOSE YOUR NEXT
RADIO SET FROM
THESE PATTERNS



A WIDE selection of patterns, far more simple than those for a lady's dress pattern, have been developed by CONSRAD for the man who has never handled a radio part before. Every smallest detail is explained simply, made easy to understand. Step by step the building of the set is explained so that you can't go wrong.

Each CONSRAD pattern contains two or more large, full sized blueprints. One of the detailed panel layout and the others of the wiring diagrams. A 9 x 12 booklet goes with each pattern explaining everything and giving illustrations at various stages of the work.

COMPLETE LIST OF CONSRAD PATTERNS

- No. 2—A Two-Stage Amplifier.
- No. 4—A Reinartz Receiver.
- No. 5—A Reflex Receiver.
- No. 6—A Cockaday Receiver.
- No. 7—A Neutrodyne Receiver.
- No. 9—The S. T. 100 Receiver.
- No. 11—A Five-Tube Cockaday Receiver.
- No. 12—A Portable Receiver.
- No. 13—A Harkness Receiver.
- No. 15—A Low Loss Receiver.
- No. 16—The Tropadyne Superadio.

"SOLD EVERYWHERE"

50c EACH

If Your Dealer Cannot Supply You
Write Direct

THE CONSRAD CO., INC.,
53 Park Place, New York, N. Y.

TWO BIG OFFERS for "RADIO NEWS" READERS

FREE 100 page illustrated book given away with every subscription to

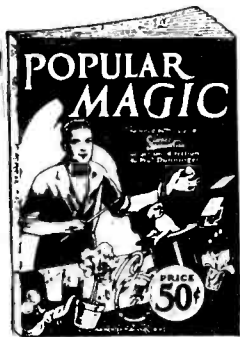

THIS BOOK FREE

AMAZING STORIES

A new kind of magazine. Scientifiction by world-famed writers. Marvelous, Amazing Stories by great men such as Jules Verne, H. G. Wells, etc., appear in this new magazine AMAZING STORIES every month.

Stories of flying into space at dazzling speed on a comet; Mesmerizing the dead; remarkable situations of all kinds. Tremendously interesting—yet instructive.

Keeps you in touch with the writings of the men with the greatest imaginations in the world. A magazine for young and old.

PRICE \$2.50 THE YEAR

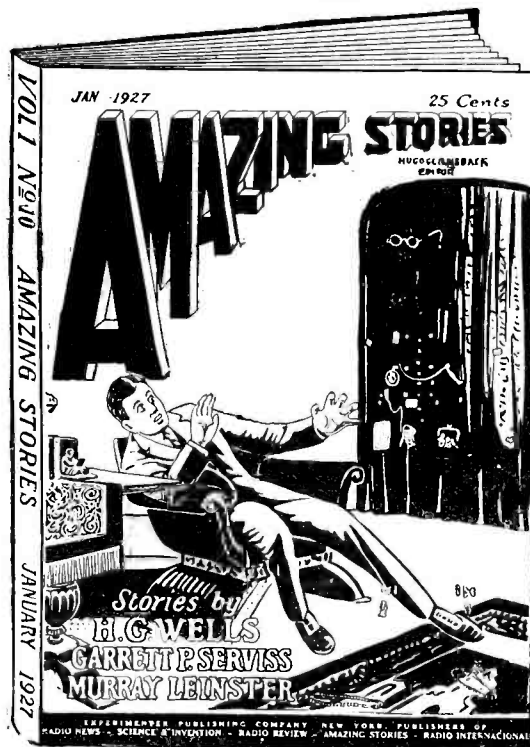

Big January Issue Just Off the Press

Containing the following feature stories: "The Red Dust," by Murray Leinster. "The Man Who Could Vanish," by A. Hyatt Verrill. "The First Men in the Moon," (Part II), by H. G. Wells. "The Man With the Strange Head," by Dr. Miles J. Breuer, and others.

Here's another big FREE offer!

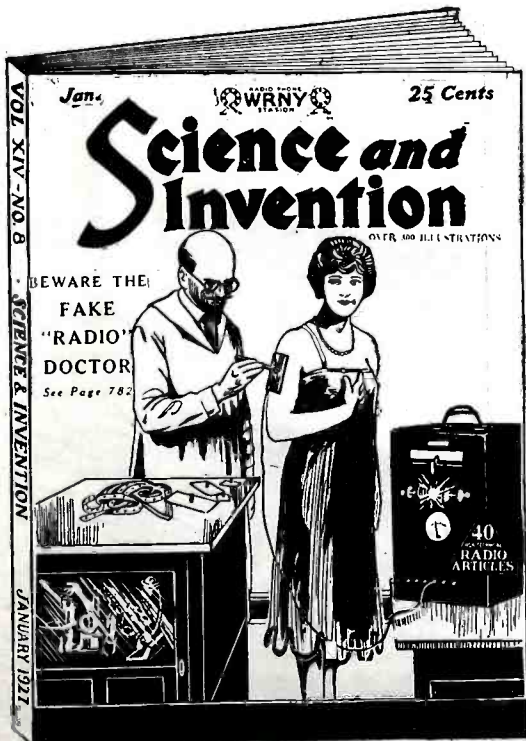

Every subscriber to SCIENCE AND INVENTION, using the coupon below will be entitled to one FREE copy of the 100-page book "HOW TO MAKE IT." This book tells how to make hundreds of useful things at home at low cost including furniture, home appliances, sport devices, etc.

Read

SCIENCE and INVENTION

SCIENCE AND INVENTION is the magazine of wonders — marvelous, astounding inventions, scientific discoveries and magic are shown with pictures. The news of the scientific and inventive world is displayed in "Science and Invention" like a motion picture of the progress of the world.



Now you can obtain this great magazine for 12 months for \$2.50 and a big book illustrated FREE if you act now. The coupon below will bring it to you.

USE THIS COUPON

Experimenter Pub. Co., Inc.
53 Park Place, New York City

EXPERIMENTER PUBLISHING CO., Inc.,
53 Park Place, New York, N. Y.

Gentlemen: I enclose \$..... for one year's subscription to, you are also to send me free one copy of.....

Name
Address
City State.....

Now it's complete ~ ~ ~ Ready for your radio bookshelf



The First Radio Encyclopedia ~ Ever Published ~

Edited by **SIDNEY GERNSBACK**, Editor of "Radio Listener's Guide and Call Book (Radio Review)." Editor of "Money Making." Author of "Wireless Course in Twenty Lessons"—"One Thousand and One Formulas"—"Practical Electricity Course"—etc.

S. GERNSBACK'S RADIO ENCYCLOPEDIA is the only standard work ever published in America attempting to classify alphabetically the countless words used in the highly specialized science of RADIO.

The ENCYCLOPEDIA is written in plain English so that everybody can understand the definitions and descriptions.

This is not a Dictionary, but a real Encyclopedia of Radio.

The book contains as a supplement a classified cross-index designed to bring together radio references under one heading having relations in common.

All circuits new and old are described by word and picture and every part and apparatus used in Radio is explained and made understandable by means of photographs and drawings.

The work contains 1,930 definitions, 549 photographs, drawings and diagrams. Size of book is 9 x 12 inches, nearly an inch thick, 168 pages printed on strong heavy paper, specially made for books of this kind. It is bound in stiff Keratol covers, hand sewed and gold stamped.

PRICE \$2.00 Postage Paid

SEND ALL ORDERS DIRECT TO THE EDITOR

SIDNEY GERNSBACK

53 PARK PLACE

NEW YORK CITY

WIRELESS COURSE IN TWENTY LESSONS, by S. Gernsback, A. Lescarbourea and H. W. Secor. Experimenter Publishing Company, New York, N.Y. 6x9 inches, 264 pp. in flexible leather. Price, \$2.00.

Fifteen years ago, when radio was vaguely regarded by the public as something of a freak, the authors brought out the first edition of "Wireless Course in Twenty Lessons," and found their pioneer work eagerly read by the handful of existing experimenters who listened-in with simple crystal sets. The book is now in its twelfth edition, more than 200,000 copies having been sold. Today it is still one of the most admirable and comprehensive treatises on radio ever published for the radio amateur.

The object of the book is to familiarize the layman thoroughly with the underlying principles of radio, giving him a brief outline of elementary electricity, magnetism, electric circuits, etc., in order that he may be able to understand the operation of various radio instruments and later progress to the more advanced stages of the field.

The contents have been brought right up to date, and cover the most recent developments in broadcasting. The manual is profusely illustrated with more than 500 diagrams and photographic reproductions, practically every page containing one or more illustrations. It is almost a complete radio education in itself, and makes an ideal textbook for study by the person without specific technical schooling.

THE RADIO TROUBLE FINDER, compiled by the staff of RADIO NEWS. The E.I. Company, New York, N.Y. 6x9 inches, 47 pp. paper covers. Price, \$25.

Any radio man who studies this handy little book and acquaints himself with the multitude of tests described in it may go forth in the world and proclaim himself an expert "trouble shooter." Every experimenter should hang a copy of it in a readily accessible place near his workbench, for he undoubtedly will find frequent occasion to refer to it.

Every standard radio part is described, its characteristics outlined, and its weak points marked for special attention.

One complete chapter of seven pages is filled with a systematized chart listing all known symptoms of radio trouble. The cause of each is given and remedies for its alleviation prescribed. Special recommendations are given for the diagnosis and treatment of ills in sets of the following types: tuned-radio-frequency; regenerative; reflex; and superheterodyne. The "A" and "B" batteries, frequent sources of trouble, are also considered, and suggestions are made about their care and treatment.

500 RADIO WRINKLES, edited by Leon L. Adelman. Experimenter Publishing Company, New York, N.Y. 8½x11¼ inches, illustrated, 96 pp. paper covers, Price, \$50.

Five hundred ingenious wrinkles, each accompanied by a clearly-drawn illustration, serve to make this book a highly interesting one for the inveterate radio dabbler who is always trying new little kinks. They cover the entire range of radio set detail from the erection of aerial masts 38 feet high to the proper soldering of catwhisker wires.

The book is divided into fourteen sections, comprising respectively the subjects of antennae, batteries, coil mountings, condensers, crystal detectors, inductances, lightning protectors, loud speakers, miscellaneous, resistances, sockets, switches, transformers, and vernier dials.

Every imaginable angle of set construction and embellishment seems to be covered in this exhaustive volume. The items represent a judicious selection by the editor from several of the most recent volumes of RADIO NEWS, and contain the ideas of radio experimenters in all parts of the world.

1001 RADIO QUESTIONS AND ANSWERS, edited by Leon L. Adelman. Experimenter Publishing Company, New York, N.Y. 8½x11¼ inches, 96 pp. paper covers. Price, \$50.

About five years ago, when radio broadcasting was first beginning to impress itself on the public as one of the most interesting and fascinating means of entertainment and diversion ever devised, people who visited radio stores and examined radio receivers asked one question: "How far will this set receive?" This inponderable query was flung at radio dealers and radio editors with such distressing frequency that it soon took its place with equally-famous and unanswerable puzzles like "How far is up?" and "When is never?"

As people's curiosity grew, their questions increased in number and variety, as the staff of RADIO NEWS knows only too well. Questions by the score, by the hundred and by the thousand were piled upon the desks of the editors, who kept whole corps of stenographers busy wrestling with technical terms and expressions. After five years, the most representative and most frequently repeated of these queries have been selected, carefully sorted, and compiled between the covers of a single book for the edification of the radio fan with an inquiring turn of mind.

S. GERNSBACK,
53 Park Place, New York, N. Y.

R. N. -1

I enclose \$2.00 for one copy of your new "RADIO ENCYCLOPEDIA" as advertised above.

NAME

ADDRESS

CITY, STATE

One thousand and one questions, along with their answers and numerous explanatory illustrations, are contained in this volume, which is a veritable gold mine of information. No phase of radio-set theory, design, construction or operation has been overlooked by the compiler, who has classified the queries into eight groups for convenient reference. These sections are: miscellaneous circuits, popular circuits, tube data, transmitting circuits, current supply, amplifiers, antennae, and miscellaneous apparatus. If you are puzzled by any problem whose subject is covered by these headings, all you have to do is to turn to the proper chapter and browse through the various queries until you find one that resembles your own.

The book makes excellent light reading even if you have no definite questions in mind, because its paragraphs are terse, brightly written, and come right to the point.

DICTIONARY OF WIRELESS TECHNICAL TERMS. Compiled by S. O. Pearson, B.Sc., A.M.I.E.E., 254 pages, board covers, 3 1/8 by 5 inches, illustrated. Published by Iliffe & Sons, Ltd., London. Price, 2 shillings, (50 cents).

This small volume is intended to serve as a guide, not only to the great army of radio experimenters and students who have not the advantage of a training in electrical engineering, but also to those who have been or are now studying radio. Nearly everyone in his reading comes across terms and expressions of which he does not know the meaning; and for this reason, a dictionary of this type is of value and utility to all radio workers.

The volume contains ample definitions of technical terms and expressions that are commonly encountered, and highly technical language has been avoided, so far as possible, in defining words. An extended system of cross-references makes it possible for the book to be understood by those possessing the minimum of knowledge concerning radio theory and practice. The book is well illustrated and, wherever necessary, an explanatory diagram has been added to make a definition more clear.

PRACTICAL RADIO AND THE TESTING OF RECEIVING SETS, by James A. Moyer and John F. Wostrel. McGraw-Hill Book Company, Inc., New York, N.Y. 5x7 3/4 inches, 271 pp., stiff cloth, Price, \$1.75.

The authors' own preface is an admirable review of this exhaustive book. They say, in part:

"Much that has been written on the subject of radio has been so technical, so brief, that the average reader is unable to get a clear understanding of even the fundamental principles. It is the object of this book to present the fundamentals of the subject so simply and clearly that any person of average training will be able to read, understand and apply them. Above all, the intention has been to make this book practical, as the name indicates; and in furtherance of this idea working drawings are given in one of the chapters for a number of popular, typical radio receiving sets. It is believed that sufficiently complete information is given so that the reader will have very little difficulty in constructing his own receiving set if he wishes to do so."

Among the subjects which are treated in the volume are the following: radio direction-finding, and directional distortion caused by buildings and other structures; new types of radio receiving sets, especially the Browning-Drake and improved superheterodynes; and super-power broadcasting stations and their effects on distance, fading, interference and static. Practical methods of reactivation of vacuum tubes are explained in detail.

An important section is a Radio Trouble Chart, similar to those in books on automobile operation, to show at a glance the probable cause of the most common troubles, and the remedies when these are not obvious from the nature of the defect in the receiving set or its auxiliary equipment. Another chart shows the important characteristics of various types of radio receiving sets, indicating by the words "excellent", "good", "fair" and "poor", the relative desirability of the various types.

Current Radio Articles

RADIO BROADCAST, New York, November, 1926 issue.

The two leading articles in the November issue of *Radio Broadcast* are entitled "The Radio Patent Structure and What It Means," by French Strother, and "Looking Back Over Thirty Years of Radio," by Guglielmo Marconi.

Mr. Strother, who is covering the muddled radio patent situation in a series of well-written articles, expresses the opinion that the future of radio, so far as patents affect it, is in the hands of the courts. He further remarks that if patents are the decisive element in the radio field, the logic of events points to the eventual leadership by the Radio Corporation of America, with only a possible one or two smaller organizations operating independently under few patents.



PIN MONEY EXTRA MONEY SPARE TIME MONEY

Which do you prefer?
MONEY MAKING
tells you how to get it!

The people who really enjoy the little luxuries that have become so important in today's home are those who do not have to sacrifice essentials to do so. A second income, no matter how small, solves this problem.

Why not start today. There are hundreds of ways to develop a steady additional income that will bring to your home the many little things that make life more enjoyable.

MONEY MAKING tells you how, each issue takes various ways and means and explains them in such a way that you can immediately apply them to your own benefit. Some plans require no initial outlay while others, for a small first cost, return many dollars a year to your pocket.

BEGIN NOW—LET TODAY BE THE STARTING POINT FOR YOU INTO A BIGGER INCOME AND A THOROUGH ENJOYMENT OF THE LUXURIES OF THIS LIFE.

Published and Distributed by
THE CONSRAD COMPANY
53 Park Place New York, N. Y.

JUST OFF THE PRESS

132 Pages—Illustrated

Over 48 Articles on every phase of money making enterprises.

25c On All Newsstands

A BIG HANDY FRIEND

for
WINTER RECEPTION

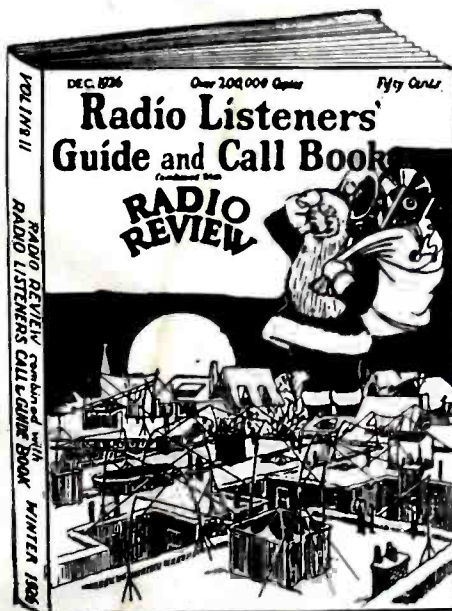

Winter brings Radio Magic. Distance—volume, clarity—all those things you may have striven for all summer without success.

Enjoy good reception to its fullest—**Radio Listeners' Guide and Call Book (Winter Edition)** gives you the latest list of every Broadcast station in the United States, Canada and Foreign countries, gives wavelength, power, location and even the hours of operation.

Also this book has a whole section of illustrated articles on how to build sets and accessories.

And the final supplement of S. Gernsback's famous *Radio Encyclopedia*.

More data in one book than you have ever before encountered.

196 PAGES

Photos of Broadcast Stars and Stations
SIZE 9 x 12

BUY YOUR COPY NOW

Published by
THE CONSRAD CO., Inc.
53 Park Place, New York

If your dealer cannot supply you write direct

RADIO'S GREATEST CALL BOOK

Completely Revised and brought up-to-date for Winter use

50c ON ALL NEWSSTANDS

Don't Hire An Expert

Keeping a Radio Receiver In First Class Condition Is Easy with These Simplified Books

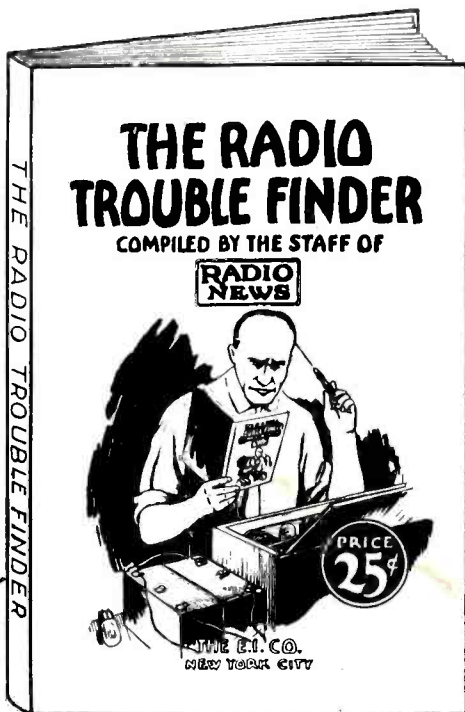

TITLES IN THIS SERIES

- 1—Tips for the Radio Amateur Constructor
- 2—How to Make Practical Radio Receiving Sets
- 3—Radio Questions Answered
- 4—Radio Frequency Amplification
- 5—Loud Talkers, How to Build Them
- 6—How to Tune Your Radio Set
- 7—One Hundred and Fifty Radio Hook-ups
- 8—All About Radio Parts
- 9—History and Operation of the Vacuum Tube
- 10—The Neutrodyne—All About It
- 11—How Radio Is Received
- 12—How to Locate Troubles in Your Radio Set
- 13—Reflex Radio Receivers
- 14—The Super-Heterodyne, Theory and Construction

NO longer do you need to hunt all over radiodom for the information you need on this hookup or that hookup or on this method of construction or that method.

The E. I. Company books, standardized and compiled expressly with this idea in view, will give you the latest and most authentic radio information on any question of construction or operation.

One of these books are shown here. Each is of the standard size 6 inches by 9 inches, containing 64 pages, with plenty of illustrations, diagrams and hookups, written in simple terms so that anyone can understand all that is in them.

Why not, in view of their extremely low price, obtain a complete library of the books? They are the most convenient, most practical and most helpful reference books on the radio market today.

25^c EACH
Complete Set \$3.00

Distributed by
THE CONSRAD CO., INC.
 53 Park Place, New York City

THE CONSRAD CO., Inc.,
 53 Park Place, New York City.

Gentlemen: I enclose \$.....for one copy each of books
 Number

NAME.....

ADDRESS.....

CITY, STATE.....

The greatest complication of all surrounds the vacuum tube, declares the author. There are 256 unexpired patents covering the tube and relating to everything from the use of thorium in the making of tungsten filaments to the relation of grid to plate. There is a total of about 2,400 radio patents in all, he says, which are the basis of hundreds of lawsuits by almost everybody against almost everybody else.

Other articles in the November issue are "High Efficiency 'B' Battery Transmitters," by Keith Henney; "Constructing the R.B. 'Lab.' Receiver," by John Brennan; "Modernizing the Atwater-Kent Model 20 Receiver," by James Millen; and "A New Plan to Regulate Radio Broadcasting," by Carl Dreher.

POPULAR RADIO, New York, November, 1926.

"Are There Ether Waves After All?" This query greets the reader as he turns to the first article in the magazine. Reading on, he discovers the answer, given by E. E. Free, is a carefully qualified "yes."

Dr. Free describes in non-technical language the experiments which Professor Dayton C. Miller, now of the Case School of Applied Science, Cleveland, Ohio, has been carrying on for about a quarter of a century. He states simply in his third paragraph that "ether waves must exist after all," and then goes on to describe in detail the researches of Professor Miller which enable him to voice this conclusion.

As a theoretical treatise the article is interesting enough to the serious student of science who can get excited over the Einstein theory of relativity. Radio fans concerned with more earthly subjects will find more practical material in an article by Lawrence M. Cockaday on the construction of a power unit eliminating "A" and "B" batteries and in several other well-written stories. Sir Oliver Lodge, in the first of a series of articles on "Waves and Wavelengths," describes radio waves and their characteristics in elementary language. For the beginner this is an educational piece, though more experienced readers will gaze rather wearily at the time-worn photograph of a water pond and the waves set up in it by a stone.

Orrin E. Dunlap, Jr., gives the details of the Baird "Televisor," the Scotch invention for transmitting pictures of moving objects by radio. Edgar H. Felix tells how to patent radio inventions; his article should be filed by every hopeful radio experimenter.

Other subjects covered in the magazine are as follows: "Radio Transmits Weather Maps To Ships," by Commander Standford C. Hooper; "Inside Information on New Radio Receivers," by S. Gordon Taylor; "Recruiting an Army of Radio Fans," by C. A. Oldroyd; and "How to Solder," by Robert Hertzberg.

RADIO, San Francisco, Cal., November, 1926.

The theoretical considerations governing the use of shields, along with some practical suggestions about their installation, are discussed for the benefit of the radio beginner in an article by H. Melchior Bishop. Shields serve several purposes, says the author; they make a receiver more selective than it would be otherwise, by preventing radio impulses from directly affecting the coils in the set, and they prevent magnetic coupling between interstage tuning inductances. He describes in detail the correct application of shields and the theory involved in their design.

Another excellent article bears the name of J. E. Anderson, and deals with the effects of "B" battery impedance on amplification. A battery with a high A.C. resistance is shown to be the cause of considerable distortion, and the writer offers some suggestions for its correction. The theoretical discussion of the phenomenon is mathematical and involved, but the expedients suggested by the author are easily applied.

"The Development of Radio Apparatus in the Navy," "The Operation and Construction of Quartz Crystals," and "A Multi-Purpose Oscillator-Wavemeter" are some of the other articles in the magazine.

QST, Hartford, Conn., November, 1926 issue.

The amateur who wants to build a compact transmitter, employing a crystal for steady control of the generated waves, must use shields between the various tube units to avoid difficulties with harmonics and with feed-back troubles in general, declares John M. Clayton, who describes a shielded crystal-controlled unit in this magazine, and asserts the advantages to be secured from shielding make the time, trouble and money involved in its installation well worth while. Complete constructional data on a shielded outfit suitable for amateur service are given in the article.

In another article Zeh Bouck boosts the use of radio-frequency amplification for short-wave receivers, saying that when a properly-designed amplifier is connected before the usual short-wave regenerative set it provides a distinct intensification of signals. He offers as proof of his contention an actual R.F. amplifier which he has constructed and operated successfully.

Other articles in the same issue are: "R.F. Amplification—A Rehash," by Elmore B. Lyford, a fine discussion, in physical terms, of all the R.F. circuits in use today; "A Sensitive Vacuum-Tube Relay," by W. H. Hoffman and F. H. Schnell; and "Horizontal-Wave Experiments at 2AER," by John M. Hollywood.

3rd EDITION

So Huge Has Been the Demand For the First Two Issues of "AMATEURS' HANDIBOOK" That They Are Entirely Sold Out. Now a Third Edition Is Ready—Completely Revised With All Brand New, Up-to-Date Articles From Radio's Greatest Magazine, "RADIO NEWS".

(HERE IT IS) →

Just glance through this partial list of contents and notice the tremendous amount of real, new, valuable data contained in this book. A glance is sufficient. Every real radio fan will recognize articles on sets and equipment that would cost many dollars to procure elsewhere.

An easily constructed Crystal Receiver.

A remarkable quality (6 tube) Receiver.

A single Control Regenerator. The Autoregenerator.

How to build a 3-foot Cone Speaker.

A new idea in set Construction.

The Eusonic Receiver (6 tube)

A Duplex Crystal Detector Hookup.

The Roberts Circuit.

A Bell Wire Receiver.

An Autotransformer Receiver.

An Inverse Duplex Receiver.

The Dyadyne (4 tube) Receiver.

Construction of the Duodyne.

A Knockout Portable.

Something New in Wave Traps.

A Plug-in Coil Short Wave Receiver.

The Infradyne.

A Super-Heterodyne with Matched Transformers.

Methods of "B" Elimination.

A Batteryless Receiver.

Radio Wrinkles.

118 other standard Hookups illustrated and described.

And so on this list of the finest Radio Articles published appears without end—Don't fail to get your copy now!

RADIO NEWS AMATEURS' HANDIBOOK

VOL. 3

RADIO NEWS

Amateurs' Handibook

by the most eminent Radio Experts

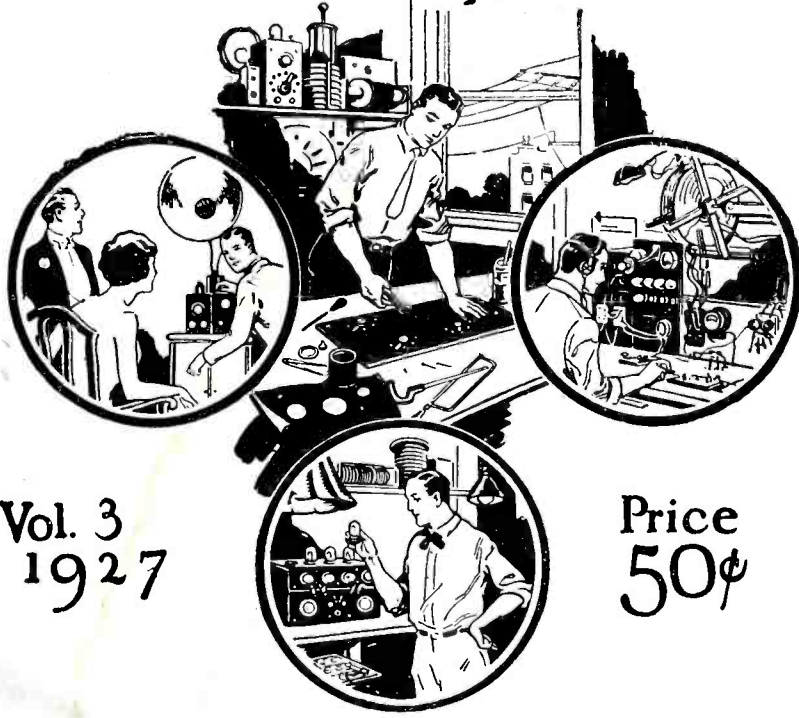

Vol. 3
1927

Price
50¢

EXPERIMENTER PUBLISHING COMPANY, INC.
NEW YORK

AUTHORITATIVE-CONSTRUCTIONAL

If you were one of the lucky one's to get copies of the last two issues of the "Amateurs' Handibook" before they were entirely sold out—we need not boast about our third edition, except to say that it surpasses in a thousand and one ways the elder editions.

There are more sets described and illustrated complete—More circuits shown—More articles of general nature. And they're all up-to-date, that is, new, fresh from the pen points of Radio's biggest Editors and Engineers.

116 Pages, full of information, size 9 x 12 inches, 2 color cover, illustrated profusely.

50c THE COPY EVERYWHERE

If your dealer cannot supply you write direct

EXPERIMENTER PUBLISHING CO., Inc., 53 Park Place, N. Y. City

FREE

This 84 Page Wonder Book of RADIO Bargains



Send
for
it
10-DAY

Over
2000
—ITEMS—
Everything
in RADIO

Send for this guide to Radio prices and Radio quality. All of our vast resources and radio experience have been utilized to assemble for you in one gigantic institution, the best and newest things in radio. The Randolph catalog is indeed the radio market place of the world—a masterpiece of merchandising that befits our house—the largest exclusive radio mail order house in the world.

What Our Catalog Contains

Over 2,000 items—from the most beautiful, fully equipped console model radio set, down to the smallest part or tool for the set builder—kits, parts, and supplies of every conceivable type and style. All beautifully illustrated and interestingly described. And to give this book added value, we have included radio data that makes it an invaluable text book for every lover of today's most fascinating and most wonderful achievement—RADIO.

Radio Sets

In this great radio market place you will find table model sets and console types with built-in loud speakers; the newest ampliphonic console sets; new Spanish period consoles; five, six, seven, and eight tube sets, with three dial, two dial, and the newest and most popular single simplified control. All sets are assembled in beautiful, genuine mahogany and walnut cabinets in a choice of latest types and designs.

**5 Tube sets as low as \$24.90
Latest 1927 Models**

All Randolph sets are sold at amazingly low prices. No matter what kind of set you want—no matter how little you want to pay—you can select YOUR SET AT YOUR PRICE from the Randolph catalog.

Radio Kits

The radio kits we offer for sale are approved by the world's foremost radio engineers. Wonderful values in the latest kits, including all classes of radio frequency, super-heterodynes and every other approved popular and advertised circuit. There is nothing in the line of radio kits and parts of any value and which are in demand which we do not carry.

YOU MUST HAVE THIS BOOK

Space limitations here prevent our telling you more about the Randolph Catalog. Simply fill out and mail the coupon—or you may send a postal or letter—and this truly remarkable Radio book will come to you **ABSOLUTELY FREE. MAIL THE COUPON NOW.**

Randolph Radio Corporation
180 North Union Avenue • Dept. 211 • Chicago, Ill.

Radio Parts and Supplies

The Randolph catalog also contains a most complete line of "B" Battery Eliminators, including the famous Raytheon Eliminators; the latest type of Loud Speakers, Cone Speakers, a complete line of quality "A" power units—in fact, you will find listed in this wonder book every part that goes into the construction of a radio set, or any accessories you desire, at prices that mean a substantial saving to you.

Free Radio Service

Everyone has need for radio service. The average man has no time to keep up with the rapid developments of radio. We employ Radio Engineers who have made radio their life work. Their expert advice and helpful suggestions solve every radio problem of our customers.

Our Guarantee

Every article in our catalog is based on careful laboratory analyses and tests. We guarantee to back up every item in our catalog with our own as well as manufacturer's assurance of quality.

Why We Save You Money

Because we handle radio exclusively and sell a tremendous volume of everything in Radio, we can concentrate our buying power for the benefit of our customers.

Volume purchases regulate prices. We command rock bottom prices from manufacturers, and in many cases we contract for entire factory output of exclusive products. You will benefit by our great volume of purchases and sales, by securing anything you may want in radio at a substantial saving.

This Coupon Brings the Great RADIO Book FREE

RANDOLPH RADIO CORPORATION
180 N. Union Ave., Dept. 211
Chicago, Illinois

Send me—free—your 84-page, 1927 Radio Book.

Name _____

Street and No. _____

R. F. D. _____ Box _____

City _____ State _____

30 DAYS FREE IN YOUR HOME

Tested and approved by all of Radio's Highest Authorities



Send Coupon for Amazing Special Offer!

Unless Trial Proves Your Miraco The Most Selective, Clearest Toned and Most Powerful Distance Getter Among Sets up to 8 Tubes, Don't Buy It! Special Wholesale Prices

BEAUTIFUL-BIG-POWERFUL Ultra Selective **MIRACO** Ultra 5

Retail \$ LIST Price **49.75** now only **49.75** GET SPECIAL OFFER one year GUARANTEE

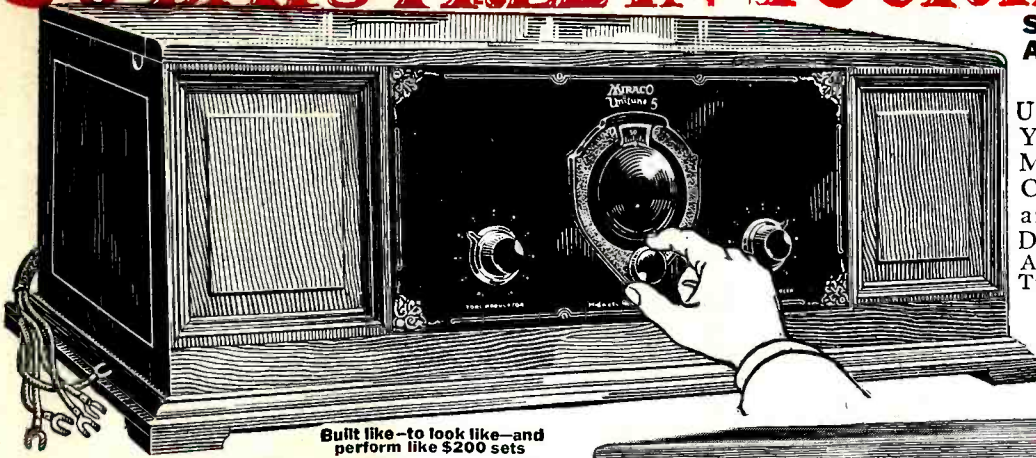

Built like—to look like—and perform like \$200 sets

Real Single Dial Control! Magnificent Big Powerful Miraco "Unitune-5" Get Special Offer Amazing Low Price!

The celebrated Miraco Ultra-5—U.S. Navy type circuit, has also been adapted to Single Dial Tuning—without sacrifice of selectivity, volume, clearness, power, tone, or distance getting qualities! In the magnificent big Miraco Unitune-5, above shown, you turn one vernier knob for stations everywhere. Beautiful hand-rubbed, piano hinged, solid walnut cabinet, 28 in. long, 15 in. deep, 10 in. high. Sloping Bakelite panel is walnut finished to match. Also offered on 30 days free trial!

Coast to Coast and Foreign Reception Certified by Miraco users



Enormous sales of the celebrated Miraco big fine Receivers (resulting from delighted users so highly endorsing them to friends) again enable us to add hosts of costly new features, latest refinements and up-to-the-minute improvements such as you might expect to find only on much higher priced sets. Miraco's this year are still better—more beautiful—more selective—more powerful for less money than ever before.

USER-AGENTS WANTED - WRITE!

Reports from users everywhere leave little for us to add. These are only a few of the many in our files and which we receive daily. Send coupon for plenty of additional proof and testimony of nearby users.

HAS NO EQUAL FOR TONE, VOLUME, DISTANCE. North Wildwood, N.J. Miraco best packed set I ever saw shipped. Words cannot express the wonderful tone quality volume and distance. First night received 47 stations on loudspeaker. Up to last night, the 5th day, I have received exactly 100 stations. Finest is KGO, Oakland, Calif., on loudspeaker. Also Porto Rico, Cuba and Canada. Francis B. Lee.

ONE. Philadelphia, Pa. Everyone that hears the Miraco is very pleased with tone, distance, etc. Tuned in during International Test Week; KGO, Oakland, Calif.; KGB, Mexico City; Mex.; KKW, Cuba; 2EH, Edinburgh, Scot.; also a station in Buenos Aires, Argentina. Geo. W. Hill, Jr.

UTAH ENJOYS COAST TO COAST PROGRAMS. Heber, City, Utah. The Miraco sure can't be beat at any price. Coast to coast it sure does and more. I have had stations in New York and Cuba in the east, and scores of other stations on the west coast. I have logged up to date 150 stations and they all come in wonderfully. Monte Giles.

MIRACOWINS AGAINST 3 OTHER MAKES. Pearland, Texas. I tried three other makes and the Miraco is the best of them all. Received KFI, Los Angeles, Calif. on loudspeaker. G. H. Richards.

COAST TO COAST LOUD AND CLEAR. Guthrie, Minn. We logged over 80 stations and got over 1500 mhos on the loud speaker the first night—our first experience tuning a radio. The third night we got WJAX, Jacksonville, Florida and KFI Los Angeles, Calif., on the loudspeaker. Neighbors say Miraco is the best they have ever heard. O. E. Wolf.

MIRACO BEATS A SUPER EIGHT. Cobalt, Ontario, Canada. Miraco is one of the best radios in all the north country. There is a man here who has a big Super eight and our Miraco beat it. W. S. Smith.

OUTPERFORMS SOME \$300 SETS. Blakely, Ga. I am well pleased with my Miraco. It does better than machines that cost \$300 or more. J. D. Tison.

MOST SELECTIVE—SUPERIOR TO \$120.00 SET. Santa Cruz, California. I do not hesitate to show my friends the "Miraco Superiority" over my (near another set) costing \$120.00. The Miraco is the most selective set I have seen yet and cuts out the jumble of stations on the low wave lengths in 1 1/2 weeks. Wm. Schuetz.

MELLOW TONE—LOUD AND CLEAR. Indian River City, Fla. A wonder set. Am having splendid results. Have had Miraco four nights and have stations on my list from Cuba to New York, Chicago, Denver, Texas, all coming in loud, mellow in tone and clear. I have one sold already and did not even try. Mr. H. G. Duff.

REFUSED TO TRADE IT FOR EXPENSIVE SET. Prosper, Ore. Over 81 stations brought in first night on loud speaker. I ordered the Miraco for a friend and he is more than pleased. I offered to trade my Neutrodyne for it but he refused and it has the name of the best set in the community. M. E. Hulston.

PENNSYLVANIA BEGINNER GETS 'EM ALL OVER. Corry, Pa. Have had Miraco one month today and have received over 115 stations from all parts of the United States, Canada, Cuba, and Mexico. I think this is pretty good for one that never had any experience before. Clarence Drugfelder.

LIKES IT BETTER THAN \$150—\$250 SETS. Westville, Ill. Miraco sure is a wonderful set. I get the stations easily without noise—that's one of the things I like about the Miraco. I've had three other sets that have ranged from \$150 to \$250 each but Miraco beats them all. My friends all like the Miraco. I have had stations all over the U.S.A. I tune in Mexico City and Havana. Cuba any time they are on the air. Alex Kinder.

BEATS COSTLIER SETS WITH MORE TUBES. Lexington, O. I have given Miraco a thorough try out and find it to do all you claim. 85 stations logged so far; getting no ones even now. This list includes coast to coast, Canadian, Cuban and Mexican stations. The selectivity is remarkable. Others here in town have more expensive and elaborate sets with more tubes but do not ever do this. Fuller Temple.

MIRACO OUTPERFORMS THEM ALL. St. Francis, Kansas. I've heard a lot of radios but the Miraco is the best all around. I am proud of mine. Comes in fine and clear. No noises. Get lots of distant stations. Surely am satisfied. Orvey Sharpe.

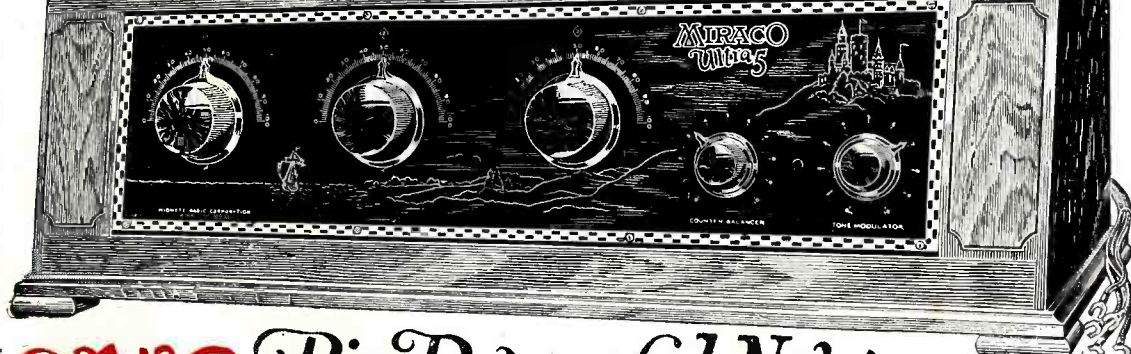

Solid Walnut Cabinet

Unitune 5 28 in. long

Big Powerful New MIRACO Ultra 5

Solid Walnut Cabinet

27 in. long ULTRA-SELECTIVE LONG DISTANCE 5 TUBE SETS EASY ON BATTERIES

Why run down your costly batteries buying 6, 7 or 8 tubes when users everywhere report that powerful big Miraco sets actually are unsurpassed (even at 2 to 4 times the price) for razor-edge selectivity, extreme long distance reception, clear natural tone, quiet easy tuning and powerful loud speaker volume—combined with great savings in use of battery current.

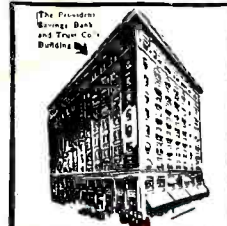

RELIABILITY! The Midwest organization was one of the very first to engage in the manufacture of radio sets. We consider them to be both morally and financially responsible. They have a reputation for fair and square dealings.—THE PROVIDENT SAVINGS BANK & TRUST CO.

Factory Prices Save You Up to 1/2. Save or make a lot of money on sets, speakers, tubes, batteries, etc., by getting our Amazing Special Offer. Wonderful bargains! Everything we sell is high-grade. Don't confuse Miraco's with small cheap radios. Satisfaction unconditionally guaranteed.

You'll Be Proud of a Miraco! Yes, you'll be proud to have friends see and hear your Miraco in its big, handsome, expensive-looking solid walnut cabinet with sloping front. In construction and performance too, every inch a high priced set. Handsomely gold illustrated genuine Bakelite front panel finished in grained walnut. Finest parts obtainable—the kind used in \$200 sets. Many exclusive features. Each Miraco reaches you completely assembled, rigidly tested, splendidly packed and factory guaranteed for one year. Easy to install and operate—full instructions supplied. Send NOW for testimony of nearby users and Amazing Offer!

Compare the construction with highest priced sets—study this picture

Real View of Celebrated Ultra

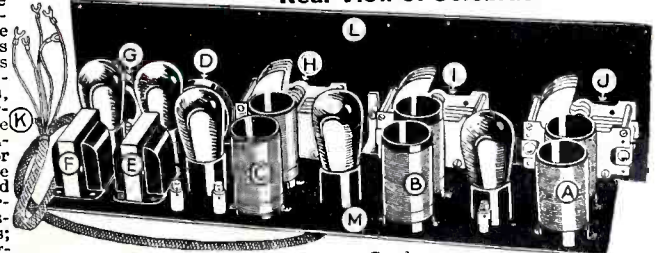

Note the neat sturdy high-class construction; wide spacings between parts eliminate losses and interference. All wiring concealed under genuine Bakelite base panel (M). Flexible wiring prevents broken or noisy connections. Flush-type sockets for the new tubes. (A) (B) (C)—"Duoformers"—famous exclusive Miraco Ultra low loss, self shielded and matched coils—one of the Miraco secrets of selectivity with powerful volume on long distance stations. (D) "Counter Balancer"—patented feature, NOT a rheostat or potentiometer. Controls oscillations on all wave lengths, reduces "B" battery consumption and further increases selectivity, distance range, clarity, power and volume. (E) (F) Shielded transformers of famous make evenly amplify all notes; beautiful tone quality. (G) Tone Modulator—regulates volume, switches current off or on. (H) (I) (J) Low Loss Straight Line Frequency Condensers—highest grade—equipped with ball bearings. Solid brass plates. Evenly separate all stations. (K) Connect E-Z Cable for attaching batteries. (L) Genuine Bakelite front panel. And many other latest features of costliest sets. Literature describes them fully, send for it!

Agents! Dealers! Write for proposition. Nation-wide popularity, superior performance, amazingly low prices make Miracos easy to sell.

All the Proof you want is waiting for You!

Coupon or postal brings reports from hosts of users in your vicinity and elsewhere proving that Miraco sets at rock-bottom money-saving factory prices, outperform sets costing up to four times as much. You can also buy speakers, tubes, batteries, etc., at big savings from us! Get our proposition before spending money elsewhere.



MIDWEST RADIO CORPORATION
Pioneer Builders of Sets
Cincinnati, O.

404-S Miraco Building
Without obligation, send free literature, testimony of users, AMAZING SPECIAL OFFER and full particulars of your big money-saving factory-price proposition on Guaranteed Miraco sets and all radio supplies. () Agent () Dealer

NAME _____
ADDRESS _____

This Coupon is NOT an Order



As in the Harp, whose short and long strings produce high and low notes, the SAAL Ec-centric provides a short radius for high notes, a long radius for bass tones.

Ec-centric

—the new scientific SAAL EC-CENTRIC CONE whose balanced tone color is the sensation in radio today.

Your receiving set may be getting all of the best that's on the air—but are you getting it? You cannot know the capabilities of your radio set, in volume, clarity, beauty of tone till you give it the advantage of the Saal Ec-centric.

On the principle of the harp, whose short strings produce the high treble notes, whose long strings give forth the deep bass tones, the Saal Ec-centric, with its "center" actually off-center, pro-

vides a short vibrating radius for the high notes, a long radius for the rich low tones.

These exact relative proportions of vibrating area, definitely fixed by scientific principles, are now provided for the first time in the Saal Ec-centric Cone. All rumble or "barrel tone" is eliminated. True balanced tone from soprano, flute and violin to pipe organ or 'cello. A demonstration will convince you.

Hear the Saal Ec-centric at your dealer's, or write us to direct you where it can be heard.

The Saal Ec-centric comes in two models: 20-inch, \$25; 14-inch (Junior), \$15. Slightly more west of Rockies.

H. G. SAAL COMPANY, 1800 Montrose Ave., Chicago, U. S. A.

WORLD FAMOUS MAKERS OF HORNS — CONES — PEDESTALS



The SAAL Pedestal is an ornament to the most beautiful surroundings. Its pure wooden tone chamber, three feet in length, gives exceptionally clear mellow reception. Price, \$38



The famous SAAL Soft Speaker, the outstanding speaker of its type. Is giving satisfaction regardless of the set or equipment used. Standard with radio engineers. Price, \$22.50

SAAL