

OVER 335,000 COPIES OF THIS ISSUE PRINTED AND DISTRIBUTED

RADIO NEWS

REG. U.S. PAT. OFF.

25 Cents

May

1924

Over 200 Illustrations

Edited by H. GERNSBACK

DIRECTED RADIO RAYS

On two meters wave length

See Page 1566



IN THIS ISSUE:

Prof. J. M. Morecroft

Prof. W. P. Powers

Dr. Karl Rottgardt

Prof. René Mesny

F. W. Dunmore

Bureau of Standards

Morris S. Strock

Bureau of Standards
and 50 others

THE RADIO BEGINNER

SEE PAGE
1578

THE 100% RADIO MAGAZINE

CIRCULATION LARGER THAN THAT OF ANY OTHER RADIO PUBLICATION

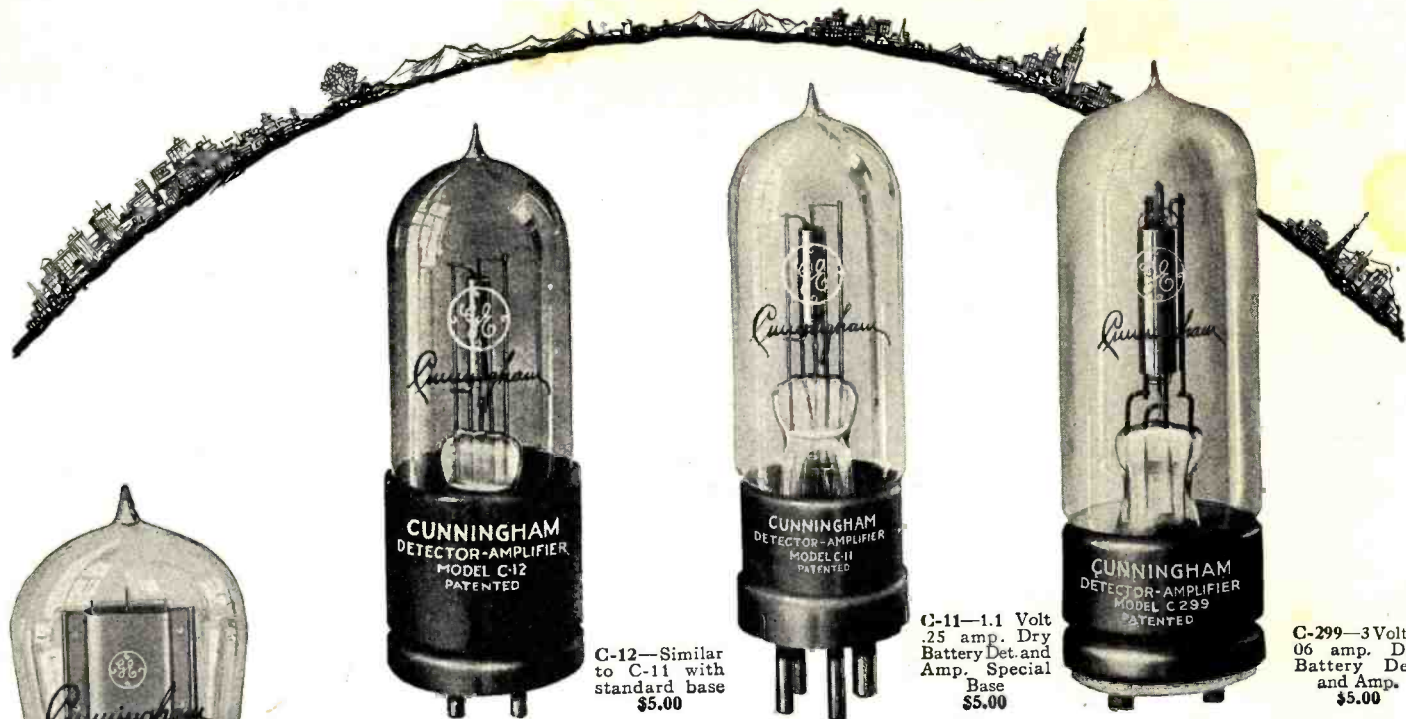

C-300—6 Volts Gas Content Detector \$5.00



C-301A—6 Volts 1/4 amp. Amplifier \$5.00

C-12—Similar to C-11 with standard base \$5.00

C-11—1.1 Volt .25 amp. Dry Battery Det. and Amp. Special Base \$5.00

C-299—3 Volts. .06 amp. Dry Battery Det. and Amp. \$5.00

The complete line of Cunningham RADIO TUBES FOR EVERY TYPE OF RECEIVING SET

WHATEVER type of receiving set or circuit you are using—one or more of these five Cunningham receiving tubes will be ideal for obtaining maximum distance reception with perfect reproduction of both voice and music.

Three of the five tubes are designed to use dry batteries for filament lighting. C-299, the latest development in Radio Tubes, is compact in design and highly efficient in operation as a radio frequency amplifier, a detector and as an audio-frequency amplifier. When used for the latter purpose, the output of two stages is sufficient for the operation of a small loud speaker.

The most remarkable feature of this tube is the new patented filament used which draws only .06 amperes at 3 volts.

C-11 is a dry battery tube with a special base for use in sets having special sockets. It is a good detector and audio-frequency amplifier. The filament is lighted from a single dry battery and draws .25 amperes.

C-12 is identical to C-11 in operating characteristics, but is mounted on a standard base to permit the use of a dry battery tube in sets equipped with standard sockets without the aid of special adaptors.

Whenever storage battery supply is available for filament lighting, the C-300 will be the best tube to use as a detector because it is the most sensitive for the reception of distant and weak signals.

Under the same condition, C-301A will be the best tube for amplification at either radio or audio frequency, because it gives greater gain per stage than any other tube on the amateur market. The new patented filament used, similar to that in C-299 draws only .25 amperes at 6 volts, reducing the necessity of frequent storage battery charging.

Patent Notices Cunningham tubes are covered by patents dated 2-18-08 and others issued and pending. Licensed for amateur, experimental and entertainment use in radio communication. Any other use will be an infringement.

The care and operation of each model of Receiving Tube is fully explained in our new 40-page "Radio Tube Data Book." Copies may be obtained by sending ten cents to our San Francisco office.

E. J. Cunningham Inc.

Home Office: 182 Second St. San Francisco, Calif.

154 West Lake Street Chicago, Illinois

30 Church Street New York City, N. Y.

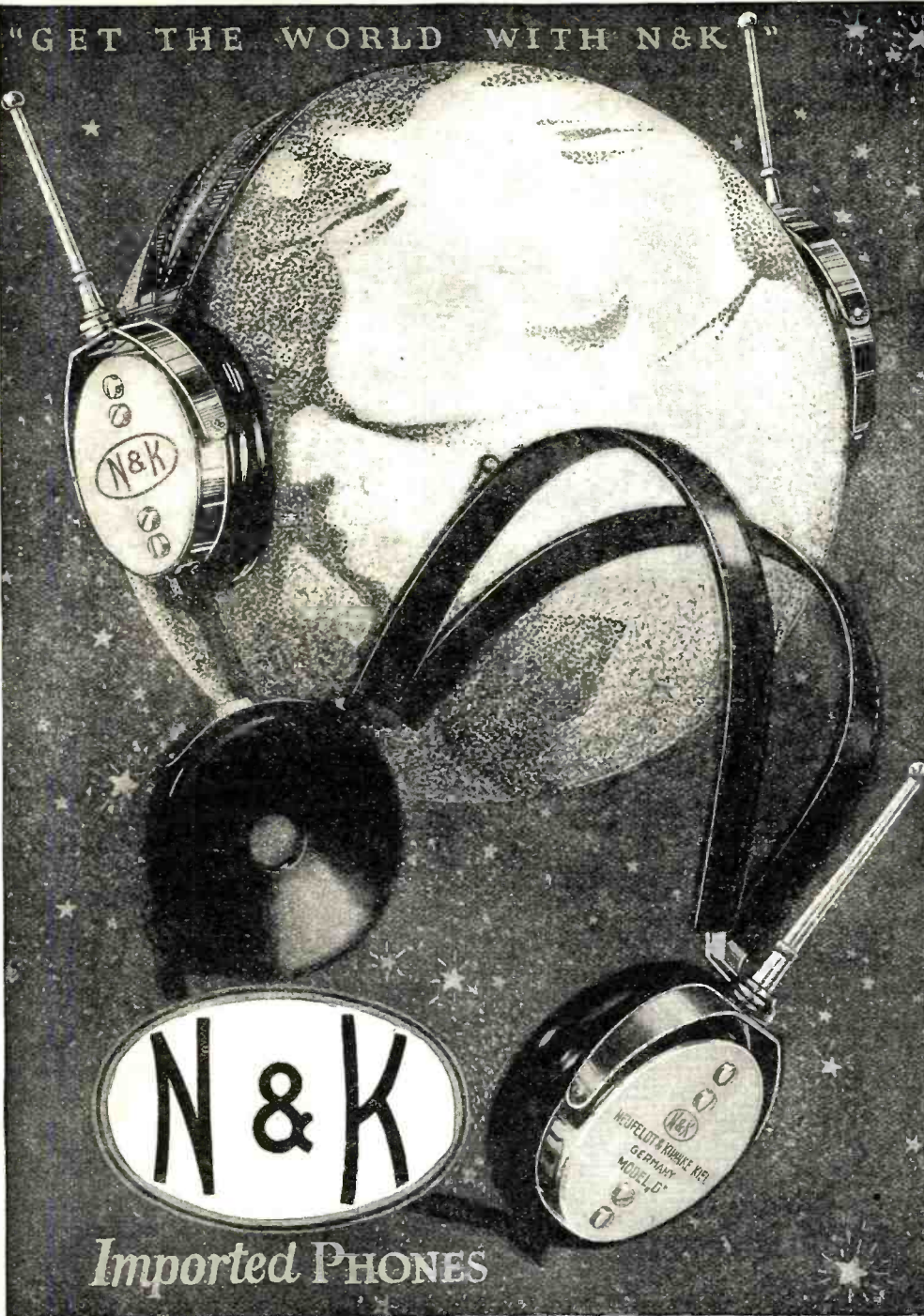

Any of the Stores listed below or any other Store displaying this advertisement will send you an N & K Head Set to make this trial.

- Athol, Mass. M. Steinert & Sons Co.
- Atlanta M. Rich & Bros. Co.
- Baltimore Hochschild, Kohn & Co.
- Bangor, Me. Little Joe Wiesenfeld Co.
- Bloomfield, N. J. Joel Gutman & Co.
- Boston Jones Electric Radio Co.
- Bridgeport M. Steinert & Sons Co.
- Brooklyn Abraham & Straus
- Chicago Frederick Loeser & Co.
- Cleveland A. I. Namm & Son
- Colorado Springs Royal Eastern Elec. Sup. Co.
- Dayton 20th Century Radio Corp.
- Denver United Cigar Store
- Des Moines Marshall Field & Co.
- Detroit Radio Instruments Co.
- East Orange, N. J. The May Company
- Elmira H. Lesser & Co.
- Fall River Kaufman & Co., Inc.
- Fitchburg Teason Bros.
- Harrisburg The Anderson Piano Co.
- Hartford Daniel & Fisher
- Houston Stores Co.
- Indianapolis Younker Brothers
- Jamaica, L. I. J. L. Hudson Co.
- Johnstown Crowley, Milner Co.
- Kansas City Detroit Electric Co.
- Long Island City United Cigar Store
- Los Angeles Barker, Rose & Clinton Co.
- Lowell M. Steinert & Sons Co.
- Memphis M. Steinert & Sons Co.
- Milwaukee Pomeroy's Inc.
- Minneapolis Sage, Allen & Co.
- Newark, N. J. W. C. Mann Co.
- New Haven Alamo Sales Corp.
- New Orleans Bangert Electric Co.
- New York City Royal Eastern Electric Supply Co.
- Johnstown United Cigar Store
- Kansas City Penn Traffic Co.
- Long Island City The Schmeltzer Co.
- Los Angeles Western Radio Corp.
- Lowell J. W. Jenkins Sons Music Co.
- Memphis Royal Eastern Electric Supply Co.
- Milwaukee Hamburger's
- Minneapolis M. Steinert & Sons Co.
- Newark, N. J. Bon Marche D. G. Co.
- New Haven Bry-Block Mercantile Co.
- New Orleans J. Goldsmith & Sons
- Philadelphia Gimbel Brothers
- Pittsburgh L. S. Donaldson Co.
- Pittsfield, Mass. L. Bamberger & Co.
- Portland, Me. Edward Malley Co.
- Portland, Ore. M. Steinert & Sons Co.
- Providence D. H. Holmes Co.
- Rochester Davega (11 stores)
- San Francisco Gimbel Brothers
- Savannah John Wanamaker
- Seattle Herbert & Huesgen Co.
- Sioux City United Cigar Stores (10 stores)
- Springfield, Mass. David Killoch Co.
- St. Louis Royal Eastern Elec. Supply Co.
- St. Paul J. L. Lewis, Inc.
- Syracuse Hanes-Zener Co.
- Tulsa Haynes-Griffin Radio Service, Inc.
- Washington J. W. Jenkins Sons Music Co.
- Waterbury Oakford Music Co.
- Worcester Richard M. Shiles
- Pateron, N. J. Paterson Radio Co.
- Pawtucket M. Steinert & Sons Co.
- Peoria Block & Kuhl Co.
- Philadelphia Gimbel Brothers
- Pittsburgh John Wanamaker
- Pittsfield, Mass. Lit Brothers
- Portland, Me. N. Snellenburg & Co.
- Portland, Ore. Boggs & Buhl
- Providence Kaufmann & Baer Co.
- Rochester Ludwig Hommel & Co.
- San Francisco Holden & Stone Co.
- Savannah M. Steinert & Sons Co.
- Seattle Meier & Frank Company
- Sioux City The Outlet Co.
- Springfield, Mass. M. Steinert & Sons Co.
- St. Louis Kelman Electric Co.
- St. Paul The Emporium
- Syracuse Leopold Adler
- Tulsa Frederick & Nelson, Inc.
- Washington Davidson Bros. Co.
- Waterbury Radio Exchange
- Worcester M. Steinert & Sons Co.
- Philadelphia Famous & Barr Co.
- Pittsburgh Van-Ashe Radio Co.
- Portland, Me. Pioneer Electric Co.
- Providence Alexander Grant's Sons
- Rochester J. W. Jenkins Sons Music Co.
- San Francisco Woodward & Lothrop
- Savannah M. Steinert & Sons Co.
- Seattle M. Steinert & Sons Co.
- Sioux City M. Steinert & Sons Co.

You shall be the Sole Judge

A Most Unusual Offer



TEST N & K Phones on your radio set alongside any other phones made. If the N & K Phones do not reproduce both high and low tones more perfectly, if they do not give a clearer, more mellow tone, if they do not fit more comfortably on the head, send them back to the store within three days, and your money will be

promptly refunded. No obligation whatsoever will be incurred. You shall be the sole judge. The N & K Head Set, Model D, 4000 ohms, is the imported head set that the radio "fans" are all talking about. Larger diaphragms. Nicked brass sound chamber. Leather covered bands. \$8.50 at leading stores. Ask for descriptive folder.

TH. GOLDSCHMIDT CORP., 15 WILLIAM ST., DEPT R5, NEW YORK CITY

Dealers: We authorize you to refund the price of any N & K Head Set returned under the conditions named in this ad. We will exchange or replace any sets that come back to you.

RADIO NEWS

Published by EXPERIMENTER PUBLISHING COMPANY, INC.,
 Publishers of "Radio News," "Science and Invention" and "Practical Electrics."
 Publication Office: Brooklyn, N. Y. Editorial and General Offices: 53 Park Place, N. Y. City.
 H. GERNSBACK, President. S. GERNSBACK, Treasurer. R. W. DEMOTT, Secretary.

MEMBER: AUDIT BUREAU OF CIRCULATIONS

VOL. 5

CONTENTS FOR MAY

NO. 11

1924

	Page		Page
Editorial.....By H. Gernsback	1553	Double Anglo-French Broadcasting, By Laurence S. Lees	1577
Radio Beacons Non-Directive and Directive. By F. W. Dunmore	1554	Radio in Germany.....	1577
President Coolidge Broadcasts.....	1557	Your Radio Batteries.....By Marius Logan	1578
Artificial Voice Speaks to Audience.....	1558	Choosing and Installing a Receiving Set, By Parker L. Worthington	1579
A Federal Radio Tax?—No!.....	1559	Whistling Interference.....By W. P. Powers	1580
Mexican Broadcast Station CYL.....	1560	Why Bother With Radio Frequency Amplifica- tion?.....By J. R. Balsley	1581
The License Question.....	1560	The Vacuum Tube and How It Works, By Prof. John H. Morecroft	1582
What Station Do You Want? By Howard Wilmot	1562	Timely Notes on Aerial Installations, By Harold Jolliffe	1585
The New High Powered Station at Buenos Aires	1564	Possibilities of Unique Receiving Circuits, By Morris S. Strock	1586
A Radio Auxiliary Language for Trans-Oceanic Work.....By O. C. Roos	1565	Wired Radio Experiments for Amateurs— Part II.....By Dr. Karl Rottgardt	1589
The Production and Use of Ultra Short Wave- Lengths.....By Prof. René Mesny	1566	With the Amateurs.....	1590
Some Recent Radio Developments, By S. R. Winters	1568	Pierre Louis' Station, F8BF.....	1592
Radio in Ceylon.....By H. Don Clement	1569	A Good Rectifier and Filter for the C. W. Set, By William H. Schick	1593
Radio Television—The Mihaly Telehor Machine, By Nicholas Langer	1570	Some Real DX.....	1594
A New Portable Radio Compass, By S. R. Winters,	1572	Awards of the \$50 Radio Wrinkle Contest.....	1595
The Vacuum Tube Patent Situation, By John B. Brady	1573	Correspondence from Readers.....	1597
Broadcasting in Australia..By Oliver W. Tuttle	1574	Radio News Laboratories.....	1598
Can American Radio Sets Be Sold in Great Britain?.....By Frank W. Challis	1575	International Radio Notes.....	1599
Improvements on the Super-Heterodyne Receiver	1576	New Radio Patents.....	1600
		I-Want-To-Know.....	1601
		Calls Heard.....	1693
		Index to Advertisers.....	1544

General Advertising Dept., 53 Park Place, New York City. Western Advertising Representatives, Finucan & McClure, 720 Cass Street, Chicago, Ill. Kansas City Representative, Geo. F. Dillon, Republic Bldg., Kansas City, Mo. Pacific Coast Advertising Representatives, A. J. Norris Hill Co., Hearst Bldg., San Francisco, Cal.

RADIO NEWS is published on the 10th of each preceding month. There are 12 numbers per year. Subscription price is \$2.50 a year in U. S. and possessions. Canada and foreign countries, \$3.00 a year. U. S. coin as well as U. S. Stamps accepted (no foreign coins or stamps). Single copies, 25 cents each. A sample copy will be sent gratis on request. Checks and money orders should be drawn to order of EXPERIMENTER PUBLISHING CO., INC.

All communications and contributions to this journal should be addressed to Editor, RADIO NEWS, 53 Park Place, New York, N. Y. Unaccepted contributions cannot be returned unless full postage has been included. All accepted contributions are paid for on publication. A special rate is paid for novel experiments; good photographs accompanying them are highly desirable.

RADIO NEWS. Monthly. Entered as second-class matter at the Post Office, at Brooklyn, N. Y., under the act of March 3, 1897. Title registered U. S. Patent Office. Copyright, 1923, by E. P. Co., Inc., New York. The Experimenter Publishing Co., 53 Park Place, N. Y. The contents of this magazine are copyrighted and must not be reproduced without giving full credit to the publication. Copyright in Germany. Publication and reproduction of articles in Germany is reserved for Radio, Berlin 42, Germany.

RADIO NEWS is for sale at all newsstands in the United States and Canada;

also at The International News Co., Ltd., Bream's Building, London E. C. 4, England, and at Brentano's, 37 Avenue de l'Opera, Paris.

HOW TO SUBSCRIBE FOR RADIO NEWS. Send your name, address and remittance to Experimenter Publishing Co., 53 Park Place, New York. Mention the name of the magazine you are ordering. We also publish SCIENCE AND INVENTION and PRACTICAL ELECTRICS. Write early.

RATES AND TERMS. The subscription rate for RADIO NEWS is \$2.50 per year. (12 numbers). When remitting do so by check, money order, or registered letter if cash is enclosed. Avoid sending cash through the mail if possible. Subscriptions for less than one year are not accepted. Subscription may be made in combination with SCIENCE AND INVENTION or PRACTICAL ELECTRICS with considerable saving.

POSTAGE. We prepay postage in all parts of the United States, Mexico and Island possessions. For foreign or Canadian subscriptions we require 50 cents in addition to the subscription price for additional postage charges.

CHANGE OF ADDRESS. Notify us as far in advance as possible. It requires several weeks to make an address change on our records. Always write clearly, giving your old address as well as your new.

ON EXPIRATION of your subscription we enclose a renewal blank in our last number to you; we stop our delivery to you on expiration.

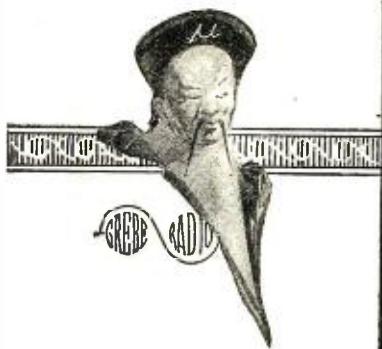

"The gods cannot help one who loses opportunities."

—Mencius

If you are wise you will lose none of the opportunities for entertainment that a Grebe Broadcast Receiver will bring.

Doctor M



Type CR-12. A 4-tube Receiver combining Regeneration and Tuned R.F. \$175.00 (Accessories extra)

Trustworthy Performance

WHETHER the evening's feature be the broadcasting of the World's Heavyweight Championship or a Sunday Night Concert, you will anticipate it with keen pleasure and confidence when you tune in with your

GREBE Broadcast Receiver

Made in two easily operated types, in which every detail of craftsmanship is an assurance of trustworthy performance.

Each Instrument is the result of more than ten years of radio manufacturing experience.

Ask your Dealer or write us for literature

A. H. GREBE & CO., Inc.
VanWyck Blvd., Richmond Hill, N.Y.
Western Branch: 451 East 3rd Street
Los Angeles, Cal.

Licensed Under
Armstrong U.S.
Pat. No. 1,113,149

Type CR-14—A 3-tube dry cell Regenerative Receiver \$110.00 (Accessories extra)



Index to Advertisers

Name	Page
A	
A-C Electrical Mfg. Co., The.	1668
Ackerman Bros. Co., Inc.	1656
Acme Apparatus Co.	1631
Acme Engineering Co.	1654
Acorn Radio Mfg. Co.	1608
Adams-Morgan Co.	1659
Adams Radio Mfg. Co.	1678
Alden Mfg. Co.	1640
Allen-Bradley Co.	1708
Allen Co., Inc., L. B.	1628
Alter & Co., Harry	1699
American Art Mache Co.	1672
American Hard Rubber Co.	1606
American Map Co.	1618
American Radio Mfg. Co.	1697
American Radio & Research Corp.	1638
American Radio Tube Works	1687
American Specialty Co., The	1694
American Standard Electric Co.	1697
American Transformer Co.	1632
American Writing Machine Co.	1685
Andrea, Inc., F.A.D.	1655
Atlantic & Pacific Radio Co.	1663-1684-1696
Atwater Kent Mfg. Co.	1621
Automatic Electrical Devices Co., The	1674
B	
Bakelite Corp.	1695
Barawik Co., The	1550-1551
Barklewe Electric Mfg. Co.	1636
Bel-Canto Mfg. Co.	1652
Bell Mfg. Co.	1676
Benson Engineering Co.	1662
Bleadon-Dun Company	1648
Blue Seal Mfg. Co.	1678
Bogue, B. N.	1686
Boice, W. & J.	1670
Boonton Rubber Mfg. Co.	1673
Box 94	1691
Box 233	1694
Brach Mfg. Co., L. S.	1634
Brandes, Inc., C.	1615
Branston, Inc., Chas. A.	1618
Breakers, The	1770
Bremer-Tully Co.	1606
Bristol Co., The	1642
Brown Co., Thos.	1684
Brownlie, Roland	1620
Bryant Radio Electric Co.	1682
Bunnell & Co., J. H.	1618
C	
Cannon & Miller Sales Corp.	1694
Carter Radio Co.	1679
Celerundum Radio Products Co.	1693
Central Radio Laboratories	1644
Chemical Institute of New York, Inc.	1661
Chevrolet Motor Co.	1617
Chicago Salvage Stock Store	1669
Chicago Solder Co.	1694
Clapp-Eastham Co.	1665
Clearstone Radio Co., The	1670
Cleveland Engineering Lab. Co., The	1666
Consolidated Instrument Company of America, Inc.	1677
Conrad Co., The	1649-1702
Continental Fibre Co., The	1680
Continental Radio & Electric Corp.	1650
Cooper Corp., The	1683
Cosmopolitan Radio Co., Inc.	1691
Coto-Coil Co.	1696
Coyne Electrical Schools	1610
Crescent Mfg. Co.	1654
Cressman, Russell B.	1705
Crosley Radio Corp., The	1613
Cunningham, E. T., Inc.	1625
Cutler-Hammer Mfg., The	1674
Cut Rate Radio Co., The	1674
D	
D. X. Radio Research Laboratories, The	1604
Dalton, Whittier, True Co.	1686
Dey's Radio Service	1678
Diamond Electric Specialties Corp.	1656
Diamond State Fibre Co.	1679
Dictograph Products Corp.	1545
Dieterich, Albert E.	1682
Dixie Supply Co.	1667
Dobbins, Ray	1686
Dodge Radio Short Kut.	1632

Name	Page
Domino Radio Service	1699
Dowie, Jr., James A.	1642
Dubilier Condenser & Radio Corp.	1684
Duck Co., The Wm. B.	1671
Durkee-Thomas Products Co.	1654
E	
E. I. Company, The	1647
Eagle Radio Co.	1632
Eastern Radio Mfg. Co.	1668
Eisemann Magneto Corp.	1701
Electrad, Inc.	1675
Electrical Research Laboratories	1639
Electric Service Supplies Co.	1707
Electric Specialty Co.	1642
Electric Storage Battery Co., The	1627
Electrotype Blocking Co.	1614
Elgin Radio Supply Co.	1646
Eric Fixture Supply Co.	1680
Evans & Co., Victor J.	1616
Experimenters Information Service	1637
F	
Fahnestock Electric Co.	1610
Fansteel Products Co., Inc.	1697
Ferbend Electric Co.	1677
Ford Mica Company, Inc.	1606
Formica Insulation Co., The	1623
Fox Mfg. Co.	1636
French Battery & Carbon Co.	1676
Freshman Company, Inc., Chas.	1626
Friedlander Kopple Radio Service	1675
Frost, Inc., Herbert H.	1646
G	
G. A. Sales, The	1684
Gay, Mr.	1652
General Electric Co.	1681
General Insulate Co.	1662
General Radio Corp.	1648
General Radio Winding Co.	1664
General Research Laboratories	1693
Golden-Leutz, Inc.	1611
Goldschmidt Corp., Th.	1541
Goodell-Pratt Co.	1632
Gould Storage Battery Co.	1634
Graham Co., Alfred	1684
Great Lakes Radio Co.	1688
Grebe & Co., Inc., A. H.	1543
Gunn Furniture Co., The	1640
H	
H. & H. Radio Co.	1681
Halldorson Co., The	1648
Hammer Radio Co., S.	1608
Hammerlund Mfg. Co.	1688
Handicap Mfg. Corp.	1703
Harvard Radio Laboratories	1673
Hayden Radio & Research Co., A. C.	1612
Heath Radio & Electric Mfg. Co.	1707
Herbert, Inc., Harold	1694
Hill Mfg. Co., A. E.	1622
Holtzer-Cabot Electric Company, The	1620
Hommel & Company, Ludwig	1638
Hygrade Electrical Novelty Co.	1705
I	
Insulation Products Co.	1604
International Correspondence Schools	1604
Inter-State Signal Co.	1644
J	
Johnson Smith Co.	1670
Jones, Howard B.	1606
K	
K. Electric Co.	1689
Kanter Mfg. Corp.	1685
Keller's Furniture Shop.	1662
Kelley Radio Laboratories, Inc., The	1781
Kellogg Switchboard & Supply Co.	1643
Kennedy Co., The Colin B.	1650

Name	Page
Kensington Radio Supply Co.	1698
Kilbourne & Clark Mfg. Co.	1663
Kimley Electric Co., Inc.	1616
Klaus Radio & Electric Co.	1692
L	
Lacey & Lacey	1692
Lambert Leon	1674
Lancaster & Allwine	1692
Lee Electric & Mfg. Co.	1624
Lefax, Inc.	1634
Leich Electric Co.	1604
Liberty Mail Order House	1650
Liggett & Myers Tobacco Co.	1624
Lincoln Mfg. Co.	1636
Listen-In Publishing Co.	1701
M	
M. & M. Co., The	1703
Magnavox Co., The	1603
Main Electric Co.	1662
Manhattan Radio Co.	1690
Marko Storage Battery Co.	1644
Marle Engineering Co.	1610
Marshall-Gerken Co., The	1678
Marshall Radio Products	1610
Martin-Copeland Co.	1683
Marvel Radio Specialty Co.	1620
Mason, Fenwick & Lawrence	1674
Mason & Parker Mfg. Co.	1680
Mead Cycle Co.	1642
Michigan Radio Corp.	1688
Midwest Radio Co., The	1657
Mitchell & Co., R.	1666
Modell's	1641
Modern Electric Mfg. Co., The	1678
Montrose Mfg. Co.	1688
Morrison Laboratories, Inc.	1682
Mozart-Grand Co., The	1699
Multiple Electric Products Co., Inc.	1619
Munn & Co.	1695
Mu-Rad Laboratories, Inc.	1689
Murdock Co., Wm. J.	1633
Myers Co., Ltd., E. B.	1630
N	
Nassau Radio Co., Inc.	1692
National Airphone Corp.	1546-1547
National Carbon Co., Inc.	1607
National Outdoor Sports Exposition	1608
National Radio Institute	1548-1549
Newman-Stern Co., The	1686
New York Coil Co.	1678
N. Y. Institute of Photography	1648
New York Radio Co.	1616
Norden, Hauck & Co.	1644
O	
Omnigraph Mfg. Co., The	1626
O'Neil Mfg. Co.	1612
Owen, Richard B.	1660
Ozarka Inc.	1692
Ozment, C. J.	1686
P	
Pacent Electric Co., Inc.	1660
Parker, C. L.	1604
Pathe Phonograph & Radio Corp.	1691
Pfanstiehl Radio Service	1674
Phenix Radio Corp.	1687
Pioneer Radio Corp.	1703
Precision Coil Co., Inc.	1696
Press Guild, Inc., The	1616
Primary Mfg. Co.	1670
Progress Press	1686
Pyramid Products Co.	1672
R	
Radiall Company	1685
Radio Association of America	1683
Radio Corporation of America	1683
Radio Equipment Co.	1622
Radiogram Corp.	1671
Radio Industries Corporation	1686
Radio Instruments Co.	1682
Radio Panel & Parts Corp.	1666
Radio Parts Mfg. Co.	1670, 1690
Radio Printers	1640
Radio Rabat Co., The	1662
Radio Research Laboratories	1692

Name	Page
Radio Specialty Co.	1629
Radio Stores Corp.	1552
Radio Tube Corp.	1651
Radio Tube Exchange	1676
Radio Units, Inc.	1612
Randel Wireless Co.	1646
Randolph & Co.	1650
Rauland Mfg. Co.	1693
Red Seal Coal Co.	1676
Reliable Parts Mfg. Co., The	1696
Remler Radio Mfg. Co.	1634
Rose Radio Supply	1640
Rusonite Products Corp.	1692
Ryder, Frank A.	1660
S	
S. & R. Radio Co.	1696
Sadler Mfg. Co.	1690
Sahara Dry Battery Co.	1658
Saturn Mfg. & Sales Co., Inc., The	1698
Scanlon, Everett	1690
Scientific Electric Works, The	1664
Service Battery Co.	1680
Shamrock Mfg. Co.	1690
Shepard-Potter Co., Inc.	1667
Shipman-Ward Mfg. Co.	1668
Sidbenel Radio Equipment Mfg. Co.	1630
Signal Electric Mfg. Co.	1676
Silver-S. Battery Co.	1608
Simplex Radio Supply Co.	1688
Sinclair, Mr.	1670
Southern Radio Corp. of Texas	1687
Southern Toy Co., Inc., The	1686
Specialty Service Co.	1695
Springfield Wire & Tinsel Co.	1664
Stammerers Institute	1672
Sta-Rite Battery Co.	1660
Sterling Mfg. Co., The	1688
Stevens & Co.	1672
Stransky, John A.	1656
Stromberg-Carlson Telephone Mfg. Co.	1614
T	
Telephone Maintenance Co.	1668, 1674
Terlee Elec. Mfg. Co.	1682
Thompson Mfg. Co., R. E.	1653
Thor Radio Company	1628
Times Square Auto Supply Co., Inc.	1654
Tresco	1672
Triangle Rubber Co.	1669
Trimm Radio Mfg. Co.	1676
Tuska Co., The C. D.	1635
U	
U. S. Mfg. & Dist. Co.	1652
U. S. Tool Company, Inc.	1707
Union Radio Corporation	1614
United Electric Stores Company	1636
United Mfg. & Distributing Company	1705
United Sales Co.	1689
Unity Mfg. Company	1604
Utility Supply Co.	1684
V	
V-De-Co Radio Mfg. Company	1690
Valley Electric Co.	1680
Vesco Radio Shop	1686
W	
Walbert Mfg. Company, The	1665
Walker Company, Inc., G. E.	1658
Walwart Electric Mfg. Co.	1646
West Angus Show Card Service, Ltd.	1680
Western Coil & Electrical Company	1612
Western Radio Mfg. Co.	1658
Western Rubber Mold Company	1656
Weston Electrical Instrument Company	1652
Willard Storage Battery Co.	1609
Wilmington Fibre Specialty Co.	1638
Wireless Mfg. Company, The	1638
WorkRite Mfg. Co., The	1645
World Battery Co.	1614
Wright, H. G.	1696
XYZ	
Y. M. C. A. Radio School	1654
Zenith Radio Corporation	1605

San Francisco Hears Japan and Newark on the DICTOGRAND!

N. J. Radio Message Picked Up in Japan
Voice Crosses America and Pacific Ocean by Wireless

Communication by means of radio telephony across the American continent and the Pacific ocean was accomplished yesterday morning by WOR, L. Bamberger & Co., Newark, N. J., broadcasting to Japanese, Australian and New Zealand stations, according to engineers of the Howard Radio Company here who intercepted the broadcast and state that a Japanese station made acknowledgment by voice.

FIRST TO REACH JAPAN

This is the first time that both continent and ocean have been spanned by the human voice and it is believed that the group at the Howard laboratory were the only ones in this vicinity to hear both stations.

The following sworn statement was issued yesterday by Thomas L. Kennon, manager of E. C. Howard Radio Co.

"We, the undersigned, swear that at 2:10 a. m., December 3, 1923, we tuned in on WOR, Newark, N. J., and heard a conversation between these two stations on a DictoGrand

From the San Francisco Chronicle

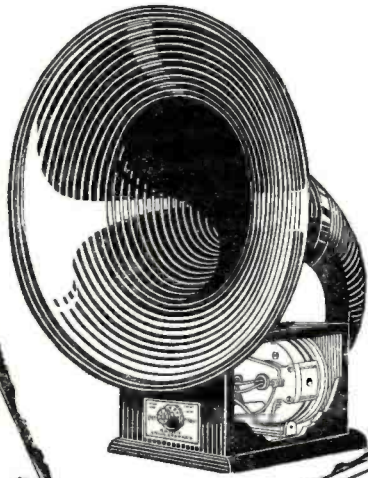

The Master Instrument That Made the Record

1. Operates without extra batteries.
2. Adjustable dial controls volume.
3. Handsomely compact in construction.
4. Finished in a rich ebony; set off by a glistening silvered rim on the bell.
5. Fully guaranteed.

ONLY \$24.50

Ready to Operate

loud speaker and a 'Kennon-Croft-Martineau circuit' neutrodyne."

AFFIDAVIT MADE

The affidavit was signed by Count Christian Denmark, Lerche-Lerchenborg and Croft and T. L. Kennon.

The "Aristocrat" Dictograph Headset

1. 3,000 ohms
2. 10 ounces (None lighter)
3. Head-fit headband
4. Cup-curved ear pieces
5. Finished in black and orange
6. Guaranteed fully



WHAT a superb loud speaker! The instrument that broke all records by reproducing faint signals from far away Japan with audible loud speaker volume!

Clearly! With such clarity that this communication between the ends of the earth

was understood distinctly by the 4 listeners-in!

Why not get many more distant points on a loud speaker than you are now getting with your present equipment? Get a DictoGrand today. Tune in some distant point tonight. See your dealer.

The Dictograph "Phono-Unit"

Makes a loud speaker of your phonograph!

1. Uses no extra batteries
2. Has adapters to fit any make of phonograph
3. Attached and detached in a moment
4. Calibrated dial on back controls volume
5. Finished in nickel
6. Fully guaranteed

\$10.00

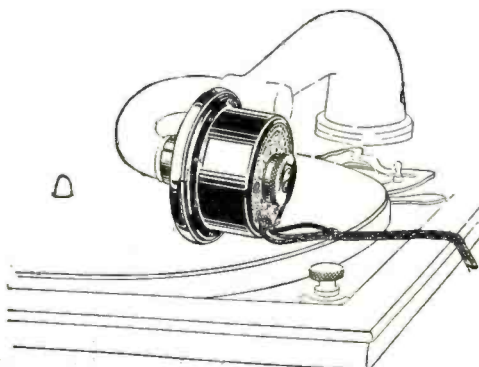

FREE "Applause Cards"

"—Station W-J-A-Z signing off. If you have enjoyed the artist's program, won't you write in and tell them?"

By all means! Quickly and easily with "Applause Cards." They're handsomely printed mailing cards. All ready for you to fill in with your comments, sign, and drop in the mail box.

Keep a pack of them near your receiving set. You can use "Applause Cards" liberally because they are FREE AT YOUR RADIO DEALER'S.

"Applause Cards" were originated by this Company, makers of the popular DictoGrand Loud Speaker and the Aristocrat Dictograph Headset. The only "Applause Cards" are Dictograph Copyrighted "Applause Cards."

A big FREE package of them awaits you at your dealer's. Or if he has not yet stocked, write us, and we'll ship you a generous supply of "Applause Cards" free, prepaid direct, provided you give us your dealer's name. Dept. D-5.

D I C T O G R A P H PRODUCTS CORPORATION
 220 West 42d St., N. Y. City

*Reg. U. S. Pat. Office.

Monodyne -



\$10.00
Without Tube

NATIONAL
MONODYNE
PAT. TRADE MARK PDG.
TUBE SET
MODEL GT-1

Special MONODYNE Features

1. The single tube on the Monodyne acts as amplifier and detector equaling a volume of two tubes.
2. Uses but one dry cell tube, preferably WD-12 or C-12.
3. Only one tuning control—simple and easy to operate.
4. Selectivity — sharp-tuning always on all wave lengths.
5. No storage batteries. Operates on single dry cells.
6. Easy to install—permits all kinds of "hook-ups."
7. Can be used with head phones or loud speaker.
8. Costs only \$10 post-paid (without tube).

Even a child can operate this inexpensive, highly efficient, simplified Radio Set

Every member of the family can enjoy listening in to broadcast entertainments, political speakers, market reports, sporting events and religious sermons right in your own home and at a trifling cost. There are thousands of Monodyne users all over the country who are daily praising the wonderful merits and long distance receiving qualities of this set.

NATIONAL
AIRPHONE
CORPORATION
18 HUDSON ST. NEW YORK

Radio Dealers

Send for information and prices. Sensation of radio — selling like wildfire all over the country.

Have You Been Waiting for SIMPLIFIED RADIO? It Has Come!

Remember how the bicycle, the automobile, and other popular inventions were complicated and costly at first? They were simplified and brought within the reach of everybody's pocket-book.
SIMPLIFIED RADIO IS HERE!

RADIO PUBLIC

Simple and Easy to Operate
Here is the most practical, guaranteed Radio Receiver you will want. Brings in local and distant broadcast entertainments clear and loud without distortion. The only set made in the world with but one tuning control, no dials to fuss with. By a simple turn of the knob you can tune in or out desired stations. No storage batteries. Thousands of testimonials. A trial will convince the most skeptical. If your dealer cannot supply you, fill out the coupon below and mail it promptly.

DEALERS

One Sells Another

The Monodyne tube set is the Receiver that is in big demand to-day—it has made many radio shops popular—it will attract the crowd to your store. Can be used anywhere, indoors or outdoors. Meets the big call for an inexpensive, highly satisfactory set. Easy to handle and demonstrate. Sells at list. Quick turnover. Every one guaranteed. Send for Sample and Prices.

National Monodyne Amplifier

Want to use a LOUD SPEAKER? Two Monodyne Amplifiers will operate a loud speaker on any set without howling or distortion. One or more stages of amplification can be added to suit.

\$8.50
without
tube

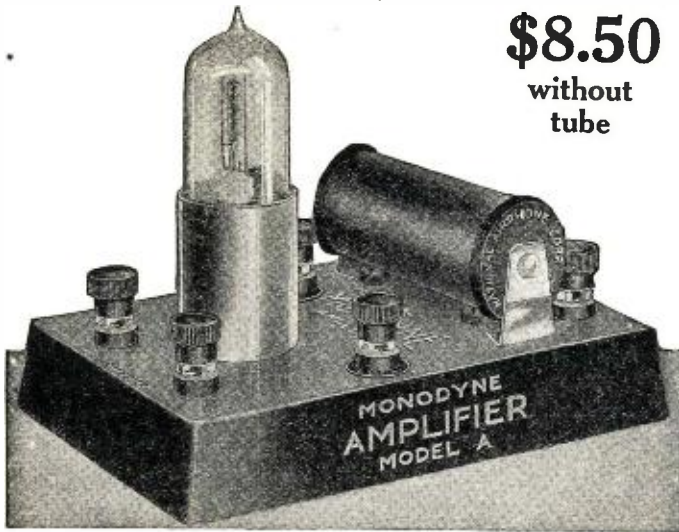

National Interference Eliminator

Bothered with interference? Get a National Interference Eliminator. Will make any set tune sharper—cuts out broadcasting and code interference. Can be used to increase or shorten wave lengths.

\$7.50
complete with
two inductance
coils



**NATIONAL
AIRPHONE
CORPORATION**

18 HUDSON ST.

NEW YORK

SEND NO MONEY

National Airphone Corporation,
18 Hudson Street, New York City, N. Y.

R. N. 5

Gentlemen:

Send prepaid the articles marked, for which I will pay postman upon delivery the Advertised Price.

- National Monodyne.
- National Amplifier.
- Interference Eliminator.

NAME
STREET
CITY STATE

Earn \$75 to \$200 a Learn at Home

The astounding growth of Radio has created thousands of wonderful opportunities for earning big money. Millions upon millions of dollars are being spent every year since broadcasting has become so popular. Radio is indeed sweeping the world like a forest fire!

A few years ago only a very small number of men were actively engaged in Radio. Today, with but few exceptions, these men are holding key positions in this marvelous new industry. In the same way, the young men and ambitious boys who get into Radio now will be the leaders a few years hence. The opportunities right now are a hundred times greater than they were ten years ago.

Recognized Radio Experts In Urgent Demand

Trained experts—not just half trained amateurs—are needed for the many big paying positions which have developed as a result of the tremendous expansion of Radio. Broadcasting stations are constantly needing operators, stores are sadly in need of trained experts as salesmen, installers, repair men, demonstrators. Factories need inspectors, assemblers, testers and executives.

These are just a few of the opportunities. Radio operators on board ship travel all over the world without one cent of expense, see historically important places, meet prominent people on board ship, mingling with the passengers and earning salaries equal to \$200 a month in any land job. How often you've dreamed of travel, of being able to talk from experience of gay Paris, the beauties of the Mediterranean sunset, the awe of Egypt's pyramids. As a radio operator you can see them first hand.

Hundreds of Big Paying Positions Open Right Now - in Radio !

Hardly a week goes by without our receiving calls for our graduates. This is how some of them read: "We need the services of a competent radio engineer"; "We want men with executive ability in addition to radio knowledge to become store managers"; "We require the services of several resident demonstrators."

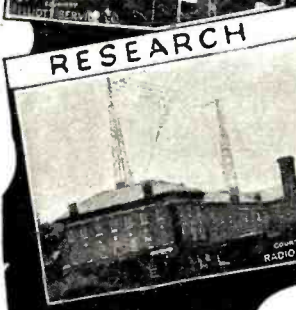
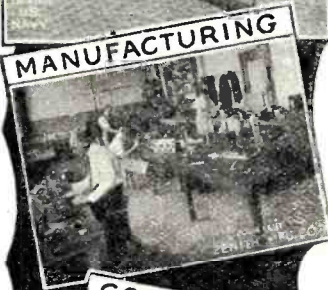
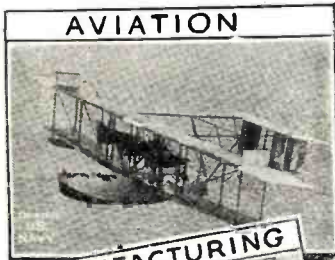

FREE Instruments



This 1,000-mile Regenerative receiving set is included in our course without charge. Our book, "Rich Rewards in Radio," tells you all about the practical training given with it.

Week as a Radio Expert in Spare Time

The big radio firms are coming to us for their men—they call on us first because they know that our graduates are one hundred per cent. trained experts—they are Recognized Radio Experts.

Earn Big Money While Learning

No matter if you know nothing at all about radio or electricity, you can easily and quickly become an expert. Age is no drawback. Our method of teaching makes it fascinating and interesting to learn the mysteries of this new science. Instruments for practical training given FREE with this course are shown at the bottom of this page.

Scores of our students earn big money during their spare time after finishing the first few lessons. Mathew Waldron made \$150 in one month—Fred W. Sullivan, of Fall River, Mass., made \$84.60 in three weeks. Many students more than pay for their course in this way—while they are studying.

Satisfaction is Guaranteed

Our faith in our method of training and in our ability to fit you for a bigger pay is evidenced by our guarantee to refund every cent of your money if you are not satisfied when you finish the course. The National Radio Institute, established in 1914, the first school to successfully teach Radio by mail, and now the largest radio training organization in the world, stands behind that guarantee.

Send for FREE BOOK

We will gladly send you Free, without any obligation on your part, our book, "Rich Rewards in Radio," which gives you more facts about the big pay opportunities in Radio, tells you how we prepare you at home in spare time, and about how we are asked to fill hundreds of fine positions every year. No matter what you are doing now—no matter what your plans for the future are—send for this Free Book of wonderful opportunities. Mail the coupon NOW.

NATIONAL RADIO INSTITUTE

Dept. 13EA

Washington, D. C.

for practical training at home



These parts with instructions are given for experience and practical training in making and operating regenerative receiving apparatus.



This is the world-famous Natrometer—one of the three instruments given for scientific and practical home training in mastering the code.



These parts with complete instructions are given for practice in building a receiving set of the more simple kind.

READ WHAT THESE GRADUATES SAY

Cleaned Up \$405 in One Month

Peculiar, Mo.
National Radio
Institute,
Washington,
D. C.

Gentlemen:—
I have not heard from you for some time. I know you will be glad to hear from me again.

I sure have been coining the dough. I was a Radio Salesman for eight months which paid me \$300 a month and expenses, but now I have a business of my own, building and repairing Radio sets. You surely treated me excellent so I shall say a good word for you whenever possible. I never will regret the money I paid for your course.



I cleaned up \$405 last month. Not so bad—is it—for a fellow who did not know anything about Radio a short time ago?
Sincerely yours,
Emmet Welch.



Makes \$250 a Month As Chief Operator

Havana, Cuba
National Radio Institute,
Washington, D. C.

Gentlemen:—
You will be glad to know that I am Chief Operator of the broadcasting station PWX at Havana, Cuba, at a salary of \$250 a month. I am disposed to make unusually favorable comments among my friends regarding your good course.

Yours very truly,
Austin Riu.



**Mail
Coupon
For this
FREE
BOOK**

National Radio Institute,
Dept. 13EA.,
Washington, D. C.

Without any obligation on my part, send me your book, "Rich Rewards in Radio," which tells all about the big-money opportunities in Radio, how spare time study will qualify me as a recognized Radio Expert and also how your Employment Service will help me get a good position.

Name Age.....

Street Occupation

City State

BUILD YOUR SET BETTER-AT LOWER COST

SUPERIOR 180° VARIOCOUPLER

V521 Each...\$1.10
A wonderful value. Produces excellent results. Green silk windings on black fibre tubes. Rigid mounting support for table or panel mounting. Primary tapped for fine tuning. 1/4 inch shaft. Range 200 to 650 M. V522 Variometer—same style. Each \$1.10

SUPERIOR VARIOCOUPLER

V523 Each...\$3.35
A handsome instrument of superior design and construction. Stator tube and rotor ball of moulded red brown bakelite. Large size green silk windings insure highest efficiency. Table or panel mounting. 1/4 inch shaft. Superior results in circuits for 180 to 650 meters. Tapped primary for finest tuning. Noiseless contacts. V526 Special single circuit type. \$3.75



SUPER MOULDED VARIOMETER

V412 Each...\$2.48
Polished black moulded rotor and stator forms. Maximum inductance with greatest efficiency and minimum distributed capacity. A high grade instrument that will get the best results. Wave length 180 to 600 meters.

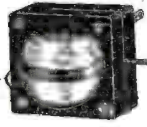

EXCEL MOULDED VARIOMETER

V524 Each...\$4.45
A wonderful value at our price. Properly designed and constructed. Polished black bakelite rotor and stator forms. Large size green silk wire insures greatest efficiency. 1/4 inch shaft. Noiseless split connection. Table or panel mounting. Split stator winding with binding post connections.



SUPERIOR VARIOMETER

V525 Each...\$3.68
Forms moulded of red brown bakelite. A neat handsome instrument. Green silk windings calculated for highest efficiency. 1/4 inch shaft. Noiseless pigtail connections. Table or panel mounting. Produces superior results in any type circuit 180 to 650 meters.



SPIDER WEB COIL FOR REINARTZ CIRCUIT

V296 Each...\$1.30
Lists for \$2.50. A very unusual bargain. Made of green silk covered wire, spider web wound to produce greatest efficiency and lowest losses. 21 taps so arranged that crossing is avoided. Two fibre strips and wooden rod furnished permit various styles of mounting. With this coil a high grade set can be built at a low cost. Directions included.

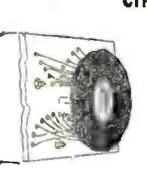

ULTRA AUDION COIL

V297 Each...\$.85
Spider web wound of green silk covered wire. Four taps. Produces wonderful results. Fibre strips and wooden rod for mounting and directions included.

COCKADAY COILS

V298 Per Set...\$1.95
Complete set coils for Cockaday circuit. Properly calculated and made to give best results on this new wonder circuit.



NEUTRODYNE TRANSFORMERS

V571 Each \$1.75. Per set of three. \$4.95
An air core transformer for use in neutrodyne method of reception. Can also be used for tuned radio frequency or as a fixed coupler with condenser across secondary. Proper design for results and efficiency. Green silk windings on bakelite tubes with adjustable mounting brackets to fit most any condenser.

NEUTRALIZING CONDENSERS

V572 Per set of two...\$.40c
Simple, inexpensive, effective precision type. Micrometer adjustment is attainable.

STANDARD NEUTRODYNE PARTS

V851 WorkRite Neutroformer (combined transformer and condenser). Each...\$4.78
V852 WorkRite Neutrodyne Kit...\$14.95
Includes 3 WorkRite Neutroformers, 2 WorkRite Neutrodons, panel layout, paper template and book of instructions.

V853 WorkRite Neutrodon. Each...\$.43c
A very accurate and easily adjusted condenser for neutralizing tube.

SPIDER WEB COILS

V290—25 turn 39c V32—50 turn 47c
V291—35 turn 42c V293—75 turn 54c
V294—100 turn. Each...\$.68c
A new popular type of inductance of highest efficiency. Lowest distributed capacity and lowest high frequency resistance. Firm green silk windings with fibre mounting strips.

YOU SAVE MONEY WHEN YOU BUY FROM US

We Pay Transportation Charges East of the Rockies

THE PRICES QUOTED DELIVER THE GOODS TO YOUR DOOR

FAST SERVICE—TRY US AND BE CONVINCED

THIS GUARANTEE PROTECTS YOU—Examine the goods we ship you. They must suit you in every respect. If you are not satisfied with your purchase return the goods at once and we will refund the price you paid.

OUR SPECIAL VARIOMETER AND VARIOCOUPLER

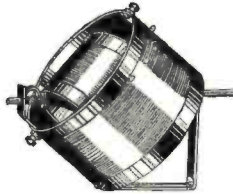

Build into your set reliable instruments. You can depend on this variometer and variocoupler to give you the best results in any circuit working from 180 to 650 meters. In design and construction they are the best. Only the highest grade materials are used. The prices quoted save you 30 to 40 per cent. Why pay more?

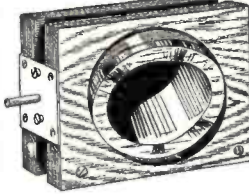

V418 Variocoupler. Each...\$2.45

The most efficient type of coupler, insures better tuning and louder signals. Primary and secondary wound on natural uncolored genuine bakelite tubes. Primary tapped for fine tuning. Can be panel or table mounted. 3-16 inch shaft.

SOLID BARE COPPER WIRE

Solid bare copper wire for aerials, leads or wiring instruments.

Solid Bare Copper Wire, size 14.
V240 100 ft. coil...\$.48c
V242 500 ft. coil...\$2.25

Solid Bare Copper Wire, Size 12.
V244 100' coil 67c V245 500' coil \$3.05

STRANDED ANTENNA WIRE

Cabled of fine copper strands. Very flexible. High tensile strength. Best for aerials.
V248 100' coil 58c V249 500' coil \$2.75

MAGNET WIRE

Insulated copper wire. Best quality even drawn wire, one piece to a spool. Prices quoted are for 8 oz. spools unless otherwise stated. Note, our prices are prepaid.

Double Cotton Covered	Enameled Insulation	Single Green Silk-Covered
Number V990	Number V992	Number V991
Gauge Price	Gauge Price	Gauge Price
18 39c	20 35c	20 \$0.75
20 48c	22 45c	2290
22 60c	24 50c	24 1.05
24 65c	26 55c	26 1.15
26 80c	30 60c	30 (4 oz.) .90
28 95c	32 65c	32 (4 oz.) 1.00
30 \$1.15	36 85c	36 (4 oz.) 1.30

ANTENNA INSULATORS

V260 Size 1 1/4. Composition, metal eyelets. Two for...\$.17c
V263 Ribbed Porcelain insulator, 2 1/2 in. long. Ea. 6c
Dozen...\$.55c
V265 Ribbed porcelain insulator—5 inches long. Each...\$.15c

LEAD-IN INSULATORS

V270 For 4 inch walls or less...\$.42c
V271 For 9 inch walls or less...\$.69c

The only practical lead-in insulator for aerial wires. Small, neat, effective, durable. Fits 5/8 inch hole. Securely locked by two adjustable nuts.

OUTDOOR LIGHTNING ARRESTER

V980 Price \$1.24
Protect your instruments with this lightning arrester. Weatherproof Bakelite case. Air gap type. Permanent. Durable. Underwriters approved.

JEWELL LIGHTNING ARRESTER

V981 Each .85c
A dependable protector, always on guard. Small and compact. Weatherproof porcelain case. Easily fastened and connected. Underwriters approved. Lists for \$1.10.

PANEL MOUNTING VARIABLE CONDENSERS

These are especially high grade condensers and we guarantee them to be mechanically and electrically perfect. Fine polished end plates of heavy bakelite. Shafts 1/4 inch diameter. Sturdy, heavy aluminum alloy plates perfectly spaced to insure smooth, even, reliable capacity. Our low prices save you money. These condensers are of the very best make and are not to be compared with many inferior, cheap condensers offered. We guarantee them to please you or your money back. The vernier style has one separately controlled plate which permits of the finest tuning. Quality considered, these values are unapproached by others.

REGULAR STYLE

V815—3 plate...\$.58c
V816—5 plate...\$.97c
V814—11 plate .00025 mfd...\$1.13
V813—21 plate .0005 mfd...1.27
V812—43 plate .001 mfd...1.47

V410 Variometer. Each...\$2.10

Perfect in design and construction. Accurate wood forms thoroughly seasoned. Correct inductive ratios. Solid baked windings. Plenty of large sized wire insures highest efficiency. A strong high grade instrument that will give you lasting service, 3/16 inch shaft.

TINNED COPPER "BUS BAR" WIRE

Size 14 tinned copper wire. For wiring sets. Best size for neat job and easy soldering.
V957 Round. Ten feet for...\$.12c
V958 Square. Ten feet for...\$.14c

SPAGHETTI

For covering connecting wires in sets. For size 12 and 14 wires.
V955 Finest quality braided and saturated with best baked lustrous transparent insulating varnish, 3 feet for...\$.10c
V956 Best quality braid and covered with black insulating compound. 3 feet for...\$.90

PORCELAIN BASE SWITCHES

Fine white porcelain bases. Copper contacts and blades. Can be used as antenna switches.
V385 Single Pole Single Throw. Ea. 20c
V383 Single Pole Double Throw. Ea. 32c
V384 Double Pole Double Throw. Ea. 50c

RADIO SOLDER SET

V538 Complete...\$.85c
Handy for soldering radio connections or for general small repair jobs. Consists of soldering iron with handle, sal ammoniac, soldering salts, solder and sand paper.

RADIO SOLDERING IRON

V540 \$1.35
Soldered connections in radio sets produce better results. This guaranteed iron is exactly right for radio work. A neat solid connection quickly and easily made. Operates on any lighting current 100 to 120 volts. 6 ft. cord with attaching plug. Length 13 inches. Heats quickly, will not overheat.

MIGNON VERNIER VARIABLE CONDENSERS

V827 .0002 M.F. Each...\$.230
V828 .0005 M.F. Each...\$.270
V829 .001 M.F. Each...\$.295
Highest grade instruments. Accurate rating. Extremely low dielectric losses. Independent friction vernier control insures perfect positive adjustment. 1/4 inch shaft. No dial included.

HEAVIER IRONS FOR GENERAL REPAIR WORK

Wonderful value at our prices.
V541 Medium size...\$.348
V542 Large size...\$.425

OUR SPECIAL AUDIO FREQUENCY AMPLIFYING TRANSFORMERS

V550 Each...\$2.25

In quality of tone and volume of sound, the things a transformer is built for we guarantee it to equal or surpass any other transformer. Neat in appearance. Carefully made. Fully mounted with plainly marked binding post connections. Wonderful results on one, two or three steps without distortion or howling. A quality item in every respect.



SHIELDED TRANSFORMER

V551 3 1/2 to 1 Ratio. \$2.48
V552 6 to 1 Ratio...2.68
Note that our price is prepaid. The same high grade style of transformer as above enclosed in a metal case which completely shields it from any outside magnetic influences. Free from howling and local disturbances.

OTHER STANDARD BRANDS AUDIO FREQUENCY TRANSFORMERS

Fresh, clean stock in original containers.
V232 THORPARSON Ratio 3 1/2 to 1 \$3.30
V233 THORPARSON Ratio 6 to 1 3.70
V553 Acme. Each...4.20
V554 Coto. Each...4.45
V555 Federal Each...4.45
V712 Radio Corp. Each...5.70
V234 All American 10 to 1 Shielded 3.80
V239 All American 5 to 1 Shielded 3.80
V236 All American 3 to 1 Shielded 3.60
V231 All American Push Pull...5.10

TRICOL RADIO FREQUENCY AMPLIFYING TRANSFORMER

P560 For 201A or 301A Tubes...\$1.58
V561 For 199 or 11 or 12 Tubes...1.58
This transformer will produce wonderful results in any type of regular or reflex radio frequency circuit. Perfect for one, two or three stages. Compact, convenient form easily mounted. Range 175 to 600 meters.



OTHER STANDARD BRANDS RADIO FREQUENCY TRANSFORMERS

V568 Our special—as good as any of them...\$.48
V562 Dubilier. Each...3.48
V563 Acme. First stage. Each...4.45
V565 Acme. First stage. Each...4.45
V566 Acme. Second stage. Each...4.45
V567 Acme. Third stage. Each...4.45
V714 Radio Corp. Each...5.95
V955 All American. Each...3.95
V575 Eria. First stage. Each...3.45
V576 Eria. Second stage. Each...3.45
V577 Eria. Third stage. Each...3.45
V578 Eria. Reflex No. 1, 2 Ea...4.35

FAHNESTOCK CONNECTORS

V366 Single. Dozen...\$.25c
V367 Double. Dozen...\$.30c
Handy and convenient for connecting wires or making connections on binding posts or other parts of instruments. Wires held firmly in spring grip but may be instantly removed.
V368 Antenna Connector. Each...\$.08c
Requires no soldering. Makes connection in a few seconds.



LIGHT SOCKET ANTENNA

V251 Each...\$.97c
Screws into any light socket. Replaces the regular out door antenna. Very satisfactory for nearby stations and under favorable conditions will bring in distant stations. Easy to install. No danger. Gives clear reception with little static interference. Ideal for people in apartment buildings.

TINOL V969 Per tube 19c

A combined solder and flux in handy form. Put a little on the connection, heat with a match, torch or solder iron and you have a neat electrically and mechanically perfect joint.

AUTOMATIC BLOW TORCH

V543 Each...\$1.19
Burns denatured alcohol. Automatically generates pointed flame in a few seconds. Easy to solder joints in hard places. Lights with a match. Burns 20 minutes on one filling. 5 1/2 inches high, 1/2 inch diameter cylinder. Works fine with Tinol listed above.



ANTENNA LEAD-IN

V259 Each...\$.25c
Solves a hard problem. With it you can bring in the antenna wire without drilling a hole in an insulator. Place on window sill and window can be closed down tight and locked as before. Takes but a minute to install. Perfectly insulated. Can be bent into any shape. Made of copper strip properly insulated. Neat and durable.



THE BARAWIK CO.

Chicago's Original Radio Supply House. Beware of Imitators

102 South Canal St., Chicago, Ill.

WITH BARAWIK QUALITY RADIO GOODS

VACUUM TUBES
Standard Brands—Cunningham, Radiotron. Every one guaranteed new and perfect. We will ship brand in stock unless you specify otherwise.

V105 Detector UV200 C300 Each \$4.30
V112 Amplifier, UV201A C301A Each 4.30
V118 5-Watt Transmitter 7.70
V107 WD11 C11. Each 4.30
V101 WD12 C12. Each 4.30
V102 UV199 C299. Each. 4.30
V104 UV199 Adapter fits 199 tube to standard socket. .39
V108 WD11 Socket. .30
V109 WD11 Adapter. Each. .42

BAKELITE TUBE SOCKET
V140 Standard base.39c
V141 UV199 base. .39c

Moulded of genuine red brown bakelite. Binding post connections. For table or panel mounting. Neat and strong.

199 SOCKET
V145 Each. .59c

Moulded of high insulating material. Spacing rubber base prevents ringing in. Plainly marked binding post connections. Neat and compact.

STANDARD TUBE SOCKET
V150 Each. .76c

Bakelite base. Polished nickelled tube. Highest quality socket on the market. Best insulation. Positive contact. Matted terminals. For base or panel mounting.

FILAMENT CONTROL RHEOSTATS
V132 6 ohm. Each. .38c
V129 20 ohm. Each. .43c
V131 30 ohm. Each. .44c
V135 6 ohm. Vernier 95c

Best grade. Will give best service. Durable and lasting. High heat resistant base. diam. 1 1/4" in. Tapered polished black knob 1 1/4" diam. Potentiometers. Match above rheostats. Same high grade construction.

V151 200 ohm. Each. .50c
V152 400 ohm. Each. .55c

OTHER STANDARD BRAND RHEOSTATS AND POTENTIOMETERS
V207 Filkostat. Each. \$1.90
V208 Bradlystat. Each. .174
V209 Bradlystat 200 ohm. Each. 1.89
V210 Bradlystat 400 ohm. Each. 2.89
V211 Howard 6 ohm. Plain Rheo. Ea. .85
V212 Howard 6 ohm. Ver. Rheo. Ea. 1.25
V213 Howard 25 ohm. Plain Rheo. Ea. 1.25
V214 Howard 25 ohm. Ver. Rheo. Ea. 1.25
V215 Howard 40 ohm. Plain Rheo. Ea. .85
V216 Howard 40 ohm. Ver. Rheo. Ea. 1.25
V217 Howard 20 ohm. Potentiometers. Each. .125
V218. Howard 400 ohm Potentiometers. Each. .169
V219 Klossner 6 ohm Vernier. Each 1.19
V221 Klossner 30 ohm Vernier. Each 1.45
V222 Amperite with mounting. .95

SUPERIOR RHEOSTATS
V153 6 ohm. Each. .69c
V154 20 ohm. Each. .76c
V155 30 ohm. Each. .83c

The finest rheostat. Smooth, even action. Best design. Best workmanship. Supplied with attractive dial and knob.

Potentiometers to match above rheostats with dial and knob.
V156 30 ohm. .98c

UNIVERSAL CONTROL DIAL
V918 For 3/16 inch shaft. \$1.15
V919 For 1/8 inch shaft. \$1.15

Replaces ordinary knob or dial. Gives perfect vernier control on condenser, variometer, varicap, tickler, etc. Positive easy action. Looks fine. Easily installed. Especially desirable in tuning neodyne sets.

COMPOSITION DIALS
V921 Diam. 2 in. for 3-16 in. shaft. Ea. 16c
V922 Diam. 2 in. for 1/4 in. shaft. Ea. .16c
V923 Diam. 3 in. for 3-16 in. shaft. Ea. 22c
V924 Diam. 3 in. for 1/4 in. shaft. Ea. 22c
V925 Diam. 3 1/2 in. for 1/4 in. shaft. Ea. 27c

Handsome dials moulded in one piece of polished black composition. 2 inch size has 270° scale marked 0 to 100 finely engraved in contrasting white enamel. 3 and 3 1/2 inch size have 180° scale marked 0 to 100.

BAKELITE DIALS
V931—2 in. Diam. for 3-16 in. shaft. Each. .35c
V932—2 in. Diam. for 1/4 in. shaft. Each. .35c
V933—3 in. Diam. for 3-16 in. shaft. Each. .39c
V934—3 in. Diam. for 1/4 in. shaft. Each. .39c
V935—4 in. Diam. for 1/4 in. shaft. Ea. 48c

Moulded in one piece of genuine bakelite in polished black finish. Finely engraved scale in contrasting white enamel. Sure grip knob that fits the fingers. Higher grade dials for foot sets. Match perfectly.

VERNIER DIAL ADJUSTER
V941 Each. .19c

Easily installed at edge of dial, gives finest vernier adjustment of condenser or inductance. A great value. Polished black knob.

WE PAY TRANSPORTATION CHARGES East of the Rockies PRESERVE THESE PAGES—ORDER FROM THEM AND SAVE MONEY

FAST SERVICE—TRY US AND BE CONVINCED THE PRICES QUOTED DELIVER THE GOODS TO YOUR DOOR

OUR GUARANTEE PROTECTS YOU—We handle only the best goods, carefully tested and checked by expert radio engineers. You are assured of getting guaranteed apparatus that will give superior results. And while our goods are best, our prices are lowest. Our goods equal or surpass the claims we make for them. We do not attempt to deceive or mislead. Our reputation for fair dealing is our most valued asset.

HOW TO ORDER—Write your Order plainly, state Article Number, Description and Price of items wanted. Send Postoffice or Express Money Order, Certified Check or Bank Draft for Total of Order. Prompt Shipment is assured when these directions are followed.

CABINETS
Fine looking cabinets solidly built. Elegant hand rubbed dark mahogany finish. You will be proud of your set mounted in one of these cabinets. Hinged tops. Front rabbeted to take panels. Panels not included. Prices are transportation paid. Note that our prices are prepaid.



Panel Size	Inside Dimensions (High x Wide x Deep)	Art. No.	Price Each
6x7"	5 1/2" x 6 1/2" x 7"	V420	\$1.95
6x10 1/2"	5 1/2" x 9 1/2" x 7"	V422	2.45
7x10"	6 1/2" x 9 1/2" x 7"	V421	2.80
7x12"	6 1/2" x 11 1/2" x 7"	V424	3.05
7x14"	6 1/2" x 13 1/2" x 7"	V423	3.20
7x18"	6 1/2" x 17 1/2" x 7"	V425	3.45
7x21"	6 1/2" x 20 1/2" x 7"	V425	3.85
7x24"	6 1/2" x 23 1/2" x 7"	V429	4.35
7x26"	6 1/2" x 25 1/2" x 7"	V431	5.50
8x14"	8 1/2" x 13 1/2" x 10"	V428	5.55
12x14"	11 1/2" x 13 1/2" x 10"	V430	4.00
12x21"	11 1/2" x 20 1/2" x 10"	V432	5.05

CRYSTAL DETECTORS
The latest development in Crystal Detectors. Give better results and more reliable than old style. Used in Reflex circuits.

V742 Grevol Detector. Each. \$1.48
V743 B Metal Detector. Each. 1.39
V744 B Metal Crystal. Each. .45
V741 Gold Grain Detector. Each. .83
V745 Yellow Tip Detector. Each. 1.79
V746 Du-tee Crystal. Each. .27

SUPERIOR VARIABLE GRID RESISTANCE
V167 Each. .80c
V168 With .00025 Condenser. .98c

Eliminates hissing. Capacity smoothly varied from 0 to 6 megohms by half turn of knob. Easily mounted on any panel.

RADIO "BAKELITE" PANELS
Notice our very low price on this fine quality material. Others ask as much for hard rubber panels which are worth much less. We supply genuine Bakelite, Condensite Celoron or Formica, all of which are materials with practically identical mechanical, chemical and electrical properties. Machines well without chipping. Won't warp. Waterproof. Highest mechanical and dielectric strength. Attractive natural polished black finish which can be sanded and oiled. Note that our prices are prepaid.

Panel Size Inches	1/2" thick	3/16" thick	1/4" thick
	Art. No. Price	Art. No. Price	Art. No. Price
6x7	V450 \$5.55	V460 \$8.99	V470 \$1.15
6x10 1/2"	V451 \$8.66	V461 \$1.10	V471 \$1.73
7x14	V458 \$1.38	V468 \$1.73	V478 \$2.76
7x18	V453 \$1.78	V463 \$2.27	V473 \$3.56
7x21	V457 \$2.05	V467 \$2.65	V477 \$5.10
7x24	V459 \$2.42	V469 \$2.97	
7x26		V462 \$3.25	
9x14	V454 \$1.85	V464 \$2.35	V474 \$3.56
12x14	V455 \$2.42	V465 \$2.97	V475 \$4.78
12x21	V456 \$3.62	V466 \$4.25	V476 \$7.13

GRID LEAKS
V177 Freshman back of panel style. .59c
V178 Freshman back of panel style with .00025 Condenser 79c
V171 Freshman base mounting type with .00025 Condenser. 79c
V172 Durham Variable Grid Leak with Mounting. .89c
V173 C.R.L. Variable Grid Leak. \$1.19
V175 C.R.L. Variable Grid Leak with grid condenser. \$1.48

DUBILIER MICADON TYPE 601
V502 .0001. .28c V507 .0025. .32c
V503 .00025. .28c V508 .004. .40c
V504 .0005. .28c V509 .004. .40c
V505 .001. .32c V510 .005. .48c
V506 .002. .32c V511 .006. .60c

BARAWIK QUALITY HEADSETS
V770 Per Set. 2000 ohms. \$2.60

These headsets have proven on rigid tests to be one of the very best on the market. The tone quality is excellent with an unusual volume. Skilled workmen make them from only the best selected materials. The receiver cases are fine polished finish with polished black ear pieces. Fabric covered head band comfortably and quickly fitted to the head. Supplied with 5-foot cord. These sets were designed to sell for much higher prices than we ask, and at our price are a wonderful bargain. We guarantee that you will be pleased with them and agree that they are the best value by far yet offered. If they don't suit you we will cheerfully return your money.

STANDARD BRAND HEADSETS
V754 Baldwin Type C with universal jack plug \$10.45 V766 Frost, 2000 ohm \$3.95
V758 Western Elec. \$9.50 V759 Federal. \$5.50
V751 Murdock 56, 2000 ohm. \$3.25
V752 Murdock 56, 3000 ohm. \$3.90
V757 Dictograph Aristocrat. \$6.60

SUPERIOR RADIO JACKS
Finest grade jacks. Improved design. Best materials. Phosphor bronze springs. Silver contact points. Nickel finish. Mount on panels 1/4 to 3/8 in.

V390 Open circuit. Each. .36c
V391 Closed circuit. Each. .45c
V392 Two circuit. Each. .54c
V393 Single circuit filament control. 52c
V394 Two circuit filament control. 68c

STANDARD JACKS AND PLUG
V387 Open circuit jack. Each. .27c
V388 Two circuit jack. Each. .35c
V395 Plug takes two sets of phones. 35c

Well made, durable, smooth working, nickel finished frame. Well insulated.

SUPERIOR RADIO PLUGS
V395 With Set Screws for fastening cord. Each. .35c
V397 Two set contact points. Takes two pair any style cords. Lists for \$1.00. Each. 59c

Highest grade plugs. Fit any standard jacks. Polished round barrels.

SWITCH CONTACT POINTS
Brass polished nickel finish. All have 5/8 in. long size 6-32 screws and two nuts. All prices the same.

Dozen 15c Hundred \$1.00

Order by Article Number.

V360 Head. 3/4" diam.; 1/4" high
V362 Head. 3-16" diam.; 1/4" high
V367 Two set Contact Points

Also for connecting wires to binding posts, etc.

V365 Dozen 8c Hundred 30c

SWITCH LEVER STOP
Brass polished nickel finish.
V386 Dozen 18c Hundred \$1.05

SWITCH LEVERS
Very neat polished black composition knob. Exposed metal parts polished nickel finish. Fitted to panel binding and two set nuts. A high grade switch.

V381 1 1/4" Radius. Each 14c

INDUCTANCE SWITCH
V285 Price including knob and dial. \$1.19

Mounts switch points and contact lever behind panel. Only one hole needed to mount. 15 switch points, any number of which may be used.

BINDING POSTS
Brass, polished nickel finish. Washer and 6-32 in. screw extending 3/4 in.

V370 Large size—barrel and knob 3/4" long. Dozen. .70c
V372 Smaller size—V376-8 barrel and knob 9-16" long. Dozen. 70c
V374 Large size with composition knob. Dozen. 45c
V376 Large size with hole for phone tip or wire. Dozen. 80c
V378 Small size with hole for phone tip or wire. Dozen. 35c

SUPERIOR INDUCTANCE SWITCH
V288 Each. .85c

Quickly and securely mounted by drilling one hole. Only knob and pointer show in front of panel. Connections can be soldered before fastening switch, making assembly much easier.

STANDARD BRAND LOUD SPEAKERS AND UNITS
V610 Murdock Loudspeaker. \$2.75
V613 Barawik with Baldwin unit. 9.75
V615 Pathe Loudspeaker. 15.95
V616 Atlas Loudspeaker. 22.50
V612 Magnavox R3 Loudspeaker. 29.50
V614 Magnavox M1 Loudspeaker. 29.50
V617 Music Master Loudspeaker type C unit 5.10
V619 Murdock Special Unit. 2.60
V618 Brandes Table Talker. 9.25
V620 Baldwin Loud Speaker. 22.50
V609 Dictograph Dictorand. 21.50
V608 Atlas Unit. Each. 10.75
V607 Western Electric Unit. Each 10.75

PLATE CIRCUIT "B" BATTERIES

You can make real savings on these batteries. We guarantee them to equal any on the market regardless of price. Extra long life. Don't throw away your money on cheaper inferior useless batteries.

V180 Signal Corps type, small size, 15 cells, 22 1/2 volts. Each. \$1.10
V182 Large size, 5 taps 16 1/2, 18, 19 1/2, 21 and 22 volts. Each. \$1.45
V184 Variable Large size, 10 1/2 x 3 inches, 5 taps, giving range from 16 1/2 to 22 1/2 volts in 1 1/2 volt steps. Each \$1.70
V188 Combination Tapped 45 volts 30 cell. 13x4x3 battery. Tapped to give 45, 22 1/2, 21, 19 1/2, 18 and 16 1/2 volts. Handles both detector and amplifier tubes. Ea. \$3.28



"B" BATTERY METER
V189 Each. .98c

Reads 0 to 50 volts. Accurately tells you the exact condition of your "B" Battery. Convenient wench size. Polished nickel case with wire lead.

STORAGE "A" BATTERY
A high grade battery. Guaranteed for three years. Made of best new materials. Full capacity. The best battery buy on the market. Try one of these batteries on your set for 10 days. If at the end of that time you are not fully satisfied with the battery return it and we will refund the purchase price.

V194 6 volt, 60 amp. size. Each. \$9.90
V196 6 volt, 100 amp. size. Each. \$13.25



HOMECHARGER BATTERY CHARGING RECTIFIER
Charge your home charger night for a few cents. Simply connect to any 110 volt 60 cycle light socket, turn on current and rectifier does the rest automatically. Will work for years without attention. Simple connections. Give your "A" and "B" charge which batteries should have. You can make it pay a profit charging your "A" or "B" batteries. Long connecting cords with pair of battery clips.

V201 For 6 volt battery. \$12.95
V203 For 12 volt battery. 12.95

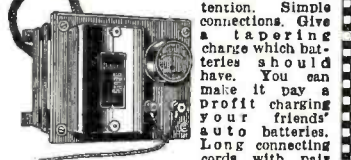

HYDROMETER
V190 Each. .48c

Accurately tells you the condition of your storage battery. Helps you keep your battery in better condition.

BATTERY CLIPS
V198 Two for. .28c

Clip onto storage battery terminals, lead cord. Make positive non-corrosive contact at all times.

WIRE CONNECTING CLIPS
V199 Per dozen. .30c

Small connecting clips for quickly fastening leads on to binding posts, etc. Handy and useful. Every radiolist should have at least a dozen.

RUBBER COMPOUND PANELS
Made of a special compound having a rubber base. Equal in appearance and in all essential points to any other class of panels. Fine smooth polished finish. Can be drilled or cut without chipping. Guaranteed not to warp and to be a perfect insulator for radio use. Smooth clean edges. Thickness 3/16 inch. Size given is in inches.

V481 7x10. \$.88 V484 7x18. \$1.60
V482 7x12. 1.05 V483 7x21. 1.85
V483 7x14. 1.22 V486 7x24. 2.10

RADIO SWITCH
V287 Each. .28c

Cuts current on any off instantly by a push or pull. Very neat. Well made. Durable. Saves tubes and batteries.

BEZELS
V399 Diameter 3/4 inch. Each. .15c
V400 Diameter 1 1/4 inch. Each. .15c

Polished nickel finish. Finest quality. Fit any thickness panel. Greatly improve appearance of any set.

Supremacy Proven by Every Test

FIL-KO-STAT

THE SCIENTIFICALLY CORRECT RADIO RHEOSTAT

The **FIL-KO-STAT** Makes Good

OR
WE
DO!!

Our unconditional guarantee of complete satisfaction is your assurance that FIL-KO-STAT will give you infinite adjustment of filament heat, noiseless tube operation and consequently more DX stations from *any* type of hook-up using *any* type of tube. *The Proof is up to you.*



Write for a free copy of our new booklet, "Improved Reception Through Scientific Tube Tuning". Address Dept. R. N. 5



Radio Stores Corporation
Sole International Distributors
Home Office, 220 West 34th St.
New York, N. Y.

BRANCHES IN LEADING CITIES)

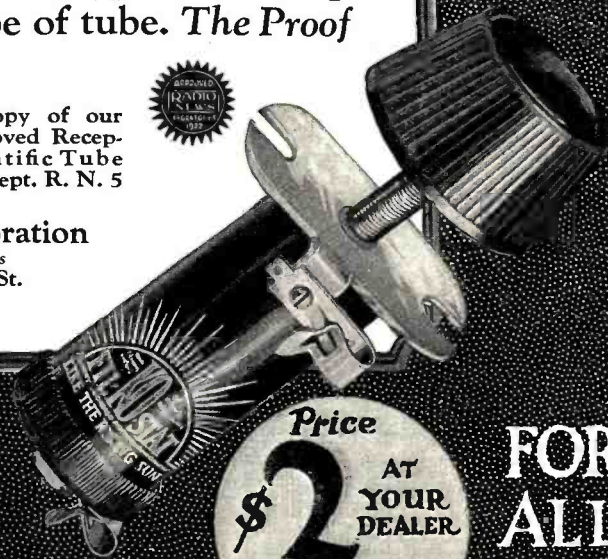

Unconditionally Guaranteed

BY THE MAKERS

DX INSTRUMENT Co

HARRISBURG, PA.

Price
\$2 AT YOUR DEALER
IN CANADA **2.75**

FOR ALL TUBES



RADIO NEWS

H. GERNSBACK—Editor and Publisher
ROBERT E. LACAULT, Associate Editor

EDITORIAL AND GENERAL OFFICES, 53 PARK PLACE, NEW YORK

Vol. 5

MAY, 1924

No. 11

The Radio Beginner

By H. GERNSBACK

OF all the people, the Radio Beginner—or shall we call him novice—is entitled to the greatest amount of sympathy; and he of all people does not get much of it. Perhaps the radio industry itself is to blame most for this condition.

In the past, only too often has the novice gone to a radio store, only to be sneered at and have fun made of his questions that seemed logical enough to him, but foolish to the "Know-It-All" behind the counter. Even today this feeling has not been eradicated entirely, and it is therefore small wonder that the beginner is not always very anxious to become initiated into the mysteries of radio.

There are two sorts of novices: The one who buys a set complete, and the one who buys the parts, in order to construct the set himself. At the present time the former is in the minority, as there are more people who "build their own" than there are who buy sets complete. For the man who buys the outfit already assembled, his task is simple. If he is a novice we might say this to him:

If you have not much money to spend and you wish to receive local stations only, start in, by all means, with a small crystal set. The crystal set requires no batteries and uses a pair of telephone receivers. It is not possible to attach a loud speaker to a crystal set, as the power delivered by it is very minute. For purity of sound, the crystal set has no peer; however, it does not work well as a rule for greater distances than 15 miles. The tuning of most manufactured sets is not very sharp either; by that is meant, if you are near a broadcast station it will be almost impossible to tune that station out in order to receive another one. Long distance stations *cannot* be received except under unusual conditions.

The next low priced set to consider is a one tube set. There are some very excellent sets of this kind on the market, some of these being able to occasionally receive stations 2,000 miles away. These sets as a rule also work with a pair of head phones. If a loud speaker is to be added, you need what is called an amplifier, which means one or two more tubes and more batteries. We suggest to the novice that he make himself familiar first with the one tube set before he attempts to work a loud speaker. The one tube set as a rule has but few controls, that is, few knobs and dials with which to make adjustments, and for the novice the fewer adjustments there are the better. More than one dial makes tuning somewhat complicated until you get the hang of it.

If you have more money to spend, and wish to get a larger outfit—one that works a loud speaker—there are any number to choose from. As a rule, an outfit with less than three tubes does not work a loud speaker well. To get long distance (DX) stations clearly, you need at least a five tube receiver. The storekeeper will be glad to show you how to operate it. The operation of most of these sets is very simple after you have become accustomed to working it. The thing that you should not tamper with until you understand more about electricity and radio, is the apparatus itself.

The batteries are of great importance. All vacuum tube sets have two kinds of batteries: First, the "A" battery, which supplies the current for lighting the filaments of the lamps or vacuum tubes. It is usually a storage battery, or when dry cell tubes are in the set, dry cells may be used.

Next, we have the "B" battery or high tension battery. In order to memorize this better, the writer suggests that you associate the letter "B" with *BEWARE*. The reason is that unless you are careful, the "B" battery will cost you a good deal of money. It makes a huge difference how the two batteries, the "A" and "B" types, are connected. Every radio outfit has, as a rule, two binding posts marked for the "A" and the "B" batteries. It is *ABSOLUTELY* essential that the "A" battery be connected to the "A" binding posts and the "B" battery to the "B" binding posts.

"B" *E*W *A*R *E*, therefore, not to change these connections. If you do, and if you have a five-tube set, this slight mistake is apt to cost you \$25 in the twinkling of an eye, as you will burn out all your vacuum tubes at \$5 each.

After you have used your "A" and "B" batteries for a certain length of time, you will find that the sounds in the loud speaker or telephone receivers gradually become weaker, which is an indication that either the "A" or "B" batteries are getting low. Sometimes it is only the storage battery that is discharged, or the "A" dry batteries run down. This can be usually ascertained by looking at the bulbs themselves. If they emit a very dim light, the storage battery, if such is used, needs recharging; otherwise, the dry cells will have to be renewed. Dry "A" and "B" batteries cannot be recharged, notwithstanding the claims made by a lot of wisecracks. The only thing that run down dry cells are good for is the ash can.

If the "A" battery has been renewed and still the outfit does not work well, the "B" battery probably is run down as well. Here is a simple test, to find out if the "B" battery is still good or must be discarded:

Take an ordinary 25-watt 110-volt lamp such as you use in your house for lighting purposes. Connect the two metallic parts of the lamp to the two extreme terminals of the "B" battery. If the lamp does not light up at all the "B" battery is dead. This test can only be made with a 45-volt "B" battery or two 22½-volt "B" batteries, which of course must be connected in series in order to make the test. By series we mean attaching the plus (+) terminal of one battery to the minus (—) terminal of the other with a short piece of wire. That will leave one plus (+) and one minus (—) terminal on each of the 22½-volt "B" batteries. Connect two short wires to these terminals and with the two wires touch the two metal parts of the incandescent lamp. Unless the lamp lights, one or both batteries are dead. In connecting "A" and "B" batteries with a set it is of *extreme* importance that the plus (+) and minus (—) connections match up with the markings on the binding posts. Plus (+) must connect with the plus (+) and minus (—) must be connected with the minus (—) terminal.

We now come to the Aerial—one of the most important parts of your outfit. For best results, the total length of your aerial should be less than 100 feet. It must be insulated from *ALL* points on the building with good insulators. By 100 feet we mean the *total* length of the wire from your outfit up to the other end on the roof. The bare wire should *never* come in contact with the building, with the window moulding, etc. Where the aerial wire leads to the outfit it must positively be insulated, as a matter of fact the entire aerial can be insulated contrary to popular opinion. The radio waves pass easily through all insulation, so it makes no difference whether the wire is insulated or not, but the wire *MUST* be insulated wherever it touches stone, coping, woodwork, walls, etc. The best aerial is an *uninterrupted* piece of wire. If you must use more than one piece, do not attempt to just twist the wire ends together or you will have trouble. If you cannot solder the pieces together yourself, have someone do it for you.

The Ground is all important. By ground is meant a connection direct to Mother Earth. Any continuous wire or metallic object that makes a permanent and good union with the earth is called a ground. As such we have water pipes, gas pipes and radiator pipes. A gas pipe should never be used because it is sometimes insulated and does not establish a real connection with the earth. The radiator ground is not always good either because not all radiator pipes are connected with the earth. The safest bet is always a cold-water pipe. But again, here is where the little thing is important. Do not attempt to just wrap the ground wire—which connects to the ground binding post of your set—to the water pipe. This will spell F-a-i-l-u-r-e. Get a 10c or 15c ground clamp from your radio store and attach it to the cold-water pipe. The important part is that the pipe must be scraped *metallically* clean where the ground clamp is attached. This is most important. The ground clamp must be attached so tightly that it cannot be moved by hand. The wire is then connected with the ground clamp as tightly as possible—then you may safely forget it.

Radio Beacons Non-Directive and Directive

By F. W. DUNMORE

PHYSICIST, BUREAU OF STANDARDS

The ingenuity of those of the staff of the Bureau of Standards Laboratories is again manifested in the recently developed Radio Beacon systems fully described in this article by Mr. Dunmore.

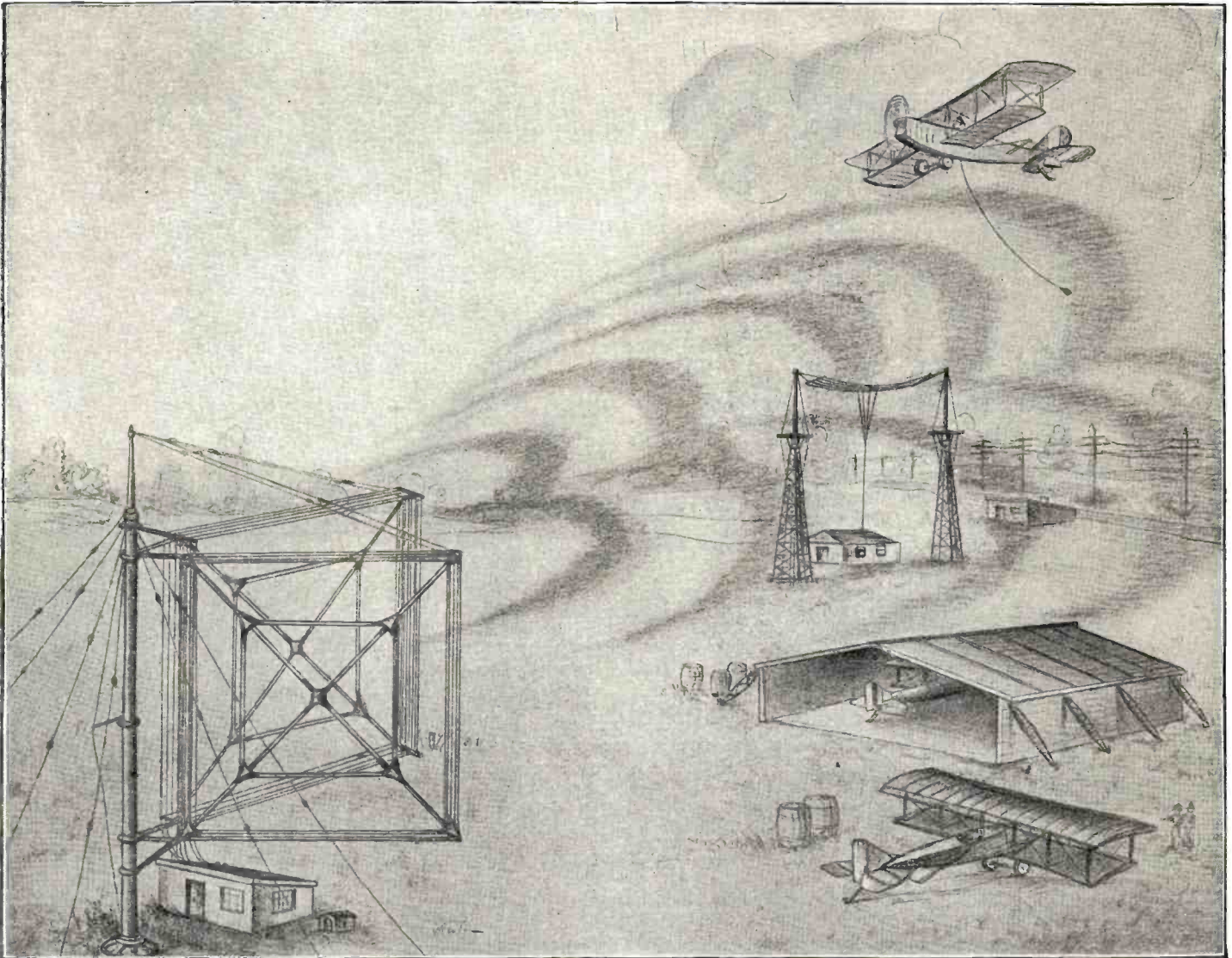

The direction of airplanes at night or during fog may be accomplished by means of transmitters used with loop aerials. This arrangement produces two radio signals that are both of the same intensity in one direction. The pilot guides his plane by keeping it in such a position as to hear both signals with the same intensity while flying in the general direction of the transmitter.

ARADIO beacon functions for the same purpose as a light beacon, namely, to aid navigators in maintaining a correct course. The radio beacon, however, has a great advantage over the light beacon in that it serves as a guide equally well under all conditions of weather, fog or otherwise, whereas a light beacon is rendered useless in a fog, when it is most needed. For this reason, radio beacons are now coming more into use.

There are two general types of radio beacons, the non-directive and the directive. The former type emits a radio wave which travels out equally well in all directions and is useful to navigators provided with a radio direction finder on shipboard. The latter type emits a radio wave of varying degrees of intensity in certain general directions. This type of beacon requires a less elaborate receiving equipment than a direction finder on shipboard, although its application is somewhat more limited in scope.

It is the purpose of this article to give a general outline of the construction, operation and application of the non-directive type of radio beacon, and one type of directive beacon which seems especially adapted to aerial navigation.

THE NON-DIRECTIVE RADIO BEACON

The non-directive beacon has been developed by the U. S. Bureau of Standards in co-operation with the U. S. Bureau of Lighthouses. It is installed on light-vessels or light-houses and is used in conjunction with the radio direction finder on shipboard. It consists of an ordinary quenched spark radio transmitting set which operates automatically when once set in operation. These beacons operate during a fog, and at stated times given in published schedules, on a frequency of 300 kilocycles (1,000 meters). Each beacon sends a different distinctive characteristic signal at given intervals, the interval being different for each neighboring

beacon. Fig. 1 shows the circuit diagram of the automatic key arrangement for giving the desired characteristic. The signals are of a group-dot nature and are as easily recognized by the untrained ear as the characteristic light flashes of a lighthouse are differentiated by the eye. A photograph of the automatic key and radio beacon transmitting set is shown in Fig. 2.

A frequency of 300 kilocycles was chosen since it is well below the natural frequency of the metallic structure of any ship. Should a high frequency, such as 3,000 kilocycles (100 meters) have been chosen for this work, there would be greater liability of errors in bearings, as some metal structure of the ship might have a corresponding natural frequency.

Fig. 3 shows the results of some experiments which were made to determine the error caused in a radio direction finder by a neighboring object, an antenna in this case, the natural period of

which corresponded to the frequency being used for direction finding. This figure also illustrates the importance of grounding or opening the ship's antenna whenever radio direction finding bearings are being taken.

The great importance of radio beacon installations on light-vessels may be realized from an illustration of their application. Consider the three radio beacon light-vessels, Nantucket Shoals, Fire Island and Ambrose Channel. These vessels lie on the trans-Atlantic track between New York City and Europe. By means of these beacons, a ship equipped with a radio direction finder may maintain a straight course in a fog from one light-vessel to the next, either on the west or eastbound trip between New York and Europe. When 100 miles from Nantucket Shoals light-vessel, a ship may take a radio bearing on it, and thus set a direct course to it. With such beacon installations on a series of light-vessels, there is little need for three-point bearings in order to determine the actual position of the ship. Since the light-vessels lie on the course a single bearing on any one of them makes possible the navigation of the ship directly to it. It is only within the last two years that the great value of such beacon installations has been extensively realized and many instances are now on record of navigators having found them material aid to navigation in fog.

BEACONS IN OPERATION

The first radio beacons to be put into actual operation by the Bureau of Lighthouses were on Ambrose Channel and Fire Island light-vessels and at Sea Girt Light-house, Sea Girt, N. J. These installations, two of which are shown in Figs. 4 and 5, were made in the summer of 1920. Many tests have been carried out by the author as to the reliability of these beacons by actual direction finder observations on shipboard. In all cases it was found possible to navigate the ship in fog just as though the radio beacons were visible to the eye as guiding marks.

Up to February, 1924, the following radio beacons had been put into operation by the Bureau of Lighthouses:

The future developments along the line of

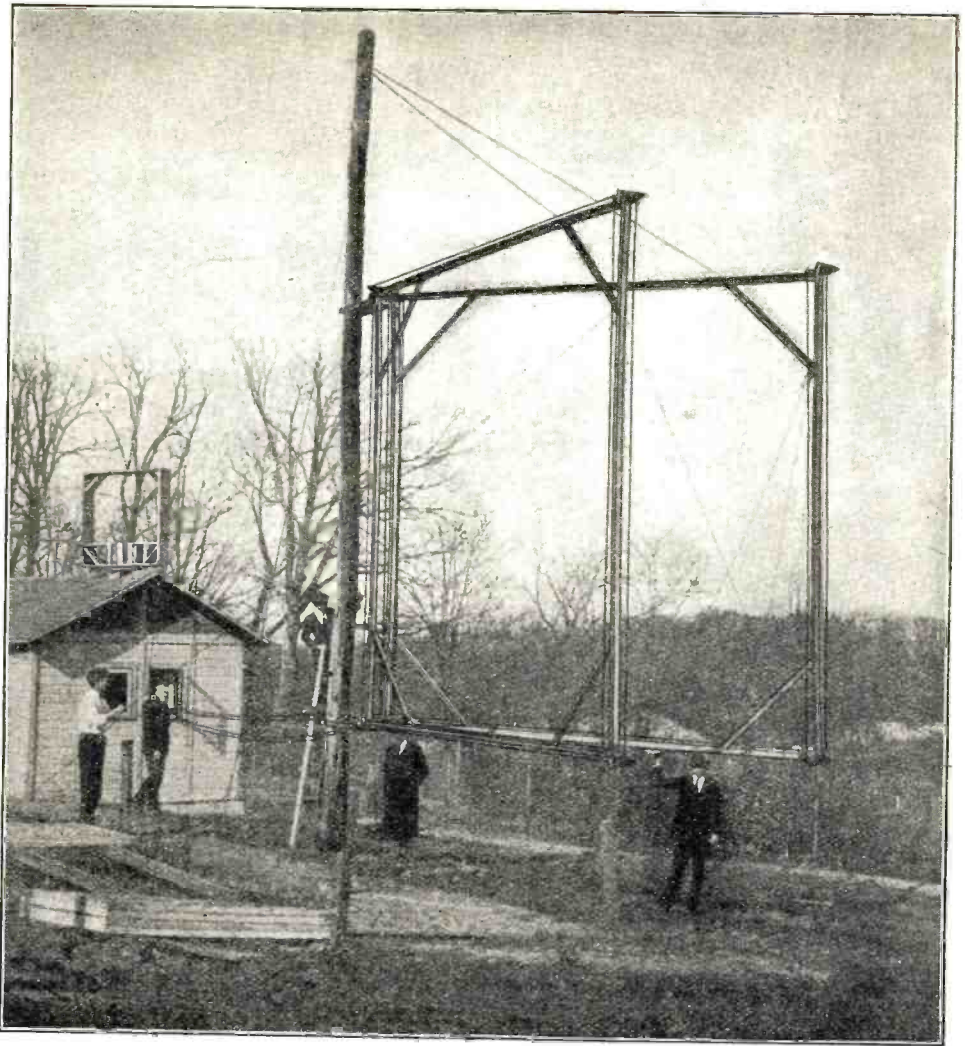

Fig. 6. Experimental type of equisignal double-coil antenna, arranged to be rotated about the telegraph pole as an axis.

possible the reception of the beacon signal on a non-oscillating direction finder circuit and will cause less interference. Ultimately, all

ship in the immediate vicinity may, by taking radio direction finder bearings on this ship, pass her at a safe distance.

DIRECTIVE RADIO BEACON

In aerial navigation where weight is of prime importance, the amount of radio equipment carried on board must be reduced to a minimum. It is preferable, therefore, for the purposes of aerial navigation, to make use of a directive type of radio beacon on the ground which makes possible the navigation of the airplane on a given course by means of the plane's radio receiving apparatus and without the use of direction-finding equipment on the plane. Such a beacon was developed about three years ago by the Bureau of Standards working in co-operation with the U. S. Signal Corps and U. S. Air Service. The results of this work have been held as confidential until recently, when permission for their release was granted and the information published in full.*

BEACON	SIGNAL	CHARACTERISTIC
Ambrose Channel Light-vessel, N. Y.....	One dash	20 secs. on 20 secs off.
Sea Girt Light Station, N. J.....	Three dashes	30 " " 180 " "
Fire Island Light-vessel, L. I., N. Y.....	Two dashes	25 " " 25 " "
Diamond Shoals Light-vessel, N. C.....	Two dashes	30 " " 30 " "
San Francisco Light-vessel, Calif.....	Two dashes	30 " " 30 " "
Boston Light-vessel, Mass.....	One dash, one dot	15 " " 15 " "
Nantucket Shoals Light-vessel, Mass.....	Four dashes	30 " " 25 " "
Cape Henry Light-station, Va.....	Two dots, one dash	20 " " 15 " "
Blunt's Reef Light-vessel, Calif.....	One dash	30 " " 35 " "
Columbia River Light-vessel, Ore.....	Three dashes	20 " " 20 " "
Swiftsure Bank Light-vessel, Wash.....	Two dashes	35 " " 25 " "

non-directive radio beacons will probably be in the direction of improving the type of transmitting set, that is, replacing the spark transmitting sets with electron tube sets with 500-cycle current as high voltage supply for the plates of the tubes. This will still make

ships may carry a low power beacon operated at the beacon frequency of 300 kilocycles. The range of such beacons need not be over five miles. These low-power beacon signals would be sent out as the ship proceeds in a fog along her course and any other

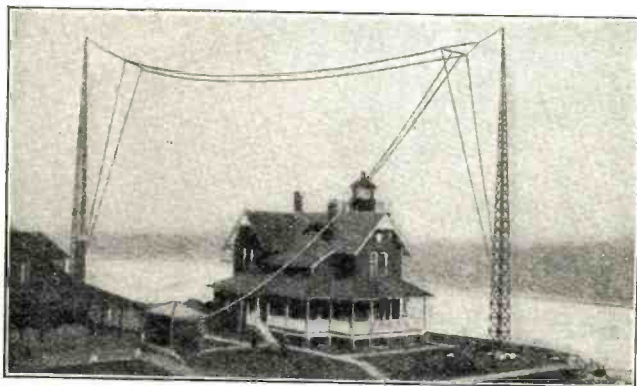
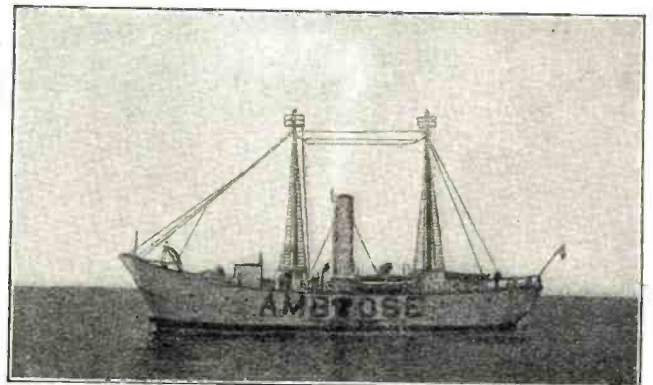

Fig. 4. The Sea Girt Light-house Radio Beacon.
Fig. 5. The Ambrose Channel Light-ship, also equipped with the radio beacon.



*See Bureau of Standards scientific paper No. 480, "A Directive Type of Radio Beacon and Its Application to Navigation," by F. H. Engel and F. W. Dunmore

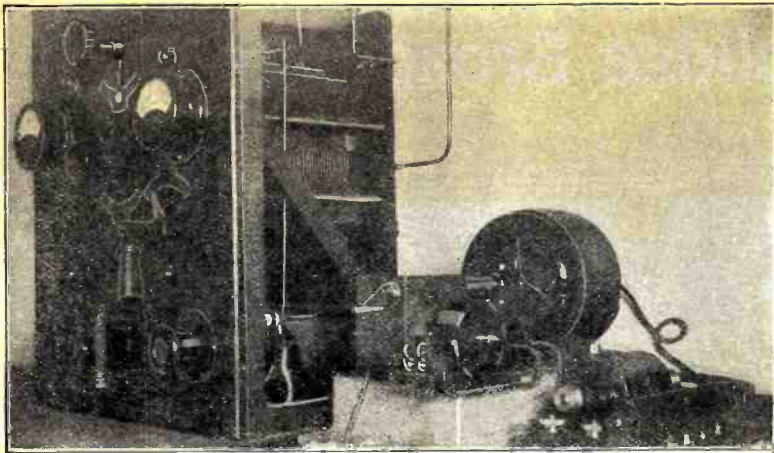

Fig. 2. Radio beacon transmitting equipment with motor operated key for making the characteristic signal.

The method makes use of the directive transmission properties of a coil antenna. Through it the familiar "figure eight" transmitting characteristic is obtained. A receiving set located on a line along the plane of the coil transmitting antenna receives a strong signal. The signal will decrease gradually to zero intensity, however, if the receiving set is moved through a 90-degree arc to a position at right angles to the plane of the transmitting antenna.

By a combination of two transmitting coil antennae crossed at an angle of 135 degrees, this directive transmission characteristic may be made use of in a way to be described.

Fig. 6 shows one of the first experimental double-coil arrangements mounted so as to be rotatable about a telegraph pole as an axis.

Fig. 7 shows the circuit and coil antenna arrangement finally used. Here the two coil antennae, 50 feet high and 50 feet long, are shown as single-turn or loop antenna, A and T. One is arranged at an angle of 135 degrees with respect to the other. These loop antennae are arranged to be connected alternately, first loop A and then loop T, by means of a rapidly operated high-voltage D. P. D. T. switch, S. The transmitting set was a 5-k.w. quenched spark set, as it was the best type available at the time of the tests. A small inductance was provided in each loop circuit so that they could be adjusted to 300 kilocycles, when the rest of the tuned circuit was thrown into circuit by means of the switch S. It will be noted that when the switch connects one loop, the other is detuned, preventing any absorption which would tend to change the true directive transmitting properties of the connected loop. The switch S is automatically operated and the letter "A" automatically transmitted while the A loop is connected. Likewise, "T" is sent when the T loop is connected. Thus the two loops transmit separate signals intermittently and directionally in accordance with the "figure eight" directive characteristic mentioned above.

ZONE SYSTEM

The effect of this combination is to produce four zones in which signals of equal strength from the two loops A and T will be received. (That is, the letter "A" sent from one loop will be equal in intensity to

the letter "T" sent from the other loop). As these two signals follow each other rapidly, it is easy to judge of their equality in intensity. These equisignal zones extend out from the crossed loops as a center, much

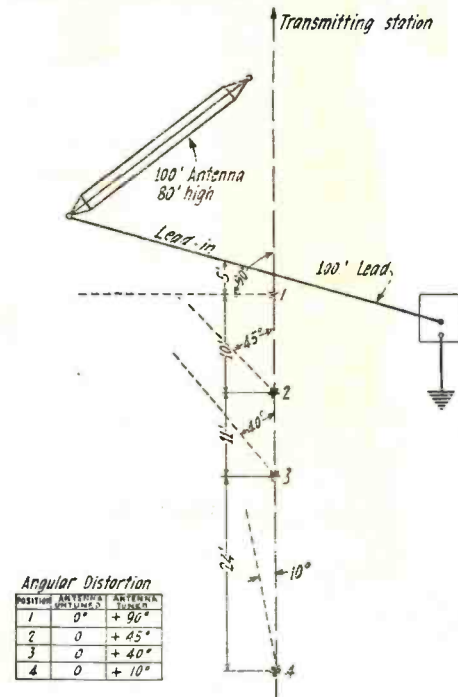

Fig. 3. Tests to determine the amount of wave distortion in degrees at different distances from an antenna, tuned and untuned.

as the four spokes of a wheel lying on the ground extend out from the hub as a center. These equisignal zones lie along the four bisectors of the four angles formed by the two crossed loops. The two zones along the bisectors of the two 135-degree angles are much sharper or narrower than those along the two 45-degree angles and are consequently the ones used. The practical application of these equisignal zones is apparent. It is only necessary to orient the two crossed coils so that the

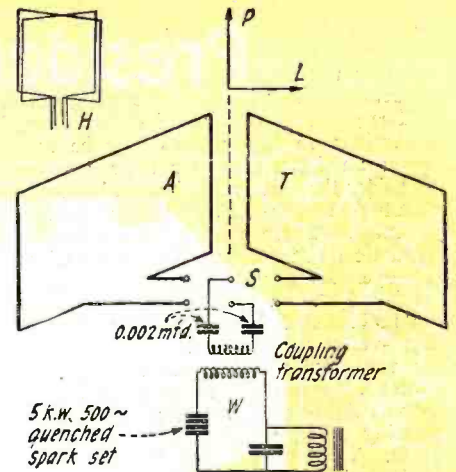

Fig. 7. Circuit diagram of equisignal directive radio beacon.

bisector of the 135-degree angle formed by their intersection lies along a definite route, as, for example, between two cities.

A navigator of an airplane equipped with an ordinary receiving set tuned to 300 kilocycles may maintain a straight course between these two cities merely by guiding the plane so that the intensity of the letters from the transmitter are of equal intensity. No visual observations are necessary so that the navigator may be at any altitude. In fog or clouds, cross winds or calm, the course may be maintained. This method makes it possible for the navigator not only to tell when he is drifting away from the course, but indicates the direction in which he is drifting, either to the right or to the left. This is made possible by the fact that if the navigator is flying away from the equisignal beacon and drifts off to the right, the signal "T" becomes louder than the signal "A." Should he drift to the left, the reverse is true. His course may be altered accordingly.

A reference to Fig. 8 may perhaps make this clearer. Here the degree of shading at any point indicates the relative signal strength which would be received at that point from the two loop antennae A and T. Thus a plane at C would receive a strong "A" and a weak "T." At D, the "A" signal would be slightly weaker and the "T" would become inaudible. At E, the "A" would be still weaker and the "T" audible

(Continued on page 1685)

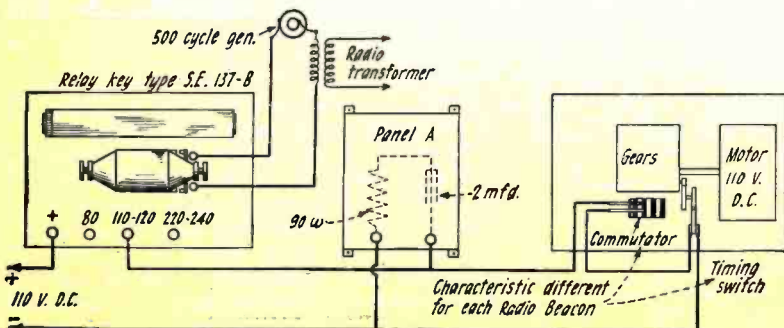
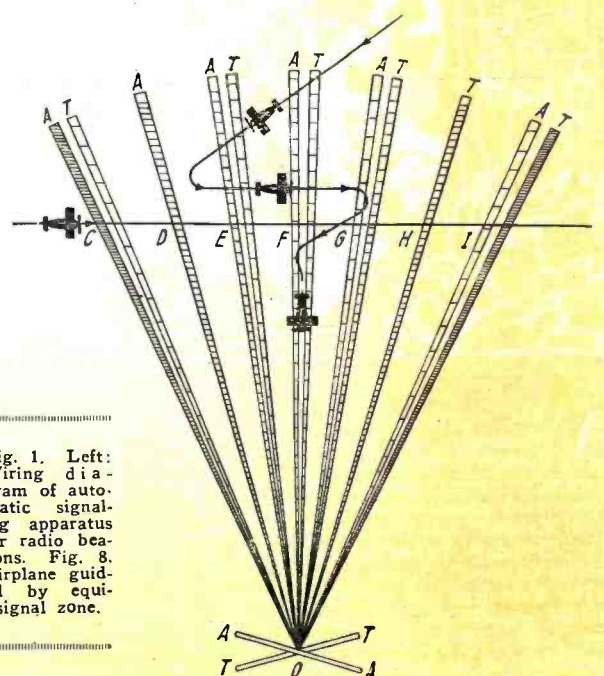

Fig. 1. Left: Wiring diagram of automatic signaling apparatus for radio beacons. Fig. 8. Airplane guided by equisignal zone.



President Coolidge Broadcasts



A FEW years ago, the country heard frequently of Roosevelt's "Tennis Cabinet"; more recently it read of Harding's interest in golf which extended to so many members of the cabinet that a "Golf Cabinet" was forecast. To-day, President Coolidge is the central figure of a "Radio Cabinet."

The President and all except two of his cabinet, possess radio receiving sets, and if they cannot all be classified as real radio fans, they are at least all interested in the commercial, scientific or entertaining fea-

tures of this three-sided art. The President and six cabinet members have given radio talks or had their addresses broadcast from Washington and other stations. The remaining four members are being sought al-

President Calvin Coolidge delivering his Lincoln's Birthday address from the Waldorf-Astoria Hotel, New York City. The microphone on the right picked up his voice and transmitted it to a chain of broadcast stations from where it was hurled into the air and eventually received by radio fans in the remotest corners of the United States.

most daily to talk, but so far they have refused, or avoided introductions to "Mike." One is even charged with being "Mike-shy," but officials of WRC and WCAP hope to complete the series of cabinet talks soon.

Radio is a feature of nearly every Government Department, being used in the daily routine in the Navy, Army, Post Office, Treasury and Agriculture. Several other departments use radio in emergencies or for

(Continued on page 1685)

Radio Features

Below: Talking vacuum tubes! No records, no microphones yet with this table full of apparatus two vacuum tubes are made to pronounce simple words such as ma-ma, pa-pa, etc. A detailed description is given in the article below.
Courtesy of Western Electric Co.



There's many a fan who would like to get his hands on this outfit. The lower set is an eight-tube super-heterodyne, the upper one a Neutrodyne.
Courtesy of Experimenters' Information Service



Mary and Doug rehearsing before the microphone prior to their talk from WJZ on March 12th. Both seem to be thoroughly enjoying themselves, but we wonder if they did the night of the event?

© Kadel & Herbert



Artificial Voice Speaks to Audience

A CLOSE imitation of many spoken sounds was produced recently before members of the New York Electrical and Telephone Societies during a lecture by Dr. Harvey Fletcher, of the Engineering Department of the Western Electric Company. Using a combination of vacuum tube oscillator, amplifier and tuned circuits, a loud speaker was made to say "a, e, i, o, u" in unmistakable fashion. The oscillator and amplifier were the electrical prototype of the human vocal cords and throat, producing a musical note rich in overtones, while the tuned circuits played the part of the mouth in strengthening certain of the overtones.

This demonstration of how simple sounds can be combined and manipulated so that

the result resembles the complex sounds of human speech followed an explanation of how the vocal organs operate to produce speech. The lungs force air upward through a narrow slit the edges of which are the vocal cords. These cords are set into vibration by the air current. The vibrations in turn allow rapid puffs of air to escape up the throat. The puffs are rapid enough to set up a train of air waves in the throat, mouth and nose, and these cavities modify the waves, so that they emerge from the mouth with the characteristics of voice sounds. All the vowels and some of the consonants are produced in this way. Thus for these sounds the vibrations started by the vocal cords serve as a "carrier" on which other

vibrations are impressed. This is quite like the operation of radio transmitting, in which a carrier wave is modulated by speech waves.

The actual energy of the air vibrations as they leave the mouth is exceedingly small; in fact, it would require 5,000,000 people all talking at once to produce as much power as is used by a 50 watt lamp. Then remembering that this energy is distributed over a range of pitches from 100 cycles per second up to more than 5,000 cycles, and that most of the energy goes into the lower pitches, it will be seen how relatively feeble are the higher pitches on which we depend for intelligibility. Were it not that the human ear is marvelously sensitive, we could converse only over the shortest distances.

Radio Review



The above photo shows the children of Public School No. 76, New York City, who gave vocal selections through station WJZ under the direction of Miss May O'Conner, from the Board of Education Building. The photo below shows the Board grouped around the microphone.
© Kadel & Herbert



Left: Captain Robert Huntington, Principal of the Navigation School at Seamen's Church Institute, has done more for the sailor ill at sea than any other man in the world. He conceived the idea of prescribing treatment by radio for sick seamen on vessels carrying no doctor. At the right is a spherical angle calculator for locating a vessel's position, a time-saving device invented by the captain. ©Gilliams Service, N. Y.

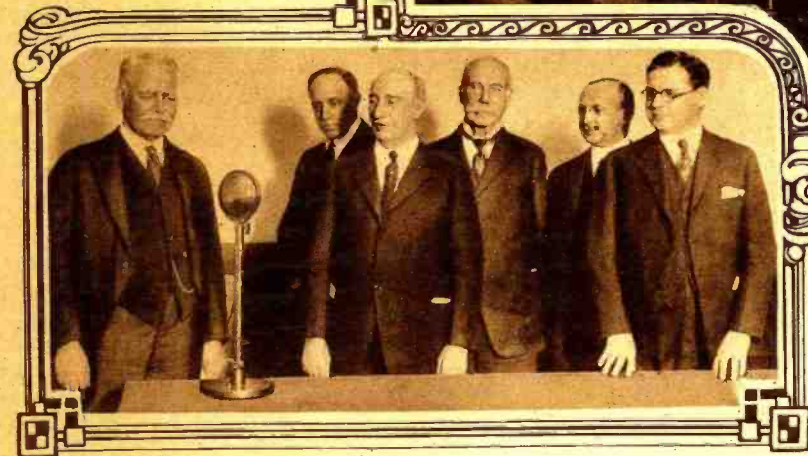

Following the practice of the Police Department in a number of the larger cities in the United States, the Berlin Police Department has fitted up a number of motorcycles with side cars and installed in them radio receiving apparatus, sensitive enough so that constant touch can be kept with various Headquarters up to a distance of 140 miles. The receiving range can be increased by the insertion of a special amplifier. The above photo clearly shows the hexagonal loop aerial which is employed for reception. The signals transmitted from any of the principal Police stations are picked up by rotating the loop until either of its ends points in the general direction of the desired station.

A Federal Radio Tax?—No!

By CHARLES P. KOPPERMAN

OF all taxes, the direct tax is the most obnoxious. The income tax isn't popular, though it is perhaps as fair a method of taxation as has yet been worked out. A broadcast listener's tax would be just about as popular as a lion in a sheepfold and would cause about the same results. What about the boy who saves and scrapes for the greater part of a year for that crystal set? How can he pay any tax, however small? Should we put a price on his ambition and ingenuity? And the radio "bug" who is continually testing new hook-ups, whose every loose cent is invested in radio. Six dollars to him means a tube, a transformer, or perhaps one of the new Super-Heater Wave-Length Inhalers. Can he pay a tax? And how about the "ham," who has perhaps done more for the development of radio than any other group? Would it be just to tax the average "ham," who cares very little for the broadcast program?

A Federal radio receiver, or BCL, tax would do one thing with neatness and dispatch. It would make us a nation of radio bootleggers!

The broadcast stations themselves are not begging for aid. Every industry has its failures. Those who jumped into broadcasting without experience, knowledge of costs, and an adequate source of capital simply built their houses upon sand.

The advertising possibilities of broadcasting have been greatly overlooked. "This is station FREE, All Weather Aerial Co., located in the Superior Hotel, Duck's Hollow, N. Y. The program this evening has been furnished through the courtesy of the Budweiser Malted Milk Co." is not cast on empty air or vacant minds. An announcement of this kind is a subtle form of advertising when projected simultaneously into upwards of 50,000 pairs of listening ears. How many of us know of the Drake Hotel

in Chicago, the Statler, Buffalo, the Gibson, Cincinnati, the Hampton, Albany, N. Y.? If we visit these places, what name will come first to our minds when looking for a place to stop? When thirsty, hasn't Budweiser Malted Milk first call? And if we are not using an "All Weather Aerial," we will certainly look into the matter!

VALUABLE ADVERTISING

The American Society of Authors, Composers and Publishers sought revenue out of the wrong end of broadcasting. Recent tests have established the fact that radio can put across a new song by an unknown author in minimum time. An independent publisher in New York states that he placed a song with one broadcast station and sold 25,000 copies in a short time. A small publisher in Nebraska gets 20 requests a day

(Continued on page 1676)

Mexican Broadcast Station CYL



The accompanying photographs are of the 500-watt radio broadcast station CYL, "El Radio," Mexico City, Mexico. CYL is owned by La Casa Del Radio (The House of Radio) Mexico City and is operated jointly with El Universal, a daily newspaper of Mexico City. The station was inaugurated September 15, 1923, by broadcasting the returns from the Dempsey-Firpo fight as received by telegraph from the ringside. The engineers who installed the station, however, were not satis-

fied with the way the transmitter was working and shut it down on October 10 to make some alterations in the antenna system. When the station was again put in commission on December 7, reports were received on the first test from nearly every state in the United States and from many points in Canada as well as Havana and Central America. The transmitting apparatus was installed by a Texas radio syndicate of San Antonio, Texas, under the supervision of Mr. S. A. Hodges.

THE LICENSE QUESTION

THE question of whether or not commercial and amateur radio operators should be licensed by the Government is very likely to come up in connection with Congressman White's bill to regulate radio communication. Like the former bill, which did not pass last year, the new bill will require that existing regulations for the licensing of all operators be continued and in addition that fees be established, whereas no fees are charged today. Since the question affects over 18,000 amateurs, about 6,000 commercial operators, and a large percentage of the public, an outline of the situation, with some of the pros and cons follows:

Certain Government officials, acting for what they believe the best interests of the Government and the public, seek to abolish the present requirements for both commercial and amateur licenses, which they claim are unnecessary, making needless work for the Department of Commerce and its Radio Supervisors. Transmitting station licenses for commercial, ship and shore stations and amateur stations, they believe, are necessary and adequate, as far as the Government need concern itself. The ship operators, commercial station owners, and amateurs possessed of transmitting stations would see to it that regulations were observed and proper operation maintained.

Locomotive engineers do not have operating licenses, even though handling trains filled with people, they point out, explaining that the railway companies are responsible in case of accidents, and sufficiently interested in efficiency to keep only skilled and experienced men at the throttles. It is also shown

that the Navy and Signal Corps operators are not subject to regulations and requirements for commercial or amateur operators, the two Government departments being responsible. Many examples are given by those who advocate the abolition of the operators' examinations, of lack of Government control where the safety of the public may be at stake, some even citing that the Steamboat Inspection Service is unnecessary.

On the other hand, other Government officials insist on the necessity of standardized commercial and amateur examinations and licenses in the interest of efficiency, safety of life at sea and the minimization of radio interference. One of their chief defenses is that it is in accordance with the international agreement, especially on ship stations.

If the question comes up in the forthcoming public hearings, officials of the radio section of the Department of Commerce will probably testify that it would be practically impossible to control radio stations without controlling the operators who transmit. Station licenses do not require any technical ability or knowledge on the part of the owner. Unskilled operators, if used, would increase interference and break rules as to

operation before the Department inspectors could detect and inspect the station offending. The field force of 53 inspectors and supervisors is busy all day now. Aboard ships the risk of permitting unlicensed operators to handle sets and transmit is more than the present officials care to assume responsibility for. There is constant need for ship stations to be in operating condition in the interests of safety at sea. If a set were burned up by an incompetent operator, or he could not send an "S O S" properly, the results would be the loss of a ship. In such a case who would be responsible? Advocates of eliminating licenses say the owners, just as on railroads.

Shippers and commercial operators do not object to the licensing system used the past 12 years, and the Department records do not show the failure of a single operator licensed in that time.

ON the status of the amateur, the Department of Commerce records show that most of the trouble today is with the unlicensed amateurs, through breaches of the law and radio interference. Licensed amateurs behave very well, and most of them are proud of their certificates.

One value in licensing both commercial and amateur operators is the establishment of lists of efficient operators from which the military arms of the Government can draw its men, as was done during the past war. These lists change, as the licenses are for two years' duration, and only 50 per cent. of the licensed operators renew their licenses. During the past two years, 5,966 commercial operators were licensed. Out of

(Continued on page 1656)

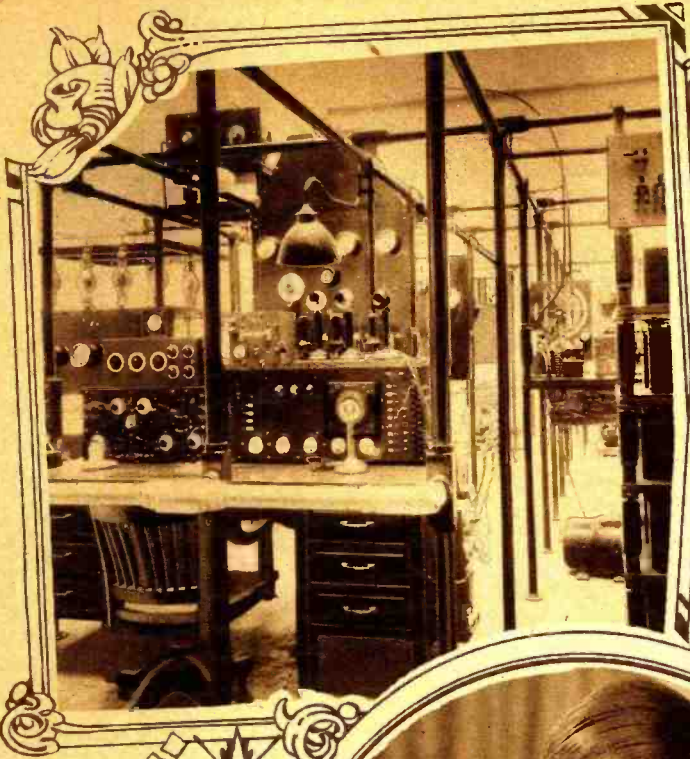

Above: The 500-watt transmitter of station WDAP, owned and operated by the Chicago Board of Trade. The two main transmitter panels can be seen behind the desk, the one to the left containing the large vacuum tubes. A wave-meter for keeping check on WDAP's wave-length can be seen on top of the control panel.

Right: Jack Nelson, Program Director of station WDAP who has the "delightful" task of trying to please all listeners.

Above: The Studio of Station WDAP in the Drake Hotel, Chicago. A receiving set with an amplifier and loud speaker is provided for the artists when programs from outside sources are being broadcast.

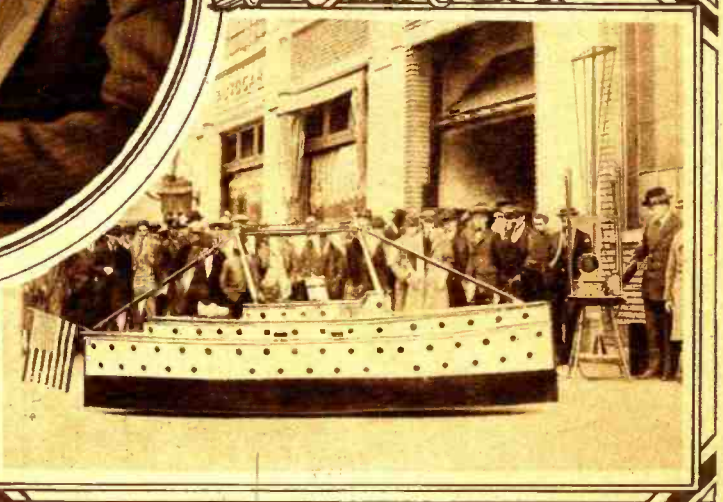

Above: This radio controlled vessel, which is being demonstrated on the vaudeville stage is creating considerable interest among radio fans. It is an adaption of the invention of John Hays Hammond, Jr. With the manipulation of a few controls this vessel will run forward, backward, stop short, fire its cannons, etc.

Left: The equipment used on the recent Exploration Expedition up the Amazon River, headed by Dr. Alexander Hamilton Rice, included a portable radio set with which the party kept in constant touch with stations in the United States and Europe while invading the haunts of head-hunting cannibals. Photo shows John W. Swanson, New York Radio Inspector, operating the set in the heart of a South American jungle.

© The Gillians Service, N. Y.

What Station Do You Want?

By HOWARD WILMOT

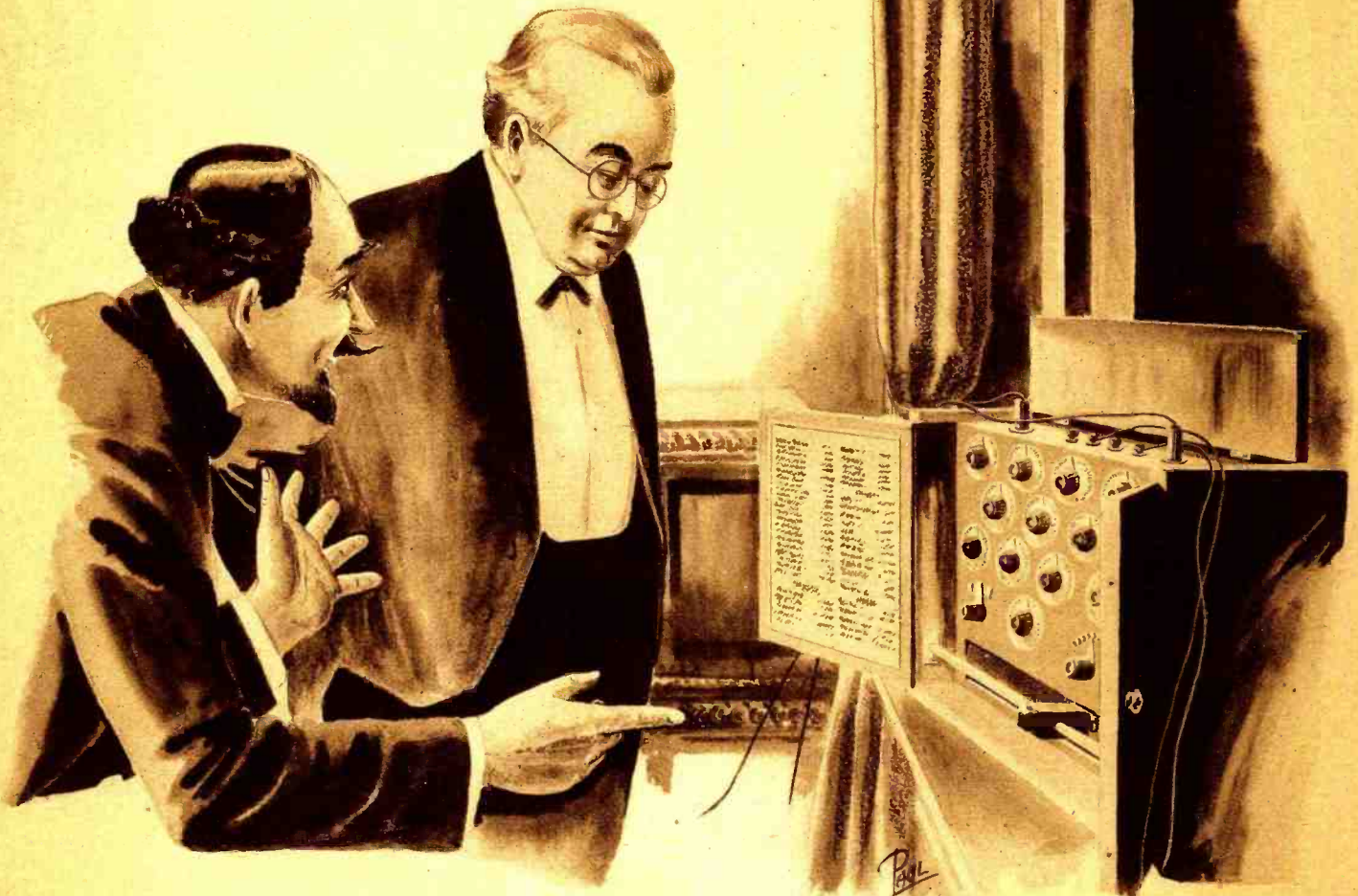

Mr. Franzbeau then opened the front of the cabinet which held his new set. It was a door-like arrangement very similar to the upper doors on a Victrola. On the inside of the doors were charts. On the panel there were 12 dials and two switches and at the bottom a rod running the length of the cabinet. It looked as if it were glass. Mounted on this there was a square black object which would slide like the slider on a tuning coil.

“GOOD evening, is Mr. Palling at home?”

“And, who are you, Sir?”

“Why, I’m Mr. Franzbeau from the Industrial Radio Corporation.”

“Step right in there, Sir, and I’ll see if he has finished his dinner.”

A gentleman evidently of foreign parentage who appeared to have stepped straight from the fashion plate of a Parisian catalog, leisurely walked into the reception hall. Accepting an offered chair he thoughtfully stroked his beard as his eyes judiciously studied a pattern of the rug.

Mr. Palling, a well preserved man of small physique who was just entering his early sixties, peered over his glasses at the card just handed him. Forcing himself to the calm with which he had been perusing the evening newspaper, he entered the reception hall.

“Good evening, Mr. Franzbeau.”

Mr. Franzbeau turned quickly from the window and replied, “Oh! Good evening, Mr. Palling; I thought I saw lightning.

Hope my eyes are not deceiving me, as it would make an ideal night to prove that my radio set was not effected by static electricity.”

“Well, suppose we sit over at this table where we can get together a little closer on this matter. Here, have a cigar.”

“Thanks, very kindly. My! This is a comfortable chair. Ahem, now Mr. Palling, I don’t want to impress you as being over enthused, but this set which I have been talking to you about will revolutionize the radio industry. Great progress has been made in the past few years, but you’ll agree with me that radio is still only in its infancy. Since the end of the war I have worked night and day in my laboratory on a theory of my own. My analysis showed that the sets in vogue today have an efficiency of from two and one-half to five per cent., whereas, in that set you see on the stand, the efficiency is from 90 to 96 per cent.”

“Do you mean to say, Mr. Franzbeau, that you have incorporated in such a small cabinet as that, an outfit that is 20 times more

efficient than my set upstairs?”

“Oh! You have a set? Perhaps you will allow me to prove my statement?”

“Yes. I have a seven tube set, three radio and three audio. How will your set compare with that?”

“Exactly as I said, Mr. Palling, 20 times better.”

“All right, come upstairs. I’d like to see your set in operation.”

“What is the greatest distance you have been able to get, that is, with the loudspeaker?”

“Davenport, I think.”

“Don’t bother to get a stand,” replied Mr. Franzbeau as he hurriedly placed a small mahogany cabinet, about half the size of a suit-case, on the window sill. Then, after asking a few questions, he connected several wires from Mr. Palling’s set to his, explaining that he was putting a jumper from the aerial and ground to his set and also, a pair of wires from the storage and “B” battery to supply the necessary power.

(Continued on page 1657)

Radio Pictorial

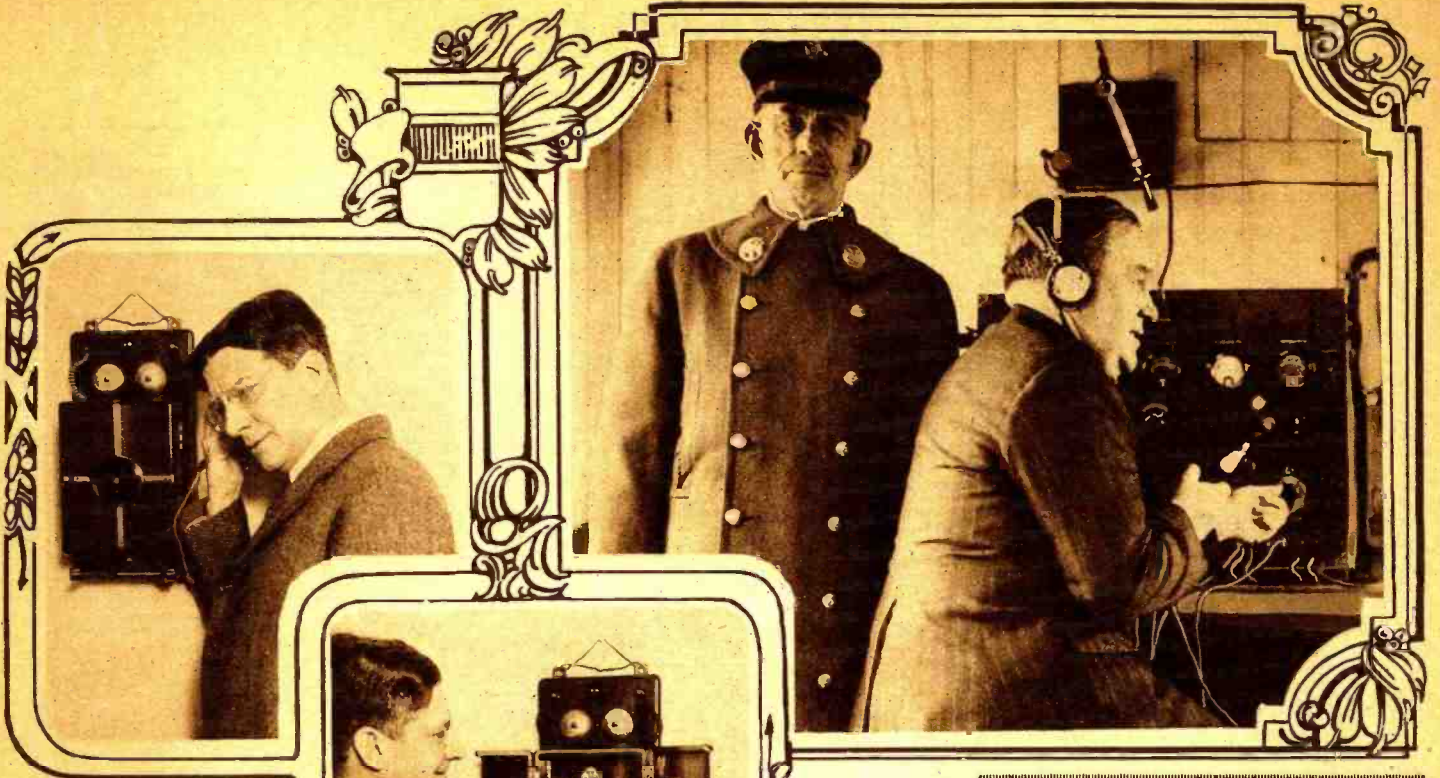

Above: The radio installation aboard the Boston fire boat *Angus J. McDonald*, which is employed for keeping in touch with fire headquarters. This set is identical with those used on the destroyers of the U. S. Navy. © P. & A. Photos.



Many a surprise was in store for friends of Arthur S. Lee, managing director of the Hotel McAlpin, N. Y., who invited his friends to inspect the "Booze-o-phone," the latest European creation. When the receiver is taken from the hook, lo and behold, the doors spring open and reveal a liquor cabinet with all the necessary glasses!

© Kadel & Herbert.

Below: C. L. Farrand and his Super Pliodyne receiver embodying six stages of tuned radio frequency amplification. All six stages are controlled by one dial which makes the set easily adjustable in spite of the number of stages of R. F. amplification. The radio frequency transformers can be seen situated between the vacuum tubes, and the variable condensers that control them, hugging the panel. © Foto Topics, Inc.



Why "Swifties" get back on time. Eager to hear the radio, they deliver their messages with unbelievable speed hastening back for football, baseball scores and news, to say nothing of Jazz. The boys are of station BZ Fifty-second Street, Western Union. The manager, E. S. Clark, is seen at the right. © Foto Topics.

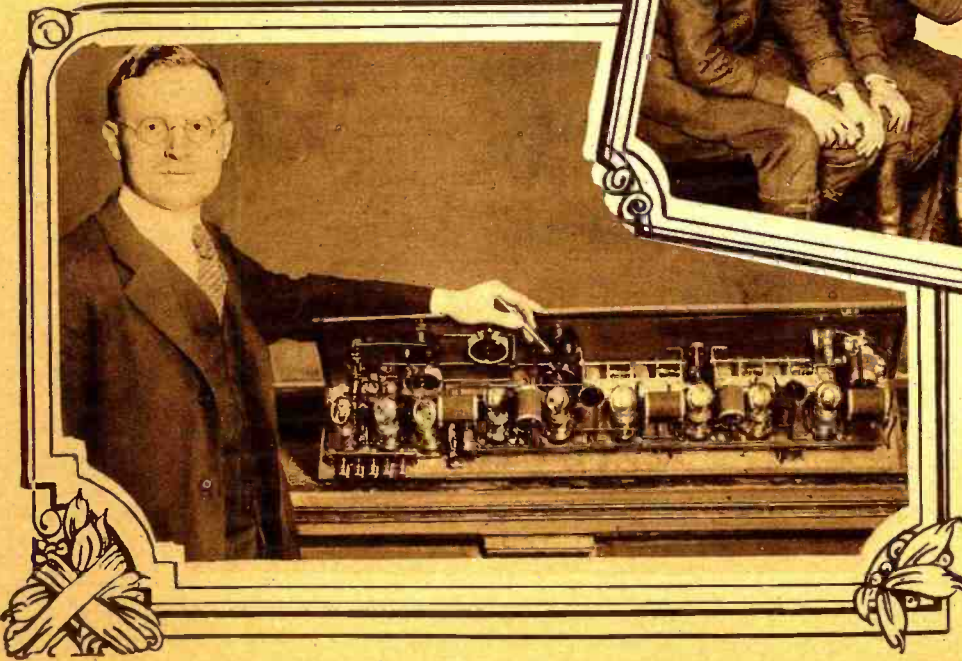

The New High Powered Station of Buenos Aires



Above, to the left, is a view of the high frequency alternators in the new Buenos Aires station; and at the right is shown the large condenser bank. The lower photo, at the left, shows the main control board with its switches, rheostats and meters.

struction is similar to that of the American station of the Radio Corporation of America with which the new station communicates. The station itself is connected to the city of Buenos Aires by special lines over which all messages are sent from the central office installed in the middle of the business section.

According to present day practice, the receiving station is erected a few miles away from the transmitting station and is composed of loop receivers used with ultra selective tuned radio frequency amplifiers equipped with static preventing apparatus and other refinements recently developed in the research laboratories of all the companies which furnished the equipment for this station. The construction and erection of this station was supervised by American, French, English and German engineers representing their respective companies in Argentine. Thanks to this co-operation, the new Monte Grande high powered station is most up-to-date in every respect. The receiving system is particularly efficient, as it was necessary to design a complete system which would work consistently in spite of the tremendous amount of static interference always present in this latitude.

The photographs illustrating this article show the inside of the transmitting station and one of the towers supporting the antenna which is insulated from the ground on specially built insulators.

THE republic of Argentine now has a high powered station for international communication. It was erected by the Transradio Company to connect the great South American republic with other nations engaged in commercial traffic the world over. The station which is erected at Monte Grande in a large field, was constructed by European and American radio companies which furnished the necessary apparatus for the erection of the station, antenna, receiving apparatus and other instruments. The transmitting station sends on long wave-lengths and is in constant communication with Nauen

in Germany, Sainte-Assise in France, Carnation in England and Rocky Point, Long Island, in the United States. The station is equipped with high frequency alternators capable of furnishing frequencies ranging from 11,000 to 44,000 cycles corresponding to wave-lengths of 6,400 to 27,500 meters. The output of these alternators when working together is 750 volts at 1,000 amperes.

The antenna is supported by 600-foot towers and is constructed in sections so that several messages may be sent at the same time by using the various alternators on the different sections of the aerial. This con-

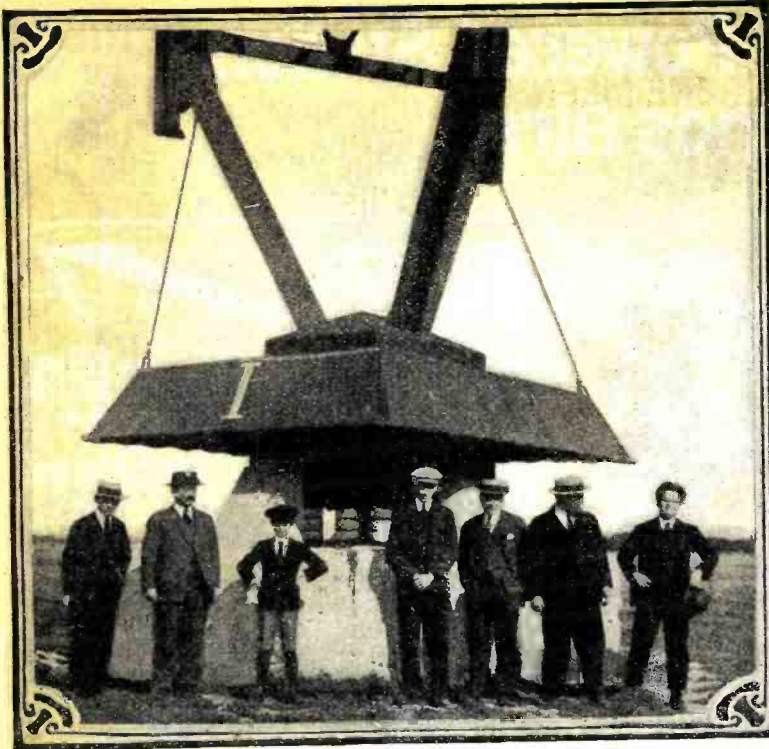

Above: The base of one of the towers supporting the aerial of the new station at Buenos Aires. These towers are supported by guy cables only as they are insulated from the ground and so designed that they do not absorb energy. Note the large insulators between the tower and the cement base, and the ingenious method in which the tower is pivoted. To the right is a photo of one of the monstrous aerial inductances supported on large porcelain insulators.

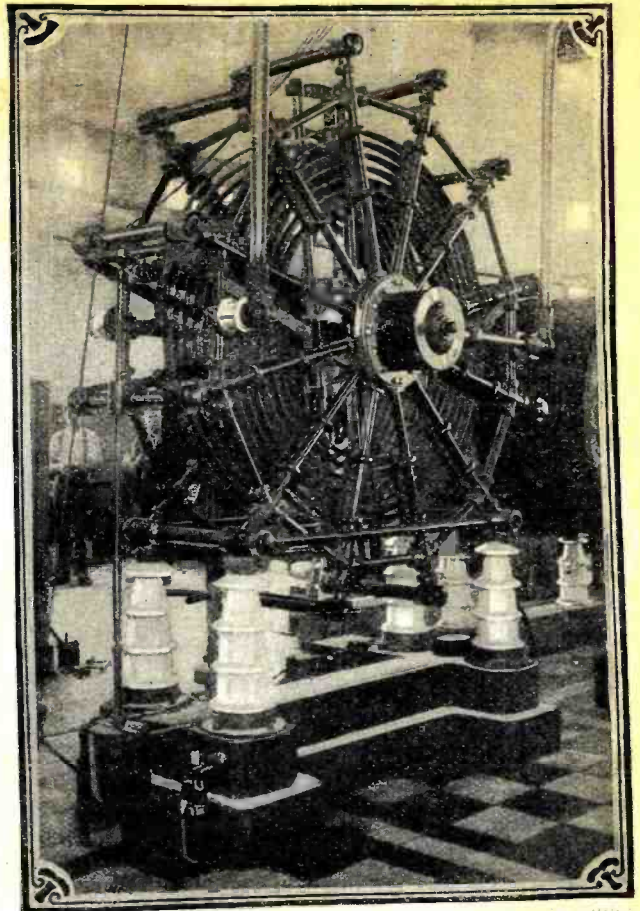

A Radio Auxiliary Language for Trans-Oceanic Work

By O. C. ROOS, B.S., M.E., Fellow I.R.E.

A FEW months ago, the language barriers of India caused the plans for a powerful official news broadcast station in Delhi to be abandoned. The innumerable dialects of the 300,000,000-odd inhabitants of that semi-continent would have required the tying up for 24 hours of the station in order to transmit 500 words to all the people who have not learned Hindustani. There would be 45 races, and 170 languages to cover!

This is a profoundly significant episode; for Hindustani is a semi-artificial, or at least, an officially prepared language given to the inhabitants by the Mogul conquerors in the 16th century. Hence, we have here an example of the failure of irregular common speeches, even though officially sanctioned, to reach natives below a certain mental calibre.

Now, this should drive home the lesson that radio fans who want to start writing DX cards to Europe or South America in the next two years should learn a simple international language if such can be found. Most radio fans have no knowledge of Latin or any modern tongue but their own. How can they be helped?

Since 1907 we have had just such an auxiliary language, named "Ilo" from "I.L."; International Language. It is absolutely dependable and already in extensive use.

There are refinements of the system enabling one to translate Bergson's "Notion of Time", and Einstein's "Relativity" exactly, or even difficult patent documents, but we do not translate poetic literature. "Ilo" is a "tool" not a "paint brush," and all that is necessary to use it in Radio work for DX postal cards is a logical mind, and 10 lessons. Two study hours a week for 6

months, and 26 lessons will suffice for letters and papers of a very advanced grade.

We have allowed "Ilo" to evolve from a primitive vocabulary of 3,000 roots, under a system of selection somewhat like that employed by Luther Burbank, who gets rid of "unfit forms" in his products.

One may say that with our 30,000-word Ilo-English dictionary of roots or ideas, we may have at hand the equivalent of a 150,000-word dictionary.

To show how simple is the grammar of the I.L., a short survey of its general features will now be given, taken from a five-cent pamphlet containing grammar, syntax, and 1,700 roots which can be expanded into more than 15,000 words. The meaning of *every one* is *self-evident* from strict rules of derivation which is not true of any natural language.

GENERAL REMARKS

In the "I.L." the terminations "o" "i" denote singular or plural nouns; that is,—things, acts, or ideas; adjectives have the termination "a" e.g.—"bona kato"—good cat; derived adverbs are shown by the termination "e",—"posible bona"—possibly good. Verbs end in "r" for the infinitive,—"parolar"—to speak, and "s" in the indicative,—"me parolas"—I speak. A verbal contract would, therefore, be—"parola kontrato." He agreed verbally—"Il konsentis parole."

Here we see that the user of the "I.L." must know exactly what he wants to say from a logical standpoint, just as the lawyer approaches an intended statement. He cannot afford to think in groups of phrases, or "catch words," or mere rhetorical ornaments. Hence, "Ilo" is as good a discipline as geometry and far better than dead lang-

uages as a preparation for modern tongues; as it is based on all of the latter, minus their absurdities of spelling, grammar, and syntax.

We shall abbreviate the phrase "Radio Auxiliary International Language," by the word RAIL, which is easily remembered. There is a new society for the teaching of the RAIL idea practically, by radio and DX work. It is called the "RAILS" and is rapidly growing.

Radio men have a wonderful future to prepare for, by the early adoption of a suitable language as a "RAIL."

There are certain classes of professional men such as doctors, and the clergy, whose education makes it a mere matter of reading, to master the language in a few weeks. It is easy to visualize the transmission of medical advice in emergencies by the RAIL with a doctor at the microphone.

For careful and subtle argument, the "RAIL" called Ilo is fully capable of extending the use of Radio to internationally broadcast debates on theological or philosophical questions. Bergson and other leaders in these fields of knowledge have been adequately handled.

The adoption of a good "RAIL" would bring into play the Customs, Emigration and Police systems of every large county for newly extended activities. The language barrier today greatly increases the expenses of running these Departments of the various governments.

The press service between widely separated continents will be greatly helped by the use of a language easily learned. Calcutta has heard Pittsburgh by re-broadcasts from England. Inside of a year or two the Antipodes will listen to British, French or American Radio stations. If this induces

(Continued on page 1674)

The Production and Use of Ultra Short Wave-Lengths

By Prof. RENÉ MESNY

Part I

In this article, especially written for RADIO NEWS, are described the results of numerous experiments with wave-lengths of two meters, carried out in the research laboratories of the French Army Signal Corps.

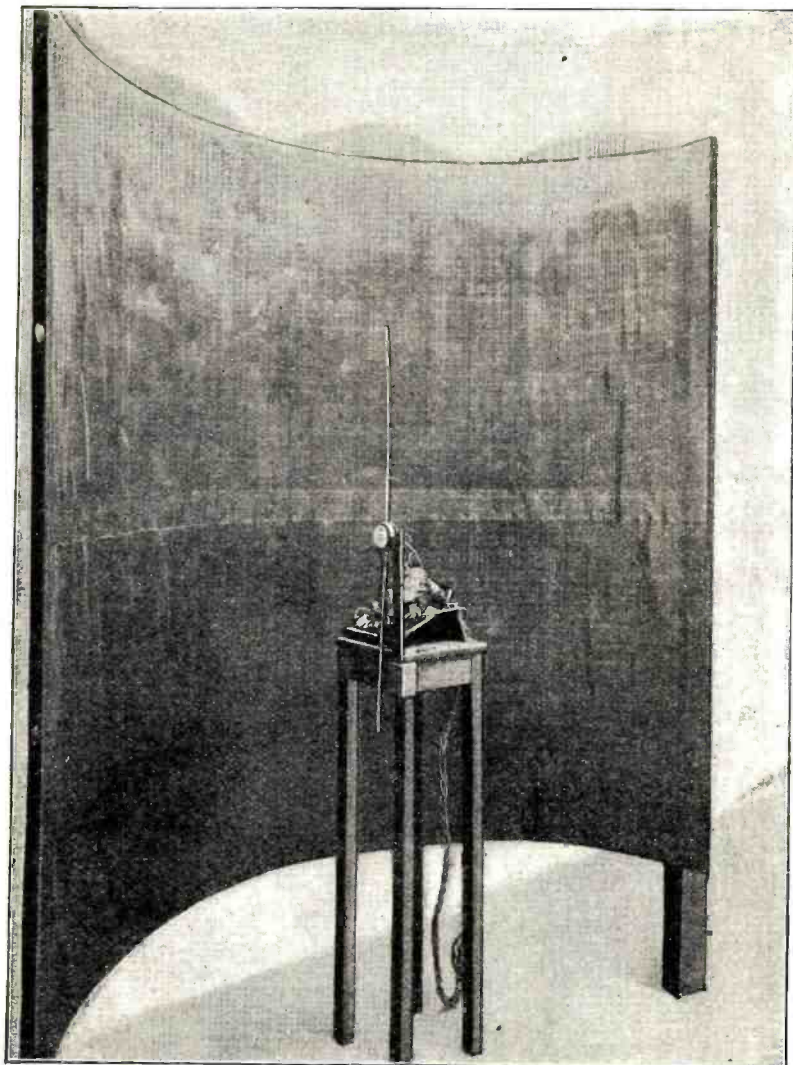

Fig. 6. The special transmitter radiating a two meter wave is seen here in the focus of a special screen which concentrates the energy into a single narrow beam.

that such short wave-lengths directed by means of reflectors would take the place of the ordinary light signaling which very often was not practical on account of fog or dust. Very often, also, the smoke from artillery prevented the operators at one station seeing the other station in spite of the fact that they were only a short distance apart. Unfor-

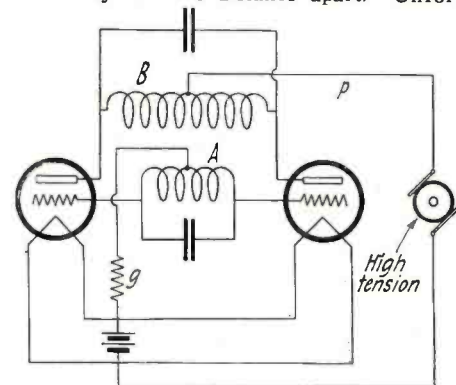

Fig. 1

The special balanced circuit used for ultra short wave-length transmission.

tunately the radio receiving systems employed at that time were still imperfect and prevented this interesting system from being developed further.

The experiments with directed short waves carried out by Franklin, in England, and the Bureau of Standards in the United States, have been described in various radio publications. It is the purpose of this article to describe the tests made in the radio research laboratories of the French Signal Corps, under the direction of General Ferrié, and which at present are quite successful.

THE CIRCUIT USED

It is a well-known fact that as the frequency increases, the tube transmitters become more and more difficult to handle and that it is necessary to take many precautions to obtain stable and powerful oscillations. The first problem to solve in order

THE increasing number of radio transmitting stations has made very difficult the transmission of messages without interference and there is, at the present time, a tendency to use the shorter waves below 300 meters for commercial purposes. The shorter wave-lengths ranging from 100 to 300 meters were proven very efficient by the amateurs who were compelled by regulations to work at these higher frequencies. The recent trans-Atlantic test and two-way communication carried out by American and French amateurs demonstrated conclusively the high efficiency of short wave-lengths. Their possibilities are now being investigated by commercial companies. We shall describe in the second part of this article the experiments carried out by Commander Chaulard and Captains Taulier and Staut on wave-lengths of 45 meters and the results obtained under various conditions.

During the war, in 1917, Prof. Gutton had already succeeded in producing, with ordinary vacuum tubes, oscillations of about one meter wave-length. At that time he thought of using this very short wave as a beam to be directed by means of parabolic screens. Such systems were recently described in

RADIO NEWS by F. W. Dunmore and F. H. Engel. It was expected, at that time,



Fig. 7. The two meter set was installed on top of a car to determine the effect of obstacles upon the propagation and also the range over which it was possible to work.

to produce very short wave-lengths, is the designing of special transmitting apparatus. After a great many experiments we decided on the balanced systems illustrated in Fig. 1. This system which had been used previously for receiving on a loop aerial has been found to be the most efficient. It was patented in October, 1921, and had already been pointed out by Eccles in 1919.

The construction of the transmitting set is as follows: Two inductances A and B, wound in opposite directions, are connected on one side to the grids and on the other side to the plates of the two tubes. The condenser mounted in parallel with each inductance permits tuning over a certain band of wave-lengths and may be removed entirely for the production of extremely short waves. The center of the windings are connected to the filament battery through the connections G and P. In the center grid lead is inserted a resistance of a few thousand ohms to reduce the grid filament current, and the high tension source is connected in the common plate lead. In this arrangement the electrodes of the two tubes are, therefore, at the same potential, but of opposite polarity and the oscillations are concentrated within the grid and plate inductances. No oscillating current passes in the common leads of the grids and plates which may thus be placed without any special precaution. It is the main advantage of this system over the ordinary circuit where only one tube is used, in which case it is necessary to use special choke coils to prevent oscillations from flowing into the supply leads.

PRODUCING 300,000 KILOCYCLE OSCILLATIONS

With the circuit described above, we pro-

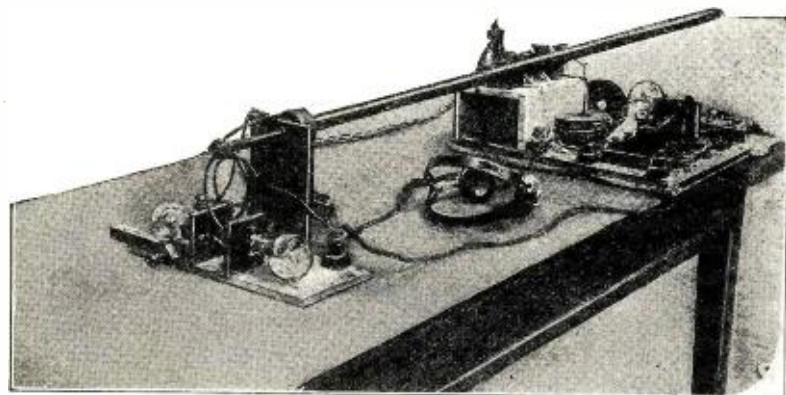

Fig. 5. The super regenerative receiver used to detect the short wave signals. The long rod is the antenna, the length of which may be varied.

duced, in 1921, some transmitting apparatus working on wave-lengths of 50 meters and we shall describe further the results obtained during this series of experiments.

Experiments on very short wave-lengths have been carried out by several engineers and the shortest waves produced were undoubtedly those of .6 meter, using the Lecher wire system and a special circuit in which the grid of the tube is supplied with high tension. This interesting test carried on by Kurz and Barkhausen was merely a demonstration, as it was not possible to transfer any appreciable amount of energy from the

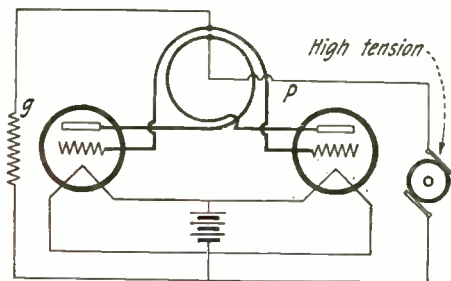

Fig. 2

This circuit is that of the transmitter shown in Fig. 4. No condensers are used and the inductances are composed of only one turn.

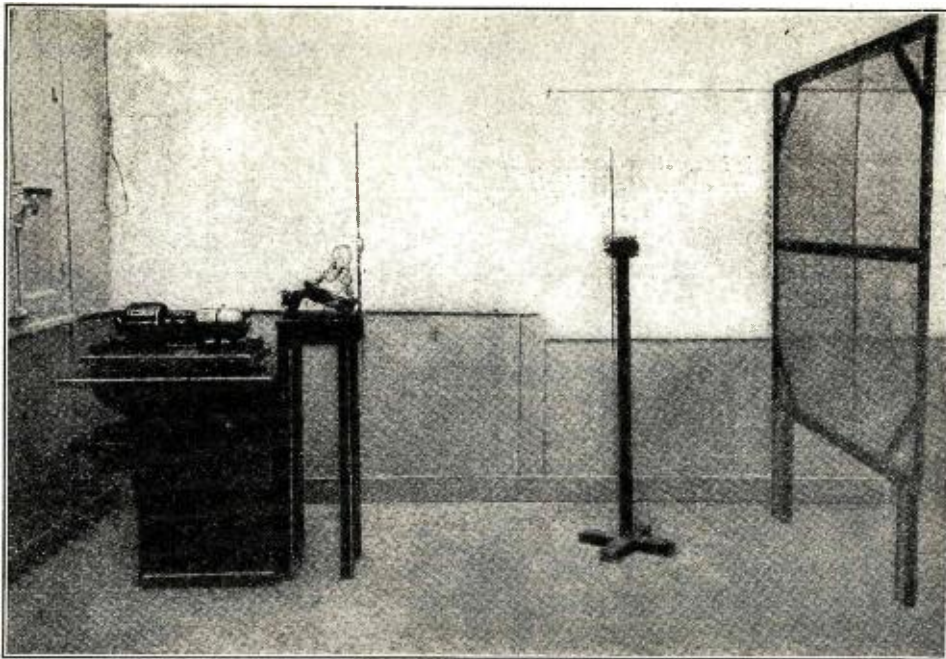

Fig. 8. With this short wave transmitter and receiver the phenomena of reflection and refraction may be demonstrated by moving the square screen at various distances from the set.

oscillating system into a radiating circuit. The most interesting results were obtained by Franklin who, with special reflectors, was able to communicate up to a distance of about 20 miles using wave-lengths of three to four miles concentrated in a beam.

With standard vacuum tubes of the French

above the ground supposed to be a perfect conductor is in ohms $r_w = 1600 (h/\lambda)^2$. Under these conditions the radiation resistance of an antenna for which h equals 170 meters and which radiates a wave of 17,000 meters is .16 ohms; if h equals 20 meters and λ 450 meters, the radiation resistance equals 3.1 ohms. For the very short wave-length, the above formula must be replaced by much more complicated ones. Since the antennae are of the same size as the wave-lengths radiated, it is necessary in the calculations to take care of the difference between the elementary fields coming from various points along the antenna. This reduces in a certain proportion, the radiation in directions inclined in respect to the horizon. On the other hand no modification of the field results in the horizontal direction. If, therefore, one wants to compare the horizontal

(Continued on page 1682)

type, we were able to produce stable oscillations in a circuit tuned to 2 meters, and it was possible to induce 180 milliamperes in an antenna vibrating at $\frac{1}{2}$ wave-length. It was even possible to lower the wave-length to 1.5 meters, but the operation was unstable and it was not possible to transfer energy into the antenna system. The circuit used was the one described above, but without the tuning condensers and with the coils composed of one turn, eight centimeters in diameter. The turn connecting the plates was connected so as to have the proper direction to produce oscillations in the circuit.

With special vacuum tubes having very low capacity between the grid and plate it was possible to make the circuit oscillate and transfer energy on a wave-length of 1.2 meters. It was possible with this system to radiate .6 ampere in the antenna inductively coupled with the oscillating circuit, corresponding to a radiated power of about 30 watts. It is one of the greatest advantages of very short wave-lengths to radiate much more than the longer wave for a given intensity in the antenna. This is shown by the formula which may be explained as follows: If h is the height of radiation of an antenna vibrating on a wave-length λ much greater than h , the radiation resistance

Fig. 4. Close up of the short wave oscillator. Note the special tubes with grid and plate leads passing through the glass, and the oscillating circuit. The radiation meter supports the aerial and counterpoise rods.

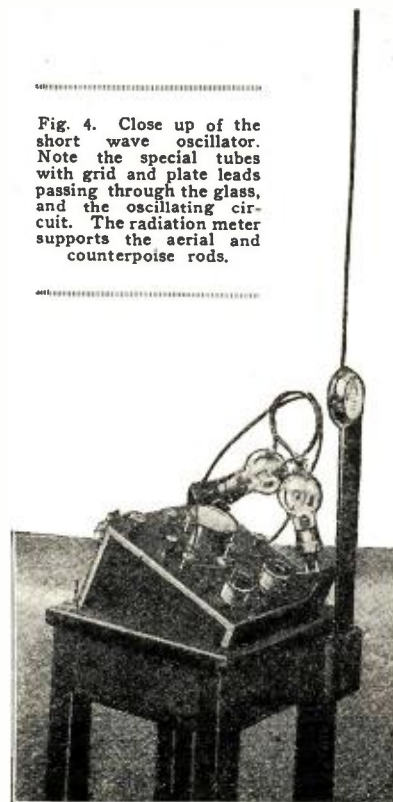

Some Recent Radio Developments

By S. R. WINTERS



This interesting review of the recent developments made by the Radio Division of the Navy Department covers numerous subjects that, in the future, will no doubt be valuable acquisitions in the radio broadcast field.

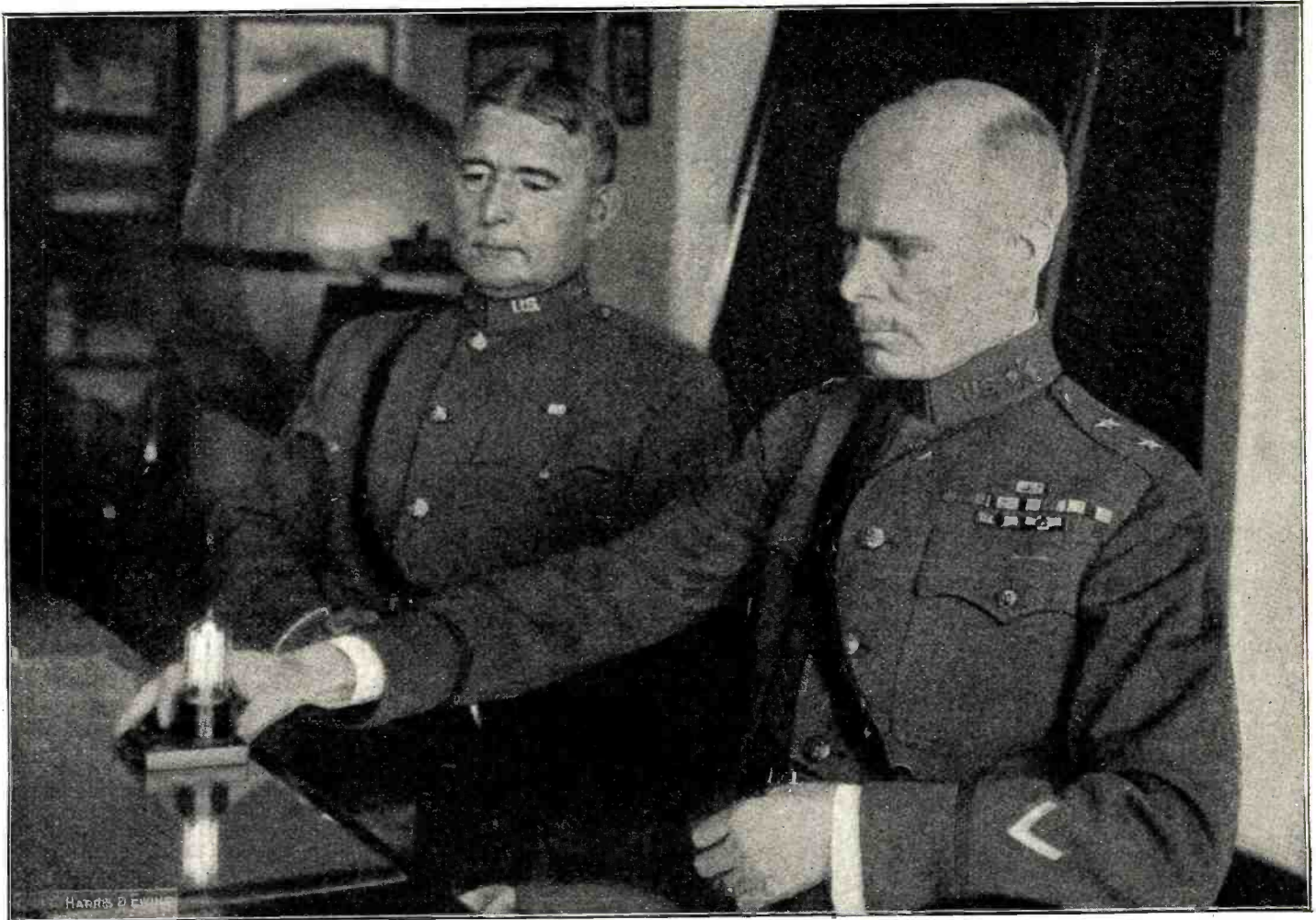

Major General George O. Squier, right, who retired January 1, after 40 years' service, seated with Col. Charles McK. Saltzman, left, who succeeds him, assuming the title of Chief Signal Officer with the rank of Major. Radio attained its present high standards in the army under the direction of General Squier.

THE development of a differential recorder—apparatus for automatically copying radio telegraph signals—is the latest instrument perfected by the Radio Division of the Bureau of Engineering, United States Navy Department. This device was designed by Lieutenant Commander A. Hoyt Taylor and Alfred Crossley. Recent tests with the apparatus in the Naval station at San Diego, California, have demonstrated its possibilities in automatically copying the dots and dashes of telegraph code.

Although the details of this mechanism are withheld from publication for the present, experimental tests have indicated that it is capable of copying approximately 100 words a minute. The notable advantage gained by its use, however, is its ability to copy messages when interference or static is three times as strong as the signal strength of the dots and dashes. This has been the chief difficulty with most instruments for dispensing with the human element in copying radio telegraph signals. A first-class radio telegraph operator can copy messages when static interference is three and one-half or four times as strong as the message signals.

According to claims, this automatic recorder overcomes this inherent weakness. If

we are to accept the conclusions of preliminary tests of the naval radio station at San Diego, California, this mechanical device almost equals human reception in overcoming the presence of atmospheric disturbances. One of these instruments has been placed in practical service on the *Seattle*, and eventually one will be installed at Balboa. Its possibilities for commercial service are being investigated. The research problem with reference to this new apparatus has already been completed.

NEW DUPLEX SYSTEM

The model TL radio transmitter is another apparatus recently perfected by the Bellevue Experiment and Research Laboratory of the Navy Department. This equipment is peculiarly fitted for installation on ships, it having already been put into service on the *Wyoming*. By means of this type of transmitting apparatus, duplex communications may be conducted on seafaring vessels readily. With this transmitter in operation in one room, supplying 36 amperes to the main antenna on a wave-length of 507 meters, radio reception was negotiated in another room on the same ship simultaneously. The receiving apparatus consisted of three stages of radio frequency, a detector and two stages of audio frequency amplifi-

cation. Still another creditable performance of the model TL apparatus was reception of radio signals on one vessel situated a distance of 1,000 yards from a second vessel equipped with the same apparatus operating at full power on a wave-length varying only five per cent. from the wave-length used for reception.

A vacuum-tube transmitter for aircraft and tactical communication has been installed on the *Wyoming*. Tests will be made with this apparatus to determine the wisdom of using it to displace the present tube transmitters which were originally designed for spotting aircraft. This new transmitting device is capable of communicating within a radius of 60 miles between airplanes and 150 miles between ships. This equipment was designed and manufactured at the Washington Navy Yard.

CONSTANT WAVE TRANSMISSION

The activities in the development of a constant-wave transmitter for aircraft have been completed. Tests under flight conditions have indicated that the electro-magnetic waves emitted from this transmitting apparatus are constant, despite the variation of the length of the antenna to approximately one-sixth. Or, differently expressed, the bank-

ing or other movement of the craft which changes the relative position of the antenna has no appreciable effect on this newly designed transmitter. Heretofore, it has been almost impossible to receive signals from aircraft with continuous wave transmitters while the airplane was being subjected to bumpy weather or other conditions which varied the capacity of the antenna. The new transmitter will correct this condition, and, according to claims, will meet the requirements for an instrument especially adapted to the spotting of aircraft.

The Navy Yard at Philadelphia recently completed design details of a portable compass coil. It was developed as a versatile instrument for use on any type of vessel. Its adaptability is said to qualify it as a valuable military asset. A related radio compass experiment is the recent installation of a special long-wave radio compass at Cape Henlopen, Delaware. This instrument was designed for the purpose of conducting experiments relative to the dependability of long-wave, long-distance radio stations, and the application of the radio compass for the guidance of trans-Oceanic and trans-Continental flights.

CIRCUIT FOR ELIMINATING HARMONICS

A new 100-kilowatt arc transmitter with a current transformer has been installed at the



A multiplex receiving system that can pick up signals from five different stations at the same time on a single aerial.

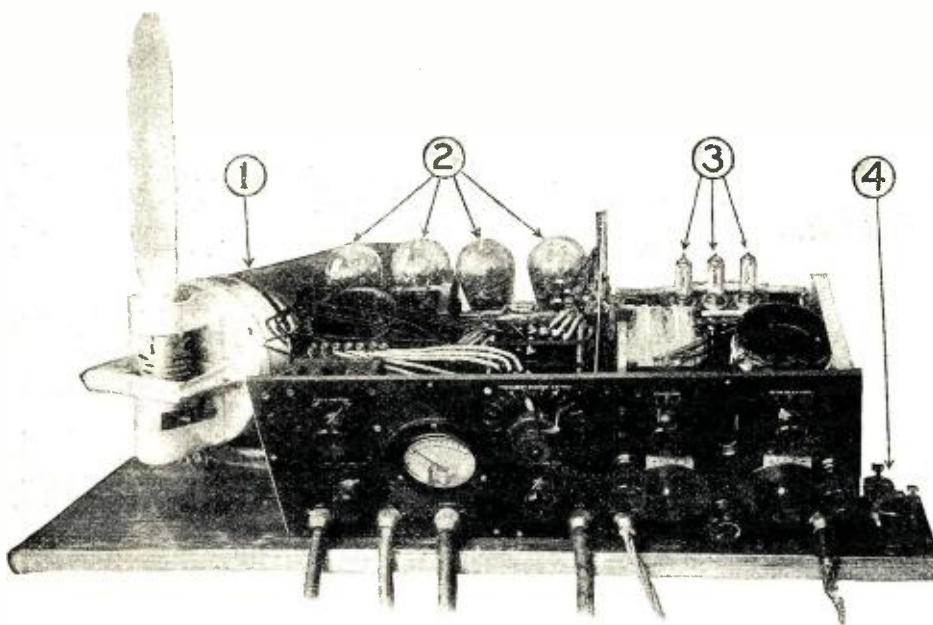

A new type of Navy transmitter and receiver that when enclosed in its cabinet is entirely water-proof. No. 1 is the wind operated electric generator, 2 the transmitting vacuum tubes, 3 the receiving vacuum tubes and 4 the telegraph key.

Mare Island high-power radio station. The results of preliminary tests tend to show that the use of this apparatus will effect a substantial decrease in the power input. Of equal importance is the fact that it will, to a great extent, eliminate interference due to compensating waves, harmonics and mush. A similar circuit has been installed on the 200-kilowatt arc transmitter at San Diego. Also an inductively coupled arc circuit, similar to the current transformer circuit, is being installed at the 200-kilowatt Sayville, L. I., station. A similar circuit is also being installed at the 500-kilowatt Annapolis station. These installations are designed to suppress mush, harmonics and like interference which, for a long time, have been trouble-makers for radio amateurs.

Experiments conducted at the Naval Air Station, Anacostia, D. C., have shown the feasibility of using five radio receiving sets on one antenna system, each receiving unit copying messages on different wave-lengths, with no confusion resulting from this alliance. This demonstration, although details are not available, offers a suggestion to radio novices and amateurs who are confronted with the problem of antenna construction in apartment houses and other quarters where many people live under one roof.

Radio in Ceylon

By H. DON CLEMENT

THE officer in charge of the radio station Colombo (Mr. M. J. Goleghtly, A.M.I.R.E.), who was experimenting with a two-tube radio receiving set of special design which was made in Ceylon, has recorded messages from the American stations Marion (WSO), and Long Island (WQL), a distance of approximately 9,000 miles, without the use of any relay system. He recorded the funeral arrangements of the late President Harding six days before Reuter's cables were published in the Ceylon press. With the new instrument, time and other signals of the French stations, St. Assise (UFT), Lyons (YN), and Bordeaux (LY), and the German station Nauen (POZ), and other European stations could be heard very clearly at all times, even when the telephones were placed well away from the listener.

This certainly is wonderful in view of the failure, so far, of the big seven-tube Government wireless installation at Colombo to

receive any of the above named signals or even signals of a much closer range.

This new development has put a stop to the preparations made by the Ceylon Government to install at the Colombo Radio Station an up-to-date sensitive receiving plant, with a view to establishing connections with the station at Oxford, either direct or through the medium of the high power station at Cairo, and with the aid of a few minor high power stations on the east coast of the island, to do away with much, if not all of the screening troubles met with in communicating with ships plying on the Australian run.

The new development will make possible the establishment, at small cost, in a very short time, of a net-work of receiving stations in the Empire.

If under the old conditions the charges for radio messages could be lower than the cable rates, under the new conditions they

should be lower still. In view of the increased efficiency and the reduced cost of receiving apparatus, radio is bound to be supported strongly by the press and the trade.

With Mr. Goleghtly's new improvement, it may not be impossible to listen to a London concert from Ceylon. Even if there is a fair chance of success in this direction, people of India and Ceylon, not to speak of those in other parts of the world, will not be slow to make full use of the advantage.

Clearly there is an excellent time before the broadcasting centers of Europe and America.

FUTURE PLAN OF WORK

Further experiments are now being carried out by Mr. Goleghtly, this time with Mr. Harper, M.I.R.E., chief engineer of the Ceylon Postal Department, to improve further the apparatus, to patent it and to
(Continued on page 1628)

Radio Television

The Mihaly Telehor Machine By Nicholas Langer

In this exclusive article Mr. Langer describes an interesting television machine designed and built by Mr. Mihaly, an Austrian scientist, who obtained some remarkable results with it.

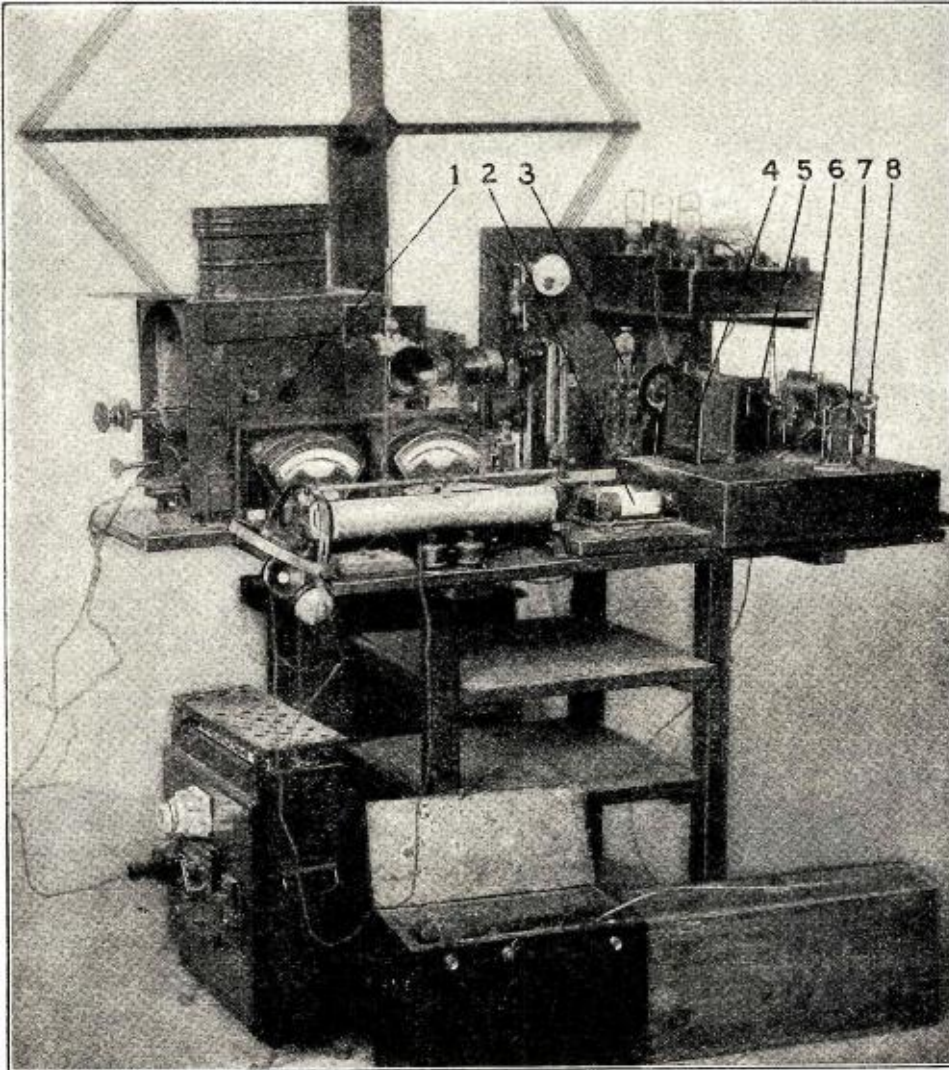

Fig. 6. The Mihaly Telehor machine. 1 is the arc lamp, 2 the light relay oscillograph, 3 the tuning fork, 4 the screen, 5 the diaphragm, 6 the oscillograph, 7 electro-magnet of phone drum, and 8 the brush.

is based. Through a number of present systems of telephotography, actual photographs may be transmitted either by wire or radio and the reproduction of photographs at receiving stations will be very similar to the original. One of the best of the present telephotography systems was devised by Korn, another which has achieved comparatively large practical use is that conceived by Belin. The chief difficulty with both of these systems is the extreme length of time which is required for transmission and reception. If the time element is disregarded, we may easily imagine the transmission and reception of animated pictures consisting of a series of photographs, each of which is a "still" photograph of the object being depicted. If this series of still photographs reconstructed at the receiving station is displayed in the same order as that in which they were taken, and are exposed to view with proper speed of succession, animated pictures will result. The time required for transmission in the present systems makes this impossible, since 20 minutes is needed for transmission and reception of a single photograph measuring 6x9 centimeters. It is obvious, of course, that if the time element is disregarded, or if science arrives at some method of increasing the speed of transmission and reception, television is not a far distant fact.

SOME EXPERIMENTS

About five years ago I conducted many experiments along these lines. Later, through interest and knowledge of these experiments, I became acquainted with the Hungarian engineer, Dionys Mihaly, who was at that time making very rapid progress in experiments along practically the same lines as those in which I was engaged. I accepted his kind offer to become his assistant and it is through this relation that I am able to make public this article which is the first detailed account of his experiments to be published in America. I am sure the American public will be greatly interested in the following description of Mihaly's apparatus.

It may be advisable to review some of the general considerations of television before plunging into a description of the apparatus and its method of operation. Disregarding

ONE of the oldest dreams of mankind is to extend his vision over great distances and in spite of obstructions. The telescope was the first step through which man increased his range of vision, but even with this instrument the path between the telescope and the object observed must be clear of obstructions. The word television, in its use throughout this article, means the ability to see an object with the help of special apparatus without regard to intervening obstacles between the observer and the object observed. Television does for the eye what the telephone does for the ear. It does not need to rely upon a unilateral path of vision.

Numerous physicists and engineers have attempted to solve this elusive problem, but for the most part their work has remained principally speculative. Scarcely any of the projects of Senlecq, Carey, Pavia, Sczapanik and Nipkow ever existed, even experimentally, because they were quite impracticable and at best succeeded only in transmitting photographs of comparatively poor quality.

In order to understand thoroughly the questions involved in the construction and

operation of television apparatus, it will be necessary to consider briefly some of the chief principles upon which such apparatus

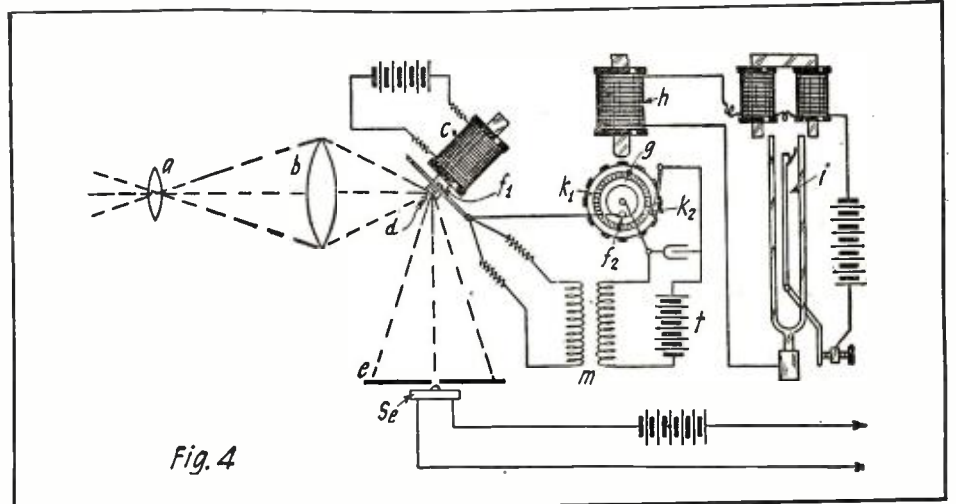

Fig. 4

The transmitting apparatus of the telehor. The object to be seen at the receiver is placed in front of the lens.

coloring, a photograph of any object, whether stationary or in motion, can be considered as consisting of many small areas of different shading. For the sake of simplicity we shall call these minute areas "picture elements." This system of reproduction of photographs has long been in use in the halftone method of printing, in which each of the small areas is reproduced in the printing plate as a larger or smaller dot, depending upon the shading of the area it represents in the original picture. If the element is made sufficiently small, each one will have a uniform shading over its entire surface. This fact is of cardinal importance.

By dividing the picture being reproduced into these small elements, it is a comparatively easy matter to transform the degree of shading of each area into an electric current. This transformation is effected usually, through the agency of a photoelectric cell. There are a number of such agencies, one of the most important of which is the selenium cell.

Selenium cells are based on the fact first observed by the English cable engineer, Smith, that the electrical resistance of selenium was reduced when light fell upon it. It was found that the resistance of the substance decreased as the light increased, within certain limits.

PRESENT CELLS

Present selenium cells are constructed with large cross section and small length which results in decreasing the very high specific resistance of the substance itself. One of the principal types in use at present consists of two thin parallel wires wound about a porcelain plate so that the distance separating the two wires is about .5 millimeter. A coating of amorphous selenium is then placed over the wires. A heat treatment to which the cell is then subjected carries the selenium into its gray-crystalline form which has been found to be most sensitive to light variations. An average cell made in this fashion has an electrical resistance varying between 60,000 and 100,000 ohms. By illuminating this cell with a 16-candle power incandescent lamp placed at a distance of one meter, its resistance drops to approximately 30,000 or 40,000 ohms, which is about half of the "dark resistance."

One of the chief difficulties encountered in all present day selenium cells is the low current which they pass, due to their high resistance. This current is usually on the order of one microampere. A more important defect than this is the lag in the restoration of the "dark resistance" after

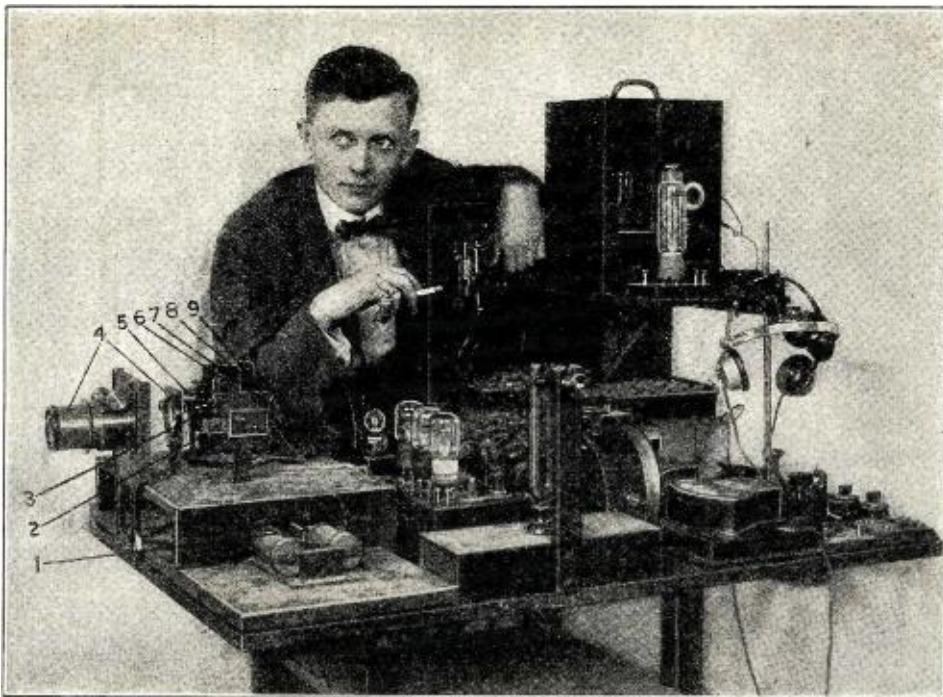

Fig. 7. Another view of the telehor machine with its inventor, Mr. Dionys Mihaly. The numbers refer to 1 tuning fork interrupter, 2 selenium cell, 3 mirror of oscillograph, 4 lenses, 5 phonic drum, 6 armature, 7 electromagnet of phonic drum, 8 diaphragm, 9 oscillograph.

the removal of the illumination from the cell. Several different methods have been worked out as a means of compensation for this lag.

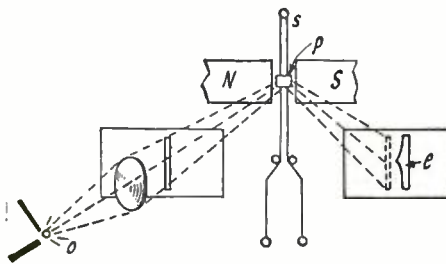

Fig. 1

The oscillograph arrangement which converts the variable current into picture elements at the receiving apparatus.

The first step in television is always the division of the pictures to be transmitted into the small picture elements. Each element is of the same size, but may vary as to bright-

ness. Each of these is then projected upon a light-sensitive cell which transforms the degree of brightness of the element into a correspondingly weak or strong electric current. This current is transmitted either by wire or radio to the receiving station. Here a method is arranged through which the strength of each individual current produces a light in direct proportion to the current strength. Through this method, each of the small elements is reconstructed at the receiving end so that when they are collected in their proper relation, a picture is formed which is very similar to the original.

THE PROBLEMS

The problems of television may be briefly stated as follows:

In dividing the picture to be transmitted into the small elements.

Converting the variations of brightness between the elements into an electric current of proportional amplitude.

Transmitting these differences in amplitude by wire or radio.

Rearranging the fluctuations representing the picture elements, with their corresponding degrees of brightness.

Projecting the elements on a screen in the same order as that in which they originated.

Each of these is a very difficult problem within itself. The most serious one of the lot, however, is probably that of converting the extremely small differences of brightness into an exactly proportional current. This, as has been said, is done through the aid of a selenium cell. Until recent years, the very small current fluctuations caused in such a cell by the variation of light falling upon it, have been so small as to be hardly measurable. By means of electronic valve amplifiers, however, we are today in a position to magnify these minute currents to an extent which makes television possible.

THE TELEHOR

The chief feature of the Telehor, Mr. Mihaly's television apparatus, is the system of very small oscillating mirrors, of an area of one millimeter or less, which convert the fluctuating currents into picture elements of correspondingly illuminated spots on the screen.

The small mirror P in Fig. 1, is fixed to a loop of extremely fine platinum wire S. This wire support is approximately .01 millimeter in diameter and is stretched between
(Continued on page 1686)

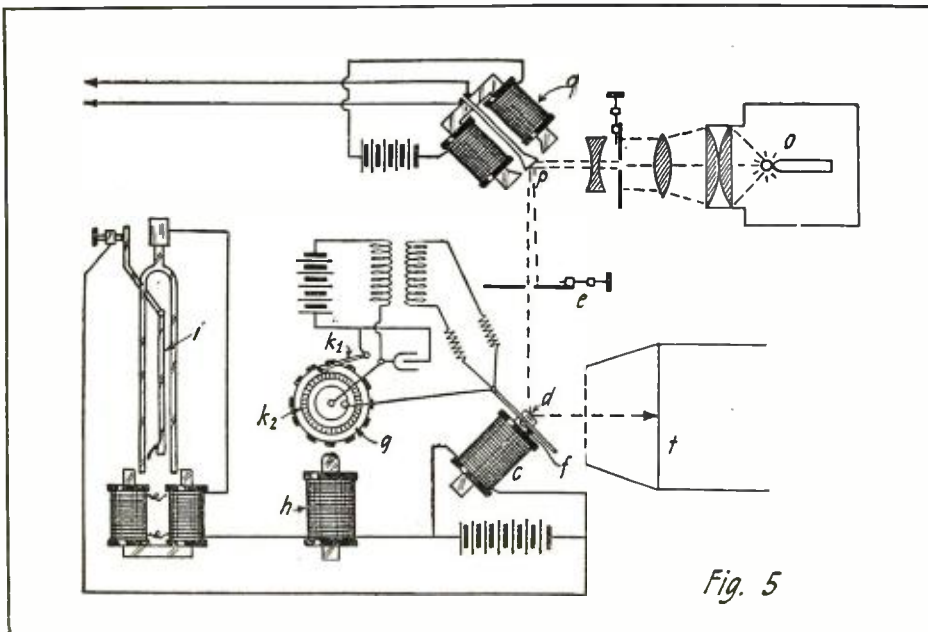

Fig. 5

Diagram of the receiving apparatus through which the current from the transmitter is transformed into a picture which may be seen on the screen.

A New Portable Radio Compass

By S. R. WINTERS

An interesting description of a compact portable Radio compass for Army and Navy use. It will prove particularly useful in emergency cases.

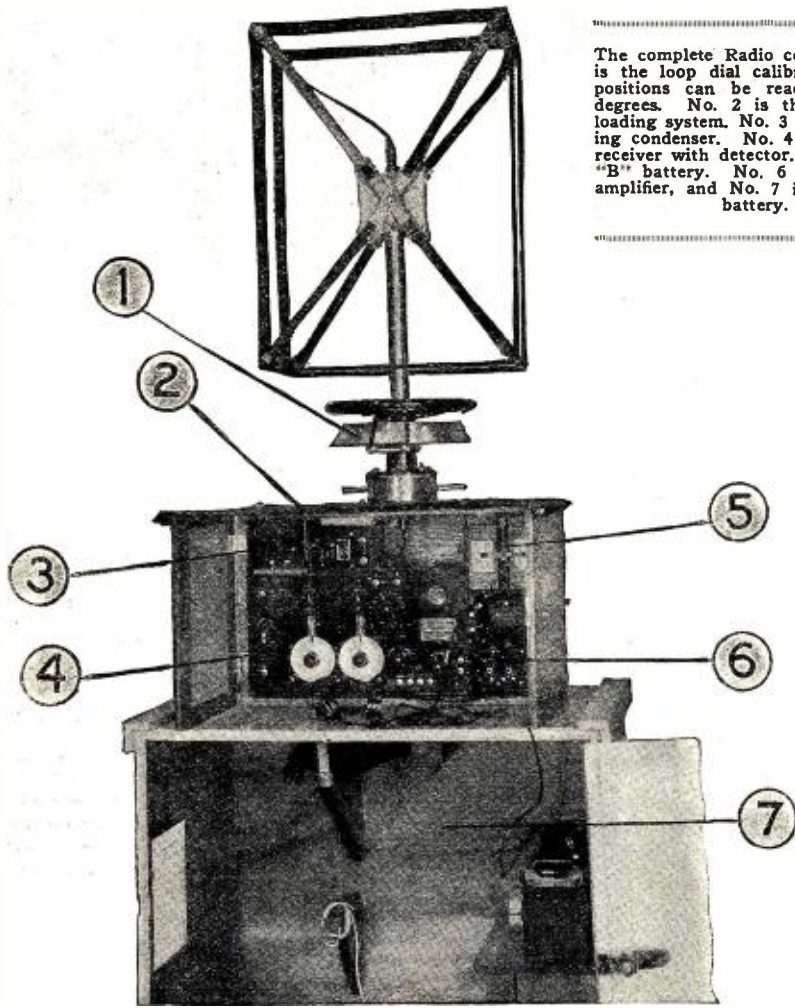

The complete Radio compass No. 1 is the loop dial calibrated so that positions can be read directly in degrees. No. 2 is the long wave loading system. No. 3 is the balancing condenser. No. 4 is the R. F. receiver with detector. No. 5 is the "B" battery. No. 6 is the A. F. amplifier, and No. 7 is the storage battery.

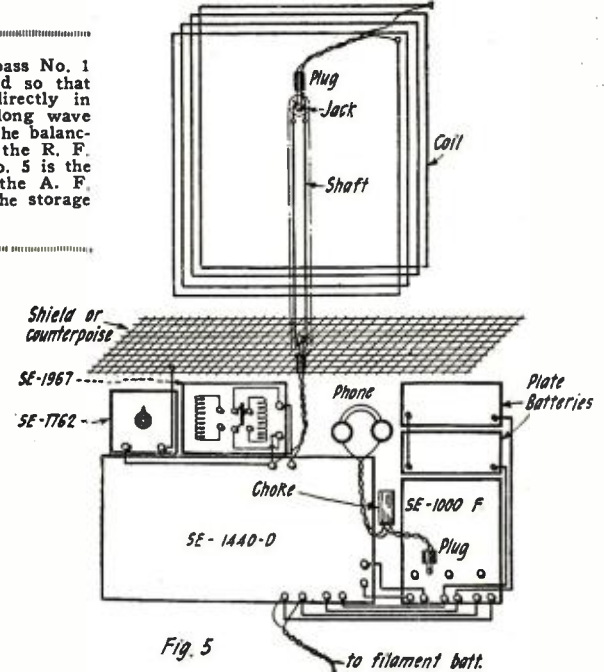

General layout of apparatus showing arrangement of instruments. The shield, which acts as a counterpoise, is in the cover of the cabinet.

desired objective in the design of any portable outfit. This is particularly true in the case of the radio compass coil system being described, where a number of units are to be contained in one cabinet. Therefore, in the design of this direction-finding system a "limited rotation" mechanism was resorted to instead of the usual slip-ring arrangement. That is to say, this compass coil is not continuously rotatable, the limiting factor taking the form of stops contained within the base mounting which confines the total rotation of the coil approximately 430 degrees.

There is a stud on the coil shaft which engages a similar stud upon a plate at each end of a complete revolution. The latter, in turn, has a quarter circle groove cut in it, which moves about a third stud held rigid to the base. The coil shaft at the limit of its normal rotation, engages the steel plate.

A RADIO compass coil that is at once portable and rugged has been designed and built by the Radio Division of the Bureau of Engineering, United States Navy Department. The coil and tripod are collapsible, and together with the radio receiving instruments are self-contained in a wooden box or cabinet which can withstand severe treatment. Moreover, once this radio direction-finding system is snugly enclosed in the casing, it is not exposed to the weather or other conditions that might impair its term of usefulness.

The marked advantage of this radio compass coil over previous designs of direction-finding systems is its ready adaptability to service. That is to say, this collapsible equipment may be taken on ship or shore and within a period of five minutes set up, ready for operation. With equal facility, the various instruments may be disassembled and transported to any point where demands dictate. The complete outfit, including compass coil, coil shaft, radio receiving cabinet and instruments, and the weather-proof container, weighs only 315 pounds. The "A" battery is the only necessary unit not provided with accommodations in the cabinet.

The weather-proof packing-case was accepted as the form of construction best serving the interests of sturdiness, portability and simplicity.

COIL DESIGN

The coil winding is secured in a conventional frame, aligned on the shaft by a guiding screw. By means of plugs, 180-degree orientation in the setting of the coil

on the shaft is prohibited. The coil system is fastened to the shaft by use of a set screw, and the coil winding is plugged into the top of the shaft by means of a weather-proof plug. The leads extend through the shaft from the jack in the top to the jack in the bottom, and a plug in the bottom is the connecting link between the coil system and the receiving instruments.

A reduction of weight to a minimum is a

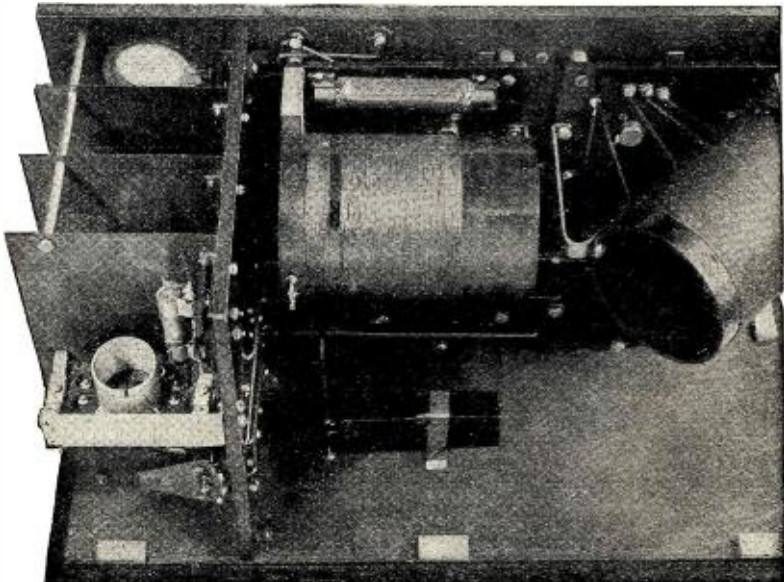

The interior of the receiver. Note the shielding between radio frequency stages at the left.

This action permits of an additional rotation of 90 degrees, minus the thickness of the several studs. A like manner of operation is in effect when the rotation is reversed. Thus, the total rotation of this coil is 430 degrees.

REDUCES WEIGHT

When assembled, the coil shaft is secured to the plate on top of the cabinet by inserting bolts into holes in the base. A pin is provided to lock this base to the securing plate. This arrangement allows the shaft to be placed on the cabinet in only one way. Thus, once the coils and shaft are in place, the operator may be certain that the alignment is correct. The device for limiting the rotation of the coil subtracts from the weight of the complete equipment by eliminating the common slip-ring arrangement. Accommodations are afforded in the cabinet for a type SE-1440-D receiver, SE-1000-F amplifier, SE-1762 compensating condenser, SE-1967 shunt inductance box and accessories. Space is reserved for the storing of eight vacuum tubes, head telephones, and leads for the batteries. These various instruments and units are safeguarded from rough treatment by means of one-inch hair felt as packing. This cabinet slides into grooves provided on the top side of the packing case.

The inside fittings employed in securing the compass coil, shaft and radio receiving cabinet, when they are collapsed for shipment, are graphically shown in the photo-

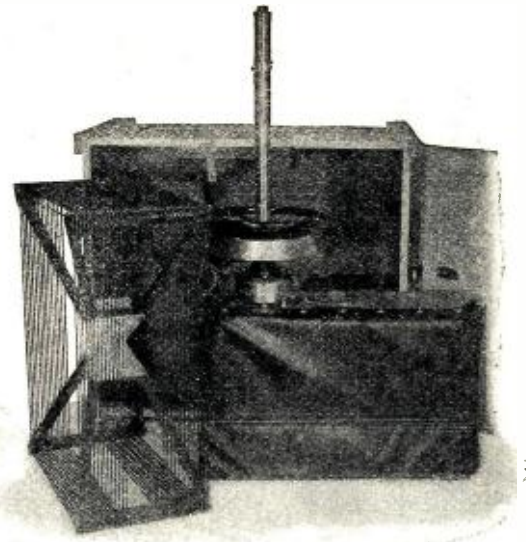
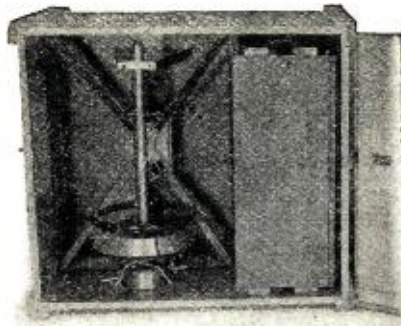

At the left the receiver and loop are packed away in the box which ordinarily acts as a table for the set. At the right is the set in the process of packing.

graph Fig. 3. A collapsible shelf for holding the "A" battery is provided.

This portable radio compass is a decided military asset. As an instrument on shipboard, it lends itself to service on any type of vessel. On shore, this radio compass coil is adapted to the needs of the U. S. Marine

Corps for maneuvers, and in actual military operations will prove an invaluable instrument in the maintenance of advance bases.

Radio direction-finding systems are finding increasing applications in time of peace. Such equipment was employed in studying the wave phenomena on the hangar at Lakehurst, the home of the *Shenandoah*. Direction finders have been applied in original investigations of the United States Navy Department. A major portion of the original data relative to electromagnetic-wave variations and deviations caused by different media over which they travel is afforded by this portable direction finder. It is an invaluable instrument in studying the distortion of electric-wave fronts as well as determining the source or station from which these waves emanate. Also, the phenomenon of atmospheric disturbances or "static" may be better analyzed and ways and means for combating this bane to radio communication more intelligently advanced.

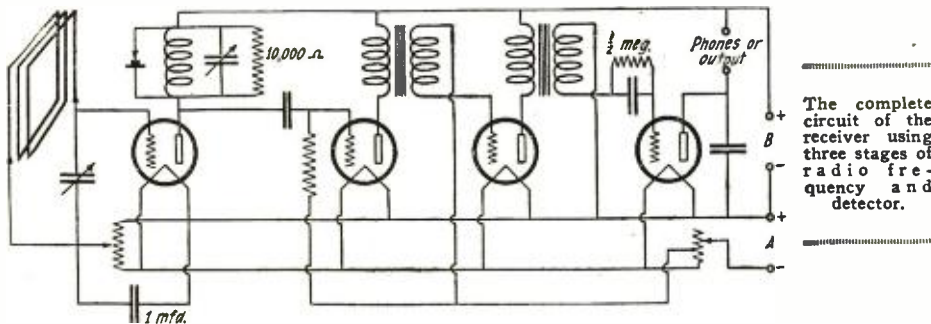

The Vacuum Tube Patent Situation

By JOHN B. BRADY*

WITH the expiration of the De Forest patent 841,387 on January 15 of this year, radio manufacturers have, in general, taken a new lease on life with expectations that at last an end of the control heretofore enforced by the present owner of the patent had come. It is quite natural that radio manufacturers should look for some loophole to develop new trade channels with reference to the very heart of radio, the electron tube.

Perhaps in anticipation of manufacturers flooding the market with electron tubes of

poor quality, the Radio Corporation of America caused to be published in various periodicals shortly before January 15 an advertisement reading as follows:

The expiration, on January 15, 1924, of vacuum tube patent No. 841,387, will not permit the general manufacture, sale, importation or use of three element vacuum tubes as generally constructed, in which the grid or its equivalent is interposed or located between the filament and the plate.

This type of vacuum tube is still covered by U. S. Letters Patent No. 879,532, under which Radiotrons are manufactured and sold to the public.

This latter patent has been sustained by the Courts, and unlicensed radio tubes have been held by the Courts to be infringements of this patent.

The De Forest patent 841,387, which expired on January 15, the drawings of which are shown in Fig. 1, covers the three electrode electron tube used as an amplifier. This was one of the patents litigated in the suit of Marconi Wireless Telegraph Company of America v. De Forest Radio Telephone and Telegraph Company. The art will remember that this suit was initiated by the Marconi Company against the De Forest

(Continued on page 1678)

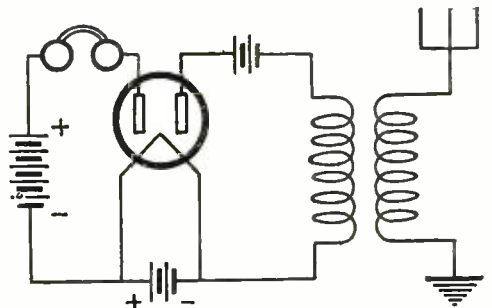
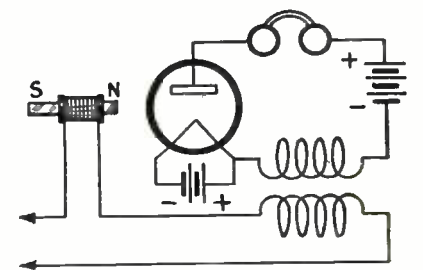

Two other circuits under Patent 841,387.

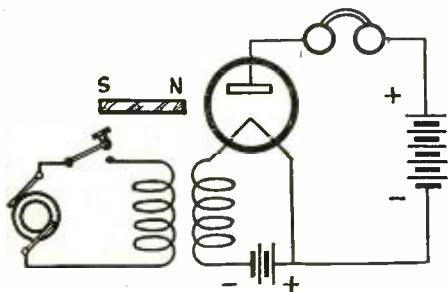

Fig. 1. De Forest Patent 841,387, which expired on January 15, 1924.

* Patent Attorney, Washington, D. C.

Broadcasting in Australia

By OLIVER W. TUTTLE

A brilliant account of the introduction of radio broadcasting in Australia which covers the established legal procedure for the erection of a station and a description of Australia's principal broadcast station.

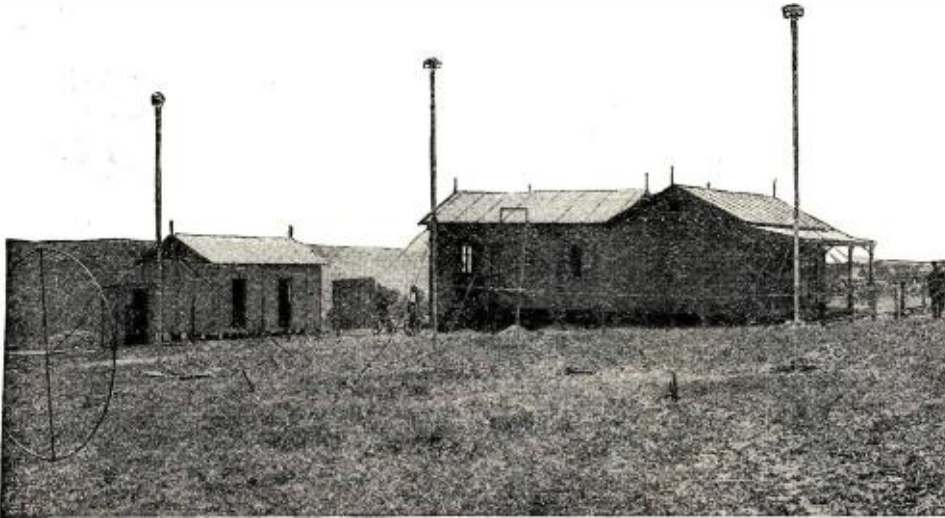

The building which houses the transmitting apparatus of Farmer & Company's broadcast station. The station is situated at Northbridge in the municipality of Willoughby, about seven miles from Sydney, and is connected with the Company's Retail Store in Pitt Street, Sydney, by trunk line. The official call is 2FC.

RADIO broadcasting has now been introduced into Australia. A scheme which is unique and which has been drafted after the experience of other countries has been evolved. In considering the broadcasting problem in Australia, difficulties which were unknown in other parts of the world presented themselves. The immense area of the Commonwealth, with its almost minute and very greatly scattered population, rendered it impossible for any of the systems which have been adopted in America or England to be employed.

It was realized, of course, that the establishment of broadcasting should be on such a basis as to render it permanent, and with this end in view a conference of those interested was summoned by the Postmaster-General, Mr. Gibson, who is the Minister responsible for the administration of the Wireless Telegraph Act of the Commonwealth. This conference discussed the matter and eventually evolved a scheme which, at a later date, was approved by the government and was made the subject of special regulations.

Under this scheme those wishing to erect stations and broadcast, after being approved of by the government and also after providing a bond of £1,000, a guarantee of continuity of service for five years, are allotted a certain wave-length upon which to transmit. Receivers designed to respond to the wave-length of the service and sealed so as to respond only to that wave-length are then available for purchase by those wishing to avail themselves of broadcasting. This system is an entirely new one and the exact manner in which it functions is being watched with keen interest by experts. The providing of a service under it becomes very similar to the providing of an ordinary telephone service, except that in the case of broadcasting, a set is purchased and not hired, and also that it is a receiver only. At first sight, the scheme may appear strange and complicated, but the exact manner in which it will operate becomes quite clear. If the case of, say, one broadcasting company is considered.

If a company is desirous of establishing a broadcasting service, a wave-length is allotted to it, after it has been granted the necessary approval and license. The com-

pany then erects its station and transmits programs of speech and music, according to its own arrangements. The person desirous of receiving then purchases a set designed by experts and tuned so as to receive telephony on the wave-length of the service for which it is sold. It is set to that wave-length and is not alterable except by deliberate tampering. The testing is done by the government and the seal is a government seal applied by the manufacturer under government permit.

A FEE FOR RECEIVING

The government fee for a broadcasting (receiving) license is 10 shillings per annum. The broadcast stations control the issue of these licenses and also charge yearly whatever subscription fee they may think fit. The license can only be issued after the broadcast company's subscription has been paid.

Arrangements have been completed whereby radio dealers become agents of the broadcasting companies for the issue of licenses and the collection of the subscription fees for the broadcasting service. No person can purchase a radio set unless a license has first been obtained.

Most people have now thoroughly realized that, if broadcasting is to be maintained in a regular and high-class manner, it must be established on some basis which provides a certain measure of profit for those respon-

sible for its maintenance. It was with this end in view that the Australian regulations were adopted.

There are, of course, many details in connection with the Australian scheme which make it elastic. For instance, a genuine experimenter, after being tested by the government authorities, is allowed perfect freedom on all wave-lengths after payment of license fees only. Similarly, the person who decides to receive more than one broadcasting service may have his receiver altered and resealed so as to respond to a number of wave-lengths—providing, of course, that he has paid the necessary fees of the broadcast stations using those wave-lengths. Under this scheme it is expected that the Australian broadcasting movement will be a success.

Farmer & Company, Limited, of Sydney, has commenced broadcasting in a large way. This company enjoys the position of senior broadcast station in Australia, having been allotted No. 1 license by the government. They have erected one of the most powerful and up-to-date stations in the world—a station which operates on 5,000 watts power, and on a wave-length of 1,100 meters. When in full swing, the station should cover the whole of New South Wales, portions of Victoria and Queensland, and should also be heard under ideal conditions in other parts of the world.

Situated on the highest point of Willoughby, about eight miles on the northern side of Sydney, New South Wales, the station, which is officially known as 2FC, has now commenced transmission.

The two steel towers which support the aerial system are 200 feet high and are built in lattice fashion. The distance between them is 575 feet. Across this space the aerial system is stretched. Directly beneath the aerial and almost in the center of the two towers is situated the operating house and quarters for the staff. A large room houses the 5,000-watt set, which is used for the transmission of programs, and also a smaller 500-watt set. Adjoining the instrument room are the living quarters for the operating staff.

(Continued on page 1630)

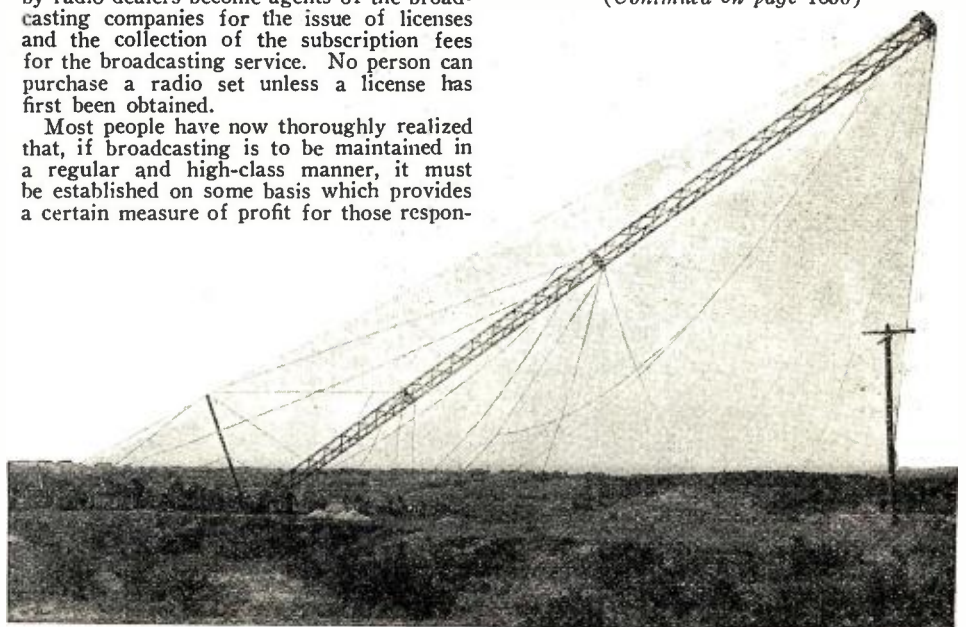

The novel means that was employed for erecting one of the large 200-foot lattice-work steel towers to support the aerial of station 2FC.

Can American Radio Sets Be Sold In Great Britain?

By FRANK W. CHALLIS, M. A.*

This article, although primarily concerned with the import trade problem, is also an interesting sidelight on the broadcast situation in Great Britain. Mr. Challis has outlined the principal British radio regulations and explained their importance in connection with the import of American radio apparatus.

AMERICAN Radio goods may be sold in England but under conditions which are somewhat unusual.

Great enthusiasm is being created in Great Britain at the moment by reason of the new successes achieved in radio broadcasting experiments. A considerable impetus has been given thereby to the radio trade, which, in the earlier months of 1923 had received a set-back, and I am told that a good many firms in America would be interested to know what are the prospects (if any) which Great Britain now offers as a market for the sale of American radio material. It may, therefore, be convenient if I endeavor briefly to state the conditions under which radio apparatus may be imported into Great Britain and Northern Ireland.

Generally speaking, the only component parts which are affected by British tariffs are the following, viz., vacuum tubes and headphones. The former are subject to a duty of 33½ per cent. *ad valorem* under the Key Industries Schedule of the Safeguarding of Industries Act, 1921. The latter are dutiable only in respect of the permanent magnets they contain. These being of trifling value, and the duty being reckoned as only 33½ per cent. on the value of the

A British broadcast receiver designed to cover both Continental and American broadcast wavelengths. It comprises a four stage radio frequency amplifier, a detector and an audio frequency amplifier of the push-pull type. (Courtesy of Ashley Wireless Telephone Co., Ltd.)

Another broadcast receiver of British manufacture, the design of which is rather unique. Scales and pointers behind glass windows replace the usual knob and dial. (Courtesy of Radio Communication Co., Ltd.)

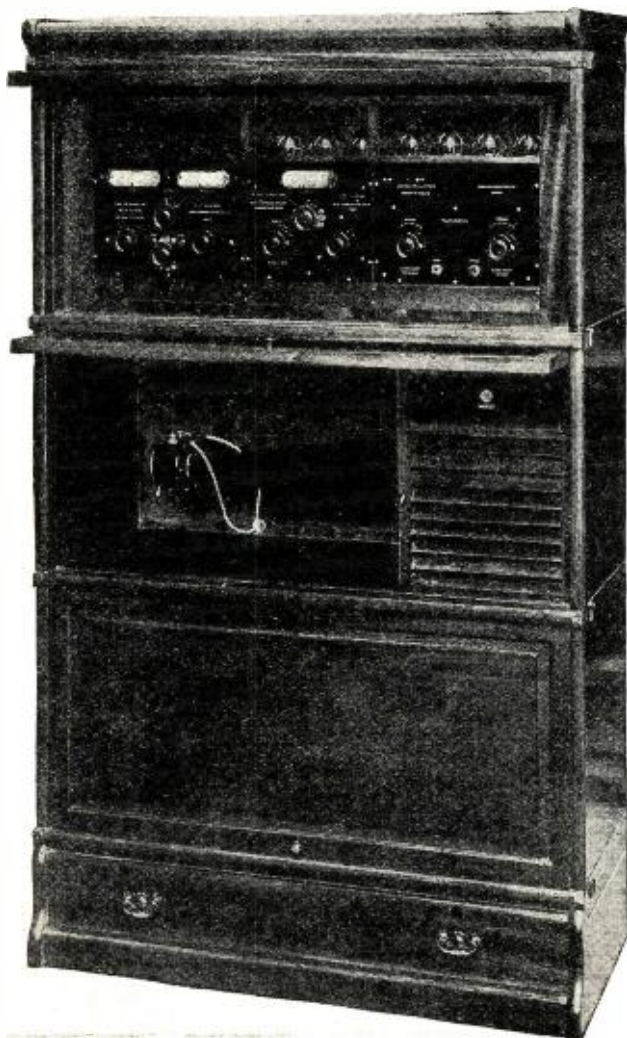
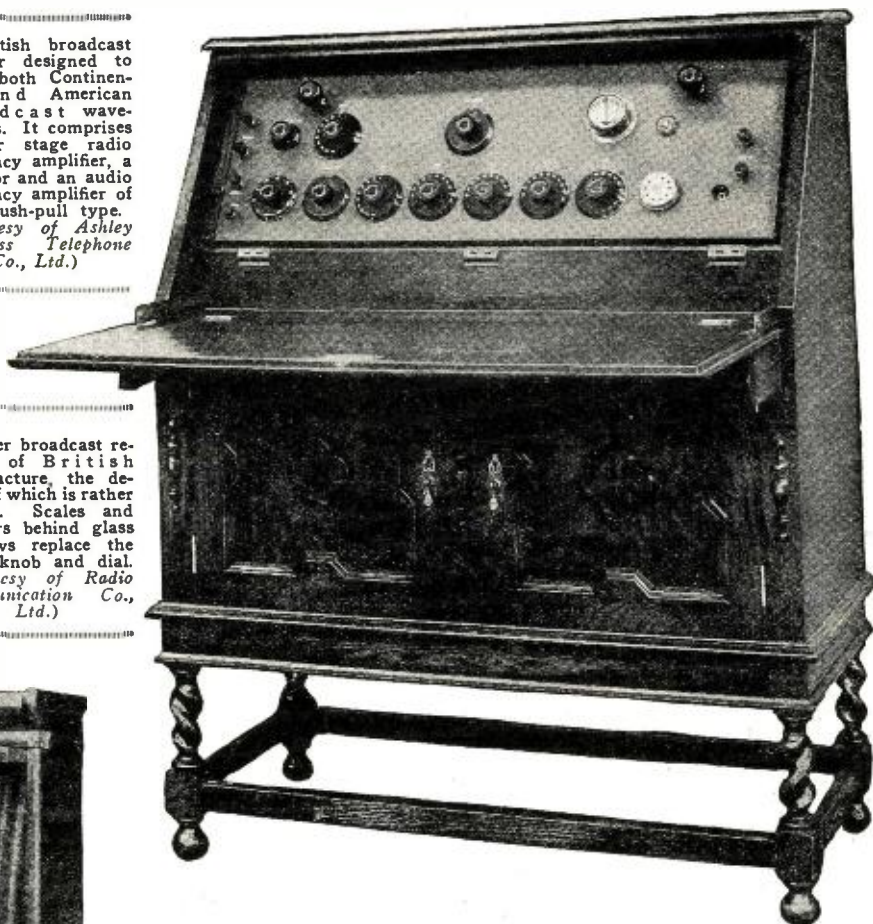

magnets, the tariff is almost negligible. There are no other tariffs imposed at British ports which affect American radio receiving apparatus or component parts.

It should also be made clear that H. M. Customs impose no embargo upon the importation of these goods. There seems to be an idea abroad that the import of broadcast receiving apparatus is prohibited, but such is not the case.

There are, however, certain regulations in force in Great Britain which are aimed to produce the same effect as a Customs prohibition, and the object of the present article is to make clear exactly what these regulations are. For this purpose a brief account of recent developments is necessary.

FORMATION OF THE B.B.C.

At the end of 1922 a company was incorporated, known as the British Broadcasting Company. The first members were a group of large electrical manufactur-

ers—interested, of course, in the production of radio sets. This company was incorporated to acquire from the British Government, through the Post Office, an exclusive license to establish broadcast stations in the British Isles. Under the Wireless Telegraphy Act, 1904, the Postmaster-General was given control of the conditions of transmission; consequently, these stations could not be established except under Post Office licenses.

Obviously the purpose of the electrical firms involved was to establish, by broadcasting, a public demand for receiving apparatus, and they relied mainly upon the sale of this apparatus for their profits from the broadcasting company. The Postmaster-General decreed that, as shareholders in the B. B. C., they would not be entitled to receive more than a dividend of 7½ per cent. per annum on the capital invested. In order, therefore, to prevent the benefits of their enterprise from going very largely into the pockets of overseas manufacturers, the promoters of the B. B. C. requested Mr. F. G. Kellaway (who was then Postmaster-General) to insert clauses in their license contract which would give them power to control the sale of receiving apparatus in England. One of the conditions agreed upon was that the only apparatus which should be approved by the Post Office for the consumer's use should be that which (in addition to satisfying official technical requirements) should bear the trade mark of the

(Continued on page 1632)

* Secretary, Electrical Importers' and Traders' Association, London.

Improvements on the Super-Heterodyne Receiver

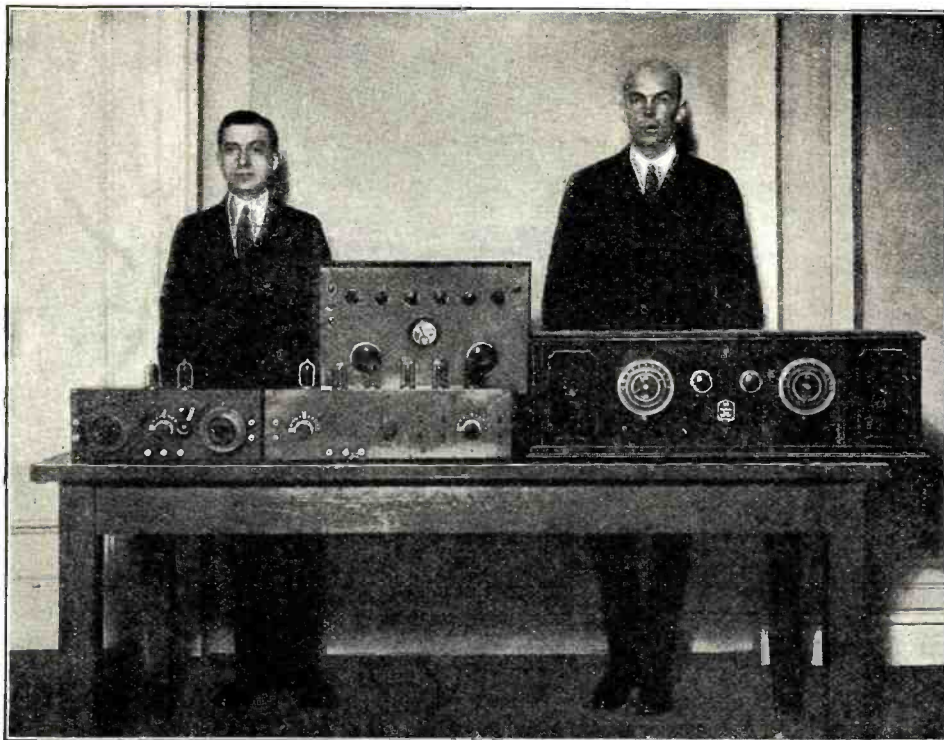

On the table are the original super-heterodyne, the improved model and a commercial type using the new circuit. Standing are Mr. H. Houck, left, and Major E. H. Armstrong, right. © Wide World Photo

way, how the signal is amplified through the six vacuum tubes which are employed in this type of receiver.

It is claimed that this arrangement is extremely sensitive and has the main advantage to require only six tubes to do the work of eight or nine, which number would be necessary in a standard circuit to produce the same amplification.

The photograph, Fig. 3, shows an inside view of a portable receiver, built by Major Armstrong and Mr. Houck, in which this arrangement is incorporated. The cabinet is so designed that it may contain the dry cells and "B" batteries necessary to the functioning of the tubes, and a small loop aerial which has been found large enough to pick up distant stations. The receiver thus constructed is entirely self contained and will operate a loud speaker.

Our other photograph illustrates the development of the super-heterodyne from its invention to the present day. On the table, at the left, may be seen the original super-heterodyne receiver built in France during the war and composed of two separate cabinets; the first one contains the tuner and oscillator and the other the radio and audio frequency amplifier. Above is the self-contained receiver just described and shown in detail in Fig. 3, and on the right is the latest type of super-heterodyne receiver for broadcast reception embodying the improvement previously described.

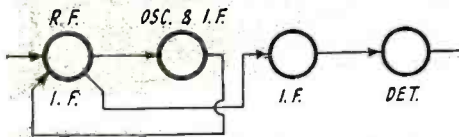

Fig. 2. This diagram shows how the signals are amplified at radio frequency. On the right is the actual circuit of the improved super-heterodyne.

At the last meeting of the Institute of Radio Engineers, Major E. H. Armstrong described an interesting improvement to the super-heterodyne system. After retracing the history of the invention and the development of this system of short wave reception, he explained the interesting modification of this circuit made by Mr. Harry Houck and which is now being incorporated in a commercial type of super-heterodyne receiver designed for broadcast reception. This improvement was made after carrying out experiments with radio frequency amplification of the incoming signal before it is heterodyned by the oscillator. The use of radio frequency amplification at the incoming frequency helped in sharpening the tuning but, of course, required some additional tubes and it was in trying to simplify this circuit, that the use of the second harmonic was found to be the practical solution of the problem.

The diagram of Fig. 1 shows how the oscillator tube may be used to amplify by tuning the oscillating circuit to the second harmonic of the incoming signal. As may be seen, the first tube amplifies at radio frequency and is coupled to the oscillator tube by a short wave radio frequency transformer. Passing through the oscillator the incoming signal is heterodyned and its frequency reduced by the well known beat method. The out-put of the oscillator passes through an intermediate frequency transformer which is connected to the first tube reflex fashion so that it amplifies at two frequencies simultaneously. From the out-put circuit of the first tube, the intermediate frequency passes through another transformer and is further amplified by the third tube, then detected by the detector and amplified at audio frequency through the two last tubes. Fig. 2 shows in a diagrammatical

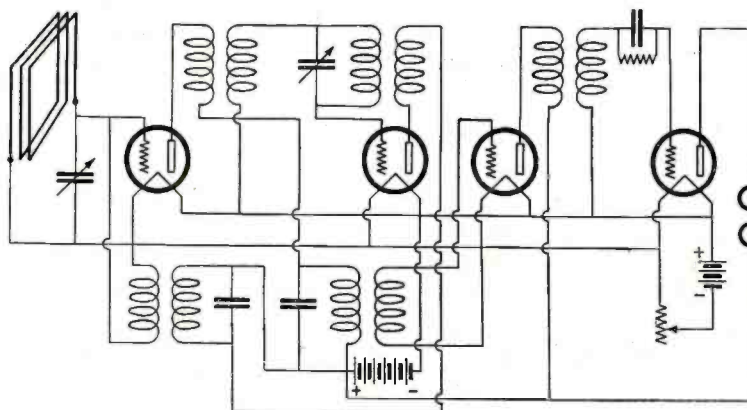
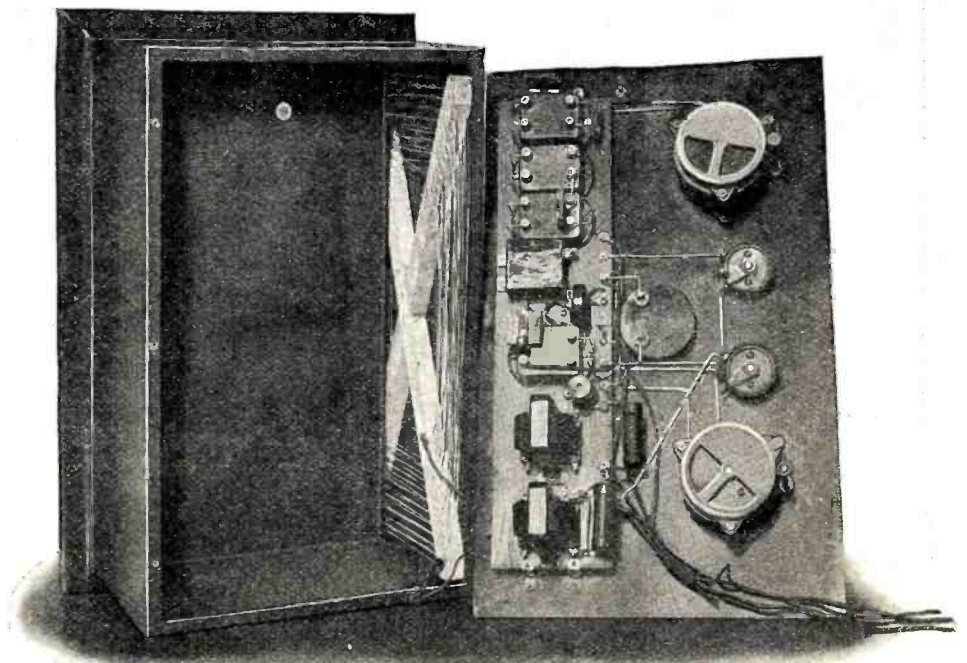

Fig. 1

Fig. 3. The photograph below shows the inside of the improved super-heterodyne receiver built by Messrs. Armstrong and Houck. © Wide World Photo



Double Anglo-French Broadcasting

By LAURENCE S. LEES

A RADIO program was broadcast simultaneously on two wave-lengths in two different countries recently. Music and speech, executed before a microphone in the Radiola Studio, Boulevard Haussmann, Paris, was heard by French amateurs, on 1,780 meters and by British amateurs on 369 meters.

It was announced that Monsieur Poincaré, Prime Minister of France, would deliver a message of greeting to the British Nation from the French Foreign Office on the Quai d'Orsay. Captain Lewis, the Art Director of the British Broadcasting Company, had come over to Paris with the company's engineer, Mr. Thompson, in order to make arrangements. However, much to Monsieur Poincaré's regret, he was unable to fulfill his part of the program. This was learned only 24 hours before the program took place.

In order that the vast audiences on both sides of the Channel should not be disappointed, Captain Lewis set about making other arrangements. Thanks to him and the excellent co-operation of the French and British Postal authorities and the Société Française de Radiophonie, the broadcasting of an excellent program was carried out. In the 24 hours at their disposal, they transferred two trunk lines connecting Paris and London from the Foreign Office at the Quai d'Orsay to the Radiola Studio. 2LO's microphone and amplifier were brought over from London, successful preliminary tests were made, and a program was arranged. The microphone and amplifier were attached to one of the trunk lines, the other being kept free for communication between Paris and London as a sort of order wire.

At nine o'clock on the evening of the program, the Anglo-French double broadcast began. Captain Lewis opened up with the words, "Hello, Great Britain, Paris call-

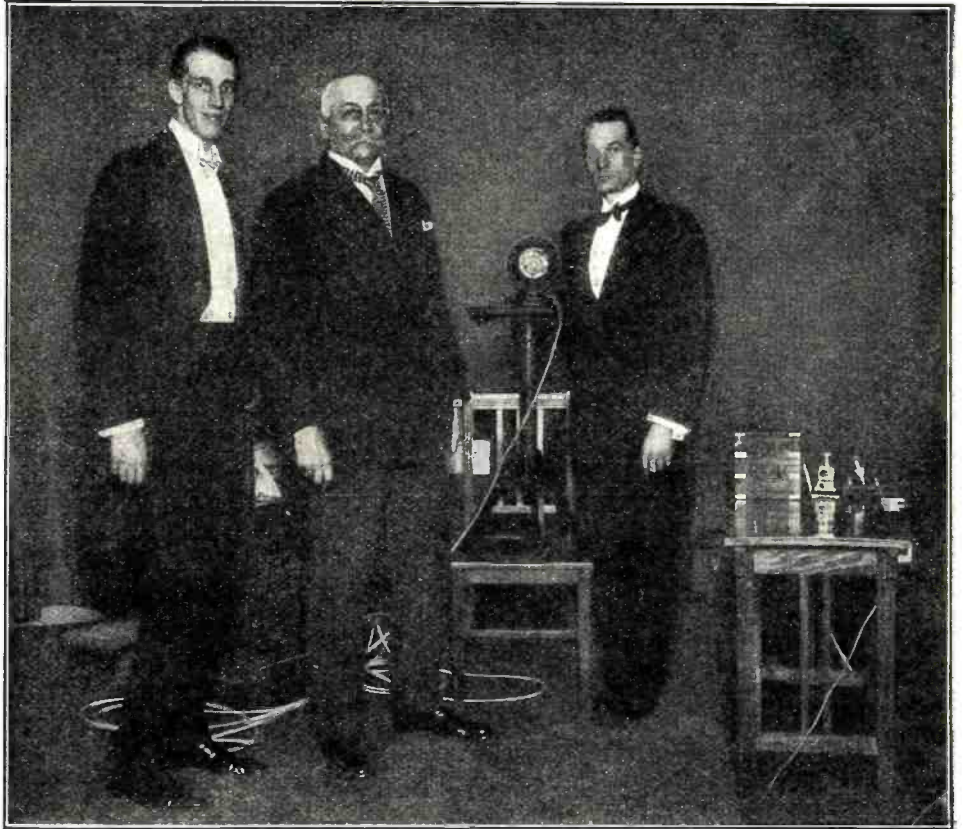

The men responsible for the interesting experiment of double broadcasting carried out simultaneously in France and England. From left to right are Captain Lewis, General Anthoine and Mr. Thompson.

ing!" As the evening's program was being broadcast simultaneously from the nine stations of the British Broadcasting Company a microphone (Continued on page 1638)

RADIO IN GERMANY



Dr. Marx, left, Chancellor of the German Republic, accompanied by members of his Cabinet, airing his views on political subjects through the microphone at one of Germany's broadcast stations. © Wide World Photos.

CONSIDERABLE difficulties were experienced before the first German broadcast station, working on a regular schedule, was completely installed. No suitable set and no suitable room were available, but it has now been definitely put up in a room of the Vox House in Berlin, Potsdamer Street. Vox is a concern making phonographs and records.

The set was built by the Federal Telegraph Department and was completed on October 1; on October 2, the installation began; on October 18, the antenna was strung, and broadcasting began on October 29.

On the roof of the Vox House and on the roof of the adjacent Hotel Esplanade two tube towers 25 meters high were set up. These were anchored 7 meters in the roof, so that the effective height above the roof is 18 meters. The distance between the towers is 80 meters and a 30-meter antenna of hexagonal cross section is strung between the towers. The antenna capacity is 600 centimeters (.000666 mfd.) and its fundamental wave is 400 meters. Experiments are being carried on at present to determine if a ground or an already installed counterpoise will give better results. The station operates on 400 meters.

The station calls "Hier Sendestelle Berlin, Vox-Haus, Welle 400." (This is broadcast station Berlin, Vox House, on a wave of 400 meters.) Call letters have not been assigned to this station yet.

Oscillations are produced with a Telefunken tube, type RS-15 of 1.5 K.W. Heising modulation is used. The filaments of both tubes are connected in series and receive

(Continued on page 1638)

The Radio Beginner

Your Radio Batteries

By MARIUS LOGAN

We are pleased to state that RADIO NEWS is able to inaugurate this new department devoted exclusively to the problems of the beginner with an article by Mr. Logan. His ability to explain radio problems in the simplest of terms will be noted in the present article on the use and care of radio batteries.

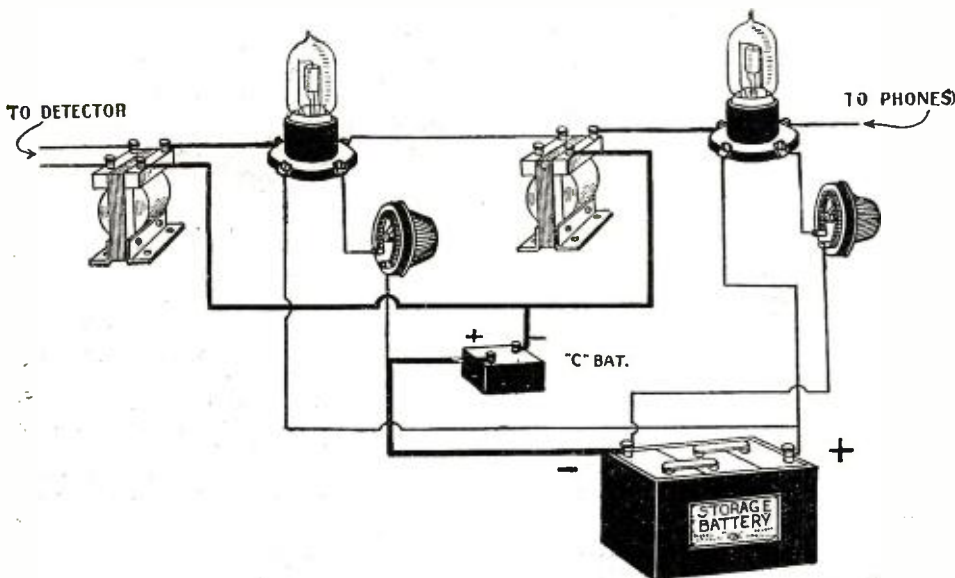

Fig. 7. This clearly shows the manner in which a "C" battery is connected in the circuit of a two-stage audio frequency amplifier.

NO matter what type of vacuum tube receiving set you purchase or construct, batteries are required to operate it. To the beginner unacquainted with radio, the kind of batteries used with a radio set, how many are required, how they are connected up and the necessary care they demand, is all very important. Without this knowledge you cannot get the most out of your set. What is more, a mistake in connecting up your batteries will result in one or more burned out vacuum tubes at about \$5 each.

THE "A" BATTERY

The "A" battery of a radio set is employed for

Fig. 1. A standard type of No. 6 dry cell which develops a pressure of 1½ volts.



lighting the filaments of the vacuum tubes. It is connected to each filament through a variable resistance or rheostat which controls the current flow or amperes. A decrease of the resistance of any one of these rheostats will increase the current flow and consequently the filament of the particular vacuum tube will increase in brilliancy.

Every battery has a rated voltage and it is the type of vacuum tube that you are to use that will determine the voltage of the bat-

tery employed to light them. WD-11 and WD-12 vacuum tubes have 1½-volt filaments and hence require only a 1½-volt "A" battery. Since they draw only ¼ ampere of current, a dry cell is sufficient to operate one. A common form of dry cell used for this purpose is shown in Fig. 1. If your set requires three WD-11 or WD-12 vacuum tubes, it stands to reason that power required to light them all would be three times as much as for one tube. It is then necessary to use three dry cell batteries, as one will not stand up to such a high current drain. However, it is still of paramount importance that the voltage for all three tubes does not exceed 1½ volts. This is accomplished by connecting the three dry cells in parallel, as shown in the diagram, Fig. 2. If these three dry cells were to be connected in series, the total voltage at the terminals would be 4½, sufficient to burn out all three tubes as soon as the circuit was closed. Each rheostat used with these tubes has a resistance of 6 ohms.

If you are going to use UV-199 or C-299

Fig. 5. A 22½-volt and a 45-volt "B" battery block. Taps are provided on both for fine voltage regulation.

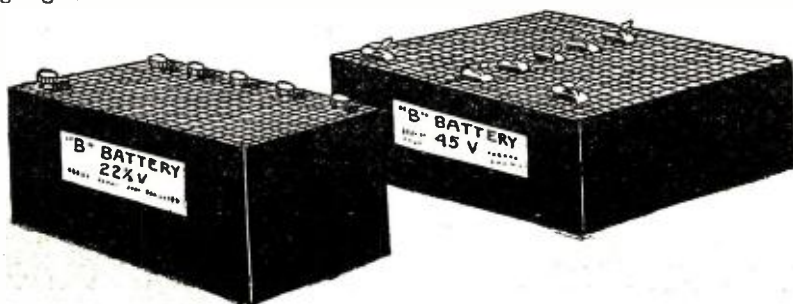

vacuum tubes, a higher voltage will be required than for the WD-11 or WD-12 tubes. Each UV-199 or C-299 draws .06 ampere at 4½ volts. This voltage is obtained by connecting three dry cells in series, as shown in Fig. 3, that is, the positive (+) pole of one battery is connected to the negative (-) pole of the next, and so on, thus giving a pressure of 4½ volts at the two terminals. It is evident that even if one tube is used, three dry cells will be necessary in order to obtain the 4½ volts. However, since one of these tubes draws only .06 ampere, these three dry cells, connected in series, can easily stand up to the current drain required to light the filaments of the three tubes to normal brilliancy. The rheostats used in conjunction with these tubes, have a resistance of from 25 to 30 ohms each.

If UV-200, C-300, UV-201, C-301, C-301A or UV-201A vacuum tubes, which require a pressure or potential of six volts on their filaments are used, it will be necessary to use a six-volt storage battery. Although enough dry cells could be connected in

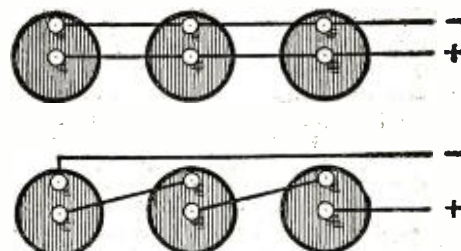

Above: Fig. 2. Three dry cell "A" batteries connected in parallel (1½ volts) and below, Fig. 3, three dry cells connected in series (4½ volts).

series to give a potential of six volts, they could not stand up to the high current drain that these tubes demand. A storage battery can deliver high amperage (power), or in other words a large amount of current for long periods without running down. The life of the storage battery is dependent upon this rating, which rating is in ampere hours. For an example, a battery having a rating of 60 ampere hours can deliver steadily, a current of five amperes for 12 hours, at the end of which time it will be run down. A

(Continued on page 1668)

Choosing and Installing A Receiving Set

By PARKER L. WORTHINGTON



To the tyro, anxious to get into the radio swim, but knowing nothing at all about radio, this article sets out in simple terms just what the different classes of radio receivers are and some of the results that may be expected of them. Price is discussed with special attention to accessories—which may amount to almost as much as the set.



WHAT kind of a set shall I buy? This is the usual question the beginner will ask after he decides that he must have a "radio." And this is a question that no one can answer for him. We can tell him what different types of receivers there are and what their approximate performance will be, but it is then up to him to decide. In the first place, how much does he wish to pay? That is the starting point of the whole thing. If only about \$10 or \$15 is to be expended, a crystal receiver is about all that can be purchased. Such a receiver requires a fairly long antenna for good reception. The average range of a good crystal receiver is approximately 15 to 30 miles. Under exceptional conditions such a set will sometimes pick up stations 500 or more miles distant. This, of course, is unusual and must not be expected as a steady performance.

Next on the list is the single vacuum tube receiver. This type of set can be regenerative or non-regenerative. A non-regenerative receiver does not howl or squeal, but is limited in volume and distance reception. For real good reception, a regenerative receiver should be used. With this type, using a good aerial, consistent reception of broadcast stations 100 to 500 miles away can be expected.

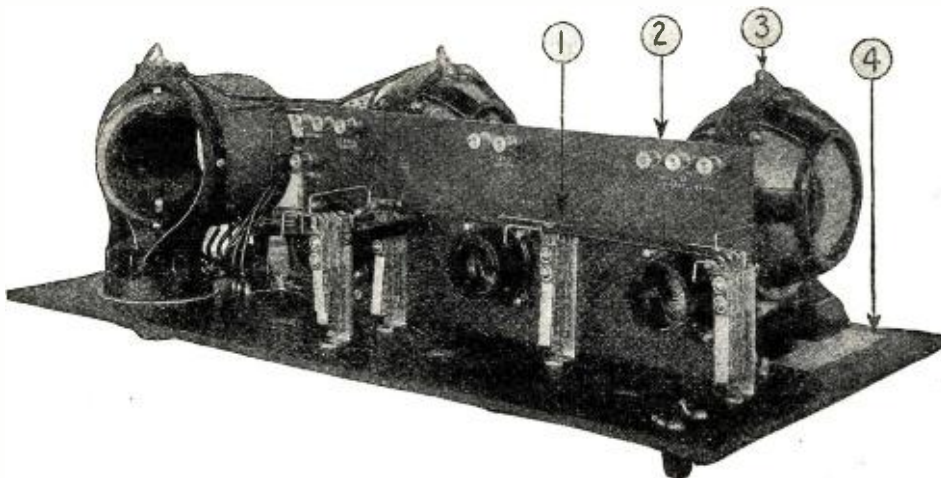

A three-tube receiver of the three circuit type. No. 1 shows the neat wiring to jacks. No. 2—accessibility to binding posts. No. 3—pig tail connections to rotor. No. 4—shielding. All of these are important considerations in a receiving set.

and TWO STAGES OF AUDIO FREQUENCY AMPLIFICATION. This is the number of tubes employed in most of the receivers on the market. A set of this type will actually cost from \$125 to \$200, according to the grade of apparatus in its make up. This price includes all accessories

a small loop being all that is necessary. Such receiver costs from \$150 to \$300.

DRY CELL AND STORAGE BATTERY TUBES

When buying a receiver, always find out if it is complete or if \$50 or more will have to be spent for tubes, and other accessories that are not included in the purchase price. There are many good receivers on the market that are furnished complete, and if little is known about radio, it would prove the best policy to obtain such a set.

How about batteries for the filament of the tubes? Some tubes are designed to be used with a STORAGE BATTERY and others will give fine results when used with DRY CELLS. If a storage battery is used, some means must be employed to charge it when it is run down. There are many chargers on the market designed for this purpose, but one should find out before buying, what kind of current is used in the house. It may be Direct Current (D.C.) or Alternating Current (A.C.) and the charger to use in each case is different. Dry cell tubes, although not able to handle the amount of energy of a storage battery tube, will nevertheless, give very good results. Outfits can be obtained which use either storage battery or dry battery tubes and this

(Continued on page 1672)

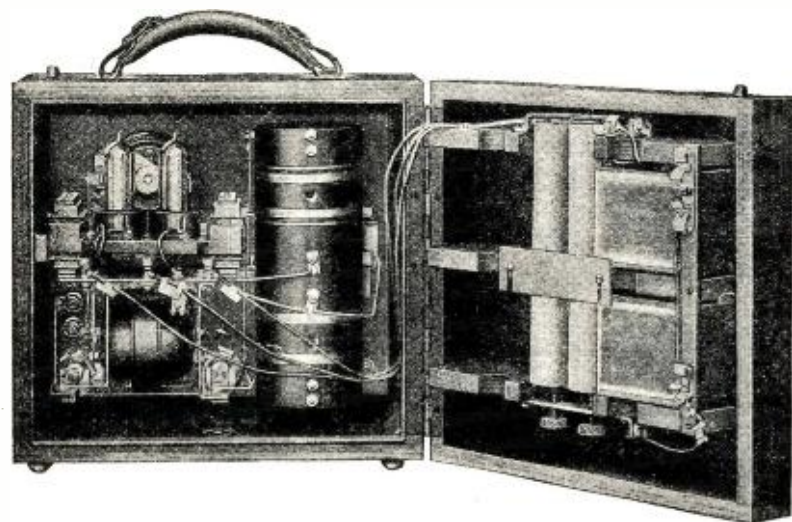

A compact and efficient portable receiver. Note the neatness of wiring and arrangement of the apparatus.

There are various circuits used in such an outfit, the most common being the SINGLE CIRCUIT. Such a receiver has a minimum of controls and will do very good long distance work. This type, although easy to tune, will not prove very selective and interference from local stations may be very troublesome. If possible, a receiver should be chosen using a TWO CIRCUIT TUNER. This form will usually have one more control but will prove more selective and will give greater satisfaction.

AUDIO FREQUENCY AMPLIFIERS

A one tube set can only be used with ear-phones and will not actuate a loud speaker. If loud speaker operation is desired, at least two tubes must be employed, the second being used as an audio frequency amplifier. With this combination only local stations, as a rule, will operate the loud speaker, hence for best results three tubes should be utilized. This will comprise a DETECTOR

such as tubes, batteries, loud speaker and phones.

RADIO FREQUENCY AMPLIFIERS

Now we come to receivers using RADIO FREQUENCY AMPLIFICATION. In any receiver using a detector and audio frequency, the reception is limited to the sensitiveness of the vacuum tube detector. If the incoming signal is not strong enough to actuate the detector, it will not, of course, be amplified through the audio frequency stages. If, however, these signals are amplified before they reach the detector, they will be built up in strength to a point where the detector will respond to them. This is known as the RADIO FREQUENCY AMPLIFICATION and will result in reception from more distant stations. If a sufficient number of stages of radio frequency amplification are employed, an outside antenna and ground need not be used;



A compact two-tube set. UV-199 tubes are employed with excellent results. The same circuit employed in the portable set is used here.

Whistling Interference

By W. P. POWERS

ASSISTANT PROFESSOR OF ELECTRICAL ENGINEERING, STEVENS INSTITUTE OF TECHNOLOGY



Professor Powers has, in this article, placed before you an elementary explanation of the workings of radio waves, how they interfere with each other and create whistles. Furthermore, he gives information on a non-radiating receiving set in which sensitivity has not been sacrificed.

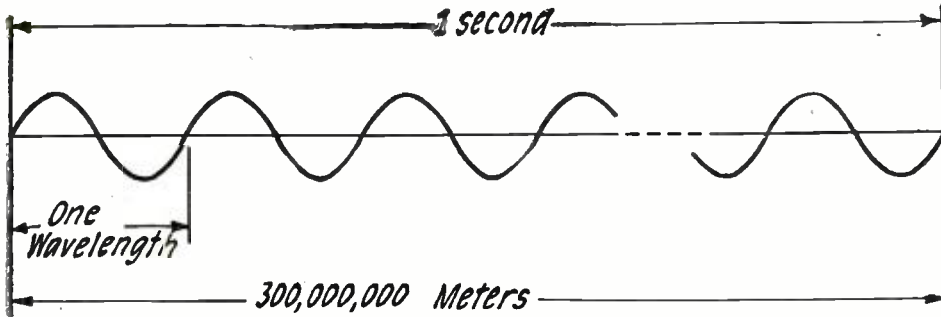

Fig. 1

A radio wave covers a distance of 300,000,000 meters or 186,400 miles per second. The number of waves radiated per second is equal to the velocity divided by the wave-length.

SATISFACTORY broadcast reception cannot be accomplished when interference prevails. The slightest disturbance, if it occurs during certain delicate passages, will frequently completely obscure the artist's efforts. The complete enjoyment of musical programs can only be experienced if interference is absent.

There are many forms of interference. Interference originating at the transmitting stations; interference which results from natural atmospheric conditions; and interference which is due to the improper operation of receivers. "Whistling," in its worst form, comes under this third class, and is by far one of the most prevalent forms. Especially is this true in the more congested districts. This interference is directly under the control of the receiving operators, and can be reduced if certain precautions are observed. It is the purpose of this article to show how it is caused, and to indicate how each receiving operator in co-operation with his neighbors can materially contribute to the improvement of receiving conditions in his locality.

FUNDAMENTAL RELATIONS

Radio impulses are propagated through space at a velocity of 300,000,000 meters per second, this velocity being constant for all radio signals. Each transmitter has what is called a certain "wave-length" and so each station transmits programs on a given wave-length. We can then imagine that the transmitter radiates a series of waves, and that at the end of one second the first wave will have reached a distance of 300,000,000 meters, as illustrated in Fig. 1. It is then apparent that the number of waves radiated

per second is obtained by dividing the velocity by the wave-length. This we call the frequency. We say, for instance, that a 300-meter station is operating on a frequency of 1,000,000 cycles (1,000 kilocycles) per second.

This situation can be explained in very elementary terms by realizing that in walk-

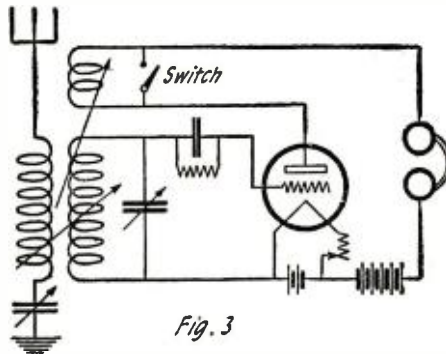

Fig. 3

An arrangement whereby the tickler coil is short circuited by a switch, during periods of reception from local stations.

ing a certain distance in a minute, a certain number of steps have been taken. Obviously, the number of steps per minute (frequency) is found by dividing the distance per minute (velocity) by the length of each step (wave-length).

PRODUCTION OF THE WHISTLE

When two waves exist simultaneously they may, under certain conditions, produce a continuous whistle in the surrounding receivers. If the difference in frequencies of

the stations is within the audible range (say below 20,000 cycles per second and above 16 cycles per second), and if the waves are of sufficient intensity at the receiving point, then we may expect to hear this steady whistle.

This problem has been partially solved by legislation which extended the range of frequencies allotted to broadcast stations. However, it is not to be expected that this type of interference can be completely eliminated, when we consider the vast number of broadcast stations in existence, and the fact that our receivers reach out for thousands of miles.

Let the wave A, in Fig. 2, represent the carrier wave of a distant transmitter. Wave B is the carrier wave of another transmitter having a slightly different frequency. The resultant wave is shown at C. Note that the effect is as if the amplitude of wave A were continually varied. Wave A is, therefore, "modulated," and the modulation frequency is equal to the difference in the frequencies of the component waves. Any modulation (change of amplitude) of a carrier wave, if within audible range (and of sufficient intensity), will of course be heard in the receiver. Hence we hear a steady whistle in the background.

Inspection of Fig. 2 will show that at regular intervals the two waves A and B are in phase (in step), and at regular intervals they are directly out of phase. There is a gradual transition from one of these extreme conditions to the other, resulting in the musical note at audible frequency.

It is not unusual for a station 1,000 miles in one direction to produce this sort of interference with a station 1,000 miles away in another direction. Ship operators at sea frequently report whistling due to stations thousands of miles apart.

This form of whistling interference is due entirely to the adjustments of the transmitters, and results in a steady whistle. It cannot be corrected at the receiving point, and the subject has been considered in order that the reader may differentiate between this form of interference and the more prevalent form of whistling, which is caused by radiating receivers.

WHISTLING DUE TO RADIATING RECEIVERS

A receiver of the regenerative type may, under certain conditions, oscillate. When oscillating, a receiver radiates energy into space unless certain precautions are observed. Such a receiver becomes a transmitter, and

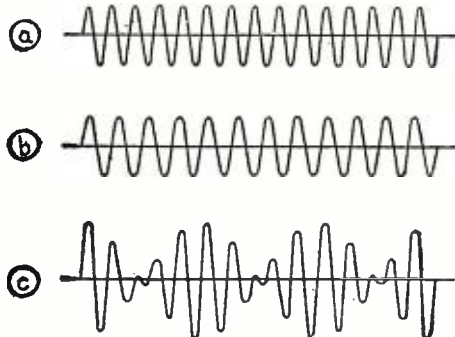
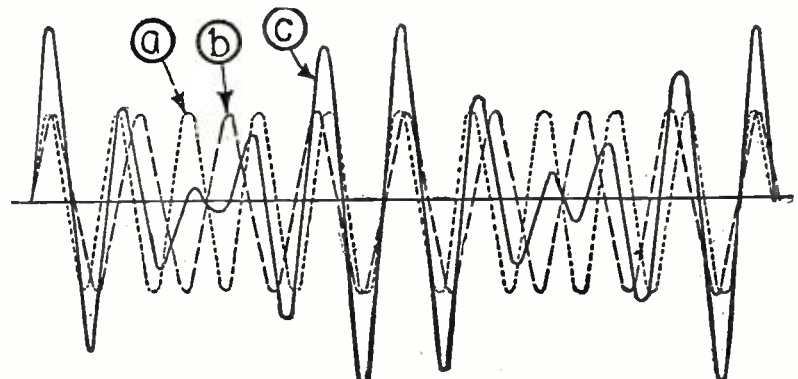

Fig. 2. When radio waves a and b combine, a beat wave is produced as at c, which varies in accordance with waves a and b as they go in and out of phase with each other. At the right is shown how the two waves combine to produce the beat note.



is effective as a rule for a considerable distance. Turning the dials of the receiver changes the frequency of the receiver transmission, and so the entire neighborhood is subjected to this continually changing frequency. Other receivers, regardless of their adjustments will pick up a whistle as this variable frequency passes through the frequency to which they are set. This is an experience familiar to all broadcast listeners. The interfering receiver sends out a frequency which is continually changing, as the operator, by turning the dials, sweeps through the sky in search of signals. The neighboring receivers pick up the resultant effect as a musical note of extremely high pitch, rapidly reducing to a point below audibility (below 16 cycles per second) and then increasing in frequency through the audible range and disappearing at frequencies above audibility. The whistle may vary in character from a full siren effect to a delicate "tweet." The interfering frequency may cause comparatively little trouble for surrounding receivers which are operating on other frequencies (adjusted for other wavelengths), but if the two receivers are tuning in the same program, the result is disastrous. The interfering operator, not being content with his adjustment, is continually adjusting and readjusting his receiver, with the result that his frequency is always close to the transmitter frequency, and so produces an audible note in all the surrounding receivers which are listening to that particular program.

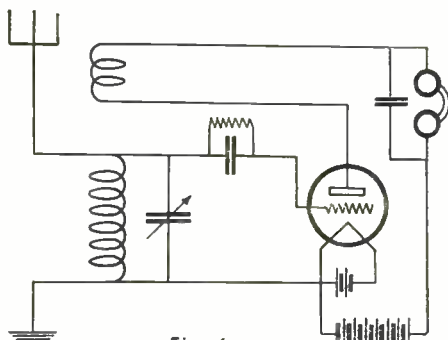

Fig. 4
This, the single circuit tickler feed-back type of regenerative set, is by far the worst offender in point of interference.

PRECAUTIONS

If the receiver is of the regenerative type, it is well to use only as much regeneration (tickler or feedback) as is required for good reception. If a note is heard which is controllable by manipulating the dials, you can be sure the set is oscillating. Reduce the tickler or feedback adjustment until the whistle disappears.

The quality of reproduction is usually

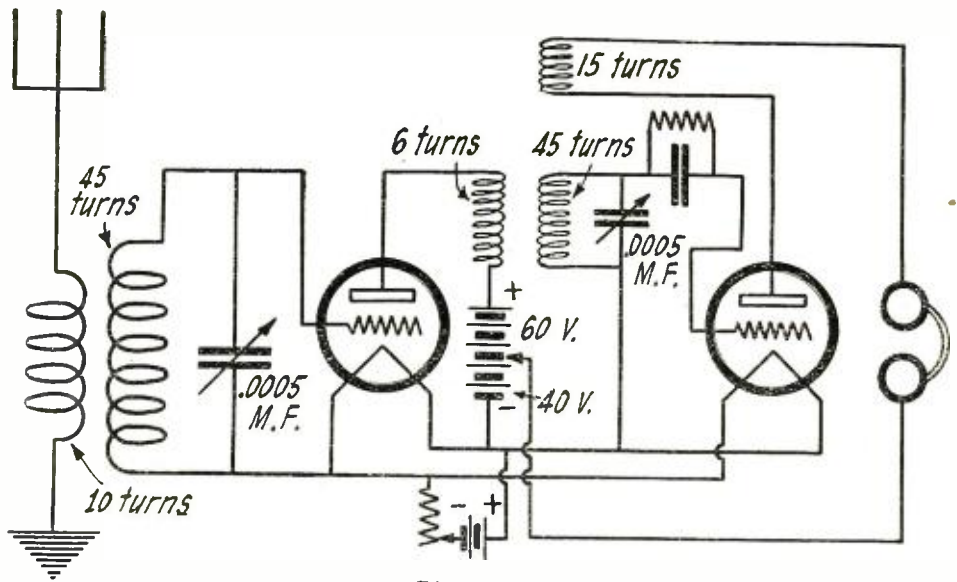

Fig. 5

A regenerative circuit combined with a muffer, commonly known as a radio frequency amplifier. This arrangement prevents radiation and increases the sensitivity of the circuit.

much improved when the tickler adjustment is reduced (using less regeneration). Doubtless many receivers are located so close to the broadcasting station that regeneration is not required for good reception. Some have already discovered this, and have provided their sets with a switch which actually cuts out the regenerative (feedback) coil, when working locally. When working for distance, the feedback coil is used. One scheme of this kind is shown in Fig. 3.

Certain receivers rely considerably upon regeneration for their selectivity, and naturally the above suggestion will, in these cases, be looked upon with little favor. Ordinarily a reasonable degree of selectivity can be restored by the use of some form of "wave trap" or "wave filter."

Probably the worst offender in the long list of receivers is the so-called single circuit regenerative receiver. A form of this receiver is indicated in Fig. 4, and is shown here simply as an example of what not to use.

Unfortunately this receiver is inexpensive and simple in construction, and as a consequence it has enjoyed altogether too much popularity. A modified form of this receiver is shown in Fig. 5 and is to be recommended as a substitute for the single circuit shown in Fig. 4.

IMPROVED CIRCUIT

Fig. 5 shows a two-tube circuit having two tuning adjustments and the usual tickler or feedback adjustment. The circuit is so

arranged that there is comparatively little radiation. The regeneration occurs in the second tube, and the oscillations (if they exist) are more or less confined to this stage. Radiation can not occur easily because of the interposition of the first tube, and the large step-down ratio of the antenna coupling transformer.

DESCRIPTION OF APPARATUS

The antenna coupling transformer is constructed by winding 45 turns of No. 24 D. C. C. copper wire on an insulating tube 3 inches in diameter. The turns are wound in a single layer, and 10 turns are then wound directly over the 45 turns, the 10 turns being concentrated at the center of the spool in a single layer. The 10 turns are connected in the antenna circuit.

The transformer between tubes is constructed in a somewhat similar manner. Wind 45 turns of No. 24 D. C. C. wire in a single layer, on a 3-inch diameter tube. Directly over the center of this winding, place six turns of No. 24 D. C. C. wire in a single layer. Arrange a tickler coil of 15 turns of No. 30 D. C. C. wire so that it couples to the 45 turns, and the coupling may be varied. Connect the six turns in the plate circuit of the first tube.

UV-201A tubes can be used with this circuit, in which case 60 volts will be found suitable for the plate circuit of the first tube, and 40 volts (tapped as indicated) will be correct for the second tube

Why Bother With Radio Frequency Amplification?

By J. R. BALSLEY

I HAVE received many letters of comment upon an article on elimination of interference which appeared in January RADIO NEWS. These letters contained various degrees of praise or criticism, but almost invariably indicated the belief that the suggested addition to the set would be a general cure-all. The amplifier described greatly increases the range of the receiver and eliminates radiation from it.

In 56 of the letters received, the writer of each complained of some "rock-crusher" in his neighborhood that makes it impossible to enjoy a concert. They seek to eliminate the whistles coincident with the tuning of some regenerative receiver in the neighborhood. The only way to eliminate this kind

of interference is to eliminate it at its source, and, unfortunately, there are criminal laws governing this particular branch of interference elimination.

When any kind of a regenerative receiver without radio frequency amplification is

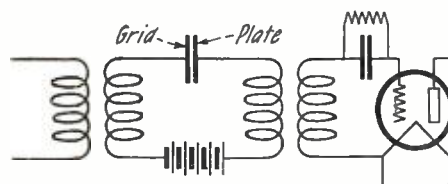

The grid and plate elements of a vacuum tube actually compose a small condenser, as illustrated.

operated with a high degree of feed back (as they nearly all are) the receiver acts as a transmitter and the antenna will radiate a percentage of the energy generated, depending upon the type of tube and the kind of receiving circuit used.

Of this class the single circuit and ultra-audion are the worst because they are so designed that the oscillating circuit is conductively coupled to the antenna circuit. The so-called two and three-circuit tuners are a little less annoying because they do not always employ maximum coupling and, therefore, have more losses between the oscillating circuit and the inductively coupled antenna circuit.

(Continued on page 1662)

The Vacuum Tube and How It Works

By Prof. John H. Morecroft, E. E.

Assoc. Professor of Electrical Engineering, Columbia University

Part I



There are few men better equipped than Professor Morecroft to tell the story of the vacuum tube. He has related, in a comprehensive manner, how the vacuum tube works and the various roles it plays in the radio field. This is by no means a theoretical study, but a practical, informative article written in a manner which will prove of interest to all.



IN studying the action of the vacuum tube it is very necessary to get a clear idea of the modern scientific concept of the constitution of matter. What does a piece of metal, such as the filament of a vacuum tube, consist of? Is it as dense and solid as it appears? A piece of tungsten wire such as is used for the filament of most vacuum tubes, is made up of a tremendous number of separate particles called atoms, or molecules, and there is much empty space between, and in, these atoms.

Each atom consists of a central portion, called a nucleus of *proton*, and around this proton are grouped many smaller particles called *electrons*. A simple atom may be much like our solar system, the sun corresponding to the proton and the planets, whirling around the sun, to the electrons of the atom.

Many atoms are much more complex than this picture would lead one to believe. Thus the tungsten atom has 74 negative electrons grouped about a cluster of nearly 200 positive protons, together with over 100 other electrons tightly held together. A solar system to be similar to such an atom would have to have about 25 times as many planets revolving about the sun, as has our present system. The hydrogen atom, however, has only one electron revolving about its proton, so that it is very much like the combination of our earth and the moon. The electrons are probably in no closer contact with the proton than are the planets with the sun.

ILLUSTRATION

If we imagine a piece of tungsten, the size of a ball, like those used in the ordinary ball bearing, magnified to the size of the earth, then the atom would be as large as a baseball, and an electron would be less than one thousandth of an inch in diameter. That is, the whole group of electrons and proton making up the atom would occupy as much space as a baseball, but most of this space would be empty as there would be in it, besides the small central nucleus, nearly 100 small particles much less than one thousandth of an inch in diameter.

Insulators and Conductors.—In general the electrons that belong to a certain atom stick to it very tightly and cannot be taken away by another atom; in the same way none of the planets which revolve around the sun are taken away by other systems in the stellar universe. In certain substances, however, principally the metals, it seems that one electron per atom is more or less free to leave the atom and wander about at will among the other atoms and electrons, sometimes attaching itself to one atom and sometimes to another. In other substances such as glass, rubber, bakelite and porcelain, all the electrons are rigidly attached to their atoms and cannot move about. These substances we call *insulators*, whereas the others, like the metals, are called *conductors*.

The Electric Current.—If a wire is connected with a battery, so that one end becomes positive with respect to the other, the free electrons, really negative electricity, will

be attracted towards the positive end of the wire, and they will gradually drift along through the crowd of atoms from one end of the wire to the other. This drift of the free electrons through the substance of the wire is called an *electric current*. This motion of the electrons resembles that of a troop of men advancing through a woods; the individual men go in very irregular fashion, going sideways, and backwards even,

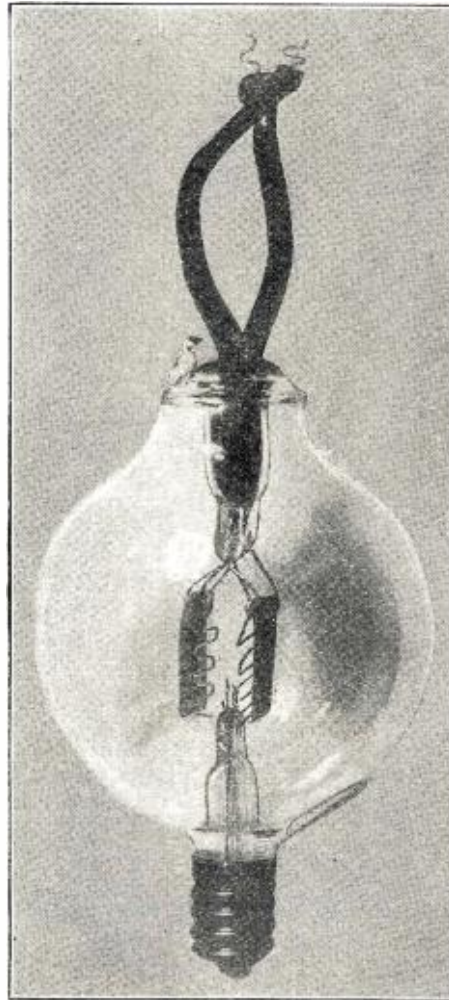

The Adam of the three element valves, the original De Forest "Audion." The plate and grid leads issue from the top of the tube.

to avoid rocks and trees, but on the whole the troop moves slowly forward. The electrons drift in much the same manner; they bump into the atoms and into one another, sometimes going sideways and sometimes being bumped backwards, but on the whole drifting from one end of the wire to the other.

We can apply this idea of current to the ordinary electric lighting system. An individual electron starting out from the generator in the power station may take a

month or more to make a circuit of the system and get back to the generator; in the meantime it has been bumping its way along through the wires hung on poles in the street, through the house wiring, then through perhaps an electric iron or lamp, and so back through the wires to the station.

Motion of Atoms and Electrons.—At ordinary temperatures the atoms of which a body is composed are not stationary but have a very rapid to and fro motion, going zigzag fashion in all directions. They bump into one another and bound away much as would a lot of tennis balls shaken about in a big box. Between the atoms, the free electrons, if there are any, bound back and forth with even greater velocity. It is this velocity of the atoms and electrons that gives the body its temperature; at absolute zero temperature (about 460 degrees below zero on the Fahrenheit scale) all the atoms of a body are at rest.

At ordinary temperature the average velocity of the atoms is several hundred feet a second. There is a fundamental law of physics which says that the free electrons in a metal must have the same amount of energy of motion as do the atoms. As the electrons are so small and light when compared to the atoms, the average velocity of the electrons must be correspondingly high. This average velocity of the electrons at ordinary temperatures proves to be about 50 miles a second.

WHY THINGS GET HOT

Although we cannot attempt to prove it in a non-mathematical article of this kind, it is a fact that the temperature of a body is measured directly by the amount of energy expended by the motion of the atoms that make up the body; the greater the motion of the atoms and electrons the hotter is the body. Anything that increases the average velocity of its atoms will correspondingly raise the temperature of the body; if a piece of iron is hammered vigorously the iron and hammer both heat up, because the average speed of the atoms of which each is composed has been increased by the blows. If two bodies are rubbed together, as in a bearing, the shaft and bearing metal both get hot because the friction between the two has increased the average velocity of the atoms.

Metals Are Porous.—Anyone who has grasped the ideas set forth thus far will have reached the conclusion that what seems to be a hard and dense metal is really nothing of the sort, but a collection of complex particles, each of which in itself resembles a solar system, with the electrons revolving about the proton; there is an empty space between the atoms and also in the atoms themselves. From this viewpoint it is reasonable to believe that small particles, such as individual electrons or atoms, might be shot right through a piece of metal if they have sufficient velocity. Such is really the case. These high-speed particles go right through sheets of metal. They shoot through the spaces between the atoms or perhaps right through the atoms themselves.

WHY AN ELECTRIC CURRENT HEATS A WIRE

When a wire is carrying current, the free electrons are forced to drift along the wire. Hence, in such a conductor, the electrons have an additional velocity as well as the irregular motion due to the temperature of the body. As the electrons crowd their way along the conductor, they bump into the atoms and other electrons more vigorously than they would if there were no current in the conductor; due to this effect the average velocity of the atoms will increase when the conductor carries current and will increase with the amount of the current. This accounts for the heating of a wire carrying current, such as the filament of an incandescent lamp; in such a filament the intense heat is caused merely by the electrons pushing their way along the wire and so bumping the atoms and speeding them up.

WHAT "EVAPORATION" IS

We all know that such substances as water or gasoline will evaporate in an open dish. Just what is evaporation from the viewpoint so far presented? Perhaps you have seen a swarm of bees hanging in a cluster from the limb of a tree; the writer has often cut off such a limb, carried the swarm to the front of a new hive, and shaken the bees off on the ground. They will roll over the ground in a layer perhaps 100 bees thick, almost like thick molasses and will gradually move into the entrance to the new hive; but if the queen has been lost, they will start to fly back into the air. So we have on the ground a mass of bees, perhaps half a bushel, corresponding to a liquid in their motion, and, leaving the surface of this mass, are the individual bees taking wing. We may say that the bees are "evaporating" as they leave the crawling mass on the ground and fly up into the air.

This is a fairly good picture of what happens at the surface of a liquid. Most of the atoms of the liquid stay in the mass, but some of those at the surface, having sufficiently high velocity, will fly away from the liquid all together, in spite of the effect that the rest of the atoms of the liquid try to hold them in. The high speed atoms at the surface break away and become free individual atoms of the substance floating about among the air atoms at the surface of the liquid, gradually bumping their way through the air atoms and so away from the liquid. It is these individual atoms that break away from the surface of the liquid and cause it to evaporate.

It is evident that those atoms at the surface with the highest velocity are the most likely to break away from the pull of their companion atoms, and such is always the case. In evaporation it is the fast ones that get away. It follows, therefore, that as the high speed atoms get away, those left behind will have on the average a lower velocity than before evaporation began to take place; but lower average velocity of the atoms means a lower temperature, and we know that this is just what occurs when a liquid evaporates. Alcohol allowed to evaporate from the hand will cool several degrees; liquid air left free to evaporate will so cool down that what is left behind actually freezes.

Effect of Temperature on Evaporation.—The higher the speed of the atoms the more likely are they to break away from the attraction of their companions and so evaporate; thus hot water evaporates much more rapidly than cold water. Metals evaporate very slowly at ordinary temperatures, but as they are heated the rate of evaporation increases. If the metal is surrounded by air it will generally oxidize before reaching a temperature at which appreciable evaporation takes place; but if the metal is in a vacuum it will actually evaporate or boil away just as do liquids. In the ordinary electric lamp the tungsten is so

hot that appreciable evaporation takes place; the metallic vapor condenses when it reaches the comparatively cold walls of the glass bulb. This is the black deposit of tungsten visible in the bulb of any tungsten lamp which has run a thousand hours or more.

Evaporation of Electrons.—About 20 years ago it was predicted by Richardson that if a metal were sufficiently heated, not only would it evaporate, but *electrons might be made to evaporate from the metal* also. Moreover, it was evident that the electrons would be the same in kind, no matter what metal was heated. As the electrons move so much faster than the heavier atoms it was predicted that the electrons would evaporate at a lower temperature than would the atoms of the metal itself, and such proves to be the case. In a good vacuum (space from which practically all air or gas has been pumped out) a glowing piece of tungsten, platinum or similar metal may be maintained at a white heat for thousands of hours without appreciable evaporation of the metal itself; yet in one hour the number of free electrons evaporated is several

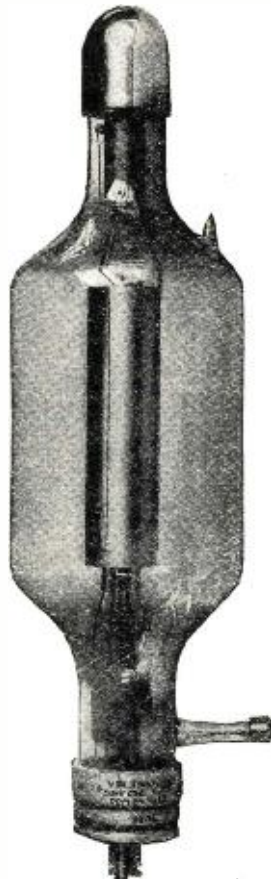

A Navy 5 K.W. air cooled transmitting vacuum tube of the type employed at the Navy station at Arlington, Va. It is 22 $\frac{1}{4}$ inches long and 6 inches in diameter, really small for a tube of such capacity but a monster in comparison to a receiving vacuum tube.

times as great as the total number of free electrons in the piece of metal. Of course as the free electrons evaporate, others must be supplied to take their place, as will be explained later.

Effect of Gas on Evaporation.—In order to get appreciable electron evaporation it is necessary that the space surrounding the hot metal, from which the electrons are being emitted, be very well evacuated, not only to prevent the metal from oxidizing, but because of the effect of the gas on the electrons that are trying to leave the hot surface. The mass of the electron is so extremely small that if it collides with an atom of any kind it bounds backwards at about the same velocity with which it was rushing forward. This action is the same as when a tennis ball collides with a cannon ball going in the opposite direction; the path of the cannon ball is scarcely disturbed by the collision, but the tennis ball bounds back in about the same way it would have done had it struck against a rigid wall. Thus

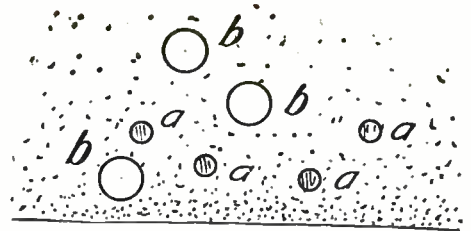

Hot tungsten
Fig. 1

Fig. 1. The atmosphere surrounding a hot tungsten filament contains, aside from the electrons, atoms of gas (a) and atoms of tungsten (b).

if there are any atoms of gas surrounding the hot metal, the electron bounding out of the surface of the metal strikes against these atoms and so bounds right back into the hot metal from which it has escaped. The gas thus acts as a screen surrounding the hot metal, pushing the electrons back into the metal as fast as they escape.

Effect of Surface Condition.—We know that if the surface of water is covered with a layer of oil the water is effectually prevented from evaporating. A similar effect is often noticed when studying electron evaporation, other things taking the place of the oil layer. Thus, if some certain gas sticks to the surface of the hot metal (such gas is said to be "absorbed"), it may practically stop the electron evaporation, whereas certain other gases have no effect at all. Langmuir and his co-workers in research have done most thorough work in investigating these effects of different gases in a vacuum tube; those especially interested should consult the scientific journals where such work is reported.

Effect of Oxides.—As noted above, certain impurities on the surface of a hot metal prevent electron evaporation, yet Wehnelt discovered that certain oxides, spread over the surface of the hot metal, very much increased the rate of emission. Van der Bijl and his associates have developed this phase of the question and have produced an oxide-coated platinum filament that gives profuse electron emission at temperatures much lower than required for pure platinum or tungsten filaments. To get much emission from pure tungsten the metal must be at a dazzling white heat, whereas a properly coated oxide filament will give the same amount of emission at a dull red heat. An oxide-coated filament should never be raised to a temperature hotter than that which gives a dull yellow color; otherwise the oxide coating will be spoiled.

Electron Atmosphere.—The evaporation of electrons from a hot surface is pictured in Fig. 1, the small dots representing electrons, the larger circles *a, a, a*, representing some gas atoms, and the still larger circles *b, b, b*, representing some tungsten atoms which have evaporated with the electrons. It must of course be remembered that no matter how well the containing vessel has been pumped there will always be many gas atoms left in the vessel, around the filament. If there is no action pulling the electrons away from the hot surface from which they have come, the height of the electron atmosphere represented in Fig. 1 will be only a few hundredths of an inch. Unless the metal is above a dazzling white temperature, but few electrons get more than five hundredths of an inch from the surface before they slow down and then fall back into the hot metal.

THE STRANGE DISCOVERY THAT EDISON MADE

The first observer of the effect of electron evaporation was Thomas A. Edison. In the early days of incandescent lamp manufacture he noticed a peculiar action that could not be satisfactorily explained at the

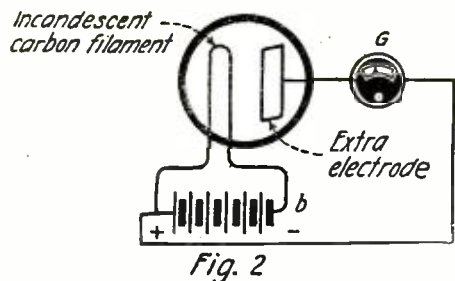

Fig. 2

Circuit for illustrating the "Edison effect" of electron evaporation.

time. In an ordinary incandescent lamp bulb he introduced an extra plate, having a connecting wire to the outside of the bulb, as shown in Fig. 2. Edison noticed, when the filament was incandescent, that if this plate were connected through a galvanometer to the negative side of the battery heating the filament, no current flowed through the galvanometer, but that if the wire *a* were connected to the positive side of the battery, the galvanometer showed that a current was flowing. This current stopped as soon as the filament cooled down, showing that it was an effect depending upon the temperature of the filament. Although the phenomenon could not be explained at that time we know that it was due to the electrons evaporated from the carbon filament. When the plate was connected to the negative end of the battery it offered no attraction to the electrons coming off the filament, but when made positive by being connected to the positive end of the filament it did attract the electrons, and so caused current to flow.

It is to be noticed that this current is due to the electrons evaporating from the filament, streaming across the vacuous space between the filament and plate, entering the plate, then drifting along through the wire and galvanometer, back into the filament, and so re-evaporating and starting on their course once more. The same electrons will evaporate many times if the filament is kept heated long enough.

For 20 years the "Edison effect" was known, but not used until Dr. Fleming, working with Senator Marconi in his early radio experiments, got the idea of using it in place of the coherer, as a detector, or rather a rectifier, of the high frequency signals.

HOW FLEMING APPLIED EDISON'S DISCOVERY IN RADIO

In the upper part of Fig. 3 are shown three groups of high frequency waves such as would be sent out by three spark discharges at a transmitting station sending out spark-wave telegraph signals. The frequency, or number of reversals per second, of the current set up in the transmitting antenna, and the corresponding current set up in the receiving antenna, might be 1,000,000 cycles per second and the number of these groups per second perhaps 1,000. As the ear cannot hear 1,000,000 vibrations per second, but can hear 1,000 vibrations per second, it is necessary to use in the receiving circuit some apparatus which will give one

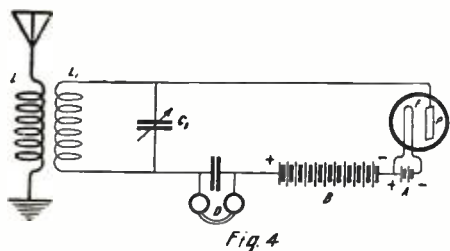

Fig. 4

Showing how Fleming used the Edison effect to make a useful piece of radio apparatus, the Fleming valve or rectifier.

impulse to the telephone diaphragm for one group of waves. If in series with the telephones there is some device which permits current to flow only in one direction (a device called a "rectifier") the current in the telephone will look as shown in the lower curve of Fig. 3. Each of these current pulses consists of a rectified (and smoothed out) group of waves of the upper part of the figure. Each of these current pulses will give one pull to the telephone diaphragm, and so the groups of high frequency waves, through the rectifier, do give in the telephone an audible tone of 1,000 vibrations, which is a musical note of that frequency for which the ear is most sensitive. In other words, the Fleming valve passed spurts or gushes of electricity instead of a steady stream, and these gushes came slowly enough to enable a telephone receiver to respond with an audible musical note.

Action of the Fleming Valve.—Fleming used the Edison effect to detect radio signals in the manner shown in Fig. 4. The filament *F*, was heated by battery *A*, the extra electrode *P*, which we shall call the "plate," was held at positive voltage, or potential, by battery *B*. Whatever electrons flowed to the plate returned to the filament by going through the telephones *D*. When a signal (high frequency wave-train as in upper part of Fig. 3) came in, the voltage between *P* and *F* was alternately raised and lowered about the average value maintained by battery *B*.

The plate current (amount of current

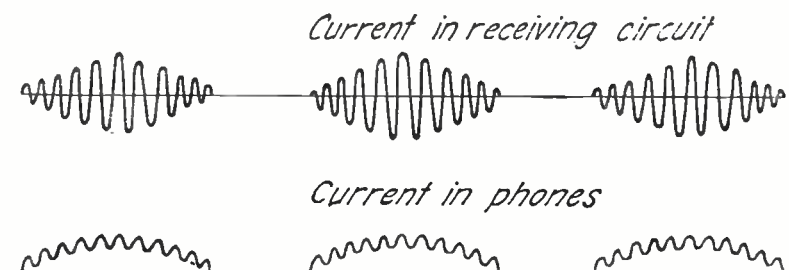

Fig. 3

from filament to plate caused by electron evaporation from *F*) varies with the plate voltage about as shown in the full line curve of Fig. 5; the signal voltage is shown below and the corresponding plate current shown to the right. It will be noticed that while the plate voltage increases and decreases symmetrically about its average value, which is the voltage of battery *B*, the plate current variation is not symmetrical about its normal value, owing to the curvature of the plate current curve. The average plate current, which flows through the phones, is indicated by the dotted line and shows an increase during the time the wave train lasts. From this it follows that if a series of wave trains similar to those shown in Fig. 3 is impressed on the antenna circuit of Fig. 4 the phone current will show a "hump" for every wave train; hence 1,000 humps per second, and this will give a note of 1,000 vibrations per second in the phones.

It will be noticed that when using the Fleming valve for a detector there is current flowing through the phones all the time, whether there is a signal coming in or not. But if a steady current flows through a telephone receiver no noise is sent off from the diaphragm at all; it is the changes of current only that cause the diaphragm to vibrate and sound.

When using a crystal detector no current at all flows through the phones until a signal is coming in, so the current will be about as shown in the humps of Fig. 3. When using the Fleming valve the phone current looks as shown in Fig. 6. There is always a large current flowing, and on the top of this are the humps of current caused by the

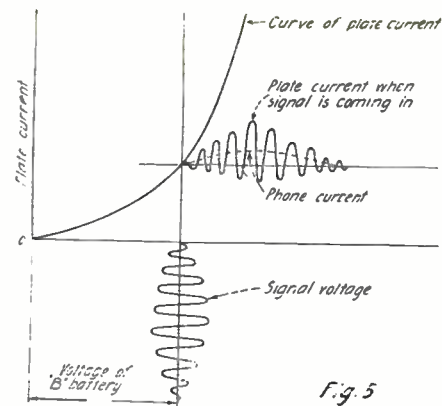

Fig. 5

When a high frequency voltage is received, the plate current of the valve alternately rises and falls; the rise is greater than the fall so that the average current through the phones is increased by the signal.

signal. The noise given off by the phone will be just the same, however, as it is for the current shown in the lower part of Fig. 3.

The foregoing analysis has been made on the assumption that the telegraph signal received was sent out by a spark transmitter, and we have shown that a musical note is heard in the receiving telephones which has a pitch fixed by the number of sparks per second at the transmitter station. In case a radio telephone signal is being received the voltage impressed on the plate of the Fleming

If a rectifier is connected in series with the telephones, high frequency voltages, as in the upper curves, will give through the telephones pulses of current, as shown in the lower curves.

valve will be a very high frequency current, the amplitude of which follows the shape of the voice-wave acting at the transmitting station. In such a case the current through the phones will be somewhat as shown in Fig. 6, but the humps in the current will not be regular and smooth but of a frequency and shape fixed by the pitch and quality of the voice acting at the transmitter.

DE FOREST INTRODUCES THE GRID

Probably the greatest single step in the advance of radio communication was due to De Forest. He conceived the idea of introducing into the Fleming valve an extra electrode in the form of a lattice or grid, this grid being so placed that electrons on their way over from the filament to the plate had to pass through it. Other names for this "three electrode valve," in more or less common use, are the *audion* (De Forest's original name) *oscillion*, *radiotron*, *pliotron* and *triode*. The last named seems to be the most applicable of the lot.

In reading the following explanation of (Continued on page 1646)

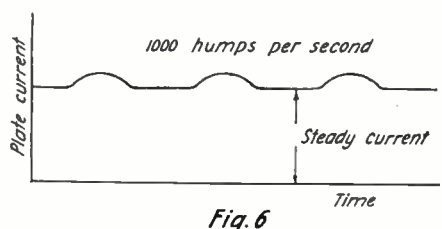

Fig. 6

When a spark signal of 1,000 cycles is received the current through the phones has 1,000 humps per second, giving a 1,000 cycle note.

Timely Notes on Aerial Installations

By HAROLD JOLLIFFE



Very few novices realize the importance of a good aerial installation. The feeble currents from long distance stations will never reach the receiving set if the aerial is poorly insulated or strung close to large metallic objects. Mr. Jolliffe has taken up all the important considerations in this article.

WHEN the average man-in-the-street decides to install a radio receiving set for the purpose of listening to the various programs of music, stock reports, educational matter and lectures that are being broadcast hourly for his amusement and edification, he is, almost without exception, in a very great hurry to get his outfit set up and in working order. In the majority of cases he has listened in on receivers belonging to friends and by so doing has become inoculated with the ever-contagious radio germ. Therefore, he does not rest until his own set is in operation.

In a way, this is natural and pardonable, for it is logical to assume that he is eagerly anticipating the novelty of experiencing the thrill of listening to what is transpiring at some point many miles away when he himself is comfortably seated in his favorite chair, with friendly pipe or a good brand of cigar at hand, before a glowing fire in his own home. It was this thrill that captivated the majority of us when we first delved into the ramifications of the fascinating and instructive hobby, whether we are of the old or the new school. It is still this particular phase of radio which continues to offer the greatest appeal and which, without the shadow of a doubt, places the reception of distant broadcast concerts far above all else as being the most popular form of home entertainment and pastime. For the beginner, the novelty has not yet lost its keen edge, so the quicker he can get his receiver working the better he likes it.

All very well. But—here's where the rub lies: Walk along a street in any fair-sized town and take note of some of the aerials that adorn the house-tops. In most cases, they are crude looking affairs that required no more than a half-hour to erect. In many instances, they have been installed with the intention of listening to a concert the same evening. No description is necessary; you have all seen them. Not a thought given to appearance, or efficiency for that matter. It shows what some people think of their prop-

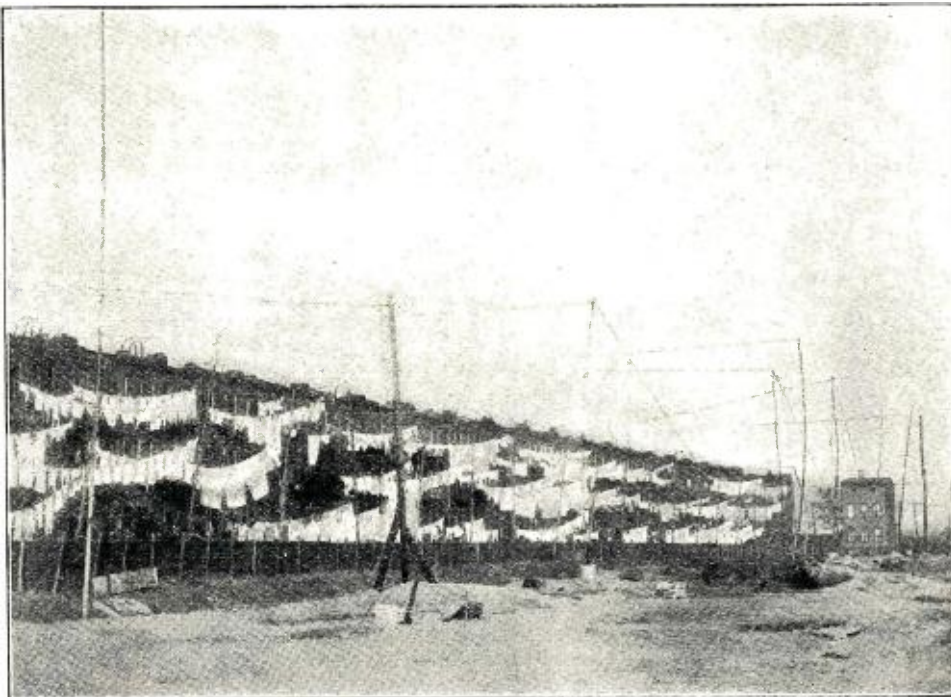

©Kadcl & Herbert

Very, very poor practice. All these aerials are parallel to each other, consequently each person interferes with the reception of his neighbor. These aerials should be at right angles to each other.

erty when they stick up something that looks as if it were intended to catch sparrows and not radio waves, on top of a beautiful house. They're in too much of a hurry to listen in and consequently will not take time to do a neat job. The whole idea seems to be to get the aerial up as quickly as possible and then go down and listen to So-and-So's Gloom Dispellers. As an acquaintance of the writer's recently said, "I'm going to put up a decent aerial next Saturday afternoon, but this will have to do for the present as I expect the crowd over to-night to hear the Jazz-bow Six from station XYZ."

THE USUAL METHOD

A great many of them, unfortunately, are of the same procrastinating, put-it-off-until-to-morrow, attitude in that they're going to put up a better aerial "just as soon as I've listened to a few concerts." But, somehow they never seem to progress past the "thinking about it" stage. The excuses they put forward are many and varied. Although many of them, doubtless, really do intend to make a few improvements, the original installation, in nine cases out of ten, is never improved upon, but is permitted to display itself prominently, for all to see, as a monument to the owner's sloppy, careless, don't-give-a-darn nature.

Viewing the matter from a different angle, i.e., from the standpoint of efficiency, the following presents itself as being worthy of the deepest consideration to those who are in the game for the greatest possible results:

It has been said time and again that the best results are obtained only by the intelligent use of the best apparatus procurable. This is an oft-repeated statement, but the more it is propounded the truer it becomes and it applies not only to the receiving equipment proper, but also to the antenna system. It may be said that the receiving range of any type of receiver, in connection with which no radio frequency amplification is employed to boost the weak signals before they are rectified, depends entirely upon the efficiency of the aerial when other conditions such as geographical, atmospheric, power of distant transmitter, skill of receiving operator, etc., are equal. This applies most emphatically to receivers of the crystal detector type and to non-regenerative audion outfits. The aerial *must* be efficient if the reception of long-distance stations, theoretically within the range of the receiver, is desired.

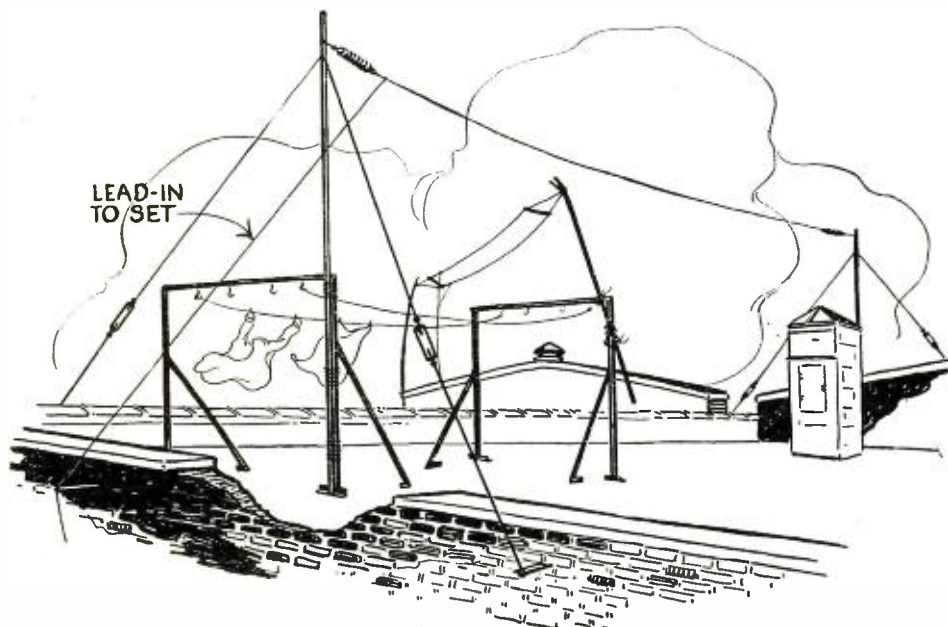

Is it necessary to say that the man with the single wire aerial, well insulated and well supported, gets much better results than the man with the small, uninsulated, poorly supported two-wire aerial?

(Continued on page 1664)

Possibilities of Unique Receiving Circuits

By MORRIS S. STROCK

ASST. PHYSICIST, BUREAU OF STANDARDS

A very interesting outline of experiments with new forms of receiving circuits carried on by Mr. Strock, of the Bureau of Standards Laboratories. This opens up a new and colorful field of endeavor for those absorbed in the art of radio reception.

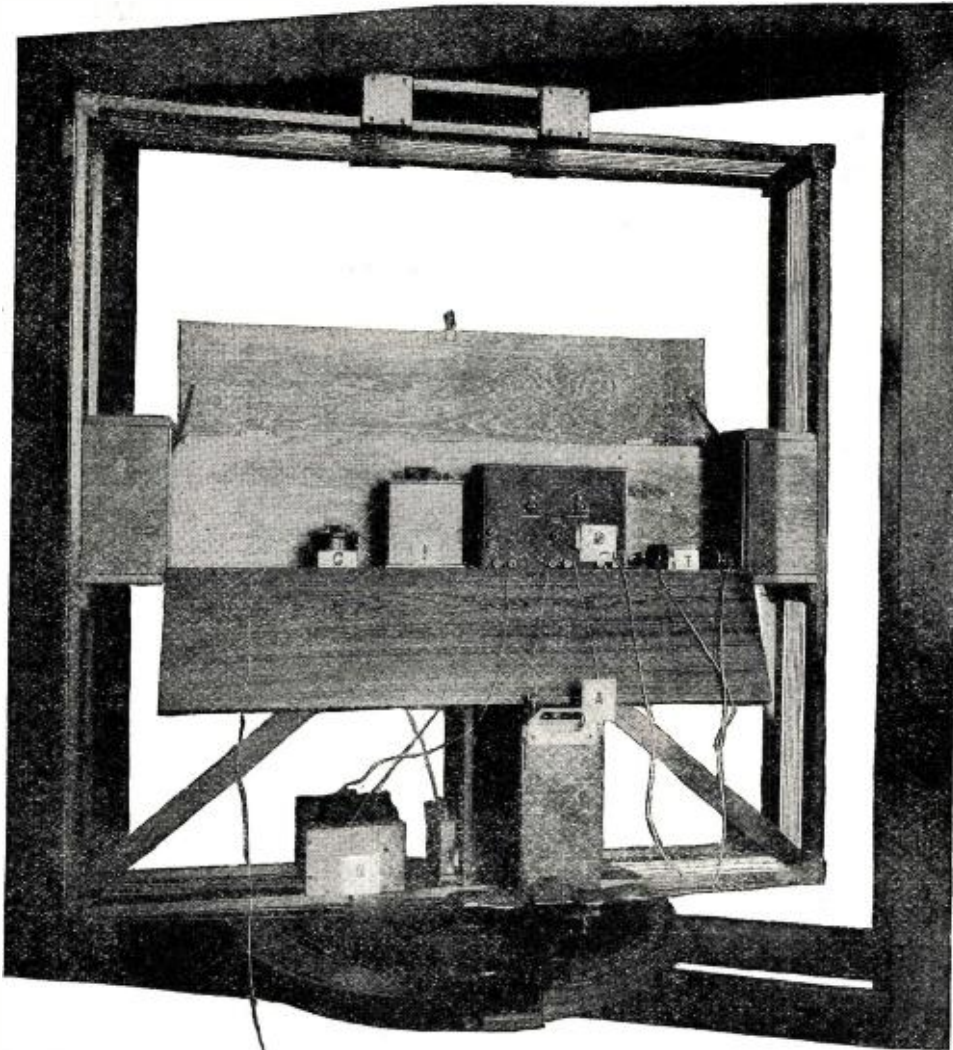

Fig. 3. Apparatus used in the indoor experiments. The vertical wire at the left of the battery B is connected to earth.

IN Fig. 1-A is shown, in conventional form, a grounded vertical antenna, a vertical oscillator. Such a device has a natural period of oscillation which depends upon certain electrical characteristics, which in turn are influenced by its height or length. If, while a transmitting station is emitting radio waves, the height of the vertical oscillator could be varied, it would for some particular height become "tuned" to the transmitting station and oscillate at the same frequency. A high electrical potential would then be manifested at its free end.

A method of varying the height of the antenna, electrically speaking, is to insert in it a coil of wire so constructed that its inductance can be varied. This is conventionally shown in Fig. 1-B. Now if the inductance of the coil be increased, the physical height of the antenna must be proportionally decreased if it is to remain in tune with the transmitting station. We may then still further increase the coil inductance until the antenna becomes squeezed down in compact form. In effect it is an antenna; actually, it

is a grounded conductor which can be tuned. If the free end of this conductor which has a high electrical potential, be connected to the grid of an electron tube, we might expect the effect to be registered in the plate circuit of the tube.

The writer proposes the discussion just given as a basis for experiments with novel receiving circuits. Reception circuits in general are described in numerous radio articles and most of them have been tested and proven to be reliable. To the experimenter, the fascination of trying out such circuits is usually lost, since many of them are substantially the same and the results may be very well predicted in advance. Most radio articles also assume that the open antenna (or aerial) and the coil antenna (also called loop antenna or radio compass) are the only means of intercepting the radio waves.

In this article are described experiments which gave code reception from a distance of 200 miles without an antenna or loop antenna. In making this statement, the term loop antenna is defined as any coil of wire having directional properties. In other ex-

periments which gave improved results, the loop antenna was used in conjunction with the original circuit. The complete scheme of connections is new—at least the writer has never heard of such circuits being used.

Eventually some of the circuits were combined to give an effect such that the absolute direction of the transmitting station could be determined. This idea was the basis of a patent which was dedicated to the public as explained at the close of this article. However, only the most significant results are submitted in this article so that the person who is interested in experimenting may use these novel circuits as a basis for others. Just now the numerous broadcast stations offer a great advantage in making such experiments. Indeed, it should be possible to obtain some interesting results with relatively insensitive apparatus.

APPARATUS USED

Some of the experiments were made in the open air, while others were made in the laboratory. The apparatus used in these outdoor and indoor tests will now be briefly described.

The outdoor experiments were made in a fairly unobstructed location, there being no trees, buildings or other obstacles closer than 75 feet. The apparatus, exclusive of that which will be specially mentioned later, is shown in the photograph, Fig. 2, and included a variable inductor (I), a variable condenser (C), a six-tube detector-amplifier (M), telephone receivers (T), "A" battery (A) and "B" battery (B). The amplifier consisted of three stages of radio frequency amplification, a detector, and two stages of audio frequency amplification. The "A" battery was insulated from the ground, but occasionally it was placed on the table. This had no effect upon the received signals other than necessitating a slight readjustment of the tuning units.

The indoor experiments utilized the same apparatus, but instead of being placed on a table it was arranged on a horizontal shelf at the center of a four-foot loop antenna which rotated about a vertical axis, as shown in Fig. 3. "A" and "B" batteries were placed on the lower part of the rotating framework. A ground wire was led by a circuitous route to the apparatus.

GROUNDING INDUCTOR TO INTERCEPT WAVES

All experiments in this group employed the

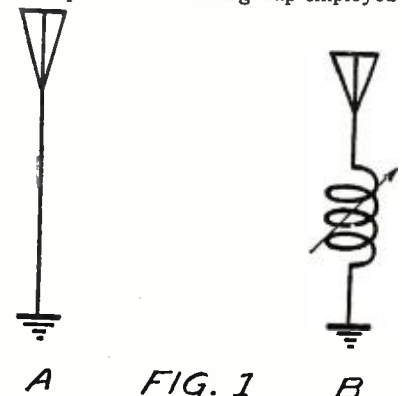

The electrical height of the grounded vertical antenna shown at A can be changed by the insertion of a coil of wire as at B.

connections shown at Fig. 4. This applies the voltage from the tuned inductor to the grid of the electron tube. The inductor acts as an antenna in extremely compact form. The amount of energy which the device picks up from the radio wave depends mostly upon its vertical height measured from the point where the ground connection forms contact with the true conducting earth. Although the device is, in effect, an antenna, its physical dimensions are too small to make this definition acceptable.

In the very first experiment, signals were received by carefully adjusting the inductor and variable condenser (Figs. 2 and 4). In this and most other outdoor tests, the table was placed over a wire screen about eight feet square to which was attached the ground wire. This wire was sometimes connected to a water faucet, but the intensity of received signals was about the same. The signals were received from a code transmitting station 200 miles distant and their wavelength was about 2,700 meters. The signals were of very good audibility, about one-half that which could be obtained from a four-foot loop antenna connected as conventionally shown in Fig. 5. For best signal strength the variable condenser (Fig. 4) was set at a very low capacity. When a length of insulated wire was connected to the grid amplifier terminal and allowed to lie upon the screen, a tendency of the circuit to be noisy and unstable was very much reduced and when the inductor was carefully readjusted the signal strength was the same as before. This wire was probably acting as a very high resistance and permitted some of the excessively high potential charge of the grid to leak away. It is interesting to note that when the inductor as a unit was turned about in various positions, the signals did not change in intensity, which showed that there was no directional effect and that therefore the device was not acting as a loop antenna.

A little variation of the tests just described was afforded by connecting the variable condenser in series with the wire leading to the grid amplifier terminal. Just about the same results were obtained, although it was necessary to use the condenser at a rather high setting.

INDOOR WORK

Some effects obtained indoors with the apparatus arranged as in Fig. 3 but using the same circuit as Fig. 4 may be interesting.

Since the floor of the laboratory is several feet above the ground, and since the shelf of the rotating framework upon which the inductor was placed was several feet above the floor, one might expect to pick up a greater amount of energy. This was indeed

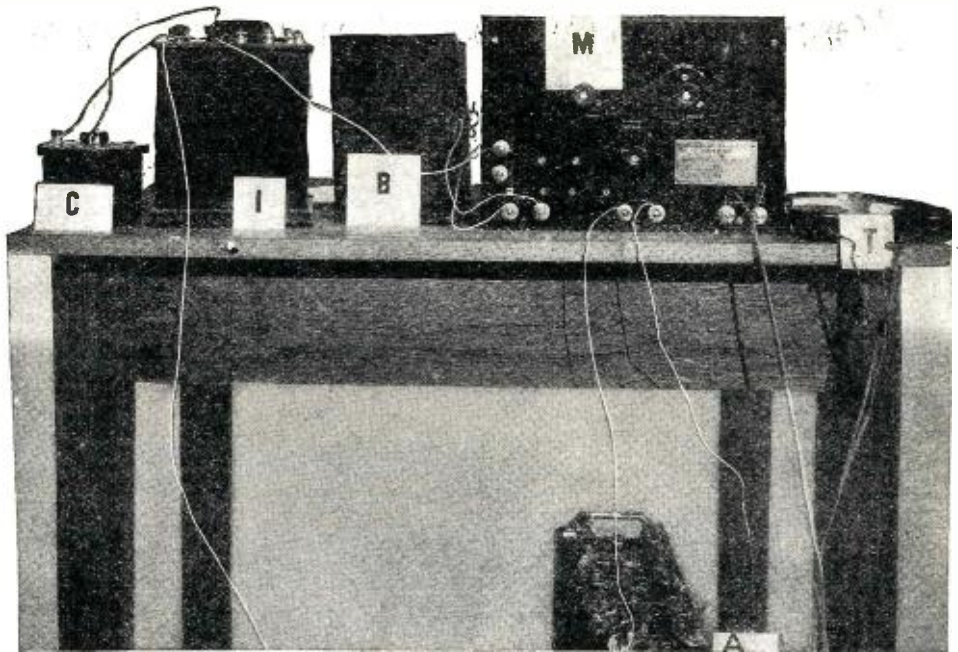

Fig. 2. Apparatus used in most of the outdoor experiments. The wire near the left table leg connects to a metal screen on the ground.

found to be the case, as evidenced by the fact that the same station received in the outdoor tests could usually be tuned in so as to give a louder signal than the loop antenna itself, connected in the ordinary manner,—that is, as shown in Fig. 5. The

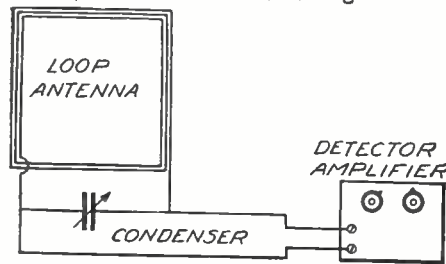

FIG. 5

The manner in which a loop aerial and variable capacity are usually connected to a detector or amplifier unit.

adjustments were more critical than in the outdoor tests; this could probably be attributed to a considerable number of electrical disturbances in the vicinity of the laboratory.

An interesting measurement was made upon the intensity of atmospheric disturb-

ances (static). Using the settings of the inductor and condenser, which tuned in the station just mentioned, an audibility meter gave a static audibility reading of 800; the same amplifier was then connected to the rotatable loop antenna as ordinarily used,—that is to say, as shown in Fig. 5,—and a second audibility measurement of static gave a reading of 1,000.

Static effects an oscillatory system by shock excitation, that is, it sets it into oscillation at its own natural period and since the special connection to the grid was found too sensitive in adjustment, it might be expected that such a system would be greatly affected by atmospherics. In addition, static disturbances may usually be assumed to come from all points, but the loop being directional would not be sensitive to all these disturbances. Although the audibility meter is a rather inaccurate device, particularly when measuring sounds of such varying intensity as static, still there was enough difference in results from the two circuits being compared to be noted readily.

Summing up the tests just described, it may be stated that this novel circuit has some interesting possibilities. Although it is critical in adjustment, it seems to intercept more energy from the wave than a loop antenna of average size; the sensitivity of the system is increased by increasing the height of the apparatus above the ground. In passing, it should be noted that the insertion of something in the form of a very high resistance,—such as the cotton insulation of a wire,—across the condenser terminals, makes the circuit more stable. The next group of experiments combines this circuit with the loop antenna.

COMBINING A GROUNDED INDUCTOR AND A LOOP ANTENNA

All experiments in this group, used the circuit shown at Fig. 6 (conventional form of Fig. 4), in combination with a single connection from a loop antenna; that is, the circuit conventionally shown in Fig. 7 was employed and the actual arrangement of the apparatus (indoors) is shown in Fig. 4. Here the voltage from the tuned loop antenna is combined with the voltage from the inductor. The former voltage is applied to the filament; the latter voltage is applied to the grid. Thus although the loop antenna is used, its method of connection is different from that ordinarily employed.

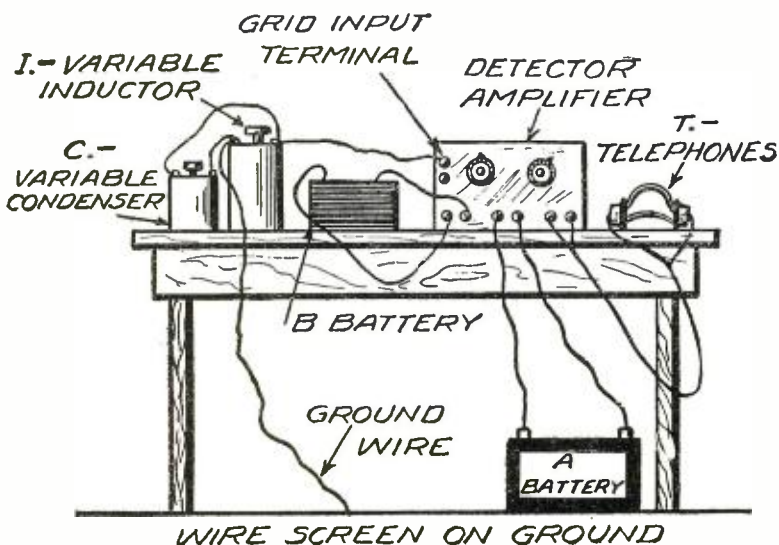

FIG. 4

The connections employed during the first group of experiments with a grounded inductor.

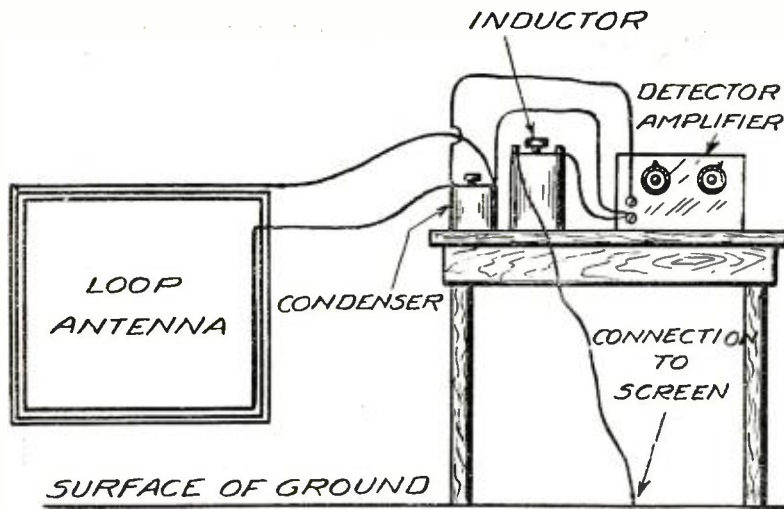

FIG. 8

Essential connections combining a loop antenna with a grounded inductor. The phones, "A" battery and "B" battery are not shown.

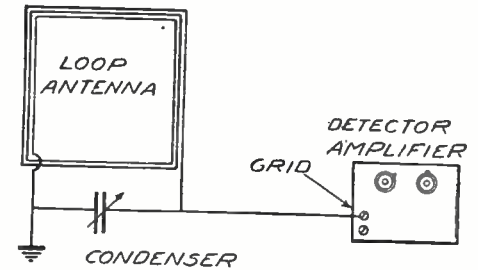

FIG. 9

Connections which led to a trial of the circuit of Fig. 10

Experiments involving this circuit gave further interesting results in that it was less difficult of adjustment and the signal strengths were usually better than those obtained from tests in the preceding group; the signal audibilities were also, in most cases, quite noticeably better than those obtained from the ordinary loop antenna connection of Fig. 5. It must not be inferred from this that the new circuits are at par with the loop antenna, for although the circuit of Fig. 7 was less difficult to tune than the grounded inductor previously employed, it was, nevertheless, very critical in adjustment. Quite aside from this is the added objection that the special circuits were, at best, noisy. The point to be stressed is that when adjustments were properly made, these circuits did give better signal audibilities than the ordinary loop antenna.

A little detailed explanation of the tests involving the circuit of Fig. 7 will now be given; all of these tests were made in the laboratory.

In the first experiment it was noted that when the loop antenna (Fig. 3) was oriented for a maximum signal its plane was in alignment with the transmitting station, this being the same directional effect obtainable with the ordinary loop antenna connection. It was further noted that rotating the loop antenna through 180 degrees produced at times a different signal intensity in the new position. This was most probably due to a shifting phase relation between the voltages applied to the grid and filament. The signals used in this experiment were received from a distance of 70 miles and had a wave-length of 600 meters. These results were later confirmed on signals of undetermined origin and having a wave-length of 1150 meters. Again, signals of a wave-length of 1,600 meters were received from a distance

of 70 miles and similar results noted. Finally, a number of separate tests were made upon a 2,700-meter station 200 miles distant, giving further confirmation of the results noted above.

A result of special interest was obtained in one of the tests made above, wherein 600-meter signals were being received; when the wire connecting the inductor to the ground was removed, the signals became

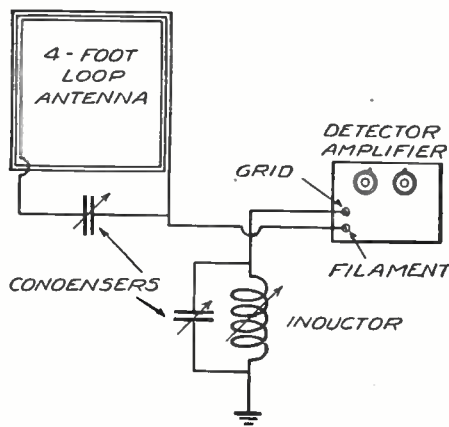

FIG. 7

Schematic connections of circuit which utilized voltages from loop antenna and grounded inductor.

faint, but they were still readable. When this wire was again connected and the wire leading from the other inductor terminal to the grid amplifier terminal was removed, the signals were lost. Quite evidently the ungrounded inductor was picking up an appreciable amount of energy!

The summarizing of these tests is actually included in the introduction to this group, yet one point is well adapted for a concluding statement, namely, that the addition of the loop antenna to the original circuit gave somewhat more satisfactory results.

MODIFICATIONS OF THE TWO CIRCUITS USED

Under this heading experiments are described which used practically the same apparatus as described at the beginning of this article. By referring to the photographs it will not be difficult to understand its arrangement.

The first experiment of this group was made out of doors. In addition to the usual equipment, a loop antenna consisting of five or six turns of wire on a wooden frame nine by four feet, was employed. This is not shown in Fig. 2, but the wiring of the complete circuit is shown in Fig. 8. Here

achieved is, however, summed up as follows:

By properly tuning the inductor, the loop antenna was made to act both as a loop antenna and as an ordinary antenna; it could then be held in any position, except horizontally, without greatly affecting the signal intensity. When the condenser was detuned the signal strength was decreased because the effect from the loop antenna was lost. The results show that both loop antenna and ordinary antenna effects were manifested.

The last two experiments were made in the laboratory and as they are rather closely related, they will be discussed so as to emphasize this relationship.

It has been shown that a rather sensitive arrangement may be obtained by applying the voltage from a tuned circuit independently to the grid terminal of the amplifier as for instance, in the case of a grounded inductor tuned to resonance with the received wave (Fig. 6). It was also shown that if the inductor be shunted by more than a very small capacity, its sensitivity is lost. Applying these ideas to the loop antenna, the connections were made as shown conventionally in Fig. 9. When the condenser was properly adjusted, signals from a 2,700-meter station could be easily read. The loop antenna gave a directional effect, but the signal intensity was considerably less than that obtained from the ordinary loop antenna connection. When the ground wire was removed, the signal was but little changed.

These results were rather to be expected, but they strengthened the idea that very good results should be obtained if one terminal of the tuned loop antenna could be applied to the grid as before, provided that some means could be used to increase the voltage impressed upon the grid. Accordingly, the connections shown in Fig. 10 were

(Continued on page 1656)

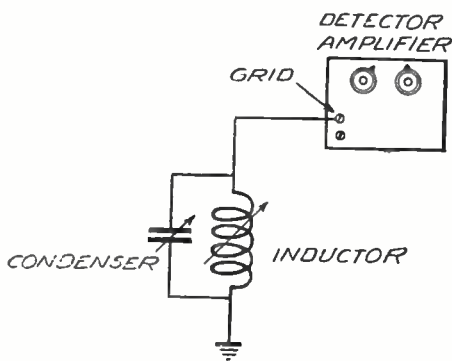

FIG. 6

Connections which give a louder signal than the loop antenna, when the inductor was critically tuned.

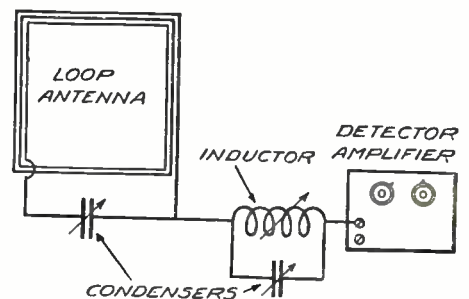

FIG. 10

Connections impressing a high voltage upon the grid of the amplifier tube.

Wired Radio Experiments for Amateurs

By DR. KARL ROTTGARDT*

PART II

IN the previous article of this series, a system of wired radio communication used between central and sub-power stations and also arranged in such a manner that it would be used in conjunction with ordinary line telephony, was described. The details of the method by which the high frequency waves generated by an ordinary thermionic valve oscillator were transferred to the high tension lines as well as the method which was used to pick them up at the receiving station and the use of different wave-lengths for each transmitter in order that simultaneous two-way conversation could be carried on, was thoroughly described.

This article details some methods through which the amateur may carry out further

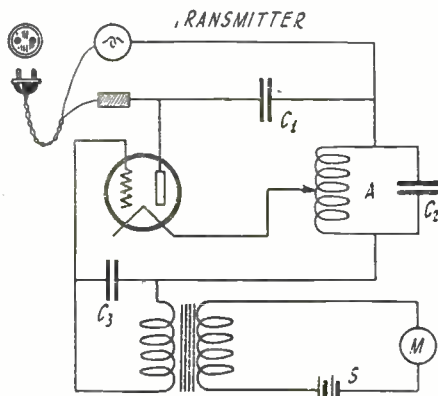

Fig. 3

Transmitter using the grid system of modulation. The lighting circuit supplies plate voltage and acts as the antenna.

investigations along the same line. Various protective precautions, as well as the values for various circuits and hints as to operations will be given in this, the second article of this series.

The principle of wireless telephony on high tension lines was explained in a former paper. Everyone who is interested in the problems of this system of telephony has not an electric station at hand with transformers and appliances similar to those described before. He must, therefore, look for a substitute field for his experiments. He generally has such a field available in the electric light conductors in his own home. (See Fig. 1.) Each socket in the different rooms may serve as an electric station. The leads running from socket to socket are his high tension conductors, and it is his work to connect high frequency apparatus to lamp or to socket, and therewith to speak from room to room, or perhaps, from house to house.

But before experiments can be started, it is necessary to prevent the waves which pass over his light wires carrying the tele-

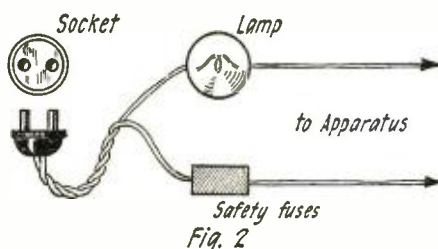
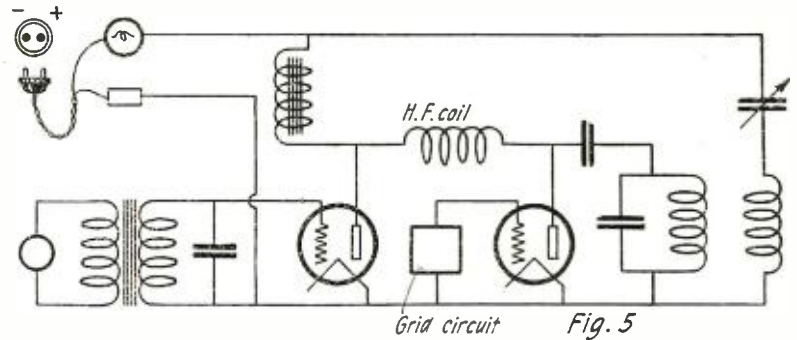

Fig. 2

Short circuiting of the line is prevented by a lamp and a fuse of small value.

In this transmitting circuit the Heising system of modulation is employed. One tube acts as an oscillator and one as a modulator.



Grid circuit Fig. 5

phonic messages, from straying off out of the house and going, without permission, to his neighbor, who is on the same circuit. This is effected by putting a high frequency choke coil between the electric meter and the point where the house circuit connects with the main power line. The choke coil will naturally affect the house system and, therefore, the one selected must have the lowest possible ohmic resistance in order to cause the least effect. That is to say one must be used that has a large iron core or jacket, with very few turns of wire and that of large cross-section. It is advisable to keep the ohmic resistance of the choke below one ohm.

The following observations are restricted to direct current installations.

Our amateur lives in the dwelling B, and has three rooms at his disposal; in each, there is a socket. In room No. 3, with socket 3, is his laboratory. The proposition is, in the simplest possible aspect, to talk through the medium of electric waves over his house wires from one room to another. Here again the simplest problem is for him to speak only from room No. 3

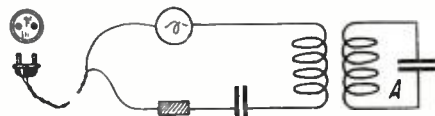

Fig. 4.

Working circuit of the transmitter. "A" is the same oscillating circuit shown in Fig. 3.

and to be heard only in room No. 1 or No. 2. This example will be enlarged upon.

The next step is to insure the power lines against short circuiting. Accordingly, everywhere between the plug and the radio apparatus there is connected in the circuit a lamp of the circuit voltage, together with a fuse of small value. The lamp will not give normal incandescence, as the current it passes is far too slight for its regular brilliancy.

As transmitting tube, an ordinary receiving tube—for example, a UV-201—may be used with 100 volts potential, applied to the plate. This voltage will give quite adequate oscillations. Naturally, smaller tubes may be adopted; only due regard must be had to the plate potential they will stand. If, as in Fig. 3, the potential of the house circuit is taken as the plate potential, caution should be used to see that the smaller tubes will stand the 100 volts.

Coming now to Fig. 3, the positive lead of the lighting circuit passes from the socket to the safety fuse and light to the plate. The negative lead passes from the socket to one side of a variable condenser C_1 , of .001 mfd.

capacity which is placed across the two power leads and then to the inductance L of 90 microhenry connected to the transmitting tube grid. The grid is also connected to the terminal of the self induction coil of the oscillating circuit, through the secondary winding of the transmitting transformer (parallel condenser $C_3 = .00022$ MF). This induction coil is connected in parallel with the condenser $C_2 = .0011$ MF. This gives a wave-length of about 600 meters. The proper point at which to tap the coil L must be found by trial, so as to get the best and most stable oscillating effect. If one speaks into the microphone M, connected to the primary winding of the telephone transformer with the low current source (dry battery S), modulated oscillations will be delivered to the wires through the condenser C_1 . The best transmission must be sought by adjusting C_1 . This completes the transmitter.

It naturally rests with every amateur to choose the transmitting and receiving connections which will be most convenient and give best results. The selection of these will present no difficulty to the experienced amateur. It will also be an easy matter to use special "A" and "B" batteries, in case it is impossible to use the lighting supply.

Instead of directly transferring the oscillations from the oscillating circuit LC₂ to the circuit line, it can also be done by induction, as shown in Fig. 4. Fig. 5 shows a connection on a telephone transmitting system of another order (Kuehn hook-up) using inductive transfer of the oscillations from the operating circuit to the line.

We now come to the receiver (Fig. 6). An ordinary vacuum tube connection, such

(Continued on page 1666)

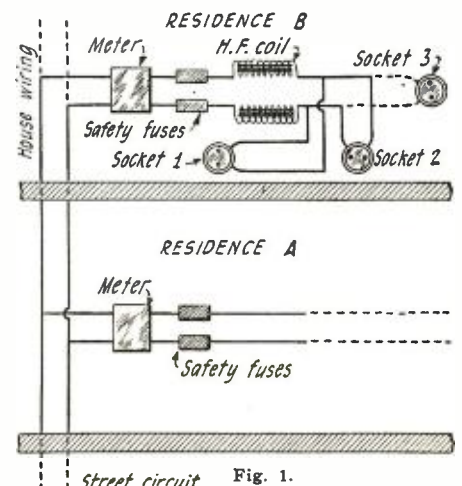

Fig. 1.

Showing the protective measures to prevent high frequency surges into the line.

* Director of the Dr. Erich F. Huth Company, m.b.H.



The Second District Amateur Convention

By A SUGAR CURED HAM

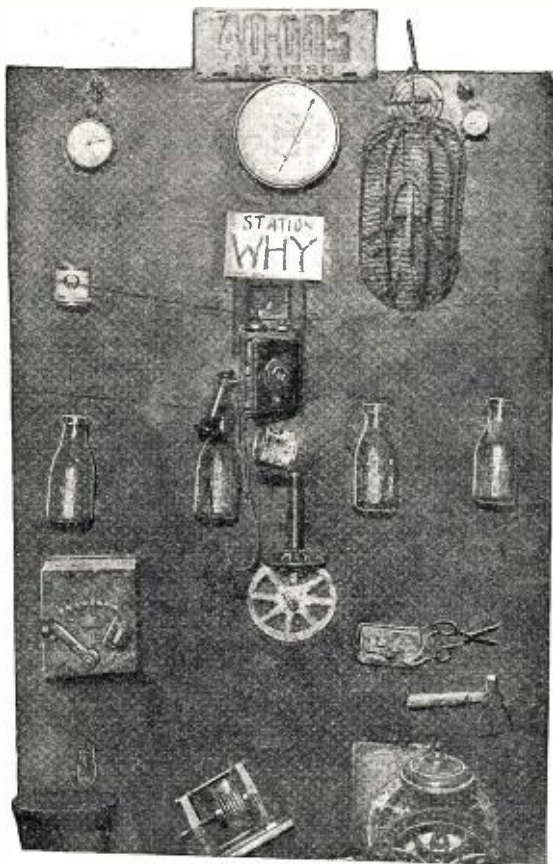

© Foto Topics, Inc.

Station WHY is now in competition with WEAF. Having four 5-K.W. bottles, one pacifier and three osculators, they expect to blanket the country with their milky wave.

THE fourth annual Ham convention of the second district opened with a zip on March 3, and closed with a bang on March 7. The boys, as the custom goes, picked the Hotel Pennsylvania as the official camping grounds, and a fine place it is. The out-of-town Hams can vouch for the comfort of that Hotel and say a word or two in favor of the excellent management.

We arrived in time for the fireworks and got the first rocket in the eye while wandering around Penn's lobby. A bell-boy spied us and immediately, without even a preliminary sign, balled out "radio in the blah-blah rum—take elevator end o'hall to yer left." If we had been carrying vacuum tubes minus the boxes we could have understood his outbreak, but as it was, we had the same appearance as the next person. They say these bell boys have their sixth sense well trained. Let it stand at that.

After a half hour we located the elevator that was taking the Hams to the "Blah-blah room" and eventually landed in the paradise garden all blooming over with radio.

THE CIRCUIT DIAGRAM

The circuit diagram of this here place is queer. We passed booth after booth of commercial stuff, all kinds of trick receivers

built for the parlor, but nary an amateur layout in sight. "We've been bunked," I yelled to my second op'. "Dit dah dit," said he, "let's go!" We started, but didn't get more than one meter away when we heard someone calling CQ with a Flivver horn. This was answered with everything from a police whistle to a siren. Grand and glorious-feelin'? Oh boy; we had our "loop ears" trained on 'em in no time and dashed for a set of stairs over in one corner of the room, laughing and shouting as we climbed them into Hamland. There was the gang; there were the sets—zowee, and here's what we saw!

THE HAM LAYOUT

The Radio Association of Greater New York headed the list, followed by the Ridgewood Radio Club, which was the proud displayer of 20M's prize gold lined silver drinking cup. It's a dandy and we envy 20M. Then there was the Hackensack Radio Club (Hackensack is noted for its "meadows"). The Married Men's Radio Club, whose booth contained no living being when we struck it (We wonder why?), had a couple of fine looking super-het sets on exhibition. The Hudson River Yacht Club was next and then the Bronx Radio Club, which had a regular Ham station built into the booth and it was the Rat's Rubbers. We felt right at home. The Radio Club of Brooklyn had a new transmitting circuit on display which we were lucky enough to get a photo of. Their 5-KW water

cooled tube went fluey while we were standing near by. One of the boys had to go out and get another milk bottle! The Hudson Radio Club had a nice layout of well built sets. The Radio Club of Long Island and the Rockville Center Radio Club didn't leave anything out of their booths. We saw a couple of nifty transmitters that we should have liked to trundle home with us. This they wouldn't allow, though, so we moved on the booth of the Radio Club of Jamaica and studied the miniature antenna systems they had on display. The Staten Island Radio Club came next with a neat bunch of vacuum tubes, including every type from the old Mooreheads to the new XL babies. Last, but not least, was the Bronxville Radio Club with a cracker-jack display of home-made receivers, including two employing "antenna regeneration," a Radio Corporation stunt.

We talked a bit with some of the gang and then beat it off to take in Broadway while waiting for the big feed.

THE OPERATION

The food operation took place on the night of March 5, and believe us, we got in such high spirits we could have smashed our pet five-watter and laughed it off—and that's going some! There was plenty of noise made so as to produce a bit of local color; it made the boys feel as if they were at home with the "ear muffs" on, as some BCL's call the "cans." Still we felt that if some of the boys had left their fog and automobile horns at home we would have enjoyed ourselves much more. The speakers of the evening found it pretty tough at times to make themselves heard. Oh, well, they say boys must be boys and it certainly sounds logical, but we wish the originator of that clever little saying had been there. We piped the celebrities right off the bat, and in naming them we stick K. B. Warner in front. Then there was "Paragon" Paul F. Godley, Mr. Bogardus of the radio inspector's office, who handles the "lid," Arthur H. Lynch, Lloyd Jacquet, Editor of *Amateur Radio*, the official organ of the 2d district, George Clark *artiste-comédien* of the party, and a great little joy-maker he is. And don't let us forget 2PI, a natural born columnist, although



© Kadel & Herbert

Mr. Charles Murphy, 2CTG, and his eight-tube super-het which he exhibited at the convention. It is very original in layout and design and we just bet it grabs the DX.

the newspapers haven't found it out yet. When they do, guess he won't find time to continue his radio column.

There was at least one Ham present from every district and also Canadian 2CO, as well as Canadian 2BN, who has that "re-converted Westinghouse transmitter."

The speakers of the evening were Mr. Howell, Mr. Warner, Mr. Godley, Mr. Bogardus, Mr. Lynch, Mr. Jacquet, Capt. Arnold of the U. S. Signal Corps and—of course—Mr. Clark.

The Bronx Radio Club won a guaranteed one half of one per cent. wavemeter for having the best exhibit, and by gosh they did. Thus ended the banquet and a glorious one it was. We hung around though, and got in on the arm waving and rag-chewing until someone said that the Singer Regeno-duplex was the best circuit, when we knew that there was a BCL in the crowd. We beat it for bed and dreamed of 6,000 miles on a five-watter.

TO THE 202—WHO BLEW
(Oujia, please apologize to Shelley)

I

VT quench the glare of power
Struggling on thy glowing plate;
Coolness for this hour
Or you'll wreck your destiny;
For the ray morn's bloom revealing
Can never boast so bright a hue
As that which mocks concealing,
And sheds its loveliest light in you.

II

Yet is the key departed
Which bound thy lovely plate to this?
Has decay already started
While you are so cold as this!
Yet, though blinking, soft one,
Power's self thy cup has given,
'Steen watts, 'twas all you'd give, son,
Wish you better luck in Heaven.

III

Existence you should barter
For a dream so dear as mine,
And smile to bow a martyr
To ambition's bloodless shrine.
Nor would I change for pleasure
That withered plate and ashy grid,
For your glass enshrines a treasure
Of DX you went an' did.

L. W. Hatry, 5XV.

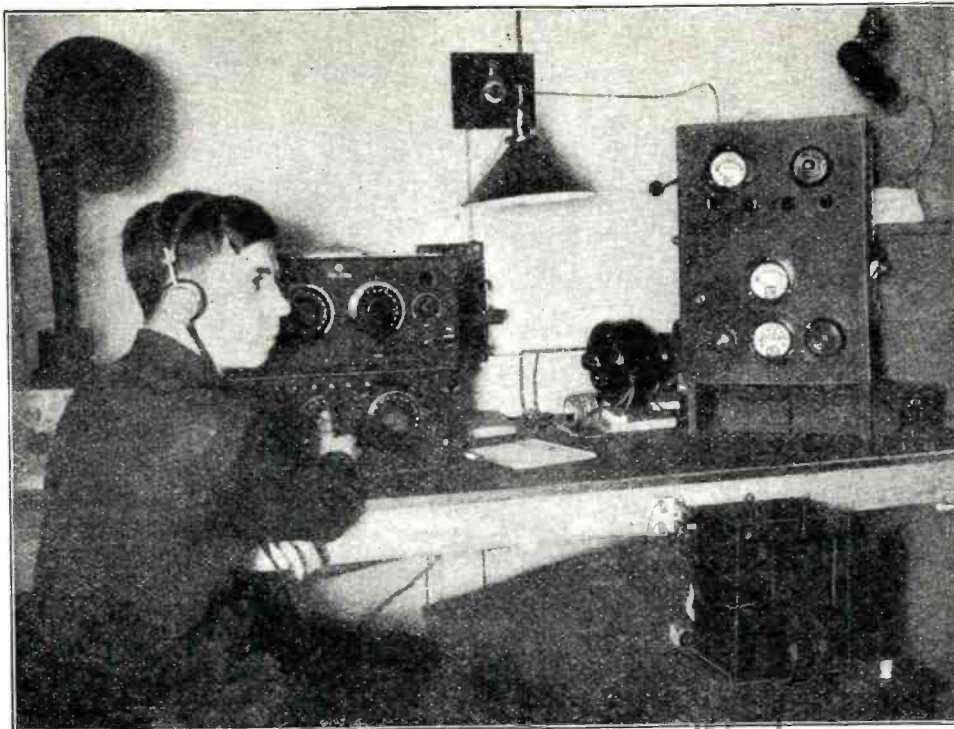

© P & A Photos

Frederick Mumm, 9CVS, recently made a nice little record by breaking through to New Zealand. His C. W. has been heard in Europe a number of times.

Hamitorial

WHILE THE SUN SHINES

ONE quite often feels that research along some definite line must be close to its termination only to have some new field opened up right under his nose. How many times has this happened in the radio field? Recall the running jumps made in the old days, from crystal detector to the two element valve, then to the three element valve, each a pleasant jolt on the radio complex. Research in any line of endeavor is bound to bring about new discoveries and open up new fields. The amateur has a distinctive advantage of profiting by every new discovery, and incidentally prove an important factor in actual development work.

With each new advancement that can be profitably applied to amateur radio, yells of delight issue from every district and transmitters or receivers are hastily dismantled and assembled again in a new form with the incorporation of either an improved piece of apparatus or a new circuit. Immediately thereafter old DX records are broken and a new page is written in amateur history. But such events are not sufficient to keep the average amateur in a peaceable state of mind for any length of time. There are always new fields to conquer. It is all important that he reach out further, and to accomplish such a feat as the addition of possibly only a few more miles to his transmitting range, he will labor day after day in constructing and reconstructing his antenna or counterpoise system or some other detail of the entity, and stick to it until he has attained his ambition. When his transmitting range reaches the 2,000-mile mark, he must then strive for the 3,000 mark and so on. There is no end to it, just as there is no end to research work. The amateur has, does and will contrive new systems that will further increase the efficiency of his transmitter.

All notable DX work, as we know, is carried on after dark and at early dawn. Very little in the way of DX transmission in the daytime has been accomplished. Daylight is an obstacle at present, but it will not continue to be one. With the new broadcast craze that has swept the country, the amateur has had to ease off a bit and give a goodly portion of the evening ether to the new born radio broadcast enthusiast. Consequently, if relay work or DX work is to be handled, it necessitates burning the midnight oil.

Working in the day time, and there are numerous Hams who are in a position to do so, is not desirable at the present, for two reasons. First, as previously mentioned, DX work is hardly possible, and second, taking away the DX takes away the kick.

A few amateurs have found a new field in 100-meter work and more are turning to it every day for this band is free from the common forms of interference, and hence offers better opportunities for long distance

(Continued on page 1675)

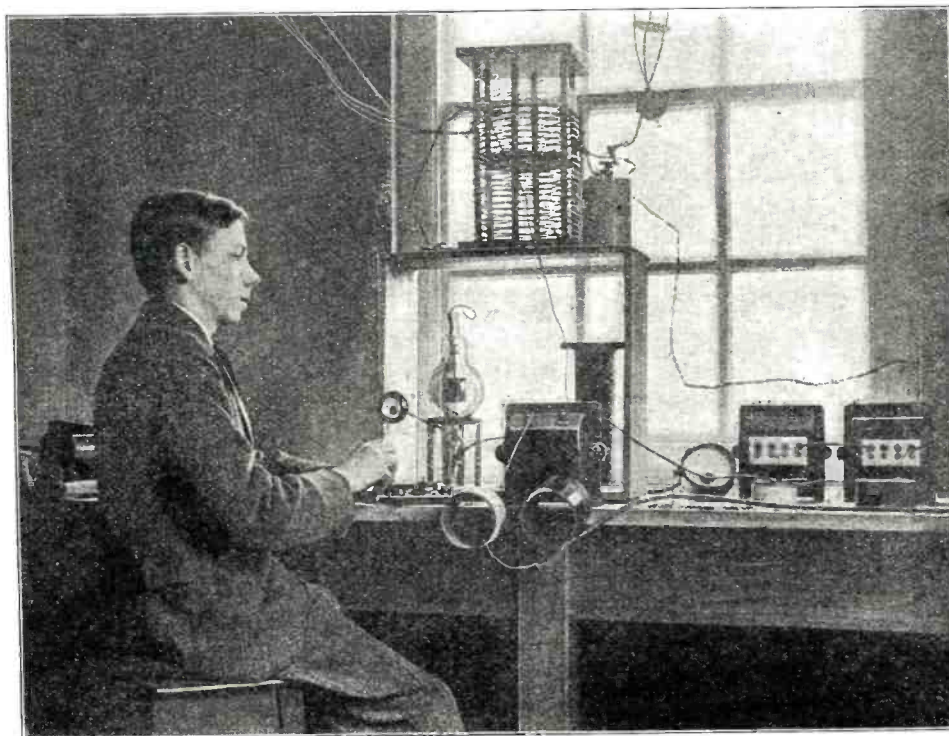

C. W. Goyder, a young British amateur, who has been communicating with an amateur in Pittsburg. The distance is estimated at 3,500 miles. All of Mr. Goyder's apparatus is home-made.

Pierre Louis' Station, F8BF

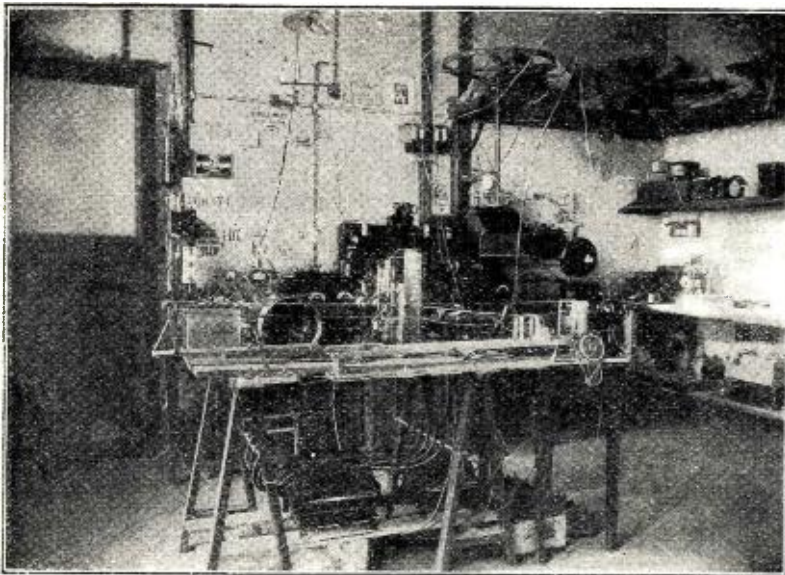

The left photo is that of the transmitter at F8BF. On and under the table may be seen the apparatus and power supply. On the right is a view of the receiver. Note the American cards on the wall.

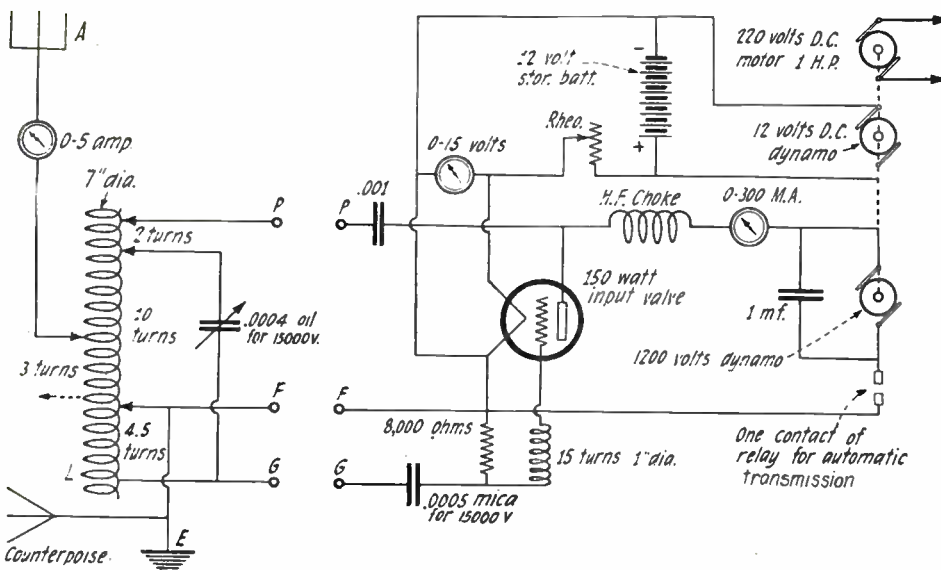
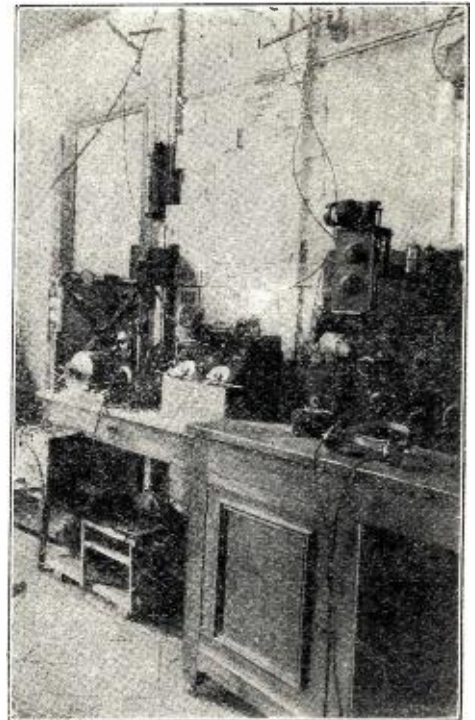

Mr. Louis' short wave transmitter is so constructed that a different oscillating circuit may easily be substituted to work on a longer wave. The circuit shown above is that of the 108-meter transmitter.

STATION F8BF was the second one to establish two way communication with the American amateurs. This station was heard on December 11, 1923, by 2AJF and also by C1DD and C1BQ and on December 16, two way communication was established with U1MO during three-quarters of an hour without a single interruption. Since, contact was established very often with U1BW, U2AGB and U1BDT. The transmitting set used during this test, shown in one of the photographs, was tuned to 108 meters working with antenna of 175 meters fundamental period. Two 50-watt tubes with 1,200 volts on the plate supply the power and the intensity in the antenna varies from .8 amp. at 108 meters to 2.4 amp. at 195 meters.

The receiver consists of one stage of tuned radio frequency and a detector with tickler feed back, which may be used alone or with audio frequency amplification. Another transmitter was also used on the same oscillating circuit and consisted of a 1 K. W. Marconi transmitting tube with 8,000 volts, 25 cycles on the plate. With this tube the intensity in the antenna is 1.8 amp. at 108 meters.

An automatic transmitter made with mecano parts was used, to send during long periods, with a moving picture film cut to

make contact between two blades connected in the primary of the transformer.

The antenna is a cage composed of six wires of seven strand enameled cable, six feet in diameter, and 55 feet long. The lead-in is also a cage erected in a north south direction. The counterpoise built directly under the antenna is composed of nine wires and offers a very large surface.

This station has been heard in the United States by 1NA, 1WO, 1BVL, 1AUC, 1AUR, 1CBG, 1CZ, 1BT, 2AJF, 2CEG, 2CQJ, 2BQH, 2CEE, 2CEI, 2CEH, 2CMR, 2CXB, 2BSC, 2NP, 3YO, 3XM, 3APV, 3OT, 5DW, 5AC, 8ASB, 8CKN and 9DES; in Canada by 1DD, 1BQ, 1DT, 1EB, 1AF, 2BN, 3HT, 3BQ, 9AL, and has worked a number of times with American stations.

F8BF will be glad to arrange special tests with American amateurs and sends to all the Hams his best wishes for real DX.

PIERRE LOUIS,
8 Rue de la Mouillère,
Orléans-Loiret, France.

(Amateur Section continued on page 1693)

F8BF uses a small cage aerial which is installed in a good location and well insulated. The station is installed in his garage, which may be seen below the lead-in.

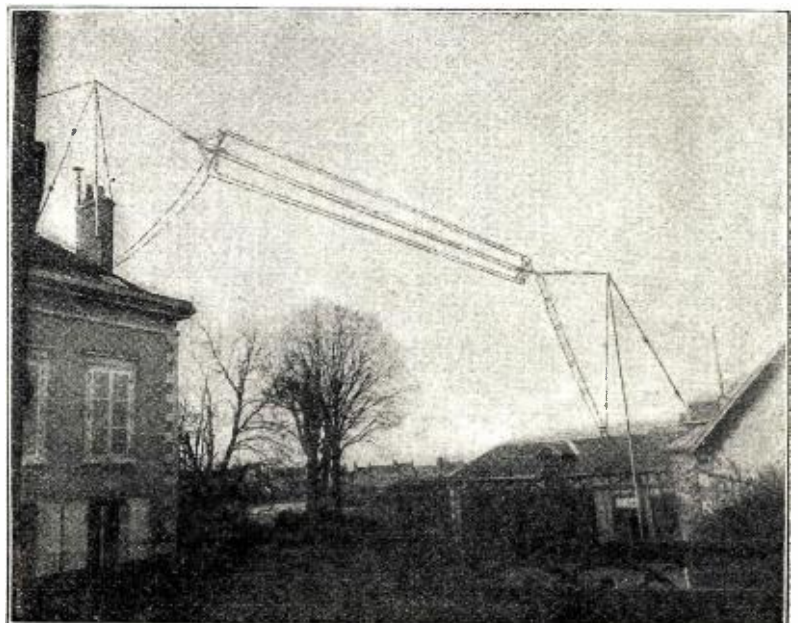

A Good Rectifier and Filter for the C.W. Set

By WILLIAM H. SCHICK, 2MU

Those "Hams" who are forced to roll their own to produce a transmitter plate supply will heartily welcome this article which describes the construction of a simplified rectifier and filter that gives excellent results. Notes on the care and operation of the apparatus are also appended.



I HAVE read many articles on electrolytic rectifiers for converting A. C. into D. C. for the plate supply of vacuum tubes for C. W. transmission and have tried a number of different kinds. After a few weeks either the aluminum plates become covered with black scabs or they draw too much current on the transformer.

Most articles told how to make the plates, but none of them told how to set up the whole jar system so that it made a neat piece of apparatus. I have seen many electrolytic rectifiers in operation and most of them left an otherwise well made transmitting set look very untidy because the jars were not covered.

This article gives a complete description of the rectifier and filter system in use at the writer's station. Many of the fellows have asked me if I am using a motor generator because my phone is so clear, and more noteworthy is the fact that loop absorption modulation is used. If there is any hum it can hardly be noticed a few miles away. The C. W. signals sound like pure D. C.

The first thing to remember when constructing a rectifier, is to allow at least one square inch of aluminum and lead surface in the solution for every 40 milliamperes of space current on the plates of the tubes. If there are 200 milliamperes on the plates, there should be at least 5 square inches of the electrode surface immersed in the solution.

Also, use at least one jar for every 50 volts of current you wish to rectify. For instance, if you use a transformer giving 1,100 volts across the whole secondary winding, there should be at least 22 jars in the circuit or 11 jars on each side of the center tap. For 1,500 volts use 30 jars or 15 on each side of the center tap. A few more jars in the circuit will do no harm, especially with the poor grade of aluminum sheeting sold in some localities. With more jars there will be less sparking and naturally less heating of the solution.

In the writer's station there are 60 pint jars across the high voltage winding of 3,000

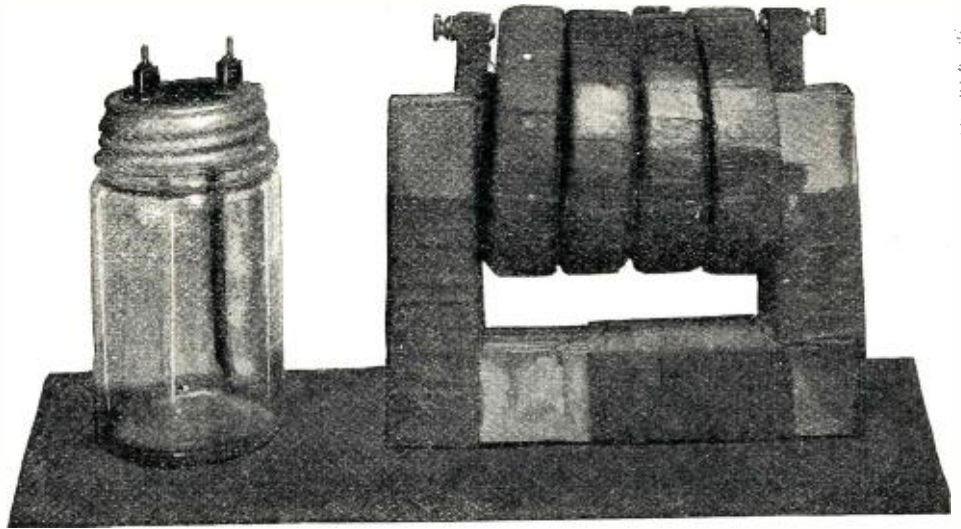

A photo of one of the completed rectifier jars; on the right is shown the completed filter.

volts; that is to say, 30 jars on each side of the center tap. There is practically no drop on the 110-volt A. C. line. Always remember that when using the center tap system, the high voltage is cut in half. In my case the current, after leaving the jars, is about 1,500 volts; it may be about 50 volts

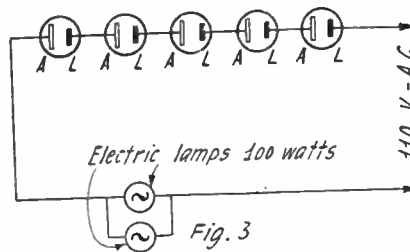

The connection employed for forming the rectifier plates. Two 100-watt lamps in parallel will do the trick.

Get a sufficient quantity of pure sheet aluminum and lead 1/16 inch to 1/8 inch thick. The size of the plates depends on the amount of milliamperage the plates of the tubes draw. Do not forget to use at least one jar for every 50 volts and 1 square inch of electrode surface for every 40 milliamperes. The size of my plates are as follows: 5 inches long, 1 3/4 inches wide and about 1/8 inch thick. They are cut as shown in the diagram, Fig. 1. This applies to both the aluminum and lead plates. Drill a small hole in each plate to pass the binding post. The plates are then bent at right angles about 3/8 inch from the top and are assembled to the fibre or rubber discs. Attach one lead and one aluminum plate to each disc with a binding post or screw, as shown in the diagram, Fig. 2. When the solution is poured in the jars it should come up to where the plates are cut in. This will give 3 x 1 3/4 inches or 5 1/4 square inches of plate surface, which is large enough for four 5-watt or one 50-watt transmitting tube.

less, due to loss after passing through the jars, which is quite natural.

DIRECTIONS

The jars should be of the screw top 1-pint type, such as those used for preserving. They will not heat up as easily as the smaller ones after a few hours of continuous operation. These jars measure 2 1/2 inches in diameter at the top. Get some fibre or hard rubber about 1/8 inch thick and saw out with a scroll saw, as many discs 2 1/2 inches in diameter as there are jars. In the center of these discs drill a hole 1/4 or 3/8 inch in diameter for filling the jars when the solution has evaporated below the normal level. Next drill two holes large enough to pass the binding posts or brass machine screws. These holes may be about 3/4 inch on each side of the center hole. These holes are for connecting the electrodes to the discs. They also serve as binding posts. The center of the tin tops that come with the jars are then cut out with a can opener. Make this cut about 1/4 inch from the edge. When this is done, you will find that the disc fits snugly inside the jar with the disc inside resting on top of the jar.

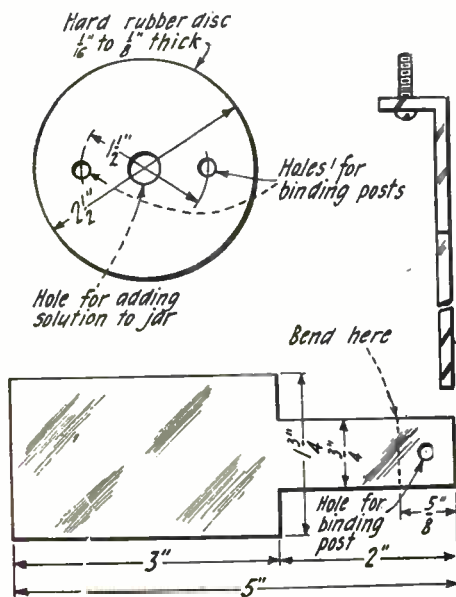

Details of the plates and the cover for the rectifier jars.

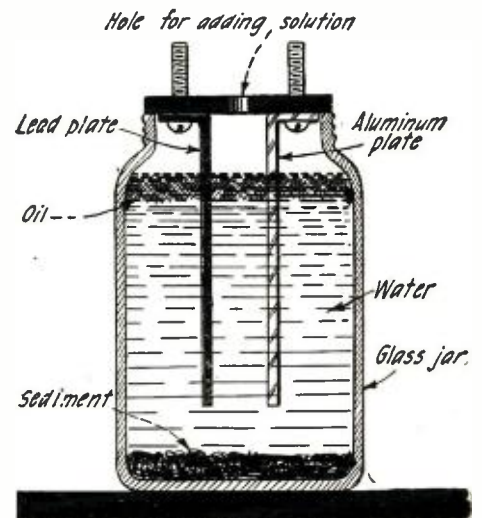
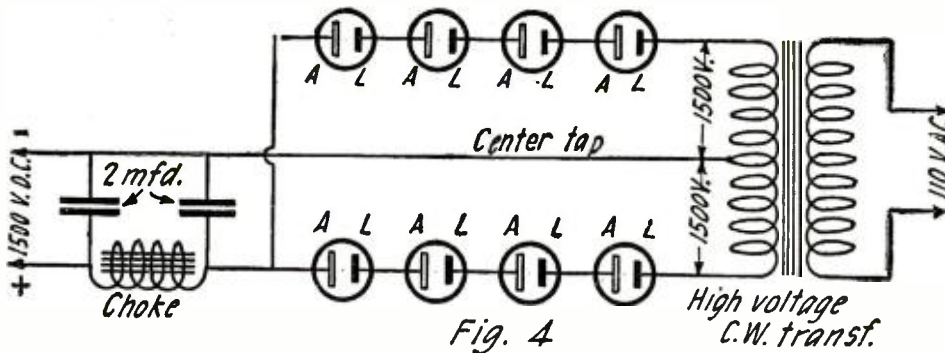

Fig. 2

A small quantity of oil floating on the solution will prevent it from evaporating.



How the rectifier jars and the filter system are connected to the transformer output.

THE SOLUTION

Get about 1 lb. of good household borax, which is enough for six gallons of solution and make a saturated solution with distilled water. This is done by stirring the borax in the required amount of water until it begins to settle in the bottom of the container. This means that the water cannot dissolve more borax. Siphon off the solution into a bottle or crock without disturbing the sediment at the bottom. A clear solution of borax and water will result.

Always make a little more solution than is necessary to fill the jars, as the water will evaporate and more solution of the same density will be needed. Fill the jars to where the plates are cut in, put on the top discs and screw down the tin caps. Connect the lead of one jar to the aluminum of the next. The plates must now be formed for use. (Fig. 3.) The easiest way to form them is to put all the jars in series with one or more 100-watt lamps as shown, and connect to the 110-volt A. C. line. Leave the jars on for about 12 hours. Then put the jars across the lowest voltage winding on the secondary of the transformer leaving them on for about half an hour. Then put the jars across the whole transformer secondary winding for another half hour.

If the jars are put directly on the transformer without being formed they will not pass any voltage, practically short circuiting the transformer. The lamp gives them a chance to form so as to pass current. All the jars may be left connected to the transformer and time will do the rest of the forming while using the transmitter. If the plates are of the highest grade aluminum, there will be very little drop on the 110-volt line. If, after a few weeks' operation, the jars heat up excessively and draw too much current, the jars are not operating effectively. They should not draw more than 20 to 30 watts across the primary of the transformer without the load of the tubes.

It is easy to tell if the jars are working correctly. Darken the room and look at the aluminum plates while the transformer is on. When operating properly there will be a greenish glow much like the hands and numbers on a phosphorescent watch in the dark. If they are sparkling it may indicate that there are not enough jars in the circuit. The remedy of this condition is obvious, add jars until it ceases.

At the output of the jars there now is a pulsating D. C. which is nearly as bad as raw A. C. It will have to be smoothed out with chokes and condensers in order to get the supply pure enough for phone use.

CHOKE AND CONDENSERS

The choke coil is made as follows: Get four L-1500 honeycomb coils and some transformer steel wide enough to fit through the center of the coils tightly. The cross-section of the core should be the same on all sides which is 1 3/8 inches. A diagram of this is shown in Fig. 5, but it is not necessary to make the core exactly the same as the size shown here. The core of an old 1/4-K. W. spark transformer will fill the bill

very nicely. Another good choke is made by filling the center of the coils with spark coil core wire, but be sure that it is tightly packed, otherwise it will vibrate. Connect all the wires together and bring the two end wires out through pieces of "spaghetti" so that they will not touch the core. The coils should be taped with empire cloth or ordinary tape so that the wire will not come in contact with the core. Connect two 2-mfd. high voltage condensers across the positive and negative side of the high voltage and put the choke in the positive lead between

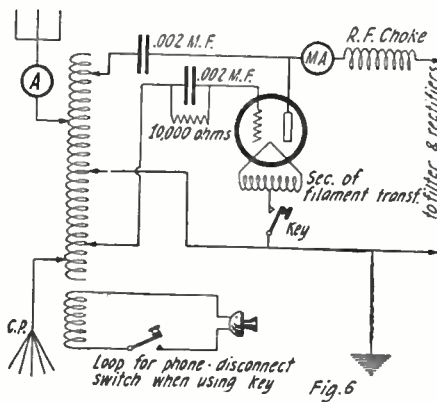

The Hartley circuit, which 2MU employs in conjunction with his rectifier and filter system.

the two condensers, as shown in the diagram at Fig. 4. Now connect this high voltage supply to the plates of the vacuum tubes. You will be proud of the note produced by the transmitter after a few weeks of operation. This current, I think, is better than some generator sets with their roaring commutator hum. The jars will make a neat appearance. This system is also noiseless and may be operated all night without disturbing the folks' slumber.

After the jars have been in use for some time, it may be found that they need cleaning. Through long usage, a sediment may appear at the bottom of the jars. If it does not touch the aluminum plates it will not matter, but if it does the old solution must be emptied and new solution substituted. If black spots appear on the aluminum plates they should be scraped off leaving only the bright aluminum. These little black spots are the cause of many an electrolytic rectifier going wrong. Do not use the same solution if black spots are found. The lead plate gives no trouble.

For loop absorption phone, use about three turns of No. 14 insulated wire coiled the same size as the antenna inductance. This loop should be about an inch or two away from the inductance on the grid or ground side of the transmitter, and must be put in series with a microphone, as shown in the diagram at Fig. 6. It may be necessary to vary the distance between the loop and the inductance and to try different numbers of turns in the loop before the best point for working with phone is found.

This system costs very much less than a

generator set. I do not believe a generator set will get out much further than a good rectified A. C. set if properly filtered and placed under the same antenna.

However, a loop system of phone will not be heard as far as the Hiesing system used with a generator set. It will be necessary to inspect the jars every couple of weeks to make sure that there are no black spots on the aluminum plates. The longer these spots are left, the quicker the remainder of the plate blacks.

The black spots on the aluminum plates are the seat of most rectifier trouble, therefore, watch them carefully. If after use for some time the plates begin to spot more frequently, necessitating more frequent cleaning it is well to change the solution. If the solution is changed in one jar change it in all the jars using clean water.

I don't think many broadcast listeners will complain of the broadness of signals produced with this apparatus if the instructions given above are carried out.

Some Real DX

My friend, Mr. Francis McCown, of 3 Park Terrace, San Juan, P. R., and I have combined our radio stations into one using the assigned call letters 4OY and 4RJ, respectively, 4OY being my call, and 4RJ Mr. McCown's.

A few nights ago, to be exact, on December 9, 1923, at 11 P. M. E. S. T. (about 10 P. M. local time), we were experimenting with a De Forest honeycomb set of our own construction, consisting of a set of coils, two De Forest variable condensers (one in series with the primary circuit, the other in series parallel with the secondary circuit) and having a detector, with two stages of audio frequency amplification, and 60 volts on the plates of the tubes. We had a telegraph key connected in series with the ground terminal of the receiver and the main ground lead. Our antenna consists of one single wire about 100 feet long and about 50 feet high.

My friend and I had the receiver tuned to a very high oscillating point so that it produced continuous oscillations of a steady frequency, which could be varied at will by the honeycomb coils and condensers. We were merely experimenting with this equipment and had no idea that our signals were being radiated for such a great distance, as is shown by postal cards from two amateurs in the States who heard our signals, and who have reported their reception as being QSA, QRK, etc. The cards bear witness and sufficient evidence that these signals carried over 1,500 miles. Mr. R. U. Waite, radio 3BDO, of Northwest Avenue, Vine-land, N. J., was the first to receive our signals transmitted on the above mentioned equipment and promptly notified us by QSLing with his card. This card gives the complete data. On January 14, 1924, at 6 P. M., Eastern Standard Time, Mr. Lucius Bryant,

(Continued on page 1655)

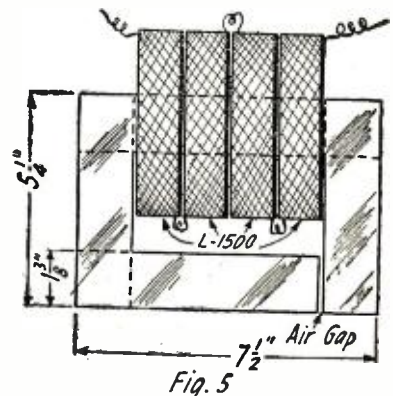

Fig. 5

The choke coil is made up of four 1500-turn H. C. coils on a closed iron core.

Awards of the \$50 Radio Wrinkle Contest

First Prize

AUTOMATIC POTENTIOMETER SWITCH

By JULIUS PHILLIPS

Wherever a potentiometer is used there is a constant drain of current from the "A" battery, even when the set is not in use. This is particularly true when a potentiometer of low resistance is employed. To overcome this, an "A" battery switch may be inserted in one of the filament leads to disconnect the battery from the set when not in use. This switch, however, is not necessary and can be eliminated. Only one side of the potentiometer is connected to the battery, the other side going to one terminal of the rheostat. When the rheostat is turned to the "off" position, the potentiometer is also disconnected. The extra resistance of part

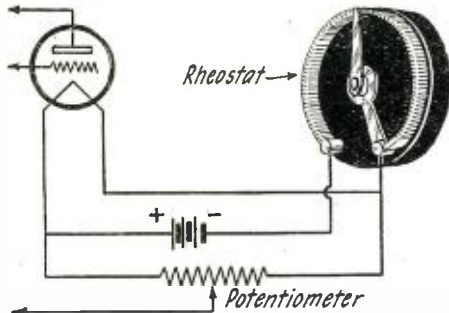

Why use a potentiometer switch? Make the Rheostat serve the purpose as shown here.

of the rheostat is added to that of the potentiometer, but as this is only one or two ohms and as the rheostat is varied very little after the correct position has been found, it will make no difference in the functioning of the potentiometer. The diagram shows all connections clearly.

Second Prize

UNIQUE SERIES-PARALLEL SWITCH

By S. STARR WALBRIDGE

In constructing a honeycomb coil set, the diagram of which calls for a series-parallel switch to put the primary condenser in either series or parallel with the primary coil, a very neat job can be done by using a four-spring, two-closed contact jack. The jack should be connected as shown in the accompanying diagram. The change from series to parallel is made by inserting a

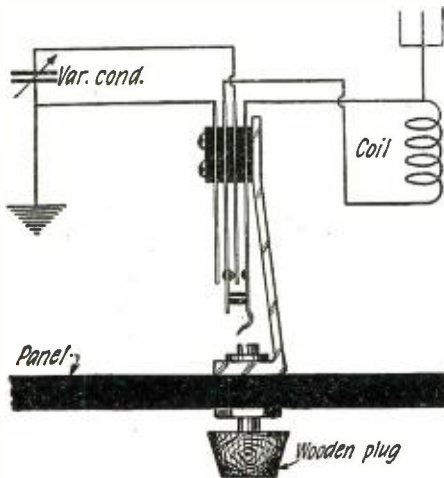

A neat and efficient series-parallel switch can be made by employing a jack of the type shown.

Prize Winners

FIRST PRIZE \$25

An Automatic Potentiometer Switch

By Julius Phillips,
2618—8th Avenue,
New York City.

SECOND PRIZE \$15

Unique Series-Parallel Switch

By S. Starr Walbridge,
2246—14th Street,
Troy, New York.

THIRD PRIZE \$10

A Quickly Made Grid Leak

By Wilford Lahman,
Mt. Morris College,
Mt. Morris, Illinois.

wooden plug where the phone plug would ordinarily go. If you have an old violin key, this may be cut off and will suit the purpose very well. Another method of making the plug is to cut a small spool in half, shape the cut end of one-half to suit yourself, and insert a short, round stick just the size of the hole in the spool. The plug may be enameled black.

This arrangement not only works well, but requires a very short time for installation, and takes up very little panel room. Only one hole need be drilled in the panel instead of several as for the ordinary series-parallel switch, and the result is much nicer in appearance.

Third Prize

A QUICKLY MADE GRID LEAK

By WILFORD LAHMAN

An efficient grid leak can be made directly on the base of the tube, and will give excel-

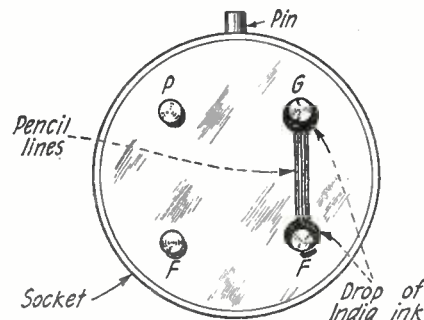

An excellent grid leak can be made directly on the base of the detector tube with a bit of India ink and a pencil.

lent results. Holding the tube with the base facing you, having the pin up as shown in the diagram, the top and bottom posts on the right are the grid and filament terminals respectively. A drop of india ink is placed at the base of these posts and allowed to dry. Several pencil lines are now drawn from one drop to the other according to the resistance of the leak desired. Best results will usually be had by connecting the positive terminal of the "A" battery to the leak.

THE ELBOW ANTENNA

The portable aerial shown in the accompanying sketch supersedes the loop aerial

and has a distinguished feature in that it can be placed in any position and be made of any size desired. On the top of a roof or from the side of a window it will adapt itself, and take very little room.

Referring to the sketch, the parts are G-guy wires, Sr-spreader, S-insulator, R-rod extending from the pole P to rod D which is held by a spring hinge to R. Ws are wall insulators placed through the rod D whose duty it is to insulate the aerial

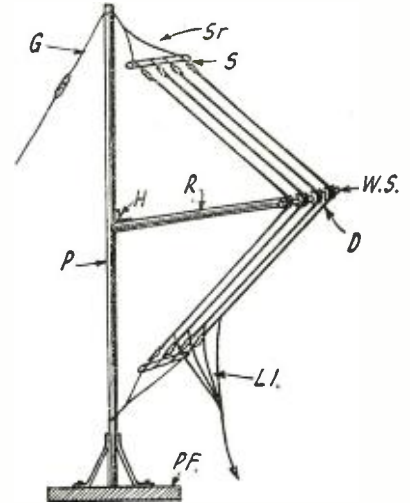

An aerial of this type proves very serviceable in locations where space is limited.

wires from the rod. L-1 are the lead-in wires and PF a plate for fastening the pole in place. H is a common door hinge used so as to give free run to the aerial wires in case of heavy wind.

Contributed by Anthony A. Kiedis, Jr.

A GOOD SOLDERING FLUX

For soldering connections in a radio set it is advisable to use resin instead of an acid flux. An acid flux is easier to work with and for this reason is more commonly used, to the detriment of any connection where fine wires are employed. The acid, besides corroding the wire, has a bad habit of "creeping," which often provides a high resistance leakage path between connections. This is particularly noticeable when soldering connections to jacks. An excellent flux, having resin for its base, may easily be made by the experimenter. It is non-corrosive, does not "creep" and leaves a neat looking joint. This flux is made by dissolving resin in a small quantity of denatured alcohol. If the resin is powdered, it will be dissolved much more quickly. This flux should be kept in a corked bottle and when used, can be applied with a toothpick.

Contributed by Frederick E. Wilkins.

AN EFFICIENT LEAD-IN INSULATOR

A cheap and efficient antenna lead-in insulator may be constructed from a piece of 5/8-inch boiler glass tubing, two corks and a 1/8-inch brass rod. The glass tube, which should be 12 inches long, may be obtained from most any plumbing shop at a low price.

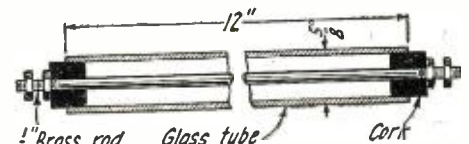

A very good lead-in insulator composed of a glass tube, two corks and a brass rod.

For best results, the corks may be dipped in hot paraffin to make them water proof. They are then forced tightly in the ends of the glass tube. The brass rod should be 14 inches long and should be threaded about one inch on each end. A hole large enough for the brass rod to pass through is bored through each cork and the rod inserted. A nut is screwed on both ends of the rod and the lead-in insulator is complete. The insulator is passed through a hole bored in the wall, large enough for it to fit snugly and the antenna and receiver connected to their respective ends of the rod.

Contributed by Harrison Schoolfeld, Jr.

AN ALL WAVE REINARTZ

The advantages of the Reinartz tuner on short waves are well known. However, when the amateur desires to hear the high wave broadcasters, ships or trans-Atlantic stations he finds that he must build another set or find some way of loading the Reinartz. With the scheme outlined in this article all wave lengths can be received on the Reinartz with the same sharpness and efficiency as the short waves.

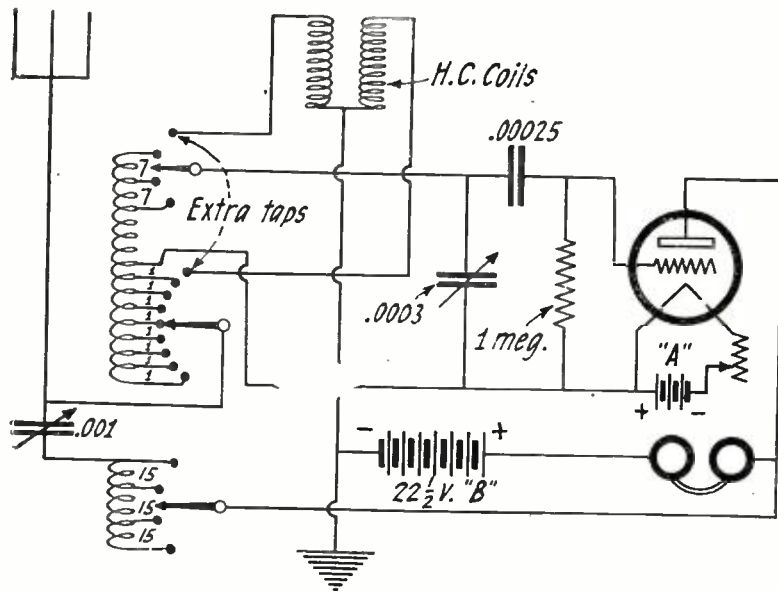

The addition of two honeycomb coils in the Reinartz circuit, as shown, permits the covering of high wave-lengths.

All the additional apparatus needed is a double honeycomb coil mounting and the coils. The mounting should preferably be one with a long handle for varying the coupling between the coils. This style of mounting is very convenient as well as practical, as it keeps the hands away from the coil.

The honeycomb mounting can be attached to the panel, if there is room, or it may be put by the side of the cabinet, convenient to the operator's hand.

Contributed by Maxwell K. Murphy.

AN EFFECTIVE DIAL ATTACHMENT

Many people have difficulty in accomplishing the delicate tuning necessary to pick up

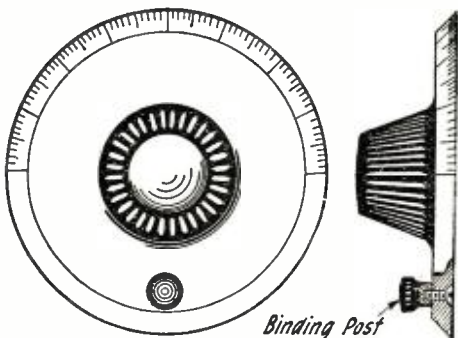

A small binding post mounted close to the periphery of a knob, and dial will serve as a Vernier control.

DX broadcast stations. If a binding post cap, of the moulded type, is mounted on the dial near the circumference, as shown in the accompanying sketch, it will prove very effective in making fine adjustments. All that is necessary is to drill a small hole through the dial into which a machine screw of the correct size and length to take the binding post cap can be fitted and screwed up tight against the dial facing.

Contributed by Louis Sussman.

IMPROVING METAL HORNS FOR LOUD SPEAKERS

Metal horns are subject to tinny vibrations when used in radio and are usually discarded. Radio fans can greatly improve them and overcome the tinny sound by giving the horn the following treatment.

Buy a 10-cent sack of salt and 1/2 pound of paraffin. Melt the paraffin over a steady flame in a pan or pie tin; when very hot, put in salt until nearly all the wax is taken up. The salt will not melt. Add several drops of vinegar to make the mixture adhesive. Then, using a small spoon, spatter the mixture all over the inside of the horn until it is 1/8 to 1/4 inch thick. It will

be crystal-like, rough and white. The work must go along slowly to allow the wax to set and the horn to cool off, or it will not stick. Be sure to cover all the surface inside. In a day or two, paint it thoroughly three to five times inside and out with a flat black paint and, if a proper amount of the wax mixture has been spattered on the inside, a clear tone, non-vibrating horn will be the result. My horn is from an Edison phonograph, rather large and made of brass. After giving it this treatment, all voice and music were produced in very clear tones.

Contributed by J. B. Cook.

SENSITIVE SYNTHETIC CRYSTALS

Super-sensitive crystals at 25c per gross! Here's how. Get some pure lead (Pb), not solder or lead alloy. Also some flowers of sulphur—ordinary powdered sulphur. Cut the lead in small pieces and mix with the sulphur in the ratio of seven parts by weight of lead to one part of sulphur. Place the mixture in a crucible, a tin cup, or some convenient container other than glass or porcelain. Heat over a Bunsen burner or over red coals in a stove. In a very short time the mixture will begin to glow and the lead and sulphur will fuse together. At this point, remove the mixture from the heat and place the container in a basin of cold water to cool.

CAUTION: Do not let any water get on the crystals, as it will ruin them. If you have had things just right, you will have

a lump of material that is supersensitive over its entire surface. If the lump is crumbly, you have "cooked" it too long, and if it is streaked with lead, you did not cook it long enough, or else you used too much lead. Your crystal will then be sensitive only in spots and not over the entire surface as it should. Use a very light contact. I have home-made crystals that are as good or better than the best natural crystal I ever used. Fine for reflex, too!

The above materials may be purchased at any drug store.

Contributed by R. L. Potts.

A VERNIER ATTACHMENT FOR HONEYCOMB COILS

This wrinkle, as the diagram illustrates, consists of a metal disk attached to a lever made of brass or other suitable substance.

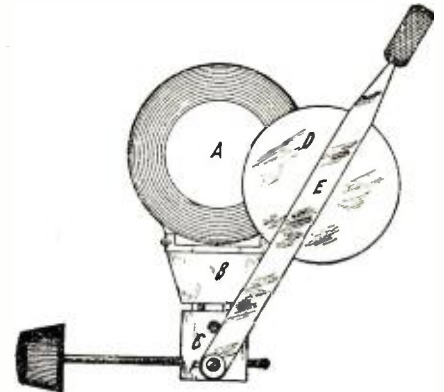

Details of the Vernier attachment. The parts are: A, Honeycomb coil; B, coil plug; C, socket; D, copper disc; and E, the brass lever.

A brass screw provided with a spring passes through one end of the lever into the coil socket as illustrated. The spring washer is necessary to insure smooth running and rigidity. The brass lever must be bent so as to clear the edges of the honeycomb coil. A small insulating knob is mounted on the other end of the lever for convenience in handling.

There are no particular dimensions necessary, but the disk should not be too large. The greater the diameter of the disk,



A side view of the Vernier attachment for Honeycomb coils.

of course, the greater will be the change in wave-length. Disks about two inches in diameter should be about right in the average case. The wave-length increases more rapidly as the disk approaches the center of the coil than when approaching the edge, so it is advisable to set the condenser first when the disk is near the edge, then a slight increase or decrease of wave-length is obtained by moving the disk in or out as required.

Contributed by E. H. Wood.

A SIMPLE PHONE CONNECTOR

The radio listener sometimes wishes to connect two or more pairs of phones in series, and not having a regular connector on hand is at a loss as to how it is to be done. The following stunt is simple and quick and should prove welcome. Two brass machine screws about 3/4 inch long and three nuts to fit is all the apparatus necessary. A nut

(Continued on page 1656)

Correspondence From Readers

HOT FROM THE GRID!

Editor, RADIO NEWS:

I wish to protest vigorously against any radio reception license scheme evolved by any of the gigantic intellects which are at present directing their energies in the direction of an over-wearied, over-taxed public. We are the victims of more petty stunts to extract fees than any other commonwealth in the world. I pay an irritating, futile tax (frequently duplicated many times) on my car, my motor boat, my dog; I cannot even fish in my own pond without a license; I do not recall a single recreational diversion which is not loaded with as many fees as the traffic will bear. And the end is not yet.

If these various assessments were spent in improving the conditions under which we strive to exist, one would not object so much, but all these fees are greedily absorbed by a mob of politicians whose effrontery becomes less bearable every day. I am compelled to use a car, and I have kept my dog for sentimental reasons, but I have given up my boat, my gun and my rod because I do not propose being continually insulted by an ignorant lot who have no means of support save by leeching the unfortunate who must of necessity come in contact with them.

I am quite willing to contribute any reasonable sum to the broadcasting companies but I will not pay another sou in taxes! If it is the desire to kill radio—tax it.

Wilfred Taylor,
Thompson, Conn.

RE- LESS JAZZ

Editor, RADIO NEWS:

Replying to Mr. Stauer's letter for "less jazz," I wish to state pertinent "facts" regarding the music situation. I am more or less familiar with the phonograph record business, and from personal experience in selling records, also quoting from an authoritative trade journal, *The Talking Machine World*, which collected a census of record sales through dealers, the life of the record business is in the hands of people under 35 years of age. Also, the demand for records of the jazz type is so large in comparison with old-time music that the latter would almost be termed dead stock. Therefore, it would seem that the popularity of radio broadcasting would be determined by the same facts.

Archie H. Klingbeil,
258 Prospect Street,
Ashtabula, Ohio.

IN USE SINCE 1878

Editor, RADIO NEWS:

I have just been reading, in the correspondence section, a letter by J. M. Gregory of Morristown, N. Y., in which he mentioned telephoning with receivers. A few years ago I had a somewhat similar experience. The details, however, are different and may be of interest.

It was during the ban on wireless at the time of the war. My chum and I tried connecting buzzer sets with a wire between our homes, which were about a block apart. We used a ground return. It was quite accidentally that we noticed we could talk to each other through the phones. They were of the low resistance type. The interesting part of this is the fact that we used no power, no batteries, or transformers whatsoever. The only way I can see that an electrical field was set up, is the fact that our line

paralleled a 507-volt power line, though it was nearly 31 feet from the line.

J. RUSSEL SALSBURY,
2825 Que St., Lincoln, Neb.

[Any vibration of the diaphragm of a telephone receiver sets up a current in the coils of the electro magnet. This is due to the displacement of the ever present magnetic field. The Bell telephone was originally used in this manner for talking and for listening.]

FOR MORE MODERN MUSIC

Editor, RADIO NEWS:

Being a constant reader of RADIO NEWS and a "Radiophan" also, I naturally read the letter of H. S. Stauer, of Winnett, Montana, in the February number.

I agree with Mr. Stauer that announcers should state their call letters and location of their station after each number played. However, I think that the situation at present in this respect is quite satisfactory, and such

Interesting Articles to Appear in May Issue of "Practical Electrics"

- High Tension Condensers—By Curtis Kissel.
- Electric Oil Feed for House Furnace.
By George G. McVicker.
- Some Primary Batteries. La Nature of Paris.
- Building a Thermogalvanometer.
By Dr. Russell G. Harris.
- Battery Charging Switchboards.
By Amedeo Giolitto.
- Efficient Electrophorus and Electroscopes.
By R. G. Morgan.
- Tesla Coil—By Horace Brooks.
- Experimental Microphone.
By Frank W. Godsey, Jr.
- Utilizing Solar Heat.

stations as do not now announce their location, etc., after each selection, will probably do so in a short time.

From there on, however, I cease to agree—and very much so! Being a Radiophan, I am also interested in the kind of programs sent into the ether. Talk about old time music! If Mr. Stauer would operate his tuner a little more, I'm sure that he would be able to locate all the old timers that his heart would desire. Night after night I sit before my instrument and I find station after station broadcasting music that was old before the 20th century put in an appearance. In fact, I believe that 90 per cent. of the music is old time stuff, instead of jazz, which is directly opposite to what Mr. Stauer says, until about 10 o'clock at night. After that time, some of our Western stations are kind enough to connect up with remote control to some big hotel and give us the modern music played by good orchestras.

I do not call the modern music, such as is played by the larger orchestras, "jazz" There is very little discordant music, but rather a continuous succession of perfect chords, and it makes us appreciate to the full extent the wonderful combinations obtained these days by the better grade players.

I would rather see a considerable reduction in the broadcasting of "classical" music,

which most of us don't understand, and a good many simply say they like it for the effect they "think" they may create. How many people, especially in the West here, are past masters in judgment of operatic music? I venture to say that mighty few out of the grand total have seen very many operas, or understood them if they did.

Mr. Stauer, tune in on T-H-J, Los Angeles, KPO, San Francisco, KGO, Oakland, California, KGW at Portland, Oregon, or the new Westinghouse Station at Hastings, Nebraska. You can get your desire gratified at any of the above named any evening. I know your receiver will reach them or you would not be able to reach WBAP at Fort Worth. On January 23, KGW, at Portland, gave out a long program of nothing but "hoe-downs." I have been in the back woods of Montana, and I am now in the back-woods of Washington, where "hoe-down" music and old time stuff is more appreciated than anywhere else.

Part of my business is playing in orchestras in various parts of the country, and from my experience the modern stuff is much more appreciated than the old—and it doesn't matter whether the folks hearing the music are of the new or old school, either.

I say, give us more modern music and of the more understandable kind, and less classical or old, buried and forgotten stuff that was mouldy with age when we were born.

E. WEBER,
Wellpinit, Wash.

BROADCAST REVIEW

Editor, RADIO NEWS:

If we BCL's could "Sass back" or applaud, through our sets, I can assure you that the air would be well filled with applause and no speaker, artist or other performer would be neglected.

My receiver will not even regenerate, so I feel that I must tell someone by letter of the wonderful time I am having this winter out in a little mountain town in the coal fields of West Virginia.

I am a Grand-dad of three summers, and a Fan of three months, and, believe me, more fun, amusement and pleasure has been furnished me during the past three months than in all the years before.

All this, too, while I occupy an easy chair in my own room with my old pipe and tobacco in easy reach, and no more effort required to secure all this than to push a button for ice water.

I care nothing at all for DX, nor for a long list of "Stations Received" or other fancies in way of "Records," nor do I have any use for a headset, the loud speaker covering a radius of 1,000 miles or more making reception possible for at least 100 stations, about 70 of which I have already heard.

On more than one occasion I have held KDKA for an hour and a half, then immediately tuned in the WEA-F-WCAP combination for same length of time, and for third period of same length have enjoyed the wonderful organ recitals from WCAP.

I have listened to the voice of President Coolidge, heard an address by the late Woodrow Wilson, talks by Geo. B. Christian, Edward Bok and many others of note.

WOR recently permitted me to hear Gustav Lindenthal, the bridge builder, and civil engineer, of which profession I am a modest member.

WWJ, on New Year's Eve, permitted me to enjoy the full midnight service in the Episcopal Cathedral at Detroit, one and one-

(Continued on page 1604)



RADIO manufacturers are invited to send to RADIO NEWS LABORATORIES, samples of their products for test. It does not matter whether or not they advertise in RADIO NEWS, the RADIO NEWS LABORATORIES being an independent organization, with the improvement of radio apparatus as its aim. If, after being tested, the instruments submitted prove to be built according to modern radio engineering practice, they will each be awarded a certificate of merit, and a "write-up" such as those given below will appear in this department of RADIO NEWS. If the apparatus does not pass the Laboratories tests, they are returned to the manufacturers with suggestions for improving them. No "write-ups" sent by manufacturers are published on these pages, and only apparatus which has been tested by the Laboratories and found to be of good mechanical and electrical construction is described. Inasmuch as the service of the RADIO NEWS LABORATORIES is free to all manufacturers whether they are advertisers or not, it is necessary that all goods to be tested must be forwarded prepaid, otherwise they cannot be accepted by the Laboratories. Address all communications and all parcels to RADIO NEWS LABORATORIES, 53 Park Place, New York City.

Apparatus Awarded Certificates

VACUUM CRYSTAL DETECTOR

As a protection from injury, as well as against burning out due to excessive static discharges, this fixed crystal detector is mounted in a vacuum inside a glass bulb shaped similar to an electric light bulb. It is claimed by the manufacturer, Henry Hirsch, 224 Lexington Avenue, New York City, that as there is no oxygen around the crystal, a



heavy static discharge of electricity will not destroy its sensitive adjustment. The detector is of the combination type having two different crystals touching each other. It is a very sensitive detector.

Arrived in good packing.
AWARDED THE RADIO NEWS LABORATORIES CERTIFICATE OF MERIT NO. 378.

TURN-IT GRID LEAK

This variable grid leak is of somewhat different construction than the usual type in that it employs a high resistance liquid as a resistance element. The liquid is contained in a sealed glass tube, and is plainly visible. The grid leak fits a standard



base and the resistance is varied by rotating it, thus connecting more or less of the liquid in the circuit. A resistance range of 325,000 ohms to 5½ megohms is covered with one-half turn of the instrument. The control is very uniform. Manufactured by Charles E. Bonine, 205 15th St., Philadelphia, Pa.

Arrived in excellent packing.
AWARDED THE RADIO NEWS LABORATORIES CERTIFICATE OF MERIT 279.

INSULINE PANEL

The annoying effect of body capacity so noticeable in regenerative receiving sets may be entirely eliminated with the use of a shielded panel. The Insuline anti-capacity panel has very low dielectric losses and is easily cut and drilled. The salient feature of this panel is the perforated metallic shield that is compressed into the back of it. This shield is easily cut and removed from places where binding posts or instruments are mounted so as to prevent short circuiting, and when grounded it eliminates body capacity. The

front of the panel is highly finished. Manufactured by the Radio Panel & Parts Corp., Inc., 61 Warren St., New York City.

Arrived in excellent packing.
AWARDED THE RADIO NEWS LABORATORIES CERTIFICATE OF MERIT NO 402.

MICRO-TUNE VARIABLE CONDENSER

The salient feature of this condenser is the simple and ingenious method of obtaining a micrometer adjustment. This adjustment is obtained by moving half of the stationary plates nearer to or further from the rotary plates, which is accomplished by turning the vernier knob. By this arrangement the capacity variation of the vernier knob is always in proportion to the total capacity of the condenser in the circuit. The dielectric absorption losses are fairly low. They are equivalent to a series resistance of 120 ohms at



a frequency of 1,000 cycles. It is manufactured by the Felt & Kimmel Company, Bluffton, Ohio.

Arrived in excellent packing.
AWARDED THE RADIO NEWS LABORATORIES CERTIFICATE OF MERIT NO. 382.

MUTER LIGHTNING ARRESTER

For protection against lightning or other high voltage discharges into the aerial circuit, an arrester is recommended. The arrester shown in the illustration is of pleasing appearance and does not occupy much space. The porcelain base has a chocolate glazed finish. It is designed for inside use. Manufactured by Leslie F. Muter Co., 32 W. 69th St., Chicago, Ill.



Arrived in excellent packing.
AWARDED THE RADIO NEWS LABORATORIES CERTIFICATE OF MERIT NO. 380.

X LABORATORIES CONDENSER

This 23-plate variable condenser is of the grounded rotor type, which has been proven the most efficient by radio engineers. The dielectric absorption losses are fairly low. They are equivalent to a series resistance

of 90 ohms at 1,000 cycles. The condenser is equipped with a vernier adjustment and is furnished with knobs and dial. Manufactured by the X Laboratories, 25 West 45th St., New York City.



AWARDED THE RADIO NEWS LABORATORIES CERTIFICATE OF MERIT NO. 383.

BRACH LIGHTNING PROTECTOR

As a protection against lightning the L. S. Brach Mfg. Co., Newark, N. J., has produced three types of radio lightning arresters. The type No. 223 is for out-door use and consists of a vacuum gap in a glass tube protected by moulded insulating parts that shield it from rain and snow. It is furnished with a rugged Fahnestock clip for attaching the antenna lead-in and a binding post for the ground connection. The types No. 200 and No. 210 are for



in-door use. Both are of the vacuum type and are mounted on porcelain bases. The illustration shows the out-door type arrester.

Arrived in excellent packing.
AWARDED THE RADIO NEWS LABORATORIES CERTIFICATES OF MERIT NOS. 385, 386, 387.

GILFILLAN VARIOCOUPLER

The type R 1050 variocoupler shown in the illustration is especially designed for use in radio frequency amplifiers. The coupling between the primary and secondary coils is very loose, which makes tuning sharp and selective. The instrument covers the entire broadcast wave-length range



with the secondary shunted by a 17-plate variable condenser. It is well constructed and of small size. The coils are bank wound. Manufactured by Gilfillan Bros., Inc., 225 West 57th St., New York City.

Arrived in excellent packing.
AWARDED THE RADIO NEWS

LABORATORIES CERTIFICATE OF MERIT NO. 388.

GILFILLAN INDUCTANCE SWITCH

This inductance switch, type R 950, is of rugged mechanical construction and is so designed that the contact lever stops on the contact points and not between them. The form is of moulded bakelite and the switch lever of phosphor bronze. There are 15 contact points, which are arranged so that the connecting wires may be soldered directly to them. The instrument is furnished



with a dial graduated to correspond with the 15 contact points. Manufactured by Gilfillan Bros., Inc., 225 West 57th St., New York City.

Arrived in excellent packing.
AWARDED THE RADIO NEWS LABORATORIES CERTIFICATE OF MERIT NO. 389.

GILFILLAN STANDARD SOCKET

This socket, type R 300, is for use with standard vacuum tubes and is constructed of moulded bakelite with double phosphor bronze contact springs. It is designed for both base and panel mounting. Manufactured by Gilfillan Bros., 225 West 57th St., New York City.



Arrived in excellent packing.
AWARDED THE RADIO NEWS LABORATORIES CERTIFICATE OF MERIT NO 390.

D-X-ALENA

This synthetic detector crystal is very sensitive over its entire exposed surface and is well mounted in the standard sized ½-inch metal base. The crystal is manufactured by the Everett Radio Company, 5207 Dorchester Ave., Chicago, Illinois. It is supplied with a circular giving directions for using.

Arrived in excellent packing.
AWARDED THE RADIO NEWS LABORATORIES CERTIFICATE OF MERIT NO 397.

APEX AUDIOTRON TYPE 201A

This audiotron is similar in construction and operation to the familiar UV-201A vacuum tube. The filament consumes .25 amperes at 5 volts. The tube works efficiently as

both detector and amplifier and has a comparatively steep characteristic curve. The samples submitted for test by the Radio Tube Corporation, 70 Halsey Street, Newark, New Jersey, were very close to their rated characteristic.

Arrived in excellent packing.
AWARDED THE RADIO NEWS LABORATORIES CERTIFICATE OF MERIT NO. 403.



APEX AUDIOTRON TYPE 200

The type 200 Apex audiotron is especially recommended for detection purposes. It is of the so-called "soft" type and has not such a high vacuum as the amplifier tube. It requires 1 ampere at 5 volts for the filament and operates best on a plate voltage of 16 to 45. The samples submitted by the Radio Tube Corporation, Newark, New Jersey, were found to be exceptionally sensitive.

Arrived in excellent packing.
AWARDED THE RADIO NEWS LABORATORIES CERTIFICATE OF MERIT NO. 404.

APEX AUDIOTRON TYPE 199

This type of tube may be operated from dry cells, as it only requires .06 ampere for the filament from a 3- to 4-volt source. The tube is small in size and is excellent for use in



portable sets. Despite its small size, it makes an exceptionally good detector and amplifier and it may be used with plate voltages up to 90 volts. This tube is manufactured by the Radio Tube Corp., 70 Halsey Street, Newark, New Jersey.

Arrived in excellent packing.
AWARDED THE RADIO NEWS LABORATORIES CERTIFICATE OF MERIT NO. 405.

NOLTE INDUCTANCE COILS

The Nolte Manufacturing Company of Jersey City also submitted samples of its type C and type D



inductance coils. These coils are for use in Reinartz circuits and are of similar construction to that company's wave trap coil. They are wound with green silk insulated wire bound together with cord, thus eliminating the use of shellac or varnishes.

Arrived in excellent packing.
AWARDED THE RADIO NEWS LABORATORIES CERTIFICATE OF MERIT NO. 400.

NOLTE WAVE TRAP COIL

This wave trap coil is of the spider-web type and is wound in two sections so that it may be coupled to the antenna circuit. The center sec-



tion is wound with a few turns of heavy wire which is connected in series with the antenna. The remainder of the coil is of green silk covered wire, which coil is to be connected to a variable condenser. With this arrangement, interference from unwanted stations of slightly different wave-lengths than that of the desired station may be eliminated. The windings are bound together with cord, thus avoiding the use of shellac or other insulating varnishes with their accompanying dielectric losses. Manufactured by the Nolte Manufacturing Company, 61 Gautier Ave., Jersey City, N. J.

Arrived in excellent packing.
AWARDED THE RADIO NEWS LABORATORIES CERTIFICATE OF MERIT NO. 399.

PFANSTIEHL INDUCTANCE UNITS

The Pfanstiehl inductance units are wound spider-web fashion with green silk covered wire, held together with an insulating varnish of low dielectric losses. A 50- and 75-



turn coil and a tapped coil in addition to a Reinartz coil were submitted. The Reinartz coil is supplied

with wooden and fibre supports for mounting as shown in the illustration. These coils are manufactured by the Pfanstiehl Radio Service Company, Highland Park, Illinois.

Arrived in excellent packing.
AWARDED THE RADIO NEWS LABORATORIES CERTIFICATE OF MERIT NOS. 395 AND 396.

BALLANTINE VARIO-TRANSFORMER

This radio frequency amplifier unit is of compact construction and gives very good results when employed with practically any type of tuner. The transformer is variable and the



instrument is tuned by turning the small knob. In this way regeneration is controlled without the use of a potentiometer, and maximum amplification is easily obtained. The transformer is also supplied separately with fixtures for base and panel mounting. It covers the entire broadcast wave-length range. The model No. 5 instrument, shown in the illustration, is equipped with a vacuum tube socket, rheostat and binding posts for connections. Manufactured by the Boonton Rubber Mfg. Co., Boonton, N. J.

Arrived in excellent packing.
AWARDED THE RADIO NEWS LABORATORIES CERTIFICATE OF MERIT NO. 401.

WEST WYRE VARIABLE CONDENSER

This variable condenser is of the grounded rotor type and is of very



rugged mechanical construction. The dielectric absorption losses are comparatively low. It has a three-plate vernier and is furnished complete with knobs and dial. Manufactured by the West Wyre Radio Company, Westfield, Mass.

Arrived in excellent packing.
AWARDED THE RADIO NEWS LABORATORIES CERTIFICATE OF MERIT NO. 381.

GILFILLAN ADAPTER

It is sometimes desirable to use UV-199 or C-299 tubes in a set equipped with standard sockets. In

order to do this, an adapter is necessary. The adapter shown in the illustration is of very good construction and is manufactured by Gilfillan



Bros., Inc., 225 West 57th St., New York City. It is of moulded bakelite with phosphor bronze contact springs.

Arrived in excellent packing.
AWARDED THE RADIO NEWS LABORATORIES CERTIFICATE OF MERIT NO. 391.

GILFILLAN VARIABLE CONDENSER

The type R-725 Gilfillan 43-plate vernier condenser is of rugged mechanical structure and has low di-



electric absorption losses. The losses at 1,000 cycles are equivalent to a series resistance of 80 ohms. The capacity range is from 25.01 mmf. to 850.4 mmf. The plates are shaped so as to give a straight wave-length curve, thus facilitating tuning.

Arrived in excellent packing.
AWARDED THE RADIO NEWS LABORATORIES CERTIFICATE OF MERIT NO. 394.

GILFILLAN UV-199 TUBE SOCKET

The type R-500 vacuum tube socket, manufactured by Gilfillan Bros., New York City, is of similar construction to that company's large socket and adapter. It is constructed of moulded bakelite with phosphor bronze contact springs, and is for use with UV-199 or C-299 vacuum tubes.



Arrived in excellent packing.
AWARDED THE RADIO NEWS LABORATORIES CERTIFICATE OF MERIT NO. 392.

International Radio Notes

GREAT BRITAIN has about 580,000 licensed listeners-in, compared with only 30,000 a year ago, and broadcasting is still increasing, reports to the U. S. Government state. This year manufacturers expect a large increase in their business. About 225,000 individuals who first took out temporary licenses were later given constructors' licenses, which are permits to build sets. This type of license seems popular, as between 32,000 and 75,000 per month were issued toward the close of 1923. All told, 165,000 British broadcasting licenses were issued to owners of British manufactured sets, 75 per cent. of whom are said to own crystal sets. Since the broadcast stations are mostly located in popular districts, a large majority of set owners are satisfied with simple crystal sets.

France has no regularly licensed radio transmission stations assigned to broadcasting, according to advices from the Under Secretary of State on Posts and Telegraphs. Until the matter has been definitely settled by the Government, there will be no special

broadcasters. There is, however, one private station authorized to try out general radio dissemination, with the aid of three Government stations, under provisional authority.

The three French Government stations co-operating are: The Military Station in the Eiffel Tower, "FL," operating on a wave-length of 2,600 meters, and 5-K.W. power; the Superior School P. T. T. at Paris, "ESP," with a wave-length of 450 meters and a 450-watt power, and the Lyons station "YN," wave-length 740 meters and a 250-watt power. The private experimental station is that of the French Radiotelephony Co., in Paris, "8AJ," wave-length 1,789 meters and 6-K.W. power.

The urge to broadcast and listen in has reached Hong Kong, China, where a few foreigners interested in radio got together and formed the Hong Kong Radio Society, membership in which now numbers over a hundred, according to a report made to the Department of Commerce. Today there are over 500 listeners-in, but it is estimated that this number will be doubled within a year's time.

So far there are only two broadcast stations in Hong Kong, the report states. One is a 100-watt American set, operated by the local telephone company which transmits phonograph music for an hour each evening; and the other is a 10-watt Canadian made set which is operated by the Radio Communication Co., Ltd. This company is planning to install a 1-K.W. set for broadcasting at Kowloon to serve South China with piano and vocal music, news bulletins, weather and shipping reports. Fans are also able to receive entertainment three evenings a week from the Manila Electric Supply Co. and from the Evening News of Shanghai, somewhat irregularly. Broadcasting seems to await the genius and enterprise of American manufacturers and exporters.

The Chinese love anything mysterious, and consequently radio telephony has a strong appeal to the natives. In South China, there should be a good potential market for radio equipment, but commercial and climatic requirements must be considered if American manufacturers and exporters go

(Continued on page 1673)



RADIO RECEIVING SYSTEM

(Patent No. 1,477,413. Issued to Ernst F. W. Alexanderson of Schenectady, N. Y. December 11, 1923.)

This invention relates to radio receiving systems, and more particularly to means for preventing interference in such systems with the reception of desired signals.

The object of this invention is to provide in a radio receiving system a means for preventing interference with the reception of desired signals from a near-by transmitting station having a different wave-length.

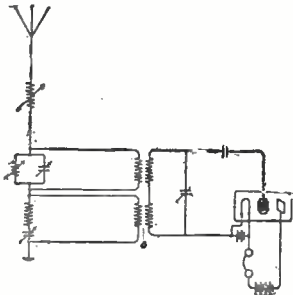

In carrying this invention into effect there is provided, in connection with a receiving antenna, means for impressing upon the receiving circuit two equal and opposing potentials produced in the antenna by the interfering wave. This means is so arranged that it will also impress upon the receiving circuit two potentials produced by the desired signaling waves, but these two potentials will be of different magnitude and of the same phase, or will have such phase relation to each other that they will add in the receiving circuit and will not neutralize one another.

ELECTRICAL SIGNALING

(Patent No. 1,476,691. Issued to Louis Cohen and Joseph O. Mauborgne, of Washington, D. C. December 11, 1923.)

In pending applications, Serial Numbers 401,752 and 419,383, we have described a method for receiving radio signals, in which resonance wave coils are made use of, and utilizing the wave development effects produced by electrical excitation acting on the antenna. The present invention is another modification of the same general idea, embodying novel features with a view of securing still greater improvements in the results desired, namely, more effective elimination of static disturbances and other interferences in the reception of radio signals.

The method consists in connecting a wave coil to a relatively high potential point of a tuned antenna circuit, transmitting the received signal energy over the wave coil and detecting the signals by connecting electrically a suitable detector to a point on the wave coil. The principle involved appears to be as follows: By tuning the antenna

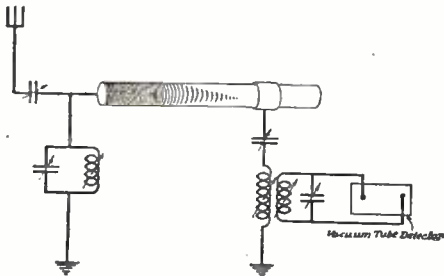

circuit to the frequency of the signal to be received, and suitably adjusting the capacity and the inductance reactances of the antenna circuit, the potential of the signal energy across the condenser or the inductance may be increased many times through the resonance process so that the signal energy is transformed to high potential energy, and this high potential is impressed on the wave coil. The term "wave coil" is understood to mean a coil having a sufficient length of wire on it in relation to the wave length of the signal to secure a wave development on the coil. The coil may be made in many forms, preferably in the form of a long helix wound uniformly with fine wire so as to obtain a coil of distributed inductance and capacity and thus the equivalent condition of a long line in the matter of wave development. If the length of the coil is properly adjusted in rela-

tion to the wave-length of the signals, one or more maximum potential points are developed on the wave coil, and by connecting the detector, preferably the grid of a three-electrode tube, to a point of maximum potential on the wave coil, a large signal effect is produced in the detector. In case of any other electrical effects acting on the antenna, such as interfering signals of different frequencies or electro-static effects, the conditions for the potential building-up process through resonance, which obtain in the case of signals of the frequencies for which the system is adjusted, do no longer exist, and consequently their effect on the detector is relatively small. In this way, a much larger ratio of signal to foreign disturbances is produced on the detector than can be obtained with the usual circuit arrangements heretofore used in the reception of radio signals.

INDUCTANCE UNIT

(Patent No. 1,477,608. Issued to Alexander Taylor, of Flushing, N. Y. December 18, 1923.)

This invention relates to inductance units and has particular value when these units are used in wireless telegraphy and telephony as the primary, secondary and tickler coils, which are adjustable toward and from one another in a manner well known in the art.

An object of the invention is to provide an inductance unit which will have a minimum self inductance and distributed capacity and thereby a minimum radio frequency resistance, which enables more selective tuning of the coils and which has a maximum range of resonance. A further object is to provide a unit of this type which is durable, sensitive, efficient and inexpensive.

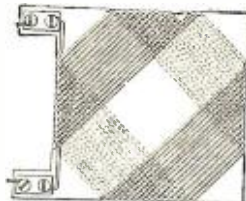

The invention comprises a comparatively thin sheet of a suitable dielectric material which acts as a form or frame upon which a conductor is wound cornerwise and alternately across opposite faces so that there will be no crossing of the conductor upon any face and the portion of the winding upon one face will be transverse to that upon the other face. By this arrangement the crossing occurs when the conductor portions are separated by the thickness of the dielectric. The sheet may have any suitable shape and preferably is provided with approximately rectangularly disposed grooves in its edges in which the conductor is wound to prevent its displacement along the edges.

RADIO MODULATION SYSTEM

(Patent No. 1,477,316. Issued to Frank Conrad, of Pittsburgh, Pa. December 11, 1923.)

This invention relates to radio telephone transmission and it has particular relation to means for measuring the modulation and to methods of and apparatus for controlling the modulation.

One object of this invention is to provide a meter registering the alternating-current component of the modulated current supplied to an oscillator tube, said meter being calibrated to indicate directly the ratio of the effective alternating-current component to .7 times the steady direct-current component.

A further object of this invention is to provide a mechanism and a method of operation wherein the intensity of the modulation is controlled in accordance with a chart showing various average effective values of the modulating current or, in general, of the modulation envelope. Such values are worked out with respect to the different kinds of sound being transmitted in such manner that the loudest individual units of the sound shall not, in general, cause the instantaneous intensity of modulation to materially exceed the value at which distortion from over-modulation begins.

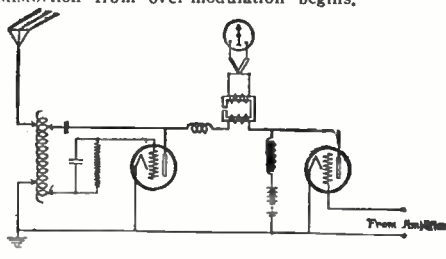

RADIOTELEGRAPHY

(Patent No. 1,473,719. Issued to Ralph R. Beal, of Palo Alto, Calif. November 13, 1923.)

The invention relates to radio telegraphy and particularly to radio telegraphy signaling systems.

An object of the invention is to provide a system of single wave radio signaling, in which waves having a frequency above the limit of audibility are converted into signals having a frequency within the range of audibility. Continuous radio oscillation generators, such as the Poulsen arc generator, for instance, produce continuous waves

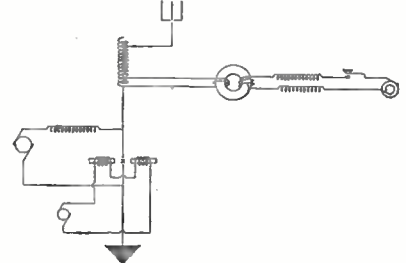

having a frequency above the range of audibility, but many receiving stations are not equipped to receive and identify waves of such frequency. This invention, therefore, contemplates so manipulating the high frequency waves, that signals will be received by such stations and this is preferably accomplished by converting the continuous waves into wave trains or wave groups, the frequency of the groups being within the range of audibility, so that signals so transmitted are readily received and identified by all receiving stations.

The invention further contemplates the use of waves of a single wave-length, eliminating the compensating wave. Thus, when the signaling key is depressed, a plurality of groups of waves of a single frequency are radiated and when the key is released, practically no radiation occurs.

CURRENT-CONTROLLING AND STATIC REDUCING SYSTEM

(Patent No. 1,477,017. Issued to Clarence A. Sprague, of East Orange, New Jersey. December 11, 1923.)

The present invention in its broad aspect relates to a method and means for combining the properties of a plurality of electric discharge devices, or their equivalents, arranged in parallel relation, to secure a desired resultant property. It involves controlling the order and extent of operation of the discharge devices, which may, for example, be thermionic vacuum tube devices.

In a more specific aspect the invention relates to

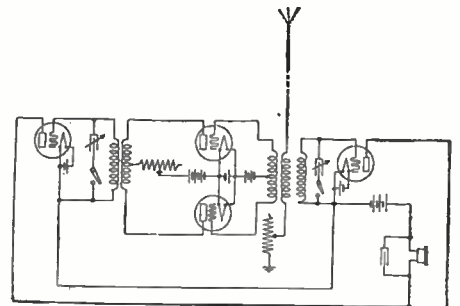

the reception of relatively weak signal energy in the presence of large electrical disturbances. It is particularly adapted to the reception of electromagnetic signal waves at radio receiving stations during atmospheric or other disturbances, but is not limited to such use, since it is applicable also, for example, to wire or cable signaling systems in which disturbing current waves are received together with the signal waves.

The invention is designed particularly for overcoming the disturbing effects of abnormal surges of energy of low periodicity compared with the signal currents. These relatively slow impulses of great amplitude are very troublesome and are difficult to control not only in radio signaling, but in high frequency carrier current wire systems and in systems of great capacity, such as the submarine cable. Without some correcting means for these large undesired currents, the receiving instrument or the operator's ear may be temporarily rendered insensitive or permanently injured, or at least it may be impossible to receive the signal during the persistence of the disturbances, owing to its being

(Continued on page 1654)



I Want to Know

THIS Department is conducted for the benefit of our Radio Experimenter. We shall be glad to answer here questions for the benefit of all, but we can publish only such matter as is of sufficient interest to all.

1. This Department cannot answer more than three questions for each correspondent.
2. Only one side of the sheet should be written upon; all matter should be typewritten or else written in ink. No attention paid to penciled matter.
3. Sketches, diagrams, etc., must be on separate sheets. This Department does not answer questions by mail free of charge.
4. Our Editors will be glad to answer any letter, at the rate of 25c. for each question. If, however, questions entail considerable research work, intricate calculations, patent research, etc., a special charge will be made. Before we answer such questions, correspondents will be informed as to the price charge. You will do the Editor a personal favor if you will make your letter as brief as possible.

USE OF HYDROMETER

(900). Mr. Clyde G. Lothrop, Whitman, Mass., requests:

- Q. 1.** Why are radio tubes so costly?
A. 1. To bring vacuum tubes to their present state of perfection, thousands of dollars have been spent in development. Part of this development expense is compensated for by the present price of the tubes.
- Q. 2.** What condition of a storage battery is determined by a hydrometer?
A. 2. A hydrometer reading shows the specific gravity, or density of the electrolyte. A reading of 1.250 or higher shows a fully charged battery and a reading less than 1,200, a discharged one.
- Q. 3.** What substances may be used for nickel plating on copper or brass?
A. 3. A nickel anode in a solution of double sulphate of nickel and ammonium, specific gravity 1.03. This solution must be neutral or slightly alkaline, as an acid bath will cause the nickel to peel off. Approximately a pound of the double salt to each gallon of solution, is used.

INCREASING WAVE-LENGTH RANGE

(901). Mr. E. G. Kausrud, Oakland, Calif., requests:

- Q. 1.** How can 509 meters be reached with a single circuit tuner?
A. 1. Connect a fixed condenser across the grid coil, of .00025 mfd., or .0005 mfd. capacity.
- Q. 2.** What determines the number of ohms a pair of phones may have?
A. 2. The resistance of the coils in a pair of phones is expressed in ohms, this usually being about 1,000 ohms for each single phone. Very fine wire must be used to get the necessary number of ampere turns on the coils which gives the phone its high resistance.
- Q. 3.** How many lamps are needed to charge a 6 volt battery at 5 amps., using a 2-jar rectifier?
A. 3. Five 100-watt lamps in parallel, or equivalent.

BEST SOLDERED JOINT

(902). Mr. Joseph Meller, Dathan, Alabama, asks:

- Q. 1.** How is a Peerless coil to be connected?
A. 1. This circuit will be found in answer to Question No. 636 in the "I-Want-to-Know" column of the April, 1923, issue of Radio News.
- Q. 2.** What is the correct per cent. of solder materials?
A. 2. This depends on intended use of the solder. Average soft solder for copper is 60 per cent tin and 40 per cent lead.
- Q. 3.** How is a good copper joint made?
A. 3. By bringing the two surfaces as close together as possible and using a minimum of solder. This is necessary as copper has seven times the conductivity of solder.

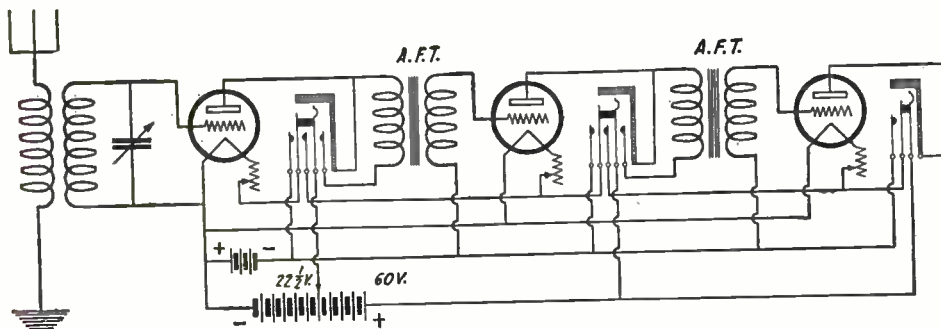

(Q. 913). Filament control jacks may be employed in any circuit in place of double circuit jacks. This diagram shows the proper connections.

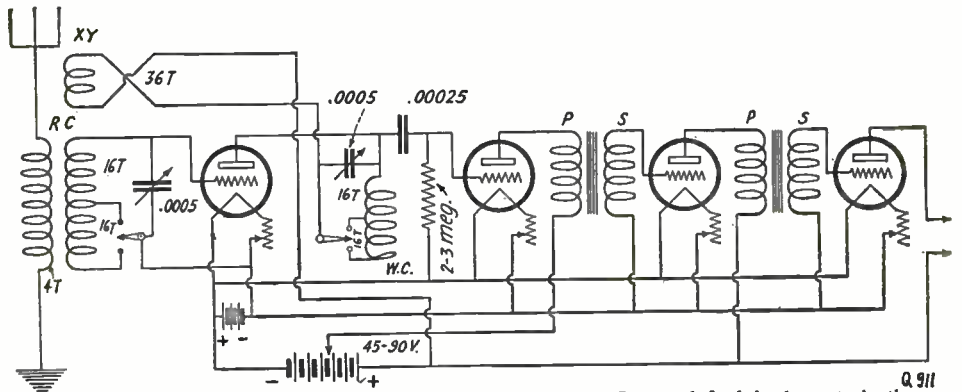

The Superdyne circuit with two stages of audio frequency. Reversed feed back controls the oscillation of the R. F. tube.

ULTRADYNE QUERIES

(903). Mr. S. S. Walbridge, Troy, N. Y., says:

- Q. 1.** Using UV-199 or UV-201A tubes, what size should the potentiometer in the Ultradyne be?
A. 1. A potentiometer of 300 or 400 ohms is recommended for any tubes.
- Q. 2.** Can the Ultradyne be used with three tubes?
A. 2. Not very successfully. It would work with four tubes but would not be efficient.

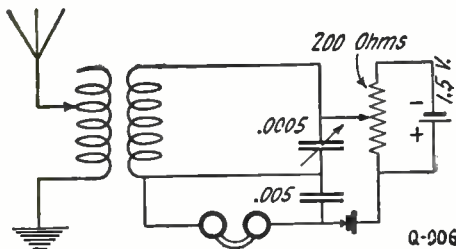

The sensitivity of a crystal set can be increased by adding a battery and potentiometer.

- Q. 3.** What is the best two-tube set to use with a condenser plug?
A. 3. Any regenerative or radio frequency set should function in favorable locations.

POWER AMPLIFIER TRANSFORMERS

(904). Mr. Swain Solon, Shenandoah, Iowa, requests:

Q. 1. What are the full dimensions for the push-pull transformers mentioned in the article, "Balanced Feed-Back Power Amplifier," on page 1082 of RADIO NEWS for February, 1924?

A. 1. There are 4,000 turns on the primary and 18,000 turns on the secondary of the input transformer. The output transformer has 18,000 turns on the primary and 4,000 turns on the secondary. No. 40 wire is used. The silicon steel laminations may be .02 inch thick and 1/2 inch wide. They are in the form of an L, being 3 inches long each way. Twenty laminations are used. The input transformer has its secondary tapped at the middle point or 9,000 turns. The output transformer has its primary tapped at the middle (9,000 turns).

RADIO BIOGRAPHY

(905). Mr. Robert S. Shull, Chambersburg, Pa., writes:

Q. 1. Compare a book condenser with one of the interleaving type.

A. 1. Book condensers do not have a straight-line capacity curve unless a special mechanical design is employed; they stand a higher voltage; dielectric losses are greater; almost impossible to short-circuit; have greater mechanical strength; require less space; are not sufficiently accurate for laboratory work; can be used on front or back of a panel.

Q. 2. What is the effect of tight variocoupler coupling?

A. 2. Broadens the tuning of both circuits; increases the natural wave-length of both coils; increases high frequency resistance of both coils; induces a current of greater value.

Q. 3. What were Marconi's major steps in developing radio?

A. 3. Marconi applied for a British patent June 3, 1896. He conducted demonstrations before British Post Office Officials, first for a distance of about 300 ft. (between the Savings Bank Department in Queen Victoria St., and the General Post Office), then 1 1/4 miles on Salisbury Plain. At the next trial, also on Salisbury Plain, four miles were covered. Bristol Channel was crossed in May, 1897. Ship to shore, and vice versa, experiments were conducted for a distance of about 10 miles in July, 1897. British Lighthouse radio service was instituted in December, 1898. March 1899, the Straits of Dover were crossed. From that time on, increasing distances were covered until, December 12, 1901, the now famous letter "S" was unmistakably received at St. John's, Newfoundland, from a Marconi station located at Poldhu, Cornwall.

IMPROVING THE CRYSTAL SET

(906). Mr. H. C. Newton, Los Angeles, Calif., wants to know:

Q. 1. How can I use a battery with my crystal set?

A. 1. The diagram appears in these columns.

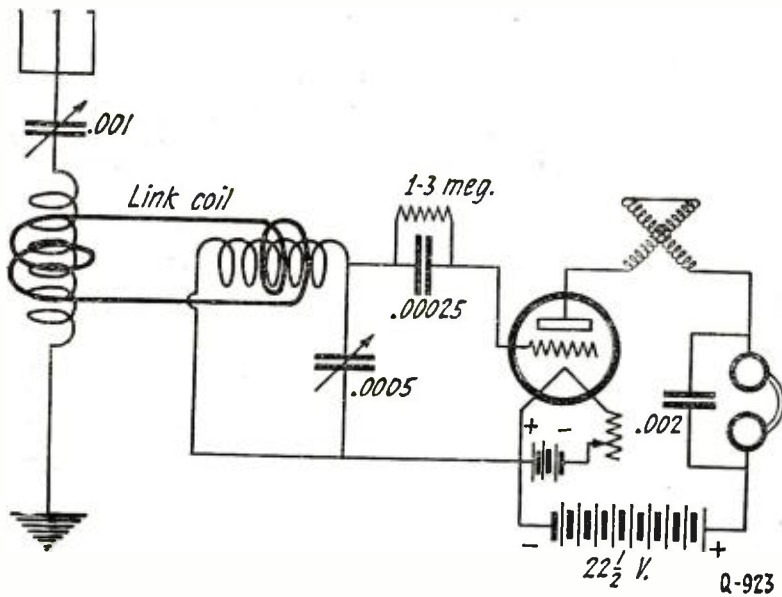

A. 1. It is experimental and not to be advised.

ADDING R.F. TO A FLEWELLING
(918). Mr. Willard Gossett, Topeka, Kansas, requests:

Q. 1. Can radio frequency amplification be added to a Flewelling set?
A. 1. Yes, but it will not increase the set's efficiency.

LOOP AERIAL
(919). Mr. John Hancock, Plainfield, N. J., makes these requests:

Q. 1. Please give instructions for building a loop.
A. 1. An efficient loop to cover the broadcast wave-lengths may be constructed by winding 15 turns of flexible stranded wire on a form 18 inches square. This form may be constructed by fastening two sticks, 3/4 inch square and 22 inches long, together in the form of a cross. One stick should preferably be about 3 inches longer than the other to provide an extension to fasten to a base. The wire should be spaced 1/2 inch and starting from the outside, may be wound spiral fashion toward the center. Upholstery tacks may be used to space the wire.

CORRECT GRID LEAK
(920). Mr. James Sims, Little Rock, Ark., wants to know:

Q. 1. Why does the music come in clear for a few seconds and then cut off and then start again, with a continuous repetition of this effect?
A. 1. This is due to incorrect grid leak adjustment. Lowering the grid leak resistance will correct it. If this is noticed only on long distance stations it is known as fading, or swinging, and cannot be avoided.

VACUUM TUBE CONSTRUCTION
(921). R. M. Hatch, Toronto, Canada, asks:

Q. 1. Why does the filament quickly burn out, in home constructed tubes, even though highly evacuated?
A. 1. This may be due to an imperfection of the filament wire. It may also be caused by a poor juncture of the lead-in wire and the glass, due to a difference in the co-efficient of expansion of the lead-in wires and the glass. Occluded gases will also effect the filament life.
Q. 2. Where can vacuum tube construction data be obtained?
A. 2. See Scott-Taggart's book, "Thermionic Tubes in Radio Telegraphy and Telephony."

PUSH-PULL AMPLIFICATION
(922). G. H. Beaudry, Montreal, Canada, requests:

Q. 1. What dry cell tubes will work best in the push-pull amplifier described in the October, 1923, issue of Radio News?
A. 1. Use UV-199 or C-299 tubes.
Q. 2. What is the voltage for "B" and "C" batteries, using these tubes?
A. 2. Sixty to 90 volts for the "B" battery. Try voltages between 4 1/2 and 9, for the "C" battery.
Q. 3. What is the capacity of condenser "C"?
A. 3. Try using a three plate variable condenser.

LINK CIRCUIT
(923). Mr. E. Heitner, New York City, wants to know:

Q. 1. Please publish the sharpest tuning circuit available?
A. 1. Circuits may often be sharp without seeming so. There are several methods of securing very sharp tuning. The "link" circuit, using one turn of very low resistance, rubber covered wire, around each of two tuning inductances will form a very sharp tuner and it can be used with almost any set. The two coils must be in non-inductive relation to each other.
Q. 2. What are the dimensions of a long wave transformer (10,000 meters) made with honeycomb coils?

(Continued on page 1660)

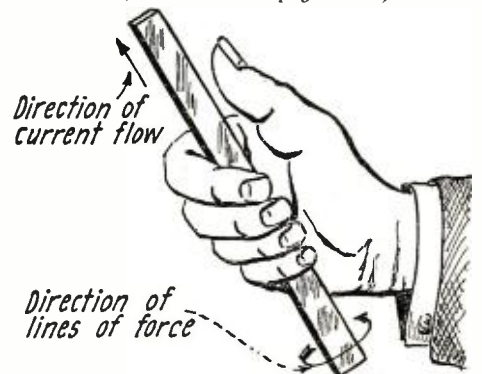

Q-914

When the direction of the current flow is known, the direction of the lines of force can easily be determined.

CONNECTING A LAMP RESISTANCE
(907). Mr. W. H. Johnson, Hilo, Hawaii, requests:

Q. 1. Should six 60-watt lamps be connected in series when charging "A" batteries from an electrolytic rectifier?
A. 1. The lamps should be connected in parallel.

IMPROVED SUPERDYNE

(908). Mr. Hugh Miller, Snyder, Okla., asks:

Q. 1. Can a UV-200 tube lose its efficiency without the filament burning out?
A. 1. Yes. Through constant use, the electron emission may considerably decrease, necessitating an increase in battery current to maintain efficiency.
Q. 2. What is the improved Superdyne circuit?
A. 2. Nearly the same as shown in answer to question No. 911, excepting that a variometer is used instead of the original reaction coil and variable condenser. Conductive antenna coupling of the Reinartz type is used. The ground then connects to the "A" battery.
Q. 3. In what position should a variocoupler rotor be, for sharp tuning?
A. 3. For selective tuning the rotor should be at an angle between 45 and 90 degrees.

MORE ULTRADYNE

(909). Mr. Edward F. Weis, Chicago, Ill., requests:

Q. 1. Will there be any advantage in using an 11 plate, or 23 plate variable condenser in place of the .00025 mfd. fixed condenser across the primary of the first long wave transformer used in the Ultradyne?
A. 1. A variable condenser would aid in tuning this circuit sharply.

"SUPER" RANGE

(910). Thomas J. Stansel, Electra, Texas, wants to know:

Q. 1. What is the best tube for "Super" circuits?
A. 1. Use a UV-202, or WE-216A.
Q. 2. What is the average range of a one tube Super Regenerative set using a two foot loop, as compared to an outside aerial.
A. 2. About the same.

SUPERDYNE CIRCUIT

(911). Mr. Reustle, Chicago, Ill., asks:

Q. 1. What is the Superdyne circuit?
A. 1. The circuit you request is shown in these columns.
Q. 2. Should the reactance coil and variocoupler be in inductive relation?
A. 2. No. The reactance coil and variocoupler should be at right angles to each other.
Q. 3. How are the coils made for broadcast and amateur reception?
A. 3. Secondary inductance, RC, is on a 4-inch tube. The negative-feedback rotor, XY, is a 3 3/8-inch ball. Plate Reactor inductance, WC, is on a 4-inch tube. Correct wire turns for broadcast wave-lengths are shown. For amateur wave-lengths, use the 16 turn tap on RC and the 16 turn tap on WC. XY remains the same. The aerial and ground are coupled to RC by four turns of No. 18 lamp cord wound tightly around it.

TUBE QUERY

(912). Mr. Robert A. Fox, Jr., West Long Branch, New Jersey, requests:

Q. 1. Can a UV-200 be made to work, if it stops working as soon as it gets hot?
A. 1. A change of "B" battery voltage would probably cause the tube to function for a time.

FILAMENT CONTROL JACKS

(913). Mr. F. Grampp, Jr., Elizabeth, N. J., asks:

Q. 1. Can a step of radio frequency amplification be added to an Autoplex receiver?
A. 1. No.

Q. 2. How can filament control jacks be added to my set?
A. 2. The diagram of a two stage amplifier using filament control jacks is shown in these columns.

TUNING

(914). Mr. R. L. White, Desdemona, Texas, wants to know:

Q. 1. What are some general instructions for tuning?
A. 1. The aerial should be adjusted to the

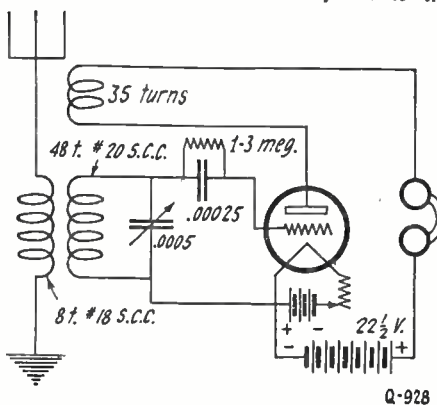

Very good results are secured with this circuit using a fixed coupler. A tickler coil provides regeneration.

approximate wave-length it is desired to receive. Follow up with an adjustment of the grid and plate controls.

Q. 2. What is a simple way, when direction of the current in a wire is known, to determine the direction of flow of the magnetic lines of force?
A. 2. With the wire grasped in the right hand, the thumb extended and pointing in the direction of the current flow, the curved fingers will denote the direction of the magnetic lines of force. A diagram showing this will be found on these pages.

REDUCING BODY-CAPACITY

(915). Mr. D. Bailey, Toronto, Canada, asks:

Q. 1. How can I reduce body-capacity?
A. 1. Keep filament current as low as possible. Reverse connections to condensers from which effect is noted. If capacity effect is noticed from the variocoupler, try reversing the rotor leads. Reverse variometer leads, if effect is noticed from this instrument.

MUSHY SIGNALS

(916). Mr. D. H. Peters, Omaha, Neb., wants to know:

Q. 1. Why do certain stations come in "mushy"?
A. 1. This is ordinarily caused by some station (receiving or sending) heterodyning with the wave of the station you are trying to receive. Should the trouble originate in your receiving set, try changing the grid leak.

INVERSE-DUPLEXING THE NEUTRODYNE

(917). Mr. F. G. Watson, Washington, D. C., inquires:

Q. 1. Can the Inverse-Duplex principle be used in a three tube Neutrodyne receiver?

Announcing
the greatest
recent contribution
to Radio ~

R3

New Model

This instrument sets a new and higher
standard of adaptability, refinement and
economy of operation.



Volume
Control

R3 (New Model), with Volume
Control - - - - - \$35.00

M1 requiring no battery for its
operation - - - - - 35.00

THE MAGNAVOX CO. OAKLAND, CALIF.

New York Office: 370 SEVENTH AVENUE

Canadian Distributors: Perkins Electric Limited, Toronto, Montreal, Winnipeg

MAGNAVOX

The Reproducer Supreme

Now you can UNDERSTAND RADIO!

Take the mystery out of it—build and repair sets—explain the vacuum tube—operate a transmitter—be a radio expert!

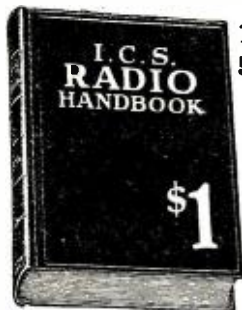

**1 VOLUME
514 PAGES**

Compiled by
**HARRY F. DART
E.E.**

Formerly with
the Western
Electric Co.,
and U. S.
Army In-
structor of
Radio.

Technically Edited by **F. H. Doane**
40,000 ALREADY SOLD

This practical and authoritative handbook is considered the biggest dollar's worth in radio to-day. Over 40,000 homes rely on the I. C. S. Radio Handbook to take the mystery out of radio. Why experiment in the dark when you can quickly learn the things that insure success? Hundreds of illustrations and diagrams explain everything so you can get the most out of whatever receiver you build or buy.

It contains: Electrical terms and circuits, antennas, batteries, generators and motors, electron (vacuum) tubes, many receiving book-ups, radio and audio frequency amplification, broadcast and commercial transmitters and receivers, wave meters, super-regeneration, codes, license rules. Many other features.

A practical book. Written and edited by experienced engineers, in plain language. Something useful on every one of its 514 pages. The authority that covers every phase of radio, all under one cover in one book for one dollar. Don't spend another cent for parts, turn a dial or touch a tool until you have mailed \$1 for this I. C. S. Radio Handbook.

Send \$1 at once and get this 514-page I.C.S. Radio Handbook—the biggest value in radio to-day. Money back if not satisfied.

—TEAR OUT HERE—

INTERNATIONAL CORRESPONDENCE SCHOOLS
Box 8283-B, Scranton, Penna.

I enclose One Dollar. Please send me—post-paid—the 514-page I. C. S. Radio Handbook. It is understood that if I am not entirely satisfied I may return this book within five days and you will refund my money.

Name.....

Address.....

MAKE YOUR OWN PANELS

RADOPAINT withstands 4000 volts.

Resists Acid and all Climatic Conditions.

Makes a perfect panel from any kind of wood.

From Your Dealer or
One quarter pint can post paid U.S.A. 50c

INSULATION PRODUCTS CO.
426 Plymouth Court CHICAGO, ILL.
Dealers Write for Prices

LEICH ELECTRIC CO.

Leich Headphones, Non Tune Rectifiers
L- Radio Jacks and Plugs
Write for complete Radio Bulletin 101-C
GENOA, ILLINOIS

Correspondence From Readers

(Continued from page 1597)

half hours, following which KSD afforded the opportunity to enjoy for one hour similar services in a Catholic Cathedral in St. Louis.

I am able to hear a sermon, at the church of my own choice, every Sunday evening.

I have attended foot ball games, prize fights, theatricals, Grand Opera, organ recitals, fiddlers' contests, barn dances, glee clubs, dinner concerts and midnight frolics, but I tune out all bed-time stories—an old-timer does not need so much sleep anyhow,—and I don't want to be sent off to bed.

I went to a circus the other night, too, at WTAS, and they had a circus band, wild animals, ringmaster 'n'everything, with pink lemonade; at least they were offering "Peanuts and Popcorn," and a voice said, "No lady, money is *not* refunded when the gum's been chewed," so I know it was a circus.

I have a regular perch with the Radiowls at WSB, occasionally stay out late with the Nighthawks at WDAF, have served a few terms in Stripes with WOS, have won my right to a Certificate for Radio Truth at WBAP, and my application is in for Late Hours Club at WDAR, and am honored to be in the Family Circle of WWJ, with all my late hours.

WRC, "The Voice of the Capitol," has it all, Religion, Politics, Science, Art or just plain mechanics, and seems to be delighted to put it on the air for us. I can get the whole works within a short night, from Markets and Weather reports and News Crier, to the Classical and Grand Opera, by pushing the button on WDAP, WJAZ and KYW. I have not seen KYW's Cat yet, but have heard the dog speak at WOR.

KFKX has caught the "wrinkle" from KDKA, and not only boosts the latter but puts out a brand under his own trade mark with so much clarity and volume that KDKA will have to watch his step.

WGY is another of our "local stations" and I will say that nothing not first-class reaches us from that fine station. WBZ recently furnished the best violin music I have heard; no, not "fiddles," fellows; these were real old time violins and the performers must have grown up with them. WJAR and WSAD have furnished a few good numbers, also. WHAZ has an output as pleasing as it is varied and is well received, the only trouble being there are too many silent nights.

WHAS, WMC, WSB and WFAA all furnish fine music in varied programs, from Foster's melodies to everything you like, all with a touch of that Dixie Land hospitality that makes you like it better.

WBAP sends out plenty that is modern, but if you listen you will, if you are old enough, get a thrill from the old-time numbers as well.

The Hired Hand there is busily engaged in preserving the truth from being abused or overworked, and is supported by more than 100,000 working members; what they have done to Radio Truth is almost enough.

WSAI and WLW are well equipped and will furnish any brand of entertainment you want, or can use, from High-brow to Jazz, and they seem to enjoy doing it. WBAV and WPAL would have you know that Columbus is something more than a spot on the map. WTAM and WJAX turn out in quality more than is lacking in quantity and the same may be said of WWJ and WCX, I enjoy them all from Dinner Concert to Midnight Frolic as often as possible.

WCBD may not be able to establish the fact of the Earth being flat, but the brothers

As bottle glass differs from a brilliant diamond



Even the most inexperienced would note the difference immediately. There is just as much difference between results from an ordinary rheostat and the gem of them all—the

UNITY Vernier Rheostat

It is the highest type electrical instrument made for controlling resistance. A single wire followed its entire length by a contact permits the most infinitesimal variation. A built-in cut-out switch is an exclusive UNITY feature. Satisfaction guaranteed or money refunded.

Use 6 Ohm Rheostat
for most tubes but
25 Ohms for 201-A and 301-A
40 Ohms for 199 and 299

Price, \$2.00

"TUBE CONTROL," a book by J. Elliott Jenkins, Engineer of Broadcasting Station WDAP—tells how to eliminate noises. Send 14c, cost and postage; or 10c at your dealers.

If your dealer cannot supply, take no substitute. Write us direct

UNITY MFG. CO.
228 N. HALSTED STREET, CHICAGO

FOR MAXIMUM DETECTION PANFONITE

is the crystal that stands supreme, either as a simple detector or for use in reflex circuits. Each crystal is tested and finely mounted.

Mailed for 50c.

The feeble radio currents are precious
One application of

COVAR

on inductance coils will prevent all leakage and keep the turns firmly in position. COVAR is a colorless varnish, it renders the silk and cotton covering of wires absolutely impervious to moisture and dust, but does not produce the electro-static damping effect, which is the objectionable feature of shellac and other varnishes.

Mailed ready for use with solvent for \$1.

Soldering Radio joints is a vital necessity, easily accomplished by using

SOLOX

the IDEAL fluid soldering flux. It is non-acid, non-aqueous, not greasy. It cannot produce galvanic action between dissimilar metals, therefore does not produce corrosion or imperfect joints. The surplus fluid evaporates under the heat of soldering, leaving the joint clean, electrically and mechanically perfect.

Mailed ready for use for 50c.

THE D. X. RADIO RESEARCH LABORATORIES

Crugers-on-Hudson New York

PATENTS

C. L. PARKER
Formerly Member
Examining Corps,
U. S. Patent Office.
PATENT - LAWYER
McGill Bldg., Wash., D. C.

Patents, Trade Marks, Copyrights, Patent Litigation
Handbook for Inventors, "Protecting, Exploiting and Selling Inventions." sent upon request.

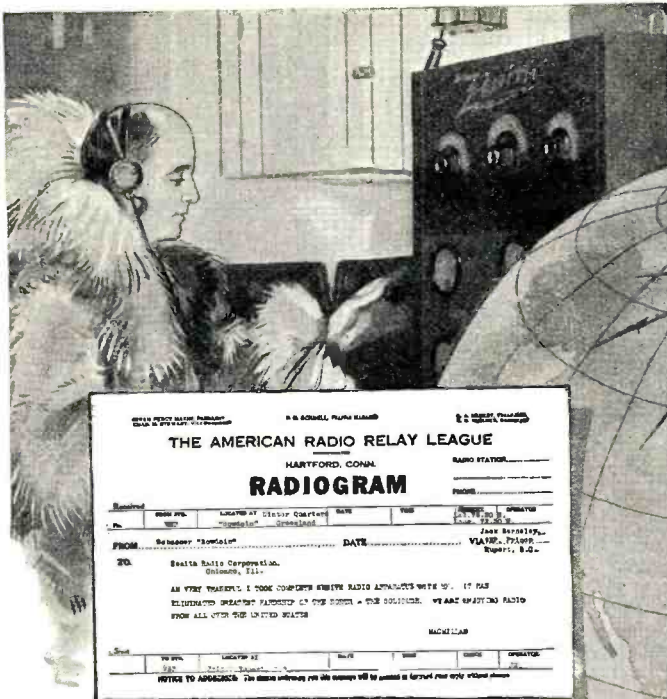

THE AMERICAN RADIO RELAY LEAGUE
HARTFORD, CONN. RADIO STATION

RADIOGRAM

TO: South Radio Corporation, Chicago, Ill.

FROM: Reseater "Bowdoin" via W.P. 1100

DATE: _____ VIA: _____

REMARKS: _____

ZENITH

Licensed under Armstrong U. S. Patent No. 1,113,149

AT THE NORTH POLE

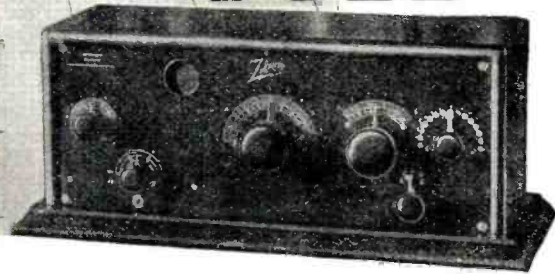

Model 4R—The new Zenith 4R "Long-Distance" Receiver-Amplifier comprises a complete three-circuit regenerative receiver of the feed-back type. It employs the Zenith regenerative circuit in combination with an *audion detector* and *three-stage* audio-frequency amplifier, all in one cabinet. Because of the unique Zenith "selector," unusual selectivity is accomplished without complication of adjustment.

The Zenith 4R may be connected directly to any loud-speaker *without* the use of other amplification for full phonograph volume, and reception may be satisfactorily accomplished over distances of more than 2,000 miles **\$85**



Model 3R—The new Zenith 3R "Long-Distance" Receiver-Amplifier combines a specially designed distortionless three-stage amplifier with the super-efficient Zenith three-circuit regenerative tuner. Fine vernier adjustments—in connection with the unique Zenith aperiodic or non-resonant "selector" primary circuit—make possible extreme selectivity.

2,000 to 3,000 Miles with Any Loud-Speaker
The new Zenith 3R has broken all records, even those set by its famous predecessors of the Zenith line. Satisfactory reception over distances of 2,000 to 3,000 miles, and over, is readily accomplished in full volume, using *any ordinary loud-speaker*. No special skill is required.

The Zenith is the only set built which is capable of being used with all present-day tubes as well as with any tubes that may be brought out in the future. The Model 3R is compact, graceful in line, and built in a highly finished mahogany cabinet **\$160**

Inside the Arctic Circle, nine degrees from the North Pole, a little 89-foot schooner is frozen fast in the ice of Smith Sound. Aboard this schooner a group of brave men are enduring, as best they can, the desperate cold of the Arctic—cold that often drops to 60 degrees below zero. Human atoms in a boundless field of ice!

Cold is hard to endure, but far more terrible is the Arctic solitude—unbelievably oppressive. Radio, at length, has broken this spell forever!

Concerts from Honolulu!

Daily, by means of powerful sending and receiving apparatus, the crew of the "Bowdoin" are in communication with relatives and friends in the far-off States. Daily they listen to concerts as far away as Chicago, Dallas, and Honolulu!

When the sanity, the very lives of one's shipmates may depend upon contact with the outside world, none but the *best* is good enough.

Dr. MacMillan's Choice—the Zenith

Out of all the radio sets on the market, Dr. MacMillan selected the Zenith exclusively—because of its flawless construction, its unusual selectivity, its dependability and its tremendous *reach*.

Already his operator, on board the "Bowdoin" in *Northern Greenland*, has tuned in several hundred stations. You along the Atlantic who brag a little when you tune in Catalina Island—what would you say if you tuned in Hawaii *from the Arctic Circle?*

The set that Dr. MacMillan has is a standard Zenith receiving set. And you can do all that MacMillan does, and more, with either of the two new models shown at the right. Their moderate price brings them easily within your reach. Write today for full particulars.

Zenith Radio Corporation
McCormick Building
CHICAGO

ZENITH RADIO CORPORATION, DEPT. K
328 South Michigan Avenue, Chicago, Illinois
Gentlemen:—
Please send me illustrated literature on Zenith Radio.

Name

Address



MAHOGANITE Dials that match the set

Like all other distinctive products, Mahoganite has its imitators. But, these imitations are on the surface only. Mahoganite is not a surface finish. The electrical values of Mahoganite extend through the material.

The only way to assure yourself of genuine Mahoganite Panels, or Dials which match the panels, is to make sure that the RADION Trademark is on every one that you buy.

21 Stock Sizes

Mahoganite and Black

6 x 7	7 x 14	8 x 26
6 x 10½	7 x 18	9 x 14
6 x 14	7 x 21	10 x 12
6 x 21	7 x 24	12 x 14
7 x 9	7 x 26	12 x 21
7 x 10	7 x 30	14 x 18
7 x 12	7 x 48	20 x 24



Look for this stamp on every genuine Radion Panel. Beware of substitutes and imitations.



RADION

The Supreme Insulation

PANELS

Dials, Sockets, Knobs, Insulators

American Hard Rubber Co.

11 Mercer St.

New York

and sisters there certainly have a harmony factory, and turn out only the high-grade brands. WOC will straighten your spine, if you but listen; KFKB will renew your youth (Here comes Brinkley), while WOAW will mail a nice check to your merry widow, if you have taken their advice, and Brinkley doesn't get you.

PWX and 6KW give you a Spanish flavor, while CHYC and CFCA will furnish either the English or French accents; WLAG and WCAL "Shoot it all" in about 17 languages.

Late in December, I heard General Smedley D. Butler "airing his views" and broadforecasting what his Marines would do to Philadelphia, and it seems that they have gone over the top down there and have begun to "treat 'em rough;" I only hope that they have left their wire pliers out of their kits, for I don't want WOO nor WIP disturbed, as they are both good friends of mine.

I have heard many other stations, all good, and have on several occasions picked up both ends of amusing air duels and dialogues between stations, so with all this I will ask, can you blame me for being a "Radiotic Fan," and glad of it?

The uniform courtesy extended me by members of staff at the different stations where I have feebly attempted to show some gratitude for their entertainment, and appreciation of the talent employed, has been very agreeable to me, as well as quite a surprise to learn that they also had time to freely dispense this courtesy to an unknown "Hill Billy" hundreds of miles away, whom they need never expect to see or know.

P. W. EARLY, *Broadcatcher,*
Welch, W. Va.

[At last the "contented" letter has arrived. We thank the Lord that radio broadcasting is not in vain; here at least is one who is being well served. We who only put out a magazine can think of him with kindness in our eyes, thank him for his appreciation of broadcasting, reveal him as the "right sort" and pray that his spirit will eventually dominate.—EDITOR.]

RIGHTO!

Editor, RADIO NEWS:

Please allow me a little space in your valued magazine, to correct a few minor points in 2-ADH's letter in the March issue.

The reason amateurs are not bothered to any extent by receiver squeals is not that amateur receivers are operated in a non-oscillating condition—they must oscillate, in order to pick up straight C.W. signals—but because amateurs do not make a practice of slopping around on a number of stations, as some BCLs with oscillating receivers do.

About the statement that "the average amateur wave is not as sharp as a good broadcast station's wave": This is not true. In order for a C. W. wave to be heard, an oscillating detector must be used, and the signal can only be heard from the upper limit of audibility on one side, down to the zero beat, and up to the limit of audibility on the other side, or about 10,000 cycles, regardless of what type of tube transmitter is used. I have never seen a tube transmitter which would give any reading of broadness on a decimeter, and have reason to believe that no such transmitter exists. And then, further, it is claimed that the use of Heising modulation on a phone set broadens its wave on account



For Better Tuning

Bremer-Tully Vernier Tuner. The original three cross section circuit Tuner.

Bremer-Tully Vernier Variable Condenser. The original Vernier Variable Condenser.

Bremer-Tully Air Core Transformer.

Better Tuning

Tells you why and shows you how.

Mailed on receipt of 10c.

One packed free with each Tuner.

**Better
Tuning
B-T
Price 10c**

BREMER-TULLY CO.

Canal & Harrison Sts., Chicago, Ill.

SUPERTRAN

Registered U. S. Patent Office

CERTIFIED!

Supertran Audio Transformers have been certified by the largest testing laboratory in the United States. They are "certified" by scientific measurements to be unequalled for volume, quality, and electrical efficiency.



**Price
\$6.00**

These transformers are specially designed for the Neutrodyne and Reflex circuits.



Can be used with any amplifying tube on the market with excellent results.

At your dealer—or direct by mail on receipt of purchase price.

FORD MICA COMPANY, INC.
33 East 8th St. New York

JONES MULTI-PLUG & CABLE

(Patents applied for)
The Standard Radio Set Connector

Put this type on your new set; it is small and may be mounted anywhere with cord and plug \$4.00 Type P. M.

Put this type on seven binding posts of your present set. With cord and plug \$5.00 Type B. P.

Put your Batteries on shelf in basement and run this 8-ft. cable through floor to set.

5A and B. Battery wires in cable. Antenna and ground are separate leads from cap. Guaranteed not to impair efficiency of set. For sale by all Jobbers and Dealers. Fully covered by patents applied for. Manufactured by

HOWARD B. JONES
608 S. Canal St. Chicago, Ill.

“THE AIR IS FULL OF THINGS YOU SHOULDN'T MISS”



Get ready now for summer radio

YOUR radio batteries have served you well and faithfully over the long winter months. Now a great radio summer is at hand. To enjoy summer radio at its best, equip your receiver with the best batteries you can get. Put in your Eveready Radio “B” Batteries and see what wonderful, long-lived service they will give.

Made especially for radio use, Eveready “B” Batteries will operate the loud speaker at maximum volume for long or shorter periods, depending on how rapidly the current is taken out of them. Packed full of pep and punch and go, Eveready “B” Batteries pour out their power the moment you turn on the tubes. Scientifically made for long-lived radio service, the cells renew their vitality when idle—responding instantly with fresh vigor.

Eveready “B” No. 767 is the standard amplifier “B” Battery, and gives 45 powerful, dependable, zippy volts. Five sturdy Fahnestock Clips make this big “B” Battery available for soft detector tube use as well—varying the voltage from 16½ to 22½ as required.

Insist on Eveready “B” Batteries, remembering that they are the product of thirty years of experience and know-how in battery making. Designed and made under the supervision of the finest electro-chemical laboratory known to science, the quality and efficiency of Eveready Radio Batteries are assured. For maximum battery economy and service, buy Eveready Radio Batteries—they last longer.

Manufactured and guaranteed by

NATIONAL CARBON COMPANY, INC.

Headquarters for Radio Battery Information

New York San Francisco

Canadian National Carbon Co., Limited
Factory and Offices: Toronto, Ontario

Informative and money-saving booklets on radio batteries sent free on request. If you have any questions regarding radio batteries, write to Radio Division, National Carbon Company, Inc., 122 Thompson Ave., Long Island City, N. Y.

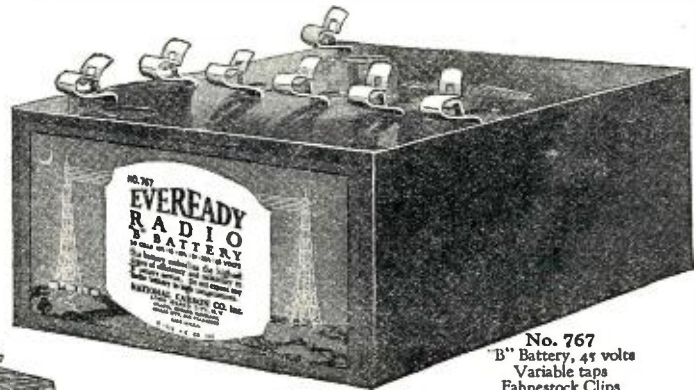

No. 767
“B” Battery, 45 volts
Variable taps
Fahnestock Clips

Eveready
6-volt
Storage
“A”
Battery



No. 764
The Space
Saver
Vertical
22 ½-volt
“B” Battery



Eveready
“A” Dry Cell
The best
battery for use
with dry cell
tubes

No. 766
“B” Battery, 22½
volts. Six Fahne-
stock Spring Clips



No. 771
“C” Battery
Clarifies tone
and prolongs
“B” Battery
life



EVEREADY

Radio Batteries

—they last longer

NATIONAL OUTDOOR SPORTS EXPOSITION

Grand Central Palace
New York City
May 26-31, 1924

RADIO

Radio in all forms will be one of the important features of the National Outdoor Sports Exposition. This display will attract thousands of radio enthusiasts able and willing to purchase the latest equipment in this fast developing industry.

No finer opportunity will be offered this year for Radio manufacturers, jobbers and dealers to get in touch with the world's greatest market.

For information regarding space, rates, etc., address:

NATIONAL OUTDOOR
SPORTS
EXPOSITION
Room 1102
Grand Central Palace
New York City

of the fact that a change in plate voltage will change the wave slightly, and when the voltage is being rapidly varied by the modulation, the wave will rapidly move up and down, giving the effect of broadness, although I do not think that even this would show on a decimeter.

I would ask 2ADH to please bear in mind the fact that the amateur radio man has nothing to apologize for, and in every single case that I have been in touch with, where a complaint was made concerning amateur interference which was found to actually result from amateur transmission and not commercials, the receiving set was to blame for the trouble. I have never seen a case of interference by amateur C. W. stations in which the trouble could not be remedied by installing a selective receiver. In many cases, exactly this remedy was applied with gratifying results to everyone concerned—the BCL was able to get better and clearer concerts, as well as being able to tune out local interference.

OLIVER E. ROSEBANK,
24 Wyndham St.,
Guelph, Ont.

FAVORS KNOBS AND DIALS

Editor, RADIO NEWS:

Ever since subscribing to RADIO NEWS, the first item I read on receiving each issue is the "Editorial." It is hard to express sometimes the ambitions and development "dreams" resulting from the study of these editorials.

I venture, however, to take issue with you on your belief that the knob and dial idea is all wrong. It is the simplest system yet, and much less confusing than the jack and plug system you advocate. Say by your own argument that you have 12 allotted stations to your receiver. You have 12 jacks and 12 little verniers. In fine, a miniature telephone exchange. Having some little experience of telephone exchanges, I would vote for the knob and dial. Lately I have built a receiver, not on my own initiative, but from careful plans given out by a contemporary paper. This operates a speaker very satisfactorily with a loop aerial. Instead of 12 jacks, as in the instance taken, there is *one control* with a vernier, and the control is calibrated in *stations* on the dial. Thus my "good lady" does not even have to know what the dial is for nor anything about tuning or frequencies, but sets the pointer to WGY or KDKA and it is there, not *once* but *all the time*. I believe the time is coming, however, when our outside aerials with their (in many congested places) attendant difficulties in erection will be completely discarded, and consistent loop aerials such as you picture in Dr. Rogers' tests in a recent issue will be the main source of reception in the "Family receiver." Radio equipment is daily being made better and what is more important, less expensive. Two years ago a man paid \$150 for a Victrola, and thought it was all right. Today this figure will cover the expense of a six-tube receiver easily if home built, and it won't be long before this will be a factory built price, if the three or four "intermediate discounts" can be eliminated. Then the average salaried man will be able to obtain a good, carefully calibrated set with little expense, without trouble.

A. W. MASON,
St. Andrews, N. B.

STRAIGHT FROM THE SHOULDER

Editor, RADIO NEWS:

Every time a new RADIO NEWS comes out, there are a whole flock of new woes aired in the "Correspondence from Readers" columns, so I'm going to put the reverse on some of these tales of woe, if I can, and show that a large percentage of the trouble is imaginary. Before I begin, I might add



Better Tone for Your Radio!

FRANK D. PEARNE, famous Radio engineer, says TRANSCONTINENTAL RIBBON Aerials aid reception by combining maximum surface with minimum resistance. FORREST, eminent inventor, says, "I get best results by twisting Ribbon Aerial, 2 twists per 50 feet." Complete with snap hooks soldered to ends for instant attachment to insulators.

Transcontinental 50-Foot
RIBBON COPPER AERIAL \$1.50
75-Ft. \$2.25
100-Ft. \$3.00
150-Ft. \$4.50

Clearer tone, greater volume, increased distance and selectivity guaranteed or your money refunded! Improves any set, tube or crystal. A laboratory product, with capacity, resistance and strength calculated to give better results.

Try It Without Risk! If your dealers cannot supply you, order direct from manufacturer, enclosing price. 100-foot length most generally used. Money-back guarantee protects you.

Acorn Radio Mfg. Co. 1806 S. Racine Ave. Dept. 305 CHICAGO



DEALERS! Write for Special Offer!



SAVES YOU 50%
Genuine AHBELL NEVERLEAK Solid Rubber Case
2-Year Unconditional Guarantee

SILVER S BATTERY

For AUTO and RADIO

Tremendous saving for you on this non-leakable, Guaranteed Superior Quality Storage Battery. One-piece indestructible case, can't leak, spill, or injure rugs or clothing. No more breakage of jars or acid eaten boxes. 2-year written unconditional guarantee covers leakage as well as performance and fully protects you. Silver-S quantity production and Big Buying Power makes possible this unheard-of-value.

50% - SEE WHAT YOU SAVE - 50%

5 per cent Discount for cash in full with order.

AUTO PRICES	RADIO PRICES
6-V, 11 Plate - \$13.00	6-V, 100 Amps. \$13.50
6-V, 13 Plate - 15.00	6-V, 120 Amps. 15.50
12-V, 7 Plate - 18.00	6-V, 140 Amps. 17.00

Inspect this Wonder Battery. Read our 2-year Guarantee before you pay one cent. Satisfy yourself you are getting the best battery made—50 per cent saving. Shipment made by express. Government C. O. D. subject to examination. No delay. Send name and address and style wanted TODAY.

SILVER-S BATTERY COMPANY
201 E. Ontario St., Dept. 50, Chicago, Ill.

SEND NO MONEY

S. HAMMER RADIO CO. 303 Atkins Ave., Brooklyn, N. Y.

GENUINE Complete Parts for the COCKADAY Improved 4 CIRCUIT TUNER.....\$55.00

EXTRA SPECIAL!!!
\$120 GENUINE FADA 4 TUBE NEUTRODYNE SET NO. 160\$95.00

\$80.00 GENUINE FRED EISEMANN Knockdown Parts for 5 TUBE NEUTRODYNE SET.....\$70.00

PHONES
Federal No. 65.....\$3.55
Acme.....3.80
All American.....3.75
Amertran.....5.60
Como Du.p.p.dr.....10.55
Modern p.p.dr.....10.55
Eria.....4.20
Duratran R.F.....4.35
Rasla R.F.....3.60
All American p.p.....10.00

CONDENSERS
\$2.00 Signal or Admiral 11 pl. Variable....\$ 1.45
2.50 Signal or Admiral 23 pl. Variable.... 1.50
3.00 Signal or Admiral 43 pl. Variable.... 1.75
4.50 U.S. Tool or Ameco Vernier 11 plate... 3.45
5.00 U.S. Tool or Ameco Vernier 23 plate... 3.70
5.50 U.S. Tool or Ameco Vernier 43 plate... 4.20

LOUD SPEAKERS
\$30.00 Music Master.....\$24.00
35.00 Magnavox.....29.00
55.00 Western Electric 10-D.....48.00
17.50 Pathe, New Type.....18.00
10.00 Brandes, Table Talker.....9.25

Orders Over \$5.00 Shipped Prepaid
Money Orders or C.O.D.—Write for Price List
Not Insured Unless Insurance Charges Included

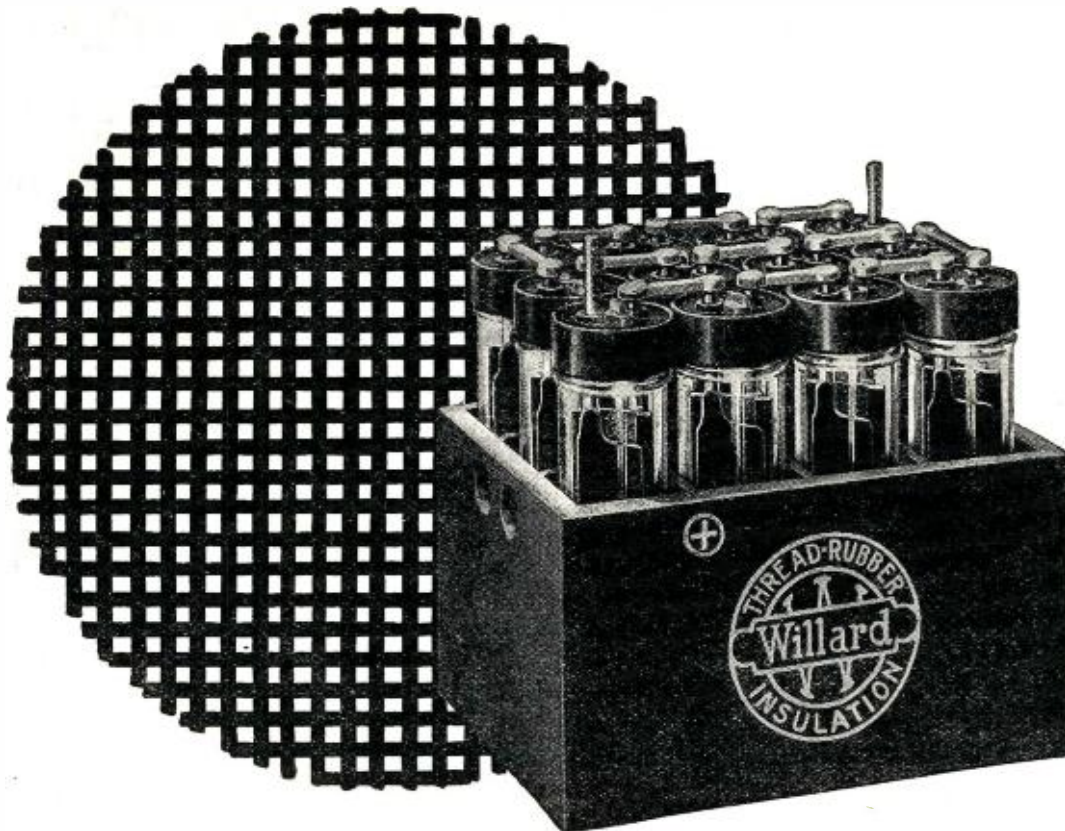

Willard B Batteries

Willard Rechargeable B Batteries are made in 24 or 48 volt blocks, each type in two capacities, 2500 m.a.h. and 4500 m.a.h.

104 Broadcasting Stations Use Willard B Batteries



Willard A Batteries

Good A Batteries are as important as good B Batteries. There are several types of Willard A Batteries in a range of prices, including the Willard All-Rubber A Battery, with rubber case and Threaded Rubber Insulation. Five sizes, 20 to 125 a.h.

Broadcasting Station engineers are keen buyers of radio apparatus. Radio is *their* business. These men know quality. The reputation of their stations depends upon their judgment.

During the past eighteen months 104 Broadcasting Stations have replaced other batteries with Willard Bs. They are using them in voice amplifying circuits on account of quietness in operation.

An Investment in Quality and Economy

The purchase of a Willard B is an investment in quality; because its even full-powered current, delivered over long periods without fluctuation, enables your set to receive at its best. Economy, too, is served. Willard Bs last four or five years. Recharging is necessary only at rare intervals and can be done with

Willard Colloid Rectifier without disconnecting the battery from the set.

Your Willard Service Station or Radio Dealer will be glad to demonstrate the superiority of Willard B Batteries. Ask him, too, for booklet, "Better Results from Radio," or write Willard Storage Battery Company, Cleveland, Ohio.



Willard C. T. R.

4 volt B Battery with rectifier for U. V. 199 and C-299 tubes.

Willard

Rechargeable Batteries for

Radio



Radio & Audio Frequency TRANSFORMERS

"The Heart of a Good Receiver"

EQUAL to the widest range of reception requirements. *Marle Transformers* amplify the weakest broadcasting, over frequencies all the way up to 3500 cycles without variation. Perfect tone quality. Utter absence of howling or distortion. To get the most out of radio—use *Marle Transformers*.

Specially adapted to the latest circuits, the
SUPERDYNE
SUPERHETERODYNE
FOUR CIRCUIT TUNER
NEUTRODYNE
INVERSE DUPLEX
 and any circuit that makes high requirements of a transformer.

Type A9
 Ratio 5 to 1
 Shelltype
 \$6.00

Type A4
 Audio F
 Ratio
 3 3/4 to 1
 \$3.75

Type A6
 Ratio 5 to 1
 Audio F
 \$4.25

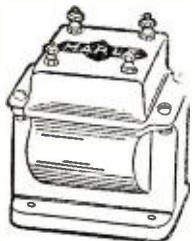

MARLE ENGINEERING COMPANY

Orange,
 New Jersey

Type A7
 Ratio
 3 3/4 to 1
 Audio F
 \$4.50



Types R1
 and R2
 Radio F
 \$4.00

that my fifth first-grade commercial license is now seven months old.

What's all the howl about interference? Right now, we are located one mile, no more, from KSE, the R. C. A. Marine Station at Wilmington, Calif. KSE has a 2-K.W. R. C. A. quenched spark transmitter, radiating about 12 amperes on 706 meters. Does he interfere with the broadcasts? Not on my receiver! What's the trick? Extremely loose coupling and one stage of tuned radio frequency amplification. It seems to help, to use an undersized variometer as an inductance in the R. F., and shunt it with a .00025 mfd. fixed condenser. Selectivity was noticeably increased in this manner, compared to a R. F. using inductance without the shunt capacity. Why, I don't know, but the fact remains. Last trip, while tied to this same dock, I heard WOAW and KYW, and a gang of nearer broadcasts while KSE went merrily on with his Marine traffic. He was dimly audible, as a sort of faint background, but at no time did he constitute interference. With 10 bucks worth of apparatus I can make any good single circuit do the same, because I've done it. Anyone who wants the circuit, just drop me a line.

I don't know how it is on the East Coast, but all our West Coast stations are now on 706 meters. That helps a lot, both from a commercial and BCL standpoint. Also, we are ordered, not requested, to refrain from using the 450-meter wave during broadcast hours. It gets pretty thick on 600 between supper time and midnight, but we all seem to be getting through all right. We've got to, or do something else for our coffee and cakes.

Mr. Charters, of KUVB, has a grievance that all commercial operators have met with. Here's the way it looks to me. OM. Grant that they don't respect the job, then make them respect the man holding the job. Throw the old tunic with the gold braid on it overboard, and get a nice flannel shirt to take its place. If you're running coastwise, cut out the press. Tell them that you didn't get it, not that you couldn't get it. If someone laughingly accuses you of getting your press from the *Literary Digest*, laugh with him, and kid him out of it. If he doesn't laugh when he says it, invite him out on a hatch.

A Chief Engineer refused to supply me with juice in the daytime, on one occasion. I thought it over, and decided to lay low until the Old Man wanted to send something. The Old Man obliged with a nice message at noon on the same day. I politely informed T. O. M. that there was nothing doing, because the Chief wouldn't give me juice in the daytime. There ensued hard words over the engine room speaking tube, and juice on request from then on. On another ship, the wireless room juice would go off during the day, even though the dynamo was never shut down. Careful inquiry revealed the fact that only the Chief pulled the switch; no one else touched it. I informed the Chief at the mess table that the next time the switch was out at sea, I would look him up and personally and painstakingly punch him in the eye. No more trouble with the juice. Our second mate likes to check his chronometer occasionally, which is a commendable fault. I agree to get time signals for him at ten P. M., if he will please ring my telephone bell about ten minutes before the hour so that I may close off any correspondence I may be handling, or shut off the soldering iron, or whatever I may be doing. Result, the second mate is responsible for whether or not we get time signals, so if we miss them, nobody kicks. We've got to do a little more than the

"Build Your Own" with Marshall Complete Knock Down Sets

It's easy to build your own Radio Set the Marshall way. Best results are assured because we show you exactly how to do it right, with our detailed directions and an isometric drawing of the set assembled, showing the location of every part, and the exact, correct way of wiring. Outfit includes everything you need; parts, drilled panel; base board; every screw, nut and wire. Soldering Outfit

FREE with every set

Our 5 tube, 3 tube and 1 tube sets are fully described and pictured in the Marshall Radio Products Specialty Catalog, sent free upon request.

Also a quality line of Storage Batteries, Chargers, Cabinets, Loud Speakers, and all other parts and accessories of interest to the radio enthusiast who wants low prices and quality goods. Mail post card for it today. **It's FREE.**

Everything we sell is of standard manufacture, tested and approved by Marshall inspectors. If Marshall radio goods do not prove all that we claim for them, we cheerfully refund your money. Write today. Get this specialty catalog at once.

**Marshall Radio Products, Dept. 59-45
 19th St. and Marshall Blvd., Chicago**

FAHNESTOCK'S RADIO PRODUCTS

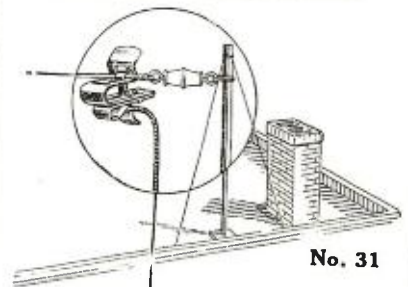

The Antenna Connector

Snap larger connector over Antenna Wire; insert Lead-in Wire into smaller clip and a perfect connection is the result.



Improved Ground Clamp

Equipped with Fahnestock Patent Wire Connectors Easily Attached.

No Soldering—For Radio Use Only.

Our name stamped on all products. None genuine without it. At Your Dealers

**FAHNESTOCK ELEC. CO.
 LONG ISLAND CITY, NEW YORK**

Learn Electricity by actual work in Great School of Coyne, on massive apparatus. Complete in 31-2 months. Enter anytime. R. R. Fare Free. Special limited offer. Send for Big Free Catalog. Coyne Electrical School Dept. 59-45 1300-1310 W. Harrison St., Chicago, Ill.

“GOLDEN-LEUTZ” “SUPER-PLIODYNE 9”



“The Perfect Broadcast Receiver”



Size 40 x 8 x 8

Weight 65 Lbs.

MANUFACTURED UNDER FARRAND LICENSE

A New Broadcast Receiver having 5 Stages of Tuned Neutralized Radio Frequency Amplification, Detector and 3 Stages of Audio Frequency Amplification

BUILT FOR PEOPLE WHO WANT THE BEST

Complete Illustrated Catalog and Instruction Book mailed on Request

GOLDEN-LEUTZ, Incorporated
476 BROADWAY
NEW YORK CITY

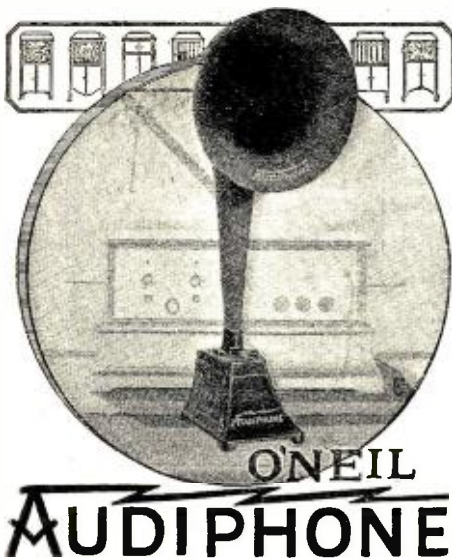

**O'NEIL
AUDIPHONE**

THE Audiphone began beyond the limits of the average "loud speaker." Radio acoustic engineers and phonograph craftsmen coordinated the tone principles of the finest phonographs with those of radio. The result is a NEW naturalness: Sensitive enough to perfectly amplify the weaker signals, and flexible enough to reproduce on a neutrodyne, superheterodyne or other multiple sets without rattle or chatter. Satisfaction or your money refunded. At most good dealers, or you can order direct, giving your dealer's name.

No extra batteries needed
Complete, with connecting cord

ART MODEL
Beautiful Antique Bronze Finish **\$30**

14 Inch Horn \$5 Additional

Write for literature



Note the similarity of construction between the phonograph reproducer (illustrated in the upper panel) and the reproducer of the O'Neil AUDIPHONE (below): both have a mica diaphragm set in a sound-box chamber actuated by an elbow stylus bar.



**O'Neil
Mfg. Co.**

719 Palisade Avenue
West New York, New Jersey

law specifically calls for, if we are going to get along with our shipmates. I don't check freight without being paid for it, but if the Chief comes up with an oil pipe to be soldered, I solder it. If there is a light out somewhere, I'll fix that, too. As a result, when I want to send down the antenna, or pull out the motor generator armature (did both this trip), I get all the help I need. I've been forced to wait my turn at the table because it was full, but I have also knocked a steward over a table because he refused a new "tin cow" with just a little too much sneer on his face. There's nearly always a way to get along, and if there isn't, we can always quit.

For Mr. Schbaugh, there seems to be only one solution. More selectivity in the receiver seems to be the answer. Sparks do not jam first-class receivers unless they are violating the law, or are in the immediate vicinity. By immediate vicinity, I mean within a couple of miles. This class of receiver may not hear London from the West Coast, and it may be a little bit harder to handle than the one you are now using, but you get unbroken concerts with them. "Blankets" from high-powered C. W. transmitters are much worse than spark interference. NPG, with his big tube set, puts a 350-meter blanket on the San Francisco district that no receiver on earth will get DX through, but KPH and KFS do not bother us unless we have stone-age receivers. Neutrodynes are especially susceptible to spark interference, unless slightly reconstructed. I know one that was bothered by a 706-meter spark 185 miles away, while receiving on 469 meters. No excuse for that, and a loose coupled, tuned antenna circuit, costing \$9.75 with panel and base, cured it entirely, with no decrease in signal strength on broadcast waves.

Mr. Tetly, of Brooklyn, puts forward a very feasible plan. As T. O. M. said a couple of years ago, the solution will have to be "less and better" broadcasting. There are so darn many of them that their carrier waves heterodyne on each other and make a form of interference which is pretty hard to get away from. I know it's carrier waves, because I've heard it a thousand miles from the nearest BCL, and the radiating receiver doesn't carry that far.

I forgot to tell Mr. Schbaugh why ships use rock-crushers (spark transmitters); 90 per cent. of ship installations were made before there were any broadcast stations. The set I am operating would cost more than \$6,000 to duplicate. No part of it could be used for a C. W. set; therefore, the investment would be a total loss. Then again, C. W. would not be satisfactory as a distress equipment. I. C. W. might be, but then you're right back where you started. If we did legislate the American spark sets out of existence, could we put the Foreign sparks off the air because they interfered with our pleasure? Echo answers, "Verily, Nix!" Foreign ships furnish a large proportion of our interference. The fellow we have trouble with here usually signs a "J" call.

Someone shouts "Put the Commercials on a longer wave." All of them? Foreign ships, too? How about the poor little steam-schooner with the short antenna, who can just reach 600 meters as it is? If you put him on 1,000 meters, he would be so far from his antenna's fundamental wave-length that he wouldn't carry around the block. I tried it with submarines during the war. Worked like a charm on 378, and fell flat on waves above 600. If we can make it work then the Navy would have to move up to give us room, and the trans-Oceanics would have to move up to give the Navy room, and pretty soon they'd have to put hinges in the towers to let the moon by. It's really extremely complicated. It is necessary to keep in mind that Marine wire-

Radiodyne

"The Voice of the Nation"

NO LOOPS NO ANTENNA

The air is your theatre, college, church and newspaper if you own a Radiodyne. New York, Cuba, San Francisco and Honolulu can be picked up clear and distinct without interference from nearby stations.

The RADIODYNE is ready for operation by simply grounding to a water pipe or radiator, and throwing a few feet of wire on the floor. Uses any standard tube—dry cell or storage battery. Extremely selective. Simple to operate—Only two controls—you can tune in on any program you select—any wavelength from 200 to 700 meters.

For use in apartments, boats, automobiles, railroad trains, etc., the RADIODYNE is enjoyable where other receiving sets would not be practical.

PRICE \$150.00

Write for illustrated folder which describes the RADIODYNE in detail. Every radio fan will be interested in this new type (antennalless) receiving set.

WESTERN COIL & ELEC. CO.
314 5th St. Racine, Wisconsin

A Pleasant Surprise Awaits the User of the **A. C. H. SHARP TUNER DIALS**

Why the A.C.H. is different

3 in. DIAL (156-10-1)
4 in. DIAL (215-10-1)

Will improve any receiving set, making difficult tuning easy

Money Back Guarantee

Price 3" size...\$2.50 Price 4" size...\$5.00
Regular fitting 5/16 shaft ¼ and 3/16, 5c each extra

Extra Advantage of the A.C.H.

1. Can be attached or removed from any instrument.
2. Rough tuning same as any dial.
3. Movement so fine that the eye cannot detect but the ear can.
4. Automatically locks instrument so no jar can disturb it.
5. Dial grounded reducing the body capacity to a minimum.
6. Special dial 2 graduations where ordinarily one.

MAIL ORDERS SENT PREPAID IN U. S. A.
A. C. HAYDEN RADIO & RESEARCH CO.
BROCKTON, MASS., U. S. A.

TINY-TURN

Superior Vernier Control
—makes exact tuning easy! No lost motion. Installed in 3 minutes. If your dealer hasn't TINY-TURN—Write us.

75c EACH

RADIO UNITS INC.
Manufacturers of the famous DUO-SPIRAL Indoor Loop Aerial
1305 First Ave. Maywood, Ill.

The SIGNAL FIRE of TODAY

PIONEERS of the old west were amazed to see how quickly the Indians learned of their presence.

The advance of a wagon train was known days ahead. Even a lone trader was known long before he arrived in the Indian camp.

Eventually the pioneers learned that the savages had a highly perfected signal code. From mountain top the signal fire blazed its message at night, or by day sent up its smoke in columns, wreaths, puffs—white smoke, black smoke—it carried a story far and wide.

Gone are the signal fires. Scattered are the tribes. Today the Westerner in remotest places receives his message by Radio—the Modern Signal Fire.

The Crosley Radio Corporation owns and operates Broadcasting Station WFLW

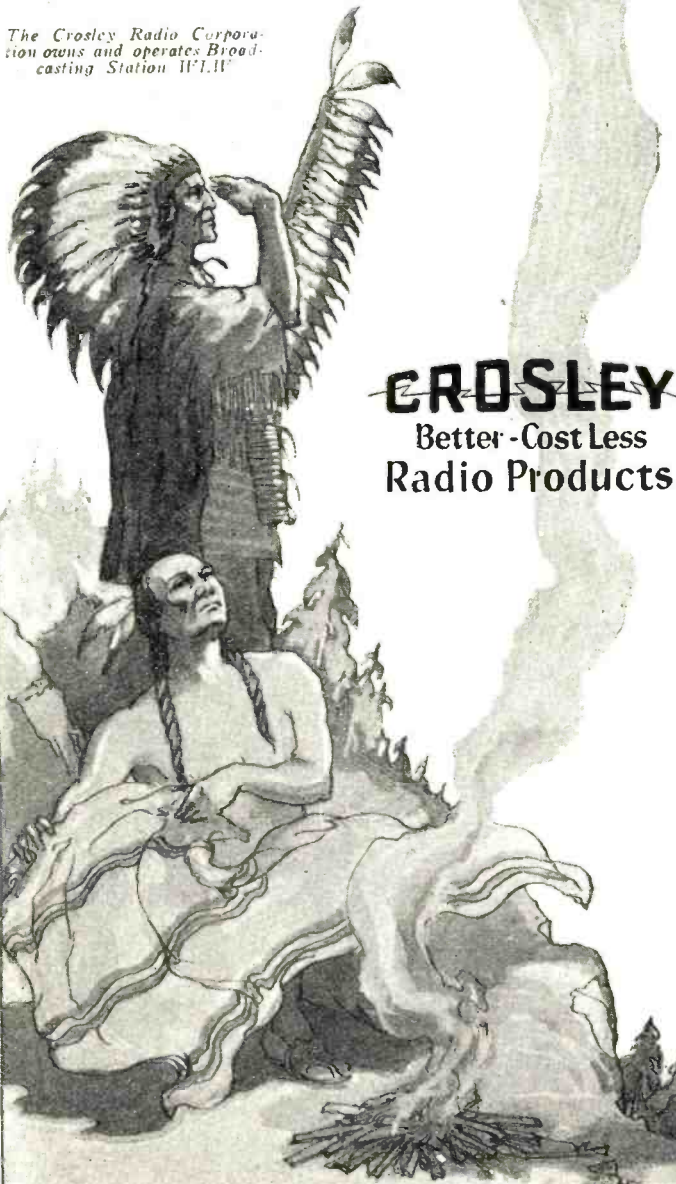

CROSLEY
Better - Cost Less
Radio Products

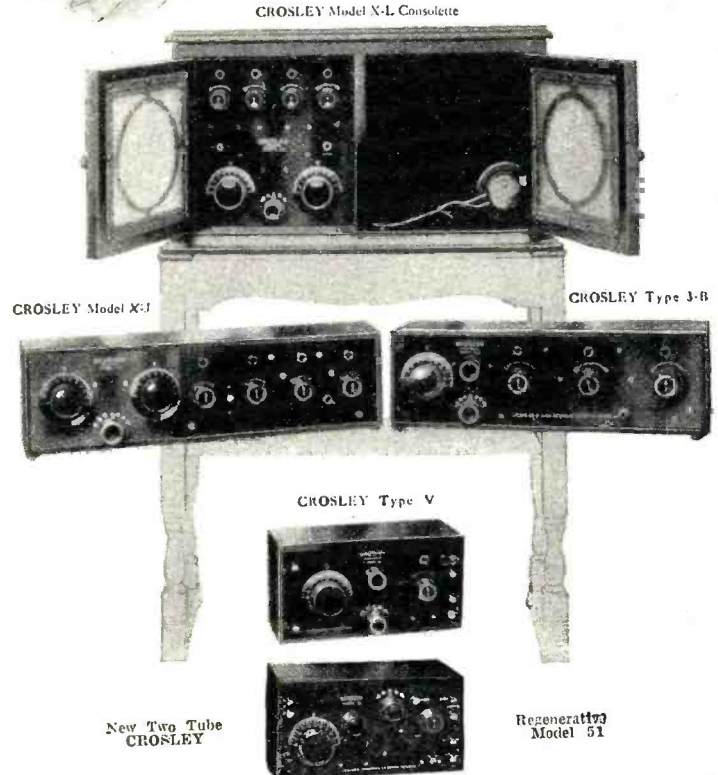

A CROSLEY RECEIVER FOR EVERYONE

- CROSLEY MODEL 51—PRICE \$18.50**
The wonderful instrument that has astounded the radio world. It is an Armstrong Regenerative two tube set containing detector and one stage of audio frequency amplification and yet sells at the remarkably low price of \$18.50.
- CROSLEY TYPE V—PRICE \$16.00**
A one tube Armstrong regenerative set. Actual performances of this little receiver have proven a revelation to the radio world.
- CROSLEY TYPE 3-B—PRICE \$42.00**
This three tube Armstrong regenerative receiver combines the Crosley Type V and the Crosley two stage amplifier. It has consistently outperformed sets costing a great deal more.
- CROSLEY MODEL X-J—PRICE \$55.00**
A four tube radio frequency set combining one stage of Tuned Radio Frequency Amplification, a Detector and two stages of Audio Frequency Amplification. At bringing in distant stations we believe no instrument can equal it. Local interference is easily and quickly tuned out.
- CROSLEY MODEL X-L CONSOLE—PRICE \$120.00**
A duplicate of the Model X-J except for the arrangement and mounting into a beautiful mahogany cabinet with the addition of a built-in loud speaker. Space is provided in the cabinet for housing the necessary batteries. A special mahogany stand as illustrated in outline for the Model X-L may be had for \$25 extra.

Crosley Instruments Are Sold By Best Dealers Everywhere
Write for Complete Catalog which fully describes the Crosley line of regenerative and radio frequency receivers and parts.
Crosley Regenerative Receivers are manufactured under Armstrong U. S. Patent Number 1,113,149.

The Crosley Radio Corporation
POWEL CROSLEY, JR., President
Formerly

The Precision Equipment Company and Crosley Manufacturing Company
522 ALFRED STREET CINCINNATI, OHIO

MAIL THIS COUPON TODAY

The Crosley Radio Corporation.
522 Alfred St., Cincinnati, O.
Gentlemen:—Please mail me free of charge your complete catalog of Crosley instruments and parts.

Name

Address

Improve Your Set

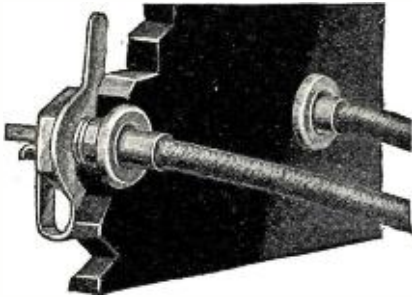

Union Radio Tip Jacks

(Patent Pending)

Only 25c a Pair

No more trouble with binding posts, no more noises from poor connections. Use these tip jacks for all antenna, ground and battery connections and contacts. They give you quickly made, positive connections, and improve the appearance of your set. Now being used by leading set manufacturers.

Two sizes for all mountings. STANDARD TYPE A for panels up to 3/4" thick. SPECIAL TYPE B for panels, cabinet walls and partitions from 1/8" to 1/2" thick. Will firmly grip all wires from No. 11 to No. 24 B. & S. gauge and can be reamed to hold antenna wire.

No parts to chip, lose or deteriorate. All parts heavily nickel plated.

25c a Pair in U. S.; 35c in Canada

OTHER GUARANTEED UNION RADIO PARTS

DIAL ADJUSTERS for minute variations in capacities of variable condensers. Price 60c.

TUBE SOCKETS of molded condensite highly polished. Phosphor Bronze contact springs. Reinforced bayonet slot prevents breakage. Accommodates all standard tubes. Price 70c.

Should your favorite Radio Store not carry Union Radio Tip Jacks and other Guaranteed Parts send your order direct to us; also write for your copy of "The Union Radio Catalogue F."

Retailers and Wholesalers

Samples of our guaranteed reasonably priced "Quality Products" sent on request. Our terms and trade discounts are liberal. Write for our proposition. Also write for your copy of the Union Radio Catalogue "F."

UNION RADIO CORPORATION
200-MT. PLEASANT AVENUE, NEWARK, N.J.
NEW YORK OFFICE 116-WEST-32-STREET

less telegraphy is essential communication, and broadcast listening is entertainment. The safety of one far-down coal-passer is worth more than all the millions of concerts received from now until they sell VT-1's for a nickel.

G. B. HORNE,
General Delivery,
San Pedro, Calif.

PERPLEXING RADIO PROBLEM OVERCOME

Editor, RADIO NEWS:

Having had occasion to enter a radio store one evening, recently, I came upon a large crowd gathered around one of the expensive Neutrodyne sets on the market at the present time which was emitting a terrible humming sound through the loud speaker to which it was connected. No one seemed to know what the trouble was; it was most pronounced when the set was tuned to receive distant broadcasting, being almost imperceptible on local reception.

Upon inquiring, I found that the proprietor had been troubled for several days with this condition and was very much worried, as his prospective customers were disappointed with the demonstrations. The hum was not characteristic of the generator of a transmitting station because the pitch was too low. It was that of a 60-cycle alternating current, which was what gave me the clue to the trouble.

I investigated the adjacent premises, but found no motors running. Upon entering the store again, I noticed the slightest flicker in one of the nitrogen-filled lamps in the dome above; I then knew the source of the trouble and suggested that the lights be turned off, which was done, and the noise immediately vanished. Removing the light from the socket, I found that the filament was broken, thus causing a minute arc which caused the oscillations heard in the loud speaker. A lamp loose in its socket could cause the same trouble. This particular lamp was a 100-watt one.

Francis C. Le Merle,
1444 W Street, N. W.,
Washington, D. C.

WANTED—A RADIO FAN

Editor, RADIO NEWS:

Being a reader of your magazine, and having a growing interest for radio in general, I should be greatly obliged if you would put me in touch with a radio "fan" through the medium of your columns. I might state that I am 20 years of age and should prefer to correspond with a young American of about the same age.

My idea is to exchange ideas, views, and circuits (hook-ups) and of course experiences with same.

A. MARTIN GIBBS.

"Bramber" 435, Barking Rd. London, E.13

A SHIPMASTER SPEAKS

Editor, RADIO NEWS:

As a shipmaster, of a number of years' standing, also as a "broadcast listener" who has financed the building of three sets of various types, and assisted "Sparks" in the building of same, I would like to say, a few words in regard to the letter published in March, 1924, issue of your publication, signed by Mr. A. J. Charters, Radio, KUVB.

I have been aboard ships with radio since it was first installed on the American liner *Philadelphia*, which was one of the first, if not the first American ship to have one. So my remarks can cover quite a few years and a great many operators. Like all humanity, there are good and bad amongst us. From his letter I



A cross-section cut through a receiver of the Stromberg-Carlson Radio Head Set reveals the layer wound and layer insulated coils.

Stromberg-Carlson coils are wound a layer at a time with a wrapping of tough insulating material between layers, and are used exclusively in

Stromberg-Carlson Radio Head Sets

This high grade coil construction combined with powerful magnets ensures permanent sensitivity, fine tonal quality, and enables these Head Sets to stand up under the high plate voltages now prevalent.

Our 30 years' experience is your warrant of quality and service.



Send for booklet 1029 R. N., which tells more about these superior Head Sets.

Sold by dealers everywhere

Stromberg-Carlson Telephone Mfg. Co.
1060 University Ave.
Rochester, N. Y.

World's Greatest BATTERY BARGAIN

FREE

Written 2-Year Guarantee Your Proof of Performance

SAVE 50%

and Get a "B" Battery and Hydrometer Free

Thousands of Radio News readers will do just that through this amazing World Battery offer. They will buy the famous 2-year guaranteed World Battery at the lowest price ever quoted and with it they will get free a hydrometer and a "B" battery.

COMPARE THESE PRICES

Special 2 Volt Storage Battery	\$5.00	For U.V.199 Tubes Same features as 2 Volt.
For W.D. 11 and W.D. 12 Tubes. Will run 200 hours on one charge.	6 Volt, 60 Amps. \$8.50	8 Volt, 80 Amps. 10.00
Rechargeable.	10 Volt, 100 Amps. 12.50	12 Volt, 120 Amps. 14.50
Special 4 Volt Storage Battery	\$6.00	6 Volt, 140 Amps. 16.00

SEND NO MONEY

You need not send a penny. Just clip this ad, and mail with your name and address. The battery you specify will be shipped to you the day your order is received. When the battery arrives, inspect it—read our 2-year guarantee before you pay one penny. Convince yourself you are protected from every angle—that the World Battery saves you 50 per cent. Get the "B" Battery and hydrometer FREE. Clip the ad, and send your order today.

World Battery Co.

1219 So. Wabash Ave.
Dept. 10 R.N.
CHICAGO, ILL.

"B" Battery and Hydrometer

5 per cent discount for cash in full with order.

RADIO CABINETS

"Ebcos Specials" and Standards. Solid Mahogany. Packed in Test Cartons. Prompt delivery. Write for prices.

ELECTROTYPE BLOCKING CO.
410 West 27th St., New York City
Phone Chickering 9843

Better Radio— right through the summer!



Some three million more listeners than there were last year—and they'll all have a season of real enjoyment!

ALL through the country fans are headed straight for the most amusing and enlightening season that radio ever offered. Daily treats! Daily helps! Daily marvels!

Three Main Developments

contribute to the tremendous step-ahead of this summer's radio regime. Better programs—stronger broadcasting—clearer reception.

Better Programs

Selected more keenly—and chosen according to the tastes of the vast audience whose opinions are molding the quality and tone of the programs. An outstanding feature will be the coming presidential campaign. All important messages of all the parties will be broadcasted. More churches are planning to send their services to vacationists. Sports will be vividly and adequately reported. All round programs—packed with vital interest—art—news—home hints—business—fun—good music!

Better Sending and Receiving

Sending over diversified wave lengths to permit greater selectivity. More powerful sending stations—interconnections of important stations for simultaneous broadcasting of messages of national import—rebroadcasting from high power stations through substations located at distant points. All these make for more satisfactory reception. And the vast improvements in sets and circuits, in tubes and loudspeakers assure clearer and truer reception. Surely this will be a season of jollity and interest. Tune in—and get the good things that crowd the air!

All Brandes Products are sold under a money-back guarantee by reliable dealers everywhere.

Table Talker . \$10.00
In Canada . 14.00
50c additional west
of the Rockies
Navy Type Headset 8.00
In Canada . 11.00
Superior Headset 6.00
In Canada . 7.00

Brandes

The name to know in Radio

YOU CAN LEARN NEWSPAPER WORK

**Experienced Editor Will Teach You
How to Become a
Reporter**

FASCINATING WORK--GOOD PAY

**Only a Few Months' Work Required
To Qualify You for a
Better Position**

Regular reporters earn from \$40 to \$125 a week. Good deskmen on a daily paper are paid from \$60 to \$100 a week. A "Star" Reporter can command his own salary. Hundreds of ambitious men and women enhance their income materially by corresponding for newspapers or writing for magazines in their spare time.

We Will Teach You at Home

We can develop your talent for writing and lead you into this well paying profession. Our Practical Course in Journalism was personally prepared by Henry J. Brockmeyer, Assistant City Editor of the New York Evening Post. Mr. Brockmeyer has trained hundreds of men and women, many of whom have, under his guidance, developed into front rank reporters or feature writers.

Mr. Brockmeyer's course will teach you what it would take years of actual newspaper work to learn. It consists of six comprehensive lessons just brimful of everything a reporter must learn. The following are only a few of the subjects covered.

Starting in Journalism. What is a Newspaper? What is News? Start and Finish of a News Story. Technical Terms. The Type Point System. Styles of Type, Proof Reading. Capitalization and Punctuation. A Late Fire Bulletin. Court Stories. Libel Laws, Copyright. Hints to Reporters. Personal Conduct. Re-Writing and Condensing Stories. Paragraphs and Short Items. Good and Bad Styles. Broadening the Vocabulary. Aids to Good Style. Special Stories. Suggestions for Stories. Rhetoric. Preparing Your Story. Don'ts for Writers. Office Organization. Syndicated Matter. Business Office. Mechanical Department. Hints for Headline Writers. The Make-Up. The Country Correspondent, etc., etc.

Use Coupon—Save 50%

Although the price for the entire course is \$10, entitling the student to full consulting services directed by Mr. Brockmeyer personally, we will accept enrollments, if the coupon below is used before June 20, at \$5—exactly half price.

Five Days' Trial

Just pin a check, money order or five dollar bill to the coupon below and mail. Then take five days after the course arrives to decide whether you want to keep it. If not, return it at our expense and your money will be immediately refunded.

THE PRESS GUILD, Inc., 66-R West Broadway, N. Y.

THE PRESS GUILD, Inc. (Expires June 20, 1924)
66-R West Broadway, New York City.

Enclosed find \$5 for which you are to ship me at once, prepaid, Henry J. Brockmeyer's complete course in Practical Journalism with the distinct understanding that if I return the course in five days my full \$5 will be refunded and no questions asked.

(Name)
(Address)
(City) (State)

judge our KUVB operator to be a very young man. He has gone aboard ship with privileges and rights that an officer has had to work years to get. He is a youngster among much older men. He knows nothing of the traditions of the sea and cares less, rubs it in that he got at once what it took others years to get. He assumes a position that he is responsible to no one except the radio company which has charge of his set. He has not such long hours of duty at sea, and practically nothing to do in port. He broods over his fancied wrongs that comes from many idle moments. In fact, feels very sorry for himself.

I have had operators whom I have looked upon as I would my own sons. Bright, clean, honorable boys. And I have had others I could not get rid of quickly enough. One of my "boys" is now connected with one of our best broadcast stations in Philadelphia. He was with me a year and was liked and respected by the whole ship's company. Another one thought the ship could not sail without him, and told me so, but having a crew of 41, and the ship being ready for sea, "Sparks" could not be found. We sailed and, strange to say, we arrived in safety.

Radio has its place in the world, a mighty important one! I am glad to have it. It has been a source of great pleasure and comfort to me. Through it I have been able to render assistance to others in distress. Fortunately I have never been compelled to send out an SOS as yet, but we never know our luck.

There is possibly a lot to say on both sides; the sea is a very old profession, radio is in its infancy. Let "Sparks" realize that he is only a youngster among much older men as a rule. A little respect on his part, and he will find he will receive it. It is up to him. Let him go aboard a ship and keep his opinions to himself until they have been asked for, and after others have found him out and what kind of a person he really is, then they will thaw out, if he deserves it. But he must not go aboard and think the routine of the ship will be changed to suit him. It will not! I could go on and say a great deal more, but as there are so many really good young men among the operators they might think I was trying to knock the whole crowd. Personally, I do not want other work out of them than radio, but I do want them to mind their own business, keep their place on board ship, and as far as their authority goes as an officer, it starts and stops right at the door of the "Radio Shack," and as I said before, be a "Good Fellow." "Flies can be caught with molasses far quicker than with vinegar," although both are very useful commodities in their places.

R. H. W., Master, KIRZ.

ANOTHER ARC RECORD

Editor, RADIO NEWS:

While reading the November issue of RADIO NEWS, I noted an article written by "AER" of the *Ecuador*, stating that with their arc, which he also states is a 5-K.W., WBN successfully worked station "KFS" of San Francisco consistently from Baltimore to San Francisco via the canal. Wish to state that station "WXE" (U. S. A. T. *St. Mihiel*, better known as "KDHW") did just a little better. On our last trip from New York to Cristobal to San Juan and return to New York, the *St. Mihiel* worked "KFS" direct from New York to Panama, then on the return trip from Cristobal to San Juan, and on leaving San Juan, we could not read him through the mush emitted from the Naval Arc station at that port, though I have no doubt that we were not heard

SILVERTRON TUBES \$3.75 Prepaid



Type 201A operates as either Detector or Amplifier on ¼ amp. filament consumption.

Type WD12 1½ volt.

The Silver Tube with the Golden Voice

**A Super
Vacuum Tube for
\$3.75**

Operates as either detector or amplifier on 1½ volts. When ordering specify if detector or amplifying tube is preferred. Fits standard socket. Filament consumption 1/5 of an ampere. Guaranteed to give entire satisfaction or money refunded. Sent parcel post prepaid carefully packed to any address on receipt of \$3.75.

Sole Distributors for U.S.A. and Canada

New York Radio Company

71 West Broadway

New York City, N. Y.

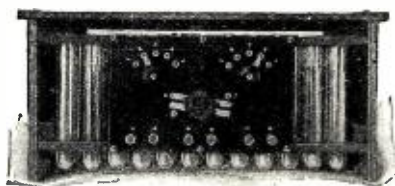

100 Volt Panel Type

"I've found KIC-O 'B' batteries the most satisfactory"



A prominent New York engineer said the above. KIC-O batteries make good with professionals and novices. Alkaline type; won't sulphate or buckle. Life unlimited. Not harmed by short-circuiting, overcharging, idleness. Panel switches give single cell variations. Recharge from any 110-volt A.C. line with small home rectifier. Charge lasts 3 to 6 months in detector plate circuit.

GUARANTEE

Your money back on any KIC-O battery if not satisfied within 30 days. Write for full information on "A" and "B" Batteries.

Cells	Volts	Price	With Panels
16	22	\$5.50
24	32	7.25	\$11.75
36	48	9.50	14.00
50	68	12.50	17.00
78	100	17.50	22.50
108	145	23.50	28.50

KIMLEY ELECTRIC COMPANY, Inc.
2665 Main Street Buffalo, N. Y.

KIC-O Storage "B" Batteries
—long service, low cost

PATENTS WRITE for our Three Guide Books and "REC-ORD OF INVENTION" before disclosing inventions. Send model or sketch and description of your invention for Examination and Instructions. Electrical cases a specialty. Highest references, reasonable terms, prompt attention.

No charge for the above information.

VICTOR J. EVANS & CO.
919 NINTH ST. WASHINGTON, D. C.

for Economical Transportation

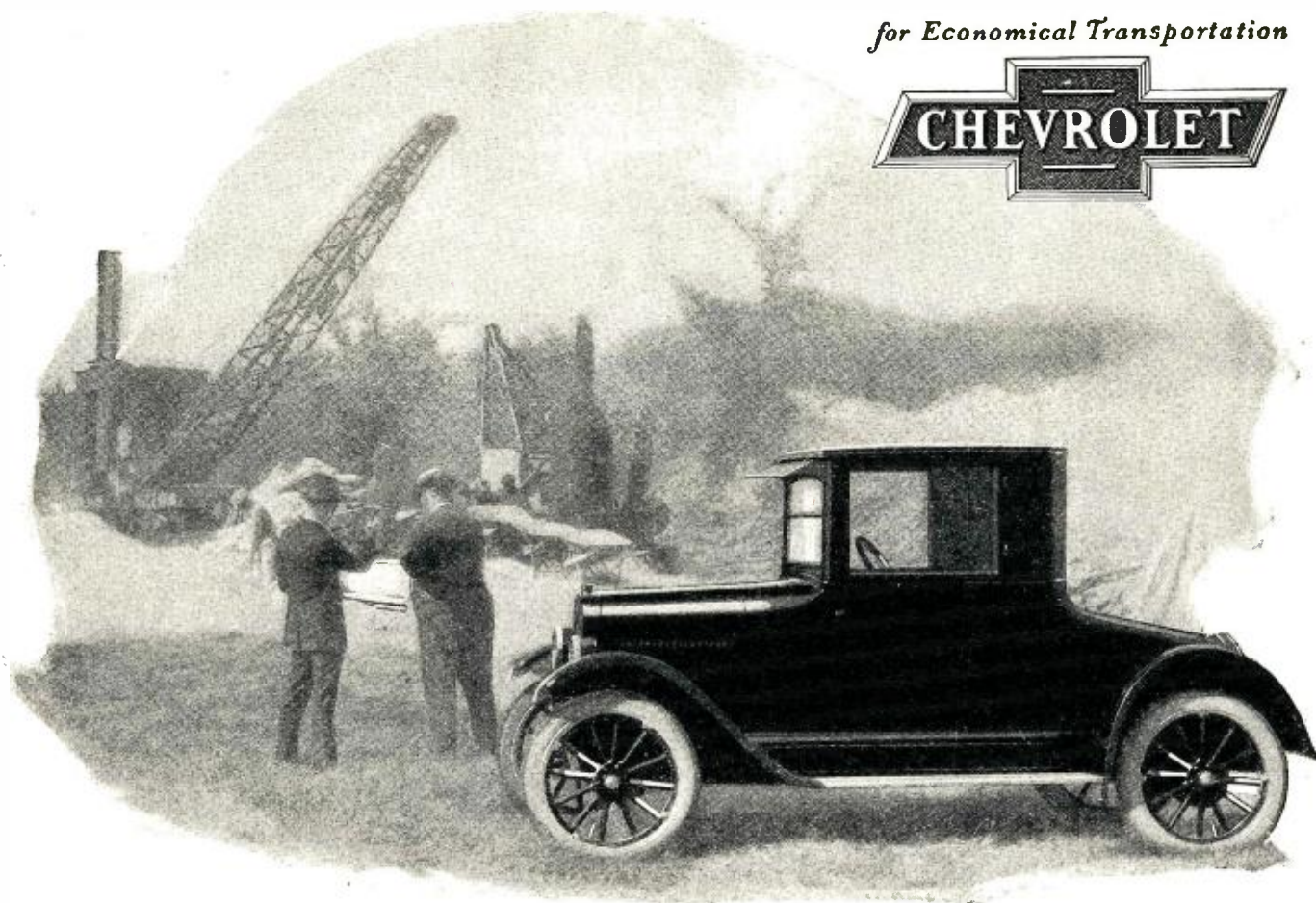

Superior Utility Coupé

\$640

f. o. b. Flint, Mich.

Prices f. o. b. Flint, Mich.

SUPERIOR Roadster - -	\$490
SUPERIOR Touring - -	495
SUPERIOR Utility Coupe -	640
SUPERIOR 4-Pass. Coupe -	725
SUPERIOR Sedan - -	795
SUPERIOR Commercial Chassis	395
SUPERIOR Light Delivery -	495
Utility Express Truck Chassis	550

Fisher Bodies on closed models

First Aid to Business

The popularity of this car has at all times taxed our large productive capacity.

It meets completely the requirements of most business and professional workers.

The quality of this Chevrolet model is high and along strictly practical lines. The design, construction and finish of the body pleases discriminating motorists, and the economy of operation averages lowest for this type of car.

The mammoth rear compartment is of constant value to all who must carry luggage, equipment, samples, etc.

The best salesmen of this car are the people who use it daily. Ask any Chevrolet dealer, or talk to owners anywhere.

Chevrolet Motor Company, Detroit, Mich.

Division of General Motors Corporation

In Canada—Chevrolet Motor Company of Canada, Limited
Oshawa, Ontario

Five United States manufacturing plants, seven assembly plants and two Canadian plants give us the largest production capacity in the world for high-grade cars and make possible our low prices.

Chevrolet Dealers and Service Stations everywhere. Applications will be considered from high-grade dealers only, for territory not adequately covered.



R-90 — Oscillator Coupler, complete, with mounting brackets, bank wound inductances and adjustable coupling coil with locking device. It covers a band of wave lengths from 150 to 800 meters and generates the maximum amount of current..... **\$5.00**



R-91 — Intermediate Radio Frequency Transformer, very sharply tuned and shielded **\$6.50**

R-93 — Specially Designed Coupler for Using Antenna. **\$4.50**



R-92 — Special Transfer Coupler for Last Stage of Intermediate Frequency, Very sharply tuned and shielded **\$7.50**

AT LAST! Intermediate Radio Frequency Transformers

YOU can construct a Super Heterodyne Receiver with the assurance that you will possess the "last word" in Radio Reception. You can log each station and later single it out again with the same dial setting. List your stations in phone book style. Musical reception of crystal clarity, loud speaker volume and minimum interference.

The Branston Special Transformer is not an adaption, it was specially designed for this specific purpose. Rigorous tests prove it greatly superior to anything available prior to this announcement.

Our publication, "Super Heterodyne Construction," makes it possible for the amateur to construct a complete and efficient Super Heterodyne Receiver.



Add Miles and Smiles with Branston Standard Radio Parts

PROMPT DELIVERY AT YOUR DEALER'S OR WRITE FOR DETAILED INFORMATION

CHAS. A. BRANSTON, Inc.
817 Main Street, Buffalo, N. Y.

Manufacturers of
BRANSTON VIOLET RAY HIGH
FREQUENCY GENERATORS

In Canada Chas. A. Branston, Ltd. Toronto, Ont.

RADIO PIN-MAP

of United States, Canada and West Indies with indexed Broadcasting booklet guide.

SPOT STATIONS YOU HAVE HEARD WITH COLORED MAP-PINS

Map size, 22x14 in. mounted on map-pin board. Shows all broadcasting cities, distance scale, relay and time divisions. Guide gives all call signals, locations, stations, wave lengths, etc., indexed separately by call signals and cities. Price complete, 85c; Map pins, 10c per dozen. Any color. Above booklet with folded paper map, 35c. At your dealer, or direct.

AMERICAN MAP CO.
MAP MAKERS PUBLISHERS
MAPS OF EVERY DESCRIPTION

7 West 42nd St. Dept. A. New York
Representative Wanted

TELEGRAPH INSTRUMENTS



One dry cell is all that is required to operate this instrument. Made by the best Telegraph Instrument Makers in the World. Other types carried in stock. Send stamp for Telegraph Manual No. 43R.

Instrument only...\$5.00 With dry battery...\$5.50

Special Price to Dealers
Send stamp for new and complete No. 29 General catalogue just off the press.

J. H. BUNNELL & CO. 32 Park Place, N. Y.

Get a Handy Binder for your RADIO NEWS. Holds and preserves six issues, each of which can be inserted or removed at will. Price 65c. Experimenter Pub. Co., Inc., Book Dept., 53 Park Place, New York.

at San Francisco. WXE maintained a daily schedule with the Federal station at Frisco, and our arc consisted of only a 2-K.W. converter.

The *St. Mihiel* employs three operators and all are excellent arc operators. Our spark equipment is better known on the New York to Panama run and excellent results have been obtained.

G. L., "WXE,"
Brooklyn, N. Y.

FROM A SEA-GOING OPERATOR

Editor, RADIO NEWS:

In looking over the February number of RADIO NEWS, I came across the letter from L. J. Peel, operator on the S.S. *West Elcasco*, and was especially interested in his knock on NAA's tube transmitter and also the rotten fists that are allowed to pound the brass at that station. Why, oh why, if the strikers must learn the code, can't they use a buzzer and key? Recently, five nights out of seven, NAA was unreadable when over a distance of 200 miles, due to double note emission and the other two nights bum fist. What say, commercial ops, let us all write to our District Supervisors and try to make NAA a good station! The old Fessenden had it all over the new C. W. set for a good note and although the present set has a greater range, the spark could be copied at a much greater distance.

Notice also quite a few complaints about QRM from hams and commercial land stations, but most from the latter as the hams stick to their allotted wave-lengths. What's the matter with C.W. on 600? It works as can be seen from WIM and NAM. Even new installations on land and ship stations are still getting the ancient spark.

Have bought RADIO NEWS from newsstands for the last three years and certainly have found a lot of fine dope in it. As this is the first QRM from this station, guess I'll QRT and hope to hear some more from other ops on these subjects.

ARTHUR HJORTH,
Radio Operator, KOXV,
Port Arthur, Tex.

THE INTERFERENCE QUESTION

Editor, RADIO NEWS:

Lately there has been considerable comment from readers of RADIO NEWS, as well as other radio publications, regarding the serious menace to the broadcasting game of interference from both radiating receivers and commercial radio telegraph stations. Articles have been printed dealing with the situation from the broadcast listener's point of view, hence a few comments from the commercial operator's viewpoint would perhaps be of interest. And perhaps more so from one who not only dispenses the despised code signals; but also one who is an ardent broadcast fan himself.

Last season there were only a few radio receivers in Ludington, consequently one could enjoy, night after night, the wonderful programs from all over the country, for we are far from the maddening crowd of local broadcast stations. The writer was proud to invite people to come in and share the enjoyment of listening to the programs. But alas! This year the craze struck town with a bang, bringing with it every make of cheap regenerative set under the sun. It is now practically impossible to hear one number through without its being punctuated with shrieks, howls, moans, and jungle calls from cheap regenerative receivers in the hands of small boys and "Radio golf hounds." Consequently, I am now ashamed to invite anyone into my home to listen in. Recently, while listening in on a vessel 30 miles out on the lake, the shrieks from regenerative receiving (?)

Attend the Presidential Conventions!

through the

Atlas

TRADE MARK

RADIO-REPRODUCTION

LOUD SPEAKER



TRADE MARK

Complete
\$25

Atlas Unit

With phonograph coupling\$13.50

Without phonograph coupling\$12.50

HEAR the famous speakers as distinctly as though you were actually present. The ATLAS produces this marvelous illusion. Give your family and friends a real treat. Order your ATLAS Loud Speaker now.

Booklet "F" Upon Request

Multiple Electric Products Co. Inc.

Makers of

MONO-TIME LAG FUSES—MULTIPLE

2 Orange St.

Newark, N. J.

District Offices

New York, Chicago, Baltimore, Philadelphia, Boston, Pittsburgh, Detroit, San Francisco, Kansas City, St. Louis, Louisville, Denver.

Sole Canadian Distributors:

MARCONI WIRELESS TELEGRAPH CO. OF CANADA, LTD., MONTREAL, CANADA

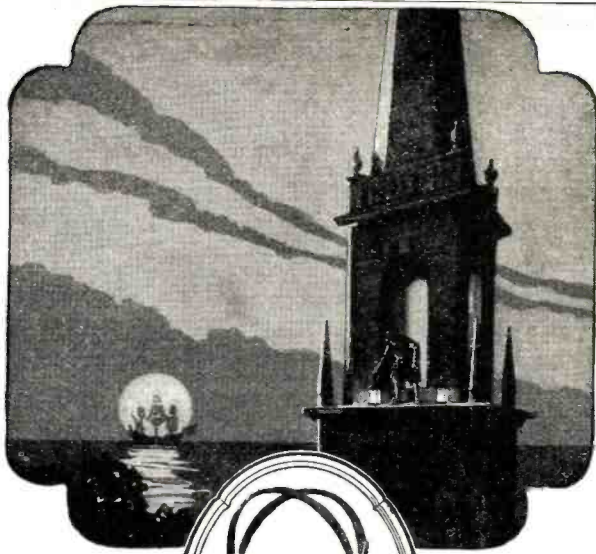

PAUL

REVERE

ON the eighteenth of April in 1775 two lanterns were hung in the tower of the Old North Church in Boston signaling to Paul Revere in Charlestown the movement of the hostile troops. Thus began the famous ride which will always live in our history.

Paul Revere's broadcasting, although romantic and spectacular, seems crude to us today. The death of a president, an earthquake in far-off Japan, and many other instances which history may

deem fully as important are now flashed almost instantaneously to millions of homes.

Only one key is necessary to gain access to this wonderland of Radio. The key is satisfactory receiving apparatus.

HOLTZER-CABOT Headphones and Loud Speakers enable your receiving set to give its utmost in sensitivity, volume and quality.

The fullest enjoyment of Radio is yours if you own HOLTZER-CABOT equipment.

- Holtzer-Cabot Loud Speaker \$25.00
- Loud Speaker Phonograph Attachment 10.00
- No. 2 Universal Headphones 9.50
- No. 4 National Headphones 6.00

Write for booklets explaining how the exclusive features of these instruments enable you to enjoy the wonders of Radio

THE HOLTZER-CABOT ELECTRIC CO.

125 Amory Street, Boston, Mass.
6161-65 South State Street, Chicago, Ill.
Dept. D1.

Holtzer-Cabot
BUSINESS ESTABLISHED 1875

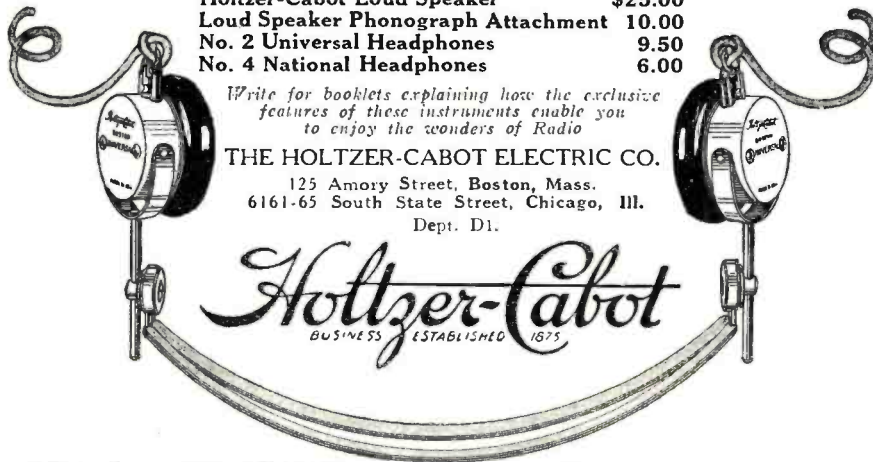

sets could be heard just as loudly as at home!

Yet, whenever the writer passes a group of fans on the street, they look at him out of the whites of their eyes, clench their teeth and hiss "There goes the fellow who spoils all our concerts!" And beyond a doubt the ones who yell the loudest are the very persons who sit and twist their dials the most.

And now, right here, let us look into the matter from the side of the commercial station: Long before radio broadcasting was ever thought of the radio telegraph station was rendering service to the public in the form of protection of lives at sea (the most valuable service radio is capable of giving), adding to the convenience and comfort of those who travel by water, as well as those who go down to the sea in ships, by furnishing them with the latest news, markets, and telegraph service. Yet a number of broadcast fans, who have only had a receiving set for a few days or so, quickly arrive at the ridiculous conclusion that all of this long established service should immediately be driven out of existence because it interferes with their pleasure for a few minutes now and then. Moreover, it has been found that in many instances the interference which they blame on the commercial stations has **nothing** whatsoever to do with them at all. For instance, a number of fans thought that the very howls and shrieks which they themselves were making came from the code station. Others thought that the induction from leaks in power lines in the vicinity were code signals. Still others thought that the nearby coast station was causing the atmospheric strays during stormy weather.

This particular coast station with which the writer is connected was requested not to transmit anything except rush orders to vessels during the evening listening-in hours from 7 P. M. to 11 P. M., and this was not only complied with but also routine form messages and methods of calling other stations were reduced to the least possible number of code characters. Later on, a wave-length of 1,666 meters was employed for all point to point traffic, so that listeners-in would not be bothered with a volume of that variety of traffic on 706 and 450 meters. This change cost the Company about \$1,000. for their two stations. But there are fans who think that our sole ambition is to see how much interference we can cause them.

Many people say: "Why don't you throw away your spark set and get a C. W. transmitter?" Well, in the first place, this particular station, as well as about every other commercial spark type station, was purchased in good faith from the U. S. Navy only a couple of years back. Therefore, the company operating the station must have a reasonable return on their investment before relegating it to the scrap heap—a total loss. When a typical visitor advocating the "scrap heap solution" was questioned recently as to just how much he thought it would cost to install a C.W. commercial set of suitable power, he replied: "Oh, about \$400, so an expert told me." He was quite astounded when he was informed that it involved the expenditure of quite a nice little sum in the thousand dollar line. Moreover, C.W., on 600 meters, would still cause interference to local listeners.

It would be well for the listener-in to realize that the man behind the key, as well as his employers, are just as much—if not more—interested in radio broadcasting as he is. And in nine cases out of ten have broadcast receivers in their

BROWNIE CRYSTAL

Guaranteed the Best \$1.00

"REFLEX SPECIAL" QUICK CONTACT RECTIFIER

Withstands Heavy Plate Voltage
The Acme Apparatus Co. says "prevent distortion and howling by using a BROWNIE CRYSTAL in REFLEX SETS."

Order From Your Dealer or Direct
ROLAND BROWNIE & CO.

22 Saunders Street Medford, Mass.

DEALERS!

WE OFFER YOU MERCHANDISE AT PRICES BELOW COMPETITION! WRITE NOW FOR OUR Amazing Offer!

- \$18.50 Homcharger "Gold Seal" A.C. \$14.95
- 18.00 Westinghouse Rectigon A.C. 14.65
- 5.50 Improved Cockaday Coils 4.85
- Amplex Grid-densers, small variables... 1.25
- \$2.65; 23 Pl.—\$4.00; 43 Pl. 4.25
- 12.50 Pr. Como Push & Pull Trans. (Dr.)... 10.50
- 7.00 Bakelite Moulded Pioneer Variocoupler... 4.95
- 6.50 Bakelite Moulded Pioneer Variometer... 4.85
- 6.00 Brandes Superior Phones 4.75
- 2.50 Radio Soldering Set, including paste, tube Neutrodyne Standard parts, for 5
- Highest Quality. 46.75

Send for our Free Monthly Price List Remittance Must Include Postage. Dept. RN

MARVEL RADIO SPECIALTY CO.
132 Nassau St., New York City

Insure your copy reaching you each month. Subscribe to Science and Invention—\$2.50 a year. Experimenter Publishing Co., 53 Park Place, N. Y. C.

ATWATER KENT

Philadelphia

Highly Selective and Easy to Operate

IT is easy to operate an ATWATER KENT Receiving Set—anyone can tune in a distant station and obtain clear reception—its wide range, accuracy, and simplicity have made it an outstanding preference among families the nation over.

The tonal fidelity of an ATWATER KENT Loud Speaker is the delight of every owner.

ATWATER KENT MANUFACTURING CO.
4943 STENTON AVE., PHILA., PA.



STANDARD EQUIPMENT **HILCO** SCIENTIFIC RADIO APPARATUS IN THE BEST RECEIVING SETS

Hilco Variocoupler

Type "E"

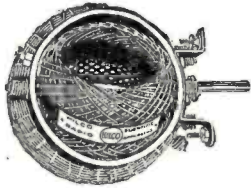

\$7.00

The HILCO Type E Variocoupler contains a primary and secondary winding of the HILCO Lattice Banked Type and is ideal for use in single, two or three circuits. The primary winding is so tapped as to give very close adjustments to wave lengths of 200 to 600 meters. The position of the secondary winding makes this instrument very selective, sharp tuning and its coupling is variable thru a wide range. Price \$7.00.

Hilco Variometer

Type "S"



\$6.00

The HILCO Type S Variometer contains four sections of HILCO Lattice Banked Winding, assembled so as to give a wide range of inductance thruout the entire movement of the rotor. This instrument is very selective, sharp tuning and can be mounted in any desired position. Note suspension of wires in air with successive turns crossing at right angles, and minimum amount of energy-absorbing material. Price \$6.00.

Hilco Tuning Inductance



\$2.50

The HILCO Type "RI" Tuning Inductance is designed for use in connection with the Reinartz Receiving Circuit. It consists of two HILCO Lattice Banked Windings combined in one unit, tapped so as to conform to the original Reinartz Tuning System. This Inductance will tune to wave lengths of from 200 to 575 meters.

The HILCO Variocoupler's success in the ERLA Reflex Circuit has brought it unprecedented popularity. The lattice-banked winding (which is an exclusive feature of all HILCO equipment, and should not be confused with honeycomb winding), suspends the coils in air, preventing the accumulation of moisture, and insures clear, distinct reception of distant stations.

If your dealer can't supply you, send his name with order and we will see you are supplied.

Dealers and Jobbers—HILCO Radio Products are profitable, satisfactory merchandise, with quick turnover. Write for literature and discounts.

A. E. HILL MANUFACTURING CO.
ATLANTA, GEORGIA

91 1/2% OF ALL RADIO TUBES ARE NEEDLESSLY DESTROYED

Accurate estimates show that less than 9 out of every 100 tubes give their full normal service and 91 are destroyed—usually burnt out from excess current. The chances are 10-1 against you unless you use

RADECO SAFETY FUSES

These tube savers are now saving thousands of tubes. They are endorsed by the leading Radio Publications.

They slip on the filament terminals of the tube and in no way interfere with the operation of the set.

Price, \$.50 each
(The cheapest insurance)

Install Radeco Safety Fuses now and whenever you buy a new tube insist on a Radeco Fuse to protect it.

Jobbers:—We want a few live distributors to whom we can offer a very attractive proposition.

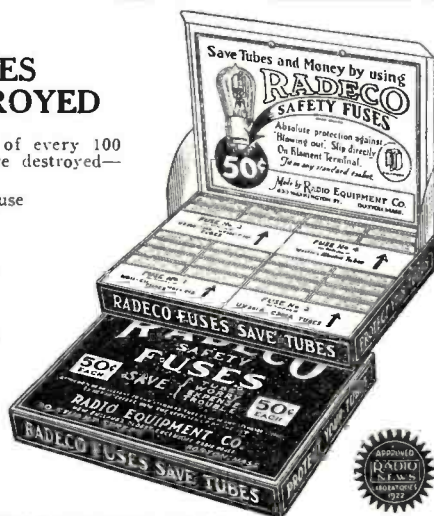

RADIO EQUIPMENT COMPANY

20 STUART STREET New England's Oldest Exclusive Radio House BOSTON, MASS.

homes also, and are just as anxious as any of the rest to have a general betterment of conditions.

In conclusion it might be stated that the following measures—all of which have been suggested by various authorities from time to time heretofore—seem logical:

Abandon the manufacture of the radiating receiver. We have splendid DX getters such as the Neutrodyne and the regenerative circuit with tuned R. F. amplification. So why in the name of common sense still make receivers which are better sending sets than anything else?

Many magazines and newspapers are doing missionary work along this line. But on the other hand we have certain unscrupulous manufacturers and dealers spreading propaganda against these efforts in order that they can unload their stocks of trouble-making sets. They claim people can be "educated" how to use them. Perhaps so; but you can't "educate" the "dial twister," the "golf hound," or the reckless small boy any more than you can "educate" the cheap receiving set not to howl and moan.

Outlaw the radiating receivers now in use. Compel them to be rebuilt or else junked within a reasonable period of time. Few people want to be seen on the street with a model 1912 auto. Radiating receivers are even more out of date than this, today.

Outlaw the "rockcrusher" transmitter, both amateur and commercial. However, make some sort of provision—if possible—whereby the Government would be able to sell C.W. equipment at cost to the stations compelled to make the change. This is only reasonable because the Government has "unloaded" most of the "rockcrusher" commercial stations in use today.

Have the next International Convention abolish the present 300 and 600 standard commercial waves. If these wave-lengths were raised a bit, interference from local commercial stations and ships bound in and out of ports would be reduced to a minimum.

DWIGHT V. JOHNSON,
P. O. Box 242,
Ludington, Mich.

COMMON SENSE

Editor, RADIO NEWS:

I am very much interested every month in your "Correspondence from Readers" columns, and I would like to add a few words myself to the arguments on the single circuit and radiating receivers. I own one of the much-cussed and discussed radiating receivers and, believe me, I wouldn't trade it for any other, as far as results are concerned. My set is home-made and consists of variocoupler, variometer, variable condenser, adjustable grid condenser, WD-11 tube and socket, rheostat and a pair of good phones.

On this set I have received a total of 187 stations from all parts of the United States, Canada, Cuba, Porto Rico, and also received 2LO, London. Some of the more distant stations are CFAC, CFCN, CKCK, DN4, KGW, KFCF, KGO, KPO, KFI, KHJ, KUO, KFAR, KMJ, KLZ, WBAP, WFAA, WOAI, 6KW, PWX, WKAQ, KFKB, KFKX, WAAW, WDAF, WHB, WOA, W, KFNQ, WPAM, WOQ and WBL, all of which are more than 1,000 miles by air line from Auburn. 2LO is over 4,000 miles from here and I have had him twice, while KPO and KGO are over 2,500 miles. Now, of course, some of these were not of the six-inches-from-the-ear kind of reception and these results were not all obtained before the

125 MANUFACTURERS USE FORMICA FOR RADIO PANELS AND INSULATING TUBES



FORMICA won the unquestioned leadership among radio insulating materials when practically every well known independent radio manufacturer adopted it. These men have tried everything and they know what they are doing.

Formica keeps its leadership by pioneering the way. The Formica laboratories developed the finest, most beautiful finish that ever went on a Bakelite product. They made the top softer for easy engraving — the bottom hard for perfect enduring insulation. They developed the finest mahogany finish panel that has ever been offered the radio trade.

Formica quadrupled its tube capacity last year to give its tube customers service when the Neutrodyne boom struck. It found a way to give tubes a handsome high gloss finish. You only have to look at Formica to see that it is better!

Dealers and distributors find Formica service, advertising and support the best in the business. The Formica name means something in radio!

THE FORMICA INSULATION COMPANY

4618 Spring Grove Avenue, Cincinnati, Ohio



Sales Offices

50 Church St., New York, N. Y.
422 First Ave., Pittsburgh, Pa.
1042 Granite Bldg., Rochester, N. Y.
415 Ohio Bldg., Toledo, Ohio

1210 Arch St., Philadelphia, Pa.
1819 Lyndale Ave., S. Minneapolis, Minn.
Sheldon Bldg., San Francisco, California
Whitney Central Bldg., New Orleans

516 Caxton Bldg., Cleveland, Ohio
9 S. Clinton St., Chicago, Ill.
313 Title Bldg., Baltimore, Md.
47 King St. Toronto, Ontario

FORMICA

Made from Anhydrous Bakelite Resins
SHEETS TUBES RODS

**"What a whale of a difference
just a few cents make!"**



**— all the difference
between just an ordinary cigarette
and—FATIMA, the most skillful
blend in cigarette history.**

**Dispense with Variometers, Vario-Couplers,
Variable Condensers—Use the**

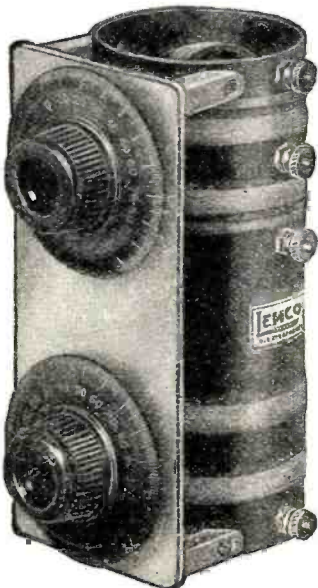

**LEMCO
EQUIPMENT**

TRIPLE DUTY TUNER

Best of its kind on market. Increases receiving range and efficiency of control.

Striking Special Features—Pig-tail connections; built-in cast aluminum shield; moulded Bakelite rotors; 7/16 inch rigid Brass Bearings. Removable independent shafts—200 to 600 wavelengths.

Insist on Lemco Tuner No. 100 from your supply dealer; if he hasn't it we'll ship one, prepaid on receipt of \$7.50.
No. 100. Broadcast Tuner list (less dials)..... \$7.50
With Bakelite dials (as illustrated)..... 8.70
No. 340. Crystal Set 7.50

Circulars with diagrams for simple regenerative, Flewelling, radio frequency and other circuits sent on request.

**DEALERS and JOBBERS
Write for Attractive Proposition**

LEE ELECTRIC & MFG. CO.

220 Eighth St.

San Francisco, Cal.

time signals, but some of them in the wee small hours of the morning. I have a four-circuit tuner and a three-tube reflex set, but get more enjoyment out of my old set as I know just what is going to happen whenever I turn any of the dials, and that is how you get good results with any set in knowing what the things are for and exactly what happens when you move something.

I admit that this set will squeal and could no doubt be heard for two miles, but if it does it is my fault and not the set's fault, as it doesn't squeal unless I make it. There are lots of people here in town, who either do not know or don't care if they are spoiling the other fellow's fun, as sometimes it is almost impossible to pick up anybody and enjoy the program unless you are particularly fond of nature and like to hear canaries, crows and coyotes. But what I think we need to do, instead of getting rid of this type of set, is to get rid of the type of BCL, who does not know how to operate it. If a fellow persists, after he has been instructed, then deal with him harshly. My set may squeal out once in a while, but never long enough to bother anyone, as I know when it does and *immediately* turn back the regeneration. Any one else can do the same.

All the squeals you hear do not come from regenerative receivers, as there is a fellow about a mile from here who bought a set containing three stages of radio frequency and when he first got it, it put stronger oscillations in the air than any other set I ever heard, but as he has found out how to run it he gets good results and doesn't bother now, but formerly he wasn't getting anything, and neither was anyone else who was near him.

I think that we should spend less of our time knocking these radiating receivers and try to show the owners something about how to tune their sets without putting out a disturbance. On the Saturday that the last world series was being broadcasted I personally went and tuned in five sets and had the owners leave them until I had made the rounds of all of them and then went back and readjusted two sets, and after this we heard the rest of the game, while before that we got nothing but a lot of squeals and howls. After this, I spent one evening during the next week with each of them and that neighborhood is fine now, as far as nearby interference is concerned. I know that some of the people will not welcome you, but there is someone you know who can get in to show them without offending, but most of them are willing to be shown.

J. KENNETH REED,
10 Anna St.,
Auburn, N. Y.

HOVEY'S LATEST INVENTION

H. Gernsback,

Editor, RADIO NEWS:
53 Park Place,
New York City.

My Dear Gernsback:—For many months I have greatly appreciated your department devoted to Laboratory Experiments. I note that no matter how big, nor no matter how little, the inventor may be, he gets fair play at your hands. It affords me great pleasure to inform you that I am now an inventor. I have not yet a model made, but am sending you a sketch of my wonderful device, with the feeling that you will at once see that it is a great thing, and destined to revolutionize the entire radio business.

I was not led into this trance of invention through any jealousy of any manufacturer or inventor now in the field. Far from it. Here is what started me and got me "off my nut." For months and more months, I have been reading of wonderful radio sets being turned out. For three or more years I have been selling sets—lots of them. During the past two years a large

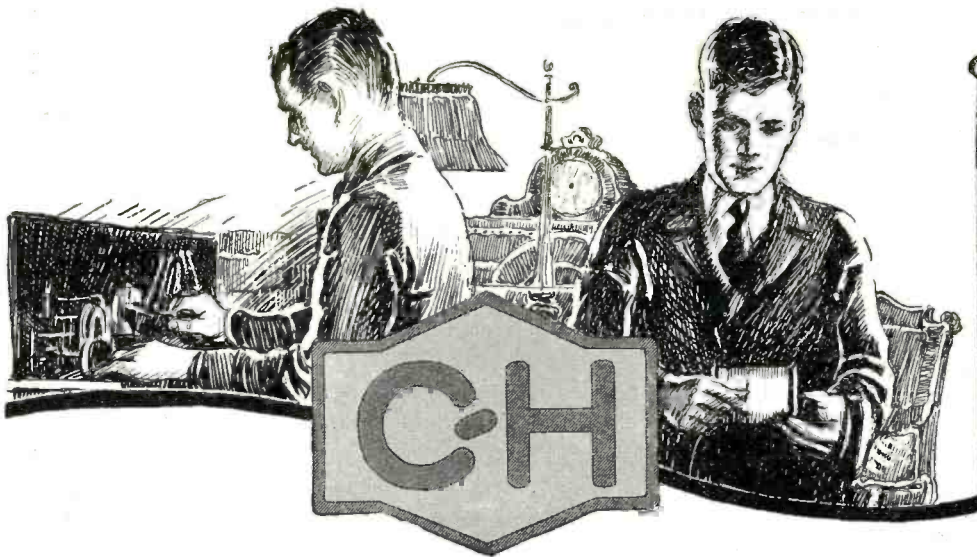

You Can Build With Confidence When You Demand This Trade Mark

Radio men of experience agree that more sets are ruined by careless buying than by careless construction. Most people take pains to see that diagrams are followed faithfully—that connections are tight—and instruments are properly placed. But this alone cannot assure results—the poor design of one single part can destroy the efficiency of the most elaborate set. Radio parts must be purchased with a knowledge of their maker—it is the only measure of their quality of which the average buyer can be certain.

A Complete Line of Radio Current Control Apparatus by the Most Famous Electrical Control Engineers

For more than a quarter of a century the name Cutler-Hammer has been demanded by engineers throughout the world in their specifications on current control. Gliding under the sea on the delicate apparatus of submarines; shooting skyward on the operator's handle of the modern office building elevator; keeping day and night watch over thousands of automatic industrial machines—in every branch of industry and in every country in the world you will find this famous trade mark justifying the confidence with which it was demanded. In radio it affords an easy way to be sure of quality in the parts you buy; demand it and build with satisfaction.

THE CUTLER-HAMMER MFG. CO.

Member Radio Section, Associated Manufacturers of Electrical Supplies
MILWAUKEE, WISCONSIN

"BUILT BY THE MASTER BUILDER"

CUTLER-HAMMER



Instruments of Guaranteed Quality Assure Success in Radio

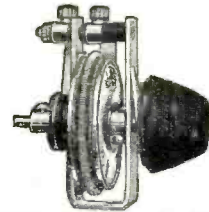

The C-H 4 Ohm Vernier Rheostat
Perfect detector tube control. Also furnished without vernier for amplifier tube control.



The C-H 30 Ohm Radio Rheostat
For control of the $\frac{1}{2}$ ampere, "UV201A-C301A" type receiving tubes and the "UV199-C299" type.



The C-H 125 Ohm Radio Rheostat
The rheostat that makes it possible to use a 6V storage cell with the UV199 or C299 tubes.

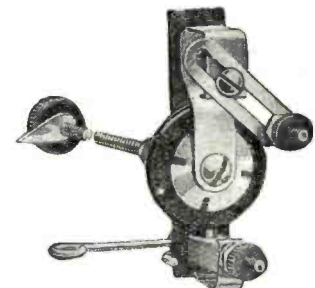

The C-H Variable Grid Leak
Mounted on the tube socket—panel controlled. Adjustable for all grid condensers.

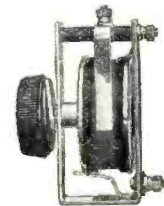

The C-H Radio Potentiometer
The potentiometer with the resistance unit that does not wear and cannot be displaced under constant usage.

The Stamp of Approval the World Over



**FRESHMAN
Variable Grid Leak**

The Standard Unit for Every Tube Set

EVERY tube and every circuit requires a different grid leak resistance. The method employed in the Freshman Variable Grid Leak permits you to adjust your circuit to any resistance you wish, from 0 to 10 megohms in an unbroken range of 180 degrees.

The Freshman Variable Grid Leak and Condenser combined takes the place of a grid condenser, leak mounting and grid leak—and, in addition, permits an adjustment to the correct amount of resistance. The Freshman Variable Grid Leak is the most compact, the most perfect, the most efficient, the most readily adapted to all grid circuits—and the only one which is entirely sealed and always remains unaffected by any climatic conditions. It is the

**ORIGINAL
VARIABLE GRID LEAK**

Either Base or Panel Type Complete with .00025 or .0005 m.f. Freshman Condenser \$1.00
Either type without Condenser, 75c

Ask your dealer or write for our free diagrams of Neutrodyne, Tri Flex, Kaufman, Heterodyne circuits.

Chas. Freshman Co. Inc.
Radio Condenser Products
106 SEVENTH AVE., NEW YORK, N. Y.

At your dealer's—otherwise send purchase price and you will be supplied without further charge.

number of manufacturers of sets have extended me the highly appreciated courtesy of sending me samples of their sets, with a view to my trying them out, and if satisfactory, and adapted to the needs and financial conditions of my prospects, selling these sets.

Now here is the result of my try-outs, etc. I find that most manufacturers in their advertising put it far too strong on the points of simplicity of tuning and operation, as well as volume produced. I am free to admit that in the minds of these inventors and manufacturers these sets are wonderfully simple, and simply wonderful. They are experts, and of course expected to get perfect results. But why do not these fellows get it through their heads that these sets are sent out to be bought and used, not by experts, but by common people—in fact in many cases by simply dampfools like myself? I don't know a thing about the technical part of a set. I am, however, a real salesman. I have had sets sent to me for a try-out, that the literature stated could be



The Hovey Ultra-Nitroglycerine Reverse Implex Thunder Box in operation.

“set up, tuned in perfectly, and operated by a ten-year-old child within ten minutes from being taken from the shipping case; and that the volume and clarity of reception was little short of a burst of angelic music from heaven.” Well, I am not a ten-year-old kid, although I was about sixty years ago. I've monkeyed with sets for four years. I've unpacked the sets, hooked them up, tried all manner of battery voltages, all manner of tubes, and listened for the wonderful burst of music. In its stead I have, after long hours of trial, often secured a sweet little whisper from second or third stage. This therefore, in a measure, accounts for my inventive spasm. The diagram enclosed shows that I have arrived at absolute simplicity and exactness. This set should take the world (including Africa and Teapot Dome) by storm. It will put every Radio manufacturer out of business (and into the bughouse), including even the R. C. A. Description of “Hovey's Ultra-Nitroglycerine - Reverse Implex - Thunder - Box.” (See illustration.)

K is the cabinet.
The panel will be made of plate mirror so as to reflect the happy ex-

LEARN THE CODE AT HOME

“Just Listen—The Omnigraph will do the teaching”

with the
OMNIGRAPH



THE OMNIGRAPH Automatic Transmitter will teach you both the Wireless and Morse Codes—right in your own home—quickly, easily and inexpensively. Connected with Buzzer, Buzzer and Phone or to Sounder, it will send you unlimited messages, at any speed, from 5 to 50 words a minute.

THE OMNIGRAPH is not an experiment. For more than 15 years, it has been sold all over the world with a money back guarantee. The OMNIGRAPH is used by several Depts. of the U.S. Govt.

—in fact, the Dept. of Commerce uses the OMNIGRAPH to test all applicants applying for a Radio license. The OMNIGRAPH has been successfully adopted by the leading Universities, Colleges and Radio Schools.

Send for FREE Catalog describing three models, \$14 to \$30. DO IT TODAY.

The Omnigraph Mfg. Co., 20 Hudson St., New York City

▲ If you own a Radio Phone set and don't know the code—you are missing most of the fun

WANTED—Back numbers of Radio News, Dec., 1921, Jan. and Feb., March and April-May, 1922. Experimenter Publishing Co., 53 Park Place, New York City.

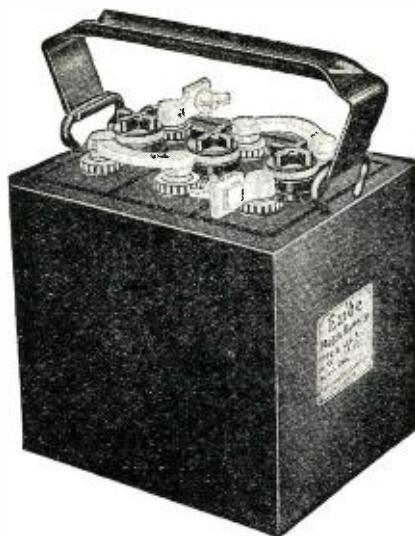

"A" Battery for
six-volt tubes

When is a battery cheap?

A BATTERY that allows your soloist to be accompanied by a noise like a thunder storm is never a cheap battery; because it's certain that you will be dissatisfied and soon supplant it with a good battery.

Obviously, a battery that does not last long is not a cheap battery.

The battery that is really cheap is the one that gives perfect service and gives it a long time; one that does not have to be recharged too frequently—a silent, long-lasting battery, steady and dependable.

Because they give such good service and such long service, you will find Exide Radio Batteries cheap in the true sense of the word. They may cost you more than some to start with, but long life and freedom from repairs make the last cost low. And the added enjoyment you get from your set, through clarity and lack of needless bother, will be priceless.

In replacing a worn-out battery or when buying a new set, be good to yourself and get an Exide.

Complete line of Exides for Radio

There is a complete line of Exide Radio Batteries—batteries that give uniform filament current over a long period of discharge.

Apart from the 12-cell "B" battery there are three "A" batteries for whatever type tube you use. The Exide for 6-volt tubes gives full-powered, ungrudging service. It has extra-heavy

plates and requires only occasional recharging. It comes in four sizes—of 25, 50, 100, and 150 ampere hours capacity.

The Exides for low-voltage tubes are midgets in size but giants in power. The 2-volt battery weighs only five pounds, has a single cell, and will heat the filament of WD-11 or other quarter-ampere tube for approximately 96 hours. The 4-volt "A" battery has 2 cells and will light the filament of UV-199 tube for 200 hours.

The dominant battery

On sea and on land the Exide plays an important role in the industrial life of the nation. In marine radio, Exide Batteries provide an indispensable store of emergency current. A majority of all government and commercial radio plants are equipped with Exides.

Exide Radio Batteries are sold by Radio Dealers and Exide Service Stations everywhere.

Ask your dealer for booklets describing in detail the complete line of Exide Radio Batteries. Or write direct to us.

Exide

RADIO BATTERIES

THE ELECTRIC STORAGE BATTERY COMPANY, PHILADELPHIA

In Canada, Exide Batteries of Canada, Limited, 133-157 Dufferin Street, Toronto

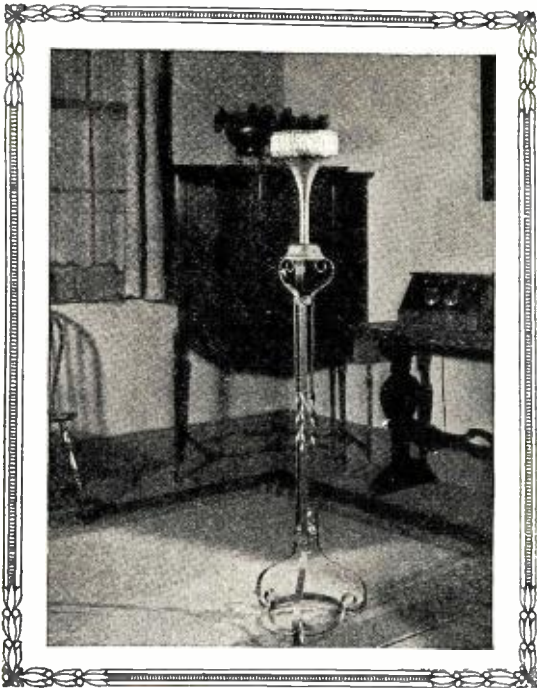

The diversity of styles offered for selection makes it an easy matter to choose according to requirements. Befitting the dignity of the finest living room, the Thor Reproducer illustrated here represents a very handsome torchiere. The base is stippled polychrome, finished in old gold and burnished copper. Price, including base and any type deflector, \$50.00

RADIO'S NEWEST MAGIC

Can this be a loud speaker? Your surprise is natural! For this shows what a transformation is possible with a

Thor Reproducer

Yesterday a loud speaker, in the form of an ugly horn! Today, a charming torchiere, floor or table lamp that brings a tone of luxury to your living room and harmonizes with your decorative scheme.

Thor Reproducer is a non-directional loud speaker, which distributes its mellow tone in all directions with equal clarity and volume. Its remarkable acoustic properties win it instant approval.

Immediate delivery guaranteed. All prices F. O. B. San Francisco

Dealer and Jobber connections are still open. For full information and catalog, address the

THOR RADIO COMPANY

Claus Spreckels Building, San Francisco, California

(101)

pressions of the family as they use the set. It is not stated what the cabinet contains. That's my secret, and no one's business.

There is a control or Station Lever. When set at the center position, as indicated in the sketch, there's nothing doing; the whole thing is as dead as some sets that have been sent me for try-out.

Move the lever "east" and you get everything east of the Mississippi River. After two levers are set, pulling the third lever shoots it through the horn with a volume that will make King Tut sit up and listen. Place the first lever in position "west" and you get everything west of the Mississippi river, clear to Honolulu. By simply turning the set half way round and operating the levers as directed, the set will bring in everything from the North to the South Poles.

Now I cannot as yet say when I will have these sets on the market, but I am dead sure that if right NOW I should get out literature advertising such a ridiculous thing, that there are a bunch of suckers who would rob the kid's savings bank to get money to send me for one. This is a wonderful world for sure, and I wonder what it will be like after I have spent another hundred years or so in it.

I hope by thus confiding the secrets of my wonderful invention to you someone won't get ahead of me and patent the ideas.

Sincerely yours,

O. H. HOVEY,
Perry, Okla.

Radio in Ceylon

(Continued from page 1569)

install a series of minor receiving sets in different parts of the island so that the screening effects attributed to tropical vegetation and the mineral charged mountain center of the island might be overcome.

By and by Mr. Goleightly will apply himself to the broader question of the screening effects met with in communicating, through radio, over tropical seas and lands generally. The scheme of research work planned by that gentleman is very wide. It is hoped to go step by step to avoid confusion, and to check each item against all possible conditions.

The great electric energy necessary for transmitting long distance radio messages has so far checked the construction of radio transmitting stations freely in all parts of the world. It is now said that in this direction developments even more remarkable than the one just recorded might be chronicled from Ceylon at an early date.

In any case the local Postmaster General, on the recommendation of Lieutenant Dick, the radio expert of the East India Squadron, has taken steps to order from England additional transmitting and rectifying valves, so that the maximum power available at the generator at the Colombo Radio Station will be used. He has also ordered a new balanced earth system designed to improve the efficiency of transmission, and to minimize screening effects.

At the same time, the Government of Ceylon is making preparations to start up the big Aberdeen-Laxapana Hydro Electric Scheme with a view toward establishing a high power radio station at a place where it will be of value to the Army and Navy in the Near East, and then to electrify the Ceylon railway, which is now losing heavily through motor bus competition.

More than anything else, it is pleasing to be able to record that the English official who comes to Ceylon now is more alive and smart than his predecessor. Carelessness and indifference commonly attributed to English officials attached to Colonial Gov-

NAME
ADDRESS
CITY STATE

L. B. ALLEN CO., INC.,
4564 No. Lincoln St.
Chicago, Ill.
I enclose 10 cents (U. S. stamps or coin) for one can Allen special radio soldering paste with valuable soldering information sent prepaid.

SODER EVERY
JOINT AND TERMINAL
WITH
ALLEN-SPECIAL



RADIO SODERING PASTE

It eliminates all unnecessary noises, squeals, hums and whistlings caused by loose connections in your lead ins, grounds or set connections.

Sodered joints fluxed with this Paste are guaranteed non-corrosive. Volume is increased and wide reception assured.

This Sodering Paste was developed in our laboratory especially for radio work.

Acids and rosin increase the resistance in your set, pull down your volume and limit your reception.

 **L. B. ALLEN CO. INC.** 
4564 NO. LINCOLN ST. CHICAGO, ILL.

"BUILD YOUR OWN" WITH "RASCO" PARTS!

Buy from the Oldest and Original Exclusive Radio Parts House in the United States

We pay ALL transportation charges in U. S. ALL GOODS SENT PREPAID IN 24 HOURS

Order direct from this page.

SPECIAL PRICES FOR THIS MONTH ONLY

Money refunded if goods do not satisfy

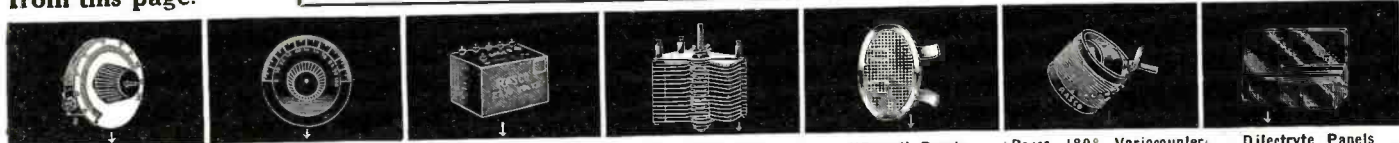

Rheostats and Potentiometers
Come with metal dials and composition knob. Excellent merchandise despite low price.
Y4210 6 ohm Rheo. \$.27
Y4211 50 ohm Rheo. .30
Y4212 200 ohm Potentiometer .45

Moulded Dials
Only very best grades handled. Bushings absolutely true. Dials cannot wobble. Letters inlaid in fast white enamel. All dials for 1/2" shaft.
Y3074 Dial 3" .20
Y3075 Dial 3" .25
Y3076 Dial 4" .40

Tapped "B" Batteries
We positively guarantee these batteries to be of long life. We carry only fresh stocks. All with taps.
Y2250 Sm. 22 1/2 V. \$.85
Y2251 Medium Navy size, 22 1/2 volt. 1.20
Y4500 Large size, 45 volt .230

Panel Mounting Condensers
Positively no better condenser on the market. Save from 40% to 60% by assembling condenser yourself.
Y1111 11 plate... \$1.10
Y2121 21 plate... 1.22
Y4343 43 plate... 1.33

"Rasco" Bezels
Finest Bezel on the market. Bezel comes entirely nickel plated. Can be used on 1/2" or 3/16" panel.
Y1700 Rasco Bezel... \$.15
Y1701 Bezel, 1 1/2" diam. .20

Rasco 180° Variocoupler
Silk wire wound on bakelite tubes. Six taps. Wave length, 150 to 600 meters. For panel mounting. 1/2" shaft. Your money refunded if it is not all we claim.
Y3100 Variocoupler prepaid... \$1.50

Dilectryte Panels
Highest dielectric strength as per Bureau of Standards.
Y7100 7x10x3-16" .70
Y7120 7x12x3-16" .85
Y7140 7x14x3-16" .95
Y7180 7x18x3-16" 1.25
Y7210 7x21x3-16" 1.45
Y7240 7x24x3-16" 1.65



Silicon Steel
Used practically in all audio-frequency transformers. Better than iron. Extremely soft, 3/8" wide and .007" thick.
Y4900 Silicon steel, per foot .08

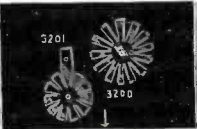

Spider Web Forms
Fine forms to wind your spider webs. Made from baid, well seasoned fibre. 1-1/8" thick, center and side holes for wiring. Both 5" diameter.
Y3200 Spider form. \$.25
Y3201 Spider form. .25

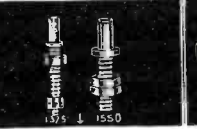

Y1375 Universal Bearing
to hold rotors. Length of bearing 2 3/4" shaft 1 1/4" thread 1 1/2" long threaded sleeve 3/4" long. each .25
Y1550 Sockettes. Four of these take one vacuum tube. Grasp tube firmly. Best by test. Set of 4 \$2.50



Brass Strip and Tubing
Brass strip 1/2" wide, 1-1/8" thick, 6" long. Y1430 Per length. \$.10
Y1431 Brass tubing, dia. 1/4" long. length \$1.15
Y1432 3/8" thread. \$1.08
Y6032 3/8" thread. .06



Alcohol Blow Torches
Best made. Give intense hot flame. Great for fine work.
Y8881 5" Torch... \$.85
Y8882 3" Torch... .50
Y4104 Rosin Core Solder. A non-corrosive solder with flux inside. 18" length \$2.65



Monodyne Socket
This socket takes up 25% less room than any other. Nickel plated shell. Has fiber bottom with 1/2" sockettes. Sockettes hold socket to panel or board.
Y6502 Socket .25

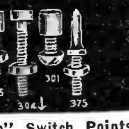

"Rasco" Switch Points
Nickel and polished.
Y301 1/4" x 1/2" x 3/16" 6-32" .18
Y304 3/4" dia. 3/8" .18
Y305 1/2" dia. 3-16" .18
Y375 Switch stop 3/8" long, with nut, doz. .18



FREE
The big "Rasco" catalogue. Contains all Armstrong circuits. Every up-to-date vacuum tube book. Greatest little book reprinted. Free upon receipt of postal.



The Radiogem
The simplest radio outfit made. Includes all parts for tuning: coil, tapped switch, crystal, catwhisker, Y5353 Radiogem, no aerial \$3.75
Y5354 Radiogem, with 1000 ohm phone and 3 ft. cord \$3.75

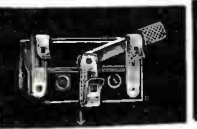

Throw Switches
Mounted on composition block. Small enough for all radio purposes.
Y4100 Single pole. \$.25
Y4101 Double Throw Single Pole \$3.35



Bakelite 180° Coupler De Luxe Style
Tubes of natural color bakelite, wound with green silk. Cast aluminum bracket, 3/4" shaft. Primary 13 taps. 180 to 350 meters.
Y3150 Coupler... \$2.35



"Rico" (Adjustable) Loud-Speaker Phone
Has rubber gasket underneath diaphragm, making phone fully adjustable. Gives amazing results as loud-talker on 1 and 2 stages of amplification.
Y2525 Speaker with 5 ft. cord \$2.65

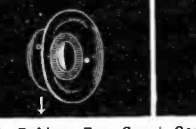

Soft Rubber Ear Cap
At last! Ear Caps that will relieve headaches, earaches, and undue pressure on the ears. Fit radius 1 1/4".
Y3500 Ear caps: pair .30



Series Parallel Switch
Quick change from one circuit to another. Black composition knob, nickel plated fittings. Blade radius 1 1/4".
Y2950 Series parallel switch .25



Melotone Loud Speaker
Best popular loud speaker. Fibre horn, heavy metal base, 5-ft. cord. Nickel goose neck. Greatest tuned (adjustable) talker. Horn length 11 1/2", bell 6 1/2", total height 9".
Y255 Melotone Speaker \$4.75



Nickel Lugs
All lugs are nickel plated.
Y310 Brass Lugs for No. 8 screw, doz. \$1.10
Y311 Copper Lugs for Nos. 6 and 8 screws, dozen \$1.10
Y309 Copper Lugs for Nos. 4, 6 and 8 screws, dozen \$1.10



Wood Cabinets
Highest grade mahogany cabinets made. Top is binged. Made of 1/2" stock.
Y714 Panel, 7x14" \$3.35
Y718 Panel, 7x18" 3.60
Y724 Panel, 7x24" 4.40
Y710 Panel, 7x10" 2.60
Y712 Panel, 7x12" 3.00
Y721 Panel, 7x21" 3.90

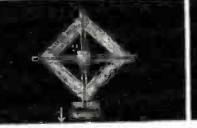

Loop Aerial
Made entirely of well-seasoned hard wood. Complete with all parts and base. Total height of loop 36". Can be put together by anyone in less than 5 minutes.
Y2600 Two ft. loop aerial, complete \$1.15

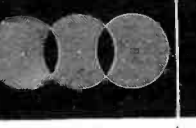

Mica Diaphragms
Made of special India mica in two sizes, 2 1/2" diameter and 1-13/16" diameter. Cement in washer in center for seal results on your phones.
Y2550 Diaphragm, 2 1/2" \$2.20
Y2551 Diaphragm, 1-13/16" .15



Nickel Screws
Made of brass, nickel plated. Flat and round head style. Any thread up to 10/32".
Price, 3/4", 3/8", 1/2" long, dozen \$1.15
Price, sizes 3/4" and 1" long, dozen \$3.30



NEW! Push Pull Transformer
For many new circuits. See any radio magazine. Made of best materials. Coils impregnated. Silk-steel laminations. Save 50 per cent by assembling yourself. Simple instructions furnished.
Y1159 Transformer. Ratio 6 1/2 to 1. \$4.00



Binding Posts
Y030 Sm. size, 1/2" high, nickel finish, each \$.04
Y124 Initialed Binding Posts: Antenna; B. Bat. making your phonograph a loud talker. Made of cast metal, nickel plated. 3 soft rubber bushings.
Y45 Spring Posts, ea. .04
Y44 Spring Posts, ea. .07



Double Phonodapter
Fits all phonographs and will take any standard double head set, thus making your phonograph a loud talker. Made of cast metal, nickel plated. 3 soft rubber bushings.
Y1320 Double Phonodapter \$1.65



Cardboard Tubing
Only seamless tubing made (I-Inside Diameter. O-Outside Diameter. L-Length).
Y6601 1/2" x 7' L. \$3.30
Y6602 3/4" x 7' L. 3.35
Y6603 1" x 7' L. 3.35
Y6604 1 1/4" x 7' L. 3.35
Y6605 2" x 7' L. 3.35
Y6606 2 1/2" x 7' L. 3.35
Y6607 3" x 7' L. 3.35



Radio Cement
Weather resisting. Used particularly for cementing plates with all parts and covered wires. Coils covered with this cement require no form. Wires hold together solely with this cement.
Y1750 Cement, 2-oz. bottle \$1.50



Bus Bar Wire
Square wire, 1/16" x 1/16", already tinned, making soldering easy. Sold in 2-foot lengths only.
Y6400 Bus Bar, length \$1.05
Green Silk Cord Rubber Insulation. Y4400 per foot \$0.02



Phonodapter
Will fit any phone. Make your phonograph a loud talker. Fits all phonographs. Made entirely of pure soft rubber with brass tube insert.
Y1310 Phonodapter \$1.38



Skinderviken Button
Famous Microphone for Transmitters. Sold all over for \$1. This is the genuine article. No imitation. Smallest and most sensitive microphone made. Diameter 3/8".
Y9595 Microphone. \$.85

VACUUM TUBES

Only the best make tubes carried in stock. All tubes guaranteed to work. Money refunded or tubes exchanged as long as filament lights.
Each
Y201A 5 volts, .25 amp. \$3.75
Y199 3 volts, .06 amp. 3.75
Y12 1 1/2 volts, .25 amp 3.75
All above types Amplifiers and Detectors.
Y200 5 volts, 1 amp. \$3.35
Detector type.

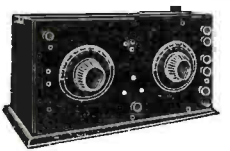

THE ONE TUBE SET THAT BRINGS 'EM IN ON THE LOUD-TALKER.

AUTOPLEX CIRCUIT

The famous Autoplex circuit described in RADIO NEWS has taken the country by storm. The only single tube outfit that works a loud-talker. Results guaranteed.
1-Y7140 Mahogany Cabinet. 7x14" \$3.35
1-Y7140 Dilectryte Panel 7x14" 1.20
2-Y5350 Moulded Variometers 6.00
2-Y3076 3" Dials. .80
1-Y5014 1250 turn Honeycomb coil 1.95
1-Y6500 Vacuum Tube Socket .35

1-Y4310 6 ohm Rheostat. \$4.45
8-Y201 "Rasco" Binding Posts .80
8-Assorted Binding Post Name Plates \$1.25
1-Y6400 Feet Bus Bar Wire \$1.50
1-Y5209 Consolidated Autoplex pattern .50
Total \$15.83
Our special price, Complete \$15.25
Complete with Melotone Loud-speaker. \$20.00

"Aristocrat" Post

The Binding Post illustrated is the latest style and has been enthusiastically received. The illustration shows full size. Hard Rubber Composition. Pad a top knob, nickel plated bottom piece. Brass screw furnished. Introduction price: Y2022 Posts—Each \$.07 Dozen .80
Y2022



RADIO SPECIALTY CO., 98 Park Place, New York City

Factories: Brooklyn, N. Y. Elkridge, Md.

HERE IS THE MOST POWERFUL "B" BATTERY MADE



HERE is the battery that will last indefinitely. Re-charged for less than one cent. Gets you distant stations exceptionally loud and clear. Look over the above picture.

COMPARE the parts with any other type of battery.

NOTE rigid construction—the material used.

THE plates are exceptionally large, size 2 1/8 x 1 3/4, allowing the use of from one to ten tubes. The container is of genuine hard rubber (not glass), the well-treated cedar separators, the vent caps and the separate cover for each cell and the price is less than any other first-class battery. The economic advantage of this battery is that it can be easily re-charged by being connected to your lamp socket, rectifier, home charger, or farm lighting generator.

YOU CAN ASSEMBLE THIS BATTERY YOURSELF

We will send you all the necessary parts either knocked-down or assembled with complete instructions so you can assemble the battery yourself ready for use. The entire operation takes but a short while and any boy 10 years old can do it without the slightest difficulty. The only tool necessary is a soldering iron.

PRICES

Variable Type 201D	Assembled	Knocked Down
1 unit 22 1/2 volts	\$5.00	\$4.00
2 units 45 volts	9.80	7.75
4 units 90 volts	18.00	14.75
5 units 115 volts	22.50	17.75
Alternating current rectifier for charging direct from lamp socket.....	.75	.50

Write for our latest catalogue. It is Free. If you want a Sidbenel Radio Map of United States and Canada, enclose 10 cents for postage.

Sidbenel
RADIO EQUIPMENT MFG. CO.
 29 West Mt. Eden Avenue
 New York City, N. Y.

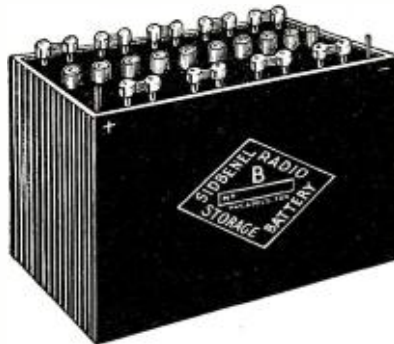

ernments a few years ago will not apply to English officials in Ceylon today.

Ceylon is excellently favored in the matter of varied climate and conditions generally for carrying out scientific research work of value. It is earnestly hoped that the existing spirit of active progress will be maintained for long, encouraged by the "Ceylon Journal of Science," planned to be issued shortly under the editorship of Dr. Joseph Pearson, the Director of the Colombo Museum.

Broadcasting in Australia

(Continued from page 1574)

THE AERIAL AND GROUND

The aerial is of the cage type and consists of four wires stretched taut and kept in position by means of huge brass hoops, which are secured at regular intervals along the wire and to which the wire itself is attached. Special attention has been given to the "earth" system, which is most elaborate. No direct contact is made with earth, but a complicated earth-screen has been constructed. This comprises a counterpoise arrangement, the wire used in connection with it being supported by small steel masts each carrying heavy insulators and holding the earth-screen a distance of about 15 feet from the ground.

A special steel tower, set in concrete, is erected near the side of the operating room and to this tower the "lead in" from the aerial is led and a connection is also made with the "lead" from the earth-screen. This small tower stands upright against the house and from it the various wires are carried by heavy insulators to the actual instruments.

The programs of speech and music, which are transmitted in connection with Farmer & Company's service, are provided in elaborate studios which have been constructed on the roof garden of the company's big retail store in Pitt, Market and George Streets, Sydney, and about eight miles from the station. A land-line conveys the speech and music to Willoughby, where it is transmitted. The studios have been constructed at considerable expense from plans and specifications obtained after consultation with representatives of broadcasting interests in all parts of the world. No stone has been left unturned to insure the very best results being achieved, and the studios have been planned accordingly.

Constructed in a special manner so as to be sound-proof, the town station comprises a large and a small studio, an instrument room and a special reception room for the artists. The instrument room adjoins both studios and the operator is able to watch the progress of the concerts being broadcast through a special double sound-proof plate-glass window. Walls and ceilings have been draped carefully with thick felt. All doors are double and have been constructed on sound-proof principles.

DELAY REDUCED

The use of two studios results in there being very little delay, the manager of the service being able to arrange his artists in one room while another item is actually being rendered in the other. A quick change-over on the part of the operator results in one item following another in rapid succession. The microphones into which the ar-



Actual Size

30 STATIONS in one hour!

—heard with one Myers Tube (name and address furnished on request). The remarkable results being obtained with Myers Tubes are due, largely to the elimination of socket with its bunched leads.

Myers Tubes

(practically unbreakable) give you distance with clarity. They add 50% to the efficiency of any set by reducing interference.

See that you get the New Improved Myers. Others are not guaranteed. Insist on Myers at your dealers'—otherwise send purchase price and be supplied postpaid.

Two types: Dry Battery and Universal (for storage battery). Write for free circuit diagrams.

\$5 EACH, complete with clips ready to mount on your set; no sockets or other equipment necessary.

E. B. Myers Co. Ltd.
Radio Vacuum Tubes
 240 CRAIG STREET, W.
 MONTREAL, CANADA



HOW MANY STATIONS DO YOU GET ?

and do you hear them
“LOUD and CLEAR”

WHEN the fellow from next door comes in and wants to tell you about his set, and shows you a list of stations that look like a Chinese newspaper, what have you got to show? Can you sit down and tune them in so that they sound as if they were in the next room? That's what thousands of radio owners can do who have learned how to get loud and clear messages from the far away stations by the Acme method.

The importance of amplification

IN ORDER to hear clearly and distinctly, you must be sure that you are using amplifying transformers that amplify the sound without distorting it. Amplification is the key to radio—it increases the tiny sound waves that reach your set and makes them loud enough for you to hear and enjoy.

But it is not enough to amplify the sound, you must be sure that in amplifying it you do not blur it and make muffled, unintelligible sounds out of messages that should be clear and distinct. That is the danger of distortion.

ACME APPARATUS COMPANY

Dept. 27

CAMBRIDGE, MASS.

How to get amplification without distortion

THE Acme engineers have perfected two instruments that give you maximum amplification without distortion. The Acme R-2 (also R-3 and R-4) Radio Frequency Transformer builds up the radio energy before it reaches your detector. This increases your range. The Acme A-2 Audio Amplifying Transformer gives you greater volume of sound. It builds up the audio energy that leaves your detector and gives it to you “loud and clear.” If you want to get the most out of your set, be sure to use Acme Transformers.



THE Acme A-2 Transformer (shown above) and Acme R-2, R-3 and R-4 Radio Frequency Transformers sell for \$5 each at radio and electrical stores. Your dealer will be glad to help you.

How to get the best results

IN ORDER to get the best results, send for “Amplification Without Distortion”—an instructive and helpful book which not only explains exactly how to get the best results by proper amplification, but also contains a number of reliable wiring diagrams. It will help you build a set. Send the coupon with 10 cents for your copy.

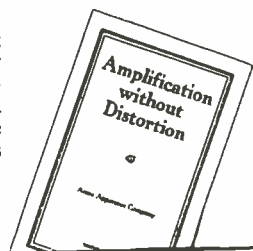

ACME

for amplification

ACME APPARATUS COMPANY,
 Dept. 27, Cambridge, Mass., U. S. A.
 Gentlemen: I am enclosing 10 cents (U. S. stamps or coin) for a copy of your book, “Amplification without distortion.”

Name

Street

CityState



Eagle Neutrodyne Balanced! RADIO RECEIVER

THE sheer weight of overwhelming merit has given to the name "Eagle" in a short time a tremendous significance—the greatest of neutrodyne receivers. The secret of the EAGLE'S marked superiority is its infinitely fine balance—as perfect, as flexible, as dependable as that of the carefully trained tight-rope walker to whom balance means life itself.

Guaranteed without reservation.

Licensed by Independent Radio Manufacturers, Inc. under Hazeltine Patent No. 1,150,080, dated March 27th, 1923, and other patents pending.

Write for Literature



20 Boyden Place

Perfect Balance
Secret of
Eagle
Supremacy

tists sing are kept in the studios, and the sound is "stepped-up" before being carried by telephone wire to the station at Wiloughby.

A special series of switches enables the operator and studio manager to control the operation of the studio with the utmost simplicity, and a series of signal lamps is arranged so as to give full warning to artists and staff when the station is in operation.

One of the greatest achievements by the directors of Farmer & Company has been the securing of the sole broadcasting rights from the largest Australian theatrical organization of the whole of their musical and dramatic productions. For this purpose the four theatres controlled by the organization have been connected by trunk lines with the broadcasting studios, and the productions are broadcast as they are produced, direct from the theatres.

In addition, Farmer & Company has secured the sole rights of the "Sydney Morning Herald," Australia's principal morning newspaper, and the "Evening News," the principal evening newspaper, for broadcasting purposes. A regular feature of the broadcast program will be Stock Exchange quotations and market reports embracing all the primary products of the country. The Sydney Town Hall, the headquarters of the City Municipal Council, has also been connected with this broadcast station by a trunk line, while arrangements are being made for the connection of the New South Wales Conservatory of Music, which is controlled by the state government and is the seat of musical education in the Commonwealth.

Farmer & Company has received many congratulations on its enterprise in establishing the station.

Can American Radio Sets Be Sold In Great Britain?

(Continued from page 1575)

B. B. C. The use of this trade mark was only to be authorized by the company to British firms applying for membership to the B. B. C., paying a certain deposit as a token of good faith, and taking at least one share in the company.

To this general rule (which would have had the effect of excluding the use of imported material) there were certain exceptions agreed upon, namely, no stipulation was made as to the origin of any outside aerial equipment, dry or storage batteries, which might be used in connection with the scheme. Also the exclusive clauses did not cover experimental work *i. e.* they were only intended to apply to receiving stations which were established for the purpose of listening to the entertainments broadcast by the B. B. C.

The contract was cemented by the issue of two types of Post Office licenses:

(a) The "B. B. C." license, issued to amateurs who wished to receive the B. B. C. transmissions.

(b) Constructor's license, issued to bona fide experimenters who were able to satisfy the Post Office experts as to their technical qualifications. The latter for their experiments were to be allowed to use suitable apparatus, regardless of its country of origin.

This, in broad outline, is the scheme which was put into operation early in 1922.

OUTCRY IN THE TRADE

Immediately the terms of the license were made known, there was an outcry in the electrical trade. A considerable number of smaller manufacturers and dealers took exception to the constitution of the B. E. C.

**STANDARD
of
EXCELLENCE**

for audio amplification

With all tubes—In all stages



AMERTRAN

TRADE MARK REG. U.S. PAT. OFF.

Improve your set with an AmerTran

Send for Circular No. 1005

When a band or orchestra is broadcasting, do you hear all the instruments in their balanced harmony?
Can you distinguish one speaker from another through his articulation and the tone of his voice?

If you have not used an AmerTran, perfect reproduction is as yet unknown to you.
Type AF-6: turn ratio 5:1. Price, \$7. At your Dealer's; or, sent carriage charges collect.

American Transformer Company, 177 Emmet St., Newark, N. J.
Designers and builders of radio transformers for over 22 years.

Write for free catalog illustrating and describing our complete line of 1500 Good Tools
GOODELL-PRATT COMPANY
Toolsmiths
Greenfield, Mass., U. S. A.

Code Instructions That Instruct Only \$2.00. Students now licensed mastered Code 15 Minutes. Ten word speed 3 Hours. Information free. Dodge Radio Shortkut, Dept. N. Mamaronck, N. Y.



If you closed your eyes you'd think you were in the Fifth Row Center

You can hear the softer tones

P LUG in a pair of Murdock Radio Phones—and tune-in on New York. You'll think you are in the fifth row center at a Broadway musical show—at the Symphony Concert, or the Opera. Everything is reproduced—the clear notes of the singer's voice, the high and the low tones of the violin, the saxophone of the jazz orchestra.

Perfect diaphragm adjustment the secret

THE correct seating and clamping of the diaphragms are important factors in the success of Murdock Radio Phones. This adjustment keeps the diaphragms in place—and prevents distortion. The sensitivity of the diaphragms gives natural reproduction to voice and music.

Light and comfortable

THE Murdock weighs only 13 ounces. This extremely light weight makes it possible for the

user to wear these 'phones for hours without discomfort. Ear caps are especially designed to exclude outside noises. The improved flat head-band is feather-weight, and does not bind the head. And there are no screws in the band or adjusting rods, which means added comfort to the wearer.

OVER 1,000,000 Murdocks are in use today. Quantity production has enabled us to standardize our price—so that when you buy a Murdock you are sure of getting the best possible value. Get a Murdock today and test it out. It is fully guaranteed.

Murdock Multiple Plug Jack

THIS effective plug jack permits the use of one to four 'phones at the same time. Get one—and let the whole family listen in.

The Murdock Five Tube Neutrodyne Set is now ready. See this new type at your dealer's.

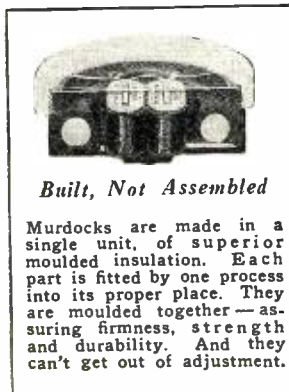

Built, Not Assembled

Murdocks are made in a single unit, of superior moulded insulation. Each part is fitted by one process into its proper place. They are moulded together—assuring firmness, strength and durability. And they can't get out of adjustment.

WM. J. MURDOCK COMPANY
362 Washington Avenue, Chelsea, Mass.
Branch Offices: Chicago and San Francisco

MURDOCK RADIO PHONES

Standard since 1904

Mail Coupon for Free Booklet

WM. J. MURDOCK CO.,
362 Washington Avenue, Chelsea, Mass.

Gentlemen: Please send me, without obligation, your free booklet "The Ears of Radio"—which explains the importance of radio 'phones to efficient radio reception.

Name

Street

City..... State.....

All You Want to Know about **RADIO**

Here is a Radio information mine. It can't grow old nor out-of-date. It grows with new Radio discoveries. It is in loose leaf form and every purchaser is a registered owner. Every month, by mail, you get in printed, finely illustrated, punched pages every new fact concerning Radio without extra charge. You buy the book *once*.

LEFAX PERPETUAL RADIO HANDBOOK

was written by Dr. J. H. Dellinger and L. E. Whittemore, Chiefs of the Radio Laboratory, U. S. Bureau of Standards, Washington, D. C. You simply insert the pages instantly and easily in the handy pocket size, flexible bound Lefax Handbook.

It is finely, accurately illustrated. It has linen index tabs. It is clearly, cleanly printed. It gives a full list of broadcasting stations with full information about them—and new ones as they are established. Lefax is a reference and instruction book that takes all the mystery out of Radio.

Ordinary Radio guides become obsolete rapidly. Radio is developing every day. Only Lefax develops with it. The best way to keep up is to own Lefax and get the added facts every month by mail. See it, examine it, buy it from your Radio supply house, your stationer or book-seller.

Lefax, Incorporated, Publishers
147 South Ninth St., Philadelphia

They pointed out that while its membership was, theoretically, open to any genuine British manufacturer, in practice the control of the enterprise was vested in six large firms. The company is governed by a board of nine directors, six of whom are, under the Articles of Association, permanent nominees of the six firms in question. The seventh, the Chairman, was to be the nominee of these six firms acting jointly. This left only two seats on the Board for the representatives of other firms, though the latter seemed likely to run to many hundreds. In addition to this it was pointed out that of the nominal share capital, £100,000, £60,000 was underwritten in advance by these "Big Six" (as they came to be called). This means if a poll were demanded on any question of policy, the deciding voice rests with the "Big Six." There were other minor objections to the contract, but the ones I have mentioned were the pivot of the controversy—which became very heated towards the middle of the year.

Meanwhile there had been two changes in the office of Postmaster-General, and when Sir William Joynson-Hicks succeeded Mr. Neville Chamberlain (who had signed the contract drafted by Mr. Kellaway), the Electrical Importers' and Traders' Association, with the support of other bodies, succeeded in convincing him that it was necessary to hold an investigation. He, therefore, appointed a strong independent committee, under the chairmanship of Sir Frederick Sykes, to report upon this particular matter and also to make recommendations regarding the whole problem of future broadcasting. The contract already made with the B. B. C. was understood to be binding until the end of 1924.

THE SYKES' REPORT

Sir Frederick Sykes' Committee received a great deal of evidence and presented a report which was published in the fall of the year. On most points this report upheld the contentions of the opponents of the original contract, but it was recognized that the hands of the Post Office were somewhat tied by virtue of the fact that a legal contract had been ratified. Nevertheless it was recognized that the objectors had a legitimate grievance in so far as the effect of the contract was to debar the public from the use of imported overseas apparatus *upon whose importation Parliament had placed no embargo whatever*. It was argued that in principle it was thoroughly bad for a single Government Department to issue regulations which ran counter to the fiscal policy of the country as submitted by the House of Commons.

When the report appeared, the Postmaster-General issued with it a memorandum defining the new policy. In certain minor respects he agreed to adopt forthwith the recommendation that bona fide radio dealers were to be admitted to the B. B. C. as well as manufacturers, and certain alterations were agreed upon in respect of the Articles of Association of the Company. But, regarding the question of imports, no alteration was made except the issue of an *interim* license, to retrospectively cover those users who had purchased foreign apparatus or component parts during the months when the controversy had been raging.

THE PRESENT RESTRICTIONS

This brings us to the present position. If the question is asked: "Can American radio apparatus enter Great Britain and find a market?" the answer must be (a) there is no barrier against its entry at British ports and (b) its salability must depend upon the general attitude of the ordinary private buyer to the regulations issued by the Post Office.

These regulations require that any person who applies for a license to use receiving



NOW You Can Buy the **BRACH** COMPLETE RADIO ANTENNA SETS

Ten Parts In One Purchase

No more guessing—no more doubting, when you go to buy what you need for an aerial antenna.

Here's the "whole works"—the set our radio engineers have selected. Nothing is omitted—everything is of maximum strength and high insulation—conforming to requirements of National Board of Fire Underwriters.

Protects your fire insurance

Full, easily followed, directions with each set. No questions to ask.

Radio Dealers Everywhere Can Supply Them

L. S. BRACH MFG. CO., Newark, New Jersey

REMLER

Apparatus Radiates Quality
REMLER RADIO MFG. CO.

Home Office
182 Second St. San Francisco
154 W. Lake St. Chicago
30 Church St. New York

Operate your radio from your
lamp socket with a

Gould Unipower Battery

For complete information address

GOULD STORAGE BATTERY CO.,
30 East 42nd Street. New York

TUSKA RADIO

The Superdyne Radio
Frequency Receiver
Armstrong circuit,
licensed under patent
1,113,149

Employing a new radio principle, the Superdyne with four tubes equals or surpasses the range and volume of six-tube sets. Great for loud speaker reception of distant stations. An outdoor aerial is optional; an indoor aerial works perfectly. Splendid tone. Priced lower than you might expect!

Write for Special Folder
No. 11-L

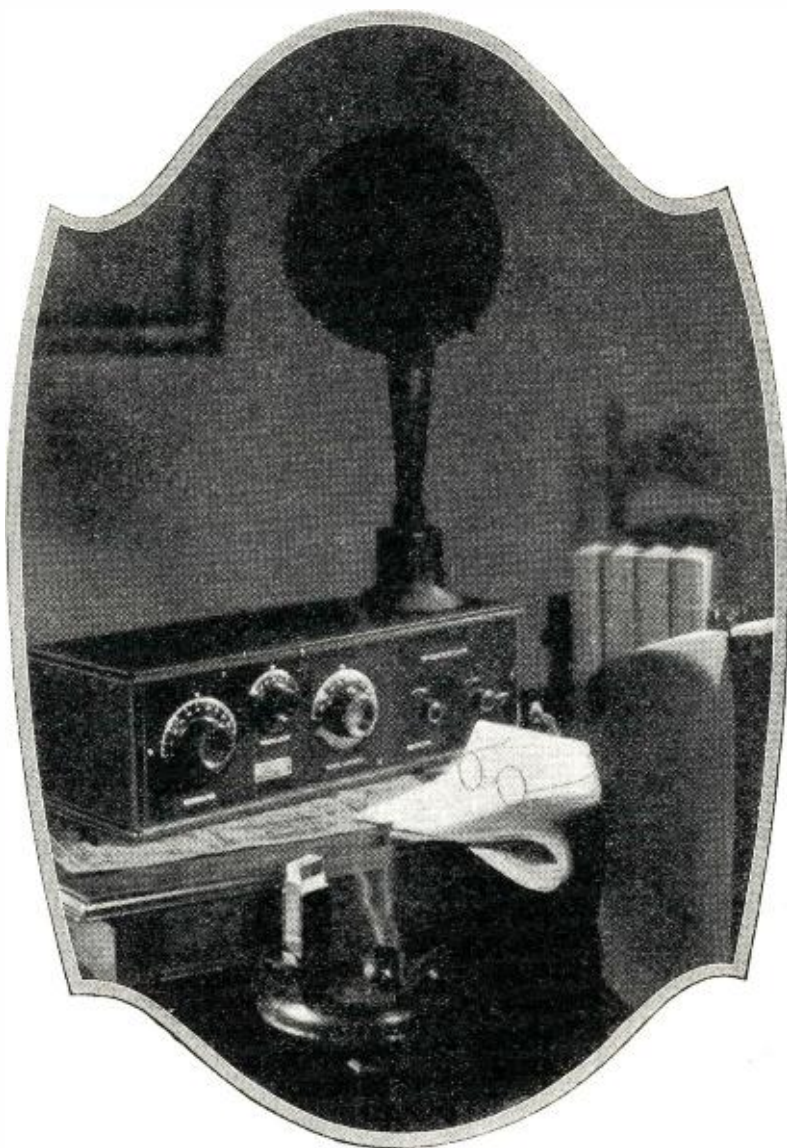

If you wonder which is best

SO MANY claims! So many different radio sets! It is confusing . . . and yet, in radio as in older industries, you can quickly name the leaders whose reputation rests firmly on the rock of sustained QUALITY. It invariably takes years to lay this solid foundation. Even as long as the thirteen years that Tuska has been a noted name that identifies fine radio apparatus.

Tuska Radio is built by New Englanders trained in fine mechanical skill. From the creative laboratory where the Superdyne and other great radio contributions were born, down to the final searching inspection; from the President to the nimblest assembler, every worker on Tuska Radio takes pride in helping produce one of the world's best receivers. Ability! Experience! Integrity! With these materials we build Tuska Radio—for lasting satisfaction.

You are safe in buying Tuska Radio, whether you can only spend \$35 for a one-bulb set, or four times that. Tuska Radio will give you years of trouble-free radio entertainment. Have no fear that the Tuska you buy this year will soon be obsolete. Tuska Radios ten years old are still efficient and serviceable, as yours will be years from now.

THE C. D. TUSKA CO.
Hartford, Conn.

Hears 43 stations in summer

In a few weeks last summer, Mr. Peter Ditges, Jr., of Paterson, N. J., received 43 stations, and compiled a log of 11,000 miles. He used a Tuska No. 225. His record was equaled by other Tuska owners.



Michigan hears Honolulu

"On Saturday night my Tuska and I picked up Station KGU, Honolulu Advertiser, and listened to them for an hour through my loud speaker. It was wonderful!"

E. A. PHILLIPS,
Durand, Michigan."



Barkeley Four-Phone Plug

PATENTS PENDING

Connects one to four head sets and all in series to any radio set employing standard telephone jacks.

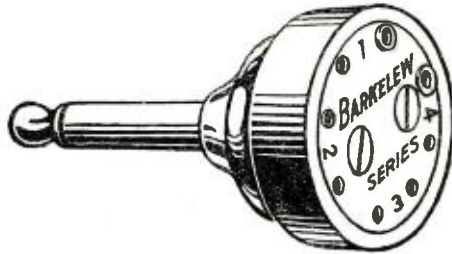

Cat. No. 616
Price \$1.50

It adds to the appearance of any set. With all phone tips adjusted, the diameter is but $1\frac{1}{4}$ inches. Improvements in the 1924 model make it the most reliable buy on the radio market.

CHICAGO, ILL.
15 S. CLINTON ST.
NEW YORK
50 CHURCH ST.

BARKELEY

ELECTRIC MANUFACTURING CO.
MIDDLETOWN, OHIO.

SAN FRANCISCO.
72 FREMONT ST.
LOS ANGELES
411 S. MAIN, ST.

"KILLS YOUR REFLEX TROUBLES"

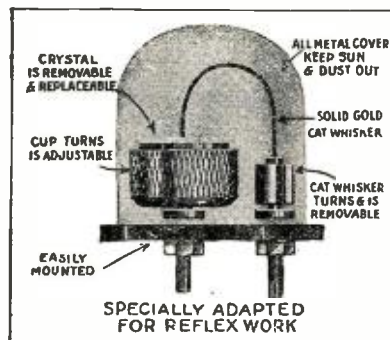

"Lincoln" Enclosed Fixed Adjustable Detector

And now you, too, can get it—the wonderful detector which has created a sensation. Thousands in use already. Fully tested—guaranteed for one year—Price only \$2.00. If your dealer hasn't it, write us—today. Mention this advertisement. Jobbers, dealers, agents: Fans demand this remarkable appliance. Wire or write for our worthwhile proposition. Address Dept. E.

LINCOLN MANUFACTURING CO.
LOS ANGELES, CALIF.



East
Pittsburgh,
Pa.

Next door
to
KOKA

Same Day Shipments

Wholesale
Radio
Equipment



RADIO HORN

Let the whole family listen to the music. Add to the appearance and value of your set. Mail a dollar bill for horn like picture, knocked down, prepaid. Easily assembled by anyone.

\$1.00

FOX MFG. COMPANY, DEPT. B
247 So. Broadway, Los Angeles, Cal.

apparatus (except the experimenter) must sign an agreement that he will "not knowingly use" any component parts that have been manufactured outside of Great Britain and Northern Ireland. No doubt, by a very large number of licensees, this undertaking is being carried out, not only in the letter but in the spirit. Unfortunately, however, it leaves room for evasion where the apparatus does not bear any indication of its country of origin, and where both dealer and purchaser are silent on the subject at the time of their transaction. The buyer then maintains that he does not know the origin of the apparatus and, therefore, he is not knowingly using foreign materials.

No one can pretend that this is a satisfactory situation. Every business man knows that, where foreign parts of good quality and reasonable price are available in a market, regulations such as I have outlined will never prevent their finding purchasers. This explains what to many of our overseas friends have been an enigma, *i. e.* why it is, although foreign parts are supposed to be barred, they are, nevertheless, coming into Great Britain in considerable quantities.

To avoid misunderstanding, I wish to make it plain that I am making no attack upon the B. B. C., nor am I challenging the reasonableness of the demand which many of its members have made to be safeguarded. All I am pointing out is that their demand has been met in a way which, unfortunately for everybody concerned, offers no real safeguard, but leaves the trade to bear the kind of burden which is most embarrassing to business men, the burden of uncertainty.

For the American exporter, the position may be summed up as follows: (a) He is finding, and will continue to find, among genuine experimenters in Great Britain, a demand for radio goods which are of good quality. The number of these experimenters is considerable. (b) So far as the amateurs are concerned he will find that the British importing agents are somewhat nervous in making contracts until, as months go by, they get some clearer idea as to the extent to which the goods are salable to the wholesale and retail trades in this country.

AFTER 1924?

With regard to the future, the probable trend of events after the end of 1924 is a little obscure. The Postmaster-General has in point of fact agreed to extend the B. B. C. contract for a further period of two years, *i. e.* to the end of 1926, but he reserves to himself the right to review certain of the license conditions. Therefore, it is quite possible that the import regulations may be modified after next January. It is rather too early to predict probable changes.

Last year there was a great deal of criticism on the quality of the B. B. C. entertainments. Everybody agrees that the company is to be congratulated on the progress since made, and it is as well known in America as it is in this country that great success had attended the efforts of the B. B. C. enterprise on the technical side. The electrical trade here is naturally grateful to the promoters of this enterprise, which has been responsible for a considerable revival in the trade at a time when it seemed threatened with prolonged depression.

At the same time it must be recognized that there is a clear distinction in principle as well as in practice between the rights of transmission, which obviously must be subject to some centralized authority, and on the other hand the right to control conditions of the manufacture and the sale of receiving apparatus. It is this latter aspect of the question which for the moment mainly concerns the trade, and it is to this aspect that I have addressed my observations.

SUPER-HETERODYNE

The World's Best Radio Receiver

BY PERFORMANCE

ADVANTAGES NO OTHER RECEIVER CAN EQUAL

1. UNIFORM EFFICIENCY over the entire wavelength range of 160 to 850 meters. This means that all stations, Radio-Phone Broadcasting, Amateur and Commercial within this wavelength range, will be received with maximum intensity. This very desirable feature is not obtainable by any other practical method using Radio Frequency amplification.

2. SELECTIVITY by this system, greatly exceeds that obtained in all other methods of reception. Using the Model "C" with a loop in the Suburbs of New York, WOR 15 miles distance, operating on 405 meters, can be completely eliminated, and PWX 1300 miles distance operating on 400, can be received on a loud speaker. This holds true on an average cool night. There is no telegraphic interference from 200 meter amateur stations or 600 meter ship stations.

3. SIMPLICITY to change from one station to another, there are only two dials to vary. The two dials can be calibrated for all the various stations, as there is only one best position for each station.

4. AMPLIFICATION is much greater than obtainable in any other standard receiver. Total is as follows: 1st the Heterodyne Amplification in the 1st Detector; 2nd, the Regenerative Amplification in the 1st Detector; 3rd the 3 stages of Tuned Regenerative Radio Frequency Amplification; working at a low advantageous frequency; 4th, the second Detector action, and 5th, the two stages of low ratio distortionless audio frequency amplification.

5. RECEIVING RANGE other factors correct, the receiving range is in proportion to the effective radio frequency amplification applied. As this receiver has much greater effective radio frequency amplification than all others, the range is proportionally greater.

Complete Constructional Blue Prints Consisting of Two Sheets 50x21" and Two Sheets 27x21", Our Numbers 30141-145. \$2.00 Postpaid.

Designers of the Highest Class Radio Apparatus in the World

Experimenters Information Service 476 Broadway :: :: New York City



"THE ROLLS-ROYCE OF RECEPTION"

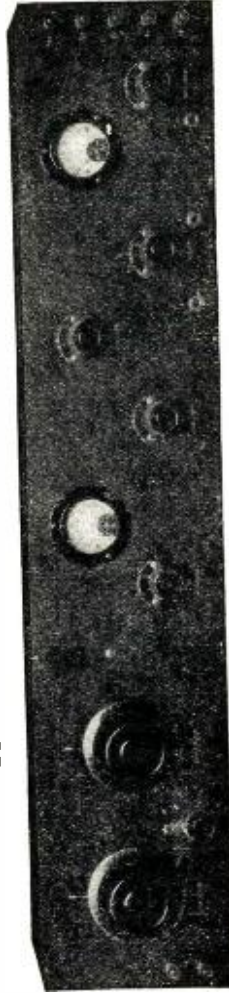

MODEL "C" SUPER-HETERODYNE

Wavelength Range 160 to 850 meters. Tubes, 2 Detectors, Oscillator, 3 Tuned Radio Freq. Amplifiers, 2 Audio Amplifiers.

The Super-Heterodyne is the most efficient method of short wave radio frequency amplification known. It is used extensively by the Commercial radio companies and various governments, when it is necessary to receive over extremely long distances, without interference from near-by stations.

The remarkable results are due to the Super-Heterodyne action, which is briefly as follows: the incoming signal, which may be any wave from 160 to 850, is changed thru the use of a local oscillator, to a wavelength of 10,000 meters. At this wavelength an exact duplicate of the original signal is amplified at radio frequency with the very highest efficiency possible, rectified and amplified at audio frequency.

During this change a very high degree of selectivity is secured, due to the amplifier, which is designed to pass nothing but 10,000 meters. Accordingly while there may be ten or more signals in the loop, only one will be received at a time, the one that the oscillator heterodynes thru the amplifier.

Double Anglo French Broadcasting

(Continued from page 1577)

connected with Radiola's station at Levallois enabled the whole of France to hear the same musical selections and addresses. The principal speaker of the evening was General Anthoine, President of the Compagnie Française de Radiophonie.

Captain Lewis made a short and graceful reply to the General's greeting on behalf of the British Broadcasting Company and the large body of British amateurs.

These friendly interchanges were followed by the singing of "God Save the King" and "The Marseillaise." The performance closed with a good-night message from the Gay City. At the close I was privileged to hear the conversation which took place by trunk line to London between General Anthoine and Mr. Litt, the Controller of the British Broadcasting Company. The whole program had been received without difficulty and broadcast with great success by the company's stations; the furthest one south is situated at Bournemouth and the furthest north at Aberdeen. Every amateur in England was able to hear the General's rousing speech. The unqualified success of this essay marked a decided advance in broadcasting.

It is to be hoped that before long a London program will be heard by the French amateurs on their own wave-length. Besides an exchange of friendly greetings, such an arrangement would be of considerable artistic value, as the French and British musical programs differ very largely in character, and both nations would benefit by the exchange. At the same time, since the mechanical difficulties are not insuperable, an exchange of programs between the Irish and British broadcasting companies would be of the greatest interest. The inhabitants of troubled Erin, now that peace has at last been established, might, by such a method, come to think a little more kindly of the Sassenach, and the English might be induced to forget the past and think well of their neighbor.

Radio in Germany

(Continued from page 1577)

their current from a D.C. converter unit. This converter unit works 220 volts on the primary side and generates a current of 36 volts and 28 amperes. This is one K.W., and the tubes only require 16 to 17 amperes at 16 volts or about 500 watts. The generator is directly excited from the power line. Chokes are provided in order to keep the filament voltage as steady as possible. The correct voltage is measured with a voltmeter which can be switched to either tube. A rheostat is in parallel with one of the tubes for current control.

The plate current is generated by a unit consisting of a 4-K.W. D.C. motor coupled to a 3-K.W. A.C. generator of 150 volts and 1,000 cycles. The A.C. is stepped up in a transformer to 3,500 volts, and then rectified with a gas rectifier. This produces a D.C. of 3,000 volts at 1 ampere.

The rectifier is built with a calcium oxide cathode. The heating energy for this cathode is also furnished by the 3 K.W. A.C. generator. Trouble is being experienced in the elimination of the generator hum.

The rectifier can be observed through a peephole. As soon as the rectifier cathode is glowing yellow, the voltage may be applied to the transformer. In order to prevent a heavy current surge, a rheostat is provided in the transformer primary circuit. The positive side of the rectifier is connected with both plates. Iron core choke coils and a high frequency choke coil are provided.

THE AMRAD BASKETBALL

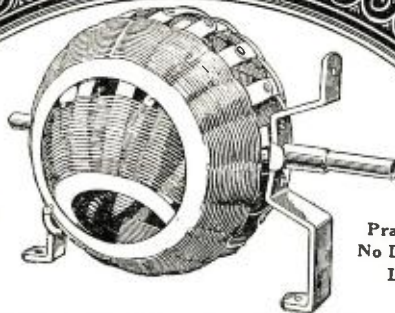

Makes any Set Better

Practically No Dielectric Losses

INDUCTANCE TUNING With Your Set

is possible only with AMRAD Basketballs. Use them for greater range and volume, greater tone and extreme selectivity. Get that peak voltage (now possible for the first time) on the grid of your detector, by using the great scientific principle of INDUCTANCE TUNING.

ONLY \$3.75

Basketballs are now available to everyone—both Variometers and Couplers. Makes any set better, yet one of the most inexpensive things you can buy.

Write today for Bulletin V describing the Basketball.

HOW TO PURCHASE

Order from your local dealer. If you are not located near a dealer, or he can't supply you promptly, send remittance direct with full information.

AMERICAN RADIO AND RESEARCH CORPORATION
Department N, Medford Hillside, Mass.

Let HOMMEL'S experience guide you



This organization was one of the pioneer wholesale distributors of radio equipment. They have seen hundreds of retailers come and go,—they know from experience "what and when and how" dealers can best sell radio supplies and enjoy a satisfactory margin of profit.

HOMMEL distributes only recognized nationally advertised apparatus that is guaranteed by the manufacturer,—their dealer discounts are very liberal,—their stocks are always ample to take care of any requirement,—they wholesale exclusively and do not compete with dealers by retailing.

HOMMEL'S Dealer Service Department is maintained for your benefit,—their experience and advice will prove helpful to you in many ways, and this service is cheerfully given any time without charge. Get in touch with us to-day, write for the new HOMMEL encyclopedia 246-S—profit by HOMMEL'S experience—it is paying hundreds of other dealers—why not you?

LUDWIG HOMMEL & CO
530-534 FERNANDO ST. ———— PITTSBURGH, PENNA

VULCANIZED FIBRE
So sure and specify "WILMINGTON FIBRE"
Sheets, Rods, Tubes, Washers, Etc., Specialties
Wilmington Fibre Specialty Co. Wilmington, Del.
Branch Offices "Everywhere"

199 NECESSITIES
WIMCO 199 SOCKET \$.75
WIMCO 199 C SOCKET 1.00
WIMCO 199 ADAPTER75
Send for free literature.
Jobbers' Inquiries solicited.
THE WIRELESS MFG. CO., Canton, Ohio
MANUFACTURERS—DISTRIBUTORS

No Circuits Equal These In Range, Purity, Volume!

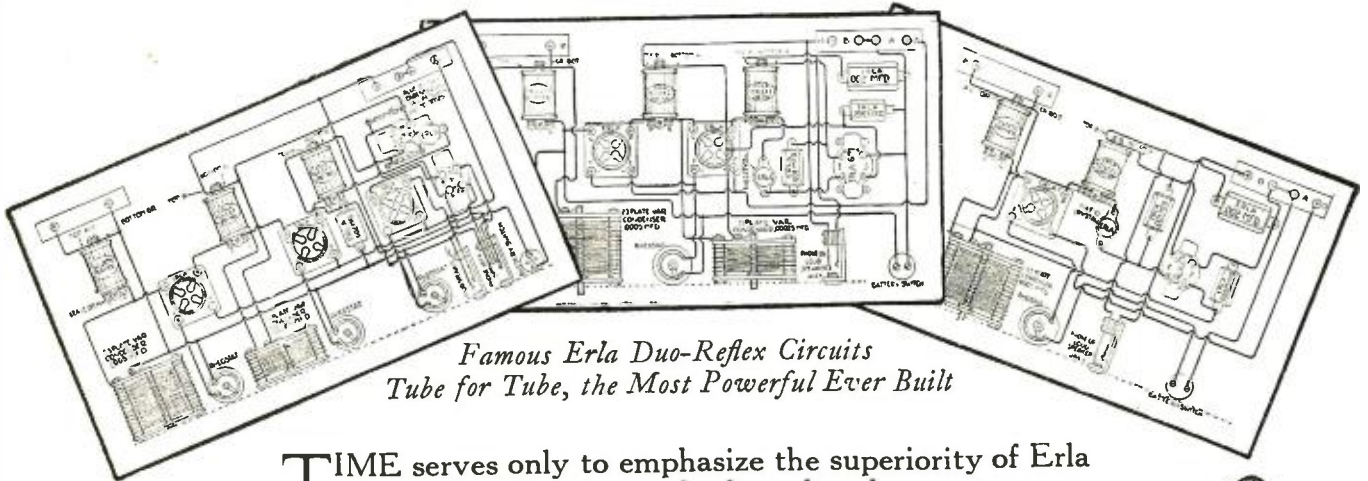

*Famous Erla Duo-Reflex Circuits
Tube for Tube, the Most Powerful Ever Built*

TIME serves only to emphasize the superiority of Erla Duo-Reflex Circuits—tube for tube, the most powerful circuits ever built.

An Erla circuit introduced efficient one-tube loud speaker reception, and still stands unsurpassed. So too, Erla two and three-tube circuits remain unchallenged in range, selectivity and volume, outstripping four and five tubes otherwise employed.

Even in minor phases of operation, Erla superiority is pronounced. Control is positively fool proof, eliminating body effects, reradiation and distortion, while stability is so complete that every station is heard invariably with the same dial setting.

Underlying the efficiency of these circuits, and the main-spring of their success, are Erla radio and audio transformers. Through synchronizing perfectly received radio, reflexed radio and reflexed audio frequency currents, they enable vacuum tubes to do triple duty, multiplying amplification without flaw.

Equally indispensable to maximum sensitiveness, stability and ease of operation are Erla Selectoformer, Erla fixed crystal rectifier and Erla tested capacity condensers, meeting completely the exacting requirements of reflex work, supreme test of radio apparatus design.

For complete information, ask your dealer for Erla Bulletin No. 20; or write, giving your dealer's name.

Electrical Research Laboratories
Dept. C. 2500 Cottage Grove Ave., Chicago

ERLA



Maximum range, selectivity and volume are positively assured through Erla radio frequency transformers. Reflex and cascade types. \$5



Erla condensers alone bear the words "tested capacity" on their labels, guaranteeing superior accuracy at no extra cost. 35c to 75c ea.



Extreme sensitiveness and perfect stability of Erla fixed crystal rectifiers meet every requirement of reflex operation. List, \$1



Exclusive features of Erla sockets are now available in 199 as well as standard size. Quality and workmanship unequalled. 65c and 75c



Erla Selectoformer better coupling between any antenna and any receiver, with resultant increase in range and selectivity. List, \$5



Superior quality of Erla audio transformers stands clearly revealed in their ability to amplify three stages without flaw. \$5

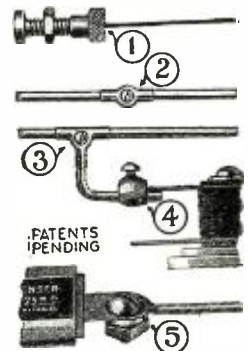

Erla connectors speed up and simplify assembly of radio apparatus, besides avoiding danger of injury to costly parts. 3c to 5c

Na-ald No. 499 Na-ald Small Space No. 401 Cross Section De Luxe Socket Na-ald No. 411 Na-ald Adapter No. 429

Na-ald De Luxe No. 400

IT'S THE CONTACT THAT COUNTS

Na-ald Sockets embody features which insure dependable contact under all conditions, a fact which makes them leaders among radio sockets. Each contact strip in Na-ald Sockets is either of a wiping nature, or it maintains contact over a broad surface. It is so designed that strong and permanent tension is assured, no matter how much the terminals in the tube vary, or how often the tube may be removed. All Na-ald Sockets are moulded of Bakelite with uniform cross-section and cure. These, together with other engineering features, make it possible to secure full efficiency from tubes. Na-ald Sockets cost no more than ordinary sockets. Volume of sales and straight line production methods make this high quality and low cost possible. Na-ald Small Space Sockets sell at 35c, or 3 for \$1.00. Na-ald No. 499 is priced at 50c. All other sockets are priced at 75c.

Send 15c or cover of Na-ald carton for copy of new booklet, "What to Build?"

ALDEN MANUFACTURING COMPANY
DEPT. K 52 WILLOW STREET SPRINGFIELD, MASS.

The plate voltage is 2,500 volts, the plate current about .6 ampere, which is equal to 1.5 K.W. The antenna current is about 5 amperes. The antenna resistance is estimated to be between 15 and 20 ohms so that the antenna output would be about .4 to .5 K.W. If it is found necessary to increase the antenna current this will be effected by increasing the plate voltage to 3,000. The plate current would then be about .8 to 1 ampere. The tube output, therefore, about 2.4 to 3 K.W., the antenna current about 8 to 9 amperes, or the antenna output about 1 to 1.6 K.W. It seems as if a 5-ampere radiation is sufficient.

The studio itself is two stories lower than the transmitting room. Ordinary carbon microphones are used to pick up the sound waves and deliver them through a lead insulated cable to an amplifier in the transmitting room. The amplifier tubes work with 440 volts on the plate, which is taken direct from the power line. The whole amplifying unit is housed in a completely closed iron plate box.

Transmitting hours are from 8 to 9 o'clock each day. Experiments are still being conducted to find the most favorable transmitting conditions. The station has been heard all over Germany and in the surrounding countries. It is significant that the majority of the German listeners-in, who wrote to the station after having picked up the music, did not care to sign their letters with either name or address. This is the best proof that there are more unlicensed sets than licensed ones and probably this will hardly change as long as the present regulations are in force.

RADIO AT THE RECENT LEIPZIG FALL FAIR, 1923

The Leipzig semi-annual merchandising fair is the most important one in Germany. At the recent Fall Fair approximately 35 manufacturers of radio sets and parts exhibited their goods. A certain improvement in the quality of material and workmanship was noticeable, although some smaller firms exhibited inferior goods.

The prices were no lower than similar American or English sets. No sales were transacted with inland buyers or jobbers on account of the prohibition of amateur radio activities. Foreign buyers were not in evidence anywhere, so the few orders which were placed were evidently given by exporters.

Spare parts were featured most. Crystal sets were abundant, some were of pocket size and neat workmanship. There was an absence of good one-tube receivers. Also, there were very few sets using reflex circuits. Sets with regeneration were also very scarce, as patents for Germany are held by one concern and no licenses are issued to other manufacturing concerns.

Most firms showed four-tube receivers; these were mostly one radio, detector, and two stages of audio frequency amplification. Several manufacturers showed radio play-boxes consisting of all single parts necessary for quite a number of different circuits, which can be hooked up at will and experimented with. The price for these, however, was very high. Several loud speakers were shown, but the general result was not satisfying with regard to their clear tone qualities.

Considerable attention among experts was attracted by a four-tube receiving set using honeycomb coils for tuning. According to rather vague descriptions offered by the manufacturers and in the press, the principle embodied in this apparatus seems to be very similar to the Neutrodyne circuit invented and perfected by Professor Hazeltine. It is stated that no regeneration is used in the set and that any self-oscillations are suppressed.

How and where does the German amateur buy his radio sets? Looks like an innocent question, doesn't it?

GUNN SECTIONAL RADIO CABINET

Radio Equipment Concealed and Free from Dust when Compartments are closed.

The upper section for Radio Machine is 12 $\frac{3}{4}$ in. high inside. The drop lid with framed-in panel provides a convenient table and arm rest when open.

Center book section is 9 $\frac{1}{4}$ in. high and Battery section is 11 $\frac{1}{4}$ in. high inside.

Outside length 34 $\frac{1}{4}$ in., height 48 in.

Inside length 32 $\frac{1}{2}$ in., depth 10 $\frac{1}{4}$ in.

Made in Quartered Oak, Birch Mahogany and Genuine Mahogany.
Dealers Everywhere...If unable to locate the Gunn Dealer in your town, write us.

THE GUNN FURNITURE COMPANY, - GRAND RAPIDS, MICHIGAN
BRANCH OFFICES: 11 E. 36th St., New York - 312 W. 10th St., Los Angeles

ROSE RADIO SUPPLY

Complete Stock—Both Sets and Parts—
All Makes

129 Camp Street New Orleans, La.
Send 10c for latest catalog

Use **INDIVIDUAL** Call Cards and Radiograms with **YOUR OWN** Name, Address and Station

ARRL Emblem Added if Requested
MONEY REFUNDED if Not Satisfied

Cards: Red call, black printing.
High quality. 100—\$1.75; 200—\$2.75;
300—\$3.60, postpaid. Gov. post cards 1 cent extra per card.
Radiograms? Same prices.

Write for **INDIVIDUAL** Radio Stationery and log samples and prices
Send order with check or money order **Today - NOW.**
RADIO PRINTERS, Dept. 25 Mendota, Illinois



RADIO AT NEW YORK PRICES

Via Daily Parcel Post

The Prices Quoted Below Deliver Goods to Your Door

REFERENCES:

R. G. Duns, Bradstreet, Corn Exchange Bank, N. Y. City. No salvaged goods handled. Only standard brands in original packing, which bears our and the manufacturers' guarantee. Due to our tremendous output we can undersell any of our competitors. Send your order in today and insure prompt delivery.

HOW TO ORDER—Write your order plainly: state number, description and price of items wanted. Send Post Office or Express Money Order, personal check or bank draft.



VACUUM TUBES

Standard brand Radio Corp. tubes. Guaranteed brand new.

- 150 Detector, U.V. 200 ea. \$4.79
- 151 Amplifier, U.V. 201A ea. 4.79
- 152 1 1/2 volt W.D. 11 ea. 4.79
- 153 W.D. 12 ea. 4.79
- 154 U.V. 199 ea. 4.79
- 155 U.V. 199 Adapter for U.V. 199 tube fits any socket, ea. .50
- 156 W.D. 11 Adapter fits W.D. 11 tube and any standard socket, ea. \$0.50

AUDIO FREQUENCY TRANSFORMERS

The following transformers are guaranteed standard makes, and will produce very efficient results.

- J83 Dietzen 3 to 1 Ratio \$3.95
- J64 Dietzen 5 to 1 Ratio 3.95
- J65 Dietzen 10 to 1 Ratio 3.95
- J86 Acme Audio 3.95
- J87 Amertran 5.95
- J68 General Radio \$4.65
- J69 Modern Audio 4-1 4.65
- J216 Modern Audio 10-1 4.95

INDOOR LOOP AERIAL

J76 Can be assembled by anyone in five minutes, all wood parts, wire and binding posts included, complete while quantity lasts...79c

MOULDED BAKELITE VARIOMETER or VARIOCOUPLER

J79 Ea. \$4.65 List. \$8.00
A high grade instrument. Takes in the wave lengths from 250 meters to 800 meters. Table or Panel Mounting.

FRESHMAN VARIABLE GRID LEAK AND GRID CONDENSER

Lowest filament current increases battery life; eliminates howling; zero to 5 megohms.

J102 Freshman Variable Grid Leak alone. \$0.65
J103 Freshman Variable Grid Leak and Condenser combined. .85

FILAMENT CONTROLLED RHOESTATS

Highest grade of bakelite used, tapered knob.

- J104—6 ohm .49
- J105—30 ohm .49
- J106—200 ohm Potentiometer .79
- J107—400 ohm Potentiometer .79

HONEYCOMB COILS UNMOUNTED

Turns	Cat. No.	Price
25	J 200	\$0.40
35	J 201	.40
50	J 202	.45
75	J 203	.50
100	J 204	.55
150	J 205	.70
200	J 206	.80
250	J 207	.85
300	J 208	.95
400	J 209	1.05
500	J 210	1.15
600	J 211	1.35
750	J 212	1.50
	J 213	1.70
	J 214	1.95
	J 215	2.20

HONEYCOMB COIL MOUNTINGS

- J140 2-coil mounting. \$2.85
- J141 3-coil mounting. 3.79
- J142 Single coil mounting. .40
- J143 Receptacle for single coil mounting. .50

MISCELLANEOUS

- J163 Spaghetti Tubing per yd. \$0.09
- J164 Synthetic Crystal. .30
- J165 Ground Clamps. .17
- J166 Black Rubber Binding Posts. .05
- J167 Nickel Plated Binding Posts 2 for J168 No. 13 Annunciated Wire half pound coil. .39
- J169 6 ft. Phone Cord with tips. .79
- J170 20 ft. Extension Cord with tips. 1.95
- J171 Wall Insulators, Porcelain. .05
- J172 Tubular Porcelain lead-in Insulators. 6 In. .10
- J173 Reinartz Coil. 1.45
- J174 Cockaday Coil. 2.45
- J175 2 In. Dial and knob. .25
- J176 3 In. Dial and knob. .35
- J177 Switch Arm—tapered knob. .19

BUILD YOUR OWN SET

COCKADAY 4 CIRCUIT TUNER

Consisting of

- 1 Cockaday 4 circuit tuner and 7 pigtail connections
- 2 .0005 Variable Condensers
- 1 Socket
- 1 Panel 7x12
- 2 Dials, 3 in.
- 1 Grid Leak and Condenser
- 1 Rheostat
- 1 Switch Lever
- 1 Base Board
- 12 Ft. Bus Bar
- 7 Switch Points
- 8 Marked Binding Posts
- 1 Jack

Wiring Diagram and Instructions

J178 - - Our Price \$9.85

DIETZEN SUPER HEAD SET

J181 2200 ohms \$2.95
Reg. Price \$5 per pair.
Since we are wholesale distributors for this wonderful headset we pass this bargain on to you. The Tone quality is of unusual volume. These phones can be used as a loud speaker unit. Sold with a money back guarantee if not satisfactory.

HARD RUBBER PANELS

The highest grade panel on the market. Highly polished finish; cut in the following sizes:

- J88—7x10 .50.95
- J89—7x12 1.15
- J90—7x14 1.25
- J91—7x18 1.65
- J92—7x21 1.95
- J93—7x24 2.20

FISHER WOODEN VARIOMETERS

J97 Price \$3.45
A real high grade job at extremely low price. Takes in all wave lengths.

AMPLITONE LOUD SPEAKERS

Make a loud speaker of your headphone. This speaker will give efficient results when used with any pair of headphones; highly nickel plated; 18 inches high.

J117\$3.95

MAGNET WIRE (8 oz.)

Double Cotton Covered	Price	Green Silk	Price
J144 18	\$0.43	J145 18	\$0.73
J146 20	.53	J147 20	.85
J148 22	.68	J149 22	1.00
J150 24	.78	J151 24	1.13
J152 26	.88	J153 26	1.25
J154 28	1.07	J155 28	1.95
J156 30	1.58	J157 30	2.65

REINARTZ CIRCUIT COMPLETE

Consisting of

- 1 Reinartz Coil and 16 pigtail connections
- 2 3 in. Dials
- 2 .0005 Variable Condenser
- 1 Socket
- 1 Vernier Rheostat
- 3 Switch Levers
- 1 7x12 Panel
- 1 Base Board
- 8 Marked Binding Posts
- 12 Ft. Bus Bar
- 1 Grid Condenser
- 2 doz. Switch Points and stops

Wiring Diagram and Instructions

J-179 - - Our Price \$10.85

DOUBLE PHONOGRAPH ATTACHMENT

This attachment fits all phonographs; will take any headset. It converts your phonograph into a loud speaker.

- J132 Double attachment. \$0.85
- J180 Single attachment fits any single phone unit to be used on phonograph. .49

WAVE TRAP

Simplifies tuning. Eliminates interfering stations, thereby improving the selectivity of your set. Selects between conflicting stations. Special white quantity lasts.

J95 Each. \$4.95

BAKELITE TUBE SOCKETS

Moulded of brown bakelite: Binding Post Connections.

- J99 Standard Type for 201A
- 301A W.D. 12 .49c
- J100 For U.V. 199. U.V. 299 Socket .49c
- J101 For W.D. 11, C11 49c

RADIO SOLDERING IRON

Indispensable for the man who builds his own sets.

J109 1.95

VARIABLE AIR CONDENSERS

These condensers are made of heavy aluminum plates, high grade bakelite ends.

- J110—21 Plate .0005 Mfd. \$1.75
- J111—11 Plate .00025 Mfd. 1.25
- J112—3 Plate .00005 Mfd. .90.95
- J113—43 Plate .001 Mfd. 2.25

VERNIER VARIABLE CONDENSERS

Specifications the same as above.

- J114—14 Plate Vernier with knob and dial. \$2.95
- J115—26 Plate Vernier with knob and dial. 3.45
- J116—43 Plate Vernier with knob and dial. 3.95

RADIO CABINETS

Highest grade Mahogany piano finish Cabinets. Hinged top. These cabinets are being sold at less than one-half regular value.

- J157 Cabinet; panel size 7"x10". Ea. \$2.95
- J58 Cabinet; panel size 7"x12". Ea. 3.45
- J59 Cabinet; panel size 7"x14". Ea. 3.95
- J60 Cabinet; panel size 7"x18". Ea. 4.45
- J61 Cabinet; panel size 7"x21". Ea. 4.95
- J62 Cabinet; panel size 7"x24". Ea. 5.75
- J127—7"x26" 6.50

RADIO FREQUENCY TRANSFORMERS

- J70 Tri-coil for 201A or 301A tubes \$1.95
- J71 For 199, 299 or W.D. 11 and 12 tubes. 1.95
- J72 Erla AB1 3.75
- J73 Erla AB2 3.75
- J74 Erla AB3 3.75
- J75 Erla Reflex 4.65
- J218 Rasla Reflex 3.95

VARIOCOUPLER

J77 High Grade 180 Degree Coupler made of Bakelite tubing woven with green silk wire. Special \$2.45
J78 Variometer same specifications 2.45

PLATE CIRCUIT "B" BATTERIES

The highest grade of battery made at prices lower than they ever were sold before.

- J80—22 1/2 Volt Small \$1.15
- J81—22 1/2 Volt Medium 1.45
- J82—22 1/2 Volt Large 1.95
- J83—45 Volt Medium 1.95
- J84—45 Volt Large 2.50
- J85—45 Volt Extra Large 3.50
- J86—860 hr. 1 1/2 Volt twin double duty "A" Battery. .75

JACKS AND PLUGS

Jacks are polished nickel constructed with pure silver contacts.

- J118 One Spring open circuit. \$0.39
- J119 Two Spring closed circuit. .49
- J120 Round plug as illustrated. .49

AERIAL WIRE

- J121 100 ft. solid copperweld wire coil \$4.49
- J122 7 strand 100 ft. .69
- Ground Wire Rubber Covered No. 14
- J123 25 ft. coil. \$4.49
- J124 50 ft. coil. 85

INSULATORS

These are very strong strain type Insulators.

- J158 Moulded Insulator shown Ea. \$0.10 \$1.20 above

LOUD SPEAKERS

- J125—Dictogrand Loud Speaker. Reproduces the voice naturally. Formerly \$28.50. Now \$19.95.
- J126 Magnarox new type M1. \$28.50
- J127 Music Master 27.50
- J128 Brandes Table Talker 8.95
- J129 Magnarox R. 3 28.50
- J130 Dietzen Speaker 28.50
- J131 Adjustable Phonograph Unit. 3.95

The above prices delivered to your door.

Modell's 71 Cortlandt St.
New York, N. Y.

America's Greatest Radio Mail Order House
ELEVEN NEW YORK STORES

Send 10c for our big catalog containing hundreds of Radio bargains. We will send FREE with every catalog, a 62-page book the A B C of Radio, written in clear simple terms, by a nationally known radio expert.

We Thank You, Mr. Cockaday, For This Compliment!!

HOW TO BUILD AN AMATEUR TRANSMITTER

*By Laurence M. Cockaday, R.E.

Cost of Parts: About \$150. Transmitting Range: About 25 Miles
HERE ARE THE ITEMS YOU WILL NEED—

- A—inductance coil (see Figure 5);
- B—antenna fixed condenser, .0015 mfd. (Any standard make of high-voltage mica condenser can be used in place of the home-made one);
- C—grid condenser, .0008 mfd. (Not critical, a .0005 mfd. can be used);
- D—Ward Leonard resistance, 7,000 ohms;
- E and F—filament rheostats (resistance values to suit tubes used);
- G—honeycomb coil, size L200, used as a radio-frequency choke;
- H and I—vacuum tubes, either VT-2 tubes or UV-202 tubes can be used;
- J—Acme double-coil iron-core choke, 1½ henries, 150 - milliamperes carrying capacity;
- K—Federal paper condenser, No. 58-B, 2 mfd.;
- L—General Radio hot-wire ammeter, scale reading from 0 to 2.5 amperes (for mounting on front of panel);
- M—Century buzzer (H-F);
- N—single-circuit jack (well-insulated type);
- O—single-turn modulating loop wrapped tightly around inductance coil A;
- P—composition panel; two switch levers; eight binding posts; twenty switch points and four switch stops;
- Q—cabinet;
- R—Esco 350-volt motor generator;
- S—DPDT starting switch, 25-ampere carrying capacity;
- T—connection wire, solder, etc.

TRADE "ESCO" MARK

FOR QUALITY

ELECTRIC SPECIALTY CO.

211 SOUTH STREET, STAMFORD, CONN., U. S. A.

PIONEERS IN DEVELOPING HIGH VOLTAGE WIRELESS APPARATUS

*Reprint by permission of "Popular Radio"—March, 1924, Issue.

BRISTOL SINGLE CONTROL RADIO RECEIVER

MOST SIMPLE TO OPERATE

The set for those who want results with little effort. Anyone in the family can quickly learn to operate it because technicalities and guesswork are eliminated—One Control Dial does it all.

DOES NOT INTERFERE WITH YOUR NEIGHBOR
Other close by reception is not disturbed when you tune in with this non-radiating Receiving Set. It gives you a comfortable sensation of freedom to be able to change from one station to another knowing that you will not interfere with your neighbor's receiving.

CHOICE OF AERIAL OR LOOP

Where conditions make it difficult to install an outside aerial, as in congested sections of cities, good results

can usually be had by using inside Loop. In fact, the directional feature of the Loop often brings in stations not possible with a stationary aerial.

Mounted in solid mahogany case with walnut finish, the Bristol Single Control Radio Receiver is handsome in appearance. The price is \$190.00. Bulletin 3013-S describing this set will be mailed on request.

BRISTOL AUDIOPHONE LOUD SPEAKER

This is known everywhere as the Loud Speaker with the quality tone. Not only is the tone natural and without mechanical distortion, but is sufficiently big in volume to be easily heard in a large room or all through the house. Comes to you

ready to use—no auxiliary batteries are required.

Made in three models:
Audiophone Senior...Price \$32.50
Audiophone Junior...Price 22.50
Baby Audiophone...Price 12.50

The Bristol Company, Waterbury, Conn.



The amateur who has applied for a receiving license and who has been lucky enough to pass all the bureaucratic license issuing formalities finally gets his license, and may then buy a set. The manufacturers and dealers are not allowed to sell any sets unless the purchaser shows a license.

The slow inauguration of broadcasting in Germany has naturally prevented any dealers from taking the risk of opening stores exclusively for radio. The turnover would be so slow and the overhead so large that profits would be quite out of the question at the present.

The few electrical dealers who were retailing radio goods before the new law was passed were handling former army sets which they had bought up after the armistice in 1918. As a rule the sets were taken apart and the single parts sold, although this was clearly against the law.

When broadcasting was officially started, the three large trust firms, Telefunken, Huth and Lorenz, formed a joint selling organization with salesrooms under the name of "Rundfunk G. M. B. H." They are thus their own jobbers, wholesalers and retailers, surely an ingenious scheme for cutting costs. Whether this is very advantageous for the buyer or the development of broadcasting, however, is quite another matter.

For about two weeks radio sets have been on show in some stores in Berlin. These are for the most part luxury shops, selling expensive gifts, and patronized only by very wealthy buyers. Music stores, handle radio sets much the same as phonographs; optical stores handle radio as a side line to field glasses, cameras and moving picture machines.

In some of the stores, small stocks have been put in and exhibits made in the windows. In several others only signs appear stating that orders will be taken for samples on show.

It is, therefore, more the rule than the exception that the amateur buys his sets directly from the manufacturers. Far from trying to prevent this and establish a regular retail business, the manufacturers, in extraordinary shortsightedness, are even encouraging this policy.

CAN AMERICAN RADIO SETS BE SOLD IN GERMANY?

Can American radio sets be sold in Germany? This question can not be answered by a plain "Yes" or "No." Before anybody unfamiliar with the peculiar situation in Germany can understand it, it is first necessary to go into some details about the Foreign Trade Control Boards.

In January, 1919, the Dollar in Berlin was being quoted at an average of 8 Marks (In 1914, 4.20). In November, 1923, the Dollar was being quoted at 630 billions of Marks in Berlin. Naturally this whole depreciation has taken place gradually.

In 1919 and 1920 the German manufacturers who were taking up production after the five-year war interruption found that the currency depreciation was selling their goods for them. German goods were so cheap that they flooded quite a number of markets and in many instances the result was heavy "dumping". This was possible only on account of the lower production costs, the lower wages, raw material and prices.

In order to prevent dumping, the German Government, early in 1920, created the "Foreign Trade Control Boards". These official organizations constituted a tremendous and bureaucratic control organization for all imports and exports. They protected all competitive German industries better than any high tariff could have protected them.

In 1923, German production costs in spite of currency depreciation became so great that any control of exports was absolutely superfluous and only increased the cost of the goods, which were already approaching the world price level. The whole export con-

Rider Agents Wanted

Select from 44 Styles, colors and sizes of Ranger Bicycles. Ride and exhibit sample Ranger and make money. Delivered free, express prepaid, on Approval. \$5 a Month on any Ranger if desired. Write today for our marvelous prices and Easy Payment terms. Tires, lamps, horns, wheels, parts, equipment, and repairs at half usual price. Bicycles from \$21.50 up.



Mead CYCLE COMPANY Write us today for free catalog
DEPT. 118 CHICAGO

"I Earn \$50 to \$83 Weekly!"
At work nicer than movies!
\$5 to \$10 made daily while taking
Lowest-cost, Simple-to-learn, Fun-giving, Personal Radio Instruction.
First 4 jobs pay instruction cost. Be an expert by MARVELOUS NEW METHOD.
Pay by installment. Write for details

JAMES A. DOWIE, R.E.
E-544 RADIO, VA.

PULLING POWER

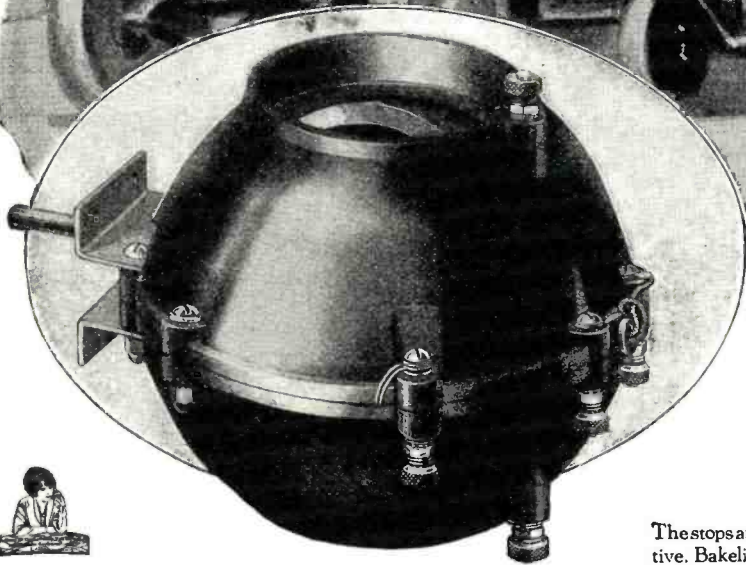

Heavy Bakelite shells of rich brown color. Windings of correct guage wire and properly proportioned for best reception. Large bearings assure smooth operation and long life. No sliding contacts; rotor connections made with special flexible wires, through hollow shaft to binding posts on stator shell.

The stops are a part of the stator and rotor and are positive. Bakelite especially treated to prevent distributed capacity. Arranged for either panel or base mounting.

VOLUME!

THE variometer or variocoupler is responsible for the strength of the signals received. Therefore, the size, shape, gauge of wire and number of turns in the Kellogg variometers and variocouplers are the result of exhaustive tests for equipment that will give the best radio reception.

Therefore, it is to your advantage to demand Kellogg variometers and variocouplers and know that you will receive better reception, resulting in maximum entertainment, and value from your radio set.

If your dealer does not handle Kellogg, communicate direct with us.

KELLOGG SWITCHBOARD & SUPPLY CO.

1066 West Adams Street, Chicago

Is Your Set Stable? Or Does It Howl?



C R L POTENTIOMETERS
 No. 110 (400 ohms)\$1.75
 No. 111 (2000 ohms)\$2.00
 By Parcel Post, 10c. extra.

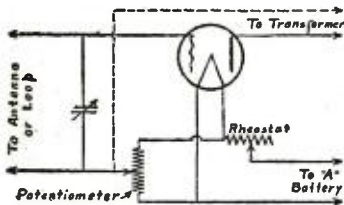

Diagram of radio frequency amplifying stage showing use of C R L Non-Inductive Potentiometer.

If it does, you need a C R L Non-Inductive Potentiometer to bias the grids of your radio frequency amplifiers.

Just shunt the potentiometer across your "A" Battery as shown in the accompanying diagram, and then connect the grid return for the first radio stage to the sliding contact (middle binding post). For additional radio stages the return from the secondaries of the transformers would be connected as shown by the dotted line.

Adjust the grid potential to a point just preceding oscillation by turning the control knob of the potentiometer. You will find the set stable and most sensitive at that point.

No by-pass condenser is needed for this potentiometer because it is absolutely non-inductive and does not choke back the delicate, high frequency currents.

Ask for a C R L at your dealer's

Central Radio Laboratories
 305 16th St., Milwaukee, Wis.

C R L NON-INDUCTIVE POTENTIOMETER



MARKO "A" BATTERY

90 and 120 AMP. HRS.

IN RUBBERLITH CASE
Ornamental As Well As Efficient

The Rubberlith case is a composition case with a high gloss giving the appearance of ebony. It is moulded in one piece, including handles and cells—no jars to break—and is practically indestructible. A worthy addition to your set.

All sizes, from 2 volt Batteries up, carried in Mahogany Finish Cases.

DISTRIBUTED BY

- MARKO STORAGE BATTERY CO., 210 West 54th St., New York, N. Y.
- MARKO STORAGE BATTERY CO., 102 Jefferson Ave., Brooklyn, N. Y.
- RADIO DISTRIBUTING CORP., 8 W. Park St., Newark, N. J.
- NATIONAL LIGHT & ELEC. CO., 289 Market St., Newark, N. J.
- SCHIMMEL ELECTRIC SUPPLY CO., 526 Arch St., Philadelphia, Pa.
- CONSOLIDATED WIRE & ASSOCIATED CORPORATIONS, Green and Congress Sts., Chicago, Ill.
- THE VERMONT RADIO CO., Richford, Vt.
- WEINIG-URBAN ELEC. CO., INC., 66 Allen St., Buffalo, N. Y.

Sold by Radio Supply Stores and all Marko Service Stations

MADE BY
MARKO STORAGE BATTERY CO.
 1402 ATLANTIC AVENUE, BROOKLYN, N. Y.

control system was, therefore, lifted in September, 1923, except for some raw materials and foodstuffs, because the danger of dumping was past.

However, all import prohibitions remain. All imports of manufactured goods into Germany are still subject to control. For radio goods, the import licenses, without which no goods can pass the customs in the port of entry, are issued by the "Foreign Trade Control Board for Electrical Goods".

The policy of this Control Board has been to prevent imports of any electrical goods which are already being manufactured in Germany or which could be made in Germany. This rule naturally bars all foreign goods, for the present time from being imported. It is, therefore, really not a matter of price or salesmanship or selling policy or quality, it is at present absolutely impossible to enter goods.

However, the movement for the complete abolition of this last power of the Foreign Trade Control Board is growing, and it seems as if the day is not far distant when they will be completely abolished. All preparations for the abolition of the board are being made in great secrecy and little is allowed to leak out about the proposed new rates or the probable date of the abolition of the control board. Rumors, which cannot be controlled and which may be erroneous, state that the new law will be passed early in 1924.

In many industries, as for example the automotive and tractor, as well as some textile, the prices of German goods are considerably higher than the prices which would have to be paid for similar American goods. It is the opinion of some of the leaders in the trade that even an unprecedented high tariff would not prevent goods from being imported into Germany. Naturally the present buying power of the population is another very important factor which would greatly influence possible sales.

The average buyer in Germany does not yet realize that he can get the same and better goods at lower prices, or else the whole abolition of the foreign trade control boards would be a much more rapid one. As soon as this truth is brought home, he will be a good prospect for imported goods. The automotive industry may be quoted as an example here. There are quite a number of prospects for American cars in Germany, but the import prohibitions cut them out. The recent heavy invasion of American cars into the occupied territory is the best proof for this statement, because the power of the foreign trade control boards was naturally crippled by the French invasion. There will be a market for American radio goods in Germany as soon as import control is abolished.

GERMANY'S EXPORT TRADE IN RADIO GOODS IN AUGUST, 1923

The following table has been compiled from official export statistics published every month in the "Monthly Survey of Germany's Foreign Trade" prepared in the Federal Statistical Office in Berlin.

For comparison, the export figures for August, 1922, are given in the second column. The third and fourth columns show the total shipments in the eight months from January to August inclusive in 1923 and 1922 respectively:

EXPORTS OF RADIO SETS AND PARTS FROM GERMANY

Country of Destination	August		Jan.-Aug.	
	1923	1922	1923	1922
Netherlands	2.6	0.8	40.0	55.3
Czecho Slovakia....	1.1	6.9	10.6	15.1
Spain	0.2	..	19.6	8.5
Dutch Indies.....	0.1	..	5.6	6.7
Argentina	30.4	..	113.0	25.3
United States.....	1.0	2.0	12.7	15.9
Other Countries ...	21.0	14.4	183.0	50.8
Total	56.4	24.1	384.5	177.6

In 1922, Germany's chief market for radio

VIA PARCEL POST 10% OFF RADIO

Personal attention given all orders. No matter what you want we will ship it to you. No catalog or expensive literature. Simply state what you want, giving full description to avoid errors. Remit list price.

Less 10% and your order will be promptly filled. Add Shipping Charges

NORDEN, HAUCK & CO.

"Purchasing Agents DeLuxe"

25 S. Ashmead Place Germantown, Phila., Pa.

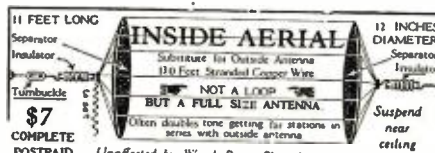

INTER-STATE SIGNAL(A), COLUMBUS, OHIO

Announcing The **WORKRITE** Neutro-Grand



Five-Tube Neutrodyne Receiver
Coast-to-coast on a built-in Loud Speaker.
Send for catalog and complete information.

*(Licensed under Hazeltine Patent
No. 1450080)*

THE WORKRITE MANUFACTURING CO.
1829 E. 30th ST. :: :: :: :: CLEVELAND, OHIO
(Branch Office, 536 Lake Shore Dr., Chicago)

FROST-RADIO

A tremendously popular item



THE most popular and certainly one of the fastest-selling metal frame rheostats on the market today is this **FROST-RADIO** Metal-Frame Vernier Rheostat. Popular because made exactly right. Fast selling because priced at 75c. Has nickel plated metal parts, black polished BAKELITE fluted knob, and best grade resistance wire. 6 or 35 ohms.

Also furnished in plain type

Without vernier, in either 6 or 35 ohm type, this rheostat lists at 60c. Also supplied as 400 ohm potentiometer at same price. Superbly constructed.

No. 601-75c
FROST-RADIO

Write for 40 page catalog

Your dealer can supply you with **FROST-RADIO**. See him today about these rheostats or other items in the **FROST-RADIO** line. Forty page catalog of all items free on request.

Address Dept. 10F132.



A post card from you will bring this 40-page catalog

HERBERT H. FROST, Inc.
154 WEST LAKE STREET, CHICAGO, ILLINOIS.
NEW YORK CITY KANSAS CITY, MO.

goods was the Netherlands. It can be safely assumed that only a very small part remained there and that the largest part was re-exported. However, in 1923, Argentine became the chief buyer, taking about 27 per cent. in the first eight months and an even 54 per cent. in August, 1923. This seems to indicate that since German prices on a gold basis are quickly approaching or passing the world market prices, a change in policy was necessary for the manufacturers in radio goods. They were obliged to reach the far-away markets, since Dutch re-exporters no longer found a large profit in the sale of German goods.

Exports to the United States, the Netherlands and Czecho Slovakia decreased. They have increased to Spain and to Argentine. Total exports in the first eight months of 1923 were more than twice as large as in the same period of 1922. This is particularly interesting, as the total export figures for all electric goods show an increase of only 1.6 per cent. in the same time. This proves that the radio industry is not affected as badly by the present slump as the majority of manufacturers of electric material.

The Vacuum Tube and How It Works

(Continued from page 1584)

the action of the triode the fundamental law of electric charges must be remembered: *Negative* electricity is repelled by a *negatively* charged body and is *attracted* by one which is *positively* charged. The general arrangement of a triode is shown in Fig. 7; the grid is here shown as a zigzag piece of wire, which was the form originally used by De Forest. An electron *a*, having evaporated from the filament is attracted by the plate, which is maintained at a positive potential by the battery *B*. The electron, however, in getting to the plate must pass between the grid wires, and these grid wires may be charged either positively or nega-

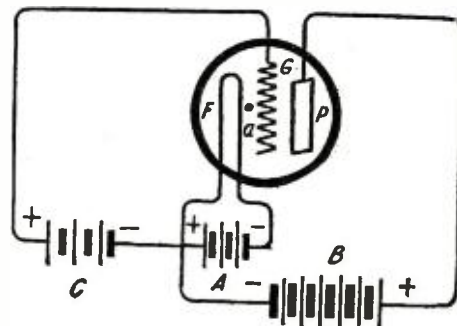
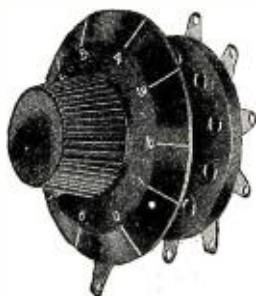

Fig. 7

De Forest conceived the idea of putting a grid between the plate and filament of a Fleming valve and thus produced the Audion or Triode.

tively by the battery *C*. If the grid is charged positively the electrons are attracted and therefore helped on their way over to the plate, but a few of them will go to the grid itself on their way through the spaces of the grid. Thus, making the grid increasingly positive gives greater and greater flow of electrons over to the plate. This increase in plate current with increasing grid voltage, will continue as long as there are plenty of electrons evaporating from the filament. After a certain positive grid potential is reached, however, all the electrons being evaporated are drawn over to the plate or grid, and so no further increase in grid voltage can increase the plate current. This amount of plate current is said to be *saturation current* for the tube; evidently the

It's Good Contacts That Count



\$1.25

Poor contacts reduce the efficiency of any set. That's why the Walnut Inductance Switch has proven so popular. **CONTACTS ARE POSITIVE.** One to ten points. Solder terminal and contacts one piece. Only one hole to drill. Solder connections first and then mount. A simple and neat job. Numbered Bakelite dial shows position of contact at all times.

Write for illustrated folder

Complete line of Walnut Quality Radio Products

WALNART ELECTRIC MFG. CO.

Dept. 609, 1249 West Van Buren St., Chicago

In Canada:

Wright Radio Company, Overbrook, Ottawa, Ontario
Pirt & Pirt, Regina, Sask.

The base of this instrument is Continental Bakelite Dielectoxx (licensed under Bakelite patents). Known for its high efficiency as a dielectric insulation.

GREWOL The Fixed-Reflex DETECTOR

At your dealer's or direct \$2

Randel Wireless Co.
11 Central Ave., Newark, N. J.



ELGIN SUPER-REINARTZ

The Set Which Copied

2LO LONDON, ENGLAND

ON ONE TUBE

Send Stamp for Descriptive Circular.

ELGIN RADIO SUPPLY CO.

207 E. Chicago Street,

Elgin, Ill.

TIPS!

FOR THE Radio Amateur Constructor

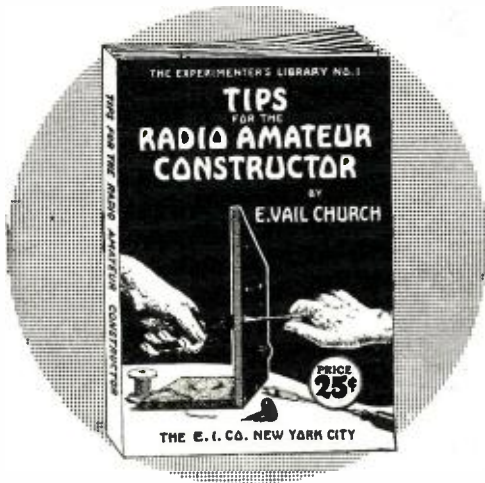

The Latest Book of the Experimenters' Library: It gives everyone the inside tricks on constructing his own Radio Set. It combines the experience of an Expert Set Builder. It is of value to everybody. One chapter is devoted exclusively to the fine points of drilling the Radio Panel and Cabinet. Another to the Mounting of the Instruments and so on till every detail of Radio Set Construction is covered. This Book is now in Circulation. Ask your dealer for a copy.

PRICE 25c

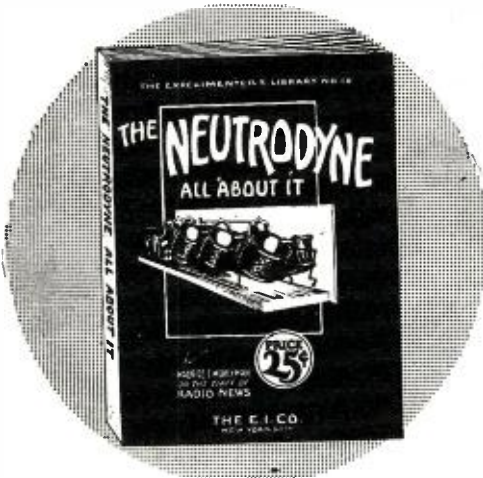

THE NEUTRODYNE ALL ABOUT IT

Twenty-one Chapters on the Neutrodyne are covered in this neat, handy book. Anyone interested in the Neutrodyne Set and how it works should have a copy. It is complete to the smallest detail—such as "Locating Trouble," "Adding Regeneration," "Drilling the Panel" etc. The book covers only the up-to-the-minute data. It is an advance in Radio Literature. Get a copy now.

PRICE 25c

Other Books in the
EXPERIMENTERS LIBRARY

→
PRICE 25 CENTS EACH.



AT ALL RELIABLE DEALERS

THE E. I. COMPANY
233 FULTON STREET

(The Consrad Company, Selling Agents)
NEW YORK CITY

HALLDORSON



4-Tube Sets
as low as
\$65.00

Radio Receivers

Beauty of design—clear and undistorted reception at long as well as close range—ease of control and selectivity—plus low price with the highest quality—has made the HALLDORSON RECEIVER the most popular set for the home. Beginners will appreciate the compact simplicity which enables them to secure maximum results. Write for our Descriptive Folder today.

Dealers and Jobbers:
Write immediately
for our attractive
proposition.

The HALLDORSON COMPANY

1772 Wilson Avenue

CHICAGO

The B-D Electric Soldering Outfit

\$2.00 RETAIL



Not an ordinary soldering iron but a complete soldering outfit. Besides the advantages of the Spring Handle, the thin construction of the B-D Electric Soldering Iron makes it particularly adaptable for work in narrow spaces and is therefore the only soldering iron suitable for radio and telephone switchboard work.

Made entirely of copper from accurate dies. The heating element is contained in a unit of one-piece construction, eliminating loose tips.

Nichrome wire is used in the element. It is wound on, and insulated with high grade mica. Two-piece plug used. Auxiliary tip may be clamped on any part of the heating element, to secure any angle or penetrate any small space for soldering.



Used by Housewife



For Wire Connections



For Radio



For Automobile

GUARANTEE

The workmanship and heating element of the B-D Electric Soldering Iron is fully guaranteed for a period of one year.

Manufacturers

BLEADON-DUN CO.

Dept. B.D. 5

213 S. Peoria Street

Chicago

value of this saturation current will depend entirely upon the temperature of the filament, that is, upon the filament current.

Now, if the grid is made negative the electrons can get to the plate only by passing through this *negatively* charged grid and this negative grid *repels* the electrons. What will the electrons do? Many of them will be hurled back into the filament from which they have just evaporated and some will sneak through, keeping as far away from the negative wires as possible. Once through they will travel over to the plate with even greater velocity than they would have if the grid were not there. For once they have passed through the grid, and so enter into the space between the grid and plate, they are not only attracted towards the plate by its positive potential but are also pushed towards the plate by the negative grid behind them.

One must imagine then, the tremendous crowd of electrons having evaporated from the hot filament, pausing on their way over to the plate because of the repelling influence of this negative grid; some of them, being near the center of the holes in the grid, and perhaps being pushed by some of their companions from behind, do dash through and reach their goal, the positively charged plate, but many of them, apparently less daring or fortunate, cannot run the gauntlet and so fall back into the filament. The more negative the grid the more formidable an obstacle it becomes to the electrons endeavoring to

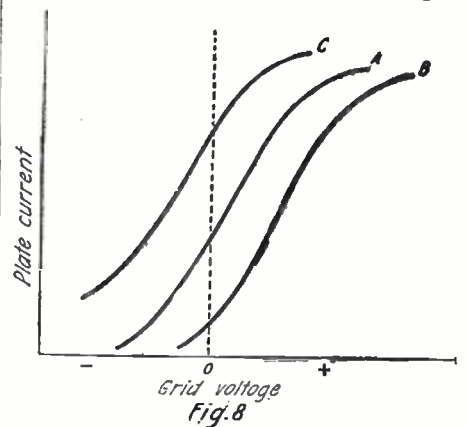

If the plate voltage of a triode is held constant and the grid voltage varied, both positively and negatively, the plate current will vary about as shown here, the three curves being for different plate voltages.

get to the plate, and in the ordinary tube used in radio receiving sets it takes only a few volts negative on the grid to stop practically all electron flow to the plate.

One may also imagine the grid as a lattice shutter, such as were used on house windows a few years ago, or such as are sometimes used in front of the radiator of an automobile. A positive grid corresponds to a wide open shutter that lets all the electrons through, and as the grid becomes more negative we must imagine the shutter more and more tightly closed.

If the plate voltage (determined by the "B" battery of Fig. 7) is held constant and the voltage of the "C" battery is changed in gradual steps, both positive and negative, the variation of plate current with grid voltage will be as shown in Fig. 8, curve A. With increasing grid potential the plate current continually increases until saturation current is obtained, and then further increase in grid potential can produce no further increase in plate current. If the same changes in grid voltage are carried but with a lower voltage in the "B" battery, curve B of Fig. 7 is obtained, and, if for greater than normal "B" battery, curve C is obtained. With the ordinary detector tube curve A might be obtained with a 20-volt "B" battery, B with a 10-volt battery and C with a 30-volt battery.

We now see that the grid voltage of the triode can control the plate current in the

Parts and Accessories
for makers of radio apparatus



Details and Prices on request
GENERAL RADIO CORPORATION
Mfrs. & Distributors of
First Quality Radio Equipment
including **MUSIC MASTER RADIO Reproducer**
10th and Cherry Streets Philadelphia

BECOME A PROFESSIONAL PHOTOGRAPHER



EARNING \$35 TO \$125 A WEEK
Three to six months' course
Motion Picture, Commercial,
Portraiture. Practical instruction.
Day or Evening Classes.
Ask for Catalog No. 56.
N. Y. INSTITUTE OF PHOTOGRAPHY
NEW YORK CHICAGO BROOKLYN
141 W. 36th St. 630 S. Wabash Ave. 505 State St.

**Just off
the Press**

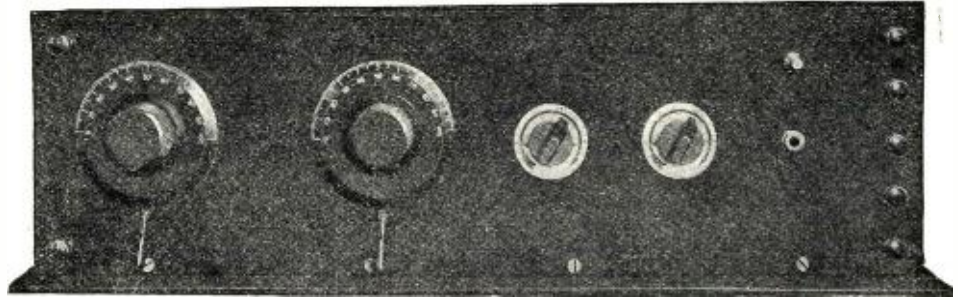

HOW TO MAKE THE ULTRADYNE

This receiver is the last word in improved Super-heterodynes. It employs six tubes and is, without doubt, the most sensitive circuit in existence at the present time. It employs what has been called the "Modulation system" of rectification in place of the usual "frequency change" of the received radio currents as in the standard Super-heterodyne.

The description of this Pattern is written by R. E. Lacault, who devised the Ultradyne; thus, the constructor can feel assured that he is following authentic data.

Complete instructions given in a Four-Page Pamphlet, one large Blue-Print Pattern showing Perspective Wiring Diagram, Coil Winding Forms, Full Size Panel Layout and details for building a cabinet. Contained in a heavy two-color printed envelope. Size 9 x 12 inches. **PRICE 50c**

The description of this Pattern is written



"CONSRAD" Make Your Own Patterns

No.

- 1 How to Make a Short Wave Regenerative Receiver.
- 2 How to Make a Two Stage Amplifier.
- 3 How to Make a Radiophone Crystal Set.
- 4 How to Make a Reinartz Receiver.
- 5 How to Make a Reflex Receiver.
- 6 How to Make a Cockaday Receiver.
- 7 How to Make a Neutrodyne Receiver.
- 8 How to Make an Autoplex Receiver.
- 9 How to Make the ST 100 Receiver.

Packet B 20 Radiophone Diagrams with Supplements.

Packet C 14 Radio Formulas and Diagrams.

Packet D All About Aerials and Their Construction.

Packet E Radio Amateur's Practical Design Data.

PRICE 50c EACH

Pattern No. 9 The S. T. 100 Receiver

The S. T. 100 receiver employing a circuit devised by John Scott-Taggart, of London, is one of the most efficient sets of reflex variety.

While only two tubes, a crystal detector are used, the energy amplified of incoming signals is powerful enough to operate all loud speakers without additional amplification.

Another important feature is that the set tunes sharply, which is one of the utmost requisites of an ideal receiver.

The packet consists of blue prints for drilling the panel, wiring the apparatus, and a four-page instruction pamphlet giving complete details as to the parts required, tools needed, and even how to tune.

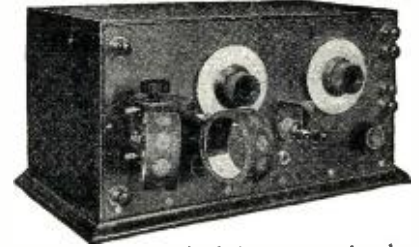

All these are contained in a two-color heavy manila envelope, 9 1/2 x 12".

PRICE 50c

Broadcast Stations Made Easy to Locate

The Consrad Radio Map is different from all other maps in that it is printed on CLOTH. With proper care will last a lifetime.

The Map measures 17 x 22" and contains a special distance computing gauge of our own design which enables one to determine the distance in miles between any broadcast station and his receiving set at a glance.

Another special feature of this map is a novel Finder device for locating a broadcast station in quick time.

A complete list of broadcast stations are given on a separate sheet which can be fastened to the map by ordinary paper fasteners.

The map furnished in two colors with the sheet of broadcast stations, enclosed in a two-color heavy manila envelope 9 1/2 x 12 inches.

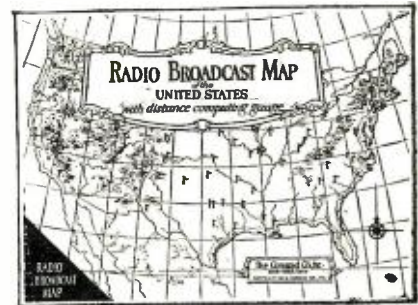

PRICE 50c

THE RADIO READING COURSE

Here is Your Chance to Learn All You Can About RADIO
The \$10.00 "Radio Reading Course"

All the technical details and a thorough explanation of radio reception, written in easily understood, non-technical language by a foremost radio engineer and inventor. The five Lecture Books with over 100 graphic drawings give you the knowledge to intelligently buy, design, build, operate

and maintain radio receiving apparatus. This set of five handsome Lecture Books are a complete radio library.

SPECIAL AT \$1.25

THE CONSRAD COMPANY

Publishers and Sales Agents

233 Fulton Street

New York City



CONTINENTAL

"New York's Leading Radio House"

Radiola III and Amplifier



Radiola III, an improved two tube receiver of antenna type, sensitive and selective. Complete with two WD-11 Radiotrons and headphones (everything except batteries and antenna). Set the pace for the radio public and order your stock now.

Radiola III Amplifier. Two tube balanced amplifier for Radiola III, including two Radiotrons WD-11. Sell nationally advertised radio sets.



2970-Q

CONTINENTAL RADIO and ELECTRIC CORPORATION
FIFTEEN WARREN STREET, NEW YORK, U. S. A.

SEND NO MONEY

for Goods—Just Pay Postman on Delivery—Satisfaction Guaranteed

Largest radio stock in New York. Everything guaranteed brand new and first class. Price includes delivery to your door. Orders shipped quickly and with care. You can get it from us for less because we buy in large quantities, pay spot cash, sell for cash and have no losses. Our business is radio only. Reference—Corn Exchange Bank, Terminal Branch.

Order Direct from this Advertisement—TO-DAY

\$7.00 Coupler. Genuine Capitol "All-Wave," 150-3,000 meters, space and money saver...\$5.45

\$15.00 Loud Speaker. Adjustable, Perfectone. Just what its name indicates...\$11.45

\$3.45 Loud Speaker Unit. Blue streak, single, with cord, use with any horn, extra good at...\$2.45

\$4.00 Head Set. Little Tatler, none ever returned as unsatisfactory, big bargain at...\$2.95

\$12.00 Head Set. Celebrated Baldwin, Type C, double, none better made, cheap at...\$8.45

Send 10c for
**BARGAIN
RADIO
CATALOG**

Amount refunded on receipt of your first order. Crammed full of money-saving offers of sets, parts, accessories and diagrams. Ask for catalog A.
WRITE FOR IT TO-DAY

\$4.75 Transformer. "All American" 3-1, 5-1, 10-1, 500,000 in use, bargain at...\$3.45

\$6.00 Tube. O-T 2, 4 volt, Dry Cell, genuine, made under De Forest patents, and only...\$3.95

\$5.00 Tube. Genuine RCA WD-11 or WD-12, 1½ volt, Dry Cell, supply your needs at...\$4.35

\$5.00 Variometer. Liberty, moulded, 150-600 meters, great bargain at...\$2.95

\$17.50 Neutrodyne Kit. Work-Rite, made under Hazeltine patents, extra value at...\$14.25

FREE! With your first order we will send you free a 28 x 38 in. radio station map of the U. S. and a set of 31 Decalcomania name transfers for your panel. Send order today. **FREE!**

LIBERTY MAIL ORDER HOUSE
Dept. 6795, 106 Liberty Street, New York

same fashion as it was controlled in the Fleming valve by the plate voltage. Moreover, with a construction of grids as ordinarily used a variation of grid voltage of one volt will produce from five to 100 times as much change in plate current as would a change of one volt in the plate voltage. That is, the grid gives us a very sensitive control over the flow of electrons to the plate, acting as a valve in the plate current circuit. Comparatively weak radio signals impressed on the grid so as to vary its voltage may produce changes in the plate current perhaps 25 times as great as would be produced if a Fleming valve were used and

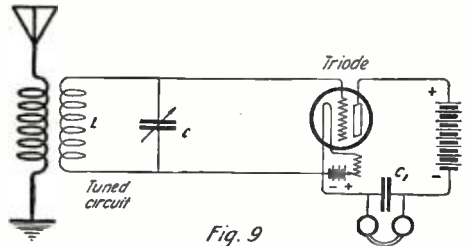

Showing how the triode is connected for receiving radio signals.

the signal voltage impressed on the plate circuit as shown in Fig. 4. The finer the holes in the grid, that is, the closer the wires are spaced, the more rigid is the control of the grid over the plate current.

HOW THE VACUUM TUBE DETECTS TELEGRAPH SIGNALS

When the triode is used as a detector in a radio receiving set it is connected to the circuit as shown in Fig. 9. The signal current, coming in the antenna, induces a corresponding current in the tuned circuit, the inductance and capacity of which have been properly chosen for the wave-length of the signal being received. The grid of the tube will then be affected by the signal, and as the voltage of the grid goes up and down, the plate current must correspondingly go up and down according to the shape of the curves given in Fig. 8. A part of curve B of Fig. 8 given in Fig. 10, drawn downwards, is the form of the voltage impressed on the grid of the triode when one wave train comes in the antenna. For any grid voltage the

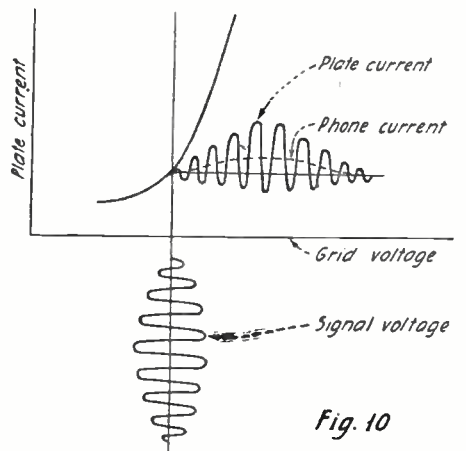

Owing to the controlling action of the grid, the triode is more sensitive than the Fleming valve.

KENNEDY
The Royalty of Radio

See your dealer for demonstration of Kennedy receiving sets or write us for descriptive literature.
THE COLIN B. KENNEDY CO.
Saint Louis San Francisco

PATENTS

If you have an invention and desire to secure a patent, send for our Free Guide Book, HOW TO GET YOUR PATENT. Tells our Terms, Methods, etc. Send model or sketch and description for our opinion of its patentable nature.

RANDOLPH & CO.
Dept. 459 Washington, D. C.

plate current may be found from the curve of plate current; these values have been picked off the curve and are drawn to the right in Fig. 10. Due to the curvature of the plate current curve the plate current has more of an increase when the grid goes positive than it has decrease when the grid goes equally negative, and this results in an increase in the average plate current while the wave train is acting on the grid. The

Approved
by the
Radio News
Laboratories



LIST \$4.00

APEX AUDIOTRON GUARANTEE

All Apex Audiotron tubes are guaranteed, and Dealers, as well as the manufacturers, will make replacement or refund the money on all tubes that prove unsatisfactory in any way. The only requirement is that the tube must not have been burned out.

APEX AUDIOTRONS

“Sound Perfection”

Apex Audiotrons have been on the market for a considerable length of time. They have been sold throughout the country and results have been highly gratifying. Apex Audiotrons are now being advertised nationally for the reason that the factory output has become large enough to take care of a great demand.

This is the first time that a manufacturer has sold a tube with a full guarantee. Apex Audiotrons may be relied upon at all times.

ALL TUBES ARE GUARANTEED TO WORK IN RADIO FREQUENCY. ESPECIALLY ADAPTED FOR NEUTRODYNE SETS.

The following tubes are now on sale:

	PRICE
Type 201A—5 volts, .25 amperes. Amplifier and Detector	\$4.00
Type 199—3--4 volts, .06 amperes. Amplifier and Detector	\$4.00
Type 12—1½ volts, .25 amperes. Platinum Filament—Amplifier and Detector	\$4.00
Type 200—5 volts, 1 ampere..... Detector Tube	\$4.00

“ATTENTION DEALERS”

The following Distributors supply “Apex Audiotron” tubes.

Radio Tube Exchange,
200 Broadway,
New York City

Radio Equipment Co.,
761 N. Gower St.,
Los Angeles, Calif.

Radio Specialty Co.,
25 W. Broadway,
New York City

Standard Automotive Equipment Co.,
1074 Boylston St.,
Boston, Mass.

Radio Auto Supply Co.,
920 D St., N.W.,
Washington, D. C.

Baltimore Hub Wheel & Mfg. Co.,
Gay Street and Fallsway,
Baltimore, Md.

Wm. Spalding & Co., Inc.,
109-113 W. Jefferson St.,
Syracuse, N. Y.

Radio Tube Exchange
17 So. Union St.,
Rochester, N. Y.

“Radiotubes,”
39 W. Adams St.,
Chicago, Ill.

Wellston Radio Co.,
1479 Hodiarnont Ave.,
St. Louis, Mo.

Ridenour, Seaver & Kendig,
Caxton Bldg.,
Cleveland, Ohio

Globe Electric Co.,
Chamber of Commerce Bldg.,
Pittsburgh, Pa.,

W. P. Mussina,
1625 Barnard Ave.,
Waco, Texas

The Radio Shop, Inc.,
189 Union Ave.,
Memphis, Tenn.

Specialty Sales Co.,
535 Main St.,
Springfield, Mass.

Eisenberg & Schaefer,
137 Market Street,
Philadelphia, Pa.

CANADIAN DISTRIBUTOR: Windsor Radio, Ltd., 26 Ferry Street, Windsor, Ontario

If your local dealer cannot supply you, order direct.

RADIO TUBE CORPORATION

70 HALSEY STREET

NEWARK, N. J.

\$25 for \$10

The Famous Bel-Canto Acoustical Amplifier

Direct from Manufacturer to You!



YOU cannot buy the Bel-Canto through any dealer, only direct from us. We save you these three profits—Distributor, Jobber and Dealer.

Sent prepaid to any part of U. S. and Possessions. Delivered C.O.D. free to your door.

PRICE \$10

Bel-Canto Mfg. Co.

BENSIL-BONIS, Inc., Dept. R.N.
General Office & Factory, 417-419-421 E. 34th St., N. Y. C.
Tel. 8959 Vand.

7 POINTS OF BEL-CANTO SUPERIORITY

1. Our own Fiber horn, Crystalline finish.
2. Our own adjustable loud speaking unit, giving a wide range of tone quality and volume without distortion.
3. The base of cast iron, weighing four pounds, eliminating top heaviness.
4. All other metal parts are of heavy cast aluminum, highly polished.
5. Complete instrument stands 22 1/2 inches high, 10-inch bell.
6. Guaranteed for one year from date of purchase against all mechanical defects of any kind.
7. No auxiliary batteries required. Just plug in on second stage.

Guarantee

Money back any time within ten days if dissatisfied. We further guarantee to the publication carrying this advertisement that each and every speaker sold will be exactly as advertised in this issue.



All-Purpose Voltmeter

Every good set deserves one. A high resistance, double range, portable instrument for accurately measuring filament, plate and grid voltages. Locates trouble immediately. Eliminates guessing. Instantly indicates the state of batteries. Invaluable for accelerating exact tuning, lengthening tube life and eliminating noise. Ranges 150 and 7 1/2 volts. May be mounted on panel if desired. Built by the World's leading authorities on electrical instruments for 35 years.



Weston Model 489 Double Range Portable Voltmeter. One of seven described in Circular J which shows instrument connections for both transmitting and receiving sets. Write today for particulars.

WESTON ELECTRICAL INSTRUMENT CO.
173 Weston Ave., Newark, N. J.
Branches in all principal cities.

Electrical Indicating Instrument Authorities Since 1888

WESTON

STANDARD - The World Over

SUNSET REFLEX CRYSTALS

A GUARANTEED crystal, mounted in wood metal to retain and increase sensitivity and volume. Practical for DX, and with the reflex circuit.

50c



Granular Galena in Bulk
Mfrs., Dealers, Jobbers; Write for Proposition
U. S. MFG. & DIST. CO.
45 CLINTON ST., NEWARK, N. J.

RADIO FANS

Would you like to get a start as salesman or dealer in the radio field? We manufacture one of the best receiving sets and parts on the market. We want local representatives in your district. We show you how to get started in the radio business. If you are familiar with radio you can earn a big income immediately. This is open to part time men. Write to

Mr. Gay, 4884 N. Clark Street,
Chicago, Ill.

high frequency fluctuation in the plate current, which is of the same frequency as the voltage acting on the grid, passes through the condenser C_1 in Fig. 9, but the average increase shown by the dotted line in Fig. 10 goes through the telephone. So we see that one wave train impressed on the grid of the tube will give a hump in the current through the telephones, just as it did in the Fleming valve. The size of the hump, however, will be much greater in the case of the triode than in the case of the two element valve. This fact is expressed by saying that the triode is a "more sensitive" detector than is the Fleming valve.

Tube with Gas or Soft Tube.—A tube which has been evacuated as well as modern methods will permit, and therefore has a very high vacuum, is said to be a "hard" tube; on the other hand, some gas is actually introduced into the tube in special cases, so that the vacuum is not as good as it is possible to make it and such tubes are said to be "soft" tubes. If an appreciable amount of gas has been put into the tube the plate-current *vs.* grid potential curve is not the smooth curve shown in Fig. 8, but has a small kink in it, where the curvature is much greater than is the case with the hard tube. If the plate voltage is adjusted to just the right value the plate-current, with no signal coming in, will be on the kink in the curve. Now as the curvature is greatest at the kink, and as the size of the hump in the phone current of Fig. 10 depends directly upon the curvature of the plate current curve, it is evident that the tube with gas may be made a better detector than one without gas.

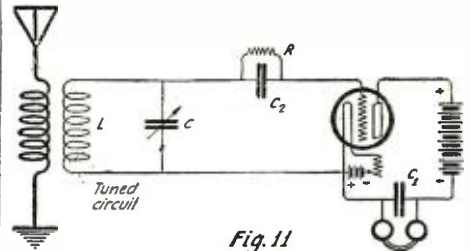

Fig. 11

The average triode is somewhat more sensitive as a detector when a grid condenser (C_2) and a grid leak (R) are used.

These gas tubes are much used as detectors, but it must be remembered that to give the best results with such tubes the plate voltage must be regulated to just the right amount and this can only be found out by trial after the set is connected and put in operation.

Action of Tube with Grid Condenser.—The average triode is a somewhat better detector if it is used with a suitable condenser in series with the grid instead of being connected as in Fig. 9. In this case the connection is made as in Fig. 11; it will be noticed that the connection of the tube is nearly the same as before, but the grid is connected to the tuned circuit through a condenser C_2 which is itself shunted by a resistance R , called the "grid leak resistance."

The action of the tube in this case is somewhat different than that previously analyzed. When the signal gives a voltage across condenser C (Fig. 11), the grid is made to go up and down in potential, almost the same as if condenser C_2 were not in the circuit. Now when the grid goes positive it attracts to itself some of the electrons which are flowing through its spaces on their way over to the plate; when the grid goes negative the electrons cannot leave the grid inside the tube, as electrons cannot evaporate from a cold metal. When the grid again goes positive at the beginning of the next cycle, electrons are again attracted to the grid and thus as long as the signal is coming in the grid accumulates electrons, and the number it accumulates depends upon how positive the signal causes the grid to become. A strong signal will make the grid swing positive by

a large amount, while a weak signal will force it less positive and so accumulate fewer electrons on the grid than will the strong signal.

The accumulation of electrons on the grid would soon make it so negative that the plate current would stay permanently low, and the detecting action of the tube would be very poor if means were not provided to let these accumulated electrons flow back to the filament from which they came. This is the purpose of the leak resistance R , Fig. 11. The electrons which accumulate on the grid while it is positive, not being able to get off the grid inside the tube by evaporation (the way they got off the filament) flow back to the filament through the resistance R and coil L . The values of C_2 and R must be properly chosen to make the tube operate at its best; for the average tube about 200 micro-microfarads (.0002 mid.) of capacity and a leak resistance of one million ohms (1 megohm.) seem best.

From the foregoing it is, therefore, seen that as a signal of varying amplitude is coming into the tuned circuit, the grid accumulates more or less electrons, which gradually leak off through R ; with a strong signal many electrons are caught by the grid, and with a weak signal but few are captured. Now, as electrons are *negative* electricity it follows that the average grid potential, due to this accumulated charge of electrons, will be lowered the stronger the signal. Thus the signal voltage might be of the form shown in curve a of Fig. 12, which is part of a word spoken at a radiophone transmitting station. When the high-fre-

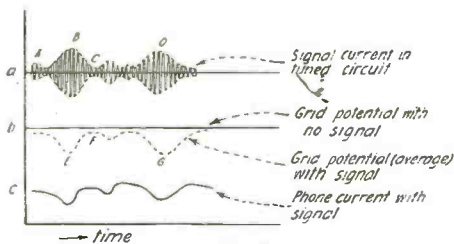

Fig. 12

The stage by stage conversion of a radio wave as it passes through a radio receiving circuit.

quency current in the tuned circuit is of low amplitude, as at A , the electrons are accumulated by the grid at a slow rate and so the average potential of the grid is about the same as when no signal is coming in. But when the signal current increases in intensity, as at B , the electrons accumulate more rapidly on the grid, and so its average potential falls, as shown at E of curve b in Fig. 12. At c the signal voltage is again low, and so the average grid potential again approaches its normal value at F . In fact the average potential of the grid will follow quite closely the envelope (dotted line through the peaks of the waves of the high-frequency current) of the voltage in a , and if the radio transmitting set is working properly this envelope will correspond with the form of the voice wave at the transmitter.

Now as the plate current of the triode, which flows through the phones, must go up and down as the average grid potential goes up and down it follows that there will be humps and hollows in the form of the plate current which will have the form of the voice sound as indicated in curve c of Fig. 12. But the telephone receivers give off a noise which corresponds to the form of the current flowing through them, and so the sound given off by the receivers will resemble the sound uttered at the transmitter station.

In the foregoing paragraphs the action of the three electrode tube has been outlined as a rectifier and detector of high-frequency

The Thompson MAGNAPHONE

For Every Radio Receiver

Conceived, designed and constructed to remedy the faults inherent to the ordinary loud speaker

The radio reproducer that permits your receiving set to perform at its best. It is ALL THERE—the volume, the quality, the control, that you've been seeking and that you haven't been able to find elsewhere—you'll notice the difference instantly, when you plug in a Magnaphone.

Cone-shaped special composition diaphragm, vibrating equally over its whole area—two-to-one driving armature, reducing the permissible air gap 50 per cent.—laminated magnetic pole pieces—individually and together form a structure giving results so incomparably superior as to make the Magnaphone the choice of those who demand the best.

Price \$35.00

At Good Dealers Everywhere



THOMPSON NEUTRODYNE RADIO

Model 5A Receiver

The "Neutrodyne" as a type is admittedly the last word in radio receivers. The Thompson "Neutrodyne" has all the advantages of the type plus the engineering skill and experience of one of the oldest radio organizations, one which has produced a majority of the high-grade commercial and government type of radio apparatus. To hear it is to realize the great difference even in various "Neutrodyne" sets.

A 5-tube balanced receiving set as supreme in its class as the MAGNAPHONE is among loud-speakers—yet the price is only \$150.00. Licensed under Hazeltine patent No. 1,450,080 and pending application Ser. No. 433,729. Other patents pending.

Manufactured by

R. E. THOMPSON MANUFACTURING CO.

SALES OFFICE:
150 Nassau St., N. Y.

FACTORY:
Jersey City, N. J.

At Last! *a real* SILENT-super



BATTERY CHARGER

At a price every fan can afford
Only

\$1050

AT YOUR DEALER'S
or postpaid on receipt of price

Charges BOTH
"A" and "B"
Storage Batteries
**FULLY
GUARANTEED**

Dealers:

This charger is truly a sensation. Wire or write for our proposition and receive the benefits of the national advertising campaign now starting.

The Acme Battery Charger contains no bulbs, no glass, no contacts, no moving parts. It never needs adjustment, is fool proof, silent and practically indestructible. Charges both "A" and "B" Batteries properly without overheating or overcharging. Stops charging automatically when your battery reaches full strength. Simple and efficient—absolutely the last word in battery charging.

ACME ENGINEERING CO., Dept. 3, Louisville, Ky.

waves, which we now summarize. Sent off from the antenna of the transmitting station are high-frequency waves the amplitude of which varies. In the case of a radio-telephone transmitter the variation is such that the amplitude of the waves sent off closely resembles the form of the sound wave of the voice. When these waves strike the receiving antenna they set up currents in it and also in the local tuned circuit. These currents make the grid potential vary with high frequency fluctuations, the amount of this fluctuation varying as does the high frequency current in the antenna of the transmitting station. The variation of grid potential causes corresponding changes in the amount of plate current, which is the current flowing through the telephone receivers. As the sound given off by the phones is fixed by the shape of the current flowing through them, it follows that the sound given off by the receiving phones will resemble that at the transmitting station.

(To be concluded in next issue)

New Radio Patents

(Continued from page 1600)

"swamped" by the disturbing waves. Protective devices are known for preventing too large current from reaching the receiver but such devices wipe out the message as well as the excess current. It is an object of the invention to prevent too large current from reaching the receiver, but at the same time to permit the signal currents to be received.

ELECTRON-DISCHARGE DEVICE

(Patent No. 1,478,076. Issued to Howard W. Weinhart, of Elizabeth, N. J. December 18, 1923.)

This invention relates to electron discharge devices and to improvements in the electrode mounting for such tubes to adapt them for use with high voltages. It has been found that when high voltages are employed for energizing an electron discharge device that a leakage current flows between the wires sealed into the vacuum tube and leading to the various electrodes.

An object of the present invention is to reduce this leakage current to a minimum and also to dispense with the arbor commonly employed for supporting electrodes, whereby a more rugged construction is provided.

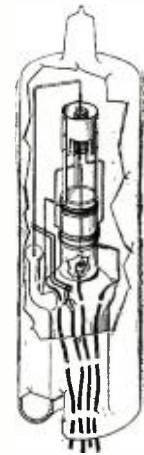

These objects are accomplished by providing a wide separation for the lead wires, whereby a comparatively high resistance is afforded to a passage of leakage currents. To this end the stem or inwardly projecting neck of the vacuum tube is terminated in a dome, so that the sealing-in points for the leading-in wires may be widely separated. To provide a wider separation of the supporting connections for the electrodes than is usual when the electrodes are supported from the single glass rod or arbor, this arbor is dispensed with, the electrodes being supported from a tubular member which arises from the stem and which forms an extension thereof. The supporting connections for the electrodes, or some of them, are spaced along this tubular portion at intervals great enough to prevent any substantial or serious flow of leakage currents.

HIGH FREQUENCY SIGNALING SYSTEM

(Patent No. 1,477,899. Issued to Chester W. Rice, of Schenectady, N. Y., December 18, 1923.)

The object of this invention is to provide an improved system for the reception of high frequency radio signals whereby the stray or static ratio may be materially improved.

DUTHO RECHARGEABLE STORAGE "B" BATTERIES

Fans and dealers alike are enthusiastic about Dutho "B" Batteries. Fans—for their unfailing performance and long life. Dealers—because of their unvarying satisfaction with their customers. Testimonial letters from dealers would indicate this was almost universal.

DUTHO "B" BATTERIES COST YOU LESS—LAST LONGER

They eliminate all battery noise and internal action. This prevents distortion. Heavy, individual glass tubes permit visibility at all times and make surface discharge impossible. You can see when and how to "keep them up." Condensing chamber in each cell overcomes fumes and prevents spilling.

DUTHO Batteries are sold DRY CHARGED, with solution in separate container. Once filled your battery is fully charged, ready for immediate use. Ordinary care in following directions will make DUTHO "B" Batteries last indefinitely. Thousands in use today.

Dealers: Write for attractive proposition.

Chemical Rectifier

\$1.95

DURKEE-THOMAS PRODUCTS COMPANY

1228 FOLSOM STREET

SAN FRANCISCO

\$5 6" x 2 1/4" x 2 1/4" Weight 2 1/2 lbs.

\$9 6" x 2 1/4" x 4 1/4" Weight 4 1/2 lbs.

\$17 6" x 2 1/4" x 9" Weight 8 1/2 lbs.

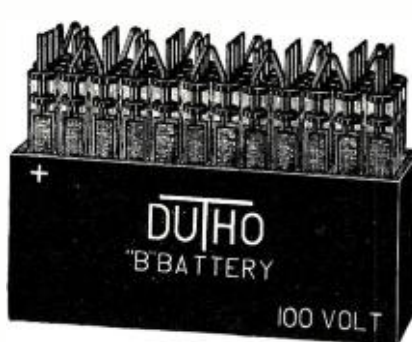

701

A Well Paying Field Radio

Last year was a \$175,000,000 radio year, and Radio has just commenced to grow! Get in on the ground floor. Train for a position as Radio Operator or Radio Installation and Service man. New Radio Sales and Service course just started.

Send Today for Illustrated Booklet
Y. M. C. A. RADIO SCHOOL
158 East 86th St., New York
"Best Radio School In The East"

RADIO

SEND FOR OUR COMPLETE
MONEY SAVING CATALOG

TIMES SQ. AUTO SUPPLY CO. INC.

MAIL ORDER DEPT.

1743 BROADWAY at 56th STREET
NEW YORK, N.Y.

In carrying this invention into effect there is provided at the receiving station a means for storing up the energy of the received high frequency impulses for a plurality of successive cycles of the high frequency current and means for impressing simultaneously upon the receiving apparatus a plurality of currents produced by energies received at different time periods. The energy storing means may be in the form of an artificial transmission line which preferably has an effective length equal to a plurality of wave-lengths of the signals to be received. The signals to be

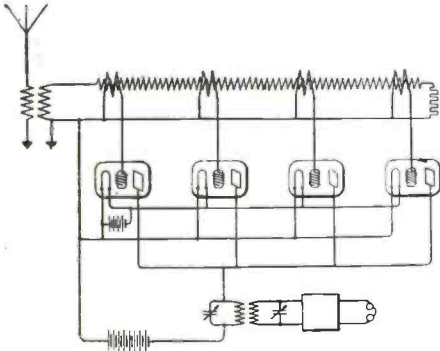

received are impressed upon this transmission line and currents in the transmission line from a plurality of selected points along its length are impressed upon receiving apparatus in such a way that these currents will add amplitudes in the receiving apparatus. The amplitude of the current impressed upon the receiving apparatus will consequently be equal to the arithmetical sum of the amplitudes of the respective currents or the product of the number of separate currents and the maximum amplitude of one, all these currents being substantially proportional to the amplitude of the signaling current in the transmission line. Stray currents of short duration, which may be impressed upon the transmission line, will, however, be of different amplitude at the different points in the transmission line from which currents are selected, and in case by chance these stray currents add amplitudes in the receiving apparatus their sum will not be equal to the product of the number of stray currents by the maximum amplitude, but will be of a value somewhat smaller than such product. Stray currents having a different frequency from that of the signaling current will have different phase relations along the transmission line from the signaling currents, and as a result such currents will not add amplitudes in the receiving apparatus, but will merely add energies. As a result the stray ratio may be considerably improved.

Some Real DX

(Continued from page 1594)

radio 4HS, located at Lakeland, Florida, mailed us his card, informing us that he had also heard our signals.

There is nothing so very remarkable about a receiver acting as a transmitter, providing it is adjusted to oscillating periods. The writer has communicated between warships several times in the past by having two receivers in tune with each other, the operators merely touching the binding posts of each receiver to make and break the signals. However, this was accomplished over very short distances only, so you can imagine our surprise upon receipt of this proof that our signals had been heard in the United States, while using nothing but a simple receiver as a transmitter.

To be frank, we were dumfounded at the receipt of such news, and yet we cannot really believe that it is true. The distance from San Juan, Porto Rico, to New York City is approximately 1,600 miles, air line, and from San Juan to Key West, Florida, approximately 1,100 miles, air line. It seems to us a sort of freak of nature, unbelievable, uncanny and savoring of the unusual. Whether we are located in a "peculiar spot of the ether" where freaks of this kind often occur, we do not know, but the cards tell the story.

It stands to reason that if either radio 4HS or radio 3BDO had made a mistake in looking up or copying our call letters, neither of them would have notified us about the same message, although sent on different dates and

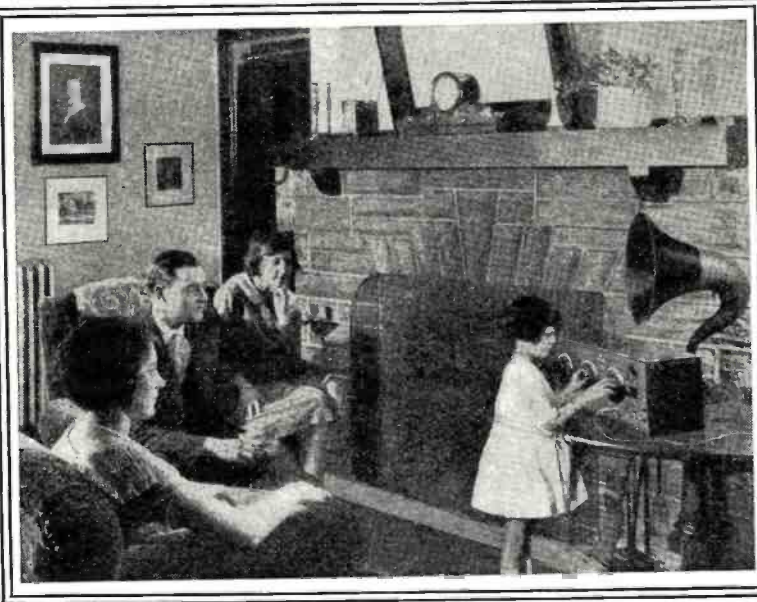

FADA "ONE SIXTY" NEUTRODYNE RADIO RECEIVER

Simplicity

When a radio receiver is so simple that a child can operate it as well as a grown person, then radio has reached a stage of development that is little short of perfection.

The Neutrodyne principle as applied to the FADA "One Sixty" has produced a radio receiver that is simplicity itself. Once the notations have been made of the dial settings of any stations, *anyone* can reset the dials in the given positions and listen to that station at will.

Because of FADA engineering skill, the FADA "One Sixty" four-tube Neutrodyne receiver is as selective, brings in distance and produces as great volume as any five-tube set. And, best of all, the FADA "One Sixty" can be depended upon to bring in most of the programs—local and far distant—on the loud speaker.

The pleasing design of the cabinet and its beautiful finish make it an ornament to any home. Its efficiency makes it a delight to all who listen. It is a receiver that you will be proud to own. See the FADA "One Sixty" at your dealer's. Price, exclusive of tubes, batteries and phones, \$120.

F. A. D. ANDREA, INC., 1581 Jerome Ave., New York

FADA

Radio



Ackerman
REG. U. S. PAT. OFF.

LOUD SPEAKER

Complete.
Ready for
Immediate
Use.

\$9.50

Delivered
Anywhere
in the
U. S. A.

A marvelous speaker for
the price of a headset.

Superior to many of the higher-priced amplifiers.

Thousands of radio fans have welcomed this popular-priced quality speaker.

Standing 21" high, with 11" bell and made of heavy (Non-Vibrating) metal, together with its special loud speaking unit, this speaker reproduces voice and music far beyond expectations. Finished in plain black or brown; also special alligator grain in black and green or black crystalline.

This speaker has been selected as the best value by one of the largest selling organizations in the country.



MODEL "A" LOUD SPEAKER UNIT, for use with horn or phonograph, complete with 5 foot cord and rubber coupling.

\$4.00

If your local dealer is unable to supply you, send order direct to us and pay postman on delivery.

Sold on a Money-Back Guarantee

Ackerman Brothers Co., Inc.
301 West 4th St. Dept. "R. N." New York City



It's a



Radio Plate Battery

*Night after Night—
They Continue to Serve
After Others are Scrapped*

On Sale at All Good Dealers

DIAMOND ELECTRIC SPECIALTIES Corp.

103 So. Orange Ave., Newark, N. J.

Dealers, Jobbers: Write for Proposition

BATTERY CHARGER \$8.75

Charges at rate of four amperes per hour. Absolutely no noise. Cannot possibly overcharge. Electrolytic type. Nothing to get out of order. No contact points to stick—no bulbs to burn out. This home charger which comes in handsomely enameled metal housing, now sold direct to you from factory. Get one now, at this low price.

Western Rubber Mold Company

Radio Dept.

907-913 W. 19th St., Chicago

Ford Runs 57 Miles on Gallon of Gasoline

A new automatic and self-regulating device has been invented by John A. Stransky, 2285 Fourth Street, Pukwana, South Dakota, with which automobiles have made from 40 to 57 miles on a gallon of gasoline. It removes all carbon and prevents spark plug trouble and overheating. It can be installed by anyone in five minutes. Mr. Stransky wants agents and is willing to send a sample at his own risk. Write him today.—Adv.

different times. 4RJ could easily be distinguished from other local calls such as 4OI, 4BJ, etc., which are local stations. Besides, we have proof that neither of these stations was transmitting at the time mentioned.

When I think of how some amateurs struggle with their 5, 10, 20, 50, 100 and 200-watt sets to get distance and compare that power with the output of a small honeycomb receiver which transmits signals for 1,500 miles, it indeed seems strange and unbelievable. We would greatly appreciate your viewpoint on this question.

We are building a 100-watt C.W. transmitter, similar to that of 4OI, Louis Rexach, San Juan, and with the combined efforts of these two radio stations we hope to place the Island of Porto Rico, on the map again, our aim being co-operation and keeping the standard of amateur radio communication to as high a degree as possible.

S. H. BUCHANAN,
Radio 4OY, San Juan, P.R.
FRANCIS McCOWN,
Radio 4RJ, San Juan, P.R.

A Simple Phone Connector

(Continued from page 1596)

should be placed on each screw and the screws then inserted into the third nut from opposite sides, and tightened. The phone cord tips are then placed between the heads of the screws and the movable nuts, and the nuts screwed up tight. This makes a good connection and can be left on permanently.

Contributed by T. B. Beatty, Jr.

The License Question

(Continued from page 1560)

3,131 applicants in 1923, only 1,877 qualified, showing that 1,254 who thought they were efficient, found they were not. This tends to show the necessity of Government licensing. Amateurs to the total of 18,828 were licensed in 1922-23, of which 16,846 were new men.

Instead of eliminating examinations and licenses, the Department is understood to favor making qualifications harder in order to establish a high class of operators, both for commercial and amateur work.

Congressman White has not yet expressed a willingness to change his bill or eliminate operators' licenses, but it is known that both sides of the question have been called to his attention.

The Possibilities of Unique Receiving Circuits

(Continued from page 1588)

adopted. When the loop antenna condenser was kept at a low setting and when the inductor-condenser circuit was properly tuned, a loud signal was obtained. The loop antenna was then connected and tuned in the ordinary manner and the received signals were of considerably less intensity. It was found that the inductor-condenser circuit was not tuned to the frequency of the received wave; instead, the inductive reactance exceeded the capacity reactance. This condition demanded a low setting of the loop antenna condenser so that the complete circuit might be tuned to the incoming wave. The voltage applied to the grid was thereby increased.

UNI-DIRECTIONAL EFFECT

These experiments culminated in a series of further tests, employing some of the circuits described in this article in combination with inductive coupling between these circuits so that when the loop antenna was turned through a complete revolution, one signal of maximum intensity was obtained, thus indicating the absolute direction of the transmitting station. Lack of space precludes a description of these tests.

The writer has secured a patent, dedicated to the public, covering the principles of this uni-directional effect, Patent No. 1,449,253, "A Radio Receiving System Indicating the Absolute Direction of the Transmitting Station." Reference to this patent will show how some of the circuits described in this article are employed to obtain the uni-directional effect.

This article is written principally for the experimenter with the suggestion that he utilize the ideas brought out in the descriptions of the experiments. Herein a field is explored which is somewhat new. The resonant circuit contains a very small amount of capacity and the tuning coil is used close to its natural frequency. How much more will the enjoyment of a broadcast program be increased by the use of this novel method! Herewith is a suggestion for starting such experiments:

Place a dry-cell electron tube in its socket; connect filament battery, plate battery, rheostat and phones in the ordinary manner. Connect the grid to one terminal of a coil of many turns which may be varied; a large inductance is necessary. Connect the other terminal of the coil to the radiator, and even with this insensitive arrangement, you can, if within two or three miles of a broadcast station, literally pick music out of the ground. Some experimenting will be necessary to determine the proper number of turns for the coil; one of the long tuning coils of bygone days should prove useful, and shunting the coil with a variable condenser may help. If you live on the top floor of an apartment house, so much the better, for the elevated pipes of the heating system approximate a good sized antenna to the top of which the receiving set is attached.

Published by permission of the Director, Bureau of Standards, U. S. Dept. of Commerce.

What Station Do You Want?

(Continued from page 1562)

"I'll give you a little advance warning, Mr. Franzbeau. I have worked on that set of mine for about eight months and all my friends who are radio fans say it's the best they have ever seen or heard."

"Well, as you say you are able to get Davenport on the loud-speaker, suppose we commence with stations about a thousand miles away?"

"Just the same to me, only I was thinking that you may not be able to get away from local interference as well as I can."

"Now, Mr. Palling, as you have shown great interest in this new set of mine, I think that you are entitled to know how it works. Naturally you are a little skeptical, and to play fair with you I will explain my theory. First of all, radio stations must have power at the receiving or sending end. We know that electricity travels at the speed of 186,000 miles per second. Light waves also have the same velocity. Wherever there is light there is heat, and where there is heat there is light. No human being has ever made light without heat. Now take one of your bulbs for example; your storage battery heats the filament and light is produced. Electricity produces both light and heat. But



Every One Can Now Own a Quality Radio Set



This is Model K—the much-talked-of outfit with which Mr. E. D. Elliott, of Milford, New York, got London, England; Fairbanks, Alaska; La Palma, Panama; San Francisco, Los Angeles and about 122 other long distance stations.

It's a two-tube outfit **\$29.50** that sells for only.....

MODEL M W

Shown in the illustration at the top of the page is our 4-tube outfit that can be used with a loud speaker. It sells for only \$54.50.

Write for Bulletin

These two Improved Miraco models make it possible for every family to own their own set—to have a choice seat for the opera or symphony or jazz concert right in their own living room.

Improvements and refinements that appear in expensive sets only are built in each and every MIRACO. In other words, *highest quality at the lowest price* has been solely responsible for the sale of thousands of our sets that are bringing radio-joy to each and every family who own one. Users of Miraco sets report getting as many as fifty stations in one evening. The cabinets are of solid mahogany and workmanship is unexcelled. Easy and simple to operate and always dependable. Fully GUARANTEED against any defects in workmanship.

Write for our new bulletin TODAY

DEALERS—JOBBER

Write for proposition quickly

AGENTS

There's still some territory open—write or wire

THE MIDWEST RADIO COMPANY

804 Main Street, Cincinnati, Ohio

The Improved
MIRACO

For Your Protection

Bell molded Bakelite Sockets and Dials are sold in individual blue boxes, branded with the BELL trade mark. Every socket or dial reaches you smooth and clean, without a nick or scratch. Use BELL Dials and Sockets for your pet hook-up.

The BELL Dial

Highly polished molded Bakelite (not composition). Clean white engraving. Accurate brass bushings that will not wobble on the shaft. Being Bakelite, these dials are strong mechanically, and are unaffected by moisture and temperature. Will not fade. In 2, 3, 3 1/2 and 4-inch sizes. Made also with hole through knob for vernier attachment. Vernier knob to match can be supplied.

The BELL Square Socket

One-piece molded Bakelite, for base or panel mounting. Its unusual double-wide spring contact makes firm, sure contact with tube prongs, even after constant use. Gets the best results from your tubes.

DEALERS: If your jobber does not have BELL Radio Products, write us for circular on molded sockets and dials.

BELL MANUFACTURING CO.
11 Elkins Street Boston 27, Mass.

what are your bulbs anyway? Nothing more than a relay. We don't hear the transmitting station. You could stand within a foot of an aerial with a transmitting range of thousands of miles and not hear a murmur. What we hear is only a mechanical reproduction. The bulbs only relay current from the "B" battery in direct unison with the vibrations from the sending station. As I said before, light rays have the same velocity as electric waves. Electricity produces both light and heat. With these facts in mind, I labored upon a theory of my own that the light rays were wasted in the reception of radio signals. Just after the war I opened a laboratory to perfect a machine or device which would utilize these waves. Any questions so far, Mr. Palling?"

"No, no, go on, you are interesting me immensely."

"I'm not a very eloquent talker, and I thought perhaps I was not making myself plain. Well, to continue: I developed a bulb which I have termed a 'Rayotectum.' It has four elements, the filament, the grid, the plate, and the receptor. No doubt you have noticed that the new bulbs have a silver coating. My bulbs, as you see, are painted black with a secret emulsion which I have made. Now, on the inside they are silvered, just like a mirror. Notice the shape also, a perfect parabola. The light rays which I utilize are passed through a small but powerful magnifying glass which centers them upon the fourth element which I have termed the receptor. This receptor is a small black cup which completely absorbs them. From this cup a wire is led to this 'X' battery which is a chemical device to react on the light waves and it produces electrical impulses in direct proportion to the incoming waves. Then from the 'X' battery another wire feeds back to the grid. As the light rays have the same velocity as electric waves, they coincide at audio frequency. When the electric waves pass between the grid and plate, the light waves pass simultaneously. The current then bypassed from the 'B' battery is about 20 times greater because of the influx of the 'X' battery."

"But there's one thing I don't quite understand, Mr. Franzbeau."

"I trust I can make it plain, Mr. Palling."

"Well, you've been talking a lot about light rays and waves, and it sounds logical. But what I can't understand is why I have never noticed any of these rays while working my set."

"That's a very good question, Mr. Palling, and I'll try to make it clear to you. In fact, I'm glad you asked it, as I want you to fully understand everything before you become financially interested in my company. Let's see—of course you know that the X-ray was so called because an unknown ray was discovered and, as in algebra, they called it 'X' for the unknown. That ray is invisible to the eyes. It takes a fluoroscope to detect it."

"Yes, that's very true, Mr. Franzbeau; a doctor friend of mine explained it to me."

"That's fine, Mr. Palling; well it was about a year before I discovered the 'Wireless Ray' through the use of a very special fluoroscope which I devised. Incidentally, before I perfected one suitable to continue my work I had expended something like ten thousand dollars."

Mr. Franzbeau then opened the front of the cabinet which held his new set. It was a door-like arrangement very similar to the upper doors on a Victrola. On the inside of the doors were charts. On the panel there were 12 dials and two switches and at the bottom, a rod running the length of the cabinet. It looked as if it were glass. Mounted on this there was a square black object which would slide like the slider on a tuning coil. After carefully examining the connections and pushing the cabinet a little

SEND TODAY

Solid Rubber Box furnished either with strap or side handles

6 Volts
80 Amperes

Don't Spoil Rugs, Floors, Tables.

USE A SAHARA STORAGE BATTERY. IT'S DRY. Think of its advantages. There is no liquid acid to spill and ruin floors, rugs or creep up posts and ruin clothes—ideal for portable sets. Recharges quickly—easily—and cannot be harmed either by overcharging or drawing down too far. Cuts down noise in ear phones and loud speaker. These exclusive features are what you want. We guarantee them. It is not a gelatin battery. It's dry and "chock full" of pep and life. Be the first in your town to have one of these remarkable batteries.

Order Today—Send No Money

We ship C.O.D. subject to your inspection, carrying charges to be paid by you. The price is \$25 if you order at once. Shipments made same day order is received. Remember there is no liquid—it's Dry. Orders are coming in fast. Get yours in today.

SAHARA DRY BATTERY CO.
Dept. C PAWTUCKET, R. I.

Dealers: There is a big business for you if you show this battery new. Send for discounts and get exclusive right in your territory.

G. W. 5 Circuit Radio Plug

PATENT APPLIED FOR

PHONES
LOUD SPEAKER
SERIES
PARALLEL
SHUNT

Accommodates Head Set and Loud Speaker or Two Head Sets—permitting instant choice of Five Circuits without removing plug or changing tips.

Price \$1.50

At Your Dealer or Direct From Us
MADE OF GENUINE BAKELITE
Jobbers Write for Quantity Discounts
Manufactured by
G. E. WALKER CO., Inc.
1926 CHESTNUT ST. ST. LOUIS, MO.

"The Loud Speaker" FREE

To Radio Dealers

We believe that this latest issue of the "LOUD SPEAKER" is the most useful and complete book of its kind ever published for dealers. It not only contains big values in the fastest selling standard parts for radio, but also has detailed diagrams of the very latest and most practical hook-ups. The prices shown are list prices which enables you to sell your customers direct from the book. A confidential dealers' discount sheet is enclosed. Send for a copy at once, you will be highly pleased with it.

DEALERS USE YOUR LETTERHEADS
We have only a limited edition of these "LOUD SPEAKERS"

WRITE FOR YOUR COPY AT ONCE

WESTERN RADIO MFG. CO.
Manufacturers and Distributors
138 W. LAKE ST., CHICAGO, ILLINOIS

closer to the window, Mr. Franzbeau asked Mr. Palling what station he would like to hear.

"I've never heard San Francisco. Can you get that one?"

"Easiest thing in the world and I'm going to let you do it, Mr. Palling. First, find San Francisco on the chart. Now, it says 1-15, 2-6, 3-18, 4-45, 5-33, 6-70, 7-0, 8-0, 9-0, 10-0, 11-0, 12-66. That means to set the first dial at 15, the second at 6, the third at 18, the fourth at 45, and so on. There, now you have it. Now take that slider at the bottom and move it back and forth until you hear them."

In a few moments they heard . . . "San Francisco, our next selection this evening will be 'To the Moon Blues' by Jimmy Smith's Orchestra."

"Wonderful, Mr. Franzbeau, so clear and strong. Oh! Say, by the way, could you get London? I hear that very few are able to get them, and we've gone about as far west as we can."

"Any station in the world, Mr. Palling. Just make believe it's your set, and get anything you want. London, I think, is on the other chart."

Mr. Palling set the dials as called for on the chart and moved the slider back and forth a few times as instructed. Much to his delight came, "Gr gr grrr g-r-r whew-e-e r-r London, England. We will now play the 'Angels Serenade' by Kent Williams and his orchestra."

"I'm thoroughly convinced, Mr. Franzbeau, that when this set is put on the market it will mean a fortune for its stockholders. I think you had better sell me \$50,000 worth of your stock. That will give me a fairly large interest in the corporation."

"Fine, Mr. Palling; I will try to deliver them to you sometime tomorrow. No, wait a minute. I have that much right here in my case. Might as well give them to you tonight."

"Satisfactory to me; get them ready and I'll give you my check. While you are preparing them, I will listen to London. Mr. Adams, an old friend of mine, is in London now and according to the newspapers he is scheduled to speak over the radio. How surprised he will be when he gets back and I tell him all about this set and that I heard him."

"That music isn't clear as it should be, Mr. Palling, I'll adjust it. There, now I've done it, screwdriver slipped and broke a terminal. My, that's too bad, and just as Mr. Adams was about to deliver his talk. I should have let it alone, but I was so anxious to have it clear and free from distortion."

"I'm sorry, too, Mr. Franzbeau, but things will slip. We all do it. I let a pair of pliers slip and broke a bulb last month."

"That only interferes with that combination, though, you can get some other English station."

"Guess I'll try for DCCT. That's only a small station at the factory, but I have some money invested in that company. Say, it's not on the chart, how'll I get them?"

"What's their wave-length, Mr. Palling?"

"429 meters."

"Use the same combination as for DVOK, only set No. 7 dial to 42."

"Don't hear them, Mr. Franzbeau."

"Pardon me, Mr. Palling, I forgot, but I read in the paper this afternoon that they had some trouble at the power plant and they wouldn't be on the air for a few days."

Just then a car drove into the yard. "That's my nephew, Mr. Franzbeau. He was out to the plant today. I'll have to ask him about it. I was never able to get them on my set, but as yours will get any one of them I just wanted to see what kind of a program they put on."

"Here's the stock ready, Mr. Palling; do you want to use my pen?"

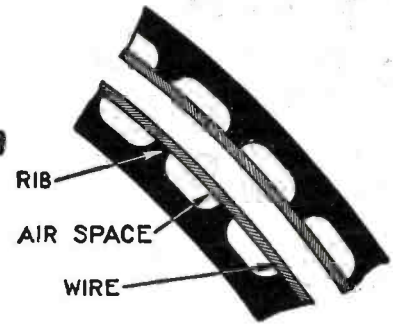
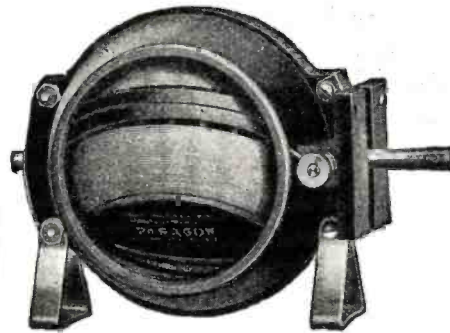

The Paragon Variometer No. 60

reduces dielectric losses to the minimum. It is the first variometer to combine coils surrounded by air with the mechanical strength necessary in such an instrument. It has no equal in the radio field.

Both stator and rotor forms are of polished black, moulded Condensite, each having 24 narrow raised ribs upon which windings are supported, thus practically surrounding them with air. This design, the result of eight years' experience, meets the rigid electrical requirements of PARAGON Receivers and fulfills the high mechanical standards of PARAGON parts. Price \$5.00.

Paragon Variocoupler No. 65



The ultimate in Variocouplers. Coils of double-silk covered wire wound on moulded, black, Condensite tubes with highly polished finish. Only multiple turn taps are brought out in the primary. Single turn taps and switch for same are unnecessary. Is simple to operate and insures better reception. Price \$3.50.

Write for Illustrated Catalog of Paragon Radio Parts

ADAMS-MORGAN CO., 6 Alvin Avenue, Upper Montclair, N. J.

PARAGON

Reg. U. S. Pat. Off.

RADIO PRODUCTS

Corner of plate, showing method of spacing in the Pacent Condenser.

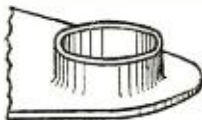
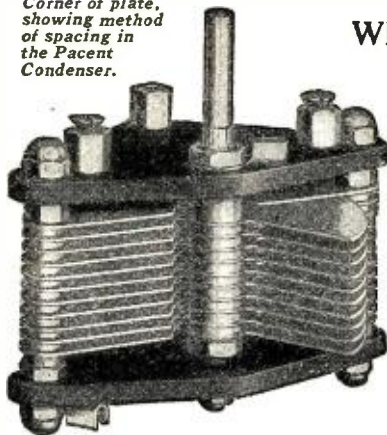

Why Pacent Condensers are Standard with Leading Manufacturers

1. Spacers, integral part of plates eliminating washers.
2. Four finger contact with shaft.
3. Adjustable lock bearing.
4. Bakelite ends (high grade Hard Rubber supplied if preferred).
5. Extra heavy Aluminum plates.
6. High ratio of minimum to maximum capacity.
7. Lower resistance—more selectivity.
8. Endorsed by well-known radio engineers.
9. Made by pioneer radio manufacturers.

Prices on special sizes and specifications will be supplied to manufacturers upon receipt of definite information as to their requirements.

Send for catalogue N-5 describing all Pacent products

Pacent RADIO ESSENTIALS

PACENT ELECTRIC CO., INC.
22 Park Place, New York

STA-RITE RADIO BATTERIES SAVE YOU 60%

And Guarantee You in Writing 2 Years of Better Battery Performance
STA-RITE RADIO BATTERIES are made especially for Radio and the big saving is made possible by coming direct to you instead of thru distributors dealers etc. Boxes are made of oak finished in mahogany and the plates very thick and will give a steady discharge over a long period. No premiums, just good honest battery value.

TRY TO BEAT THESE PRICES

2 Volt for W.D. 11 and 12	\$4.00	6 Volt 60 Ampr.	\$ 7.50
4 Volt for U. V. 199 Tubes	7.00	6 Volt 80 "	8.50
RADIO B. STORAGE Glass Jars, Heavy Plates—Case of 12 Cells 24 V.	4.90	6 Volt 100 "	10.00
		6 Volt 120 "	12.10
		6 Volt 150 "	14.00
		6 Volt 200 "	17.00

Get Yours Today — NOW — Send No Money

The batteries are fully guaranteed in writing and shipped subject to examination on the day your order is received. You pay on delivery or deduct 5 per cent if full cash accompanies order. You may deduct 10 per cent if two or more are ordered at one time

STA-RITE BATTERY CO.

Dept. 3

LOUISVILLE, KY.

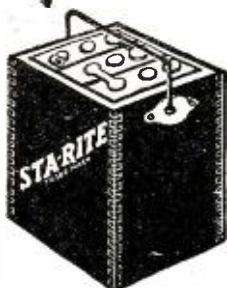

PATENTS

To the Man with an Idea

I offer a comprehensive, experienced, efficient service for his prompt, legal protection and the development of his proposition. Send sketch, or model and description, for advice as to cost, search through prior United States patents, etc. Preliminary advice gladly furnished without charge. My experience and familiarity with various arts frequently enable me to accurately advise clients as to probable patentability before they go to any expense.

Booklet of valuable information and form for properly disclosing your idea free on request. Write today.

RICHARD B. OWEN
PATENT LAWYER

2 Owen Building, Washington, D. C.
2276A Woolworth Bldg., N. Y. City

Set Manufacturers

WHO are building, or have planned to build limited quantities of extremely high-class receiving sets and who desire to secure for these sets the very highest possible grade of audio frequency amplifying transformers of surprisingly superior musical reproduction covering the entire band of audio frequencies can satisfy their requirements for 1924 and 1925 on a scheduled monthly delivery.

Correspondence invited

Frank A. Ryder
19 South La Salle Street, Chicago

"Wait a minute, I want to get San Francisco again so he can hear it when he comes in."

* * * * *

About 15 minutes later Mr. Palling's nephew Edward came rushing up the stairs all out of breath.

"Uncle Frank, what are you doing?" were the first words he uttered.

"Why, this is Mr. Franzbeau of the Industrial Radio Corporation. He brought in his new set to show me. It operates on the light waves. We have had stations all over the country and England too. Some set, isn't it? I just invested \$50,000 in it. In about six months I'll be worth more than our neighbors, the Waldrons. Had San Francisco on a few minutes ago. I wanted you to hear it, but something happened out there and they shut off."

Edward grabbed Mr. Franzbeau by the collar and almost choked him.

"Give my uncle back that check or I'll choke the life out of you." Mr. Franzbeau struggled and caught Edward by the legs and upset him. The pair went rolling across the floor while the uncle stood spell-bound. Edward's army training gave him the upper hand and the struggle was brief.

"Well, Uncle, don't be alarmed," said Edward as soon as he had his breath. "It was very dark and I was driving with my spot light. As I passed that little elm tree a branch pushed the light upwards and when I stopped it was shining right on your aerial. I noticed a wire leading from the aerial to that old house of Higgins. I also heard music. Looking up in your window I saw red and green lights. After standing there a few moments trying to puzzle it out, the lights in your window changed positions and a white light came up. Then I heard someone murmur, 'He wants San Francisco now: put on 'When the Moon Plays Hide-and-Go-Seek in the Clouds.' I crept over to the window of the Higgins house and found a phonograph with a telephone right in front of the horn. Three or four men were there and one of them said, 'If Nick only gets \$30,000 or \$40,000 out of old man Palling, we'll all live in Florida this winter.' A wire from the telephone was attached to your aerial. They had a list from the newspapers of what was playing at each station and would put on a record and one of them would announce that it was station so-and-so."

"Well, the old scoundrel, and he has my check for \$50,000."

"Here it is, uncle," said Edward, handing Mr. Palling a crumpled piece of paper.

Mr. Franzbeau had been playing possum. He knew he was no match for the athletic Edward. Like a flash he was up, and flying downstairs, through the front door and out into the night.

I Want to Know

(Continued from page 1602)

A. 2. A DL-500 and a DL-1,000 honeycomb coil (the latter shunted by a .00025 mfd. fixed condenser) will make a very excellent long wave transformer of high efficiency. These two coils may be fastened together mechanically.

FORD COIL "B" BATTERY

(924). Mr. Grady McPherson, Bellevue, Tenn., writes:

Q. 1. Will I be able to send 20 miles with a UV-201 tube using 100 volts on the plate?

A. 1. Under exceptional conditions this distance can be covered. It will be much better to use a UV-202 tube and about 250 volts on the plate.

Q. 2. Can a Ford coil be used as a source of plate current for this transmitter?

A. 2. It could be used for code transmission. It will be necessary to use some other form of current supply, if voice transmission is desired.

ONE-TUBE COLPITTS TRANSMITTER

(925). Mr. C. C. Gregson, Corwith, Iowa, asks:
Q. 1. What size honeycomb coil is used in the Colpitts circuit transmitter shown in answer to question No. 659, in the March, 1923, issue of RADIO NEWS?

A. 1. A 25 or 35 turn honeycomb coil will be satisfactory.

Q. 2. Will this circuit enable one to transmit phone for five or ten miles, under good conditions?

A. 2. The range will depend upon the tube and plate voltage used.

Q. 3. Can this set be used as a receiver without tube noises or howling, on account of its high "B" battery voltage and its oscillating qualities?

A. 3. This set will function the same as any other regenerative set.

ULTRAFORMERS

(926). Mr. R. J. Prendergast, Winnipeg, Ont., Canada, requests:

Q. 1. Will the Sodian tube function as detector without serious modification of the Ultradyné set?

A. 1. The Sodian tube should work quite well in the Ultradyné, but we have no information about its so being used. A special R. F. transformer with comparatively loose coupling would have to be employed.

Q. 2. Will a variometer in the plate circuit of the detector tube improve the set?

A. 2. There will be no advantage gained.

Q. 3. Is the Ultraformer advertised by the Phenix Radio Corp., on page 1367 of the March, 1923 issue of RADIO NEWS, exactly as described in the Ultradyné article?

A. 3. Yes.

FORD COIL VOLTAGE

(927). Mr. Wendell Walker, Auburndale, Mass., wants to know:

Q. 1. Can a Ford coil be used to supply the current to the plates of the amplifier tubes of a receiving set?

A. 1. No.

Q. 2. What is the approximate secondary voltage and amperage of a Ford coil with four to six volts on the primary?

A. 2. About 9,000 volts and one-half milli-ampere.

FIXED COUPLER

(928). W. L. Hale, Cleveland, Ohio, asks:

Q. 1. Please give the details of a fixed coupler and the circuit in which it would be used.

A. 1. A diagram showing the connections for this coupler will be found in these columns. Both coils may be wound on a form 3 1/2 in. in diameter; the primary being wound directly over the secondary. The tickler rotates inside of the secondary.

CALCULATING SPIDER WEB INDUCTANCES

(929). Mr. H. W. Loder, Montclair, N. J., asks this department:

Q. 1. Is there any considerable difference in the inductance value of a single layer coil and a double layer bank wound coil using the same number of turns, and the same size tube?

A. 1. The inductance of the double bank wound coil will be approximately four times that of the single layer coil.

Q. 2. What is the dielectric constant of celluloid?

A. 2. The dielectric constant of celluloid, taking air at 1.0, varies between 4.2 and 16.0.

Q. 3. How can the inductance of spider-web and honeycomb coils be calculated?

A. 3. To calculate the inductance of a spider web coil the following formula may be used

$$L = \frac{100,000}{m^2 d}$$

Where L=Inductance in millihenries.
m=The number of turns in coil
d=Mean or average diameter in centimeters.

Honeycomb coils may have their inductance calculated by employing this formula

$$L = 0.315 r^2 N^2$$

Where L=Inductance in microhenries
N=Number of turns
r=Average or mean radius in centimeters
e=Thickness of the coil measured from inside to outside diameter in centimeters
h=Length of coil in centimeters. One inch equals 2.54 centimeters.

RADIO SERVES AS ALARM CLOCK

At the Great Lakes Naval Training Station, where radio operators are trained, the new fangled psychological method of increasing speed in code reception, while the partly trained gobs sleep, is being used with as great success as met the initial sleep instruction tests at Pensacola. One night, after sending at high speed to 17 sleeping embryo operators, equipped with "ear-muffs," a petty officer ended his watch with the code message: "Hey, Gobs, get up; it's five-fifty-

No Matter What Your Vocation



Whether Professional Man
Business Man or Daily Worker

A Thorough Training In

CHEMISTRY

Will Help You To Get Ahead

TO be successful today is to know Chemistry! Every line of business, every branch of industry depends upon Chemistry in some form. You may not realize it, but your own proficiency in whatever work you are doing would be increased by a knowledge of Chemistry. In many lines such knowledge is absolutely essential. In others it is a guarantee of promotion and more money.

The keen competition that exists in every commercial activity today requires that a man know all there is to know about his vocation. If you have something to sell—no matter what—Chemistry enters into its makeup. The salesman who knows the chemical composition of his article can talk about it more intelligently than the one who lacks this information, and his sales are proportionately larger. In the building trades Chemistry is of prime importance. The mason, electrician or painter who knows something about Chemistry can do better work and command more money than the one who does not. Through Chemistry a shop-keeper learns how to attract the most trade, and even in clerical positions one can capitalize his chemical skill.

Chemistry should be as much a part of your mental equipment as the ability to calculate or to write correct English. The world is paying a thousandfold more for ideas than for actual labor. The big rewards go to the man who can show how to turn out a little better product at a little lower cost. And Chemistry will give you the ideas that will save money for yourself or your firm in the very fundamentals of your business. There is nothing remarkable about this; it is going on every day. If you have not heard of it before, it is because the general public has been slow to recognize the tremendous value of chemical training. People have been content to leave Chemistry in the hands of a few trained chemists who could not possibly develop the subject to anywhere near its greatest extent.

Now we are on the eve of a great awakening. Our heritage from the World War has been an intense development of the chemical industries in the United States and a tremendous interest in all the applications of Chemistry. People are taking up the subject merely for the goal it will do them in their own line of business.

It is no longer necessary to enter college in order to learn this fascinating science. Our Home Study Course trains you just as thoroughly, and with the same assurance of success, as those who took the longer way. And our methods are so simple that we can teach you no matter how little previous education you may have had. Many of our graduates now hold responsible positions or have materially increased their incomes from private enterprises as a result of taking our course. Hundreds of letters from students testifying to the benefits they have derived from our training are here for your inspection.

Remember that you do not need to study Chemistry with the idea of actually practicing as a chemist, although a great many of our students are taking our course with this object in view. If you want to know more about what Chemistry will do for you, if you want to know what our home study course offers, sign and mail the coupon today for FREE BOOK, "Opportunities for Chemists."

**Chemical Institute
of New York, Inc.**

HOME EXTENSION DIVISION 5
66-R West Broadway, New York City

DR. T. O'CONOR SLOANE
Will Teach You Chemistry
In Your Own Home

The Chemical Institute of New York, of which Dr. T. O'Conor Sloane is Educational Director, was founded to fill the need of ambitious, far-sighted men who realize and recognize the splendid future Chemistry offers them, but who cannot spare either the time or the money to attend college. Dr. Sloane, a foremost authority on Chemistry, will teach you and will give you any individual help you may require. He will personally go over your papers, correct them, point out your faults, teaching you in a practical and interesting way. No special education required other than the ability to read and write English. One student has characterized our lessons as "The course that takes the mystery out of Chemistry."

**Read What One of Our Recent
Graduates Reports**

"I thought I would let you know of my success. I finished your course about two months ago and now have a fine position as chemist at the DuPont Dye Works. I am getting along fine with my work and like it very much. It was through your course alone that I have been so successful. It is wonderful and I hope you have great success with it."
(Name and Address on request.)

Easy Monthly Payments

You do not have to have even the small price of the course to start. You can pay for it in small monthly payments—so small that you won't feel them. The cost is very moderate, and includes everything, even the Laboratory Equipment—there are no extras to buy with our course. Our plan of monthly payments places a chemical education within the reach of everyone.

**Laboratory Equipment Given
To Every Student Without
Additional Charge**

We give to every student without additional charge his chemical equipment, including forty-two pieces of laboratory apparatus and supplies, and seventeen different chemicals and reagents. These comprise the apparatus and chemicals used for the experimental work of the course.

Special 30-Day Offer

For a short period we are making a special offer that will be worth your while to take advantage of. Write for particulars, using the coupon below or simply a postal card. This will not obligate you in the least. Do not wait until tomorrow. Send the coupon now while you think of it.

**Sign and Mail the Coupon for
FREE BOOK**

CHEMICAL INSTITUTE OF NEW YORK, Inc.
Home Extension Division 5
66-R West Broadway, New York City

Please send me at once without any obligation on my part, your Free Book "Opportunities for Chemists," and full particulars about the Laboratory Equipment furnished to every student. Also please tell me about your plan of payment and your special 30 day offer.

NAME

ADDRESS

CITY

STATE
R.N., 5-24

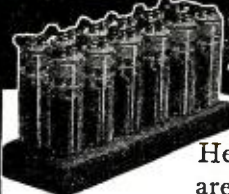

The RABAT Junior \$3.96

A Rechargeable Wet 'B' Battery. Capacity 800 Mil-Amps.
12 CELLS 24 VOLTS

Here are two acid type wet "B" radio batteries that are entirely free from internal current leakage. All elements visible through clear glass cells. RABATS have longer life with higher and more continuous voltage—Noiseless and compactly constructed—The RABAT Junior with a capacity of 800 mil-amps at \$3.96 and the RABAT Senior with a capacity of 2800 mil-amps at \$9.60 represent more actual battery value at a lower cost. More economical to buy—more economical to maintain. Easily recharged from ordinary house current. If your dealer cannot supply you send direct.

Prices F. O. B. Cleveland, Ohio

The Radio Rabat Company

914 Bangor Building
Cleveland, Ohio



The RABAT Senior

A Rechargeable Wet 'B' Battery. Capacity 2800 Mil-Amps. 48 VOLTS \$17.88
12 CELLS VOLTS 24 \$9.60

five!" Much to his surprise, the snoring ceased, three of the men awoke, and in a few minutes the other 14 rolled out, asking what was the matter. The flabbergasted petty officer now admits night code practice may increase receiving speed, but he knows it will get the students up at four bells.

Why Bother With Radio Frequency Amplification?

(Continued from page 1581)

Perhaps the worst offender of the lot is the incorrectly designed receiver with one or more steps of radio frequency amplification. There are several receivers of this class being sold now, at least one of which has an enormous sale. The grid circuit is tuned to the incoming signal. The plate circuit is tuned to the same frequency. The coils are close together and there is no provision made for biasing the grid of the tube. As a result, it is absolutely impossible to keep the radio frequency tube from oscillating. This set is much worse than the ordinary regenerative receiver because music can be heard with the radio tube oscillating, whereas with a regenerative receiver no music can be heard clearly unless the detector tube is not oscillating. An amplifier constructed in this manner is an efficient high frequency generator and unless tuned very sharply on some wave, will radiate a strong wave of a slightly different wave-length and create all kinds of interference for anyone else trying to hear the same concert. Such an amplifier obviously defeats its own purpose.

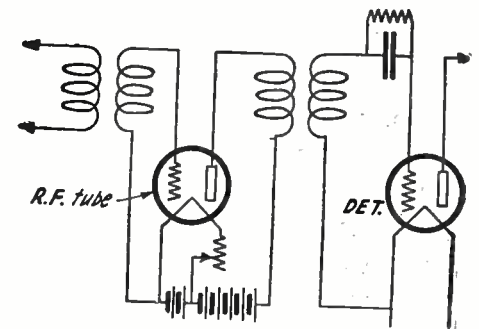

A single stage of radio frequency amplification will increase the range of your receiver and at the same time prevent radiation.

To properly construct a radio frequency amplifier, a potentiometer must be included to get anything like satisfactory results. This will put the proper bias on the grid to keep the tube from oscillating. When an amplifier is constructed with the greatest care in placing of coils and in wiring, it will frequently oscillate on short waves, due to the capacity between the elements in the tube, as illustrated. Sufficient energy is fed back through the condenser formed by the plate and grid to accomplish it. To prove it, turn out the filament of one tube in any radio frequency amplifier of more than one step and the signals can be heard with slightly diminished volume. The circuit from the secondary of one transformer to the primary of the next is apparently open because there is no connection between the plate and grid terminals of the tube between them. It would be an open circuit for low frequencies, but is a closed circuit containing inductance and capacity for the high frequencies employed. For this condition to remain true with the low frequencies used in the audio frequency side of the receiver, this capacity between the elements would have to be between .5 and 1 mfd.

"INSULATE"

(Molded Composition)



"HI-HEET"

(Bakelite)



ALSO

100 STYLE

Knobs, Dials, Binding Posts, Headset Caps, Insulators, etc.

In stock for prompt shipment

Insist on "Insulate" from your regular dealer.

GENERAL INSULATE CO. 1025 Atlantic Ave., Brooklyn, N. Y.

IS YOUR SET WORTH A REAL CABINET?

Solid walnut or mahogany 3/4" stock. Hand rubbed satin finish, felt covered bottom. Side grooved for panel. Stay hinge on lid. Moulded edge on base and top.

14 x 7 x 7.....\$5.75	21 x 7 x 7.....\$7.25
18 x 7 x 7..... 6.50	24 x 7 x 7..... 7.75

SUPER-HETERODYNE SPECIAL

40 x 8 x 8.....\$9.85

Postpaid East of Mississippi
Postpaid West of Mississippi add 25c

Send for descriptive pamphlet and prices on special sizes.

Keller's Furniture Shop

Steubenville, Ohio

MAIN

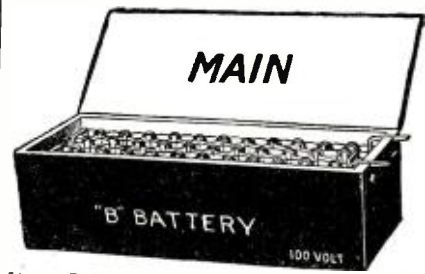

"B" BATTERY
100 VOLT

Storage B Batteries, Lead Plate, Acid type, Rechargeable, in Cabinet (24, 48 and 96 Volts). Popular Prices. Write. Dealers Wanted.

Main Electric Co., Cleveland, Ohio

ULTIMATE RESULTS

Please consider for a moment the injustice to everyone and the selfishness of a person who knowingly operates one of the squeal factories and the possible result of such practice if continued unhindered.

The Government has enacted laws which are being rigidly enforced to control amateur transmission, most of which is absolutely inaudible to the broadcast listener. These amateurs must send on a very short wave and at certain hours only. There are only a few sparks left and they are fast disappearing. There are also a few who send on a wave longer than that prescribed, but they are few and are being corrected. The main point is that each amateur uses one wave-length only, which is out of the broadcast range, and their total number is a small percentage of the number of receivers. They are subject to all kinds of unfair and malicious criticism, mainly by those who do not understand what is happening. While one single circuit receiver operated in the congested residential districts of Chicago or New York will positively ruin an evening for more people than all the amateurs in the country combined. This receiver is, in

NEUTRODYNE



THE MOST BEAUTIFUL AND EFFICIENT NEUTRODYNE SET IN THE WORLD

Perfectly constructed according to the most scientific specifications. Equipped with filament voltmeter for detector, automatic filament control, switch and jacks together with many other advanced features. It is encased in a solid mahogany cabinet that has a beautiful light SATIN FINISH.

\$97.50
Tubes, Batteries and Loud Speaker, Extra

This set has become famous because it receives **LONG DISTANCE ON A LOOP.**

Fully guaranteed to **WORK PERFECTLY** for **ONE YEAR**
WHEN ORDERING BY MAIL INCLUDE POSTAGE WITH ORDER

ATLANTIC & PACIFIC RADIO CO.
223 WEST 34th ST., NEW YORK CITY

Radio Products of **K**uality & **C**haracter

“Plug A Plug In

A Plug”

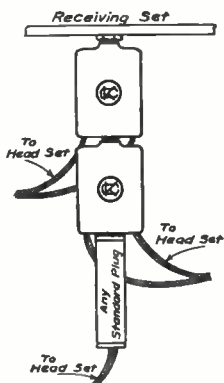

K. & C. NEW TYPE PLUG

In the K. & C. Series-Automatic Plug the radio enthusiast will find a longfelt want. How many times, when listening in on long distance stations, has it been desired to share the pleasure with a friend? Hitherto there has been the inconvenience of removing the plug, demounting it, unscrewing the phone tips, connecting the extra pair in series, replacing the tips and rescrewing the plug. Usually the long distance station has signed off before all of this has been accomplished. The K. & C. Series-Automatic Plug makes all of these operations unnecessary. If an extra set of headphones is desired, just plug them in the new K. & C. Plug. If the extra phones are equipped with the K. & C. Series-Automatic Plug as many may be added as desired without removing the original plug from the jack. With K. & C. Series-Automatic Plugs the only operation necessary to add extra phones is “plug a plug in a plug.” Use them on your loud-speaker, too.

Price, \$1.25

Chicago, 453 First National Bank Building,
Phone Randolph 3480.
San Francisco, 591 Mission St.,
Phone Sutter 40.

Portland, Ore, 305 Larrabee St.,
Phone East 6156.

New York, Reprs. Steelman, Inc., 24 Murray St.,
Phone Barclay 7941-2.

Los Angeles, 1103 West 10th St.,
Phone 552-63



KC Your Guarantee

A HIGH-GRADE COMPLETE LINE OF RADIO PARTS AND SETS FOR EXCLUSIVE USERS

For 10 years we have built radio parts for ships, shore stations, U. S. Navy, amateur and experimental use



All Navy Radio Men Know Kilbourne & Clark Ask Them

The Kilbourne & Clark Manufacturing Company is one of the oldest manufacturers of radio apparatus. It has kept pace with the progress of radio and today is one of the recognized leaders in the industry. The United States Government recognizes the quality of Kilbourne & Clark workmanship, many contracts for the manufacture of radio apparatus having been awarded to this firm and the apparatus is now in use in the U. S. Navy. The same skilled engineers and mechanics that have been building our radio equipment for the U. S. Navy and Merchant Marine for the past ten years build the finest radio apparatus for your home.

Write for catalog or see your nearest dealer.

For
Transcontinental
Reception

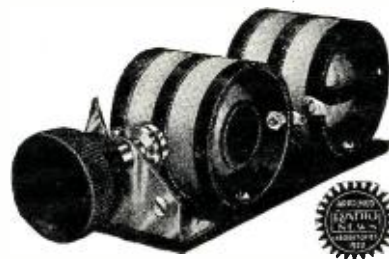

K. & C. RADIO Frequency Transformer

This Radio Frequency Transformer is continuously variable over a wave length of 150 to 550 meters and uniformly efficient over the entire range. Its range covers the entire band of the present broadcasting wave lengths. This unit is not a miniature variometer as its appearance suggests. It acts in the circuit as an impedance. It is the ideal coupling for non-regenerative radio frequency circuits. It is this transformer that is employed in the Haymond hook-up. All connections pig-tailed.

Price, single stage.....\$5.50
Two stage (operated on one shaft)....10.00
Send 25c for blueprint giving details of highly efficient radio frequency circuit.

KILBOURNE & CLARK MFG. CO.

Head Office and Works, Seattle.

BRANCH OFFICES:

COCKADAY UNIT
Full Set A, B, C and D Coils

Made strictly in accordance to Mr. Cockaday's Specifications.

GEN-WIN
TRADE MARK
PRODUCTS



Range 150 to 600 Meters

For 1 and 3 Tube Set
Price \$4.50
Genuine XX Bakelite tubing wound with No. 18 single cotton covered wire.

For 5 Tube Set
Price \$5.50
Best quality Radlon hard rubber tubing 1/2" wall wound with No. 18 double silk covered wire.

Guaranteed mechanically and electrically perfect. The outstanding features: Complete set of A, B, C and D Coils with beautifully knurled binding posts, eliminating loose end wires, insuring perfect contact and easier wiring. Made of the best quality material combined with expert workmanship. Distributed capacity or leakage and dielectric losses practically eliminated. Insures selectivity with maximum sensitivity and volume.

Two large blue prints and illustrated instructions together with list of parts necessary for building Cockaday Tuners furnished with each unit.

Unconditionally Guaranteed to Give Absolute Satisfaction
At Your Dealer, Otherwise Shipped to You Postpaid
Dealers and Jobbers Write for Attractive Proposition

GENERAL RADIO WINDING CO. Dept. R.5
214 FULTON ST. NEW YORK, N. Y.

reality, a transmitter which is sending out squeaks and squeals on all waves covered by his tuner.

Why should he not be subjected to even more stringent regulation than the short wave transmitter? He is infinitely more of a nuisance and has no excuse for existence.

The enormous amount of money invested in radio receivers need not be wasted. The public will eventually demand protection from these general nuisances and if it does we may expect to be handicapped even more than the English are, if past experience on prohibitory laws is any criterion.

I, therefore, recommend that this subject be given a lot of thought and any suggestions that might be of value be given publicity. The amplifier suggested above is not a cure-all by any means, but it is a virtue and, oddly enough, it contains its own reward.

Timely Notes on Aerial Installations

(Continued from page 1585)

OLD-TIME EFFICIENCY

Away back in the early days of wireless, memories of which time are dear to the heart of every old-timer, some astonishing records were established by experimenters in receiving from telegraph stations, when using an outfit consisting, in the main, of a carborundum (crystal) detector, a single-slide tuning coil, which was probably wound on an old rolling-pin, and a headset. As a matter of fact, some of the distances covered by these early pioneers in wireless apparatus would make a modern electron tube receiver turn green with envy. This, of course, when comparing the theoretically possible ranges of the two entirely different forms of rectifiers.

However, in those days amateurs designed and constructed their aerials with meticulous care; this was absolutely necessary, for the power used at the transmitting stations and the sensitivity of the crude receiving circuits then in use were ludicrously insignificant when compared to present-day apparatus. The antenna system constituted the most important part of their equipment and this being the case it was imperative that it be as near perfect as possible. Therefore, it was constructed with the greatest care and, as a reward, excellent results were obtained.

Nowadays, because we have a modern regenerative receiver with a two-stage amplifier many experimenters are prone to regard the aerial question, if they think of the matter at all, as something of secondary importance—something like, "Oh, well, I guess that's good enough." Some think that even a clothes-line will answer the purpose. It will—on local stations, but it will prove to be an absolute failure when trying to receive consistently from stations a thousand miles away. The word "consistently" is used advisedly, since there are cases of freak reception from distant stations, by receivers employing more-than-freakish antennae, occurring every day. Once the writer heard WOC, at Davenport, Iowa, about 800 miles away, when using for an aerial a piece of ordinary magnet wire, No. 22 to be exact, about 10 feet in length. They were heard with the utmost clarity for a period of two minutes, after which they faded out completely. This with detector only, in a non-oscillating circuit. But every-day long distance reception is what the average fan wants and if he is going to get it, his aerial must be constructed with the same care as his receiver.

AN ILLUSTRATION

Prospective fans, who know nothing about the art, and those already in the game who

WEIGHS ONLY 8 OZ

The Scientific

A \$200,000.00 COMPANY stands squarely back of the guarantee on every Scientific headset

SEND NO MONEY!

20,000 TURNS EQUIVALENT TO 3,000 OHMS

Order TODAY by Postcard and Pay Postman on arrival

\$2.95

POST-PAID

LOUD SPEAKER UNIT \$1.95

THE PHONE IT TOOK A SOLID YEAR TO DESIGN

We Guarantee The Scientific Headset to be the greatest value on the market. Try it for five days. If not satisfactory send it back and your money will be refunded immediately. Circular on request. Dealers wanted.

THE SCIENTIFIC ELECTRIC WORKS
98 Brookline Ave. DEPT. H. BOSTON, MASS.

Increase your Range



Springfield Braided Wire

About 1/4 inch in circumference



Ordinary Antenna Wire

About 1/4 inch in Circumference

From 15 to 100 per cent

You can, with your present equipment, by using **SPRINGFIELD 16-STRAND BRAIDED ANTENNA**.

Most wonderful wire for indoor loops. Its extra large surface—twice that of ordinary wire—enables you to get greater distance and clearness.

125 feet in your attic, in strands 3 feet apart, gives better results than 150 feet of ordinary wire outdoors. Write for free booklet.

At dealers—or send us \$2.50 for 100 feet.
Dealers and Jobbers—write for prices and terms.

SPRINGFIELD WIRE & TINSEL CO.
67A Taylor St., Springfield, Mass.

Springfield 16 Strand Braided Antenna

are dubious regarding the results they are getting, should seek the advice and, if possible, the aid of someone sufficiently competent to advise. If this is done, the novice will save himself considerable time and annoyance. As witness to this fact, the following incident from the writer's experience is quoted:

A budding fan had an aerial suspended only four feet above a building, which was covered with tin roofing. The lead-in ran down the side of the building which was also covered with tin. Using a standard variometer circuit with two stages of audio frequency amplification, he could barely hear a 500-watt radiophone less than 25 miles distant. After fussing around for a couple of weeks in a vain attempt to locate the trouble, he decided that he would consult a local amateur. One glance at the aerial and the cause of the unsatisfactory operation of the receiver was located. Without even looking at the outfit itself, the amateur advised that the aerial be elevated another 20 feet and that the lead-in be arranged in such a fashion as to place it 10 feet away from the wall of the building, and where the lead-in entered the building, to run it straight into the lead-in insulator.

After complying with these instructions, the results secured, to the beginner, were astonishing. He later stated that he was able to work a small home-made loud speaker on all of the principal broadcasting stations within a radius of 500 miles and that his range, with a headset, was considerably greater than that. Doubtless, with the experience he was sure to acquire through the continued operation of the receiver, he was able to do better than that as time went on.

THE REASON

The reason that he was unable to hear anything with his first aerial was because the aerial and lead-in were too close to the metal covered building. The metal absorbed prac-

could hardly believe that it was my own set"



Diam. dial, 3 3/4"; knob, 2 1/4"
Made in sizes:
No. 188 for 1/8" shafts.
No. 251 for 1/4" shafts.



UNIVERNIER with black knob and silver dial \$1.25
UNIVERNIER with mahogany knob and gold-plated dial \$1.50

UNIVERNIER
Micro-selective tuning control

"Put three UNIVERNIERS on my Neutrodyne last night and got 20 stations I never heard before!" An enthusiastic fan told us that the other day. He had tried 3", then 4" dials. But even the added inch didn't help much. Finally he tried UNIVERNIERS. Their 12-to-1 ratio, giving the equivalent of a 2-foot dial, enabled him to tune-in and log accurately DX stations 1/2" apart. No wonder he heard 20 new stations!

Costs no more than a good dial— which it simply replaces without otherwise altering set. The UNIVERNIER'S single knob gives either direct or continuous 12-to-1 control at will —Micro-selective control of the whole Condenser, Variometer, Potentiometer, etc., throughout the entire range of the set. Rigidly attached pointer always indicates true position and assures accurate logging.

At your dealer or postpaid upon receipt of purchase price.

Jobbers and Dealers: Write for Discounts
THE WALBERT MANUFACTURING CO.
935 Wrightwood Avenue, Chicago, Ill.

ONE TUBE OR FIVE!!



\$25.00

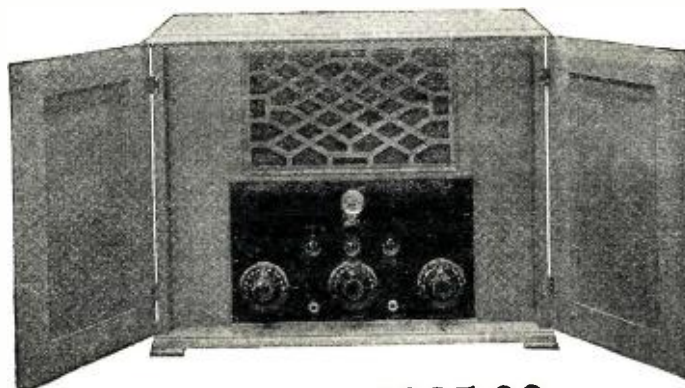

\$225.00

or

RADAK

quality is the same; the highest from every angle.

We are selling you not a mere mechanical assembly, although the materials are the best the market affords, but a pleasure box which contains music you can enjoy, speech you can understand, with simplicity you can master and all the distance you have a right to expect. You need not experiment with untried products unless you want to. RADAK is backed by seventeen years' exclusive radio manufacture—the oldest in America.

Licensed under Armstrong U. S. Patent 1113149. Bulletin on request.
INSIST UPON RADAK. Your Dealer will secure one for you.

CLAPP-EASTHAM COMPANY
107 MAIN STREET, CAMBRIDGE, MASS.

395 Broadway
New York, N. Y.

Caxton Bldg., Cleveland, Ohio

709 Mission Street
San Francisco, Cal.

RADIO



PRODUCTS

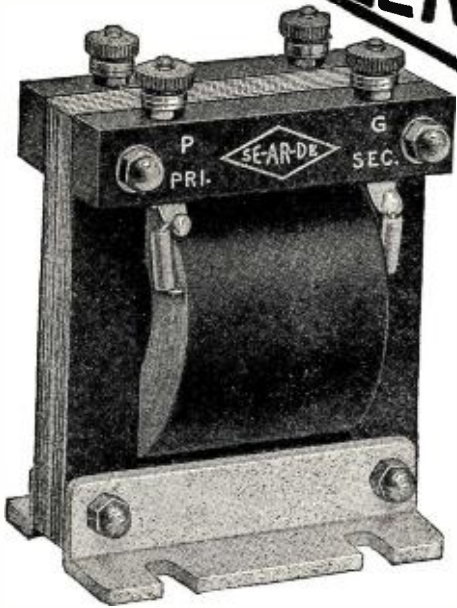

**ANOTHER
WINNER
AMPLIFYING
TRANSFORMER**

Ratio 4 to 1
Prim. 4000 Turns
No. 38 Wire
Sec. 16000 Turns
No. 38 Wire
CATALOGUE NO. 132

\$5.00

R. MITCHELL & CO.
225 Atlantic Ave., Boston, Mass.
PACIFIC COAST OFFICE:
709 Mission St., San Francisco, Calif.

STORAD

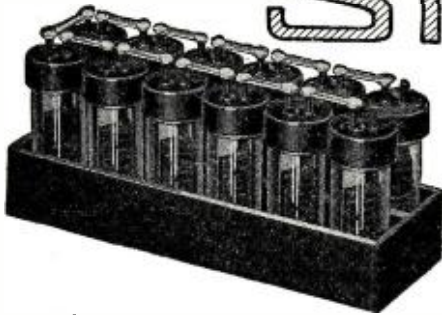

**"B" BATTERY
24 Volt Unit**

Radio engineers now unanimously recommend storage "B" Batteries for use with the new Multi-tube sets. Their Voltage is constant and steady until discharged. They aid long distance reception and eliminate many noises in the set.

The Ultimate "B" Battery for Radio Reception

Storads have extra heavy 1/4" plates and large acid capacity. Storads will last for years and pay for themselves in less than a year. Your present charger is or can be adapted for "B" battery charging which is done while set is not in use.

No. 225 unit. 2250 M.A.H. capacity. Size 4 3/4 x 13 1/4 x 6".
No. 450 unit. 4500 M.A.H. capacity. Size 4 3/4 x 13 1/4 x 7 1/2".
Write for Bulletin and complete information

ALL BATTERIES SHIPPED DRY.
THE CLEVELAND ENGINEERING LABORATORIES CO.
2117 Superior Viaduct, N.W., CLEVELAND, OHIO



INSULINE ANTI-CAPACITY PANELS

Mean the BEST in Radio Panels

Because they come already shielded. Our patented tin foil embedding process eliminates the "Sticky Job." Can be peeled from panel where the shielding is undesirable.

MANUFACTURERS
We have special facilities for turning out work on short notice, whether it be a rubber or a bakelite (CELORON CONDENSITE) Panel, we can DRILL, BEVEL or ENGRAVE it and guarantee you a high grade job at a moderate price. Write for Anti-Capacity and Plain Panel Samples with Prices. Of course all standard sizes are carried in stock. Other sizes cut to order.

**AT YOUR
DEALER OR RADIO PANEL & PARTS CORP.**
61 Warren St. New York City

WANTED—Back numbers of Radio News, Dec., 1921, Jan. and Feb., March and April-May, 1922. Experimenter Publishing Co., 53 Park Place, New York City.

tically all the energy in the immediate vicinity, leaving very little for the aerial to intercept. It is an established scientific fact that metal does absorb radio frequency energy. All objects such as trees, houses and poles do this more or less, but metal, to a greater extent than all. This is readily understood when it is remembered that your aerial itself is metal. And if the above-mentioned beginner had taken the time to get a little authoritative information beforehand, he would have been saved considerable annoyance.

Summing up, the above remarks may be condensed into the following:

1. Install a decent-looking aerial, even if it does take a little longer to put it up. The resulting appearance always justifies the extra time and labor involved.
2. Construct an efficient aerial, if you're out for real results.
3. If you don't know how to do either of the above, enlist the aid of someone who does know. There is an old saying that, "Where ignorance is bliss, 'tis folly to be wise." But, in radio at least, this proverb, which certainly does not apply to the twentieth century, is reversed, as doubtless many have discovered to their sorrow and dismay.

**Wired Radio Experiments
for Amateurs**

(Continued from page 1589)

as is common in radio telephony, is sufficient, if the condenser C_1 is reduced about .0045 mfd. and the condenser C_2 about .0005 mfd., which two are in the line between socket and receiver. The grid circuit with the condenser C_3 will be adapted for waves of around 600 meters. Its self-induction must be correctly figured. Before the grid of the receiving connections is the condenser C_4 —.00025 mfd., which is short-circuited by a graphite resistance of about one megohm. If now the transmitter is connected at socket

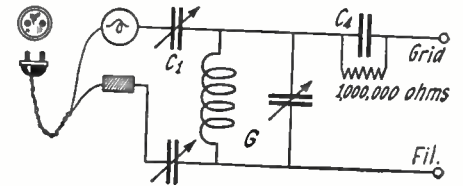

Fig. 6

The circuit used at the receiving end. An ordinary receiving tube may be employed.

No. 1, and the receiving set is put on the wire at socket No. 3, communication is established.

There remains for the amateur a great number of problems to be solved.

Operating the receiving tube direct from the lighting circuit, if direct current is available; combination of transmitter and receiver for talking both ways, so that an apparatus can be connected to either socket to enable one to talk from room to room; apparatus for connecting the set with the public telephone system making possible conversations from any room of the house over the telephone wires to any other telephone; use of alternating current lines and finally development of methods for overcoming the sounds due to the alternating currents.

In a succeeding article the combination of radio and wired radio telephony (train telephony) will be treated.

SOUP EATERS HEARD BY RADIO?

The musical program given during the Food Show in Cincinnati was broadcast by station WLW directly from Music Hall. A wag telegraphed he heard some one eating soup.

The New Genuine Guaranteed "SHEPCO" "ALL WAVE" JR.

TRADE MARK—PATENTS GRANTED AND PENDING

DX COUPLER FOR NON RADIATING CIRCUIT

Combination Flat and Bank Wound



"All Wave," Sr.
\$7.00
150 to 3000 Meters
Guaranteed Wave
Length

Set of six efficient hook-ups packed with every "All Wave" Coupler or mailed on receipt of 10c in stamps to cover cost of mailing.

All the SELECTIVITY of TUNED RADIO FREQUENCY at a SMALL FRACTION OF ITS COST. Like its companion the 3,000 meter Capitol "All Wave" Coupler, Sr., it may be used in a single circuit with the added feature that it may be used in a double or triple circuit.

Used in the "All Wave" triple circuit, the "All Wave," Jr., is guaranteed to reduce radiation and interference to a minimum. Log your stations and get them at the same setting every time. Only one dial to tune.

THE "SHEPCO" "ALL WAVE" Jr.

Eliminates use of all variometers, vario couplers and loading coils. Permits building most efficient, sharp tuning, loud, long distance receiver at lowest cost.

Read These Results:

F. S. Thompson, DeKalb, Mo.
"Picked up London, England so it could be heard through two rooms."

J. W. Sutcliffe, Providence, R.I.
"Got KFI, Los Angeles, Cuba, Porto Rico and Nebraska. Convinced of quality of your product."

J. M. Bleuvelt, Dallas, Texas.

"For selectivity it is the goods. I can tune out and in any station at will."

Augustus H. Gill, Ph.D., Cambridge, Mass.

"Far superior to any combination of loose coupler, variometers or vario coupler."

SHEPARD - POTTER CO., Inc.
PLATTSBURGH, N. Y



"All Wave," Jr.
\$6.00
150 to 1000 Meters
Guaranteed Wave
Length

On sale at all dealers in standard radio parts or sent direct on receipt of price. ABSOLUTE MONEY BACK GUARANTEE.

Real Radio Essentials!

50¢

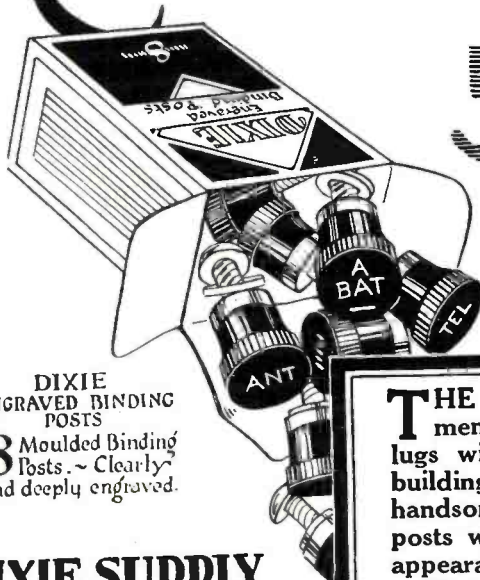

DIXIE ENGRAVED BINDING POSTS

8 Moulded Binding Posts. ~ Clearly and deeply engraved.

DIXIE SUPPLY COMPANY
91 Seventh Ave.
New York City

THE well-rounded assortment of screws, nuts, and lugs will greatly simplify the building of your set. The handsomely engraved binding posts will improve its finished appearance.

You need these two radio essentials! At fifty cents per box they are a wonderful buy. SEND FOR BOTH TODAY!

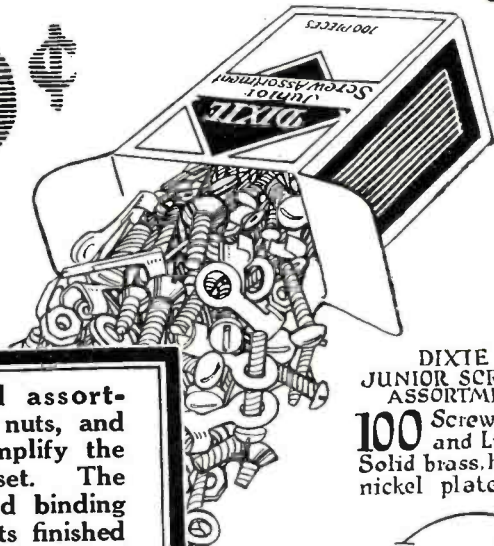

DIXIE JUNIOR SCREW ASSORTMENT

100 Screws, Nuts and Lugs. ~ Solid brass, heavily nickel plated. ~

DEALERS ~ Write about these attractive display cartons

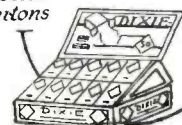

The Best in Radio

Telmaco Radio Guide Book describes all, 10c.

Our new 64-page Catalog No. TCR contains twenty of the most popular radio circuits printed in blue. These include the Hazeltine Neutrodyne, Grimes Inverted, Colpitts, Flewelling, Reinartz, Diode Electrad, Heterodyne, Super-Regenerative and many others. Each article used in circuit is attractively pictured instead of appearing in straight schematic form. Besides containing blue prints, the best in radio is also illustrated and described. Catalog sent postpaid for Ten Cents. Each circuit worth double. Send for your copy today.

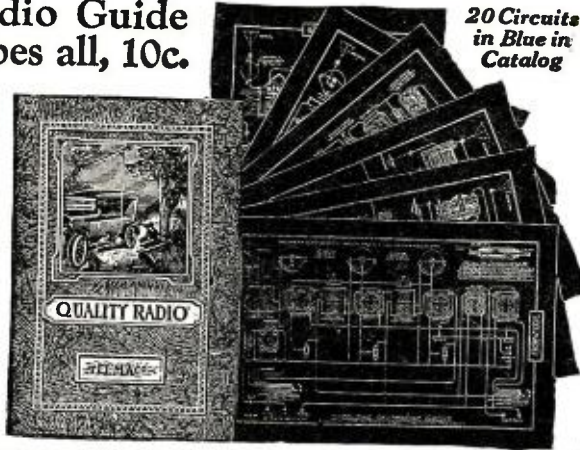

20 Circuits in Blue in Catalog

DEALERS! Our New Dealers' Catalog and Price List describes nearly all the better Standard Radio Lines. You should have it. Mailed FREE to all bonafide dealers making request on their business stationery.

TELMACO
Quality Radio Exclusively

Radio Division
TELEPHONE MAINTENANCE CO.
20 So. Wells St., Dept. B, Chicago, Ill.



Patent Pending
THE COPP VARIO-SELECTOR

Sold with Guarantee in Sealed Cabinet, \$11.50. Order direct or thru your Dealer. Circular on request. Note: The Copp Vario-Selector is NOT a Wave Trap.

CHANGE YOUR SINGLE CIRCUIT SET TO A DOUBLE CIRCUIT TUNER By Connecting With a COPP VARIO-SELECTOR

1. CHANGES any Single Circuit Set to a Double Circuit Set, without re-wiring and without re-building. Simply connects to antenna and ground and it is done.
2. ELIMINATES RE-RADIATION. This will be a great boon to Broadcast Stations and to all owners of Broadcast Receiving Sets.
3. GIVES SELECTIVITY to a Single Circuit Set equal to any three circuit tuner, preserving the Single Circuit simplicity of tuning.

THE A-C ELECTRICAL MFG. COMPANY, DAYTON, OHIO
Makers of Electrical Devices for Over 20 Years

Your Radio Batteries

(Continued from page 1578)

storage battery has one great advantage over dry cells in that it can be recharged while when dry cells are run down they are no longer of any use. Storage batteries used for radio work are of the same appearance and construction as the storage batteries used in automobiles. A well known type of storage battery is illustrated in Fig. 4. The types of six-volt tubes mentioned

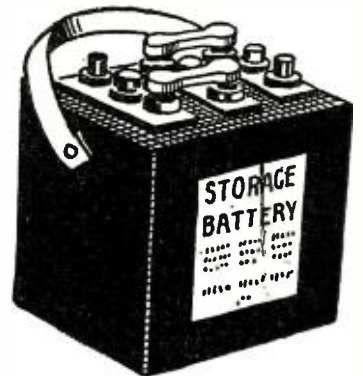

Fig. 4. A standard 6-volt lead plate storage "A" battery.

previously draw approximately 1.3 amperes each, except the UV-201A and the C-301A, which draw only ¼ ampere. It is always the best policy, when the total amount of current to be consumed by a number of vacuum tubes exceeds ½ ampere, to use a storage battery. Suppose for example, that your set employs one UV-201A vacuum tube; since this tube only draws ¼ ampere, four dry cells connected in series to equal 6 volts will run it the same length of time as one dry cell will run one WD-11 vacuum tube. However, they probably would not last a month and at such a time four new cells would have to be purchased. It is far cheaper in the long run to use a storage battery. Whether you are going to use three or five tubes it is best that the storage battery you purchase has a capacity of from 60 to 80 ampere-hours.

THE "B" BATTERIES

The "B" battery is the power house of the radio set and is the direct source of energy that supplies the volume to an incoming signal. The amount of current extracted from a "B" battery in a radio circuit is considerably less than the current drawn from the "A" battery. The voltage of the "B" battery, however, is very high in comparison to that of the "A" battery and if by chance it should be connected across the "A" battery filament terminals or binding posts, the vacuum tube filaments would immediately burn out. One cannot be too careful in this respect. Always be sure that the "B" battery is connected to the proper terminals. These are always marked B+ and B- while the "A" battery terminals are marked A+ and A-.

The most common forms of "B" batteries come in two sizes, viz., 22½-volt blocks and 45-volt blocks, as illustrated in Fig. 5. The detector tube in a receiving set most usually has a lower "B" battery voltage than the radio or audio frequency amplifier tubes. "B" battery voltage for the usual detector tube should be 22½ volts, although some tubes such as the UV-199 or UV-201A, when used as detector tubes, sometimes require 45 volts. "B" battery voltage for radio and audio amplifiers depends a great deal upon the type of tube employed. On small capacity tubes such as the WD-11, WD-12, UV-199 and C-299, the maximum "B" voltage should not exceed 60; usually 45 will be sufficient. On the larger amplifier tubes such as the UV-201, C-301, C-301A,

EASTERN COIL SETS

FOR THE
COCKADAY
CIRCUIT

are the
STANDARD
and in
UNIVERSAL
USE
due to
their proved
EFFICIENCY
in this
WONDER
CIRCUIT

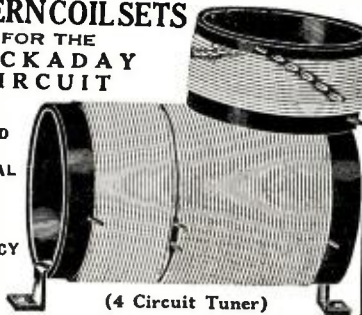

(4 Circuit Tuner)

Made as per specifications of Mr. Cockaday, "D" Coil bank-wound.

Complete assembled Set of B, C and D Coils on GENUINE BAKELITE TUBING, wound with No. 18 double silk covered wire. **\$4.25**

Original and new improved hook-ups with material lists FREE with each set of coils. GENUINE LAVITE RESISTANCES 48,000 OHMS. **\$1.50**

These resistances CONTROL the TONE of the COCKADAY CIRCUIT and eliminate all transformer distortion; modulating the tone after the fashion of the best of phonographs.

Mail Orders Filled. Dealers Communicate.

EASTERN RADIO MFG. CO.
22 Warren Street, Dept. R.N., N. Y. City

\$3 Brings you a Genuine
UNDERWOOD
TYPEWRITER

10 DAYS FREE TRIAL Your \$3.00 unconditionally returned if at end of 10 days you are not satisfied with this late model UNDERWOOD typewriter rebuilt by the famous Shipman Ward process.

GREAT PRICE SAVING Direct to you from the largest typewriter factory in the world by our money saving methods.

EASY MONTHLY PAYMENTS So small that you will not notice it while you enjoy the use of this wonderful machine.

FREE BOOK OF FACTS Explaining Shipman Ward's wonderful system of rebuilding typewriters and also valuable information about the typewriter industry both instructive and entertaining.

Act Today!
Mail
Coupon



5
Year
Guarantee

Shipman Ward
Mfg. Company
1855 Shipman Building
Montrose & Ravenswood
Aves., Chicago

Please send me a copy of your free book of facts, explaining bargain offer.

Name.....
St. and No.....
City..... State.....

USE HARD RUBBER PANELS FOR THE BEST QUALITY INSULATION

CELESTO PANELS

The Finest Genuine Hard Rubber Panels at 50 per cent Off



Hard Rubber with its superior Electrical properties is generally acknowledged by the foremost authorities as the best for the Radio Set. Don't be satisfied with a Panel "Just as Good." Get the real hard rubber panel and have no regrets.

CELESTO PANELS are made of the very finest, tested, hard rubber—and CELESTO PANELS are 50% lower in price. If your Jobber can't supply you write direct, giving his name and address and we will arrange to supply your needs. Prompt Service.

MANUFACTURERS—DEALERS

Make your plans now to give your trade service on this superior panel material. All panels are finished in a beautiful mirror-like gloss. A dull finish can be supplied on order.

Territories Still Open. Write at Once for Details.

TRIANGLE RUBBER & SUPPLY CO.

719 ATLANTIC AVE.

BOSTON, MASS.

Sizes

Black and Mahogany Finish

7x 9		6x24
7x10	8x12	
7x12	8x40	6x26
7x14	9x28	6x28
7x18		6x30
7x21	6x10	6x40
7x24	6x12	
7x26	6x14	
7x28	6x18	
7x30		6x 9
7x40	6x21	

USE HARD RUBBER PANELS FOR SUPERIOR ELECTRICAL PROPERTIES

Complete Parts for 1 and 3 Tube COCKADAY

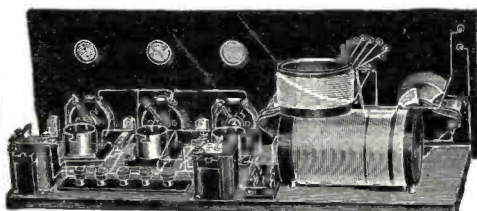

COCKADAY Parts for 3-Tube Set as Follows

7x21x3-16 Drilled Panel and baseboard	Our Price \$2.94
1 Cockaday Coil	1.95
2 Comsco 26-Plate Var. Cond. with Dials and Vern. Knobs	6.90
2 A. F. Trans.	8.00
1 Howard Ver. Rheo.	1.35
2 Howard 25-Ohm Rheos.	2.00
3 Firth Sockets	1.35
1 Switch Lever	.25
7 Points, 2 Stop and 8 Binding Posts	.55
1 Binding Post Strip	.05
2 Patent 2-Cir. Jacks	1.00
1 Patent 1-Cir. Jack	.35
3 Eria Bezels	.45
20 Feet Bus Bar Wire and Miscellaneous Screws, Nuts, Etc.	.25
Schematic Blueprint	.50
Grid Leak and Mica Condenser	.65
1-Tube Set (with pl. condrs.)	\$11.95
3-Tube Set	\$27.95

Panels Drilled FREE

Specially drilled panels are included with each of the sets illustrated and described above. We give this free service only on panels included with complete sets.

Complete Parts for ALL Receivers	
Herald & Exam. Set	\$ 5.95
1-Tube Eria	20.90
2-Stage Amplifier	12.95
Honeycomb Receiver	17.95
Ultra Audion	8.95
Overland Circuit	8.25
Haynes DX	10.95
Superdyne Receiver	15.85
Lang-45 Circuit	16.25



MAIL ORDERS: Address, Dept. N-6, Chicago, Ill.

SALVAGE MEANS Save, Service, Satisfaction

When you buy that radio apparatus from the Chicago Salvage Stock Store, the world's greatest radio store, you can be certain of these three things:

1. You have saved money through the hundreds of radio bargains made possible by our enormous buying power.
2. You have been served intelligently by men who are qualified radio experts.
3. You have bought quality apparatus because we handle nothing but brand-new merchandise GUARANTEED to give complete satisfaction.

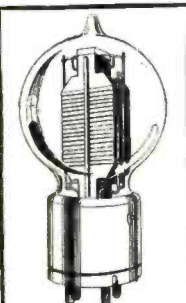

Western Electric VT-2 Tubes \$7.45

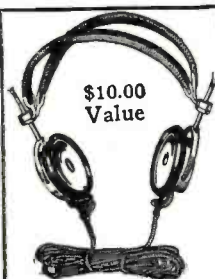

Automatic Electric Headset \$3.65

Complete Parts for 1 and 3 Tube REINARTZ

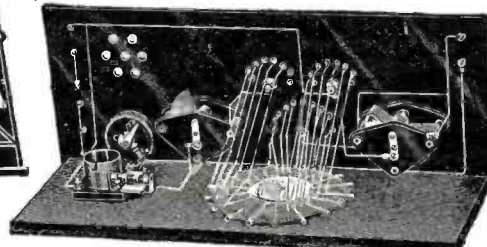

7x18 Formica Panel	Our Price \$1.70
Bakelite Socket	.45
Howard Ver. Rheo	1.35
23-Plate Var. Condr.	1.45
11-Plate Var. Condr.	1.35
1 Reinartz Var. Grid Leak and Condr. comb.	.75
3 Switch Levers	.75
8 Binding Posts	.40
2 Doz. Switch Pts.	.40
25 Ft. Tinned Wire	.15
Baseboard for Mtg.	.25
Blueprint with complete instruction for assembling and wiring	.50
Reg. Price, \$21.69	
Our Price . . . \$11.45	

New Catalog Ready! Send 10c for copy today!

Complete Parts for 3 & 5 Tube NEUTRODYNE

- With FREED-EISMAN OR FADA LICENSED PARTS
- Parts for 5-Tube Set as follows:
- 7x28x3-16 drilled and engraved panel with baseboard.
 - 2 Audio Frequency Trans.
 - 3 Eria Bezels.
 - 1 .001 Mica Condenser.
 - 1 I. M. F. D. By-Pass Cond.
 - 3 Filament Control Jacks.
 - 3 4-Inch Dials.
 - 1 Howard Vernier Rheostat.
 - 1 Howard Plain Rheostat.
 - Strip of Bakelite.
 - 8 Binding Posts.
 - 2 Firth Sockets.
 - 1 3 Gang Firth Socket with mountings and screws.
 - 20 Feet Bus Bar Wire.

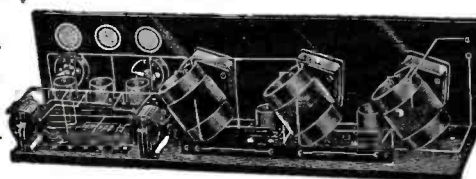

3-Tube Set \$28.60

Screws, Nuts and Miscellaneous set. Construction Book and Schematic Print. Grid Leak and Mica Condenser.

5-Tube Set \$46.25

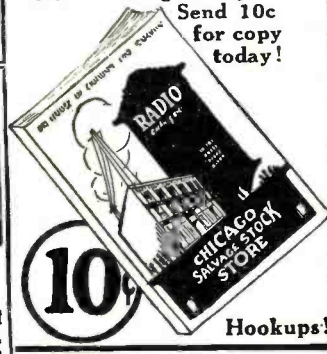

ONE "GOLDCREST" MODEL

\$60

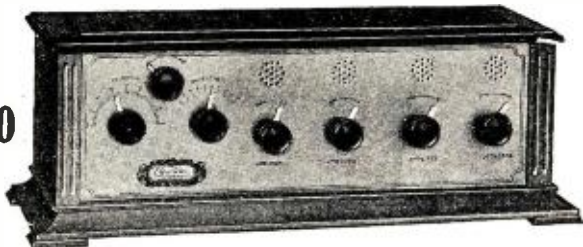

DON'T LOOK AT THIS AD UNLESS

you are looking for the Best Radio receiving set ever offered to you.

NOT A BARGAIN, A REAL BUY!

LOOK at the beautiful solid mahogany cabinet and the distinctive gold finished panel which is beautifully etched. You would be proud to own this receiver and show it to your friends. It is not only beautiful, it is efficient. It will consistently bring in with loud speaker volume stations from one thousand to fifteen hundred miles away.

We have an offer to make you so that you can see for yourself what the model 60 will do. Just think, a four-tube radio frequency receiver for \$60.00. We have other models also that are just as great values. **DONT HESITATE. WRITE TO US NOW FOR FREE ILLUSTRATED CIRCULAR AND OUR OFFER. IMMEDIATE SHIPMENTS MADE ON ALL ORDERS.**

ENJOY THE WONDERFUL EASTER PROGRAMS WITH A GOLDCREST RECEIVER

Model 60, \$60.00; Model 61, \$75.00. Solid mahogany console Model 62, \$120.00.

DEALERS, JOBBERS—Don't miss this opportunity; write for our interesting proposition. We will have information of even greater value to you very soon.

The Cleartone Radio Company

Cincinnati, Ohio

The Ideal Battery for *WD12* or *UV201A* Tubes

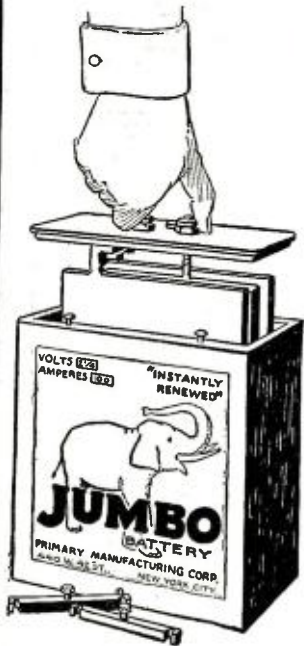

The single Jumbo for *WD12* tubes, the Double Jumbo for *UV201A* tubes, will each operate 3 tubes four hours daily for forty days—with a renewal cost of 65c and 95c, respectively.

The statement is made after renting thousands of Jumbo Batteries to radio fans in the New York territory at a flat monthly rate, regardless of the number of times the battery might require recharging.

Instantly Renewable

Jumbo Batteries require no service station or electric current for recharging. Spare renewal plates may be obtained from your dealer or by mail from the factory.

Prices—Single Jumbo, \$5.25; Double Jumbo, \$10.00
Write for descriptive folder and special offer

Primary Manufacturing Co.
442 West 42nd St. New York

It's Easy to Build Things

With a **JUNIOR BENCH SAW**
Does your ripping, mitering, grooving, rabbeting, tenoning, sanding, grinding, and many other operations with surprising ease and accuracy. Top 10"x13". Saws 1 1/2" stock. Cuts 3/4"x3/4". Machine built entirely of metal. Driven by 1/4 or 1/3 hp. motor. Portable. Attaches to any light socket. Extremely accurate.



Descriptive circular tells many things of interest to workers in wood and soft metals

W. & J. BOICE, 1730 Norwood Ave., Dept. 805, Toledo, O.

DEALERS

Send for new price list of parts & knocked down outfits.
RADIO PARTS MANUFACTURING CO.
1515 Marlborough Detroit, Mich.

BLANK CARTRIDGE PISTOL



Well made and effective revolver modeled on latest type of Revolver. A spare magazine also is enough to secure a burglar. When loaded it may be as effective as a real revolver without danger to life. It takes standard .32 Cal. Blank Cartridges obtainable everywhere. Price 50c. Superior quality \$1.00 post paid. Blank Cartridges, by order, 50c per 100.
JOHNSON SMITH & CO., Dept. 113 Racine, Wis.

WHY NOT spend Spring, Summer and Fall gathering butterflies, insects? I buy hundreds of kinds for collections. Some worth \$1 to \$7 each. Simple outdoor work with my instructions, pictures, price-list. Send 10 cents (not stamps) for my illustrated Prospectus before sending butterfly. Mr. Sinclair, Dealer in Insects, Dept. 37 Ocean Park, Calif.



UV-201A and *216A*, plate voltages from 60 to 100 can be used. An increase of "B" battery voltage on amplifier vacuum tubes will increase the resultant volume of incoming signals but above a certain point it will be found that, though the volume is considerable, speech and music is distorted.

THE "C" BATTERY

When employing high "B" battery voltage for obtaining volume, a "C" battery should be employed. The explanation of the functioning of the "C" battery is above the head of the beginner and it is enough to say that it allows the use of high "B" battery voltage without creating distortion of speech and music. Distortion will sometimes occur in amplifiers employing low "B" battery voltage. The use of a "C" battery in this case will also eliminate distortion. The commercial form of "C" battery is illustrated in Fig. 6 and the way it is connected in the

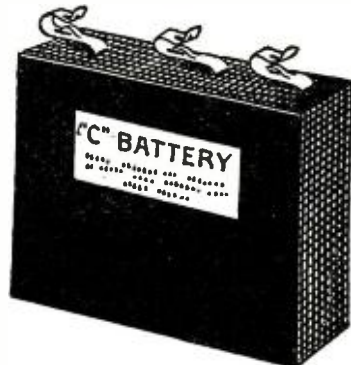

Fig. 6. A 4 1/2-volt "C" battery of the dry cell type, with a tap at 3 volts.

radio circuit having a two stage audio frequency amplifier is shown in Fig. 7. Tracing this circuit out, it is seen that the two lower secondary terminals of the audio frequency transformers are connected together and a wire from this connection leading to the negative (-) post of the "C" battery. The positive post of the "C" battery is connected by a wire to the negative post of the "A" battery.

THE CARE OF RADIO BATTERIES

Dry cell "A" batteries do not really require any care, but as previously mentioned, it is necessary to renew them at definite intervals. When the dry cell "A" batteries

start to run down, the filaments of the vacuum tubes naturally will not light to their full brilliancy. This cannot always be determined by the eye since the filaments of *WD-11* and *WD-12* vacuum tubes do not burn very brightly. Run down "A"



Fig. 8. A hydrometer used for determining the specific gravity of the electrolyte of a lead plate storage battery.

batteries, however, are denoted by a dropping off of volume or the inability of the radio set, if it be of the regenerative type, to oscillate at the upper portion of the regeneration dial. Oscillation is denoted by a clucking noise in the head phones or the loud speaker when a certain position on the dial is reached.

Storage "A" batteries require attention from time to time. There are two ways of determining whether a storage battery is run down, or, in other words, discharged. First by the method described above and second by the use of a hydrometer (see Fig. 8).

The liquid, known as electrolyte, in the storage battery has what is known as a specific gravity. The specific gravity of the liquid is much higher when the battery is charged than when it is in a discharged condition. The hydrometer is employed for measuring the specific gravity of this liquid and consists of a long glass tube with a rubber bulb at one end and a rubber tube at the other end for sucking up the electrolyte. Inside the glass tube is a small float weighted with lead shot, at one end, with a graduated scale at its other end. The specific gravity of the liquid in the tube is determined by reading the number on the graduated scale that is level with the top of the liquid. A storage battery when in a fully charged state gives a gravity reading of the electrolyte of 1.275 and 1.110 when completely discharged. The battery, however, should never be allowed to get in a completely discharged state. When the specific gravity of the electrolyte reaches a rating of 1.150, the storage battery should be charged and left until the hydrometer again reads 1.275. Remember to take a gravity reading of the electrolyte in all three cells of the battery. There are a number of types of storage battery chargers on the market and the type used is more a matter of preference than anything else. It is not necessary to cover the means of charging the storage battery here, for full directions are always given with the chargers. There is, however, one important point to mention and that is, "does the electric light system in your house employ direct current or alternating current?" If it is direct current you must purchase a direct current charger and if it is alternating current, an alternating current charger is required.

"B" batteries similiar to "A" batteries sooner or later run down since current is being drawn from them. The way to determine whether a "B" battery has come to the end of its useful life is by measuring the voltage across its terminals. This is done by means of a voltmeter which is illustrated in Fig. 9. When the leads of the

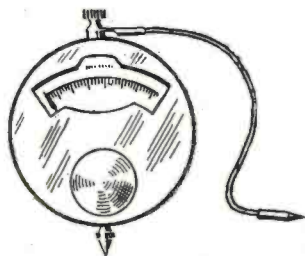

Fig. 9. A voltmeter used for reading the voltage of "A," "B" and "C" batteries.

voltmeter are touched by the two terminals of the "B" battery, the little needle will move along the scale and stop at some definite number which will be the voltage of the battery. As soon as a 22½ volt "B" battery reaches a voltage of 10 it should be replaced by a new one; it is no longer of any use. You will find by experience that after the "B" battery gets down around 17 volts that from then on the voltage drops rapidly. It is very important therefore, that you should take frequent voltage readings of every battery in the circuit. The life of the "C" battery in the radio set is pretty near equal to its shelf life, that is, its life when not connected to any apparatus. This is for the reason that no current is taken from the "C" battery. A good "C" battery should last for a period of eight months or a year after which time it is best to replace it with a new one.

RAVING BEAUTIES

The recent beauty contest held by radio in the studio of WLW brought a number of requests from girls who wanted to participate. Perhaps their not being selected by the judges made them raving beauties.

Announcing the "GEMPHONE"

the DOLLAR 1000 ohm ADJUSTABLE PHONE

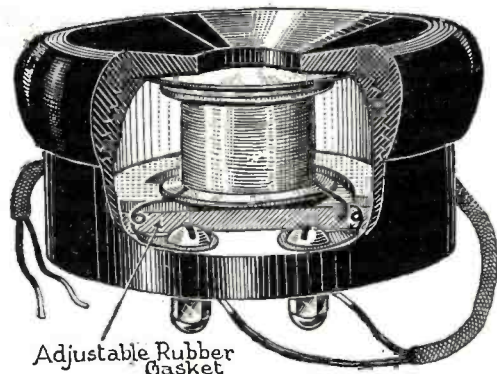

Adjustable Rubber Gasket (Patent Pending)

Don't judge the "GEMPHONE" by its price. It is the cheapest radio phone on the market but its exclusive features place it in a class by itself. Its performance, the clarity and volume of sound reproduction, the faithfulness with which it reproduces radio broadcasting and code, the exquisite quality of tone together with a remarkably loud and clear volume, make it the equal to, and in many cases the superior of, phones at three and four times its price.

The "GEMPHONE" is of standard type and made of the very best grade of materials throughout. It is adjustable—one set screw enables you to adjust the phone to secure perfect reception under any condition.

The case is made of turned wood, an exclusive feature with the "GEMPHONE." This feature is responsible for its exceptionally rich and mellow tone.

The "GEMPHONE" is sold unassembled. The coil is wound to 1000 ohms—all you need to do is to place the parts into the case, tighten up the adjusting screw and connect the terminals and cord. Our instruction pamphlet shows how to assemble it in two minutes, using only a screw driver.

\$1 with 3 ft. Cord \$1
Shipping Charges Prepaid to any point in the U. S.

This Complete Radio Receiving Set

Consisting of Radiogem Gemphone and Aerial
\$250



This outfit is absolutely complete. It includes everything you need to hear the Broadcast Programs, market reports, time signals, slip calls or land station messages. Nothing more to buy—no batteries or tubes needed—no upkeep of any kind. The simplest radio outfit made—yet as practical as the most expensive. A crystal receiving set that you can operate and enjoy even though you know absolutely nothing about radio. You receive the RADIOGEM unassembled, together with a clearly written instruction book, which shows you how to quickly and easily construct the set, using only your hands and a screwdriver. The instruction book explains simply and completely the principles of radio and its graphic illustrations make the assembling of the RADIOGEM real fun.

Price of Radiogem without phone or aerial, \$1.00

Order Direct or From the Following Dealers:

- | | | | |
|---|---|--|--|
| Akron, Ohio
H. Kaplan Radiogram Agency | Dallas, Texas
Cullum & Boren Co. | Media, Pa.
Media Elec. Co. | Rew, Pa.
R. B. Rupert |
| Astoria, Ore.
Cook & Foster | Emmitsburg, Md.
Maryland State Adv. Serv. | Melbourne, Australia
Maris & Abrahams, Pty., Ltd. | Rockland, Mass.
D. & H. Motor Co. |
| Boston, Mass.
Farley & MacNeill | Gary, Ind.
Tribe of K | New York City, N. Y.
Conrad Co. | Saginaw, W. S., Mich.
J. A. Loubert & Co. |
| Brooklyn, N. Y.
D. S. Qualey | Grand Rapids, Mich.
Specialty Sales Bureau | Norfolk, Va.
F. J. Sawyer | St. Louis, Mo.
United Supply Co. |
| Burlingame, Cal.
I. G. McCrory Co. | Hamilton, Ohio
W. Hoffmeister | Northampton, Mass.
Parsons Elec. Shop | Seranton, Pa.
Haywood Tire Surgery |
| Capetown, South Africa
H. J. Williams | Hawera, New Zealand
H. H. Blake | Omaha, Neb.
Burgess-Nash Co. | Seattle, Wash.
Frank B. Wilson |
| Chicago, Ill.
Barawik Co. | Holyoke, Mass.
The Johnson Co. | Oregon City, Ore.
R. M. Shlaes Co. | Springfield, Ohio
Moore Sales Service |
| Home Supply Co.
International Industries | Jersey City, N. J.
Maizie Music & Radio Shop | Pullman, Wash.
Elec. Supply Store | Syracuse, N. Y.
Syracuse Supply Co. |
| Cleveland, Ohio
Anderson Elec. Co. | Los Angeles, Cal.
Lester's Radio Shoppe | | Washington, D. C.
Capital Radio Co. |
| Service Publishing Co. | Lynn, Mass.
E. C. Woodman Co. | | J. T. Smyth |

THE RADIOGEM CORP., 66-R-West B'way, N. Y. City
DEALERS--Write for Prices and Circulars.

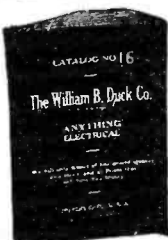

DUCK'S

have blazed the way with the best and most dependable radio products.
FREE

Big 256 pp. Combined Radio Catalog and Text Book—No. 16. Mailed for 25c. in coin or money order. Not sent otherwise. Full of radio information and hook-ups. Prices extraordinarily attractive. Ever since 1909 Duck's catalogs have been the best and most dependable radio products.

Send postal for our special price list on all radio instruments in our catalog and countless new instruments and sets not in Catalog No. 16. Of special importance to those having catalog No. 16.

THE WILLIAM B. DUCK CO.

711-12 ADAMS STREET Dept. 3 TOLEDO, OHIO

Spintite Wrenches

MAKE THE HEX "BEHAVE"

That's exactly what this new tool does for you—makes the hex nut "behave!" Puts an end to fussing and mussing with pliers in cramped corners.

Held securely in the hexagon head of "Spintite," a hex nut can be screwed tight, no matter how confined the working space.

Hollow stem goes over projecting screw-end. Ebonized handle, built to fit the finger grip, spins hex on in a jiffy. Hooking up becomes a joy with the "Spintite." You'll get greater distance and volume.

Sizes $\frac{1}{8}$ " to $\frac{3}{8}$ ". 35c each. Large phone jack sizes, $\frac{1}{4}$ " and $\frac{3}{16}$ ", 65c each.

If your Dealer can't supply you send his name and write us direct

STEVENS & CO.

Toolsmiths since 1899

373 Broadway, New York

Send \$3.50 for Set 73 (professional); 7 sizes, $\frac{1}{8}$ " to $\frac{1}{2}$ " in handsomely finished metal base.

Send \$1 for Set 71 with three popular radio sizes.

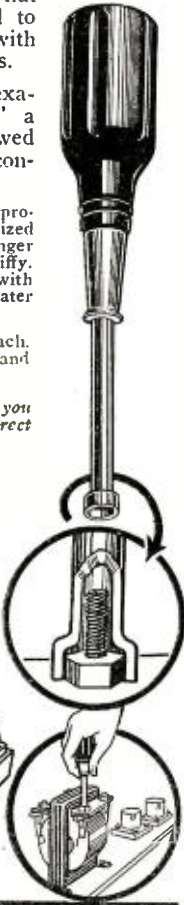

Stevens SPEED UP Tools

Choosing and Installing a Receiving Set

(Continued from page 1579)

point should be decided before buying a set. If the beginner lives in some locality that is not supplied with commercial electricity, a storage battery will not prove practicable, as there will be no means of charging it. The battery can, of course, be carried to some charging station, but this procedure, besides being very inconvenient, necessitates a period of time wherein the receiver must remain inoperative. This is a case where dry cell tubes can be used to advantage. UV-199 or C-299 tubes will prove best, as their current consumption is very low—being .06 ampere. This tube must be used with three dry cells, but if only one tube is employed in the set the dry batteries will last three or four months. If three tubes are used, new batteries will not be needed for one or two months. This of course applies where the set is not used more than an average of two or three hours a day.

AERIAL AND GROUND

If the receiver selected is to be used with an aerial, there are several points that must be observed when erecting it if best results are to be obtained. The antenna should, if possible, be at least 40 feet high and 60 feet long. The best all-round receiving antenna is a single wire about 100 to 120 feet long, including the wire leading in to the set. It should be strung in such a manner that it will not swing and come in contact with trees or buildings. If one end is connected to a tree, it should be so arranged that the actual antenna does not enter the foliage of the tree. This can be done by connecting the antenna, through an insulator, to a rope that is long enough to carry it beyond the tree's branches. In some localities it is not possible to use an outdoor antenna, in which case very good results can usually be obtained by winding 100 feet of wire around the walls of the room, near the ceiling. Although this type does not equal the usual outdoor antenna, with a good regenerative set distance reception should be had. The lighting circuit can sometimes be used as an antenna very effectively by employing one of the antenna plugs on the market for this purpose. The plug is screwed into the electric light socket and a wire run from the binding post provided, to the antenna binding post on the set.

A good ground is very important in the efficient operation of the receiver. An excellent ground can be made by connecting to a water pipe or radiator. If possible, a cold water pipe should be used, although a hot water pipe or a radiator can be employed with excellent results. Under no circumstances should a ground be taken from a gas pipe. In connecting a ground to a pipe the pipe should be filed perfectly clean and the connection made by means of a good ground clamp. The ground wire running from the actual ground to the set should be just as short as it is possible to make it.

CONNECTING UP THE SET

A radio set is very easily connected up, although it is of prime importance that the person doing the actual installing keep his wits about him.

Every radio receiver has a series of binding posts to which the necessary connections are made. First, there are the two "A" or filament battery binding posts. They are marked A+ and A-. Naturally the positive (+) post of the "A" battery connects to the A+ binding post and the negative (-) post of the "A" battery to the A- binding post. Next, there are "B" battery binding posts, two of them on a one tube set and three of them on a three tube set. Of this number there is only one binding post



SIMPLE SIMON

A new regenerative tuner using no switches and only one control. Three thousand miles has been conservative range during winter. This set works on a loop up to hundreds of miles, or with a ground wire only, without either aerial or loop. Just the thing to stop re-radiation. Priced at \$18.00. Add P.P. on 9 pounds. This is our type SS Amplifier to match at \$18.00.

3000 MILE RADIO TRESCO TYPE X REGENERATIVE RECEIVER



Licensed under Armstrong U. S. Patent No. 1113149. For resale to amateurs only. Thirty customers report receiving Scotland during Radio Week. A complete 3,000-mile Armstrong Regenerative tuner for \$25. Use it with any make bulb WD11 or 12, or dry battery operation as well as storage battery. Complete with bulb, batteries, phones, etc. . . . \$37.50 Circular for 2 cents. This set received "Chicago American" Regional prize of \$350.

plates with bulb, batteries, phones, etc. . . . \$37.50 Circular for 2 cents. This set received "Chicago American" Regional prize of \$350.



500 TO 1000 MILE Regenerative Tuner

Two controls at \$12.50 only. Add P.P. on 9 pounds. This set is portable and uses any type tube.

Send Stamp for Circular

TRESCO, DAVENPORT, IOWA



No. 806 Height, 23 in. Bell, 10 1/4 in. \$1750

"Madera" Die Cast WOOD

"Clearspeakers"

Give Radio a New Power and Tone-Purity

"Madera," a wonderful artificial wood, twice as dense as seasoned hardwood, is cast in steel dies under great pressure and heat.

It gives our "Clearspeakers" a harmonious resonance that glorifies any radio set, reproducing signals with remarkable purity, clearness and volume.

Each "Madera Clearspeaker" is fitted with a special loudspeaker unit, and is ready to attach to any set designed for loudspeaker service—even the better crystal sets.

You'll never know real radio till you hear it thru a Madera Clear-speaker.

No. 804 \$15.00

Madera Clearspeakers

are offered in 5 styles and sizes, two of which are shown here.

Your Dealer should have them in stock. If he has not, write us for circulars giving us dealer's name and address.

American Art Mache Co. 343 W. Austin Avenue CHICAGO



12 in. high

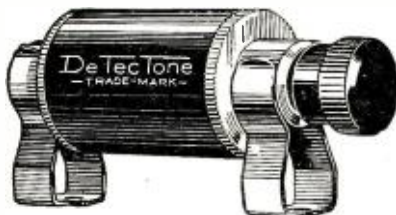

DE-TEC-TONE CRYSTAL DETECTOR

Just turn the knob—DE-TEC-TONE does the rest. Ends reflex troubles. If your dealer hasn't it, send \$1.50 for one, postpaid, complete in carton with mountings. Manufactured by

PYRAMID PRODUCTS CO.

117 N. Dearborn St., Chicago, Ill.

STAMMERER'S
We can cure you. Write for free Booklet telling how.
STAMMERER'S INSTITUTE
246 Huntington Ave., Boston, Mass.



Charge Your Battery For A Nickel

The Gold Seal Homecharger Charges Radio and Auto Batteries at home overnight for a nickel. Your dealer has it. Write for FREE booklet and list of broadcasting stations.

The Automatic Electrical Devices Co. 118 W. 3rd St., Cincinnati, O.

marked B— and the negative (—) pole of the "B" battery connects to it. The second post, and the first B+, is for the detector tube and to this is connected a wire from the 22½-volt tap on the "B" battery, which is a positive (+) pole. The second B+ binding post is for the amplifier vacuum tubes and to this is connected the positive (+) pole of the "B" battery that has the largest voltage. This, you will find, proves to be the terminal farthest away from the negative (—) pole.

There are two more binding posts, one for the aerial and one for the ground. The aerial binding post is marked A and the ground binding post either E or G. After these connections are made, the vacuum tubes placed in the sockets and the earphones or loud speaker plugged in or attached to the "phone" binding posts as the case may be, the set is ready for reception.

International Radio Notes

(Continued from page 1599)

into this field. English apparatus is high-priced and German imports are irregular. Only dry-cell sets and tubes are desired, since there are few charging plants. A popular piece of apparatus is a three-tube dry cell, American set, capable of receiving 300 miles with a loop aerial. The humidity and continued static make good insulation and radio frequency necessary. Prices for receiving sets vary from \$15 for crystal sets to \$250 for three-tube sets.

Colonial authorities have not taken definite action on the use of radio sets in the Foreign Colony, but are awaiting the arrival of an expert from London, temporarily permitting experimental broadcasting and receiving subject to the approval of the Hong Kong Radio Society. Regenerative sets are prohibited. Assurance that American sets will not be discriminated against is given.

Radio exports for the year 1923 totaled \$3,448,112, compared with \$2,897,799 last year, according to Department of Commerce statistics. While the shipments of radio apparatus form only about 5 per cent. of the total value of all electrical exports, which in 1923 passed the \$72,000,000 mark, radio exports increased about 7 per cent. out of a total gain of \$9,000,000. December radio exports totaled \$335,308, compared with \$381,827 for November and \$270,061 in October. In November, the bulk of American radio apparatus sent out of the country went to Argentine, Quebec, Ontario, Australia, Panama, Mexico and England. Twenty-four countries purchased apparatus valued at over \$1,000 from American exporters.

More than 12,260 miles of aerial wire have been erected in Great Britain in the last 12 months, so much has the radio craze seized the public. It is estimated by officials of the British Broadcasting Company that 2,000,000 people are entertained daily at a cost of a farthing each.

The company claims that wireless has stimulated industry considerably. It has necessitated the opening up of a new sub-head in the directory for "radio supplies dealers;" £100,000 has been paid to the entertainment industry in salaries, fees and copyright royalties, and large numbers of engineers and studio staffs receive employment at the various sending stations.

RADIO FREQUENCY AMPLIFICATION with the BALLANTINE VARIOTRANSFORMER

How to get increased distance with your crystal set



with BALLANTINE VARIOTRANSFORMER UNITS

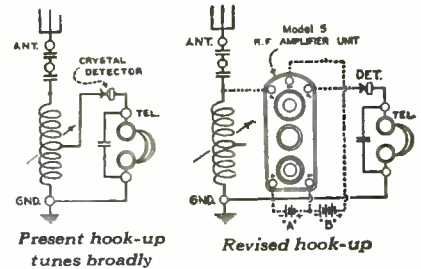

YOUR crystal set is the starting point on which to build a good distance receiver. For authorities agree that there is nothing finer than a good crystal for clean-cut detection—not so loud as a tube, perhaps, but much clearer. Simplicity itself is the crystal. And its improved modern forms and mountings make adjustment easy. By all means, keep this element with which you are already familiar.

Use tubes to best advantage

Tubes, of course, are needed for amplification—to build up weak distant signals so that they may operate your crystal detector. But, by putting your money for tube equipment into one or more stages of radio frequency amplification, tuned with BALLANTINE VARIOTRANSFORMER Units, you will get increased distance. And with this method there comes a greater selectivity, accompanied by a reduction of interfering noises. In fact,

BALLANTINE amplification into a crystal detector may be made as clear as a victrola. Furthermore, the full possibilities of your tubes may be developed without annoying your neighbors.

Easy changes quickly made

The above diagrams show how one popular make of crystal set can be brought up to date quite readily—only a slight rearrangement of wiring to hook in the first BALLANTINE Unit. And it's just as easy with any other crystal hook-up. Additional BALLANTINE Units may be inserted from time to time.

Try this instrument. Then, if there's anything you don't understand, our staff engineers will help you out.

Booklet tells how to improve crystal sets

"Radio Frequency Amplification with the BALLANTINE VARIOTRANSFORMER," is the title of our 25-page booklet, packed with useful data, charts and diagrams. Send for your copy now.

BOONTON ROEBER MFG. Co.
Pioneers in Bakelite Moulding

624 Fanny Road, Boonton, N. J.



RADIO FREQUENCY AMPLIFICATION with the BALLANTINE VARIOTRANSFORMER

Save 1/2 Cost of New Tube

GUARANTEED VACUUM TUBE REPAIRS AT POPULAR PRICES.

- We try to maintain 24-hour service.
- All repairs guaranteed.
- Tubes satisfactory or money refunded.
- Special discounts to dealers.
- Send broken and burned out tubes parcel post.
- Repaired tubes returned parcel post, C. O. D.

HARVARD RADIO LABORATORIES
200 OLD COLONY AVE. SO. BOSTON, MASS.



TRY the Marvelous Improved Eliminator of Undesired Signals

Pfanstiehl

SILENCER



TRAPS THE ENEMY WAVE

and silences the interfering station and enables you to get the signals you want to hear.

May be used to sharpen tuning, and will diminish A. C. hum, spark interference and some static noises.

\$8 Postpaid
Or at your dealer's.

Pfanstiehl RADIO SERVICE COMPANY
Highland Park, Illinois

ANNOUNCEMENT

You must try the new **PURE-TONE Amplifier (2 Stage)**



It achieves a new standard of rich quality. The full pure tone of this instrument is the result of recent advances in the art of amplification.

SPECIAL PRICE COUPON

Send me Pfanstiehl Pure-Tone Amplifier. Enclosed find money order or draft for \$17.50 (or send C. O. D.) Satisfaction guaranteed.

.....
.....
.....

Pfanstiehl **PURE INDUCTANCE** for radio efficiency

RADIO PARTS

Try the **NEW** *Pfanstiehl* **TUNING UNIT** in the **Efficiency** hook-up and hear stations you never heard before



Price \$5.00

Postpaid or at your dealer's

A Radio Auxiliary Language for Trans-Oceanic Works

(Continued from page 1565)

greater governmental tolerance regarding amateur activities, a great volume of new business is bound to result. It is true that transmitting stations will be held down at first to a relatively small number; with narrow restrictions as to power, antennae, etc., but in the end the impulse for adventure among even Oriental radio fans will react on the authorities to produce greater freedom of radio activities.

MORE ADVANTAGES

So far, I have not mentioned the great advantages which will accrue to those whose activities are along technical or scientific lines.

There are probably not more than 250,000 real leaders of thought in the world today. For such as these, the burden of Russian, for example, which is ponderously rich in technical literature, is a real "thought retarder." The Russian Communists have officially adopted Ilo and made it compulsory in their propaganda. It is a sign that the use of the RAIL as a medium of propaganda is a tremendous advantage. The Russian organ is called "Nia Standardo" (Moscow).

The problem of a radio vocabulary has been practically solved by engineers in Europe and America. I have a list of 1,300 radio and electrical terms in "Ilo" which are truly international and enable any radio enthusiast to talk with a fellow fan after a few lessons. These terms are read at sight, as they are self-explanatory.

It is hardly necessary to dwell on the advantages to manufacturers and engineers, conferred by being able to communicate with 10 to 40 countries in one simple tongue. The Crosley Radio Corporation has received orders from Switzerland in Ilo, and I have done business with French, German, Swiss and Swedish business men who have taken up Ilo as a pastime.

Those who want to start in with Ilo may write to Thanet Radio Society, 114 North-down Road, Margate, England. There are several hundred members. Edgar Gurle, Beckenham, Engineers' Club, Coventry St., London, S.E., has a fine laboratory and wants to try the RAIL.

A. Crane, 44 Brookbank Rd., London, S.E. 13, (2AAA) wants to get to work with American amateurs and so does Percy V. Jarves, Boaz Island, Bermuda.

To receive the latest "flashes" of radio news from 20 countries first hand is well worth a few weeks or even months of easy study and practice.

PRACTICAL APPLICATION

The radio fan may now very properly ask "whom shall we write to on the Continent?"—In the first place, there are "I.L." Radio Clubs in Europe whose members are already asking for addresses of radio fans in other countries. There are 120 pages of addresses (4,800) in the Ilo correspondents' list issued annually at Luxemburg. It is called "VAK."

Russian radio engineers who have done wonders, under their present difficulties, as indicated in Bashenoff's "I.R.E." (June) paper,—welcome such a simple language in order to get "checks" in their experiments from a greater number of radio listeners. The communists and the Germans used the "I.L." during the war extensively.

The International Union of Scientific Radio Telegraphy will be enabled to do far better work, using "Ilo" in checking its results by the co-operation of fans in both Europe and the Western Hemisphere than

JUST THE BOOK YOU WANTED



"Radio News" Amateurs' Handbook

Volume No. 1. (Second Edition)

Chock full of radio constructive and instructive articles from cover to cover. Written by foremost radio authorities, in plain everyday language which everyone can understand. Sections include articles on Receiving Sets and Sundry Apparatus, Transmitters and Accessories, Radio Theory, Vacuum Tube Data, and Practical Hints for the Amateur. A book which also serves as a ready reference and should find a place in the library of every amateur. It contains 224 pages and over 375 illustrations, diagrams, and photographs, bound in a multi-colored heavy board.

On sale at all leading radio stores. If your dealer cannot supply you, send a dollar bill and the book will be forwarded to you postpaid.

Price \$1.00

EXPERIMENTER PUBLISHING Co., INC.

53 Park Place, New York

HUNDREDS OF RADIO FANS

Are saving money by buying their radio supplies from us. Send stamps for large radio catalog. **24-HOUR SHIPMENTS**

The Cut Rate Radio Co.
P.O. Box 472 Dept. C Newark, N. J.

PATENTS ON RADIO IMPORTANT PROTECT

Mason, Fenwick & Lawrence
Patent & Trade Mark Lawyers
Washington, D. C. New York Chicago
Established over 60 years

TYPE WC-10 RADIODYNE RECEIVER

A super receiver of the compound circuit type. For use without outside aerial. So sensitive will pick up radio music and speech when other types fail. Price without tubes and batteries \$150. Big catalog 10c. Dealers write. Distributed by **TELEPHONE MAINTENANCE CO.** 20 So. Wells St., Dept. B-1, Chicago, Ill.

YOU DON'T NEED TUBES

to hear programs from stations 400 to 1000 Miles Away. I can show you how to get them on **YOUR CRYSTAL SET.** Changes often cost **Less Than One Dollar.** Send self-addressed envelope for picture of my set.
LEON LAMBERT
595 So. Volusia, Wichita, Kansas

by having to obtain test data from a relatively limited body of observers, in several languages.

It requires no imagination to appreciate what internationally readable tests sent out simultaneously on I.C.W. from various broadcast stations would mean in locating static producing sources or areas of fading. The obscure factors affecting these phenomena would be more quickly traced than ever before.

I hope that every ambitious and intelligent person who is reading this article will try to imagine how their interest in radio will be deepened by correspondence with radio fans in the countries of Europe.

It will make DX work truly international by breaking down the differences of speech which take so heavy a toll of our ideas as soon as we start to cross intellectual "customs barriers." We should not hesitate—thought is liberated by the "RAIL."

Station "WLW", the Crosley Mfg. Co., Cincinnati, Ohio, has been teaching "Ilo" by radio. The first broadcast station in the world to "go across" with an "I.L." talk to Europe was "WGI", at Medford Hillside, Mass., with a talk in English, and "Ilo" at 8:45 P.M., December 19, 1922. Other stations soon followed. "WNAC", Boston, gave local "Ilo" talks in November 1922.

The writer will be glad to help those who are in doubt about the relative naturalness and ease of Ilo. Comparative translations of a text into the systems will be furnished to those who want a decisive proof of the expressiveness and logic of "Ilo."

Do you want to communicate with your co-workers in Europe without wracking your brains during the next 18 months in trying to learn French, Swedish, Danish, German, Spanish, Italian, and perhaps Russian? The very idea is preposterous! Help to banish it by learning "Ilo" now. Write to me at Beacon Chambers, Boston, Mass. on how to get books and form classes.

While the Sun Shines

(Continued from page 1591)

relay work. This has proven to be "fine business" as can be easily judged by referring to the results obtained by French 8AB, and 1XAM and 1MO, who first worked him from this side of the water. Whether or not anyone has worked below the 100-meter wave for any length of time during the daylight, I do not know, but from recent tests made by the Westinghouse Electric and Manufacturing Co. between their broadcast stations KDKA and KFKX, it seems evident that there is an entirely new field for the amateur below 100 meters. It has always been taken for granted that no matter what the wave-length of a transmitted signal might be, its propagation during the daytime was retarded by the effect of the sun's rays and that consequently its freeness from obstacles during the dark hours increased the transmitting range about one-half. This assumption has been well supported for the reason that no other phenomenon ever made itself evident and for the reason that no research work was carried on below 100 meters. Audibility curves of the reception of daylight signals from KDKA have revealed a rather startling phenomenon in connection with waves in the vicinity of 70 to 90 meters. The accompanying curve tells the whole story. It will be seen from this that the 100-meter signal has about twice the audibility at a definite receiving station in the night time as it has in the day time. The 80-meter wave, however, has directly opposite characteristics, namely, its audibility during the day has twice the amplitude at a

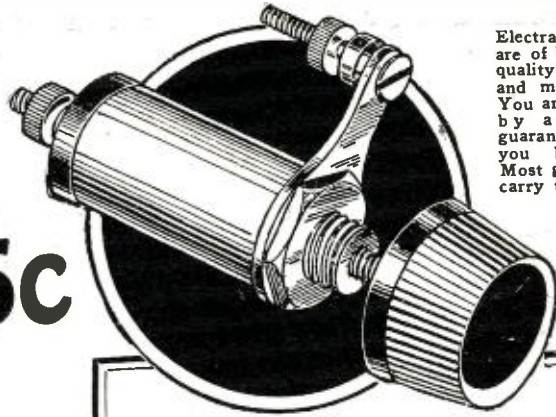

Electrad products are of the highest quality electrically and mechanically. You are protected by an absolute guarantee when you buy them. Most good dealers carry them.

75c

Double your distance with this Variohm

THE latest invention in grid leaks enables you to get exactly the correct resistance for your individual set as it receives in your home. With the Variohm you can secure and maintain any resistance from 1/2 to 30 megohms. Once adjusted to your individual set, the setting is permanent.

With it you get maximum distance and sensitivity. Without it your set is working at a disadvantage. It eliminates circuit noises, is moisture-proof and non-microphonic. Suitable for panel or base-mounting. Unmounted 75c, mounted \$1.00. Equipped for use with standard fixed condensers.

Displayed, sold and recommended by all dealers. If your dealer cannot supply you, send us his name and purchase price and we will send it to you post-paid. Satisfaction guaranteed or money back.

Dealers Electrad Radio Products of guaranteed superior quality offer you wonderful opportunities for quick turnover and good profits. Write for details on our greatly increased advertising campaign, dealer helps and package of fast moving items.

Electrad, Inc., Dept. H, 428 Broadway, New York, N. Y.

ELECTRAD

a name stamped only on Superior Radio Products

Other Electrad Products of Superior Quality & Dependability



FIXED GRID LEAKS

Absolutely uniform, unvarying fixed resistance. A superior product of dependability in all resistances from 1/4 to 10 megohms. Price 30c.



LEAD-INS

No longer do you need to ruin your window frames. Electrad Lead-Ins fit under closed windows, can be bent to any shape. Covered with fireproof insulation of 1000 volts resistance which prevents grounding on wet sills. Fitted with Fahnestock Clips 40c.



INDORARIALS

Ideal for sharp tuning. Wonderful directional effects. Reduces static. Can be used anywhere. Hang on door or wall behind draperies or laid under rug. Can also be used as ground. Price \$1.50.

8-TUBE SUPERHETERODYNE

The ultimate circuit for long distance and perfect reception. Every power station in the U. S. A. and Canada is a regular performance.

We have complete parts for the latest Eight Tube Radio Receptor Superheterodyne Circuit. Radio Receptor Kit including special trans-

formers, by-pass condensers, and coils, with a simple blue print chart for easy building, \$55. Sockets, loop, beautiful engraved Bakelite panel, variable and fixed condensers, rheostats, potentiometer, grid leaks, and all necessary parts, \$55. Complete, Radio Receptor Kit and all parts, \$110.

Dealers: Write for attractive proposition

FRIEDLANDER-KOPPLE RADIO SERVICE, Distributors

149 Church Street—NEW YORK—Barclay 4919-9337

\$35.00



TRIMM GRAND

Highest quality loud speaker made. CAST ALUMINUM vibrationless horn, extra large and sensitive unit. Adjustment lever tones down local stations and strengthens weak signals from distant stations just like focussing a camera.

TRIMM Standard Model

Same wonderful unit, with same lever for instantly increasing or decreasing distance between poles and diaphragm. Fitted with non-metallic horn 21 1/2 inches high with bell 10 inches wide.

TRIMM Phonograph Attachment

Same giant size unit with coupling to make a high grade loud speaker of any phonograph.

\$10.00

Trimm Headsets

Dependable \$5.00

Professional \$7.65

Lifetime guarantee with every Trimm product.

Write for folder.

TRIMM RADIO MFG. COMPANY
Dept. 64, 24 S. Clinton St., Chicago, Ill.



\$22.50

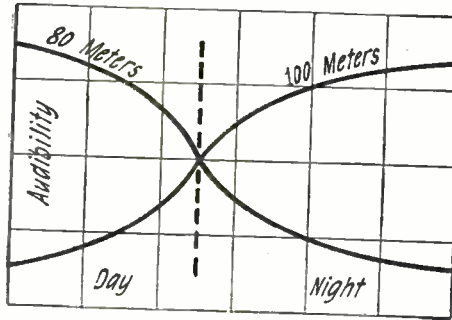

Audibility curves of signals transmitted from the Westinghouse station KDKA at Pittsburgh.

receiving station as the same wave transmitted after dark.

Of course, these tests were carried out with radio telephony only, and the audibility curves are those of the speech frequencies. However, these are directly relative to the amplitude of the carrier wave and, therefore, the same phenomenon should be apparent in C.W. and I.C.W. transmission.

What might be accomplished on these very low waves by amateur stations cannot, of course, be determined, but if the system should prove of advantage it would be an easy matter to slightly redesign the transmitting set so that one could shift to the very low wave for daylight transmission, and to a wave above 100 meters for work after dark. Thus advantage could be taken of the best part of the curve of each respective wave band.

More than likely, a good deal of experimental work would have to be done before this low wave-length would prove of sufficient utility to the amateur, but, having possibilities, it is a thing that should not be overlooked. Why not try this out and determine what really can be done during the daytime? The first Ham who makes a new daylight record on short wave work is going to get wide publicity, and his name will stick.

M. L. MUHLEMAN

A Federal Radio Tax?—No!

(Continued from page 1559)

for a song which received no advertising or "plugging" except through broadcasting. The Victor Phonograph Company has made arrangements to broadcast the work of its artists, which is good advertising.

The tremendous advertising possibilities of broadcasting must not be overlooked.

The idea of having all broadcast stations under one central control is, perhaps, a solution of the broadcasting problem, but I do not think so. What we would gain in efficiency would be lost in other ways. The broadcast station should be a community affair like the public library. Every city should be proud of its station, and if Chambers of Commerce, Boards of Trade, or other civic organizations do not see the opportunity in broadcasting, I am sure a little political activity of the local radio fans will convince the city fathers that a municipal broadcast station is an absolute necessity. I do not know how stations WDAP, Chicago Board of Trade, KOP, Detroit Police, and many others are financed, but I do not think they are dependent upon the profits of any radio manufacturer. WEA, New York City (A. T. & T. Co.), is, I understand, a commercial station and anyone who so desires may secure its services for a definite price for a stated period. Doesn't the local station idea appeal to you?

To return to the Federal radio tax idea as promulgated in an article in the January issue of RADIO NEWS by Raymond Francis



How Are Your Radio Batteries Made?

Cut into any spent "B" Battery — compare the construction with Ray-O-Vac. Look at insulation, connections, cell construction, the block—every detail. There's where Ray-O-Vac design and workmanship count — the only places where a battery can make any difference in the performance of your set. Look thoroughly into this subject of batteries, explained clearly in our book on the use and care of Radio Sets. Ask for "Radio Trouble Finder" today. Your name and address on margin of this advertisement bring it to you. It shows why thousands of radio enthusiasts will have nothing but Ray-O-Vac Batteries. There is one for every radio use.

FRENCH BATTERY & CARBON CO.
Madison Wisconsin
Atlanta Dallas Denver Kansas City
Chicago New York Minneapolis

RAY-O-VAC

Radio's Best Batteries

Reception Loud and Clear. Single Tube "SUPERFLEX" in Leatherette Case, Very Neat. Order NOW—will be sent C. O. D. parcel post anywhere on receipt of \$1.00 with order, to cover postage.

PRICE..... \$65.00 COMPLETE
Ready to operate. Dealers write
BENSON ENGINEERING COMPANY
2125 N. Halsted Street, Chicago, Illinois

IT IS A PORTABLE

No aerial, ground or loop required for Local Stations. You can take it with you when visiting. Use it in your Hotel room — On your vacation — Anywhere, Anytime.

LONG RANGE — coast to coast — Wide range on loud speaker.

SIGNAL ELECTRIC MFG. CO.
Menominee, Mich.
Manufacturers of Radio Apparatus, Receiving and Sending. Dealers send for discounts and catalog.

RADIO TUBE EXCHANGE

We Repair All Standard Makes of Tubes Including

W.D.-11 or 12
U.V.-199 or C.-299
C.-11 or 12
U.V.-201A or C301-A
D.V.-1 or D.V.-2
U.V.-200 or 201
C.-300 or 301

\$2.50

All tubes guaranteed to do the work.

RADIO TUBE EXCHANGE
200 BROADWAY NEW YORK CITY, N. Y.
All Mail Orders Given Prompt Attention
Orders sent Parcel Post C. O. D.

MAN WANTED Handle County BUSINESS. Experience unnecessary. Largest concern of its kind in the world. **OUR MEN NOW GETTING \$200 WEEKLY.** Lowest prices.

RED SEAL COAL CO.
220 Coal Exchange Bldg., Armour Sta., Chicago

Yates, which says: "Some will ask, how would it be possible to collect this broadcasting fee? The answer is, how is it possible to collect any other legal fee? How is the revenue tax collected, the income tax and all the other various collections that the Government has to make? It is true that there are a certain number of evaders, but they are greatly in the minority. In the case of radio, legislation could be enacted that would make it illegal to own a radio receiving set without being obligated to pay a small yearly fee, and it is certain that the Government would meet with just as much success in collecting this charge as it has met with in the many other tax collections it has to make."

NO FAIR COMPARISON

The automobile tax is not a fair comparison with the proposed radio tax. The automobile can be, and often is, an engine of destruction. Some check must be kept upon those who operate them. There is no tax for possessing an automobile in any state as long as it is not taken on the public highways. Of course, this virtually includes all machines as you cannot very well operate a motor in your attic or cellar.

The cost of collecting the income tax is not definitely known, but anyone who looks into the subject at all will be convinced that it costs plenty.

I believe that most radio fans believe with Mr. David Sarnoff, vice-president and general manager of the Radio Corporation of America, that the air must be kept free. Mr. Sarnoff in a recent address said:

"It has been said by a great many people and a great many corporations—some very large and able—that broadcasting depends upon finding a means through which the consumer will pay for the entertainment he receives. It has been said that unless some method provides a means for collecting revenue from the user of a broadcast instrument, the whole industry is bound to collapse in time because there will be no means of supporting it. It is my firm conviction this solution to the problem is not necessary, that broadcasting can be made commercially practicable without collecting from the consumer. The greatest advantage of broadcasting lies in its universality—free entertainment, culture and instruction. It is up to us with intelligence and technique and broadness of spirit and vision as to the future, to preserve that most delightful element in the whole situation, namely, the freedom of radio.

FREEDOM VALUABLE

"Just so soon as we destroy that freedom and universality by confining it to those who pay for it, just so soon we destroy the fundamental of the whole situation. And, therefore, I believe very definitely that broadcasting as constituted today is commercially sound and that it will remain so in the future, although there may be selective methods which will do no harm. These may supplement the present system. There may be wired wireless and the like, but fundamentally there will remain, and there must remain and be preserved, that element of the broadcast situation which makes it possible for grand opera to go to the slums and to districts of the poor as well as the rich, everywhere in the world, without any charge. The real picture of a \$15 or a \$25 set in the home of the slums receiving the magnificent things in the air is the picture we must preserve."

Hasn't Mr. Sarnoff voiced just your idea?

A FAIR COMPARISON

"Your head," said the Professor, after a particularly poor recitation by a student, "is just like a vacuum tube. It's sealed tight, makes a lot of useless noises and there's nothing in it."

Contributed by Harry Gershonowitz.

An Easy Way to Cut Out Interference

Add a Ferbend Wave Trap to Your Set

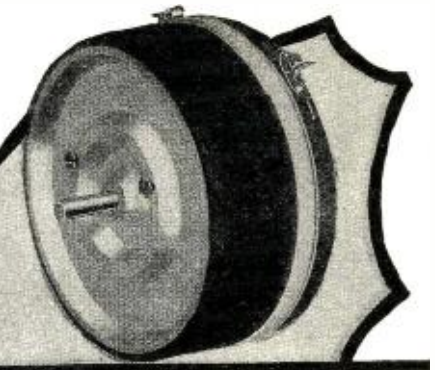

Why Listen to Three Stations at a Time?

Why rebuild and enlarge your set to the last pitch of refinement just to get better selectivity, when you can get a WAVE TRAP which, connected by two wires to your old set, will TRAP OUT the powerful waves from the interfering station, and leave the voice you want to hear just as "clear as a bell"?

The FERBEND is the original WAVE TRAP, designed and manufactured complete by us, after years of careful experimenting. Do not confuse it with imitations, hastily assembled from ordinary radio parts.



The Original Wave Filter



GUARANTEE

Every FERBEND WAVE TRAP is warranted to be of best materials, designed and manufactured complete by the Ferbend Electric Co. (not assembled from stock radio parts). When connected to any workable radio receiving set, and properly adjusted, according to directions, we guarantee that any interfering broadcasting station can be tuned out, while the station desired continues to be heard as before.

This Man Takes His Choice-- Why Don't You?

FERBEND ELECTRIC CO.,
25 E. South Water St., Chicago.

I have installed the WAVE TRAP I purchased from you some time ago and given it a thorough try-out. There are five broadcasting stations in this city, four of them I can trap out by moving dial ten points, the other KFI, the most powerful one, I can silence by changing the dial twenty points. This station is heard on the Atlantic coast and Hawaiian Islands.

JOHN F. PARSONS,
109 N. Avenue 19,
Los Angeles, Calif.

USE THIS COUPON
—to double the pleasure from your **RADIO SET**

FERBEND ELECTRIC CO., 25 E. South Water St., Chicago, subject to your definite guarantee as printed at the left. I will pay the price which I have marked to the postman when he delivers the left. (If remittance is sent with the coupon, then the Wave Trap comes post-paid. **THE POSITIVE GUARANTEE APPLIES JUST THE SAME.**)
 Check here for Ferbend Wave Trap, UNMOUNTED... \$6.00
 Check here for Ferbend Wave Trap, MOUNTED... \$8.50
 Name.....
 Street.....
 City.....
 State.....
 Send me full information.

Bakelite Jack



- No. 30-Single circuit open \$.80
- No. 31-Single circuit closed .85
- No. 32-Double Circuit90
- No. 33-"A" Battery Switch .90

Every CICO PRODUCT is packed in a distinctive GREEN BOX and unqualifiedly guaranteed against all defects.



ADDITIONS TO ANY SET

CICO Jacks moulded from Bakelite—no metal in frame construction. Connections made to Binding Posts—no soldering necessary. Phosphor Bronze Springs—will last a life-time without adjustment. Sterling Silver Contact Points.

CICO 2-Way Plugs constructed so that loud speaker and headphones can be connected simultaneously or individually whichever you desire. Fit all standard jacks. Take all types of tips.

Consolidated Instrument Co. of America, Inc.
41 East 42nd Street, New York

2-Way Plug



Price 60c

QUALITY IS FIRST!
—in all M-G products

**"Read'em"
Binding Posts**

Tell at a glance whether it is Antennae, Ground, A or B Battery, etc. Name neatly engraved for keeps on top of each post. (See illustration). Price 15c each. Set of 10 for \$1.50.

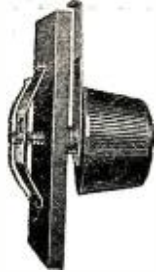

**"Minute Man"
SWITCH LEVER**

Positive contact. Newest design. Panel collar consists of six small nickel-plated washers. Proper tension by using proper number of washers. Can be used on all types of switch points. Price 25c each.

**TYPE S-12 "THOROBRED"
STANDARD TUBE SOCKET**

Thick tube, nickel-plated, molded Bakelite base.

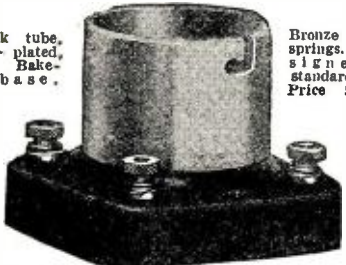

Bronze contact springs. Designed for standard tubes. Price \$1.00.

If your dealer does not handle M-G Products write direct.

The MARSHALL-GERKEN Co.
Toledo, Ohio

Dept. A 27 No. Ontario St.

Amplify the MODERN way!

"PUSH-PULL"

Power Amplifying Transformers

More volume—less distortion—perfect reproduction of music or speech. New bulletin of amplifier hook-ups and circuits using "Push-Pull" amplification, at your dealer's or sent free on request to us.



Modern "Reflex" Audio Transformers 10 to 1 ratio for all reflex circuits using crystal detectors. Will work satisfactorily with any standard Radio Frequency Transformer.

Modern Standard Audio Transformers 4 to 1 ratio for all 2-step amplifiers and specially designed for use with Modern "Push-Pull" Transformers.

If your dealer can't supply you, write us giving his name.

The Modern Electric Mfg. Co.
Toledo, Ohio



TUBES REPAIRED

Only Middle West Tube Service Station
8 Hour Service. No Extra Charge for Broken Glass.
WD-11, WD-12, C-11, C-12 \$3.00 Ea.
UV-201, C-301 3.00 Ea.
UV-201-A, C-301-A, UV-199, C-299 3.00 Ea.
UV-200, C-300 2.75 Ea.
We Buy Burnt out Tubes.
All Tubes GUARANTEED and Returned P.P. C.O.D.
DEY'S RADIO SERVICE
Dept. 1, 5413 Race Avenue Chicago, Ill.

The Vacuum Tube Patent Situation

(Continued from page 1573)

Company under the Fleming valve patent 803,684, which expired November 7, 1922. When the De Forest Company was sued under the Fleming patent they in turn entered a countersuit under various De Forest patents, including, among others, the amplifier patent 841,387 and the "grid" patent 879,532. On consent decree the amplifier and grid patents were sustained and the Fleming patent held valid as limited to a detector of radio frequency oscillations. The early construction by Edison of the two electrode tube, as disclosed in his patent 307,031 showing the two electrode tube employed in low frequency circuits, was the principal cause of the limitation upon the Fleming invention to radio frequency circuits.

MARCONI ROYALTIES

Subsequently in the accounting proceedings in the Marconi and De Forest suit it was decreed that the Marconi Company was entitled to royalties upon tubes used not only as detectors, but also as oscillators and amplifiers. In subsequent litigation by the Radio Corporation of America v. Radio Audion Company, the Fleming patent was more narrowly construed and limited to cover only tubes used as detectors. The art will remember that until the Fleming valve patent expired the Radio Audion Company was compelled by order of the court to restrict the sale of its tubes to amplifiers or oscillators and the following notice was required to be attached to the individual boxes, cartons and containers in which the Radio Audion Company tubes were shipped:

This tube is not sold or purchased to be used as a detector of wireless waves. Any use or sale of it for such use renders the vendor or user liable to prosecution for infringement of patent. This tube is sold for use in tandem with another device acting as a detector, for the purpose of amplifying either radio or audio frequency currents, or as a generator of high frequency currents, or as a generator of high frequency electrical oscillations.

Then with the expiration of the Fleming patent the art will remember how the Radio Audion Company began to sell electron tubes not only as amplifiers and oscillators but also as detectors.

Of course this activity on the part of the Radio Audion Company presupposed some rights under the De Forest amplifier and grid patents and it was not until the injunction issued in the case of American Telephone and Telegraph Company v. Radio Audion Company and De Forest Radio Telephone and Telegraph Company that the defendant was compelled to desist from the further manufacture and sale of electron tubes.

Now with the Fleming detector patent expired, and the De Forest amplifier patent expired, the art may rightfully wonder what remains in the way of a monopoly on the tube situation.

THE GRID PATENT

The De Forest grid patent 879,532, the drawings of which are illustrated in Fig. 2, contains 21 claims and each claim contains the limitation "an oscillation detector." The spirit of the claims, however, is to set forth a structure of audion in which a grid is interposed between a filament and plate. There has been no occasion heretofore to judicially determine what is meant by the expression "an oscillation detector" in these De Forest claims. It might well have been that, in view of other patents De Forest was securing, it was necessary to limit this patent, 879,532, to a detector, in order to dis-

**High Grade Representatives
Wanted as Branch Managers
\$8,000.00 to \$12,000.00 Per
Year. Would You Like
to Make That?**

Could you organize and manage a sales organization of five to ten men or over?
Have you the cash (\$500 to \$1,000) to get started?

Have you a store or can you obtain one or space in one suitable for the sale of **high grade Radio Equipment**.

If so, tell us all about it in your first letter and we will consider appointing you as our "District Manager" in your territory and letting you open a "Branch Store" for us for the sale of

Blue Seal "Guaranteed" Radio Equipment

The Radio Industry has grown faster and bigger than any other business that ever existed.

The Blue Seal system offers opportunity to the right men to get in on the ground floor and make a killing with the fastest growing organization of its kind in America today.

Tell us who you are, what you have done and what you think you can do.

Write today.

Blue Seal Manufacturing Co.

1406-1408 So. Michigan Ave.
Dept. 2
Chicago, Illinois

SIMPLIFY TUNING

The **Adams**
Perfected

Panel Shielding

Eliminates the effect of body capacity—gives you the full range of your set; clearer signals; greater volume; preserves a uniform tone. An aluminum alloy made specifically for this purpose.

Made for the following size panels:

7"x18".....85c each 7"x28".....70c each
7"x21".....60c each 12"x18".....75c each
7"x24".....65c each

(Special panel sizes made up in wholesale quantities only)

If your dealer cannot supply you at present, your order direct will receive immediate attention. Check the size desired and mail with money order.

Adams Radio Mfg. Co.

716 W. Madison St., Chicago

Guaranteed Head-Sets

"RED-HEADS" are guaranteed radiophones. You run no risk when you buy them. Money back if, after 7 days' trial, you're not satisfied that they're the best receivers on the market at the price. Why not act right now and get a pair? It'll mean getting the maximum from broadcasting from the day you put them into use.



**RED-HEAD
RADIO
RECEIVERS**

NOW READY

The new 1924 Model F | The new "Red-Head" Jr.
\$6.50 Per Pair Complete | \$5.00 Per Pair Complete

"Red-Heads" sent prepaid on receipt of price if you are unable to get them at your dealer's.

The NEWMAN-STERN COMPANY
Dept. R.N., Newman-Stern Bldg. Cleveland

tinguish it and not confuse it with applications he had filed or planned to file on amplifiers or other circuits. This becomes a very vital issue because if this patent relates only to detectors the field is wide open for the manufacture of the early P. N. type of De Forest tube, wherever such tubes are only used as amplifiers or oscillators. This is a question for judicial determination. The fact that the amplifier patent was running concurrently with the grid patent precluded this problem from arising heretofore, but now it has become acute and it will probably be but a short while before the Radio Corporation will have to take this point to court.

The large interests were of course thoroughly cognizant of the state of affairs which might exist upon the expiration of the tube patents, and it is accordingly fairly apparent from the Patent Office records that they have endeavored to leave no stone unturned in order to cover the tube with patents from various angles. Before any manufac-

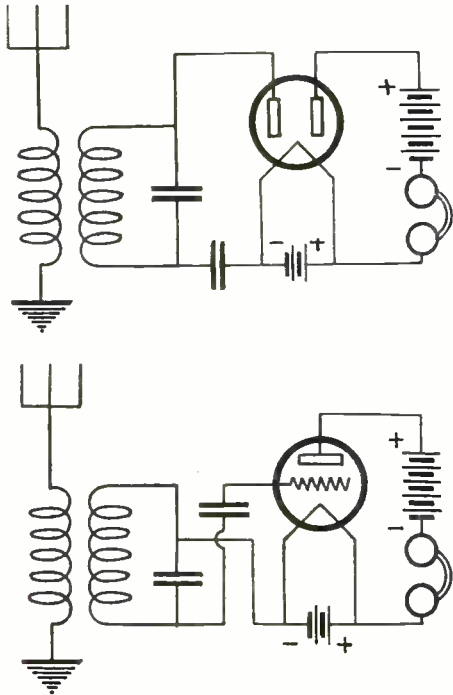
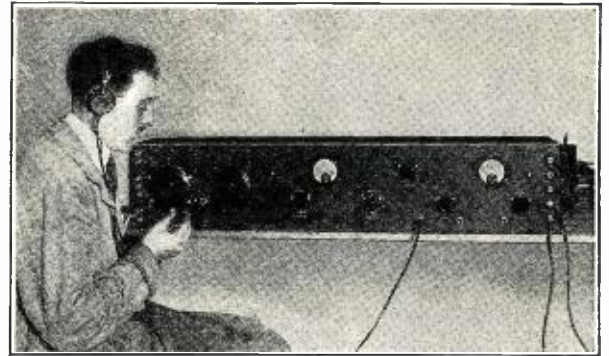

Fig. 2. Two circuits illustrating the De Forest grid Patent 879,532.

turer embarks upon a production program, he should be familiar with the patent situation surrounding the article he proposes to manufacture and sell. This is especially true of the electron tube situation. Take for example the subject of the electron tube filament. The Western Electric Co. has secured numbers of patents on different kinds of filament. One patent claims the filament as a "twisted metallic ribbon having an oxide coating for increasing the electron emission in the tube." Walter G. Hudson secured a patent on the idea of wrapping a tungsten filament with a tantalum wire, having the idea that tantalum would throw off a larger body of ions. Another Western Electric patent claims an electron-emitting filament consisting of platinum having a multiple coating which consists of alternate layers of barium oxide, and strontium oxide. More recently the Western Electric Co. has been granted claims on a filament for an electron tube wherein the filament is coated with silver and a metal of the alkaline earth group. Still another Western Electric patent covers a cathode which consists of an insulating material such as a glass rod with a thermionically active coating on the rod which is heated to throw off electrons. Still another Western Electric Company patent claims the filament as an electric conductor upon which is deposited coatings of mixed

For expensive, delicate parts— what panel will you use?

THE picture shows the front of a Super Heterodyne hook-up. This set has a normal range of 3,000 miles. When a radio fan builds this set he must use the best radio parts he can buy. And he needs a panel that will help those parts operate most efficiently.



A weak battery, a burned-out tube—any defective part—merely reduces the range of a set instantly. A cheap radio panel can hinder the effectiveness of the best instruments made.

Radio fans all over the country construct their sets around Celoron Standard Radio Panels. One of them, Mr. Phil Davies, of Grand Rapids, Michigan, writes about his Celoron panel:

"I bought a Celoron Panel, first, because of the low loss of high frequency currents and its high dielectric capacity; second, because of its strength and durability; third, because of its beautiful finish; fourth, because of its convenient size."

Radio set manufacturers who use Celoron panels in their cabinets help fans get greater volume and clearer reception. Manufacturers of radio parts who mount their instruments on Celoron bases give insulation those parts need. In Celoron they have a bakelite product that is one of the best insulating materials known. Its dielectric strength has been proved time and again. The U. S. Signal Corps and U. S. Navy approve it heartily.

Radio manufacturers can buy Celoron in sheets, tubes, rods, and special forms.

Leading radio parts makers have already found that Celoron is an ideal material to use for cabinets, switch bases, and other radio and wireless equipment.

Radio fans who buy completed sets containing Celoron Standard Radio

Panels and instruments insulated with Celoron can be sure of getting the insulation their sets need. Write to us for complete information regarding the use of Celoron in the manufacture of sets and individual radio parts.

Write for our free booklet, "Getting the Right Hook-up with Celoron." It contains

diagrams, list of broadcasting stations, and valuable radio information for the set-builder.

To radio dealers: Send for special dealer price list showing standard assortments.

DIAMOND STATE FIBRE COMPANY

Bridgeport, Pennsylvania
(near Philadelphia)

Branches in Principal Cities:
Toronto, Canada London, England

CELORON

STANDARD RADIO PANEL

CARTER JACK SWITCH

Mounts like a jack. Pure silver Contacts. Long phosphor-bronze springs. No sliding contacts. The only battery switch with "On and Off" Name plate.

Write for illustrated catalog.



- No. 2 Two springs.....\$1.00
 - No. 3 Three springs..... 1.15
 - No. 4 Four springs..... 1.30
 - No. 6 Six springs..... 1.60
- Will Carry 10 Amperes



CARTER JACK SWITCH

To switch on or off "A" Battery.

Switch from short to long wave lengths.

Switch on battery charger or loud speaker. And many other uses.

If your dealer cannot supply, write us.

Get a Handy Binder for your RADIO NEWS. Holds and preserves six issues, each of which can be inserted or removed at will. Price 65c. Experimenter Pub. Co., Inc., Book Dept., 53 Park Place, New York.



Perfect Panels

for any set—
big or little!

Supreme for super-heterodyne or single circuit! No other material known possesses the many combined advantages of Bakelite-Dilecto for radio paneling!

bakelite dilecto

(A Laminated Phenolic Condensation Material)

Once the installation is completed, Bakelite-Dilecto panels remain absolutely unchanged, no matter what abuse it is given by heat, cold, water, steam, oil, solvents and weather elements. They do not warp, swell, shrink, crack, check or split. Highest in dielectric strength. Surpassingly tough, yet readily machined. Your dealer can get it cut and drilled to fit your needs.

The Continental Fibre Co.
Factory: Newark, Delaware.

Service on Bakelite-Dilecto (also Continental-Bakelite, Conite, Conitex and Vulcanized Fibre) from:

New York, Woolworth Bldg.
Pittsburgh, 301 Fifth Ave.
Los Angeles, 307 So. Hill St.
Chicago, Wrigley Bldg.
San Francisco, 75 Fremont St.
Seattle, 1041 Sixth Ave., So.

Offices and Agents Throughout the World

EARN MONEY AT HOME

YOU can make \$15 to \$60 weekly in your spare time writing show cards. No canvassing or soliciting. We instruct you by our new simple Directograph System, supply you with work and pay you cash each week. Write today for full particulars and free booklet.
WEST-ANGUS SHOW CARD SERVICE LIMITED
Authorized Capital \$1,250,000.00
144 Colborne Building, Toronto, Can.



"Lighting Fixtures"
READY TO HANG
(Direct from Manufacturer)
Completely wired including glassware.
Send for Catalogue No. 26.
(Just off the Press)
Special Proposition to Dealers
ERIE FIXTURE SUPPLY CO.
STATION R ERIE, PA.

barium, strontium and calcium compounds and platinum distributed between the coatings and then the barium, strontium and calcium compounds reduced to their oxides. The last patent of importance on filament construction claims the cathode as a combination of intertwined twisted ribbons, each of thermionically active material. The idea is that more length of filament material is obtainable with corresponding increase in the number of electrons emitted. Thus it will be seen that there are patent problems just within the filament structure itself.

Many patents have been granted on ways and means of mounting a filament with respect to the grid and plate electrodes in the tube to prevent the filament from sagging over and touching the grid, and thereby preventing the functioning of the tube, by interposing positive spacing means between the electrodes.

FILAMENT MOUNTING PATENTS

There are patents directed to the idea of stretching the filament taut as it increases in temperature, for preventing the filament from sagging over and touching the grid, thereby destroying the operation of the tube. One patent claims the interposition of a spiral spring in the filament support tending to stretch the filament as it expands. Another patent claims a resilient filament support formed by a V-shaped wire having a coil spring adjacent to the extremity of the V, one end of the wire being supported in an insulated block secured within the tube and the other end of the wire having a hook which engages the filament and tends to constantly stretch the filament as it expands. Still another patent shows a filament mounting in which the filament is supported at its top in the form of a V and rigidly stretched by means of a pair of resilient V-shaped wires embedded in the lower portion of the tube. The V-shaped wires tend to spring toward the end of the tube, stretching the filament as its temperature increases.

SUBSTITUTE FOR FILAMENT ELECTRODES

A number of patentees have recognized the expense involved in the replacement of electron tubes and have accordingly developed tube structures having filament substitutes, which either do not require renewals or which may be readily replaced. Samuel S. Torrisi of Philadelphia has secured a patent on a cathode for an electron tube in which the electron emitting element is a metallic tube extending into the audion. This tube is heated by a removable heating coil. When the coil deteriorates, a new coil is inserted. Eugene L. Mueller of Chicago has secured a patent in which the electron emitting element is formed by an arc discharging within a chamber interposed concentrically within the plate and grid electrodes.

PATENTS ON THE MOUNTING OF GRID ELECTRODES

Considerable attention has been given by patentees to the subject of mounting the grid electrodes within the electron tube. One patent shows a grid which carries a series of mica strips, in which strips the filament is laced back and forth, thereby placing the filament and grid in juxtaposition. Another patent claims a grid support which consists of a square insulated glass frame around which the grid wire is woven, the filament being supported lengthwise of the frame interior thereof, and extremely close to the grid. Another patent discloses the mounting of a filament grid extremely close to the filament which is laced back and forth on a flat frame parallel with the grid. High power tubes have been patented in which the grid is formed of a heavy spiral arranged around the filament electrode. Another patent claims the mounting of such a spiral grid by supporting it at diametrically opposed points

See What \$7.95 Will Buy

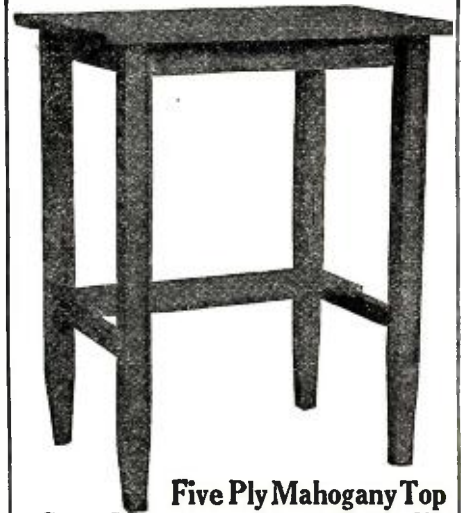

Five Ply Mahogany Top Solid Mahogany Legs and Shelf

A Beautiful Piece of Furniture
30" High 25" Long

Same construction with
QUARTERED OAK TOP and SHELF
Price \$3.95

Table Prices—F. O. B. Winchendon
GENUINE MAHOGANY CABINETS
FINISH AT HOME AND SAVE ONE-HALF
SHIPPED KNOCKED DOWN
Panel Size Price
7 x 9 \$1.25
7 x 12 1.50
7 x 18 2.00
7 x 21 2.25
7 x 24 2.50
9 x 14 2.75
CABINET PRICES—DELIVERED
Send Money Order or Check with Order
Money Returned if not satisfied.
MASON & PARKER MFG. CO., Winchendon, Mass.

WHY PAY MORE?



RECHARGEABLE
50 Volts \$5.50
75 Volts \$7.75
100 Volts \$10.00
125 Volts \$12.50

Recharge from any 110 volt A.C. line with small home rectifier. Shipped fully charged and ready for use after adding acid. Will last for years with ordinary care.

SERVICE "A" BATTERY

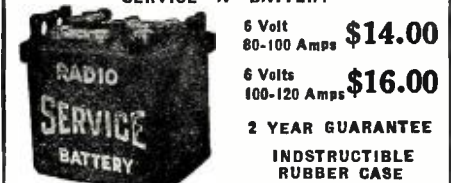

6 Volt 80-100 Amps \$14.00
6 Volts 100-120 Amps \$16.00

2 YEAR GUARANTEE
INDSTRUCTIBLE RUBBER CASE

SERVICE BATTERY CO.
704 East 102nd St., Cleveland, Ohio



One Charger for All Batteries

Charges 2-volt peanut tube batteries, 6-volt A Batteries, 6- and 12-volt automobile batteries, and 1 to 4 B Batteries. It's the

Valley Type ABC
Battery Charger
VALLEY ELECTRIC CO., St. Louis, Mo.

by longitudinally extending rods, each rod having a small helix secured thereto, between the turns of which the spiral electrode is secured, rigidly securing the turns apart. The Western Electric Co. has secured patents on the ladder grid construction and also a method of making it, in which a number of cross wires are secured to longitudinally extending frame wires at the sides thereof. Still another patentee has secured claims on the idea of supporting the grid electrode from one end of the tube while the other electrodes are supported from the opposite end of the tube. There are grid-making machines patented which are directed to the idea of turning out grid electrodes in great quantities within a short time.

PATENTS ON PLATE MOUNTINGS

The idea of providing integral strips as part of a cylindrical plate electrode, which strips protrude as tongues to be soldered to upstanding supporting wires in the interior of the tube, has also been patented by the General Electric Co. The Osram-Robertson Lamp Works, Ltd., of London, England, have secured a number of patents on two-end tubes wherein the plate is supported between the two ends allowing insertion of the other electrodes within the plate. Another patent by the General Electric Co. is directed to a plate electrode and an assembly of electrodes in an electron tube in which the plate is formed of nickel in the shape of an inverted cap which fits over and is in close relation to the grid and filament in the tube. A London inventor has secured a United States patent on a tube construction in which the plate and filament are in the form of hollow hemispherical surfaces. This same patentee has also secured claims upon a plate electrode in the form of a spiral sheet of material bent upon a horizontal axis with an integral extension which is embedded in the glass press of the tube forming both a substantial support and an electrical connector for the plate. There are several patents which claim the mounting of plate electrodes on resilient supports within the tube to permit expansion and contraction of the plate under different temperature conditions.

Claims have also been granted on the idea of supporting the plate by twisted wire connections at different points along an insulated frame or arbor within the tube. Still another patent broadly claims the application of a black coating to the plate electrode such as a coating of nickel oxide. There is a very important patent secured by the Western Electric Co. directed to a machine for cutting and pressing plate electrodes for an audion in quantity production so that the electrodes are all ready to be bent to shape for producing the electron tube.

A very interesting patent has been obtained by the General Electric Co. on an electron tube which has a shield positioned around the electrodes and interposed between the electrodes and the glass press where the various electrode supporting wires enter the press. The idea is to shut off the passage of electrons in this direction so as to prevent the tendency of the electrons to produce a minute conductive coating on the glass between the electrode supporting wires and thereby afford an undesired leakage path.

It is remarkable to observe in the Patent Office records the number of patents secured on sockets for electron tubes. These sockets, of course, differ from incandescent lamp sockets so that there is plenty of room for the granting of patentable claims. All manner of sockets have been patented.

THE SODION

A great deal of interest has been aroused by the infant arrival in the tube industry, the Sodian, on which patents have been issued. The claims of the patents are directed to the idea of increasing the electron emission of a filamentary cathode by con-



Super-service

Wide-awake radio fans prepare for clear reception of all programs by keeping the storage battery full-powered with the Tungar. For super-service the Tungar is used to recharge both radio and auto batteries. The result is longer battery life and more "pep"—plus convenience.

In homes with electricity Tungar recharges the run-down radio or auto battery overnight at a saving. Sold by Electrical, Auto-accessory and Radio dealers.



Tungar is one of the many scientific achievements contributed by the G-E Research Laboratories toward the wonderful development of electricity in America.

Tungar Battery Charger operates on Alternating Current. Prices, east of the Rockies (60 cycle Outfits)—2 ampere complete, \$18.00; 5 ampere complete, \$28.00. Special attachment for charging 12 or 24 cell "B" Storage Battery \$3.00. Special attachment for charging 2 or 4 volt "A" Storage Battery \$1.25. Both attachments fit either Tungar.



Tungar
REG. U.S. PAT. OFF.
BATTERY CHARGER

Tungar—a registered trade mark—is found only on the genuine. Look for it on the name plate.

Merchandise Department
General Electric Company
Bridgeport, Connecticut

GENERAL ELECTRIC

48E-9

We repair the following RADIO TUBES and Guarantee Them



WD-11	3.00	DV-6	3.00	UV-201A	3.00
WD-12	3.00	DV-1	3.00	C-301A	3.00
UV-200	2.75	DV-2	3.00	Marconi	5.00
UV-201	3.00	DV-6A	3.00	Moorhead	3.00
C-300	2.75	UV-199	3.00	6 v. Plain Detector	2.75
C-301	3.00	C-299	3.00	6 v. Plain Amplifier	3.00

Mail Orders solicited and promptly attended to
Dealers and Agents write for Special Discount

H. & H. RADIO CO.

P. O. BOX 22-H

CLINTON HILL STA.

NEWARK, N. J.



Insure your copy reaching you each month. Subscribe to Radio News—\$2.50 a year.
Experimenter Publishing Co., 53 Park Place, N. Y. C.

Morrison



Loud Speaker

To hear a radio concert reproduced by Morrison creates an instant desire to own one of these faithful Loud Speaking Units. For it seems like magic to hear so truly the singing quartet and the sweet-toned violin. Even with full volume no harshness nor vibration creeps in.

Then, too, Morrison is adjustable—turn a little dial and regulate the volume to your taste. It isn't surprising that once you own a Morrison you cannot be satisfied with less. Distant stations are unbelievably loud and clear and you can soften the tone if you wish.

Every Morrison carries a "money-back" guarantee.

Handsomely
Nickel Plated

\$10.00

Complete with 5-foot cord

Free 2 color catalog on request

JOBBER—DEALERS

The market on Morrison is active. Our merchandising plan will interest you. Write immediately for details and discounts.

Morrison Laboratories, Inc.
339 East Jefferson Ave., Detroit, Mich.

EASY TO BUILD

Your Own Radios
With the Church

Universal Template



It lays out your panel base board accurately and quickly. No loss of time, temper or panels. Complete with extra bushing and complete instructions.

\$1.00

At all Dealers or

RADIO INSTRUMENTS CO.
17 N. WABASH AVE. CHICAGO—U. S. A.

tinuously attracting electrically charged particles of sodium to the cathode. This may be done by constructing the glass envelope of the tube of sodium glass and providing an exterior circuit arrangement causing positively charged molecules of sodium to be released within the evacuated space of a tube containing a cathode and anode so that the particles are attracted and deposited upon the cathode for increasing its thermionic activity.

TUBE MANUFACTURE

Many patents have been granted on manufacturing processes for electron tubes. One of these relates to the sealing of tubes while the tubes are connected in a circuit, which enables the characteristics of the tubes to be studied and accurately determined to indicate when the evacuation process is complete. Still another patent is directed to the driving out of occluded gases from the electrodes in the electron tube by inductive heating. The tube is surrounded by a coil producing a high frequency magnetic field. Eddy currents are produced in the electrodes during the evacuation process and the occluded gases driven out before the tube is sealed off.

THE HIGH VACUUM TUBE

The hard tube is the result of research of more recent years. The patentable subject matter has been contested over a period of years by Langmuir of the General Electric Co. and Arnold of the Western Electric Co., and the ultimate control of the hard tube is still a matter of judicial determination.

It is quite apparent from the Patent Office records that many patentees have endeavored heretofore to avoid the De Forest grid patent. Patents have been secured on the external control electrode and the external plate by Weagant of the Radio Corporation and Donle of the Connecticut Telephone & Telegraph Co.

Dr. De Forest himself must have observed the limitations in the claims of his tube patents which practically limited them to a tube having its electrodes within a gaseous medium in a surrounding envelope, in that he secured a more recent patent on an open air audion in which the electrodes, while arranged the same as in the ordinary electron tube are disposed in the open air to atmospheric conditions. A Nernst filament was employed in this construction.

An interesting patent was recently secured by William J. Herdman of Toronto, Canada, for a tube avoiding the De Forest grid patent. This tube operates upon the principle of magnetostriction in which this property is utilized to effect a movement of the anode or plate with respect to the cathode or filament, to thereby decrease or increase the distance between the filament and plate, and to likewise decrease or increase the effective plate area, to produce an extremely wide variation of the plate current.

A review of the several hundred tube patents shows that the patent problem in the manufacture of tubes is one which cannot be lightly passed over, and that careful consideration of existing patents must be given in each detailed case, having in mind the construction of the tube which it is proposed to manufacture.

The Production and Use of Ultra Short Waves

(Continued from page 1567)

fields only, the above formula may be used. For an antenna height of $\frac{1}{2}$ wave-length, the formula is

$$h = \frac{\lambda}{\pi}$$

Enjoy the Thrill of Greater Distance NOW!

Listen-in to those far away stations—get them on YOUR set and get them strong and clear.

TERLEE

VARIO COUPLERS

—give you this greater receiving efficiency and better tone quality. They eliminate the losses of the radio energy in the vario coupler, the first place where losses in tuner decrease the amount of energy delivered to your detector.

Terlee Radio Engineers have solved the vario coupler problem in perfecting the Terlee high efficiency vario coupler. Taps are arranged to give maximum adjustment with no dead end losses on taps not in use. The windings of the primary and secondary coils use no varnish or cement, and have a minimum volume of dielectric as support. They give low distributed capacity and low dielectric losses, thereby increasing the selectivity of the coupler.

The 180° couplings assure close adjustment and the die cast parts insure permanent adjustment. The Bakelite used throughout protects against moisture and warping. They can be arranged for either panel or table mounting. The Type "R" Terlee Vario Coupler meets the needs for regenerative or non-regenerative radio frequency amplification giving a remarkable degree of selectivity, not obtainable on any type of close primary and secondary couplings.

If you want better radio results use a Terlee Vario Coupler—the Type "S" for crystal or audion circuits and the Type "R" for radio frequency, regenerative or non-regenerative circuits. All Terlee products are quality products and are definitely guaranteed against defects in material and workmanship.

Type "S" \$6.00 Type "R" \$7.50

If your radio dealer cannot supply you, write us direct. When you need radio advice our radio experts of the service department will be glad to assist you. Write us today.

Terlee Electric & Mfg. Co.

Dept. A-5

443 S. Dearborn St., Chicago, Ill.

"Makers of Radio's Best for Better Radio Results"



Genuine AUDIO TRON \$2.50
Double Filament
Detector

When one filament burns out the other filament is ready for use

Genuine AMERTRON
A.V.-200—6v. \$3.75
A.V.-201A—6v. 3.75
A.V.-12—1½v. 3.75

Standard base only
Send your order and we will mail tubes Parcel Post C.O.D. with an absolute Guarantee to function.

Bryant Radio Electric Co.
203 Park Row Bldg.
NEW YORK CITY

PATENTS

Trade-Marks, Copyrights and Patent Litigation
Write for advice and instructions how to proceed, costs, etc. Hand Book with illustrations of 100 Mechanical Movements sent free on request.

ALBERT E. DIETERICH
Patent Lawyer and Solicitor

Successor to Fred G. Dieterich & Co.
690A Ouray Bldg., Washington, D. C.

and r equals 160 ohms. If one wants to use the resistance r to calculate the total radiated power, it is necessary to use the exact formulae given for the average height of the antenna above the ground, the results of which are about half as large.

The advantage of very short wave-lengths is emphasized if one considers the resistance of the antenna (and ground when one is used) as compared with the radiation resistance. The antenna resistance of a big station such as is used for trans-Atlantic communication, is generally from one to three ohms and that of amateur stations from five to ten ohms. The resistance of an antenna vibrating at $\frac{1}{2}$ wave-length used in the transmission of very short wave-lengths of about one to two meters is about one ohm. Another advantage of the very short wave-lengths is that they may be reflected in the same way that a beam of light is reflected by a parabolic mirror.

MINIMUM WAVE-LENGTH OBTAINABLE

The shortest wave-length which may be produced with a given type of vacuum tube is determined by the grid to plate capacity inside of the tube, which is the main factor

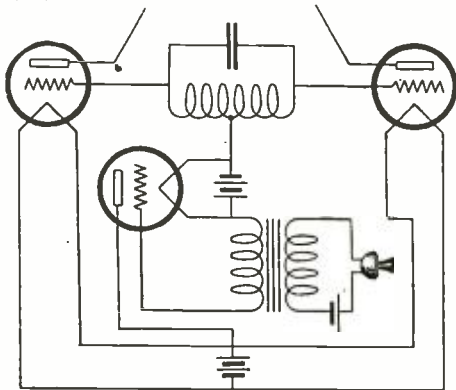

Fig. 3

The circuit used for modulating the output of the short wave transmitter.

limiting the frequency which may be produced and radiated. We also notice that, all the constants remaining the same, the lower wave-length limit decreases as the plate voltage increases and the distance from plate to filament decreases.

RADIOPHONE EXPERIMENTS

It has been found possible to modulate efficiently the output of a very short wave transmitter by using the circuit shown in Fig. 3. In this system the grid resistance is replaced by the plate filament space of a vacuum tube, the grid of which is connected to a modulation transformer with a microphone and battery in its primary circuit. This modulation arrangement is quite efficient and the quality is very good.

Fig. 4 shows one of the very short wave transmitters radiating a wave of 1.80 meters. In this photograph is seen the two vacuum tubes with the grid and plate connections taken out through the glass, and upon which are mounted the two single turns composing the oscillating circuit. The antenna system is also plainly visible. It is composed of two straight rods mounted on a hot wire ammeter connected in the exact center of the radiating system one-half of which may be taken as the antenna and the other as the counterpoise. There is no coupling coil in this antenna, the proximity of the straight rods to the oscillating coils being sufficient to induce the energy. Fig. 8 is another view of the same transmitter set upon a table with the high tension generator furnishing 500 volts to the plates of the tubes.

The receiver of the super regenerative type uses the same symmetrical arrangement as the transmitter and is illustrated in Fig. 5. On the left is the balanced tuning circuit to

U. V. 199



Accessories

MAR-CO RADIO PRODUCTS INSURE SUCCESS

Mar-Co Accessories are particularly designed to work well with dry cell tubes. Their small size allows short, heavy connections and a most compact, trouble-proof assembly.



Mar-Co U. V. 199 Socket

Strong compression springs re-enforce extra long contact points. Wiring runs over Bakelite surface. Polished nickel cylinder and Bakelite base.

Price 75c

Each Mar-Co Radio Product is carefully inspected and tested before leaving the factory, and is guaranteed to give good service.



Mar-Co U. V. 199 Adapter

This is a very handsome article and provides the best possible means of using U. V. 199 tube in standard socket.

Price 65c

It Will Pay You To Insist that Your Dealer Supply You with

MAR-CO RADIO PRODUCTS



Mar-Co Variable Grid Leak

The resistance range of this instrument is absolutely guaranteed. Grid condenser mounts directly on terminals. One hole panel mounting.

Price \$1.50

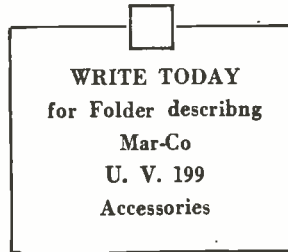

Mar-Co Armorclad 30-Ohm Rheostat

Only $1\frac{1}{8}$ " diameter. Nichrome resistance unit will never wear nor burn out. Protected by heavy, polished nickel shell. Bakelite knob and pointer. One hole panel mounting.

Price \$1.00

Address

Dept. R-N

MARTIN-COPELAND CO.
PROVIDENCE, R.I. U.S.A.
ESTABLISHED, 1880.

RADIO
BIG MONEY IN A BIG FIELD
Wanted — and wanted quick are men who can qualify for big pay positions in the enormous, fast growing Radio Industry. Once in a lifetime chance. Fast, easy to learn. No previous experience needed.
Be A Radio Expert \$3000 to \$10,000 a Year
Learn at home, by actual practice, to design, construct, install, operate, repair and sell Radio Equipment. Pleasant, fascinating, profitable. My methods are simple, clear and successful. Turn your spare time into cash.
FREE WONDERFUL 1000 MILE TUBE RECEIVING SET. Write today for Booklet "Radio Facts" FREE.
A. C. Mehnert, Radio Eng., Radio Assn. of America
4513 Ravenswood Ave., Dept. 155, Chicago

Rub-Mika

The ideal material for Radio Panels. Low absorption, high tensile and dielectric strength. If your dealer cannot supply you write us direct.

The Cooper Corporation

Rub-Mika Dept.
Cincinnati, Ohio

Insure your copy reaching you each month. Subscribe to Radio News—\$2.50 a year. Experimenter Publishing Co., 53 Park Place, N. Y. C.

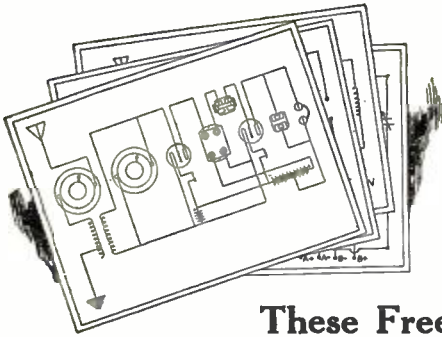

These Free Blueprints of Duratran Hook-ups Increase Your Range

Don't throw your one-tube regenerative set away because you can't get the distant stations. The Duratran, the wonderful Dubilier radio-frequency transformer, will bring them in.

Simply add a stage of Duratran radio-frequency amplification. And you will save the ten or fifteen dollars you would spend in building a new radio-frequency set.

The Duratran will enable you to bring in the distant stations because it amplifies on all broadcasting wave lengths twenty times. All the stations come in with equal clarity because of this unrivalled uniform amplification.

Your dealer sells Dubilier Duratrans. Price \$4.00.

Free Blueprints of Radio-Frequency Hook-ups

Write for free blueprints of Duratran hook-ups. They show how a Dubilier Duratran will convert your one-tube set into a sensitive radio-frequency receiver.

Dubilier Condenser & Radio Corporation
40-46 West Fourth Street
NEW YORK



VACUUM TUBES REPAIRED

WD-11, WD-12, UV-201A, UV-199 and others for **\$2.50**

Quick service. All tubes repaired by us guaranteed to work as good as new. Send your dead tubes. All you pay is \$2.50 plus postage to postman.

THOMAS BROWN CO.
511-519 ORANGE ST. NEWARK, N. J.

AMPLION
The World's Standard
Loud Speaker

which is connected an oscillator producing the variation frequency. When a reflector is used in connection with the receiving set, the tuning is made by means of the long rod shown horizontally above the table and which, in this case, may be adjusted from behind the screen. It is with this receiver that Mr. David carried out the first experiments in the open country to the steadiness of such a complete system of transmission. At that time we did not have at our disposal the several elements which have since permitted us to obtain from .5 to .6 ampere radiation, and we only used about 80 milliamperes in the transmitting antenna. Under these conditions, in an open field with only a few trees, it was possible to carry on radio telephone communication at a distance of about 1½ miles without any reflector to concentrate the waves into a uni-directional beam. When the transmitting and receiving apparatus were installed in a forest, it was still possible to communicate over a distance of one-third of a mile. Owing to bad weather we have been unable to carry on out-door experiments with reflectors, under various conditions. The reflectors employed in the laboratories are of the type shown in Fig. 6; each is composed of a wooden frame upon which is stretched some copper screening. Fig. 7 shows one of the portable stations which had been installed upon the roof of a car in order to avoid obstructions and which could be carried around at various distances from other stations.

LABORATORY EXPERIMENTS

With the small transmitting set previously described, some very interesting demonstrations were given at the Physical and Radio Exposition recently held in Paris. The receiving system was composed of an antenna in the center of which, instead of an am-

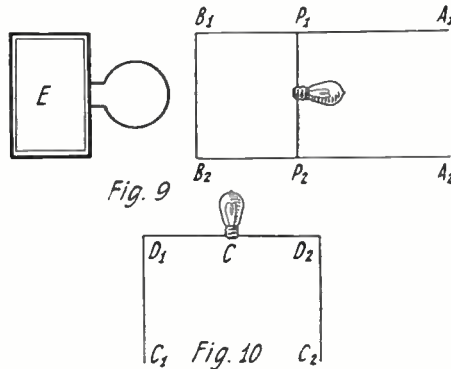

With a lamp sliding on two parallel wires coupled to the oscillator the nodes and loops may be seen.

meter, an ordinary tungsten lamp having a resistance of 25 ohms was connected. The antenna could revolve around a horizontal axis and is shown in Fig. 8. When the antenna was vertical, the lamp would become incandescent at a distance of nine feet from the transmitter. By turning the antenna around its axis, the brightness of the lamp filament could be decreased to zero as the antenna approached horizontal. This experiment demonstrated the polarization of the field, which it was also possible to demonstrate by means of a grid placed between the transmitter and the receiver. When the wires composing the grid were horizontal, they had no effect upon the transmission of the energy, but when they were vertical, the lamp did not light.

Another interesting experiment was the interference produced with a reflector composed of a piece of copper screening about five feet square mounted on a frame. This reflector is shown in Fig. 8. It was placed perpendicular to the plane of the two antennae and the distance between the screen and the plane of the antennae was varied. When this distance is equivalent to a number of ½ wave-lengths, the reflected field is in

IMPROVED AND PRACTICAL SUPER-HETERODYNE

"The Rolls Royce of Radio"

The improvement worked out by our Chief Radio Engineer and his staff has definitely established the superiority of our Super-Heterodyne because:

1. It is easy to control.
2. It has only two dials for tuning (which can be calibrated).
3. It employs a tuned intermediate wave amplifier—so
4. It is more selective and more sensitive than other S.H. sets.
5. No potentiometer is used, thereby eliminating a very critical control. Moreover,
6. Balancing of tubes is entirely unnecessary, and
7. Filament control is not at all critical.
8. Regeneration and oscillation on intermediate wave amplifier is controlled by a small feed back condenser that can be permanently set at most sensitive point.
9. Tuned plate system at the first tube gives additional Short Wave Radio Frequency Amplification.
10. Any regenerative or Radio Frequency tuner may be used with the oscillator and intermediate wave amplifier.

A complete description of this improved circuit appeared in the New York Evening Mail Radio Magazine of January 19, 1924. A copy of this editorial will be sent FREE on request.

All parts for this

8-Tube Set

Every part needed is included and Each part is absolutely guaranteed. **\$75**

This Famous 8-Tube Set

built in a beautiful piano finish solid mahogany cabinet. Unconditionally guaranteed for one year..... **\$150**

When ordering by Mail Include Postage with Order

Atlantic & Pacific Radio Co.
223 West 34th St., New York City



FROM "FACTORY TO USER"

High grade Radio Cabinets, sturdy built and fine looking. Made of selected birch or genuine mahogany. Elegantly finished in Adam Brown mahogany, dull rubbed. Hinged top, front rabbeted to take panel. Panel not included. Money back if not satisfied.

No.	For Panel	Birch	Adam Brown Mahog.	Genuine Mahog.	
67	6x7	7"	depth	\$1.75	\$3.05
610 ½	6x10 ½	7"	"	2.50	4.35
614	6x14	7"	"	2.75	4.80
621	6x21	7"	"	3.25	5.65
79	7x9	7"	"	2.00	3.50
710	7x10	7"	"	2.25	3.90
714	7x14	7"	"	2.50	4.35
718	7x18	7"	"	3.25	5.65
721	7x21	7"	"	3.50	6.10
724	7x24	7"	"	3.75	6.55
726	7x26	7"	"	4.00	7.00
728	7x28	7"	"	4.25	7.45
914	9x14	10"	"	3.25	5.65
921	9x21	10"	"	4.00	7.00
924	9x24	10"	"	4.50	7.85
1214	12x14	10"	"	4.00	7.00
1221	12x21	10"	"	4.75	8.30

All Prices F.O.B. Milwaukee, Wis.
UTILITY SUPPLY COMPANY
435-439 27th Street,
Milwaukee, Wis.

SUPER HETERODYNE

What everyone has been waiting for, a complete set of blue prints and templates drawn to full size in picture form with actual layout of instruments, Template for drilling panel, also detailed description of assembling and wiring worded so that you can understand it. Complete set prepaid, \$1.50.

THE G. A. SALES
1336 Grand Ave., St. Paul

Insure your copy reaching you each month. Subscribe to Radio News—\$2.50 a year. Experimenter Publishing Co., 53 Park Place, New York City.

opposition to the direct field and the lamp connected in the receiving antenna does not light. When the distance is equal to a number of $\frac{1}{2}$ wave-length plus $\frac{1}{4}$ wave-length, the fields are in phase and the lamp lights. It is possible with this reflector to obtain three nodes and two loops. Besides these experiments in space, we produced along parallel wires the classical experiments of nodes and loops by means of ordinary lamps connected on bridges sliding along the parallel wires. The nodes and loops were very well defined and could be observed by a very large audience, as the lamp would light brightly at every tension loop along the wire. See Fig. 9.

It was also possible to demonstrate the strength of the field in the neighborhood of the parallel wires by means of coils of wire connected to incandescent lamps.

President Coolidge Broadcasts

(Continued from page 1557)

broadcasting information, while the Bureau of Navigation of the Commerce Department supervises all commercial and amateur radio operation.

Radio was introduced in the White House during President Harding's occupancy, when a powerful Navy receiver was set up in "The Study." President Coolidge, while perhaps not as keen a fan as was his predecessor, is understood to listen in on special occasions. Mrs. Coolidge frequently "goes to church" on Sabbath afternoons via the ether, and is said to listen in Sunday nights to Roxy's gang. A loud speaker is connected with the White House set, so that all the executive family may listen in. An outside aerial runs from a tree to the porte cochere and an inside loop is also provided for reception. Both the Coolidge boys, now away at school, are also interested in radio. A new broadcast receiving set is being installed on the Presidential Yacht *Mayflower*. During the President's many trips on the Potomac, future cruising parties may listen in.

Radio Beacons Non-Directive and Directive

(Continued from page 1556)

again, but not as strong as the "A." At F they would both be of equal intensity. The equisignal zone, therefore, extends along the line FO. The figure shows an airplane coming in from the right, circling to find this zone and then following it in to O.

After overcoming many difficulties incident to the development of this beacon system, actual tests were made both as to its efficacy as an aid to marine navigation as well as to aerial navigation. In the first test, a 300-kilocycle receiving set and amplifier was installed on the light-house tender *Maple*. An equisignal type of directive beacon was built at the Bureau of Standards and oriented so that the sharper equisignal zone extended north and south. At a point on the Potomac River, about 35 miles south of Washington, D. C., it was found by observations on the tender *Maple* that the equisignal zone did exist and was about one mile wide. This was determined by listening to the "A" and "T" signal as the ship was on an east and west course.

A similar directive beacon was installed

RADIO'S REAL MARVELOUS INVENTION

Positively Prevents Blowing Out Radio Tubes

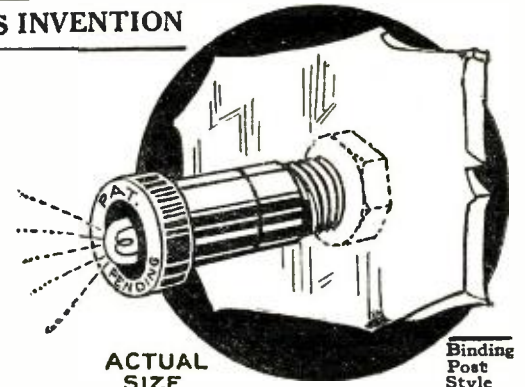

ACTUAL SIZE

Binding Post Style

The impossible has been done. Most radio owners have thought that it was impossible to prevent the accidental blowing-out of expense radio tubes. Now You CAN

Prevent Blowing Tubes. The KANT-BLO Protective Unit has been perfected, tested and fully approved by the most noted radio authorities.

Kant-Blo



One KANT-BLO Protects any Set regardless of kind or number of Tubes, or "A" and "B" Voltage.

"Lights on any Short Circuit"

Simply replace your present Binding Post or Switch with the KANT-BLO Protective Unit, and no matter how many short circuits develop in your radio set the tubes will not blow out. Only one KANT-BLO Signal of either style is needed to protect any number of tubes. And the KANT-BLO Signal will protect all tubes whether the "A" Battery is on or off, and regardless of the amount of voltage of your "B" batteries.

Insist on KANT-BLO Signals when you build or buy a new Radio Set.

The KANT-BLO Signal will light and let you know that there is a short circuit, in order that you may examine the wiring and locate the short circuit at once. This saves not only the tubes but saves wearing out the batteries.

Easily Installed

The KANT-BLO Signal is installed easily. Simply takes the place of either the "A" Battery Switch or one "B" Battery Binding Post now on set.

Money-Back Guarantee

KANT-BLO Signals—both Binding Post Style and Switch Style—are at all the best radio stores. If your dealer is out of stock send us \$1.80 for a KANT-BLO Binding Post Style, or \$2.80 for the Switch Style, and we will see that your order is filled.

If you are not fully satisfied your money will be refunded upon receipt of returned KANT-BLO. USE THE COUPON.

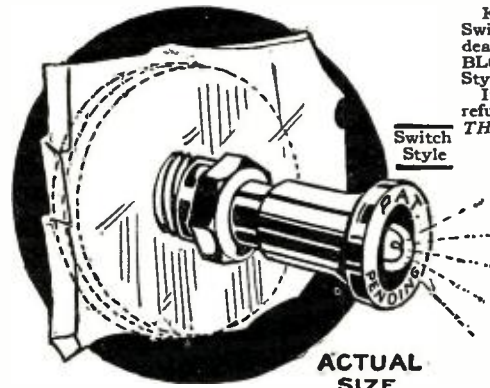

Switch Style

ACTUAL SIZE

KANTER MANUFACTURING CORP.,
120 Broadway, New York, N. Y. Dept. R.N.

Enclosed is money-order for for which please send me KANT-BLO Signals of the Type, at \$1.80 for Binding Post Style, and \$2.80 for Switch Style. If I am not fully satisfied with the KANT-BLO Signal I will return same within 10 days and you will return my money.

Name.....
Address.....



SEND NO MONEY
5 DAYS FREE TRIAL

WINNIBLE! Rebuilt GUARANTEED STANDARD No. 10 Self Starter Model REMINGTON

A real bargain. All late improvements—84 characters, standard type, back spacer, etc. As near new in appearance and operation as modern methods and expert mechanics can produce. Many other standard makes. Time payments if desired. Shipments from nearest of our 29 stores. Order now or write for circular. Resident salesmen wanted.

American Writing Machine Co.
Est. 1880
Factory 468-R Central Ave., Newark, N. J.

USE ONLY

AMPERITE

THE SELF ADJUSTING RHEOSTAT FOR AMPLIFYING TUBES
\$ 1.29 WITH MOUNTING

ELIMINATES HAND RHEOSTATS
SAVES YOUR TUBES



VACUUM TUBE
A BATTERY

GIVES LOUDER AND CLEARER MUSIC
SIMPLIFIES WIRING
GREATER DISTANCE

ASK YOUR DEALER

RADIALL CO. 320 WEST 42ND STREET
NEW YORK



A very popular style of Radio Table. Designed especially for receiving. Plenty of leg room. Battery cabinet is on right instead of left as shown in cut.

Specifications

Hardwood, rubbed mahogany or golden oak finish.
Height, 31 inches; top, 20x34 inches.
Drawer with lock, size 4x10x13 inches.
Battery cabinet, size 17x14x16 inches.

PRICE

No. 30-R Radio Table

Freight prepaid to east of Mississippi River\$18.00
To Rocky Mt. States, freight prepaid.. 20.00

This Table is a very handsome piece of furniture weighing, crated, 85 lbs. We make these in our own factory in large quantities and sell direct to you at a small factory profit.

RADIO CABINETS

Our cabinets are high-grade in every respect and are not to be classed with the cheaply made stained cabinets with which the market is flooded.

Hardwood, hinged tops, tops splined to prevent warping, rubbed dark red mahogany finish.

SIZES AND PRICES

7x14x10 deep	\$3.00
7x18x10 "	3.25
7x21x10 "	3.59
7x24x10 "	3.75
7x26x10 "	4.50

Postage prepaid to east of Mississippi River. To Rocky Mt. States add 25 cents each.

Cash Must Accompany All Orders.

Send for Free Catalogue

THE SOUTHERN TOY CO., Inc.
HICKORY, NORTH CAROLINA



Wonderful, new device, guides your hand; corrects your writing in few days. Big improvement in three hours. No failures. Complete outline FREE. Write C. J. Ozment, Dept. 32 St. Louis, Mo.

You can be quickly cured, if you

STAMMERER
Send 10 cents for 288-page book on Stammering and Stuttering. "Its Cause and Cure." It tells how I cured myself after stammering 20 yrs. B. N. Bogue, 898 Bogue Bldg., 1147 N. 111 St., Indianapolis

RADIO BOOKS Latest and Best. Henley's 222 Radio Circuit Designs, a new book very complete \$1.00. Ideas for the Experimenter's Laboratory 25c. Design Data 25c. Construction of Radio Sets 25c. Radio Hook-Ups 25c. (Coin) Postpaid. Satisfaction or money back. Order Now. You can't lose. RAY DOBBINS, 146 W. 27th St., Indianapolis, Ind.

at McCook Field, Dayton, Ohio, where it was found possible to guide an airplane into Dayton from a point along the equisignal line 100 miles distant entirely by means of signals from the two crossed loops.

From the foregoing, one can readily appreciate the possibilities of the new beacon system, since by its use a navigator in clouds, fog, wind or storm may proceed directly to his destination.

Radio aids to both marine and aerial navigation mean the saving of life and property and it is hoped that full advantage may be taken of such aids as quickly as they can be established and that funds may be forthcoming to extend such a valuable service.

Published by permission of the Director of the Bureau of Standards.

Radio Television

(Continued from page 1571)

the poles of a powerful electromagnet, NS. This arrangement is a well-known Siemens oscillograph.

Another great difficulty encountered in all television apparatus is the synchronization of the sending and receiving instruments. Two special devices have been made use of in the Telehor to perform the service. One is the tuning-fork interrupter and the other is the La Cour phonic drum. Since these devices play a most important part in the instrument described here, it might be well to give a short account of both. The tuning-fork interrupter, as illustrated in Fig. 2, is very

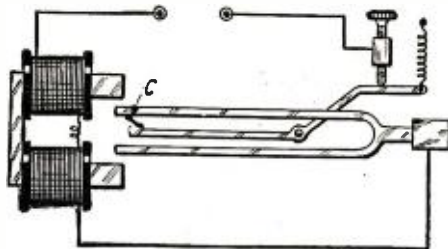
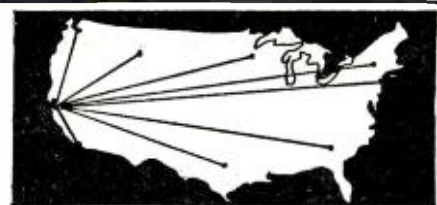

Fig. 2

The tuning fork interrupter which is kept vibrating with an electro magnet.

similar in operation to the ordinary buzzer. The fork is placed between the poles of an electromagnet so that, as current passes through the coils, the two arms of the fork are attracted to the pole pieces. But immediately the prongs of the fork are separated, the current is broken and they return to their former position, making a new contact and being separated again. This process is continued as long as current is connected to the instrument. By this means, a pulsating current may be produced which has an exceptionally constant frequency.

The phonic drum illustrated in Fig. 3 represents the simplest possible synchronous motor. It is composed of a hollow drum made of wood or some non-magnetic metal and is partly filled with mercury. On the periphery are mounted thin iron strips I, I, etc., at equal distances. The drum is pivoted near the pole pieces of an electro-magnet. If the magnet is connected to an alternating current or a direct interrupted current supply, and the drum is caused to rotate at such a speed that the number of bars passing the pole pieces per second is equal to the frequency or interruptions of the current passing through the magnet, the drum will remain in phase, i. e., it will rotate at a speed depending upon the exact frequency of the current.



ON ONE TUBE

Broadcasting from Atlantic Coast, Canada, Mexico, Cuba and Hawaii heard in California by users of the CROSS COUNTRY CIRCUIT. Range due to simplicity. One tuning control. ANY NOVICE can build easily and cheaply. Dry cell tubes used. No soldering. Complete instructions, Blue print panel layout, Assembly Photo, etc., postpaid 25 cents. Stamps accepted.

WHAT USERS SAY

EAST—Am more than pleased with the parts ordered from you. The first night I hooked it up and received Omaha. Since then Minneapolis and Los Angeles. It works better without amplification than most sets with two stages. —Donalds, S. C.
WEST—I am sending you a list of some of the stations heard on one tube: WSB, WGY, KDKA every night. PWX, WWJ, WTAM, WLW every night. CPAC, CHCB. Not long ago I purchased another set of parts from you and first night got WGR, Buffalo, and KDKA. —Ione, Calif.
NORTH—Received coils OK today. If I have same results with these that I had with last will be wanting more. I am 1,500 miles from nearest station and have picked 56 to date. Chicago, Havana, Mobile, New Orleans and TWO IN ENGLAND. —Lunenburg, Canada.

Send stamp for further information.
Vesco Radio Shop BOX RN-117 OAKLAND, CALIF.



Used in 40 States, 7 Provinces, 2 Foreign Countries Within 4 Months After First Issued

"WHERE I GO BY RADIO"

IDEAL RADIO RECORD BOOK

Unique System. Every Line Complete Record When, Where, How and What You "Tuned in" also Accurate List Radio Stations. Other useful features. Popular Edition, space 300 Records, 2 for \$1.00. Holiday Ed., space 700 Records, only \$1.00. Get at any Newsstand, Bookstore or Dealers, or send \$1.00 direct Now to

Radio Dept. R., Progress Press, Union, South Carolina, U. S. A.

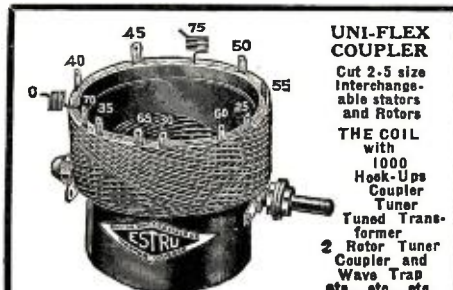

UNI-FLEX COUPLER

Cut 2.5 size interchangeable stators and Rotors
THE COIL with 1000 Hook-Ups Coupler Tuner Tuned Transformer 2 Rotor Tuner Coupler and Wave Trap etc., etc., etc.

Lattice Coil Specialties



VARIO-METERS Variocouplers Plain Coils Tapped Coils R F Transformers Load Coils Micro-Mike Condensers

Write for Descriptive Literature
DALTON, WHITTIER-TRUE CO.

Dept. R-11 2905 W. MADISON ST. CHICAGO

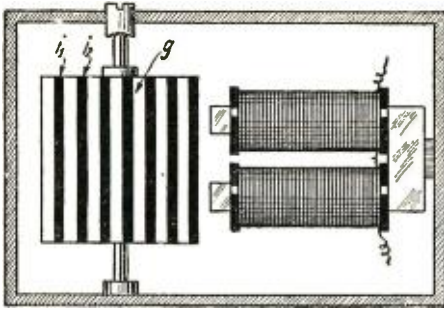

Fig. 3

The phonic drum used to synchronize the telehor.

SYNCHRONIZING STATIONS

This synchronous motor is used in connection with the tuning-fork interrupter. By installing a synchronous motor which operates in phase with a tuning-fork interrupter at both sending and receiving station, and carefully tuning the forks at each station to exactly the same pitch, the two drums may be rotated at a high speed and yet in exact synchronism for hours without attention. This arrangement has also been used for high speed telegraphy.

In the transmitting apparatus illustrated in Fig. 4, the lenses A and B reduce the picture, which is to be transmitted, in area and project it in the small oscillating mirrors D which form the oscilligraph C. The mirror D is caused to oscillate at a rate of 500 vibrations per second by supplying the small platinum suspension wire with a 500-cycle alternating current. The mirror also vibrates at a much slower rate in another plane, which is at right angles to the plane of the 500 per second oscillations. These vibrations are produced by attaching the platinum wire to a lever which bears on an eccentric which is fixed to the phonic drum.

The drum is caused to rotate through the electromagnet—which is connected to the tuning-fork interrupter I. The tuning-fork is pitched to 100 vibrations per second. There are 20 of the iron strips attached to the periphery of the drum which revolves five times per second.

The alternating current supply to feed the platinum wire is obtained by interrupting a current from the battery by means of a small 100-segment commutator, which is attached to the shaft of the phonic drum. This produces an intermittent direct current which is supplied to the primary of a transformer, the secondary of which is connected to the platinum suspension wire.

The picture is broken into its small elements in the following manner: The image from the lenses falls on the oscillating mirror and is reflected upon the diaphragm e. This reflection is practically the same size as the original, on account of the divergence of the light rays caused by the mirror. The selenium cell is placed behind an aperture approximately one square millimeter in area. The mirror vibrates 500 times per second in the vertical plane with the result that the picture actually moves 500 times per second up and down across the aperture. But the mirror also vibrates in a horizontal plane at five vibrations per second which means that during 1/10 of a second, while the mirror makes 50 vibrations per second in a vertical plane, half an oscillation is made in a horizontal plane, thus through the double oscillation of the mirror, the picture is broken up into the small elemental areas. The complete decomposition of the picture requires only 1/10 of a second. At Fig. 8, an idea of the order of this decomposition is given.

PICTURE CURRENTS

The selenium cell Se is connected in series

"THE STANDARD OF COMPARISON"

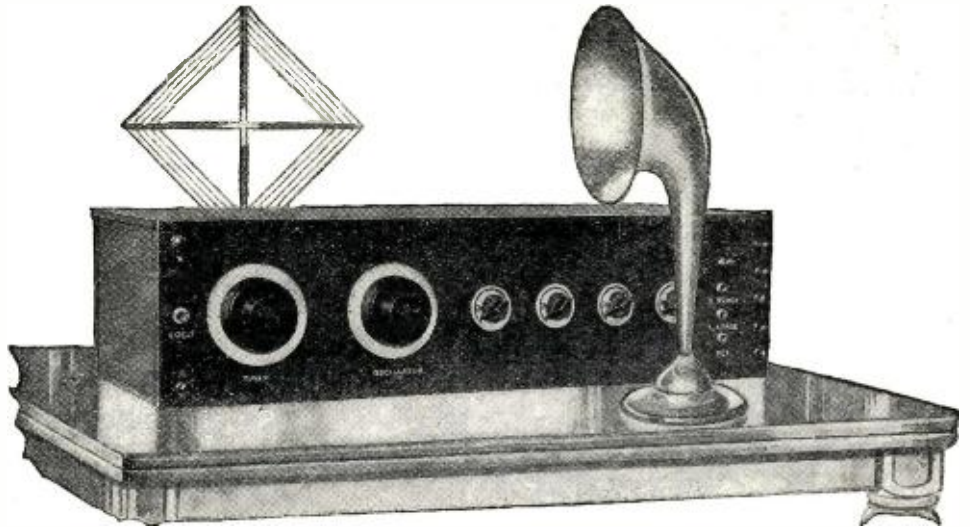

Most Selective Receiver Known

ULTRADYNE
The Improved
SUPER-HETERODYNE

Ultradyné Kit includes tuning coil, oscillator coil, one Ultraformer type "A," three Ultraformers type "B".

\$24.50



Send for the 32-page illustrated book giving latest authentic information for drilling, assembling, wiring and tuning six and eight tube Ultradyné receivers.

50c

Employs "Modulation System," an entirely new principle of radio reception just developed and perfected by R. E. Lacault, A.M.I.R.E., formerly Radio Research Engineer with the French Signal Corps Research Laboratories.

This principle is of such a basic character that the sensitiveness is increased over that of any known receiver. Weakest signals are made to operate the loud speaker. Results secured by the Ultradyné exceed by far those obtained with Reflex, Super-Regenerative, Neutrodyne and even the well-known Super-Heterodyne. This is true in regard to selectivity, range, signal audibility, simplicity and general efficiency.

The "Modulation System" is employed exclusively in the Ultradyné, the improved and simplified Super-Heterodyne.

Write for descriptive circular

PHENIX RADIO CORPORATION
3-7 Beekman Street, New York City



ALL TUBES REPAIRED
Guaranteed Like New
Detectors or Amplifiers... **\$2.65**

One Amp., 6 Volt Tubes Changed to 1/2 Amp. Tubes
Write Today for Tube Circular on New and Refilled Tubes

American Radio Tube Works
Irvington, New Jersey, U. S. A.
Agents Wanted Everywhere

The GREBE Broadcast Receiver
Type CR-12



DISTRIBUTORS

All STANDARD APPARATUS in STOCK
SOUTHERN RADIO CORP. OF TEXAS
608 WEST EVERGREEN STREET
SAN ANTONIO, TEXAS

Sterling

PORTABLE RECTIFIER

USE
The
BATTERY CHARGER
WITHOUT A
WEAKNESS

and know no regrets

WHILE rechargeable "A" and "B" Batteries have played such a prominent part in the progress of radio as to need no comment, the effectiveness of these batteries is only commensurate with the vim and vigor maintained by the rectifier.

A rectifier should be judged solely by its ability to recharge the battery *safely, simply and surely*. These are the three factors that have characterized the work of the Sterling Rectifier—The Charger Without A Weakness.

It is made according to the latest 5 ampere maximum charging rate. There is no freezing nor sticking. It weighs but 8 lbs. and cannot be used incorrectly. The tapering charge prevents "overcharge" of battery. Almost total absence of sparking.

Price **\$16.00**
West of Rockies..... **\$17.00**

THE STERLING MFG. COMPANY
2850 Prospect Ave., Cleveland, Ohio



RADIO BY MAIL

UV200, UV201A, WD11, WD12, UV199 **\$4.24**
Genuine RCA RADIOTRON TUBES.....

COCKADAY PARTS

511K wound coil sets on Bakelite tubing..... \$3.38
Cotton wound coil sets on plain tubing..... 2.19
"LAVITE" resistances (48000 ohms)..... 1.19
"AMPLEX" Grid-densers..... .89
"AMSCO" 6-ohm rheostat with pointer knob..... .84
"AMSCO" 20-ohm rheostat with pointer knob..... 1.04
"AMSCO" 400-ohm potentiometer..... 1.47
"AMSCO" 26-plate vernier condenser and dial..... 3.69

COMO Duplex Audio Push-Pull Transformers (per pair).... **\$9.38**

ERLA REFLEX PARTS

"ERLA" Reflex or Audio transformers..... \$3.89
"ERLA" Crystal detector..... .79
"HILCO" Lattice wound variocoupler..... 5.78
"RATHBUN" Condensers 11-plate..... 2.56
"RATHBUN" Condensers 23-plate..... 2.86

BRANDES "SUPERIOR" Phones..... \$4.69
"TABLE-TALKER"..... 8.12

"HEGEHOG" 3-1 and 5-1 Audio transformers..... \$2.79
"ACME" Audio and Radio transformers..... 3.87
"ALL AMERICAN" Push-Pull transformers..... 9.86
"THORNDARSON" Push-Pull transformers..... 9.97

"BREMER-TULLY" Vernier tuner..... \$3.94
"UNCLE SAM" Tuning coil..... 4.76
"GOLD BEAL" Homecharger..... 14.69
"VALLEY" New style battery charger..... 14.38

23-Plate variable condenser... \$1.19 Vernier... \$2.19
43-Plate variable condenser... 1.34 Vernier... 2.49

CASH OR C. O. D.—SEND FOR COMPLETE LIST
SIMPLEX RADIO SUPPLY CO.
1804 Lafayette Avenue St. Louis, Mo.

MICHIGAN RADIO CORP.
Detector and Amplifier Units
Grand Rapids, Mich.

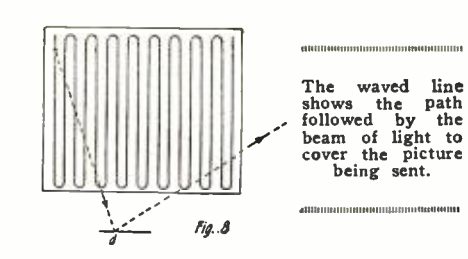

with the battery. The small current changes caused in this circuit through the change in the conductivity in the selenium cell caused by the difference in the amount of the light falling upon it, as the mirror reflecting the image vibrates, is amplified through an ordinary vacuum tube amplifier working at audio frequencies. This amplified current is passed directly to the transmission line or to the radio sending apparatus.

The receiving apparatus, as illustrated in Figs. 5 and 7, is, in its chief features, very similar in its construction to the transmitter. The tuning-fork interrupter and phonic drum represented by I and G and the oscillograph, C, will at once be recognized as being of the same form as the corresponding pieces of apparatus in the transmitter. The most important part of the receiver, of course, is the so-called "light-relay," the device which converts the current fluctuations supplied to it into light, the intensity of which varies in direct relation to the intensity of the supplied current. The light-relay consists of a very sensitive bifilar oscillograph of special design. The arc lamp O casts a narrow but very intensive beam of light on the mirror P of the oscillograph. The received pulsating current from the transmitter is led into the wire supporting the small mirror, causing it to be deflected in direct proportion to the strength of the current originating at the sending station. This deflection causes more or less of the light beam to fall on the aperture depending on the strength of the received current, all the beam being used at maximum current which represents a light spot on the original and little of it falling on the aperture for small currents which represent dark picture elements.

When no current is passing into the loop, the narrow beam of light reflecting from the mirror is projected close to the diaphragm aperture E so that no light can pass through it. At a deflection, however, caused by the passage of current from the transmitter, the light beam passes through the diaphragm and falls upon the mirror of the oscillograph which corresponds to the same arrangement as the transmitter. This mirror, of course, through the agency of the synchronized motor and the tuning-fork interrupter, oscillates in exactly the same manner as its counterpart in the transmitter. Thus, by means of the reflected light, falling upon the vibrated mirror and being reflected on the screen R, the picture is reproduced.

MOVING PICTURES

Since the reproduction of a single picture requires but 1/10 second and since 10 of them may be transmitted per second, the constancy of vision, or the lag in the eye (the same principle which makes moving pictures possible), gives the effect of a moving image on the screen. Of course, only movements which are of medium swiftness may be reproduced through this process.

The success of this apparatus depends entirely upon the synchronism of the two mirrors of the oscillographs. The very smallest deviation at this point causes the screen to show a meaningless conglomeration of light and dark spots instead of the photograph. If the tuning-forks at the transmitting and receiving stations are set into vibration simultaneously, the operation of the two stations will remain in perfect phase for hours. Frequently, through a difference in tempera-

New Model "B" HAMMARLUND



Patents Pending

Vernier Variable Condenser
Sharpest Tuning—Minimum Losses
Will Increase Your Range and Volume—
Eliminates Interference

Grounded Panel - Brass Plates
PRICES FOR PANEL MOUNTING
43 Plate .001 Mfd. \$7.00 17 Plate .00037 Mfd. \$5.75
23 Plate .0005 Mfd. \$6.00 13 Plate .00025 Mfd. \$5.50
3/2" pure Bakelite Dial \$1.75
4" pure Bakelite Dial \$1.00

At your dealers—otherwise send purchase price and you will be supplied postpaid.
Write for New and Interesting Folder.

HAMMARLUND MFG. CO.
144-146 W. 18th St. New York City

The RADI-OWL IS FREE To the RADIO FAN



Book includes 14 Latest Hook-ups.
List of Broadcasting Stations.
Log for Radio Records and

Amazing Values in Standard Radio Parts

Every Radio Fan Should Have One
Write for Your Copy To-day

GREAT LAKES RADIO CO.
RADIO SPECIALISTS
MARINE BLDG., DEPT. A
136 W. Lake St., Chicago, Ill.

Ask Your Dealer For a
MONTROSE VERNIER CONDENSER

The condenser with genuine bakelite end pieces. Has positive contact between the vernier plate and main shaft. Will get the results where others fail, guaranteed to give entire satisfaction.

MONTROSE MANUFACTURING CO.
1333 Fulton St. Brooklyn, N. Y.

New York Coil Company's
Radio Products are the better kind
Mfg'd by
NEW YORK COIL CO.
338 Pearl Street,
NEW YORK CITY, N. Y.



Fig. 9

By means of three dots placed at some point on the screen the synchronism between the transmitter and receiver may be checked.

ture or other natural causes, the tuning-forks are caused to change their rate of vibration which will ordinarily necessitate adjustment of the apparatus.

In order to make corrections for such changes, Mr. Mihaly has provided a very ingenious automatic arrangement. At the transmitting station a glass plate, which has three opaque spots at its edge. X, Y and Z, Fig. 9, is interposed before the lens B in the path of the light rays. This causes three similar spots to appear in the reproduced picture. These spots must, while the transmission is correct, fall always at the same place. If three selenium cells are placed in these spots at the receiving station, their resistance will be very great while the transmission is perfect. When the synchronism is disturbed, however, light will fall upon the cells decreasing their resistance. Sensitive relays, magnetic coupling apparatus and brakes may be connected to these cells, and may be made to operate through them in such a way as to restore synchronism.

CONCLUSION

A simple calculation shows that by increasing the size of the picture to be transmitted, the number of picture elements is also greatly increased and the difficulties of the transmission also increase very considerably. If we are working with picture elements of 1 square millimeter, as in the experiment described, which makes only a very rough reproduction of the object possible, we have in the case of a picture of 10X10 cm. = 10,000 picture elements to transmit 10 times a second, i. e., a frequency of the "picture currents" must be 100,000 cycles a second. Fortunately the neighboring picture elements are generally of similar brightness, so that the frequency of the picture currents increases at a more moderate rate than the number of picture elements. The number of oscillations the decomposing mirror has to perform depends also upon the size of the picture to be transmitted. As stated, this was, at the experiments described, 500 oscillations a second, but through its very small inertia it can easily produce oscillations up to 5,000 or 10,000 a second.

Experiments were also carried out on wireless television with about the same success as by wire. Personally I am sure, that in the case of greater distances transmission by wireless must prove even easier than by wire. In consequence of the high frequency of the picture currents themselves, the use of very short waves for radio transmission is to be preferred.

The experiments were conducted partly under very difficult conditions, especially during the great war and in some of the subsequent years. The materials of many kinds necessary for experimental purposes were scarcely obtainable then, so much so that at times, the experimenters were obliged to undertake the making of their own amplifier-valves. Material difficulties interrupted the experiments in the middle of 1923, but it is hoped to be able to continue them in the near future and by using more elaborate arrangements and some innovations to obtain more perfect results.

I have tried, in the preceding paragraphs, to give a short account of these experiments, which contributed perhaps something of importance to the problems of television, but it is an impossibility to describe the work of seven years in the few pages of my

Perfect Mastery of Radio

MU-RAD
RECEIVERS
MA-15

"I am ready to obey thee as thy slave, and the slave of those who have that lamp in their hands"

—The Arabian Nights

Establishes a New Horizon for Radio

RECEPTION CONSERVATIVELY GUARANTEED 6 1000 MILES

WRITE FOR ILLUSTRATED LITERATURE

MU-RAD LABORATORIES, INC.
801 FIFTH AVE. ASBURY PARK, NEW JERSEY

SEND FOR YOUR FREE COPY

TESTED HOOK-UPS

SUBMITTED BY USERS OF OUR



Price \$1.00
POSTPAID
with instructions

WONDERFUL
TRANSMITTER

BUTTON FOR LOUD
SPEAKERS

AMPLIFICATION
AND EXPERIMENTS

K. ELECTRIC CO.

15 PARK ROW

NEW YORK

The DREADNAUGHT

famous side-swinger hand ejector revolver 32, 38 and 32-20 calibre guaranteed imported from Spain. **\$11.95** Reg. \$25 value.

The Super Dreadnaught
Imported from Spain.
Made of fine tool steel 32, 38 and 32-20 calibre. **\$14.50** Reg. \$35 value.

World famous German Luger, 30 cal. \$15.45. Imported Top Break Revolver, automatic ejecting 32, or 38 cal. \$7.85. Genuine Mueser, 9 shots automatic 25 cal. \$11.50. 32 cal. \$12.50. All brand new and absolutely perfect. Guaranteed imported. Use Standard Cartridges. Pay on arrival plus few cents postage. Satisfaction or money refunded. **SEND NO MONEY**
UNITED SALES CO., 16 E. 22nd Street Dept. 300 New York



A real balancing condenser

THE newly perfected Shamrock Balancing Condenser practically eliminates all body capacity. This and other exclusive features make this condenser a little wizard of efficiency. It permits one to balance a set with ease and precision. Makes your work the equal of factory experts.



The Shamrock Kit, \$20 List

CONTAINS two of the above balancing condensers—and three Shamrock air core transformers mounted and properly balanced on U. S. Tool condensers. Another exclusive Shamrock feature.

Inspect this kit at your dealer's today. If he hasn't it in stock, send us the coupon below.

SHAMROCK MANUFACTURING CO.
Dept. 60, Market St., Newark, N. J.

Send No Money
SHAMROCK MANUFACTURING CO.
Dept. 60, Market St., Newark, N. J.

Free Our Guarantee of money refunded if the kit is not satisfactory, gives you a free trial over a reasonable period of time.

Gentlemen: Send me prepaid one Shamrock Kit, upon receipt of which I will pay postman \$20.

Name

Address

Dealer's Name

Shamrock—For Selective Tuning

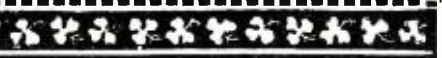

WHOLESALE ONLY

We Specialize in Equipping NEW DEALERS

with Complete Radio Stocks
MANHATTAN RADIO CO.
112-114 Trinity Place
NEW YORK CITY



BALLOON AERIAL! The best yet with tube or crystal. Overcomes range-troubles and over-amplifying. Price, all complete, \$5.00 with extra pilot balloon. Everett Scanlon, Radio Specialties, Lakewood, Rhode Island.

present survey. Should they be, however, among the readers, some who are interested in the problem of television, or who have conducted experiments themselves, I should be glad to answer their questions concerning details of the arrangements described, or to hear about their own experiments.

AUTHORS WILL FIGHT PLAY BROADCASTING

The Society of American Dramatists of 148 West Forty-fifth Street, New York, recently announced that they had taken steps to stop the broadcasting of plays by radio stations. In the future the society will bring suit against stations that include plays in their programs without the written consent of the authors.

The meeting was called after members had reported hearing their own plays on radio programs, though they had not given permission for the broadcasting.

Edward Childs Carpenter, president of the society, explained that numerous complaints had been received from members. He was unwilling, however, to name the offenders or those who had made complaints.

"The broadcasting stations probably did not know that these plays were protected by copyrights," said Mr. Carpenter. "We do not know how they got possession of the text of the plays.

"Most authors are opposed to broadcasting under any circumstances, contending that in the radio they are hurting the stage value of their plays.

"We are notifying all the radio stations and all the dramatic agents of our decision and sending each a copy of our resolution.

"Recently an author, 'listening in' on the radio, was amazed to hear the lines of his play. After considerable trouble he succeeded in getting a small fee for its unauthorized use.

"Under such circumstances a station is liable for a fee both under the copyright law and the common law. We propose to make it hot for any station that broadcasts our works without permission."

The society's resolution follows:
"Resolved, That henceforth the Society of American Dramatists will not permit the broadcasting of the plays of any member without the written consent of the member to the broadcast station;

"That this resolution is arrived at inasmuch as the plays of members are fully protected against unauthorized broadcasting both under the copyright law and the common law, and inasmuch as it is a fundamental principle that dramatic, literary and artistic works may not be reproduced in any way without the consent of the author, either with or without payment of royalty:

"That it is essential to the best interests of the members of the Society of American Dramatists that their plays be not broadcast without their consent, since in the estimation of the American Dramatists broadcasting is injurious to the production value of a play and tends to lessen the desire of the public to attend the regular performance."

RADIO BROADCASTERS FIGHT SONG LICENSES

Radio broadcasters entered a finish fight with the music publishers who refused to allow their songs to be broadcast without the payment of a license fee. Backed by 16,000 theatre owners, 2,000 hotel owners, 200 dancing masters and music teachers, they refused to enter into negotiations with the publishers and accused them of coercion.

The broadcasters scoffed at the American Society of Composers, Authors and Publishers, and pointed out that two of its members, Watterson, Berlin and Snyder and Will Rossiter, had resigned as members.

Referring to the suit reported to have been

OUR NEW MODEL
"Clear as a bell"
"It Speaks for Itself"

QUALITY
and
PRICE
\$6⁷⁵



TYPE B
Stands 22" High.
Bell Diameter 11".



For Any Single Receiver

Trutone Amplifying Radio Horns are scientifically constructed of Seamless, Non-Metallic composition. They are entirely free from the objectionable metallic ring common to most Loud Speakers. It is hand made and finished in crystalline enamel.

SADLER MFG. CO.

86 Fourth St., San Francisco, Calif.



A 2c Stamp Brings This Loop on Trial

Compare reception on your present aerial with reception on this new **IMPROVED Loop**—at our expense! Put our claims of selectivity, directional capacity, sensitivity to the test on your set in your own home. Ten days in which to make every conceivable experiment. Ten days to find out *all* about this loop before you buy it. Unless it entirely satisfies, you may return it or have your money promptly refunded. Select your type and send C. O. D. Order **NOW!**

- Type A-737 (300-700 meters) 6 inches square—non-directional \$10
- Type A-7236 (175-1000 meters) 6 inches square—non-directional \$12
- Type B-2537 (300-700 meters) 18 inches square—directional \$20
- Type BL-2520 (200-18,000 meters) with honey-comb coil mounting. 18 inches square—directional \$25

SEND FOR BULLETIN T-102

V-DE-CO RADIO MFG. CO.
Dept. N, Asbury Park, N. J.

DON'T expect good results from Neutrodyne, Acmedyne or Reflex receivers if questionable materials used. Our knocked down outfits contain high grade instruments of proven merit at reasonable cost. Send card today and see for yourself.
RADIO PARTS MANFG. CO.
1249 Marlborough, Detroit, Mich.

planned by the Society against the two publishers, E. F. McDonald, Jr., President of the National Association of Broadcasters, representing 526 stations, said:

"They can't sue one of their members without that member's consent and how can they get a member's consent for the organization to sue himself? That's what it amounts to, and it is a joke."

The challenge followed a session at the Blackstone Hotel, at which the theatre owners, hotel men and the dancing and music teachers' representatives met with the Executive Committee of the Broadcasters' organization. Afterward members of the Executive Committee of all the organizations departed for Washington.

"This controversy has become national in scope, and it is being echoed in Washington," said Paul B. Kulgh, executive chairman of the National Association of Broadcasters. He implied that efforts may be made to obtain action in Washington and possibly legislation. He made public a letter, which, after referring to the publishers' demands, says:

"Unfortunately your objections go far beyond ordinary recognition of what you term your rights. They enter the realm of high taxation with every likelihood that the burden will grow each year.

"Your methods are, to say the least, unusual. You are in the position of extorting money from a radio station through coercive methods, for a license which was not wanted and not asked for, and your music will not be used. It is difficult to reconcile such strong-arm methods with any bona fide desire to seek a fair solution of this question."

WHEN IS A SET COMPLETE?

Efforts are being made to standardize radio apparatus and the nomenclature which describes sets and parts. Is it not time all manufacturers and dealers standardized descriptions of sets? When is a set complete? How much more must one expend for tubes, batteries, aerial and phones?

Just after Christmas, a woman called the Chesapeake & Potomac Telephone Company and asked for aid, explaining that although she knew WCAP was broadcasting, she could not get it on her new set.

The operator inquired if the tubes lit up, whereupon she asked what they were, and being told, said there didn't seem to be any in the set. Further inquiry showed that she had neither tubes, batteries, aerial nor phones, but that the donor of the gift supposed he had presented her with a radio receiver ready for operation.

Other examples, such as this, prove the need of better salesmanship and also of better advertising, for some advertisements are found to be misleading, although probably not intended to be deceptive. The dealer who sold the above set lost the sale of accessories and the purchaser was embarrassed and disappointed when he learned that vital parts were missing from the "set." The word "set" implies that it is a complete entity. An automobile salesman would not sell or advertise a car without a battery, headlights and tires; therefore, why should a radio salesman do so? If the set is not complete and ready to operate, why not say: "without tubes, batteries or phones," as a few agencies do? Complete sets could also be advertised and then the purchaser would know just how much money he would have to spend.

AMBIDEXTERIOUS MENTALITIES

Several of our old friends defend the belief that experienced operators can copy or memorize more than one English message at a time, citing one expert in San Francisco, credited with having taken three despatches at once—all proving to be correct when writ-

Pathé
REG. U.S. PAT. OFF.



"MINUTE MAN" Radio Receiving Set

Incorporating
Pathe Type "P" Phusiformers

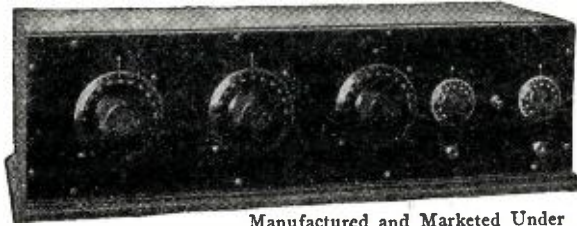

Manufactured and Marketed Under
License Agreement, Patent Pending.

Price \$125.00
(Tubes, Batteries Extra)

A 5-tube de luxe set combining all the desirable features of the best receiving sets:

- Does not oscillate.*
- Does not re-radiate.*
- Highly selective.*
- Sensitive to distant stations.*
- Free from hand capacity.*
- Simple to operate.*

The Pathé "Minute Man" is housed in a genuine mahogany cabinet equipped with beautiful mahogany panel and gold engraved dials, making a handsome as well as efficient instrument.

FREE

A most complete and detailed instruction book showing how to construct a "Minute Man" Receiving set will be sent you absolutely free of charge. Address Dept. 215.

Jobbers and Dealers

Write Dept. 215 for catalogs and prices of Pathé line.

PATHÉ PHONOGRAPH AND RADIO CORP.
20 Grand Ave., Brooklyn, N. Y.

"Push-Pull" Crescent Transformers

Experts admit "Push-Pull" amplification gives greatest satisfaction. The Crescent is a high grade Transformer. Specially designed to give maximum amplification on the new and improved circuits. Perfectly balanced. Gives clearer tones, reducing distortion to a minimum. Crescent "Push-Pull" Transformers are sold in matched pairs at \$8.50 per pair. Complete diagram, hook-up, list of necessary parts,

all sent free with each pair. Crescent Audio Transformer, 3 1/2 to 1 ratio, specially designed for 2-step amplifier to match above "Push-Pull" at 2.95 each. At your dealer's or sent post paid on receipt of price. Satisfaction guaranteed.
CRESCENT MFG. COMPANY
P.O. Box 337 Cent. Sta., Toledo, O.



WANTED—Well known radio corporation requires the services of an engineer thoroughly acquainted with radio and telephone receivers (headsets) also loud speakers. Applicant must have theoretical and practical knowledge. Company is prepared to pay a good salary. Excellent prospects for the future. Company is located in New York City. Give full details and experience, education, present earning capacity and address all replies to Box 94, care of Radio News, 53 Park Place, New York City.

Insure your copy reaching you each month. Subscribe to Radio News—\$2.50 a year. Experimenter Publishing Co., 53 Park Place, N. Y. C.



Enjoy Radio On Vacation

This year you can make your vacation far more enjoyable than last year. Carry one of these small portable radio instruments wherever you go.

Take it with you camping, fishing or hunting, and best of all, when you get back, set it up in your home. You'll enjoy the OZARKA all year 'round.

Away back from civilization you can still have at your command, the baseball scores and music from hundreds of radio broadcasting stations. Think of being in camp and yet be able to listen to all the wonderful things being broadcasted.

Just turn a dial or two and pick out what is the most interesting to you.

OZARKA

Portable Radio

is a compact three tube instrument, the case is 16 inches long, 10 inches wide and 5 inches high and weighs 10 pounds. In this small space you have a wonderful little instrument and yet built to receive long distances, very often from 1000 miles.

No matter where you go you will always be in touch with the best of radio broadcasting and the OZARKA is so simple a child can operate it. The OZARKA PORTABLE is completely equipped with aerial, "A" and "B" batteries, three No. 199 tubes and one set of head phones, all in one case. Nothing more to buy—all ready to tune in the concerts. PRICE COMPLETE \$65.00. Extra phones, per pair, \$5.50.

Local Representatives WANTED!

Over 1800 OZARKA agencies have already been established. If you would be interested in the fastest selling article on the market today write for full particulars. Be sure and give the name of your county.

OZARKA INCORPORATED
63 North Peoria St. Chicago, Ill.

THE FRANSDEN TUNER AND VARIOCOUPLER

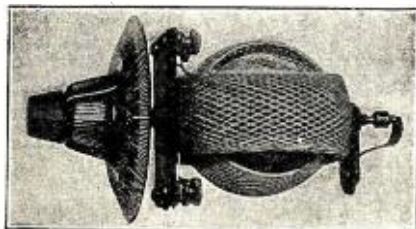

Patent applied for

AT LAST THE PERFECT TUNER for Broadcast Reception.

The most efficient and selective tuner made. For single circuit with tickler or variocoupler with loose coupled primary and secondary circuits. Perfect and continuous variation of the inductance of the antenna circuit without SWITCHTAPS and without a VARIABLE CONDENSER in the antenna circuit.

Complete for panel mounting, postpaid, \$7.50.
RADIO RESEARCH LABORATORIES
Frank Frandsen
ATASCADERO, CALIFORNIA

PATENTS As one of the oldest patent firms in America we give inventors at lowest consistent charge, a service noted for results, evidenced by many well known Patents of extraordinary value. Book, Patent-Sense, free. Lacey & Lacey, 631 F St., Wash., D.C. Estab. 1869.

ten out. There is a former Naval operator, now in a high Government radio position, who claims that while copying one message, he has often been able to note mentally other messages, interfering with the reception of the first, and later write them out. Whenever he was copying some dull and uninteresting report, he says, he was always able to note with accuracy messages pertaining to shore leave, pay or other features in which he was especially interested.

Another Government official says he once got the same message from two shore stations, transmitting simultaneously, while he was aboard ship off California. An important message for his ship was routed via San Francisco and also via Los Angeles. Both KPH and KPJ called him at the same time, and when he told San Francisco to go ahead, both began to send simultaneously. He tried to take them both, which proved very easy when he discovered they were identical. His O. K., intended for KPH, was considered by both stations as acknowledgment. The only trouble arose later, when both shore stations billed his ship for the message, each claiming credit for transmission.

NEW RADIO ASSOCIATION IN IRELAND

The awakening interest in radio development in the Irish Free State has prompted a group of professors, electrical engineers, and other prominent persons interested in radio work to organize a society which is to be called "The Radio Association of Ireland." This Association is to have its head offices in Dublin, and according to its constitution its objects are:

"To foster the interests of members engaged in Radio Work. To co-operate with the authorities and secure the utilization of the facilities afforded in conformity with regulations; to assist in having regulations complied with; and to assist in the framing of regulations. To establish relations and co-operate with kindred associations in other countries. To obtain experimental licenses and equip experimental stations for the purpose of research work."

All radio license holders and others interested in the development of the radio science and radio communication are eligible for membership. The membership fee is to be ten shillings per annum—equivalent to \$2.20 at current exchange rate—and the funds so collected are to be used in carrying out the various programs of the Association and in equipping experimental stations. The Association is also planning to publish a periodical devoted to radio work when its membership is large enough to finance such an undertaking. Already several hundred applications for membership have been received, and it is expected that the number of applicants will swell considerably when the contemplated broadcast station has been established at Dublin, and the present restrictions upon private ownership of radio sets have been removed.

THE PSALM OF RADIO

Radio is my hobby, I shall want no other.
It maketh me to stay home at night.
It leadeth me into much trouble.
It draweth on my purse.
I go into paths of debt for its namesake.
Yea, though I understand it perfectly, it will not oscillate.

Its concerts and speeches they comfort me.
Yet, it will not work in the presence of mine enemies.

I anoint the coils with shellac;
But the tube spillesh over.
Surely the radio bug won't follow me all the days of my life.
For if it does I will dwell in the house of poverty forever.

HARRY R. LUBCKE.

The Peak of Radio Perfection

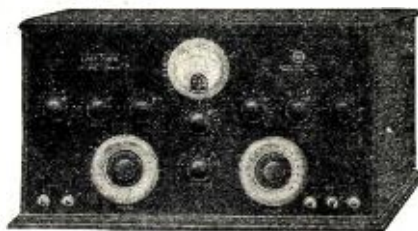

Type LR-170, 3 Stages Radio, Detector
3 Stage Audio Frequency Amplification

Uni-Tune

TRADE MARK

Receiver and the LOOP TUNER

TRADE MARK

Eliminates Aerial and Ground with Clearer Reception. EXTREME SELECTIVITY with easy manipulation. FLEXIBILITY—4 to 7 tubes may be used at will. RANGE—DX stations on the Loud Speaker. SPECIAL WESTON VOLT-METER—Showing A and B Battery voltages. Contains all batteries for dry cell operation. Write for Circular "R."

NASSAU RADIO CO., Inc.
60 COURT ST., BROOKLYN, N. Y., U. S. A.

KLAUS

Complete Stock of

Broadcast Receivers

Ready for shipment, KLAUS carries a complete stock of the latest and best broadcast receivers. All apparatus distributed by KLAUS is manufactured by the best manufacturers and bears the KLAUS GUARANTEE. Get our prices on amateur receiving and transmitting equipment.

KLAUS RADIO BULLETIN

for Dealers—Do You Get It?

Expert advice regarding radio problems, latest information about new equipment, and hints on radio merchandising which helps dealers make more money, is in every issue of the KLAUS RADIO BULLETIN. If you are not on our mailing list of dealers receiving the bulletin, send us your name and also receive our trade discount lists.

KLAUS RADIO & ELECTRIC Co.

Authorized Distributors
Dept. 200 EUREKA, ILL.

RUSONITE

RADIO CRYSTAL

Used All Over the World
Guaranteed Price Mounted 50c
RUSONITE CATWHISKER 14K. GOLD 25c
Rusonite Products Corporation
15 Park Row, New York, N. Y.

EVIDENCE OF CONCEPTION PATENTS

DON'T LOSE YOUR RIGHTS
Before disclosing your invention to anyone send for blank form "EVIDENCE OF CONCEPTION" to be signed and witnessed. Form and information concerning patents free.
LANCASTER & ALLWINE
270 Ouray Bldg., Washington, D. C.
Originators of the form "Evidence of Conception"

With the Amateurs

(Continued from page 1592)

DIRGE OF THE RADIO CLUB

(To be sung to the tune of "I'm Forever Blowing Bubbles," to the accompaniment of the distant clank of eight silver dollars.)

We climbed on high,
And, 'gainst the sky.
Our "bird-cage" lingers yet;
We pooled our stuff—
Had just enough—
And built a See Dubya set.
But here's one thing we've been learning:
Y' can't keep those five-watters burning!

We're forever blowing bub-bulbs,
When our station's on the air!
Radiation's parked
Near the two amp. mark.
Then in a wink that tube goes dark!
Hear those nines CQ-ing.
Eights, too, here and there;
But—we're forever blowing bub-bulbs
When the rest are on the air!

Contributed by J. O. Wood, of 5.A.G.A.

QRA'S

- 1AVG—(Reassigned) E. B. Moore, Litchfield St., Springfield, Vt.
- 3DM—(Reassigned) S. Sabaroff, 2936 W. Morris St., Philadelphia, Pa.
- 4HV—Herman E. Kennedy, Cumnock, N. C., 3 watts C.W. All cards answered.
- 9AQR—G. C. Kellersman, 36 N. Elm Ave., Webster Groves, Mo. All cards answered.
- 8ANM—H. J. Crisick, W. Washington St., Medina, Ohio. Pse QSL. All cards answered.
- 5PC—(Reassigned) Meredith Schaff, Vicksburg, Miss. 5-watt S.P.C.W. QSL's appreciated.
- 3SJ—(Reassigned) Arthur B. Cochran, 317 Main St., Crisfield, Md. QSL's appreciated.
- 8ABL and 8JD have been reassigned to amateurs outside the local district of Grand Rapids. Cards cannot be forwarded.
- 2DW—Meyer Knoll, 304 East Tremont Ave., Bronx, N. Y. 10 watts C. W., I.C.W. and Fone.
- 4DH—L. A. Savage, 208 Laurens St., Camden, S. C. All cards answered.
- 8DNQ—Frank F. Babb, 1307 S. Fountain Ave., Springfield, Ohio. All cards answered.
- 8DCV—Edmond Schrecengost, 412 E. Francis Ave., Connellsville, Pa. 10 watts C. W. All QSL's answered.

CALLS HEARD

This space is set aside each month for the listing of amateur calls heard. We invite you to send us a list of the stations you have heard, typewritten if possible, or at least sufficiently readable to prevent mistakes. Print the calls on a separate sheet of paper, using but one side. These should be arranged alphabetically for each district. To distinguish the stations that have been worked, they should be put in parentheses, and, according to the rules now in use, the C.W. stations should be mentioned in a separate list. The lists should reach us by the first of the month for publication in the following issue.

8BRB, APOLLO, PA.

- C. W. 1AH, 1ALJ, 1ANA, 1ARP, 1BCG, 1CJK, 2AAO, 2AJA, 2AJX, 2ANA, 2BEL, 2BY, 2CI, 2CEA, 2CIU, 2CMI, 2CPY, 2CTK, 2CXW, 2DEI, 2RB, 2TS, 2VW, 2YD, 3ADB, 3AKY, 3ALG, 3ARM, 3BDO, 3BDR, 3BNU, 3BOO, 3BUY, 3CA, 3LG, 3QT, 3TA, 3WF, 4SR, 4ZA, 5EK, 5ZA, 8ACT, 8ADT, 8AEX, 8AEY, 8AFI, 8AGP, 8AHC, 8AIG, 8ALF, 8ALG, 8ANM, 8ANN, 8APN, 8APT, 8ARV, 8ASV, 8AVU, 8AWT, 8AXA, 8BAV, 8BBF, 8BBM, 8BBU, 8BBW, 8BCP, 8BGG, 8BGJ, 8BGZ, 8BHF, 8BJR, 8BJS, 8BKY, 8BMG, 8BMK, 8BNN, 8BOE,

MR. BOWDEN WASHINGTON, CHIEF ENGINEER OF THE Cutting & Washington

RADIO CORPORATION

Says: "All-American Audio Frequency Transformers were adopted as standard for the Cutting and Washington Receiver after thorough tests in our laboratories demonstrated that they faithfully reproduce broadcasted music and voice with excellent volume and stand up in service better than any other transformers we have tested. We consider All-American Audio Frequency Transformers the best on the market." Many other leading set builders have similarly standardized on the best the market affords: All-Americans! Benefit by their experience. Add All-Americans to your set now. Dealers everywhere.

Radio Frequency: 150 - 550 meters, \$4.50

Audio Frequency: 3:1, 4.50; 5:1 and 10:1, \$4.75



ALL-AMERICAN

AMPLIFYING TRANSFORMERS

Largest Selling Transformers in the World

AND NOW!—THE ALL-AMERICAN RADIO FREQUENCY

Long Wave Transformer

SPECIAL OFFER
All-American Book of 22 Tested Radio Hook-ups and diagram - circular on Power Amplification mailed for 4c in stamps.

4,000 to 10,000 meters (75 to 30 K.C.). Suitable for all long wave radio frequency circuits such as Super-Heterodyne, Ultradyne, Reflex, Etc. Placed on the market only after long and thorough tests. Again All-American leads! Features: Windings of extremely low capacitance, properly treated and impregnated. Housed in a handsomely nickel-plated shell of same physical design as All-American Audio Frequency Transformers—to insure neatness and ease of assembly. Shielded to prevent inter-stage coupling or reaction. Price, \$6.

Rauland Mfg. Co., 2650 Coyne St., Chicago

Pioneers in

the Industry



A TYPE FOR

EVERY CIRCUIT

ALL-AMERICAN

AMPLIFYING TRANSFORMERS

Largest Selling Transformers in the World



The Crystal With a Soul
(Reg. U. S. Patent Office)

Reception Louder Clearer More Natural
Functions with any conductor.
No special Cat-Whisker necessary. 50c
Will not burn out. \$1.25
Celerundum "DE-TEX-IT"

A perfect fixed detector. \$1.25

Needs no adjustment
Celerundum Products carry a MONEY BACK GUARANTEE

Celerundum Radio Products Co.
170 Summer Street, Boston

Be in the advance line of discovery

You can work new wonders in voice modulation and carry on advance experiments in radio with the Cummings long life stable Photo - Electric Cell. You can enter the field of telephotography and television. Diagram of connections furnished with order.

A New Photo-Electric Cell
Long life
No lag \$17.50
Sent prepaid

GENERAL RESEARCH LABORATORIES
326 River Street, Chicago

Include your copy reaching you each month. Subscribe to Radio News—\$2.50 a year. Experimenter Publishing Co., 53 Park Place, N. Y. C.

3 Regal

MASTERPIECES!

Perfect Contact Vernier Rheostat

For fine filament control of tubes and superfine tuning, the Regal Vernier stands alone. Nothing just like it on the market.

Complete with Knob
6-Ohms. . . \$1.25
30-Ohms. . . 1.25



Fifteen Taps — But Only One Drill Hole Required!

A 15 Point Switch complete in one unit. No more messy soldering. No more drilling of holes. No more clipped panels. Complete with hard rubber Knob and Dial
Type No. 162 . . . \$1.50

Broadcast Tested High Quality Audio Transformer

For clearness of tone, amplification of voice and music from nearby and distant broadcasting stations, Regals are unequalled by any transformers on the market.
3/2 to 1 Ratio. . \$4.25
5 to 1 Ratio. . 4.50



At all good dealers—otherwise write direct for complete descriptive folder No. 18, sending dealer's name

AMERICAN SPECIALTY CO.
Bridgeport, Connecticut, U. S. A.

KESTER SOLDER

Self-Fluxing

for Radio Work

For heavier Radio and general soldering, use Kester Acid-Core Solder — (Underwriters' Laboratories inspected).

For delicate Radio work use Kester Rosin-Core Solder.

For household and general mending, use Kester Metal Mender.

Kester Solder is genuine solder that supplies the necessary flux from tiny pockets within itself as it is consumed. Radio, Electrical, Hardware and Auto Supply dealers can supply you.

"Requires Only Heat"



8BOY, 8BOI, 8BTM, 8BUL, 8BVR, 8BZC, 8BZP, 8CBX, 8CDI, 8CDZ, 8CEI, 8CFS, 8CGI, 8CHV, 8CMJ, 8CNW, 8CPJ, 8CPK, 8CQO, 8CQS, 8CSM, 8CUV, 8CVK, 8CUM, 8CWP, 8CX, 8CYU, 8DAA, 8DAF, 8DCY, 8DED, 8DGI, 8DGR, 8DH, 8DHN, 8DIA, 8DIF, 8DJV, 8DKB, 8DKM, 8FM, 8HD, 8IV, 8JJ, 8JK, 8KG, 8KO, 8LW, 8MK, 8NO, 8TI, 8VQ, 8WA, 8XN, 8YN, 8YV, 8ZR, 9AAA, 9ADY, 9AEM, 9AFY, 9AIB, 9AJQ, 9AJW, 9AND, 9APD, 9AST, 9AUE, 9AZP, 9BA, 9BBI, 9BCB, 9BEP, 9BEZ, 9BIV, 9BP, 9BOS, 9BSC, 9BVO, 9BWB, 9BZT, 9CCG, 9CGN, 9CYO, 9DAY, 9DAI, 9DFC, 9DJZ, 9DUG, 9DXS, 9EFO, 9EHV, 9EJA, 9EQ, 9LB, 9LE, 9MA, 9QR, 9RU, 9VC, 9VZ, 8CKD, 8CDZ, 8CKK.

Phone—5ZA, 5AMP, 5CX, 5WX, 9BAY, WBAP, KFKB, KFKY, WOC.
A card to all the above if they will drop me a card.

9CKM, KANSAS CITY, KANSAS

1ER, 1GY, 1II, 1JV, 1JX, 1LC, 1OA, 1VA, 1WO, 1WS, 1ASP, (1ACL), 1ARY, 1AUA, 1AUR, 1AWY, 1AXO, 1BCG, 1BES, 1BHM, 1BOQ, (1BSZ), 1CAR, 1CAL, 1CKI, (1CPN), 1BOI, (1YB), 1ZD, 1ZH, 2AL, 2BJ, 2BY, 2FZ, 2GK, 2HS, 2LG, 2RK, 2RM, 2TS, 2WB, 2AFP, 2AQY, 2AWF, 2AYV, (2BQH), 2BRD, 2BTE, 2BUC, 2CNK, 2CCD, 2CEE, 2CLA, 2CLU, 2COR, 2CUA, 2CWP, 3BA, 3CC, 3DE, 3DZ, 3GG, 3IR, 3JY, 3KO, 3LG, 3MB, 3ME, 3MP, 3MS, 3OB, 3OF, 3OV, 3PH, 3RG, 3TR, 3ABI, 3ADP, 3AEK, 3AHD, 3AQR, 3BDO, 3BPU, 3BDZ, 3BEI, 3BIZ, 3BJK, 3BLP, 3BMN, 3BSS, 3BTU, (3BVA), 3BVN, 3CCD, 3CDV, 3CFI, 3CJNA, 3CRR, 3COZ, 3YV, 3ZH, 4AY, 4FZ, 4GL, 4GZ, 4HR, 4HS, 4HW, 4IH, 4IT, 4IU, 4JK, 4MB, 4NA, 4NV, 4OA, 4OM, 4PD, 4PK, 4RH, 4TH, 5AA, 5BX, 5EK, 5FM, 5GM, 5JC, (5JE), (5JK), 5KD, (5LR), 5NZ, 5PF, 5PH, 5OD, 5OL, (5OW), 5SD, 5SR, 5UA, (5UD), 5UK, 5UO, 5VF, 5XD, (5XV), (5YW), 5ZA, 5AAC, 5AAT, (5ABG), 5ABY, 5ACM, 5AVB, 5ADC, 5ADE, 5ADH, 5ADO, 5AFH, 5AFO, 5AII, (5AIU), 5ASP, (5AKN), (5ALK), 5AMH, 5AMK, 5AMW, (5XAO), 6AK, 6DD, 6FP, 6FY, 6GR, 6LV, 6MB, 6MH, 6NX, 6PL, 6RM, 6RN, 6VF, 6AAO, 6AAQ, 6ACM, 6AFO, 6AGK, 6AJA, 6AJH, 6AJV, 6AKZ, 6ANI, 6AOS, 6APE, 6ATQ, 6AAU, 6AUW, 6AWB, 6AWO, 6AWT, 6AWX, 6BAH, 6BBC, 6BEO, 6BBEW, 6BFG, 6BFH, 6BIC, 6BIH, 6BIN, 6BLG, 6BLM, 6BLN, 6BNG, 6BON, 6BPM, 6BRF, 6BUM, 6BUN, 6CND, 6CGW, 6CHE, 6CHU, 6CKR, 6CLK, 6CMR, 6CMF, 6ZH, 6ZV, 6ZAH, 6ZAR, 6ZBN, 7AF, 7AH, 7BR, 7CO, 7DC, 7FD, 7KK, 7LU, 7NY, 7OT, 7QC, 7OD, 7SC, 7ADH, 7AFN, 7AGV, 7AHV, 7AIF, 7AIP, 7AJD, 7AJJ, 7AJT, 8BQ, 8CR, 8CT, 8DC, 8DP, (8ES), (8JJ), 8MY, (8OA), 8OE, 8PL, 8PT, (8RR), 8VE, 8WA, 8WX, (8ABL), 8ACT, (8AEG), 8AGA, 8AGP, 8AIC, 8ALF, (8ALW), 8APE, 8APN, 8APT, 8ATP, 8AZO, 8BBN, 8BBW, 8BCJ, (8BDA), 8BDU, 8BGR, (8BGH), 8BGO, 8BHO, 8BKK, 8BNH, 8BOL, 8CAP, 8CDZ, 8CKO, 8CKV, 8COP, 8CRC, (8CSE), 8CVH, 8CXV, 8CWR, (8CWU), 8CXI, (8CYT), 8CZZ, 8DAA, 8DAG, 8DAT, 8DB, 8DDC, (8DED), 8DDN, (8DFV), 8DFZ, (8DGO), 8DJP, 8DIT, (8XE), 8XBI, 8YN, (8YW), 8ZC, 8ZZ.
Canadian—1CI, 2AM, 2BE, 2BG, 3AA, 3AC, 3BO, 3HE, 3HI, 3LY, 3MN, 3PZ, 3WG, 3YH, 3YV, 4EA, 4HN, 5CE, 5GO, 9BP, 9BX.

9DHJ, CROWN POINT, INDIANA

(ONE TUBE)
CW, 1BOO, 1CKP, 1ER, 1HY, 1MO, 1VV, 1XH, 1XM, 1XZ, 1YB, 2AZY, 2AYN, 2BUY, 2BY, 2BM, 2CSR, 2CCD, 2EL, 2FMA, 2WB, 2XQ, 3ADV, 3BDD, 3BP, 3CDV, 3HK, 3ME, 3PG, 3TB, 3TI, 3VV, 3WM, 3ZL, 4AI, 4BF, 4BNU, 4BK, 4BL, 4CS, 4EB, 4EL, 4FT, 4HL, 4QF, 4SB, 4SF, 4SH, 4BQ, 5AIV, 5AHR, 5AGO, 5AIR, 5ADS, 5FVI, 5HT, 5HL, 5LF, 5IG, 5KS, 5LO, 5MI, 5MO, 5QL, 5TG, 5VV, 5WO, 5XA, 9BCB, 9BEZ, 9BLY, 9BOF, 9BQQ, 9BUN, 9BXA, 9BZI, 9BZN, 9CAA, 9CCZ, 9CEA, 9CFI, 9CGA, 9CJY, 9CKJ, 9CLD, (daylight), 9CLY, 9COC, 9CSS, 9CTR, 9CUN, 9CVC, 9CVS, 9CVT, 9CWX, 9CZM, 9DBF, 9DGV, 9DHW, 9DIB, 9DKQ, 9DKY, 9DPP, 9DRW, 9DTE, 9DUG, 9DUN, 9DVM, 9DWB, 9DNA, 9DXN, 9DXR, 9DXU, 9DYR, 9DZO, 9EDB, 9EHJ, 9EKY, 9ELV, 9HN, 9LA, 9MC, 9QE, 9RC, 9ZT.
Canadian CW—4CL, 9AV, 9BJ.

5ZA, 6AHU, 6AMB, 6BGW, 6BVC, 6BUP, 6ZC, 7OL, 8AA, 8AIG, 8AFD, 8ATZ, 8BZC, 8BRC, 8BCS, 8BHO, 8BYI, 8BFB, 8BFD, 8BNZ, 8CID, 8DQU, 8DDT.

Spark—5BW, 8BA, 8EB, 9BWS, 9BUX, 8CTD, 9BTG, (9CBH), 9DHG, 9DHz, 9DN, 9DWK, 9ROF, 9EDH, 9COX, 9CFP, 9LF, 9WX.
Glad to QSL to any above.

6CMI, OAKLAND, CALIFORNIA

1AKL, 1ALL, 1BSG, 1CMP, 5AC-5BX, 5CU, 5NW, 5QD, 5RU, 5TU, 5TO, 5TS, 5XD, 5ZA, 5ZAV, 6CEU, 6TQ, 6AMW, others too numerous, 7MN, others too numerous, 8AZG, 8APT, 8CWG, 9FM, 9LZ, 9TO, 9TW, 9QE, 9ZKY, 9AAU, 9AFM, 9AGA, 9AGB, 9AGY, 9AIM, 9AMN, 9APF, 9ASH, 9AVN, 9AVU, 9AYR, 9AXX, 9AZG, 9BAB, 9BED, 9BFH, 9BRS, 9BQI, 9BJK, 9BZI, 9CAA, 9CTP, 9CTR, 9DCR, 9DKR, 9DQA, 9ELD, 9EAE. Phone 6BRF, 7VN.
W. T. Campbell, 20 watts phone and C. W., reports appreciated.

2BZP, BROOKLYN, N. Y. (TWO TUBES)
1ABC, 1AEZ, 1ACA, 1AML, 1APC, 1ATW, 1AVW, 1AZN, 1AZI, 1BAM, 1BCG, 1BHF, 1BIS, 1BWT, 1CAZ, 1CDI, 1CKQ, 1CI, 1CMX, 1KD, 1II, 3ADN, 3APW, 3BJ, 3BNE, 3BPF, 3CHB, 3CDV, 3HH, 3YV, 3VP, 3CLT, 4CH, 4DB, 4EQ, 4FT, 4GX, 4IS, 4JK, 4KU, 4MY,

A Pure Tone Phone for any Loud Speaker Horn

or Phonograph. It is reasonable to believe that men who have spent over eight years in perfecting and manufacturing Radio Headsets have the necessary qualifications to create and produce a real Loud Speaker Unit. The clear, true tone of the Camco Loud Speaker Unit reflects the high ideals of its makers. Price \$6.

Camco Headsets

Cannon Ball, \$3.50; Superb, \$4.50; Grand, \$5; De Luxe, \$7.50.

At your dealers or write

Cannon & Miller Sales Corp.
47 W. Huron St., Buffalo, N. Y.



SALESMEN

Largest radio publishing organization in the world, wants salesmen, either whole or side line, to sell an assortment of 20 books to the trade.

Liberal commission to hustlers.

Box 233, RADIO NEWS
New York City.

Non-Inductive Resistances

1,000
12,000
48,000
50,000
80,000
100,000

\$1.00 Each

No Stamps Accepted

HAROLD HERBERT, Inc.

160 West 46th St., Just East of Broadway
NEW YORK CITY

TO THE RADIO DEALER

Let us explain how you can make the sale of our publications a worth while, well paying part of your business. Every one that enters your store is a prospective buyer of RADIO NEWS. RADIO NEWS will sell with little effort on your part.

You may sell our publications on a single copy basis with a fine margin of profit or on a subscription basis with a generous commission allowance.

Write now for further details.

Experimenter Publishing Co.
53 Park Place
New York

9AHJ, 9APF, 9AP, 9APS, 9ARF, 9ATZ, 9AHV, 9AVI, 9AVT, 9AWF, 9AZJ, 9AVE, 9AAR, 9BAK, 9BAB, 9BCB, 9BCF, 9BCX, 9BED, 9BFF, 9BFU, 9BGB, 9BGY, 9BHX, 9BIB, 9BKH, 9BKR, 9BMK, 9BMX, 9BOF, 9BT, 9BQV, 9BRC, 9BRX, 9CA, 9CDO, 9CHK, 9CJA, 9CMF, 9CRA, 9CWP, 9CZM, 9DAW, 9DGG, 9DHB, 9DKV, 9DLM, 9DFC, 9DSL, 9DWK, 9DXC, 9DXU, 9EGW, 9EHI, 9ER, 9EQD, 9FM, 9FB, 9PW, 9QR, 9WU, 9VC, 9ZLT.

Spark—4FG.
Phone—3ALE, 9AUS, 8XS.
Will gladly QSL all crds.

F. A. ESTEP, PITTSBURGH, PA.
(ONE TUBE)

1ARJ, 1AWK, 1CPW; 2BF, 2WX, 2BBN, 2BIJ, 2CEE, 3CLA, 2CLU, 2CQS; 3CC, 3LL, 3AGF; 4FT, 4JW, 4PK; 5ZAE (received several 6's and 7's, but was unable to copy them through heavy QRM). 8AA, 8BW, 8GU, 8HK, 8IH, 8JJ, 8OC, 8TH, 8UT, 8UV, 8YN, 8ZP, 8ZU, 8ZW, 8ADZ, 8AFD, 8AGO, 8AGP, 8AHC, 8AIG, 8AJV, 8AKY, 8ALQ, 8ALW, 8ALX, 8APN, 8ARB, 8ASQ, 8AYW, 8BCF, 8BCH, 8BGZ, 8BIM, 8BLG, 8BMV, 8BNH, 8BOA, 8BOS, 8BOU, 8BUA, 8BWP, 8CEO, 8CES, 8CHR, 8CMF, 8COP, 8CRM, 8CTF, 8CUN, 8CUZ, 8CVX, 8CYU, 8DAL, 8DGE, 8DHJ, 8DHK, 8DJP, 8DMZ, 8DNK; 9GV, 9PB, 9WE, 9WU, 9AHG, 9AHJ, 9APC, 9APE, 9ASN, 9AXW, 9BAL, 9BMO, 9BOM, 9BOY, 9BRS, 9BWF, 8BWX, 9CEE, 9CUY, 9DBU, 9EME.

9RC, CHICAGO, ILLINOIS

C.W. IAAC, (1ABF), 1AIO, 1AKZ, 1ARY, (1AVO), 1AWE, 1BOQ, 1BSZ, 1BVB, 1CAK, 1CGQ, (1CMP), 1CMX, 1CPC, (1CPN), (1KA), 1KC, 1YD, 1ZD, 1ZJ; 2AAV, 2AED, 2AGB, 2AL, 2ANA, 2AWA, 2AZY, 2BE, 2BIJ, (2BIR), 2BKL, 2BZ, (2BRB), 2BT, 2BY, 2CAR, (2CCD), 2CCX, 2CE, (2CEE), 2CNH, 2CQZ, (2CPZ), 2CRP, 2HG, 2KX, (2LE), 2QS, 2RB, (2RK), 2TS, 2XX; 3AA, 3AAK, (3AAO), 3AB, 3ADV, 3AJS, 3APC, 3AQR, 3AY, 3BAL, 3BDO, 3BG, 3BF, 3BIJ, (3BNV), (3BPF), 3BTY, 3BUY, 3BVA, (3BVL), 3BWI, 3CCD, 3CCV, 3CDN, 3CFI, 3CJN, 3GG, (3HH), 3HK, 3IW, 3KG, 3LX, 3OG, (3OV), 3OQ, 3NF, 3SS, (3TF), 3WF; (4AB), 4AF, (4AG), 4AY, (4BA), 4AL, 4BN, 4CR, 4CS, 4DX, 4EB, (4EQ), 4FG, 4FT, 4FV, 4FZ, 4GZ, (4HR), 4IO, 4IT, 4JH, 4LJ, (4MI), 4ND, 4OA, 4OT, 4QF, 4QK, (4SH), 6AGE, 6AHP, 6AJH, 6AOS, 6AQF, 6AQO, 6ARB, 6ARU, (6AUV), (6AVR), 6AWT, 6BEO, 6BIC, 6BHK, (6BII), 6BKN, 6BLG, 6BLM, 6BNF, 6BRF, 6BUO, 6CEU, 6CGD, 6CGW, 6CIE, 6CNI, 6CZ, 6FP, 6GG, (6GT), 6KA, 6NG, (6NAD), 6ZB, 6ZU, 7CO, 7WP, (7YL), 7ZU, (KDEF), NKE.

Hawaiian—6CEU.
Canadian—2BE, (2BN), 2CG, 2EI, 2FU, 2HG, 2IC, (3ADN), (3AFZ), 3IV, 3PH, 3TB, 3WS, 3YV, 3ZT, 4EA, 4FZ, (5CN), 5GO, 5OH(?).
British—2KL, 5WS.

6CNL, LOS ANGELES, CALIF.

5BE, 5FT, 5QD, 5XD, 5ADB, 5ADO, 5AIB, 5AKY, 6's and 7's too numerous, 8FM, (8ZY), 8APT, 8BDA, 8BNK, 8BYO, 9AP, 9AEF, 9AEY, 9AIM, 9AVS, (9BLY), 9CCG, (9CEH), 9DFH, 9DYR, 9EKY, 9ELV. The following were heard in 40 minutes on the nite of January 28, 1924: 4OA, 5FT, 5AKY, 5ZAV, 7IO, 7OT, 8AA, 9AAU, 9AFO, 9APE, 9APF, 9AXX, 9BGX, 9BGY, 9BIJ, 9BIZ, 9BOF, 8BUJ, 9BVO, 9CAA, 9CJY, 9EBI. Anyone hearing 6CNL pse QSL crd. All crds answered and appreciated.

9DHJ, CROWN POINT, INDIANA
(ONE TUBE)

CW. 1AR, 1AW, 1BIZ, 1CKP, 1KC, 1MO, 1X, 1YB, 2BAW, 2BOR, 2BUY, 2CCD, 2CSR, 2BM, 2WB, 3ADV, 3BDD, 3CCX, 3CDV, 3HK, 3ME, 4AI, 4BK, 4BLP, 4MI, 4QF, 5AIU, 5AIM, 5AGJ, 5KA, 5TJ, 5XA, 5ZA, 6AHU, 6BM, 6BGW, 6BUC, 6LV, 6MH, 6ZC, 7AJV, 7AHZ, 7CB, 7TO; over 200 8's and 9's; sparks 4FG, 4RG, 5BW, 9AOY, 9BGO, 9BDH, 9BEF, 9CA, (9CBH), 9COX, 9DIL, 9DWK, 9ECR, 9GC, 9HU, 9MB, 9WX, 8BDA, 8CTD, Can 4CO spk?
Can.—5EF, 9BP.

4SS, CHARLESTON, S. C.

C.W. 1AHB, 1AUR, (QRA), 1AW, 1AXN, 1BGC, 1BGO, 1BHR, 1BOO, 1BSX, 1CRF, 2ANA, 2BSZ, 2CJB, 2CKA, 2GR, 2HJ, 2TS, 3AF, 3AKR, 3BDO, 3CC, 3QW, 4AF, 4AI, 4AJ, 4BA, 4BG, 4CH, 4CL, 4DB, 4EH, 4EL, 4EP, 4ER, 4EZ, 4FA, 4FT, 4IF, 4II, 4IO, 4IT, 4IU, 4IZ, 4JA, 4KC, 4LJ, 4LR, 4MA, 4ME, 4MI, 4MY, 4NA, 4NE, 4OG, 4PK, 4PT, 4Q, 4QW, 4QY, 4SH, 5AAC, 5ABF, 5ABW, 5AC, 5AFV, 5AGJ, 5AIR, 5AIU, 5AL, 5AMH, 5AMZ, 5ANA, 5EK, 5GF, 5GI, 5GN, 5JL, 5JW, 5KL, 5LP, 5LR, 5MI, 5MO, 5NN, 5OV, 5PL, 5QI, 5QR, 5RD, 5RH, 5SU, 5SY, 5TW, 5UA, 5VT, 5VV, 5VY, 5WG, 5XK, (5QRA), 5YW, 5ZA, 5ZAS, 5ZC, 5ZG, 6AIG, 6AWG, 6BIC, 6BJJ, 6BUN, 6BUY, 6CBI, 6CGD, 6CGF, 6CGW, 6CHR, 6CIB, 6CKV, 6CKW, 6DOG, (QRA), 6EB, 6FM, (QRA), 6FR, (QRA), 6NB, 6PP, (QRA), 6ZH, 6ZZ, 7CO, 7LO, 8BWX, 8ADB, 8AJC, 8AMA, 8BDI, 8BDU, 8BWN, 8CHB, 8CQH, 8CYH, 8DGL, 8FM, 8RJ, 8U, 8AHJ, 8AHZ, 9AMU, 9APF, 9APS, 9ARM, 9AUE, 9BBG, 9BBR, 9BC, 9BCC, 9BDT, 9BED, 9BHT,

BAKELITE

TRADE MARK REG. U. S. PAT. OFF.

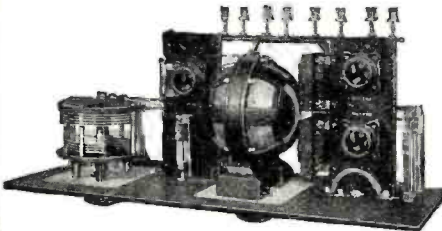

Grebe and Bakelite

The character of broadcast reception enjoyed by users of Grebe Radio Sets is due, in no small measure, to the extensive use of Bakelite.

Grebe standards of craftsmanship demand the best, and in selecting a dependable insulating material which would present a refined physical appearance, they chose Bakelite as the one material which would meet their requirements.

The excellence of Bakelite and the dependability of its qualities is indicated by the fact that a large majority of Radio Manufacturers choose Bakelite as insulation, and

for improving and simplifying the design of their sets and parts.

Bakelite combines in ONE material the essential properties of many. It is highly dielectric and mechanically strong; it is unaffected by moisture, temperature or climatic changes; its color will not fade, even in strong sunlight; it will not warp, bloom or crack—but the most important property of "The Material of a Thousand Uses" in its relation to Radio is that of providing *permanently* effective insulation regardless of temperature or atmospheric conditions.

Write for a copy of our Radio Booklet B.

BAKELITE Condensite REDMANOL

are the registered Trade Marks for the Phenol Resin Products manufactured under patents owned by **BAKELITE CORPORATION**

Send for our Radio Map

Enclose 10c. to cover mailing cost and we will send you a large Radio Map which lists the call letters, wave length and location of every broadcasting station in the world. Address Map Department.

BAKELITE CORPORATION

247 Park Avenue, New York, N. Y.
Chicago Office: 636 West 22d Street

THE MATERIAL OF A THOUSAND USES

**SURE-FIRE
D-X
CRYSTAL**

**THE MARVEL OF ALL
SYNTHETIC CRYSTALS**

Extraordinarily supersensitive all over. Ideal on Reflex circuits. Tested, sealed, guaranteed. Indorsed by N. Y. Mail and Tribune.

50c. Mtd. at all dealers or sent postpaid.

Specialty Service Co., 9 Hanson Pl., Bklyn, N. Y.
Radio, Ltd., Montreal, Can. Canadian Distributors.

PATENTS

Hand Books on Patents, Trade Marks, etc., sent free. Our 78 years of experience, efficient service, and fair dealing assure fullest value and protection to the applicant. The Scientific American should be read by all inventors.

MUNN & CO.
687 Woolworth Building, New York
Scientific Amer. Bldg., Washington, D. C.
Tower Bldg., Chicago, Ill.
Hobart Bldg., 582 Market St.,
San Francisco, Cal.
Van Nuys Building, Los Angeles, Cal.

WANTED—Back numbers of Radio News, Dec., 1921, Jan. and Feb., March and April-May, 1922. Experimenter Publishing Co., 53 Park Place, New York City.

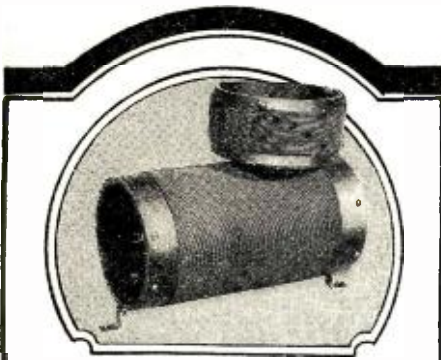

The Only Authorized Cockaday Coil

Capacity effects, high dielectric losses, leakage, broad tuning and howling caused by coils made of cardboard tubes, shellac, and cotton covered wire must be eliminated to get efficient results from Cockaday sets and other circuits.

Replace your old coils with the only Authorized Cockaday Coil, built exactly in accordance with latest specifications of Laurence M. Cockaday, inventor of the famous Cockaday Four Circuit Tuner.

Each Authorized Coil bears Cockaday's personal signature. Built on 1/4" hard rubber tubes, threaded—no shellac, and wound with double silk covered wire. Gives maximum selectivity, greater volume, sharp tuning, maximum sensitivity and tonal quality when properly hooked up. Guaranteed. At your dealers, otherwise send purchase price and you will be supplied postpaid

\$5.50

Approved by

SW Cockaday

PRECISION COIL CO., Inc.

209-D Centre Street

New York



Get a WRIGHT'S RADIO LOG

EVERY FAN NEEDS ONE!

Wright's Radio Log is the finest, the most comprehensive and the handiest record book ever produced for radio fans. Nothing else like it in existence. Ruled to fit any set from 1 to 8 tubes—special pages for local stations and programs. All stations in United States and Canada listed—separate pages for every big station. Absolutely indispensable to every fan; helps you get full enjoyment from your set. Beautifully bound—convenient pocket size—64 pages—indexed. Standard Style, bound in Castilian cover, 50c. DeLuxo Style, bound in Molloy embossed cover, \$1.00. Sent postpaid on receipt of price. Guaranteed to satisfy or money instantly refunded. Order yours today. Dealers write.

MAIL THIS COUPON

H. G. WRIGHT, 1502 Fisher Bldg., Chicago, Ill.
Enclosed find for WRIGHT'S RADIO Log as indicated.

Standard Edition—50c DeLuxo Edition—\$1.00
My money back if not satisfactory to me.

Name
Address



"Built first to Last" RADIO PRODUCTS
Coto-Coil Co.
Providence, R. I.

9BJI, 8BRK, 9BST, 9CCS, 9CEE, 9CIN, 9CYO, 9CYW, 9CZM, 9DEU, 9DNN, 9DRX, 9DTE, 9DWK, 9DWM, 9ECV, 9ER, 9LN, 9VM, 9VZ, I. C. W., 1CKP, 8APZ, Spark 4RK. Phone 1ALJ, 4FT, 5AMF.

Would appreciate QSL by crd, especially those who are QRA.

C.W., ROBERT MITCHELL, 401 N. CHESTNUT ST., BARNESVILLE, OHIO (DET. & ONE STEP)

1ADN, 1AH, 1AUR, 1AEZ, 1AOL, 1AJG, 1ASK, 1AYT, 1AVF, 1ANR, 1ALJ, 1AAC, 1ARK, 1AHZ, 1BIP, 1BIY, 1BGC, 1BKR, 1BQM, 1BEZ, 1BWJ, 1BV, 1CAC, 1CAZ, 1CGB, 1CGQ, 1CRE, 1CDO, 1DN, 1BQ, 1SW, 1ZL, 1CJ, 1EF, 1FH, 1GL, 1XAK, 1EF, 1NR, 1SE, 1H, 2ATE, 2ADJ, 2AYW, 2AOS, 2ANA, 2APV, 2AWA, 2AZ, 2AWF, 2AAZ, 2AAM, 2AQR, 2BRB, 2BLM, 2BQU, 2BGI, 2BUQ, 2BWP, 2BYW, 2CXY, 2CNL, 2CYW, 2CRU, 2CNH, 2CEI, 2CWP, 2CNK, 2HM, 2FC, 2XX, 3ADN, 3AQR, 3ADH, 3AOU, 3AEN, 3BDI, 2BNE, 3BHV, 3BPF, 3BQH, 3BFP, 3BCO, 3CA, 3CCU, 3CEZ, 3CC, 3CDN, 3DT, 3HS, 3HH, 3PH, 3DB, 3MF, 3NI, 3OO, 3WN, 3LX, 3WC, 4AI, 4AF, 4BA, 4BE, 4BZ, 4DV, 4EL, 4FT, 4GV, 4II, 4JD, 4JK, 4ME, 4MI, 4MB, 4PD, 4RR, 4VZ, 5VV, 5NZ, 5XV, 5WS, 5XK, 5AFQ, 5ALV, 5ABD, 5TS, 5QW, 5RW, 5AAC, 5AJG, 5AJB, 5GJ, 5HT, 5AR, 5AMF, 5VC, 5EH, 6AAO, 6AHV, 6AOU, 6AWQ, 6AKW, 6AGH, 6BBC, 6BCB, 6BIC, 6BM, 6BRF, 6BQB, 6CBI, 6CMR, 6COK, 6CMU, 6CGW, 6CO, 6CIN, 6CJV, 6FP, 6GR, 6LV, 6OF, 6TV, 6RN, 6JA, 6UX, 7LU, 7HW, 7QC, 7FQ, 7QD, 7CO, 7AB, 7FR, 7ACM, 9BXO, 9DFH, 9EHJ, 9AIB, 9AGY, 9CK, 9BOP, 9ADP, 9DCT, 9CEA, 9DRF, 9APE, 9CFY, 9CWF, 9CEH, 9AIM, 9CCZ, 9CAA, 9CJY, 9EHT, 9CIN, 9CGB, 9BWC, 9DLM, 9DFG, 9AJD.

3BPM, PHILADELPHIA, PA.

C.W. 5AAW, 5ADS, 5AGD, (5ALV), 5AMH, 5BC, 5BT, 5BX, 5DM, 5FC, 5HT, 5LR, 5RH, 5ZAV, 6AGE, 6AOS, 6ARO, 6ARU, 6BJO, 6BUY, 6CCL, 6CDN, 6CJX, 6CNL, 6COJ, 6GT, 6VM, 6XAD, 7ABB, (7CO), 7KS, 7LU, 7SH, 7VN, (9ACP), 9AGD, 9AHZ, 9AKE, 9APF, 9APS, (9ARU), 9ASH, 9ATN, 9ATO, 9AVS, 9AWR, 9BAB, 9BAU, 9BGC, 9BCH, 9BGS, 9BHI, 9BHK, 9BLY, 9BSZ, (9BVN), 9CJY, 9CSN, (9DAY), 9DMW, 9CDB, 9EFH, (9ELB), (9ES), 9HM.

Canada—4MZ. British—5BV.
Phone—(9DAY), 9XY.

Glad to get reports on my 5-watt C.W.

3BLI, PHILADELPHIA, PA. (ONE TUBE)

C.W. 1CI, 1EO, 1ER, 1FM, 1GL, 1IV, 1JV, 1KA, 1KX, 1ML, 1MY, 1MZ, 1ND, 1OE, 1SE, 1UJ, 1YB, 1YK, 1ABF, 1ABX, 1AAP, 1AWP, 1AHZ, 1ATJ, 1AVL, 1ALL, 1AFL, 1AGH, 1APC, 1AXN, 1AGV, 1ALW, 1ASR, 1AOK, 1AHF, 1AVF, 1AXA, 1ARY, 1AFA, 1AUX, 1ASA, 1AJG, 1BAU, 1BEL, 1ES, 1BHB, 1BJA, 1BJO, 1BJP, 1BOM, 1BQE, 1BSL, 1BSZ, 1BWJ, 1BZN, 1CAC, 1CKP, 1CMP, 4AB, 4AF, 4BA, 4BG, 4BU, 4DB, 4EB, 4EH, 4EQ, 4FT, 4GU, 4HS, 4IK, 4JR, 4MB, 4MI, 4OA, 4OG, 4SH, 5GG, 5MB, 5QO, 5XA, 5VD, 5ZA, 5AMW, 5ALV, 6PE, 8AA, 8AL, 8BK, 8DG, 8DX, 8EF, 8FC, 8FM, 8HV, 8HY, 8JJ, 8KC, 8LV, 8NB, 8ND, 8NZ, 8DE, 8PC, 8PL, 8PU, 8RM, 8RN, 8RV, 8TR, 8UE, 8UH, 8VQ, 8VY, 8WA, 8WY, 8WZ, 8AAJ, 8ADG, 8AFN, 8AGO, 8AIG, 8AJE, 8AJJ, 8AJN, 8ALW, 8ALX, 8AMM, 8ANB, 8AQM, 8ARO, 8ARZ, 8ASE, 8ATR, 8ATZ, 8AVD, 8AWP, 8AYL, 8AZH, 8BAF, 8BAU, 8BBF, 8BBI, 8BCE, 8BCP, 8BDA, 8BDR, 8BFH, 8BGO, 8BGR, 8BGZ, 8BHG, 8BKD, 8BMB, 8BPF, 8BRB, 8BSY, 8BTA, 8BTM, 8BUL, 8BVT, 8BVX, 8BWJ, 8BZC, 8BZY, 8CB, 8CCI, 8CGI, 8CGU, 8CKV, 8CNW, 8COJ, 8COK, 8CPC, 8CDU, 8CVK, 8CWB, 8CXK, 8CXM, 8CVI, 8CYU, 8DA, 8DAW, 8DAL, 8DAW, 8DBU, 8DDC, 8DDJ, 8DES, 8DFK, 8DFP, 8DGJ, 8DJF, 8DKE, 8DKU, 8DLB, 9AN, 9EB, 9EI, 9ER, 9ES, 9GS, 9HW, 9IH, 9LB, 9MC, 9OY, 9QE, 9QR, 9RC, 9RI, 9SZ, 9TA, 9VC, 9VZ, 9ZL, 9AAQ, 9AAU, 9AAV, 9ABF, 9ADY, 9AEI, 9AEN, 9AEX, 9AFY, 9AGB, 9AIG, 9AID, 9AJW, 9AKD, 9AMF, 9APD, 9APN, 9AQW, 9ARS, 9ARU, 9ATN, 9ATO, 9ATU, 9AWF, 9AWV, 9AYX, 9AZX, 9BCB, 9BGT, 9BHQ, 9BIZ, 9BOE, 9BRK, 9BRX, 3BRV, 9BYE, 9CAH, 9CCM, 9CFI, 9CJC, 9CLY, 9BOE, 9CTR, 9CVE, 9CVS, 9CWU, 9CYW, 9CZM, 9CZY, 9DAY, 9DBF, 9DCE, 9DCW, 9DHB, 9DHR, 9DMI, 9QU, 9DTC, 9DWK, 4DWY, 9DXK, 9EEQ, 9EHJ, 9EJA, 9EKF, 9ELB, 9ELL, WZV-qra?

Phone—8KG.

Can.—3WV, 3DB?, 3GG.

5XV, PORT ARTHUR, TEXAS

1ADN, 1ALJ, 1ARF, 1BOQ, 1CGI, 1CJ, 1CPN, 1ER, 1HX, 1MO, 1RR, 1RV, 1YB, 2BRB, 2BXW, 2BY, 2CPA, 2IU, 3ABW, 3BUV, 3BVA, 3CAV, 3CC, 3HG, 3IA, 3WF, 4AG, 4BK, 4FG, 4HH, 4HW, 4IO, 4JH, 4OA, 4PD, 4SD, 4SQ, 6AJF, 6AWT, 6AY, 6ASR, 6AHU, 6AUW, 6AKZ, 6AFO, 6AWQ, 6AWX, 6AIP, 6AOS, 6ADM, 6ACD, 6AGM, 6ATO, 6AU, 6ASI, 6AUV, 6BVE, 6BJJ, 6BNA, 6BIH, 6BFF, 6BFZ, 6BIC, 6BBC, 6BGF, 6BEG, 6BUA, 6BSC, 6BTS, 6BIQ, 6BLM, 6BEQ, 6CFZ, 6CGW, 6CKR, 6CHG, 6CBW, 6CNG, 6CMR, 6ACZ, 6FH, 6JX, 6GR, 6NX, 6NB,

NEUTRODYNE

5 TUBE KNOCK-DOWN NEUTRODYNE SET

with blue print, drilled and engraved panel. Every part needed to build this set is included as follows:

- 3 Neutro-Coils, silk wire wound on all genuine Bakelite tubes.
- 3 Variable Condensers, high grade capacity .000375; 6 Mounting Brackets—Neutralizing Condensers (sets of parts with glass Dielectric), 5 Bakelite Sockets, One 20 ohm Rheostat, One 5 ohm Rheostat, Two shielded Audio Transformers, 3 Dials, 3 Mica Fixed Condensers (capacities .006, .001, .00025), 1 Tubular Grid Leak and Mounting, 9 Binding Posts, Lugs, 9 lengths Bus Bar, 2 lengths Spaghetti, 1 Panel (drilled and neatly engraved), Blue Print (large, with complete and simple diagrams), 1 Copper Sheet, 1 Print for placing parts.

\$25.95

ENCLOSE POSTAGE WITH ORDER

We guarantee these parts to be the best quality money can buy, irrespective of price.

NEWS ITEM FROM "FINANCE and COMMERCE"

At last, however, the price objection has been overcome. Naturally it was one of the oldest of radio firms, one of the substantial units in the radio world, that brought this about.

The Atlantic & Pacific Radio Company set its technical department to work upon this problem of producing a neutrodyne set to be sold at moderate cost. The radio world, as a result, has just welcomed the announcement by the Atlantic & Pacific radio stores of complete parts for a neutrodyne set, the "Set of Heart's Desire" at the incredibly low price of \$25.95.

Atlantic & Pacific Radio Co.
223 West 34th St., New York City

AT LAST! YOU CAN



NO TAPS 200-650 METERS



2 ROTOR DOUBLE CIRCUIT TUNER TAKES PLACE OF AND IS MORE EFFICIENT THAN EITHER 3 HONEY-COMB COILS OR VARIO-COUPLER AND VARIOMETER

Tunes in Distant Stations Without Interference from Near-by Stations

Used with Double Circuit Regenerative Hook-up the SELECT-A-WAVE will give you

Maximum Volume, Coast-to-Coast Range and Super-Selectivity

Not just a part but a Quality Tuner, highly recommended by leading radio engineers. If your dealer can't supply you send us \$5.00 and we will ship postpaid with diagram and instruction blueprint.

TO DEALERS

SELECT-A-WAVE has taken the country by storm. We are receiving hundreds of inquiries from consumers in every State in the Union. We are taking on new dealers as fast as our production facilities will permit. Write us NOW for proposition.

S. & R. RADIO COMPANY

3786 BROADWAY NEW YORK CITY

THIS IS THE BUG THAT CHASES DISTORTION "Say, brother, here's a tip. Quit worrying about distortion. Don't think that radio and static are inseparable. Maybe you can't always have things perfectly your own way, but give the Reliable Neutralizing Condenser a chance to show you what six bits will do toward removing that hoarseness from the throat of your receiving apparatus." See Your Dealer or write Only 75c—\$1.00 on base mount The Reliable Parts Mfg. Co. 7306 Madison Ave. Cleveland :: Ohio



neutralizing condensers

6MH, 6LV, 6OL, 6OH, 6FP, 6YB, 6ZV, 6ZR, 6ZH, 6XAD, 7AF, 7AFO, 7AHS, 7AEA, 7CO, 7DC, 7HG, 7GS, 7IO, 7LR, 7LU, 7MO, 7OO, 7QC, 7PK, 7SC, 7SZ, 7YL, 7ZU, 7ZT, 7SH, 7ABB, 8BAU, 8DAE, 8GZ, 8CHB, 8DKJ, 8NZ, 8HN, 8EK, 8BUM, 8CFB, 8ANL, 8ACV, 8BYM, 8DIO, 8PX, 8BGZ, 8BT, 8CBC, 8UK, 8BIV, 8WG, 8TT, 8AOL, 8CUQ, 8TR, 8ALM, 8BF, 8VT, 8CCI, 8CQS, 8BGE, 8DCG, 8CRF, 8AGP, 8BAG, 8AWL, 8CDY, 8BQY, 8CJY, 8ACH, 8DSM, 9AMK, 9ANY, 9AVG, 9BEZ, 9AYP, 9CY, 9DXL, 9ELD, 9CZO, 9CMK, 9ASN, 9ZT, 9CKP, 9CCZ, 9BOF, 9CKW, 9CCS, 9AEE, 9DYY, 9AAW, 9DKY, 9DON, 9AIM, 9DWW, 9BUH, 9CCW, 9PB, 9CZW, 9CGO, 9AIM, 9ELV, 9CGY, 9EFF, 9ES, 9AEP, 9CJS, 9DVR, 9ER, 9DIP, 9BG, 9DAI, 9EDM, 9BNA, 9CZM, 9BJK, 9SD, 9BHB.

Canada—2IC, 2BN, 2CG, 3WS, 3OJ, 3GO, 3GQ.

5AKZ, CORPUS CHRISTI, TEXAS

C. W. (U. S.)—1AAC, 1AKL, 1AQM, 1AR, 1AW, 1AYT, 1BCD, 1BCG, 1BGQ, 1CKP, 1CMK, 1EE, 1ER, 1FD, 1GV, 1PN, 1ZE, 1ZJ, 2ANA, 2BY, 2CEE, 2CEI, 2CLA, 2CVJ, 2GK, 2NF, 3AJD, 3AVA, 3BGJ, 3CEL, 3GK, 3TJ, 3ZD, 3ZY, 4BL, 4CL, 4CS, 4DB, 4DP, 4EL, 4ER, 4FT, 4FZ, 4GH, 4IO, 4IT, 4IU, 4IZ, 4JE, 4OI, 4PD, 4QF, 4SB, 4SC, 4SP, 5AAO, 5ABC, 5ABI, 5ABY, 5ADB, 5ADO, 5ADV, 5AEC, 5AEU, 5AFH, 5AGH, 5AGJ, 5AHD, 5AHR, 5AHZ, 5AIC, 5AIR, 5AIU, 5AIB, 5AKF, 5AKI, 5AKN, 5ALJ, 5AMA, 5AMB, 5AMK, 5AMW, 5AMU, 5ANA, 5BE, 5BW, 5BZ, 5CE, 5CV, 5DG, 5DW, 5EK, 5FT, 5FV, 5FX, 5GE, 5GF, 5GJ, 5GN, 5GP, 5HT, 5IN, 5JC, 5JF, 5JL, 5JJ, 5KC, 5KR, 5KW, 5LG, 5LJ, 5LR, 5LW, 5ML, 5MM, 5MT, 5MZ, 5NA, 5NN, 5NW, 5OH, 5OK, 5OO, 5OV, 5PA, 5PB, 5PH, 5PZ, 5OI, 5OP, 5OL, 5OV, 5OW, 5OY, 5RG, 5RO, 5RW, 5SZ, 5TH, 5TO, 5UK, 5UO, 5UU, 5VF, 5VC, 5WF, 5XA, 5XAO, 5XAU, 5XD, 5XW, 5XU, 5XV, 5YK, 5YW, 5ZA, 5ZAV, 5ZG, 5ZM, 5ZU, 6AAO, 6AGE, 6AHU, 6AJJ, 6AKK, 6AKZ, 6ANB, 6AQQ, 6AAU, 6AWQ, 6BBC, 6BBH, 6BBQ, 6BFG, 6BGC, 6BIC, 6BIH, 6BIJ, 6BIW, 6BIJ, 6BJO, 6BON, 6BQE, 6BRA, 6BRF, 6BSG, 6BUO, 6BUY, 6BVZ, 6CBU, 6CEK, 6CEI, 6CFM, 6CFS, 6CGW, 6CGZ, 6CJV, 6CKP, 6CKW, 6CMR, 6CNF, 6CNL, 6CTD, 6FP, 6GT, 6HG, 6HU, 6JA, 6JM, 6LA, 6MH, 6MM, 6NN, 6OD, 6OL, 6OJ, 6RN, 6VF, 6VT, 6VB, 6ZAR, 6ZG, 6ZH, 7AFA, 7AGJ, 7AGV, 7ALD, 7CO, 7LH, 7MY, 7NG, 7PZ, 7QB, 7OD, 7OJ, 7OU, 7MA, 7ZO, 7ZU, 8AAF, 8ACY, 8AOL, 8AOT, 8ARD, 8ASV, 8BRF, 8BDA, 8BF, 8BQI, 8BXX, 8BZD, 8CDZ, 8CEW, 8CGU, 8CKN, 7CDM, 8CRN, 8CUD, 8CWX, 8DET, 8DJP, 8DOL, 8IL, 8KC, 8MM, 8OK, 8VT, 8WG, 8XAD, 8XE, 8YAE, 8ZD, 8ZZ, 9AAU, 9ADM, 9ADY, 9AEM, 9AFR, 9AHJ, 9AHZ, 9AIM, 9AIL, 9AIW, 9AQU, 9AM, 9AMW, 9APP, 9APS, 9AQB, 9ARD, 9ARP, 9AUE, 9AVG, 9AVM, 9AVN, 9AVZ, 9AWG, 9AWV, 9AYL, 9BAK, 9BBA, 9BCB, 9BED, 9BEY, 9BEZ, 9BFB, 9BHI, 9BHY, 9BJK, 9BOF, 9BOZ, 9BRI, 9BRU, 9BSP, 9BTO, 9BYC, 9BYX, 9BZG, 9CAA, 9CBA, 9CBL, 9CBZ, 9CCS, 9CCV, 9CCZ, 9CDJ, 9CDO, 9CEA, 9CFK, 9CFI, 9CFY, 9CHD, 9CHT, 9CHB, 9CJC, 9CMC, 9CMK, 9CMN, 9CNY, 9COW, 9CRH, 9CSB, 9CVM, 9CZG, 9CZM, 9DBF, 9DES, 9DHR, 9DIX, 9DJB, 9DKY, 9DLM, 9DRC, 9DXM, 9DNS, 9EAC, 9ECI, 9EER, 9EFE, 9EFF, 9EHT, 9EI, 9EKF, 9EKY, 9ELL, 9ES, 9GD, 9MC, 9SS, 9UR, 9VC, 9ZT, KDEF.

Fone—5ABY, 5ADO, 5AHD, 5AKI, 5ALI, 5ALR, 5AMW, 5AMZ, 5EK, 5FT, 5OK, 5PZ, 5TH, 5ZA, 5ZAV, 6CGZ, 9BSP, 9CBA, 9CHB, KDEF.

I. C. W.—4OI, 5UK, 5YK, 5XD, 5ZA, 9AHJ, 9AM, 9AVZ, 9BRI, 9CFI, 9MC.
Spark—4CH, 5JD, 5UD, 9DNS.
Mexico—C. W.—BX.
Canada, CW—1AR, 1DD, 2IC, 3KP, 3GO, 9BP.
France, CW—8AB.
ORK 5W CW? All crds answered promptly!

FRANKLIN BOWERS, R.F.D. NO. 8, PHOENIX, ARIZ.

C. W. 2EL, 2TS, 3LG, 3YO, 4IN, 4KU, 4OA, 4SC, 5ACC, 5ABW, 5AE, 5AES?, 5AHD, 5AHR, 5AIC, 5AIU (daylight), 5AIB, 5AIN?, 5AJQ, 5AJT, 5AJU, 5AKI, 5AKN, 5AKO, 5AKR, 5ALJ, 5AMB, 5AMC, 5AMU, 5AMW, 5ATC, 5BED, 5CT, 5CV, 5DM, 5DO, 5EH, 5GJ, (daylight), 5GM, 5HT, 5HZ, 5IN (daylight), 5JC, 5JL, 5KC, 5KH, 5KN, 5IR, 5MI, 5ML, 5NA, 5NK, 5NW, 5OO, 5OT, 5OV, 5OD, 5OL, 5OQ, 5RG, 5RH, 5RV, 5SG, 5T, 5UA, 5UO (daylight), 5VF (daylight), 5WG, 5XB, 5XD, 5ZAV, 5ZB, 5ZM, 6's too many, 7AGV, 7AK, 7ALK, 7CO (daylight), 7FF, 7NY, 7OD, 7ZD, 7ZL, 7ZU, 8APT, 8BDA, 8BZY, 8CGU, 8DO, 8VT, 8XE, 8YN, 9AAQ, 9AAW, 9AFG, 9AHG, 9AHH, 9AHZ, 9AIM, 9AOU, 9AOC, 9AON, 9AUE, 9AVS, 9BAB, 9BAL, 9BAQ, 9BCB, 9BEZ, 9BLY, 9BOF, 9BOQ, 9BUN, 9BXA, 9BZI, 9BZN, 9CAA, 9CCZ, 9CEA, 9CFI, 9CGA, 9CJY, 9CKJ, 9CLD, (daylight), 9CLY, 9COC, 9CCS, 9CTR, 9CUN, 9CVC, 9CVS, 9CVT, 9CWJ, 9CZM, 9DBF, 9DGW, 9DHW, 9DIB, 9DKQ, 9DKY, 9DPP, 9DRW, 9DTE, 9DUG, 9DUN, 9DVM, 9DWB, 9DXA, 9DXN, 9DXR, 9DXU, 9DYR, 9DZO, 9EDB, 9EHI, 9EKY, 9ELV, 9HN, 9LA, 9MC, 9QE, 9RC, 9ZT.
Canadian CW—4CL, 9AV, 9BJ.

7ALI, MT. VERNON, WASH. (ONE TUBE)
1AIX, 1YB, 2BQH, 2LG, 2RK, 3ALX, 3AZY,

Tested and listed as standard by Underwriters' Laboratories



The **FANSTEEL**
Balkite
battery charger

PATENTS APPLIED FOR

has no vibrators, bulbs or moving parts and is entirely noiseless

The Fansteel Balkite Battery Charger for Radio "A" Batteries [6 volt] is an entirely new type of rectifier, based on the use of Fansteel Balkite, a new and rare metal developed for this purpose. It is entirely noiseless. It cannot deteriorate through use or disuse. It has nothing to replace, adjust, or get out of order. It cannot discharge or short circuit the battery, and requires no attention other than an occasional filling with distilled water. It will not overcharge, and cannot fail to operate when connected to the battery and line current. It is unaffected by temperature or fluctuations in line current. It is simple, efficient, and indestructible except through abuse. The charger may be used while the radio set is in operation. Without added attachments it may also be used to charge "B" storage batteries.

FANSTEEL BALKITE

is a new metal developed for this charger. It acts as a valve, allowing current to flow into the battery but not out of it. It is the most efficient charger valve made, is practically indestructible, and does away with noisy, delicate vibrators and fragile bulbs.

The Gould Storage Battery Company is also marketing, under the Fansteel Balkite Patents, a complete battery and recharging unit known as the Gould Unipower, into which this charger, under the name, "The Fansteel Balkite Rectifier," has been incorporated.

The Fansteel Balkite Battery Charger will charge the ordinary 6 volt radio "A" or automobile storage battery at 3 amperes, from 110-120 AC, 60 cycle current. It comes complete and ready for use. Get it from your dealer, or use the coupon below.

Price, \$19.50 { \$20.00 West of the Rockies }

FANSTEEL PRODUCTS CO., Inc., Dept. 5-A, North Chicago, Ill.

FANSTEEL PRODUCTS Co., Inc., Dept. 5-A
North Chicago, Illinois
Enclosed please find \$19.50 (\$20.00 west of the Rockies). Send me the Fansteel Balkite Battery Charger for Radio 6 volt "A" Batteries. If I am not entirely satisfied I will return it and you will refund my money.

Name
Street
City State

CATALOG L-25-148 PAGES FREE!

Latest Reflex Neurodyne and Super-Heterodyne Circuits. 40 Diagrams, latest Hook-ups. Largest Complete Stock.

SPECIAL American Reflex Crystal, 35c ea. Hot as Hot, Every Spot. Hear stations clearly. **GUARANTEED ONE YEAR** Jobbers and Dealers write for Quantity Discounts.

10 HOUR SERVICE

AMERICAN RADIO MFG. CO.
WHOLESALE DISTRIBUTORS
Dept. A 6 WEST 14TH ST. KANSAS CITY, MO.

YOU NEED THIS
Amerex Universal Tuner
Perfect Electrically

Replaces three honeycomb coil circuit; designed for regenerative or non-regenerative circuits.
At your dealer or order direct.

Free hook-up on request. **\$3.75**
Send money order for sample. Returnable within five days, if not satisfactory.

American Standard Elec. Co.
243 West 34th St., N. Y. City

Get a Handy Binder for your RADIO NEWS. Holds and preserves six issues, each of which can be inserted or removed at will. Price 65c. Experimenter Pub. Co., Inc., Book Dept., 53 Park Place, N.Y.

COSMOPOLITAN PHUSIFORMER

(Licensed under Patents Pending)

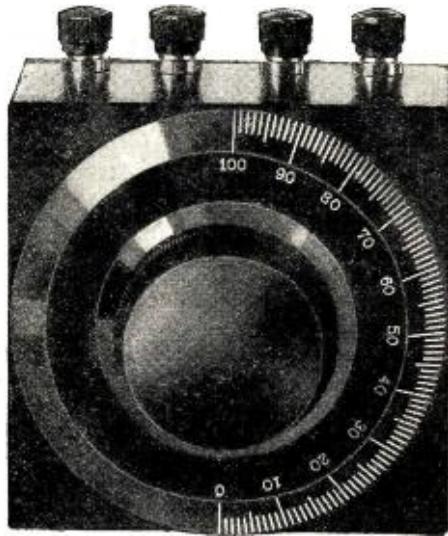

**PRICE
\$8.50**

IS REVOLUTIONIZING RADIO

It is not a "part"—it is a complete unit that at one stroke, like a magic word, accomplishes all the following miracles:

1. Simplifies the construction of any set by doing away with all coils and variable condensers.
2. Gives greater distance and volume than any other type of set using same number of tubes.
3. Can be used in any standard set to make it superior to a five tube neutrodyne.
4. Eliminates bothersome neutralizing condensers.
5. Once a station is logged, it will always come in on the same dial settings.

Write for the manual of Phusiformer Possibilities, giving complete information including constructional details, diagrams, photographs, templates and the theory of the Phusiformer. Price 50c.

Just like magic? Then get this: **IT IS A TUNED RADIO FREQUENCY TRANSFORMER THAT WILL GET ON THE PEAK OF THE WAVE WITHOUT CAUSING OSCILLATIONS!**



ASK YOUR DEALER TO PROVE THESE MARVELS BY ACTUAL DEMONSTRATION

COSMOPOLITAN RADIO COMPANY, INC.

15-17 WEST 18TH STREET NEW YORK CITY

Note to Dealers: Demonstration Sets equipped with Cosmopolitan Phusiformers will be supplied to Dealers.

3LG, 4AI, 4GU, 4GZ, 4MY, 5ADO, 5AGF, 5AHD, 5AHR, 5AIC, 5AJJ, 5AJO, 5ALX, 5AMB, 5ANC, 5BE, 5BX, 5CV, 5EF, 5FC, 5FT, 5GJ, 5GM, 5HK, 5JG, 5JT, 5JW, 5KC, 5LP, 5ML, 5NW, 5NY, 5PW, 5QL, 5QQ, 5QW, 5RG, 5RH, 5RW, 5SP, 5XAB, 5XD, 5YW, 5ZAV, 6AAO, 6ACV, 6ACZ, 6AFQ, 6AGC, 6AGE, 6AGK, 6AIK, 6AJA, 6AJD, 6AJH, 6ALV, 6ALW, 6AOH, 6ARE, 6ARU, 6ATZ, 6AUU, 6AWE, 6AWQ, 6BBC, 6BBW, 6BIN, 6BIW, 6BRX, 6BLQ, 6BLZ, 6BM, 6BNF, 6BNU, 6BON, 6BOU, 6BPF, 6BQ, 6BRI, 6BUF, 6BUH, 6BUI, 6BUM, 6CAY, 6CBB, 6CBI, 6CBW, 6CC, 6CCU, 6CGD, 6CGG, 6CHW, 6CIS, 6CJB, 6CJV, 6CLZ, 6DD, 6DO, 6FM, 6HS, 6KF, 6KW, 6LQ, 6LV, 6NX, 6OL, 6PL, 6PU, 6QB, 6UX, 6ZX, 6ZAR, 6ZBO, 6ZBS, 6ZBU, 8ABX, 8ACN, 8ACV, 8AIG, 8ANM, 8APN, 8APT, 8BAU, 8BCP, 8BDA, 8BDR, 8BJY, 8BK, 8BMB, 8BNH, 8BSI, 8BTM, 8BVT, 8BYB, 8BWC, 8BWJ, 8BZC, 8COM, 8CFK, 8CSE, 8CTO, 8CWX, 8CWP, 8CWU, 8CZY, 8DAE, 8DAT, 8DDC, 8DP, 8ER, 8FM, 8JY, 8MZ, 8NB, 8OE, 8PL, 8RV, 8VO, 8VY, 8WO, 8YD, 8YN, 8ZZ, 9AAW, 9AC, 9ACI, 9ACK, 9AEC, 9AFM, 9AGB, 9AGL, 9AHZ, 9AIC, 9AIM, 9ALC, 9AMB, 9AMF, 9AMP, 9AMZ, 9ANY, 9AOG, 9AOU, 9AP, 9ARU, 9ASN, 9ATO, 9ATT, 9AVG, 9AYS, 9AWV, 9AXS, 9AXX, 9AYJ, 9BAL, 9BBG, 9BDZ, 9BEZ, 9BFV, 9BIS, 9BJI, 9BLX, 9BLY, 9BMX, 9BNU, 9BP, 9BPV, 9BQJ, 9BQQ, 9BRK, 9BRS, 9BZI, 9CAA, 9CAJ, 9CCM, 9CCA, 9CEA, 9CEE, 9CEG, 9CHC, 9CJM, 9CKA, 9CLY, 9CMS, 9CPO, 9CSI, 9CVS, 9CVV, 9CWX, 9CZM, 9DAW, 9DBF, 9DEQ, 9DIB, 9DLI, 9DMW, 9DSW, 9DUM, 9DUN, 9DXU, 9DYR, 9EAK, 9EBH, 9EGU, 9EHJ, 9EKY, 9ELB, 9ER, 9FE, 9LB, 9MC, 9OY, 9PF, 9QL, 9VM, 9ZT, 9ZY, Canada—3BQ, 3HE, 3NI, 4AB, 4AW, 4CO, 4CR, 4FN, 4FZ, 4GH, 4HH, 4IO, 9BJ, 9BX. Fone—7OB, 7QC, 6.

8BNH, AKRON, OHIO
5ADB, 6AAO, 6ACM, 6AFQ, 6AJA, 6AO, 6AUU, 6BKK, 6BNC, 6BQE, 6BQE, 6BRF, 6BUM, 6BUY, 6BVE, 6CDG, 6CGW, 6CJV, 6CKP, 6CMR, 6FP, 6JA, 6LV, 6MH, 6NX, 6RN, (6XAD), 6ZAH, 6ZH, 7ABB, 7BJ, 7QC, 9AMB, 9APF, 9AVS, 9BJI, 9CAA, 9CFY, Canada—1EF, 2BE, 2BN, 2CG, 2IC.

9CKA, ELKPOINT, S. DAK.
Calls heard and worked during January. 2CEE, 3BG, 3CC, 3RD, 4AI, 4GU, 4FT, 4MB, 5AAT, (5ADE), 5AAC, (5AGN), (5GA), 5ALV, (5AJT), 5ANZ, 5ABN, 5ANC, 5EI, 5CE, 5DW, 5EK, 5IN, 5JG, 5MM, 5NW, 5NZ, 5OS, 5PZ, (5PV), 5QY, 5RG, 5ADB, 5SD, (5TS), 5KC, 5UK, 5ZA, 5AMU, 5ADV, (6AJA), 6ARU, 6PE, 6ZAU, (7MP), 8AGO, 8APT, 8ARW, 8BDR, 8BNC, 8BVU, 8CGJ, 8CYU, 8CRW, 8DCY, 8DFB, 8DLA, 8DIG, 8GZ, 8BBI, 8KJ, 8OA, 8PU, 8VE, 8ZY, Spark—8BDA. QRA, 6AJA?, QRK my 50 watt CW.

8CPM, FRANKFORT, MICH.
C.W.—1AAC, 1AAL, 1ABC, 1AEZ, 1AF, 1AFP, 1AGH, 1AGK, 1AJU, 1AJX, 1ALJ, (1ARF), 1ARP, 1ARY, 1ATJ, (1AUR), 1AVF, 1AVM, 1AYT, (1BBH), 1BES, (1BOQ), 1BTT, 1BVB, 1BWJ, 1CCX, 1CIT, (1CJC), 1CJR, 1CMP, 1CMX, 1CPI, 1CON, 1CRE, 1CTP, 1FD, 1FN, 1FS, 1HX, 1IL, 1IL, 1JV, 1KC, 1MY, 1PP, 1VA, 1XAM, 1XZ, 1YB (1BCR), 2ABN, (2APY), 2ATZ, 2AXF, 2AZY, (2BBN), 2BCK, 2BLP, 2BQB, 2BQD, 2BSC, (2BTV), 2BUY, 2BWN, 2BXW, 2BY, 2BYV, 2CCX, 2CEE, 2CEI, (2CNH), 2CON, 2CPA, 2CPO, 2CQI, 2CQU, 2CSL, 2CTN, 2CUR, 2CUW, 2CWV, (2CXG), 2CYX, (2IU), 2KU, 2NC, 2WR, 2XQ, 3AB, 3ABW, 3ACY, 3AD, 3ADB, 3AEK, (3AEN), 3AGF, 3AHP, (3AJD), 3AKL, 3AKY, 3ALE, 3APB, (3APV), 3AS, 3ATB, 3AUV, 3BBS, (3BDI), 3BDR, 3BE, 3BG, 3BHM, 3BKL, (3BLP), 3BLU, 3BMN, 3BMS, 3BPF, 3BPP, 3BUV, 3CAH, 3CAQ, (3CCU), 3CDN, 3CDU, 3CEZ, 3CHB, 3CHP, 3CIA, (3CJN), 3GC, (3HH), 3HS, 3IW, 3IG, 3ME, 3OE, 3PG, 3RZ, 3SU, 3TF, 3TJ, (3TR), 3VO, 3WN, 3YP, (4AF), 4AI, 4BA, 4BQ, 4BZ, 4CB, 4DB, 4DV, 4EL, 4ER, 4FG, 4FS, 4FT, 4FZ, 4GX, 4HS, 4IT, 4JK, 4JL, 4LL, (4MI), 4MV, 4NA, 4OA, (4PD), 4QF, 4QW, 4RR, 4SH, 5AAC, 5AAT, 5ABB, 5ABH, 5ABN, (5AC), 5ACM, 5ADH, 5ADS, 5AES, (5AFQ), 5AGJ, 5AGN, 5AGO, 5AGS, 5AGV, 5AHD, 5AHR, (5AIC), 5AJJ, 5AIR, 5AIU, 5AJB, 5AJI, 5AJQ, 5AIT, 5AKF, 5AKP, 5ALV, 5AMH, 5AMJ, 5AMT, 5AMU, 5ANC, 5AP, 5BX, 5CE, 5CN, 5CV, 5DH, 5DI, 5DM, (5DW), 5EY, (5FU), 5FV, 5GA, 5GI, 5GF, 5GP, 5HT, 5IN, 5IR, (5JE), (5JL), 5JW (5JY), 5KA, 5KC, 5KR, 5LH, 5LI, (5LR), 5MI, 5ML, 5NA, 5NV, 5NY, 5OD, 5OV, (5PF), 5PH, 5PV, 5PY, 5QD, 5QI, 5QL, (5QQ), 5QW, 5QY, 5QZ, 5RB, 5RD, 5RG, 5RH, 5SD, 5SK (5SR), 5SZ, 5TJ, 5TO, 5TS, 5UK, 5UO, 5UW, 5VC, 5VV, 5XA, 5XAP, 5YG, 5ZA, 5ZAS, 5ZAV, 6AGE, 6AHP, 6AHZ, 6AKZ, 6AM, 6AMS, 6AOL, 6AOU, 6AVV, 6BEG, 6BIC, 6BII, 6BSG, 6BUH, 6BUO, 6BUR, 6BWD, 6CBG, 6CDG, 6CGW, 6CKP, 6CNH, 6EA, 6MH, 6PI, 6PL, 6XAD, 6YB, 6ZH, 7ABB, 7ADR, 7BJ, 7CO, 7HG, 7LU, 7MP, 7NR, 7SF, 7ZU, 9ACK, 9AFM, 9AFV, 9AGL, 9AMB, 9AMP, 9APF, 9APS, 9ASE, 9AZG, 9BJK, 9BKD, 9BOF, 9BRI, 9BXQ, (9CAA); 9CFY, 9CKQ, 9COW, 9CTU.

The Saturn
Perfect Jack & Automatic Plug
Your order filled by mail promptly. Every article absolutely guaranteed.
Write for Literature
The SATURN Mfg. & Sales Co., Inc.
48 Beekman St.
New York, N. Y.

RADIO SUPPLIES AT CUT PRICES

Baldwin (Type C) Headsets.....	\$8.75
Brandes Headsets.....	4.95
Turney Headsets 3000 ohm.....	2.95
Aemo Audio or Radio Transformers.....	3.95
Modern Push-Pull Transformers (Set of Two).....	10.95
Federal Audio Transformers No. 65.....	5.75
Jefferson Star or W-P Audio Transformers.....	1.95
Koehler 180 Couplers or Variometers.....	2.95
22½ Volt Eveready Var. B Battery No. 765.....	1.95
45 Volt Eveready Var. B Battery No. 767.....	1.95
Cook-A-Day Coils.....	1.95
Electric Soldering Iron.....	1.95
Voltmeters—0-50 Volts.....	1.50
Ammeters (Standard Make).....	1.25
Bakelite Sockets for WD-11, UV-199 and V.T. Tubes.....	.50
Switch Levers..... 25¢ 2 and 3 Inch Dials.....	.25

ALL ORDERS MUST INCLUDE POSTAGE
KENSINGTON RADIO SUPPLY CO.
4417 18th Avenue Brooklyn, N. Y.

Insure your copy reaching you each month. Subscribe to Radio News—\$2.50 a year. Experimenter Publishing Co., 53 Park Place, N. Y. C.

9DLF, 9DLI, 9DUI, 9DWE, 9DWN, 9EEZ, 9UZ, 9VZ, 9TM, 9YU.
 Canadian—C. W.—(2AN), 2CG, (2BN), (3GG), 3QS, 4CB, 4CL, 4CO, 4EA, 4FV, WI, QSL, all crds. QSL'S appreciated.

LIST OF BRITISH AMATEUR STATIONS

(Continued from the April issue)

- 2NV H. Littley, 15, Lodge Road, W. Bromwich.
- 2NW H. Littley, 15 Lodge Road, W. Bromwich.
- 2NY J. N. C. Bradshaw, Ambrose House, Bilsborough, near Preston.
- 2NZ J. N. C. Bradshaw, Ambrose House, Bilsborough, near Preston.
- 2OA F. Townsend, 46, Grove Lane, Ipswich.
- 2OD E. J. Simmonds, Meadowlea, Queensway, Gerard's Cross, Bucks.
- 2OF H. C. Trent, Secondary School, Lowestoft.
- 2OG A. Cooper, 16, Wentworth Road, York.
- 2OI C. Bain, 51, Grainger Street, Newcastle-on-Tyne.
- 2OJ E. A. Houghton, 52, First Avenue, Hove, Sussex.
- 2OK H. D. Butler, 222, Gt. Dover Street, W.
- 2OL H. D. Butler, Trebarwith, South Watfield.
- 2OM H. S. Walker, A.M.I.R.E., Park Lodge, Brentford, Middlesex.
- 2ON Major Parker, Walthamstow, 56, Stern-Hall Street.
- 2OP G. Courtenay Price, 8, Lansdown Terrace, Cheltenham.
- 2OQ D. P. Baker, Cleveland Road, Wolverhampton.
- 2OT Ilford Radio Society, Ilford.
- 2OU Ilford Radio Society, Ilford.
- 2OW F. W. Woodward, 5, Portland Gardens, Harringdy, N.W.
- 2OX J. R. Radcliffe (Dr.), Birmingham.
- 2OY Capt. E. J. Hobbs, M.C., A.M.I.R.E., 4th Tank Battalion, Wareham, Dorset.
- 2OZ Worcester Cadet Sig. Co., R.C. of Sigs. Junior Tech. School, Sansome Walk, Worcester.
- 2PA G. Z. Auckland & Son, 395, St. John Street, E.C.
- 2PB D. E. O. Nicholson, 41, Upper Kennington Park Lane, Lambeth, S.E. 11.
- 2PC A. G. Davies, Redcot, Park Road, Timperley, Cheshire.
- 2PD W. H. Marston, The Manor, Willenhall, Staffs.
- 2PF F. Foulger, London, S.E. 14.
- 2PG B. Hesketh, High Street, Chalvey, Slough.
- 2PH L. Dore, 139, Milcote Road, Bearwood, Smethwick, Staffs.
- 2PI Loughborough College, Leicester.
- 2PJ Loughborough College, Leicester.
- 2PL Major L. N. Stephens, R.A., Haddon House, Bridport.
- 2PO N. C. Hardwan, "Magfield," Cloughfold, near Manchester.
- 2PP J. S. Knight, Clark's Hill, Nursery, Prestwich.
- 2PQ G. E. Mortley & Co., Nelson Road, Tunbridge Wells.
- 2PR A. E. Whitehead, Hollingwood, King's Ride, Camberley, Surrey.
- 2PS J. H. Gill, 18, Fourth Avenue, Sherwood Rise, Nottingham.
- 2PT J. Jardine, Crosby, Blundellsands.
- 2PU C. W. R. Chapman, Nirvana, 44, Chaplin Road, Wemhley.
- 2PV Capt. G. T. Smith-Clarke, Waverley Road, Kenilworth.
- 2PW Mr. Matthewson, 35, Capel Road, Forest Gate.
- 2PX H. H. Lassman, 429, Barking Road, East Ham, E. 6.
- 2PY H. Carter Bowles, 51, Gunterstone Road, West Kensington.
- 2PZ A. Symonds, Addison Avenue, Holland Park.
- 2QA H. W. Taylor, Cambridge.
- 2QD J. Ayers, 18, Seaford Avenue, New Malden, Surrey.
- 2QG J. S. Alderton, 1542, Stratford Road, Hall Green, Birmingham.
- 2QH C. Hewins, 42, St. Augustine Avenue, Grimshy.
- 2QI Hurst & Lucas, Mayford Road, Balham, S.W.
- 2QJ H. R. Walton, 70, Moorfield Road, Pendleton, Manchester.
- 2QK J. Bever, 85, Emm Lane, Bradford.
- 2QL R. J. Hibberd, Graywood School, Haslemere.
- 2QN A. Hobday, Flint House, Northdown Road, Margate.
- 2QO P. Pritchard, Blenheim House, Broad Street, Hereford.
- 2QP L. C. Grant, 3, Langhorn Street, Newcastle.
- 2QQ Burndept, Ltd., Wembley.
- 2QR F. W. G. Jowery, Handsworth, Birmingham.
- 2QS S. Ward, Ravenswood, 339, Brixton Road, S.W. 9.
- 2QT C. C. Barnett, Lower Farm, Nether Compton, Sherborne, Dorset.
- 2QU Hurst & Lucas, Lansdown Road, Blackheath.
- 2QV Altrincham Wireless Society, Plane Tree Road, Hale, Cheshire.

Considering

The MOZART Baby GRAND



OUR new reproducer is now under consideration by thousands of radio enthusiasts throughout the country. Singularly, many of the most expert are making quick decisions and below we quote from an opinion, entirely unsolicited, given us by Mr. C. E. Mattson, Baltimore,

"I gave the sample a test at one of the radio stores. About 15 customers crowded round and all agreed it was equal to the \$35.00 . . . and won by several lengths against the \$30.00 . . . My own opinion is that the M-G is going to be the greatest hit in radio this and next season. . . ."

Within five days (date of going to press) from receiving above, we have had orders for immediate shipment, aggregating exactly 146 complete reproducers and a large quantity of extra units for other makes of horns and phonographs from Mr. Mattson and his customers.

Prices. An Explanation.

We have been reluctantly obliged to slightly increase our price and to prospective purchasers a full explanation will be mailed on receipt of a postal card.

Complete with (gold plated) unit and cord, ready for attaching.....\$12.00
 West of the Rockies..... 12.65
 Unit only (gold plated) with cord ready for attaching..... 5.00
 Unit only (nickel plated) with cord ready for attaching..... 4.00

THE MOZART-GRAND CO.

Manufacturers of Fine Instruments

NEWARK, N. J. U. S. A.

By THE MORNING MAIL

IT Works—NEUTRODYNE—All Standard Parts

3 Rho. 30 ohms. . . \$2.00	2 Liberty trans. . . \$9.50
1 Rho. 6 ohms. . . .90	9 Readem binding .85
3 Air core R. F. trans. mounted on U.S. cond. . . .20.00	1 8x26 Mahog. panel 3.50
3 Silver contactjacks 2.70	3 4" Mahog. Dials. 3.00
1 Grid leak65	24 ft. D-K gold bus bar1.20
5 Bakelite base sockets5.00	Total. \$49.30

ONLY \$38.45 DELIVERED

\$5.50 Turney head sets \$2.85	5.00 Cockaday coils 2.29
5.00 Manhattan speaker20.25	Everything sold on an absolutely money back guarantee.
\$5.00 Man. speaker. 20.25	

\$55.00 SUPER-HETERODYNE KITS—WITH FREE ASSEMBLY BOOK. ONLY \$49.50

SEND FOR BIG FREE COMPLETE PRICE LIST

DOMINO RADIO SERVICE

83 Barclay St. New York, N. Y.

Send for DEALERS Catalog

HARRY ALTER'S "POCKETBOOK" is a monthly net price catalog of Radio, Electrical and Lighting supplies. All good dealers should have a copy—get on our mailing list now. No obligation. Use your letterhead.



HARRY ALTER & CO.
 WE SELL WHOLESALE ONLY
 1060N BOUL. CARROLL AV. CHICAGO

Insure your copy reaching you each month. Subscribe to Radio News—\$2.50 a year. Experimenter Publishing Co., 53 Park Place, N. Y. C.

SEND FOR
FREE
SAMPLE COPY

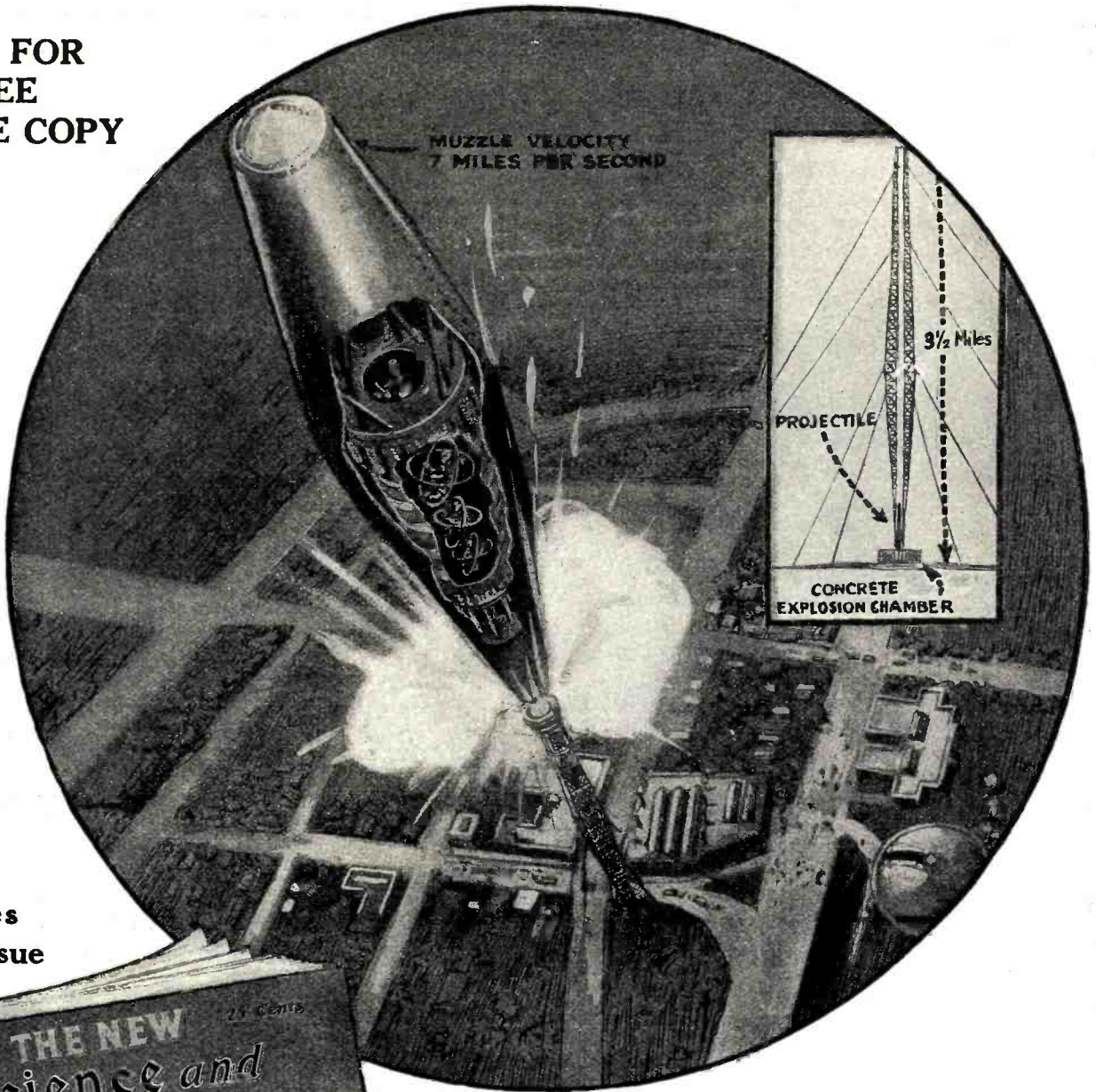

25
RADIO
Features
Every Issue



The Wonders of Science Told in Pictures

SCIENCE and INVENTION is the only magazine that tells all of the up-to-the-minute Scientific marvels in PICTURES. It makes hard subjects easy to understand.

SCIENCE and INVENTION costs 25c the copy at Your Newsdealers or \$2.50 per year by subscription. Use the coupon below when subscribing.

EXPERIMENTER PUB. CO., INC.
53 Park Place, N. Y. City

Experimenter Publishing Co., Inc. 53 Park Place, New York	R.N.5
Enclosed find.....dollars for which please enter my subscription to SCIENCE and INVENTION for.....years.	
Name	
Address	

- 2QZ B. H. Colquhoun, 3, Eastbrook Road, Blackheath.
- 2RB H. B. Grylls, Trenay Fawton, Carew Road, Eastbourne.
- 2RD G. W. Fairall, 27, Newbridge Street, Wolverhampton.
- 2RG E. W. Scamell, Birmingham.
- 2RH H. A. Pound, 101, High Street, Broadstairs.
- 2RJ Major F. S. Morgan, East Farleigh, Kent.
- 2RK A. E. Blackhall, 7, Maple Road, Surbiton.
- 2RM D. Cross, 3, Norman Road, Heaton Moor, near Stockport.
- 2RN D. W. Richards, "Mamety House," Bontnewydd Tce., Trelewis, Glam.
- 2RP F. W. Emerson, 178, Heaton Moor Road, Heaton Moor, near Stockport.
- 2RQ E. C. N. Strong, 119, Church Lane, Handsworth Wood, Birmingham.
- 2RR W. V. Waddoup, 56, Wellington Road, Handsworth Wood, Birmingham.
- 2RS T. Hesketh, 42, Castle Hall Avenue, Folkestone.
- 2RT N.-Eastern Instrument Co., Low Fell, Gateshead; Rowlands Mill Co., near Newcastle-on-Tyne.
- 2RU N.-Eastern Instrument Co., Low Fell, Gateshead; Rowlands Mill Co., near Newcastle-on-Tyne.
- 2RV A. L. Rawlings, 162, Burnt Ash Hill, Lee, S.E.
- 2RW T. Belshaw & D. M. Burn, 6, Manor Gardens, Merton Park.
- 2RY S. Hanley, Forbury, Kintbury, Berks.
- 2RZ Mr. Wood, 50, Parker Road, Winton, Bournemouth.
- 2SA Sir Hanbury Brown, Crawley Down, Sussex.
- 2SD John Mayall, A.I.M.E.E., M. Soc. C.E. (France), Burfield, St. Paul's Road, Gloucester.
- 2SF C. Midworth, Sunia, Ridgeway Road, Osterley Park, Middlesex.
- 2SG Arthur Taylor, 146, King's Road, Cardiff.
- 2SH F. L. Hogg, 37, Bishop's Road, Highgate, N. 6.
- 2SI L. C. Holton, 112, Conway Road, N. 14.
- 2SK K. G. Styles, 52, Jerningham Road, New Cross, S.E. 14.
- 2SL A. G. Styles, Kitscot, 57, Bower Mount Road Maidstone.
- 2SM R. J. Bates, Abbeygate Street, Bury St. Edmunds.
- 2SO T. Geeson, Alder Cottage, Peel Street, Macclesfield.
- 2SP L. Mansfield, Cregneish, Ley Hey Park, Marple, Cheshire.
- 2SQ A. J. Spears, 25, Rawlings Road, Birmingham.
- 2SS Mr. Evans, Bradford Technical College.
- 2ST L. Lambert, 46, Clarendon Road, Holland Park, W. 11.
- 2SU Mr. Eskdale, 230, Manchester Road, Bradford.
- 2SX F. B. Baggs, 24, Westhorpe Street, Putney, S.W. 15.
- 2SY H. Stevens, 25, Oaklands Road, Wolverhampton.
- 2SZ W. H. Brown, Mill Hill School, N.W. 7.
- 2TA H. Andrews, 8, North Grove, Highgate, N. 6.
- 2TB H. W. Sellers, Caresbrooke, Langley Avenue, Bingley, Yorks.
- 2TC H. W. Sellers, Caresbrooke, Langley Avenue, Bingley, Yorks.
- 2TF Edinburgh and District R.S., Edinburgh.
- 2TG Dr. T. F. Wall, Department of Applied Science, Sheffield University.
- 2TH Dr. T. F. Wall, Department of Applied Science, Sheffield University.
- 2TI H. Bevan Swift, A.M.I.E.E., 49, Kingsmead Road, Tulse Hill, S.W.
- 2TJ Burndept, Ltd., St. George Street, Leeds.
- 2TL E. V. R. Martin, 128, Dairy House Road, Derby.
- 2TM L. H. Mansell, Woodfield, Madersfield, Malvern.
- 2TN C. E. Stuart, Lyndon Lodge, Polesworth Tamworth.
- 2TO F. T. G. Townsend.
- 2TP C. W. Andrews, 26, Melody Road, Wandsworth, S.W.
- 2TQ T. C. Macnamara, 31, Rollscourt Avenue, Herne Hill.
- 2TR F. O. Sparrow, 8, North Drive, Swinton, Manchester.
- 2TT P. Hamilton, Junr., The Villa, Glenfield, Paisley.
- 2TV E. W. Wood, 79, Colwyn Road, Northampton.
- 2TW E. W. Wood, 79, Colwyn Road, Northampton.
- 2TX A. R. C. Johnston, Twyford Avenue, Ealing, W.
- 2TY S. Scott, Field Villa, Norton, Malton.
- 2TZ E. Jones, Newholme, Hemphaw Lane, Offerton, near Stockport.
- 2UA S. P. B. Barnes, 38 Avenue Road, Highgate, N. 6.
- 2UC E. J. Winstone, West Kensington.
- 2UD E. W. Smith, 77, Grove Lane, Camberwell.
- 2UF H. Bailey, 51, Manchester Road, Denton, Manchester.
- 2UG W. Humphreys Burton, 103 Portland Road, Nottingham.
- 2UI A. R. Ogston, 41, Broomfield Avenue, Palmer's Green.
- 2UJ L. R. Rowlands, Mona, 25, Cholneley Park, Highgate, N. 6.
- 2UK Coleridge Day Continuation School, King's Norton, Birmingham.

Introducing -
A new Broadcast Receiver

Type RF-2, a receiving set of surpassing excellence is offered to the radio public.

Radio frequency amplification at its best is employed—a transformer-coupled tuned radio frequency circuit with two stages of audio frequency amplification.

There are but two controls and tuning is extremely simple. Extraordinary sensitivity is combined with a high order of selectivity. Broadcast programs from far distant points are received with marked clarity and volume.

The assembly of instruments is encased in solid mahogany.

SEE IT! HEAR IT! COMPARE IT!

Ask your dealer

EISEMANN MAGNETO CORP.
William N. Shaw, President
50 Thirty-Third St., Brooklyn, N. Y.





EISEMANN

LISTEN-IN
RADIO RECORD
REGISTERED U.S. PAT. OFF.
THE ONLY "LISTEN-IN" BOOK

KEEP A RECORD OF STATIONS HEARD, DIAL SETTINGS, RECEIVING CONDITIONS, ETC.

Flexible cloth binding. Gold stamping. 160 pages. Printed on Bond Paper. Contains introductory article "How to Receive Radio Broadcast," by Lloyd C. Greene, Radio editor Boston Globe. Many Radio Hints and Tips. Complete list of Broadcasting Stations and double page map of United States.

PRICE 75 cents
At Your Dealers or Sent Prepaid on Receipt of Price

LISTEN-IN PUBLISHING CO.
119 MAIN ST.
CAMBRIDGE, MASS.

THE KANTBLO
(Protective Unit)

is an absolute safeguard against the blowing out of tubes. Can be used in all types of set.

IT COSTS \$3
IT MAY SAVE YOU \$30 OR MORE

THE TESTIT
(TESTING SET)

is invaluable to the man who builds his own set. Has any number of uses for the radio fan. Neutralize your set with this unit. Price complete, packed with full instructions..... **\$8**

WE DESIGN, BUILD AND REPAIR SETS

THE KELLEY RADIO LABORATORIES, INC.
26 East 42nd Street
New York City
Telephone Vanderbilt 1261



Noted Musical and Radio Authorities Select three Distinctly New Radio Song and Dance Hits

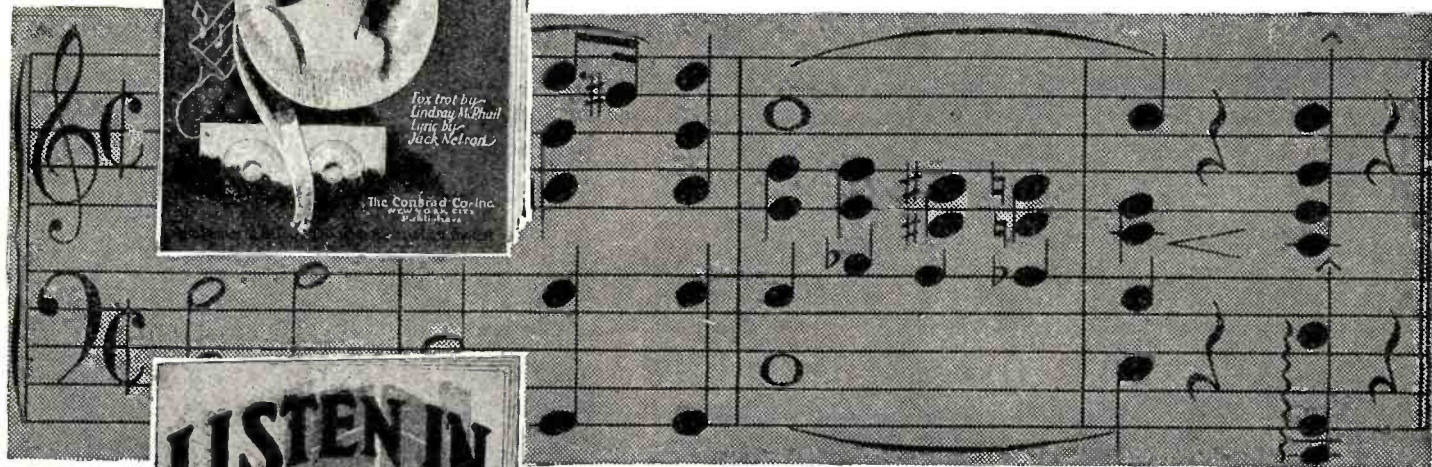

Now We Have Radio Song and Dance Hits

35c
EACH
Postpaid

In a recent nation-wide Musical Radio Contest three compositions were selected from the hundreds of Manuscripts submitted as prize winners. These numbers have now been published in the conventional form so that Radio Music Lovers and also Music Lovers everywhere can enjoy these distinctly new hits in Popular Music.

These prize Radio Hits will be a sensation in your dance folio. They offer you the opportunity of buying three fine melodies at the same time each better than the other. It were as if you had picked the choice numbers out of hundreds of songs at your dealer.

These Radio Song and Dance hits will be exclusively Radio—to and for the Radio Public. They will be Broadcast from your local Broadcasting station. Listen in for them. Your local Radio Dealer will have copies for you. Look them over the next time you visit him or write us direct for your copies.



Published and Distributed by

THE CONSRAD COMPANY, INC.
233 Fulton Street, New York City

Radio Jazz:

Irresistible foxtrot. One of the prize winners of RADIO NEWS Broadcast contest! Young feet dance—old feet tap time, to the fascinating melody of this real smashing hit.

Listen In:

Featured in RADIO NEWS Broadcast contest, has caught the fancy of all America! Its rare swing hypnotizes—and its tuneful melody makes it simply irresistible.

Radio March:

Another Prize Winner of RADIO NEWS Broadcast contest. Here, music lovers, is a wonderful number! Is there anything so appealing as the stirring strains of a military march?

- 2UM H. Lloyd (B. Eng.), 3, Ventnor Place, Sharrow, Sheffield.
- 2UN Y. M. C. A. (Boys' Dept.), Cardiff.
- 2UP Dept. of Physics, Armstrong College, University of Durham, Newcastle-on-Tyne.
- 2UQ H. F. Abell Sanderson, 23, Palace Road, Llandaff.
- 2US Wireless Society of Highgate, Highgate Literary and Scientific Institute, 11, South Grove, Highgate, N. 6.
- 2UV W. E. F. Corsham, 104, Harlesden Gardens, N.W. 10.
- 2UX A. T. Headley, 255, Galton Road, Warley, near Birmingham.
- 2UY W. Fenn, Holly Cottage, Polesworth, Tamworth.
- 2UZ C. V. Stead, 29, Spolebrook View, Chapel-town, Leeds.
- 2VC A. S. Gosling, 63, North Road, West Bridgeford, Nottingham.
- 2VD Capt. E. L. Crowe, Juniper Rough, Har-dres, near Canterbury.
- 2VF H. A. Blackwell, Whyte House, Bispham, near Blackpool.
- 2VH S. E. Payne, 11, St. Mark's Road, Bush Hill Park, Enfield.
- 2VI Mr. Curtis, Lower Hall Lane, Walsall.
- 2VJ B. J. Axten, 78, Ealing Road, Wembley.
- 2VK Burndep't, Ltd., Blackheath.
- 2VL Messrs. Mitchells' Experimental Station, McDermott Road, S.E. 15.
- 2VM J. Lipowsky, 614, Old Ford Road, Bow, E. 3.
- 2VN M. H. Drury-Lavin, Old House, Sonning, Berks.
- 2VO A. C. Holmes, Aire View, Cononely, Keighley, Yorks.
- 2VP P. G. A. H. Voigt, 121, Honor Oak Park, S.E. 23.
- 2VQ H. Old, St. Jude's Avenue, Mapperley, Nottingham.
- 2VR H. J. Jackson, 8th Walthamstow Troop Boy Scouts.
- 2VS L. E. Owen, 186, Beulah Hill, Norwood, S.E. 19.
- 2VT W. K. Hill, Norwood.
- 2VU J. W. Hobley, Mill Road, Wellingborough.
- 2VV Installations, Ltd., Southampton.
- 2VW E. H. Robinson, 125c, Adelaide Road, N.W. 3.
- 2VX H. H. Thompson, 44, Northumberland Road, Coventry.
- 2VY R. Ely, Highlands, Brighton Road, Sut-ton.
- 2WA J. Pigott, Manor Farm, Wolvercote, Ox-ford.
- 2VB G. W. Jones, 33-34, Worcester Street, Wolverhampton.
- 2WD C. W. Clarabut, Beechcroft, Beverley Crescent, Bedford.
- 2WF Prof. A. M. Low, "The Yews," Wood-stock Road, Bedford Place, W. 4.
- 2WG Gambrell Bros., Ltd., Merton Road, Southfields, S.W. 18.
- 2WI C. J. Munday, Tiverton, Devon.
- 2WJ R. L. Royle, "Southwold," Alderman's Hill.
- 2WK G. R. Lewis, 10, Lansdowne Road, Pal-mers Green, N. 13.
- 2WL F. J. Cripwell, Lonkhill, Thorpe Tam-worth.
- 2WM J. W. Pallett, 24, Glenfield Road, Lei-cester.
- 2WN A. H. Wilson, 67, Broad Street, Hanley, Stoke-on-Trent.
- 2WO J. H. Brown, Redbrook, Baguley, Chesh-ire.
- 2WP Western Electric Co., Witton, Birming-ham.
- 2WQ C. H. Gardner, Denmark Hill.
- 2WR L. W. Burcham, Gouzeacourt, Chestnut Avenue, Oulton Broad.
- 2WS H. Squelch Jr., 35, Crown Lane, Bromley.
- 2WT H. Chadwick, 9, Raimond Street, Bolton.
- 2WU Capt. C. H. Bailey, Monkswood, Usk, Mon.
- 2WX G. Gardner.
- 2WY A. W. G. Gamage, Holborn, London.
- 2WZ A. Hare-Hobson, 32, Wilbury Road, Hove, Sussex.
- 2XA Rev. C. H. Townson, Wilts. Farm School, Warminster.
- 2XB A. T. Croucher, 35, Douglas Road, High-bury.
- 2XC H. Johnson, Avondale, Chestnut Walk, Worcester.
- 2XD H. R. Gladwell, London Road, Abridge, Essex.
- 2XF E. T. Chapman, Abbotsford, Serpentine Road, Poole.
- 2XI R. Wagner, 6, Maresfield Gardens, N.W. 3.
- 2XJ Sheffield District Wireless Society.
- 2XK Sheffield District Wireless Society.
- 2XL Capt. E. Davis, 22, Lavender Hill, S.W. 11.
- 2XM Downside School, Stratton-on-the-Foss, Bath.
- 2XN Downside School, Stratton-on-the-Foss, Bath.
- 2XP J. F. Payne, 22, Shakespeare Crescent, Manor Park, E.
- 2XR J. F. Haines, 36, Zetland Street, Poplar E. 14.
- 2XU A. H. A. Kilbourn, Bath Street, Abington.
- 2XW H. A. Woodyer, 118, Buckingham Road, Heath Moor.
- 2XX D. F. Young, 23 Holcombe Road, Ilford.
- 2XZ L. T. Dixon, 4, Heythorpe Street, South-fields, S.W. 18.

The Pioneer of 'Perfection'

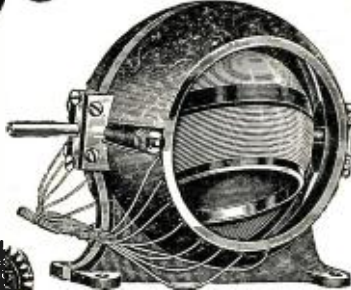

Pioneer Variocoupler \$7.00

The first impression you get from looking at Pioneer Variocouplers and Variometers is that beyond doubt they are the most beautiful instruments yet devised.

The beautiful Bake-lite in a grained mahogany finish has a richness that has never been equaled before.

The heavy copper wire, covered with green silk, gives a contrast that makes the instruments irresistible and adds tremendously to the beauty of any set.

The mechanical parts are no less wonderful. The hardware of heavy bronze—the close-coupler rotor and stator—the positive contacts, all demonstrate the highest mechanical skill and attention to detail.

A special feature is the winding of the vario-coupler on the inside of the shell—which is original and exclusive with Pioneer.

Ask your dealer to show you these instruments. If he cannot supply write us, giving his name and address.

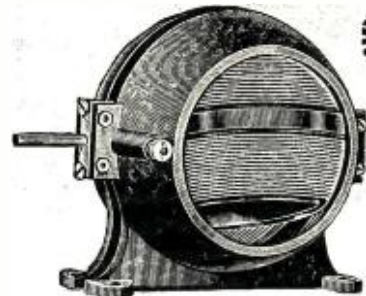

Pioneer Variometer \$6.50

PIONEER RADIO CORPORATION
101 Pioneer Ave. Galesburg, Illinois

BRANCH OFFICES
European Branch Office: 27-28 Aning Street, London, England
Gaston E. Marbaix, European Manager
New York City.....220 Fulton St.
Chicago Ill.....33 So. Clinton St.
Kansas City, Mo.....208 Baltimore Bldg.
Minneapolis, Minn.....705 Plymouth Bldg.
San Francisco.....623 Larkin St.

INSULATORS
DRY—SAFE

Weather and waterproof lead-in insulators for walls or window sash. Made from hard rubber with brass conductor in center.

4" Insulator50c
10" Insulator80c

THE M & M CO.
Cleveland :: Ohio

Wall Insulator 60c EACH

JIFFY BLOW TORCH and SOLDERING OUTFIT

A complete Soldering Outfit consisting of self-blowing torch, holder, copper iron, non-corrosive flux and solder. Unexcelled for radio work. Delivered postpaid, price \$2.00. Send stamps or money order to

HANDYCAP MFG. CORP.
Dept. N., Riverdale, Ill.

WANTED—Back numbers of Radio News, Dec., 1921, Jan. and Feb., March and April-May, 1922. Experimenter Publishing Co., 53 Park Place, New York City.

- 2YA R. A. Miles, 4, Cambridge Green, New Eltham.
- 2YF J. R. Clay, Upper Longbottom, Ludden-den Foot, S.O.
- 2YG L. G. Boomer, 42nd Camberwell Troop Scouts.
- 2YH Burndept, Ltd., 40, Park Lane, London, W.
- 2YI W. J. Hewitt, 83, Reddings Road, Mose-ley, Birmingham.
- 2YJ Wireless Equipment, Ltd., 90 Charing Cross Road, W.C. 2.
- 2YK T. M. Ovenden, 12a, Elgin Court, Elgin Avenue, Hampstead.
- 2YL W. H. Allan, 8, Newington Causeway, London, S.E. 1.
- 2YM R. W. Piper, 62, Chiltern View Road, Uxbridge.
- 2YN A. W. Thompson, 32, St. Nicholas Street, Scarborough.
- 2YQ W. P. Wilson, Christ Church Vicarage, South Norwood.
- 2YR W. Pike, Hounslow Wireless Society, Council House, Hounslow.
- 2YU G. W. Hayle and R. Lyle, 36, Dagnal Park, S. Norwood.
- 2YV G. M. Whitehouse, Allport House, Can-nock.
- 2YW J. H. F. Town, 4, Eversley Mount, Hali-fax.
- 2YX F. E. B. Jones, Hill Crest, Wylde Green, Birmingham.
- 2YY O. H. Patterson, 26, Allerton Road, Stoke Newington.
- 2YZ Western Electric Co., Ltd., North Wool-wich.
- 22B Clacton Electric Co., Clacton-on-Sea.
- 22C General Radio Co., Twyford Abbey Works, Acton Lane, Harlesden, N.W. 10.
- 22D A. Woodcock, Montague Road, Hands-worth, Birmingham.
- 22G W. J. Badman, 9, Orchard Street, West-onsuper-Mare.
- 22H B. T. H. Co., Rugby.
- 22K W. L. Turner, Purley, Cald, near Bir-kenhead.
- 22L H. W. Gee, 44, Gordon Street, Gains-borough, Lincs.
- 22M T. H. Isted, Terling, Witham, Essex.
- 22O L. H. Sowndy, 60, Bellevue Road, Ealing.
- 22P G. H. Forwood, West Chart, Limpsheld, Surrey.
- 22Q H. Nunn, 49, Leigh Road, Highbury.
- 22S F. J. Dinsdale, 14, Highfield View, Stony-croft, Liverpool.
- 22T C. M. Benham, "Benhilton," New Mal-den.
- 22U T. Heckles, 30, Thackeray Street, Liver-pool.
- 22V F. T. Smith, Rutlands, Felstead.
- 22Y B. B. C., Manchester Station.
- 22Z D. V. L. Fellows, Cumberland Avenue, Park Royal, N.W. 10.
- 5AA "The Leicester Mercury," Leicester.
- 5AC W. G. Kimber, 39, Bargery Road, Cat-ford.
- 5AF J. A. H. Devey, 232, Great Bricklin Street, Wolverhampton.
- 5AG A. E. Gregory, 77, Khedive Road, E. 7.
- 5AI A. H. Sheffield, 139, Wallwood Road, Leytonstone, E. 11.
- 5AJ W. C. Barraclough, 61, Bridge Street, Manchester.
- 5AK H. G. Mansell, Cleeve View, Harvington, near Evesham.
- 5AN W. J. Joughin, Edison Bell Works, Glen-gale Road, Peckham.
- 5AO H. H. Elson, 142, Birchfield Road, Bir-mingham.
- 5AQ D. Douet, 10, Rovington Gardens, Put-ney, S.W. 15.
- 5AS F. A. Bourne, 10, Linley Road, S. Tot-tenham.
- 5AT The Dubilier Condenser Co., Ltd., Shep-herd's Bush, W. 12.
- 5AU The Dubilier Condenser Co., Ltd.
- 5AV R. W. Harvey, 25, Shakespeare Avenue, Portswood, Southampton.
- 5AW F. Hough (Southport), Ltd., 60, Sussex Road, Southport.
- 5AY T. F. Crowther, 29, N. Drive, St. Annes-on-Sea.
- 5AZ F. Charnley, 43, Reads Avenue, Black-pool.
- 5BA Chase Motors, Ltd., Sandyford Square, Newcastle-on-Tyne.
- 5BB Vickers, Ltd., Vickers House, Broadway, Westminster, S.W.
- 5BC Sir Trevor Dawson, Bart., Edgwarebury House, Elstree, Herts.
- 5BG J. B. Kaye, Close Hill, Huddersfield.
- 5BI G. E. Beale, Bournemouth.
- 5BJ Autoveyors, Ltd., 84, Victoria Street, Westminster, S.W. 1.
- 5BK W. G. H. Brown, 52, Winstonian Road, Cheltenham.
- 5BL Mr. Vick, Gresham Road, Hall Green, Birmingham.
- 5BM J. T. Quick, 164, Portland Road, Edgbas-ton.
- 5BT L. V. Clark, 4, Compton Crescent, Grove Park, W. 4.
- 5BV H. N. Ryan, 88, Home Park Road, Wim-bledon Park.
- 5BA A. du Villiers, 79 St. George's Road, S.E.
- 5CA N. L. Yates-Fish, "Cleveland," 10, Mans-field Road, Reading.
- 5CB K. E. Hartridge, 14, Westbourne Cres-cent, W. 2.
- 5CC Bath Electro-Pl. Works, Foxcombe Road, Bath.



Follow the crowd!



RUI \$3.50

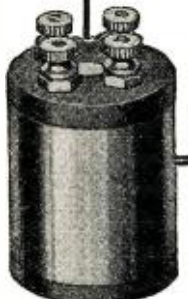

RI \$2.50



A1 A2 \$4.50

Two things make Radio receiving. Radio and Audio Frequency Amplification. Radio Frequency for distance and selectivity. Audio frequency for volume and tone. United Radio Frequency. Amplifying Transformers give you distance. United Audio Frequency Amplifying Transformers give you volume and tone. The tremendous number of people who have shown their preference for United transformers, and who have been satisfied, has given us an increased assurance of the superiority of United Transformers. We believe you too will be safe in following the crowd and purchasing United.

Sold by leading dealers. Catalog on request.

UNITED MFG. & DIST. CO.

9701 Cottage Grove Ave., Chicago, Ill.

New York Office:

145 W. 45th St., N. Y. City

San Francisco Office:

709 Mission St., San Francisco, Calif.



UNITED

Tufglas Battery Trays

UNDERNEATH RADIO BATTERIES
SAVE CARPETS AND RUGS



Tufglas Tray, Regd. Size: 8 1/4 x 9 3/4" inside

Made of Acid Resisting Glass of great mechanical strength. Sent Parcel Post collect to any part of United States. Add \$.75 to price if west of Mississippi.

PRICE \$1.50 EACH

Dealers and Agents Wanted

Dept. N

RUSSELL B. CRESSMAN

GENERAL SALES AGENT

200 Fifth Ave.

N. Y. City

HYGRADE SPECIALS

V.T. Sockets—Federal 85c—Paragon	\$.85
Fada 85c—Signal 75c—Na-Ald	.65
Phone Plugs—Federal 69c—Firc	.85
Paent 45c—Weston 89c Cies	.45
2 in 1 Variable Grid Control	1.75
Bradleystat (new type)	1.59
Filokstats (new type)	1.75
Ambassador 3000 Ohm Head Set	3.25
Ambassador Coils	4.85
Brandes Matched Tone Head Set	4.98
Nerco 2200 Ohm Head Sets	3.49
Skindorvikin Transmitter Buttons	4.50
General Radio Loud Speaker Units	8.95
Morrison Loud Speaker Units	8.95
Acme R.F. Transformers Types R2, R3, R4	3.98
Audio Frequency Transformers Thordarson	3.49
Jefferson No. 41—\$3.49, Paragon	4.50
Federal No. 226W—\$4.50, Federal No. 65	5.98
No. 164A—Fada Neutrodron Condensers	1.10
No. 163A—Fada Neutrodrons	6.49
No. 165A—Fada Hazeltine Parts	21.50
Marke Storage Batteries	\$8.75 up

All Orders Must Include Parcel Post Charges

Hygrade Electrical Novelty Co.,
41 WEST 125th STREET, NEW YORK, N. Y.

Insure your copy reaching you each month. Subscribe to Radio News—\$2.50 a year. Experimenter Publishing Co., 53 Park Place, N. Y. C.

(To be concluded in the next issue)

OPPORTUNITY AD-LETS

Follow these advertisements every month. Reliable advertisers from all over the country offer their most attractive specials in these columns.

Classified advertising rate eighteen cents a word for each insertion. Ten per cent. discount for 6 issues, 20 per cent discount for 12 issues. Name and address must be included at the above rate. Cash should accompany all classified advertisements unless placed by an accredited advertising agency. No advertisement for less than 10 words accepted.

Objectionable or misleading advertisements not accepted. Advertisements for the July issue must not reach us later than May 1st.

THE DISTRIBUTION OF RADIO NEWS IS OVER 335,000
 EXPERIMENTER PUBLISHING CO., INC., 53 Park Place, New York, N. Y.

Agents Wanted

Agents Wanted in every city and town to sell standard radio apparatus. Attractive discounts given. If interested write us at once stating age and radio experience. Wilmington Electrical Specialty Co., Inc., 405 Delaware Ave., Wilmington, Delaware.

General Agents—Service Men! Genuine Gold Letters for store windows easily applied. 20 per cent cash commission on all orders from local agents appointed by you anywhere. 50 per cent discount on your own orders. Free samples. Metallic Letter Co., 422 N. Clark St., Chicago.

Big Money and fast sales. Every owner buys gold initials for his auto. You charge \$1.50; make \$1.35. Ten orders daily easy. Write for particulars and free samples. American Monogram Co., Dept. 133, East Orange, N. J.

We want Salesmen and Agents, either whole or side line, to sell our low priced radio books to the trade. Excellent proposition for live wires. The E. I. Company, Publishers, 233 Fulton St., New York City.

You can make \$75.00 to \$100.00 a week selling our big line of 150 articles, used constantly in every home. Write us, we will send you our handsome \$15.00 Sample Case Outfit on trust. Federal Pure Food Co., Dept. T, Chicago.

Use our handsome Catalog; get orders from every home for Dr. Blair's famous home products. Liberal pay. Dr. Blair Laboratories, Dept. 541, Lynchburg, Va.

Sells like Blazes! New, Instant Stain Remover. Fine Premium every sale. Big profits. Outfit free. Write quick. Christy, 32 Union, Newark, New York.

Formulas, Processes, Trade Secrets—Different, dependable, profitable. Catalog free. R. Thaxly Co., Washington, D. C.

Attention—Agents! Big Money-Making proposition. Mozart Felt Rug, guaranteed made of entirely new felt. Rapid seller. 100% profit. Sample prepaid \$1.75. Write today for full particulars. Maisey-Payne Mfg. Co., 20-N Sudbury St., Boston, Mass.

Gold Mine for Salesmen. New invention, a complete outfit. Washed and dried windows, screens, mops, etc. Costs less than brooms. Over 100% profit. Greatest year 'round seller. Write Harper Brush Works, 160 2nd St., Fairfield, Iowa.

Start in a Permanent Business of your own selling guaranteed Hosiery, Underwear and Sweaters. We deliver and collect if you prefer it. No capital or experience needed. Sworn Proof of Profits \$12 daily up, furnished. Become our District manager—Get others working for you. Write for details to The Mac-O-Chee Knit Goods Company, Room 4745, Cincinnati, Ohio.

A Business of Your Own. Make Sparkling Glass Name and Number Plates, Medallions, Checkboards, Signs. Big illustrated book free. E. Palmer, 515, Wooster, O.

Agents Wanted to sell Tufflas Battery trays used under radio batteries. Sells Carpets and Rugs. Write R. B. Cressman, 200 Fifth Ave., N. Y. City.

American Made Toys

Manufacturers on Large Scale, also homeworkers, wanted to manufacture small Toys. Novelties. Millions needed of Barking Dogs, Wag Tail Pups, Wild Animals, Automobiles, Indians, Cowboys, Baseball Players, Cannons, Toy Soldiers, Crowing Roosters, Statues of Liberty, Miniature castings of Capitol, Bathing Girl Souvenirs and others. Unlimited possibilities. Guaranteed Casting forms furnished manufacturers at cost price from \$5.00 up with complete outfit. No experience or tools necessary. Thousands made complete per hour. We buy goods all year and pay high prices for finished goods. Cash on delivery. Contract orders placed with manufacturers. Catalog and information free. Correspondence invited only if you mean business. Metal Cast Products Co., 1696 Boston Road, New York.

Art

Art Objects, Books, Pictures, Particulars free. Send no money. O. W. Miller, 27NX Warren St., New York, Alaska, St. Louis.

Automobiles

Build a Real Automobile—Weight 150 pounds. Handy men or boys build at small cost. Complete book. Easy-To-Follow-Plans, 25c.; also sold complete. Famous 2 1/2 H. P. Shaw motor supplies power. Stamp brings descriptive circular. Shaw Manufacturing Company, Dept. R. N. 2, Galesburg, Kansas.

Books

Radio Log Books, sizes 5x7., a record for 500 stations, 50c. cash (no stamps). Lester Stretcher, Marion, Kansas.

Business Opportunities

Bookkeeping in a Week, \$1 postpaid. Dukes, 1857 Walton Ave., New York.

Inch Display 100 Magazines, thrice \$8. Beck, 5453 Alaska, St. Louis.

Experimenters—Manufacturers—Amateurs—Steel moulds for casting heart shaped crystal mountings with shank—\$3.00. Sample mounting 25c. Alfred J. Heyman, 712 5th Ave., S. E., Minneapolis, Minn.

Don't Buy a Business. Start one yourself. Little capital necessary. Information, Paul Kare, 149 Broadway, N. Y., Dept. X.

Business Opportunities (Continued)

Make \$100 Weekly in Spare Time. Sell what the public wants—long distance radio receiving sets. Two sales weekly pays \$100 profit. No big investment, no canvassing. Sharpe of Colorado made \$955 in one month. Representatives wanted at once. This plan is sweeping the country—write today before your county is gone. Ozarka, 813 Washington Blvd., Chicago.

Free Instructive Book. Start your own little mail order business. Home employment evenings. Also secure agents to sell for you. We tell you how. Also furnish beginner's outfit circulars, samples, specialties. Book sent free. Pier, 754 Cortlandt Street, New York.

Sell us your spare time. Write showcards for us. We instruct and supply work. No experience necessary. Wilson Methods, Limited, Dept. 51-C, Toronto, Canada.

Chemistry

Learn Chemistry at Home—Dr. T. O'Connor Sloane, noted educator and scientific authority, will teach you. Our home study correspondence course fits you to take a position as chemist. See our ad on page 1661 of this issue. Chemical Institute of New York, 66 West Broadway, New York City.

Correspondence Courses

Used correspondence courses of all schools sold, rented and exchanged. New 1924 catalogue free. (Courses bought). Lee Mountain, Pisgah, Alabama.

Exchange

For Sale: Airway Type G including Radiotrons. A five-tube Radio Frequency set. New \$95.00. W. C. Bennett, Lisbon, Ohio.

For Inventors

Inventors' Educator: 900 mechanical movements. 50 perpetual motions. How to prepare and sell patents. Mechanical movements greatly assist inventors, suggest new ideas. Explains how to select an attorney and avoid Patent Sharks. Price \$1.50. Postage free. Albert E. Dieterich, 690 Ouray Building, Washington, D. C.

Health

Free—Stop using tobacco. We will give free information how to conquer habit easily and permanently. Results guaranteed. Anti-Tobacco League, Box M, Omaha, Neb.

Help Wanted

We want Salesmen and Agents, either whole or side line, to sell our low priced radio books to the trade. Excellent proposition for live wires. The E. I. Company, Publishers, 233 Fulton St., New York City.

Earn \$25 Weekly, spare time, writing for newspapers, magazines. Experience unnecessary; details free. Press Syndicate, 973, St. Louis, Mo.

All Men, Women, Boys, Girls, 17 to 65 willing to accept Government Positions \$117-\$250 traveling or stationary; Write Mr. Oment, 251, St. Louis, Mo., immediately.

Get Posted—Good prices paid for butterflies, insects. See Sinclair display advertisement, page 1670.

Employment in South America. Classified lists of employers \$1. South America Information Bureau, Portland, Oregon.

Detectives Needed Everywhere. Travel. Experience unnecessary. Write George Wagner, former Government Detective, 1968 Broadway, N. Y.

Inventors to send for FREE Inventors' Private Record Blanks. Fischer & Lusaard, patent attorneys, 1026 Merchants Nat'l Bank Bldg., St. Paul, Minnesota, or 207 Ouray Bldg., Washington, D. C.

Improved Made Toys

Wanted—Manufacturers and Houseworkers to manufacture Metal Toys and Novelties. Wonderful opportunity. Millions needed. In Whistling Birds, Wild Animals, Wag Tail Pups, Crowing Roosters, Automobiles, Baseball Players, Statues of Liberty, Indians, Toy Soldiers, Barking Dogs and 50 others. No experience or tools necessary. Guaranteed casting forms with complete outfit, at cost. From \$3.50 up. We buy goods all year. Cash on delivery. Higher price for finished goods. Contract orders placed. Send for catalog and information free. The Improved Metal Casting Co., 342 E. 145th St., New York.

Insects Wanted

Get posted—Good prices paid for butterflies, insects. See Sinclair display advertisement, page 1670.

Instruction

Learn Chemistry at Home—Dr. T. O'Connor Sloane, noted educator and scientific authority, will teach you. Our home study correspondence course fits you to take a position as chemist. See our ad on page 1661 of this issue. Chemical Institute of New York, 66 West Broadway, New York City.

Instruction (Continued)

Used Correspondence Courses bought and sold. Bargain catalogue 1,000 courses free. Students' Exchange, Dept. 5, 47 West 42 St., New York

Miscellaneous

Get posted—Good prices paid for butterflies, insects. See Sinclair display advertisement, page 1670.

Healthy, Intelligent, Registered Mammoth. Great Danes for sale. Box 23, New Richmond, Ind.

Morand will save your hair. Write for trial size, 20c. The Morand Co., 142 Hunterdon St., Newark, N. J.

Paint attractive signs and showcards with letter patterns. Samples for stamp. John Rahn, P 2433 Greenview Ave., Chicago.

Increase your volume of radio sets. Send twenty-five cents in coin for diagram. Radio Store, Hinsdale, N. H., Box 584.

Radio Builders—Send \$1.50 for 50 Secret formulas of any color. One dollar additional brings consulting service for one year. Saginaw Experimental Laboratories, 1615 Williams St., Saginaw, Mich.

Latest in visiting cards. Write for free sample. A. F. Schumert, 322 N. Fourth St., Belleville, Ill.

Cornetists—Trumpetists—Saxophonists—Clarinetists. Get "Free Pointers." Name instrument. Virtuosa Music School, Concord, Mass.

Motorcycles—Bicycles

Don't Buy a Bicycle Motor Attachment until you get our catalog and prices. Shaw Mfg. Co., Dept. 6, Galesburg, Kansas.

News Correspondents

Earn \$25 Weekly Spare Time writing for newspapers, magazines. Experience unnecessary; details free. Press Syndicate, 972 St. Louis, Mo.

Patent Attorneys

Patents. Send drawing or model for examination and report as to patentability. Advice and booklet free. Highest references. Best results. Promptness assured. Watson E. Coleman, Patent Lawyer, 644 G Street, Washington, D. C.

Patents—Inventors should write for Free Guide Books and Record of Invention Blank before disclosing inventions. Send model or sketch of your invention for our Free opinion of its patentable nature. Radio, Electrical, Chemical, Mechanical and Trade-Mark experts. Victor J. Evans & Co., 922 Ninth, Washington, D. C.

Lacey Patent-Sense. See page 1692.

Patents—Send for form "Evidence of Conception" to be signed and witnessed. Form, fee schedule, information free. Lancaster and Allwine, 269 Ouray Bldg., Washington, D. C.

Patents—My fees in installments. Advice book free. Frank Fuller, Washington, D. C.

Personal

Lonely Hearts—Exchange letters; make interesting new friends in our jolly club. Eva Moore, Box 908, Jacksonville, Florida. Enclose stamp.

Correspondence Club—Many wealthy members everywhere. Fascinating particulars free. Smith, Box 1167Y, Denver, Colo.

Exchange Cheery Letters with new friends. Write Betty Lee, Inc., 4254 Broadway, New York City. Stamp appreciated.

Lonesome—Join our club—make acquaintances everywhere. Big illustrated book with descriptions and photos, sent in plain wrapper for ten cents. BonaFide Co., Dept. 58, Kansas City, Mo.

Photo Finishing

Films Developed 5c—Prints 3c each. The new Davo finish. Davis Photo Shop, Dept. E, Cincinnati, Ohio.

Fifty assorted flathead solid brass machine screws, nuts, washers, copper lugs—50c. Eight initialed binding posts, set 60c. Twelve nickeled binding posts—50c. All three items—\$1.50. Radio List for stamp. All prepaid. Stamps accepted. Kladag Radio Laboratories, Kent, Ohio.

Radio

Radio Panels. Cut exactly to size and a guaranteed 12 hour shipment. 3/4" thick, 0.1 1/2c. per square inch. 3-16" thick .01 1/4c. Made of the highest grade black fibre. This material possesses electrical strength of 200 volts per mil, is inexpensive, unbreakable, easy to work and takes a fine finish. We pay postage. Radio Instrument & Panel Co., 564 W. Monroe St., Chicago, Illinois.

Boys! Don't Overlook This. The "Rasco" Baby Detector. Greatest detector ever brought out with molded base. Fully adjustable. See former advertisements in this publication, or our catalog. Detector with Galena Crystal, complete 50c, the same detector with Radiocite Crystal 75c. prepaid. Send for yours today. Radio Specialty Company, 96-98 Park Place, New York City.

Capacity 1,000



The Breakers

Atlantic City, N. J.

ON THE OCEAN FRONT

Fireproof

American and European Plans

Orchestra Dancing
Golf Privileges Cabinet Baths

Garage

JOEL HILLMAN, President

HEATH

RADIANT CONDENSERS

PRECISE, when you examine them at the store and, still more important, p-r-e-c-i-s-e always. Plates made PERMANENTLY FLAT, by the Heath process of stamping and hardening.



Micrometer-Adjusting Geared Vernier

Reducing gear, engaging with teeth cut into the outer rim of the vernier plate affords infinitely delicate adjustment.

Jobbers and Dealers Write Immediately for Proposition

HEATH RADIO & ELEC. MFG. CO.
206 First Street Newark, N. J.
Exclusive Canadian Distributor:
Marconi Wireless Telegraph Co., Ltd.,
Montreal, Canada

To the Radio Dealer

Let us explain how you can make the sale of our publications a worth while, well paying part of your business. Every one that enters your store is a prospective buyer of RADIO NEWS. RADIO NEWS will sell with little effort on your part.

You may sell our publications on a single copy basis with a fine margin of profit or on a subscription basis with a generous commission allowance.

Write now for further details.

EXPERIMENTER PUBLISHING CO.
53 Park Place New York

Radio—(Continued)

Attention!—50 Vacuum tube hook-ups. The greatest collection of vacuum tube circuits ever brought under two covers at such insignificant cost. These diagrams will be found in the great "Rasco" catalog, which contains raw materials and parts in a greater profusion than any other catalog. 15c in stamps, or coin, will bring the catalog to you. Radio Specialty Co., 96-98 Park Place, New York City.

Build Your Own. The best hook-up I ever tried. Yours for a dollar. Any complaint your money back. E. F. Waits, Corinth, Miss.

Radio Panel-White "Pyrain Ivory" makes the most beautiful set of all. Guaranteed satisfactory. Any size 3-16" thick, 3c per square inch. Sample sent. E. P. Haltom, 614 Main St., Fort Worth, Texas.

Boys! Music 4,000 miles, one tube, circuit and letter proving same fifty cents, no stamps. Barry, 103 Main St., White Plains, N. Y.

A-1: A new crystal Service. A-1 Crystals are guaranteed tested by reception of distant station broadcasting. Fifty cents each postpaid. Harry Grant, Jr., 904 Oak Grove, Burlingame, California.

Make Radio Crystals—Guaranteed instructions \$1. Sentive. Cheap. Home Radio Shop, Box 935, Wichita, Kansas.

1000 Mile Tube Set complete \$18. Send for price list. Kale Radio, 274 N. Troy St., Chicago, Illinois.

A New Method of making and calibrating a wavemeter at home, makes it easy. No calculations or guesses. Send 10c for instructions. R. M. Moore, North Fourth Ave., Tucson, Ariz.

Radio Cabinets—Standard Sizes Made to Order. Miami Cabinet Company, 503 Ludlow Building, Dayton, Ohio.

Munzig Circuit—Two tubes do five operations. 500 miles on loop. Write for circuit and circulars. Ray-Dee-Artcraft Instrument Co., Redlands, Calif.

Magnavox R3 or M1. Latest nationally advertised reproducers. List \$35. Introductory \$25. The factory sealed carton is your guarantee. Radio Central, Dept. R, Abilene, Kansas.

Tube Repairs. UV 200—\$2.50; UV 199, 201, 201A, De Forest, etc., \$2.75; UV 202—\$3. Satisfaction guaranteed. 12 Hour Service assumed. S. Strobel & Co., 3923 N. 6 St., Phila., Pa.

Winko Diamond Coil Tuning Coil. Two circuit. Non-radiating no hand capacity \$2. Winklehaus, 493 Evergreen Ave., Brooklyn, N. Y.

Experimental Electricity Course in 20 Lessons. By S. Gernsback and H. W. Secor, E. E. A course of the theory and practice of Electricity for the Experimenter. Every phase of experimental electricity is treated comprehensively in plain English. New experiments are described and explained and nearly every application of Electricity in modern life is given. 160 pages—400 illustrations. Flexible cloth cover, 75c postpaid. Stiff cloth cover, \$1.25 postpaid. Experimenter Publishing Co., Book Dept., 53 Park Place, New York City.

How to Make Radio Frequency Amplifiers. This book is for the more advanced amateur, showing the construction of the Radio Frequency Amplifying Transformer and giving complete constructional data. It shows the application of Radio Frequency to amplifying units that the amateur may already possess and gives 15 hook-ups showing practically every use Radio Frequency Amplifying Transformers can be put to. 32 pages, 15 illustrations; bound in beautiful two-color cover. Prepaid 25c. The E. I. Company, 233 Fulton St., New York City.

Radio Batteries

Super Radio A and B Circuit Batteries, which bring in long distances reception. Sold for cash or on payment plan. Write for prices and details. Radio Battery Corporation, 501-B Industrial Bank Bldg., Flint, Mich.

Salesmen Wanted

A Salesman wanted in every town or city within 25 miles of a broadcasting station to sell Radiogem, the complete radio receiving set that retails for \$2.50. With Radiogem there is nothing else to buy—the outfit includes the Radiogem receiving apparatus, 1,000 ohm phone, and aerial outfit. The cheapest radio outfit on the market—yet as practical as the most expensive. Big money to the right men. Send \$1.35 for sample outfit. The Radiogem Corp., 66-B West Broadway, New York City.

Sell coal in carload lots. Side or main line. Experience unnecessary. Earn Week's Pay in an hour. Washington Coal Company, 745 Coal Exchange Building, Armour Station, Chicago.

Lightning Strange Battery Compound. Charges discharged batteries instantly. Eliminates old method entirely. Gallon free to agents. Lightning Co., St. Paul, Minn.

Scenery to Rent

Settings for Opera, Plays, Minstrels. Plush Drops. Address Amelia Grain, Philadelphia.

Song Poems Wanted

Poems Wanted—Sell your song-verses for cash. Submit Mus. at once, or write New Era Music Co., 152 St. Louis, Mo.

Stammering

St-Stu-t-t-aring and Stammering cured at home. Instructive booklet free. Walter McDonnell, 121 Pottomac Bank Bldg., Washington, D. C.

Stamps and Coins

California gold. Quarter size 27c; half-dollar size 53c; Half-dime and Catalog 10c. Norman Schultz, Colorado Springs, Colo.

Telegraphy

Telegraphy—Both Morse and Wireless taught thoroughly and quickly. Tremendous demand. Big salaries. Wonderful opportunities. Expenses low; chance to earn part. School established fifty years. Catalog free. Dodge's Institute, Cour St. Valparaiso, Ind.

Wanted to Buy

Full Value Paid for Old Gold, Jewelry, Watches, Diamonds, crowns, bridges, dental gold, silver platinum, gold or silver ore, magneto points, old false teeth. Packages returned if our offer is not satisfactory. United States Smelting Works (The Old Reliable), 120 So. State St., Dept. 16, Chicago, Ill.



Approved by Public Demand

The huge sale of U. S. Tool Condensers proves that these condensers are RIGHT

100% GUARANTEED End Plates of CELORON

FOR Superheterodyne
USE Inverse Duplex
Superdyne
New Four Circuit Tuner

or
Types CS-114
23 Plate Plain of Capacity 0.00055 Mfd.
Type CV-123
24 Plate Vernier of Capacity 0.00057 Mfd.

U. S. Tool Condensers for other Standard Circuits Sold by leading Radio Dealers Everywhere

Write for booklet

U. S. Tool Company, Inc.
118 Mechanic St., Newark, N. J.

BUY the New \$1 50



KEYSTONE RADIO LIGHTNING ARRESTERS

The new Keystone, made of genuine Bakelite, approved by Underwriters. Absolutely weather, dust, damp proof and has no vacuum to lose.

At Your Dealers



Electric Service Supplies Co.

Mfrs. of Lightning Arresters for over 31 years.
17th & Cambria Sts., PHILADELPHIA, PA.
Monadnock Bldg., CHICAGO, ILL.
50 Church St., NEW YORK, N. Y.

WANTED—Back numbers of Radio News, Dec., 1921, Jan. and Feb. and April-May, 1922. Experimenter Publishing Co., 53 Park Place, New York City.

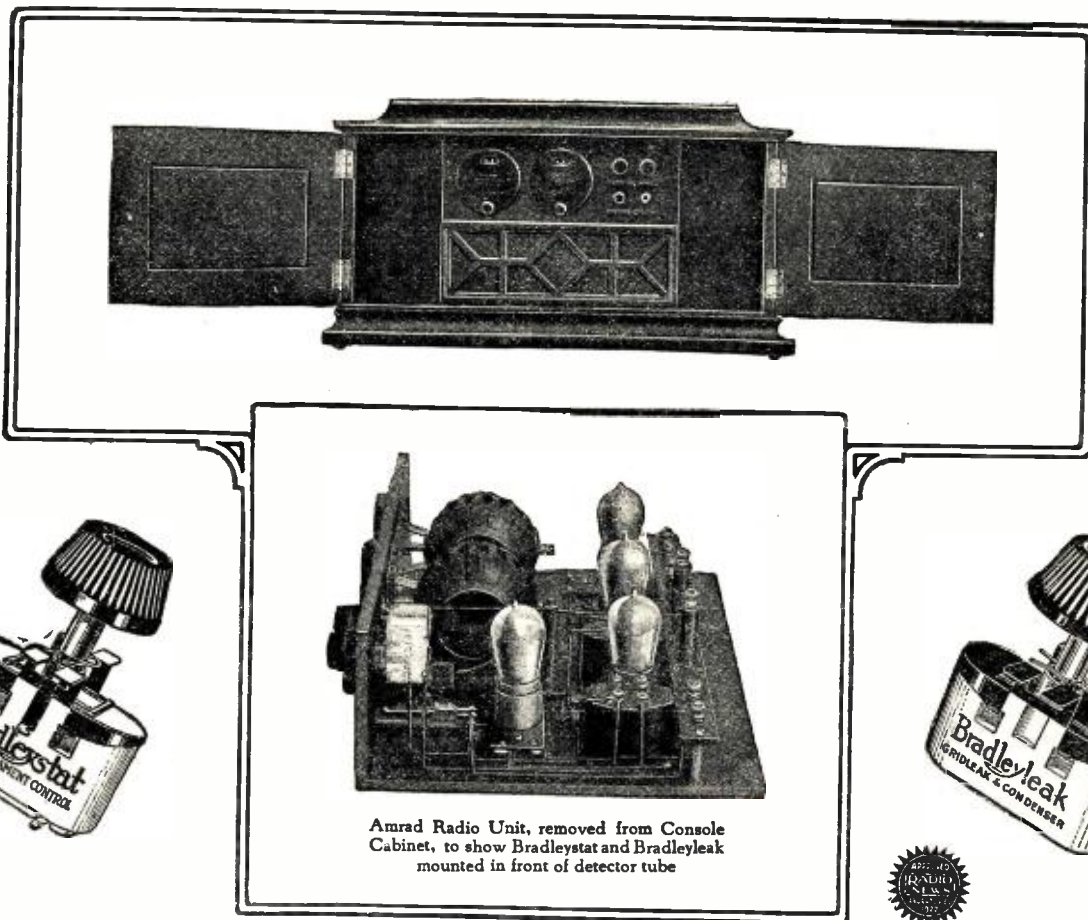

Amrad Radio Unit, removed from Console Cabinet, to show Bradleystat and Bradleyleak mounted in front of detector tube

Amrad Adopts Both Bradleystat and Bradleyleak!

The Amrad Jewel—Italian Renaissance Period Art Model
Is Now Equipped With Ultra-Fine Tuning Control

ALL of the more expensive Amrad receiving sets, including the beautiful Jewel Console models, are now equipped with Bradleystats and Bradleyleaks! The noisy wire rheostats have given way to the noiseless Bradleystat. The old type of grid leak is replaced by the stepless Bradleyleak. The perfect filament control of the Bradleystat means greater range and louder reception. The stepless grid leak adjustment of the Bradleyleak, from $\frac{1}{4}$ to 10 megohms, means higher tube efficiency.

The Console models, with self-contained loud speaker, battery compartment, and highly perfected tuner, are made more selective with the ultra-fine filament and grid control, so essential for long range reception.



YOUR radio receiving set will afford new possibilities and new thrills if equipped with Bradleystats and Bradleyleaks. Many radio dealers replace the wire rheostats of ready-built sets with Bradleystats, and they invariably recommend them to set builders who seek the best in radio.

The Bradleyleak has the endorsement of Amrad, Flewelling, Kennedy, Crosley, Clarkson, Cockaday, and other radio engineers. It is pronounced "the perfect grid leak" by all users.

Get the benefit of the graphite disc design by avoiding all substitutes. Carbon or metallic powder was abandoned, years ago, as impractical and unreliable. Insist that your dealer supply you with the genuine Bradleystat and Bradleyleak.

Send for the latest bulletins
on closer tuning and perfect
grid leak control

Allen-Bradley Co.
Electric Controlling Apparatus

287 Greenfield
Ave.



Milwaukee,
Wis.

There is no substitute for
the scientifically-treated
graphite discs

THE ALLEN-BRADLEY CO. HAS BUILT GRAPHITE DISC RHEOSTATS FOR OVER TWENTY YEARS

The "RICO" Grand Opera Loud Speaker Unit

Patented Dec. 25, '23

\$7.50

You have read and heard no doubt that every loud-speaker is positively the best one ever manufactured. We could with very little effort make similar claims—on paper—and perhaps go the other "ad" writer one better. Modesty, however, forbids. For that reason, we make the following statement:

GET A "RICO" GRAND OPERA LOUD-SPEAKER UNIT FROM YOUR DEALER OR DIRECT FROM US. COMPARE IT WITH ANY LOUD-SPEAKER THAT YOU HAVE NOW OR THAT YOU HAVE EVER HEARD. MERELY CONSIDER THAT THE MONEY YOU HAVE PAID IS ON DEPOSIT WITH YOUR DEALER OR WITH US. IF AFTER 5 DAYS YOU FIND THAT THE "RICO" GRAND OPERA LOUD-SPEAKER UNIT DOES NOT GIVE YOU GREATER VOLUME, DOES NOT GIVE YOU GREATER CLARITY OF SOUND, DOES NOT GIVE YOU GREATER JOY, THAN ANY OTHER LOUD-SPEAKER UNIT, THEN OUR DEALERS OR OURSELVES WILL BE GLAD TO REFUND THE PURCHASE PRICE.

DESCRIPTION: This loud-speaker unit is ideal for phonographs. By means of this unit, you can turn your phonograph into a loud-speaker. Any good horn, however, can be attached to it. (Speaker does not work with crystal sets, only on vacuum tubes.)



No Metal Can Touch the Diaphragm

Patented Dec. 25, '23

This is a feature not found in any loud-speaker except in the "RICO" GRAND OPERA LOUD-SPEAKER UNIT. Diaphragm cannot rattle. Metallic, harsh sounds are entirely eliminated

AND

The "RICO" GRAND OPERA LOUD-SPEAKER

UNIT is FULLY ADJUSTABLE. For light or soft tones, simply turn the milled rim for best results. With this arrangement you can get either tremendous volume or soft tones as desired by you. Aluminum shell and cap highly nickel-plated and polished. Five-foot green cord furnished. No. 75 "RICO" GRAND OPERA LOUD-SPEAKER UNIT as described. Price \$7.50.

THE "RICO" STRAIGHT LINE CONDENSER

This condenser marks a revolution in condenser building. It is the simplest and most practical type of condenser as yet developed for broadcast and amateur work. This condenser has been developed by our engineers after considerable research work and has been pronounced perfect by experts.

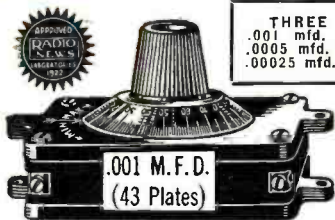

NEW TYPE

THREE STYLES
.001 mfd. (43 Plate)
.0005 mfd. (23 Plate)
.00025 mfd. (11 Plate)

VERNIER

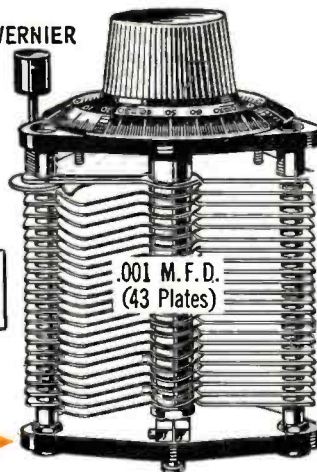

OLD TYPE

Now manufactured in three types, to replace 43 plates, 23 plates and 11 plates.

No. 450 "Rico" Condenser .001 mfd. (43 plate capacity) \$1.75

No. 423 "Rico" Condenser .0005 mfd. (23 plate capacity) \$1.75

No. 411 "Rico" Condenser .00025 mfd. (11 plate capacity) \$1.75

All above types without dial \$1.50

This Replaces This →

BOTH INSTRUMENTS ARE DRAWN TO SCALE

The "Rico" condenser weighs 6 oz. The old style weighs 15 oz. "Rico" vernier type has only one dial. Old type requires difficult mechanism.

Here are Some of the Outstanding Points:

- 1—Large capacity.
- 2—Replaces all standard condensers.
- 3—Uses a minimum of space size, 3 1/2" x 2 1/2" x 1 3/4".
- 4—For panel mounting or for table mounting—universal in its scope.
- 5—One complete revolution of dial adjusts condenser from minimum to maximum.
- 6—Vernier effect.
- 7—Absolute straight line curve.
- 8—Accumulates no dust between plates as is the case with air condensers.
- 9—Light weight. Condenser only weighs 3 oz.
- 10—Less than 1-10th amount of parts as used in old style mesh plate condenser.
- 11—Can never get out of order.
- 12—Impossible to short circuit.
- 13—Works in any position, vertical or horizontal. No counterweights needed.
- 14—Lowest in price for high class condenser.
- 15—Compactness. Size only 3 1/2" x 2 1/2" x 1 3/4" over all.

The "Rico" Straight Line Condenser must be seen to be appreciated. Made of the best materials that money can buy. Stands in a class by itself. All metal parts finished in nickel plate. We will refund your money if this condenser is not all we claim for it.

SEND NO MONEY.

Radio Industries Corp., R.N.-5
131 Duane St., New York City.
Gentlemen:—Please send me by Parcel Post....
for which I will pay the postman the amount of \$.....
Name.....
Street.....
City..... State.....

Dealers and Jobbers
Write or Wire for
Territory that is Still
Open for Proposition

RADIO
INDUSTRIES
CORPORATION

131 Duane Street, New York City

Cable Address: Ricotrade, New York

Here — the new Radiolas!

*New Triumphs of Radio Invention—
New Performance Records*

"There's a Radiola for every purse"

\$35 to \$425

	† Model	Price	Approximate Range	Type of Antenna	Degree of Selectivity
	Radiola III With two WD-11 Radiotrons* and head telephones.	\$35	Up to 1500 miles with headphones. Local stations on Loudspeaker.	Outdoor or indoor antenna.	Improved selectivity. Minimum radiation.
	Radiola Balanced Amplifier To be used with Radiola III. With two WD 11 Radiotrons.*	\$30	Gives Loudspeaker operation with Radiola III up to 1500 miles under favorable conditions.	Outdoor or indoor antenna.	
	Radiola III-A with four WD-11 Radiotrons,* head telephones and Radiola Loudspeaker. Same without Loudspeaker.	\$100	Loudspeaker operation up to 1500 miles under favorable conditions.	Outdoor or indoor antenna.	Improved selectivity. Minimum radiation.
		\$65			
	Radiola Regenoflex with four WD-11 Radiotrons,* and Radiola Loudspeaker. Same without Radiotrons or Loudspeaker.	\$206	Loudspeaker operation up to 2000 miles under favorable conditions.	Outdoor or indoor antenna.	Extraordinary selectivity. Non-radiating.
		\$150			
	Radiola X with four WD-11 Radiotrons.* Loudspeaker built-in.	\$245	Loudspeaker operation up to 2000 miles under favorable conditions.	Outdoor or indoor antenna.	Extraordinary selectivity. Non-radiating.
	Radiola Super-Heterodyne with six UV-199 Radiotrons* and Radiola Loudspeaker. Same without Radiotrons or Loudspeaker.	\$286	Loudspeaker operation up to 2000 miles with internal loop. With external loop up to 3000 miles under favorable conditions.	No antenna. (Concealed small loop built into set.)	Super-selectivity. Non-radiating.
		\$220			
	Radiola Super-VIII with six UV-199 Radiotrons.* Loudspeaker built-in.	\$425	Loudspeaker operation up to 3000 miles under favorable conditions.	No antenna. (Concealed large loop built into set.)	Super-selectivity. Non-radiating.

All Radiolas sold without batteries.

* Only dry batteries used.

Send this coupon for an illustrated booklet that tells the story completely, with detailed description of every set

RADIO CORP. OF AMERICA
Dept. 25 [Address office nearest you]
Please send me your new free Radio Booklet.

Name _____
Street _____
City _____ State _____



This symbol of quality is your protection

Radio Corporation of America

Sales Offices: 233 Broadway, New York

10 So. La Salle St., Chicago, Ill. 433 California St., San Francisco, Cal.

Radiola

REG. U.S. PAT OFF